

# ETSI TS 136 321 V12.7.0 (2015-10)



**LTE;  
Evolved Universal Terrestrial Radio Access (E-UTRA);  
Medium Access Control (MAC) protocol specification  
(3GPP TS 36.321 version 12.7.0 Release 12)**



---

Reference

RTS/TSGR-0236321vc70

---

Keywords

LTE

**ETSI**

650 Route des Lucioles  
F-06921 Sophia Antipolis Cedex - FRANCE

Tel.: +33 4 92 94 42 00 Fax: +33 4 93 65 47 16

Siret N° 348 623 562 00017 - NAF 742 C  
Association à but non lucratif enregistrée à la  
Sous-Préfecture de Grasse (06) N° 7803/88

---

**Important notice**

The present document can be downloaded from:  
<http://www.etsi.org/standards-search>

The present document may be made available in electronic versions and/or in print. The content of any electronic and/or print versions of the present document shall not be modified without the prior written authorization of ETSI. In case of any existing or perceived difference in contents between such versions and/or in print, the only prevailing document is the print of the Portable Document Format (PDF) version kept on a specific network drive within ETSI Secretariat.

Users of the present document should be aware that the document may be subject to revision or change of status. Information on the current status of this and other ETSI documents is available at  
<http://portal.etsi.org/tb/status/status.asp>

If you find errors in the present document, please send your comment to one of the following services:  
<https://portal.etsi.org/People/CommiteeSupportStaff.aspx>

---

**Copyright Notification**

No part may be reproduced or utilized in any form or by any means, electronic or mechanical, including photocopying and microfilm except as authorized by written permission of ETSI.

The content of the PDF version shall not be modified without the written authorization of ETSI.  
The copyright and the foregoing restriction extend to reproduction in all media.

© European Telecommunications Standards Institute 2015.  
All rights reserved.

**DECT™**, **PLUGTESTS™**, **UMTS™** and the ETSI logo are Trade Marks of ETSI registered for the benefit of its Members.  
**3GPP™** and **LTE™** are Trade Marks of ETSI registered for the benefit of its Members and of the 3GPP Organizational Partners.  
**GSM®** and the GSM logo are Trade Marks registered and owned by the GSM Association.

---

## Intellectual Property Rights

IPRs essential or potentially essential to the present document may have been declared to ETSI. The information pertaining to these essential IPRs, if any, is publicly available for **ETSI members and non-members**, and can be found in ETSI SR 000 314: *"Intellectual Property Rights (IPRs); Essential, or potentially Essential, IPRs notified to ETSI in respect of ETSI standards"*, which is available from the ETSI Secretariat. Latest updates are available on the ETSI Web server (<http://ipr.etsi.org>).

Pursuant to the ETSI IPR Policy, no investigation, including IPR searches, has been carried out by ETSI. No guarantee can be given as to the existence of other IPRs not referenced in ETSI SR 000 314 (or the updates on the ETSI Web server) which are, or may be, or may become, essential to the present document.

---

## Foreword

This Technical Specification (TS) has been produced by ETSI 3rd Generation Partnership Project (3GPP).

The present document may refer to technical specifications or reports using their 3GPP identities, UMTS identities or GSM identities. These should be interpreted as being references to the corresponding ETSI deliverables.

The cross reference between GSM, UMTS, 3GPP and ETSI identities can be found under <http://webapp.etsi.org/key/queryform.asp>.

---

## Modal verbs terminology

In the present document "**shall**", "**shall not**", "**should**", "**should not**", "**may**", "**need not**", "**will**", "**will not**", "**can**" and "**cannot**" are to be interpreted as described in clause 3.2 of the [ETSI Drafting Rules](#) (Verbal forms for the expression of provisions).

"**must**" and "**must not**" are **NOT** allowed in ETSI deliverables except when used in direct citation.

# Contents

|   |    |
|---|----|
| Intellectual Property Rights .....                              | 2  |
| Foreword.....   | 2  |
| Modal verbs terminology.....                                    | 2  |
| Foreword.....   | 6  |
| 1 Scope .....   | 7  |
| 2 References .....  | 7  |
| 3 Definitions and abbreviations.....                            | 8  |
| 3.1 Definitions .....   | 8  |
| 3.2 Abbreviations .....   | 9  |
| 4 General .....   | 10 |
| 4.1 Introduction .....  | 10 |
| 4.2 MAC architecture .....                                      | 10 |
| 4.2.1 MAC Entities .....  | 10 |
| 4.3 Services .....  | 13 |
| 4.3.1 Services provided to upper layers .....                   | 13 |
| 4.3.2 Services expected from physical layer.....                | 13 |
| 4.4 Functions .....   | 13 |
| 4.5 Channel structure.....                                      | 14 |
| 4.5.1 Transport Channels .....                                  | 14 |
| 4.5.2 Logical Channels .....                                    | 14 |
| 4.5.3 Mapping of Transport Channels to Logical Channels .....   | 15 |
| 4.5.3.1 Uplink mapping.....                                     | 15 |
| 4.5.3.2 Downlink mapping.....                                   | 15 |
| 4.5.3.3 Sidelink mapping .....                                  | 16 |
| 5 MAC procedures .....  | 17 |
| 5.1 Random Access procedure .....                               | 17 |
| 5.1.1 Random Access Procedure initialization .....              | 17 |
| 5.1.2 Random Access Resource selection.....                     | 18 |
| 5.1.3 Random Access Preamble transmission .....                 | 19 |
| 5.1.4 Random Access Response reception.....                     | 19 |
| 5.1.5 Contention Resolution .....                               | 20 |
| 5.1.6 Completion of the Random Access procedure.....            | 21 |
| 5.2 Maintenance of Uplink Time Alignment.....                   | 22 |
| 5.3 DL-SCH data transfer.....                                   | 23 |
| 5.3.1 DL Assignment reception .....                             | 23 |
| 5.3.2 HARQ operation.....                                       | 24 |
| 5.3.2.1 HARQ Entity.....  | 24 |
| 5.3.2.2 HARQ process .....                                      | 25 |
| 5.3.3 Disassembly and demultiplexing .....                      | 26 |
| 5.4 UL-SCH data transfer.....                                   | 26 |
| 5.4.1 UL Grant reception .....                                  | 26 |
| 5.4.2 HARQ operation.....                                       | 27 |
| 5.4.2.1 HARQ entity .....                                       | 27 |
| 5.4.2.2 HARQ process .....                                      | 28 |
| 5.4.3 Multiplexing and assembly .....                           | 30 |
| 5.4.3.1 Logical channel prioritization .....                    | 30 |
| 5.4.3.2 Multiplexing of MAC Control Elements and MAC SDUs ..... | 31 |
| 5.4.4 Scheduling Request.....                                   | 31 |
| 5.4.5 Buffer Status Reporting .....                             | 31 |
| 5.4.6 Power Headroom Reporting .....                            | 33 |
| 5.5 PCH reception .....   | 35 |
| 5.6 BCH reception.....  | 35 |

|            |   |    |
|------------|---|----|
| 5.7        | Discontinuous Reception (DRX).....  | 35 |
| 5.8        | MAC reconfiguration .....   | 37 |
| 5.9        | MAC Reset.....  | 37 |
| 5.10       | Semi-Persistent Scheduling .....  | 37 |
| 5.10.1     | Downlink .....  | 38 |
| 5.10.2     | Uplink .....  | 38 |
| 5.11       | Handling of unknown, unforeseen and erroneous protocol data .....                       | 39 |
| 5.12       | MCH reception .....   | 39 |
| 5.13       | Activation/Deactivation of SCells.....  | 39 |
| 5.14       | SL-SCH Data transfer .....  | 40 |
| 5.14.1     | SL-SCH Data transmission.....   | 40 |
| 5.14.1.1   | SL Grant reception and SCI transmission .....   | 40 |
| 5.14.1.2   | Sidelink HARQ operation.....  | 41 |
| 5.14.1.2.1 | Sidelink HARQ Entity.....   | 41 |
| 5.14.1.2.2 | Sidelink process.....   | 41 |
| 5.14.1.3   | Multiplexing and assembly .....   | 42 |
| 5.14.1.3.1 | Logical channel prioritization.....   | 42 |
| 5.14.1.3.2 | Multiplexing of MAC SDUs .....  | 42 |
| 5.14.1.4   | Buffer Status Reporting.....  | 43 |
| 5.14.2     | SL-SCH Data reception .....   | 44 |
| 5.14.2.1   | SCI reception.....  | 44 |
| 5.14.2.2   | Sidelink HARQ operation.....  | 45 |
| 5.14.2.2.1 | Sidelink HARQ Entity.....   | 45 |
| 5.14.2.2.2 | Sidelink process.....   | 45 |
| 5.14.2.3   | Disassembly and demultiplexing .....  | 46 |
| 5.15       | SL-DCH data transfer.....   | 46 |
| 5.15.1     | SL-DCH data transmission .....  | 46 |
| 5.15.1.1   | Resource allocation .....   | 46 |
| 5.15.1.2   | Sidelink HARQ operation .....   | 46 |
| 5.15.1.2.1 | Sidelink HARQ Entity.....   | 46 |
| 5.15.1.2.2 | Sidelink process.....   | 47 |
| 5.15.2     | SL-DCH data reception .....   | 48 |
| 5.15.2.1   | Sidelink HARQ operation.....  | 48 |
| 5.15.2.1.1 | Sidelink HARQ Entity.....   | 48 |
| 5.15.2.1.2 | Sidelink process.....   | 48 |
| 5.16       | SL-BCH data transfer.....   | 49 |
| 5.16.1     | SL-BCH data transmission .....  | 49 |
| 5.16.2     | SL-BCH data reception.....  | 49 |
| 6          | Protocol Data Units, formats and parameters.....  | 49 |
| 6.1        | Protocol Data Units .....   | 49 |
| 6.1.1      | General.....  | 49 |
| 6.1.2      | MAC PDU (DL-SCH and UL-SCH except transparent MAC and Random Access Response, MCH)..... | 49 |
| 6.1.3      | MAC Control Elements .....  | 50 |
| 6.1.3.1    | Buffer Status Report MAC Control Elements.....  | 50 |
| 6.1.3.1a   | Sidelink BSR MAC Control Elements .....   | 53 |
| 6.1.3.2    | C-RNTI MAC Control Element.....   | 54 |
| 6.1.3.3    | DRX Command MAC Control Element .....   | 54 |
| 6.1.3.4    | UE Contention Resolution Identity MAC Control Element.....                              | 55 |
| 6.1.3.5    | Timing Advance Command MAC Control Element.....   | 55 |
| 6.1.3.6    | Power Headroom Report MAC Control Element .....   | 55 |
| 6.1.3.6a   | Extended Power Headroom Report MAC Control Element .....                                | 56 |
| 6.1.3.6b   | Dual Connectivity Power Headroom Report MAC Control Element .....                       | 57 |
| 6.1.3.7    | MCH Scheduling Information MAC Control Element .....                                    | 58 |
| 6.1.3.7a   | Extended MCH Scheduling Information MAC Control Element .....                           | 59 |
| 6.1.3.8    | Activation/Deactivation MAC Control Element.....  | 60 |
| 6.1.3.9    | Long DRX Command MAC Control Element.....   | 60 |
| 6.1.4      | MAC PDU (transparent MAC).....  | 60 |
| 6.1.5      | MAC PDU (Random Access Response).....   | 60 |
| 6.1.6      | MAC PDU (SL-SCH).....   | 61 |
| 6.2        | Formats and parameters.....   | 63 |
| 6.2.1      | MAC header for DL-SCH, UL-SCH and MCH.....  | 63 |

|                               |   |           |
|-------------------------------|---|-----------|
| 6.2.2                         | MAC header for Random Access Response .....       | 64        |
| 6.2.3                         | MAC payload for Random Access Response .....      | 65        |
| 6.2.4                         | MAC header for SL-SCH .....                       | 65        |
| 7                             | Variables and constants .....                     | 66        |
| 7.1                           | RNTI values .....                                 | 66        |
| 7.2                           | Backoff Parameter values.....                     | 67        |
| 7.3                           | PRACH Mask Index values.....                      | 68        |
| 7.4                           | Subframe_Offset values .....                      | 68        |
| 7.5                           | TTI_BUNDLE_SIZE value.....                        | 68        |
| 7.6                           | DELTA_PREAMBLE values .....                       | 68        |
| 7.7                           | HARQ RTT Timer .....                              | 69        |
| <b>Annex A (normative):</b>   | <b>Handling of measurement gaps .....</b>         | <b>70</b> |
| <b>Annex B (normative):</b>   | <b>Contention resolution for RACH access.....</b> | <b>71</b> |
| <b>Annex C (informative):</b> | <b>Intended UE behaviour for DRX Timers .....</b> | <b>72</b> |
| <b>Annex D (informative):</b> | <b>Change history .....</b>                       | <b>73</b> |
| History .....                 |   | 78        |

---

## Foreword

This Technical Specification has been produced by the 3<sup>rd</sup> Generation Partnership Project (3GPP).

The contents of the present document are subject to continuing work within the TSG and may change following formal TSG approval. Should the TSG modify the contents of the present document, it will be re-released by the TSG with an identifying change of release date and an increase in version number as follows:

Version x.y.z

where:

- x the first digit:
  - 1 presented to TSG for information;
  - 2 presented to TSG for approval;
  - 3 or greater indicates TSG approved document under change control.
- y the second digit is incremented for all changes of substance, i.e. technical enhancements, corrections, updates, etc.
- z the third digit is incremented when editorial only changes have been incorporated in the document.

---

# 1 Scope

The present document specifies the E-UTRA MAC protocol.

---

# 2 References

The following documents contain provisions which, through reference in this text, constitute provisions of the present document.

- References are either specific (identified by date of publication, edition number, version number, etc.) or non-specific.
- For a specific reference, subsequent revisions do not apply.
- For a non-specific reference, the latest version applies. In the case of a reference to a 3GPP document (including a GSM document), a non-specific reference implicitly refers to the latest version of that document *in the same Release as the present document*.

- [1] 3GPP TR 21.905: "Vocabulary for 3GPP Specifications".
- [2] 3GPP TS 36.213: "Evolved Universal Terrestrial Radio Access (E-UTRA); Physical Layer Procedures".
- [3] 3GPP TS 36.322: "Evolved Universal Terrestrial Radio Access (E-UTRA); Radio Link Control (RLC) protocol specification".
- [4] 3GPP TS 36.323: "Evolved Universal Terrestrial Radio Access (E-UTRA); Packet Data Convergence Protocol (PDCP) Specification".
- [5] 3GPP TS 36.212: "Evolved Universal Terrestrial Radio Access (E-UTRA); Multiplexing and channel coding".
- [6] 3GPP TS 36.214: "Evolved Universal Terrestrial Radio Access (E-UTRA); Physical layer; Measurements".
- [7] 3GPP TS 36.211: "Evolved Universal Terrestrial Radio Access (E-UTRA); Physical Channels and Modulation".
- [8] 3GPP TS 36.331: "Evolved Universal Terrestrial Radio Access (E-UTRA); Radio Resource Control (RRC); Protocol specification".
- [9] 3GPP TS 36.133: "Evolved Universal Terrestrial Radio Access (E-UTRA); Requirements for support of radio resource management".
- [10] 3GPP TS 36.101: "Evolved Universal Terrestrial Radio Access (E-UTRA); User Equipment (UE) radio transmission and reception".
- [11] 3GPP TS 36.216: "Evolved Universal Terrestrial Radio Access (E-UTRA); Physical layer for relaying operation".
- [12] 3GPP TS 36.306: "Evolved Universal Terrestrial Radio Access (E-UTRA); User Equipment (UE) radio access capabilities".



## 3 Definitions and abbreviations

### 3.1 Definitions

For the purposes of the present document, the terms and definitions given in TR 21.905 [1] and the following apply. A term defined in the present document takes precedence over the definition of the same term, if any, in TR 21.905 [1].

**Active Time:** Time related to DRX operation, as defined in subclause 5.7, during which the MAC entity monitors the PDCCH.

**mac-ContentionResolutionTimer:** Specifies the number of consecutive subframe(s) during which the MAC entity shall monitor the PDCCH after Msg3 is transmitted.

**DRX Cycle:** Specifies the periodic repetition of the On Duration followed by a possible period of inactivity (see figure 3.1-1 below).

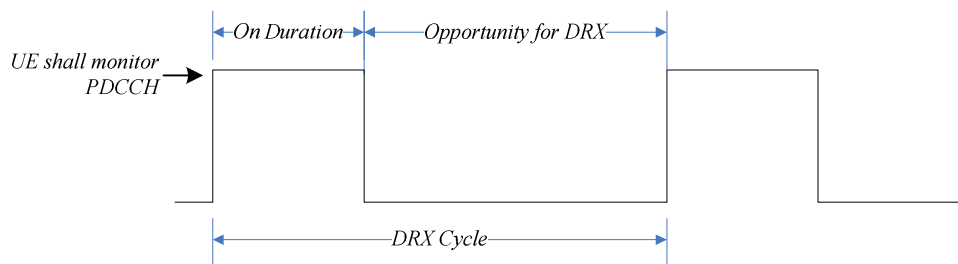

**Figure 3.1-1: DRX Cycle**

**drx-InactivityTimer:** Specifies the number of consecutive PDCCH-subframe(s) after the subframe in which a PDCCH indicates an initial UL, DL or SL user data transmission for this MAC entity.

**drx-RetransmissionTimer:** Specifies the maximum number of consecutive PDCCH-subframe(s) until a DL retransmission is received.

**drxShortCycleTimer:** Specifies the number of consecutive subframe(s) the MAC entity shall follow the Short DRX cycle.

**drxStartOffset:** Specifies the subframe where the DRX Cycle starts.

**HARQ information:** HARQ information for DL-SCH or for UL-SCH transmissions consists of New Data Indicator (NDI), Transport Block (TB) size. For DL-SCH transmissions the HARQ information also includes HARQ process ID. For UL-SCH transmission the HARQ information also includes Redundancy Version (RV). In case of spatial multiplexing on DL-SCH the HARQ information comprises a set of NDI and TB size for each transport block. HARQ information for SL-SCH and SL-DCH transmissions consists of TB size only.

**HARQ RTT Timer:** This parameter specifies the minimum amount of subframe(s) before a DL HARQ retransmission is expected by the MAC entity.

**Msg3:** Message transmitted on UL-SCH containing a C-RNTI MAC CE or CCCH SDU, submitted from upper layer and associated with the UE Contention Resolution Identity, as part of a random access procedure.

**onDurationTimer:** Specifies the number of consecutive PDCCH-subframe(s) at the beginning of a DRX Cycle.

**PDCCH:** Refers to the PDCCH [7], EPDCCH (in subframes when configured) or, for an RN with R-PDCCH configured and not suspended, to the R-PDCCH.

**PDCCH-subframe:** Refers to a subframe with PDCCH. For a MAC entity configured with only FDD serving cell(s), this represents any subframe; for a MAC entity configured with at least one TDD serving cell, if a MAC entity is capable of simultaneous reception and transmission in the aggregated cells, this represents the union over all serving cells of downlink subframes and subframes including DwPTS of the TDD UL/DL configuration indicated by *tdd-Config* [8], except serving cells that are configured with *schedulingCellId* [8]; otherwise, this represents the subframes where the SpCell is configured with a downlink subframe or a subframe including DwPTS of the TDD UL/DL

configuration indicated by *tdd-Config* [8].

For RNs with an RN subframe configuration configured and not suspended, in its communication with the E-UTRAN, this represents all downlink subframes configured for RN communication with the E-UTRAN.

**PRACH Resource Index:** The index of a PRACH within a system frame [7]

**Primary Timing Advance Group:** Timing Advance Group containing the SpCell.

**ra-PRACH-MaskIndex:** Defines in which PRACHs within a system frame the MAC entity can transmit a Random Access Preamble (see subclause 7.3).

**RA-RNTI:** The Random Access RNTI is used on the PDCCH when Random Access Response messages are transmitted. It unambiguously identifies which time-frequency resource was utilized by the MAC entity to transmit the Random Access preamble.

**SC Period:** Sidelink Control period, the time period consisting of transmission of SCI and its corresponding data.

**SCI:** The Sidelink Control Information contains the sidelink scheduling information such as resource block assignment, modulation and coding scheme and Group Destination ID [5].

**Secondary Timing Advance Group:** Timing Advance Group not containing the SpCell. A Secondary Timing Advance Group contains at least one Serving Cell with an UL configured.

**Serving Cell:** A Primary or a Secondary Cell [8].

**Sidelink:** UE to UE interface for ProSe direct communication and ProSe direct discovery. It corresponds to the PC5 interface.

**Special Cell:** For Dual Connectivity operation the term Special Cell refers to the PCell of the MCG or the PSCell of the SCG, otherwise the term Special Cell refers to the PCell.

**Timing Advance Group:** A group of Serving Cells that is configured by RRC and that, for the cells with an UL configured, using the same timing reference cell and the same Timing Advance value.

NOTE: A timer is running once it is started, until it is stopped or until it expires; otherwise it is not running. A timer can be started if it is not running or restarted if it is running. A Timer is always started or restarted from its initial value.

## 3.2 Abbreviations

For the purposes of the present document, the abbreviations given in TR 21.905 [1] and the following apply. An abbreviation defined in the present document takes precedence over the definition of the same abbreviation, if any, in TR 21.905 [1].

|            |  |
|------------|--|
| BSR        | Buffer Status Report   |
| C-RNTI     | Cell RNTI  |
| CQI        | Channel Quality Indicator                                      |
| eIMTA      | Enhanced Interference Management and Traffic Adaptation        |
| eIMTA-RNTI | Enhanced Interference Management and Traffic Adaptation - RNTI |
| E-UTRA     | Evolved UMTS Terrestrial Radio Access                          |
| E-UTRAN    | Evolved UMTS Terrestrial Radio Access Network                  |
| MAC        | Medium Access Control  |
| MCG        | Master Cell Group  |
| M-RNTI     | MBMS RNTI  |
| LCG        | Logical Channel Group  |
| PCell      | Primary Cell   |
| PSCell     | Primary Secondary Cell   |
| PHR        | Power Headroom Report  |
| PMI        | Precoding Matrix Index   |
| P-RNTI     | Paging RNTI  |
| ProSe      | Proximity-based Services                                       |
| pTAG       | Primary Timing Advance Group                                   |
| PTI        | Precoding Type Indicator                                       |
| RA-RNTI    | Random Access RNTI   |

|                |   |
|----------------|---|
| RI             | Rank Indicator  |
| RN             | Relay Node  |
| RNTI           | Radio Network Temporary Identifier                          |
| SCell          | Secondary Cell  |
| SCG            | Secondary Cell Group  |
| SCI            | Sidelink Control Information                                |
| SI-RNTI        | System Information RNTI                                     |
| SL             | Sidelink  |
| SL-RNTI        | Sidelink RNTI   |
| SR             | Scheduling Request  |
| SRS            | Sounding Reference Symbols                                  |
| SpCell         | Special Cell  |
| sTAG           | Secondary Timing Advance Group                              |
| TAG            | Timing Advance Group  |
| TB             | Transport Block   |
| TPC-PUCCH-RNTI | Transmit Power Control-Physical Uplink Control Channel-RNTI |
| TPC-PUSCH-RNTI | Transmit Power Control-Physical Uplink Shared Channel-RNTI  |

---

## 4 General

### 4.1 Introduction

The objective is to describe the MAC architecture and the MAC entity from a functional point of view. Functionality specified for the UE equally applies to the RN for functionality necessary for the RN. There is also functionality which is only applicable to the RN, in which case the specification denotes the RN instead of the UE. RN-specific behaviour is not applicable to the UE. For TDD operation, UE behaviour follows the TDD UL/DL configuration indicated by *tdd-Config* unless specified otherwise.

### 4.2 MAC architecture

The description in this sub clause is a model and does not specify or restrict implementations.

RRC is in control of configuration of MAC.

#### 4.2.1 MAC Entities

E-UTRA defines two MAC entities; one in the UE and one in the E-UTRAN. These MAC entities handle the following transport channels:

- Broadcast Channel (BCH);
- Downlink Shared Channel(s) (DL-SCH);
- Paging Channel (PCH);
- Uplink Shared Channel(s) (UL-SCH);
- Random Access Channel(s) (RACH);
- Multicast Channel(s) (MCH);
- Sidelink Broadcast Channel (SL-BCH);
- Sidelink Discovery Channel (SL-DCH);
- Sidelink Shared Channel (SL-SCH).

The exact functions performed by the MAC entities are different in the UE from those performed in the E-UTRAN.

The RN includes both types of MAC entities; one type for communication with UEs and one type for communication with the E-UTRAN.

In Dual Connectivity, two MAC entities are configured in the UE: one for the MCG and one for the SCG. Each MAC entity is configured by RRC with a serving cell supporting PUCCH transmission and contention based Random Access. In this specification, the term SpCell refers to such cell, whereas the term SCell refers to other serving cells. The term SpCell either refers to the PCell of the MCG or the PCell of the SCG depending on if the MAC entity is associated to the MCG or the SCG, respectively. A Timing Advance Group containing the SpCell of a MAC entity is referred to as pTAG, whereas the term sTAG refers to other TAGs.

The functions of the different MAC entities in the UE operate independently if not otherwise indicated. The timers and parameters used in each MAC entity are configured independently if not otherwise indicated. The Serving Cells, C-RNTI, radio bearers, logical channels, upper and lower layer entities, LCGs, and HARQ entities considered by each MAC entity refer to those mapped to that MAC entity if not otherwise indicated.

If the MAC entity is configured with one or more SCells, there are multiple DL-SCH and there may be multiple UL-SCH and RACH per MAC entity; one DL-SCH and UL-SCH on the SpCell, one DL-SCH, zero or one UL-SCH and zero or one RACH for each SCell.

Figure 4.2.1-1 illustrates one possible structure for the UE side MAC entity when SCG is not configured, and it should not restrict implementation.

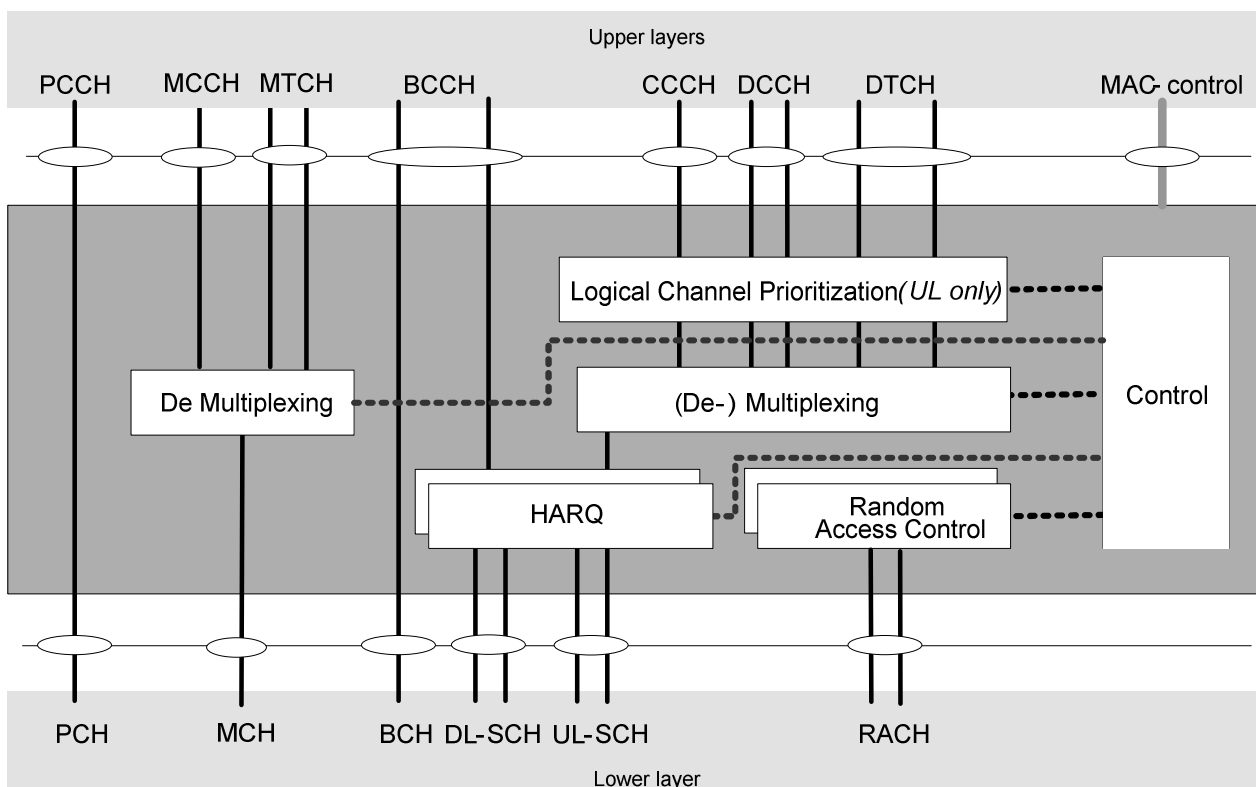

Figure 4.2.1-1: MAC structure overview, UE side

Figure 4.2.1-2 illustrates one possible structure for the UE side MAC entities when MCG and SCG are configured, and it should not restrict implementation. MBMS reception is excluded from this figure for simplicity.

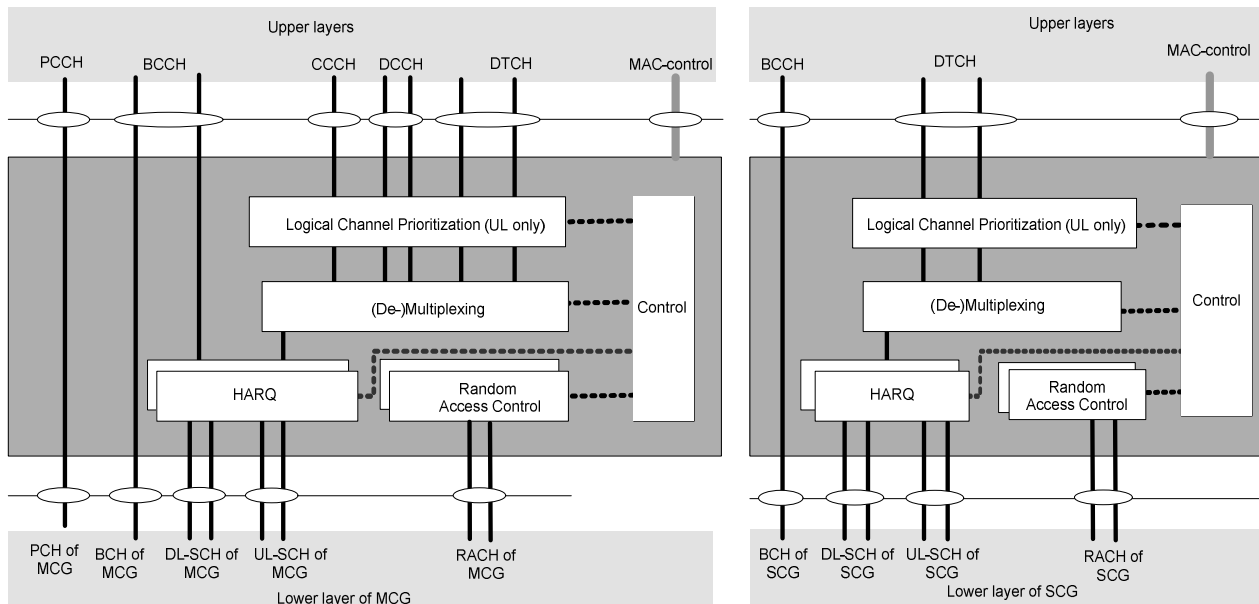

Figure 4.2.1-2: MAC structure overview with two MAC entities, UE side

Figure 4.2.1-3 illustrates one possible structure for the UE side MAC entity when sidelink is configured, and it should not restrict implementation.

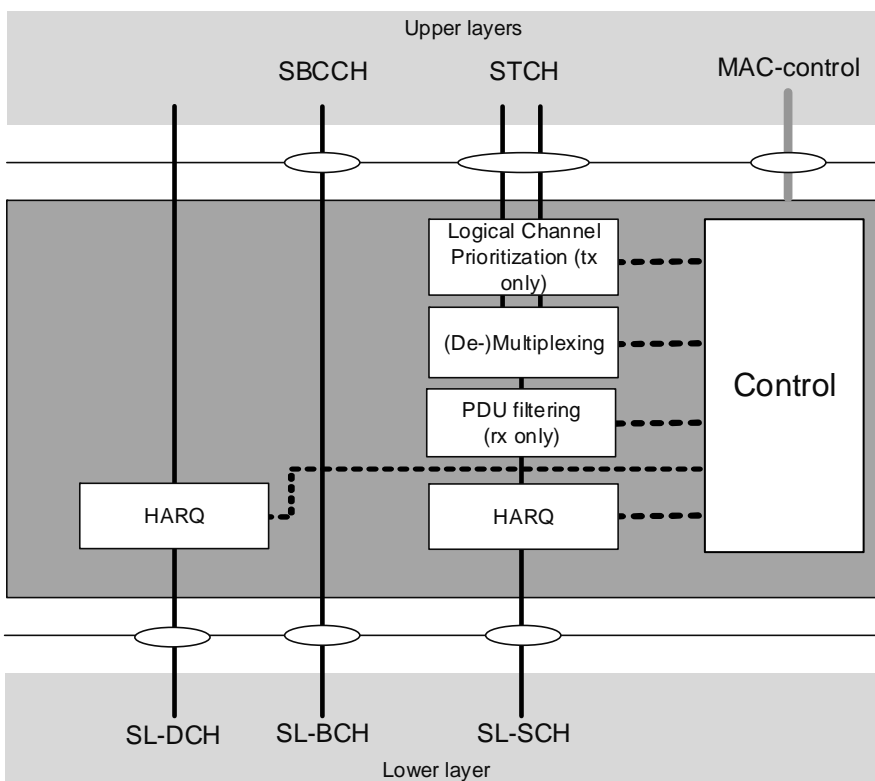

Figure 4.2.1-3: MAC structure overview for sidelink, UE side

## 4.3 Services

### 4.3.1 Services provided to upper layers

This clause describes the different services provided by MAC sublayer to upper layers.

- data transfer
- radio resource allocation

### 4.3.2 Services expected from physical layer

The physical layer provides the following services to MAC:

- data transfer services;
- signalling of HARQ feedback;
- signalling of Scheduling Request;
- measurements (e.g. Channel Quality Indication (CQI)).

The access to the data transfer services is through the use of transport channels. The characteristics of a transport channel are defined by its transport format (or format set), specifying the physical layer processing to be applied to the transport channel in question, such as channel coding and interleaving, and any service-specific rate matching as needed.

## 4.4 Functions

The following functions are supported by MAC sublayer:

- mapping between logical channels and transport channels;
- multiplexing of MAC SDUs from one or different logical channels onto transport blocks (TB) to be delivered to the physical layer on transport channels;
- demultiplexing of MAC SDUs from one or different logical channels from transport blocks (TB) delivered from the physical layer on transport channels;
- scheduling information reporting;
- error correction through HARQ;
- priority handling between UEs by means of dynamic scheduling;
- priority handling between logical channels of one MAC entity;
- Logical Channel prioritisation;
- transport format selection;
- radio resource selection for SL.

The location of the different functions and their relevance for uplink and downlink respectively is illustrated in Table 4.4-1.

**Table 4.4-1: MAC function location and link direction association.**

| MAC function   | UE | eNB | Downlink | Uplink | Sidelink tx | Sidelink rx |
|--|----|-----|----------|--------|-------------|-------------|
| Mapping between logical channels and transport channels      | X  |     | X        | X      | X           | X           |
| Multiplexing   | X  | X   | X        | X      | X           |             |
| Demultiplexing   | X  | X   | X        |        |             | X           |
| Error correction through HARQ                                | X  | X   | X        | X      | X           | X           |
| Transport Format Selection                                   |    | X   | X        | X      |             |             |
| Priority handling between UEs                                |    | X   | X        | X      |             |             |
| Priority handling between logical channels of one MAC entity |    | X   | X        | X      |             |             |
| Logical Channel prioritisation                               | X  |     |          | X      | X           |             |
| Scheduling information reporting                             | X  |     |          | X      |             |             |
| Radio Resource Selection                                     | X  |     |          |        | X           |             |

## 4.5 Channel structure

The MAC sublayer operates on the channels defined below; transport channels are SAPs between MAC and Layer 1, logical channels are SAPs between MAC and RLC.

### 4.5.1 Transport Channels

The transport channels used by MAC are described in Table 4.5.1-1 below.

**Table 4.5.1-1: Transport channels used by MAC**

| Transport channel name     | Acronym | Downlink | Uplink | Sidelink tx | Sidelink rx |
|----------------------------|---------|----------|--------|-------------|-------------|
| Broadcast Channel          | BCH     | X        |        |             |             |
| Downlink Shared Channel    | DL-SCH  | X        |        |             |             |
| Paging Channel             | PCH     | X        |        |             |             |
| Multicast Channel          | MCH     | X        |        |             |             |
| Uplink Shared Channel      | UL-SCH  |          | X      |             |             |
| Random Access Channel      | RACH    |          | X      |             |             |
| Sidelink Broadcast Channel | SL-BCH  |          |        | X           | X           |
| Sidelink Discovery Channel | SL-DCH  |          |        | X           | X           |
| Sidelink Shared Channel    | SL-SCH  |          |        | X           | X           |

### 4.5.2 Logical Channels

The MAC layer provides data transfer services on logical channels. A set of logical channel types is defined for different kinds of data transfer services as offered by MAC.

Each logical channel type is defined by what type of information is transferred.

MAC provides the control and traffic channels listed in Table 4.5.2-1 below.

**Table 4.5.2-1: Logical channels provided by MAC.**

| Logical channel name               | Acronym | Control channel | Traffic channel |
|------------------------------------|---------|-----------------|-----------------|
| Broadcast Control Channel          | BCCH    | X               |                 |
| Paging Control Channel             | PCCH    | X               |                 |
| Common Control Channel             | CCCH    | X               |                 |
| Dedicated Control Channel          | DCCH    | X               |                 |
| Multicast Control Channel          | MCCH    | X               |                 |
| Dedicated Traffic Channel          | DTCH    |                 | X               |
| Multicast Traffic Channel          | MTCH    |                 | X               |
| Sidelink Traffic Channel           | STCH    |                 | X               |
| Sidelink Broadcast Control Channel | SBCCH   | X               |                 |

### 4.5.3 Mapping of Transport Channels to Logical Channels

The mapping of logical channels on transport channels depends on the multiplexing that is configured by RRC.

#### 4.5.3.1 Uplink mapping

The MAC entity is responsible for mapping logical channels for the uplink onto uplink transport channels. The uplink logical channels can be mapped as described in Figure 4.5.3.1-1 and Table 4.5.3.1-1.

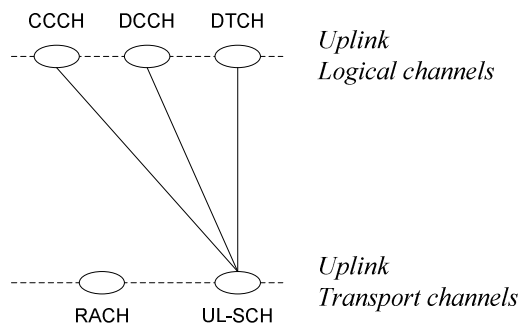

**Figure 4.5.3.1-1**

**Table 4.5.3.1-1: Uplink channel mapping.**

| Logical channel | Transport channel | UL-SCH | RACH |
|-----------------|-------------------|--------|------|
| CCCH            |                   | X      |      |
| DCCH            |                   | X      |      |
| DTCH            |                   | X      |      |

#### 4.5.3.2 Downlink mapping

The MAC entity is responsible for mapping the downlink logical channels to downlink transport channels. The downlink logical channels can be mapped as described in Figure 4.5.3.2-1 and Table 4.5.3.2-1.



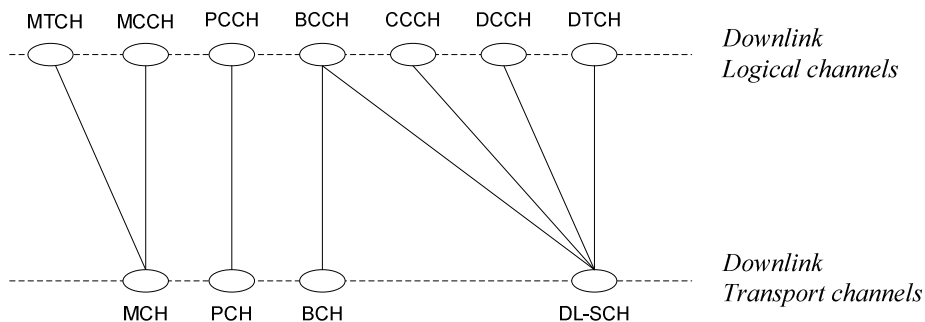

Figure 4.5.3.2-1

Table 4.5.3.2-1: Downlink channel mapping.

| Logical channel | Transport channel | BCH | PCH | DL-SCH | MCH |
|-----------------|-------------------|-----|-----|--------|-----|
| BCCH            |                   | X   |     | X      |     |
| PCCH            |                   |     | X   |        |     |
| CCCH            |                   |     |     | X      |     |
| DCCH            |                   |     |     | X      |     |
| DTCH            |                   |     |     | X      |     |
| MCCH            |                   |     |     |        | X   |
| MTCH            |                   |     |     |        | X   |

4.5.3.3 Sidelink mapping

The MAC entity is responsible for mapping the sidelink logical channels to sidelink transport channels. The sidelink logical channels can be mapped as described in Figure 4.5.3.3-1 and Table 4.5.3.3-1.

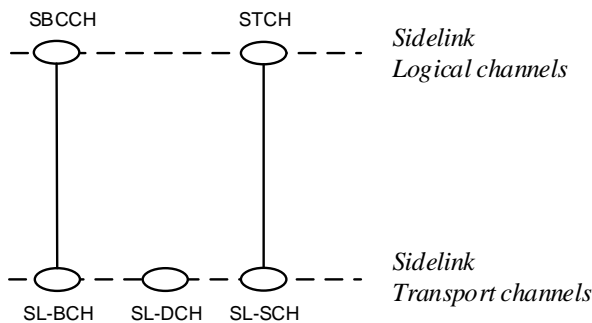

Figure 4.5.3.3-1

Table 4.5.3.3-1: Sidelink channel mapping.

| Logical channel | Transport channel | SL-SCH | SL-BCH | SL-DCH |
|-----------------|-------------------|--------|--------|--------|
| STCH            |                   | X      |        |        |
| SBCCH           |                   |        | X      |        |

## 5 MAC procedures

### 5.1 Random Access procedure

#### 5.1.1 Random Access Procedure initialization

The Random Access procedure described in this subclause is initiated by a PDCCH order, by the MAC sublayer itself or by the RRC sublayer. Random Access procedure on an SCell shall only be initiated by a PDCCH order. If a MAC entity receives a PDCCH transmission consistent with a PDCCH order [5] masked with its C-RNTI, and for a specific Serving Cell, the MAC entity shall initiate a Random Access procedure on this Serving Cell. For Random Access on the SpCell a PDCCH order or RRC optionally indicate the *ra-PreambleIndex* and the *ra-PRACH-MaskIndex*; and for Random Access on an SCell, the PDCCH order indicates the *ra-PreambleIndex* with a value different from 000000 and the *ra-PRACH-MaskIndex*. For the pTAG preamble transmission on PRACH and reception of a PDCCH order are only supported for SpCell.

Before the procedure can be initiated, the following information for related Serving Cell is assumed to be available [8]:

- the available set of PRACH resources for the transmission of the Random Access Preamble, *prach-ConfigIndex*.
- the groups of Random Access Preambles and the set of available Random Access Preambles in each group (SpCell only):

The preambles that are contained in Random Access Preambles group A and Random Access Preambles group B are calculated from the parameters *numberOfRA-Preambles* and *sizeOfRA-PreamblesGroupA*:

If *sizeOfRA-PreamblesGroupA* is equal to *numberOfRA-Preambles* then there is no Random Access Preambles group B. The preambles in Random Access Preamble group A are the preambles 0 to *sizeOfRA-PreamblesGroupA* - 1 and, if it exists, the preambles in Random Access Preamble group B are the preambles *sizeOfRA-PreamblesGroupA* to *numberOfRA-Preambles* - 1 from the set of 64 preambles as defined in [7].

- if Random Access Preambles group B exists, the thresholds, *messagePowerOffsetGroupB* and *messageSizeGroupA*, the configured UE transmitted power of the Serving Cell performing the Random Access Procedure,  $P_{\text{CMAX},c}$  [10], and the offset between the preamble and Msg3, *deltaPreambleMsg3*, that are required for selecting one of the two groups of Random Access Preambles (SpCell only).
- the RA response window size *ra-ResponseWindowSize*.
- the power-ramping factor *powerRampingStep*.
- the maximum number of preamble transmission *preambleTransMax*.
- the initial preamble power *preambleInitialReceivedTargetPower*.
- the preamble format based offset DELTA\_PREAMBLE (see subclause 7.6).
- the maximum number of Msg3 HARQ transmissions *maxHARQ-Msg3Tx* (SpCell only).
- the Contention Resolution Timer *mac-ContentionResolutionTimer* (SpCell only).

NOTE: The above parameters may be updated from upper layers before each Random Access procedure is initiated.

The Random Access procedure shall be performed as follows:

- Flush the Msg3 buffer;
- set the PREAMBLE\_TRANSMISSION\_COUNTER to 1;
- set the backoff parameter value to 0 ms;
- for the RN, suspend any RN subframe configuration;
- proceed to the selection of the Random Access Resource (see subclause 5.1.2).

NOTE: There is only one Random Access procedure ongoing at any point in time in a MAC entity. If the MAC entity receives a request for a new Random Access procedure while another is already ongoing in the MAC entity, it is up to UE implementation whether to continue with the ongoing procedure or start with the new procedure.

## 5.1.2 Random Access Resource selection

The Random Access Resource selection procedure shall be performed as follows:

- If *ra-PreambleIndex* (Random Access Preamble) and *ra-PRACH-MaskIndex* (PRACH Mask Index) have been explicitly signalled and *ra-PreambleIndex* is not 000000:
  - the Random Access Preamble and the PRACH Mask Index are those explicitly signalled.
- else the Random Access Preamble shall be selected by the MAC entity as follows:
  - If Msg3 has not yet been transmitted, the MAC entity shall:
    - if Random Access Preambles group B exists and if the potential message size (UL data available for transmission plus MAC header and, where required, MAC control elements) is greater than *messageSizeGroupA* and if the pathloss is less than  $P_{\text{CMAX,c}}$  (of the Serving Cell performing the Random Access Procedure) – *preambleInitialReceivedTargetPower* – *deltaPreambleMsg3* – *messagePowerOffsetGroupB*, then:
      - select the Random Access Preambles group B;
    - else:
      - select the Random Access Preambles group A.
  - else, if Msg3 is being retransmitted, the MAC entity shall:
    - select the same group of Random Access Preambles as was used for the preamble transmission attempt corresponding to the first transmission of Msg3.
  - randomly select a Random Access Preamble within the selected group. The random function shall be such that each of the allowed selections can be chosen with equal probability;
  - set PRACH Mask Index to 0.
- determine the next available subframe containing PRACH permitted by the restrictions given by the *prach-ConfigIndex*, the PRACH Mask Index (see subclause 7.3) and physical layer timing requirements [2] (a MAC entity may take into account the possible occurrence of measurement gaps when determining the next available PRACH subframe);
- if the transmission mode is TDD and the PRACH Mask Index is equal to zero:
  - if *ra-PreambleIndex* was explicitly signalled and it was not 000000 (i.e., not selected by MAC):
    - randomly select, with equal probability, one PRACH from the PRACHs available in the determined subframe.
  - else:
    - randomly select, with equal probability, one PRACH from the PRACHs available in the determined subframe and the next two consecutive subframes.
- else:
  - determine a PRACH within the determined subframe in accordance with the requirements of the PRACH Mask Index.
- proceed to the transmission of the Random Access Preamble (see subclause 5.1.3).

### 5.1.3 Random Access Preamble transmission

The random-access procedure shall be performed as follows:

- set PREAMBLE\_RECEIVED\_TARGET\_POWER to  $preambleInitialReceivedTargetPower + DELTA\_PREAMBLE + (PREAMBLE\_TRANSMISSION\_COUNTER - 1) * powerRampingStep$ ;
- instruct the physical layer to transmit a preamble using the selected PRACH, corresponding RA-RNTI, preamble index and PREAMBLE\_RECEIVED\_TARGET\_POWER.

### 5.1.4 Random Access Response reception

Once the Random Access Preamble is transmitted and regardless of the possible occurrence of a measurement gap, the MAC entity shall monitor the PDCCH of the SpCell for Random Access Response(s) identified by the RA-RNTI defined below, in the RA Response window which starts at the subframe that contains the end of the preamble transmission [7] plus three subframes and has length  $ra-ResponseWindowSize$  subframes. The RA-RNTI associated with the PRACH in which the Random Access Preamble is transmitted, is computed as:

$$RA-RNTI = 1 + t\_id + 10 * f\_id$$

Where  $t\_id$  is the index of the first subframe of the specified PRACH ( $0 \leq t\_id < 10$ ), and  $f\_id$  is the index of the specified PRACH within that subframe, in ascending order of frequency domain ( $0 \leq f\_id < 6$ ). The MAC entity may stop monitoring for Random Access Response(s) after successful reception of a Random Access Response containing Random Access Preamble identifiers that matches the transmitted Random Access Preamble.

- If a downlink assignment for this TTI has been received on the PDCCH for the RA-RNTI and the received TB is successfully decoded, the MAC entity shall regardless of the possible occurrence of a measurement gap:
  - if the Random Access Response contains a Backoff Indicator subheader:
    - set the backoff parameter value as indicated by the BI field of the Backoff Indicator subheader and Table 7.2-1.
  - else, set the backoff parameter value to 0 ms.
- if the Random Access Response contains a Random Access Preamble identifier corresponding to the transmitted Random Access Preamble (see subclause 5.1.3), the MAC entity shall:
  - consider this Random Access Response reception successful and apply the following actions for the serving cell where the Random Access Preamble was transmitted:
    - process the received Timing Advance Command (see subclause 5.2);
    - indicate the  $preambleInitialReceivedTargetPower$  and the amount of power ramping applied to the latest preamble transmission to lower layers (i.e.,  $(PREAMBLE\_TRANSMISSION\_COUNTER - 1) * powerRampingStep$ );
    - process the received UL grant value and indicate it to the lower layers;
  - if  $ra-PreambleIndex$  was explicitly signalled and it was not 000000 (i.e., not selected by MAC):
    - consider the Random Access procedure successfully completed.
  - else, if the Random Access Preamble was selected by the MAC entity:
    - set the Temporary C-RNTI to the value received in the Random Access Response message no later than at the time of the first transmission corresponding to the UL grant provided in the Random Access Response message;
    - if this is the first successfully received Random Access Response within this Random Access procedure:
      - if the transmission is not being made for the CCCH logical channel, indicate to the Multiplexing and assembly entity to include a C-RNTI MAC control element in the subsequent uplink transmission;

- obtain the MAC PDU to transmit from the "Multiplexing and assembly" entity and store it in the Msg3 buffer.

NOTE: When an uplink transmission is required, e.g., for contention resolution, the eNB should not provide a grant smaller than 56 bits in the Random Access Response.

NOTE: If within a Random Access procedure, an uplink grant provided in the Random Access Response for the same group of Random Access Preambles has a different size than the first uplink grant allocated during that Random Access procedure, the UE behavior is not defined.

If no Random Access Response is received within the RA Response window, or if none of all received Random Access Responses contains a Random Access Preamble identifier corresponding to the transmitted Random Access Preamble, the Random Access Response reception is considered not successful and the MAC entity shall:

- if the notification of power ramping suspension has not been received from lower layers:
  - increment PREAMBLE\_TRANSMISSION\_COUNTER by 1;
- If PREAMBLE\_TRANSMISSION\_COUNTER =  $preambleTransMax + 1$ :
  - if the Random Access Preamble is transmitted on the SpCell:
    - indicate a Random Access problem to upper layers;
  - if the Random Access Preamble is transmitted on an SCell:
    - consider the Random Access procedure unsuccessfully completed.
- if in this Random Access procedure, the Random Access Preamble was selected by MAC:
  - based on the backoff parameter, select a random backoff time according to a uniform distribution between 0 and the Backoff Parameter Value;
  - delay the subsequent Random Access transmission by the backoff time;
- proceed to the selection of a Random Access Resource (see subclause 5.1.2).

### 5.1.5 Contention Resolution

Contention Resolution is based on either C-RNTI on PDCCH of the SpCell or UE Contention Resolution Identity on DL-SCH.

Once Msg3 is transmitted, the MAC entity shall:

- start *mac-ContentionResolutionTimer* and restart *mac-ContentionResolutionTimer* at each HARQ retransmission;
- regardless of the possible occurrence of a measurement gap, monitor the PDCCH until *mac-ContentionResolutionTimer* expires or is stopped;
- if notification of a reception of a PDCCH transmission is received from lower layers, the MAC entity shall:
  - if the C-RNTI MAC control element was included in Msg3:
    - if the Random Access procedure was initiated by the MAC sublayer itself or by the RRC sublayer and the PDCCH transmission is addressed to the C-RNTI and contains an UL grant for a new transmission; or
    - if the Random Access procedure was initiated by a PDCCH order and the PDCCH transmission is addressed to the C-RNTI:
      - consider this Contention Resolution successful;
      - stop *mac-ContentionResolutionTimer*;
      - discard the Temporary C-RNTI;
      - consider this Random Access procedure successfully completed.

- else if the CCCH SDU was included in Msg3 and the PDCCH transmission is addressed to its Temporary C-RNTI:
  - if the MAC PDU is successfully decoded:
    - stop *mac-ContentionResolutionTimer*;
    - if the MAC PDU contains a UE Contention Resolution Identity MAC control element; and
    - if the UE Contention Resolution Identity included in the MAC control element matches the CCCH SDU transmitted in Msg3:
      - consider this Contention Resolution successful and finish the disassembly and demultiplexing of the MAC PDU;
      - set the C-RNTI to the value of the Temporary C-RNTI;
      - discard the Temporary C-RNTI;
      - consider this Random Access procedure successfully completed.
  - else
    - discard the Temporary C-RNTI;
    - consider this Contention Resolution not successful and discard the successfully decoded MAC PDU.
- if *mac-ContentionResolutionTimer* expires:
  - discard the Temporary C-RNTI;
  - consider the Contention Resolution not successful.
- if the Contention Resolution is considered not successful the MAC entity shall:
  - flush the HARQ buffer used for transmission of the MAC PDU in the Msg3 buffer;
  - if the notification of power ramping suspension has not been received from lower layers:
    - increment *PREAMBLE\_TRANSMISSION\_COUNTER* by 1;
  - If *PREAMBLE\_TRANSMISSION\_COUNTER* = *preambleTransMax* + 1:
    - indicate a Random Access problem to upper layers.
  - based on the backoff parameter, select a random backoff time according to a uniform distribution between 0 and the Backoff Parameter Value;
  - delay the subsequent Random Access transmission by the backoff time;
  - proceed to the selection of a Random Access Resource (see subclause 5.1.2).

### 5.1.6 Completion of the Random Access procedure

At completion of the Random Access procedure, the MAC entity shall:

- discard explicitly signalled *ra-PreambleIndex* and *ra-PRACH-MaskIndex*, if any;
- flush the HARQ buffer used for transmission of the MAC PDU in the Msg3 buffer.

In addition, the RN shall resume the suspended RN subframe configuration, if any.

## 5.2 Maintenance of Uplink Time Alignment

The MAC entity has a configurable timer *timeAlignmentTimer* per TAG. The *timeAlignmentTimer* is used to control how long the MAC entity considers the Serving Cells belonging to the associated TAG to be uplink time aligned [8].

The MAC entity shall:

- when a Timing Advance Command MAC control element is received:
  - apply the Timing Advance Command for the indicated TAG;
  - start or restart the *timeAlignmentTimer* associated with the indicated TAG.
- when a Timing Advance Command is received in a Random Access Response message for a serving cell belonging to a TAG:
  - if the Random Access Preamble was not selected by the MAC entity:
    - apply the Timing Advance Command for this TAG;
    - start or restart the *timeAlignmentTimer* associated with this TAG.
  - else, if the *timeAlignmentTimer* associated with this TAG is not running:
    - apply the Timing Advance Command for this TAG;
    - start the *timeAlignmentTimer* associated with this TAG;
    - when the contention resolution is considered not successful as described in subclause 5.1.5, stop *timeAlignmentTimer* associated with this TAG.
  - else:
    - ignore the received Timing Advance Command.
- when a *timeAlignmentTimer* expires:
  - if the *timeAlignmentTimer* is associated with the pTAG:
    - flush all HARQ buffers for all serving cells;
    - notify RRC to release PUCCH/SRS for all serving cells;
    - clear any configured downlink assignments and uplink grants;
    - consider all running *timeAlignmentTimers* as expired;
  - else if the *timeAlignmentTimer* is associated with an sTAG, then for all Serving Cells belonging to this TAG:
    - flush all HARQ buffers;
    - notify RRC to release SRS.

When the MAC entity stops uplink transmissions for an SCell due to the fact that the maximum uplink transmission timing difference (as described in subclause 7.9.2 of TS 36.133 [9]) or the maximum uplink transmission timing difference the MAC entity can handle between TAGs of this MAC entity is exceeded, the MAC entity considers the *timeAlignmentTimer* associated with the SCell as expired.

The MAC entity shall not perform any uplink transmission on a Serving Cell except the Random Access Preamble transmission when the *timeAlignmentTimer* associated with the TAG to which this Serving Cell belongs is not running. Furthermore, when the *timeAlignmentTimer* associated with the pTAG is not running, the MAC entity shall not perform any uplink transmission on any Serving Cell except the Random Access Preamble transmission on the SpCell.

The MAC entity shall not perform any sidelink transmission which is performed based on UL timing of the corresponding serving cell and any associated SCI transmissions when the corresponding *timeAlignmentTimer* is not running.

NOTE: A MAC entity stores or maintains  $N_{TA}$  upon expiry of associated *timeAlignmentTimer*, where  $N_{TA}$  is defined in [7]. The MAC entity applies a received Timing Advance Command MAC control element and starts associated *timeAlignmentTimer* also when the *timeAlignmentTimer* is not running.

## 5.3 DL-SCH data transfer

### 5.3.1 DL Assignment reception

Downlink assignments transmitted on the PDCCH indicate if there is a transmission on a DL-SCH for a particular MAC entity and provide the relevant HARQ information.

When the MAC entity has a C-RNTI, Semi-Persistent Scheduling C-RNTI, or Temporary C-RNTI, the MAC entity shall for each TTI during which it monitors PDCCH and for each Serving Cell:

- if a downlink assignment for this TTI and this Serving Cell has been received on the PDCCH for the MAC entity's C-RNTI, or Temporary C-RNTI:
  - if this is the first downlink assignment for this Temporary C-RNTI:
    - consider the NDI to have been toggled.
  - if the downlink assignment is for the MAC entity's C-RNTI and if the previous downlink assignment indicated to the HARQ entity of the same HARQ process was either a downlink assignment received for the MAC entity's Semi-Persistent Scheduling C-RNTI or a configured downlink assignment:
    - consider the NDI to have been toggled regardless of the value of the NDI.
  - indicate the presence of a downlink assignment and deliver the associated HARQ information to the HARQ entity for this TTI.
- else, if this Serving Cell is the SpCell and a downlink assignment for this TTI has been received for the SpCell on the PDCCH of the SpCell for the MAC entity's Semi-Persistent Scheduling C-RNTI:
  - if the NDI in the received HARQ information is 1:
    - consider the NDI not to have been toggled;
    - indicate the presence of a downlink assignment and deliver the associated HARQ information to the HARQ entity for this TTI.
  - else, if the NDI in the received HARQ information is 0:
    - if PDCCH contents indicate SPS release:
      - clear the configured downlink assignment (if any);
      - if the *timeAlignmentTimer* associated with the pTAG is running:
        - indicate a positive acknowledgement for the downlink SPS release to the physical layer.
    - else:
      - store the downlink assignment and the associated HARQ information as configured downlink assignment;
      - initialise (if not active) or re-initialise (if already active) the configured downlink assignment to start in this TTI and to recur according to rules in subclause 5.10.1;
      - set the HARQ Process ID to the HARQ Process ID associated with this TTI;
      - consider the NDI bit to have been toggled;
      - indicate the presence of a configured downlink assignment and deliver the stored HARQ information to the HARQ entity for this TTI.



- else, if this Serving Cell is the SpCell and a downlink assignment for this TTI has been configured for the SpCell and there is no measurement gap in this TTI; and
- if this TTI is not an MBSFN subframe of the SpCell or the MAC entity is configured with transmission mode *tm9* or *tm10* on the SpCell:
  - instruct the physical layer to receive, in this TTI, transport block on the DL-SCH according to the configured downlink assignment and to deliver it to the HARQ entity;
  - set the HARQ Process ID to the HARQ Process ID associated with this TTI;
  - consider the NDI bit to have been toggled;
  - indicate the presence of a configured downlink assignment and deliver the stored HARQ information to the HARQ entity for this TTI.

For configured downlink assignments, the HARQ Process ID associated with this TTI is derived from the following equation:

$$\text{HARQ Process ID} = [\text{floor}(\text{CURRENT\_TTI}/\text{semiPersistSchedIntervalDL}) \bmod \text{numberOfConfSPS-Processes},$$

where  $\text{CURRENT\_TTI} = [(\text{SFN} * 10) + \text{subframe number}]$ .

When the MAC entity needs to read BCCH, the MAC entity may, based on the scheduling information from RRC:

- if a downlink assignment for this TTI has been received on the PDCCH for the SI-RNTI;
- if the redundancy version is not defined in the PDCCH format:
  - the redundancy version of the received downlink assignment for this TTI is determined by  $RV_k = \text{ceiling}(3/2 * k) \bmod 4$ , where  $k$  depends on the type of system information message: for *SystemInformationBlockType1* message,  $k = (\text{SFN}/2) \bmod 4$ , where SFN is the system frame number; for *SystemInformation* messages,  $k = i \bmod 4$ ,  $i = 0, 1, \dots, n_s^w - 1$ , where  $i$  denotes the subframe number within the SI window  $n_s^w$ ;
- indicate a downlink assignment and redundancy version for the dedicated broadcast HARQ process to the HARQ entity for this TTI.

## 5.3.2 HARQ operation

### 5.3.2.1 HARQ Entity

There is one HARQ entity at the MAC entity for each Serving Cell which maintains a number of parallel HARQ processes. Each HARQ process is associated with a HARQ process identifier. The HARQ entity directs HARQ information and associated TBs received on the DL-SCH to the corresponding HARQ processes (see subclause 5.3.2.2).

The number of DL HARQ processes per HARQ entity is specified in [2], clause 7.

When the physical layer is configured for downlink spatial multiplexing [2], one or two TBs are expected per subframe and they are associated with the same HARQ process. Otherwise, one TB is expected per subframe.

The MAC entity shall:

- If a downlink assignment has been indicated for this TTI:
  - allocate the TB(s) received from the physical layer and the associated HARQ information to the HARQ process indicated by the associated HARQ information.
- If a downlink assignment has been indicated for the broadcast HARQ process:
  - allocate the received TB to the broadcast HARQ process.

NOTE: In case of BCCH a dedicated broadcast HARQ process is used.

### 5.3.2.2 HARQ process

For each subframe where a transmission takes place for the HARQ process, one or two (in case of downlink spatial multiplexing) TBs and the associated HARQ information are received from the HARQ entity.

For each received TB and associated HARQ information, the HARQ process shall:

- if the NDI, when provided, has been toggled compared to the value of the previous received transmission corresponding to this TB; or
- if the HARQ process is equal to the broadcast process and if this is the first received transmission for the TB according to the system information schedule indicated by RRC; or
- if this is the very first received transmission for this TB (i.e. there is no previous NDI for this TB):
  - consider this transmission to be a new transmission.
- else:
  - consider this transmission to be a retransmission.

The MAC entity then shall:

- if this is a new transmission:
  - attempt to decode the received data.
- else if this is a retransmission:
  - if the data for this TB has not yet been successfully decoded:
    - combine the received data with the data currently in the soft buffer for this TB and attempt to decode the combined data.
  - if the data which the MAC entity attempted to decode was successfully decoded for this TB; or
  - if the data for this TB was successfully decoded before:
    - if the HARQ process is equal to the broadcast process:
      - deliver the decoded MAC PDU to upper layers.
    - else if this is the first successful decoding of the data for this TB:
      - deliver the decoded MAC PDU to the disassembly and demultiplexing entity.
    - generate a positive acknowledgement (ACK) of the data in this TB.
- else:
  - replace the data in the soft buffer for this TB with the data which the MAC entity attempted to decode.
  - generate a negative acknowledgement (NACK) of the data in this TB.
- if the HARQ process is associated with a transmission indicated with a Temporary C-RNTI and the Contention Resolution is not yet successful (see subclause 5.1.5); or
- if the HARQ process is equal to the broadcast process; or
- if the *timeAlignmentTimer* associated with the pTAG is stopped or expired:
  - do not indicate the generated positive or negative acknowledgement to the physical layer.
- else:
  - indicate the generated positive or negative acknowledgement for this TB to the physical layer.

The MAC entity shall ignore NDI received in all downlink assignments on PDCCH for its Temporary C-RNTI when determining if NDI on PDCCH for its C-RNTI has been toggled compared to the value in the previous transmission.

NOTE: When the MAC entity is configured with more than one serving cell, UE behaviors for storing data to the soft buffer is specified in [2].

NOTE: If the MAC entity receives a retransmission with a TB size different from the last valid TB size signalled for this TB, the UE behavior is left up to UE implementation.

### 5.3.3 Disassembly and demultiplexing

The MAC entity shall disassemble and demultiplex a MAC PDU as defined in subclause 6.1.2.

## 5.4 UL-SCH data transfer

### 5.4.1 UL Grant reception

In order to transmit on the UL-SCH the MAC entity must have a valid uplink grant (except for non-adaptive HARQ retransmissions) which it may receive dynamically on the PDCCH or in a Random Access Response or which may be configured semi-persistently. To perform requested transmissions, the MAC layer receives HARQ information from lower layers. When the physical layer is configured for uplink spatial multiplexing, the MAC layer can receive up to two grants (one per HARQ process) for the same TTI from lower layers.

If the MAC entity has a C-RNTI, a Semi-Persistent Scheduling C-RNTI, or a Temporary C-RNTI, the MAC entity shall for each TTI and for each Serving Cell belonging to a TAG that has a running *timeAlignmentTimer* and for each grant received for this TTI:

- if an uplink grant for this TTI and this Serving Cell has been received on the PDCCH for the MAC entity's C-RNTI or Temporary C-RNTI; or
- if an uplink grant for this TTI has been received in a Random Access Response:
  - if the uplink grant is for MAC entity's C-RNTI and if the previous uplink grant delivered to the HARQ entity for the same HARQ process was either an uplink grant received for the MAC entity's Semi-Persistent Scheduling C-RNTI or a configured uplink grant:
    - consider the NDI to have been toggled for the corresponding HARQ process regardless of the value of the NDI.
  - deliver the uplink grant and the associated HARQ information to the HARQ entity for this TTI.
- else, if this Serving Cell is the SpCell and if an uplink grant for this TTI has been received for the SpCell on the PDCCH of the SpCell for the MAC entity's Semi-Persistent Scheduling C-RNTI:
  - if the NDI in the received HARQ information is 1:
    - consider the NDI for the corresponding HARQ process not to have been toggled;
    - deliver the uplink grant and the associated HARQ information to the HARQ entity for this TTI.
  - else if the NDI in the received HARQ information is 0:
    - if PDCCH contents indicate SPS release:
      - clear the configured uplink grant (if any).
    - else:
      - store the uplink grant and the associated HARQ information as configured uplink grant;
      - initialise (if not active) or re-initialise (if already active) the configured uplink grant to start in this TTI and to recur according to rules in subclause 5.10.2;
      - consider the NDI bit for the corresponding HARQ process to have been toggled;

- deliver the configured uplink grant and the associated HARQ information to the HARQ entity for this TTI.
- else, if this Serving Cell is the SpCell and an uplink grant for this TTI has been configured for the SpCell:
  - consider the NDI bit for the corresponding HARQ process to have been toggled;
  - deliver the configured uplink grant, and the associated HARQ information to the HARQ entity for this TTI.

NOTE: The period of configured uplink grants is expressed in TTIs.

NOTE: If the MAC entity receives both a grant in a Random Access Response and a grant for its C-RNTI or Semi persistent scheduling C-RNTI requiring transmissions on the SpCell in the same UL subframe, the MAC entity may choose to continue with either the grant for its RA-RNTI or the grant for its C-RNTI or Semi persistent scheduling C-RNTI.

NOTE: When a configured uplink grant is indicated during a measurement gap and indicates an UL-SCH transmission during a measurement gap, the MAC entity processes the grant but does not transmit on UL-SCH.

## 5.4.2 HARQ operation

### 5.4.2.1 HARQ entity

There is one HARQ entity at the MAC entity for each Serving Cell with configured uplink, which maintains a number of parallel HARQ processes allowing transmissions to take place continuously while waiting for the HARQ feedback on the successful or unsuccessful reception of previous transmissions.

The number of parallel HARQ processes per HARQ entity is specified in [2], clause 8.

When the physical layer is configured for uplink spatial multiplexing [2], there are two HARQ processes associated with a given TTI. Otherwise there is one HARQ process associated with a given TTI.

At a given TTI, if an uplink grant is indicated for the TTI, the HARQ entity identifies the HARQ process(es) for which a transmission should take place. It also routes the received HARQ feedback (ACK/NACK information), MCS and resource, relayed by the physical layer, to the appropriate HARQ process(es).

When TTI bundling is configured, the parameter `TTI_BUNDLE_SIZE` provides the number of TTIs of a TTI bundle. TTI bundling operation relies on the HARQ entity for invoking the same HARQ process for each transmission that is part of the same bundle. Within a bundle HARQ retransmissions are non-adaptive and triggered without waiting for feedback from previous transmissions according to `TTI_BUNDLE_SIZE`. The HARQ feedback of a bundle is only received for the last TTI of the bundle (i.e the TTI corresponding to `TTI_BUNDLE_SIZE`), regardless of whether a transmission in that TTI takes place or not (e.g. when a measurement gap occurs). A retransmission of a TTI bundle is also a TTI bundle. TTI bundling is not supported when the MAC entity is configured with one or more SCells with configured uplink.

TTI bundling is not supported for RN communication with the E-UTRAN in combination with an RN subframe configuration.

For transmission of Msg3 during Random Access (see subclause 5.1.5) TTI bundling does not apply.

For each TTI, the HARQ entity shall:

- identify the HARQ process(es) associated with this TTI, and for each identified HARQ process:
  - if an uplink grant has been indicated for this process and this TTI:
    - if the received grant was not addressed to a Temporary C-RNTI on PDCCH and if the NDI provided in the associated HARQ information has been toggled compared to the value in the previous transmission of this HARQ process; or
    - if the uplink grant was received on PDCCH for the C-RNTI and the HARQ buffer of the identified process is empty; or
    - if the uplink grant was received in a Random Access Response:

- if there is a MAC PDU in the Msg3 buffer and the uplink grant was received in a Random Access Response:
  - obtain the MAC PDU to transmit from the Msg3 buffer.
- else:
  - obtain the MAC PDU to transmit from the "Multiplexing and assembly" entity;
  - deliver the MAC PDU and the uplink grant and the HARQ information to the identified HARQ process;
  - instruct the identified HARQ process to trigger a new transmission.
- else:
  - deliver the uplink grant and the HARQ information (redundancy version) to the identified HARQ process;
  - instruct the identified HARQ process to generate an adaptive retransmission.
- else, if the HARQ buffer of this HARQ process is not empty:
  - instruct the identified HARQ process to generate a non-adaptive retransmission.

When determining if NDI has been toggled compared to the value in the previous transmission the MAC entity shall ignore NDI received in all uplink grants on PDCCH for its Temporary C-RNTI.

#### 5.4.2.2 HARQ process

Each HARQ process is associated with a HARQ buffer.

Each HARQ process shall maintain a state variable `CURRENT_TX_NB`, which indicates the number of transmissions that have taken place for the MAC PDU currently in the buffer, and a state variable `HARQ_FEEDBACK`, which indicates the HARQ feedback for the MAC PDU currently in the buffer. When the HARQ process is established, `CURRENT_TX_NB` shall be initialized to 0.

The sequence of redundancy versions is 0, 2, 3, 1. The variable `CURRENT_IRV` is an index into the sequence of redundancy versions. This variable is up-dated modulo 4.

New transmissions are performed on the resource and with the MCS indicated on PDCCH or Random Access Response. Adaptive retransmissions are performed on the resource and, if provided, with the MCS indicated on PDCCH. Non-adaptive retransmission is performed on the same resource and with the same MCS as was used for the last made transmission attempt.

The MAC entity is configured with a Maximum number of HARQ transmissions and a Maximum number of Msg3 HARQ transmissions by RRC: *maxHARQ-Tx* and *maxHARQ-Msg3Tx* respectively. For transmissions on all HARQ processes and all logical channels except for transmission of a MAC PDU stored in the Msg3 buffer, the maximum number of transmissions shall be set to *maxHARQ-Tx*. For transmission of a MAC PDU stored in the Msg3 buffer, the maximum number of transmissions shall be set to *maxHARQ-Msg3Tx*.

When the HARQ feedback is received for this TB, the HARQ process shall:

- set `HARQ_FEEDBACK` to the received value.

If the HARQ entity requests a new transmission, the HARQ process shall:

- set `CURRENT_TX_NB` to 0;
- set `CURRENT_IRV` to 0;
- store the MAC PDU in the associated HARQ buffer;

- store the uplink grant received from the HARQ entity;
- set HARQ\_FEEDBACK to NACK;
- generate a transmission as described below.

If the HARQ entity requests a retransmission, the HARQ process shall:

- increment CURRENT\_TX\_NB by 1;
- if the HARQ entity requests an adaptive retransmission:
  - store the uplink grant received from the HARQ entity;
  - set CURRENT\_IRV to the index corresponding to the redundancy version value provided in the HARQ information;
  - set HARQ\_FEEDBACK to NACK;
  - generate a transmission as described below.
- else if the HARQ entity requests a non-adaptive retransmission:
  - if HARQ\_FEEDBACK = NACK:
    - generate a transmission as described below.

NOTE: When receiving a HARQ ACK alone, the MAC entity keeps the data in the HARQ buffer.

NOTE: When no UL-SCH transmission can be made due to the occurrence of a measurement gap, no HARQ feedback can be received and a non-adaptive retransmission follows.

To generate a transmission, the HARQ process shall:

- if the MAC PDU was obtained from the Msg3 buffer; or
- if there is no measurement gap at the time of the transmission and, in case of retransmission, the retransmission does not collide with a transmission for a MAC PDU obtained from the Msg3 buffer in this TTI:
  - instruct the physical layer to generate a transmission according to the stored uplink grant with the redundancy version corresponding to the CURRENT\_IRV value;
  - increment CURRENT\_IRV by 1;
- if there is a measurement gap at the time of the HARQ feedback reception for this transmission and if the MAC PDU was not obtained from the Msg3 buffer:
  - set HARQ\_FEEDBACK to ACK at the time of the HARQ feedback reception for this transmission.

After performing above actions, the HARQ process then shall:

- if CURRENT\_TX\_NB = maximum number of transmissions – 1:
  - flush the HARQ buffer;

## 5.4.3 Multiplexing and assembly

### 5.4.3.1 Logical channel prioritization

The Logical Channel Prioritization procedure is applied when a new transmission is performed.

RRC controls the scheduling of uplink data by signalling for each logical channel: *priority* where an increasing *priority* value indicates a lower priority level, *prioritisedBitRate* which sets the Prioritized Bit Rate (PBR), *bucketSizeDuration* which sets the Bucket Size Duration (BSD).

The MAC entity shall maintain a variable  $B_j$  for each logical channel  $j$ .  $B_j$  shall be initialized to zero when the related logical channel is established, and incremented by the product  $PBR \times TTI$  duration for each TTI, where PBR is Prioritized Bit Rate of logical channel  $j$ . However, the value of  $B_j$  can never exceed the bucket size and if the value of  $B_j$  is larger than the bucket size of logical channel  $j$ , it shall be set to the bucket size. The bucket size of a logical channel is equal to  $PBR \times BSD$ , where PBR and BSD are configured by upper layers.

The MAC entity shall perform the following Logical Channel Prioritization procedure when a new transmission is performed:

- The MAC entity shall allocate resources to the logical channels in the following steps:
  - Step 1: All the logical channels with  $B_j > 0$  are allocated resources in a decreasing priority order. If the PBR of a logical channel is set to “infinity”, the MAC entity shall allocate resources for all the data that is available for transmission on the logical channel before meeting the PBR of the lower priority logical channel(s);
  - Step 2: the MAC entity shall decrement  $B_j$  by the total size of MAC SDUs served to logical channel  $j$  in Step 1

NOTE: The value of  $B_j$  can be negative.

- Step 3: if any resources remain, all the logical channels are served in a strict decreasing priority order (regardless of the value of  $B_j$ ) until either the data for that logical channel or the UL grant is exhausted, whichever comes first. Logical channels configured with equal priority should be served equally.
- The UE shall also follow the rules below during the scheduling procedures above:
  - the UE should not segment an RLC SDU (or partially transmitted SDU or retransmitted RLC PDU) if the whole SDU (or partially transmitted SDU or retransmitted RLC PDU) fits into the remaining resources of the associated MAC entity;
  - if the UE segments an RLC SDU from the logical channel, it shall maximize the size of the segment to fill the grant of the associated MAC entity as much as possible;
  - the UE should maximise the transmission of data.
  - if the MAC entity is given an UL grant size that is equal to or larger than 4 bytes while having data available for transmission, the MAC entity shall not transmit only padding BSR and/or padding (unless the UL grant size is less than 7 bytes and an AMD PDU segment needs to be transmitted).

The MAC entity shall not transmit data for a logical channel corresponding to a radio bearer that is suspended (the conditions for when a radio bearer is considered suspended are defined in [8]).

For the Logical Channel Prioritization procedure, the MAC entity shall take into account the following relative priority in decreasing order:

- MAC control element for C-RNTI or data from UL-CCCH;
- MAC control element for BSR, with exception of BSR included for padding;
- MAC control element for PHR, Extended PHR, or Dual Connectivity PHR;
- MAC control element for Sidelink BSR, with exception of Sidelink BSR included for padding;
- data from any Logical Channel, except data from UL-CCCH;

- MAC control element for BSR included for padding;
- MAC control element for Sidelink BSR included for padding.

NOTE: When the MAC entity is requested to transmit multiple MAC PDUs in one TTI, steps 1 to 3 and the associated rules may be applied either to each grant independently or to the sum of the capacities of the grants. Also the order in which the grants are processed is left up to UE implementation. It is up to the UE implementation to decide in which MAC PDU a MAC control element is included when MAC entity is requested to transmit multiple MAC PDUs in one TTI. When the UE is requested to generate MAC PDU(s) in two MAC entities in one TTI, it is up to UE implementation in which order the grants are processed.

### 5.4.3.2 Multiplexing of MAC Control Elements and MAC SDUs

The MAC entity shall multiplex MAC control elements and MAC SDUs in a MAC PDU according to subclauses 5.4.3.1 and 6.1.2.

### 5.4.4 Scheduling Request

The Scheduling Request (SR) is used for requesting UL-SCH resources for new transmission.

When an SR is triggered, it shall be considered as pending until it is cancelled. All pending SR(s) shall be cancelled and *sr-ProhibitTimer* shall be stopped when a MAC PDU is assembled and this PDU includes a BSR which contains buffer status up to (and including) the last event that triggered a BSR (see subclause 5.4.5), or, if all pending SR(s) are triggered by Sidelink BSR, when a MAC PDU is assembled and this PDU includes a Sidelink BSR which contains buffer status up to (and including) the last event that triggered a Sidelink BSR (see subclause 5.14.1.4), or, if all pending SR(s) are triggered by Sidelink BSR, when upper layers configure autonomous resource selection, or when the UL grant(s) can accommodate all pending data available for transmission.

If an SR is triggered and there is no other SR pending, the MAC entity shall set the *SR\_COUNTER* to 0.

As long as one SR is pending, the MAC entity shall for each TTI:

- if no UL-SCH resources are available for a transmission in this TTI:
  - if the MAC entity has no valid PUCCH resource for SR configured in any TTI: initiate a Random Access procedure (see subclause 5.1) on the SpCell and cancel all pending SRs;
  - else if the MAC entity has a valid PUCCH resource for SR configured for this TTI and if this TTI is not part of a measurement gap and if *sr-ProhibitTimer* is not running:
    - if *SR\_COUNTER* < *dss-TransMax*:
      - increment *SR\_COUNTER* by 1;
      - instruct the physical layer to signal the SR on PUCCH;
      - start the *sr-ProhibitTimer*.
    - else:
      - notify RRC to release PUCCH/SRS for all serving cells;
      - clear any configured downlink assignments and uplink grants;
      - initiate a Random Access procedure (see subclause 5.1) on the SpCell and cancel all pending SRs.

### 5.4.5 Buffer Status Reporting

The Buffer Status reporting procedure is used to provide the serving eNB with information about the amount of data available for transmission in the UL buffers associated with the MAC entity. RRC controls BSR reporting by configuring the three timers *periodicBSR-Timer*, *retxBSR-Timer* and *logicalChannelSR-ProhibitTimer* and by, for each logical channel, optionally signalling *logicalChannelGroup* which allocates the logical channel to an LCG [8].



For the Buffer Status reporting procedure, the MAC entity shall consider all radio bearers which are not suspended and may consider radio bearers which are suspended.

A Buffer Status Report (BSR) shall be triggered if any of the following events occur:

- UL data, for a logical channel which belongs to a LCG, becomes available for transmission in the RLC entity or in the PDCP entity (the definition of what data shall be considered as available for transmission is specified in [3] and [4] respectively) and either the data belongs to a logical channel with higher priority than the priorities of the logical channels which belong to any LCG and for which data is already available for transmission, or there is no data available for transmission for any of the logical channels which belong to a LCG, in which case the BSR is referred below to as "Regular BSR";
- UL resources are allocated and number of padding bits is equal to or larger than the size of the Buffer Status Report MAC control element plus its subheader, in which case the BSR is referred below to as "Padding BSR";
- *retxBSR-Timer* expires and the MAC entity has data available for transmission for any of the logical channels which belong to a LCG, in which case the BSR is referred below to as "Regular BSR";
- *periodicBSR-Timer* expires, in which case the BSR is referred below to as "Periodic BSR".

For Regular BSR:

- if the BSR is triggered due to data becoming available for transmission for a logical channel for which *logicalChannelSR-ProhibitTimer* is configured by upper layers:
  - start or restart the *logicalChannelSR-ProhibitTimer*;
- else:
  - if running, stop the *logicalChannelSR-ProhibitTimer*.

For Regular and Periodic BSR:

- if more than one LCG has data available for transmission in the TTI where the BSR is transmitted: report Long BSR;
- else report Short BSR.

For Padding BSR:

- if the number of padding bits is equal to or larger than the size of the Short BSR plus its subheader but smaller than the size of the Long BSR plus its subheader:
  - if more than one LCG has data available for transmission in the TTI where the BSR is transmitted: report Truncated BSR of the LCG with the highest priority logical channel with data available for transmission;
  - else report Short BSR.
- else if the number of padding bits is equal to or larger than the size of the Long BSR plus its subheader, report Long BSR.

If the Buffer Status reporting procedure determines that at least one BSR has been triggered and not cancelled:

- if the MAC entity has UL resources allocated for new transmission for this TTI:
  - instruct the Multiplexing and Assembly procedure to generate the BSR MAC control element(s);
  - start or restart *periodicBSR-Timer* except when all the generated BSRs are Truncated BSRs;
  - start or restart *retxBSR-Timer*.
- else if a Regular BSR has been triggered and *logicalChannelSR-ProhibitTimer* is not running:
  - if an uplink grant is not configured or the Regular BSR was not triggered due to data becoming available for transmission for a logical channel for which logical channel SR masking (*logicalChannelSR-Mask*) is setup by upper layers:

- a Scheduling Request shall be triggered.

A MAC PDU shall contain at most one MAC BSR control element, even when multiple events trigger a BSR by the time a BSR can be transmitted in which case the Regular BSR and the Periodic BSR shall have precedence over the padding BSR.

The MAC entity shall restart *retxBSR-Timer* upon indication of a grant for transmission of new data on any UL-SCH.

All triggered BSRs shall be cancelled in case the UL grant(s) in this subframe can accommodate all pending data available for transmission but is not sufficient to additionally accommodate the BSR MAC control element plus its subheader. All triggered BSRs shall be cancelled when a BSR is included in a MAC PDU for transmission.

The MAC entity shall transmit at most one Regular/Periodic BSR in a TTI. If the MAC entity is requested to transmit multiple MAC PDUs in a TTI, it may include a padding BSR in any of the MAC PDUs which do not contain a Regular/Periodic BSR.

All BSRs transmitted in a TTI always reflect the buffer status after all MAC PDUs have been built for this TTI. Each LCG shall report at the most one buffer status value per TTI and this value shall be reported in all BSRs reporting buffer status for this LCG.

NOTE: A Padding BSR is not allowed to cancel a triggered Regular/Periodic BSR. A Padding BSR is triggered for a specific MAC PDU only and the trigger is cancelled when this MAC PDU has been built.

## 5.4.6 Power Headroom Reporting

The Power Headroom reporting procedure is used to provide the serving eNB with information about the difference between the nominal UE maximum transmit power and the estimated power for UL-SCH transmission per activated Serving Cell and also with information about the difference between the nominal UE maximum power and the estimated power for UL-SCH and PUCCH transmission on SpCell.

The reporting period, delay and mapping of Power Headroom are defined in subclause 9.1.8 of [9]. RRC controls Power Headroom reporting by configuring the two timers *periodicPHR-Timer* and *prohibitPHR-Timer*, and by signalling *dl-PathlossChange* which sets the change in measured downlink pathloss and the required power backoff due to power management (as allowed by  $P\text{-MPR}_c$  [10]) to trigger a PHR [8].

A Power Headroom Report (PHR) shall be triggered if any of the following events occur:

- *prohibitPHR-Timer* expires or has expired and the path loss has changed more than *dl-PathlossChange* dB for at least one activated Serving Cell of any MAC entity which is used as a pathloss reference since the last transmission of a PHR in this MAC entity when the MAC entity has UL resources for new transmission;
- *periodicPHR-Timer* expires;
- upon configuration or reconfiguration of the power headroom reporting functionality by upper layers [8], which is not used to disable the function;
- activation of an SCell of any MAC entity with configured uplink.
- addition of the PSCell
- *prohibitPHR-Timer* expires or has expired, when the MAC entity has UL resources for new transmission, and the following is true in this TTI for any of the activated Serving Cells of any MAC entity with configured uplink:
  - there are UL resources allocated for transmission or there is a PUCCH transmission on this cell, and the required power backoff due to power management (as allowed by  $P\text{-MPR}_c$  [10]) for this cell has changed more than *dl-PathlossChange* dB since the last transmission of a PHR when the MAC entity had UL resources allocated for transmission or PUCCH transmission on this cell.

NOTE: The MAC entity should avoid triggering a PHR when the required power backoff due to power management decreases only temporarily (e.g. for up to a few tens of milliseconds) and it should avoid reflecting such temporary decrease in the values of  $P_{\text{CMAX},c}/\text{PH}$  when a PHR is triggered by other triggering conditions.

If the MAC entity has UL resources allocated for new transmission for this TTI the MAC entity shall:

- if it is the first UL resource allocated for a new transmission since the last MAC reset, start *periodicPHR-Timer*;
- if the Power Headroom reporting procedure determines that at least one PHR has been triggered and not cancelled, and;
- if the allocated UL resources can accommodate a PHR MAC control element plus its subheader if neither *extendedPHR* nor *dualConnectivityPHR* is configured, or the Extended PHR MAC control element plus its subheader if *extendedPHR* is configured, or the Dual Connectivity PHR MAC control element plus its subheader if *dualConnectivityPHR* is configured, as a result of logical channel prioritization:
  - if *extendedPHR* is configured:
    - for each activated Serving Cell with configured uplink:
      - obtain the value of the Type 1 power headroom;
      - if the MAC entity has UL resources allocated for transmission on this Serving Cell for this TTI:
        - obtain the value for the corresponding  $P_{\text{CMAX},c}$  field from the physical layer;
      - if *simultaneousPUCCH-PUSCH* is configured:
        - obtain the value of the Type 2 power headroom for the PCell;
        - obtain the value for the corresponding  $P_{\text{CMAX},c}$  field from the physical layer (see subclause 5.1.1.2 of [2]);
    - instruct the Multiplexing and Assembly procedure to generate and transmit an Extended PHR MAC control element as defined in subclause 6.1.3.6a based on the values reported by the physical layer;
  - else if *dualConnectivityPHR* is configured:
    - for each activated Serving Cell with configured uplink associated with any MAC entity:
      - obtain the value of the Type 1 power headroom;
      - if this MAC entity has UL resources allocated for transmission on this Serving Cell for this TTI or if the other MAC entity has UL resources allocated for transmission on this Serving Cell for this TTI and *phr-ModeOtherCG* is set to *real* by upper layers:
        - obtain the value for the corresponding  $P_{\text{CMAX},c}$  field from the physical layer;
    - if *simultaneousPUCCH-PUSCH* is configured:
      - obtain the value of the Type 2 power headroom for the SpCell;
      - obtain the value for the corresponding  $P_{\text{CMAX},c}$  field for the SpCell from the physical layer (see subclause 5.1.1.2 of [2]);
    - obtain the value of the Type 2 power headroom for the SpCell of the other MAC entity;
    - if *phr-ModeOtherCG* is set to *real* by upper layers:
      - obtain the value for the corresponding  $P_{\text{CMAX},c}$  field for the SpCell of the other MAC entity from the physical layer (see subclause 5.1.1.2 of [2]);
    - instruct the Multiplexing and Assembly procedure to generate and transmit a Dual Connectivity PHR MAC control element as defined in subclause 6.1.3.6b based on the values reported by the physical layer;
  - else:
    - obtain the value of the Type 1 power headroom from the physical layer;
    - instruct the Multiplexing and Assembly procedure to generate and transmit a PHR MAC control element as defined in subclause 6.1.3.6 based on the value reported by the physical layer;
- start or restart *periodicPHR-Timer*;

- start or restart *prohibitPHR-Timer*;
- cancel all triggered PHR(s).

## 5.5 PCH reception

When the MAC entity needs to receive PCH, the MAC entity shall:

- if a PCH assignment has been received on the PDCCH for the P-RNTI:
  - attempt to decode the TB on the PCH as indicated by the PDCCH information.
- if a TB on the PCH has been successfully decoded:
  - deliver the decoded MAC PDU to upper layers.

## 5.6 BCH reception

When the MAC entity needs to receive BCH, the MAC entity shall:

- receive and attempt to decode the BCH;
- if a TB on the BCH has been successfully decoded:
  - deliver the decoded MAC PDU to upper layers.

## 5.7 Discontinuous Reception (DRX)

The MAC entity may be configured by RRC with a DRX functionality that controls the UE's PDCCH monitoring activity for the MAC entity's C-RNTI, TPC-PUCCH-RNTI, TPC-PUSCH-RNTI, Semi-Persistent Scheduling C-RNTI (if configured), eIMTA-RNTI (if configured) and SL-RNTI (if configured). When in RRC\_CONNECTED, if DRX is configured, the MAC entity is allowed to monitor the PDCCH discontinuously using the DRX operation specified in this subclause; otherwise the MAC entity monitors the PDCCH continuously. When using DRX operation, the MAC entity shall also monitor PDCCH according to requirements found in other subclauses of this specification. RRC controls DRX operation by configuring the timers *onDurationTimer*, *drx-InactivityTimer*, *drx-RetransmissionTimer* (one per DL HARQ process except for the broadcast process), the *longDRX-Cycle*, the value of the *drxStartOffset* and optionally the *drxShortCycleTimer* and *shortDRX-Cycle*. A HARQ RTT timer per DL HARQ process (except for the broadcast process) is also defined (see subclause 7.7).

When a DRX cycle is configured, the Active Time includes the time while:

- *onDurationTimer* or *drx-InactivityTimer* or *drx-RetransmissionTimer* or *mac-ContentionResolutionTimer* (as described in subclause 5.1.5) is running; or
- a Scheduling Request is sent on PUCCH and is pending (as described in subclause 5.4.4); or
- an uplink grant for a pending HARQ retransmission can occur and there is data in the corresponding HARQ buffer; or
- a PDCCH indicating a new transmission addressed to the C-RNTI of the MAC entity has not been received after successful reception of a Random Access Response for the preamble not selected by the MAC entity (as described in subclause 5.1.4).

When DRX is configured, the MAC entity shall for each subframe:

- if a HARQ RTT Timer expires in this subframe and the data of the corresponding HARQ process was not successfully decoded:
  - start the *drx-RetransmissionTimer* for the corresponding HARQ process.
- if a DRX Command MAC control element or a Long DRX Command MAC control element is received:
  - stop *onDurationTimer*;

- stop *drx-InactivityTimer*.
- if *drx-InactivityTimer* expires or a DRX Command MAC control element is received in this subframe:
  - if the Short DRX cycle is configured:
    - start or restart *drxShortCycleTimer*;
    - use the Short DRX Cycle.
  - else:
    - use the Long DRX cycle.
- if *drxShortCycleTimer* expires in this subframe:
  - use the Long DRX cycle.
- if a Long DRX Command MAC control element is received:
  - stop *drxShortCycleTimer*;
  - use the Long DRX cycle.
- If the Short DRX Cycle is used and  $[(SFN * 10) + \text{subframe number}] \bmod (shortDRX-Cycle) = (drxStartOffset) \bmod (shortDRX-Cycle)$ ; or
- if the Long DRX Cycle is used and  $[(SFN * 10) + \text{subframe number}] \bmod (longDRX-Cycle) = drxStartOffset$ :
  - start *onDurationTimer*.
- during the Active Time, for a PDCCH-subframe, if the subframe is not required for uplink transmission for half-duplex FDD UE operation, if the subframe is not a half-duplex guard subframe [7] and if the subframe is not part of a configured measurement gap; or
- during the Active Time, for a subframe other than a PDCCH-subframe and for a UE capable of simultaneous reception and transmission in the aggregated cells, if the subframe is a downlink subframe indicated by a valid eIMTA L1 signalling for at least one serving cell not configured with *schedulingCellId* [8] and if the subframe is not part of a configured measurement gap; or
- during the Active Time, for a subframe other than a PDCCH-subframe and for a UE not capable of simultaneous reception and transmission in the aggregated cells, if the subframe is a downlink subframe indicated by a valid eIMTA L1 signalling for the SpCell and if the subframe is not part of a configured measurement gap:
  - monitor the PDCCH;
  - if the PDCCH indicates a DL transmission or if a DL assignment has been configured for this subframe:
    - start the HARQ RTT Timer for the corresponding HARQ process;
    - stop the *drx-RetransmissionTimer* for the corresponding HARQ process.
  - if the PDCCH indicates a new transmission (DL, UL or SL):
    - start or restart *drx-InactivityTimer*.
- in current subframe *n*, if the MAC entity would not be in Active Time considering grants/assignments/DRX Command MAC control elements/Long DRX Command MAC control elements received and Scheduling Request sent until and including subframe *n-5* when evaluating all DRX Active Time conditions as specified in this subclause, type-0-triggered SRS [2] shall not be reported.
- if CQI masking (*cqi-Mask*) is setup by upper layers:
  - in current subframe *n*, if *onDurationTimer* would not be running considering grants/assignments/DRX Command MAC control elements/Long DRX Command MAC control elements received until and including subframe *n-5* when evaluating all DRX Active Time conditions as specified in this subclause, CQI/PMI/RI/PTI on PUCCH shall not be reported.

- else:
  - in current subframe  $n$ , if the MAC entity would not be in Active Time considering grants/assignments/DRX Command MAC control elements/Long DRX Command MAC control elements received and Scheduling Request sent until and including subframe  $n-5$  when evaluating all DRX Active Time conditions as specified in this subclause, CQI/PMI/RI/PTI on PUCCH shall not be reported.

Regardless of whether the MAC entity is monitoring PDCCH or not, the MAC entity receives and transmits HARQ feedback and transmits type-1-triggered SRS [2] when such is expected.

NOTE: The same Active Time applies to all activated serving cell(s).

NOTE: In case of downlink spatial multiplexing, if a TB is received while the HARQ RTT Timer is running and the previous transmission of the same TB was received at least  $N$  subframes before the current subframe (where  $N$  corresponds to the HARQ RTT Timer), the MAC entity should process it and restart the HARQ RTT Timer.

## 5.8 MAC reconfiguration

When a reconfiguration of the MAC entity is requested by upper layers, the MAC entity shall:

- upon addition of an SCell, initialize the corresponding HARQ entity;
- upon removal of an SCell, remove the corresponding HARQ entity;
- for timers apply the new value when the timer is (re)started;
- when counters are initialized apply the new maximum parameter value;
- for other parameters, apply immediately the configurations received from upper layers.

## 5.9 MAC Reset

If a reset of the MAC entity is requested by upper layers, the MAC entity shall:

- initialize  $B_j$  for each logical channel to zero;
- stop (if running) all timers;
- consider all *timeAlignmentTimers* as expired and perform the corresponding actions in subclause 5.2;
- set the NDIs for all uplink HARQ processes to the value 0;
- stop, if any, ongoing RACH procedure;
- discard explicitly signalled *ra-PreambleIndex* and *ra-PRACH-MaskIndex*, if any;
- flush Msg3 buffer;
- cancel, if any, triggered Scheduling Request procedure;
- cancel, if any, triggered Buffer Status Reporting procedure;
- cancel, if any, triggered Power Headroom Reporting procedure;
- flush the soft buffers for all DL HARQ processes;
- for each DL HARQ process, consider the next received transmission for a TB as the very first transmission;
- release, if any, Temporary C-RNTI.

## 5.10 Semi-Persistent Scheduling

When Semi-Persistent Scheduling is enabled by RRC, the following information is provided [8]:

- Semi-Persistent Scheduling C-RNTI;
- Uplink Semi-Persistent Scheduling interval *semiPersistSchedIntervalUL* and number of empty transmissions before implicit release *implicitReleaseAfter*, if Semi-Persistent Scheduling is enabled for the uplink;
- Whether *twoIntervalsConfig* is enabled or disabled for uplink, only for TDD;
- Downlink Semi-Persistent Scheduling interval *semiPersistSchedIntervalDL* and number of configured HARQ processes for Semi-Persistent Scheduling *numberOfConfSPS-Processes*, if Semi-Persistent Scheduling is enabled for the downlink;

When Semi-Persistent Scheduling for uplink or downlink is disabled by RRC, the corresponding configured grant or configured assignment shall be discarded.

Semi-Persistent Scheduling is supported on the SpCell only.

Semi-Persistent Scheduling is not supported for RN communication with the E-UTRAN in combination with an RN subframe configuration.

NOTE: When eIMTA is configured for the SpCell, if a configured uplink grant or a configured downlink assignment occurs on a subframe that can be reconfigured through eIMTA L1 signalling, then the UE behaviour is left unspecified.

### 5.10.1 Downlink

After a Semi-Persistent downlink assignment is configured, the MAC entity shall consider sequentially that the  $N^{\text{th}}$  assignment occurs in the subframe for which:

- $(10 * \text{SFN} + \text{subframe}) = [(10 * \text{SFN}_{\text{start time}} + \text{subframe}_{\text{start time}}) + N * \text{semiPersistSchedIntervalDL}] \text{ modulo } 10240.$

Where  $\text{SFN}_{\text{start time}}$  and  $\text{subframe}_{\text{start time}}$  are the SFN and subframe, respectively, at the time the configured downlink assignment were (re-)initialised.

### 5.10.2 Uplink

After a Semi-Persistent Scheduling uplink grant is configured, the MAC entity shall:

- if *twoIntervalsConfig* is enabled by upper layer:
  - set the *Subframe\_Offset* according to Table 7.4-1.
- else:
  - set *Subframe\_Offset* to 0.
- consider sequentially that the  $N^{\text{th}}$  grant occurs in the subframe for which:
  - $(10 * \text{SFN} + \text{subframe}) = [(10 * \text{SFN}_{\text{start time}} + \text{subframe}_{\text{start time}}) + N * \text{semiPersistSchedIntervalUL} + \text{Subframe\_Offset} * (N \text{ modulo } 2)] \text{ modulo } 10240.$

Where  $\text{SFN}_{\text{start time}}$  and  $\text{subframe}_{\text{start time}}$  are the SFN and subframe, respectively, at the time the configured uplink grant were (re-)initialised.

The MAC entity shall clear the configured uplink grant immediately after *implicitReleaseAfter* [8] number of consecutive new MAC PDUs each containing zero MAC SDUs have been provided by the Multiplexing and Assembly entity, on the Semi-Persistent Scheduling resource.

NOTE: Retransmissions for Semi-Persistent Scheduling can continue after clearing the configured uplink grant.

## 5.11 Handling of unknown, unforeseen and erroneous protocol data

When a MAC entity receives a MAC PDU for the MAC entity's C-RNTI or Semi-Persistent Scheduling C-RNTI, or by the configured downlink assignment, or on SL-SCH, containing reserved or invalid values, the MAC entity shall:

- discard the received PDU.

When a MAC entity receives a MAC PDU on MCH containing reserved values, the MAC entity shall:

- ignore the MAC PDU subheaders containing reserved values and the corresponding MAC SDUs;
- in the MAC control elements, ignore the fields containing reserved values and the fields associated with the fields containing reserved values.

## 5.12 MCH reception

MCH transmission may occur in subframes configured by upper layer for MCCH or MTCH transmission. For each such subframe, upper layer indicates if *signallingMCS* or *dataMCS* applies. The transmission of an MCH occurs in a set of subframes defined by *PMCH-Config*. An MCH Scheduling Information MAC control element is included in the first subframe allocated to the MCH within the MCH scheduling period to indicate the position of each MTCH and unused subframes on the MCH. If *pmch-InfoListExt* is configured for an MCH, an Extended MCH Scheduling Information MAC control element is included in the first subframe allocated to the corresponding MCH within the MCH scheduling period to indicate the position of each MTCH and unused subframes on the MCH, and to indicate whether MTCH transmission is to be suspended. The MAC entity shall assume that the first scheduled MTCH starts immediately after the MCCH or the MCH Scheduling Information MAC control element or the Extended MCH Scheduling Information MAC control element if the MCCH is not present, and the other scheduled MTCH(s) start immediately after the previous MTCH, at the earliest in the subframe where the previous MTCH stops. When the MAC entity needs to receive MCH, the MAC entity shall:

- attempt to decode the TB on the MCH;
- if a TB on the MCH has been successfully decoded:
  - demultiplex the MAC PDU and deliver the MAC SDU(s) to upper layers.

When the MAC entity receives the Extended MCH Scheduling Information MAC control element, the MAC entity shall indicate the MTCH(s) to be suspended to the upper layers.

NOTE: The MAC entity should continue receiving MCH until the MTCH is removed from the MCCH.

## 5.13 Activation/Deactivation of SCells

If the MAC entity is configured with one or more SCells, the network may activate and deactivate the configured SCells. The SpCell is always activated. The network activates and deactivates the SCell(s) by sending the Activation/Deactivation MAC control element described in subclause 6.1.3.8. Furthermore, the MAC entity maintains a *sCellDeactivationTimer* timer per configured SCell and deactivates the associated SCell upon its expiry. The same initial timer value applies to each instance of the *sCellDeactivationTimer* and it is configured by RRC. The configured SCells are initially deactivated upon addition and after a handover. The configured SCG SCells are initially deactivated after a SCG change.

The MAC entity shall for each TTI and for each configured SCell:

- if the MAC entity receives an Activation/Deactivation MAC control element in this TTI activating the SCell, the MAC entity shall in the TTI according to the timing defined in [2]:
  - activate the SCell; i.e. apply normal SCell operation including:
    - SRS transmissions on the SCell;
    - CQI/PMI/RI/PTI reporting for the SCell;



- PDCCH monitoring on the SCell;
- PDCCH monitoring for the SCell.
- start or restart the *sCellDeactivationTimer* associated with the SCell;
- trigger PHR according to subclause 5.4.6.
- else, if the MAC entity receives an Activation/Deactivation MAC control element in this TTI deactivating the SCell; or
- if the *sCellDeactivationTimer* associated with the activated SCell expires in this TTI:
  - in the TTI according to the timing defined in [2]:
    - deactivate the SCell;
    - stop the *sCellDeactivationTimer* associated with the SCell;
    - flush all HARQ buffers associated with the SCell.
- if PDCCH on the activated SCell indicates an uplink grant or downlink assignment; or
- if PDCCH on the Serving Cell scheduling the activated SCell indicates an uplink grant or a downlink assignment for the activated SCell:
  - restart the *sCellDeactivationTimer* associated with the SCell;
- if the SCell is deactivated:
  - not transmit SRS on the SCell;
  - not report CQI/PMI/RI/PTI for the SCell;
  - not transmit on UL-SCH on the SCell;
  - not transmit on RACH on the SCell;
  - not monitor the PDCCH on the SCell;
  - not monitor the PDCCH for the SCell.

HARQ feedback for the MAC PDU containing Activation/Deactivation MAC control element shall not be impacted by PCell interruption due to SCell activation/deactivation [9].

NOTE: When SCell is deactivated, the ongoing Random Access procedure on the SCell, if any, is aborted.

## 5.14 SL-SCH Data transfer

### 5.14.1 SL-SCH Data transmission

#### 5.14.1.1 SL Grant reception and SCI transmission

In order to transmit on the SL-SCH the MAC entity must have a sidelink grant. The sidelink grant is selected as follows:

- if the MAC entity is configured to receive a sidelink grant dynamically on the PDCCH and more data is available in STCH than can be transmitted in the current SC period, the MAC entity shall:
  - using the received sidelink grant determine the set of subframes in which transmission of SCI and transmission of first transport block occur according to subclause 14.2.1 of [2];
  - consider the received sidelink grant to be a configured sidelink grant occurring in those subframes starting at the beginning of the first available SC Period which starts at least 4 subframes after the subframe in which

the sidelink grant was received, overwriting a previously configured sidelink grant occurring in the same SC period, if available;

- clear the configured sidelink grant at the end of the corresponding SC Period;
- else, if the MAC entity is configured by upper layers to transmit using a pool of resources as indicated in subclause 5.10.4 of [8] and more data is available in STCH than can be transmitted in the current SC period and if the MAC entity does not have a configured sidelink grant, the MAC entity shall:
  - randomly select the time and frequency resources for SL-SCH and SCI of a sidelink grant from the resource pool configured by upper layers. The random function shall be such that each of the allowed selections [2] can be chosen with equal probability;
  - use the selected sidelink grant to determine the set of subframes in which transmission of SCI and transmission of first transport block occur according to subclause 14.2.1 of [2];
  - consider the selected sidelink grant to be a configured sidelink grant occurring in those subframes starting at the beginning of the first available SC Period which starts at least 4 subframes after the subframe in which the sidelink grant was selected;
  - clear the configured sidelink grant at the end of the corresponding SC Period;

NOTE: Retransmissions on SL-SCH cannot occur after the configured sidelink grant has been cleared.

The MAC entity shall for each subframe:

- if the MAC entity has a configured sidelink grant occurring in this subframe:
  - if the configured sidelink grant corresponds to transmission of SCI:
    - instruct the physical layer to transmit SCI corresponding to the configured sidelink grant.
  - else if the configured sidelink grant corresponds to transmission of first transport block:
    - deliver the configured sidelink grant and the associated HARQ information to the Sidelink HARQ Entity for this subframe.

### 5.14.1.2 Sidelink HARQ operation

#### 5.14.1.2.1 Sidelink HARQ Entity

There is one Sidelink HARQ Entity at the MAC entity for transmission on SL-SCH, which maintains one Sidelink process.

For each subframe of the SL-SCH the Sidelink HARQ Entity shall:

- if a sidelink grant has been indicated for the Sidelink process and there is SL data, for sidelink logical channels of ProSe destination associated with the current SC period, available for transmission:
  - obtain the MAC PDU from the “Multiplexing and assembly” entity;
  - deliver the MAC PDU and the sidelink grant and the HARQ information to the Sidelink process;
  - instruct the Sidelink process to trigger a new transmission.
- else, if this subframe corresponds to retransmission opportunity for the Sidelink process:
  - instruct the Sidelink process to trigger a retransmission.

NOTE: The resources for retransmission opportunities are specified in subclause 14.2.1 of [2].

#### 5.14.1.2.2 Sidelink process

The Sidelink process is associated with a HARQ buffer.

The sequence of redundancy versions is 0, 2, 3, 1. The variable CURRENT\_IRV is an index into the sequence of redundancy versions. This variable is updated modulo 4.

New transmissions and retransmissions for a given SC period are performed on the resource indicated in the sidelink grant and with the MCS configured by upper layers (if configured).

If the Sidelink HARQ Entity requests a new transmission, the Sidelink process shall:

- set CURRENT\_IRV to 0;
- store the MAC PDU in the associated HARQ buffer;
- store the sidelink grant received from the Sidelink HARQ Entity;
- generate a transmission as described below.

If the Sidelink HARQ Entity requests a retransmission, the Sidelink process shall:

- generate a transmission as described below.

To generate a transmission, the Sidelink process shall:

- if there is no uplink transmission or if the MAC entity is able to perform uplink transmissions and transmissions on SL-SCH simultaneously at the time of the transmission:
  - instruct the physical layer to generate a transmission according to the stored sidelink grant with the redundancy version corresponding to the CURRENT\_IRV value.
- increment CURRENT\_IRV by 1.

### 5.14.1.3 Multiplexing and assembly

For PDU(s) associated with one SCI, MAC shall consider only logical channels with the same Source Layer-2 ID-Destination Layer-2 ID pair.

#### 5.14.1.3.1 Logical channel prioritization

The Logical Channel Prioritization procedure is applied when a new transmission is performed.

The UE shall perform the following Logical Channel Prioritization procedure when a new transmission is performed:

- the UE shall allocate resources to the sidelink logical channels according to the following rules:
  - the UE should not segment an RLC SDU (or partially transmitted SDU) if the whole SDU (or partially transmitted SDU) fits into the remaining resources;
  - if the UE segments an RLC SDU from the sidelink logical channel, it shall maximize the size of the segment to fill the grant as much as possible;
  - the UE should maximise the transmission of data;
  - if the MAC entity is given an sidelink grant size that is equal to or larger than 10 bytes while having data available for transmission, the MAC entity shall not transmit only padding.

NOTE: The rules above imply that the order by which the sidelink logical channels are served is left for UE implementation.

#### 5.14.1.3.2 Multiplexing of MAC SDUs

The MAC entity shall multiplex MAC SDUs in a MAC PDU according to subclauses 5.14.1.3.1 and 6.1.6.

#### 5.14.1.4 Buffer Status Reporting

The sidelink Buffer Status reporting procedure is used to provide the serving eNB with information about the amount of sidelink data available for transmission in the SL buffers associated with the MAC entity. RRC controls BSR reporting for the sidelink by configuring the two timers *periodic-BSR-TimerSL* and *retx-BSR-TimerSL*. Each sidelink logical channel is allocated to an LCG with LCG ID set to "11"[8] and belongs to a ProSe Destination.

A sidelink Buffer Status Report (BSR) shall be triggered if any of the following events occur:

- if the MAC entity has a configured SL-RNTI:
  - SL data, for a sidelink logical channel of a ProSe Destination, becomes available for transmission in the RLC entity or in the PDCP entity (the definition of what data shall be considered as available for transmission is specified in [3] and [4] respectively) and there is currently no data available for transmission for any of the sidelink logical channels belonging to the same ProSe Destination, in which case the Sidelink BSR is referred below to as "Regular Sidelink BSR";
  - UL resources are allocated and number of padding bits remaining after a Padding BSR has been triggered is equal to or larger than the size of the Sidelink BSR MAC control element containing the buffer status for at least one ProSe Destination plus its subheader, in which case the Sidelink BSR is referred below to as "Padding Sidelink BSR";
  - *retx-BSR-TimerSL* expires and the MAC entity has data available for transmission for any of the sidelink logical channels, in which case the Sidelink BSR is referred below to as "Regular Sidelink BSR";
  - *periodic-BSR-TimerSL* expires, in which case the Sidelink BSR is referred below to as "Periodic Sidelink BSR";
- else:
  - An SL-RNTI is configured by upper layers and SL data is available for transmission in the RLC entity or in the PDCP entity (the definition of what data shall be considered as available for transmission is specified in [3] and [4] respectively), in which case the Sidelink BSR is referred below to as "Regular Sidelink BSR".

For Regular and Periodic Sidelink BSR:

- if the number of bits in the UL grant is equal to or larger than the size of a Sidelink BSR containing buffer status for all ProSe Destinations having data available for transmission plus its subheader:
  - report Sidelink BSR containing buffer status for all ProSe Destinations having data available for transmission;
- else report Truncated Sidelink BSR containing buffer status for as many ProSe Destinations having data available for transmission as possible, taking the number of bits in the UL grant into consideration.

For Padding Sidelink BSR:

- if the number of padding bits remaining after a Padding BSR has been triggered is equal to or larger than the size of a Sidelink BSR containing buffer status for all ProSe Destinations having data available for transmission plus its subheader:
  - report Sidelink BSR containing buffer status for all ProSe Destinations having data available for transmission;
- else report Truncated Sidelink BSR containing buffer status for as many ProSe Destinations having data available for transmission as possible, taking the number of bits in the UL grant into consideration.

If the Buffer Status reporting procedure determines that at least one Sidelink BSR has been triggered and not cancelled:

- if the MAC entity has UL resources allocated for new transmission for this TTI and the allocated UL resources can accommodate a Sidelink BSR MAC control element plus its subheader as a result of logical channel prioritization:
  - instruct the Multiplexing and Assembly procedure to generate the Sidelink BSR MAC control element(s);

- start or restart *periodic-BSR-TimerSL* except when all the generated Sidelink BSRs are Truncated Sidelink BSRs;
- start or restart *retx-BSR-TimerSL*;
- else if a Regular Sidelink BSR has been triggered:
  - if an uplink grant is not configured:
    - a Scheduling Request shall be triggered.

A MAC PDU shall contain at most one Sidelink BSR MAC control element, even when multiple events trigger a Sidelink BSR by the time a Sidelink BSR can be transmitted in which case the Regular Sidelink BSR and the Periodic Sidelink BSR shall have precedence over the padding Sidelink BSR.

The MAC entity shall restart *retx-BSR-TimerSL* upon reception of an SL grant.

All triggered regular Sidelink BSRs shall be cancelled in case the remaining configured SL grant(s) valid for this SC Period can accommodate all pending data available for transmission. All triggered Sidelink BSRs shall be cancelled in case the MAC entity has no data available for transmission for any of the sidelink logical channels. All triggered Sidelink BSRs shall be cancelled when a Sidelink BSR (except for Truncated Sidelink BSR) is included in a MAC PDU for transmission. All triggered Sidelink BSRs shall be cancelled, and *retx-BSR-TimerSL* and *periodic-BSR-TimerSL* shall be stopped, when upper layers configure autonomous resource selection.

The MAC entity shall transmit at most one Regular/Periodic Sidelink BSR in a TTI. If the MAC entity is requested to transmit multiple MAC PDUs in a TTI, it may include a padding Sidelink BSR in any of the MAC PDUs which do not contain a Regular/Periodic Sidelink BSR.

All Sidelink BSRs transmitted in a TTI always reflect the buffer status after all MAC PDUs have been built for this TTI. Each ProSe Destination shall report at the most one buffer status value per TTI and this value shall be reported in all Sidelink BSRs reporting buffer status for this ProSe Destination.

NOTE: A Padding Sidelink BSR is not allowed to cancel a triggered Regular/Periodic Sidelink BSR. A Padding Sidelink BSR is triggered for a specific MAC PDU only and the trigger is cancelled when this MAC PDU has been built.

## 5.14.2 SL-SCH Data reception

### 5.14.2.1 SCI reception

SCI transmitted on the PSCCH indicate if there is a transmission on SL-SCH and provide the relevant HARQ information.

The MAC entity shall:

- for each subframe during which the MAC entity monitors PSCCH:
  - if SCI for this subframe has been received on the PSCCH with a Group Destination ID of interest to this MAC entity:
    - determine the set of subframes in which reception of the first transport blocks occur according to subclause 14.2.2 of [2] using the received SCI;
    - store the SCI and associated HARQ information as SCI valid for the subframes corresponding to first transmission of each transport block;
- for each subframe for which the MAC entity has a valid SCI:
  - deliver the SCI and the associated HARQ information to the Sidelink HARQ Entity.

## 5.14.2.2 Sidelink HARQ operation

### 5.14.2.2.1 Sidelink HARQ Entity

There is one Sidelink HARQ Entity at the MAC entity for reception of the SL-SCH which maintains a number of parallel Sidelink processes. Each Sidelink process is associated with SCI in which the MAC entity is interested as determined by the Group Destination ID of the SCI. The Sidelink HARQ Entity directs HARQ information and associated TBs received on the SL-SCH to the corresponding Sidelink processes.

The number of Receiving Sidelink processes associated with the Sidelink HARQ Entity is defined in [8].

For each subframe of the SL-SCH, the Sidelink HARQ Entity shall:

- for each SCI valid in this subframe:
  - allocate the TB received from the physical layer and the associated HARQ information to a Sidelink process, associate this Sidelink process with this SCI and consider this transmission to be a new transmission.
- for each Sidelink process:
  - if this subframe corresponds to retransmission opportunity for the Sidelink process according to its associated SCI:
    - allocate the TB received from the physical layer and the associated HARQ information to the Sidelink process and consider this transmission to be a retransmission.

### 5.14.2.2.2 Sidelink process

For each subframe where a transmission takes place for the Sidelink process, one TB and the associated HARQ information is received from the Sidelink HARQ Entity.

The sequence of redundancy versions is 0, 2, 3, 1. The variable CURRENT\_IRV is an index into the sequence of redundancy versions. This variable is updated modulo 4.

For each received TB and associated HARQ information, the Sidelink process shall:

- if this is a new transmission:
  - set CURRENT\_IRV to 0;
  - store the received data in the soft buffer and optionally attempt to decode the received data according to CURRENT\_IRV.
- else if this is a retransmission:
  - if the data for this TB has not yet been successfully decoded:
    - increment CURRENT\_IRV by 1;
    - combine the received data with the data currently in the soft buffer for this TB and optionally attempt to decode the combined data according to the CURRENT\_IRV.
  - if the data which the MAC entity attempted to decode was successfully decoded for this TB:
    - if this is the first successful decoding of the data for this TB:
      - if the DST field of the decoded MAC PDU subheader is equal to the 16 MSB of any of the Destination Layer-2 ID(s) of the UE for which the 8 LSB are equal to the Group Destination ID in the corresponding SCI:
        - deliver the decoded MAC PDU to the disassembly and demultiplexing entity.

### 5.14.2.3 Disassembly and demultiplexing

The MAC entity shall disassemble and demultiplex a MAC PDU as defined in subclause 6.1.6.

## 5.15 SL-DCH data transfer

### 5.15.1 SL-DCH data transmission

#### 5.15.1.1 Resource allocation

In order to transmit MAC PDU(s) on SL-DCH, the MAC entity shall for every discovery period and each MAC PDU:

- if the MAC entity is configured by upper layers with a specific grant as specified in [8]:
  - using the specific grant determine the set of subframes in which a transmission of new MAC PDU(s) occur according to subclause 14.3.1 of [2];
  - consider the determined set of subframes to be a configured grant for the corresponding discovery period;
  - for every subframe, if the MAC entity has a configured grant occurring in that subframe, deliver the configured grant and the MAC PDU to the Sidelink HARQ Entity;
  - clear the configured grant at the end of the corresponding discovery period.

NOTE: Mapping between grant and physical resources is specified in subclause 9.5.6 of [7].

- else if the MAC entity is configured with a single pool of resources by upper layers:
  - select a random value  $p1$  in the range from 0 to 1, where the random function shall be such that each of the allowed selections can be chosen with equal probability;
  - if  $p1$  is less than  $txProbability$ :
    - select a random resource from the pool of resources (excluding any resources which are overlapping with PRACH or resources belonging to the subframes of resources already selected for transmissions on SL-DCH in this discovery period), where the random function shall be such that each of the allowed selections (see subclause 14.3.1 of [2]) can be chosen with equal probability;
    - using the selected resource determine the set of subframes in which the transmission of a MAC PDU can occur according to subclause 14.3.1 of [2]
    - consider the determined set of subframes to be a configured grant for the corresponding discovery period;
    - for every subframe, if the MAC entity has a configured grant occurring in that subframe, deliver the configured grant and the MAC PDU to the Sidelink HARQ Entity;
    - clear the configured grant at the end of the corresponding discovery period.

#### 5.15.1.2 Sidelink HARQ operation

##### 5.15.1.2.1 Sidelink HARQ Entity

There is one Sidelink HARQ Entity at the MAC entity for transmission on SL-DCH, which maintains one Sidelink process for each MAC PDU.

For each subframe of the SL-DCH the Sidelink HARQ Entity shall:

- if a grant and a MAC PDU has been delivered for this subframe to the Sidelink HARQ Entity:
  - deliver the MAC PDU and the grant to the Sidelink process;
  - instruct the Sidelink process to trigger a new transmission.

- else, if this subframe corresponds to retransmission opportunity for the Sidelink process:
  - instruct the Sidelink process to trigger a retransmission.

#### 5.15.1.2.2 Sidelink process

The Sidelink process is associated with a HARQ buffer.

The Sidelink process shall maintain a state variable `CURRENT_TX_NB`, which indicates the number of transmissions that have taken place for the MAC PDU currently in the buffer. When the Sidelink process is established, `CURRENT_TX_NB` shall be initialized to 0.

The sequence of redundancy versions is 0, 2, 3, 1. The variable `CURRENT_IRV` is an index into the sequence of redundancy versions. This variable is up-dated modulo 4.

The Sidelink process is configured with a maximum number of HARQ retransmissions by RRC: *numRetx*.

If the Sidelink HARQ Entity requests a new transmission, the Sidelink process shall:

- set `CURRENT_TX_NB` to 0;
- set `CURRENT_IRV` to 0;
- store the MAC PDU in the associated HARQ buffer;
- store the grant received from the Sidelink HARQ Entity;
- generate a transmission as described below.

If the Sidelink HARQ Entity requests a retransmission, the Sidelink process shall:

- increment `CURRENT_TX_NB` by 1;
- generate a transmission as described below.

To generate a transmission, the Sidelink process shall:

- if there is no uplink transmission, no transmission or reception on PSCCH, and no transmission or reception on PSSCH at the time of the transmission:
  - instruct the physical layer to generate a transmission according to the grant with the redundancy version corresponding to the `CURRENT_IRV` value.
- increment `CURRENT_IRV` by 1.

After performing above actions, the Sidelink process then shall:

- if `CURRENT_TX_NB = numRetx`:
  - flush the HARQ buffer.



## 5.15.2 SL-DCH data reception

### 5.15.2.1 Sidelink HARQ operation

#### 5.15.2.1.1 Sidelink HARQ Entity

There is one Sidelink HARQ Entity at the MAC entity for reception on the SL-DCH which maintains a number of parallel Sidelink processes. The Sidelink HARQ Entity directs HARQ information and associated TBs received on the SL-DCH to the corresponding Sidelink processes.

The number of receiving Sidelink processes per Sidelink HARQ Entity is specified in [8].

For each subframe of the SL-DCH, the Sidelink HARQ Entity shall:

- receive the TB and the associated HARQ information from the physical layer;
- if this subframe corresponds to a new transmission opportunity:
  - allocate the received TB (if any) and the associated HARQ information to a non-running Sidelink process and consider this transmission to be a new transmission.
- else, if this subframe corresponds to a retransmission opportunity:
  - allocate the received TB (if any) and the associated HARQ information to its Sidelink process and consider this transmission to be a retransmission.

#### 5.15.2.1.2 Sidelink process

For each subframe where a transmission takes place for the Sidelink process, one TB and the associated HARQ information is received from the Sidelink HARQ Entity.

The sequence of redundancy versions is 0, 2, 3, 1. The variable CURRENT\_IRV is an index into the sequence of redundancy versions. This variable is updated modulo 4.

The Sidelink process shall:

- if this subframe corresponds to a new transmission opportunity:
  - set CURRENT\_IRV to 0;
- else, if this subframe corresponds to a retransmission opportunity:
  - increment CURRENT\_IRV by 1.
- if a TB was allocated to the Sidelink process:
  - if this is a new transmission:
    - optionally store the received data in the soft buffer and attempt to decode the received data according to the CURRENT\_IRV.
  - else if this is a retransmission:
    - if the data for this TB has not yet been successfully decoded:
      - optionally combine the received data with the data currently in the soft buffer for this TB and attempt to decode the combined data according to the CURRENT\_IRV.
- if the data which the MAC entity attempted to decode was successfully decoded for this TB:
  - if this is the first successful decoding of the data for this TB:
    - deliver the decoded MAC PDU to upper layers.

## 5.16 SL-BCH data transfer

### 5.16.1 SL-BCH data transmission

When instructed to send SL-BCH, the MAC entity shall:

- obtain the MAC PDU to transmit from SBCCH;
- deliver the MAC PDU to the physical layer and instruct it to generate a transmission.

### 5.16.2 SL-BCH data reception

When the MAC entity needs to receive SL-BCH, the MAC entity shall:

- receive and attempt to decode the SL-BCH;
- if a TB on the SL-BCH has been successfully decoded:
  - deliver the decoded MAC PDU to upper layers.

---

# 6 Protocol Data Units, formats and parameters

## 6.1 Protocol Data Units

### 6.1.1 General

A MAC PDU is a bit string that is byte aligned (i.e. multiple of 8 bits) in length. In the figures in subclause 6.1, bit strings are represented by tables in which the most significant bit is the leftmost bit of the first line of the table, the least significant bit is the rightmost bit on the last line of the table, and more generally the bit string is to be read from left to right and then in the reading order of the lines. The bit order of each parameter field within a MAC PDU is represented with the first and most significant bit in the leftmost bit and the last and least significant bit in the rightmost bit.

MAC SDUs are bit strings that are byte aligned (i.e. multiple of 8 bits) in length. An SDU is included into a MAC PDU from the first bit onward.

The MAC entity shall ignore the value of Reserved bits in downlink MAC PDUs.

### 6.1.2 MAC PDU (DL-SCH and UL-SCH except transparent MAC and Random Access Response, MCH)

A MAC PDU consists of a MAC header, zero or more MAC Service Data Units (MAC SDU), zero, or more MAC control elements, and optionally padding; as described in Figure 6.1.2-3.

Both the MAC header and the MAC SDUs are of variable sizes.

A MAC PDU header consists of one or more MAC PDU subheaders; each subheader corresponds to either a MAC SDU, a MAC control element or padding.

A MAC PDU subheader consists of the six header fields R/R/E/LCID/F/L but for the last subheader in the MAC PDU and for fixed sized MAC control elements. The last subheader in the MAC PDU and subheaders for fixed sized MAC control elements consist solely of the four header fields R/R/E/LCID. A MAC PDU subheader corresponding to padding consists of the four header fields R/R/E/LCID.

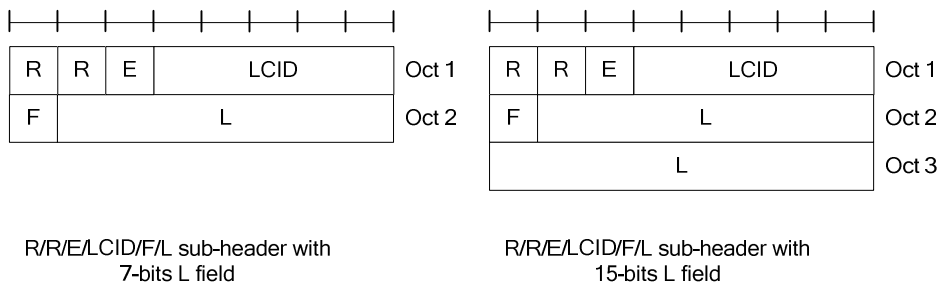

Figure 6.1.2-1: R/R/E/LCID/F/L MAC subheader

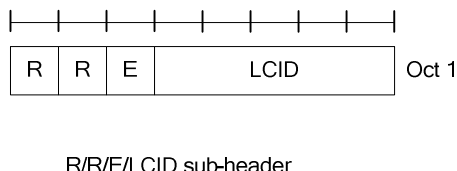

Figure 6.1.2-2: R/R/E/LCID MAC subheader

MAC PDU subheaders have the same order as the corresponding MAC SDUs, MAC control elements and padding.

MAC control elements are always placed before any MAC SDU.

Padding occurs at the end of the MAC PDU, except when single-byte or two-byte padding is required. Padding may have any value and the MAC entity shall ignore it. When padding is performed at the end of the MAC PDU, zero or more padding bytes are allowed.

When single-byte or two-byte padding is required, one or two MAC PDU subheaders corresponding to padding are placed at the beginning of the MAC PDU before any other MAC PDU subheader.

A maximum of one MAC PDU can be transmitted per TB per MAC entity. A maximum of one MCH MAC PDU can be transmitted per TTI.

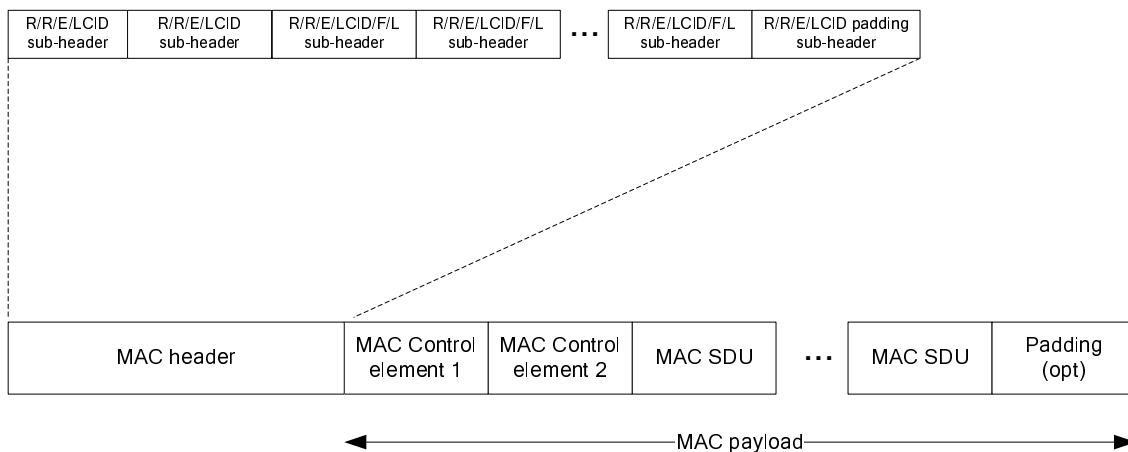

Figure 6.1.2-3: Example of MAC PDU consisting of MAC header, MAC control elements, MAC SDUs and padding

### 6.1.3 MAC Control Elements

#### 6.1.3.1 Buffer Status Report MAC Control Elements

Buffer Status Report (BSR) MAC control elements consist of either:

- Short BSR and Truncated BSR format: one LCG ID field and one corresponding Buffer Size field (figure 6.1.3.1-1); or
- Long BSR format: four Buffer Size fields, corresponding to LCG IDs #0 through #3 (figure 6.1.3.1-2).

The BSR formats are identified by MAC PDU subheaders with LCIDs as specified in table 6.2.1-2.

The fields LCG ID and Buffer Size are defined as follow:

- LCG ID: The Logical Channel Group ID field identifies the group of logical channel(s) which buffer status is being reported. The length of the field is 2 bits;
- Buffer Size: The Buffer Size field identifies the total amount of data available across all logical channels of a logical channel group after all MAC PDUs for the TTI have been built. The amount of data is indicated in number of bytes. It shall include all data that is available for transmission in the RLC layer and in the PDCP layer; the definition of what data shall be considered as available for transmission is specified in [3] and [4] respectively. The size of the RLC and MAC headers are not considered in the buffer size computation. The length of this field is 6 bits. If *extendedBSR-Sizes* is not configured, the values taken by the Buffer Size field are shown in Table 6.1.3.1-1. If *extendedBSR-Sizes* is configured, the values taken by the Buffer Size field are shown in Table 6.1.3.1-2.

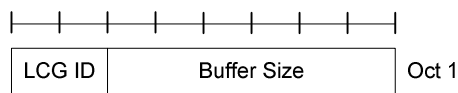

**Figure 6.1.3.1-1: Short BSR and Truncated BSR MAC control element**

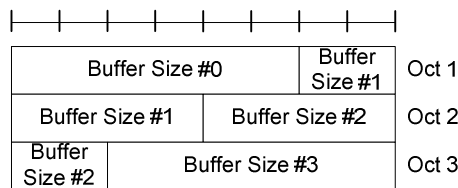

**Figure 6.1.3.1-2: Long BSR MAC control element**

Table 6.1.3.1-1: Buffer size levels for BSR

| Index | Buffer Size (BS) value [bytes] | Index | Buffer Size (BS) value [bytes] |
|-------|--------------------------------|-------|--------------------------------|
| 0     | BS = 0                         | 32    | 1132 < BS <= 1326              |
| 1     | 0 < BS <= 10                   | 33    | 1326 < BS <= 1552              |
| 2     | 10 < BS <= 12                  | 34    | 1552 < BS <= 1817              |
| 3     | 12 < BS <= 14                  | 35    | 1817 < BS <= 2127              |
| 4     | 14 < BS <= 17                  | 36    | 2127 < BS <= 2490              |
| 5     | 17 < BS <= 19                  | 37    | 2490 < BS <= 2915              |
| 6     | 19 < BS <= 22                  | 38    | 2915 < BS <= 3413              |
| 7     | 22 < BS <= 26                  | 39    | 3413 < BS <= 3995              |
| 8     | 26 < BS <= 31                  | 40    | 3995 < BS <= 4677              |
| 9     | 31 < BS <= 36                  | 41    | 4677 < BS <= 5476              |
| 10    | 36 < BS <= 42                  | 42    | 5476 < BS <= 6411              |
| 11    | 42 < BS <= 49                  | 43    | 6411 < BS <= 7505              |
| 12    | 49 < BS <= 57                  | 44    | 7505 < BS <= 8787              |
| 13    | 57 < BS <= 67                  | 45    | 8787 < BS <= 10287             |
| 14    | 67 < BS <= 78                  | 46    | 10287 < BS <= 12043            |
| 15    | 78 < BS <= 91                  | 47    | 12043 < BS <= 14099            |
| 16    | 91 < BS <= 107                 | 48    | 14099 < BS <= 16507            |
| 17    | 107 < BS <= 125                | 49    | 16507 < BS <= 19325            |
| 18    | 125 < BS <= 146                | 50    | 19325 < BS <= 22624            |
| 19    | 146 < BS <= 171                | 51    | 22624 < BS <= 26487            |
| 20    | 171 < BS <= 200                | 52    | 26487 < BS <= 31009            |
| 21    | 200 < BS <= 234                | 53    | 31009 < BS <= 36304            |
| 22    | 234 < BS <= 274                | 54    | 36304 < BS <= 42502            |
| 23    | 274 < BS <= 321                | 55    | 42502 < BS <= 49759            |
| 24    | 321 < BS <= 376                | 56    | 49759 < BS <= 58255            |
| 25    | 376 < BS <= 440                | 57    | 58255 < BS <= 68201            |
| 26    | 440 < BS <= 515                | 58    | 68201 < BS <= 79846            |
| 27    | 515 < BS <= 603                | 59    | 79846 < BS <= 93479            |
| 28    | 603 < BS <= 706                | 60    | 93479 < BS <= 109439           |
| 29    | 706 < BS <= 826                | 61    | 109439 < BS <= 128125          |
| 30    | 826 < BS <= 967                | 62    | 128125 < BS <= 150000          |
| 31    | 967 < BS <=1132                | 63    | BS > 150000                    |

Table 6.1.3.1-2: Extended Buffer size levels for BSR

| Index | Buffer Size (BS) value [bytes] | Index | Buffer Size (BS) value [bytes] |
|-------|--------------------------------|-------|--------------------------------|
| 0     | BS = 0                         | 32    | 4940 < BS <= 6074              |
| 1     | 0 < BS <= 10                   | 33    | 6074 < BS <= 7469              |
| 2     | 10 < BS <= 13                  | 34    | 7469 < BS <= 9185              |
| 3     | 13 < BS <= 16                  | 35    | 9185 < BS <= 11294             |
| 4     | 16 < BS <= 19                  | 36    | 11294 < BS <= 13888            |
| 5     | 19 < BS <= 23                  | 37    | 13888 < BS <= 17077            |

|    |                   |    |                         |
|----|-------------------|----|-------------------------|
| 6  | 23 < BS <= 29     | 38 | 17077 < BS <= 20999     |
| 7  | 29 < BS <= 35     | 39 | 20999 < BS <= 25822     |
| 8  | 35 < BS <= 43     | 40 | 25822 < BS <= 31752     |
| 9  | 43 < BS <= 53     | 41 | 31752 < BS <= 39045     |
| 10 | 53 < BS <= 65     | 42 | 39045 < BS <= 48012     |
| 11 | 65 < BS <= 80     | 43 | 48012 < BS <= 59039     |
| 12 | 80 < BS <= 98     | 44 | 59039 < BS <= 72598     |
| 13 | 98 < BS <= 120    | 45 | 72598 < BS <= 89272     |
| 14 | 120 < BS <= 147   | 46 | 89272 < BS <= 109774    |
| 15 | 147 < BS <= 181   | 47 | 109774 < BS <= 134986   |
| 16 | 181 < BS <= 223   | 48 | 134986 < BS <= 165989   |
| 17 | 223 < BS <= 274   | 49 | 165989 < BS <= 204111   |
| 18 | 274 < BS <= 337   | 50 | 204111 < BS <= 250990   |
| 19 | 337 < BS <= 414   | 51 | 250990 < BS <= 308634   |
| 20 | 414 < BS <= 509   | 52 | 308634 < BS <= 379519   |
| 21 | 509 < BS <= 625   | 53 | 379519 < BS <= 466683   |
| 22 | 625 < BS <= 769   | 54 | 466683 < BS <= 573866   |
| 23 | 769 < BS <= 945   | 55 | 573866 < BS <= 705666   |
| 24 | 945 < BS <= 1162  | 56 | 705666 < BS <= 867737   |
| 25 | 1162 < BS <= 1429 | 57 | 867737 < BS <= 1067031  |
| 26 | 1429 < BS <= 1757 | 58 | 1067031 < BS <= 1312097 |
| 27 | 1757 < BS <= 2161 | 59 | 1312097 < BS <= 1613447 |
| 28 | 2161 < BS <= 2657 | 60 | 1613447 < BS <= 1984009 |
| 29 | 2657 < BS <= 3267 | 61 | 1984009 < BS <= 2439678 |
| 30 | 3267 < BS <= 4017 | 62 | 2439678 < BS <= 3000000 |
| 31 | 4017 < BS <= 4940 | 63 | BS > 3000000            |

### 6.1.3.1a Sidelink BSR MAC Control Elements

Sidelink BSR and Truncated Sidelink BSR MAC control elements consist of one group index field, one LCG ID field and one corresponding Buffer Size field per reported target group.

The Sidelink BSR MAC control elements are identified by MAC PDU subheaders with LCIDs as specified in table 6.2.1-2. They have variable sizes.

For each included group, the fields are defined as follows (figures 6.1.3.1a-1 and 6.1.3.1a-2):

- Group index: The group index field identifies the ProSe Destination. The length of this field is 4 bits. The value is set to the index of the destination reported in *destinationInfoList* specified in [8];
- LCG ID: The Logical Channel Group ID field identifies the group of logical channel(s) which buffer status is being reported. The length of the field is 2 bits and it is set to "11";
- Buffer Size: The Buffer Size field identifies the total amount of data available across all logical channels of a ProSe Destination after all MAC PDUs for the TTI have been built. The amount of data is indicated in number of bytes. It shall include all data that is available for transmission in the RLC layer and in the PDCP layer; the definition of what data shall be considered as available for transmission is specified in [3] and [4] respectively. The size of the RLC and MAC headers are not considered in the buffer size computation. The length of this field is 6 bits. The values taken by the Buffer Size field are shown in Table 6.1.3.1-1;

- R: Reserved bit, set to "0".

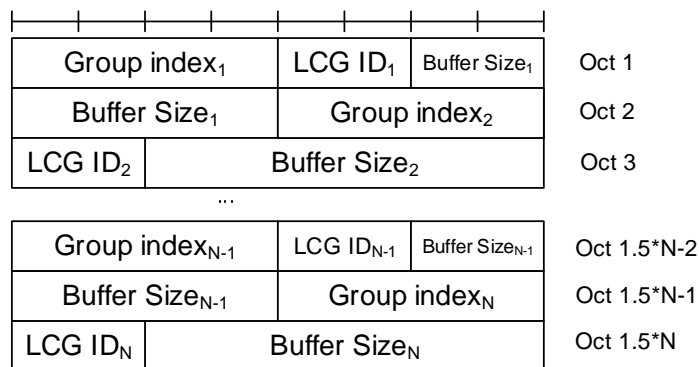

Figure 6.1.3.1a-1: Sidelink BSR and Truncated Sidelink BSR MAC control element for even N

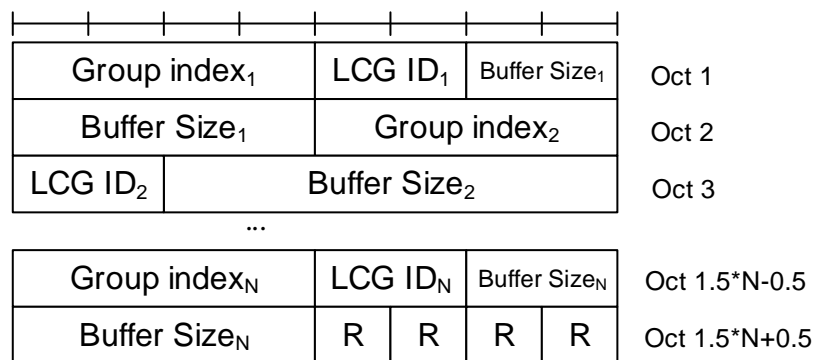

Figure 6.1.3.1a-2: Sidelink BSR and Truncated Sidelink BSR MAC control element for odd N

### 6.1.3.2 C-RNTI MAC Control Element

The C-RNTI MAC control element is identified by MAC PDU subheader with LCID as specified in table 6.2.1-2.

It has a fixed size and consists of a single field defined as follows (figure 6.1.3.2-1):

- C-RNTI: This field contains the C-RNTI of the MAC entity. The length of the field is 16 bits.

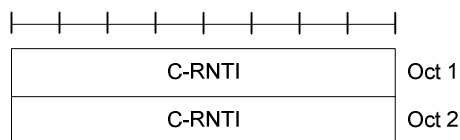

Figure 6.1.3.2-1: C-RNTI MAC control element

### 6.1.3.3 DRX Command MAC Control Element

The DRX Command MAC control element is identified by a MAC PDU subheader with LCID as specified in table 6.2.1-1.

It has a fixed size of zero bits.

### 6.1.3.4 UE Contention Resolution Identity MAC Control Element

The UE Contention Resolution Identity MAC control element is identified by MAC PDU subheader with LCID as specified in table 6.2.1-1. This control element has a fixed 48-bit size and consists of a single field defined as follows (figure 6.1.3.4-1)

- UE Contention Resolution Identity: This field contains the uplink CCCH SDU.

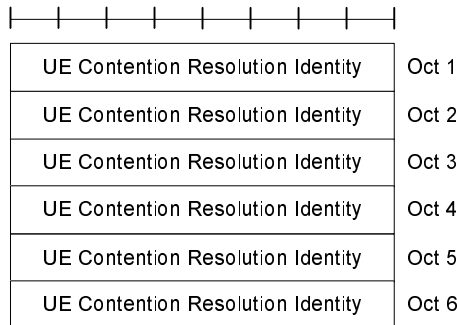

Figure 6.1.3.4-1: UE Contention Resolution Identity MAC control element

### 6.1.3.5 Timing Advance Command MAC Control Element

The Timing Advance Command MAC control element is identified by MAC PDU subheader with LCID as specified in table 6.2.1-1.

It has a fixed size and consists of a single octet defined as follows (figure 6.1.3.5-1):

- TAG Identity (TAG Id): This field indicates the TAG Identity of the addressed TAG. The TAG containing the SpCell has the TAG Identity 0. The length of the field is 2 bits;
- Timing Advance Command: This field indicates the index value  $T_A$  (0, 1, 2... 63) used to control the amount of timing adjustment that MAC entity has to apply (see subclause 4.2.3 of [2]). The length of the field is 6 bits.

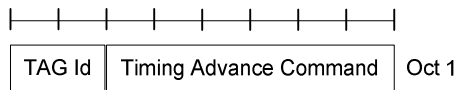

Figure 6.1.3.5-1: Timing Advance Command MAC control element

### 6.1.3.6 Power Headroom Report MAC Control Element

The Power Headroom Report (PHR) MAC control element is identified by a MAC PDU subheader with LCID as specified in table 6.2.1-2. It has a fixed size and consists of a single octet defined as follows (figure 6.1.3.6-1):

- R: reserved bit, set to "0";
- Power Headroom (PH): this field indicates the power headroom level. The length of the field is 6 bits. The reported PH and the corresponding power headroom levels are shown in Table 6.1.3.6-1 below (the corresponding measured values in dB can be found in subclause 9.1.8.4 of [9]).

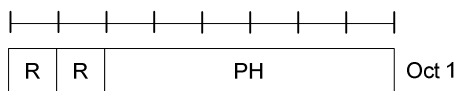

Figure 6.1.3.6-1: PHR MAC control element



**Table 6.1.3.6-1: Power Headroom levels for PHR**

| PH  | Power Headroom Level |
|-----|----------------------|
| 0   | POWER_HEADROOM_0     |
| 1   | POWER_HEADROOM_1     |
| 2   | POWER_HEADROOM_2     |
| 3   | POWER_HEADROOM_3     |
| ... | ...                  |
| 60  | POWER_HEADROOM_60    |
| 61  | POWER_HEADROOM_61    |
| 62  | POWER_HEADROOM_62    |
| 63  | POWER_HEADROOM_63    |

### 6.1.3.6a Extended Power Headroom Report MAC Control Element

The Extended Power Headroom Report (PHR) MAC control element is identified by a MAC PDU subheader with LCID as specified in table 6.2.1-2. It has a variable size and is defined in Figure 6.1.3.6a-2. When Type 2 PH is reported, the octet containing the Type 2 PH field is included first after the octet indicating the presence of PH per SCell and followed by an octet containing the associated  $P_{\text{CMAX},c}$  field (if reported). Then follows in ascending order based on the *ServCellIndex* [8] an octet with the Type 1 PH field and an octet with the associated  $P_{\text{CMAX},c}$  field (if reported), for the PCell and for each SCell indicated in the bitmap.

The Extended PHR MAC Control Element is defined as follows:

- $C_i$ : this field indicates the presence of a PH field for the SCell with *SCellIndex*  $i$  as specified in [8]. The  $C_i$  field set to "1" indicates that a PH field for the SCell with *SCellIndex*  $i$  is reported. The  $C_i$  field set to "0" indicates that a PH field for the SCell with *SCellIndex*  $i$  is not reported;
- R: reserved bit, set to "0";
- V: this field indicates if the PH value is based on a real transmission or a reference format. For Type 1 PH,  $V=0$  indicates real transmission on PUSCH and  $V=1$  indicates that a PUSCH reference format is used. For Type 2 PH,  $V=0$  indicates real transmission on PUCCH and  $V=1$  indicates that a PUCCH reference format is used. Furthermore, for both Type 1 and Type 2 PH,  $V=0$  indicates the presence of the octet containing the associated  $P_{\text{CMAX},c}$  field, and  $V=1$  indicates that the octet containing the associated  $P_{\text{CMAX},c}$  field is omitted;
- Power Headroom (PH): this field indicates the power headroom level. The length of the field is 6 bits. The reported PH and the corresponding power headroom levels are shown in Table 6.1.3.6-1 (the corresponding measured values in dB can be found in subclause 9.1.8.4 of [9]);
- P: this field indicates whether the MAC entity applies power backoff due to power management (as allowed by P-MPR<sub>c</sub> [10]). The MAC entity shall set  $P=1$  if the corresponding  $P_{\text{CMAX},c}$  field would have had a different value if no power backoff due to power management had been applied;
- $P_{\text{CMAX},c}$ : if present, this field indicates the  $P_{\text{CMAX},c}$  or  $\tilde{P}_{\text{CMAX},c}$  [2] used for calculation of the preceding PH field. The reported  $P_{\text{CMAX},c}$  and the corresponding nominal UE transmit power levels are shown in Table 6.1.3.6a-1 (the corresponding measured values in dBm can be found in subclause 9.6.1 of [9]).

**Figure 6.1.3.6a-1: Void**

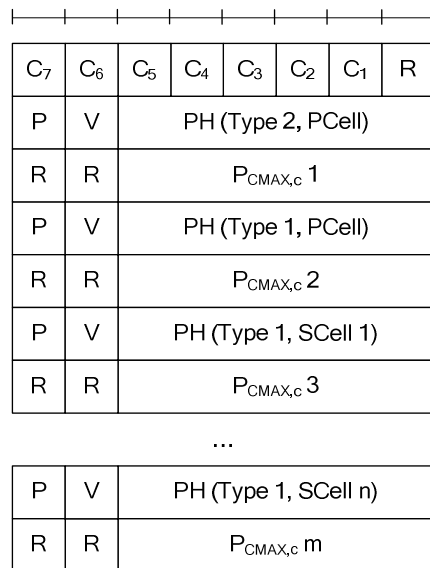

Figure 6.1.3.6a-2: Extended PHR MAC Control Element

Table 6.1.3.6a-1: Nominal UE transmit power level for Extended PHR and for Dual Connectivity PHR

| P <sub>CMAX,c</sub> | Nominal UE transmit power level |
|---------------------|---------------------------------|
| 0                   | PCMAX_C_00                      |
| 1                   | PCMAX_C_01                      |
| 2                   | PCMAX_C_02                      |
| ...                 | ...                             |
| 61                  | PCMAX_C_61                      |
| 62                  | PCMAX_C_62                      |
| 63                  | PCMAX_C_63                      |

6.1.3.6b Dual Connectivity Power Headroom Report MAC Control Element

The Dual Connectivity Power Headroom Report (PHR) MAC control element is identified by a MAC PDU subheader with LCID as specified in table 6.2.1-2. It has a variable size and is defined in Figure 6.1.3.6b-1. When Type 2 PH is reported for the PCell, the octet containing the Type 2 PH field is included first after the octet indicating the presence of PH per cell (PSCell and all SCells of all MAC entities) and followed by an octet containing the associated P<sub>CMAX,c</sub> field (if reported). Then after that, when Type 2 PH is reported for the PSCell, the octet containing the Type 2 PH field is included followed by an octet containing the associated P<sub>CMAX,c</sub> field (if reported). Then follows in ascending order based on the *ServCellIndex* [8] an octet with the Type 1 PH field and an octet with the associated P<sub>CMAX,c</sub> field (if reported), for the PCell and for all other serving cells of all MAC entities indicated in the bitmap.

The Dual Connectivity PHR MAC Control Element is defined as follows:

- C<sub>i</sub>: this field indicates the presence of a PH field for the serving cell of any MAC entity, except the PCell, with *SCellIndex* i as specified in [8]. The C<sub>i</sub> field set to "1" indicates that a PH field for the serving cell with *SCellIndex* i is reported. The C<sub>i</sub> field set to "0" indicates that a PH field for the serving cell with *SCellIndex* i is not reported;
- R: reserved bit, set to "0";
- V: this field indicates if the PH value is based on a real transmission or a reference format. For Type 1 PH, V=0 indicates real transmission on PUSCH and V=1 indicates that a PUSCH reference format is used. For Type 2 PH, V=0 indicates real transmission on PUCCH and V=1 indicates that a PUCCH reference format is used. Furthermore, for both Type 1 and Type 2 PH, V=0 indicates the presence of the octet containing the associated P<sub>CMAX,c</sub> field, and V=1 indicates that the octet containing the associated P<sub>CMAX,c</sub> field is omitted;
- Power Headroom (PH): this field indicates the power headroom level. The length of the field is 6 bits. The reported PH and the corresponding power headroom levels are shown in Table 6.1.3.6-1 (the corresponding measured values in dB can be found in subclause 9.1.8.4 of [9]);

- P: this field indicates whether power backoff due to power management is applied (as allowed by  $P\text{-MPR}_c$  [10]). The MAC entity shall set  $P=1$  if the corresponding  $P_{\text{CMAX},c}$  field would have had a different value if no power backoff due to power management had been applied;
- $P_{\text{CMAX},c}$ : if present, this field indicates the  $P_{\text{CMAX},c}$  or  $\tilde{P}_{\text{CMAX},c}$  [2] used for calculation of the preceding PH field. The reported  $P_{\text{CMAX},c}$  and the corresponding nominal UE transmit power levels are shown in Table 6.1.3.6a-1 (the corresponding measured values in dBm can be found in subclause 9.6.1 of [9]).

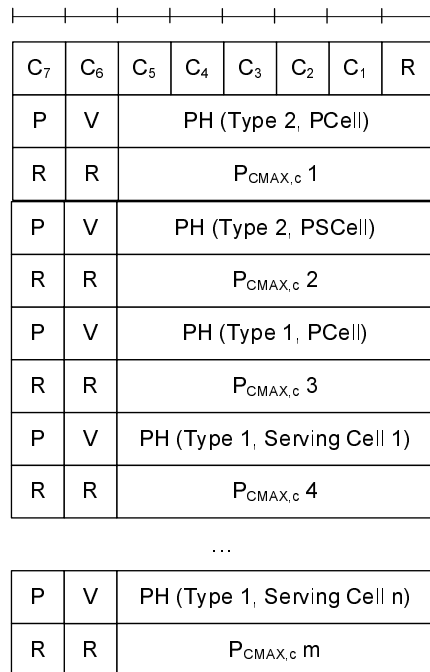
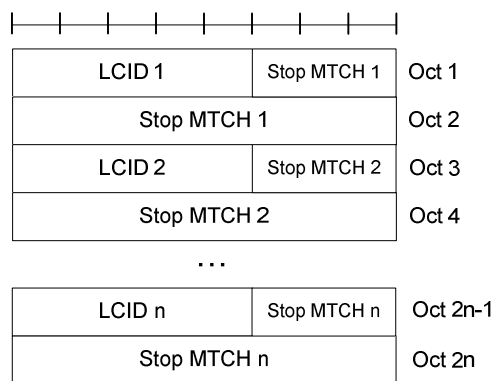

Figure 6.1.3.6b-1: Dual Connectivity PHR MAC Control Element

### 6.1.3.7 MCH Scheduling Information MAC Control Element

The MCH Scheduling Information MAC Control Element illustrated in Figure 6.1.3.7-1 is identified by a MAC PDU subheader with LCID as specified in Table 6.2.1-4. This control element has a variable size. For each MTCH the fields below are included:

- LCID: this field indicates the Logical Channel ID of the MTCH. The length of the field is 5 bits;
- Stop MTCH: this field indicates the ordinal number of the subframe within the MCH scheduling period, counting only the subframes allocated to the MCH, where the corresponding MTCH stops. Value 0 corresponds to the first subframe. The length of the field is 11 bits. The special Stop MTCH value 2047 indicates that the corresponding MTCH is not scheduled. The value range 2043 to 2046 is reserved.



**Figure 6.1.3.7-1: MCH Scheduling Information MAC control element**

### 6.1.3.7a Extended MCH Scheduling Information MAC Control Element

The Extended MCH Scheduling Information MAC control element illustrated in Figure 6.1.3.7-2 is identified by a MAC PDU subheader with LCID as specified in Table 6.2.1-4. This control element has a variable size.

For each MTCH the fields below are included:

- LCID: this field indicates the Logical Channel ID of the MTCH. The length of the field is 5 bits;
- Stop MTCH: this field indicates the ordinal number of the subframe within the MCH scheduling period, counting only the subframes allocated to the MCH, where the corresponding MTCH stops. Value 0 corresponds to the first subframe. The length of the field is 11 bits. The special Stop MTCH value 2047 indicates that the corresponding MTCH is not scheduled. The value range 2043 to 2046 is reserved.

For each MTCH the fields below may be included:

- LCID: this field indicates the Logical Channel ID of the MTCH. The length of the field is 5 bits. LCIDs  $x \dots x+y$  shall be equal to or a subset of the LCIDs  $1 \dots n$ ;
- S: this field indicates that the transmission of the corresponding MTCH is to be suspended. The S field is set to 000. All other values are reserved.

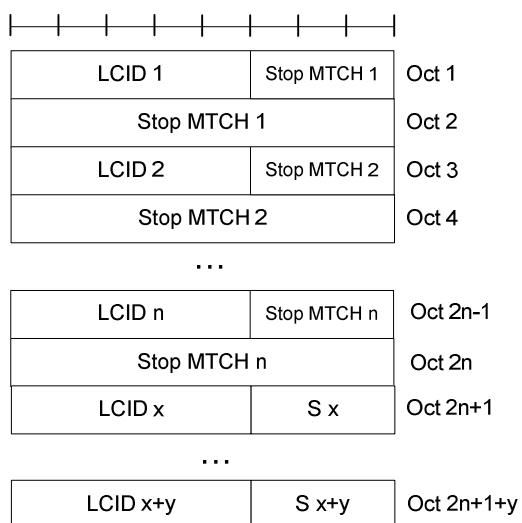
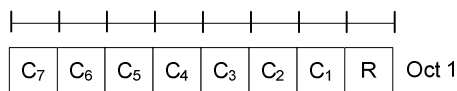

**Figure 6.1.3.7a-1: Extended MCH Scheduling Information MAC control element**

### 6.1.3.8 Activation/Deactivation MAC Control Element

The Activation/Deactivation MAC control element is identified by a MAC PDU subheader with LCID as specified in table 6.2.1-1. It has a fixed size and consists of a single octet containing seven C-fields and one R-field. The Activation/Deactivation MAC control element is defined as follows (figure 6.1.3.8-1).

- $C_i$ : if there is an SCell configured with  $SCellIndex$   $i$  as specified in [8], this field indicates the activation/deactivation status of the SCell with  $SCellIndex$   $i$ , else the MAC entity shall ignore the  $C_i$  field. The  $C_i$  field is set to "1" to indicate that the SCell with  $SCellIndex$   $i$  shall be activated. The  $C_i$  field is set to "0" to indicate that the SCell with  $SCellIndex$   $i$  shall be deactivated;
- R: Reserved bit, set to "0".



**Figure 6.1.3.8-1: Activation/Deactivation MAC control element**

### 6.1.3.9 Long DRX Command MAC Control Element

The Long DRX Command MAC control element is identified by a MAC PDU subheader with LCID as specified in table 6.2.1-1.

It has a fixed size of zero bits.

### 6.1.4 MAC PDU (transparent MAC)

A MAC PDU consists solely of a MAC Service Data Unit (MAC SDU) whose size is aligned to a TB; as described in figure 6.1.4-1. This MAC PDU is used for transmissions on PCH, BCH, SL-DCH and SL-BCH.

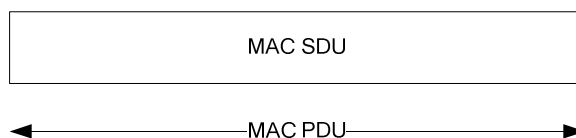

**Figure 6.1.4-1: Example of MAC PDU (transparent MAC)**

### 6.1.5 MAC PDU (Random Access Response)

A MAC PDU consists of a MAC header and zero or more MAC Random Access Responses (MAC RAR) and optionally padding as described in figure 6.1.5-4.

The MAC header is of variable size.

A MAC PDU header consists of one or more MAC PDU subheaders; each subheader corresponding to a MAC RAR except for the Backoff Indicator subheader. If included, the Backoff Indicator subheader is only included once and is the first subheader included within the MAC PDU header.

A MAC PDU subheader consists of the three header fields E/T/RAPID (as described in figure 6.1.5-1) but for the Backoff Indicator subheader which consists of the five header field E/T/R/R/BI (as described in figure 6.1.5-2).

A MAC RAR consists of the four fields R/Timing Advance Command/UL Grant/Temporary C-RNTI (as described in figure 6.1.5-3).

Padding may occur after the last MAC RAR. Presence and length of padding is implicit based on TB size, size of MAC header and number of RARs.

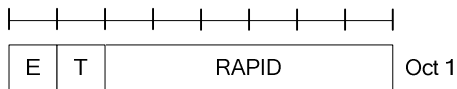

Figure 6.1.5-1: E/T/RAPID MAC subheader

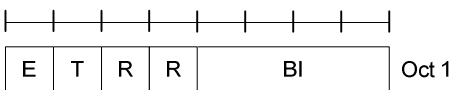

Figure 6.1.5-2: E/T/R/R/BI MAC subheader

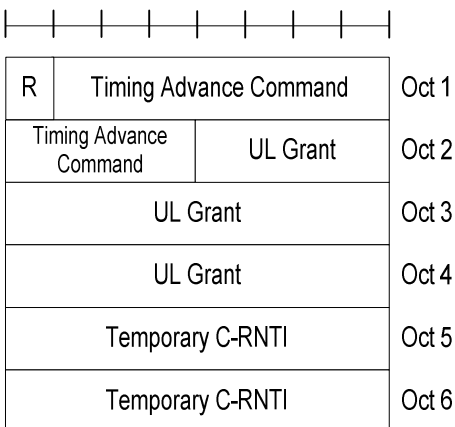

Figure 6.1.5-3: MAC RAR

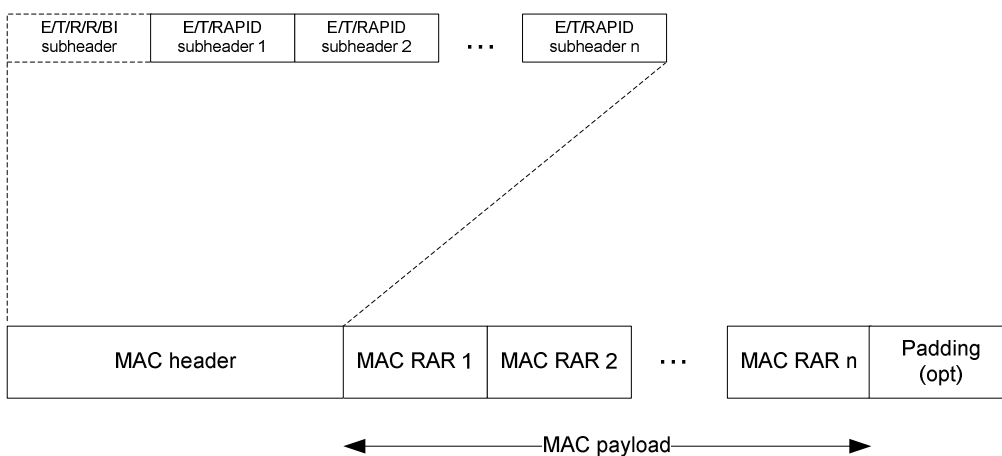

Figure 6.1.5-4: Example of MAC PDU consisting of a MAC header and MAC RARs

### 6.1.6 MAC PDU (SL-SCH)

A MAC PDU consists of a MAC header, one or more MAC Service Data Units (MAC SDU), and optionally padding; as described in Figure 6.1.6-4.

Both the MAC header and the MAC SDUs are of variable sizes.

A MAC PDU header consists of one SL-SCH subheader, one or more MAC PDU subheaders; each subheader except SL-SCH subheader corresponds to either a MAC SDU or padding.

The SL-SCH subheader consists of the seven header fields V/R/R/R/R/SRC/DST.

A MAC PDU subheader consists of the six header fields R/R/E/LCID/F/L but for the last subheader in the MAC PDU. The last subheader in the MAC PDU consists solely of the four header fields R/R/E/LCID. A MAC PDU subheader corresponding to padding consists of the four header fields R/R/E/LCID.

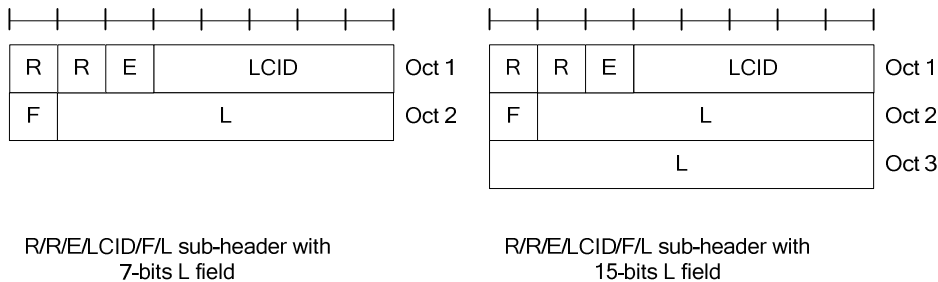

Figure 6.1.6-1: R/R/E/LCID/F/L MAC subheader

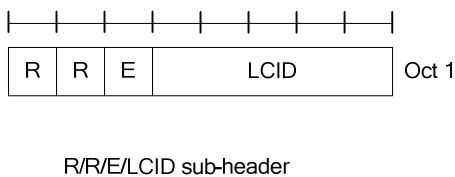

Figure 6.1.6-2: R/R/E/LCID MAC subheader

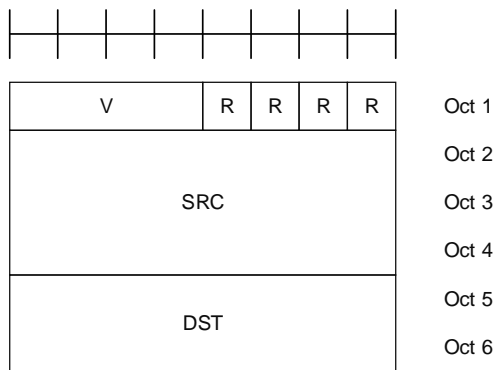

Figure 6.1.6-3: SL-SCH MAC subheader

MAC PDU subheaders have the same order as the corresponding MAC SDUs and padding.

Padding occurs at the end of the MAC PDU, except when single-byte or two-byte padding is required. Padding may have any value and the MAC entity shall ignore it. When padding is performed at the end of the MAC PDU, zero or more padding bytes are allowed.

When single-byte or two-byte padding is required, one or two MAC PDU subheaders corresponding to padding are placed after the SL-SCH subheader and before any other MAC PDU subheader.

A maximum of one MAC PDU can be transmitted per TB.

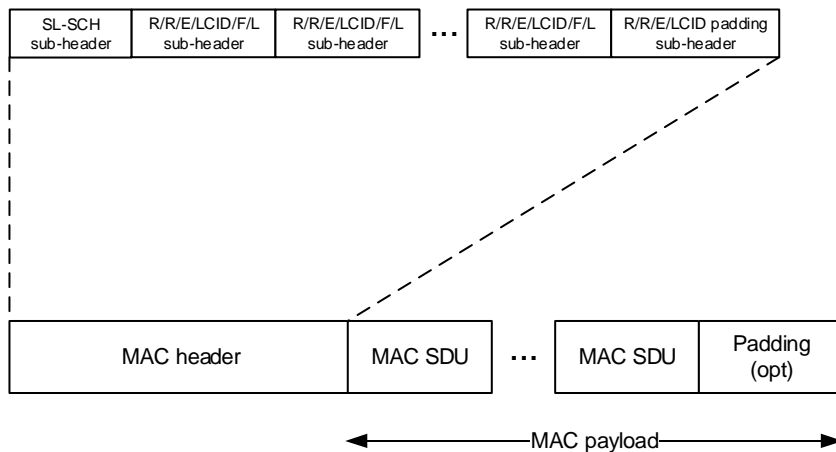

Figure 6.1.6-4: Example of MAC PDU consisting of MAC header, MAC SDUs and padding

## 6.2 Formats and parameters

### 6.2.1 MAC header for DL-SCH, UL-SCH and MCH

The MAC header is of variable size and consists of the following fields:

- LCID: The Logical Channel ID field identifies the logical channel instance of the corresponding MAC SDU or the type of the corresponding MAC control element or padding as described in tables 6.2.1-1, 6.2.1-2 and 6.2.1-4 for the DL-SCH, UL-SCH and MCH respectively. There is one LCID field for each MAC SDU, MAC control element or padding included in the MAC PDU. In addition to that, one or two additional LCID fields are included in the MAC PDU, when single-byte or two-byte padding is required but cannot be achieved by padding at the end of the MAC PDU. A UE of Category 0 [12] shall indicate CCCH using LCID "01011", otherwise the UE shall indicate CCCH using LCID "00000". The LCID field size is 5 bits;
- L: The Length field indicates the length of the corresponding MAC SDU or variable-sized MAC control element in bytes. There is one L field per MAC PDU subheader except for the last subheader and subheaders corresponding to fixed-sized MAC control elements. The size of the L field is indicated by the F field;
- F: The Format field indicates the size of the Length field as indicated in table 6.2.1-3. There is one F field per MAC PDU subheader except for the last subheader and subheaders corresponding to fixed-sized MAC control elements. The size of the F field is 1 bit. If the size of the MAC SDU or variable-sized MAC control element is less than 128 bytes, the value of the F field is set to 0, otherwise it is set to 1;
- E: The Extension field is a flag indicating if more fields are present in the MAC header or not. The E field is set to "1" to indicate another set of at least R/R/E/LCID fields. The E field is set to "0" to indicate that either a MAC SDU, a MAC control element or padding starts at the next byte;
- R: Reserved bit, set to "0".

The MAC header and subheaders are octet aligned.

Table 6.2.1-1 Values of LCID for DL-SCH

| Index       | LCID values                       |
|-------------|-----------------------------------|
| 00000       | CCCH                              |
| 00001-01010 | Identity of the logical channel   |
| 01011-11001 | Reserved                          |
| 11010       | Long DRX Command                  |
| 11011       | Activation/Deactivation           |
| 11100       | UE Contention Resolution Identity |
| 11101       | Timing Advance Command            |
| 11110       | DRX Command                       |
| 11111       | Padding                           |



**Table 6.2.1-2 Values of LCID for UL-SCH**

| Index       | LCID values                             |
|-------------|---|
| 00000       | CCCH                                    |
| 00001-01010 | Identity of the logical channel         |
| 01011       | CCCH                                    |
| 01100-10101 | Reserved                                |
| 10110       | Truncated Sidelink BSR                  |
| 10111       | Sidelink BSR                            |
| 11000       | Dual Connectivity Power Headroom Report |
| 11001       | Extended Power Headroom Report          |
| 11010       | Power Headroom Report                   |
| 11011       | C-RNTI                                  |
| 11100       | Truncated BSR                           |
| 11101       | Short BSR                               |
| 11110       | Long BSR                                |
| 11111       | Padding                                 |

**Table 6.2.1-3 Values of F field:**

| Index | Size of Length field (in bits) |
|-------|--------------------------------|
| 0     | 7                              |
| 1     | 15                             |

**Table 6.2.1-4 Values of LCID for MCH**

| Index   | LCID values   |
|---|---|
| 00000   | MCCH (see note)   |
| 00001-11100   | MTCH  |
| 11101   | Reserved  |
| 11110   | MCH Scheduling Information or Extended MCH Scheduling Information |
| 11111   | Padding   |
| NOTE: If there is no MCCH on MCH, an MTCH could use this value. |   |

## 6.2.2 MAC header for Random Access Response

The MAC header is of variable size and consists of the following fields:

- E: The Extension field is a flag indicating if more fields are present in the MAC header or not. The E field is set to "1" to indicate at least another set of E/T/RAPID fields follows. The E field is set to "0" to indicate that a MAC RAR or padding starts at the next byte;
- T: The Type field is a flag indicating whether the MAC subheader contains a Random Access ID or a Backoff Indicator. The T field is set to "0" to indicate the presence of a Backoff Indicator field in the subheader (BI). The T field is set to "1" to indicate the presence of a Random Access Preamble ID field in the subheader (RAPID);
- R: Reserved bit, set to "0";
- BI: The Backoff Indicator field identifies the overload condition in the cell. The size of the BI field is 4 bits;
- RAPID: The Random Access Preamble IDentifier field identifies the transmitted Random Access Preamble (see subclause 5.1.3). The size of the RAPID field is 6 bits.

The MAC header and subheaders are octet aligned.

### 6.2.3 MAC payload for Random Access Response

The MAC RAR is of fixed size and consists of the following fields:

- R: Reserved bit, set to "0";
- Timing Advance Command: The Timing Advance Command field indicates the index value  $T_A$  (0, 1, 2... 1282) used to control the amount of timing adjustment that the MAC entity has to apply (see subclause 4.2.3 of [2]). The size of the Timing Advance Command field is 11 bits;
- UL Grant: The UpLink Grant field indicates the resources to be used on the uplink (see subclause 6.2 of [2]). The size of the UL Grant field is 20 bits;
- Temporary C-RNTI: The Temporary C-RNTI field indicates the temporary identity that is used by the MAC entity during Random Access. The size of the Temporary C-RNTI field is 16 bits.

The MAC RAR is octet aligned.

### 6.2.4 MAC header for SL-SCH

The MAC header is of variable size and consists of the following fields:

- V: The MAC PDU format version number field indicates which version of the SL-SCH subheader is used. In this version of the specification only one format version is defined, and this field shall therefore be set to "0001". The V field size is 4 bits;
- SRC: The Source Layer-2 ID field carries the identity of the source. It is set to the ProSe UE ID. The SRC field size is 24 bits;
- DST: The DST field carries the 16 most significant bits of the Destination Layer-2 ID. The Destination Layer-2 ID is set to the ProSe Layer-2 Group ID;
- LCID: The Logical Channel ID field identifies the logical channel instance of the corresponding MAC SDU or the type of the corresponding MAC control element or padding as described in table 6.2.4-1. There is one LCID field for each MAC SDU, MAC control element or padding included in the MAC PDU. In addition to that, one or two additional LCID fields are included in the MAC PDU, when single-byte or two-byte padding is required but cannot be achieved by padding at the end of the MAC PDU. The LCID field size is 5 bits;
- L: The Length field indicates the length of the corresponding MAC SDU or variable-sized MAC control element in bytes. There is one L field per MAC PDU subheader except for the last subheader and subheaders corresponding to fixed-sized MAC control elements. The size of the L field is indicated by the F field;
- F: The Format field indicates the size of the Length field as indicated in table 6.2.4-2. There is one F field per MAC PDU subheader except for the last subheader and subheaders corresponding to fixed-sized MAC control elements. The size of the F field is 1 bit. If the size of the MAC SDU or variable-sized MAC control element is less than 128 bytes, the value of the F field is set to 0, otherwise it is set to 1;
- E: The Extension field is a flag indicating if more fields are present in the MAC header or not. The E field is set to "1" to indicate another set of at least R/R/E/LCID fields. The E field is set to "0" to indicate that either a MAC SDU, a MAC control element or padding starts at the next byte;
- R: Reserved bit, set to "0".

The MAC header and subheaders are octet aligned.

**Table 6.2.4-1 Values of LCID for SL-SCH**

| Index       | LCID values                     |
|-------------|---------------------------------|
| 00000       | Reserved                        |
| 00001-01010 | Identity of the logical channel |
| 01011-11110 | Reserved                        |
| 11111       | Padding                         |

**Table 6.2.4-2 Values of F field:**

| Index | Size of Length field (in bits) |
|-------|--------------------------------|
| 0     | 7                              |
| 1     | 15                             |

---

## 7 Variables and constants

### 7.1 RNTI values

RNTI values are presented in Table 7.1-1 and their usage and associated Transport Channels and Logical Channels are presented in Table 7.1-2.

**Table 7.1-1: RNTI values.**

| Value (hexa-decimal) | RNTI  |
|----------------------|---|
| 0000                 | N/A   |
| 0001-003C            | RA-RNTI, C-RNTI, Semi-Persistent Scheduling C-RNTI, Temporary C-RNTI, eIMTA-RNTI, TPC-PUCCH-RNTI, TPC-PUSCH-RNTI and SL-RNTI (see note) |
| 003D-FFF3            | C-RNTI, Semi-Persistent Scheduling C-RNTI, eIMTA-RNTI, Temporary C-RNTI, TPC-PUCCH-RNTI, TPC-PUSCH-RNTI and SL-RNTI                     |
| FFF4-FFFC            | Reserved for future use   |
| FFFD                 | M-RNTI  |
| FFFE                 | P-RNTI  |
| FFFF                 | SI-RNTI   |

NOTE: A MAC entity uses the same C-RNTI on all Serving Cells.

**Table 7.1-2: RNTI usage.**

| RNTI                              | Usage   | Transport Channel | Logical Channel  |
|-----------------------------------|---|-------------------|------------------|
| P-RNTI                            | Paging and System Information change notification   | PCH               | PCCH             |
| SI-RNTI                           | Broadcast of System Information   | DL-SCH            | BCCH             |
| M-RNTI                            | MCCH Information change notification  | N/A               | N/A              |
| RA-RNTI                           | Random Access Response  | DL-SCH            | N/A              |
| eIMTA-RNTI                        | eIMTA TDD UL/DL configuration notification  | N/A               | N/A              |
| Temporary C-RNTI                  | Contention Resolution<br>(when no valid C-RNTI is available)                                      | DL-SCH            | CCCH             |
| Temporary C-RNTI                  | Msg3 transmission   | UL-SCH            | CCCH, DCCH, DTCH |
| C-RNTI                            | Dynamically scheduled unicast transmission  | UL-SCH            | DCCH, DTCH       |
| C-RNTI                            | Dynamically scheduled unicast transmission  | DL-SCH            | CCCH, DCCH, DTCH |
| C-RNTI                            | Triggering of PDCCH ordered random access   | N/A               | N/A              |
| Semi-Persistent Scheduling C-RNTI | Semi-Persistently scheduled unicast transmission<br>(activation, reactivation and retransmission) | DL-SCH, UL-SCH    | DCCH, DTCH       |
| Semi-Persistent Scheduling C-RNTI | Semi-Persistently scheduled unicast transmission<br>(deactivation)                                | N/A               | N/A              |
| TPC-PUCCH-RNTI                    | Physical layer Uplink power control   | N/A               | N/A              |
| TPC-PUSCH-RNTI                    | Physical layer Uplink power control   | N/A               | N/A              |
| SL-RNTI                           | Dynamically scheduled sidelink transmission   | SL-SCH            | STCH             |

## 7.2 Backoff Parameter values

Backoff Parameter values are presented in Table 7.2-1.

**Table 7.2-1: Backoff Parameter values.**

| Index | Backoff Parameter value (ms) |
|-------|------------------------------|
| 0     | 0                            |
| 1     | 10                           |
| 2     | 20                           |
| 3     | 30                           |
| 4     | 40                           |
| 5     | 60                           |
| 6     | 80                           |
| 7     | 120                          |
| 8     | 160                          |
| 9     | 240                          |
| 10    | 320                          |
| 11    | 480                          |
| 12    | 960                          |
| 13    | Reserved                     |
| 14    | Reserved                     |
| 15    | Reserved                     |

The reserved values of the backoff parameter if received by the current release version UEs shall be taken as 960 ms.

## 7.3 PRACH Mask Index values

Table 7.3-1: PRACH Mask Index values

| PRACH Mask Index | Allowed PRACH (FDD)   | Allowed PRACH (TDD)   |
|------------------|---|---|
| 0                | All   | All   |
| 1                | PRACH Resource Index 0  | PRACH Resource Index 0  |
| 2                | PRACH Resource Index 1  | PRACH Resource Index 1  |
| 3                | PRACH Resource Index 2  | PRACH Resource Index 2  |
| 4                | PRACH Resource Index 3  | PRACH Resource Index 3  |
| 5                | PRACH Resource Index 4  | PRACH Resource Index 4  |
| 6                | PRACH Resource Index 5  | PRACH Resource Index 5  |
| 7                | PRACH Resource Index 6  | Reserved  |
| 8                | PRACH Resource Index 7  | Reserved  |
| 9                | PRACH Resource Index 8  | Reserved  |
| 10               | PRACH Resource Index 9  | Reserved  |
| 11               | Every, in the time domain, even PRACH opportunity<br>1 <sup>st</sup> PRACH Resource Index in subframe | Every, in the time domain, even PRACH opportunity<br>1 <sup>st</sup> PRACH Resource Index in subframe |
| 12               | Every, in the time domain, odd PRACH opportunity<br>1 <sup>st</sup> PRACH Resource Index in subframe  | Every, in the time domain, odd PRACH opportunity<br>1 <sup>st</sup> PRACH Resource Index in subframe  |
| 13               | Reserved  | 1 <sup>st</sup> PRACH Resource Index in subframe  |
| 14               | Reserved  | 2 <sup>nd</sup> PRACH Resource Index in subframe  |
| 15               | Reserved  | 3 <sup>rd</sup> PRACH Resource Index in subframe  |

## 7.4 Subframe\_Offset values

Subframe\_Offset values are presented in Table 7.4-1.

Table 7.4-1: Subframe\_Offset values

| TDD UL/DL configuration | Position of initial Semi-Persistent grant | Subframe_Offset value (ms) |
|-------------------------|---|----------------------------|
| 0                       | N/A                                       | 0                          |
| 1                       | Subframes 2 and 7                         | 1                          |
|                         | Subframes 3 and 8                         | -1                         |
| 2                       | Subframe 2                                | 5                          |
|                         | Subframe 7                                | -5                         |
| 3                       | Subframes 2 and 3                         | 1                          |
|                         | Subframe 4                                | -2                         |
| 4                       | Subframe 2                                | 1                          |
|                         | Subframe 3                                | -1                         |
| 5                       | N/A                                       | 0                          |
| 6                       | N/A                                       | 0                          |

## 7.5 TTI\_BUNDLE\_SIZE value

The parameter TTI\_BUNDLE\_SIZE is 4.

## 7.6 DELTA\_PREAMBLE values

The DELTA\_PREAMBLE preamble format based power offset values are presented in Table 7.6-1.

**Table 7.6-1: DELTA\_PREAMBLE values.**

| Preamble Format | DELTA_PREAMBLE value |
|-----------------|----------------------|
| 0               | 0 dB                 |
| 1               | 0 dB                 |
| 2               | -3 dB                |
| 3               | -3 dB                |
| 4               | 8 dB                 |

Where the Preamble Format is given by *prach-ConfigIndex* [7].

## 7.7 HARQ RTT Timer

For each serving cell, in case of FDD SpCell the HARQ RTT Timer is set to 8 subframes. For each serving cell, in case of TDD SpCell the HARQ RTT Timer is set to  $k + 4$  subframes, where  $k$  is the interval between the downlink transmission and the transmission of associated HARQ feedback, as indicated in subclauses 10.1 and 10.2 of [2], and for an RN configured with *rn-SubframeConfig* [8] and not suspended, as indicated in Table 7.5.1-1 of [11].

---

## Annex A (normative): Handling of measurement gaps

In this specification, the subframes which cannot be used for transmission according to subclause 8.1.2.1 of [9] are also considered as part of measurement gaps in uplink. Measurement gaps are defined in [9].

In a subframe that is part of a measurement gap, the UE shall not perform the transmission of HARQ feedback and CQI/PMI/RI/PTI, and SRS shall not be reported.

# Annex B (normative): Contention resolution for RACH access

When checking whether contention resolution was successful a MAC entity considers the MAC header structures shown below for the processing of a MAC PDU containing a UE Contention Resolution Identity MAC control element.

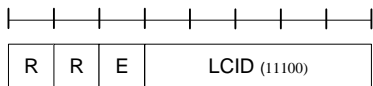

Case 1: MAC subheader for MAC control element

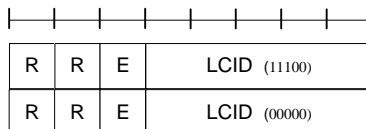

Case 2: MAC subheader for MAC control element + MAC subheader for MAC SDU (CCCH)

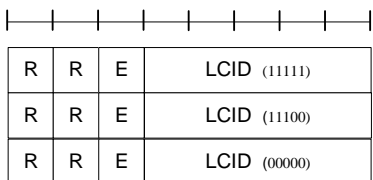

Case 3: MAC subheader for single-byte padding + MAC subheader for MAC control element + MAC subheader for MAC SDU (CCCH)

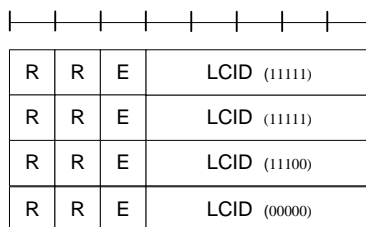

Case 4: MAC subheaders for two-byte padding + MAC subheader for MAC control element + MAC subheader for MAC SDU (CCCH)

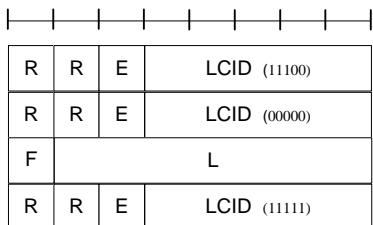

Case 5: MAC subheader for MAC control element + MAC subheader (7-bits L-field) for MAC SDU (CCCH) + MAC subheader for padding

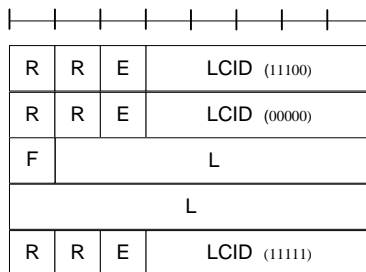

Case 6: MAC subheader for MAC control element + MAC subheader (15-bits L-field) for MAC SDU (CCCH) + MAC subheader for padding



## Annex C (informative): Intended UE behaviour for DRX Timers

When a DRX timer is set to a value of  $X$ , and  $n$  denotes the subframe in which the related event is triggered according to the subclause 5.7, the intended behaviours of each DRX timer are presented in the Table C-1 below:

**Table C-1: Intended UE behaviour for DRX timers**

| <b>DRX Timers</b>             | <b>Intended UE behaviour<br/>([x, y] means including subframe x and y)</b>  |
|-------------------------------|---|
| drx-InactivityTimer           | The MAC entity monitors PDCCH in PDCCH-subframes during the subframes [n+1, n+m].<br>The MAC entity starts or restarts drxShortCycleTimer, and uses Short DRX Cycle in the subframe n+m+1, if configured. |
| mac-ContentionResolutionTimer | The MAC entity monitors PDCCH in PDCCH-subframes during the subframes [n+1, n+X].   |
| drx-RetransmissionTimer       | The MAC entity monitors PDCCH in PDCCH-subframes during the subframes [n, n+m-1].   |
| onDurationTimer               | The MAC entity monitors PDCCH in PDCCH-subframes during the subframes [n, n+m-1].   |
| drxShortCycleTimer            | The MAC entity uses the Short DRX Cycle during the subframes [n, n+X-1].<br>The MAC entity starts to use the Long DRX Cycle in the subframe n+X.  |
| HARQ RTT Timer                | The MAC entity starts drx-RetransmissionTimer in the subframe n+X, if needed.   |
| NOTE:                         | For FDD, m is equal to X; for TDD, m is equal to the minimum number of subframes so that X PDCCH-subframes are included during the subframes [x, y].  |
| NOTE:                         | A MAC entity configured with eIMTA monitors PDCCH in some subframe(s) in addition to PDCCH-subframes, as specified in subclause 5.7.  |

For drx-InactivityTimer and drx-RetransmissionTimer, if  $X=0$ , the timer does not make the MAC entity to monitor the PDCCH.

## Annex D (informative): Change history

| Change history |             |           |      |     |  |       |       |
|----------------|-------------|-----------|------|-----|--|-------|-------|
| Date           | TSG #       | TSG Doc.  | CR   | Rev | Subject/Comment  | Old   | New   |
| 2007-06        | RAN2#58 bis | R2-072710 |      |     | MAC Protocol Specification Baseline  | -     |       |
| 2007-06        | RAN2#58 bis | R2-072912 |      |     | Text Proposal for UL HARQ (Tdoc R2-072708)<br>Text Proposal for DL HARQ (Tdoc R2-072707)<br>Text Proposal for RACH procedure (Tdoc R2-072640)<br>Text Proposal for Logical Channel prioritization (Tdoc R2-072643)   |       | 0.1.0 |
| 2007-06        | RAN2#58 bis | R2-072994 |      |     | Basic MAC PDU structure (Tdoc R2-072983) with updates<br>Agreements on time-frequency resource configuration (Tdoc R2-072993)<br>Agreement on RA-RNTI association (Tdoc R2-072993)<br>Clarification on RA Response reception (Tdoc R2-072993)  | 0.1.0 | 0.1.1 |
| 2007-08        | RAN2#59     | R2-073715 |      |     | Removed reference to non-existing table (Tdoc R2-073473)<br>Incorrect mapping of logical to transport channel (Tdoc R2-073473)<br>Un-necessary error checking in HARQ process procedure (Tdoc R2-073473)<br>Removal of reference to timing relation for HARQ feedback (Tdoc R2-073473)<br>Correction of Internal variable name (Tdoc R2-073473)<br>Correction of procedure in case of successful HARQ reception (Tdoc R2-073473)   | 0.1.1 | 0.2.0 |
| 2007-09        | RAN2#59     | R2-073885 |      |     | Text proposal for Random Access procedure<br>Text proposal on HARQ clarification for TDD<br>Text proposal on HARQ for grants   | 0.2.0 | 0.2.1 |
| 2007-09        | RAN#37      | RP-070688 |      |     | Clean version for information  | 0.2.1 | 1.0.0 |
| 2007-10        | RAN2#59 bis | R2-074530 |      |     | Editorial update with Editor's notes (Tdoc R2-074211).   | 1.0.0 | 1.1.0 |
| 2007-11        | RAN2#60     | R2-075093 |      |     | Agreements on MAC PDU format (R2-074536)<br>Corrections on Random Access Procedure (R2-074536)   | 1.1.0 | 1.1.1 |
| 2007-11        | RAN2#60     | R2-075243 |      |     | Endorsement of v1.1.1<br>Removal of FFS on DL CCCH existence   | 1.1.1 | 1.2.0 |
| 2007-11        | RAN2#60     | R2-075488 |      |     | Agreement on identity used Random Access Response (R2-075038)<br>Agreement on Local Nack1 (R2-074949)<br>PUCCH Resource handling (R2-075432)<br>UL HARQ agreements (R2-075432)<br>Agreements on semi-persistent scheduling (R2-075432, 36.300)<br>Agreements on BSR/SR triggers (R2-075432)<br>Agreements on BSR contents (R2-075432)<br>Agreements on Timing Advance principles (36.300)<br>Agreements on DRX control (36.300)<br>Handling of P-BCH, D-BCH, PCH (R2-075246) | 1.2.0 | 1.3.0 |
| 2007-11        | RP-38       | RP-070917 |      |     | Clean version, presented at TSG RAN-38 for approval  | 1.3.0 | 2.0.0 |
| 2007-12        | RP-38       | -         |      |     | Approved at TSG RAN-38 and placed under change control   | 2.0.0 | 8.0.0 |
| 2008-03        | RP-39       | RP-080162 | 0001 | 2   | CR to 36.321 with E-UTRA MAC protocol specification update   | 8.0.0 | 8.1.0 |
| 2008-05        | RP-40       | RP-080410 | 0002 | 1   | 36.321 CR covering agreements of RAN2 #61bis and RAN2#62   | 8.1.0 | 8.2.0 |
| 2008-09        | RP-41       | RP-080690 | 0003 | -   | Clarification on data available for transmission for BSR triggering  | 8.2.0 | 8.3.0 |
|                | RP-41       | RP-080690 | 0004 | -   | CR to 36.321 on failure indication after maximum number of HARQ transmissions  | 8.2.0 | 8.3.0 |
|                | RP-41       | RP-080690 | 0005 | 4   | Clarifications and Corrections of DL and UL Data Transfer (SCH, RACH and SR)   | 8.2.0 | 8.3.0 |
|                | RP-41       | RP-080690 | 0006 | -   | CR to 36.321 on Buffer size levels for BSR   | 8.2.0 | 8.3.0 |
|                | RP-41       | RP-080690 | 0007 | -   | Clarifications on DRX  | 8.2.0 | 8.3.0 |
|                | RP-41       | RP-080690 | 0008 | -   | Clarification on UE behavior for DRX and configured measurement gaps   | 8.2.0 | 8.3.0 |
|                | RP-41       | RP-080690 | 0009 | 3   | Correction to MAC Padding BSR  | 8.2.0 | 8.3.0 |
|                | RP-41       | RP-080690 | 0010 | -   | Correction to UE transmission power headroom report for LTE  | 8.2.0 | 8.3.0 |
|                | RP-41       | RP-080690 | 0011 | -   | Corrections on BSR   | 8.2.0 | 8.3.0 |
|                | RP-41       | RP-080690 | 0012 | -   | CR to 36.321 REL-8 on Format of UL grant in Message 2  | 8.2.0 | 8.3.0 |
|                | RP-41       | RP-080690 | 0015 | -   | CR to 36.321 REL-8 on PUSCH PUCCH Power Control RNTIs  | 8.2.0 | 8.3.0 |
|                | RP-41       | RP-080690 | 0016 | -   | CR to 36.321 REL-8 on RACH uniform random backoff  | 8.2.0 | 8.3.0 |
|                | RP-41       | RP-080690 | 0017 | 1   | E-UTRA MAC protocol specification update   | 8.2.0 | 8.3.0 |
|                | RP-41       | RP-080690 | 0020 | -   | TP for number of HARQ processes and MIMO   | 8.2.0 | 8.3.0 |
|                | RP-41       | RP-080690 | 0022 | -   | Update of MAC dedicated preamble expiry  | 8.2.0 | 8.3.0 |

|         |       |           |      |   |  |       |       |
|---------|-------|-----------|------|---|--|-------|-------|
|         | RP-41 | RP-080690 | 0027 | - | Handling of Semi-Persistent grants and assignments   | 8.2.0 | 8.3.0 |
|         | RP-41 | RP-080690 | 0051 | 1 | Corrections relating to RACH   | 8.2.0 | 8.3.0 |
|         | RP-41 | RP-080690 | 0058 | 1 | UL Channel Prioritisation  | 8.2.0 | 8.3.0 |
|         | RP-41 | RP-080690 | 0071 | 2 | Corrections relating to RACH partitioning  | 8.2.0 | 8.3.0 |
|         | RP-41 | RP-080690 | 0091 | - | Correction on Random Access Response reception behaviour                                       | 8.2.0 | 8.3.0 |
|         | RP-41 | RP-080690 | 0103 | - | Upper limit of logical channel id  | 8.2.0 | 8.3.0 |
|         | RP-41 | RP-080690 | 0104 | - | Clarifications and Corrections for HARQ operation at TAT expiry and RACH contention resolution | 8.2.0 | 8.3.0 |
| 2008-12 | RP-42 | RP-081018 | 0105 | - | CR0105 to 36.321 [Rel-8] on PHR Periodic Timer Start   | 8.3.0 | 8.4.0 |
|         | RP-42 | RP-081018 | 0106 | 1 | Proposed R1 of CR0106 to 36.321 [Rel-8] on PHR Reference                                       | 8.3.0 | 8.4.0 |
|         | RP-42 | RP-081018 | 0107 | 1 | CR 0107 to 36.321 Interactions between measurement gap and Msg3 transmission                   | 8.3.0 | 8.4.0 |
|         | RP-42 | RP-081018 | 0108 | 2 | Proposed R1 of CR0108 to 36.321 [Rel-8] on PHR Reporting Values                                | 8.3.0 | 8.4.0 |
|         | RP-42 | RP-081018 | 0109 | - | Correction relating to equal priorities  | 8.3.0 | 8.4.0 |
|         | RP-42 | RP-081018 | 0110 | - | CR 0110 to 36.321 on Correction to PHR   | 8.3.0 | 8.4.0 |
|         | RP-42 | RP-081018 | 0112 | 1 | CR0112r1 to 36.321 [Rel-8] Correction to BCCH Reception procedure                              | 8.3.0 | 8.4.0 |
|         | RP-42 | RP-081018 | 0113 | - | Contention Resolution Timer  | 8.3.0 | 8.4.0 |
|         | RP-42 | RP-081018 | 0114 | - | PCH reception  | 8.3.0 | 8.4.0 |
|         | RP-42 | RP-081018 | 0115 | - | Correction to reception of assignments and grants  | 8.3.0 | 8.4.0 |
|         | RP-42 | RP-081018 | 0116 | - | Correction on Contention Resolution  | 8.3.0 | 8.4.0 |
|         | RP-42 | RP-081018 | 0117 | 2 | Proposed R1 of CR0117 to 36.321 [Rel-8] on on SR Clarifications and Repetitions                | 8.3.0 | 8.4.0 |
|         | RP-42 | RP-081078 | 0118 | 2 | Clarification on Padding value   | 8.3.0 | 8.4.0 |
|         | RP-42 | RP-081018 | 0119 | - | CR 0119 to 36.321 Correction and Clarification on TTI Bundling                                 | 8.3.0 | 8.4.0 |
|         | RP-42 | RP-081018 | 0120 | 1 | Clarification of DRX Active Time   | 8.3.0 | 8.4.0 |
|         | RP-42 | RP-081018 | 0121 | 4 | Text Proposal for Dedicated Preamble Assignment  | 8.3.0 | 8.4.0 |
|         | RP-42 | RP-081018 | 0122 | - | CR0122 to 36.321 [Rel-8] on Message 3 Definition   | 8.3.0 | 8.4.0 |
|         | RP-42 | RP-081018 | 0123 | 1 | Correction to prevent wrong contention resolution by adaptive retransmission command           | 8.3.0 | 8.4.0 |
|         | RP-42 | RP-081018 | 0124 | - | Bucket Size Parameter  | 8.3.0 | 8.4.0 |
|         | RP-42 | RP-081018 | 0125 | 2 | CR0125r2 to 36.321 [Rel-8] Correction to Multiple BSR  | 8.3.0 | 8.4.0 |
|         | RP-42 | RP-081018 | 0127 | - | CR0127 to 36.321 [Rel-8] RACH preambles labelling  | 8.3.0 | 8.4.0 |
|         | RP-42 | RP-081018 | 0128 | 1 | CR0128r1 to 36.321 [Rel-8] merging CR0126r0 and CR0128r0                                       | 8.3.0 | 8.4.0 |
|         | RP-42 | RP-081018 | 0129 | 1 | CR0129r1 to 36.321 [Rel-8] Correction to PDU Format  | 8.3.0 | 8.4.0 |
|         | RP-42 | RP-081018 | 0130 | - | CQI/ SRS/PMI/RI transmission during active time  | 8.3.0 | 8.4.0 |
|         | RP-42 | RP-081018 | 0131 | 1 | NDI and Msg4 Carrying Contention Resolution ID   | 8.3.0 | 8.4.0 |
|         | RP-42 | RP-081018 | 0132 | 1 | CR0132 to 36.321 [Rel-8] on MAC BSR trigger  | 8.3.0 | 8.4.0 |
|         | RP-42 | RP-081018 | 0133 | - | Clarification about Restarting the Periodic BSR Timer  | 8.3.0 | 8.4.0 |
|         | RP-42 | RP-081018 | 0134 | - | Correction to RA procedure initiated by eNB PDCCH order  | 8.3.0 | 8.4.0 |
|         | RP-42 | RP-081018 | 0135 | 1 | Correction on PHR triggering condition   | 8.3.0 | 8.4.0 |
|         | RP-42 | RP-081018 | 0136 | - | CR 0136 to 36.321 on Correction to UL HARQ Process for the transmission of Msg3                | 8.3.0 | 8.4.0 |
|         | RP-42 | RP-081018 | 0137 | 2 | SPS occasions  | 8.3.0 | 8.4.0 |
|         | RP-42 | RP-081018 | 0138 | - | Robustness of Buffer Status Reporting  | 8.3.0 | 8.4.0 |
|         | RP-42 | RP-081018 | 0139 | - | Proposed CR to 36.321 [Rel-8] on UL HARQ and Measurement Gaps                                  | 8.3.0 | 8.4.0 |
|         | RP-42 | RP-081018 | 0142 | 1 | TAT and RACH procedure   | 8.3.0 | 8.4.0 |
|         | RP-42 | RP-081018 | 0143 | 1 | SRS and CQI Resources Release upon TAT Expiry  | 8.3.0 | 8.4.0 |
|         | RP-42 | RP-081018 | 0157 | 1 | Proposed CR to 36.321 Correction to RACH procedure   | 8.3.0 | 8.4.0 |
|         | RP-42 | RP-081018 | 0162 | 1 | BSR format for reporting empty buffers   | 8.3.0 | 8.4.0 |
|         | RP-42 | RP-081018 | 0165 | - | TTI Bundling Configuration   | 8.3.0 | 8.4.0 |
|         | RP-42 | RP-081018 | 0166 | 1 | Corrections to semi-persistent scheduling  | 8.3.0 | 8.4.0 |
|         | RP-42 | RP-081018 | 0167 | 2 | Priotitization of MAC control elements   | 8.3.0 | 8.4.0 |
|         | RP-42 | RP-081018 | 0168 | - | Correction to starting of TA timer   | 8.3.0 | 8.4.0 |
|         | RP-42 | RP-081018 | 0173 | 1 | Proposed CR to 36.321 SPS implicit release on UL   | 8.3.0 | 8.4.0 |
|         | RP-42 | RP-081018 | 0174 | - | Proposed CR to 36.321 Measurement gaps and SPS   | 8.3.0 | 8.4.0 |
|         | RP-42 | RP-081018 | 0175 | - | Proposed CR to 36.321 Setting reserved bits to zero  | 8.3.0 | 8.4.0 |
|         | RP-42 | RP-081018 | 0185 | - | Proposed CR to 36.321 [Rel-8] MAC ResetReconfig Option 2                                       | 8.3.0 | 8.4.0 |
|         | RP-42 | RP-081018 | 0188 | 2 | RV setting   | 8.3.0 | 8.4.0 |
|         | RP-42 | RP-081018 | 0189 | - | Corrections to Random Access Procedure   | 8.3.0 | 8.4.0 |
|         | RP-42 | RP-081018 | 0198 | - | Number of HARQ processes for MIMO  | 8.3.0 | 8.4.0 |
|         | RP-42 | RP-081018 | 0201 | - | Corrections to power control and random access   | 8.3.0 | 8.4.0 |
|         | RP-42 | RP-081018 | 0206 | - | Correction on the definition of the PDCCH-subframe   | 8.3.0 | 8.4.0 |
|         | RP-42 | RP-081018 | 0211 | 1 | Correction to the coexist of SPS-RNTI and SI-RNTI or RA-RNTI                                   | 8.3.0 | 8.4.0 |
|         | RP-42 | RP-081018 | 0220 | - | Explicit release of SPS  | 8.3.0 | 8.4.0 |
|         | RP-42 | RP-081018 | 0225 | 2 | Linking HARQ process ID with the SPS resource  | 8.3.0 | 8.4.0 |
|         | RP-42 | RP-081018 | 0231 | - | Bucket Parameter Update  | 8.3.0 | 8.4.0 |
|         | RP-42 | RP-081018 | 0232 | 1 | Clarification on "PDCCH indicates a new transmission" for DRX                                  | 8.3.0 | 8.4.0 |
|         | RP-42 | RP-081018 | 0233 | 1 | Editorial corrections to MAC   | 8.3.0 | 8.4.0 |
|         | RP-42 | RP-081018 | 0236 | - | RB suspension and BSR contents   | 8.3.0 | 8.4.0 |

|         |       |           |      |   |  |       |       |
|---------|-------|-----------|------|---|--|-------|-------|
|         | RP-42 | RP-081018 | 0239 | - | RV setting   | 8.3.0 | 8.4.0 |
|         | RP-42 | RP-081018 | 0240 | 2 | Preamble group selection   | 8.3.0 | 8.4.0 |
|         | RP-42 | RP-081018 | 0241 | - | Use of dedicated preambles after HO complete                         | 8.3.0 | 8.4.0 |
|         | RP-42 | RP-081018 | 0242 | - | Introduction of HARQ RTT Timer                                       | 8.3.0 | 8.4.0 |
|         | RP-42 | RP-081018 | 0243 | - | Correction to DRX configuration                                      | 8.3.0 | 8.4.0 |
| 2009-03 | RP-43 | RP-090128 | 0245 | - | CR to 36.321 on BSR clarification                                    | 8.4.0 | 8.5.0 |
|         | RP-43 | RP-090128 | 0246 | 2 | Freeing of reserved RNTIs  | 8.4.0 | 8.5.0 |
|         | RP-43 | RP-090128 | 0247 | - | Correction to MAC reset  | 8.4.0 | 8.5.0 |
|         | RP-43 | RP-090128 | 0248 | - | Correction to Initialization of Prioritization                       | 8.4.0 | 8.5.0 |
|         | RP-43 | RP-090128 | 0249 | - | Local NACKing Optionality MAC CR                                     | 8.4.0 | 8.5.0 |
|         | RP-43 | RP-090128 | 0250 | 1 | Position of the Backoff Indicator subheader                          | 8.4.0 | 8.5.0 |
|         | RP-43 | RP-090128 | 0251 | - | Missing reserved bit setting   | 8.4.0 | 8.5.0 |
|         | RP-43 | RP-090128 | 0252 | - | Expired TAT and PUSCH transmission                                   | 8.4.0 | 8.5.0 |
|         | RP-43 | RP-090128 | 0253 | - | Expired TAT and HARQ feedback  | 8.4.0 | 8.5.0 |
|         | RP-43 | RP-090128 | 0254 | 1 | Counter proposal to R2-090969 on Management for HARQ buffer with TAT | 8.4.0 | 8.5.0 |
|         | RP-43 | RP-090128 | 0255 | - | HARQ Feedback and Contention Resolution                              | 8.4.0 | 8.5.0 |
|         | RP-43 | RP-090128 | 0256 | - | Corrections to redundancy version control for system information     | 8.4.0 | 8.5.0 |
|         | RP-43 | RP-090128 | 0257 | - | Mapping of the RNTIs to different transport channels                 | 8.4.0 | 8.5.0 |
|         | RP-43 | RP-090128 | 0258 | - | DRX and UL Retransmissions   | 8.4.0 | 8.5.0 |
|         | RP-43 | RP-090128 | 0259 | - | Definition of DRX Short Cycle Timer                                  | 8.4.0 | 8.5.0 |
|         | RP-43 | RP-090128 | 0260 | - | Small corrections to RACH  | 8.4.0 | 8.5.0 |
|         | RP-43 | RP-090128 | 0261 | - | Processing of contention resolution message                          | 8.4.0 | 8.5.0 |
|         | RP-43 | RP-090128 | 0262 | - | Corrections to power control and random access                       | 8.4.0 | 8.5.0 |
|         | RP-43 | RP-090128 | 0263 | - | Missing condition for unsuccessful reception of Msg2                 | 8.4.0 | 8.5.0 |
|         | RP-43 | RP-090128 | 0264 | 1 | Corrections relating to Random Access required inputs                | 8.4.0 | 8.5.0 |
|         | RP-43 | RP-090128 | 0265 | - | Bucket Parameter Update  | 8.4.0 | 8.5.0 |
|         | RP-43 | RP-090128 | 0266 | 2 | Correction to Handling of triggered PHR                              | 8.4.0 | 8.5.0 |
|         | RP-43 | RP-090128 | 0267 | - | SPS resource release on D-SR failure                                 | 8.4.0 | 8.5.0 |
|         | RP-43 | RP-090128 | 0269 | 2 | NDI handling when measurement gap and SPS occasion collide           | 8.4.0 | 8.5.0 |
|         | RP-43 | RP-090128 | 0270 | - | Correction relating to PDCCH order                                   | 8.4.0 | 8.5.0 |
|         | RP-43 | RP-090128 | 0271 | - | Error Handling   | 8.4.0 | 8.5.0 |
|         | RP-43 | RP-090128 | 0272 | - | Various clarifications/corrections to TS36.321                       | 8.4.0 | 8.5.0 |
|         | RP-43 | RP-090128 | 0273 | 1 | Disassembly, Demultiplexing and Multiplexing functions               | 8.4.0 | 8.5.0 |
|         | RP-43 | RP-090128 | 0274 | 1 | Miscellaneous corrections to MAC                                     | 8.4.0 | 8.5.0 |
|         | RP-43 | RP-090128 | 0275 | 2 | CR on Interactions between Msg3 transmission and TTI bundling        | 8.4.0 | 8.5.0 |
|         | RP-43 | RP-090128 | 0276 | - | TTI Bundling   | 8.4.0 | 8.5.0 |
|         | RP-43 | RP-090128 | 0278 | 1 | Correction to BSR trigger at serving cell change                     | 8.4.0 | 8.5.0 |
|         | RP-43 | RP-090128 | 0279 | 1 | Correction to Release of SPS   | 8.4.0 | 8.5.0 |
|         | RP-43 | RP-090128 | 0280 | 2 | Usage of RRC Parameters  | 8.4.0 | 8.5.0 |
|         | RP-43 | RP-090128 | 0281 | - | Clarification of MAC Timer status                                    | 8.4.0 | 8.5.0 |
|         | RP-43 | RP-090128 | 0282 | 1 | Correction on MAC PDU subheader description                          | 8.4.0 | 8.5.0 |
|         | RP-43 | RP-090128 | 0283 | 1 | UE behaviour at CURRENT_TX_NB reaches maximum value                  | 8.4.0 | 8.5.0 |
|         | RP-43 | RP-090128 | 0285 | - | Reporting During DRX   | 8.4.0 | 8.5.0 |
|         | RP-43 | RP-090128 | 0289 | - | NDI handling after random access procedure                           | 8.4.0 | 8.5.0 |
|         | RP-43 | RP-090128 | 0290 | 1 | Dedicated preamble handling after random access failure              | 8.4.0 | 8.5.0 |
|         | RP-43 | RP-090128 | 0292 | - | NDI and grant in Message 2   | 8.4.0 | 8.5.0 |
|         | RP-43 | RP-090128 | 0293 | 1 | Correction relating to BCCH HARQ                                     | 8.4.0 | 8.5.0 |
|         | RP-43 | RP-090128 | 0300 | 1 | Corrections to Msg3 definition and usage                             | 8.4.0 | 8.5.0 |
|         | RP-43 | RP-090128 | 0303 | - | PRACH selection must use prach-ConfigurationIndex                    | 8.4.0 | 8.5.0 |
|         | RP-43 | RP-090128 | 0305 | - | Clarification on RETX_BSR_TIMER                                      | 8.4.0 | 8.5.0 |
|         | RP-43 | RP-090128 | 0307 | 3 | MAC Structure in UE Side   | 8.4.0 | 8.5.0 |
|         | RP-43 | RP-090128 | 0308 | - | Clarification on Random Access Procedure                             | 8.4.0 | 8.5.0 |
|         | RP-43 | RP-090128 | 0314 | - | Clarification on the CR timer  | 8.4.0 | 8.5.0 |
|         | RP-43 | RP-090128 | 0316 | - | Correction on BSR  | 8.4.0 | 8.5.0 |
|         | RP-43 | RP-090128 | 0318 | 1 | Clarification on MAC reconfiguration of timers and counters          | 8.4.0 | 8.5.0 |
|         | RP-43 | RP-090128 | 0320 | - | HARQ feedback, CQI/PMI/RI and SRS transmissions and measurement gaps | 8.4.0 | 8.5.0 |
|         | RP-43 | RP-090128 | 0324 | - | MAC PDU subheader corresponding to padding                           | 8.4.0 | 8.5.0 |
|         | RP-43 | RP-090128 | 0333 | - | CR On Backoff table  | 8.4.0 | 8.5.0 |
|         | RP-43 | RP-090128 | 0334 | 3 | TTI Bundling Operation   | 8.4.0 | 8.5.0 |
|         | RP-43 | RP-090128 | 0341 | 1 | Enforcing new transmission after flushing HARQ process               | 8.4.0 | 8.5.0 |
| 2009-06 | RP-44 | RP-090513 | 0342 | - | Correction on HARQ feedback transmission                             | 8.5.0 | 8.6.0 |
|         | RP-44 | RP-090513 | 0343 | 1 | Clarification on the DL assignment/UL grant reception in SPS         | 8.5.0 | 8.6.0 |
|         | RP-44 | RP-090513 | 0344 | 1 | PHR timer handling after handover                                    | 8.5.0 | 8.6.0 |
|         | RP-44 | RP-090513 | 0346 | 2 | MAC PDU for Msg2   | 8.5.0 | 8.6.0 |
|         | RP-44 | RP-090513 | 0347 | 2 | MAC Error handling   | 8.5.0 | 8.6.0 |
|         | RP-44 | RP-090513 | 0348 | - | Correction on SR cancellation  | 8.5.0 | 8.6.0 |
|         | RP-44 | RP-090513 | 0349 | 1 | Correction to RETX_BSR_TIMER   | 8.5.0 | 8.6.0 |
|         | RP-44 | RP-090513 | 0350 | 1 | CR to 36.321 on UL SPS Implicit Release                              | 8.5.0 | 8.6.0 |
|         | RP-44 | RP-090513 | 0351 | 2 | Various correction to MAC  | 8.5.0 | 8.6.0 |

|         |       |           |      |   |   |        |        |
|---------|-------|-----------|------|---|---|--------|--------|
|         | RP-44 | RP-090513 | 0369 | - | Correction to Uplink grant by temporary C-RNTI  | 8.5.0  | 8.6.0  |
|         | RP-44 | RP-090513 | 0370 | - | Clarification on simultaneous reception of RA-RNTI and C-RNTI                                     | 8.5.0  | 8.6.0  |
|         | RP-44 | RP-090513 | 0374 | - | Correction on timeAlignmentTimer validity in MAC  | 8.5.0  | 8.6.0  |
|         | RP-44 | RP-090513 | 0376 | 1 | CR for MAC padding  | 8.5.0  | 8.6.0  |
|         | RP-44 | RP-090513 | 0377 | - | Correction to duplicate reception of TA command (2nd method)                                      | 8.5.0  | 8.6.0  |
| 2009-09 | RP-45 | RP-090906 | 0379 | - | Correction to NDI semantics   | 8.6.0  | 8.7.0  |
|         | RP-45 | RP-090906 | 0380 | 1 | Minor corrections to 36.321   | 8.6.0  | 8.7.0  |
|         | RP-45 | RP-090906 | 0381 | 2 | UE behaviour when MBSFN subframe and a configured downlink assignment collide                     | 8.6.0  | 8.7.0  |
|         | RP-45 | RP-090906 | 0399 | - | Correction to HARQ process ID for DL SPS retransmissions  | 8.6.0  | 8.7.0  |
| 2009-09 | RP-45 | RP-090934 | 0390 | 3 | Improvement of cancellation of SR   | 8.7.0  | 9.0.0  |
|         | RP-45 | RP-090934 | 0396 | - | Periodic CQI/PMI/RI masking   | 8.7.0  | 9.0.0  |
| 2009-12 | RP-46 | RP-091341 | 0401 | 2 | Capturing MBMS agreements in MAC  | 9.0.0  | 9.1.0  |
|         | RP-46 | RP-091314 | 0403 | 2 | Clarification on BSR trigger  | 9.0.0  | 9.1.0  |
|         | RP-46 | RP-091346 | 0404 | - | Correction on HARQ Process ID for DL SPS and DRX  | 9.0.0  | 9.1.0  |
|         | RP-46 | RP-091314 | 0406 | - | RNTI for CCCH   | 9.0.0  | 9.1.0  |
|         | RP-46 | RP-091346 | 0407 | 1 | SR prohibit mechanism for UL SPS  | 9.0.0  | 9.1.0  |
|         | RP-46 | RP-091346 | 0409 | - | Clarification on monitoring of PDCCH  | 9.0.0  | 9.1.0  |
|         | RP-46 | RP-091346 | 0410 | - | Introduction of SR prohibit timer   | 9.0.0  | 9.1.0  |
| 2010-03 | RP-47 | RP-100305 | 0414 | - | Correction to MBMS scheduling terminology   | 9.1.0  | 9.2.0  |
|         | RP-47 | RP-100305 | 0415 | - | Corrections to TS 36.321 on MBMS  | 9.1.0  | 9.2.0  |
|         | RP-47 | RP-100305 | 0421 | 1 | Error handling for MBMS PDU   | 9.1.0  | 9.2.0  |
|         | RP-47 | RP-100308 | 0422 | - | Renaming CR as consequence of ASN.1 review  | 9.1.0  | 9.2.0  |
| 2010-06 | RP-48 | RP-100536 | 0424 | - | Clarification on UE behaviour w.r.t DRX cycle change and onDurationTimer test (Procedural change) | 9.2.0  | 9.3.0  |
|         | RP-48 | RP-100554 | 0425 | 1 | Correction to MBMS description  | 9.2.0  | 9.3.0  |
|         | RP-48 | RP-100556 | 0426 | - | Correction to PHR triggering  | 9.2.0  | 9.3.0  |
|         | RP-48 | RP-100536 | 0430 | - | Processing of contention resolution message   | 9.2.0  | 9.3.0  |
| 2010-12 | RP-50 | RP-101226 | 0436 | 2 | Introduction of Carrier Aggregation   | 9.3.0  | 10.0.0 |
|         | RP-50 | RP-101228 | 0437 | 1 | Introduction of relays in MAC   | 9.3.0  | 10.0.0 |
|         | RP-50 | RP-101225 | 0447 | - | HARQ operation for UL multiple antenna transmission   | 9.3.0  | 10.0.0 |
| 2011-03 | RP-51 | RP-110280 | 0449 | - | PHR Trigger for Power Reduction Due to Power Management   | 10.0.0 | 10.1.0 |
|         | RP-51 | RP-110289 | 0450 | 1 | Power Headroom Reporting  | 10.0.0 | 10.1.0 |
|         | RP-51 | RP-110289 | 0451 | - | Cancellation of BSR   | 10.0.0 | 10.1.0 |
|         | RP-51 | RP-110289 | 0453 | 1 | Counterproposal to Corrections to the Carrier Aggregation functionality in MAC                    | 10.0.0 | 10.1.0 |
|         | RP-51 | RP-110280 | 0454 | - | Adding a Power Management indication in PHR   | 10.0.0 | 10.1.0 |
|         | RP-51 | RP-110289 | 0457 | 2 | CR on SCell Activation  | 10.0.0 | 10.1.0 |
|         | RP-51 | RP-110289 | 0461 | 2 | Unification of Extended PHR MAC CE formats  | 10.0.0 | 10.1.0 |
|         | RP-51 | RP-110289 | 0465 | 1 | Clarification for CA and TTI bundling in MAC  | 10.0.0 | 10.1.0 |
| 2011-06 | RP-52 | RP-110846 | 0466 | - | CQI reporting and deactivation timer  | 10.1.0 | 10.2.0 |
|         | RP-52 | RP-110846 | 0467 | 2 | Miscellaneous Corrections   | 10.1.0 | 10.2.0 |
|         | RP-52 | RP-110846 | 0468 | - | Pcmax,c reporting for type 2 PH   | 10.1.0 | 10.2.0 |
|         | RP-52 | RP-110848 | 0469 | - | Type-1-triggered SRS transmission independent of DRX  | 10.1.0 | 10.2.0 |
|         | RP-52 | RP-110839 | 0470 | - | UL transmissions when the timeAlignmentTimer is not running                                       | 10.1.0 | 10.2.0 |
|         | RP-52 | RP-110846 | 0478 | 1 | Clarifications to Ci field in MAC CE on CA  | 10.1.0 | 10.2.0 |
|         | RP-52 | RP-110846 | 0488 | - | Clarification of padding BSR behaviour  | 10.1.0 | 10.2.0 |
|         | RP-52 | RP-110834 | 0489 | - | SPS reception in MBSFN subframes  | 10.1.0 | 10.2.0 |
|         | RP-52 | RP-110839 | 0490 | - | Power management related PHR triggering condition   | 10.1.0 | 10.2.0 |
|         | RP-52 | RP-110839 | 0491 | - | Clarifications on PHR Power Management trigger  | 10.1.0 | 10.2.0 |
| 2011-09 | RP-53 | RP-111280 | 0494 | 1 | Clarifications on MCH reception and Stop MTCH   | 10.2.0 | 10.3.0 |
|         | RP-53 | RP-111283 | 0496 | - | Configuration of extendedBSR-sizes  | 10.2.0 | 10.3.0 |
|         | RP-53 | RP-111297 | 0502 | - | CR to 36.321 on Small correction of PHR parameter   | 10.2.0 | 10.3.0 |
|         | RP-53 | RP-111283 | 0503 | 1 | Corrections to PCMAX,c field in Extended PHR  | 10.2.0 | 10.3.0 |
| 2011-12 | RP-54 | RP-111714 | 0516 | 1 | UE soft buffer handling in MAC  | 10.3.0 | 10.4.0 |
|         | RP-54 | RP-111716 | 0523 | - | Correction on determining SPS occasions   | 10.3.0 | 10.4.0 |
|         | RP-54 | RP-111605 | 0526 | 1 | CSI/SRS reporting at DRX state transitions  | 10.3.0 | 10.4.0 |
|         | RP-54 | RP-111606 | 0527 | - | CSI/SRS reporting at unexpected Active Time stopping  | 10.3.0 | 10.4.0 |
| 2012-03 | RP-55 | RP-120321 | 0539 | - | Correction to multiplexing and assembly   | 10.4.0 | 10.5.0 |
| 2012-09 | RP-57 | RP-121395 | 0559 | - | P bit in Extended PHR MAC CE  | 10.5.0 | 10.6.0 |
|         | RP-57 | RP-121395 | 0577 | 1 | Deadlock of PHR transmission  | 10.5.0 | 10.6.0 |
|         | RP-57 | RP-121382 | 0558 | - | Clarification on Measurement Gap  | 10.5.0 | 11.0.0 |
|         | RP-57 | RP-121377 | 0572 | 1 | Introduction of CA Enhancements in MAC  | 10.5.0 | 11.0.0 |
|         | RP-57 | RP-121382 | 0581 | - | Clarification of TA value maintenance at TA timer expiry  | 10.5.0 | 11.0.0 |
| 2012-12 | RP-58 | RP-121936 | 0583 | - | Clarification on DRX for Relay  | 11.0.0 | 11.1.0 |
|         | RP-58 | RP-121936 | 0585 | - | Clarification on V field in Extended PHR MAC CE   | 11.0.0 | 11.1.0 |
|         | RP-58 | RP-121951 | 0586 | 1 | Clarification related to CA enhancement in MAC  | 11.0.0 | 11.1.0 |
|         | RP-58 | RP-121957 | 0588 | - | Clarification of the Note in 5.2  | 11.0.0 | 11.1.0 |
|         | RP-58 | RP-121951 | 0590 | - | TAG Acronym   | 11.0.0 | 11.1.0 |
|         | RP-58 | RP-121951 | 0594 | - | Corrections for CA-enhancement in MAC   | 11.0.0 | 11.1.0 |
|         | RP-58 | RP-121956 | 0599 | - | CR on MAC layer support of ePDCCH   | 11.0.0 | 11.1.0 |

|         |       |           |      |   |   |        |        |
|---------|-------|-----------|------|---|---|--------|--------|
|         | RP-58 | RP-121957 | 0624 | 2 | CR to 36.321 on Annex for DRX Timers  | 11.0.0 | 11.1.0 |
| 2013-03 | RP-59 | RP-130248 | 0629 | 2 | Removing optionality on CSI/SRS transmission during transient state                   | 11.1.0 | 11.2.0 |
|         | RP-59 | RP-130245 | 0630 | - | Clarification on the PDCCH-subframe for half-duplex TDD UE                            | 11.1.0 | 11.2.0 |
|         | RP-59 | RP-130248 | 0649 | - | Draft CR to 36 321 for Clarification of PDCCH-subframe definition in Rel-11           | 11.1.0 | 11.2.0 |
|         | RP-59 | RP-130241 | 0659 | - | Correction for TM10 unicast support in MBSFN subframes                                | 11.1.0 | 11.2.0 |
|         | RP-59 | RP-130291 | 0661 | - | Clarification of DRX timers for TDD   | 11.1.0 | 11.2.0 |
| 2013-06 | RP-60 | RP-130805 | 0663 | 2 | HARQ RTT Timer  | 11.2.0 | 11.3.0 |
|         | RP-60 | RP-130808 | 0664 | - | Clarification on the PDCCH-subframe definition for TDD UE                             | 11.2.0 | 11.3.0 |
|         | RP-60 | RP-130809 | 0665 | - | Correction to the definition of drxRetransmissionTimer                                | 11.2.0 | 11.3.0 |
|         | RP-60 | RP-130809 | 0667 | - | Further issues on removing optionality of CSI/SRS transmission during transient state | 11.2.0 | 11.3.0 |
|         | RP-60 | RP-130804 | 0670 | - | Rel-11 CR on SCell activation timing  | 11.2.0 | 11.3.0 |
| 2013-12 | RP-62 | RP-131989 | 0687 | - | Clarification on the HARQ feedback for SCell activation/deactivation command MAC CE   | 11.3.0 | 11.4.0 |
|         | RP-62 | RP-132002 | 0690 | - | Clarification on Power Headroom MAC CE  | 11.3.0 | 12.0.0 |
| 2014-03 | RP-63 | RP-140355 | 0709 | - | BCCH reception for MBMS on any configured or configurable SCell                       | 12.0.0 | 12.1.0 |
|         | RP-63 | RP-140362 | 0705 | 1 | Long DRX Command MAC Control Element  | 12.0.0 | 12.1.0 |
| 2014-06 | RP-64 | RP-140888 | 0714 | - | Alternative 1: Introduction of FDD/TDD CA into 36.321                                 | 12.1.0 | 12.2.0 |
|         | RP-64 | RP-140884 | 0713 | 1 | Introduction of TDD eTMA  | 12.1.0 | 12.2.0 |
|         | RP-64 | -         | -    | - | Editorial updates   | 12.2.0 | 12.2.1 |
| 2014-09 | RP-65 | RP-141506 | 0732 | 1 | Introduction of low complexity UEs in TS 36.321                                       | 12.2.1 | 12.3.0 |
| 2014-12 | RP-66 | RP-142129 | 0739 | - | Category 0 report in Msg3   | 12.3.0 | 12.4.0 |
|         | RP-66 | RP-142140 | 0749 | - | Correction on DRX Operation   | 12.3.0 | 12.4.0 |
|         | RP-66 | RP-142140 | 0748 | - | Prohibit timer for SR   | 12.3.0 | 12.4.0 |
|         | RP-66 | RP-142135 | 0740 | 1 | Introduction of dual connectivity in MAC  | 12.3.0 | 12.4.0 |
| 2015-03 | RP-67 | RP-150373 | 0751 | - | Clarification on the Logical channel prioritization in DC                             | 12.4.0 | 12.5.0 |
|         | RP-67 | RP-150375 | 0762 | 1 | Introduction of MBMS congestion management for Public Safety Group Call               | 12.4.0 | 12.5.0 |
|         | RP-67 | RP-150374 | 0755 | 1 | Introduction of ProSe in MAC  | 12.4.0 | 12.5.0 |
|         | RP-67 | RP-150371 | 0763 | 2 | Uplink transmission time difference   | 12.4.0 | 12.5.0 |
| 2015-06 | RP-68 | RP-150921 | 0764 | - | SL-DCH transmission for autonomous resource allocation mode                           | 12.5.0 | 12.6.0 |
|         | RP-68 | RP-150921 | 0766 | - | Minor corrections for ProSe   | 12.5.0 | 12.6.0 |
|         | RP-68 | RP-150921 | 0767 | - | Clarification on deactivation operation   | 12.5.0 | 12.6.0 |
|         | RP-68 | RP-150916 | 0768 | - | Handling of erroneous PDU on MCH  | 12.5.0 | 12.6.0 |
|         | RP-68 | RP-150921 | 0769 | - | Corrections on 36.321 for ProSe   | 12.5.0 | 12.6.0 |
|         | RP-68 | RP-150921 | 0772 | - | Correction to the figure of MAC structure overview for sidelink                       | 12.5.0 | 12.6.0 |
|         | RP-68 | RP-150923 | 0782 | - | Prohibit timer for SR   | 12.5.0 | 12.6.0 |
|         | RP-68 | RP-150921 | 0783 | - | Resource selection for SL-DCH   | 12.5.0 | 12.6.0 |
| 2015-09 | RP-69 | RP-151438 | 0799 | 1 | Correction on Type 2 PH reporting   | 12.6.0 | 12.7.0 |
|         | RP-69 | RP-151441 | 0795 | 1 | Corrections for reporting and cancellation of SL BSR                                  | 12.6.0 | 12.7.0 |
|         | RP-69 | RP-151441 | 0785 | 1 | Corrections to Sidelink in MAC  | 12.6.0 | 12.7.0 |
|         | RP-69 | RP-151441 | 0790 | 1 | Miscellaneous corrections on Sidelink   | 12.6.0 | 12.7.0 |

Note: WORD version for TS 36.321 v12.4.0 was changed over from WORD 2003 to WORD 2007. Accordingly, some table formats may be converted due to the impact of compatibility mode but contents in the tables were confirmed to be consistent.

---

## History

| <b>Document history</b> |               |             |
|-------------------------|---------------|-------------|
| V12.2.1                 | October 2014  | Publication |
| V12.3.0                 | October 2014  | Publication |
| V12.4.0                 | February 2015 | Publication |
| V12.5.0                 | April 2015    | Publication |
| V12.6.0                 | July 2015     | Publication |
| V12.7.0                 | October 2015  | Publication |