

ETSI TS 136 323 V16.3.0 (2021-01)



**LTE;
Evolved Universal Terrestrial Radio Access (E-UTRA);
Packet Data Convergence Protocol (PDCP) specification
(3GPP TS 36.323 version 16.3.0 Release 16)**



Reference

RTS/TSGR-0236323vg30

Keywords

LTE

ETSI

650 Route des Lucioles
F-06921 Sophia Antipolis Cedex - FRANCE

Tel.: +33 4 92 94 42 00 Fax: +33 4 93 65 47 16

Siret N° 348 623 562 00017 - NAF 742 C
Association à but non lucratif enregistrée à la
Sous-Préfecture de Grasse (06) N° 7803/88

Important notice

The present document can be downloaded from:

<http://www.etsi.org/standards-search>

The present document may be made available in electronic versions and/or in print. The content of any electronic and/or print versions of the present document shall not be modified without the prior written authorization of ETSI. In case of any existing or perceived difference in contents between such versions and/or in print, the prevailing version of an ETSI deliverable is the one made publicly available in PDF format at www.etsi.org/deliver.

Users of the present document should be aware that the document may be subject to revision or change of status.

Information on the current status of this and other ETSI documents is available at

<https://portal.etsi.org/TB/ETSIDeliverableStatus.aspx>

If you find errors in the present document, please send your comment to one of the following services:

<https://portal.etsi.org/People/CommiteeSupportStaff.aspx>

Copyright Notification

No part may be reproduced or utilized in any form or by any means, electronic or mechanical, including photocopying and microfilm except as authorized by written permission of ETSI.

The content of the PDF version shall not be modified without the written authorization of ETSI.

The copyright and the foregoing restriction extend to reproduction in all media.

© ETSI 2021.

All rights reserved.

DECT™, **PLUGTESTS™**, **UMTS™** and the ETSI logo are trademarks of ETSI registered for the benefit of its Members.

3GPP™ and **LTE™** are trademarks of ETSI registered for the benefit of its Members and of the 3GPP Organizational Partners.

oneM2M™ logo is a trademark of ETSI registered for the benefit of its Members and of the oneM2M Partners.

GSM® and the GSM logo are trademarks registered and owned by the GSM Association.

Intellectual Property Rights

Essential patents

IPRs essential or potentially essential to normative deliverables may have been declared to ETSI. The information pertaining to these essential IPRs, if any, is publicly available for **ETSI members and non-members**, and can be found in ETSI SR 000 314: "*Intellectual Property Rights (IPRs); Essential, or potentially Essential, IPRs notified to ETSI in respect of ETSI standards*", which is available from the ETSI Secretariat. Latest updates are available on the ETSI Web server (<https://ipr.etsi.org/>).

Pursuant to the ETSI IPR Policy, no investigation, including IPR searches, has been carried out by ETSI. No guarantee can be given as to the existence of other IPRs not referenced in ETSI SR 000 314 (or the updates on the ETSI Web server) which are, or may be, or may become, essential to the present document.

Trademarks

The present document may include trademarks and/or tradenames which are asserted and/or registered by their owners. ETSI claims no ownership of these except for any which are indicated as being the property of ETSI, and conveys no right to use or reproduce any trademark and/or tradename. Mention of those trademarks in the present document does not constitute an endorsement by ETSI of products, services or organizations associated with those trademarks.

Legal Notice

This Technical Specification (TS) has been produced by ETSI 3rd Generation Partnership Project (3GPP).

The present document may refer to technical specifications or reports using their 3GPP identities. These shall be interpreted as being references to the corresponding ETSI deliverables.

The cross reference between 3GPP and ETSI identities can be found under <http://webapp.etsi.org/key/queryform.asp>.

Modal verbs terminology

In the present document "**shall**", "**shall not**", "**should**", "**should not**", "**may**", "**need not**", "**will**", "**will not**", "**can**" and "**cannot**" are to be interpreted as described in clause 3.2 of the [ETSI Drafting Rules](#) (Verbal forms for the expression of provisions).

"**must**" and "**must not**" are **NOT** allowed in ETSI deliverables except when used in direct citation.

Contents

Intellectual Property Rights	2
Legal Notice	2
Modal verbs terminology.....	2
Foreword.....	6
1 Scope	7
2 References	7
3 Definitions and abbreviations.....	8
3.1 Definitions	8
3.2 Abbreviations	8
4 General	9
4.1 Introduction	9
4.2 PDCP architecture	9
4.2.1 PDCP structure	9
4.2.2 PDCP entities.....	10
4.3 Services	13
4.3.1 Services provided to upper layers	13
4.3.2 Services expected from lower layers	13
4.4 Functions	14
4.5 Data available for transmission	14
5 PDCP procedures	16
5.1 PDCP Data Transfer Procedures	16
5.1.1 UL Data Transfer Procedures	16
5.1.2 DL Data Transfer Procedures	17
5.1.2.1 Procedures for DRBs.....	17
5.1.2.1.1 Void.....	17
5.1.2.1.2 Procedures for DRBs mapped on RLC AM when the reordering function is not used	17
5.1.2.1.2a RN procedures for DRBs mapped on RLC AM.....	18
5.1.2.1.3 Procedures for DRBs mapped on RLC UM when the reordering function is not used	19
5.1.2.1.3a RN procedures for DRBs mapped on RLC UM.....	19
5.1.2.1.4 Procedures for DRBs mapped on RLC AM or RLC UM, for LWA bearers and SLRB when the reordering function is used	19
5.1.2.1.4.1 Procedures when a PDCP PDU is received from the lower layers	20
5.1.2.1.4.2 Procedures when <i>t-Reordering</i> expires	21
5.1.2.1.4.3 Procedures when the value of <i>t-Reordering</i> is reconfigured.....	22
5.1.2.2 Procedures for SRBs	22
5.1.2.2.1 Procedures for SRBs when the reordering function is not used	22
5.1.2.2.2 Procedures for SRBs when the reordering function is used.....	22
5.1.3 SL Data Transmission Procedures	23
5.1.4 SL Data Reception Procedures	23
5.2 Re-establishment procedure	23
5.2.1 UL Data Transfer Procedures	23
5.2.1.1 Procedures for DRBs mapped on RLC AM.....	23
5.2.1.2 Procedures for DRBs mapped on RLC UM.....	24
5.2.1.3 Procedures for SRBs	24
5.2.2 DL Data Transfer Procedures	25
5.2.2.1 Procedures for DRBs mapped on RLC AM while the reordering function is not used.....	25
5.2.2.1a Procedures for DRBs mapped on RLC AM while the reordering function is used.....	25
5.2.2.2 Procedures for DRBs mapped on RLC UM when the reordering function is not used.....	25
5.2.2.2a Procedures for DRBs mapped on RLC UM when the reordering function is used.....	26
5.2.2.3 Procedures for SRBs	26
5.2.2.4 Procedures for LWA bearers.....	26
5.3 PDCP Status Report	26
5.3.1 Transmit operation.....	26

5.3.2	Receive operation	27
5.4	PDCP discard	27
5.4a	Duplicate PDCP discard	27
5.5	Robust Header Compression and Decompression.....	28
5.5.1	Supported header compression protocols and profiles.....	28
5.5.2	Configuration of ROHC.....	28
5.5.3	Protocol parameters	28
5.5.4	Header compression using ROHC	29
5.5.5	Header decompression using ROHC	29
5.5.6	PDCP Control PDU for interspersed ROHC feedback packet.....	30
5.5.6.1	Transmit Operation	30
5.5.6.2	Receive Operation.....	30
5.6	Ciphering and Deciphering.....	30
5.6.0	General.....	30
5.6.1	SL Ciphering and Deciphering for one-to-many communication.....	30
5.6.2	SL Ciphering and Deciphering for one-to-one communication.....	31
5.6.3	Handling of LWA end-marker PDCP Control PDU.....	31
5.6.3.1	Transmit operation	31
5.6.3.2	Receive Operation.....	31
5.7	Integrity Protection and Verification	32
5.8	Handling of unknown, unforeseen and erroneous protocol data	32
5.9	PDCP Data Recovery procedure	32
5.10	Status report for LWA.....	33
5.10.1	Transmit operation.....	33
5.10.2	LWA status report.....	33
5.10.3	Receive operation	34
5.11	Uplink Data compression and decompression.....	34
5.11.1	UDC protocol.....	34
5.11.2	Configuration of UDC	34
5.11.3	UDC header	34
5.11.4	Uplink data compression	34
5.11.5	Pre-defined dictionary.....	35
5.11.6	UDC buffer reset procedure.....	35
5.11.7	UDC checksum error handling	35
5.12	Uplink data switching.....	35
5.13	PDCP Reconfiguration	35
5.14	Ethernet header compression and decompression	36
5.14.1	Supported header compression protocols	36
5.14.2	Configuration of EHC.....	36
5.14.3	Protocol parameters	36
5.14.4	Header compression using EHC	36
5.14.5	Header decompression using EHC	36
5.14.6	PDCP Control PDU for EHC feedback packet.....	37
5.14.6.1	Transmit Operation	37
5.14.6.2	Receive Operation.....	37
5.14.7	Simultaneous configuration of ROHC and EHC	37
6	Protocol data units, formats and parameters.....	37
6.1	Protocol data units	37
6.1.1	PDCP Data PDU.....	37
6.1.2	PDCP Control PDU	38
6.2	Formats.....	38
6.2.1	General.....	38
6.2.2	Control plane PDCP Data PDU	38
6.2.3	User plane PDCP Data PDU with long PDCP SN (12 bits)	39
6.2.4	User plane PDCP Data PDU with short PDCP SN (7 bits)	39
6.2.5	PDCP Control PDU for interspersed ROHC feedback packet.....	39
6.2.6	PDCP Control PDU for PDCP status report	40
6.2.7	Void	41
6.2.8	RN user plane PDCP Data PDU with integrity protection.....	41
6.2.9	User plane PDCP Data PDU with extended PDCP SN (15 bits).....	41
6.2.10	User plane PDCP Data PDU for SLRB	42

6.2.11	User plane PDCP Data PDU with further extended PDCP SN (18 bits)	43
6.2.12	PDCP Control PDU for LWA status report	43
6.2.13	PDCP Control PDU for LWA end-marker packet	45
6.2.14	User plane PDCP Data PDU with long PDCP SN (12 bits) for UDC	45
6.2.15	User plane PDCP Data PDU with extended PDCP SN (15 bits) for UDC	46
6.2.16	User plane PDCP Data PDU with further extended PDCP SN (18 bits) for UDC	46
6.2.17	PDCP Control PDU for UDC feedback packet.....	46
6.2.18	PDCP Control PDU for EHC feedback packet	47
6.3	Parameters	47
6.3.1	General.....	47
6.3.2	PDCP SN	47
6.3.3	Data.....	47
6.3.4	MAC-I	47
6.3.5	COUNT	48
6.3.6	R	48
6.3.7	D/C.....	48
6.3.8	PDU type	48
6.3.9	FMS	49
6.3.10	Bitmap	49
6.3.11	Interspersed ROHC feedback packet	49
6.3.12	PGK Index	49
6.3.13	PTK Identity	49
6.3.14	SDU Type	49
6.3.15	K _{D-sess} ID	50
6.3.16	NMP.....	50
6.3.17	HRW	50
6.3.18	P	50
6.3.19	LSN.....	50
6.3.21	FU	51
6.3.22	FR	51
6.3.23	Checksum	51
6.3.24	FE.....	51
7	Variables, constants and timers	52
7.1	State variables	52
7.2	Timers	53
7.3	Constants	53
Annex A (informative):	An example of UDC Checksum calculation.....	54
Annex B (informative):	Change history	55
History		57

Foreword

This Technical Specification has been produced by the 3rd Generation Partnership Project (3GPP).

The contents of the present document are subject to continuing work within the TSG and may change following formal TSG approval. Should the TSG modify the contents of the present document, it will be re-released by the TSG with an identifying change of release date and an increase in version number as follows:

Version x.y.z

where:

- x the first digit:
 - 1 presented to TSG for information;
 - 2 presented to TSG for approval;
 - 3 or greater indicates TSG approved document under change control.
- y the second digit is incremented for all changes of substance, i.e. technical enhancements, corrections, updates, etc.
- z the third digit is incremented when editorial only changes have been incorporated in the document.

1 Scope

The present document provides the description of the Packet Data Convergence Protocol (PDCP).

2 References

The following documents contain provisions which, through reference in this text, constitute provisions of the present document.

- References are either specific (identified by date of publication, edition number, version number, etc.) or non specific.
- For a specific reference, subsequent revisions do not apply.
- For a non-specific reference, the latest version applies. In the case of a reference to a 3GPP document (including a GSM document), a non-specific reference implicitly refers to the latest version of that document *in the same Release as the present document*.

- [1] 3GPP TR 21.905: "Vocabulary for 3GPP Specifications".
- [2] 3GPP TS 36.300: "Evolved Universal Terrestrial Radio Access (E-UTRA) and Evolved Universal Terrestrial Radio Access Network (E-UTRAN); Overall description".
- [3] 3GPP TS 36.331: "Evolved Universal Terrestrial Radio Access (E-UTRA) Radio Resource Control (RRC); Protocol Specification".
- [4] 3GPP TS 36.321: "Evolved Universal Terrestrial Radio Access (E-UTRA) Medium Access Control (MAC) protocol specification".
- [5] 3GPP TS 36.322: "Evolved Universal Terrestrial Radio Access (E-UTRA) Radio Link Control (RLC) protocol specification".
- [6] 3GPP TS 33.401: "3GPP System Architecture Evolution: Security Architecture".
- [7] IETF RFC 5795: "The RObust Header Compression (ROHC) Framework".
- [8] IETF RFC 6846: "RObust Header Compression (ROHC): A Profile for TCP/IP (ROHC-TCP)".
- [9] IETF RFC 3095: "RObust Header Compression (ROHC): Framework and four profiles: RTP, UDP, ESP and uncompressed".
- [10] IETF RFC 3843: "RObust Header Compression (ROHC): A Compression Profile for IP".
- [11] IETF RFC 4815: "RObust Header Compression (ROHC): Corrections and Clarifications to RFC 3095".
- [12] IETF RFC 5225: "RObust Header Compression (ROHC) Version 2: Profiles for RTP, UDP, IP, ESP and UDP Lite".
- [13] 3GPP TS 33.303: "Proximity-based Services; Security Aspects".
- [14] 3GPP TS 23.303: "Proximity-based Services; Stage 2".
- [15] 3GPP TS 36.360: "Evolved Universal Terrestrial Radio Access (E-UTRA); LTE-WLAN Aggregation Adaptation Protocol (LWAAP) specification".
- [16] IETF RFC 1951: "DEFLATE Compressed Data Format Specification version 1.3".
- [17] IETF RFC 3485: "The Session Initiation Protocol (SIP) and Session Description Protocol (SDP) Static Dictionary for Signaling Compression (SigComp)".
- [18] IETF RFC 1979: "PPP Deflate Protocol".
- [19] 3GPP TS 38.323: "NR; Packet Data Convergence Protocol (PDCP) protocol specification".

3 Definitions and abbreviations

3.1 Definitions

For the purposes of the present document, the terms and definitions given in TR 21.905 [1] and the following apply. A term defined in the present document takes precedence over the definition of the same term, if any, in TR 21.905 [1].

DAPS bearer: a bearer whose radio protocols are located in both the source eNB and the target eNB during DAPS handover to use both source eNB and target eNB resources.

NB-IoT: NB-IoT allows access to network services via E-UTRA with a channel bandwidth limited to 200 kHz.

Split bearer: in dual connectivity, a bearer whose radio protocols are located in both the MeNB and the SeNB to use both MeNB and SeNB resources.

LWA bearer: in LTE-WLAN Aggregation, a bearer whose radio protocols are located in both the eNB and the WLAN to use both eNB and WLAN resources.

3.2 Abbreviations

For the purposes of the present document, the abbreviations given in TR 21.905 [1] and the following apply. An abbreviation defined in the present document takes precedence over the definition of the same abbreviation, if any, in TR 21.905 [1].

AILC	Assistance Information bit for Local Cache
AM	Acknowledged Mode
ARP	Address Resolution Protocol
CID	Context Identifier
DAPS	Dual Active Protocol Stack
DRB	Data Radio Bearer carrying user plane data
EHC	Ethernet Header Compression
EPS	Evolved Packet System
E-UTRA	Evolved UMTS Terrestrial Radio Access
E-UTRAN	Evolved UMTS Terrestrial Radio Access Network
eNB	E-UTRAN Node B
FIFO	First In First Out
FMS	First missing PDCP SN
HFN	Hyper Frame Number
HRW	Highest Received PDCP SN on WLAN
IETF	Internet Engineering Task Force
IP	Internet Protocol
L2	Layer 2 (data link layer)
L3	Layer 3 (network layer)
LWA	LTE-WLAN Aggregation
MAC	Medium Access Control
MAC-I	Message Authentication Code for Integrity
MCG	Master Cell Group
NB-IoT	Narrow Band Internet of Things
NMP	Number of Missing PDCP SDUs
PDCP	Packet Data Convergence Protocol
PDU	Protocol Data Unit
PEK	ProSe Encryption Key
PGK	ProSe Group Key
ProSe	Proximity-based Services
PTK	ProSe Traffic Key
R	Reserved
RB	Radio Bearer
RFC	Request For Comments
RLC	Radio Link Control
RN	Relay Node

ROHC	RObust Header Compression
RRC	Radio Resource Control
RTP	Real Time Protocol
SAP	Service Access Point
SCG	Secondary Cell Group
SDU	Service Data Unit
SLRB	Sidelink Radio Bearer carrying Sidelink Communication or V2X sidelink communication data
SN	Sequence Number
SRB	Signalling Radio Bearer carrying control plane data
TCP	Transmission Control Protocol
UDC	Uplink Data Compression
UDP	User Datagram Protocol
UE	User Equipment
UM	Unacknowledged Mode
X-MAC	Computed MAC-I

4 General

4.1 Introduction

The present document describes the functionality of the PDCP. Functionality specified for the UE equally applies to the RN for functionality necessary for the RN. There is also functionality which is only applicable to the RN in its communication with the E-UTRAN, in which case the specification denotes the RN instead of the UE. RN-specific behaviour is not applicable to the UE. The functionality specified for the UE applies to communication on Uu interface and PC5 interface [14].

4.2 PDCP architecture

4.2.1 PDCP structure

Figure 4.2.1.1 represents one possible structure for the PDCP sublayer; it should not restrict implementation. The figure is based on the radio interface protocol architecture defined in TS 36.300 [2].

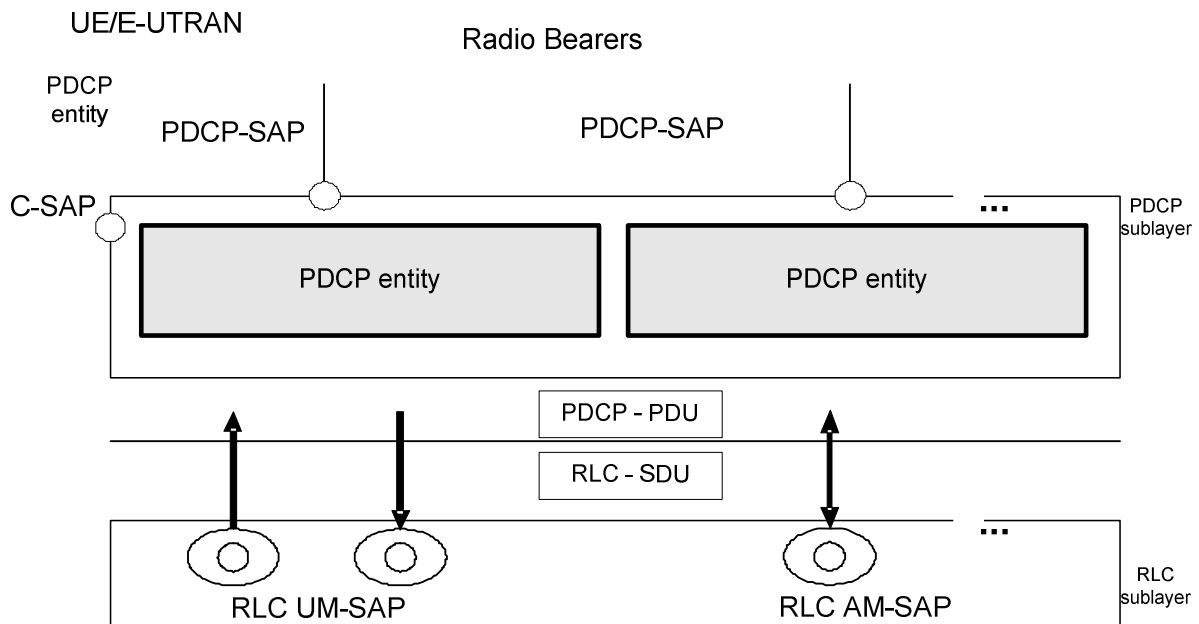

Figure 4.2.1.1 - PDCP layer, structure view

Each RB (i.e. DRB, SLRB and SRB, except for SRB0 and SRB1bis) is associated with one PDCP entity. Each PDCP entity is associated with one, two, or four (e.g uni-directional/bi-directional or split/non-split) RLC entities depending on the RB characteristic (i.e. uni-directional or bi-directional) or RLC mode:

- For split bearers or for RBs configured with PDCP duplication, each PDCP entity is associated with two (bi-directional) AM RLC entities, two (for same direction) UM RLC entities or four (uni-directional) UM RLC entities.
- For LWA bearers, each PDCP entity is associated with one (bi-directional) AM RLC entity or two (uni-directional) UM RLC entities and the LWAAP entity.
- For DAPS bearers, each PDCP entity is associated with two UM RLC entities (for same direction, one for source and one for target cell), four (uni-directional) UM RLC entities (two for each direction on source cell and target cell), or two AM RLC entities (bi-directional, one for source cell and one for target cell).
- Otherwise, each PDCP entity is associated with one UM RLC entity, two UM RLC entities (one for each direction), or one AM RLC entity (bi-directional).

PDCP entities are located in the PDCP sublayer. The PDCP sublayer is configured by upper layers, see TS 36.331 [3].

4.2.2 PDCP entities

The PDCP entities are located in the PDCP sublayer. Several PDCP entities may be defined for a UE. Each PDCP entity carrying user plane data may be configured to use either uplink data compression (UDC) or to use header compression.

Each PDCP entity is carrying the data of one radio bearer. In this version of the specification, the robust header compression protocol (ROHC), Ethernet header compression (EHC), and UDC, are supported. Every PDCP entity uses at most one ROHC, one EHC, or one UDC compressor instance and at most one ROHC, one EHC, or one UDC decompressor instance. For DAPS bearers, the PDCP entity uses at most one ROHC compressor instance (i.e. use the ROHC compressor instance for source cell before uplink data switching, and use the ROHC compressor instance for target cell after uplink data switching) and at most two ROHC decompressor instances. UDC is not supported simultaneously with ROHC or EHC for the same radio bearer. ROHC and EHC are independently configured for the same radio bearer.

A PDCP entity is associated either to the control plane or the user plane depending on which radio bearer it is carrying data for.

Figure 4.2.2.1 represents the functional view of the PDCP entity for the PDCP sublayer; it should not restrict implementation. The figure is based on the radio interface protocol architecture defined in TS 36.300 [2].

For RNs, integrity protection and verification are also performed for the u-plane.

For split and LWA bearers, routing is performed in the transmitting PDCP entity, and reordering is performed in the receiving PDCP entity.

For PDCP duplication, submission of duplicates is performed in the transmitting PDCP entity, and duplicate discard is performed in the receiving PDCP entity.

For split bearers, except when PDCP duplication is configured and activated, when requested by lower layers to submit PDCP PDUs, the transmitting PDCP entity shall:

- if *ul-DataSplitThreshold* is configured and the data available for transmission is larger than or equal to *ul-DataSplitThreshold*:
 - submit the PDCP PDUs to either the associated RLC entity configured for SCG or the associated RLC entity configured for MCG, whichever the PDUs were requested by;
- else:
 - if *ul-DataSplitDRB-ViaSCG* is set to *TRUE* by upper layers, see TS 36.331 [3]:
 - if the PDUs were requested by the associated lower layers configured for SCG:
 - submit the PDCP PDUs to the associated RLC entity configured for SCG;
 - else:
 - if the PDUs were requested by the associated lower layers configured for MCG:
 - submit the PDCP PDUs to the associated RLC entity configured for MCG.

For LWA bearers, when submitting PDCP PDUs to lower layers, the transmitting PDCP entity shall:

- if *ul-LWA-DataSplitThreshold* is configured and the data available for transmission is larger than or equal to *ul-LWA-DataSplitThreshold*:
 - submit the PDCP PDUs to either the associated RLC entity upon request from lower layers or the associated LWAAP entity;
- else:
 - if *ul-LWA-DRB-ViaWLAN* is set to *TRUE* by upper layers, see TS 36.331 [3]:
 - submit the PDCP PDUs to the associated LWAAP entity;
 - else:
 - submit the PDCP PDUs to the associated RLC entity upon request from lower layers.

NOTE: The selection of PDCP PDUs submitted to the associated LWAAP entity is left up to the UE implementation.

For bearers configured with PDCP duplication, when requested by lower layers to submit the PDCP PDUs, the transmitting PDCP entity shall:

- if PDCP duplication is activated:
 - if the PDCP PDU is a PDCP Data PDU:
 - duplicate the PDCP Data PDU and submit the PDCP Data PDU to the associated RLC entities;
 - else:
 - submit the PDCP Control PDU to the primary RLC entity;

- else:
- submit the PDCP PDU to the associated RLC entity.

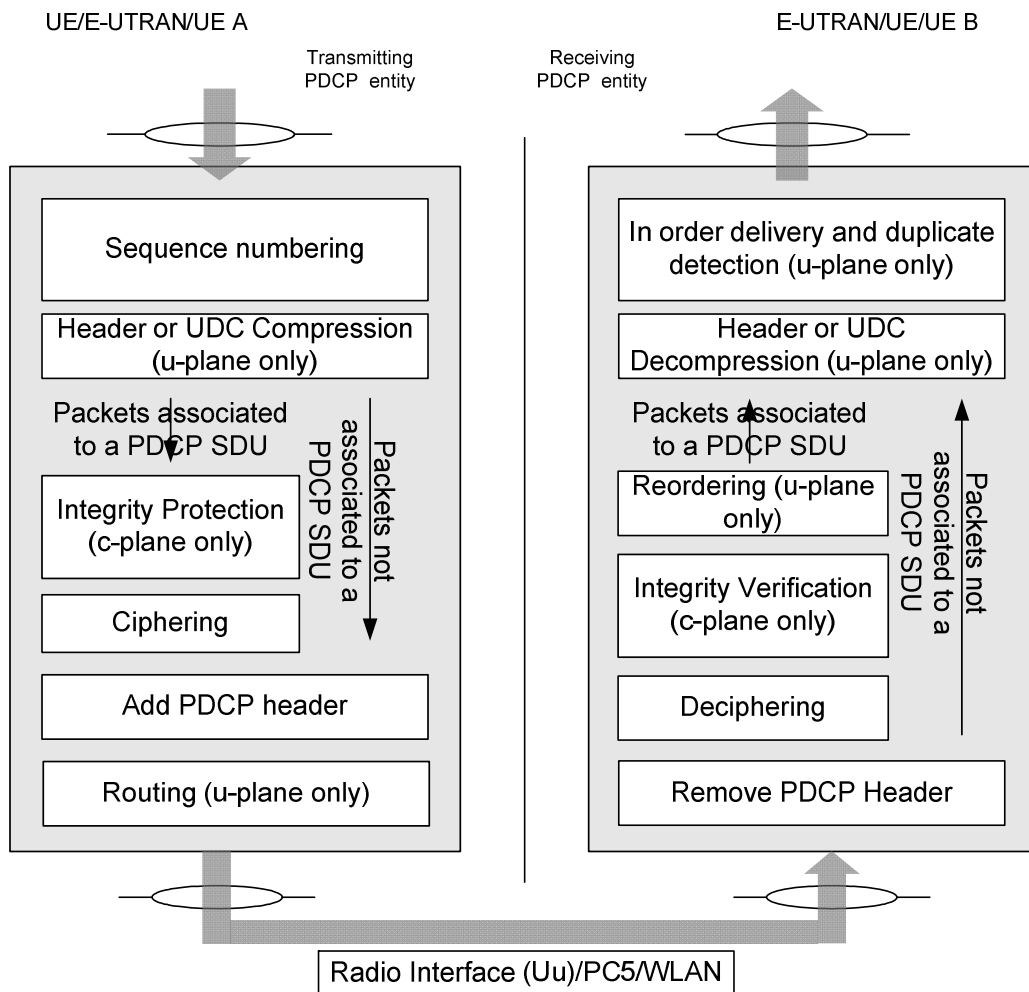

Figure 4.2.2.1 - PDCP layer, functional view

Figure 4.2.2.2 represents the functional view of the PDCP entity associated with the DAPS bearer for the PDCP sublayer; it should not restrict implementation. The figure is based on the radio interface protocol architecture defined in TS 36.300 [2].

For DAPS bearers, the PDCP entity is configured with two sets of ciphering functions and keys and two sets of header compression protocols.

For DAPS bearers, routing is performed in the transmitting PDCP entity, and reordering is performed in the receiving PDCP entity.

For DAPS bearers, when submitting PDCP PDUs to lower layers, the transmitting PDCP entity shall:

- if the uplink data switching has not been requested by upper layers:
 - submit the PDCP PDU to the RLC entity associated with the source cell;
- else:
 - if the PDCP PDU is a PDCP Data PDU:
 - submit the PDCP Data PDU to the RLC entity associated with the target cell;
 - else:

- if the PDCP Control PDU is associated with source cell:
 - submit the PDCP Control PDU to the RLC entity associated with the source cell;
- else:
 - submit the PDCP Control PDU to the RLC entity associated with the target cell.

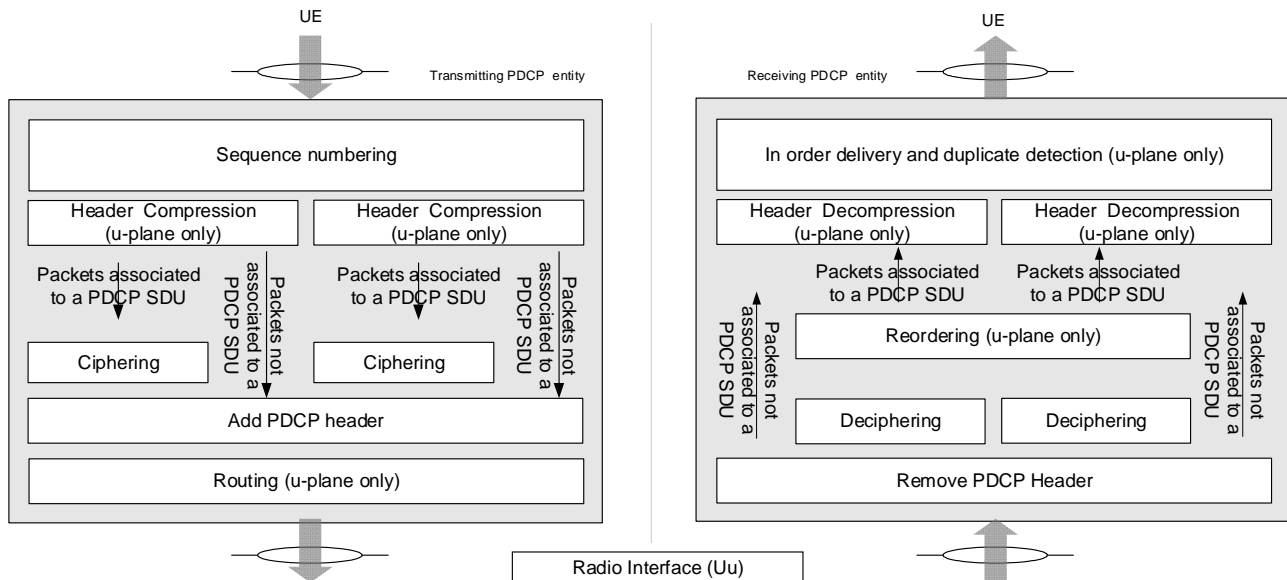

Figure 4.2.2.2: PDCP layer associated with DAPS bearer, functional view

4.3 Services

4.3.1 Services provided to upper layers

PDCP provides its services to the RRC and user plane upper layers at the UE or to the relay at the evolved Node B (eNB). The following services are provided by PDCP to upper layers:

- transfer of user plane data;
- transfer of control plane data;
- header compression;
- uplink data compression;
- ciphering;
- integrity protection.

The maximum supported size of a PDCP SDU is 8188 octets, except in NB-IoT for which the maximum supported size of a PDCP SDU is 1600 octets. The maximum supported size of a PDCP Control PDU is 8188 octets except in NB-IoT for which the maximum supported size of PDCP Control PDU is 1600 octets.

4.3.2 Services expected from lower layers

A PDCP entity expects the following services from lower layers per RLC entity (for a detailed description see TS 36.322 [5]):

- acknowledged data transfer service, including indication of successful delivery of PDCP PDUs;
- unacknowledged data transfer service;

- in-sequence delivery, except at re-establishment of lower layers;
- duplicate discarding, except at re-establishment of lower layers.

A PDCP entity expects the following services from the LWAAP entity (for a detailed description see TS 36.360 [15]):

- user plane data transfer service;

4.4 Functions

The Packet Data Convergence Protocol supports the following functions:

- header compression and decompression of IP data flows using the ROHC protocol;
- header compression and decompression of Ethernet data flows using the EHC protocol;
- compression and decompression of uplink PDCP SDU;
- transfer of data (user plane or control plane);
- maintenance of PDCP SNs;
- in-sequence delivery of upper layer PDUs at re-establishment of lower layers;
- duplicate elimination of lower layer SDUs at re-establishment of lower layers for radio bearers mapped on RLC AM;
- ciphering and deciphering of user plane data and control plane data;
- integrity protection and integrity verification of control plane data;
- integrity protection and integrity verification of sidelink one-to-one communication data;
- for RNs, integrity protection and integrity verification of user plane data;
- timer based discard;
- duplicate transmission and duplicate discarding;
- for split and LWA bearers, routing and reordering;
- for DAPS bearers, routing and reordering.

PDCP uses the services provided by the RLC sublayer and the LWAAP sublayer.

PDCP is used for SRBs, DRBs, and SLRBs mapped on DCCH, DTCH, and STCH type of logical channels. PDCP is not used for any other type of logical channels. PDCP is not used for SRB1bis. DAPS PDCP is only used for DAPS DRB.

4.5 Data available for transmission

For the purpose of MAC buffer status reporting, the UE shall consider PDCP Control PDUs, as well as the following as data available for transmission in the PDCP layer:

For SDUs for which no PDU has been submitted to lower layers:

- the SDU itself, if the SDU has not yet been processed by PDCP, or
- the PDU if the SDU has been processed by PDCP.

In addition, for radio bearers that are mapped on RLC AM, if the PDCP entity has previously performed the re-establishment procedure, the UE shall also consider the following as data available for transmission in the PDCP layer:

For SDUs for which a corresponding PDU has only been submitted to lower layers prior to the PDCP re-establishment, starting from the first SDU for which the delivery of the corresponding PDUs has not been

confirmed by the lower layer, except the SDUs which are indicated as successfully delivered by the PDCP status report, if received:

- the SDU, if it has not yet been processed by PDCP, or
- the PDU once it has been processed by PDCP.

For radio bearers that are mapped on RLC AM, if the PDCP entity has previously performed the data recovery procedure, the UE shall also consider as data available for transmission in the PDCP layer, all the PDCP PDUs that have only been submitted to re-established AM RLC entity prior to the PDCP data recovery, starting from the first PDCP PDU whose successful delivery has not been confirmed by lower layers, except the PDUs which are indicated as successfully delivered by the PDCP status report, if received.

In addition, for bearers configured with PDCP duplication, when PDCP duplication is activated, for SDUs for which a PDU has only been submitted to lower layers associated with one logical channel, for the purpose of MAC buffer status reporting associated with the other logical channel the UE shall consider:

- the PDU, if the PDU has not yet been confirmed to be successfully delivered by those lower layers.

For split bearers, when indicating the data available for transmission to a MAC entity for BSR triggering and Buffer Size calculation, the UE shall:

- if *ul-DataSplitThreshold* is configured and the data available for transmission is larger than or equal to *ul-DataSplitThreshold*:
 - indicate the data available for transmission to both the MAC entity configured for SCG and the MAC entity configured for MCG;
- else:
 - if *ul-DataSplitDRB-ViaSCG* is set to *TRUE* by upper layer, see TS 36.331 [3]:
 - indicate the data available for transmission to the MAC entity configured for SCG only;
 - if *ul-DataSplitThreshold* is configured, indicate the data available for transmission as 0 to the MAC entity configured for MCG;
 - else:
 - indicate the data available for transmission to the MAC entity configured for MCG only;
 - if *ul-DataSplitThreshold* is configured, indicate the data available for transmission as 0 to the MAC entity configured for SCG.

For uplink LWA bearers, when indicating the data available for transmission to the MAC entity for BSR triggering and Buffer Size calculation, the UE shall:

- if *ul-LWA-DataSplitThreshold* is configured and the data available for transmission is larger than or equal to *ul-LWA-DataSplitThreshold*:
 - indicate the data available for transmission to the MAC entity;
- else:
 - if *ul-LWA-DRB-ViaWLAN* is set to *TRUE* by upper layers, see TS 36.331 [3]:
 - indicate the data available for transmission as 0 to the MAC entity;
 - else:
 - indicate the data available for transmission to the MAC entity.

NOTE: For LWA bearers, only the data that may be sent over LTE (i.e., excluding UL data already sent or decided to be sent over WLAN) is considered as "data available for transmission".

For bearers configured with PDCP duplication, when indicating the data available for transmission to a MAC entity for BSR triggering and Buffer Size calculation, the UE shall:

- if PDCP duplication is activated:
 - indicate the data available for transmission to the MAC entity associated with the primary RLC entity and (if different) the MAC entity associated with the secondary RLC entity.
- else:
 - if the two associated RLC entities belong to the different cell groups:
 - if *ul-DataSplitThreshold* is configured and the data available for transmission is larger than or equal to *ul-DataSplitThreshold*:
 - indicate the data available for transmission to both the MAC entity configured for SCG and the MAC entity configured for MCG.
 - else:
 - if *ul-DataSplitDRB-ViaSCG* is set to *TRUE* by upper layer, see TS 36.331 [3]:
 - indicate the data available for transmission to the MAC entity configured for SCG only;
 - if *ul-DataSplitThreshold* is configured, indicate the data available for transmission as 0 to the MAC entity configured for MCG.
 - else:
 - indicate the data available for transmission to the MAC entity configured for MCG only;
 - if *ul-DataSplitThreshold* is configured, indicate the data available for transmission as 0 to the MAC entity configured for SCG.
 - else:
 - indicate the data available for transmission to the MAC entity.

For DAPS bearers, when indicating the data available for transmission to the MAC entity for BSR triggering and Buffer Size calculation, the UE shall:

- if the uplink data switching has not been requested by upper layers:
 - indicate the data available for transmission to the MAC entity associated with the source cell;
- else:
 - indicate the data available for transmission excluding the PDCP Control PDU for interspersed ROHC feedback associated with the source cell to the MAC entity associated with the target cell;
 - indicate the data available for transmission of PDCP Control PDU for interspersed ROHC feedback associated with the source cell to the MAC entity associated with the source cell.

5 PDCP procedures

5.1 PDCP Data Transfer Procedures

5.1.1 UL Data Transfer Procedures

At reception of a PDCP SDU from upper layers, the UE shall:

- start the *discardTimer* associated with this PDCP SDU (if configured);

For a PDCP SDU received from upper layers, the UE shall:

- associate the PDCP SN corresponding to *Next_PDCP_TX_SN* to this PDCP SDU;

NOTE: Associating more than half of the PDCP SN space of contiguous PDCP SDUs with PDCP SNs, when e.g., the PDCP SDUs are discarded or transmitted without acknowledgement, may cause HFN desynchronization problem. How to prevent HFN desynchronization problem is left up to UE implementation.

- perform header compression of the PDCP SDU (if configured) using ROHC as specified in the clause 5.5.4 and/or using EHC as specified in the clause 5.14.4;
- perform compression of the uplink PDCP SDU (if configured) as specified in the clause 5.11.4;
- perform integrity protection (if applicable), and ciphering (if applicable) using COUNT based on TX_HFN and the PDCP SN associated with this PDCP SDU as specified in the clause 5.7 and 5.6, respectively;
- increment Next_PDCP_TX_SN by one;
- if Next_PDCP_TX_SN > Maximum_PDCP_SN:
 - set Next_PDCP_TX_SN to 0;
 - increment TX_HFN by one;
- if PDCP duplication is activated for the corresponding bearer:
 - submit a duplicate of the resulting PDCP Data PDU to lower layer.
- submit the resulting PDCP Data PDU to lower layer.

5.1.2 DL Data Transfer Procedures

5.1.2.1 Procedures for DRBs

5.1.2.1.1 Void

5.1.2.1.2 Procedures for DRBs mapped on RLC AM when the reordering function is not used

For DRBs mapped on RLC AM, when the reordering function is not used, at reception of a PDCP Data PDU from lower layers, the UE shall:

- if received PDCP SN – Last_Submitted_PDCP_RX_SN > Reordering_Window or $0 \leq \text{Last_Submitted_PDCP_RX_SN} - \text{received PDCP SN} < \text{Reordering_Window}$:
 - if received PDCP SN > Next_PDCP_RX_SN:
 - decipher the PDCP PDU as specified in the clause 5.6, using COUNT based on RX_HFN - 1 and the received PDCP SN;
 - else:
 - decipher the PDCP PDU as specified in the clause 5.6, using COUNT based on RX_HFN and the received PDCP SN;
 - perform header decompression (if configured) using ROHC as specified in the clause 5.5.5 and/or using EHC as specified in the clause 5.14.5;
 - discard this PDCP SDU;
- else if Next_PDCP_RX_SN – received PDCP SN > Reordering_Window:
 - increment RX_HFN by one;
 - use COUNT based on RX_HFN and the received PDCP SN for deciphering the PDCP PDU;
 - set Next_PDCP_RX_SN to the received PDCP SN + 1;

- else if received PDCP SN – Next_PDCP_RX_SN >= Reordering_Window:
 - use COUNT based on RX_HFN – 1 and the received PDCP SN for deciphering the PDCP PDU;
- else if received PDCP SN >= Next_PDCP_RX_SN:
 - use COUNT based on RX_HFN and the received PDCP SN for deciphering the PDCP PDU;
 - set Next_PDCP_RX_SN to the received PDCP SN + 1;
 - if Next_PDCP_RX_SN is larger than Maximum_PDCP_SN:
 - set Next_PDCP_RX_SN to 0;
 - increment RX_HFN by one;
- else if received PDCP SN < Next_PDCP_RX_SN:
 - use COUNT based on RX_HFN and the received PDCP SN for deciphering the PDCP PDU;
- if the PDCP PDU has not been discarded in the above:
 - perform deciphering (if configured) for the PDCP PDU as specified in the clauses 5.6;
 - perform header decompression (if configured) for the PDCP PDU using ROHC as specified in the clause 5.5.5 and/or using EHC as specified in the clause 5.14.5;
 - if a PDCP SDU with the same PDCP SN is stored:
 - discard this PDCP SDU;
 - else:
 - store the PDCP SDU;
 - if the PDCP PDU received by PDCP is not due to the re-establishment of lower layers:
 - deliver to upper layers in ascending order of the associated COUNT value:
 - all stored PDCP SDU(s) with an associated COUNT value less than the COUNT value associated with the received PDCP SDU;
 - all stored PDCP SDU(s) with consecutively associated COUNT value(s) starting from the COUNT value associated with the received PDCP SDU;
 - set Last_Submitted_PDCP_RX_SN to the PDCP SN of the last PDCP SDU delivered to upper layers;.
 - else if received PDCP SN = Last_Submitted_PDCP_RX_SN + 1 or received PDCP SN = Last_Submitted_PDCP_RX_SN – Maximum_PDCP_SN:
 - deliver to upper layers in ascending order of the associated COUNT value:
 - all stored PDCP SDU(s) with consecutively associated COUNT value(s) starting from the COUNT value associated with the received PDCP SDU;
 - set Last_Submitted_PDCP_RX_SN to the PDCP SN of the last PDCP SDU delivered to upper layers.

5.1.2.1.2a RN procedures for DRBs mapped on RLC AM

For DRBs mapped on RLC AM, at reception of a PDCP Data PDU from lower layers, the RN should follow the procedures specified for a UE in 5.1.2.1.2 with the addition that for DRBs for which integrity verification is configured, the RN should, immediately after performing deciphering as specified in 5.6, also perform integrity verification as specified in 5.7 with the same COUNT value as used for deciphering.

In case of integrity verification failure, the RN should discard the PDCP Data PDU without performing header decompression and without delivering any stored PDCP SDU(s) to upper layers. The RN should also set the RX_HFN,

Next_PDCP_RX_SN and Last_Submitted_PDCP_RX_SN to the respective values they had before the reception of the PDCP Data PDU.

5.1.2.1.3 Procedures for DRBs mapped on RLC UM when the reordering function is not used

For DRBs mapped on RLC UM, at reception of a PDCP Data PDU from lower layers, the UE shall:

- if received PDCP SN < Next_PDCP_RX_SN:
 - increment RX_HFN by one;
- decipher the PDCP Data PDU using COUNT based on RX_HFN and the received PDCP SN as specified in the clause 5.6;
- set Next_PDCP_RX_SN to the received PDCP SN + 1;
- if Next_PDCP_RX_SN > Maximum_PDCP_SN:
 - set Next_PDCP_RX_SN to 0;
 - increment RX_HFN by one;
- perform header decompression (if configured) of the deciphered PDCP Data PDU using ROHC as specified in the clause 5.5.5 and/or using EHC as specified in the clause 5.14.5;
- deliver the resulting PDCP SDU to upper layer.

5.1.2.1.3a RN procedures for DRBs mapped on RLC UM

For DRBs mapped on RLC UM, at reception of a PDCP Data PDU from lower layers, the RN should follow the procedures specified for a UE in 5.1.2.1.3 with the addition that for DRBs for which integrity verification is configured, the RN should, immediately after performing deciphering as specified in 5.6, also perform integrity verification as specified in 5.7 with the same COUNT value as used for deciphering.

In case of integrity verification failure, the RN should discard the PDCP Data PDU without performing header decompression and set the RX_HFN and Next_PDCP_RX_SN to the respective values they had before the reception of the PDCP Data PDU.

5.1.2.1.4 Procedures for DRBs mapped on RLC AM or RLC UM, for LWA bearers and SLRB when the reordering function is used

For DRBs mapped on RLC AM and RLC UM, for LWA bearers and when PDCP duplication is used, the PDCP entity shall use the reordering function as specified in this clause when:

- the PDCP entity is associated with two RLC entities; or
- the PDCP entity is configured for a LWA bearer; or
- the PDCP entity is associated with one AM RLC entity after it was, according to the most recent reconfiguration, associated with two AM RLC entities or configured for a LWA bearer without performing PDCP re-establishment; or
- the PDCP entity is configured with PDCP duplication; or
- the PDCP entity is reconfigured to configure DAPS; or
- the PDCP entity is associated with at least one RLC entity configured with *rlc-OutOfOrderDelivery*.

For SLRBs mapped on RLC UM, the PDCP entity shall use the reordering function as specified in this clause when:

- the PDCP entity receives a PDCP SN which is not "0".

The PDCP entity shall not use the reordering function in other cases.

5.1.2.1.4.1 Procedures when a PDCP PDU is received from the lower layers

For DRBs mapped on RLC AM or RLC UM, SLRB and for LWA bearers, or for DRBs and SRBs when PDCP duplication is used, when the reordering function is used, at reception of a PDCP Data PDU from lower layers, the UE shall:

- if received PDCP SN – Last_Submitted_PDCP_RX_SN > Reordering_Window or $0 \leq \text{Last_Submitted_PDCP_RX_SN} - \text{received PDCP SN} < \text{Reordering_Window}$:
 - if the PDCP PDU was received on WLAN:
 - if received PDCP SN > Next_PDCP_RX_SN:
 - for the purpose of setting the HRW field in the LWA status report, use COUNT based on RX_HFN - 1 and the received PDCP SN;
 - else:
 - for the purpose of setting the HRW field in the LWA status report, use COUNT based on RX_HFN and the received PDCP SN;
 - if received PDCP SN > Next_PDCP_RX_SN:
 - decipher the PDCP PDU as specified in the clause 5.6, and perform integrity verification of the PDCP Data PDU (if applicable) using COUNT based on RX_HFN - 1 and the received PDCP SN.
 - else:
 - decipher the PDCP PDU as specified in the clause 5.6, and perform integrity verification of the PDCP Data PDU (if applicable) using COUNT based on RX_HFN and the received PDCP SN.
 - if integrity verification fails:
 - indicate the integrity verification failure to upper layer.
 - discard the PDCP PDU;
- else if Next_PDCP_RX_SN – received PDCP SN > Reordering_Window:
 - increment RX_HFN by one;
 - use COUNT based on RX_HFN and the received PDCP SN for deciphering and integrity verification (if applicable) of the PDCP PDU;
 - set Next_PDCP_RX_SN to the received PDCP SN + 1;
- else if received PDCP SN – Next_PDCP_RX_SN \geq Reordering_Window:
 - use COUNT based on RX_HFN – 1 and the received PDCP SN for deciphering and integrity verification (if applicable) of the PDCP PDU.
- else if received PDCP SN \geq Next_PDCP_RX_SN:
 - use COUNT based on RX_HFN and the received PDCP SN for deciphering and integrity verification (if applicable) of the PDCP PDU;
 - set Next_PDCP_RX_SN to the received PDCP SN + 1;
 - if Next_PDCP_RX_SN is larger than Maximum_PDCP_SN:
 - set Next_PDCP_RX_SN to 0;
 - increment RX_HFN by one.
- else if received PDCP SN < Next_PDCP_RX_SN:
 - use COUNT based on RX_HFN and the received PDCP SN for deciphering and integrity verification of the PDCP PDU;

- if the PDCP PDU has not been discarded in the above:
 - if a PDCP SDU with the same PDCP SN is stored:
 - perform deciphering and integrity verification (if applicable) of the PDCP PDU;
 - if integrity verification fails:
 - indicate the integrity verification failure to upper layer.
 - discard the PDCP PDU;
 - else:
 - perform deciphering and integrity verification (if applicable) of the PDCP PDU and store the resulting PDCP SDU;
 - if integrity verification fails:
 - indicate the integrity verification failure to upper layer;
 - discard the PDCP Data PDU.
- if the PDCP PDU has not been discarded in the above:
 - if received PDCP SN = Last_Submitted_PDCP_RX_SN + 1 or received PDCP SN = Last_Submitted_PDCP_RX_SN – Maximum_PDCP_SN:
 - deliver to upper layers in ascending order of the associated COUNT value after performing header decompression (if configured) using ROHC as specified in the clause 5.5.5 and/or using EHC as specified in the clause 5.14.5:
 - all stored PDCP SDU(s) with consecutively associated COUNT value(s) starting from the COUNT value associated with the received PDCP PDU;
 - set Last_Submitted_PDCP_RX_SN to the PDCP SN of the last PDCP SDU delivered to upper layers;
 - if *t-Reordering* is running:
 - if the PDCP SDU with Reordering_PDCP_RX_COUNT – 1 has been delivered to upper layers:
 - stop and reset *t-Reordering*;
 - if *t-Reordering* is not running (includes the case when *t-Reordering* is stopped due to actions above):
 - if there is at least one stored PDCP SDU:
 - start *t-Reordering*;
 - set Reordering_PDCP_RX_COUNT to the COUNT value associated to RX_HFN and Next_PDCP_RX_SN.

5.1.2.1.4.2 Procedures when *t-Reordering* expires

When *t-Reordering* expires, the UE shall:

- deliver to upper layers in ascending order of the associated COUNT value after performing header decompression (if configured) using ROHC as specified in the clause 5.5.5 and/or using EHC as specified in the clause 5.14.5:
 - all stored PDCP SDU(s) with associated COUNT value(s) less than Reordering_PDCP_RX_COUNT;
 - all stored PDCP SDU(s) with consecutively associated COUNT value(s) starting from Reordering_PDCP_RX_COUNT;
- set Last_Submitted_PDCP_RX_SN to the PDCP SN of the last PDCP SDU delivered to upper layers;

- if there is at least one stored PDCP SDU:
 - start *t-Reordering*;
 - set Reordering_PDCP_RX_COUNT to the COUNT value associated to RX_HFN and Next_PDCP_RX_SN.

5.1.2.1.4.3 Procedures when the value of *t-Reordering* is reconfigured

When the value of the *t-Reordering* is reconfigured by upper layers while the *t-Reordering* is running, the UE shall:

- stop and restart *t-Reordering*;
- set Reordering_PDCP_RX_COUNT to the COUNT value associated to RX_HFN and Next_PDCP_RX_SN.

5.1.2.2 Procedures for SRBs

5.1.2.2.1 Procedures for SRBs when the reordering function is not used

For SRBs, at reception of a PDCP Data PDU from lower layers, the UE shall:

- if received PDCP SN < Next_PDCP_RX_SN:
 - decipher and verify the integrity of the PDU (if applicable) using COUNT based on RX_HFN + 1 and the received PDCP SN as specified in the clauses 5.6 and 5.7, respectively;
- else:
 - decipher and verify the integrity of the PDU (if applicable) using COUNT based on RX_HFN and the received PDCP SN as specified in the clauses 5.6 and 5.7, respectively;
- if integrity verification is applicable and the integrity verification is passed successfully; or
- if integrity verification is not applicable:
 - if received PDCP SN < Next_PDCP_RX_SN:
 - increment RX_HFN by one;
 - set Next_PDCP_RX_SN to the received PDCP SN + 1;
 - if Next_PDCP_RX_SN > Maximum_PDCP_SN:
 - set Next_PDCP_RX_SN to 0;
 - increment RX_HFN by one;
 - deliver the resulting PDCP SDU to upper layer;
- else, if integrity verification is applicable and the integrity verification fails:
 - discard the received PDCP Data PDU;
 - indicate the integrity verification failure to upper layer.

5.1.2.2.2 Procedures for SRBs when the reordering function is used

For SRBs, the PDCP entity shall use the reordering function when:

- the PDCP entity is configured with PDCP duplication.

For SRBs, when the reordering function is used, at reception of a PDCP Data PDU from lower layers, the UE shall follow the procedures in clause 5.1.2.1.4.1.

5.1.3 SL Data Transmission Procedures

For Sidelink transmission of the SLRB for which *SL-V2X-TxProfile* is not configured or configured as *rel14*, see TS 36.331 [3], the UE shall follow the procedures in clause 5.1.1 with following modifications:

- the requirement for maintaining Next_PDCP_TX_SN is not applicable;
- determine a PDCP SN ensuring that a PDCP SN value is not reused with the same key;
- perform ciphering (if configured) as specified in clause 5.6.1 and 5.6.2;
- perform the header compression (if configured) using ROHC if SDU Type is set to 000, i.e. IP SDUs.

For sidelink transmission of the SLRBs for which the indicated *SL-V2X-TxProfile* is *rel15*, see TS 36.331 [3], the UE shall follow the procedures in clause 5.1.1 with following modifications compared to above Sidelink transmission procedure:

- the requirement for maintaining Next_PDCP_TX_SN is applicable;
- for the SLRBs associated to packets which have PPPR value lower than the configured PPPR threshold *threshSL-Reliability*, see TS 36.331 [3], the PDCP entity duplicates the PDCP PDUs, and submits the PDCP PDUs to both associated RLC entities.

For sidelink transmission, the requirement for maintaining TX_HFN is not applicable.

5.1.4 SL Data Reception Procedures

For Sidelink reception, the UE shall follow the procedures in clause 5.1.2.1.3 with following modifications, except if it receives a PDCP SN which is not "0":

- the requirements for maintaining Next_PDCP_RX_SN and RX_HFN are not applicable;
- perform the deciphering (if configured) as specified in clause 5.6.1 and 5.6.2;
- perform the header decompression (if configured) using ROHC if SDU Type is set to 000, i.e. IP SDUs.

Otherwise, if the UE receives a PDCP SN which is not "0", the Sidelink reception of the UE shall follow the procedures in clause 5.1.2.1.4.1 with following modifications compared to above Sidelink reception procedure:

- the requirements for maintaining Next_PDCP_RX_SN and RX_HFN are applicable;
- perform the re-ordering procedure as specified in clause 5.1.2.1.4.1.

5.2 Re-establishment procedure

When upper layers request a PDCP re-establishment, the UE shall additionally perform once the procedures described in this clause for the corresponding RLC mode. After performing the procedures in this clause, the UE shall follow the procedures in clause 5.1.

5.2.1 UL Data Transfer Procedures

For LWA bearers, the UE shall use the procedures corresponding to the associated RLC entity below.

5.2.1.1 Procedures for DRBs mapped on RLC AM

When upper layers request a PDCP re-establishment, the UE shall:

- reset the ROHC protocol for uplink and start with an IR state in U-mode (if configured) [9] [11], except if upper layers indicate stored UE AS context is used and *drb-ContinueROHC* is configured, see TS 36.331 [3];
- reset the EHC protocol for uplink (if configured) if *drb-ContinueEHC-UL* is not configured, see TS 36.331 [3];

- reset the compression buffer to all zeros (if configured) and prefill the dictionary (if configured) as specified in clause 5.11.5;
- if connected as an RN, apply the integrity protection algorithm and key provided by upper layers (if configured) during the re-establishment procedure;
- if upper layers indicate stored UE AS context is used, set Next_PDCP_TX_SN, and TX_HFN to 0;
- apply the ciphering algorithm and key provided by upper layers during the re-establishment procedure;
- for LWA bearers, consider all PDCP SDUs submitted to the LWAAP entity as successfully delivered;
- from the first PDCP SDU for which the successful delivery of the corresponding PDCP PDU has not been confirmed by lower layers, perform retransmission or transmission of all the PDCP SDUs already associated with PDCP SNs in ascending order of the COUNT values associated to the PDCP SDU prior to the PDCP re-establishment as specified below:
 - perform header compression of the PDCP SDU (if configured) using ROHC as specified in the clause 5.5.4 and/or using EHC as specified in the clause 5.14.4;
 - perform compression of the uplink PDCP SDU (if configured) as specified in the clause 5.11.4;
 - if connected as an RN, perform integrity protection (if configured) of the PDCP SDU using the COUNT value associated with this PDCP SDU as specified in the clause 5.7;
 - perform ciphering of the PDCP SDU using the COUNT value associated with this PDCP SDU as specified in the clause 5.6;
 - submit the resulting PDCP Data PDU to lower layer. If PDCP duplication is activated, duplicate the resulting PDCP Data PDUs and submit the PDCP Data PDUs to both associated RLC entities.

5.2.1.2 Procedures for DRBs mapped on RLC UM

When upper layers request a PDCP re-establishment, the UE shall:

- reset the ROHC protocol for uplink and start with an IR state in U-mode [9] [11] if the DRB is configured with the ROHC protocol and *drb-ContinueROHC* is not configured, see TS 36.331 [3];
- reset the EHC protocol for uplink (if configured) if *drb-ContinueEHC-UL* is not configured, see TS 36.331 [3];
- set Next_PDCP_TX_SN, and TX_HFN to 0;
- apply the ciphering algorithm and key provided by upper layers during the re-establishment procedure;
- if connected as an RN, apply the integrity protection algorithm and key provided by upper layers (if configured) during the re-establishment procedure;
- for each PDCP SDU already associated with a PDCP SN but for which a corresponding PDU has not previously been submitted to lower layers:
 - consider the PDCP SDUs as received from upper layer;
 - perform transmission of the PDCP SDUs in ascending order of the COUNT value associated to the PDCP SDU prior to the PDCP re-establishment, as specified in the clause 5.1.1 without restarting the *discardTimer*.

5.2.1.3 Procedures for SRBs

When upper layers request a PDCP re-establishment, the UE shall:

- set Next_PDCP_TX_SN, and TX_HFN to 0;
- discard all stored PDCP SDUs and PDCP PDUs;
- apply the ciphering and integrity protection algorithms and keys provided by upper layers during the re-establishment procedure.

5.2.2 DL Data Transfer Procedures

5.2.2.1 Procedures for DRBs mapped on RLC AM while the reordering function is not used

When upper layers request a PDCP re-establishment while the reordering function is not used, the UE shall:

- process the PDCP Data PDUs that are received from lower layers due to the re-establishment of the lower layers, as specified in the clause 5.1.2.1.2;
- reset the ROHC protocol for downlink and start with NC state in U-mode (if configured) [9] [11], except if upper layers indicate stored UE AS context is used and *drb-ContinueROHC* is configured, see TS 36.331 [3];
- reset the EHC protocol for downlink (if configured) if *drb-ContinueEHC-DL* is not configured, see TS 36.331 [3];
- if upper layers indicate stored UE AS context is used, set Next_PDCP_RX_SN, RX_HFN to 0 and Last_submitted_PDCP_RX_SN to Maximum_PDCP_SN;
- apply the ciphering algorithm and key provided by upper layers during the re-establishment procedure.
- if connected as an RN, apply the integrity protection algorithm and key provided by upper layers (if configured) during the re-establishment procedure.

5.2.2.1a Procedures for DRBs mapped on RLC AM while the reordering function is used

When upper layers request a PDCP re-establishment while the reordering function is used, the UE shall:

- process the PDCP Data PDU(s) that are received from lower layers due to the re-establishment of the lower layers, as specified in the clause 5.1.2.1.4;
- if the PDCP entity is to be associated with one AM RLC entity after PDCP re-establishment:
 - stop and reset *t-Reordering*;
- if the PDCP entity is associated with at least one RLC entity configured with *rlc-OutOfOrderDelivery*:
 - perform header decompression (if configured) using EHC for all stored PDCP SDUs if *drb-ContinueEHC-DL* is not configured in TS 36.331 [3];
 - reset the EHC protocol for downlink (if configured) if *drb-ContinueEHC-DL* is not configured, see TS 36.331 [3];
- apply the ciphering algorithm and key provided by upper layers during the re-establishment procedure.

5.2.2.2 Procedures for DRBs mapped on RLC UM when the reordering function is not used

When upper layers request a PDCP re-establishment, the UE shall:

- process the PDCP Data PDUs that are received from lower layers due to the re-establishment of the lower layers, as specified in the clause 5.1.2.1.3;
- reset the ROHC protocol for downlink and start with NC state in U-mode [9] [11] if the DRB is configured with the ROHC protocol and *drb-ContinueROHC* is not configured, see TS 36.331 [3];
- reset the EHC protocol for downlink (if configured) if *drb-ContinueEHC-DL* is not configured, see TS 36.331 [3];
- set Next_PDCP_RX_SN, and RX_HFN to 0;
- apply the ciphering algorithm and key provided by upper layers during the re-establishment procedure.

- if connected as an RN, apply the integrity protection algorithm and key provided by upper layers (if configured) during the re-establishment procedure.

5.2.2.2a Procedures for DRBs mapped on RLC UM when the reordering function is used

When upper layers request a PDCP re-establishment when the reordering function is used, the UE shall:

- process the PDCP Data PDUs that are received from lower layers due to the re-establishment of the lower layers, as specified in the clause 5.1.2.1.4;
- stop and reset *t-Reordering*, if running;
- deliver all stored PDCP SDUs, if any, to upper layers in ascending order of associated COUNT values;
- if the PDCP entity is associated with at least one RLC entity configured with *rlc-OutOfOrderDelivery*:
 - reset the EHC protocol for downlink (if configured) if *drb-ContinueEHC-DL* is not configured, see TS 36.331 [3];
- set Next_PDCP_RX_SN, and RX_HFN to 0 and Last_submitted_PDCP_RX_SN to Maximum_PDCP_SN;
- apply the ciphering algorithm and key provided by upper layers during the re-establishment procedure.

5.2.2.3 Procedures for SRBs

When upper layers request a PDCP re-establishment, the UE shall:

- discard the PDCP Data PDUs that are received from lower layers due to the re-establishment of the lower layers;
- set Next_PDCP_RX_SN, and RX_HFN to 0;
- discard all stored PDCP SDUs and PDCP PDUs;
- apply the ciphering and integrity protection algorithms and keys provided by upper layers during the re-establishment procedure.

5.2.2.4 Procedures for LWA bearers

When upper layers request a PDCP re-establishment, the UE shall:

- process the PDCP Data PDUs that are received from lower layers due to the re-establishment of the lower layers, as specified in the clause 5.1.2.1.4;
- stop and reset *t-Reordering*, if running;
- if the PDCP entity is associated with UM RLC entity:
 - deliver all stored PDCP SDUs, if any, to upper layers in ascending order of associated COUNT values;
 - set Next_PDCP_RX_SN, RX_HFN to 0 and Last_submitted_PDCP_RX_SN to Maximum_PDCP_SN;
- apply the ciphering algorithm and key provided by upper layers during the re-establishment procedure.

5.3 PDCP Status Report

5.3.1 Transmit operation

When upper layers request a PDCP re-establishment or PDCP Data Recovery; or when PDCP status report is triggered by polling or periodic reporting; or when PDCP status report is triggered by WLAN Connection Status Reporting of temporary unavailability (*suspended*, see TS 36.331 [3]); or when upper layers request uplink data switching during DAPS handover, or when upper layers reconfigure the PDCP entity to release DAPS and *daps-SourceRelease* is

configured in TS 36.331 [3], for radio bearers that are mapped on RLC AM, or when upper layers request uplink data switching during DAPS handover for radio bearers that are mapped on RLC UM, the UE shall:

- if the radio bearer is configured by upper layers to send a PDCP status report in the uplink (*statusReportRequired*, see TS 36.331 [3]) or the status report is triggered by PDCP status report polling or PDCP periodic status reporting or the status report is triggered by WLAN Connection Status Reporting of temporary unavailability (*suspended*, see TS 36.331 [3]) when *wlan-SuspendTriggersStatusReport* is configured, see TS 36.331 [3], compile a status report as indicated below after processing the PDCP Data PDUs that are received from lower layers due to the re-establishment of the lower layers as specified in the clause 5.2.2.1, and submit it to lower layers as the first PDCP PDU for the transmission, by:
 - setting the FMS field to the PDCP SN of the first missing PDCP SDU;
 - if there is at least one out-of-sequence PDCP SDU stored, allocating a Bitmap field of length in bits equal to the number of PDCP SNs from and not including the first missing PDCP SDU up to and including the last out-of-sequence PDCP SDUs, rounded up to the next multiple of 8, or up to and including a PDCP SDU for which the resulting PDCP Control PDU size is equal to 8188 bytes, whichever comes first;
 - setting as '0' in the corresponding position in the bitmap field for all PDCP SDUs that have not been received as indicated by lower layers, and optionally PDCP SDUs for which decompression have failed;
 - indicating in the bitmap field as '1' for all other PDCP SDUs.

5.3.2 Receive operation

When a PDCP status report is received in the downlink, for radio bearers that are mapped on RLC AM:

- for each PDCP SDU, if any, with the bit in the bitmap set to '1', or with the associated COUNT value less than the COUNT value of the PDCP SDU identified by the FMS field, the successful delivery of the corresponding PDCP SDU is confirmed, and the UE shall process the PDCP SDU as specified in the clause 5.4.

PDCP status report receive operation is not applicable in NB-IoT.

5.4 PDCP discard

When the *discardTimer* expires for a PDCP SDU, or the successful delivery of a PDCP SDU is confirmed by PDCP status report or LWA status report, the UE shall discard the PDCP SDU along with the corresponding PDCP PDU. If the corresponding PDCP PDU has already been submitted to lower layers, the discard is indicated to lower layers.

NOTE: For split and LWA bearers, discarding a PDCP SDU already associated with a PDCP SN causes a SN gap in the transmitted PDCP PDUs, which increases PDCP reordering delay in the receiving PDCP entity. It is up to UE implementation how to minimize SN gap after SDU discard.

5.4a Duplicate PDCP discard

For the transmitting PDCP entity associated with two RLC entities, the transmitting PDCP entity shall:

- if the successful delivery of a PDCP Data PDU is confirmed by one of the two associated RLC entities:
 - discard the PDCP Data PDU and indicate to the other RLC entity to discard the duplicated PDCP Data PDU.
- if the deactivation of PDCP duplication is indicated:
 - if the two associated RLC entities belong to the different cell groups:
 - if *ul-DataSplitDRB-ViaSCG* is set to TRUE by upper layer, see TS 36.331 [3]:
 - indicate to the MCG RLC entity to discard all duplicated PDCP Data PDUs.
 - else:
 - indicate to the SCG RLC entity to discard all duplicated PDCP Data PDUs.

- else:
 - indicate to the secondary RLC entity to discard all duplicated PDCP Data PDUs.

5.5 Robust Header Compression and Decompression

5.5.1 Supported header compression protocols and profiles

The ROHC protocol is based on the Robust Header Compression (ROHC) framework [7]. There are multiple ROHC algorithms, called profiles, defined for the ROHC framework. Each profile is specific to the particular network layer, transport layer or upper layer protocol combination e.g. TCP/IP and RTP/UDP/IP.

The detailed definition of the ROHC channel is specified as part of the ROHC framework in RFC 5795 [7]. This includes how to multiplex different flows (header compressed or not) over the ROHC channel, as well as how to associate a specific IP flow with a specific context state during initialization of the compression algorithm for that flow.

The implementation of the functionality of the ROHC framework and of the functionality of the supported ROHC profiles is not covered in this specification.

In this version of the specification the support of the following profiles is described:

Table 5.5.1.1: Supported ROHC protocols and profiles

Profile Identifier	Usage:	Reference
0x0000	No compression	RFC 5795
0x0001	RTP/UDP/IP	RFC 3095, RFC 4815
0x0002	UDP/IP	RFC 3095, RFC 4815
0x0003	ESP/IP	RFC 3095, RFC 4815
0x0004	IP	RFC 3843, RFC 4815
0x0006	TCP/IP	RFC 6846
0x0101	RTP/UDP/IP	RFC 5225
0x0102	UDP/IP	RFC 5225
0x0103	ESP/IP	RFC 5225
0x0104	IP	RFC 5225

5.5.2 Configuration of ROHC

PDCP entities associated with DRBs can be configured by upper layers, see TS 36.331 [3] to use ROHC either bidirectional (if *headerCompression* is configured) or uplink-only (if *uplinkOnlyHeaderCompression* is configured). If *uplinkOnlyHeaderCompression* is configured, the UE shall process the received PDCP Control PDU for interspersed ROHC feedback packet corresponding to the uplink ROHC as specified in clause 5.5.6.2, but shall not perform ROHC for the received PDCP Data PDU. PDCP entities associated with SLRBs can be configured to use ROHC for IP SDUs.

5.5.3 Protocol parameters

RFC 5795 has configuration parameters that are mandatory and that must be configured by upper layers between compressor and decompressor peers [7]; these parameters define the ROHC channel. The ROHC channel is a unidirectional channel, i.e. there is one channel for the downlink, and one for the uplink if *headerCompression* is configured, and there is only one channel for the uplink if *uplinkOnlyHeaderCompression* is configured. There is thus

one set of parameters for each channel, and the same values shall be used for both channels belonging to the same PDCP entity if *headerCompression* is configured.

These parameters are categorized in two different groups, as defined below:

- M: Mandatory and configured by upper layers.
- N/A: Not used in this specification.

The usage and definition of the parameters shall be as specified below.

- MAX_CID (M): This is the maximum CID value that can be used. One CID value shall always be reserved for uncompressed flows. The parameter MAX_CID is configured by upper layers (*maxCID*, see TS 36.331 [3]).
- LARGE_CIDS: This value is not configured by upper layers, but rather it is inferred from the configured value of MAX_CID according to the following rule:

If MAX_CID > 15 then LARGE_CIDS = TRUE else LARGE_CIDS = FALSE.
- PROFILES (M): Profiles are used to define which profiles are allowed to be used by the UE. The list of supported profiles is described in clause 5.5.1. The parameter PROFILES is configured by upper layers (*profiles* for uplink and downlink, *rohc-Profiles* in *SL-Preconfiguration* or *SL-V2X-Preconfiguration* for sidelink, see TS 36.331 [3]).
- FEEDBACK_FOR (N/A): This is a reference to the channel in the opposite direction between two compression endpoints and indicates to what channel any feedback sent refers to. Feedback received on one ROHC channel for this PDCP entity shall always refer to the ROHC channel in the opposite direction for this same PDCP entity.
- MRRU (N/A): ROHC segmentation is not used.

5.5.4 Header compression using ROHC

The ROHC protocol generates two types of output packets:

- ROHC compressed packets, each associated with one PDCP SDU
- standalone packets not associated with a PDCP SDU, i.e. interspersed ROHC feedback packets

A ROHC compressed packet is associated with the same PDCP SN and COUNT value as the related PDCP SDU.

For DAPS bearers, the PDCP entity shall perform the header compression for the PDCP SDU using the ROHC protocol either configured for the source cell or configured for the target cell, based on to which cell the PDCP SDU is transmitted.

Interspersed ROHC feedback packets are not associated with a PDCP SDU. They are not associated with a PDCP SN and are not ciphered.

NOTE 1: If the MAX_CID number of ROHC contexts are already established for the compressed flows and a new IP flow does not match any established ROHC context, the compressor should associate the new IP flow with one of the ROHC CIDs allocated for the existing compressed flows or send PDCP SDUs belonging to the IP flow as uncompressed packet.

NOTE 2: For downlink, the ROHC protocol of the target cell should maintain the IR state if operating in U-mode and O-mode during DAPS handover before release of source cell.

5.5.5 Header decompression using ROHC

If ROHC is configured by upper layers for PDCP entities associated with u-plane data the PDCP PDUs are decompressed by the ROHC protocol after performing deciphering as explained in the clause 5.6.

For DAPS bearers, the PDCP entity shall perform the header decompression for the PDCP SDU using the ROHC protocol either configured for the source cell or configured for the target cell, based on from which cell the PDCP SDU is received.

5.5.6 PDCP Control PDU for interspersed ROHC feedback packet

5.5.6.1 Transmit Operation

When an interspersed ROHC feedback packet is generated by the ROHC protocol, the UE shall:

- submit to lower layers the corresponding PDCP Control PDU as specified in clause 6.2.5 i.e. without associating a PDCP SN, nor performing ciphering.

5.5.6.2 Receive Operation

At reception of a PDCP Control PDU for interspersed ROHC feedback packet from lower layers, the UE shall:

- deliver the corresponding interspersed ROHC feedback packet to the associated header compression protocol without performing deciphering.

5.6 Ciphering and Deciphering

5.6.0 General

The ciphering function includes both ciphering and deciphering and is performed in PDCP. For the control plane, the data unit that is ciphered is the data part of the PDCP PDU (see clause 6.3.3) and the MAC-I (see clause 6.3.4). For the user plane, the data unit that is ciphered is the data part of the PDCP PDU (see clause 6.3.3); ciphering is not applicable to PDCP Control PDUs.

For RNs, for the user plane, in addition to the data part of the PDCP PDU, the MAC-I (see 6.3.4) is also ciphered if integrity protection is configured.

The ciphering algorithm and key to be used by the PDCP entity are configured by upper layers, see TS 36.331 [3] and the ciphering method shall be applied as specified in TS 33.401 [6].

The ciphering function is activated/suspended/resumed by upper layers (TS 36.331 [3]). When security is activated and not suspended, the ciphering function shall be applied to all PDCP PDUs indicated by upper layers, see TS 36.331 [3], for the downlink and the uplink, respectively.

NOTE: Security is suspended upon connection suspension (and resumed upon connection resumption).

For DAPS bearers, the PDCP entity shall perform the ciphering or deciphering for the PDCP SDU using the ciphering algorithm and key either configured for the source cell or configured for the target cell, based on to/from which cell the PDCP SDU is transmitted/received.

For downlink and uplink ciphering and deciphering, the parameters that are required by PDCP for ciphering are defined in TS 33.401 [6] and are input to the ciphering algorithm. The required inputs to the ciphering function include the COUNT value, and DIRECTION (direction of the transmission: set as specified in TS 33.401 [6]). The parameters required by PDCP which are provided by upper layers, see TS 36.331 [3], are listed below:

- BEARER (defined as the radio bearer identifier in TS 33.401 [6]. It will use the value RB identity –1 as in TS 36.331 [3]);
- KEY (the ciphering keys for the control plane and for the user plane are $K_{RRCCenc}$ and K_{UPenc} , respectively).

5.6.1 SL Ciphering and Deciphering for one-to-many communication

For SLRB used for one-to-many communication, the ciphering function includes both ciphering and deciphering and is performed in PDCP as defined in TS 33.303 [13]. The data unit that is ciphered is the data part of the PDCP PDU (see clause 6.3.3). The ciphering function as specified in TS 33.401 [6] is applied with KEY (PEK), COUNT (derived from PTK Identity and PDCP SN as specified in TS 33.303 [13]), BEARER and DIRECTION (set to 0) as input. The ciphering function is configured by ProSe Function.

If ciphering is configured, the ciphering algorithm and related parameters including PGK, PGK Identity, and Group Member Identity are configured to the UE by ProSe Key Management Function. The UE shall set PTK Identity based

on PGK, PGK Identity, and PDCP SN as specified in TS 33.303 [13]. The UE shall derive PTK from PGK using PTK Identity and Group Member Identity, and derive PEK from PTK using the ciphering algorithm. The PGK Index, PTK Identity, and PDCP SN are included in the PDCP PDU header.

If ciphering is not configured, PGK Index and PTK Identity shall be set to "0" in the PDCP PDU header.

If ciphering is not configured, for the SLRB for which *SL-V2X-TxProfile* is not configured or configured as *rel14* (see TS 36.331 [3]), PDCP SN shall be set to "0" in the PDCP PDU header.

If ciphering is not configured, for the SLRB of which the indicated *SL-V2X-TxProfile* is *rel15* (see TS 36.331 [3]), PDCP SN shall not be set to "0" in the PDCP PDU header.

5.6.2 SL Ciphering and Deciphering for one-to-one communication

For SLRB used for one-to-one communication, the ciphering function includes both ciphering and deciphering and is performed in PDCP of SLRB that needs ciphering and deciphering as defined in TS 33.303 [13]. The data unit that is ciphered is the data part of the PDCP PDU (see clause 6.3.3). The ciphering function as specified in TS 33.401 [6] is applied with KEY (PEK), COUNT (derived from $K_{D\text{-sess}}$ Identity and PDCP SN as specified in TS 33.303 [13]), BEARER and DIRECTION (which value shall be set is specified in TS 33.303 [13]) as input.

For the SLRB that needs ciphering and deciphering, the UE shall derive the KEY (PEK) based on $K_{D\text{-sess}}$ and the algorithms determined by the initiating UE and the receiving UE as specified in TS 33.303 [13]. The $K_{D\text{-sess}}$ Identity and PDCP SN are included in the PDCP PDU header.

For the SLRB that does not need ciphering and deciphering, the UE shall set $K_{D\text{-sess}}$ Identity to "0" in the PDCP PDU header.

5.6.3 Handling of LWA end-marker PDCP Control PDU

5.6.3.1 Transmit operation

When upper layers request a PDCP re-establishment for a LWA bearer mapped on RLC AM where LWA configuration is retained with the same WT (*handoverWithoutWT-Change*, see TS 36.331 [3]), the UE shall:

- compile a LWA end-marker PDCP Control PDU by setting the LSN field to the PDCP SN of the last PDCP Data PDU for which the PDCP SN has been associated, and submit it to lower layers as the next PDCP PDU for the transmission after the PDCP Data PDU corresponding to LSN has been submitted to lower layers;

NOTE 1: Whether to submit the LWA end-marker PDCP Control PDU to RLC entity or LWAAP entity is left up to the UE implementation.

NOTE 2: The UE is expected to ensure the successful transmission of the LWA end-marker PDCP Control PDU e.g., using repeated transmission of the same LWA end-marker PDCP Control PDU.

- start using the key provided by upper layers during the re-establishment procedure for the ciphering of the data part of the uplink PDCP PDUs with associated COUNT values above the COUNT value corresponding to LSN.

5.6.3.2 Receive Operation

When upper layers request a PDCP re-establishment for a LWA bearer mapped on RLC AM where LWA configuration is retained with the same WT (*handoverWithoutWT-Change*, see TS 36.331 [3]), after the LWA end-marker PDCP Control PDU is received, the UE shall start using the key provided by upper layers during the re-establishment procedure for the deciphering of the data part of downlink PDCP PDUs with associated COUNT values above the COUNT value corresponding to LSN.

NOTE 1: If PDCP re-establishment is completed before the LWA end-marker PDCP Control PDU is received, the behaviour is left up to UE implementation.

NOTE 2: After the LWA end-marker PDCP Control PDU is received, the handling of PDCP PDUs with associated COUNT values up to and including the COUNT value corresponding to LSN is left up to the UE implementation.

5.7 Integrity Protection and Verification

The integrity protection function includes both integrity protection and integrity verification and is performed in PDCP for PDCP entities associated with SRBs and the SLRB that needs integrity protection. The data unit that is integrity protected is the PDU header and the data part of the PDU before ciphering.

For RNs, the integrity protection function is performed also for PDCP entities associated with DRBs if integrity protection is configured.

The integrity protection algorithm and key to be used by the PDCP entity are configured by upper layers, see TS 36.331 [3] and the integrity protection method shall be applied as specified in TS 33.401 [6].

The integrity protection function is activated/suspended/resumed by upper layers, see TS 36.331 [3]. When security is activated and not suspended, the integrity protection function shall be applied to all PDUs including and subsequent to the PDU indicated by upper layers, see TS 36.331 [3], for the downlink and the uplink, respectively.

NOTE: As the RRC message which activates the integrity protection function is itself integrity protected with the configuration included in this RRC message, this message needs first be decoded by RRC before the integrity protection verification could be performed for the PDU in which the message was received.

For downlink and uplink integrity protection and verification, the parameters that are required by PDCP for integrity protection are defined in TS 33.401 [6] and are input to the integrity protection algorithm. The required inputs to the integrity protection function include the COUNT value, and DIRECTION (direction of the transmission: set as specified in TS 33.401 [6]). The parameters required by PDCP which are provided by upper layers, see TS 36.331 [3], are listed below:

- BEARER (defined as the radio bearer identifier in TS 33.401 [6]. It will use the value RB identity –1 as in TS 36.331 [3]);
- KEY (K_{RRCint}).
- for RNs, KEY (K_{UPint})

For the SLRB that needs integrity protection and verification, the parameters that are required by PDCP for integrity protection are defined in TS 33.401 [6] and are input to the integrity protection algorithm. The required inputs to the integrity protection function include the COUNT value and DIRECTION (which value shall be set is specified in TS 33.303 [13]). The parameters required by PDCP which are provided by upper layers, see TS 36.331 [3] are listed below:

- BEARER (defined as the radio bearer identifier in TS 33.401 [6]);
- KEY (PIK).

At transmission, the UE computes the value of the MAC-I field and at reception it verifies the integrity of the PDCP PDU by calculating the X-MAC based on the input parameters as specified above. If the calculated X-MAC corresponds to the received MAC-I, integrity protection is verified successfully.

5.8 Handling of unknown, unforeseen and erroneous protocol data

When a PDCP entity receives a PDCP PDU that contains reserved or invalid values, the PDCP entity shall:

- discard the received PDU.

5.9 PDCP Data Recovery procedure

When upper layers request a PDCP Data Recovery for a radio bearer, the UE shall:

- if the radio bearer is configured by upper layers to send a PDCP status report in the uplink (*statusReportRequired*, see TS 36.331 [3]), compile a status report as described in clause 5.3.1, and submit it to lower layers as the first PDCP PDU for the transmission;

- perform retransmission of all the PDCP PDUs previously submitted to re-established AM RLC entity in ascending order of the associated COUNT values from the first PDCP PDU for which the successful delivery has not been confirmed by lower layers.

After performing the above procedures, the UE shall follow the procedures in clause 5.1.1.

5.10 Status report for LWA

5.10.1 Transmit operation

When PDCP Data PDU with polling bit P set to 1 is received, the UE shall:

- if configured to send the PDCP status report in response to polling (*statusPDU-TypeForPolling* is configured and set to *type1*, see TS 36.331 [3])
 - compile and transmit the PDCP status report as specified in clause 5.3.1;
- else if configured to send the LWA status report in response to polling (*statusPDU-TypeForPolling* is configured and set to *type2*, see TS 36.331 [3])
 - compile and transmit the LWA status report as specified in clause 5.10.2.

When *t-StatusReportType1* expires, the UE shall:

- compile and transmit the PDCP status report as specified in clause 5.3.1,
- start *t-StatusReportType1* with value *statusPDU-Periodicity-Type1*;

When *t-StatusReportType2* expires, the UE shall:

- compile and transmit the LWA status report as specified in clause 5.10.2,
- start *t-StatusReportType2* with value *statusPDU-Periodicity-Type2*;

When *t-StatusReportType1* is configured or reconfigured by upper layers, the UE shall:

- stop *t-StatusReportType1*, if running;
- start *t-StatusReportType1* with value *statusPDU-Periodicity-Type1*;

When *t-StatusReportType2* is configured or reconfigured by upper layers, the UE shall:

- stop *t-StatusReportType2*, if running;
- if *statusPDU-Periodicity-Offset* is configured by upper layers:
 - start *t-StatusReportType2* with value *statusPDU-Periodicity-Type2* plus *statusPDU-Periodicity-Offset*;
- else:
 - start *t-StatusReportType2* with value *statusPDU-Periodicity-Type2*;

When periodic PDCP status report becomes disabled by upper layers, the UE shall:

- stop *t-StatusReportType1*, if running;
- stop *t-StatusReportType2*, if running;

5.10.2 LWA status report

When LWA status report is triggered, the UE shall:

- compile a status report as indicated below, and submit it to lower layers as the first PDCP PDU for the transmission, by:

- setting the FMS field to the PDCP SN of the first missing PDCP SDU;
- setting the HRW field to the PDCP SN of the PDCP SDU received on WLAN with highest PDCP COUNT value or to FMS if no PDCP SDUs have been received on WLAN;
- setting the NMP field to the number of missing PDCP SDU(s) as described in 6.3.16.

5.10.3 Receive operation

When a LWA status report is received in the downlink:

- for each PDCP SDU, if any, with the associated COUNT value less than the COUNT value of the PDCP SDU identified by the FMS field, the successful delivery of the corresponding PDCP SDU is confirmed, and the UE shall process the PDCP SDU as specified in 5.4.

5.11 Uplink Data compression and decompression

5.11.1 UDC protocol

The UDC protocol is based on IETF RFC 1951 (DEFLATE Compressed Data Format Specification) [16].

Static Huffman coding tree defined in [16] is used as the DEFLATE compression strategy.

UDC Data Block should be byte-alignment. Z_SYNC_FLUSH is used as the DEFLATE byte-alignment with corresponding reference [18], wherein the fixed last four bytes, 0x00 0x00 0xFF 0xFF, are removed before transmission.

5.11.2 Configuration of UDC

The PDCP entities associated with DRBs can be configured by upper layers, see TS 36.331 [3], to use UDC. If UDC is configured, the UE shall apply UDC compression function (details see clause 5.11.4) to process the received PDCP SDU from upper layers corresponding to the configured DRB. The size of compression buffer is configured by upper layer via *bufferSize*. If pre-defined dictionary is configured by upper layers, the UE shall prefill the configured pre-defined dictionary in the compression buffer upon configuration of UDC. If pre-defined dictionary is not configured by upper layers, UE shall set the compression buffer to all zeros.

5.11.3 UDC header

UDC header (1 byte) is added in UDC compression function followed by UDC data block (details see clause 5.11.4, 6.2.14, 6.2.15 and 6.2.16). The UDC header contains the information about whether the current PDCP SDU is compressed by UDC protocol or not. Only the compressed packets are stored in the buffer. The UDC header also contains a reset bit to inform the decompressor that the compression buffer has been reset. The validation bits (checksum) of the compression buffer are also contained in UDC header. Checksum mechanism could be used to resolve miss-match (if any) between the compression and de-compression buffers.

5.11.4 Uplink data compression

The UDC protocol generates UDC packets, each associated with one PDCP SDU.

A UDC packet consists of a UDC header and a UDC data block. A UDC data block contains either DEFLATE compressed blocks generated from the original PDCP SDU by UDC protocol or original PDCP SDU for SDU not compressed by UDC protocol; the type is specified in FU field (details see clause 6.3.21) in UDC header. The FR field (details see clause 6.3.22) and the Checksum field (details see clause 6.3.23) in UDC header are used only if FU field is set to 1.

A UDC packet is associated with the same PDCP SN and COUNT values as the related PDCP SDU.

5.11.5 Pre-defined dictionary

One standard dictionary for SIP and SDP and one operator defined dictionary can be used as pre-defined dictionaries in UDC. The standard dictionary for SIP and SDP consists of the first 3468 bytes of the dictionary for SigComp defined in RFC 3485 [17]. When UDC is configured, at most one dictionary, configured by upper layers, is put into the tail of the compression buffer. Also, the compression buffer acts as a FIFO and hence the content of the dictionary is to be totally pushed out of the compression buffer after the size of transmitted uncompressed packets compressed by UDC exceeds the compression buffer size. If the size of dictionary is larger than the compression buffer size, only the tail of the dictionary is inserted in the compression buffer.

5.11.6 UDC buffer reset procedure

UDC works on the condition that compression buffer and de-compression buffer are synchronized. UDC buffer reset mechanism is to resynchronize buffer when error is detected. For resynchronization, UE shall reset the compression buffer to all zeros. After performing the reset, the FR field (details see clause 6.3.22) in UDC header of the first compressed PDU shall be set to 1.

5.11.7 UDC checksum error handling

UDC checksum error notification PDCP control PDU indicates the compression buffer and de-compression buffer are out of synchronization. When receiving the notification, the UE shall trigger UDC buffer reset procedure to resynchronize the compression buffer.

5.12 Uplink data switching

For DAPS bearers, when upper layers request uplink data switching, the transmitting PDCP entity shall:

- for DRBs mapped on RLC AM, from the first PDCP SDU for which the successful delivery of the corresponding PDCP Data PDU has not been confirmed by the RLC entity associated with the source cell, perform retransmission or transmission of all the PDCP SDUs already associated with PDCP SNs in ascending order of the COUNT values associated to the PDCP SDU prior to uplink data switching to the RLC entity associated with the target cell as specified below:
 - perform header compression of the PDCP SDU using ROHC as specified in the clause 5.5.4;
 - perform ciphering of the PDCP SDU using the COUNT value associated with this PDCP SDU as specified in the clause 5.6;
 - submit the resulting PDCP Data PDU to lower layer.
- for DRBs mapped on RLC UM, for each PDCP SDU already associated with a PDCP SN but for which a corresponding PDU has not previously been submitted to lower layers, perform transmission of PDCP SDU in ascending order of the COUNT values to the RLC entity associated with the target cell as specified below:
 - perform header compression of the PDCP SDU using ROHC as specified in the clause 5.5.4;
 - perform ciphering of the PDCP SDU using the COUNT value associated with this PDCP SDU as specified in the clause 5.6;
 - submit the resulting PDCP Data PDU to lower layer.

5.13 PDCP Reconfiguration

When upper layers reconfigure the PDCP entity to configure DAPS, the UE shall:

- establish a ciphering function for the radio bearer and apply the ciphering algorithm and key provided by upper layers for the ciphering function;
- establish a header compression protocol for the radio bearer and apply the header compression configuration provided by upper layers for the header compression protocol.

When upper layers reconfigure the PDCP entity to release DAPS, the UE shall:

- release the ciphering function associated to the released RLC entity for the radio bearer;
- release the header compression protocol associated to the released RLC entity for the radio bearer.

NOTE 1: The state variables which control the transmission and reception operation should not be reset, and the timers including *t-Reordering* and *discardTimer* keep running during PDCP entity reconfiguration procedure.

NOTE 2: Before releasing the header compression protocol and the ciphering function associated to the released RLC entity, how to handle all stored PDCP SDUs received from the released RLC entity is left up to UE implementation.

NOTE 3: Upon upper layers reconfigure the PDCP entity to release DAPS, the reordering function is still maintained.

5.14 Ethernet header compression and decompression

5.14.1 Supported header compression protocols

The EHC protocol is based on the Ethernet Header Compression (EHC) framework defined in [19].

5.14.2 Configuration of EHC

PDCP entities associated with DRBs can be configured by upper layers TS 36.331 [3] to use EHC. Each PDCP entity carrying user plane data may be configured to use EHC. Every PDCP entity uses at most one EHC compressor instance and at most one EHC decompressor instance.

5.14.3 Protocol parameters

The usage and definition of the parameters shall be as specified below.

- **MAX_CID_EHC_UL**: This is the maximum CID value that can be used for UL. One CID value shall always be reserved for uncompressed flows. The parameter **MAX_CID_EHC_UL** is configured by upper layers (*maxCID-EHC-UL* in TS 36.331 [3]);

5.14.4 Header compression using EHC

If EHC is configured, the EHC protocol generates two types of output packets:

- EHC compressed packets (i.e. EHC full header packets and EHC compressed header packets), each associated with one PDCP SDU;
- standalone packets not associated with a PDCP SDU, i.e. EHC feedback packets.

An EHC compressed packet is associated with the same PDCP SN and COUNT value as the related PDCP SDU.

EHC feedback packets are not associated with a PDCP SDU. They are not associated with a PDCP SN and are not ciphered.

5.14.5 Header decompression using EHC

If EHC is configured by upper layers for PDCP entities associated with user plane data, the PDCP Data PDUs are decompressed by the EHC protocol after performing deciphering as explained in clause 5.6.

5.14.6 PDCP Control PDU for EHC feedback packet

5.14.6.1 Transmit Operation

When an EHC feedback packet is generated by the EHC protocol, the transmitting PDCP entity shall:

- submit to lower layers the corresponding PDCP Control PDU as specified in clause 6.2.18, i.e., without associating a PDCP SN, nor performing ciphering.

5.14.6.2 Receive Operation

At reception of a PDCP Control PDU for EHC feedback packet from lower layers, the receiving PDCP entity shall:

- deliver the corresponding EHC feedback packet to the EHC protocol without performing deciphering.

5.14.7 Simultaneous configuration of ROHC and EHC

If both ROHC and EHC are configured for a DRB, the ROHC header shall be located after the EHC header. Figure 5.14.7.1 shows the location of the ROHC header and the EHC header in a PDCP Data PDU.

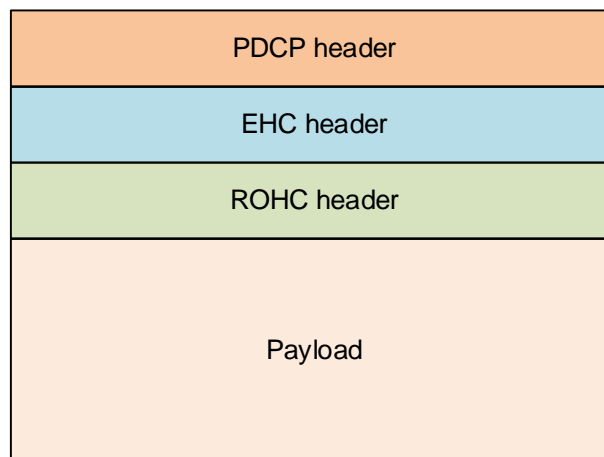

Figure 5.14.7.1: Location of ROHC header and EHC header in a PDCP Data PDU

If a PDCP SDU including non-IP Ethernet packet is received from upper layers, the EHC compressor shall bypass the ROHC compressor and submit the EHC compressed non-IP Ethernet packet to lower layers according to clause 5.1.1.

If a PDCP Data PDU including non-IP Ethernet packet is received from lower layers, the EHC decompressor shall bypass the ROHC decompressor and deliver the EHC decompressed non-IP Ethernet packet to upper layers according to clause 5.1.2.

6 Protocol data units, formats and parameters

6.1 Protocol data units

6.1.1 PDCP Data PDU

The PDCP Data PDU is used to convey:

- a PDCP SDU SN; and
- for SLRBs used for one-to-many communication, PGK Index, PTK Identity, and SDU type; or
- for SLRBs used for one-to-one communication, $K_{D\text{-sess}}$ Identity, and SDU type; and

- user plane data containing an uncompressed PDCP SDU; or
- user plane data containing a compressed PDCP SDU; or
- control plane data; and
- a MAC-I field for SRBs; or
- for the SLRB that needs integrity protection for one-to-one communication, a MAC-I field; or
- for RNs, a MAC-I field for DRB (if integrity protection is configured);

6.1.2 PDCP Control PDU

The PDCP Control PDU is used to convey:

- a PDCP status report indicating which PDCP SDUs are missing and which are not following a PDCP re-establishment.
- header compression control information, e.g. interspersed ROHC feedback or EHC feedback.
- a LWA status report.
- a LWA end-marker packet.

6.2 Formats

6.2.1 General

A PDCP PDU is a bit string that is byte aligned (i.e. multiple of 8 bits) in length. In the figures in sub clause 6.2, bit strings are represented by tables in which the most significant bit is the leftmost bit of the first line of the table, the least significant bit is the rightmost bit on the last line of the table, and more generally the bit string is to be read from left to right and then in the reading order of the lines. The bit order of each parameter field within a PDCP PDU is represented with the first and most significant bit in the leftmost bit and the last and least significant bit in the rightmost bit.

PDCP SDUs are bit strings that are byte aligned (i.e. multiple of 8 bits) in length. A compressed or uncompressed SDU is included into a PDCP PDU from the first bit onward.

6.2.2 Control plane PDCP Data PDU

Figure 6.2.2.1 shows the format of the PDCP Data PDU carrying data for control plane SRBs.

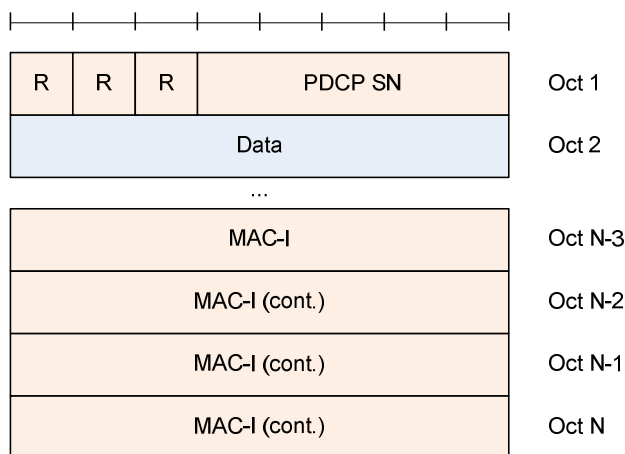

Figure 6.2.2.1: PDCP Data PDU format for SRBs

6.2.3 User plane PDCP Data PDU with long PDCP SN (12 bits)

Figures 6.2.3.1 and 6.2.3.2 show the format of the downlink and uplink PDCP Data PDUs respectively, when a 12 bit SN length is used. These formats are applicable for PDCP Data PDUs carrying data from DRBs mapped on RLC AM or RLC UM.

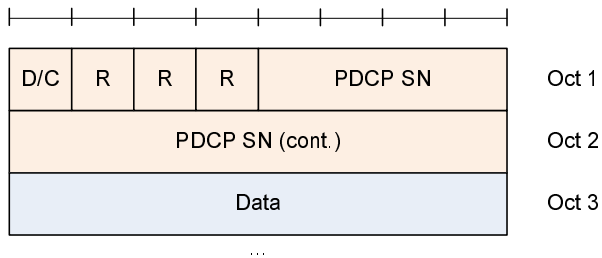

Figure 6.2.3.1: PDCP Data PDU format for DRBs using a 12 bit SN (for downlink)

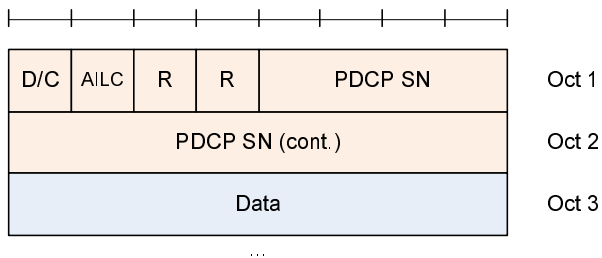

Figure 6.2.3.2: PDCP Data PDU format for DRBs using a 12 bit SN (for uplink)

6.2.4 User plane PDCP Data PDU with short PDCP SN (7 bits)

Figure 6.2.4.1 shows the format of the PDCP Data PDU when a 7 bit SN length is used. This format is applicable for PDCP Data PDUs carrying data from DRBs mapped on RLC UM or in NB-IoT DRBs mapped on RLC AM and on RLC UM.

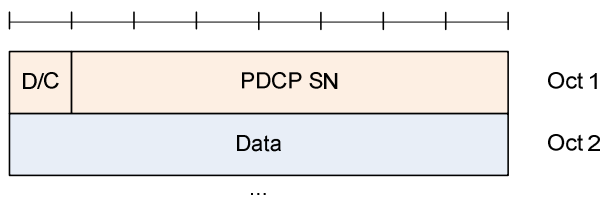

Figure 6.2.4.1: PDCP Data PDU format for DRBs using 7 bit SN

6.2.5 PDCP Control PDU for interspersed ROHC feedback packet

Figure 6.2.5.1 shows the format of the PDCP Control PDU carrying one interspersed ROHC feedback packet. This format is applicable for DRBs mapped on RLC AM or RLC UM.

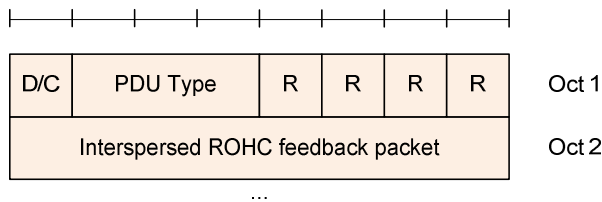

Figure 6.2.5.1: PDCP Control PDU format for interspersed ROHC feedback packet

6.2.6 PDCP Control PDU for PDCP status report

Figure 6.2.6.1 shows the format of the PDCP Control PDU carrying one PDCP status report when a 12 bit SN length is used. This format is applicable for DRBs mapped on RLC UM and RLC AM.

Figure 6.2.6.2 shows the format of the PDCP Control PDU carrying one PDCP status report when a 15 bit SN length is used, and Figure 6.2.6.3 shows the format of the PDCP Control PDU carrying one PDCP status report when an 18 bit SN length is used. These formats are applicable for DRBs mapped on RLC AM.

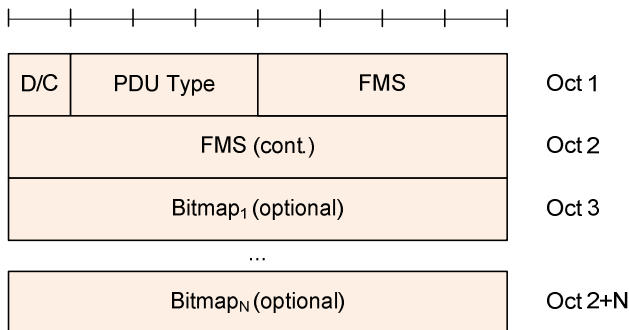

Figure 6.2.6.1: PDCP Control PDU format for PDCP status report using a 12 bit SN

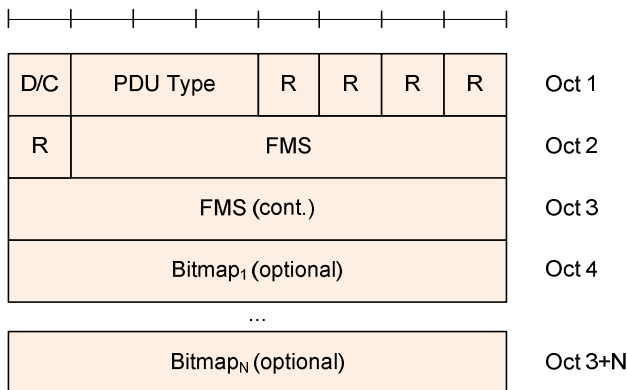

Figure 6.2.6.2: PDCP Control PDU format for PDCP status report using a 15 bit SN

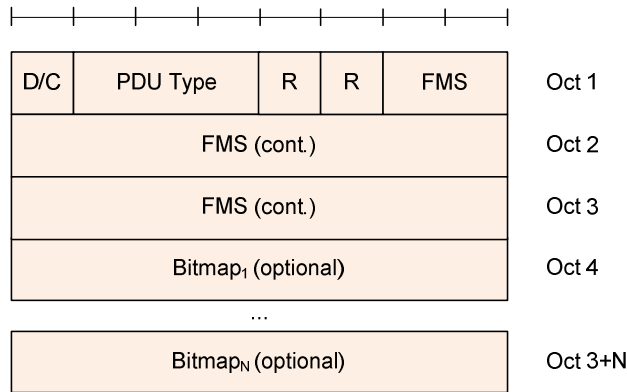

Figure 6.2.6.3: PDCP Control PDU format for PDCP status report using an 18 bit SN

6.2.7 Void

6.2.8 RN user plane PDCP Data PDU with integrity protection

Figure 6.2.8.1 shows the format of the PDCP Data PDU for RNs when integrity protection is used. This format is applicable for PDCP Data PDUs carrying data from DRBs mapped on RLC AM or RLC UM.

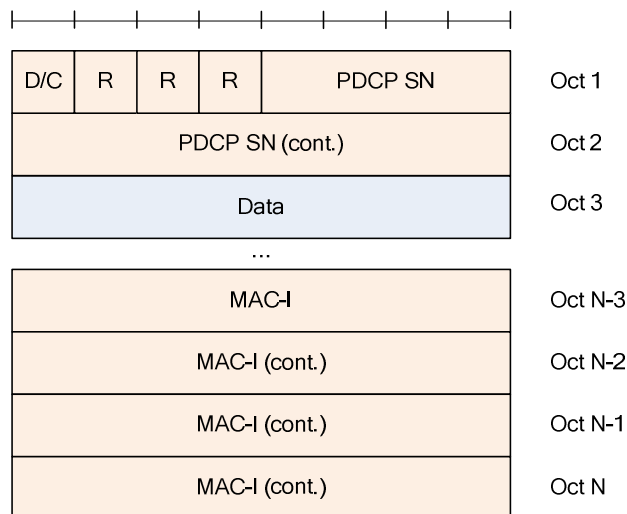

Figure 6.2.8.1: PDCP Data PDU format for RN DRBs using integrity protection

6.2.9 User plane PDCP Data PDU with extended PDCP SN (15 bits)

Figure 6.2.9.1 shows the format of the PDCP Data PDU when a 15 bit SN length is used. This format is applicable for PDCP Data PDUs carrying data from DRBs mapped on RLC AM.

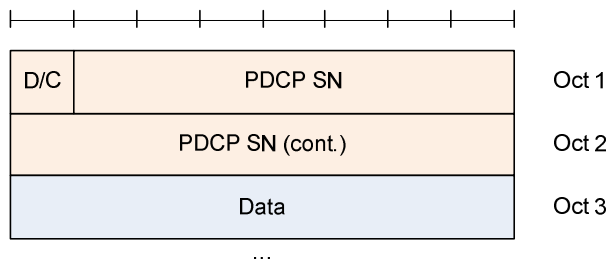

Figure 6.2.9.1: PDCP Data PDU format for DRBs using a 15 bit SN

6.2.10 User plane PDCP Data PDU for SLRB

Figure 6.2.10.1 shows the format of the PDCP Data PDU for SLRB used for one-to-many communication where a 16 bit SN length is used.

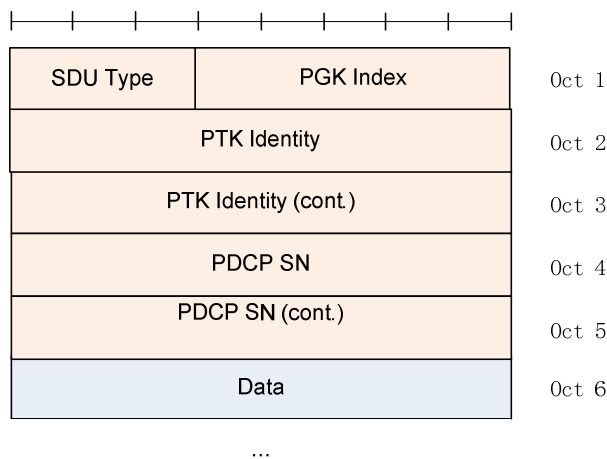

Figure 6.2.10.1: PDCP Data PDU format for SLRB used for one-to-many communication

Figure 6.2.10.2 shows the format of the PDCP Data PDU for SLRB used for one-to-one communication where a 16 bit SN length is used. MAC-I field is used only for the SLRB that needs integrity protection.

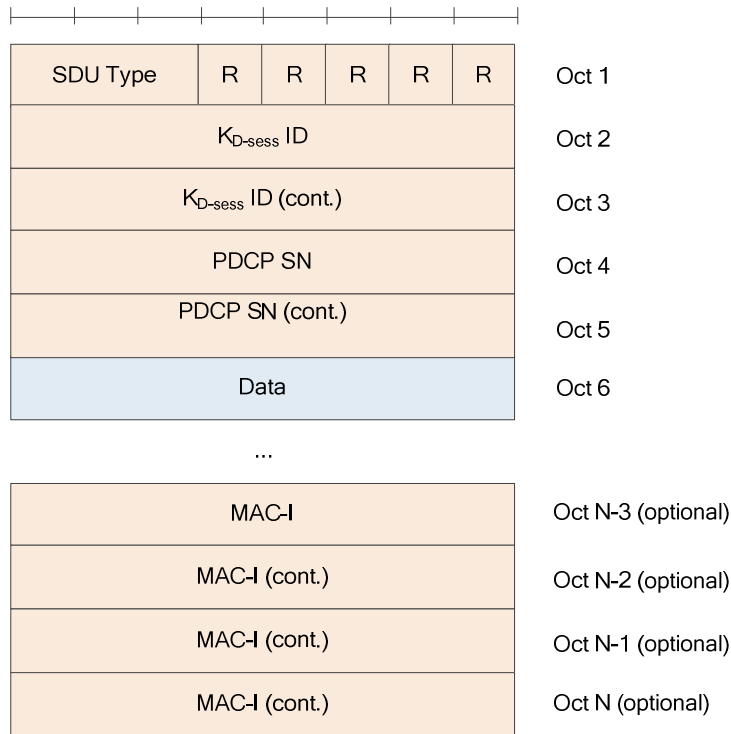

Figure 6.2.10.2: PDCP Data PDU format for SLRB used for one-to-one communication

6.2.11 User plane PDCP Data PDU with further extended PDCP SN (18 bits)

Figure 6.2.11.1 shows the format of the PDCP Data PDU when an 18 bit SN length is used. This format is applicable for PDCP Data PDUs carrying data from DRBs mapped on RLC AM. The UE not supporting LWA shall consider the PDCP Data PDU invalid if the P bit is set to 1.

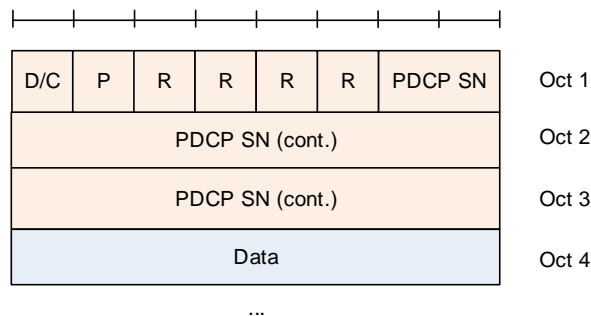

Figure 6.2.11.1: PDCP Data PDU format for DRBs using an 18 bit SN

6.2.12 PDCP Control PDU for LWA status report

Figure 6.2.12.1 shows the format of the PDCP Control PDU carrying one LWA status report when a 12 bit SN length is used, Figure 6.2.12.2 shows the format of the PDCP Control PDU carrying one LWA status report when a 15 bit SN length is used, and Figure 6.2.12.3 shows the format of the PDCP Control PDU carrying one LWA status report when an 18 bit SN length is used. This format is applicable for LWA DRBs.

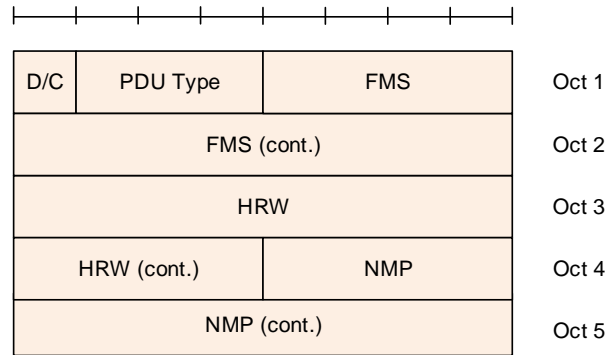

Figure 6.2.12.1: PDCP Control PDU format for LWA status report using a 12 bit SN

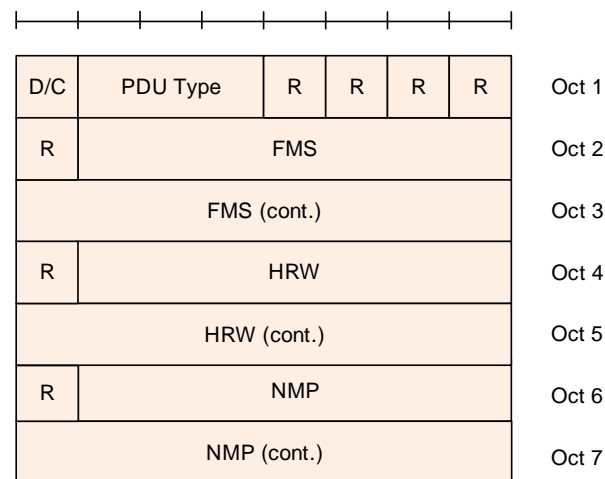

Figure 6.2.12.2: PDCP Control PDU format for LWA status report using a 15 bit SN

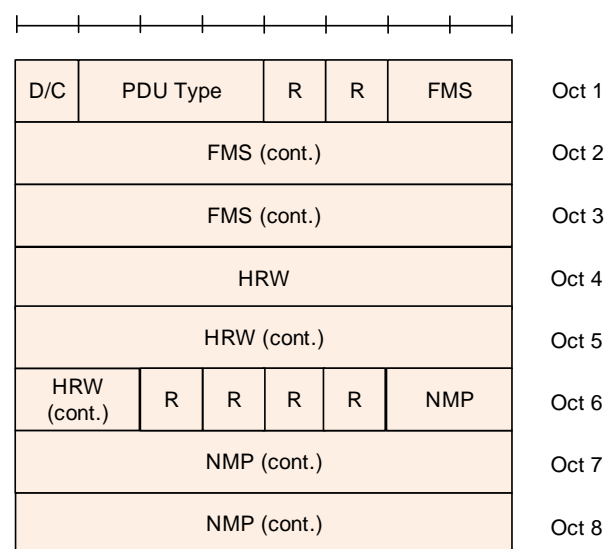

Figure 6.2.12.3: PDCP Control PDU format for LWA status report using an 18 bit SN

6.2.13 PDCP Control PDU for LWA end-marker packet

Figure 6.2.13.1 shows the format of the PDCP Control PDU for LWA end-marker packet when a 12 bit SN length is used, Figure 6.2.13.2 shows the format of the PDCP Control PDU for LWA end-marker packet when a 15 bit SN length is used, and Figure 6.2.13.3 shows the format of the PDCP Control PDU for LWA end-marker packet when an 18 bit SN length is used.

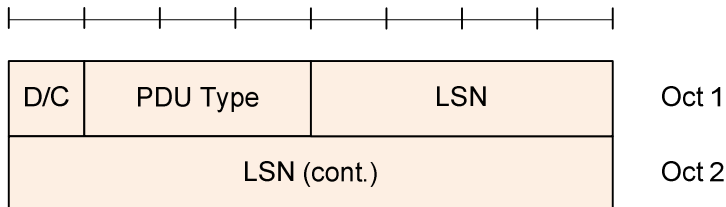

Figure 6.2.13.1: PDCP Control PDU format for LWA end-marker packet using a 12 bit SN

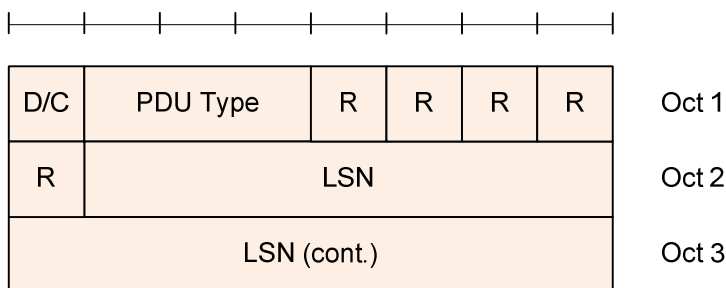

Figure 6.2.13.2: PDCP Control PDU format for LWA end-marker packet using a 15 bit SN

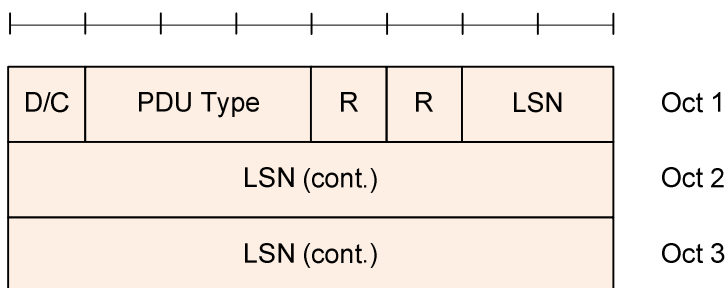

Figure 6.2.13.3: PDCP Control PDU format for LWA end-marker packet using an 18 bit SN

6.2.14 User plane PDCP Data PDU with long PDCP SN (12 bits) for UDC

Figure 6.2.14.1 shows the format of the PDCP Data PDU when a 12 bit SN length is used and UDC is configured. This format is applicable for uplink PDCP Data PDUs carrying data from DRBs configured with UDC.

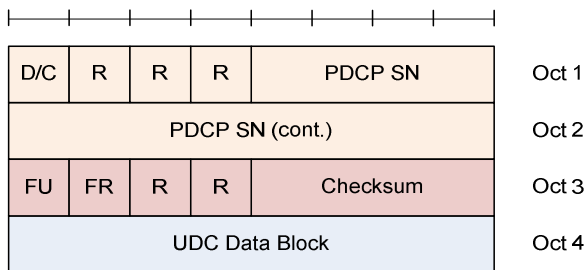

Figure 6.2.14.1: PDCP Data PDU format for DRBs using a 12 bit SN (UDC configured)

6.2.15 User plane PDCP Data PDU with extended PDCP SN (15 bits) for UDC

Figure 6.2.15.1 shows the format of the PDCP Data PDU when a 15 bit SN length is used and UDC is configured. This format is applicable for PDCP Data PDUs carrying data from DRBs configured with UDC.

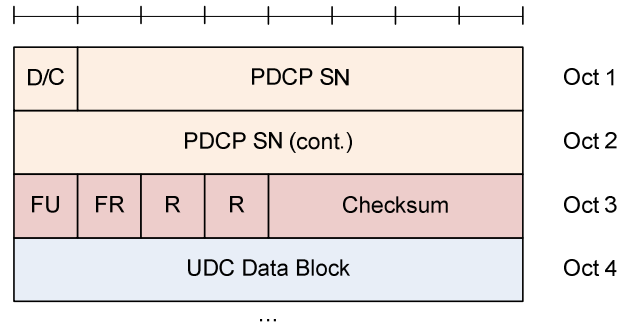

Figure 6.2.15.1: PDCP Data PDU format for DRBs using a 15 bit SN (UDC configured)

6.2.16 User plane PDCP Data PDU with further extended PDCP SN (18 bits) for UDC

Figure 6.2.16.1 shows the format of the PDCP Data PDU when an 18 bit SN length is used and UDC is configured. This format is applicable for uplink PDCP Data PDUs carrying data from DRBs configured with UDC.

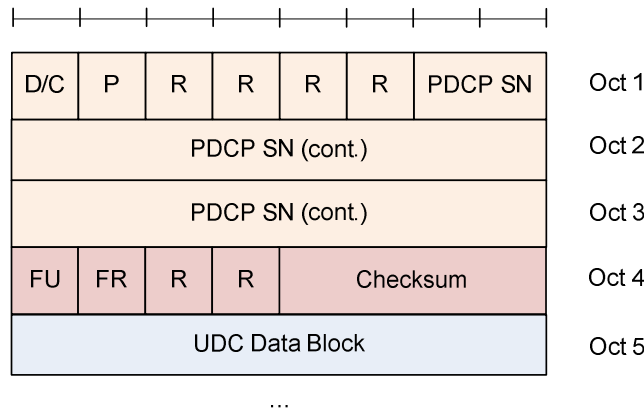

Figure 6.2.16.1: PDCP Data PDU format for DRBs using an 18 bit SN (UDC configured)

6.2.17 PDCP Control PDU for UDC feedback packet

Figure 6.2.17.1 shows the format of the PDCP Control PDU for UDC feedback packet. This format is applicable for DRBs configured with UDC.

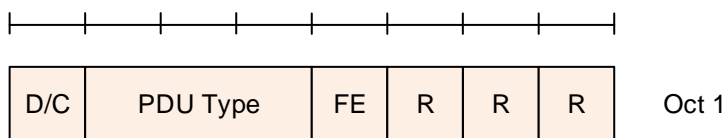

Figure 6.2.17.1: PDCP Control PDU format for UDC feedback packet

6.2.18 PDCP Control PDU for EHC feedback packet

Figure 6.2.18.1 shows the format of the PDCP Control PDU for EHC feedback packet. This format is applicable for DRBs mapped on RLC AM or RLC UM.

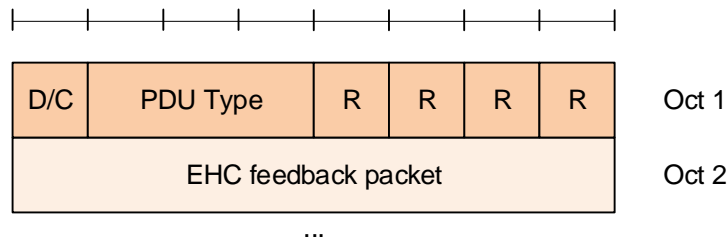

Figure 6.2.18.1: PDCP Control PDU format for EHC feedback packet

6.3 Parameters

6.3.1 General

If not otherwise mentioned in the definition of each field then the bits in the parameters shall be interpreted as follows: the left most bit string is the first and most significant and the right most bit is the last and least significant bit.

Unless otherwise mentioned, integers are encoded in standard binary encoding for unsigned integers. In all cases the bits appear ordered from MSB to LSB when read in the PDU.

6.3.2 PDCP SN

Length: 5, 7, 12, 15, 16, or 18 bits as indicated in table 6.3.2.1 except for NB-IoT which uses 7 bit PDCP SN for DRB.

Table 6.3.2.1: PDCP SN length

Length	Description
5	SRBs
7	DRBs, if configured by upper layers (<i>pdcp-SN-Size</i> , see TS 36.331 [3])
12	DRBs, if configured by upper layers (<i>pdcp-SN-Size</i> , see TS 36.331 [3])
15	DRBs, if configured by upper layers (<i>pdcp-SN-Size</i> , see TS 36.331 [3])
16	SLRBs
18	DRBs, if configured by upper layers (<i>pdcp-SN-Size</i> , see TS 36.331 [3])

6.3.3 Data

Length: Variable

The Data field may include either one of the following:

- Uncompressed PDCP SDU (user plane data, or control plane data); or
- Compressed PDCP SDU (user plane data only); or
- UDC header and UDC Data Block if UDC is configured.

6.3.4 MAC-I

Length: 32 bits

The MAC-I field carries a message authentication code calculated as specified in clause 5.7.

For control plane data that are not integrity protected, the MAC-I field is still present and should be padded with padding bits set to 0.

6.3.5 COUNT

Length: 32 bits

For ciphering and integrity a COUNT value is maintained. The COUNT value is composed of a HFN and the PDCP SN. The length of the PDCP SN is configured by upper layers.



Figure 6.3.5.1: Format of COUNT

The size of the HFN part in bits is equal to 32 minus the length of the PDCP SN.

NOTE: When performing comparison of values related to COUNT, the UE takes into account that COUNT is a 32-bit value, which may wrap around (e.g., COUNT value of $2^{32} - 1$ is less than COUNT value of 0).

6.3.6 R

Length: 1 bit

Reserved. In this version of the specification reserved bits shall be set to 0. Reserved bits shall be ignored by the receiver.

6.3.7 D/C

Length: 1 bit

Table 6.3.7.1: D/C field

Bit	Description
0	Control PDU
1	Data PDU

6.3.8 PDU type

Length: 3 bits

Table 6.3.8.1: PDU type

Bit	Description
000	PDCP status report
001	Interspersed ROHC feedback packet
010	LWA status report
011	LWA end-marker packet
100	UDC feedback packet
101	EHC feedback packet
110-111	reserved

6.3.9 FMS

Length: 12 bits when a 12 bit SN length is used, 15 bits when a 15 bit SN length is used, and 18 bits when an 18 bit SN length is used

PDCP SN of the first missing PDCP SDU.

6.3.10 Bitmap

Length: Variable

The length of the bitmap field can be 0.

The MSB of the first octet of the type "Bitmap" indicates whether or not the PDCP SDU with the SN $(FMS + 1)$ modulo $(Maximum_PDCP_SN + 1)$ has been received and, optionally decompressed correctly. The LSB of the first octet of the type "Bitmap" indicates whether or not the PDCP SDU with the SN $(FMS + 8)$ modulo $(Maximum_PDCP_SN + 1)$ has been received and, optionally decompressed correctly.

Table 6.3.10.1 Bitmap

Bit	Description
0	PDCP SDU with PDCP SN = $(FMS + \text{bit position})$ modulo $(Maximum_PDCP_SN + 1)$ is missing in the receiver. The bit position of N th bit in the Bitmap is N, i.e., the bit position of the first bit in the Bitmap is 1.
1	PDCP SDU with PDCP SN = $(FMS + \text{bit position})$ modulo $(Maximum_PDCP_SN + 1)$ does not need to be retransmitted. The bit position of N th bit in the Bitmap is N, i.e., the bit position of the first bit in the Bitmap is 1.

The UE fills the bitmap indicating which SDUs are missing (unset bit - '0'), i.e. whether an SDU has not been received or optionally has been received but has not been decompressed correctly, and which SDUs do not need retransmission (set bit - '1'), i.e. whether an SDU has been received correctly and may or may not have been decompressed correctly.

6.3.11 Interspersed ROHC feedback packet

Length: Variable

Contains one ROHC packet with only feedback, i.e. a ROHC packet that is not associated with a PDCP SDU as defined in clause 5.5.4.

6.3.12 PGK Index

Length: 5 bits

5 LSBs of PGK Identity as specified in TS 33.303 [13].

6.3.13 PTK Identity

Length: 16 bits

PTK Identity as specified in TS 33.303 [13].

6.3.14 SDU Type

Length: 3 bits

PDCP SDU type, i.e. Layer-3 Protocol Data Unit type as specified in [14]. PDCP entity may handle the SDU differently per SDU Type, e.g. ROHC is applicable to IP SDU but not ARP SDU and Non-IP SDU.

Table 6.3.14.1: SDU Type

Bit	Description
000	IP
001	ARP
010	PC5 Signaling
011	Non-IP
100-111	reserved

6.3.15 $K_{D\text{-sess}}$ ID

Length: 16 bits

$K_{D\text{-sess}}$ Identity as specified in TS 33.303 [13].

6.3.16 NMP

Length: 12 bits when a 12 bit SN length is used, 15 bits when a 15 bit SN length is used, and 18 bits when an 18 bit SN length is used.

Number of missing PDCP SDU(s) with associated COUNT value below the associated COUNT value corresponding to HRW, starting from and including the associated COUNT value corresponding to FMS.

6.3.17 HRW

Length: 12 bits when a 12 bit SN length is used, 15 bits when a 15 bit SN length is used and 18 bits when an 18 bit SN length is used.

PDCP SN of the PDCP SDU received on WLAN with highest associated PDCP COUNT value.

6.3.18 P

Length: 1 bit

Polling indication. The P field indicates whether the UE is requested to send a PDCP status report or a LWA status report for LWA. The field is not applicable to uplink PDCP PDUs and the UE shall set the P field to 0.

Table 6.3.18.1: P field

Bit	Description
0	Status report is not requested
1	Status report is requested

6.3.19 LSN

Length: 12 bits when a 12 bit SN length is used, 15 bits when a 15 bit SN length is used, and 18 bits when an 18 bit SN length is used

PDCP SN of the last PDCP PDU for which the data part is ciphered with the key used before PDCP re-establishment. Only applicable for the case when upper layers request a PDCP re-establishment for a LWA bearer where LWA configuration is retained with the same WT.

6.3.20 AILC

Length: 1 bit

The AILC field indicates that corresponding PDCP SDU in the uplink PDCP PDU may be transferred to the local cache entity when PDCP entity is configured by upper layers, i.e. ailc-BitConfig, as specified in TS 36.331 [3]. If the PDCP SDU may be transferred to the local cache entity, the AILC field shall be set to 1, otherwise to 0.

Table 6.3.20.1: AILC field

Bit	Description
0	Indicates that the SDU need not to be transferred to the local cache entity
1	Indicates that the SDU may be transferred to the local cache entity.

6.3.21 FU

Length: 1 bit

Indication of whether this packet is compressed by UDC protocol or not. Value '1' means the packet is compressed by UDC protocol.

Table 6.3.21.1: FU field

Bit	Description
0	Packet is not compressed using UDC protocol
1	Packet is compressed using UDC protocol

6.3.22 FR

Length: 1 bit

Indication of whether UDC compression buffer is reset or not. Value '1' means this is the first compressed packet after UDC buffer reset.

Table 6.3.22.1: FR field

Bit	Description
0	Compression buffer is not reset.
1	Compression buffer has been reset.

6.3.23 Checksum

Length: 4 bits

This field contains the validation bits for the compression buffer content: The checksum is calculated by the content of current compression buffer before the current packet is put into buffer.

The checksum is derived from the values of the first 4 bytes and the last 4 bytes in the whole compression buffer. The calculation is described as follows:

- Each byte is divided into two 4-bit numbers.
- The 16 4-bit numbers are added together to obtain a sum;
- The checksum is one's complement of the right-most 4 bits (i.e. 4 LSB) of the sum.

An example of checksum calculation is shown in Annex A.

6.3.24 FE

Length: 1 bit

Indication of whether checksum error is detected or not. Value '1' means checksum error is detected and the UE shall reset the compression buffer.

Table 6.3.24.1: FE field

Bit	Description
0	No Error
1	Checksum Error Notification

7 Variables, constants and timers

7.1 State variables

This sub clause describes the state variables used in PDCP entities in order to specify the PDCP protocol.

All state variables are non-negative integers.

The transmitting side of each PDCP entity shall maintain the following state variables:

a) Next_PDCP_TX_SN

The variable Next_PDCP_TX_SN indicates the PDCP SN of the next PDCP SDU for a given PDCP entity. At establishment of the PDCP entity, the UE shall set Next_PDCP_TX_SN to 0. For the PDCP entity mapped with SLRB of which the indicated *SL-V2X-TxProfile* is *rel15* (see TS 36.331 [3]), the UE shall set Next_PDCP_TX_SN to 1 at establishment of the PDCP entity.

b) TX_HFN

The variable TX_HFN indicates the HFN value for the generation of the COUNT value used for PDCP PDUs for a given PDCP entity. At establishment of the PDCP entity, the UE shall set TX_HFN to 0.

The receiving side of each PDCP entity shall maintain the following state variables:

c) Next_PDCP_RX_SN

The variable Next_PDCP_RX_SN indicates the next expected PDCP SN by the receiver for a given PDCP entity. At establishment of the PDCP entity, the UE shall set Next_PDCP_RX_SN to 0. For the PDCP entity mapped with SLRB of which the indicated *SL-V2X-TxProfile* is *rel15* (see TS 36.331 [3]), the UE shall set Next_PDCP_RX_SN to $(x + 1)$ modulo $(\text{Maximum_PDCP_SN} + 1)$, where x is the SN of the first received PDCP Data PDU with SN not set to "0".

d) RX_HFN

The variable RX_HFN indicates the HFN value for the generation of the COUNT value used for the received PDCP PDUs for a given PDCP entity. At establishment of the PDCP entity, the UE shall set RX_HFN to 0.

e) Last_Submitted_PDCP_RX_SN

The variable Last_Submitted_PDCP_RX_SN indicates the SN of the last PDCP SDU delivered to the upper layers. At establishment of the PDCP entity, the UE shall set Last_Submitted_PDCP_RX_SN to Maximum_PDCP_SN. For the PDCP entity mapped with SLRB of which the indicated *SL-V2X-TxProfile* is *rel15* (see TS 36.331 [3]), the UE shall set Last_Submitted_PDCP_RX_SN to $(x - 0.5 * \text{Reordering_Window})$ modulo $(\text{Maximum_PDCP_SN} + 1)$, where x is the SN of the first received PDCP Data PDU with SN not set to "0". When upper layers reconfigure the PDCP entity to configure DAPS for a DRB mapped on RLC UM, the UE shall set Last_Submitted_PDCP_RX_SN to $(\text{Next_PDCP_RX_SN} - 1)$ modulo $(\text{Maximum_PDCP_SN} + 1)$.

f) Reordering_PDCP_RX_COUNT

This variable is used only when the reordering function is used. This variable holds the value of the COUNT following the COUNT value associated with the PDCP PDU which triggered *t-Reordering*. When upper layers reconfigure the PDCP entity to configure DAPS, the UE shall set Reordering_PDCP_RX_COUNT to the COUNT value associated to RX_HFN and Next_PDCP_RX_SN.

7.2 Timers

The transmitting side of each PDCP entity for DRBs shall maintain the following timers:

a) *discardTimer*

The duration of the timer is configured by upper layers, see TS 36.331 [3]. In the transmitter, a new timer is started upon reception of an SDU from upper layer.

The receiving side of each PDCP entity shall maintain the following timers only when the reordering function is used:

b) *t-Reordering*

The duration of the timer is configured by upper layers, see (TS 36.331 [3]), except for the case of Sidelink reception when the reordering function is used. For when the reordering function is used reception when the reordering function is used, the *t-Reordering* timer is determined by the UE implementation. This timer is used to detect loss of PDCP PDUs as specified in the clause 5.1.2.1.4. If *t-Reordering* is running, *t-Reordering* shall not be started additionally, i.e. only one *t-Reordering* per PDCP entity is running at a given time.

The receiving side of each PDCP entity associated with LWA bearers shall maintain the following timers:

c) *t-StatusReportType1*

The duration of the timer is configured by upper layers (*statusPDU-Periodicity-Type1*, see TS 36.331 [3]). This timer is used to trigger status report transmission for LWA as specified in the clause 5.10.

d) *t-StatusReportType2*

The duration of the timer is configured by upper layers (*statusPDU-Periodicity-Type2* and *statusPDU-Periodicity-Offset*, see TS 36.331 [3]). If *statusPDU-Periodicity-Offset* is configured and it is the first run of the timer after (re)configuration, the duration of the timer is the sum of *statusPDU-Periodicity-Type2* and *statusPDU-Periodicity-Offset*, see TS 36.331 [3], otherwise the duration of the timer is *statusPDU-Periodicity-Type2*. When configured, this timer is used to trigger status report transmission for LWA as specified in the clause 5.10.

7.3 Constants

a) Reordering_Window

Indicates the size of the reordering window. The size equals to 16 when a 5 bit SN length is used, 64 when a 7 bit SN length is used, 2048 when a 12 bit SN length is used, 16384 when a 15 bit SN length is used, 32768 when a 16 bit SN length is used, or 131072 when 18 bit SN length is used, i.e. half of the PDCP SN space, for radio bearers that are mapped on RLC AM, for LWA bearers and for SLRBs when the reordering function is used.

b) Maximum_PDCP_SN is:

- 262143 if the PDCP entity is configured for the use of 18 bits SNs
- 65535 if the PDCP entity is configured for the use of 16 bits SNs
- 32767 if the PDCP entity is configured for the use of 15 bits SNs
- 4095 if the PDCP entity is configured for the use of 12 bit SNs
- 127 if the PDCP entity is configured for the use of 7 bit SNs
- 31 if the PDCP entity is configured for the use of 5 bit SNs

Annex A (informative): An example of UDC Checksum calculation

The current UDC compression/decompression buffer has the following binary values for example:

Header <1,1,0,0,0,1,0,1,0,0,1,1,1,1,1,0,0,0,1,1,0,0,1,0,1,0,1,0,1,0,0,0,1,,
0,1,1,1,1,0,1,1,0,0,0,1,0,1,0,0,1,1,1,1,1,0,0,1,1,1,0,0,1,1,1,0,0> Tail

The sum of the first 4 bytes and the last 4 bytes can be calculated:

$1100+0101+0011+1111+0001+1001+0101+0001+0111+1101+1000+1010+1001+1111+1001+1100 = 10000110;$

And checksum value will be one's complement of the right-most 4 bits (i.e. 4 LSB) of the above sum. Hence checksum is 1001.

Annex B (informative): Change history

Change history after change control							
Date	TSG	TSG Doc.	CR	Rev	Cat	Subject/Comment	New version
2007-12	RP-38	RP-070919	-	-		Approved at TSG-RAN #38 and placed under Change Control	8.0.0
2008-03	RP-39	RP-080197	0001	-		CR to 36.323 with Update of E-UTRAN PDCP specification	8.1.0
2008-05	RP-40	RP-080412	0002	-		Clarification of the BSR calculation	8.2.0
	RP-40	RP-080412	0003	1		PDCP minor changes	8.2.0
	RP-40	RP-080387	0004	3		Addition of a duplicate discard window	8.2.0
	RP-40	RP-080412	0006	-		Reference to ROHCv2 profiles	8.2.0
	RP-40	RP-080412	0010	-		Bitmap in the DL PDCP status report	8.2.0
	-	-	-	-		Corrections to clauses 5.5.1.1, 5.5.1.2.1 and 5.8 to correctly implement CR0004 Rev 3 (instead of CR0004 Rev 2 of RP-080412).	8.2.1
2008-09	RP-41	RP-080692	0013	-		Restructuring of PDCP specification	8.3.0
	RP-41	RP-080692	0016	-		Miscellaneous PDCP corrections	8.3.0
	RP-41	RP-080692	0023	-		Correction to the PDCP structure	8.3.0
	RP-41	RP-080692	0033	-		Initial TX_HFN and RX_HFN values	8.3.0
2008-12	RP-42	RP-081020	0038	-		Clarification with regards to the PDCP state variables	8.4.0
	RP-42	RP-081020	0039	-		CR 0039 to 36.323 on Correction to PDCP functional view	8.4.0
	RP-42	RP-081020	0040	-		PDCP "in-sequence delivery and duplicate elimination" always on	8.4.0
	RP-42	RP-081020	0041	-		Proposed CR to 36.323 on Processing of PDCP SDU received from upper layer	8.4.0
	RP-42	RP-081020	0042	-		Error in AM receive window behaviour	8.4.0
	RP-42	RP-081020	0047	-		Proposed CR on the described scope of Last_Submitted_PDCP_RX_SN	8.4.0
	RP-42	RP-081020	0048	-		Proposed CR to move DIRECTION from parameters provided by upper layer	8.4.0
	RP-42	RP-081020	0049	-		Clarification on COUNT	8.4.0
	RP-42	RP-081020	0050	-		Correction to PDCP procedure for SRB	8.4.0
	RP-42	RP-081020	0052	-		Correction to the PDCP re-establishment procedure	8.4.0
	RP-42	RP-081020	0054	-		Correction to PDCP functional view	8.4.0
	RP-42	RP-081020	0055	-		Miscellaneous PDCP corrections	8.4.0
	RP-42	RP-081020	0057	-		Proposed CR for error handling	8.4.0
	RP-42	RP-081020	0060	-		Proposed CR to 36.323 on Correction to PDCP Control PDU description	8.4.0
	RP-42	RP-081020	0061	1		Corrections to PDCP STATUS REPORT	8.4.0
2009-03	RP-43	RP-090130	0064	-		CR to specify maximum PDCP SDU size	8.5.0
	RP-43	RP-090130	0065	-		CR with correction on PDCP function of maintaining SNs	8.5.0
	RP-43	RP-090130	0066	-		Miscellaneous corrections to 36.323	8.5.0
	RP-43	RP-090130	0067	-		Minor issues on PDCP	8.5.0
	RP-43	RP-090130	0068	-		Security related corrections	8.5.0
	RP-43	RP-090130	0069	-		CR to 36.323 on RRC Parameters	8.5.0
	RP-43	RP-090130	0070	1		Corrections on BSR reporting and transmission/ retransmission after an Handover	8.5.0
	RP-43	RP-090130	0071	-		Corrections on PDCP services and functions	8.5.0
	RP-43	RP-090130	0077	-		PDCP Control PDU as Data Available for transmission in PDCP	8.5.0
2009-06	RP-44	RP-090515	0078	1		PDCP Status Report	8.6.0
	RP-44	RP-090515	0079	1		Correction to PDCP PDU submission condition in lower layer re-establishment	8.6.0
	RP-44	RP-090515	0080	2		Minor correction and clarification to 36.323	8.6.0
2009-12	RP-46	-	-	-		Upgrade to the Release 9 - no technical change	9.0.0
2010-12	RP-50	-	-	-		Upgrade to the Release 10 - no technical change	10.0.0
2011-03	RP-51	RP-110280	0086	-		Clarification on the number of ROHC instances in a PDCP entity	10.1.0
	RP-51	RP-110291	0087	-		Addition of integrity protection of DRBs in PDCP for RNs	10.1.0
2012-03	RP-57	RP-121377	0099	1		Introduction of Carrier aggregation enhancements	11.0.0
2012-12	RP-58	RP-121959	0100	-		CR to 36.323 on introducing ROHC context continue for intra-ENB handover	11.1.0
	RP-58	RP-121959	0104	1		ROHC mode upon handover	11.1.0
	RP-58	RP-121936	0106	-		Prevention of HFN de-synchronization due to PDCP SN over-allocation	11.1.0
2013-03	RP-59	RP-130248	0109	-		ROHC mode upon handover in UM DRB	11.2.0
2014-06	RP-64	RP-140869	0113	-		Clarification of CID reuse	11.3.0
	RP-64	RP-140892	0123	-		ROHC Feedback Handling	12.0.0
2014-09	RP-65	RP-141498	0126	-		Clarification of the decompressor state and mode after PDCP re-establishment	12.1.0
2014-12	RP-66	RP-142135	0128	1		Introduction of dual connectivity in PDCP	12.2.0
2015-03	RP-67	RP-150373	0133	-		Reconfiguration of PDCP reordering timer	12.3.0
	RP-67	RP-150374	0135	-		Introduction of ProSe Direct Communication	12.3.0
2015-06	RP-68	RP-150921	0137	-		COUNT derivation in ProSe	12.4.0
	RP-68	RP-150921	0138	-		Miscellaneous corrections for DC	12.4.0
	RP-68	RP-150921	0139	-		BSR Triggering for Split Bearers	12.4.0

2015-12	RP-70	RP-152053	0145	-		Corrections to Sidelink	12.5.0
	RP-70	RP-152053	0144	1		Update to Services expected from Lower Layers in DC	12.5.0
2015-12	RP-70	RP-152074	0146	-		Introduction of UL split bearer in PDCP	13.0.0
	RP-70	RP-152071	0148	1		Introduction of enhanced CA in PDCP	13.0.0
	RP-70	RP-152072	0149	2		Introducing enhanced ProSe	13.0.0
2016-03	RP-71	RP-160454	0155	-		Correction for KD-sess Identity in 36.323	13.1.0
	RP-71	RP-160457	0158	4		Introduction of LWA into PDCP specification	13.1.0
2016-06	RP-72	RP-161080	0160	-		Clarification on LWA	13.2.0
	RP-72	RP-161078	0162	1		Data available for transmission due to PDCP data recovery	13.2.0
	RP-72	RP-161080	0163	-		Correction for sidelink	13.2.0
	RP-72	RP-161078	0165	-		Corrections on RoHC description	13.2.0
	RP-72	RP-161080	0166	1		Clarification on Control PDU for LWA	13.2.0
	RP-72	RP-161080	0169	-		Polling for LWA status report	13.2.0
	RP-72	RP-161091	0171	4		Introduction of NB-IoT functionality to PDCP protocol	13.2.0
	RP-72	RP-161080	0172	-		PDCP CR to capture C-IoT optimizations for non-NB-IoT UEs	13.2.0
2016-06	RP-72	RP-161080	0160	-		Missing changes from CR0160 (Clarification on LWA) added	13.2.1
2016-09	RP-73	RP-161756	0175	1		Addition of COUNT determination for the purpose of HRW setting	13.3.0
	RP-73	RP-161756	0177	1		Clarification on NMP in LWA status report	13.3.0
	RP-73	RP-161756	0179	-		Corrections to PDCP Status Reporting	13.3.0
2016-09	RP-73	-	-	-		MCC cleanup and missing text from v13.2.1 added	13.3.1
2016-09	RP-73	RP-161746	0174	2		Introduction of PC5 V2V for 36.323	14.0.0
2016-09	RP-73	-	-	-		MCC cleanup	14.0.1
2016-12	RP-74	RP-162318	0182	-		Correction of security handling upon connection suspension	14.1.0
	RP-74	RP-162317	0185	1		Corrections to handling of uplink split	14.1.0
2017-03	RP-75	RP-170655	0188	-	A	Correction on channel bandwidth definition for NB-IoT	14.2.0
	RP-75	RP-170643	0189	-	F	Corrections on V2V in TS 36.323	14.2.0
	RP-75	RP-170628	0191	2	B	Introduction of Enhanced LTE-WLAN Aggregation (eLWA)	14.2.0
	RP-76	RP-171225	0197	1	F	Update of ROHC profile reference	14.3.0
	RP-76	RP-171225	0198	-	B	Enable Uplink-Only RoHC operations	14.3.0
	RP-76	RP-171244	0199	-	A	Clarification on polling	14.3.0
2017-09	RP-77	RP-171915	0200	3	C	Support of RLC UM for LWA bearer	14.4.0
2017-12	RP-78	RP-172617	0210	-	F	Correction to RLC UM for LWA	14.5.0
	RP-78	RP-172617	0216	1	F	Deliver stored PDCP SDUs for LWA bearer with RLC UM at PDCP re-establishment	14.5.0
2018-07	RP-80	RP-181221	0211	4	B	Running 36.323 CR to introduce assistance information for local cache	15.0.0
	RP-80	RP-181226	0217	3	B	Introduction of DEFLATE based UDC Solution	15.0.0
	RP-80	RP-181252	0231	2	B	Introduction of further NB-IoT enhancements in 36.323	15.0.0
	RP-80	RP-181248	0232	2	B	Introduction of V2X duplication to TS 36.323	15.0.0
	RP-80	RP-181247	0235	-	B	Introduction of Ultra Reliable Low Latency Communication for LTE	15.0.0
2018-09	RP-81	RP-181955	0237	1	F	Calculation of checksum	15.1.0
	RP-81	RP-181955	0238	-	F	Correction to description for UDC-only PDU	15.1.0
	RP-81	RP-181949	0241	-	F	Deliver stored PDCP SDUs for UM DRB at PDCP re-establishment	15.1.0
2018-12	RP-82	RP-182678	0243	2	F	CR on supporting of the ROHC for PDCP duplication	15.2.0
	RP-82	RP-182678	0249	3	F	Correction on PDCP for eV2X	15.2.0
	RP-82	RP-182679	0255	4	F	Correction on PDCP duplication	15.2.0
	RP-82	RP-182678	0264	1	F	Correction to SLRB and state variables for sidelink transmission	15.2.0
	RP-82	RP-182678	0265	-	F	Header Decompression for SLRB	15.2.0
2019-03	RP-83	RP-190552	0266	1	F	Correction on UDC data format	15.3.0
	RP-83	RP-190551	0270	1	F	CR on ROHC for V2X	15.3.0
	RP-83	RP-190552	0271	1	F	CR on PDCP structure for split bearer and LWA bearer	15.3.0
2019-06	RP-84	RP-191385	0272	1	F	CR on HFN maintainance	15.4.0
	RP-84	RP-191387	0273	-	F	Clarification of the PDCP structure	15.4.0
2019-12	RP-86	RP-192941	0277	-	F	Specify UDC Header is part of Data Field	15.5.0
2020-03	RP-87	RP-200450	0278	1	B	Introducing EHC in LTE PDCP	16.0.0
	RP-87	RP-200364	0279	2	B	Introduction of DAPS handover	16.0.0
2020-07	RP-88	RP-201168	0281	2	A	Correction on SRB duplication	16.1.0
	RP-88	RP-201195	0282	3	C	CR on 36.323 for LTE feMob	16.1.0
	RP-88	RP-201168	0284	1	A	CR on RLC out-of-order delivery configuration	16.1.0
	RP-88	RP-201181	0286	1	F	LTE PDCP corrections for NR IIOT	16.1.0
2020-09	RP-89	RP-201933	0287	1	F	Correction for PDCP status report	16.2.0
	RP-89	RP-201963	0290	1	F	CR on LTE PDCP re-establishment when t-Reordering is used	16.2.0
2020-12	RP-90	RP-202773	0291	1	F	CR on LTE PDCP re-establishment for UM DRB when t-Reordering is used	16.3.0

History

Document history		
V16.1.0	July 2020	Publication
V16.3.0	January 2021	Publication