

ETSI TS 136 331 V12.17.0 (2018-07)



**LTE;
Evolved Universal Terrestrial Radio Access (E-UTRA);
Radio Resource Control (RRC);
Protocol specification
(3GPP TS 36.331 version 12.17.0 Release 12)**



Reference

RTS/TSGR-0236331vch0

Keywords

LTE

ETSI

650 Route des Lucioles
F-06921 Sophia Antipolis Cedex - FRANCE

Tel.: +33 4 92 94 42 00 Fax: +33 4 93 65 47 16

Siret N° 348 623 562 00017 - NAF 742 C
Association à but non lucratif enregistrée à la
Sous-Préfecture de Grasse (06) N° 7803/88

Important notice

The present document can be downloaded from:

<http://www.etsi.org/standards-search>

The present document may be made available in electronic versions and/or in print. The content of any electronic and/or print versions of the present document shall not be modified without the prior written authorization of ETSI. In case of any existing or perceived difference in contents between such versions and/or in print, the only prevailing document is the print of the Portable Document Format (PDF) version kept on a specific network drive within ETSI Secretariat.

Users of the present document should be aware that the document may be subject to revision or change of status.

Information on the current status of this and other ETSI documents is available at

<https://portal.etsi.org/TB/ETSIDeliverableStatus.aspx>

If you find errors in the present document, please send your comment to one of the following services:

<https://portal.etsi.org/People/CommiteeSupportStaff.aspx>

Copyright Notification

No part may be reproduced or utilized in any form or by any means, electronic or mechanical, including photocopying and microfilm except as authorized by written permission of ETSI.

The content of the PDF version shall not be modified without the written authorization of ETSI.

The copyright and the foregoing restriction extend to reproduction in all media.

© ETSI 2018.

All rights reserved.

DECT™, **PLUGTESTS™**, **UMTS™** and the ETSI logo are trademarks of ETSI registered for the benefit of its Members.

3GPP™ and **LTE™** are trademarks of ETSI registered for the benefit of its Members and of the 3GPP Organizational Partners.

oneM2M logo is protected for the benefit of its Members.

GSM® and the GSM logo are trademarks registered and owned by the GSM Association.

Intellectual Property Rights

Essential patents

IPRs essential or potentially essential to normative deliverables may have been declared to ETSI. The information pertaining to these essential IPRs, if any, is publicly available for **ETSI members and non-members**, and can be found in ETSI SR 000 314: *"Intellectual Property Rights (IPRs); Essential, or potentially Essential, IPRs notified to ETSI in respect of ETSI standards"*, which is available from the ETSI Secretariat. Latest updates are available on the ETSI Web server (<https://ipr.etsi.org/>).

Pursuant to the ETSI IPR Policy, no investigation, including IPR searches, has been carried out by ETSI. No guarantee can be given as to the existence of other IPRs not referenced in ETSI SR 000 314 (or the updates on the ETSI Web server) which are, or may be, or may become, essential to the present document.

Trademarks

The present document may include trademarks and/or tradenames which are asserted and/or registered by their owners. ETSI claims no ownership of these except for any which are indicated as being the property of ETSI, and conveys no right to use or reproduce any trademark and/or tradename. Mention of those trademarks in the present document does not constitute an endorsement by ETSI of products, services or organizations associated with those trademarks.

Foreword

This Technical Specification (TS) has been produced by ETSI 3rd Generation Partnership Project (3GPP).

The present document may refer to technical specifications or reports using their 3GPP identities, UMTS identities or GSM identities. These should be interpreted as being references to the corresponding ETSI deliverables.

The cross reference between GSM, UMTS, 3GPP and ETSI identities can be found under <http://webapp.etsi.org/key/queryform.asp>.

Modal verbs terminology

In the present document "**shall**", "**shall not**", "**should**", "**should not**", "**may**", "**need not**", "**will**", "**will not**", "**can**" and "**cannot**" are to be interpreted as described in clause 3.2 of the [ETSI Drafting Rules](#) (Verbal forms for the expression of provisions).

"**must**" and "**must not**" are **NOT** allowed in ETSI deliverables except when used in direct citation.

Contents

Intellectual Property Rights	2
Foreword.....	2
Modal verbs terminology.....	2
Foreword.....	15
1 Scope	16
2 References	16
3 Definitions, symbols and abbreviations	19
3.1 Definitions	19
3.2 Abbreviations	20
4 General	22
4.1 Introduction	22
4.2 Architecture	23
4.2.1 UE states and state transitions including inter RAT	23
4.2.2 Signalling radio bearers	24
4.3 Services	25
4.3.1 Services provided to upper layers	25
4.3.2 Services expected from lower layers	25
4.4 Functions	25
5 Procedures	26
5.1 General	26
5.1.1 Introduction.....	26
5.1.2 General requirements.....	27
5.2 System information	27
5.2.1 Introduction.....	27
5.2.1.1 General	27
5.2.1.2 Scheduling.....	28
5.2.1.3 System information validity and notification of changes.....	29
5.2.1.4 Indication of ETWS notification	29
5.2.1.5 Indication of CMAS notification.....	30
5.2.1.6 Notification of EAB parameters change	30
5.2.2 System information acquisition	31
5.2.2.1 General	31
5.2.2.2 Initiation.....	31
5.2.2.3 System information required by the UE.....	31
5.2.2.4 System information acquisition by the UE.....	31
5.2.2.5 Essential system information missing	34
5.2.2.6 Actions upon reception of the <i>MasterInformationBlock</i> message.....	34
5.2.2.7 Actions upon reception of the <i>SystemInformationBlockType1</i> message	34
5.2.2.8 Actions upon reception of <i>SystemInformation</i> messages	35
5.2.2.9 Actions upon reception of <i>SystemInformationBlockType2</i>	35
5.2.2.10 Actions upon reception of <i>SystemInformationBlockType3</i>	36
5.2.2.11 Actions upon reception of <i>SystemInformationBlockType4</i>	36
5.2.2.12 Actions upon reception of <i>SystemInformationBlockType5</i>	36
5.2.2.13 Actions upon reception of <i>SystemInformationBlockType6</i>	36
5.2.2.14 Actions upon reception of <i>SystemInformationBlockType7</i>	37
5.2.2.15 Actions upon reception of <i>SystemInformationBlockType8</i>	37
5.2.2.16 Actions upon reception of <i>SystemInformationBlockType9</i>	38
5.2.2.17 Actions upon reception of <i>SystemInformationBlockType10</i>	38
5.2.2.18 Actions upon reception of <i>SystemInformationBlockType11</i>	38
5.2.2.19 Actions upon reception of <i>SystemInformationBlockType12</i>	39
5.2.2.20 Actions upon reception of <i>SystemInformationBlockType13</i>	39
5.2.2.21 Actions upon reception of <i>SystemInformationBlockType14</i>	39
5.2.2.22 Actions upon reception of <i>SystemInformationBlockType15</i>	39
5.2.2.23 Actions upon reception of <i>SystemInformationBlockType16</i>	39

5.2.2.24	Actions upon reception of <i>SystemInformationBlockType17</i>	40
5.2.2.25	Actions upon reception of <i>SystemInformationBlockType18</i>	40
5.2.2.26	Actions upon reception of <i>SystemInformationBlockType19</i>	40
5.2.3	Acquisition of an SI message.....	40
5.3	Connection control	41
5.3.1	Introduction.....	41
5.3.1.1	RRC connection control.....	41
5.3.1.2	Security	42
5.3.1.2a	RN security	43
5.3.1.3	Connected mode mobility	43
5.3.2	Paging	44
5.3.2.1	General.....	44
5.3.2.2	Initiation.....	45
5.3.2.3	Reception of the <i>Paging</i> message by the UE	45
5.3.3	RRC connection establishment.....	46
5.3.3.1	General.....	46
5.3.3.1a	Conditions for establishing RRC Connection for sidelink communication/ discovery	46
5.3.3.2	Initiation.....	47
5.3.3.3	Actions related to transmission of <i>RRCConnectionRequest</i> message	49
5.3.3.4	Reception of the <i>RRCConnectionSetup</i> by the UE.....	50
5.3.3.5	Cell re-selection while T300, T302, T303, T305 or T306 is running	51
5.3.3.6	T300 expiry	51
5.3.3.7	T302, T303, T305 or T306 expiry or stop.....	52
5.3.3.8	Reception of the <i>RRCConnectionReject</i> by the UE	53
5.3.3.9	Abortion of RRC connection establishment.....	53
5.3.3.10	Handling of SSAC related parameters	53
5.3.3.11	Access barring check.....	54
5.3.3.12	EAB check	55
5.3.4	Initial security activation	56
5.3.4.1	General.....	56
5.3.4.2	Initiation.....	56
5.3.4.3	Reception of the <i>SecurityModeCommand</i> by the UE.....	56
5.3.5	RRC connection reconfiguration	57
5.3.5.1	General.....	57
5.3.5.2	Initiation.....	58
5.3.5.3	Reception of an <i>RRCConnectionReconfiguration</i> not including the <i>mobilityControlInfo</i> by the UE	58
5.3.5.4	Reception of an <i>RRCConnectionReconfiguration</i> including the <i>mobilityControlInfo</i> by the UE (handover)	59
5.3.5.5	Reconfiguration failure	63
5.3.5.6	T304 expiry (handover failure)	63
5.3.5.7	Void.....	64
5.3.5.7a	T307 expiry (SCG change failure).....	64
5.3.5.8	Radio Configuration involving full configuration option.....	64
5.3.6	Counter check	65
5.3.6.1	General.....	65
5.3.6.2	Initiation.....	66
5.3.6.3	Reception of the <i>CounterCheck</i> message by the UE.....	66
5.3.7	RRC connection re-establishment.....	66
5.3.7.1	General.....	66
5.3.7.2	Initiation.....	67
5.3.7.3	Actions following cell selection while T311 is running.....	68
5.3.7.4	Actions related to transmission of <i>RRCConnectionReestablishmentRequest</i> message	68
5.3.7.5	Reception of the <i>RRCConnectionReestablishment</i> by the UE	69
5.3.7.6	T311 expiry	70
5.3.7.7	T301 expiry or selected cell no longer suitable.....	71
5.3.7.8	Reception of <i>RRCConnectionReestablishmentReject</i> by the UE	71
5.3.8	RRC connection release	71
5.3.8.1	General.....	71
5.3.8.2	Initiation.....	71
5.3.8.3	Reception of the <i>RRCConnectionRelease</i> by the UE	71
5.3.8.4	T320 expiry	72

5.3.9	RRC connection release requested by upper layers	72
5.3.9.1	General	72
5.3.9.2	Initiation	72
5.3.10	Radio resource configuration	72
5.3.10.0	General	72
5.3.10.1	SRB addition/ modification	73
5.3.10.2	DRB release	73
5.3.10.3	DRB addition/ modification	74
5.3.10.3a1	DC specific DRB addition or reconfiguration	74
5.3.10.3a	SCell release	76
5.3.10.3b	SCell addition/ modification	76
5.3.10.3c	PSCell addition or modification	77
5.3.10.4	MAC main reconfiguration	77
5.3.10.5	Semi-persistent scheduling reconfiguration	77
5.3.10.6	Physical channel reconfiguration	77
5.3.10.7	Radio Link Failure Timers and Constants reconfiguration	78
5.3.10.8	Time domain measurement resource restriction for serving cell	78
5.3.10.9	Other configuration	79
5.3.10.10	SCG reconfiguration	80
5.3.10.11	SCG dedicated resource configuration	81
5.3.10.12	Reconfiguration SCG or split DRB by <i>drb-ToAddModList</i>	81
5.3.10.13	Neighbour cell information reconfiguration	82
5.3.10.14	Void	82
5.3.10.15	Sidelink dedicated configuration	82
5.3.11	Radio link failure related actions	83
5.3.11.1	Detection of physical layer problems in RRC_CONNECTED	83
5.3.11.2	Recovery of physical layer problems	83
5.3.11.3	Detection of radio link failure	83
5.3.12	UE actions upon leaving RRC_CONNECTED	85
5.3.13	UE actions upon PUCCH/ SRS release request	85
5.3.14	Proximity indication	86
5.3.14.1	General	86
5.3.14.2	Initiation	86
5.3.14.3	Actions related to transmission of <i>ProximityIndication</i> message	86
5.3.15	Void	87
5.4	Inter-RAT mobility	87
5.4.1	Introduction	87
5.4.2	Handover to E-UTRA	87
5.4.2.1	General	87
5.4.2.2	Initiation	87
5.4.2.3	Reception of the <i>RRCConnectionReconfiguration</i> by the UE	88
5.4.2.4	Reconfiguration failure	89
5.4.2.5	T304 expiry (handover to E-UTRA failure)	89
5.4.3	Mobility from E-UTRA	90
5.4.3.1	General	90
5.4.3.2	Initiation	90
5.4.3.3	Reception of the <i>MobilityFromEUTRACommand</i> by the UE	91
5.4.3.4	Successful completion of the mobility from E-UTRA	92
5.4.3.5	Mobility from E-UTRA failure	92
5.4.4	Handover from E-UTRA preparation request (CDMA2000)	93
5.4.4.1	General	93
5.4.4.2	Initiation	93
5.4.4.3	Reception of the <i>HandoverFromEUTRAPreparationRequest</i> by the UE	93
5.4.5	UL handover preparation transfer (CDMA2000)	94
5.4.5.1	General	94
5.4.5.2	Initiation	94
5.4.5.3	Actions related to transmission of the <i>ULHandoverPreparationTransfer</i> message	94
5.4.5.4	Failure to deliver the <i>ULHandoverPreparationTransfer</i> message	94
5.4.6	Inter-RAT cell change order to E-UTRAN	94
5.4.6.1	General	94
5.4.6.2	Initiation	94
5.4.6.3	UE fails to complete an inter-RAT cell change order	95

5.5	Measurements.....	95
5.5.1	Introduction.....	95
5.5.2	Measurement configuration	96
5.5.2.1	General	96
5.5.2.2	Measurement identity removal.....	97
5.5.2.2a	Measurement identity autonomous removal	98
5.5.2.3	Measurement identity addition/ modification	98
5.5.2.4	Measurement object removal	99
5.5.2.5	Measurement object addition/ modification.....	99
5.5.2.6	Reporting configuration removal	101
5.5.2.7	Reporting configuration addition/ modification.....	101
5.5.2.8	Quantity configuration	102
5.5.2.9	Measurement gap configuration.....	102
5.5.2.10	Discovery signals measurement timing configuration	102
5.5.3	Performing measurements	102
5.5.3.1	General	102
5.5.3.2	Layer 3 filtering	104
5.5.4	Measurement report triggering	105
5.5.4.1	General	105
5.5.4.2	Event A1 (Serving becomes better than threshold).....	108
5.5.4.3	Event A2 (Serving becomes worse than threshold)	109
5.5.4.4	Event A3 (Neighbour becomes offset better than PCell/ PSCell).....	109
5.5.4.5	Event A4 (Neighbour becomes better than threshold)	110
5.5.4.6	Event A5 (PCell/ PSCell becomes worse than threshold1 and neighbour becomes better than threshold2)	111
5.5.4.6a	Event A6 (Neighbour becomes offset better than SCell)	112
5.5.4.7	Event B1 (Inter RAT neighbour becomes better than threshold).....	112
5.5.4.8	Event B2 (PCell becomes worse than threshold1 and inter RAT neighbour becomes better than threshold2)	113
5.5.4.9	Event C1 (CSI-RS resource becomes better than threshold).....	114
5.5.4.10	Event C2 (CSI-RS resource becomes offset better than reference CSI-RS resource).....	114
5.5.5	Measurement reporting	115
5.5.6	Measurement related actions.....	118
5.5.6.1	Actions upon handover and re-establishment.....	118
5.5.6.2	Speed dependant scaling of measurement related parameters.....	119
5.5.7	Inter-frequency RSTD measurement indication	119
5.5.7.1	General	119
5.5.7.2	Initiation.....	120
5.5.7.3	Actions related to transmission of <i>InterFreqRSTDMeasurementIndication</i> message.....	120
5.6	Other.....	120
5.6.1	DL information transfer	120
5.6.1.1	General	120
5.6.1.2	Initiation.....	121
5.6.1.3	Reception of the <i>DLInformationTransfer</i> by the UE	121
5.6.2	UL information transfer	121
5.6.2.1	General	121
5.6.2.2	Initiation.....	121
5.6.2.3	Actions related to transmission of <i>ULInformationTransfer</i> message.....	121
5.6.2.4	Failure to deliver <i>ULInformationTransfer</i> message	121
5.6.3	UE capability transfer	122
5.6.3.1	General	122
5.6.3.2	Initiation.....	122
5.6.3.3	Reception of the <i>UECapabilityEnquiry</i> by the UE	122
5.6.4	CSFB to 1x Parameter transfer	124
5.6.4.1	General	124
5.6.4.2	Initiation.....	125
5.6.4.3	Actions related to transmission of <i>CSFBParametersRequestCDMA2000</i> message.....	125
5.6.4.4	Reception of the <i>CSFBParametersResponseCDMA2000</i> message.....	125
5.6.5	UE Information.....	125
5.6.5.1	General	125
5.6.5.2	Initiation.....	125
5.6.5.3	Reception of the <i>UEInformationRequest</i> message	125

5.6.6	Logged Measurement Configuration	127
5.6.6.1	General	127
5.6.6.2	Initiation	127
5.6.6.3	Reception of the <i>LoggedMeasurementConfiguration</i> by the UE	127
5.6.6.4	T330 expiry	127
5.6.7	Release of Logged Measurement Configuration	128
5.6.7.1	General	128
5.6.7.2	Initiation	128
5.6.8	Measurements logging	128
5.6.8.1	General	128
5.6.8.2	Initiation	128
5.6.9	In-device coexistence indication	130
5.6.9.1	General	130
5.6.9.2	Initiation	130
5.6.9.3	Actions related to transmission of <i>InDeviceCoexIndication</i> message	131
5.6.10	UE Assistance Information	132
5.6.10.1	General	132
5.6.10.2	Initiation	132
5.6.10.3	Actions related to transmission of <i>UEAssistanceInformation</i> message	133
5.6.11	Mobility history information	133
5.6.11.1	General	133
5.6.11.2	Initiation	133
5.6.12	RAN-assisted WLAN interworking	134
5.6.12.1	General	134
5.6.12.2	Dedicated WLAN offload configuration	134
5.6.12.3	WLAN offload RAN evaluation	134
5.6.12.4	T350 expiry or stop	134
5.6.12.5	Cell selection/ re-selection while T350 is running	134
5.6.13	SCG failure information	135
5.6.13.1	General	135
5.6.13.2	Initiation	135
5.6.13.3	Actions related to transmission of <i>SCGFailureInformation</i> message	135
5.7	Generic error handling	136
5.7.1	General	136
5.7.2	ASN.1 violation or encoding error	136
5.7.3	Field set to a not comprehended value	136
5.7.4	Mandatory field missing	137
5.7.5	Not comprehended field	138
5.8	MBMS	138
5.8.1	Introduction	138
5.8.1.1	General	138
5.8.1.2	Scheduling	138
5.8.1.3	MCCH information validity and notification of changes	139
5.8.2	MCCH information acquisition	140
5.8.2.1	General	140
5.8.2.2	Initiation	140
5.8.2.3	MCCH information acquisition by the UE	140
5.8.2.4	Actions upon reception of the <i>MBSFNAreaConfiguration</i> message	140
5.8.2.5	Actions upon reception of the <i>MBMSCountingRequest</i> message	140
5.8.3	MBMS PTM radio bearer configuration	141
5.8.3.1	General	141
5.8.3.2	Initiation	141
5.8.3.3	MRB establishment	141
5.8.3.4	MRB release	141
5.8.4	MBMS Counting Procedure	141
5.8.4.1	General	141
5.8.4.2	Initiation	142
5.8.4.3	Reception of the <i>MBMSCountingRequest</i> message by the UE	142
5.8.5	MBMS interest indication	143
5.8.5.1	General	143
5.8.5.2	Initiation	143
5.8.5.3	Determine MBMS frequencies of interest	143

5.8.5.4	Actions related to transmission of <i>MBMSInterestIndication</i> message	144
5.9	RN procedures	145
5.9.1	RN reconfiguration	145
5.9.1.1	General	145
5.9.1.2	Initiation	145
5.9.1.3	Reception of the <i>RNReconfiguration</i> by the RN	145
5.10	Sidelink	145
5.10.1	Introduction	145
5.10.1a	Conditions for sidelink operation	146
5.10.2	Sidelink UE information	146
5.10.2.1	General	146
5.10.2.2	Initiation	147
5.10.2.3	Actions related to transmission of <i>SidelinkUEInformation</i> message	148
5.10.3	Sidelink communication monitoring	149
5.10.4	Sidelink communication transmission	150
5.10.5	Sidelink discovery monitoring	151
5.10.6	Sidelink discovery announcement	151
5.10.7	Sidelink synchronisation information transmission	152
5.10.7.1	General	152
5.10.7.2	Initiation	153
5.10.7.3	Transmission of SLSS	153
5.10.7.4	Transmission of <i>MasterInformationBlock-SL</i> message	155
5.10.7.5	Void	155
5.10.8	Sidelink synchronisation reference	155
5.10.8.1	General	155
5.10.8.2	Selection and reselection of synchronisation reference UE (SyncRef UE)	155
5.10.9	Sidelink common control information	156
5.10.9.1	General	156
5.10.9.2	Actions related to reception of <i>MasterInformationBlock-SL</i> message	156
6	Protocol data units, formats and parameters (tabular & ASN.1)	157
6.1	General	157
6.2	RRC messages	158
6.2.1	General message structure	158
-	<i>EUTRA-RRC-Definitions</i>	158
-	<i>BCCH-BCH-Message</i>	159
-	<i>BCCH-DL-SCH-Message</i>	159
-	<i>MCCH-Message</i>	159
-	<i>PCCH-Message</i>	159
-	<i>DL-CCCH-Message</i>	160
-	<i>DL-DCCH-Message</i>	160
-	<i>UL-CCCH-Message</i>	160
-	<i>UL-DCCH-Message</i>	161
6.2.2	Message definitions	162
-	<i>CounterCheck</i>	162
-	<i>CounterCheckResponse</i>	163
-	<i>CSFBParametersRequestCDMA2000</i>	163
-	<i>CSFBParametersResponseCDMA2000</i>	164
-	<i>DLInformationTransfer</i>	164
-	<i>HandoverFromEUTRAPreparationRequest</i> (CDMA2000)	165
-	<i>InDeviceCoexIndication</i>	166
-	<i>InterFreqRSTDMeasurementIndication</i>	168
-	<i>LoggedMeasurementConfiguration</i>	169
-	<i>MasterInformationBlock</i>	171
-	<i>MBMSCountingRequest</i>	171
-	<i>MBMSCountingResponse</i>	172
-	<i>MBMSInterestIndication</i>	173
-	<i>MBSFNAreaConfiguration</i>	173
-	<i>MeasurementReport</i>	174
-	<i>MobilityFromEUTRACommand</i>	175
-	<i>Paging</i>	178
-	<i>ProximityIndication</i>	179

–	<i>RNReconfiguration</i>	180
–	<i>RNReconfigurationComplete</i>	180
–	<i>RRCCConnectionReconfiguration</i>	181
–	<i>RRCCConnectionReconfigurationComplete</i>	185
–	<i>RRCCConnectionReestablishment</i>	186
–	<i>RRCCConnectionReestablishmentComplete</i>	186
–	<i>RRCCConnectionReestablishmentReject</i>	187
–	<i>RRCCConnectionReestablishmentRequest</i>	188
–	<i>RRCCConnectionReject</i>	188
–	<i>RRCCConnectionRelease</i>	189
–	<i>RRCCConnectionRequest</i>	192
–	<i>RRCCConnectionSetup</i>	193
–	<i>RRCCConnectionSetupComplete</i>	194
–	<i>SCGFailureInformation</i>	195
–	<i>SecurityModeCommand</i>	196
–	<i>SecurityModeComplete</i>	196
–	<i>SecurityModeFailure</i>	197
–	<i>SidelinkUEInformation</i>	197
–	<i>SystemInformation</i>	198
–	<i>SystemInformationBlockType1</i>	199
–	<i>UEAssistanceInformation</i>	203
–	<i>UECapabilityEnquiry</i>	204
–	<i>UECapabilityInformation</i>	205
–	<i>UEInformationRequest</i>	205
–	<i>UEInformationResponse</i>	206
–	<i>ULHandoverPreparationTransfer (CDMA2000)</i>	212
–	<i>ULInformationTransfer</i>	213
6.3	RRC information elements	213
6.3.1	System information blocks	213
–	<i>SystemInformationBlockType2</i>	213
–	<i>SystemInformationBlockType3</i>	215
–	<i>SystemInformationBlockType4</i>	218
–	<i>SystemInformationBlockType5</i>	219
–	<i>SystemInformationBlockType6</i>	223
–	<i>SystemInformationBlockType7</i>	225
–	<i>SystemInformationBlockType8</i>	226
–	<i>SystemInformationBlockType9</i>	231
–	<i>SystemInformationBlockType10</i>	231
–	<i>SystemInformationBlockType11</i>	232
–	<i>SystemInformationBlockType12</i>	233
–	<i>SystemInformationBlockType13</i>	233
–	<i>SystemInformationBlockType14</i>	234
–	<i>SystemInformationBlockType15</i>	234
–	<i>SystemInformationBlockType16</i>	235
–	<i>SystemInformationBlockType17</i>	236
–	<i>SystemInformationBlockType18</i>	237
–	<i>SystemInformationBlockType19</i>	237
6.3.2	Radio resource control information elements	238
–	<i>AntennaInfo</i>	238
–	<i>AntennaInfoUL</i>	240
–	<i>CQI-ReportConfig</i>	240
–	<i>CQI-ReportPeriodicProcExtId</i>	246
–	<i>CrossCarrierSchedulingConfig</i>	246
–	<i>CSI-IM-Config</i>	247
–	<i>CSI-IM-ConfigId</i>	247
–	<i>CSI-Process</i>	247
–	<i>CSI-ProcessId</i>	249
–	<i>CSI-RS-Config</i>	249
–	<i>CSI-RS-ConfigNZP</i>	250
–	<i>CSI-RS-ConfigNZPId</i>	251
–	<i>CSI-RS-ConfigZP</i>	251
–	<i>CSI-RS-ConfigZPId</i>	252

–	<i>DMRS-Config</i>	252
–	<i>DRB-Identity</i>	252
–	<i>EPDCCH-Config</i>	252
–	<i>EIMTA-MainConfig</i>	254
–	<i>LogicalChannelConfig</i>	255
–	<i>MAC-MainConfig</i>	256
–	<i>PDCP-Config</i>	260
–	<i>PDSCH-Config</i>	262
–	<i>PDSCH-RE-MappingQCL-ConfigId</i>	263
–	<i>PHICH-Config</i>	263
–	<i>PhysicalConfigDedicated</i>	264
–	<i>P-Max</i>	267
–	<i>PRACH-Config</i>	267
–	<i>PresenceAntennaPort1</i>	268
–	<i>PUCCH-Config</i>	268
–	<i>PUSCH-Config</i>	271
–	<i>RACH-ConfigCommon</i>	274
–	<i>RACH-ConfigDedicated</i>	275
–	<i>RadioResourceConfigCommon</i>	276
–	<i>RadioResourceConfigDedicated</i>	278
–	<i>RLC-Config</i>	283
–	<i>RLF-TimersAndConstants</i>	284
–	<i>RN-SubframeConfig</i>	285
–	<i>SchedulingRequestConfig</i>	286
–	<i>SoundingRS-UL-Config</i>	287
–	<i>SPS-Config</i>	288
–	<i>TDD-Config</i>	290
–	<i>TimeAlignmentTimer</i>	291
–	<i>TPC-PDCCH-Config</i>	291
–	<i>UplinkPowerControl</i>	292
6.3.3	Security control information elements	295
–	<i>NextHopChainingCount</i>	295
–	<i>SecurityAlgorithmConfig</i>	295
–	<i>ShortMAC-I</i>	295
6.3.4	Mobility control information elements	296
–	<i>AdditionalSpectrumEmission</i>	296
–	<i>ARFCN-ValueCDMA2000</i>	296
–	<i>ARFCN-ValueEUTRA</i>	296
–	<i>ARFCN-ValueGERAN</i>	296
–	<i>ARFCN-ValueUTRA</i>	297
–	<i>BandclassCDMA2000</i>	297
–	<i>BandIndicatorGERAN</i>	297
–	<i>CarrierFreqCDMA2000</i>	297
–	<i>CarrierFreqGERAN</i>	298
–	<i>CarrierFreqsGERAN</i>	298
–	<i>CarrierFreqListMBMS</i>	299
–	<i>CDMA2000-Type</i>	299
–	<i>CellIdentity</i>	299
–	<i>CellIndexList</i>	299
–	<i>CellReselectionPriority</i>	300
–	<i>CSFB-RegistrationParamIXRTT</i>	300
–	<i>CellGlobalIdEUTRA</i>	301
–	<i>CellGlobalIdUTRA</i>	301
–	<i>CellGlobalIdGERAN</i>	302
–	<i>CellGlobalIdCDMA2000</i>	302
–	<i>CSG-Identity</i>	302
–	<i>FreqBandIndicator</i>	303
–	<i>MobilityControlInfo</i>	303
–	<i>MobilityParametersCDMA2000 (1xRTT)</i>	305
–	<i>MobilityStateParameters</i>	305
–	<i>MultiBandInfoList</i>	305
–	<i>PhysCellId</i>	306

-	<i>PhysCellIdRange</i>	306
-	<i>PhysCellIdRangeUTRA-FDDList</i>	307
-	<i>PhysCellIdCDMA2000</i>	307
-	<i>PhysCellIdGERAN</i>	307
-	<i>PhysCellIdUTRA-FDD</i>	308
-	<i>PhysCellIdUTRA-TDD</i>	308
-	<i>PLMN-Identity</i>	308
-	<i>PLMN-IdentityList3</i>	309
-	<i>PreRegistrationInfoHRPD</i>	309
-	<i>Q-QualMin</i>	309
-	<i>Q-RxLevMin</i>	310
-	<i>Q-OffsetRange</i>	310
-	<i>Q-OffsetRangeInterRAT</i>	310
-	<i>ReselectionThreshold</i>	310
-	<i>ReselectionThresholdQ</i>	310
-	<i>SCellIndex</i>	311
-	<i>ServCellIndex</i>	311
-	<i>SpeedStateScaleFactors</i>	311
-	<i>SystemInfoListGERAN</i>	311
-	<i>SystemTimeInfoCDMA2000</i>	312
-	<i>TrackingAreaCode</i>	312
-	<i>T-Reselection</i>	313
6.3.5	Measurement information elements.....	313
-	<i>AllowedMeasBandwidth</i>	313
-	<i>CSI-RSRP-Range</i>	313
-	<i>Hysteresis</i>	313
-	<i>LocationInfo</i>	314
-	<i>MBSFN-RSRQ-Range</i>	314
-	<i>MeasConfig</i>	315
-	<i>MeasDS-Config</i>	316
-	<i>MeasGapConfig</i>	317
-	<i>MeasId</i>	318
-	<i>MeasIdToAddModList</i>	318
-	<i>MeasObjectCDMA2000</i>	318
-	<i>MeasObjectEUTRA</i>	319
-	<i>MeasObjectGERAN</i>	321
-	<i>MeasObjectId</i>	322
-	<i>MeasObjectToAddModList</i>	322
-	<i>MeasObjectUTRA</i>	323
-	<i>MeasResults</i>	323
-	<i>MeasScaleFactor</i>	327
-	<i>QuantityConfig</i>	327
-	<i>ReportConfigEUTRA</i>	328
-	<i>ReportConfigId</i>	332
-	<i>ReportConfigInterRAT</i>	332
-	<i>ReportConfigToAddModList</i>	333
-	<i>ReportInterval</i>	334
-	<i>RSRP-Range</i>	334
-	<i>RSRQ-Range</i>	334
-	<i>RSRQ-Type</i>	335
-	<i>TimeToTrigger</i>	335
6.3.6	Other information elements.....	335
-	<i>AbsoluteTimeInfo</i>	335
-	<i>AreaConfiguration</i>	336
-	<i>C-RNTI</i>	336
-	<i>DedicatedInfoCDMA2000</i>	336
-	<i>DedicatedInfoNAS</i>	336
-	<i>FilterCoefficient</i>	337
-	<i>LoggingDuration</i>	337
-	<i>LoggingInterval</i>	337
-	<i>MeasSubframePattern</i>	337
-	<i>MMEC</i>	338

–	<i>NeighCellConfig</i>	338
–	<i>OtherConfig</i>	338
–	<i>RAND-CDMA2000 (1xRTT)</i>	339
–	<i>RAT-Type</i>	340
–	<i>RRC-TransactionIdentifier</i>	340
–	<i>S-TMSI</i>	340
–	<i>TraceReference</i>	340
–	<i>UE-CapabilityRAT-ContainerList</i>	341
–	<i>UE-EUTRA-Capability</i>	341
–	<i>UE-RadioPagingInfo</i>	362
–	<i>UE-TimersAndConstants</i>	362
–	<i>VisitedCellInfoList</i>	362
–	<i>WLAN-OffloadConfig</i>	363
6.3.7	MBMS information elements	365
–	<i>MBMS-NotificationConfig</i>	365
–	<i>MBSFN-AreaId</i>	365
–	<i>MBSFN-AreaInfoList</i>	365
–	<i>MBSFN-SubframeConfig</i>	366
–	<i>PMCH-InfoList</i>	367
6.3.8	Sidelink information elements	368
–	<i>SL-CommConfig</i>	368
–	<i>SL-CommResourcePool</i>	369
–	<i>SL-CP-Len</i>	370
–	<i>SL-DiscConfig</i>	370
–	<i>SL-DiscResourcePool</i>	371
–	<i>SL-DiscTxPowerInfo</i>	373
–	<i>SL-HoppingConfig</i>	373
–	<i>SL-OffsetIndicator</i>	374
–	<i>SL-PeriodComm</i>	374
–	<i>SLSSID</i>	374
–	<i>SL-SyncConfig</i>	374
–	<i>SL-TF-ResourceConfig</i>	376
–	<i>SL-TxParameters</i>	376
–	<i>SL-TxPoolIdentity</i>	377
–	<i>SL-TxPoolToReleaseList</i>	377
6.4	RRC multiplicity and type constraint values	377
–	Multiplicity and type constraint definitions	377
–	End of EUTRA-RRC-Definitions.....	379
6.5	PC5 RRC messages	379
6.5.1	General message structure	379
–	<i>PC5-RRC-Definitions</i>	379
–	<i>SBCCH-SL-BCH-Message</i>	379
6.5.2	Message definitions	380
–	<i>MasterInformationBlock-SL</i>	380
–	End of <i>PC5-RRC-Definitions</i>	380
7	Variables and constants	380
7.1	UE variables	380
–	<i>EUTRA-UE-Variables</i>	381
–	<i>VarConnEstFailReport</i>	381
–	<i>VarLogMeasConfig</i>	381
–	<i>VarLogMeasReport</i>	382
–	<i>VarMeasConfig</i>	382
–	<i>VarMeasReportList</i>	383
–	<i>VarMobilityHistoryReport</i>	383
–	<i>VarRLF-Report</i>	384
–	<i>VarShortMAC-Input</i>	384
–	Multiplicity and type constraint definitions	384
–	End of <i>EUTRA-UE-Variables</i>	384
7.2	Counters	385
7.3	Timers (Informative)	386
7.4	Constants	388

8	Protocol data unit abstract syntax.....	389
8.1	General	389
8.2	Structure of encoded RRC messages	389
8.3	Basic production.....	389
8.4	Extension.....	389
8.5	Padding.....	390
9	Specified and default radio configurations.....	390
9.1	Specified configurations.....	390
9.1.1	Logical channel configurations.....	390
9.1.1.1	BCCH configuration	390
9.1.1.2	CCCH configuration	390
9.1.1.3	PCCH configuration.....	391
9.1.1.4	MCCH and MTCH configuration	391
9.1.1.5	SBCCH configuration	391
9.1.1.6	STCH configuration	391
9.1.2	SRB configurations.....	392
9.1.2.1	SRB1	392
9.1.2.2	SRB2	392
9.2	Default radio configurations.....	392
9.2.1	SRB configurations.....	392
9.2.1.1	SRB1	392
9.2.1.2	SRB2.....	393
9.2.2	Default MAC main configuration.....	393
9.2.3	Default semi-persistent scheduling configuration.....	393
9.2.4	Default physical channel configuration	393
9.2.5	Default values timers and constants.....	394
9.3	Sidelink pre-configured parameters.....	394
9.3.1	Specified parameters	394
9.3.2	Pre-configurable parameters	394
-	<i>SL-Preconfiguration</i>	395
10	Radio information related interactions between network nodes	396
10.1	General	396
10.2	Inter-node RRC messages	396
10.2.1	General.....	396
-	<i>EUTRA-InterNodeDefinitions</i>	396
10.2.2	Message definitions	397
-	<i>HandoverCommand</i>	397
-	<i>HandoverPreparationInformation</i>	398
-	<i>SCG-Config</i>	400
-	<i>SCG-ConfigInfo</i>	400
-	<i>UERadioAccessCapabilityInformation</i>	402
-	<i>UERadioPagingInformation</i>	403
10.3	Inter-node RRC information element definitions	403
-	<i>AS-Config</i>	403
-	<i>AS-Context</i>	404
-	<i>ReestablishmentInfo</i>	405
-	<i>RRM-Config</i>	406
10.4	Inter-node RRC multiplicity and type constraint values	406
-	Multiplicity and type constraints definitions	406
-	End of <i>EUTRA-InterNodeDefinitions</i>	407
10.5	Mandatory information in <i>AS-Config</i>	407
11	UE capability related constraints and performance requirements.....	407
11.1	UE capability related constraints.....	407
11.2	Processing delay requirements for RRC procedures	408
11.3	Void.....	411
Annex A (informative):	Guidelines, mainly on use of ASN.1	412
A.1	Introduction	412

A.2	Procedural specification	412
A.2.1	General principles.....	412
A.2.2	More detailed aspects	412
A.3	PDU specification	412
A.3.1	General principles.....	412
A.3.1.1	ASN.1 sections	412
A.3.1.2	ASN.1 identifier naming conventions.....	413
A.3.1.3	Text references using ASN.1 identifiers	414
A.3.2	High-level message structure	415
A.3.3	Message definition	415
A.3.4	Information elements.....	417
A.3.5	Fields with optional presence	418
A.3.6	Fields with conditional presence	418
A.3.7	Guidelines on use of lists with elements of SEQUENCE type.....	419
A.4	Extension of the PDU specifications	419
A.4.1	General principles to ensure compatibility.....	419
A.4.2	Critical extension of messages and fields.....	420
A.4.3	Non-critical extension of messages	421
A.4.3.1	General principles.....	421
A.4.3.2	Further guidelines	422
A.4.3.3	Typical example of evolution of IE with local extensions.....	423
A.4.3.4	Typical examples of non critical extension at the end of a message.....	424
A.4.3.5	Examples of non-critical extensions not placed at the default extension location	424
–	<i>ParentIE-WithEM</i>	424
–	<i>ChildIE1-WithoutEM</i>	425
–	<i>ChildIE2-WithoutEM</i>	425
A.5	Guidelines regarding inclusion of transaction identifiers in RRC messages.....	426
A.6	Protection of RRC messages (informative).....	426
A.7	Miscellaneous.....	428
Annex B (normative):	Release 8 and 9 AS feature handling.....	429
B.1	Feature group indicators.....	429
B.2	CSG support	439
Annex C (normative):	Release 10 AS feature handling	440
C.1	Feature group indicators.....	440
Annex D (informative):	Descriptive background information	443
D.1	Signalling of Multiple Frequency Band Indicators (Multiple FBI).....	443
D.1.1	Mapping between frequency band indicator and multiple frequency band indicator	443
D.1.2	Mapping between inter-frequency neighbour list and multiple frequency band indicator	443
D.1.3	Mapping between UTRA FDD frequency list and multiple frequency band indicator.....	444
Annex E (normative):	TDD/FDD differentiation of FGIs/capabilities in TDD-FDD CA.....	446
Annex F (informative):	Change history	448
History	461

Foreword

This Technical Specification has been produced by the 3rd Generation Partnership Project (3GPP).

The contents of the present document are subject to continuing work within the TSG and may change following formal TSG approval. Should the TSG modify the contents of the present document, it will be re-released by the TSG with an identifying change of release date and an increase in version number as follows:

Version x.y.z

where:

- x the first digit:
 - 1 presented to TSG for information;
 - 2 presented to TSG for approval;
 - 3 or greater indicates TSG approved document under change control.
- y the second digit is incremented for all changes of substance, i.e. technical enhancements, corrections, updates, etc.
- z the third digit is incremented when editorial only changes have been incorporated in the document.

1 Scope

The present document specifies the Radio Resource Control protocol for the radio interface between UE and E-UTRAN as well as for the radio interface between RN and E-UTRAN.

The scope of the present document also includes:

- the radio related information transported in a transparent container between source eNB and target eNB upon inter eNB handover;
- the radio related information transported in a transparent container between a source or target eNB and another system upon inter RAT handover.

2 References

The following documents contain provisions which, through reference in this text, constitute provisions of the present document.

- References are either specific (identified by date of publication, edition number, version number, etc.) or non specific.
- For a specific reference, subsequent revisions do not apply.
- For a non-specific reference, the latest version applies. In the case of a reference to a 3GPP document (including a GSM document), a non-specific reference implicitly refers to the latest version of that document *in the same Release as the present document*.

- [1] 3GPP TR 21.905: "Vocabulary for 3GPP Specifications".
- [2] Void.
- [3] 3GPP TS 36.302: "Evolved Universal Terrestrial Radio Access (E-UTRA); Services provided by the physical layer".
- [4] 3GPP TS 36.304: "Evolved Universal Terrestrial Radio Access (E-UTRA); UE Procedures in Idle Mode".
- [5] 3GPP TS 36.306 "Evolved Universal Terrestrial Radio Access (E-UTRA); UE Radio Access Capabilities".
- [6] 3GPP TS 36.321: "Evolved Universal Terrestrial Radio Access (E-UTRA); Medium Access Control (MAC) protocol specification".
- [7] 3GPP TS 36.322: "Evolved Universal Terrestrial Radio Access (E-UTRA); Radio Link Control (RLC) protocol specification".
- [8] 3GPP TS 36.323: "Evolved Universal Terrestrial Radio Access (E-UTRA); Packet Data Convergence Protocol (PDCP) Specification".
- [9] 3GPP TS 36.300: "Evolved Universal Terrestrial Radio Access (E-UTRA) and Evolved Universal Terrestrial Radio Access (E-UTRAN); Overall description; Stage 2".
- [10] 3GPP TS 22.011: "Service accessibility".
- [11] 3GPP TS 23.122: "Non-Access-Stratum (NAS) functions related to Mobile Station (MS) in idle mode".
- [12] 3GPP2 C.S0002-F v1.0: "Physical Layer Standard for cdma2000 Spread Spectrum Systems".
- [13] ITU-T Recommendation X.680 (07/2002) "Information Technology - Abstract Syntax Notation One (ASN.1): Specification of basic notation" (Same as the ISO/IEC International Standard 8824-1).

- [14] ITU-T Recommendation X.681 (07/2002) "Information Technology - Abstract Syntax Notation One (ASN.1): Information object specification" (Same as the ISO/IEC International Standard 8824-2).
- [15] ITU-T Recommendation X.691 (07/2002) "Information technology - ASN.1 encoding rules: Specification of Packed Encoding Rules (PER)" (Same as the ISO/IEC International Standard 8825-2).
- [16] 3GPP TS 36.133: "Evolved Universal Terrestrial Radio Access (E-UTRA); Requirements for support of radio resource management".
- [17] 3GPP TS 25.101: "Universal Terrestrial Radio Access (UTRA); User Equipment (UE) radio transmission and reception (FDD)".
- [18] 3GPP TS 25.102: "Universal Terrestrial Radio Access (UTRA); User Equipment (UE) radio transmission and reception (TDD)".
- [19] 3GPP TS 25.331: "Universal Terrestrial Radio Access (UTRA); Radio Resource Control (RRC); Protocol specification".
- [20] 3GPP TS 45.005: "Radio transmission and reception".
- [21] 3GPP TS 36.211: "Evolved Universal Terrestrial Radio Access (E-UTRA); Physical Channels and Modulation".
- [22] 3GPP TS 36.212: "Evolved Universal Terrestrial Radio Access (E-UTRA); Multiplexing and channel coding".
- [23] 3GPP TS 36.213: "Evolved Universal Terrestrial Radio Access (E-UTRA); Physical layer procedures".
- [24] 3GPP2 C.S0057-E v1.0: "Band Class Specification for cdma2000 Spread Spectrum Systems".
- [25] 3GPP2 C.S0005-F v1.0: "Upper Layer (Layer 3) Signaling Standard for cdma2000 Spread Spectrum Systems".
- [26] 3GPP2 C.S0024-C v2.0: "cdma2000 High Rate Packet Data Air Interface Specification".
- [27] 3GPP TS 23.003: "Numbering, addressing and identification".
- [28] 3GPP TS 45.008: "Radio subsystem link control".
- [29] 3GPP TS 25.133: "Requirements for Support of Radio Resource Management (FDD)".
- [30] 3GPP TS 25.123: "Requirements for Support of Radio Resource Management (TDD)".
- [31] 3GPP TS 36.401: "Evolved Universal Terrestrial Radio Access (E-UTRA); Architecture description".
- [32] 3GPP TS 33.401: "3GPP System Architecture Evolution (SAE); Security architecture".
- [33] 3GPP2 A.S0008-C v4.0: "Interoperability Specification (IOS) for High Rate Packet Data (HRPD) Radio Access Network Interfaces with Session Control in the Access Network"
- [34] 3GPP2 C.S0004-F v1.0: "Signaling Link Access Control (LAC) Standard for cdma2000 Spread Spectrum Systems"
- [35] 3GPP TS 24.301: "Non-Access-Stratum (NAS) protocol for Evolved Packet System (EPS); Stage 3".
- [36] 3GPP TS 44.060: "General Packet Radio Service (GPRS); Mobile Station (MS) - Base Station System (BSS) interface; Radio Link Control/Medium Access Control (RLC/MAC) protocol".
- [37] 3GPP TS 23.041: "Technical realization of Cell Broadcast Service (CBS)".
- [38] 3GPP TS 23.038: "Alphabets and Language".

- [39] 3GPP TS 36.413: "Evolved Universal Terrestrial Radio Access (E-UTRAN); S1 Application Protocol (S1 AP)".
- [40] 3GPP TS 25.304: "Universal Terrestrial Radio Access (UTRAN); User Equipment (UE) procedures in idle mode and procedures for cell reselection in connected mode".
- [41] 3GPP TS 23.401: "General Packet Radio Service (GPRS) enhancements for Evolved Universal Terrestrial Radio Access Network (E-UTRAN) access".
- [42] 3GPP TS 36.101: "Evolved Universal Terrestrial Radio Access (E-UTRA); User Equipment (UE) radio transmission and reception".
- [43] 3GPP TS 44.005: "Data Link (DL) Layer General Aspects".
- [44] 3GPP2 C.S0087-A v2.0: "E-UTRAN - cdma2000 HRPD Connectivity and Interworking Air Interface Specification"
- [45] 3GPP TS 44.018: "Mobile radio interface layer 3 specification; Radio Resource Control (RRC) protocol".
- [46] 3GPP TS 25.223: "Spreading and modulation (TDD)".
- [47] 3GPP TS 36.104: "Evolved Universal Terrestrial Radio Access (E-UTRA); Base Station (BS) radio transmission and reception".
- [48] 3GPP TS 36.214: "Evolved Universal Terrestrial Radio Access (E-UTRA); Physical layer - Measurements".
- [49] 3GPP TS 24.008: "Mobile radio interface layer 3 specification; Core network protocols; Stage 3".
- [50] 3GPP TS 45.010: "Radio subsystem synchronization".
- [51] 3GPP TS 23.272: "Circuit Switched Fallback in Evolved Packet System; Stage 2".
- [52] 3GPP TS 29.061: "Interworking between the Public Land Mobile Network (PLMN) supporting packet based services and Packet Data Networks (PDN)".
- [53] 3GPP2 C.S0097-0 v3.0: "E-UTRAN - cdma2000 1x Connectivity and Interworking Air Interface Specification".
- [54] 3GPP TS 36.355: "LTE Positioning Protocol (LPP)".
- [55] 3GPP TS 36.216: "Evolved Universal Terrestrial Radio Access (E-UTRA); Physical layer for relaying operation".
- [56] 3GPP TS 23.246: "Multimedia Broadcast/Multicast Service (MBMS); Architecture and functional description".
- [57] 3GPP TS 26.346: "Multimedia Broadcast/Multicast Service (MBMS); Protocols and codecs".
- [58] 3GPP TS 32.422: "Telecommunication management; Subscriber and equipment trace; Trace control and configuration management".
- [59] 3GPP TS 22.368: "Service Requirements for Machine Type Communications; Stage 1".
- [60] 3GPP TS 37.320: "Universal Terrestrial Radio Access (UTRA) and Evolved Universal Terrestrial Radio Access (E-UTRA); Radio measurement collection for Minimization of Drive Tests (MDT); Overall description; Stage 2".
- [61] 3GPP TS 23.216: "Single Radio Voice Call Continuity (SRVCC); Stage 2".
- [62] 3GPP TS 22.146: "Multimedia Broadcast/Multicast Service (MBMS); Stage 1".
- [63] 3GPP TR 36.816: "Evolved Universal Terrestrial Radio Access (E-UTRA); Study on signalling and procedure for interference avoidance for in-device coexistence".
- [64] IS-GPS-200F: "Navstar GPS Space Segment/Navigation User Segment Interfaces".

- [65] 3GPP TS 25.307: "Requirement on User Equipments (UEs) supporting a release-independent frequency band".
- [66] 3GPP TS 24.312: "Access Network Discovery and Selection Function (ANDSF) Management Object (MO)".
- [67] IEEE 802.11-2012, Part 11: Wireless LAN Medium Access Control (MAC) and Physical Layer (PHY) specifications, IEEE Std.
- [68] 3GPP TS 23.303: "Proximity-based services (ProSe); Stage 2".
- [69] 3GPP TS 24.334: "Proximity-services (ProSe) User Equipment (UE) to ProSe function protocol aspects; Stage 3".
- [70] 3GPP TS 24.333: "Proximity-services (ProSe) Management Objects (MO)".

3 Definitions, symbols and abbreviations

3.1 Definitions

For the purposes of the present document, the terms and definitions given in TR 21.905 [1] and the following apply. A term defined in the present document takes precedence over the definition of the same term, if any, in TR 21.905 [1].

Commercial Mobile Alert System: Public Warning System that delivers *Warning Notifications* provided by *Warning Notification Providers* to CMAS capable UEs.

Common access barring parameters: The common access barring parameters refer to the access class barring parameters that are broadcast in *SystemInformationBlockType2* outside the list of PLMN specific parameters (i.e. in *ac-BarringPerPLMN-List*).

CSG member cell: A cell broadcasting the identity of the selected PLMN, registered PLMN or equivalent PLMN and for which the CSG whitelist of the UE includes an entry comprising cell's CSG ID and the respective PLMN identity.

Dual Connectivity: A UE in RRC_CONNECTED is configured with Dual Connectivity when configured with a Master and a Secondary Cell Group.

EU-Alert: Public Warning System that delivers Warning Notifications provided by Warning Notification Providers using the same AS mechanisms as defined for CMAS.

Field: The individual contents of an information element are referred as fields.

Floor: Mathematical function used to 'round down' i.e. to the nearest integer having a lower or equal value.

Information element: A structural element containing a single or multiple fields is referred as information element.

Korean Public Alert System (KPAS): Public Warning System that delivers Warning Notifications provided by Warning Notification Providers using the same AS mechanisms as defined for CMAS.

Master Cell Group: For a UE not configured with DC, the MCG comprises all serving cells. For a UE configured with DC, the MCG concerns a subset of the serving cells comprising of the PCell and zero or more secondary cells.

MBMS service: MBMS bearer service as defined in TS 23.246 [56] (i.e. provided via an MRB).

Primary Cell: The cell, operating on the primary frequency, in which the UE either performs the initial connection establishment procedure or initiates the connection re-establishment procedure, or the cell indicated as the primary cell in the handover procedure.

Primary Secondary Cell: The SCG cell in which the UE is instructed to perform random access when performing the SCG change procedure.

Primary Timing Advance Group: Timing Advance Group containing the PCell or the PSCell.

Secondary Cell: A cell, operating on a secondary frequency, which may be configured once an RRC connection is established and which may be used to provide additional radio resources.

Secondary Cell Group: For a UE configured with DC, the subset of serving cells not part of the MCG, i.e. comprising of the PSCell and zero or more other secondary cells.

Secondary Timing Advance Group: Timing Advance Group neither containing the PCell nor the PSCell. A secondary timing advance group contains at least one cell with configured uplink.

Serving Cell: For a UE in RRC_CONNECTED not configured with CA/ DC there is only one serving cell comprising of the primary cell. For a UE in RRC_CONNECTED configured with CA/ DC the term 'serving cells' is used to denote the set of one or more cells comprising of the primary cell and all secondary cells.

Sidelink: UE to UE interface for sidelink communication and sidelink discovery. The sidelink corresponds to the PC5 interface as defined in TS 23.303 [68].

Sidelink communication: AS functionality enabling ProSe Direct Communication as defined in TS 23.303 [68], between two or more nearby UEs, using E-UTRA technology but not traversing any network node.

Sidelink discovery: AS functionality enabling ProSe Direct Discovery as defined in TS 23.303 [68], using E-UTRA technology but not traversing any network node.

Timing Advance Group: A group of serving cells that is configured by RRC and that, for the cells with an UL configured, use the same timing reference cell and the same Timing Advance value. A Timing Advance Group only includes cells of the same cell group i.e. it either includes MCG cells or SCG cells.

3.2 Abbreviations

For the purposes of the present document, the abbreviations given in TR 21.905 [1] and the following apply. An abbreviation defined in the present document takes precedence over the definition of the same abbreviation, if any, in TR 21.905 [1].

1xRTT	CDMA2000 1x Radio Transmission Technology
ACK	Acknowledgement
AM	Acknowledged Mode
ANDSF	Access Network Discovery and Selection Function
ARQ	Automatic Repeat Request
AS	Access Stratum
ASN.1	Abstract Syntax Notation One
BCCH	Broadcast Control Channel
BCD	Binary Coded Decimal
BCH	Broadcast Channel
BLER	Block Error Rate
CA	Carrier Aggregation
CCCH	Common Control Channel
CCO	Cell Change Order
CG	Cell Group
CMAS	Commercial Mobile Alert Service
CP	Control Plane
C-RNTI	Cell RNTI
CRS	Cell-specific Reference Signal
CSFB	CS fallback
CSG	Closed Subscriber Group
CSI	Channel State Information
DC	Dual Connectivity
DCCH	Dedicated Control Channel
DCI	Downlink Control Information
DFN	Direct Frame Number
DL	Downlink
DL-SCH	Downlink Shared Channel
DRB	(user) Data Radio Bearer
DRX	Discontinuous Reception
DTCH	Dedicated Traffic Channel
EAB	Extended Access Barring
EHPLMN	Equivalent Home Public Land Mobile Network
eIMTA	Enhanced Interference Management and Traffic Adaptation

ENB	Evolved Node B
EPC	Evolved Packet Core
EPDCCH	Enhanced Physical Downlink Control Channel
EPS	Evolved Packet System
ETWS	Earthquake and Tsunami Warning System
E-UTRA	Evolved Universal Terrestrial Radio Access
E-UTRAN	Evolved Universal Terrestrial Radio Access Network
FDD	Frequency Division Duplex
FFS	For Further Study
GERAN	GSM/EDGE Radio Access Network
GNSS	Global Navigation Satellite System
GSM	Global System for Mobile Communications
HARQ	Hybrid Automatic Repeat Request
HFN	Hyper Frame Number
HPLMN	Home Public Land Mobile Network
HRPD	CDMA2000 High Rate Packet Data
IDC	In-Device Coexistence
IE	Information element
IMEI	International Mobile Equipment Identity
IMSI	International Mobile Subscriber Identity
ISM	Industrial, Scientific and Medical
kB	Kilobyte (1000 bytes)
L1	Layer 1
L2	Layer 2
L3	Layer 3
MAC	Medium Access Control
MBMS	Multimedia Broadcast Multicast Service
MBSFN	Multimedia Broadcast multicast service Single Frequency Network
MCG	Master Cell Group
MDT	Minimization of Drive Tests
MIB	Master Information Block
MO	Mobile Originating
MRB	MBMS Point to Multipoint Radio Bearer
MRO	Mobility Robustness Optimisation
MSI	MCH Scheduling Information
MT	Mobile Terminating
N/A	Not Applicable
NACC	Network Assisted Cell Change
NAICS	Network Assisted Interference Cancellation/Suppression
NAS	Non Access Stratum
PCCH	Paging Control Channel
PCell	Primary Cell
PDCCH	Physical Downlink Control Channel
PDCP	Packet Data Convergence Protocol
PDU	Protocol Data Unit
PLMN	Public Land Mobile Network
ProSe	Proximity based Services
PSCell	Primary Secondary Cell
PTAG	Primary Timing Advance Group
PUCCH	Physical Uplink Control Channel
QoS	Quality of Service
RACH	Random Access CHannel
RAT	Radio Access Technology
RB	Radio Bearer
RLC	Radio Link Control
RN	Relay Node
RNTI	Radio Network Temporary Identifier
ROHC	RObust Header Compression
RPLMN	Registered Public Land Mobile Network
RRC	Radio Resource Control
RSCP	Received Signal Code Power
RSRP	Reference Signal Received Power

RSRQ	Reference Signal Received Quality
RSSI	Received Signal Strength Indicator
SAE	System Architecture Evolution
SAP	Service Access Point
SC	Sidelink Control
SCell	Secondary Cell
SCG	Secondary Cell Group
SFN	System Frame Number
SI	System Information
SIB	System Information Block
SI-RNTI	System Information RNTI
SL	Sidelink
SLSS	Sidelink Synchronisation Signal
SMC	Security Mode Control
SPS	Semi-Persistent Scheduling
SR	Scheduling Request
SRB	Signalling Radio Bearer
SSAC	Service Specific Access Control
STAG	Secondary Timing Advance Group
S-RSRP	Sidelink Reference Signal Received Power
S-TMSI	SAE Temporary Mobile Station Identifier
TA	Tracking Area
TAG	Timing Advance Group
TDD	Time Division Duplex
TDM	Time Division Multiplexing
TM	Transparent Mode
TPC-RNTI	Transmit Power Control RNTI
T-RPT	Time Resource Pattern of Transmission
TTT	Time To Trigger
UE	User Equipment
UICC	Universal Integrated Circuit Card
UL	Uplink
UL-SCH	Uplink Shared Channel
UM	Unacknowledged Mode
UP	User Plane
UTC	Coordinated Universal Time
UTRAN	Universal Terrestrial Radio Access Network
VoLTE	Voice over Long Term Evolution
WLAN	Wireless Local Area Network

In the ASN.1, lower case may be used for some (parts) of the above abbreviations e.g. c-RNTI

4 General

4.1 Introduction

In this specification, (parts of) procedures and messages specified for the UE equally apply to the RN for functionality necessary for the RN. There are also (parts of) procedures and messages which are only applicable to the RN in its communication with the E-UTRAN, in which case the specification denotes the RN instead of the UE. Such RN-specific aspects are not applicable to the UE.

This specification is organised as follows:

- sub-clause 4.2 describes the RRC protocol model;
- sub-clause 4.3 specifies the services provided to upper layers as well as the services expected from lower layers;
- sub-clause 4.4 lists the RRC functions;
- clause 5 specifies RRC procedures, including UE state transitions;
- clause 6 specifies the RRC message in a mixed format (i.e. tabular & ASN.1 together);

- clause 7 specifies the variables (including protocol timers and constants) and counters to be used by the UE;
- clause 8 specifies the encoding of the RRC messages;
- clause 9 specifies the specified and default radio configurations;
- clause 10 specifies the RRC messages transferred across network nodes;
- clause 11 specifies the UE capability related constraints and performance requirements.

4.2 Architecture

4.2.1 UE states and state transitions including inter RAT

A UE is in `RRC_CONNECTED` when an RRC connection has been established. If this is not the case, i.e. no RRC connection is established, the UE is in `RRC_IDLE` state. The RRC states can further be characterised as follows:

- **RRC_IDLE:**
 - A UE specific DRX may be configured by upper layers.
 - UE controlled mobility;
 - The UE:
 - Monitors a Paging channel to detect incoming calls, system information change, for ETWS capable UEs, ETWS notification, and for CMAS capable UEs, CMAS notification;
 - Performs neighbouring cell measurements and cell (re-)selection;
 - Acquires system information.
 - Performs logging of available measurements together with location and time for logged measurement configured UEs.
- **RRC_CONNECTED:**
 - Transfer of unicast data to/from UE.
 - At lower layers, the UE may be configured with a UE specific DRX.
 - For UEs supporting CA, use of one or more SCells, aggregated with the PCell, for increased bandwidth;
 - For UEs supporting DC, use of one SCG, aggregated with the MCG, for increased bandwidth;
 - Network controlled mobility, i.e. handover and cell change order with optional network assistance (NACC) to GERAN;
 - The UE:
 - Monitors a Paging channel and/ or System Information Block Type 1 contents to detect system information change, for ETWS capable UEs, ETWS notification, and for CMAS capable UEs, CMAS notification;
 - Monitors control channels associated with the shared data channel to determine if data is scheduled for it;
 - Provides channel quality and feedback information;
 - Performs neighbouring cell measurements and measurement reporting;
 - Acquires system information.

The following figure not only provides an overview of the RRC states in E-UTRA, but also illustrates the mobility support between E-UTRAN, UTRAN and GERAN.

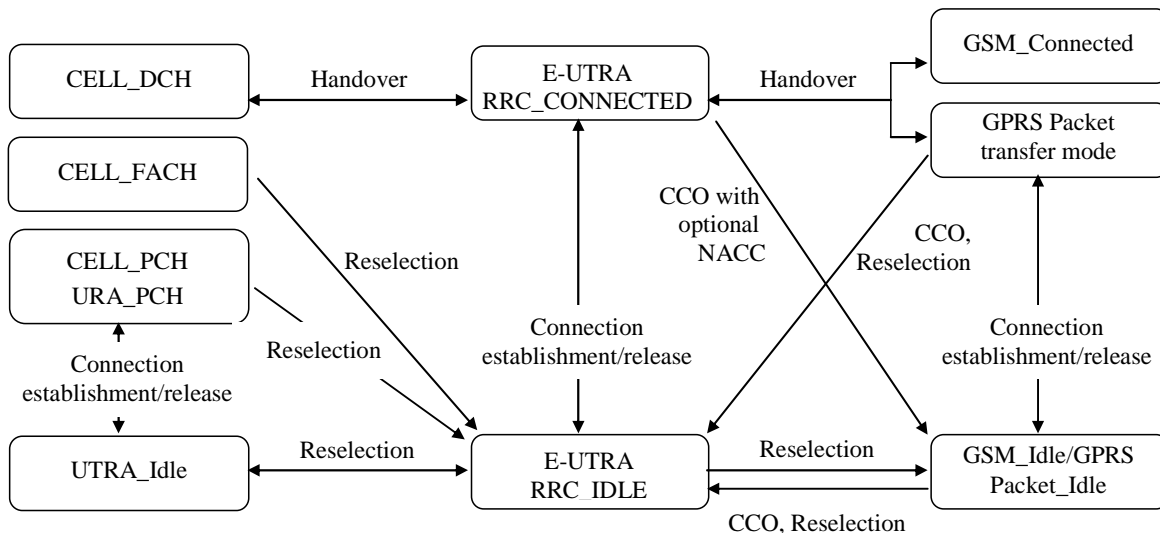

Figure 4.2.1-1: E-UTRA states and inter RAT mobility procedures, 3GPP

The following figure illustrates the mobility support between E-UTRAN, CDMA2000 1xRTT and CDMA2000 HRPD. The details of the CDMA2000 state models are out of the scope of this specification.

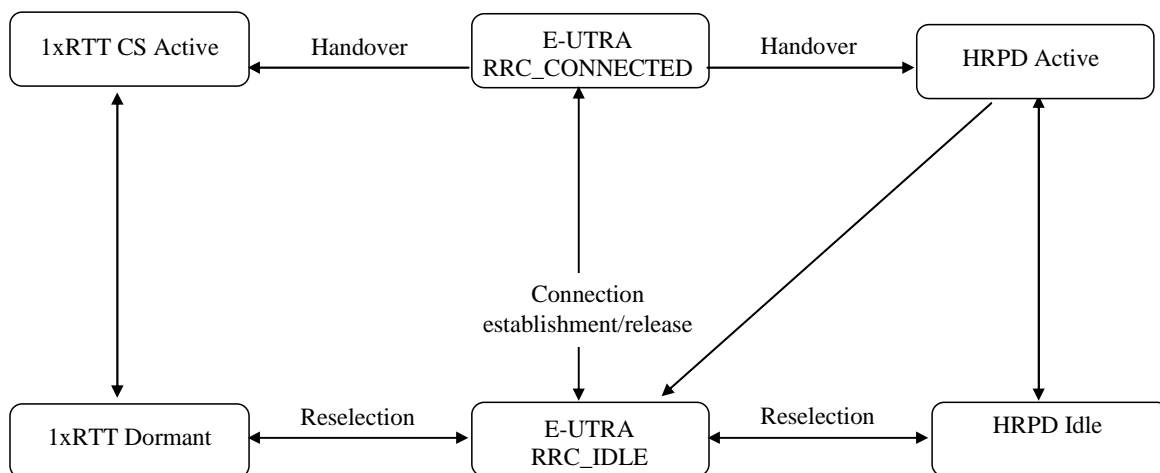

Figure 4.2.1-2: Mobility procedures between E-UTRA and CDMA2000

The inter-RAT handover procedure(s) supports the case of signalling, conversational services, non-conversational services and combinations of these.

In addition to the state transitions shown in Figure 4.2.1-1 and Figure 4.2.1-2, there is support for connection release with redirection information from E-UTRA RRC_CONNECTED to GERAN, UTRAN and CDMA2000 (HRPD Idle/ 1xRTT Dormant mode).

4.2.2 Signalling radio bearers

"Signalling Radio Bearers" (SRBs) are defined as Radio Bearers (RB) that are used only for the transmission of RRC and NAS messages. More specifically, the following three SRBs are defined:

- SRB0 is for RRC messages using the CCCH logical channel;
- SRB1 is for RRC messages (which may include a piggybacked NAS message) as well as for NAS messages prior to the establishment of SRB2, all using DCCH logical channel;
- SRB2 is for RRC messages which include logged measurement information as well as for NAS messages, all using DCCH logical channel. SRB2 has a lower-priority than SRB1 and is always configured by E-UTRAN after security activation.

In downlink piggybacking of NAS messages is used only for one dependant (i.e. with joint success/ failure) procedure: bearer establishment/ modification/ release. In uplink NAS message piggybacking is used only for transferring the initial NAS message during connection setup.

NOTE: The NAS messages transferred via SRB2 are also contained in RRC messages, which however do not include any RRC protocol control information.

Once security is activated, all RRC messages on SRB1 and SRB2, including those containing NAS or non-3GPP messages, are integrity protected and ciphered by PDCP. NAS independently applies integrity protection and ciphering to the NAS messages.

For a UE configured with DC, all RRC messages, regardless of the SRB used and both in downlink and uplink, are transferred via the MCG.

4.3 Services

4.3.1 Services provided to upper layers

The RRC protocol offers the following services to upper layers:

- Broadcast of common control information;
- Notification of UEs in RRC_IDLE, e.g. about a terminating call, for ETWS, for CMAS;
- Transfer of dedicated control information, i.e. information for one specific UE.

4.3.2 Services expected from lower layers

In brief, the following are the main services that RRC expects from lower layers:

- PDCP: integrity protection and ciphering;
- RLC: reliable and in-sequence transfer of information, without introducing duplicates and with support for segmentation and concatenation.

Further details about the services provided by Packet Data Convergence Protocol layer (e.g. integrity and ciphering) are provided in TS 36.323 [8]. The services provided by Radio Link Control layer (e.g. the RLC modes) are specified in TS 36.322 [7]. Further details about the services provided by Medium Access Control layer (e.g. the logical channels) are provided in TS 36.321 [6]. The services provided by physical layer (e.g. the transport channels) are specified in TS 36.302 [3].

4.4 Functions

The RRC protocol includes the following main functions:

- Broadcast of system information:
 - Including NAS common information;
- Information applicable for UEs in RRC_IDLE, e.g. cell (re-)selection parameters, neighbouring cell information and information (also) applicable for UEs in RRC_CONNECTED, e.g. common channel configuration information.
- Including ETWS notification, CMAS notification;
- RRC connection control:

- Paging;
- Establishment/ modification/ release of RRC connection, including e.g. assignment/ modification of UE identity (C-RNTI), establishment/ modification/ release of SRB1 and SRB2, access class barring;
- Initial security activation, i.e. initial configuration of AS integrity protection (SRBs) and AS ciphering (SRBs, DRBs);
- For RNs, configuration of AS integrity protection for DRBs;
- RRC connection mobility including e.g. intra-frequency and inter-frequency handover, associated security handling, i.e. key/ algorithm change, specification of RRC context information transferred between network nodes;
- Establishment/ modification/ release of RBs carrying user data (DRBs);
- Radio configuration control including e.g. assignment/ modification of ARQ configuration, HARQ configuration, DRX configuration;
- For RNs, RN-specific radio configuration control for the radio interface between RN and E-UTRAN;
- In case of CA, cell management including e.g. change of PCell, addition/ modification/ release of SCell(s) and addition/modification/release of STAG(s);
- In case of DC, cell management including e.g. change of PSCell, addition/ modification/ release of SCG cell(s) and addition/modification/release of SCG TAG(s).
- QoS control including assignment/ modification of semi-persistent scheduling (SPS) configuration information for DL and UL, assignment/ modification of parameters for UL rate control in the UE, i.e. allocation of a priority and a prioritised bit rate (PBR) for each RB;
- Recovery from radio link failure;
- Inter-RAT mobility including e.g. security activation, transfer of RRC context information;
- Measurement configuration and reporting:
 - Establishment/ modification/ release of measurements (e.g. intra-frequency, inter-frequency and inter- RAT measurements);
 - Setup and release of measurement gaps;
 - Measurement reporting;
- Other functions including e.g. transfer of dedicated NAS information and non-3GPP dedicated information, transfer of UE radio access capability information, support for E-UTRAN sharing (multiple PLMN identities);
- Generic protocol error handling;
- Support of self-configuration and self-optimisation;
- Support of measurement logging and reporting for network performance optimisation [60];

NOTE: Random access is specified entirely in the MAC including initial transmission power estimation.

5 Procedures

5.1 General

5.1.1 Introduction

The procedural requirements are structured according to the main functional areas: system information (5.2), connection control (5.3), inter-RAT mobility (5.4) and measurements (5.5). In addition sub-clause 5.6 covers other aspects e.g. NAS dedicated information transfer, UE capability transfer, sub-clause 5.7 specifies the generic error handling, sub-clause 5.8 covers MBMS, sub-clause 5.9 covers RN-specific procedures and sub-clause 5.10 covers sidelink.

5.1.2 General requirements

The UE shall:

- 1> process the received messages in order of reception by RRC, i.e. the processing of a message shall be completed before starting the processing of a subsequent message;

NOTE 1: E-UTRAN may initiate a subsequent procedure prior to receiving the UE's response of a previously initiated procedure.

- 1> within a sub-clause execute the steps according to the order specified in the procedural description;

- 1> consider the term 'radio bearer' (RB) to cover SRBs and DRBs but not MRBs unless explicitly stated otherwise;

- 1> set the *rrc-TransactionIdentifier* in the response message, if included, to the same value as included in the message received from E-UTRAN that triggered the response message;

- 1> upon receiving a choice value set to *setup*:

- 2> apply the corresponding received configuration and start using the associated resources, unless explicitly specified otherwise;

- 1> upon receiving a choice value set to *release*:

- 2> clear the corresponding configuration and stop using the associated resources;

- 1> upon handover to E-UTRA; or

- 1> upon receiving an *RRCConnectionReconfiguration* message including the *fullConfig*:

- 2> apply the Conditions in the ASN.1 for inclusion of the fields for the DRB/PDCP/RLC setup during the reconfiguration of the DRBs included in the *drb-ToAddModList*;

NOTE 2: At each point in time, the UE keeps a single value for each field except for during handover when the UE temporarily stores the previous configuration so it can revert back upon handover failure. In other words: when the UE reconfigures a field, the existing value is released except for during handover.

NOTE 3: Although not explicitly stated, the UE initially considers all functionality to be deactivated/ released until it is explicitly stated that the functionality is setup/ activated. Correspondingly, the UE initially considers lists to be empty e.g. the list of radio bearers, the list of measurements.

- 1> upon receiving an extension field comprising the entries in addition to the ones carried by the original field (regardless of whether E-UTRAN may signal more entries in total); apply the following generic behaviour if explicitly stated to be applicable:

- 2> create a combined list by concatenating the additional entries included in the extension field to the original field while maintaining the order among both the original and the additional entries;

- 2> for the combined list, created according to the previous, apply the same behaviour as defined for the original field;

NOTE 4: A field comprising a list of entries normally includes 'list' in the field name. The typical way to extend (the size of) such a list is to introduce a field comprising the additional entries, which should include 'listExt' in the name of the field/ IE. E.g. *field1List-RAT*, *field1ListExt-RAT*.

5.2 System information

5.2.1 Introduction

5.2.1.1 General

System information is divided into the *MasterInformationBlock* (MIB) and a number of *SystemInformationBlocks* (SIBs). The MIB includes a limited number of most essential and most frequently transmitted parameters that are needed to acquire other information from the cell, and is transmitted on BCH. SIBs other than *SystemInformationBlockType1* are carried in *SystemInformation* (SI) messages and mapping of SIBs to SI messages is

flexibly configurable by *schedulingInfoList* included in *SystemInformationBlockType1*, with restrictions that: each SIB is contained only in a single SI message, and at most once in that message; only SIBs having the same scheduling requirement (periodicity) can be mapped to the same SI message; *SystemInformationBlockType2* is always mapped to the SI message that corresponds to the first entry in the list of SI messages in *schedulingInfoList*. There may be multiple SI messages transmitted with the same periodicity. *SystemInformationBlockType1* and all SI messages are transmitted on DL-SCH.

NOTE 1: The physical layer imposes a limit to the maximum size a SIB can take. When DCI format 1C is used the maximum allowed by the physical layer is 1736 bits (217 bytes) while for format 1A the limit is 2216 bits (277 bytes), see TS 36.212 [22] and TS 36.213 [23].

In addition to broadcasting, E-UTRAN may provide *SystemInformationBlockType1*, including the same parameter values, via dedicated signalling i.e., within an *RRCCONNECTIONRECONFIGURATION* message.

The UE applies the system information acquisition and change monitoring procedures for the PCell. For an SCell, E-UTRAN provides, via dedicated signalling, all system information relevant for operation in RRC_CONNECTED when adding the SCell. However, a UE that is configured with DC shall acquire the *MasterInformationBlock* of the PCell but use it only to determine the SFN timing of the SCG, which may be different from the MCG. Upon change of the relevant system information of a configured SCell, E-UTRAN releases and subsequently adds the concerned SCell, which may be done with a single *RRCCONNECTIONRECONFIGURATION* message. If the UE is receiving or interested to receive an MBMS service in a cell, the UE shall apply the system information acquisition and change monitoring procedure to acquire parameters relevant for MBMS operation and apply the parameters acquired from system information only for MBMS operation for this cell.

NOTE 2: E-UTRAN may configure via dedicated signalling different parameter values than the ones broadcast in the concerned SCell.

An RN configured with an RN subframe configuration does not need to apply the system information acquisition and change monitoring procedures. Upon change of any system information relevant to an RN, E-UTRAN provides the system information blocks containing the relevant system information to an RN configured with an RN subframe configuration via dedicated signalling using the *RNRECONFIGURATION* message. For RNs configured with an RN subframe configuration, the system information contained in this dedicated signalling replaces any corresponding stored system information and takes precedence over any corresponding system information acquired through the system information acquisition procedure. The dedicated system information remains valid until overridden.

NOTE 3: E-UTRAN may configure an RN, via dedicated signalling, with different parameter values than the ones broadcast in the concerned cell.

5.2.1.2 Scheduling

The MIB uses a fixed schedule with a periodicity of 40 ms and repetitions made within 40 ms. The first transmission of the MIB is scheduled in subframe #0 of radio frames for which the $\text{SFN} \bmod 4 = 0$, and repetitions are scheduled in subframe #0 of all other radio frames.

The *SystemInformationBlockType1* uses a fixed schedule with a periodicity of 80 ms and repetitions made within 80 ms. The first transmission of *SystemInformationBlockType1* is scheduled in subframe #5 of radio frames for which the $\text{SFN} \bmod 8 = 0$, and repetitions are scheduled in subframe #5 of all other radio frames for which $\text{SFN} \bmod 2 = 0$.

The SI messages are transmitted within periodically occurring time domain windows (referred to as SI-windows) using dynamic scheduling. Each SI message is associated with a SI-window and the SI-windows of different SI messages do not overlap. That is, within one SI-window only the corresponding SI is transmitted. The length of the SI-window is common for all SI messages, and is configurable. Within the SI-window, the corresponding SI message can be transmitted a number of times in any subframe other than MBSFN subframes, uplink subframes in TDD, and subframe #5 of radio frames for which $\text{SFN} \bmod 2 = 0$. The UE acquires the detailed time-domain scheduling (and other information, e.g. frequency-domain scheduling, used transport format) from decoding SI-RNTI on PDCCH (see TS 36.321 [6]).

A single SI-RNTI is used to address *SystemInformationBlockType1* as well as all SI messages.

SystemInformationBlockType1 configures the SI-window length and the transmission periodicity for the SI messages.

5.2.1.3 System information validity and notification of changes

Change of system information (other than for ETWS, CMAS and EAB parameters) only occurs at specific radio frames, i.e. the concept of a modification period is used. System information may be transmitted a number of times with the same content within a modification period, as defined by its scheduling. The modification period boundaries are defined by SFN values for which $\text{SFN mod } m = 0$, where m is the number of radio frames comprising the modification period. The modification period is configured by system information.

When the network changes (some of the) system information, it first notifies the UEs about this change, i.e. this may be done throughout a modification period. In the next modification period, the network transmits the updated system information. These general principles are illustrated in figure 5.2.1.3-1, in which different colours indicate different system information. Upon receiving a change notification, the UE acquires the new system information immediately from the start of the next modification period. The UE applies the previously acquired system information until the UE acquires the new system information.

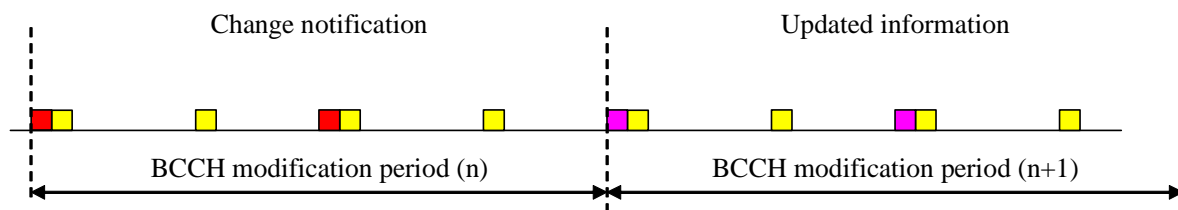

Figure 5.2.1.3-1: Change of system Information

The *Paging* message is used to inform UEs in RRC_IDLE and UEs in RRC_CONNECTED about a system information change. If the UE receives a *Paging* message including the *systemInfoModification*, it knows that the system information will change at the next modification period boundary. Although the UE may be informed about changes in system information, no further details are provided e.g. regarding which system information will change.

SystemInformationBlockType1 includes a value tag, *systemInfoValueTag*, that indicates if a change has occurred in the SI messages. UEs may use *systemInfoValueTag*, e.g. upon return from out of coverage, to verify if the previously stored SI messages are still valid. Additionally, the UE considers stored system information to be invalid after 3 hours from the moment it was successfully confirmed as valid, unless specified otherwise.

E-UTRAN may not update *systemInfoValueTag* upon change of some system information e.g. ETWS information, CMAS information, regularly changing parameters like time information (*SystemInformationBlockType8*, *SystemInformationBlockType16*), EAB parameters. Similarly, E-UTRAN may not include the *systemInfoModification* within the *Paging* message upon change of some system information.

The UE verifies that stored system information remains valid by either checking *systemInfoValueTag* in *SystemInformationBlockType1* after the modification period boundary, or attempting to find the *systemInfoModification* indication at least *modificationPeriodCoeff* times during the modification period in case no paging is received, in every modification period. If no paging message is received by the UE during a modification period, the UE may assume that no change of system information will occur at the next modification period boundary. If UE in RRC_CONNECTED, during a modification period, receives one paging message, it may deduce from the presence/ absence of *systemInfoModification* whether a change of system information other than ETWS information, CMAS information and EAB parameters will occur in the next modification period or not.

ETWS and/or CMAS capable UEs in RRC_CONNECTED shall attempt to read paging at least once every *defaultPagingCycle* to check whether ETWS and/or CMAS notification is present or not.

5.2.1.4 Indication of ETWS notification

ETWS primary notification and/ or ETWS secondary notification can occur at any point in time. The *Paging* message is used to inform ETWS capable UEs in RRC_IDLE and UEs in RRC_CONNECTED about presence of an ETWS primary notification and/ or ETWS secondary notification. If the UE receives a *Paging* message including the *etws-Indication*, it shall start receiving the ETWS primary notification and/ or ETWS secondary notification according to *schedulingInfoList* contained in *SystemInformationBlockType1*. If the UE receives *Paging* message including the *etws-Indication* while it is acquiring ETWS notification(s), the UE shall continue acquiring ETWS notification(s) based on the previously acquired *schedulingInfoList* until it re-acquires *schedulingInfoList* in *SystemInformationBlockType1*.

NOTE: The UE is not required to periodically check *schedulingInfoList* contained in *SystemInformationBlockType1*, but *Paging* message including the *etws-Indication* triggers the UE to re-acquire *schedulingInfoList* contained in *SystemInformationBlockType1* for scheduling changes for *SystemInformationBlockType10* and *SystemInformationBlockType11*. The UE may or may not receive a *Paging* message including the *etws-Indication* and/or *systemInfoModification* when ETWS is no longer scheduled.

ETWS primary notification is contained in *SystemInformationBlockType10* and ETWS secondary notification is contained in *SystemInformationBlockType11*. Segmentation can be applied for the delivery of a secondary notification. The segmentation is fixed for transmission of a given secondary notification within a cell (i.e. the same segment size for a given segment with the same *messageIdentifier*, *serialNumber* and *warningMessageSegmentNumber*). An ETWS secondary notification corresponds to a single *CB data* IE as defined according to TS 23.041 [37].

5.2.1.5 Indication of CMAS notification

CMAS notification can occur at any point in time. The *Paging* message is used to inform CMAS capable UEs in RRC_IDLE and UEs in RRC_CONNECTED about presence of one or more CMAS notifications. If the UE receives a *Paging* message including the *cmas-Indication*, it shall start receiving the CMAS notifications according to *schedulingInfoList* contained in *SystemInformationBlockType1*. If the UE receives *Paging* message including the *cmas-Indication* while it is acquiring CMAS notification(s), the UE shall continue acquiring CMAS notification(s) based on the previously acquired *schedulingInfoList* until it re-acquires *schedulingInfoList* in *SystemInformationBlockType1*.

NOTE: The UE is not required to periodically check *schedulingInfoList* contained in *SystemInformationBlockType1*, but *Paging* message including the *cmas-Indication* triggers the UE to re-acquire *schedulingInfoList* contained in *SystemInformationBlockType1* for scheduling changes for *SystemInformationBlockType12*. The UE may or may not receive a *Paging* message including the *cmas-Indication* and/or *systemInfoModification* when *SystemInformationBlockType12* is no longer scheduled.

CMAS notification is contained in *SystemInformationBlockType12*. Segmentation can be applied for the delivery of a CMAS notification. The segmentation is fixed for transmission of a given CMAS notification within a cell (i.e. the same segment size for a given segment with the same *messageIdentifier*, *serialNumber* and *warningMessageSegmentNumber*). E-UTRAN does not interleave transmissions of CMAS notifications, i.e. all segments of a given CMAS notification transmission are transmitted prior to those of another CMAS notification. A CMAS notification corresponds to a single *CB data* IE as defined according to TS 23.041 [37].

5.2.1.6 Notification of EAB parameters change

Change of EAB parameters can occur at any point in time. The EAB parameters are contained in *SystemInformationBlockType14*. The *Paging* message is used to inform EAB capable UEs in RRC_IDLE about a change of EAB parameters or that *SystemInformationBlockType14* is no longer scheduled. If the UE receives a *Paging* message including the *eab-ParamModification*, it shall acquire *SystemInformationBlockType14* according to *schedulingInfoList* contained in *SystemInformationBlockType1*. If the UE receives a *Paging* message including the *eab-ParamModification* while it is acquiring *SystemInformationBlockType14*, the UE shall continue acquiring *SystemInformationBlockType14* based on the previously acquired *schedulingInfoList* until it re-acquires *schedulingInfoList* in *SystemInformationBlockType1*.

NOTE: The EAB capable UE is not expected to periodically check *schedulingInfoList* contained in *SystemInformationBlockType1*.

5.2.2 System information acquisition

5.2.2.1 General

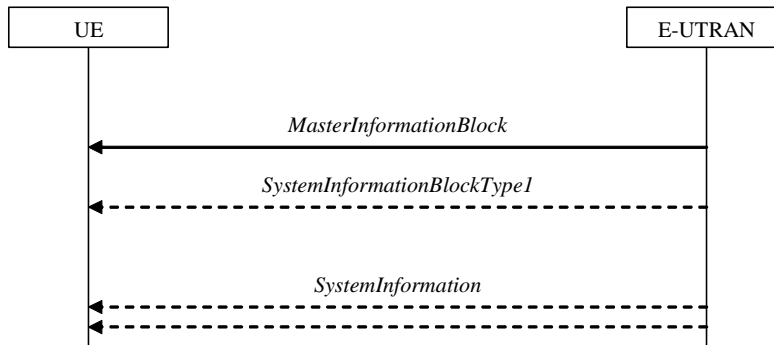

Figure 5.2.2.1-1: System information acquisition, normal

The UE applies the system information acquisition procedure to acquire the AS- and NAS- system information that is broadcasted by the E-UTRAN. The procedure applies to UEs in RRC_IDLE and UEs in RRC_CONNECTED.

5.2.2.2 Initiation

The UE shall apply the system information acquisition procedure upon selecting (e.g. upon power on) and upon re-selecting a cell, after handover completion, after entering E-UTRA from another RAT, upon return from out of coverage, upon receiving a notification that the system information has changed, upon receiving an indication about the presence of an ETWS notification, upon receiving an indication about the presence of a CMAS notification, upon receiving a notification that the EAB parameters have changed, upon receiving a request from CDMA2000 upper layers and upon exceeding the maximum validity duration. Unless explicitly stated otherwise in the procedural specification, the system information acquisition procedure overwrites any stored system information, i.e. delta configuration is not applicable for system information and the UE discontinues using a field if it is absent in system information unless explicitly specified otherwise.

5.2.2.3 System information required by the UE

The UE shall:

- 1> ensure having a valid version, as defined below, of (at least) the following system information, also referred to as the 'required' system information:
 - 2> if in RRC_IDLE:
 - 3> the *MasterInformationBlock* and *SystemInformationBlockType1* as well as *SystemInformationBlockType2* through *SystemInformationBlockType8* (depending on support of the concerned RATs), *SystemInformationBlockType17* (depending on support of RAN-assisted WLAN interworking);
 - 2> if in RRC_CONNECTED:
 - 3> the *MasterInformationBlock*, *SystemInformationBlockType1* and *SystemInformationBlockType2* as well as *SystemInformationBlockType8* (depending on support of CDMA2000), *SystemInformationBlockType17* (depending on support of RAN-assisted WLAN interworking);
- 1> delete any stored system information after 3 hours from the moment it was confirmed to be valid as defined in 5.2.1.3, unless specified otherwise;
- 1> consider any stored system information except *SystemInformationBlockType10*, *SystemInformationBlockType11*, *SystemInformationBlockType12* and *SystemInformationBlockType14* to be invalid if *systemInfoValueTag* included in the *SystemInformationBlockType1* is different from the one of the stored system information;

5.2.2.4 System information acquisition by the UE

The UE shall:

- 1> apply the specified BCCH configuration defined in 9.1.1.1;

- 1> if the procedure is triggered by a system information change notification:
 - 2> start acquiring the required system information, as defined in 5.2.2.3, from the beginning of the modification period following the one in which the change notification was received;
- NOTE 1: The UE continues using the previously received system information until the new system information has been acquired.
- 1> if the UE is in RRC_IDLE and enters a cell for which the UE does not have stored a valid version of the system information required in RRC_IDLE, as defined in 5.2.2.3:
 - 2> acquire, using the system information acquisition procedure as defined in 5.2.3, the system information required in RRC_IDLE, as defined in 5.2.2.3;
- 1> following successful handover completion to a PCell for which the UE does not have stored a valid version of the system information required in RRC_CONNECTED, as defined in 5.2.2.3:
 - 2> acquire, using the system information acquisition procedure as defined in 5.2.3, the system information required in RRC_CONNECTED, as defined in 5.2.2.3;
 - 2> upon acquiring the concerned system information:
 - 3> discard the corresponding radio resource configuration information included in the *radioResourceConfigCommon* previously received in a dedicated message, if any;
- 1> following a request from CDMA2000 upper layers:
 - 2> acquire *SystemInformationBlockType8*, as defined in 5.2.3;
- 1> neither initiate the RRC connection establishment procedure nor initiate transmission of the *RRCConnectionReestablishmentRequest* message until the UE has a valid version of the *MasterInformationBlock* and *SystemInformationBlockType1* messages as well as *SystemInformationBlockType2* ;
- 1> not initiate the RRC connection establishment subject to EAB until the UE has a valid version of *SystemInformationBlockType14*, if broadcast;
- 1> if the UE is ETWS capable:
 - 2> upon entering a cell during RRC_IDLE, following successful handover or upon connection re-establishment:
 - 3> discard any previously buffered *warningMessageSegment*;
 - 3> clear, if any, the current values of *messageIdentifier* and *serialNumber* for *SystemInformationBlockType11*;
 - 2> when the UE acquires *SystemInformationBlockType1* following ETWS indication, upon entering a cell during RRC_IDLE, following successful handover or upon connection re-establishment:
 - 3> if *schedulingInfoList* indicates that *SystemInformationBlockType10* is present:
 - 4> start acquiring *SystemInformationBlockType10* immediately;
 - 3> if *schedulingInfoList* indicates that *SystemInformationBlockType11* is present:
 - 4> start acquiring *SystemInformationBlockType11* immediately;
- NOTE 2: UEs shall start acquiring *SystemInformationBlockType10* and *SystemInformationBlockType11* as described above even when *systemInfoValueTag* in *SystemInformationBlockType1* has not changed.
- 1> if the UE is CMAS capable:
 - 2> upon entering a cell during RRC_IDLE, following successful handover or upon connection re-establishment:
 - 3> discard any previously buffered *warningMessageSegment*;
 - 3> clear, if any, stored values of *messageIdentifier* and *serialNumber* for *SystemInformationBlockType12* associated with the discarded *warningMessageSegment*;

2> when the UE acquires *SystemInformationBlockType1* following CMAS indication, upon entering a cell during RRC_IDLE, following successful handover and upon connection re-establishment:

3> if *schedulingInfoList* indicates that *SystemInformationBlockType12* is present:

4> acquire *SystemInformationBlockType12*;

NOTE 3: UEs shall start acquiring *SystemInformationBlockType12* as described above even when *systemInfoValueTag* in *SystemInformationBlockType1* has not changed.

1> if the UE is interested to receive MBMS services:

2> if *schedulingInfoList* indicates that *SystemInformationBlockType13* is present and the UE does not have stored a valid version of this system information block:

3> acquire *SystemInformationBlockType13*;

2> if the UE is capable of MBMS Service Continuity:

3> if *schedulingInfoList* indicates that *SystemInformationBlockType15* is present and the UE does not have stored a valid version of this system information block:

4> acquire *SystemInformationBlockType15*;

1> if the UE is EAB capable:

2> when the UE does not have stored a valid version of *SystemInformationBlockType14* upon entering RRC_IDLE, or when the UE acquires *SystemInformationBlockType1* following EAB parameters change notification or upon entering a cell during RRC_IDLE:

3> if *schedulingInfoList* indicates that *SystemInformationBlockType14* is present:

4> start acquiring *SystemInformationBlockType14* immediately;

3> else:

4> discard *SystemInformationBlockType14*, if previously received;

NOTE 4: EAB capable UEs start acquiring *SystemInformationBlockType14* as described above even when *systemInfoValueTag* in *SystemInformationBlockType1* has not changed.

NOTE 5: EAB capable UEs maintain an up to date *SystemInformationBlockType14* in RRC_IDLE.

1> if the UE is capable of sidelink communication and is configured by upper layers to receive or transmit sidelink communication:

2> if the cell used for sidelink communication meets the S-criteria as defined in TS 36.304 [4]; and

2> if *schedulingInfoList* indicates that *SystemInformationBlockType18* is present and the UE does not have stored a valid version of this system information block:

3> acquire *SystemInformationBlockType18*;

1> if the UE is capable of sidelink discovery and is configured by upper layers to receive or transmit sidelink discovery announcements on the primary frequency:

2> if *schedulingInfoList* of the serving cell/ PCell indicates that *SystemInformationBlockType19* is present and the UE does not have stored a valid version of this system information block:

3> acquire *SystemInformationBlockType19*;

1> if the UE is capable of sidelink discovery and, for each of the one or more frequencies included in *discInterFreqList*, if included in *SystemInformationBlockType19* and for which the UE is configured by upper layers to receive sidelink discovery announcements on:

2> if *schedulingInfoList* of the cell on the concerned frequency indicates that *SystemInformationBlockType19* is present and the UE does not have stored a valid version of this system information block:

3> acquire *SystemInformationBlockType19*;

The UE may apply the received SIBs immediately, i.e. the UE does not need to delay using a SIB until all SI messages have been received. The UE may delay applying the received SIBs until completing lower layer procedures associated with a received or a UE originated RRC message, e.g. an ongoing random access procedure.

NOTE 6: While attempting to acquire a particular SIB, if the UE detects from *schedulingInfoList* that it is no longer present, the UE should stop trying to acquire the particular SIB.

5.2.2.5 Essential system information missing

The UE shall:

- 1> if in RRC_IDLE or in RRC_CONNECTED while T311 is running:
 - 2> if the UE is unable to acquire the *MasterInformationBlock* or the *SystemInformationBlockType1*:
 - 3> consider the cell as barred in accordance with TS 36.304 [4]; and
 - 3> perform barring as if *intraFreqReselection* is set to *allowed*, and as if the *csg-Indication* is set to *FALSE*;
 - 2> else if the UE is unable to acquire the *SystemInformationBlockType2*:
 - 3> treat the cell as barred in accordance with TS 36.304 [4];

5.2.2.6 Actions upon reception of the *MasterInformationBlock* message

Upon receiving the *MasterInformationBlock* message the UE shall:

- 1> apply the radio resource configuration included in the *phich-Config*;
- 1> if the UE is in RRC_IDLE or if the UE is in RRC_CONNECTED while T311 is running:
 - 2> if the UE has no valid system information stored according to 5.2.2.3 for the concerned cell:
 - 3> apply the received value of *dl-Bandwidth* to the *ul-Bandwidth* until *SystemInformationBlockType2* is received;

5.2.2.7 Actions upon reception of the *SystemInformationBlockType1* message

Upon receiving the *SystemInformationBlockType1* either via broadcast or via dedicated signalling, the UE shall:

- 1> if in RRC_IDLE or in RRC_CONNECTED while T311 is running; and
- 1> if the UE is a category 0 UE according to TS 36.306 [5]; and
- 1> if *category0Allowed* is not included in *SystemInformationBlockType1*:
 - 2> consider the cell as barred in accordance with TS 36.304 [4];
- 1> if in RRC_CONNECTED while T311 is not running, and the UE supports multi-band cells as defined by bit 31 in *featureGroupIndicators*:
 - 2> disregard the *freqBandIndicator* and *multiBandInfoList*, if received, while in RRC_CONNECTED;
 - 2> forward the *cellIdentity* to upper layers;
 - 2> forward the *trackingAreaCode* to upper layers;
- 1> else:
 - 2> if the frequency band indicated in the *freqBandIndicator* is part of the frequency bands supported by the UE and it is not a downlink only band; or
 - 2> if the UE supports *multiBandInfoList*, and if one or more of the frequency bands indicated in the *multiBandInfoList* are part of the frequency bands supported by the UE and they are not downlink only bands:

- 3> forward the *cellIdentity* to upper layers;
- 3> forward the *trackingAreaCode* to upper layers;
- 3> if, for the frequency band selected by the UE (from *freqBandIndicator* or *multiBandInfoList*), the *freqBandInfo* or the *multiBandInfoList-v10j0* is present and the UE capable of *multiNS-Pmax* supports at least one *additionalSpectrumEmission* in the *NS-PmaxList* within the *freqBandInfo* or *multiBandInfoList-v10j0*:
 - 4> apply the first listed *additionalSpectrumEmission* which it supports among the values included in *NS-PmaxList* within *freqBandInfo* or *multiBandInfoList-v10j0*;
 - 4> if the *additionalPmax* is present in the same entry of the selected *additionalSpectrumEmission* within *NS-PmaxList*:
 - 5> apply the *additionalPmax*;
 - 4> else:
 - 5> apply the *p-Max*;
- 3> else:
 - 4> apply the *additionalSpectrumEmission* in *SystemInformationBlockType2* and the *p-Max*;
- 2> else:
 - 3> consider the cell as barred in accordance with TS 36.304 [4]; and
 - 3> perform barring as if *intraFreqReselection* is set to *notAllowed*, and as if the *csg-Indication* is set to *FALSE*;

5.2.2.8 Actions upon reception of *SystemInformation* messages

No UE requirements related to the contents of the *SystemInformation* messages apply other than those specified elsewhere e.g. within procedures using the concerned system information, and/ or within the corresponding field descriptions.

5.2.2.9 Actions upon reception of *SystemInformationBlockType2*

Upon receiving *SystemInformationBlockType2*, the UE shall:

- 1> apply the configuration included in the *radioResourceConfigCommon*;
- 1> if upper layers indicate that a (UE specific) paging cycle is configured:
 - 2> apply the shortest of the (UE specific) paging cycle and the *defaultPagingCycle* included in the *radioResourceConfigCommon*;
- 1> if the *mbsfn-SubframeConfigList* is included:
 - 2> consider that DL assignments may occur in the MBSFN subframes indicated in the *mbsfn-SubframeConfigList* under the conditions specified in [23, 7.1];
- 1> apply the specified PCCH configuration defined in 9.1.1.3;
- 1> not apply the *timeAlignmentTimerCommon*;
- 1> if in *RRC_CONNECTED* and UE is configured with RLF timers and constants values received within *rlf-TimersAndConstants*:
 - 2> not update its values of the timers and constants in *ue-TimersAndConstants* except for the value of timer T300;
- 1> if in *RRC_CONNECTED* while T311 is not running; and the UE supports multi-band cells as defined by bit 31 in *featureGroupIndicators* or *multipleNS-Pmax*:

2> disregard the *additionalSpectrumEmission* and *ul-CarrierFreq*, if received, while in RRC_CONNECTED;

5.2.2.10 Actions upon reception of *SystemInformationBlockType3*

Upon receiving the *SystemInformationBlockType3* message the UE shall:

- 1> if in RRC_IDLE, or in RRC_CONNECTED while T311 is running:
 - 2> if, for the frequency band selected by the UE (from the procedure in Section 5.2.2.7) to represent the serving cell's carrier frequency, the *freqBandInfo* or the *multiBandInfoList-v10j0* is present in *SystemInformationBlockType3* and the UE capable of *multiNS-Pmax* supports at least one *additionalSpectrumEmission* in the *NS-PmaxList* within the *freqBandInfo* or *multiBandInfoList-v10j0*:
 - 3> apply the first listed *additionalSpectrumEmission* which it supports among the values included in *NS-PmaxList* within *freqBandInfo* or *multiBandInfoList-v10j0*;
 - 3> if the *additionalPmax* is present in the same entry of the selected *additionalSpectrumEmission* within *NS-PmaxList*:
 - 4> apply the *additionalPmax*;
 - 3> else:
 - 4> apply the *p-Max*;
 - 2> else:
 - 3> apply the *p-Max*;

5.2.2.11 Actions upon reception of *SystemInformationBlockType4*

No UE requirements related to the contents of this *SystemInformationBlock* apply other than those specified elsewhere e.g. within procedures using the concerned system information, and/ or within the corresponding field descriptions.

5.2.2.12 Actions upon reception of *SystemInformationBlockType5*

Upon receiving the *SystemInformationBlockType5* message the UE shall:

- 1> if in RRC_IDLE, or in RRC_CONNECTED while T311 is running:
 - 2> if the frequency band selected by the UE to represent a non-serving E UTRA carrier frequency is not a downlink only band:
 - 3> if, for the selected frequency band, the *freqBandInfo* or the *multiBandInfoList-v10j0* is present and the UE capable of *multiNS-Pmax* supports at least one *additionalSpectrumEmission* in the *NS-PmaxList* within *freqBandInfo* or *multiBandInfoList-v10j0*:
 - 4> apply the first listed *additionalSpectrumEmission* which it supports among the values included in *NS-PmaxList* within *freqBandInfo* or *multiBandInfoList-v10j0*;
 - 4> if the *additionalPmax* is present in the same entry of the selected *additionalSpectrumEmission* within *NS-PmaxList*:
 - 5> apply the *additionalPmax*;
 - 4> else:
 - 5> apply the *p-Max*;
 - 3> else:
 - 4> apply the *p-Max*;

5.2.2.13 Actions upon reception of *SystemInformationBlockType6*

No UE requirements related to the contents of this *SystemInformationBlock* apply other than those specified elsewhere e.g. within procedures using the concerned system information, and/ or within the corresponding field descriptions.

5.2.2.14 Actions upon reception of *SystemInformationBlockType7*

No UE requirements related to the contents of this *SystemInformationBlock* apply other than those specified elsewhere e.g. within procedures using the concerned system information, and/ or within the corresponding field descriptions.

5.2.2.15 Actions upon reception of *SystemInformationBlockType8*

Upon receiving *SystemInformationBlockType8*, the UE shall:

- 1> if *sib8-PerPLMN-List* is included and the UE is capable of network sharing for CDMA2000:
 - 2> apply the CDMA2000 parameters below corresponding to the RPLMN;
- 1> if the *systemTimeInfo* is included:
 - 2> forward the *systemTimeInfo* to CDMA2000 upper layers;
- 1> if the UE is in RRC_IDLE and if *searchWindowSize* is included:
 - 2> forward the *searchWindowSize* to CDMA2000 upper layers;
- 1> if *parametersHRPD* is included:
 - 2> forward the *preRegistrationInfoHRPD* to CDMA2000 upper layers only if the UE has not received the *preRegistrationInfoHRPD* within an *RRCCONNECTIONRECONFIGURATION* message after entering this cell;
 - 2> if the *cellReselectionParametersHRPD* is included:
 - 3> forward the *neighCellList* to the CDMA2000 upper layers;
- 1> if the *parameters1XRTT* is included:
 - 2> if the *csfb-RegistrationParam1XRTT* is included:
 - 3> forward the *csfb-RegistrationParam1XRTT* to the CDMA2000 upper layers which will use this information to determine if a CS registration/re-registration towards CDMA2000 1xRTT in the EUTRA cell is required;
 - 2> else:
 - 3> indicate to CDMA2000 upper layers that CSFB Registration to CDMA2000 1xRTT is not allowed;
 - 2> if the *longCodeState1XRTT* is included:
 - 3> forward the *longCodeState1XRTT* to CDMA2000 upper layers;
 - 2> if the *cellReselectionParameters1XRTT* is included:
 - 3> forward the *neighCellList* to the CDMA2000 upper layers;
 - 2> if the *csfb-SupportForDualRxUEs* is included:
 - 3> forward *csfb-SupportForDualRxUEs* to the CDMA2000 upper layers;
 - 2> else:
 - 3> forward *csfb-SupportForDualRxUEs*, with its value set to *FALSE*, to the CDMA2000 upper layers;
 - 2> if *ac-BarringConfig1XRTT* is included:
 - 3> forward *ac-BarringConfig1XRTT* to the CDMA2000 upper layers;
 - 2> if the *csfb-DualRxTxSupport* is included:
 - 3> forward *csfb-DualRxTxSupport* to the CDMA2000 upper layers;
 - 2> else:

3> forward *csfb-DualRxTxSupport*, with its value set to *FALSE*, to the CDMA2000 upper layers;

5.2.2.16 Actions upon reception of *SystemInformationBlockType9*

Upon receiving *SystemInformationBlockType9*, the UE shall:

1> if *hnb-Name* is included, forward the *hnb-Name* to upper layers;

5.2.2.17 Actions upon reception of *SystemInformationBlockType10*

Upon receiving *SystemInformationBlockType10*, the UE shall:

1> forward the received *warningType*, *messageIdentifier* and *serialNumber* to upper layers;

5.2.2.18 Actions upon reception of *SystemInformationBlockType11*

Upon receiving *SystemInformationBlockType11*, the UE shall:

1> if there is no current value for *messageIdentifier* and *serialNumber* for *SystemInformationBlockType11*; or

1> if either the received value of *messageIdentifier* or of *serialNumber* or of both are different from the current values of *messageIdentifier* and *serialNumber* for *SystemInformationBlockType11*:

2> use the received values of *messageIdentifier* and *serialNumber* for *SystemInformationBlockType11* as the current values of *messageIdentifier* and *serialNumber* for *SystemInformationBlockType11*;

2> discard any previously buffered *warningMessageSegment*;

2> if all segments of a warning message have been received:

3> assemble the warning message from the received *warningMessageSegment*;

3> forward the received warning message, *messageIdentifier*, *serialNumber* and *dataCodingScheme* to upper layers;

3> stop reception of *SystemInformationBlockType11*;

3> discard the current values of *messageIdentifier* and *serialNumber* for *SystemInformationBlockType11*;

2> else:

3> store the received *warningMessageSegment*;

3> continue reception of *SystemInformationBlockType11*;

1> else if all segments of a warning message have been received:

2> assemble the warning message from the received *warningMessageSegment*;

2> forward the received complete warning message, *messageIdentifier*, *serialNumber* and *dataCodingScheme* to upper layers;

2> stop reception of *SystemInformationBlockType11*;

2> discard the current values of *messageIdentifier* and *serialNumber* for *SystemInformationBlockType11*;

1> else:

2> store the received *warningMessageSegment*;

2> continue reception of *SystemInformationBlockType11*;

The UE should discard any stored *warningMessageSegment* and the current value of *messageIdentifier* and *serialNumber* for *SystemInformationBlockType11* if the complete warning message has not been assembled within a period of 3 hours.

5.2.2.19 Actions upon reception of *SystemInformationBlockType12*

Upon receiving *SystemInformationBlockType12*, the UE shall:

- 1> if the *SystemInformationBlockType12* contains a complete warning message:
 - 2> forward the received warning message, *messageIdentifier*, *serialNumber* and *dataCodingScheme* to upper layers;
 - 2> continue reception of *SystemInformationBlockType12*;
- 1> else:
 - 2> if the received values of *messageIdentifier* and *serialNumber* are the same (each value is the same) as a pair for which a warning message is currently being assembled:
 - 3> store the received *warningMessageSegment*;
 - 3> if all segments of a warning message have been received:
 - 4> assemble the warning message from the received *warningMessageSegment*;
 - 4> forward the received warning message, *messageIdentifier*, *serialNumber* and *dataCodingScheme* to upper layers;
 - 4> stop assembling a warning message for this *messageIdentifier* and *serialNumber* and delete all stored information held for it;
 - 3> continue reception of *SystemInformationBlockType12*;
 - 2> else if the received values of *messageIdentifier* and/or *serialNumber* are not the same as any of the pairs for which a warning message is currently being assembled:
 - 3> start assembling a warning message for this *messageIdentifier* and *serialNumber* pair;
 - 3> store the received *warningMessageSegment*;
 - 3> continue reception of *SystemInformationBlockType12*;

The UE should discard *warningMessageSegment* and the associated values of *messageIdentifier* and *serialNumber* for *SystemInformationBlockType12* if the complete warning message has not been assembled within a period of 3 hours.

NOTE: The number of warning messages that a UE can re-assemble simultaneously is a function of UE implementation.

5.2.2.20 Actions upon reception of *SystemInformationBlockType13*

No UE requirements related to the contents of this *SystemInformationBlock* apply other than those specified elsewhere e.g. within procedures using the concerned system information, and/ or within the corresponding field descriptions.

5.2.2.21 Actions upon reception of *SystemInformationBlockType14*

No UE requirements related to the contents of this *SystemInformationBlock* apply other than those specified elsewhere e.g. within procedures using the concerned system information, and/ or within the corresponding field descriptions.

5.2.2.22 Actions upon reception of *SystemInformationBlockType15*

No UE requirements related to the contents of this *SystemInformationBlock* apply other than those specified elsewhere e.g. within procedures using the concerned system information, and/ or within the corresponding field descriptions.

5.2.2.23 Actions upon reception of *SystemInformationBlockType16*

No UE requirements related to the contents of this *SystemInformationBlock* apply other than those specified elsewhere e.g. within procedures using the concerned system information, and/ or within the corresponding field descriptions.

5.2.2.24 Actions upon reception of *SystemInformationBlockType17*

Upon receiving *SystemInformationBlockType17*, the UE shall:

- 1> if *wlan-OffloadConfigCommon* corresponding to the RPLMN is included:
 - 2> apply the *wlan-Id-List* corresponding to the RPLMN;
 - 2> if not configured with the *wlan-OffloadConfigDedicated*;
 - 3> apply the *wlan-OffloadConfigCommon* corresponding to the RPLMN;

5.2.2.25 Actions upon reception of *SystemInformationBlockType18*

Upon receiving *SystemInformationBlockType18*, the UE shall:

- 1> if *SystemInformationBlockType18* message includes the *commConfig*:
 - 2> if configured to receive sidelink communication:
 - 3> from the next SC period, as defined by *sc-Period*, use the resource pool indicated by *commRxPool* for sidelink communication monitoring, as specified in 5.10.3;
 - 2> if configured to transmit sidelink communication:
 - 3> from the next SC period, as defined by *sc-Period*, use the resource pool indicated by *commTxPoolNormalCommon* or by *commTxPoolExceptional* for sidelink communication transmission, as specified in 5.10.4;

5.2.2.26 Actions upon reception of *SystemInformationBlockType19*

Upon receiving *SystemInformationBlockType19*, the UE shall:

- 1> if *SystemInformationBlockType19* message includes the *discConfig*:
 - 2> from the next discovery period, as defined by *discPeriod*, use the resources indicated by *discRxPool* for sidelink discovery monitoring, as specified in 5.10.5;
 - 2> if *SystemInformationBlockType19* message includes the *discTxPoolCommon*; and the UE is in RRC_IDLE:
 - 3> from the next discovery period, as defined by *discPeriod*, use the resources indicated by *discTxPoolCommon* for sidelink discovery announcement, as specified in 5.10.6;
 - 2> if the *SystemInformationBlockType19* message includes the *discTxPowerInfo*:
 - 3> use the power information included in *discTxPowerInfo* for sidelink discovery transmission, as specified in TS 36.213 [23];

5.2.3 Acquisition of an SI message

When acquiring an SI message, the UE shall:

- 1> determine the start of the SI-window for the concerned SI message as follows:
 - 2> for the concerned SI message, determine the number n which corresponds to the order of entry in the list of SI messages configured by *schedulingInfoList* in *SystemInformationBlockType1*;
 - 2> determine the integer value $x = (n - 1) * w$, where w is the *si-WindowLength*;
 - 2> the SI-window starts at the subframe $\#a$, where $a = x \bmod 10$, in the radio frame for which $\text{SFN} \bmod T = \text{FLOOR}(x/10)$, where T is the *si-Periodicity* of the concerned SI message;

NOTE: E-UTRAN should configure an SI-window of 1 ms only if all SIs are scheduled before subframe #5 in radio frames for which $\text{SFN} \bmod 2 = 0$.

- 1> receive DL-SCH using the SI-RNTI from the start of the SI-window and continue until the end of the SI-window whose absolute length in time is given by *si-WindowLength*, or until the SI message was received, excluding the following subframes:
 - 2> subframe #5 in radio frames for which $\text{SFN mod } 2 = 0$;
 - 2> any MBSFN subframes;
 - 2> any uplink subframes in TDD;
- 1> if the SI message was not received by the end of the SI-window, repeat reception at the next SI-window occasion for the concerned SI message;

5.3 Connection control

5.3.1 Introduction

5.3.1.1 RRC connection control

RRC connection establishment involves the establishment of SRB1. E-UTRAN completes RRC connection establishment prior to completing the establishment of the S1 connection, i.e. prior to receiving the UE context information from the EPC. Consequently, AS security is not activated during the initial phase of the RRC connection. During this initial phase of the RRC connection, the E-UTRAN may configure the UE to perform measurement reporting, but the UE only sends the corresponding measurement reports after successful security activation. However, the UE only accepts a handover message when security has been activated.

NOTE: In case the serving frequency broadcasts multiple overlapping bands, E-UTRAN can only configure measurements after having obtained the UE capabilities, as the measurement configuration needs to be set according to the band selected by the UE.

Upon receiving the UE context from the EPC, E-UTRAN activates security (both ciphering and integrity protection) using the initial security activation procedure. The RRC messages to activate security (command and successful response) are integrity protected, while ciphering is started only after completion of the procedure. That is, the response to the message used to activate security is not ciphered, while the subsequent messages (e.g. used to establish SRB2 and DRBs) are both integrity protected and ciphered.

After having initiated the initial security activation procedure, E-UTRAN initiates the establishment of SRB2 and DRBs, i.e. E-UTRAN may do this prior to receiving the confirmation of the initial security activation from the UE. In any case, E-UTRAN will apply both ciphering and integrity protection for the RRC connection reconfiguration messages used to establish SRB2 and DRBs. E-UTRAN should release the RRC connection if the initial security activation and/ or the radio bearer establishment fails (i.e. security activation and DRB establishment are triggered by a joint S1-procedure, which does not support partial success).

For SRB2 and DRBs, security is always activated from the start, i.e. the E-UTRAN does not establish these bearers prior to activating security.

For some radio configuration fields, a critical extension has been defined. A switch from the original version of the field to the critically extended version is allowed using any connection reconfiguration. The UE reverts to the original version of some critically extended fields upon handover and re-establishment as specified elsewhere in this specification. Otherwise, switching a field from the critically extended version to the original version is only possible using the handover or re-establishment procedure with the full configuration option. This also applies for fields that are critically extended within a release (i.e. original and extended version defined in same release).

After having initiated the initial security activation procedure, E-UTRAN may configure a UE that supports CA, with one or more SCells in addition to the PCell that was initially configured during connection establishment. The PCell is used to provide the security inputs and upper layer system information (i.e. the NAS mobility information e.g. TAI). SCells are used to provide additional downlink and optionally uplink radio resources. When not configured with DC all SCells the UE is configured with, if any, are part of the MCG. When configured with DC however, some of the SCells are part of a SCG. In this case, user data carried by a DRB may either be transferred via MCG (i.e. MCG-DRB), via SCG (SCG-DRB) or via both MCG and SCG in DL while E-UTRAN configures the CG used in UL (split DRB). An RRC connection reconfiguration message may be used to change the DRB type from MCG-DRB to SCG-DRB or to split DRB, as well as from SCG-DRB or split DRB to MCG-DRB.

SCG change is a synchronous SCG reconfiguration procedure (i.e. involving RA to the PSCell) including reset/ re-establishment of layer 2 and, if SCG DRBs are configured, refresh of security. The procedure is used in a number of different scenarios e.g. SCG establishment, PSCell change, Key refresh, change of DRB type. The UE performs the SCG change related actions upon receiving an *RRCConnectionReconfiguration* message including *mobilityControlInfoSCG*, see 5.3.10.10.

The release of the RRC connection normally is initiated by E-UTRAN. The procedure may be used to re-direct the UE to an E-UTRA frequency or an inter-RAT carrier frequency. Only in exceptional cases, as specified within this specification, TS 36.300 [9], TS 36.304 [4] or TS 24.301 [35], may the UE abort the RRC connection, i.e. move to RRC_IDLE without notifying E-UTRAN.

5.3.1.2 Security

AS security comprises of the integrity protection of RRC signalling (SRBs) as well as the ciphering of RRC signalling (SRBs) and user data (DRBs).

RRC handles the configuration of the security parameters which are part of the AS configuration: the integrity protection algorithm, the ciphering algorithm and two parameters, namely the *keyChangeIndicator* and the *nextHopChainingCount*, which are used by the UE to determine the AS security keys upon handover and/ or connection re-establishment.

The integrity protection algorithm is common for signalling radio bearers SRB1 and SRB2. The ciphering algorithm is common for all radio bearers (i.e. SRB1, SRB2 and DRBs). Neither integrity protection nor ciphering applies for SRB0.

RRC integrity and ciphering are always activated together, i.e. in one message/ procedure. RRC integrity and ciphering are never de-activated. However, it is possible to switch to a 'NULL' ciphering algorithm (eea0).

The 'NULL' integrity protection algorithm (eia0) is used only for the UE in limited service mode [32, TS33.401]. In case the 'NULL' integrity protection algorithm is used, 'NULL' ciphering algorithm is also used.

NOTE 1: Lower layers discard RRC messages for which the integrity check has failed and indicate the integrity verification check failure to RRC.

The AS applies three different security keys: one for the integrity protection of RRC signalling (K_{RRCint}), one for the ciphering of RRC signalling (K_{RRCenc}) and one for the ciphering of user data (K_{UPenc}). All three AS keys are derived from the K_{eNB} key. The K_{eNB} is based on the K_{ASME} key, which is handled by upper layers.

Upon connection establishment new AS keys are derived. No AS-parameters are exchanged to serve as inputs for the derivation of the new AS keys at connection establishment.

The integrity and ciphering of the RRC message used to perform handover is based on the security configuration used prior to the handover and is performed by the source eNB.

The integrity and ciphering algorithms can only be changed upon handover. The four AS keys (K_{eNB} , K_{RRCint} , K_{RRCenc} and K_{UPenc}) change upon every handover and connection re-establishment. The *keyChangeIndicator* is used upon handover and indicates whether the UE should use the keys associated with the K_{ASME} key taken into use with the latest successful NAS SMC procedure. The *nextHopChainingCount* parameter is used upon handover and connection re-establishment by the UE when deriving the new K_{eNB} that is used to generate K_{RRCint} , K_{RRCenc} and K_{UPenc} (see TS 33.401 [32]). An intra cell handover procedure may be used to change the keys in RRC_CONNECTED.

For each radio bearer an independent counter (COUNT, as specified in TS 36.323 [8]) is maintained for each direction. For each DRB, the COUNT is used as input for ciphering. For each SRB, the COUNT is used as input for both ciphering and integrity protection. It is not allowed to use the same COUNT value more than once for a given security key. In order to limit the signalling overhead, individual messages/ packets include a short sequence number (PDCP SN, as specified in TS 36.323 [8]). In addition, an overflow counter mechanism is used: the hyper frame number (TX_HFN and RX_HFN, as specified in TS 36.323 [8]). The HFN needs to be synchronized between the UE and the eNB. The eNB is responsible for avoiding reuse of the COUNT with the same RB identity and with the same K_{eNB} , e.g. due to the transfer of large volumes of data, release and establishment of new RBs. In order to avoid such re-use, the eNB may e.g. use different RB identities for successive RB establishments, trigger an intra cell handover or an RRC_CONNECTED to RRC_IDLE to RRC_CONNECTED transition.

For each SRB, the value provided by RRC to lower layers to derive the 5-bit BEARER parameter used as input for ciphering and for integrity protection is the value of the corresponding *srb-Identity* with the MSBs padded with zeroes.

In case of DC, a separate K_{eNB} is used for SCG-DRBs ($S-K_{eNB}$). This key is derived from the key used for the MCG (K_{eNB}) and an SCG counter that is used to ensure freshness. To refresh the $S-K_{eNB}$ e.g. when the COUNT will wrap around, E-UTRAN employs an SCG change, i.e. an *RRCConnectionReconfiguration* message including *mobilityControlInfoSCG*. When performing handover, while at least one SCG-DRB remains configured, both K_{eNB} and $S-K_{eNB}$ are refreshed. In such case E-UTRAN performs handover with SCG change i.e. an *RRCConnectionReconfiguration* message including both *mobilityControlInfo* and *mobilityControlInfoSCG*. The ciphering algorithm is common for all radio bearers within a CG but may be different between MCG and SCG. The ciphering algorithm for SCG DRBs can only be changed upon SCG change.

5.3.1.2a RN security

For RNs, AS security follows the procedures in 5.3.1.2. Furthermore, E-UTRAN may configure per DRB whether or not integrity protection is used. The use of integrity protection may be configured only upon DRB establishment and reconfigured only upon handover or upon the first reconfiguration following RRC connection re-establishment.

To provide integrity protection on DRBs between the RN and the E-UTRAN, the K_{UPint} key is derived from the K_{eNB} key as described in TS33.401 [32]. The same integrity protection algorithm used for SRBs also applies to the DRBs. The K_{UPint} changes at every handover and RRC connection re-establishment and is based on an updated K_{eNB} which is derived by taking into account the *nextHopChainingCount*. The COUNT value maintained for DRB ciphering is also used for integrity protection, if the integrity protection is configured for the DRB.

5.3.1.3 Connected mode mobility

In RRC_CONNECTED, the network controls UE mobility, i.e. the network decides when the UE shall connect to which E-UTRA cell(s), or inter-RAT cell. For network controlled mobility in RRC_CONNECTED, the PCell can be changed using an *RRCConnectionReconfiguration* message including the *mobilityControlInfo* (handover), whereas the SCell(s) can be changed using the *RRCConnectionReconfiguration* message either with or without the *mobilityControlInfo*.

An SCG can only be established by using an *RRCConnectionReconfiguration* message without the *mobilityControlInfo*, while reconfiguration or release of the SCG can be done using an *RRCConnectionReconfiguration* message with or without the *mobilityControlInfo*. In case Random Access to the PCell is required upon SCG reconfiguration, E-UTRAN employs the SCG change procedure (i.e. an *RRCConnectionReconfiguration* message including the *mobilityControlInfoSCG*). The PCell can only be changed using the SCG change procedure and by release and addition of the PCell.

The network triggers the handover procedure e.g. based on radio conditions, load. To facilitate this, the network may configure the UE to perform measurement reporting (possibly including the configuration of measurement gaps). The network may also initiate handover blindly, i.e. without having received measurement reports from the UE.

Before sending the handover message to the UE, the source eNB prepares one or more target cells. The source eNB selects the target PCell. The source eNB may also provide the target eNB with a list of best cells on each frequency for which measurement information is available, in order of decreasing RSRP. The source eNB may also include available measurement information for the cells provided in the list. The target eNB decides which SCells are configured for use after handover, which may include cells other than the ones indicated by the source eNB. Handover involves either SCG release or SCG change. The latter option is only supported in case of intra-eNB handover. In case the UE was configured with DC, the target eNB indicates in the handover message that the UE shall release the entire SCG configuration. Upon connection re-establishment, the UE releases the entire SCG configuration except for the DRB configuration, while E-UTRAN in the first reconfiguration message following the re-establishment either releases the DRB(s) or reconfigures the DRB(s) to MCG DRB(s).

The target eNB generates the message used to perform the handover, i.e. the message including the AS-configuration to be used in the target cell(s). The source eNB transparently (i.e. does not alter values/ content) forwards the handover message/ information received from the target to the UE. When appropriate, the source eNB may initiate data forwarding for (a subset of) the DRBs.

After receiving the handover message, the UE attempts to access the target PCell at the first available RACH occasion according to Random Access resource selection defined in TS 36.321 [6], i.e. the handover is asynchronous. Consequently, when allocating a dedicated preamble for the random access in the target PCell, E-UTRA shall ensure it is available from the first RACH occasion the UE may use. Upon successful completion of the handover, the UE sends a message used to confirm the handover.

If the target eNB does not support the release of RRC protocol which the source eNB used to configure the UE, the target eNB may be unable to comprehend the UE configuration provided by the source eNB. In this case, the target eNB

should use the full configuration option to reconfigure the UE for Handover and Re-establishment. Full configuration option includes an initialization of the radio configuration, which makes the procedure independent of the configuration used in the source cell(s) with the exception that the security algorithms are continued for the RRC re-establishment.

After the successful completion of handover, PDCP SDUs may be re-transmitted in the target cell(s). This only applies for DRBs using RLC-AM mode and for handovers not involving full configuration option. The further details are specified in TS 36.323 [8]. After the successful completion of handover not involving full configuration option, the SN and the HFN are reset except for the DRBs using RLC-AM mode (for which both SN and HFN continue). For reconfigurations involving the full configuration option, the PDCP entities are newly established (SN and HFN do not continue) for all DRBs irrespective of the RLC mode. The further details are specified in TS 36.323 [8].

One UE behaviour to be performed upon handover is specified, i.e. this is regardless of the handover procedures used within the network (e.g. whether the handover includes X2 or S1 signalling procedures).

The source eNB should, for some time, maintain a context to enable the UE to return in case of handover failure. After having detected handover failure, the UE attempts to resume the RRC connection either in the source PCell or in another cell using the RRC re-establishment procedure. This connection resumption succeeds only if the accessed cell is prepared, i.e. concerns a cell of the source eNB or of another eNB towards which handover preparation has been performed. The cell in which the re-establishment procedure succeeds becomes the PCell while SCells and STAGs, if configured, are released.

Normal measurement and mobility procedures are used to support handover to cells broadcasting a CSG identity. In addition, E-UTRAN may configure the UE to report that it is entering or leaving the proximity of cell(s) included in its CSG whitelist. Furthermore, E-UTRAN may request the UE to provide additional information broadcast by the handover candidate cell e.g. global cell identity, CSG identity, CSG membership status.

NOTE: E-UTRAN may use the 'proximity report' to configure measurements as well as to decide whether or not to request additional information broadcast by the handover candidate cell. The additional information is used to verify whether or not the UE is authorised to access the target PCell and may also be needed to identify handover candidate cell (*PCI confusion* i.e. when the physical layer identity that is included in the measurement report does not uniquely identify the cell).

5.3.2 Paging

5.3.2.1 General



Figure 5.3.2.1-1: Paging

The purpose of this procedure is:

- to transmit paging information to a UE in RRC_IDLE and/ or;
- to inform UEs in RRC_IDLE and UEs in RRC_CONNECTED about a system information change and/ or;
- to inform about an ETWS primary notification and/ or ETWS secondary notification and/ or;
- to inform about a CMAS notification and/ or;
- to inform UEs in RRC_IDLE about an EAB parameters modification.

The paging information is provided to upper layers, which in response may initiate RRC connection establishment, e.g. to receive an incoming call.

5.3.2.2 Initiation

E-UTRAN initiates the paging procedure by transmitting the *Paging* message at the UE's paging occasion as specified in TS 36.304 [4]. E-UTRAN may address multiple UEs within a *Paging* message by including one *PagingRecord* for each UE. E-UTRAN may also indicate a change of system information, and/ or provide an ETWS notification or a CMAS notification in the *Paging* message.

5.3.2.3 Reception of the *Paging* message by the UE

Upon receiving the *Paging* message, the UE shall:

- 1> if in RRC_IDLE, for each of the *PagingRecord*, if any, included in the *Paging* message:
 - 2> if the *ue-Identity* included in the *PagingRecord* matches one of the UE identities allocated by upper layers:
 - 3> forward the *ue-Identity* and the *cn-Domain* to the upper layers;
- 1> if the *systemInfoModification* is included:
 - 2> re-acquire the required system information using the system information acquisition procedure as specified in 5.2.2.
- 1> if the *etws-Indication* is included and the UE is ETWS capable:
 - 2> re-acquire *SystemInformationBlockType1* immediately, i.e., without waiting until the next system information modification period boundary;
 - 2> if the *schedulingInfoList* indicates that *SystemInformationBlockType10* is present:
 - 3> acquire *SystemInformationBlockType10*;
 - 2> if the *schedulingInfoList* indicates that *SystemInformationBlockType11* is present:
 - 3> acquire *SystemInformationBlockType11*;
- 1> if the *cmass-Indication* is included and the UE is CMAS capable:
 - 2> re-acquire *SystemInformationBlockType1* immediately, i.e., without waiting until the next system information modification period boundary as specified in 5.2.1.5;
 - 2> if the *schedulingInfoList* indicates that *SystemInformationBlockType12* is present:
 - 3> acquire *SystemInformationBlockType12*;
- 1> if in RRC_IDLE, the *eab-ParamModification* is included and the UE is EAB capable:
 - 2> consider previously stored *SystemInformationBlockType14* as invalid;
 - 2> re-acquire *SystemInformationBlockType1* immediately, i.e., without waiting until the next system information modification period boundary as specified in 5.2.1.6;
 - 2> re-acquire *SystemInformationBlockType14* using the system information acquisition procedure as specified in 5.2.2.4;

5.3.3 RRC connection establishment

5.3.3.1 General

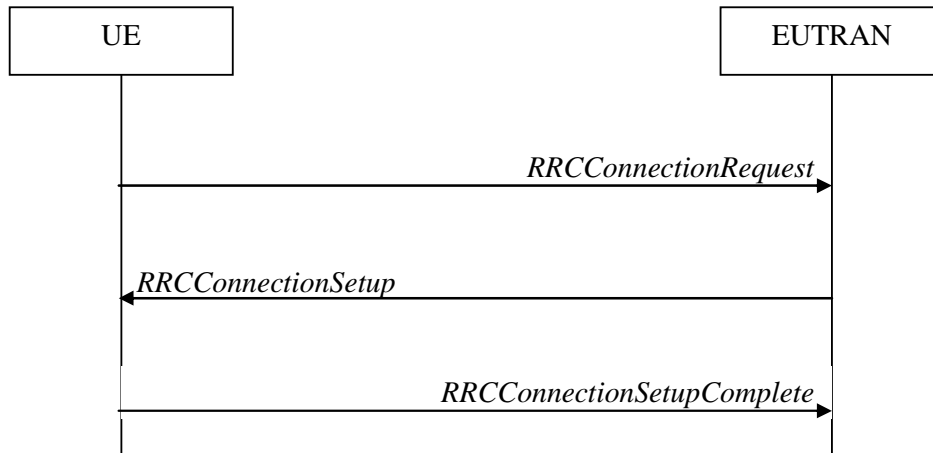

Figure 5.3.3.1-1: RRC connection establishment, successful

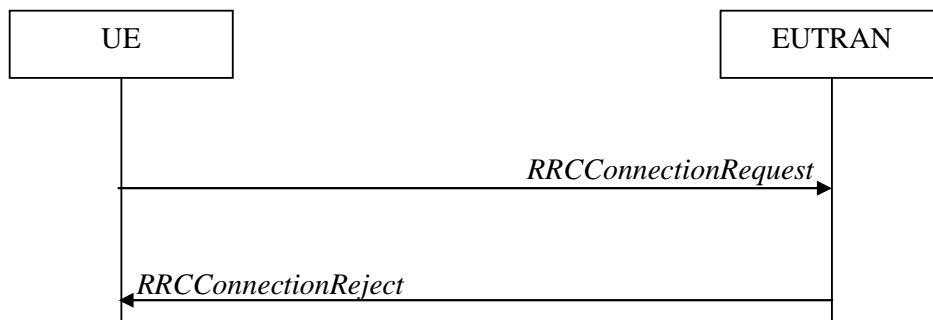

Figure 5.3.3.1-2: RRC connection establishment, network reject

The purpose of this procedure is to establish an RRC connection. RRC connection establishment involves SRB1 establishment. The procedure is also used to transfer the initial NAS dedicated information/ message from the UE to E-UTRAN.

E-UTRAN applies the procedure as follows:

- to establish SRB1 only.

5.3.3.1a Conditions for establishing RRC Connection for sidelink communication/ discovery

For sidelink communication an RRC connection is initiated only in the following case:

- 1> if configured by upper layers to transmit sidelink communication and related data is available for transmission:
- 2> if *SystemInformationBlockType18* is broadcast by the cell on which the UE camps; and if the valid version of *SystemInformationBlockType18* does not include *commTxPoolNormalCommon*;

For sidelink discovery an RRC connection is initiated only in the following case:

- 1> if configured by upper layers to transmit sidelink discovery announcements:
- 2> if *SystemInformationBlockType19* is broadcast by the cell on which the UE camps: and if the valid version of *SystemInformationBlockType19* does not include *discTxPoolCommon*;

NOTE: Upper layers initiate an RRC connection. The interaction with NAS is left to UE implementation.

5.3.3.2 Initiation

The UE initiates the procedure when upper layers request establishment of an RRC connection while the UE is in RRC_IDLE.

Upon initiation of the procedure, the UE shall:

- 1> if *SystemInformationBlockType2* includes *ac-BarringPerPLMN-List* and the *ac-BarringPerPLMN-List* contains an *AC-BarringPerPLMN* entry with the *plmn-IdentityIndex* corresponding to the PLMN selected by upper layers (see TS 23.122 [11], TS 24.301 [35]):
 - 2> select the *AC-BarringPerPLMN* entry with the *plmn-IdentityIndex* corresponding to the PLMN selected by upper layers;
 - 2> in the remainder of this procedure, use the selected *AC-BarringPerPLMN* entry (i.e. presence or absence of access barring parameters in this entry) irrespective of the common access barring parameters included in *SystemInformationBlockType2*;
- 1> else
 - 2> in the remainder of this procedure use the common access barring parameters (i.e. presence or absence of these parameters) included in *SystemInformationBlockType2*;
- 1> if upper layers indicate that the RRC connection is subject to EAB (see TS 24.301 [35]):
 - 2> if the result of the EAB check, as specified in 5.3.3.12, is that access to the cell is barred:
 - 3> inform upper layers about the failure to establish the RRC connection and that EAB is applicable, upon which the procedure ends;
- 1> if the UE is establishing the RRC connection for mobile terminating calls:
 - 2> if timer T302 is running:
 - 3> inform upper layers about the failure to establish the RRC connection and that access barring for mobile terminating calls is applicable, upon which the procedure ends;
- 1> else if the UE is establishing the RRC connection for emergency calls:
 - 2> if *SystemInformationBlockType2* includes the *ac-BarringInfo*:
 - 3> if the *ac-BarringForEmergency* is set to *TRUE*:
 - 4> if the UE has one or more Access Classes, as stored on the USIM, with a value in the range 11..15, which is valid for the UE to use according to TS 22.011 [10] and TS 23.122 [11]:
 - 5> if the *ac-BarringInfo* includes *ac-BarringForMO-Data*, and for all of these valid Access Classes for the UE, the corresponding bit in the *ac-BarringForSpecialAC* contained in *ac-BarringForMO-Data* is set to *one*:
 - 6> consider access to the cell as barred;
 - 4> else:
 - 5> consider access to the cell as barred;
 - 2> if access to the cell is barred:
 - 3> inform upper layers about the failure to establish the RRC connection, upon which the procedure ends;
 - 1> else if the UE is establishing the RRC connection for mobile originating calls:
 - 2> perform access barring check as specified in 5.3.3.11, using T303 as "Tbarring" and *ac-BarringForMO-Data* as "AC barring parameter";

- 2> if access to the cell is barred:
 - 3> if *SystemInformationBlockType2* includes *ac-BarringForCSFB* or the UE does not support CS fallback:
 - 4> inform upper layers about the failure to establish the RRC connection and that access barring for mobile originating calls is applicable, upon which the procedure ends;
 - 3> else (*SystemInformationBlockType2* does not include *ac-BarringForCSFB* and the UE supports CS fallback):
 - 4> if timer T306 is not running, start T306 with the timer value of T303;
 - 4> inform upper layers about the failure to establish the RRC connection and that access barring for mobile originating calls and mobile originating CS fallback is applicable, upon which the procedure ends;
- 1> else if the UE is establishing the RRC connection for mobile originating signalling:
 - 2> perform access barring check as specified in 5.3.3.11, using T305 as "Tbarring" and *ac-BarringForMO-Signalling* as "AC barring parameter";
 - 2> if access to the cell is barred:
 - 3> inform upper layers about the failure to establish the RRC connection and that access barring for mobile originating signalling is applicable, upon which the procedure ends;
- 1> else if the UE is establishing the RRC connection for mobile originating CS fallback:
 - 2> if *SystemInformationBlockType2* includes *ac-BarringForCSFB*:
 - 3> perform access barring check as specified in 5.3.3.11, using T306 as "Tbarring" and *ac-BarringForCSFB* as "AC barring parameter";
 - 3> if access to the cell is barred:
 - 4> inform upper layers about the failure to establish the RRC connection and that access barring for mobile originating CS fallback is applicable, due to *ac-BarringForCSFB*, upon which the procedure ends;
 - 2> else:
 - 3> perform access barring check as specified in 5.3.3.11, using T306 as "Tbarring" and *ac-BarringForMO-Data* as "AC barring parameter";
 - 3> if access to the cell is barred:
 - 4> if timer T303 is not running, start T303 with the timer value of T306;
 - 4> inform upper layers about the failure to establish the RRC connection and that access barring for mobile originating CS fallback and mobile originating calls is applicable, due to *ac-BarringForMO-Data*, upon which the procedure ends;
- 1> else if the UE is establishing the RRC connection for mobile originating MMTEL voice, mobile originating MMTEL video, mobile originating SMSoIP or mobile originating SMS:
 - 2> if the UE is establishing the RRC connection for mobile originating MMTEL voice and *SystemInformationBlockType2* includes *ac-BarringSkipForMMTELVoice*; or
 - 2> if the UE is establishing the RRC connection for mobile originating MMTEL video and *SystemInformationBlockType2* includes *ac-BarringSkipForMMTELVideo*; or
 - 2> if the UE is establishing the RRC connection for mobile originating SMSoIP or SMS and *SystemInformationBlockType2* includes *ac-BarringSkipForSMS*:
 - 3> consider access to the cell as not barred;
 - 2> else:

- 3> if *establishmentCause* received from higher layers is set to *mo-Signalling* (including the case that *mo-Signalling* is replaced by *highPriorityAccess* according to 3GPP TS 24.301 [35] or by *mo-VoiceCall* according to the subclause 5.3.3.3):
 - 4> perform access barring check as specified in 5.3.3.11, using T305 as "Tbarring" and *ac-BarringForMO-Signalling* as "AC barring parameter";
 - 4> if access to the cell is barred:
 - 5> inform upper layers about the failure to establish the RRC connection and that access barring for mobile originating signalling is applicable, upon which the procedure ends;
- 3> if *establishmentCause* received from higher layers is set to *mo-Data* (including the case that *mo-Data* is replaced by *highPriorityAccess* according to 3GPP TS 24.301 [35] or by *mo-VoiceCall* according to the subclause 5.3.3.3):
 - 4> perform access barring check as specified in 5.3.3.11, using T303 as "Tbarring" and *ac-BarringForMO-Data* as "AC barring parameter";
 - 4> if access to the cell is barred:
 - 5> if *SystemInformationBlockType2* includes *ac-BarringForCSFB* or the UE does not support CS fallback:
 - 6> inform upper layers about the failure to establish the RRC connection and that access barring for mobile originating calls is applicable, upon which the procedure ends;
 - 5> else (*SystemInformationBlockType2* does not include *ac-BarringForCSFB* and the UE supports CS fallback):
 - 6> if timer T306 is not running, start T306 with the timer value of T303;
 - 6> inform upper layers about the failure to establish the RRC connection and that access barring for mobile originating calls and mobile originating CS fallback is applicable, upon which the procedure ends;
- 1> apply the default physical channel configuration as specified in 9.2.4;
- 1> apply the default semi-persistent scheduling configuration as specified in 9.2.3;
- 1> apply the default MAC main configuration as specified in 9.2.2;
- 1> apply the CCCH configuration as specified in 9.1.1.2;
- 1> apply the *timeAlignmentTimerCommon* included in *SystemInformationBlockType2*;
- 1> start timer T300;
- 1> initiate transmission of the *RRCCConnectionRequest* message in accordance with 5.3.3.3;

NOTE 2: Upon initiating the connection establishment procedure, the UE is not required to ensure it maintains up to date system information applicable only for UEs in RRC_IDLE state. However, the UE needs to perform system information acquisition upon cell re-selection.

5.3.3.3 Actions related to transmission of *RRCCConnectionRequest* message

The UE shall set the contents of *RRCCConnectionRequest* message as follows:

- 1> set the *ue-Identity* as follows:
 - 2> if upper layers provide an S-TMSI:
 - 3> set the *ue-Identity* to the value received from upper layers;
 - 2> else:
 - 3> draw a random value in the range $0 \dots 2^{40}-1$ and set the *ue-Identity* to this value;

NOTE 1: Upper layers provide the S-TMSI if the UE is registered in the TA of the current cell.

1> if the UE supports *mo-VoiceCall* establishment cause and UE is establishing the RRC connection for mobile originating MMTEL voice and *SystemInformationBlockType2* includes *voiceServiceCauseIndication*:

2> set the *establishmentCause* to *mo-VoiceCall*;

1> else:

2> set the *establishmentCause* in accordance with the information received from upper layers;

The UE shall submit the *RRCConnectionRequest* message to lower layers for transmission.

The UE shall continue cell re-selection related measurements as well as cell re-selection evaluation. If the conditions for cell re-selection are fulfilled, the UE shall perform cell re-selection as specified in 5.3.3.5.

5.3.3.4 Reception of the *RRCConnectionSetup* by the UE

NOTE: Prior to this, lower layer signalling is used to allocate a C-RNTI. For further details see TS 36.321 [6];

The UE shall:

1> perform the radio resource configuration procedure in accordance with the received *radioResourceConfigDedicated* and as specified in 5.3.10;

1> if stored, discard the cell reselection priority information provided by the *idleModeMobilityControlInfo* or inherited from another RAT;

1> stop timer T300;

1> stop timer T302, if running;

1> stop timer T303, if running;

1> stop timer T305, if running;

1> stop timer T306, if running;

1> perform the actions as specified in 5.3.3.7;

1> stop timer T320, if running;

1> stop timer T350, if running;

1> perform the actions as specified in 5.6.12.4;

1> enter RRC_CONNECTED;

1> stop the cell re-selection procedure;

1> consider the current cell to be the PCell;

1> set the content of *RRCConnectionSetupComplete* message as follows:

2> set the *selectedPLMN-Identity* to the PLMN selected by upper layers (see TS 23.122 [11], TS 24.301 [35]) from the PLMN(s) included in the *plmn-IdentityList* in *SystemInformationBlockType1*;

2> if upper layers provide the 'Registered MME', include and set the *registeredMME* as follows:

3> if the PLMN identity of the 'Registered MME' is different from the PLMN selected by the upper layers:

4> include the *plmnIdentity* in the *registeredMME* and set it to the value of the PLMN identity in the 'Registered MME' received from upper layers;

3> set the *mmegi* and the *mmec* to the value received from upper layers;

2> if upper layers provided the 'Registered MME':

- 3> include and set the *gummei-Type* to the value provided by the upper layers;
- 2> if connecting as an RN:
 - 3> include the *rn-SubframeConfigReq*;
- 2> set the *dedicatedInfoNAS* to include the information received from upper layers;
- 2> if the UE has radio link failure or handover failure information available in *VarRLF-Report* and if the RPLMN is included in *plmn-IdentityList* stored in *VarRLF-Report*:
 - 3> include *rlf-InfoAvailable*;
- 2> if the UE has MBSFN logged measurements available for E-UTRA and if the RPLMN is included in *plmn-IdentityList* stored in *VarLogMeasReport*:
 - 3> include *logMeasAvailableMBSFN*;
- 2> else if the UE has logged measurements available for E-UTRA and if the RPLMN is included in *plmn-IdentityList* stored in *VarLogMeasReport*:
 - 3> include *logMeasAvailable*;
- 2> if the UE has connection establishment failure information available in *VarConnEstFailReport* and if the RPLMN is equal to *plmn-Identity* stored in *VarConnEstFailReport*:
 - 3> include *connEstFailInfoAvailable*;
- 2> include the *mobilityState* and set it to the mobility state (as specified in TS 36.304 [4]) of the UE just prior to entering RRC_CONNECTED state;
- 2> if the UE supports storage of mobility history information and the UE has mobility history information available in *VarMobilityHistoryReport*:
 - 3> include the *mobilityHistoryAvail*;
- 2> submit the *RRCConnectionSetupComplete* message to lower layers for transmission, upon which the procedure ends;

5.3.3.5 Cell re-selection while T300, T302, T303, T305 or T306 is running

The UE shall:

- 1> if cell reselection occurs while T300, T302, T303, T305 or T306 is running:
 - 2> if timer T302, T303, T305 and/ or T306 is running:
 - 3> stop timer T302, T303, T305 and T306, whichever ones were running;
 - 3> perform the actions as specified in 5.3.3.7;
 - 2> if timer T300 is running:
 - 3> stop timer T300;
 - 3> reset MAC, release the MAC configuration and re-establish RLC for all RBs that are established;
 - 3> inform upper layers about the failure to establish the RRC connection;

5.3.3.6 T300 expiry

The UE shall:

- 1> if timer T300 expires:
 - 2> reset MAC, release the MAC configuration and re-establish RLC for all RBs that are established;

- 2> if the UE supports RRC Connection Establishment failure temporary Qoffset and T300 has expired a consecutive *connEstFailCount* times on the same cell for which *txFailParams* is included in *SystemInformationBlockType2*:
 - 3> for a period as indicated by *connEstFailOffsetValidity*:
 - 4> use *connEstFailOffset* for the parameter $Q_{\text{offset,temp}}$ for the concerned cell when performing cell selection and reselection according to TS 36.304 [4] and TS 25.304 [40];

NOTE 1: When performing cell selection, if no suitable or acceptable cell can be found, it is up to UE implementation whether to stop using *connEstFailOffset* for the parameter $Q_{\text{offset,temp}}$ during *connEstFailOffsetValidity* for the concerned cell.

- 2> store the following connection establishment failure information in the *VarConnEstFailReport* by setting its fields as follows:
 - 3> clear the information included in *VarConnEstFailReport*, if any;
 - 3> set the *plmn-Identity* to the PLMN selected by upper layers (see TS 23.122 [11], TS 24.301 [35]) from the PLMN(s) included in the *plmn-IdentityList* in *SystemInformationBlockType1*;
 - 3> set the *failedCellId* to the global cell identity of the cell where connection establishment failure is detected;
 - 3> set the *measResultFailedCell* to include the RSRP and RSRQ, if available, of the cell where connection establishment failure is detected and based on measurements collected up to the moment the UE detected the failure;
 - 3> if available, set the *measResultNeighCells*, in order of decreasing ranking-criterion as used for cell reselection, to include neighbouring cell measurements for at most the following number of neighbouring cells: 6 intra-frequency and 3 inter-frequency neighbours per frequency as well as 3 inter-RAT neighbours, per frequency/ set of frequencies (GERAN) per RAT and according to the following:
 - 4> for each neighbour cell included, include the optional fields that are available;

NOTE 2: The UE includes the latest results of the available measurements as used for cell reselection evaluation, which are performed in accordance with the performance requirements as specified in TS 36.133 [16].

- 3> if detailed location information is available, set the content of the *locationInfo* as follows:
 - 4> include the *locationCoordinates*;
 - 4> include the *horizontalVelocity*, if available;
 - 3> set the *numberOfPreamblesSent* to indicate the number of preambles sent by MAC for the failed random access procedure;
 - 3> set *contentionDetected* to indicate whether contention resolution was not successful as specified in TS 36.321 [6] for at least one of the transmitted preambles for the failed random access procedure;
 - 3> set *maxTxPowerReached* to indicate whether or not the maximum power level was used for the last transmitted preamble, see TS 36.321 [6];
- 2> inform upper layers about the failure to establish the RRC connection, upon which the procedure ends;

The UE may discard the connection establishment failure information, i.e. release the UE variable *VarConnEstFailReport*, 48 hours after the failure is detected, upon power off or upon detach.

5.3.3.7 T302, T303, T305 or T306 expiry or stop

The UE shall:

- 1> if timer T302 expires or is stopped:
 - 2> inform upper layers about barring alleviation for mobile terminating access;
- 2> if timer T303 is not running:

- 3> inform upper layers about barring alleviation for mobile originating calls;
- 2> if timer T305 is not running:
 - 3> inform upper layers about barring alleviation for mobile originating signalling;
- 2> if timer T306 is not running:
 - 3> inform upper layers about barring alleviation for mobile originating CS fallback;
- 1> if timer T303 expires or is stopped:
 - 2> if timer T302 is not running:
 - 3> inform upper layers about barring alleviation for mobile originating calls;
- 1> if timer T305 expires or is stopped:
 - 2> if timer T302 is not running:
 - 3> inform upper layers about barring alleviation for mobile originating signalling;
- 1> if timer T306 expires or is stopped:
 - 2> if timer T302 is not running:
 - 3> inform upper layers about barring alleviation for mobile originating CS fallback;

5.3.3.8 Reception of the *RRCConnectionReject* by the UE

The UE shall:

- 1> stop timer T300;
- 1> reset MAC and release the MAC configuration;
- 1> start timer T302, with the timer value set to the *waitTime*;
- 1> if the *extendedWaitTime* is present and the UE supports delay tolerant access:
 - 2> forward the *extendedWaitTime* to upper layers;
- 1> if *deprioritisationReq* is included and the UE supports RRC Connection Reject with deprioritisation:
 - 2> start or restart timer T325 with the timer value set to the *deprioritisationTimer* signalled;
 - 2> store the *deprioritisationReq* until T325 expiry;

NOTE: The UE stores the deprioritisation request irrespective of any cell reselection absolute priority assignments (by dedicated or common signalling) and regardless of RRC connections in E-UTRAN or other RATs unless specified otherwise.

- 1> inform upper layers about the failure to establish the RRC connection and that access barring for mobile originating calls, mobile originating signalling, mobile terminating access and mobile originating CS fallback is applicable, upon which the procedure ends;

5.3.3.9 Abortion of RRC connection establishment

If upper layers abort the RRC connection establishment procedure while the UE has not yet entered RRC_CONNECTED, the UE shall:

- 1> stop timer T300, if running;
- 1> reset MAC, release the MAC configuration and re-establish RLC for all RBs that are established;

5.3.3.10 Handling of SSAC related parameters

Upon request from the upper layers, the UE shall:

- 1> if *SystemInformationBlockType2* includes *ac-BarringPerPLMN-List* and the *ac-BarringPerPLMN-List* contains an *AC-BarringPerPLMN* entry with the *plmn-IdentityIndex* corresponding to the PLMN selected by upper layers (see TS 23.122 [11], TS 24.301 [35]):
 - 2> select the *AC-BarringPerPLMN* entry with the *plmn-IdentityIndex* corresponding to the PLMN selected by upper layers;
 - 2> in the remainder of this procedure, use the selected *AC-BarringPerPLMN* entry (i.e. presence or absence of access barring parameters in this entry) irrespective of the common access barring parameters included in *SystemInformationBlockType2*;

1> else:

- 2> in the remainder of this procedure use the common access barring parameters (i.e. presence or absence of these parameters) included in *SystemInformationBlockType2*;

1> set the local variables *BarringFactorForMMTEL-Voice* and *BarringTimeForMMTEL-Voice* as follows:

2> if *ssac-BarringForMMTEL-Voice* is present:

- 3> if the UE has one or more Access Classes, as stored on the USIM, with a value in the range 11..15, which is valid for the UE to use according to TS 22.011 [10] and TS 23.122 [11], and

NOTE: ACs 12, 13, 14 are only valid for use in the home country and ACs 11, 15 are only valid for use in the HPLMN/ EHPLMN.

- 3> if, for at least one of these Access Classes, the corresponding bit in the *ac-BarringForSpecialAC* contained in *ssac-BarringForMMTEL-Voice* is set to zero:

4> set *BarringFactorForMMTEL-Voice* to one and *BarringTimeForMMTEL-Voice* to zero;

3> else:

4> set *BarringFactorForMMTEL-Voice* and *BarringTimeForMMTEL-Voice* to the value of *ac-BarringFactor* and *ac-BarringTime* included in *ssac-BarringForMMTEL-Voice*, respectively;

2> else set *BarringFactorForMMTEL-Voice* to one and *BarringTimeForMMTEL-Voice* to zero;

1> set the local variables *BarringFactorForMMTEL-Video* and *BarringTimeForMMTEL-Video* as follows:

2> if *ssac-BarringForMMTEL-Video* is present:

- 3> if the UE has one or more Access Classes, as stored on the USIM, with a value in the range 11..15, which is valid for the UE to use according to TS 22.011 [10] and TS 23.122 [11], and

- 3> if, for at least one of these Access Classes, the corresponding bit in the *ac-BarringForSpecialAC* contained in *ssac-BarringForMMTEL-Video* is set to zero:

4> set *BarringFactorForMMTEL-Video* to one and *BarringTimeForMMTEL-Video* to zero;

3> else:

4> set *BarringFactorForMMTEL-Video* and *BarringTimeForMMTEL-Video* to the value of *ac-BarringFactor* and *ac-BarringTime* included in *ssac-BarringForMMTEL-Video*, respectively;

2> else set *BarringFactorForMMTEL-Video* to one and *BarringTimeForMMTEL-Video* to zero;

1> forward the variables *BarringFactorForMMTEL-Voice*, *BarringTimeForMMTEL-Voice*, *BarringFactorForMMTEL-Video* and *BarringTimeForMMTEL-Video* to the upper layers;

5.3.3.11 Access barring check

1> if timer T302 or "Tbarring" is running:

2> consider access to the cell as barred;

1> else if *SystemInformationBlockType2* includes "AC barring parameter":

- 2> if the UE has one or more Access Classes, as stored on the USIM, with a value in the range 11..15, which is valid for the UE to use according to TS 22.011 [10] and TS 23.122 [11], and

NOTE: ACs 12, 13, 14 are only valid for use in the home country and ACs 11, 15 are only valid for use in the HPLMN/ EHPLMN.

- 2> for at least one of these valid Access Classes the corresponding bit in the *ac-BarringForSpecialAC* contained in "AC barring parameter" is set to *zero*:

- 3> consider access to the cell as not barred;

- 2> else:

- 3> draw a random number '*rand*' uniformly distributed in the range: $0 \leq rand < 1$;

- 3> if '*rand*' is lower than the value indicated by *ac-BarringFactor* included in "AC barring parameter":

- 4> consider access to the cell as not barred;

- 3> else:

- 4> consider access to the cell as barred;

- 1> else:

- 2> consider access to the cell as not barred;

- 1> if access to the cell is barred and both timers T302 and "Tbarring" are not running:

- 2> draw a random number '*rand*' that is uniformly distributed in the range $0 \leq rand < 1$;

- 2> start timer "Tbarring" with the timer value calculated as follows, using the *ac-BarringTime* included in "AC barring parameter":

- "Tbarring" = $(0.7 + 0.6 * rand) * ac-BarringTime$.

5.3.3.12 EAB check

The UE shall:

- 1> if *SystemInformationBlockType14* is present and includes the *eab-Param*:

- 2> if the *eab-Common* is included in the *eab-Param*:

- 3> if the UE belongs to the category of UEs as indicated in the *eab-Category* contained in *eab-Common*; and

- 3> if for the Access Class of the UE, as stored on the USIM and with a value in the range 0..9, the corresponding bit in the *eab-BarringBitmap* contained in *eab-Common* is set to *one*:

- 4> consider access to the cell as barred;

- 3> else:

- 4> consider access to the cell as not barred due to EAB;

- 2> else (the *eab-PerPLMN-List* is included in the *eab-Param*):

- 3> select the entry in the *eab-PerPLMN-List* corresponding to the PLMN selected by upper layers (see TS 23.122 [11], TS 24.301 [35]);

- 3> if the *eab-Config* for that PLMN is included:

- 4> if the UE belongs to the category of UEs as indicated in the *eab-Category* contained in *eab-Config*; and

- 4> if for the Access Class of the UE, as stored on the USIM and with a value in the range 0..9, the corresponding bit in the *eab-BarringBitmap* contained in *eab-Config* is set to *one*:

- 5> consider access to the cell as barred;
- 4> else:
 - 5> consider access to the cell as not barred due to EAB;
- 3> else:
 - 4> consider access to the cell as not barred due to EAB;
- 1> else:
 - 2> consider access to the cell as not barred due to EAB;

5.3.4 Initial security activation

5.3.4.1 General

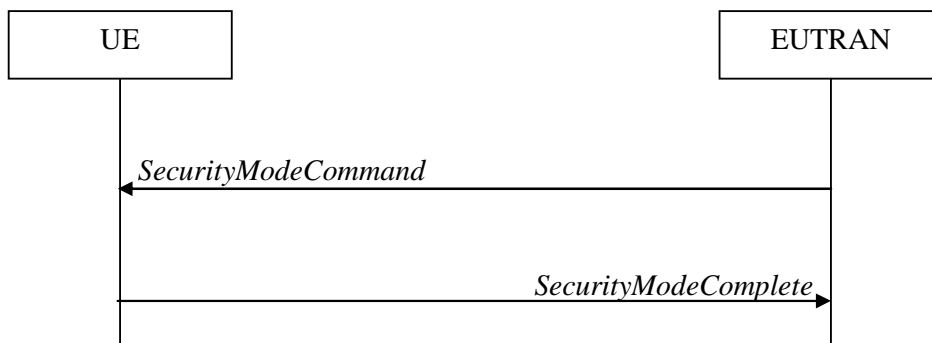

Figure 5.3.4.1-1: Security mode command, successful

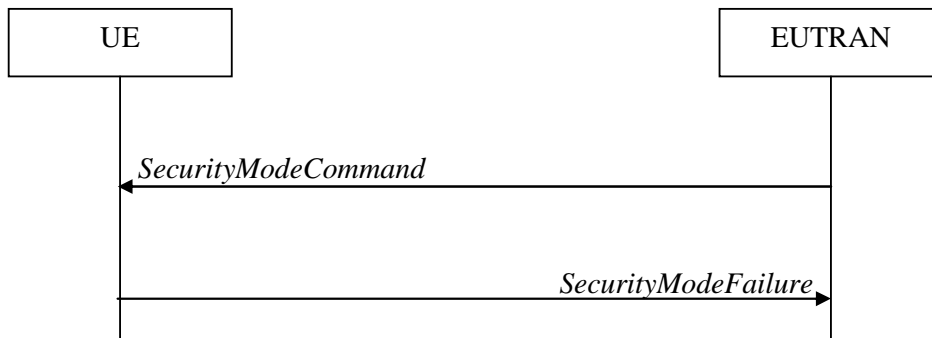

Figure 5.3.4.1-2: Security mode command, failure

The purpose of this procedure is to activate AS security upon RRC connection establishment.

5.3.4.2 Initiation

E-UTRAN initiates the security mode command procedure to a UE in RRC_CONNECTED. Moreover, E-UTRAN applies the procedure as follows:

- when only SRB1 is established, i.e. prior to establishment of SRB2 and/ or DRBs.

5.3.4.3 Reception of the *SecurityModeCommand* by the UE

The UE shall:

- 1> derive the K_{eNB} key, as specified in TS 33.401 [32];
- 1> derive the K_{RRCint} key associated with the *integrityProtAlgorithm* indicated in the *SecurityModeCommand* message, as specified in TS 33.401 [32];

- 1> request lower layers to verify the integrity protection of the *SecurityModeCommand* message, using the algorithm indicated by the *integrityProtAlgorithm* as included in the *SecurityModeCommand* message and the K_{RRcInt} key;
- 1> if the *SecurityModeCommand* message passes the integrity protection check:
 - 2> derive the K_{RRcEnc} key and the K_{UPenc} key associated with the *cipheringAlgorithm* indicated in the *SecurityModeCommand* message, as specified in TS 33.401 [32];
 - 2> if connected as an RN:
 - 3> derive the K_{UPint} key associated with the *integrityProtAlgorithm* indicated in the *SecurityModeCommand* message, as specified in TS 33.401 [32];
 - 2> configure lower layers to apply integrity protection using the indicated algorithm and the K_{RRcInt} key immediately, i.e. integrity protection shall be applied to all subsequent messages received and sent by the UE, including the *SecurityModeComplete* message;
 - 2> configure lower layers to apply ciphering using the indicated algorithm, the K_{RRcEnc} key and the K_{UPenc} key after completing the procedure, i.e. ciphering shall be applied to all subsequent messages received and sent by the UE, except for the *SecurityModeComplete* message which is sent unciphered;
 - 2> if connected as an RN:
 - 3> configure lower layers to apply integrity protection using the indicated algorithm and the K_{UPint} key, for DRBs that are subsequently configured to apply integrity protection, if any;
 - 2> consider AS security to be activated;
 - 2> submit the *SecurityModeComplete* message to lower layers for transmission, upon which the procedure ends;
- 1> else:
 - 2> continue using the configuration used prior to the reception of the *SecurityModeCommand* message, i.e. neither apply integrity protection nor ciphering.
 - 2> submit the *SecurityModeFailure* message to lower layers for transmission, upon which the procedure ends;

5.3.5 RRC connection reconfiguration

5.3.5.1 General

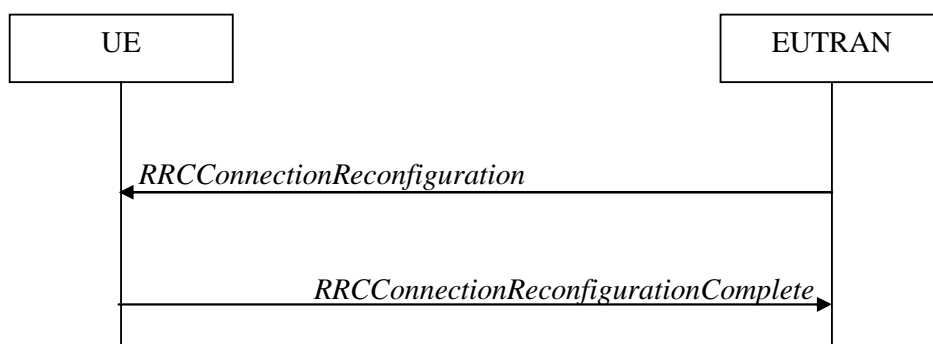

Figure 5.3.5.1-1: RRC connection reconfiguration, successful

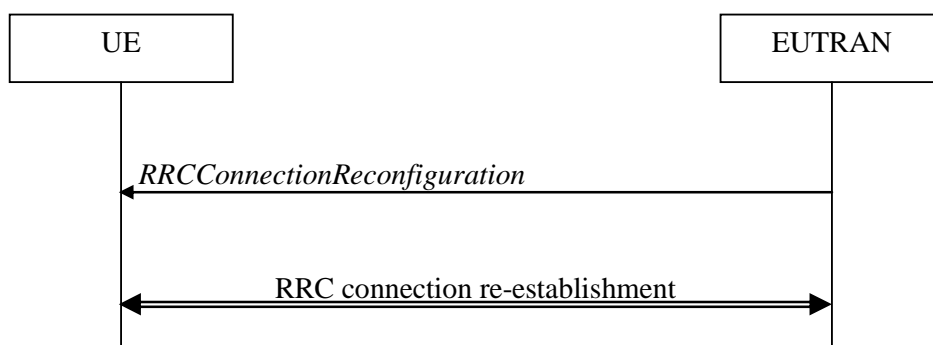

Figure 5.3.5.1-2: RRC connection reconfiguration, failure

The purpose of this procedure is to modify an RRC connection, e.g. to establish/ modify/ release RBs, to perform handover, to setup/ modify/ release measurements, to add/ modify/ release SCells. As part of the procedure, NAS dedicated information may be transferred from E-UTRAN to the UE.

5.3.5.2 Initiation

E-UTRAN may initiate the RRC connection reconfiguration procedure to a UE in RRC_CONNECTED. E-UTRAN applies the procedure as follows:

- the *mobilityControlInfo* is included only when AS-security has been activated, and SRB2 with at least one DRB are setup and not suspended;
- the establishment of RBs (other than SRB1, that is established during RRC connection establishment) is included only when AS security has been activated;
- the addition of SCells is performed only when AS security has been activated;

5.3.5.3 Reception of an *RRCConnectionReconfiguration* not including the *mobilityControlInfo* by the UE

If the *RRCConnectionReconfiguration* message does not include the *mobilityControlInfo* and the UE is able to comply with the configuration included in this message, the UE shall:

- 1> if this is the first *RRCConnectionReconfiguration* message after successful completion of the RRC Connection Re-establishment procedure:
 - 2> re-establish PDCP for SRB2 and for all DRBs that are established, if any;
 - 2> re-establish RLC for SRB2 and for all DRBs that are established, if any;
- 2> if the *RRCConnectionReconfiguration* message includes the *fullConfig*:
 - 3> perform the radio configuration procedure as specified in section 5.3.5.8;
- 2> if the *RRCConnectionReconfiguration* message includes the *radioResourceConfigDedicated*:
 - 3> perform the radio resource configuration procedure as specified in 5.3.10;
- 2> resume SRB2 and all DRBs that are suspended, if any;

NOTE 1: The handling of the radio bearers after the successful completion of the PDCP re-establishment, e.g. the re-transmission of unacknowledged PDCP SDUs (as well as the associated status reporting), the handling of the SN and the HFN, is specified in TS 36.323 [8].

NOTE 2: The UE may discard SRB2 messages and data that it receives prior to completing the reconfiguration used to resume these bearers.

1> else:

- 2> if the *RRCConnectionReconfiguration* message includes the *radioResourceConfigDedicated*:
 - 3> perform the radio resource configuration procedure as specified in 5.3.10;

NOTE 3: If the *RRCCONNECTIONRECONFIGURATION* message includes the establishment of radio bearers other than SRB1, the UE may start using these radio bearers immediately, i.e. there is no need to wait for an outstanding acknowledgment of the *SECURITYMODECOMPLETE* message.

- 1> if the received *RRCCONNECTIONRECONFIGURATION* includes the *sCellToReleaseList*:
 - 2> perform SCell release as specified in 5.3.10.3a;
- 1> if the received *RRCCONNECTIONRECONFIGURATION* includes the *sCellToAddModList*:
 - 2> perform SCell addition or modification as specified in 5.3.10.3b;
- 1> if the received *RRCCONNECTIONRECONFIGURATION* includes the *scg-Configuration*; or
- 1> if the current UE configuration includes one or more split DRBs and the received *RRCCONNECTIONRECONFIGURATION* includes *radioResourceConfigDedicated* including *drb-ToAddModList*:
 - 2> perform SCG reconfiguration as specified in 5.3.10.10;
- 1> if the received *RRCCONNECTIONRECONFIGURATION* includes the *systemInformationBlockType1Dedicated*:
 - 2> perform the actions upon reception of the *SystemInformationBlockType1* message as specified in 5.2.2.7;
- 1> if the *RRCCONNECTIONRECONFIGURATION* message includes the *dedicatedInfoNASList*:
 - 2> forward each element of the *dedicatedInfoNASList* to upper layers in the same order as listed;
- 1> if the *RRCCONNECTIONRECONFIGURATION* message includes the *measConfig*:
 - 2> perform the measurement configuration procedure as specified in 5.5.2;
- 1> perform the measurement identity autonomous removal as specified in 5.5.2.2a;
- 1> if the *RRCCONNECTIONRECONFIGURATION* message includes the *otherConfig*:
 - 2> perform the other configuration procedure as specified in 5.3.10.9;
- 1> if the *RRCCONNECTIONRECONFIGURATION* message includes the *sl-DiscConfig* or *sl-CommConfig*:
 - 2> perform the sidelink dedicated configuration procedure as specified in 5.3.10.15;
- 1> if the *RRCCONNECTIONRECONFIGURATION* message includes *wlan-OffloadInfo*:
 - 2> perform the dedicated WLAN offload configuration procedure as specified in 5.6.12.2;
- 1> submit the *RRCCONNECTIONRECONFIGURATIONCOMPLETE* message to lower layers for transmission using the new configuration, upon which the procedure ends;

5.3.5.4 Reception of an *RRCCONNECTIONRECONFIGURATION* including the *mobilityControlInfo* by the UE (handover)

If the *RRCCONNECTIONRECONFIGURATION* message includes the *mobilityControlInfo* and the UE is able to comply with the configuration included in this message, the UE shall:

- 1> stop timer T310, if running;
- 1> stop timer T312, if running;
- 1> start timer T304 with the timer value set to *t304*, as included in the *mobilityControlInfo*;
- 1> if the *carrierFreq* is included:
 - 2> consider the target PCell to be one on the frequency indicated by the *carrierFreq* with a physical cell identity indicated by the *targetPhysCellId*;
- 1> else:

2> consider the target PCell to be one on the frequency of the source PCell with a physical cell identity indicated by the *targetPhysCellId*;

1> start synchronising to the DL of the target PCell;

NOTE 1: The UE should perform the handover as soon as possible following the reception of the RRC message triggering the handover, which could be before confirming successful reception (HARQ and ARQ) of this message.

1> reset MCG MAC and SCG MAC, if configured;

1> re-establish PDCP for all RBs that are established;

NOTE 2: The handling of the radio bearers after the successful completion of the PDCP re-establishment, e.g. the re-transmission of unacknowledged PDCP SDUs (as well as the associated status reporting), the handling of the SN and the HFN, is specified in TS 36.323 [8].

1> re-establish MCG RLC and SCG RLC, if configured, for all RBs that are established;

1> configure lower layers to consider the SCell(s) other than the PSCell, if configured, to be in deactivated state;

1> apply the value of the *newUE-Identity* as the C-RNTI;

1> if the *RRCConnectionReconfiguration* message includes the *fullConfig*:

2> perform the radio configuration procedure as specified in section 5.3.5.8;

1> configure lower layers in accordance with the received *radioResourceConfigCommon*;

1> configure lower layers in accordance with any additional fields, not covered in the previous, if included in the received *mobilityControlInfo*;

1> if the *RRCConnectionReconfiguration* message includes the *radioResourceConfigDedicated*:

2> perform the radio resource configuration procedure as specified in 5.3.10;

1> if the *keyChangeIndicator* received in the *securityConfigHO* is set to *TRUE*:

2> update the K_{eNB} key based on the K_{ASME} key taken into use with the latest successful NAS SMC procedure, as specified in TS 33.401 [32];

1> else:

2> update the K_{eNB} key based on the current K_{eNB} or the NH, using the *nextHopChainingCount* value indicated in the *securityConfigHO*, as specified in TS 33.401 [32];

1> store the *nextHopChainingCount* value;

1> if the *securityAlgorithmConfig* is included in the *securityConfigHO*:

2> derive the K_{RRcint} key associated with the *integrityProtAlgorithm*, as specified in TS 33.401 [32];

2> if connected as an RN:

3> derive the K_{UPint} key associated with the *integrityProtAlgorithm*, as specified in TS 33.401 [32];

2> derive the K_{RRcenc} key and the K_{UPenc} key associated with the *cipheringAlgorithm*, as specified in TS 33.401 [32];

1> else:

2> derive the K_{RRcint} key associated with the current integrity algorithm, as specified in TS 33.401 [32];

2> if connected as an RN:

3> derive the K_{UPint} key associated with the current integrity algorithm, as specified in TS 33.401 [32];

- 2> derive the K_{RRCEnc} key and the K_{UPenc} key associated with the current ciphering algorithm, as specified in TS 33.401 [32];
- 1> configure lower layers to apply the integrity protection algorithm and the K_{RRCint} key, i.e. the integrity protection configuration shall be applied to all subsequent messages received and sent by the UE, including the message used to indicate the successful completion of the procedure;
- 1> configure lower layers to apply the ciphering algorithm, the K_{RRCEnc} key and the K_{UPenc} key, i.e. the ciphering configuration shall be applied to all subsequent messages received and sent by the UE, including the message used to indicate the successful completion of the procedure;
- 1> if connected as an RN:
 - 2> configure lower layers to apply the integrity protection algorithm and the K_{UPint} key, for current or subsequently established DRBs that are configured to apply integrity protection, if any;
- 1> if the received *RRCCConnectionReconfiguration* includes the *sCellToReleaseList*:
 - 2> perform SCell release as specified in 5.3.10.3a;
- 1> if the received *RRCCConnectionReconfiguration* includes the *sCellToAddModList*:
 - 2> perform SCell addition or modification as specified in 5.3.10.3b;
- 1> if the received *RRCCConnectionReconfiguration* includes the *scg-Configuration*; or
- 1> if the current UE configuration includes one or more split DRBs and the received *RRCCConnectionReconfiguration* includes *radioResourceConfigDedicated* including *drb-ToAddModList*:
 - 2> perform SCG reconfiguration as specified in 5.3.10.10;
- 1> if the received *RRCCConnectionReconfiguration* includes the *systemInformationBlockType1Dedicated*:
 - 2> perform the actions upon reception of the *SystemInformationBlockType1* message as specified in 5.2.2.7;
- 1> perform the measurement related actions as specified in 5.5.6.1;
- 1> if the *RRCCConnectionReconfiguration* message includes the *measConfig*:
 - 2> perform the measurement configuration procedure as specified in 5.5.2;
- 1> perform the measurement identity autonomous removal as specified in 5.5.2.2a;
- 1> release *reportProximityConfig* and clear any associated proximity status reporting timer;
- 1> if the *RRCCConnectionReconfiguration* message includes the *otherConfig*:
 - 2> perform the other configuration procedure as specified in 5.3.10.9;
- 1> if the *RRCCConnectionReconfiguration* message includes the *sl-DiscConfig* or *sl-CommConfig*:
 - 2> perform the sidelink dedicated configuration procedure as specified in 5.3.10.15;
- 1> if the *RRCCConnectionReconfiguration* message includes *wlan-OffloadInfo*:
 - 2> perform the dedicated WLAN offload configuration procedure as specified in 5.6.12.2;
- 1> set the content of *RRCCConnectionReconfigurationComplete* message as follows:
 - 2> if the UE has radio link failure or handover failure information available in *VarRLF-Report* and if the RPLMN is included in *plmn-IdentityList* stored in *VarRLF-Report*:
 - 3> include *rlf-InfoAvailable*;
 - 2> if the UE has MBSFN logged measurements available for E-UTRA and if the RPLMN is included in *plmn-IdentityList* stored in *VarLogMeasReport* and if T330 is not running:
 - 3> include *logMeasAvailableMBSFN*;

- 2> else if the UE has logged measurements available for E-UTRA and if the RPLMN is included in *plmn-IdentityList* stored in *VarLogMeasReport*:
 - 3> include the *logMeasAvailable*;
 - 2> if the UE has connection establishment failure information available in *VarConnEstFailReport* and if the RPLMN is equal to *plmn-Identity* stored in *VarConnEstFailReport*:
 - 3> include *connEstFailInfoAvailable*;
 - 1> submit the *RRCCConnectionReconfigurationComplete* message to lower layers for transmission;
 - 1> if MAC successfully completes the random access procedure:
 - 2> stop timer T304;
 - 2> apply the parts of the CQI reporting configuration, the scheduling request configuration and the sounding RS configuration that do not require the UE to know the SFN of the target PCell, if any;
 - 2> apply the parts of the measurement and the radio resource configuration that require the UE to know the SFN of the target PCell (e.g. measurement gaps, periodic CQI reporting, scheduling request configuration, sounding RS configuration), if any, upon acquiring the SFN of the target PCell;
- NOTE 3: Whenever the UE shall setup or reconfigure a configuration in accordance with a field that is received it applies the new configuration, except for the cases addressed by the above statements.
- 2> if the UE is configured to provide IDC indications:
 - 3> if the UE has transmitted an *InDeviceCoexIndication* message during the last 1 second preceding reception of the *RRCCConnectionReconfiguration* message including *mobilityControlInfo*:
 - 4> initiate transmission of the *InDeviceCoexIndication* message in accordance with 5.6.9.3;
 - 2> if the UE is configured to provide power preference indications:
 - 3> if the UE has transmitted a *UEAssistanceInformation* message during the last 1 second preceding reception of the *RRCCConnectionReconfiguration* message including *mobilityControlInfo*:
 - 4> initiate transmission of the *UEAssistanceInformation* message in accordance with 5.6.10.3;
 - 2> if *SystemInformationBlockType15* is broadcast by the PCell:
 - 3> if the UE has transmitted a *MBMSInterestIndication* message during the last 1 second preceding reception of the *RRCCConnectionReconfiguration* message including *mobilityControlInfo*:
 - 4> ensure having a valid version of *SystemInformationBlockType15* for the PCell;
 - 4> determine the set of MBMS frequencies of interest in accordance with 5.8.5.3;
 - 4> initiate transmission of the *MBMSInterestIndication* message in accordance with 5.8.5.4;
 - 2> if *SystemInformationBlockType18* is broadcast by the target PCell; and the UE transmitted a *SidelinkUEInformation* message including *commRxInterestedFreq* or *commTxResourceReq* during the last 1 second preceding reception of the *RRCCConnectionReconfiguration* message including *mobilityControlInfo*; or
 - 2> if *SystemInformationBlockType19* is broadcast by the target PCell; and the UE transmitted a *SidelinkUEInformation* message including *discRxInterest* or *discTxResourceReq* during the last 1 second preceding reception of the *RRCCConnectionReconfiguration* message including *mobilityControlInfo*:
 - 3> initiate transmission of the *SidelinkUEInformation* message in accordance with 5.10.2.3;
 - 2> the procedure ends;

NOTE 4: The UE is not required to determine the SFN of the target PCell by acquiring system information from that cell before performing RACH access in the target PCell.

5.3.5.5 Reconfiguration failure

The UE shall:

- 1> if the UE is unable to comply with (part of) the configuration included in the *RRCCONNECTIONRECONFIGURATION* message:
 - 2> continue using the configuration used prior to the reception of *RRCCONNECTIONRECONFIGURATION* message;
 - 2> if security has not been activated:
 - 3> perform the actions upon leaving RRC_CONNECTED as specified in 5.3.12, with release cause other;
 - 2> else:
 - 3> initiate the connection re-establishment procedure as specified in 5.3.7, upon which the connection reconfiguration procedure ends;

NOTE 1: The UE may apply above failure handling also in case the *RRCCONNECTIONRECONFIGURATION* message causes a protocol error for which the generic error handling as defined in 5.7 specifies that the UE shall ignore the message.

NOTE 2: If the UE is unable to comply with part of the configuration, it does not apply any part of the configuration, i.e. there is no partial success/ failure.

5.3.5.6 T304 expiry (handover failure)

The UE shall:

- 1> if T304 expires (handover failure):

NOTE 1: Following T304 expiry any dedicated preamble, if provided within the *rach-ConfigDedicated*, is not available for use by the UE anymore.

- 2> revert back to the configuration used in the source PCell, excluding the configuration configured by the *physicalConfigDedicated*, the *mac-MainConfig* and the *sps-Config*;
- 2> store the following handover failure information in *VarRLF-Report* by setting its fields as follows:
 - 3> clear the information included in *VarRLF-Report*, if any;
 - 3> set the *plmn-IdentityList* to include the list of EPLMNs stored by the UE (i.e. includes the RPLMN);
 - 3> set the *measResultLastServCell* to include the RSRP and RSRQ, if available, of the source PCell based on measurements collected up to the moment the UE detected handover failure and in accordance with the following:
 - 4> if the UE includes *rsrqResult*, include the *lastServCellRSRQ-Type*;
 - 3> set the *measResultNeighCells* to include the best measured cells, other than the source PCell, ordered such that the best cell is listed first, and based on measurements collected up to the moment the UE detected handover failure, and set its fields as follows:
 - 4> if the UE was configured to perform measurements for one or more EUTRA frequencies, include the *measResultListEUTRA*;
 - 4> if the UE includes *rsrqResult*, include the *rsrq-Type*;
 - 4> if the UE was configured to perform measurement reporting for one or more neighbouring UTRA frequencies, include the *measResultListUTRA*;
 - 4> if the UE was configured to perform measurement reporting for one or more neighbouring GERAN frequencies, include the *measResultListGERAN*;
 - 4> if the UE was configured to perform measurement reporting for one or more neighbouring CDMA2000 frequencies, include the *measResultsCDMA2000*;

4> for each neighbour cell included, include the optional fields that are available;

NOTE 2: The measured quantities are filtered by the L3 filter as configured in the mobility measurement configuration. The measurements are based on the time domain measurement resource restriction, if configured. Blacklisted cells are not required to be reported.

3> if detailed location information is available, set the content of the *locationInfo* as follows:

4> include the *locationCoordinates*;

4> include the *horizontalVelocity*, if available;

3> set the *failedPCellId* to the global cell identity, if available, and otherwise to the physical cell identity and carrier frequency of the target PCell of the failed handover;

3> include *previousPCellId* and set it to the global cell identity of the PCell where the last *RRCCConnectionReconfiguration* message including *mobilityControlInfo* was received;

3> set the *timeConnFailure* to the elapsed time since reception of the last *RRCCConnectionReconfiguration* message including the *mobilityControlInfo*;

3> set the *connectionFailureType* to 'hof';

3> set the *c-RNTI* to the C-RNTI used in the source PCell;

2> initiate the connection re-establishment procedure as specified in 5.3.7, upon which the RRC connection reconfiguration procedure ends;

The UE may discard the handover failure information, i.e. release the UE variable *VarRLF-Report*, 48 hours after the failure is detected, upon power off or upon detach.

NOTE 3: E-UTRAN may retrieve the handover failure information using the UE information procedure with *rlf-ReportReq* set to *true*, as specified in 5.6.5.3.

5.3.5.7 Void

5.3.5.7a T307 expiry (SCG change failure)

The UE shall:

1> if T307 expires:

NOTE 1: Following T307 expiry any dedicated preamble, if provided within the *rach-ConfigDedicatedSCG*, is not available for use by the UE anymore.

2> initiate the SCG failure information procedure as specified in 5.6.13 to report SCG change failure;

5.3.5.8 Radio Configuration involving full configuration option

The UE shall:

1> release/ clear all current dedicated radio configurations except the MCG C-RNTI, the MCG security configuration and the PDCP, RLC, logical channel configurations for the RBs and the logged measurement configuration;

NOTE 1: Radio configuration is not just the resource configuration but includes other configurations like *MeasConfig* and *OtherConfig*.

1> if the *RRCCConnectionReconfiguration* message includes the *mobilityControlInfo*:

2> release/ clear all current common radio configurations;

2> use the default values specified in 9.2.5 for timer T310, T311 and constant N310, N311;

1> else:

2> use values for timers T301, T310, T311 and constants N310, N311, as included in *ue-TimersAndConstants* received in *SystemInformationBlockType2*;

1> apply the default physical channel configuration as specified in 9.2.4;

1> apply the default semi-persistent scheduling configuration as specified in 9.2.3;

1> apply the default MAC main configuration as specified in 9.2.2;

1> for each *srb-Identity* value included in the *srb-ToAddModList* (SRB reconfiguration):

2> apply the specified configuration defined in 9.1.2 for the corresponding SRB;

2> apply the corresponding default RLC configuration for the SRB specified in 9.2.1.1 for SRB1 or in 9.2.1.2 for SRB2;

2> apply the corresponding default logical channel configuration for the SRB as specified in 9.2.1.1 for SRB1 or in 9.2.1.2 for SRB2;

NOTE 2: This is to get the SRBs (SRB1 and SRB2 for handover and SRB2 for reconfiguration after reestablishment) to a known state from which the reconfiguration message can do further configuration.

1> for each *eps-BearerIdentity* value included in the *drb-ToAddModList* that is part of the current UE configuration:

2> release the PDCP entity;

2> release the RLC entity or entities;

2> release the DTCH logical channel;

2> release the *drb-identity*;

NOTE 3: This will retain the *eps-bearerIdentity* but remove the DRBs including *drb-identity* of these bearers from the current UE configuration and trigger the setup of the DRBs within the AS in Section 5.3.10.3 using the new configuration. The *eps-bearerIdentity* acts as the anchor for associating the released and re-setup DRB.

1> for each *eps-BearerIdentity* value that is part of the current UE configuration but not part of the *drb-ToAddModList*:

2> perform DRB release as specified in 5.3.10.2;

5.3.6 Counter check

5.3.6.1 General

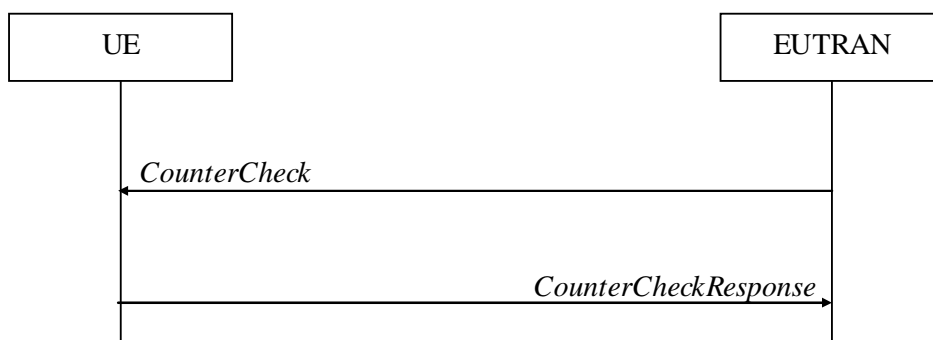

Figure 5.3.6.1-1: Counter check procedure

The counter check procedure is used by E-UTRAN to request the UE to verify the amount of data sent/ received on each DRB. More specifically, the UE is requested to check if, for each DRB, the most significant bits of the COUNT match with the values indicated by E-UTRAN.

NOTE: The procedure enables E-UTRAN to detect packet insertion by an intruder (a 'man in the middle').

5.3.6.2 Initiation

E-UTRAN initiates the procedure by sending a *CounterCheck* message.

NOTE: E-UTRAN may initiate the procedure when any of the COUNT values reaches a specific value.

5.3.6.3 Reception of the *CounterCheck* message by the UE

Upon receiving the *CounterCheck* message, the UE shall:

- 1> for each DRB that is established:
 - 2> if no COUNT exists for a given direction (uplink or downlink) because it is a uni-directional bearer configured only for the other direction:
 - 3> assume the COUNT value to be 0 for the unused direction;
 - 2> if the *drb-Identity* is not included in the *drb-CountMSB-InfoList*:
 - 3> include the DRB in the *drb-CountInfoList* in the *CounterCheckResponse* message by including the *drb-Identity*, the *count-Uplink* and the *count-Downlink* set to the value of the corresponding COUNT;
 - 2> else if, for at least one direction, the most significant bits of the COUNT are different from the value indicated in the *drb-CountMSB-InfoList*:
 - 3> include the DRB in the *drb-CountInfoList* in the *CounterCheckResponse* message by including the *drb-Identity*, the *count-Uplink* and the *count-Downlink* set to the value of the corresponding COUNT;
- 1> for each DRB that is included in the *drb-CountMSB-InfoList* in the *CounterCheck* message that is not established:
 - 2> include the DRB in the *drb-CountInfoList* in the *CounterCheckResponse* message by including the *drb-Identity*, the *count-Uplink* and the *count-Downlink* with the most significant bits set identical to the corresponding values in the *drb-CountMSB-InfoList* and the least significant bits set to zero;
- 1> submit the *CounterCheckResponse* message to lower layers for transmission upon which the procedure ends;

5.3.7 RRC connection re-establishment

5.3.7.1 General

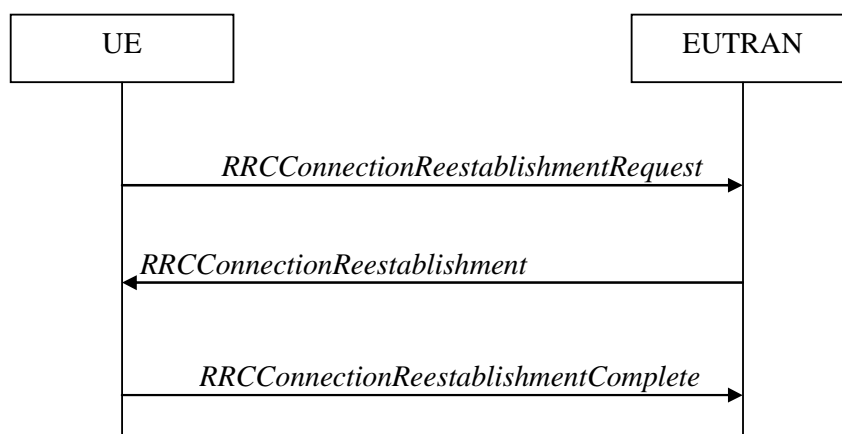

Figure 5.3.7.1-1: RRC connection re-establishment, successful

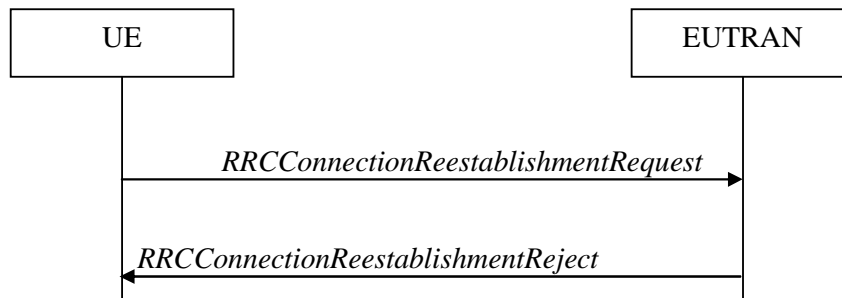

Figure 5.3.7.1-2: RRC connection re-establishment, failure

The purpose of this procedure is to re-establish the RRC connection, which involves the resumption of SRB1 operation, the re-activation of security and the configuration of only the PCell.

A UE in RRC_CONNECTED, for which security has been activated, may initiate the procedure in order to continue the RRC connection. The connection re-establishment succeeds only if the concerned cell is prepared i.e. has a valid UE context. In case E-UTRAN accepts the re-establishment, SRB1 operation resumes while the operation of other radio bearers remains suspended. If AS security has not been activated, the UE does not initiate the procedure but instead moves to RRC_IDLE directly.

E-UTRAN applies the procedure as follows:

- to reconfigure SRB1 and to resume data transfer only for this RB;
- to re-activate AS security without changing algorithms.

5.3.7.2 Initiation

The UE shall only initiate the procedure when AS security has been activated. The UE initiates the procedure when one of the following conditions is met:

- 1> upon detecting radio link failure, in accordance with 5.3.11; or
- 1> upon handover failure, in accordance with 5.3.5.6; or
- 1> upon mobility from E-UTRA failure, in accordance with 5.4.3.5; or
- 1> upon integrity check failure indication from lower layers; or
- 1> upon an RRC connection reconfiguration failure, in accordance with 5.3.5.5;

Upon initiation of the procedure, the UE shall:

- 1> stop timer T310, if running;
- 1> stop timer T312, if running;
- 1> stop timer T313, if running;
- 1> stop timer T307, if running;
- 1> start timer T311;
- 1> suspend all RBs except SRB0;
- 1> reset MAC;
- 1> release the MCG SCell(s), if configured, in accordance with 5.3.10.3a;
- 1> apply the default physical channel configuration as specified in 9.2.4;
- 1> for the MCG, apply the default semi-persistent scheduling configuration as specified in 9.2.3;
- 1> for the MCG, apply the default MAC main configuration as specified in 9.2.2;

- 1> release *powerPrefIndicationConfig*, if configured and stop timer T340, if running;
- 1> release *reportProximityConfig* and clear any associated proximity status reporting timer;
- 1> release *obtainLocationConfig*, if configured;
- 1> release *idc-Config*, if configured;
- 1> release *measSubframePatternPCell*, if configured;
- 1> release the entire SCG configuration, if configured, except for the DRB configuration (as configured by *drb-ToAddModListSCG*);
- 1> release *naics-Info* for the PCell, if configured;
- 1> if connected as an RN and configured with an RN subframe configuration:
 - 2> release the RN subframe configuration;
- 1> perform cell selection in accordance with the cell selection process as specified in TS 36.304 [4];

5.3.7.3 Actions following cell selection while T311 is running

Upon selecting a suitable E-UTRA cell, the UE shall:

- 1> stop timer T311;
- 1> start timer T301;
- 1> apply the *timeAlignmentTimerCommon* included in *SystemInformationBlockType2*;
- 1> initiate transmission of the *RRCConnectionReestablishmentRequest* message in accordance with 5.3.7.4;

NOTE: This procedure applies also if the UE returns to the source PCell.

Upon selecting an inter-RAT cell, the UE shall:

- 1> if the selected cell is a UTRA cell, and if the UE supports Radio Link Failure Report for Inter-RAT MRO, include *selectedUTRA-CellId* in the *VarRLF-Report* and set it to the physical cell identity and carrier frequency of the selected UTRA cell;
- 1> perform the actions upon leaving RRC_CONNECTED as specified in 5.3.12, with release cause 'RRC connection failure';

5.3.7.4 Actions related to transmission of *RRCConnectionReestablishmentRequest* message

If the procedure was initiated due to radio link failure or handover failure, the UE shall:

- 1> set the *reestablishmentCellId* in the *VarRLF-Report* to the global cell identity of the selected cell;

The UE shall set the contents of *RRCConnectionReestablishmentRequest* message as follows:

- 1> set the *ue-Identity* as follows:
 - 2> set the *c-RNTI* to the C-RNTI used in the source PCell (handover and mobility from E-UTRA failure) or used in the PCell in which the trigger for the re-establishment occurred (other cases);
 - 2> set the *physCellId* to the physical cell identity of the source PCell (handover and mobility from E-UTRA failure) or of the PCell in which the trigger for the re-establishment occurred (other cases);
 - 2> set the *shortMAC-I* to the 16 least significant bits of the MAC-I calculated:
 - 3> over the ASN.1 encoded as per section 8 (i.e., a multiple of 8 bits) *VarShortMAC-Input*;

- 3> with the K_{RRCint} key and integrity protection algorithm that was used in the source PCell (handover and mobility from E-UTRA failure) or of the PCell in which the trigger for the re-establishment occurred (other cases); and
- 3> with all input bits for COUNT, BEARER and DIRECTION set to binary ones;
- 1> set the *reestablishmentCause* as follows:
 - 2> if the re-establishment procedure was initiated due to reconfiguration failure as specified in 5.3.5.5 (the UE is unable to comply with the reconfiguration):
 - 3> set the *reestablishmentCause* to the value *reconfigurationFailure*;
 - 2> else if the re-establishment procedure was initiated due to handover failure as specified in 5.3.5.6 (intra-LTE handover failure) or 5.4.3.5 (inter-RAT mobility from EUTRA failure):
 - 3> set the *reestablishmentCause* to the value *handoverFailure*;
 - 2> else:
 - 3> set the *reestablishmentCause* to the value *otherFailure*;

The UE shall submit the *RRConnectionReestablishmentRequest* message to lower layers for transmission.

5.3.7.5 Reception of the *RRConnectionReestablishment* by the UE

NOTE 1: Prior to this, lower layer signalling is used to allocate a C-RNTI. For further details see TS 36.321 [6];

The UE shall:

- 1> stop timer T301;
- 1> consider the current cell to be the PCell;
- 1> re-establish PDCP for SRB1;
- 1> re-establish RLC for SRB1;
- 1> perform the radio resource configuration procedure in accordance with the received *radioResourceConfigDedicated* and as specified in 5.3.10;
- 1> resume SRB1;

NOTE 2: E-UTRAN should not transmit any message on SRB1 prior to receiving the *RRConnectionReestablishmentComplete* message.

- 1> update the K_{eNB} key based on the K_{ASME} key to which the current K_{eNB} is associated, using the *nextHopChainingCount* value indicated in the *RRConnectionReestablishment* message, as specified in TS 33.401 [32];
- 1> store the *nextHopChainingCount* value;
- 1> derive the K_{RRCint} key associated with the previously configured integrity algorithm, as specified in TS 33.401 [32];
- 1> derive the K_{RRCenc} key and the K_{UPenc} key associated with the previously configured ciphering algorithm, as specified in TS 33.401 [32];
- 1> if connected as an RN:
 - 2> derive the K_{UPint} key associated with the previously configured integrity algorithm, as specified in TS 33.401 [32];
- 1> configure lower layers to activate integrity protection using the previously configured algorithm and the K_{RRCint} key immediately, i.e., integrity protection shall be applied to all subsequent messages received and sent by the UE, including the message used to indicate the successful completion of the procedure;

- 1> if connected as an RN:
 - 2> configure lower layers to apply integrity protection using the previously configured algorithm and the K_{UPint} key, for subsequently resumed or subsequently established DRBs that are configured to apply integrity protection, if any;
- 1> configure lower layers to apply ciphering using the previously configured algorithm, the K_{RRcenc} key and the K_{UPenc} key immediately, i.e., ciphering shall be applied to all subsequent messages received and sent by the UE, including the message used to indicate the successful completion of the procedure;
- 1> set the content of *RRCConnectionReestablishmentComplete* message as follows:
 - 2> if the UE has radio link failure or handover failure information available in *VarRLF-Report* and if the RPLMN is included in *plmn-IdentityList* stored in *VarRLF-Report*:
 - 3> include the *rlf-InfoAvailable*;
 - 2> if the UE has MBSFN logged measurements available for E-UTRA and if the RPLMN is included in *plmn-IdentityList* stored in *VarLogMeasReport* and if T330 is not running:
 - 3> include *logMeasAvailableMBSFN*;
 - 2> else if the UE has logged measurements available for E-UTRA and if the RPLMN is included in *plmn-IdentityList* stored in *VarLogMeasReport*:
 - 3> include the *logMeasAvailable*;
 - 2> if the UE has connection establishment failure information available in *VarConnEstFailReport* and if the RPLMN is equal to *plmn-Identity* stored in *VarConnEstFailReport*:
 - 3> include the *connEstFailInfoAvailable*;
- 1> perform the measurement related actions as specified in 5.5.6.1;
- 1> perform the measurement identity autonomous removal as specified in 5.5.2.2a;
- 1> submit the *RRCConnectionReestablishmentComplete* message to lower layers for transmission;
- 1> if *SystemInformationBlockType15* is broadcast by the PCell:
 - 2> if the UE has transmitted an *MBMSInterestIndication* message during the last 1 second preceding detection of radio link failure:
 - 3> ensure having a valid version of *SystemInformationBlockType15* for the PCell;
 - 3> determine the set of MBMS frequencies of interest in accordance with 5.8.5.3;
 - 3> initiate transmission of the *MBMSInterestIndication* message in accordance with 5.8.5.4;
- 1> if *SystemInformationBlockType18* is broadcast by the PCell; and the UE transmitted a *SidelinkUEInformation* message including *commRxInterestedFreq* or *commTxResourceReq* during the last 1 second preceding detection of radio link failure; or
- 1> if *SystemInformationBlockType19* is broadcast by the PCell; and the UE transmitted a *SidelinkUEInformation* message including *discRxInterest* or *discTxResourceReq* during the last 1 second preceding detection of radio link failure:
 - 2> initiate transmission of the *SidelinkUEInformation* message in accordance with 5.10.2.3;
- 1> the procedure ends;

5.3.7.6 T311 expiry

Upon T311 expiry, the UE shall:

- 1> perform the actions upon leaving RRC_CONNECTED as specified in 5.3.12, with release cause 'RRC connection failure';

5.3.7.7 T301 expiry or selected cell no longer suitable

The UE shall:

- 1> if timer T301 expires; or
- 1> if the selected cell becomes no longer suitable according to the cell selection criteria as specified in TS 36.304 [4]:
 - 2> perform the actions upon leaving RRC_CONNECTED as specified in 5.3.12, with release cause 'RRC connection failure';

5.3.7.8 Reception of *RRCConnectionReestablishmentReject* by the UE

Upon receiving the *RRCConnectionReestablishmentReject* message, the UE shall:

- 1> perform the actions upon leaving RRC_CONNECTED as specified in 5.3.12, with release cause 'RRC connection failure';

5.3.8 RRC connection release

5.3.8.1 General

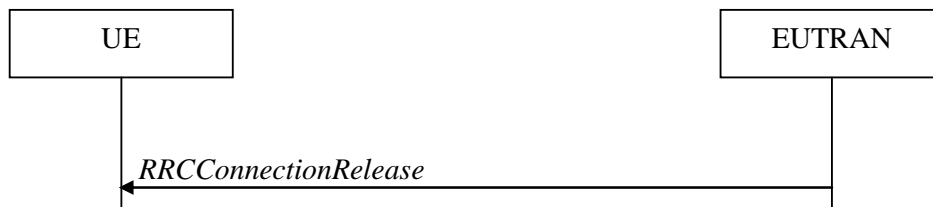

Figure 5.3.8.1-1: RRC connection release, successful

The purpose of this procedure is to release the RRC connection, which includes the release of the established radio bearers as well as all radio resources.

5.3.8.2 Initiation

E-UTRAN initiates the RRC connection release procedure to a UE in RRC_CONNECTED.

5.3.8.3 Reception of the *RRCConnectionRelease* by the UE

The UE shall:

- 1> delay the following actions defined in this sub-clause 60 ms from the moment the *RRCConnectionRelease* message was received or optionally when lower layers indicate that the receipt of the *RRCConnectionRelease* message has been successfully acknowledged, whichever is earlier;
- 1> if the *RRCConnectionRelease* message includes the *idleModeMobilityControlInfo*:
 - 2> store the cell reselection priority information provided by the *idleModeMobilityControlInfo*;
 - 2> if the *t320* is included:
 - 3> start timer T320, with the timer value set according to the value of *t320*;
- 1> else:
 - 2> apply the cell reselection priority information broadcast in the system information;
- 1> if the *releaseCause* received in the *RRCConnectionRelease* message indicates *loadBalancingTAURequired*:
 - 2> perform the actions upon leaving RRC_CONNECTED as specified in 5.3.12, with release cause 'load balancing TAU required';
- 1> else if the *releaseCause* received in the *RRCConnectionRelease* message indicates *cs-FallbackHighPriority*:

2> perform the actions upon leaving RRC_CONNECTED as specified in 5.3.12, with release cause 'CS Fallback High Priority';

1> else:

2> if the *extendedWaitTime* is present and the UE supports delay tolerant access:

3> forward the *extendedWaitTime* to upper layers;

2> perform the actions upon leaving RRC_CONNECTED as specified in 5.3.12, with release cause 'other';

5.3.8.4 T320 expiry

The UE shall:

1> if T320 expires:

2> if stored, discard the cell reselection priority information provided by the *idleModeMobilityControlInfo* or inherited from another RAT;

2> apply the cell reselection priority information broadcast in the system information;

5.3.9 RRC connection release requested by upper layers

5.3.9.1 General

The purpose of this procedure is to release the RRC connection. Access to the current PCell may be barred as a result of this procedure.

NOTE: Upper layers invoke the procedure, e.g. upon determining that the network has failed an authentication check, see TS 24.301 [35].

5.3.9.2 Initiation

The UE initiates the procedure when upper layers request the release of the RRC connection. The UE shall not initiate the procedure for power saving purposes.

The UE shall:

1> if the upper layers indicate barring of the PCell:

2> treat the PCell used prior to entering RRC_IDLE as barred according to TS 36.304 [4];

1> perform the actions upon leaving RRC_CONNECTED as specified in 5.3.12, with release cause 'other';

5.3.10 Radio resource configuration

5.3.10.0 General

The UE shall:

1> if the received *radioResourceConfigDedicated* includes the *srb-ToAddModList*:

2> perform the SRB addition or reconfiguration as specified in 5.3.10.1;

1> if the received *radioResourceConfigDedicated* includes the *drb-ToReleaseList*:

2> perform DRB release as specified in 5.3.10.2;

1> if the received *radioResourceConfigDedicated* includes the *drb-ToAddModList*:

2> perform DRB addition or reconfiguration as specified in 5.3.10.3;

1> if the received *radioResourceConfigDedicated* includes the *mac-MainConfig*:

2> perform MAC main reconfiguration as specified in 5.3.10.4;

- 1> if the received *radioResourceConfigDedicated* includes *sps-Config*:
 - 2> perform SPS reconfiguration according to 5.3.10.5;
- 1> if the received *radioResourceConfigDedicated* includes the *physicalConfigDedicated*:
 - 2> reconfigure the physical channel configuration as specified in 5.3.10.6.
- 1> if the received *radioResourceConfigDedicated* includes the *rlf-TimersAndConstants*:
 - 2> reconfigure the values of timers and constants as specified in 5.3.10.7;
- 1> if the received *radioResourceConfigDedicated* includes the *measSubframePatternPCell*:
 - 2> reconfigure the time domain measurement resource restriction for the serving cell as specified in 5.3.10.8;
- 1> if the received *radioResourceConfigDedicated* includes the *naics-Info*:
 - 2> perform NAICS neighbour cell information reconfiguration for the PCell as specified in 5.3.10.13;
- 1> if the received *RadioResourceConfigDedicatedPSCell* includes the *naics-Info*:
 - 2> perform NAICS neighbour cell information reconfiguration for the PSCell as specified in 5.3.10.13;
- 1> if the received *RadioResourceConfigDedicatedSCell-r10* includes the *naics-Info*:
 - 2> perform NAICS neighbour cell information reconfiguration for the SCell as specified in 5.3.10.13;

5.3.10.1 SRB addition/ modification

The UE shall:

- 1> for each *srb-Identity* value included in the *srb-ToAddModList* that is not part of the current UE configuration (SRB establishment):
 - 2> apply the specified configuration defined in 9.1.2 for the corresponding SRB;
 - 2> establish a PDCP entity and configure it with the current (MCG) security configuration, if applicable;
 - 2> establish an (MCG) RLC entity in accordance with the received *rlc-Config*;
 - 2> establish a (MCG) DCCH logical channel in accordance with the received *logicalChannelConfig* and with the logical channel identity set in accordance with 9.1.2;
- 1> for each *srb-Identity* value included in the *srb-ToAddModList* that is part of the current UE configuration (SRB reconfiguration):
 - 2> reconfigure the RLC entity in accordance with the received *rlc-Config*;
 - 2> reconfigure the DCCH logical channel in accordance with the received *logicalChannelConfig*;

5.3.10.2 DRB release

The UE shall:

- 1> for each *drb-Identity* value included in the *drb-ToReleaseList* that is part of the current UE configuration (DRB release); or
- 1> for each *drb-identity* value that is to be released as the result of full configuration option according to 5.3.5.8:
 - 2> release the PDCP entity;
 - 2> release the RLC entity or entities;
 - 2> release the DTCH logical channel;
- 1> if the procedure was triggered due to handover:

2> indicate the release of the DRB(s) and the *eps-BearerIdentity* of the released DRB(s) to upper layers after successful handover;

1> else:

2> indicate the release of the DRB(s) and the *eps-BearerIdentity* of the released DRB(s) to upper layers immediately.

NOTE: The UE does not consider the message as erroneous if the *drb-ToReleaseList* includes any *drb-Identity* value that is not part of the current UE configuration.

5.3.10.3 DRB addition/ modification

The UE shall:

1> for each *drb-Identity* value included in the *drb-ToAddModList* that is not part of the current UE configuration (DRB establishment including the case when full configuration option is used):

2> if *drb-ToAddModListSCG* is not received or does not include the *drb-Identity* value (i.e. add MCG DRB):

3> establish a PDCP entity and configure it with the current MCG security configuration and in accordance with the received *pdcp-Config*;

3> establish an MCG RLC entity or entities in accordance with the received *rlc-Config*;

3> establish an MCG DTCH logical channel in accordance with the received *logicalChannelIdentity* and the received *logicalChannelConfig*;

2> if the *RRCConnectionReconfiguration* message includes the *fullConfig* IE:

3> associate the established DRB with corresponding included *eps-BearerIdentity*;

2> else:

3> indicate the establishment of the DRB(s) and the *eps-BearerIdentity* of the established DRB(s) to upper layers;

1> for each *drb-Identity* value included in the *drb-ToAddModList* that is part of the current UE configuration (DRB reconfiguration):

2> if *drb-ToAddModListSCG* is not received or does not include the *drb-Identity* value:

3> if the DRB indicated by *drb-Identity* is an MCG DRB (reconfigure MCG):

4> if the *pdcp-Config* is included:

5> reconfigure the PDCP entity in accordance with the received *pdcp-Config*;

4> if the *rlc-Config* is included:

5> reconfigure the RLC entity or entities in accordance with the received *rlc-Config*;

4> if the *logicalChannelConfig* is included:

5> reconfigure the DTCH logical channel in accordance with the received *logicalChannelConfig*;

NOTE: Removal and addition of the same *drb-Identity* in a single *radioResourceConfigDedicated* is not supported. In case *drb-Identity* is removed and added due to handover or re-establishment with the full configuration option, the eNB can use the same value of *drb-Identity*.

5.3.10.3a1 DC specific DRB addition or reconfiguration

For the *drb-Identity* value for which this procedure is initiated, the UE shall:

1> if *drb-ToAddModListSCG* is received and includes the *drb-Identity* value; and *drb-Identity* value is not part of the current UE configuration (i.e. DC specific DRB establishment):

- 2> if *drb-ToAddModList* is received and includes the *drb-Identity* value (i.e. add split DRB):
 - 3> establish a PDCP entity and configure it with the current MCG security configuration and in accordance with the *pdcp-Config* included in *drb-ToAddModList*;
 - 3> establish an MCG RLC entity and an MCG DTCH logical channel in accordance with the *rlc-Config*, *logicalChannelIdentity* and *logicalChannelConfig* included in *drb-ToAddModList*;
 - 3> establish an SCG RLC entity and an SCG DTCH logical channel in accordance with the *rlc-ConfigSCG*, *logicalChannelIdentitySCG* and *logicalChannelConfigSCG* included in *drb-ToAddModListSCG*;
- 2> else (i.e. add SCG DRB):
 - 3> establish a PDCP entity and configure it with the current SCG security configuration and in accordance with the *pdcp-Config* included in *drb-ToAddModListSCG*;
 - 3> establish an SCG RLC entity or entities and an SCG DTCH logical channel in accordance with the *rlc-ConfigSCG*, *logicalChannelIdentitySCG* and *logicalChannelConfigSCG* included in *drb-ToAddModListSCG*;
- 2> indicate the establishment of the DRB(s) and the *eps-BearerIdentity* of the established DRB(s) to upper layers;
- 1> else (i.e. DC specific DRB modification; *drb-ToAddModList* and/ or *drb-ToAddModListSCG* received):
 - 2> if the DRB indicated by *drb-Identity* is a split DRB:
 - 3> if *drb-ToAddModList* is received and includes the *drb-Identity* value, while for this entry *drb-TypeChange* is included and set to *toMCG* (i.e. split to MCG):
 - 4> release the SCG RLC entity and the SCG DTCH logical channel;
 - 4> reconfigure the PDCP entity in accordance with the *pdcp-Config*, if included in *drb-ToAddModList*;
 - 4> reconfigure the MCG RLC entity and/ or the MCG DTCH logical channel in accordance with the *rlc-Config* and *logicalChannelConfig*, if included in *drb-ToAddModList*;
 - 3> else (i.e. reconfigure split):
 - 4> reconfigure the PDCP entity in accordance with the *pdcp-Config*, if included in *drb-ToAddModList*;
 - 4> reconfigure the MCG RLC entity and/ or the MCG DTCH logical channel in accordance with the *rlc-Config* and *logicalChannelConfig*, if included in *drb-ToAddModList*;
 - 4> reconfigure the SCG RLC entity and/ or the SCG DTCH logical channel in accordance with the *rlc-ConfigSCG* and *logicalChannelConfigSCG*, if included in *drb-ToAddModListSCG*;
 - 2> if the DRB indicated by *drb-Identity* is an SCG DRB:
 - 3> if *drb-ToAddModList* is received and includes the *drb-Identity* value, while for this entry *drb-TypeChange* is included and set to *toMCG* (i.e. SCG to MCG):
 - 4> reconfigure the PDCP entity with the current MCG security configuration and in accordance with the *pdcp-Config*, if included in *drb-ToAddModList*;
 - 4> reconfigure the SCG RLC entity or entities and the SCG DTCH logical channel to be an MCG RLC entity or entities and an MCG DTCH logical channel;
 - 4> reconfigure the MCG RLC entity or entities and/ or the MCG DTCH logical channel in accordance with the *rlc-Config*, *logicalChannelIdentity* and *logicalChannelConfig*, if included in *drb-ToAddModList*;
 - 3> else (i.e. *drb-ToAddModListSCG* is received and includes the *drb-Identity* value i.e. reconfigure SCG):
 - 4> reconfigure the PDCP entity in accordance with the *pdcp-Config*, if included in *drb-ToAddModListSCG*;

- 4> reconfigure the SCG RLC entity or entities and/ or the SCG DTCH logical channel in accordance with the *rlc-ConfigSCG* and *logicalChannelConfigSCG*, if included in *drb-ToAddModListSCG*;
- 2> if the DRB indicated by *drb-Identity* is an MCG DRB:
 - 3> if *drb-ToAddModListSCG* is received and includes the *drb-Identity* value, while for this entry *drb-Type* is included and set to *split* (i.e. MCG to split):
 - 4> reconfigure the PDCP entity in accordance with the *pdcp-Config*, if included in *drb-ToAddModList*;
 - 4> reconfigure the MCG RLC entity and/ or the MCG DTCH logical channel in accordance with the *rlc-Config* and *logicalChannelConfig*, if included in *drb-ToAddModList*;
 - 4> establish an SCG RLC entity and an SCG DTCH logical channel in accordance with the *rlc-ConfigSCG*, *logicalChannelIdentitySCG* and *logicalChannelConfigSCG*, included in *drb-ToAddModListSCG*;
 - 3> else (i.e. *drb-Type* is included and set to *scg* i.e. MCG to SCG):
 - 4> reconfigure the PDCP entity with the current SCG security configuration and in accordance with the *pdcp-Config*, if included in *drb-ToAddModListSCG*;
 - 4> reconfigure the MCG RLC entity or entities and the MCG DTCH logical channel to be an SCG RLC entity or entities and an SCG DTCH logical channel;
 - 4> reconfigure the SCG RLC entity or entities and/ or the SCG DTCH logical channel in accordance with the *rlc-ConfigSCG*, *logicalChannelIdentitySCG* and *logicalChannelConfigSCG*, if included in *drb-ToAddModListSCG*;

5.3.10.3a SCell release

The UE shall:

- 1> if the release is triggered by reception of the *sCellToReleaseList* or the *sCellToReleaseListSCG*:
 - 2> for each *sCellIndex* value included either in the *sCellToReleaseList* or in the *sCellToReleaseListSCG*:
 - 3> if the current UE configuration includes an SCell with value *sCellIndex*:
 - 4> release the SCell;
- 1> if the release is triggered by RRC connection re-establishment:
 - 2> release all SCells that are part of the current UE configuration;

5.3.10.3b SCell addition/ modification

The UE shall:

- 1> for each *sCellIndex* value included either in the *sCellToAddModList* or in the *sCellToAddModListSCG* that is not part of the current UE configuration (SCell addition):
 - 2> add the SCell, corresponding to the *cellIdentification*, in accordance with the *radioResourceConfigCommonSCell* and *radioResourceConfigDedicatedSCell*, both included either in the *sCellToAddModList* or in the *sCellToAddModListSCG*;
 - 2> configure lower layers to consider the SCell to be in deactivated state;
 - 2> for each *measId* included in the *measIdList* within *VarMeasConfig*:
 - 3> if SCells are not applicable for the associated measurement; and
 - 3> if the concerned SCell is included in *cellsTriggeredList* defined within the *VarMeasReportList* for this *measId*:
 - 4> remove the concerned SCell from *cellsTriggeredList* defined within the *VarMeasReportList* for this *measId*;

- 1> for each *sCellIndex* value included either in the *sCellToAddModList* or in the *sCellToAddModListSCG* that is part of the current UE configuration (SCell modification):
 - 2> modify the SCell configuration in accordance with the *radioResourceConfigDedicatedSCell*, included either in the *sCellToAddModList* or in the *sCellToAddModListSCG*;

5.3.10.3c PSCell addition or modification

The UE shall:

- 1> if the PSCell is not part of the current UE configuration (i.e. PSCell addition):
 - 2> add the PSCell, corresponding to the *cellIdentification*, in accordance with the received *radioResourceConfigCommonPSCell* and *radioResourceConfigDedicatedPSCell*;
 - 2> configure lower layers to consider the PSCell to be in activated state;
- 1> if the PSCell is part of the current UE configuration (i.e. PSCell modification):
 - 2> modify the PSCell configuration in accordance with the received *radioResourceConfigDedicatedPSCell*;

5.3.10.4 MAC main reconfiguration

The UE shall:

- 1> if the procedure is triggered to perform SCG MAC main reconfiguration:
 - 2> if SCG MAC is not part of the current UE configuration (i.e. SCG establishment):
 - 3> create an SCG MAC entity;
 - 2> reconfigure the SCG MAC main configuration as specified in the following i.e. assuming it concerns the SCG MAC whenever MAC main configuration is referenced and that it is based on the received *mac-MainConfigSCG* instead of *mac-MainConfig*:
- 1> reconfigure the MAC main configuration in accordance with the received *mac-MainConfig* other than *stag-ToReleaseList* and *stag-ToAddModList*;
- 1> if the received *mac-MainConfig* includes the *stag-ToReleaseList*:
 - 2> for each *STAG-Id* value included in the *stag-ToReleaseList* that is part of the current UE configuration:
 - 3> release the STAG indicated by *STAG-Id*;
- 1> if the received *mac-MainConfig* includes the *stag-ToAddModList*:
 - 2> for each *stag-Id* value included in *stag-ToAddModList* that is not part of the current UE configuration (STAG addition):
 - 3> add the STAG, corresponding to the *stag-Id*, in accordance with the received *timeAlignmentTimerSTAG*;
 - 2> for each *stag-Id* value included in *stag-ToAddModList* that is part of the current UE configuration (STAG modification):
 - 3> reconfigure the STAG, corresponding to the *stag-Id*, in accordance with the received *timeAlignmentTimerSTAG*;

5.3.10.5 Semi-persistent scheduling reconfiguration

The UE shall:

- 1> reconfigure the semi-persistent scheduling in accordance with the received *sps-Config*;

5.3.10.6 Physical channel reconfiguration

The UE shall:

- 1> if the *antennaInfo-r10* is included in the received *physicalConfigDedicated* and the previous version of this field that was received by the UE was *antennaInfo* (without suffix i.e. the version defined in REL-8):
 - 2> apply the default antenna configuration as specified in section 9.2.4;

- 1> if the *cqi-ReportConfig-r10* is included in the received *physicalConfigDedicated* and the previous version of this field that was received by the UE was *cqi-ReportConfig* (without suffix i.e. the version defined in REL-8):
 - 2> apply the default CQI reporting configuration as specified in 9.2.4;

NOTE: Application of the default configuration involves release of all extensions introduced in REL-9 and later.

- 1> reconfigure the physical channel configuration in accordance with the received *physicalConfigDedicated*;

- 1> if the *antennaInfo* is included and set to *explicitValue*:

- 2> if the configured *transmissionMode* is *tm1*, *tm2*, *tm5*, *tm6* or *tm7*; or
- 2> if the configured *transmissionMode* is *tm8* and *pmi-RI-Report* is not present; or
- 2> if the configured *transmissionMode* is *tm9* and *pmi-RI-Report* is not present; or
- 2> if the configured *transmissionMode* is *tm9* and *pmi-RI-Report* is present and *antennaPortsCount* within *csi-RS* is set to *an1*:

- 3> release *ri-ConfigIndex* in *cqi-ReportPeriodic*, if previously configured;

- 1> else if the *antennaInfo* is included and set to *defaultValue*:

- 2> release *ri-ConfigIndex* in *cqi-ReportPeriodic*, if previously configured;

5.3.10.7 Radio Link Failure Timers and Constants reconfiguration

The UE shall:

- 1> if the received *rlf-TimersAndConstants* is set to release:
 - 2> use values for timers T301, T310, T311 and constants N310, N311, as included in *ue-TimersAndConstants* received in *SystemInformationBlockType2*;

- 1> else:

- 2> reconfigure the value of timers and constants in accordance with received *rlf-TimersAndConstants*;

- 1> if the received *rlf-TimersAndConstantsSCG* is set to release:

- 2> stop timer T313, if running, and
- 2> release the value of timer *t313* as well as constants *n313* and *n314*;

- 1> else:

- 2> reconfigure the value of timers and constants in accordance with received *rlf-TimersAndConstantsSCG*;

5.3.10.8 Time domain measurement resource restriction for serving cell

The UE shall:

- 1> if the received *measSubframePatternPCell* is set to *release*:
 - 2> release the time domain measurement resource restriction for the PCell, if previously configured

- 1> else:

- 2> apply the time domain measurement resource restriction for the PCell in accordance with the received *measSubframePatternPCell*;

5.3.10.9 Other configuration

The UE shall:

- 1> if the received *otherConfig* includes the *reportProximityConfig*:
 - 2> if *proximityIndicationEUTRA* is set to *enabled*:
 - 3> consider itself to be configured to provide proximity indications for E-UTRA frequencies in accordance with 5.3.14;
 - 2> else:
 - 3> consider itself not to be configured to provide proximity indications for E-UTRA frequencies;
 - 2> if *proximityIndicationUTRA* is set to *enabled*:
 - 3> consider itself to be configured to provide proximity indications for UTRA frequencies in accordance with 5.3.14;
 - 2> else:
 - 3> consider itself not to be configured to provide proximity indications for UTRA frequencies;
- 1> if the received *otherConfig* includes the *obtainLocation*:
 - 2> attempt to have detailed location information available for any subsequent measurement report;

NOTE: The UE is requested to attempt to have valid detailed location information available whenever sending a measurement report for which it is configured to include available detailed location information. The UE may not succeed e.g. because the user manually disabled the GPS hardware, due to no/poor satellite coverage. Further details, e.g. regarding when to activate GNSS, are up to UE implementation.

- 1> if the received *otherConfig* includes the *idc-Config*:
 - 2> if *idc-Indication* is included (i.e. set to *setup*):
 - 3> consider itself to be configured to provide IDC indications in accordance with 5.6.9;
 - 3> if *idc-Indication-UL-CA* is included (i.e. set to *setup*):
 - 4> consider itself to be configured to indicate UL CA related information in IDC indications in accordance with 5.6.9;
 - 2> else:
 - 3> consider itself not to be configured to provide IDC indications;
 - 2> if *autonomousDenialParameters* is included:
 - 3> consider itself to be allowed to deny any transmission in a particular UL subframe if during the number of subframes indicated by *autonomousDenialValidity*, preceeding and including this particular subframe, it autonomously denied fewer UL subframes than indicated by *autonomousDenialSubframes*;
 - 2> else:
 - 3> consider itself not to be allowed to deny any UL transmission;
- 1> if the received *otherConfig* includes the *powerPrefIndicationConfig*:
 - 2> if *powerPrefIndicationConfig* is set to *setup*:
 - 3> consider itself to be configured to provide power preference indications in accordance with 5.6.10;
 - 2> else:
 - 3> consider itself not to be configured to provide power preference indications;

5.3.10.10 SCG reconfiguration

The UE shall:

- 1> if the received *scg-Configuration* is set to *release* or includes the *mobilityControlInfoSCG* (i.e. SCG release/change):
 - 2> if *mobilityControlInfo* is not received (i.e. SCG release/change without HO):
 - 3> reset SCG MAC, if configured;
 - 3> for each *drb-Identity* value that is part of the current UE configuration:
 - 4> if the DRB indicated by *drb-Identity* is an SCG DRB:
 - 5> re-establish the PDCP entity and the SCG RLC entity or entities;
 - 4> if the DRB indicated by *drb-Identity* is a split DRB:
 - 5> perform PDCP data recovery and re-establish the SCG RLC entity;
 - 4> if the DRB indicated by *drb-Identity* is an MCG DRB; and
 - 4> *drb-ToAddModListSCG* is received and includes the *drb-Identity* value, while for this entry *drb-Type* is included and set to *scg* (i.e. MCG to SCG):
 - 5> re-establish the PDCP entity and the MCG RLC entity or entities;
 - 3> configure lower layers to consider the SCG SCell(s), except for the PSCell, to be in deactivated state;
 - 1> if the received *scg-Configuration* is set to *release*:
 - 2> release the entire SCG configuration, except for the DRB configuration (i.e. as configured by *drb-ToAddModListSCG*);
 - 2> if the current UE configuration includes one or more split or SCG DRBs and the received *RRConnectionReconfiguration* message includes *radioResourceConfigDedicated* including *drb-ToAddModList*:
 - 3> reconfigure the SCG or split DRB by *drb-ToAddModList* as specified in 5.3.10.12;
 - 2> stop timer T313, if running;
 - 2> stop timer T307, if running;
 - 1> else:
 - 2> if the received *scg-ConfigPartMCG* includes the *scg-Counter*:
 - 3> update the S- K_{eNB} key based on the K_{eNB} key and using the received *scg-Counter* value, as specified in TS 33.401 [32];
 - 3> derive the K_{UPenc} key associated with the *cipheringAlgorithmSCG* included in *mobilityControlInfoSCG* within the received *scg-ConfigPartSCG*, as specified in TS 33.401 [32];
 - 3> configure lower layers to apply the ciphering algorithm and the K_{UPenc} key;
 - 2> if the received *scg-ConfigPartSCG* includes the *radioResourceConfigDedicatedSCG*:
 - 3> reconfigure the dedicated radio resource configuration for the SCG as specified in 5.3.10.11;
 - 2> if the current UE configuration includes one or more split or SCG DRBs and the received *RRConnectionReconfiguration* message includes *radioResourceConfigDedicated* including *drb-ToAddModList*:
 - 3> reconfigure the SCG or split DRB by *drb-ToAddModList* as specified in 5.3.10.12;
 - 2> if the received *scg-ConfigPartSCG* includes the *sCellToReleaseListSCG*:

3> perform SCell release for the SCG as specified in 5.3.10.3a;

NOTE: This procedure is also used to release the PSCell e.g. PSCell change, SI change for the PSCell.

2> if the received *scg-ConfigPartSCG* includes the *pSCellToAddMod*:

3> perform PSCell addition or modification as specified in 5.3.10.3c;

2> if the received *scg-ConfigPartSCG* includes the *sCellToAddModListSCG*:

3> perform SCell addition or modification as specified in 5.3.10.3b;

2> configure lower layers in accordance with *mobilityControlInfoSCG*, if received;

2> if the received *scg-ConfigPartSCG* includes the *mobilityControlInfoSCG* (i.e. SCG change):

3> resume all SCG DRBs and resume SCG transmission for split DRBs, if suspended;

3> stop timer T313, if running;

3> start timer T307 with the timer value set to *t307*, as included in the *mobilityControlInfoSCG*;

3> start synchronising to the DL of the target PSCell;

3> initiate the random access procedure on the PSCell, as specified in TS 36.321 [6]:

NOTE 1: The UE is not required to determine the SFN of the target PSCell by acquiring system information from that cell before performing RACH access in the target PSCell.

3> the procedure ends, except that the following actions are performed when MAC successfully completes the random access procedure on the PSCell:

4> stop timer T307;

4> apply the parts of the CQI reporting configuration, the scheduling request configuration and the sounding RS configuration that do not require the UE to know the SFN of the target PSCell, if any;

4> apply the parts of the measurement and the radio resource configuration that require the UE to know the SFN of the target PSCell (e.g. periodic CQI reporting, scheduling request configuration, sounding RS configuration), if any, upon acquiring the SFN of the target PSCell;

NOTE 2: Whenever the UE shall setup or reconfigure a configuration in accordance with a field that is received it applies the new configuration, except for the cases addressed by the above statements.

5.3.10.11 SCG dedicated resource configuration

The UE shall:

1> if the received *radioResourceConfigDedicatedSCG* includes the *drb-ToAddModListSCG*:

2> for each *drb-Identity* value included in the *drb-ToAddModListSCG* perform the DC specific DRB addition or reconfiguration as specified in 5.3.10.3a1

1> if the received *radioResourceConfigDedicatedSCG* includes the *mac-MainConfigSCG*:

2> perform the SCG MAC main reconfiguration as specified in 5.3.10.4;

1> if the received *radioResourceConfigDedicatedSCG* includes the *rlf-TimersAndConstantsSCG*:

2> reconfigure the values of timers and constants as specified in 5.3.10.7;

5.3.10.12 Reconfiguration SCG or split DRB by *drb-ToAddModList*

The UE shall:

1> for each split or SCG DRBs that is part of the current configuration:

2> if the corresponding *drb-Identity* value is included in the received *drb-ToAddModList*; and:

- 2> if the corresponding *drb-Identity* value is not included in the received *drb-ToAddModListSCG* (i.e. reconfigure split, split to MCG or SCG to MCG):
 - 3> perform the DC specific DRB addition or reconfiguration as specified in 5.3.10.3a1;

5.3.10.13 Neighbour cell information reconfiguration

The UE shall:

- 1> if the received *naics-Info* is set to *release*:
 - 2> instruct lower layer to release all the NAICS neighbour cell information for the concerned cell, if previously configured;
- 1> if the received *naics-Info* includes the *neighCellsToReleaseList-r12*:
 - 2> for each *physCellId-r12* value included in the *neighCellsToReleaseList-r12* that is part of the current NAICS neighbour cell information of the concerned cell:
 - 3> instruct lower layer to release the NAICS neighbour cell information for the concerned cell;
- 1> if the received *naics-Info* includes the *NeighCellsToAddModList-r12*:
 - 2> for each *physCellId-r12* value included in the *neighCellsToAddModList-r12* that is not part of the current NAICS neighbour cell information of the concerned cell:
 - 3> instruct lower layer to add the NAICS neighbour cell information for the concerned cell;
 - 2> for each *physCellId-r12* value included in the *neighCellsToAddModList-r12* that is part of the current NAICS neighbour cell information of the concerned cell:
 - 3> instruct lower layer to modify the NAICS neighbour cell information in accordance with the received *NeighCellsInfo* for the concerned cell;

5.3.10.14 Void

5.3.10.15 Sidelink dedicated configuration

The UE shall:

- 1> if the *RRCCONNECTIONRECONFIGURATION* message includes the *sl-CommConfig*:
 - 2> if *commTxResources* is included and set to *setup*:
 - 3> from the next SC period use the resources indicated by *commTxResources* for sidelink communication transmission, as specified in 5.10.4;
 - 2> else if *commTxResources* is included and set to *release*:
 - 3> from the next SC period, release the resources allocated for sidelink communication transmission previously configured by *commTxResources*;
- 1> if the *RRCCONNECTIONRECONFIGURATION* message includes the *sl-DiscConfig*:
 - 2> if *discTxResources* is included and set to *setup*:
 - 3> from the next discovery period, as defined by *discPeriod*, use the resources indicated by *discTxResources* for sidelink discovery announcement, as specified in 5.10.6;
 - 2> else if *discTxResources* is included and set to *release*:
 - 3> from the next discovery period, as defined by *discPeriod*, release the resources allocated for sidelink discovery announcement previously configured by *discTxResources*;

5.3.11 Radio link failure related actions

5.3.11.1 Detection of physical layer problems in RRC_CONNECTED

The UE shall:

- 1> upon receiving N310 consecutive "out-of-sync" indications for the PCell from lower layers while neither T300, T301, T304 nor T311 is running:
 - 2> start timer T310;
- 1> upon receiving N313 consecutive "out-of-sync" indications for the PCell from lower layers while T307 is not running:
 - 2> start T313;

NOTE: Physical layer monitoring and related autonomous actions do not apply to SCells except for the PCell.

5.3.11.2 Recovery of physical layer problems

Upon receiving N311 consecutive "in-sync" indications for the PCell from lower layers while T310 is running, the UE shall:

- 1> stop timer T310;
- 1> stop timer T312, if running;

NOTE 1: In this case, the UE maintains the RRC connection without explicit signalling, i.e. the UE maintains the entire radio resource configuration.

NOTE 2: Periods in time where neither "in-sync" nor "out-of-sync" is reported by layer 1 do not affect the evaluation of the number of consecutive "in-sync" or "out-of-sync" indications.

Upon receiving N314 consecutive "in-sync" indications for the PCell from lower layers while T313 is running, the UE shall:

- 1> stop timer T313;

5.3.11.3 Detection of radio link failure

The UE shall:

- 1> upon T310 expiry; or
- 1> upon T312 expiry; or
- 1> upon random access problem indication from MCG MAC while neither T300, T301, T304 nor T311 is running; or
- 1> upon indication from MCG RLC that the maximum number of retransmissions has been reached for an SRB or for an MCG or split DRB:
 - 2> consider radio link failure to be detected for the MCG i.e. RLF;
 - 2> store the following radio link failure information in the *VarRLF-Report* by setting its fields as follows:
 - 3> clear the information included in *VarRLF-Report*, if any;
 - 3> set the *plmn-IdentityList* to include the list of EPLMNs stored by the UE (i.e. includes the RPLMN);
 - 3> set the *measResultLastServCell* to include the RSRP and RSRQ, if available, of the PCell based on measurements collected up to the moment the UE detected radio link failure;
 - 3> set the *measResultNeighCells* to include the best measured cells, other than the PCell, ordered such that the best cell is listed first, and based on measurements collected up to the moment the UE detected radio link failure, and set its fields as follows;

- 4> if the UE was configured to perform measurements for one or more EUTRA frequencies, include the *measResultListEUTRA*;
- 4> if the UE was configured to perform measurement reporting for one or more neighbouring UTRA frequencies, include the *measResultListUTRA*;
- 4> if the UE was configured to perform measurement reporting for one or more neighbouring GERAN frequencies, include the *measResultListGERAN*;
- 4> if the UE was configured to perform measurement reporting for one or more neighbouring CDMA2000 frequencies, include the *measResultsCDMA2000*;
- 4> for each neighbour cell included, include the optional fields that are available;

NOTE 1: The measured quantities are filtered by the L3 filter as configured in the mobility measurement configuration. The measurements are based on the time domain measurement resource restriction, if configured. Blacklisted cells are not required to be reported.

- 3> if detailed location information is available, set the content of the *locationInfo* as follows:
 - 4> include the *locationCoordinates*;
 - 4> include the *horizontalVelocity*, if available;
- 3> set the *failedPCellId* to the global cell identity, if available, and otherwise to the physical cell identity and carrier frequency of the PCell where radio link failure is detected;
- 3> set the *tac-FailedPCell* to the tracking area code, if available, of the PCell where radio link failure is detected;
- 3> if an *RRCCONNECTIONRECONFIGURATION* message including the *mobilityControlInfo* was received before the connection failure:
 - 4> if the last *RRCCONNECTIONRECONFIGURATION* message including the *mobilityControlInfo* concerned an intra E-UTRA handover:
 - 5> include the *previousPCellId* and set it to the global cell identity of the PCell where the last *RRCCONNECTIONRECONFIGURATION* message including *mobilityControlInfo* was received;
 - 5> set the *timeConnFailure* to the elapsed time since reception of the last *RRCCONNECTIONRECONFIGURATION* message including the *mobilityControlInfo*;
 - 4> if the last *RRCCONNECTIONRECONFIGURATION* message including the *mobilityControlInfo* concerned a handover to E-UTRA from UTRA and if the UE supports Radio Link Failure Report for Inter-RAT MRO:
 - 5> include the *previousUTRA-CellId* and set it to the physical cell identity, the carrier frequency and the global cell identity, if available, of the UTRA Cell in which the last *RRCCONNECTIONRECONFIGURATION* message including *mobilityControlInfo* was received;
 - 5> set the *timeConnFailure* to the elapsed time since reception of the last *RRCCONNECTIONRECONFIGURATION* message including the *mobilityControlInfo*;
- 3> set the *connectionFailureType* to *rlf*;
- 3> set the *c-RNTI* to the C-RNTI used in the PCell;
- 3> set the *rlf-Cause* to the trigger for detecting radio link failure;
- 2> if AS security has not been activated:
 - 3> perform the actions upon leaving *RRC_CONNECTED* as specified in 5.3.12, with release cause 'other';
- 2> else:
 - 3> initiate the connection re-establishment procedure as specified in 5.3.7;

The UE shall:

- 1> upon T313 expiry; or
- 1> upon random access problem indication from SCG MAC; or
- 1> upon indication from SCG RLC that the maximum number of retransmissions has been reached for an SCG or split DRB:
 - 2> consider radio link failure to be detected for the SCG i.e. SCG-RLF;
 - 2> initiate the SCG failure information procedure as specified in 5.6.13 to report SCG radio link failure;

The UE may discard the radio link failure information, i.e. release the UE variable *VarRLF-Report*, 48 hours after the radio link failure is detected, upon power off or upon detach.

5.3.12 UE actions upon leaving RRC_CONNECTED

Upon leaving RRC_CONNECTED, the UE shall:

- 1> reset MAC;
- 1> stop all timers that are running except T320, T325 and T330;
- 1> release all radio resources, including release of the RLC entity, the MAC configuration and the associated PDCP entity for all established RBs;
- 1> indicate the release of the RRC connection to upper layers together with the release cause;
- 1> if leaving RRC_CONNECTED was triggered neither by reception of the *MobilityFromEUTRACommand* message nor by selecting an inter-RAT cell while T311 was running:
 - 2> if timer T350 is configured:
 - 3> start timer T350;
 - 2> else:
 - 3> release the *wlan-OffloadConfigDedicated*, if received;
 - 3> if the *wlan-OffloadConfigCommon* corresponding to the RPLMN is broadcast by the cell:
 - 4> apply the *wlan-OffloadConfigCommon* corresponding to the RPLMN included in *SystemInformationBlockType17*;
 - 2> enter RRC_IDLE and perform procedures as specified in TS 36.304 [4, 5.2.7];
- 1> else:
 - 2> release the *wlan-OffloadConfigDedicated*, if received;

5.3.13 UE actions upon PUCCH/ SRS release request

Upon receiving a PUCCH/ SRS release request from lower layers, the UE shall:

- 1> apply the default physical channel configuration for *cqi-ReportConfig* as specified in 9.2.4 and release *cqi-ReportConfigSCell*, for each SCell of the concerned CG that is configured, if any;
- 1> apply the default physical channel configuration for *soundingRS-UL-ConfigDedicated* as specified in 9.2.4, for all serving cells of the concerned CG;
- 1> apply the default physical channel configuration for *schedulingRequestConfig* as specified in 9.2.4, for the concerned CG;

Upon receiving an SRS release request from lower layers, the UE shall:

1> apply the default physical channel configuration for *soundingRS-UL-ConfigDedicated*, as specified in 9.2.4, for the cells of the concerned TAG;

NOTE: Upon PUCCH/ SRS release request, the UE does not modify the *soundingRS-UL-ConfigDedicatedAperiodic* i.e. it does not apply the default for this field (release).

5.3.14 Proximity indication

5.3.14.1 General

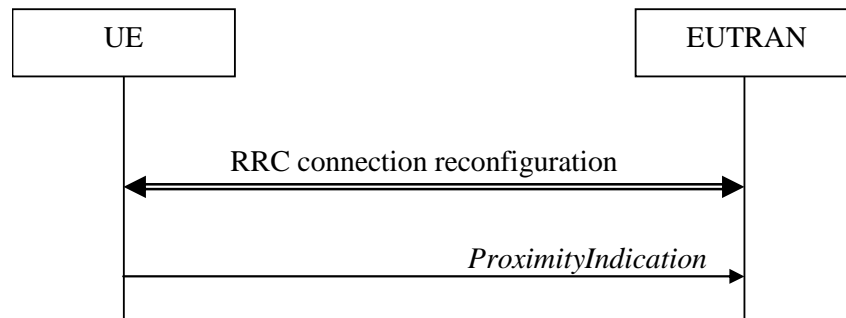

Figure 5.3.14.1-1: Proximity indication

The purpose of this procedure is to indicate that the UE is entering or leaving the proximity of one or more CSG member cells. The detection of proximity is based on an autonomous search function as defined in TS 36.304 [4].

5.3.14.2 Initiation

A UE in RRC_CONNECTED shall:

- 1> if the UE enters the proximity of one or more CSG member cell(s) on an E-UTRA frequency while proximity indication is enabled for such E-UTRA cells; or
- 1> if the UE enters the proximity of one or more CSG member cell(s) on an UTRA frequency while proximity indication is enabled for such UTRA cells; or
- 1> if the UE leaves the proximity of all CSG member cell(s) on an E-UTRA frequency while proximity indication is enabled for such E-UTRA cells; or
- 1> if the UE leaves the proximity of all CSG member cell(s) on an UTRA frequency while proximity indication is enabled for such UTRA cells:
 - 2> if the UE has previously not transmitted a *ProximityIndication* for the RAT and frequency during the current RRC connection, or if more than 5 s has elapsed since the UE has last transmitted a *ProximityIndication* (either entering or leaving) for the RAT and frequency:
 - 3> initiate transmission of the *ProximityIndication* message in accordance with 5.3.14.3;

NOTE: In the conditions above, "if the UE enters the proximity of one or more CSG member cell(s)" includes the case of already being in the proximity of such cell(s) at the time proximity indication for the corresponding RAT is enabled.

5.3.14.3 Actions related to transmission of *ProximityIndication* message

The UE shall set the contents of *ProximityIndication* message as follows:

- 1> if the UE applies the procedure to report entering the proximity of CSG member cell(s):
 - 2> set *type* to *entering*;
- 1> else if the UE applies the procedure to report leaving the proximity of CSG member cell(s):
 - 2> set *type* to *leaving*;
- 1> if the proximity indication was triggered for one or more CSG member cell(s) on an E-UTRA frequency:

- 2> set the *carrierFreq* to *utra* with the value set to the E-ARFCN value of the E-UTRA cell(s) for which proximity indication was triggered;
- 1> else if the proximity indication was triggered for one or more CSG member cell(s) on a UTRA frequency:
 - 2> set the *carrierFreq* to *utra* with the value set to the ARFCN value of the UTRA cell(s) for which proximity indication was triggered;

The UE shall submit the *ProximityIndication* message to lower layers for transmission.

5.3.15 Void

5.4 Inter-RAT mobility

5.4.1 Introduction

The general principles of connected mode mobility are described in 5.3.1.3. The general principles of the security handling upon connected mode mobility are described in 5.3.1.2.

For the (network controlled) inter RAT mobility from E-UTRA for a UE in *RRC_CONNECTED*, a single procedure is defined that supports both handover, cell change order with optional network assistance (NACC) and enhanced CS fallback to CDMA2000 1xRTT. In case of mobility to CDMA2000, the eNB decides when to move to the other RAT while the target RAT determines to which cell the UE shall move.

5.4.2 Handover to E-UTRA

5.4.2.1 General

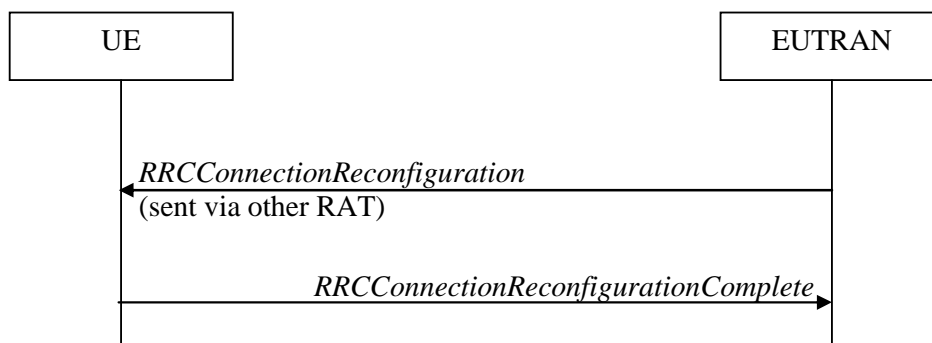

Figure 5.4.2.1-1: Handover to E-UTRA, successful

The purpose of this procedure is to, under the control of the network, transfer a connection between the UE and another Radio Access Network (e.g. GERAN or UTRAN) to E-UTRAN.

The handover to E-UTRA procedure applies when SRBs, possibly in combination with DRBs, are established in another RAT. Handover from UTRAN to E-UTRAN applies only after integrity has been activated in UTRAN.

5.4.2.2 Initiation

The RAN using another RAT initiates the Handover to E-UTRA procedure, in accordance with the specifications applicable for the other RAT, by sending the *RRCConnectionReconfiguration* message via the radio access technology from which the inter-RAT handover is performed.

E-UTRAN applies the procedure as follows:

- to activate ciphering, possibly using NULL algorithm, if not yet activated in the other RAT;
- to establish SRB1, SRB2 and one or more DRBs, i.e. at least the DRB associated with the default EPS bearer is established;

5.4.2.3 Reception of the *RRConnectionReconfiguration* by the UE

If the UE is able to comply with the configuration included in the *RRConnectionReconfiguration* message, the UE shall:

- 1> apply the default physical channel configuration as specified in 9.2.4;
- 1> apply the default semi-persistent scheduling configuration as specified in 9.2.3;
- 1> apply the default MAC main configuration as specified in 9.2.2;
- 1> start timer T304 with the timer value set to *t304*, as included in the *mobilityControlInfo*;
- 1> consider the target PCell to be one on the frequency indicated by the *carrierFreq* with a physical cell identity indicated by the *targetPhysCellId*;
- 1> start synchronising to the DL of the target PCell;
- 1> set the C-RNTI to the value of the *newUE-Identity*;
- 1> for the target PCell, apply the downlink bandwidth indicated by the *dl-Bandwidth*;
- 1> for the target PCell, apply the uplink bandwidth indicated by (the absence or presence of) the *ul-Bandwidth*;
- 1> configure lower layers in accordance with the received *radioResourceConfigCommon*;
- 1> configure lower layers in accordance with any additional fields, not covered in the previous, if included in the received *mobilityControlInfo*;
- 1> perform the radio resource configuration procedure as specified in 5.3.10;
- 1> forward the *nas-SecurityParamToEUTRA* to the upper layers;
- 1> derive the K_{eNB} key, as specified in TS 33.401 [32];
- 1> derive the K_{RRCint} key associated with the *integrityProtAlgorithm*, as specified in TS 33.401 [32];
- 1> derive the K_{RRCenc} key and the K_{UPenc} key associated with the *cipheringAlgorithm*, as specified in TS 33.401 [32];
- 1> configure lower layers to apply the indicated integrity protection algorithm and the K_{RRCint} key immediately, i.e. the indicated integrity protection configuration shall be applied to all subsequent messages received and sent by the UE, including the message used to indicate the successful completion of the procedure;
- 1> configure lower layers to apply the indicated ciphering algorithm, the K_{RRCenc} key and the K_{UPenc} key immediately, i.e. the indicated ciphering configuration shall be applied to all subsequent messages received and sent by the UE, including the message used to indicate the successful completion of the procedure;
- 1> if the received *RRConnectionReconfiguration* includes the *sCellToAddModList*:
 - 2> perform SCell addition as specified in 5.3.10.3b;
- 1> if the *RRConnectionReconfiguration* message includes the *measConfig*:
 - 2> perform the measurement configuration procedure as specified in 5.5.2;
- 1> perform the measurement identity autonomous removal as specified in 5.5.2.2a;
- 1> if the *RRConnectionReconfiguration* message includes the *otherConfig*:
 - 2> perform the other configuration procedure as specified in 5.3.10.9;
- 1> if the *RRConnectionReconfiguration* message includes *wlan-OffloadInfo*:
 - 2> perform the dedicated WLAN offload configuration procedure as specified in 5.6.12.2;
- 1> set the content of *RRConnectionReconfigurationComplete* message as follows:

- 2> if the UE has radio link failure or handover failure information available in *VarRLF-Report* and if the RPLMN is included in *plmn-IdentityList* stored in *VarRLF-Report*:
 - 3> include *rlf-InfoAvailable*;
 - 2> if the UE has MBSFN logged measurements available for E-UTRA and if the RPLMN is included in *plmn-IdentityList* stored in *VarLogMeasReport* and if T330 is not running:
 - 3> include *logMeasAvailableMBSFN*;
 - 2> else if the UE has logged measurements available for E-UTRA and if the RPLMN is included in *plmn-IdentityList* stored in *VarLogMeasReport*:
 - 3> include the *logMeasAvailable*;
 - 2> if the UE has connection establishment failure information available in *VarConnEstFailReport* and if the RPLMN is equal to *plmn-Identity* stored in *VarConnEstFailReport*:
 - 3> include *connEstFailInfoAvailable*;
 - 1> submit the *RRCCONNECTIONRECONFIGURATIONCOMPLETE* message to lower layers for transmission using the new configuration;
 - 1> if the *RRCCONNECTIONRECONFIGURATION* message does not include *rlf-TimersAndConstants* set to *setup*:
 - 2> use the default values specified in 9.2.5 for timer T310, T311 and constant N310, N311;
 - 1> if MAC successfully completes the random access procedure:
 - 2> stop timer T304;
 - 2> apply the parts of the CQI reporting configuration, the scheduling request configuration and the sounding RS configuration that do not require the UE to know the SFN of the target PCell, if any;
 - 2> apply the parts of the measurement and the radio resource configuration that require the UE to know the SFN of the target PCell (e.g. measurement gaps, periodic CQI reporting, scheduling request configuration, sounding RS configuration), if any, upon acquiring the SFN of the target PCell;
- NOTE 1: Whenever the UE shall setup or reconfigure a configuration in accordance with a field that is received it applies the new configuration, except for the cases addressed by the above statements.
- 2> enter E-UTRA RRC_CONNECTED, upon which the procedure ends;
- NOTE 2: The UE is not required to determine the SFN of the target PCell by acquiring system information from that cell before performing RACH access in the target PCell.

5.4.2.4 Reconfiguration failure

The UE shall:

- 1> if the UE is unable to comply with (part of) the configuration included in the *RRCCONNECTIONRECONFIGURATION* message:
 - 2> perform the actions defined for this failure case as defined in the specifications applicable for the other RAT;

NOTE 1: The UE may apply above failure handling also in case the *RRCCONNECTIONRECONFIGURATION* message causes a protocol error for which the generic error handling as defined in 5.7 specifies that the UE shall ignore the message.

NOTE 2: If the UE is unable to comply with part of the configuration, it does not apply any part of the configuration, i.e. there is no partial success/ failure.

5.4.2.5 T304 expiry (handover to E-UTRA failure)

The UE shall:

- 1> upon T304 expiry (handover to E-UTRA failure):

2> reset MAC;

2> perform the actions defined for this failure case as defined in the specifications applicable for the other RAT;

5.4.3 Mobility from E-UTRA

5.4.3.1 General

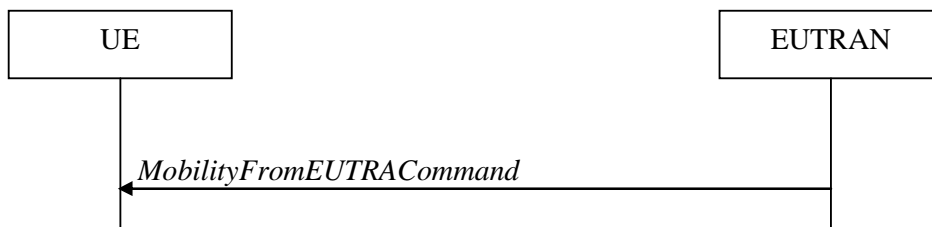

Figure 5.4.3.1-1: Mobility from E-UTRA, successful

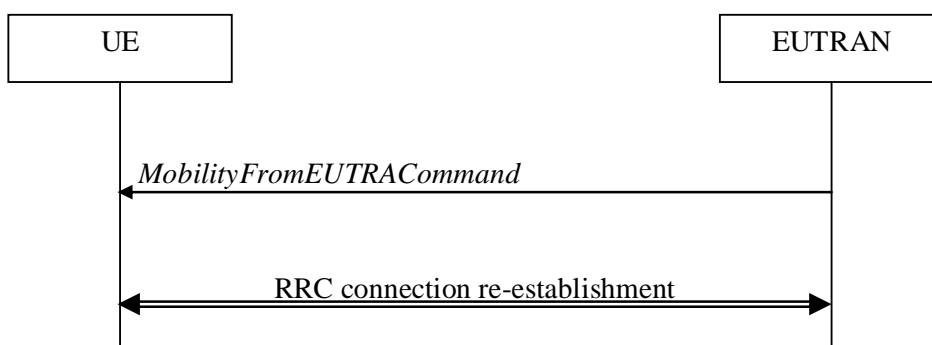

Figure 5.4.3.1-2: Mobility from E-UTRA, failure

The purpose of this procedure is to move a UE in RRC_CONNECTED to a cell using another Radio Access Technology (RAT), e.g. GERAN, UTRA or CDMA2000 systems. The mobility from E-UTRA procedure covers the following type of mobility:

- handover, i.e. the *MobilityFromEUTRACCommand* message includes radio resources that have been allocated for the UE in the target cell;
- cell change order, i.e. the *MobilityFromEUTRACCommand* message may include information facilitating access of and/ or connection establishment in the target cell, e.g. system information. Cell change order is applicable only to GERAN; and
- enhanced CS fallback to CDMA2000 1xRTT, i.e. the *MobilityFromEUTRACCommand* message includes radio resources that have been allocated for the UE in the target cell. The enhanced CS fallback to CDMA2000 1xRTT may be combined with concurrent handover or redirection to CDMA2000 HRPD.

NOTE: For the case of dual receiver/transmitter enhanced CS fallback to CDMA2000 1xRTT, the *DLInformationTransfer* message is used instead of the *MobilityFromEUTRACCommand* message (see TS 36.300 [9]).

5.4.3.2 Initiation

E-UTRAN initiates the mobility from E-UTRA procedure to a UE in RRC_CONNECTED, possibly in response to a *MeasurementReport* message or in response to reception of CS fallback indication for the UE from MME, by sending a *MobilityFromEUTRACCommand* message. E-UTRAN applies the procedure as follows:

- the procedure is initiated only when AS-security has been activated, and SRB2 with at least one DRB are setup and not suspended;

5.4.3.3 Reception of the *MobilityFromEUTRACommand* by the UE

The UE shall be able to receive a *MobilityFromEUTRACommand* message and perform a cell change order to GERAN, even if no prior UE measurements have been performed on the target cell.

The UE shall:

- 1> stop timer T310, if running;
- 1> stop timer T312, if running;
- 1> if the *MobilityFromEUTRACommand* message includes the *purpose* set to *handover*:
 - 2> if the *targetRAT-Type* is set to *utra* or *geran*:
 - 3> consider inter-RAT mobility as initiated towards the RAT indicated by the *targetRAT-Type* included in the *MobilityFromEUTRACommand* message;
 - 3> forward the *nas-SecurityParamFromEUTRA* to the upper layers;
 - 3> access the target cell indicated in the inter-RAT message in accordance with the specifications of the target RAT;
 - 3> if the *targetRAT-Type* is set to *geran*:
 - 4> use the contents of *systemInformation*, if provided for PS Handover, as the system information to begin access on the target GERAN cell;

NOTE 1: If there are DRBs for which no radio bearers are established in the target RAT as indicated in the *targetRAT-MessageContainer* in the message, the E-UTRA RRC part of the UE does not indicate the release of the concerned DRBs to the upper layers. Upper layers may derive which bearers are not established from information received from the AS of the target RAT.

NOTE 2: In case of SR-VCC, the DRB to be replaced is specified in [61].

- 2> else if the *targetRAT-Type* is set to *cdma2000-1XRTT* or *cdma2000-HRPD*:
 - 3> forward the *targetRAT-Type* and the *targetRAT-MessageContainer* to the CDMA2000 upper layers for the UE to access the cell(s) indicated in the inter-RAT message in accordance with the specifications of the CDMA2000 target-RAT;
- 1> else if the *MobilityFromEUTRACommand* message includes the *purpose* set to *cellChangeOrder*:
 - 2> start timer T304 with the timer value set to *t304*, as included in the *MobilityFromEUTRACommand* message;
 - 2> if the *targetRAT-Type* is set to *geran*:
 - 3> if *networkControlOrder* is included in the *MobilityFromEUTRACommand* message:
 - 4> apply the value as specified in TS 44.060 [36];
 - 3> else:
 - 4> acquire *networkControlOrder* and apply the value as specified in TS 44.060 [36];
 - 3> use the contents of *systemInformation*, if provided, as the system information to begin access on the target GERAN cell;
 - 2> establish the connection to the target cell indicated in the *CellChangeOrder*;

NOTE 3: The criteria for success or failure of the cell change order to GERAN are specified in TS 44.060[36].

- 1> if the *MobilityFromEUTRACommand* message includes the *purpose* set to *e-CSFB*:
 - 2> if *messageContCDMA2000-1XRTT* is present:
 - 3> forward the *messageContCDMA2000-1XRTT* to the CDMA2000 upper layers for the UE to access the cell(s) indicated in the inter-RAT message in accordance with the specification of the target RAT;

- 2> if *mobilityCDMA2000-HRPD* is present and is set to *handover*:
 - 3> forward the *messageContCDMA2000-HRPD* to the CDMA2000 upper layers for the UE to access the cell(s) indicated in the inter-RAT message in accordance with the specification of the target RAT;
- 2> if *mobilityCDMA2000-HRPD* is present and is set to *redirection*:
 - 3> forward the *redirectCarrierCDMA2000-HRPD* to the CDMA2000 upper layers;

NOTE 4: When the CDMA2000 upper layers in the UE receive both the *messageContCDMA2000-1xRTT* and *messageContCDMA2000-HRPD* the UE performs concurrent access to both CDMA2000 1xRTT and CDMA2000 HRPD RAT.

NOTE 5: The UE should perform the handover, the cell change order or enhanced 1xRTT CS fallback as soon as possible following the reception of the RRC message *MobilityFromEUTRACommand*, which could be before confirming successful reception (HARQ and ARQ) of this message.

5.4.3.4 Successful completion of the mobility from E-UTRA

Upon successfully completing the handover, the cell change order or enhanced 1xRTT CS fallback, the UE shall:

- 1> perform the actions upon leaving RRC_CONNECTED as specified in 5.3.12, with release cause 'other';

NOTE: If the UE performs enhanced 1xRTT CS fallback along with concurrent mobility to CDMA2000 HRPD and the connection to either CDMA2000 1xRTT or CDMA2000 HRPD succeeds, then the mobility from E-UTRA is considered successful.

5.4.3.5 Mobility from E-UTRA failure

The UE shall:

- 1> if T304 expires (mobility from E-UTRA failure); or
- 1> if the UE does not succeed in establishing the connection to the target radio access technology; or
- 1> if the UE is unable to comply with (part of) the configuration included in the *MobilityFromEUTRACommand* message; or
- 1> if there is a protocol error in the inter RAT information included in the *MobilityFromEUTRACommand* message, causing the UE to fail the procedure according to the specifications applicable for the target RAT:
 - 2> stop T304, if running;
 - 2> if the *cs-FallbackIndicator* in the *MobilityFromEUTRACommand* message was set to *TRUE* or *e-CSFB* was present:
 - 3> indicate to upper layers that the CS Fallback procedure has failed;
 - 2> revert back to the configuration used in the source PCell, excluding the configuration configured by the *physicalConfigDedicated*, *mac-MainConfig* and *sps-Config*;
 - 2> initiate the connection re-establishment procedure as specified in 5.3.7;

NOTE: For enhanced CS fallback to CDMA2000 1xRTT, the above UE behavior applies only when the UE is attempting the enhanced 1xRTT CS fallback and connection to the target radio access technology fails or if the UE is attempting enhanced 1xRTT CS fallback along with concurrent mobility to CDMA2000 HRPD and connection to both the target radio access technologies fails.

5.4.4 Handover from E-UTRA preparation request (CDMA2000)

5.4.4.1 General

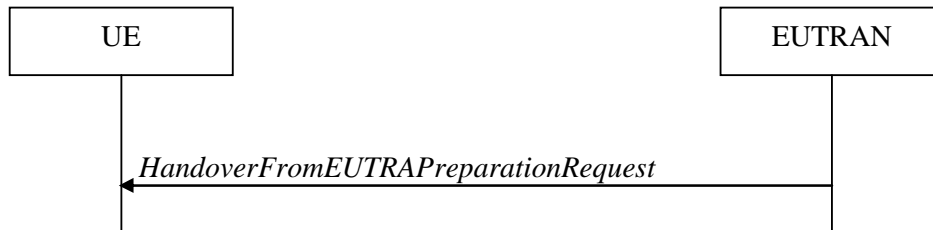

Figure 5.4.4.1-1: Handover from E-UTRA preparation request

The purpose of this procedure is to trigger the UE to prepare for handover or enhanced 1xRTT CS fallback to CDMA2000 by requesting a connection with this network. The UE may use this procedure to concurrently prepare for handover to CDMA2000 HRPD along with preparation for enhanced CS fallback to CDMA2000 1xRTT. This procedure applies to CDMA2000 capable UEs only.

This procedure is also used to trigger the UE which supports dual Rx/Tx enhanced 1xCsFB to redirect its second radio to CDMA2000 1xRTT.

The handover from E-UTRA preparation request procedure applies when signalling radio bearers are established.

5.4.4.2 Initiation

E-UTRAN initiates the handover from E-UTRA preparation request procedure to a UE in RRC_CONNECTED, possibly in response to a *MeasurementReport* message or CS fallback indication for the UE, by sending a *HandoverFromEUTRAPreparationRequest* message. E-UTRAN initiates the procedure only when AS security has been activated.

5.4.4.3 Reception of the *HandoverFromEUTRAPreparationRequest* by the UE

Upon reception of the *HandoverFromEUTRAPreparationRequest* message, the UE shall:

- 1> if *dualRxTxRedirectIndicator* is present in the received message:
 - 2> forward *dualRxTxRedirectIndicator* to the CDMA2000 upper layers;
 - 2> forward *redirectCarrierCDMA2000-1XRTT* to the CDMA2000 upper layers, if included;
- 1> else:
 - 2> indicate the request to prepare handover or enhanced 1xRTT CS fallback and forward the *cdma2000-Type* to the CDMA2000 upper layers;
 - 2> if *cdma2000-Type* is set to *type1XRTT*:
 - 3> forward the *rand* and the *mobilityParameters* to the CDMA2000 upper layers;
 - 2> if *concurrPrepCDMA2000-HRPD* is present in the received message:
 - 3> forward *concurrPrepCDMA2000-HRPD* to the CDMA2000 upper layers;
 - 2> else:
 - 3> forward *concurrPrepCDMA2000-HRPD*, with its value set to *FALSE*, to the CDMA2000 upper layers;

5.4.5 UL handover preparation transfer (CDMA2000)

5.4.5.1 General



Figure 5.4.5.1-1: UL handover preparation transfer

The purpose of this procedure is to tunnel the handover related CDMA2000 dedicated information or enhanced 1xRTT CS fallback related CDMA2000 dedicated information from UE to E-UTRAN when requested by the higher layers. The procedure is triggered by the higher layers on receipt of *HandoverFromEUTRAPreparationRequest* message. If preparing for enhanced CS fallback to CDMA2000 1xRTT and handover to CDMA2000 HRPD, the UE sends two consecutive *ULHandoverPreparationTransfer* messages to E-UTRAN, one per addressed CDMA2000 RAT Type. This procedure applies to CDMA2000 capable UEs only.

5.4.5.2 Initiation

A UE in RRC_CONNECTED initiates the UL Handover Preparation Transfer procedure whenever there is a need to transfer handover or enhanced 1xRTT CS fallback related non-3GPP dedicated information. The UE initiates the UL handover preparation transfer procedure by sending the *ULHandoverPreparationTransfer* message.

5.4.5.3 Actions related to transmission of the *ULHandoverPreparationTransfer* message

The UE shall set the contents of the *ULHandoverPreparationTransfer* message as follows:

- 1> include the *cdma2000-Type* and the *dedicatedInfo*;
- 1> if the *cdma2000-Type* is set to *type1XRTT*:
 - 2> include the *meid* and set it to the value received from the CDMA2000 upper layers;
- 1> submit the *ULHandoverPreparationTransfer* message to lower layers for transmission, upon which the procedure ends;

5.4.5.4 Failure to deliver the *ULHandoverPreparationTransfer* message

The UE shall:

- 1> if the UE is unable to guarantee successful delivery of *ULHandoverPreparationTransfer* messages:
 - 2> inform upper layers about the possible failure to deliver the information contained in the concerned *ULHandoverPreparationTransfer* message;

5.4.6 Inter-RAT cell change order to E-UTRAN

5.4.6.1 General

The purpose of the inter-RAT cell change order to E-UTRAN procedure is to transfer, under the control of the source radio access technology, a connection between the UE and another radio access technology (e.g. GSM/ GPRS) to E-UTRAN.

5.4.6.2 Initiation

The procedure is initiated when a radio access technology other than E-UTRAN, e.g. GSM/GPRS, using procedures specific for that RAT, orders the UE to change to an E-UTRAN cell. In response, upper layers request the establishment of an RRC connection as specified in subclause 5.3.3.

NOTE: Within the message used to order the UE to change to an E-UTRAN cell, the source RAT should specify the identity of the target E-UTRAN cell as specified in the specifications for that RAT.

The UE shall:

- 1> upon receiving an *RRCConnectionSetup* message:
- 2> consider the inter-RAT cell change order procedure to have completed successfully;

5.4.6.3 UE fails to complete an inter-RAT cell change order

If the inter-RAT cell change order fails the UE shall return to the other radio access technology and proceed as specified in the appropriate specifications for that RAT.

The UE shall:

- 1> upon failure to establish the RRC connection as specified in subclause 5.3.3:
- 2> consider the inter-RAT cell change order procedure to have failed;

NOTE: The cell change was network ordered. Therefore, failure to change to the target PCell should not cause the UE to move to UE-controlled cell selection.

5.5 Measurements

5.5.1 Introduction

The UE reports measurement information in accordance with the measurement configuration as provided by E-UTRAN. E-UTRAN provides the measurement configuration applicable for a UE in RRC_CONNECTED by means of dedicated signalling, i.e. using the *RRCConnectionReconfiguration* message.

The UE can be requested to perform the following types of measurements:

- Intra-frequency measurements: measurements at the downlink carrier frequency(ies) of the serving cell(s).
- Inter-frequency measurements: measurements at frequencies that differ from any of the downlink carrier frequency(ies) of the serving cell(s).
- Inter-RAT measurements of UTRA frequencies.
- Inter-RAT measurements of GERAN frequencies.
- Inter-RAT measurements of CDMA2000 HRPD or CDMA2000 1xRTT frequencies.

The measurement configuration includes the following parameters:

1. **Measurement objects:** The objects on which the UE shall perform the measurements.
 - For intra-frequency and inter-frequency measurements a measurement object is a single E-UTRA carrier frequency. Associated with this carrier frequency, E-UTRAN can configure a list of cell specific offsets and a list of 'blacklisted' cells. Blacklisted cells are not considered in event evaluation or measurement reporting.
 - For inter-RAT UTRA measurements a measurement object is a set of cells on a single UTRA carrier frequency.
 - For inter-RAT GERAN measurements a measurement object is a set of GERAN carrier frequencies.
 - For inter-RAT CDMA2000 measurements a measurement object is a set of cells on a single (HRPD or 1xRTT) carrier frequency.

NOTE 1: Some measurements using the above mentioned measurement objects, only concern a single cell, e.g. measurements used to report neighbouring cell system information, PCell UE Rx-Tx time difference.

2. **Reporting configurations:** A list of reporting configurations where each reporting configuration consists of the following:

- Reporting criterion: The criterion that triggers the UE to send a measurement report. This can either be periodical or a single event description.
 - Reporting format: The quantities that the UE includes in the measurement report and associated information (e.g. number of cells to report).
3. **Measurement identities:** A list of measurement identities where each measurement identity links one measurement object with one reporting configuration. By configuring multiple measurement identities it is possible to link more than one measurement object to the same reporting configuration, as well as to link more than one reporting configuration to the same measurement object. The measurement identity is used as a reference number in the measurement report.
 4. **Quantity configurations:** One quantity configuration is configured per RAT type. The quantity configuration defines the measurement quantities and associated filtering used for all event evaluation and related reporting of that measurement type. One filter can be configured per measurement quantity.
 5. **Measurement gaps:** Periods that the UE may use to perform measurements, i.e. no (UL, DL) transmissions are scheduled.

E-UTRAN only configures a single measurement object for a given frequency, i.e. it is not possible to configure two or more measurement objects for the same frequency with different associated parameters, e.g. different offsets and/ or blacklists. E-UTRAN may configure multiple instances of the same event e.g. by configuring two reporting configurations with different thresholds.

The UE maintains a single measurement object list, a single reporting configuration list, and a single measurement identities list. The measurement object list includes measurement objects, that are specified per RAT type, possibly including intra-frequency object(s) (i.e. the object(s) corresponding to the serving frequency(ies)), inter-frequency object(s) and inter-RAT objects. Similarly, the reporting configuration list includes E-UTRA and inter-RAT reporting configurations. Any measurement object can be linked to any reporting configuration of the same RAT type. Some reporting configurations may not be linked to a measurement object. Likewise, some measurement objects may not be linked to a reporting configuration.

The measurement procedures distinguish the following types of cells:

1. The serving cell(s)– these are the PCell and one or more SCells, if configured for a UE supporting CA.
2. Listed cells - these are cells listed within the measurement object(s).
3. Detected cells - these are cells that are not listed within the measurement object(s) but are detected by the UE on the carrier frequency(ies) indicated by the measurement object(s).

For E-UTRA, the UE measures and reports on the serving cell(s), listed cells and detected cells. For inter-RAT UTRA, the UE measures and reports on listed cells and optionally on cells that are within a range for which reporting is allowed by E-UTRAN. For inter-RAT GERAN, the UE measures and reports on detected cells. For inter-RAT CDMA2000, the UE measures and reports on listed cells.

NOTE 2: For inter-RAT UTRA and CDMA2000, the UE measures and reports also on detected cells for the purpose of SON.

NOTE 3: This specification is based on the assumption that typically CSG cells of home deployment type are not indicated within the neighbour list. Furthermore, the assumption is that for non-home deployments, the physical cell identity is unique within the area of a large macro cell (i.e. as for UTRAN).

Whenever the procedural specification, other than contained in sub-clause 5.5.2, refers to a field it concerns a field included in the *VarMeasConfig* unless explicitly stated otherwise i.e. only the measurement configuration procedure covers the direct UE action related to the received *measConfig*.

5.5.2 Measurement configuration

5.5.2.1 General

E-UTRAN applies the procedure as follows:

- to ensure that, whenever the UE has a *measConfig*, it includes a *measObject* for each serving frequency;

- to configure at most one measurement identity using a reporting configuration with the *purpose* set to *reportCGI*;
- for serving frequencies, set the EARFCN within the corresponding *measObject* according to the band as used for reception/ transmission;

The UE shall:

- 1> if the received *measConfig* includes the *measObjectToRemoveList*:
 - 2> perform the measurement object removal procedure as specified in 5.5.2.4;
- 1> if the received *measConfig* includes the *measObjectToAddModList*:
 - 2> perform the measurement object addition/ modification procedure as specified in 5.5.2.5;
- 1> if the received *measConfig* includes the *reportConfigToRemoveList*:
 - 2> perform the reporting configuration removal procedure as specified in 5.5.2.6;
- 1> if the received *measConfig* includes the *reportConfigToAddModList*:
 - 2> perform the reporting configuration addition/ modification procedure as specified in 5.5.2.7;
- 1> if the received *measConfig* includes the *quantityConfig*:
 - 2> perform the quantity configuration procedure as specified in 5.5.2.8;
- 1> if the received *measConfig* includes the *measIdToRemoveList*:
 - 2> perform the measurement identity removal procedure as specified in 5.5.2.2;
- 1> if the received *measConfig* includes the *measIdToAddModList*:
 - 2> perform the measurement identity addition/ modification procedure as specified in 5.5.2.3;
- 1> if the received *measConfig* includes the *measGapConfig*:
 - 2> perform the measurement gap configuration procedure as specified in 5.5.2.9;
- 1> if the received *measConfig* includes the *s-Measure*:
 - 2> set the parameter *s-Measure* within *VarMeasConfig* to the lowest value of the RSRP ranges indicated by the received value of *s-Measure*;
- 1> if the received *measConfig* includes the *preRegistrationInfoHRPD*:
 - 2> forward the *preRegistrationInfoHRPD* to CDMA2000 upper layers;
- 1> if the received *measConfig* includes the *speedStatePars*:
 - 2> set the parameter *speedStatePars* within *VarMeasConfig* to the received value of *speedStatePars*;
- 1> if the received *measConfig* includes the *allowInterruptions*:
 - 2> set the parameter *allowInterruptions* within *VarMeasConfig* to the received value of *allowInterruptions*;

5.5.2.2 Measurement identity removal

The UE shall:

- 1> for each *measId* included in the received *measIdToRemoveList* that is part of the current UE configuration in *VarMeasConfig*:
 - 2> remove the entry with the matching *measId* from the *measIdList* within the *VarMeasConfig*;
 - 2> remove the measurement reporting entry for this *measId* from the *VarMeasReportList*, if included;

- 2> stop the periodical reporting timer or timer T321, whichever one is running, and reset the associated information (e.g. *timeToTrigger*) for this *measId*;

NOTE: The UE does not consider the message as erroneous if the *measIdToRemoveList* includes any *measId* value that is not part of the current UE configuration.

5.5.2.2a Measurement identity autonomous removal

The UE shall:

- 1> for each *measId* included in the *measIdList* within *VarMeasConfig*:
 - 2> if the associated *reportConfig* concerns an event involving a serving cell while the concerned serving cell is not configured:
 - 3> remove the *measId* from the *measIdList* within the *VarMeasConfig*;
 - 3> remove the measurement reporting entry for this *measId* from the *VarMeasReportList*, if included;
 - 3> stop the periodical reporting timer if running, and reset the associated information (e.g. *timeToTrigger*) for this *measId*;

NOTE 1: The above UE autonomous removal of *measId*'s applies only for measurement events A1, A2, A6, and also applies for events A3 and A5 if configured for PSCell.

NOTE 2: When performed during re-establishment, the UE is only configured with a primary frequency (i.e. the SCell(s) are released, if configured).

5.5.2.3 Measurement identity addition/ modification

E-UTRAN applies the procedure as follows:

- configure a *measId* only if the corresponding measurement object, the corresponding reporting configuration and the corresponding quantity configuration, are configured;

The UE shall:

- 1> for each *measId* included in the received *measIdToAddModList*:
 - 2> if an entry with the matching *measId* exists in the *measIdList* within the *VarMeasConfig*:
 - 3> replace the entry with the value received for this *measId*;
 - 2> else:
 - 3> add a new entry for this *measId* within the *VarMeasConfig*;
 - 2> remove the measurement reporting entry for this *measId* from the *VarMeasReportList*, if included;
 - 2> stop the periodical reporting timer or timer T321, whichever one is running, and reset the associated information (e.g. *timeToTrigger*) for this *measId*;
 - 2> if the *triggerType* is set to *periodical* and the *purpose* is set to *reportCGI* in the *reportConfig* associated with this *measId*:
 - 3> if the *measObject* associated with this *measId* concerns E-UTRA:
 - 4> if the *si-RequestForHO* is included in the *reportConfig* associated with this *measId*:
 - 5> if the UE is a category 0 UE according to TS 36.306 [5]:
 - 6> start timer T321 with the timer value set to 190 ms for this *measId*;
 - 5> else:
 - 6> start timer T321 with the timer value set to 150 ms for this *measId*;
 - 4> else:

- 5> start timer T321 with the timer value set to 1 second for this *measId*;
- 3> else if the *measObject* associated with this *measId* concerns UTRA:
 - 4> if the *si-RequestForHO* is included in the *reportConfig* associated with this *measId*:
 - 5> for UTRA FDD, start timer T321 with the timer value set to 2 seconds for this *measId*;
 - 5> for UTRA TDD, start timer T321 with the timer value set to [1 second] for this *measId*;
 - 4> else:
 - 5> start timer T321 with the timer value set to 8 seconds for this *measId*;
- 3> else:
 - 4> start timer T321 with the timer value set to 8 seconds for this *measId*;

5.5.2.4 Measurement object removal

The UE shall:

- 1> for each *measObjectId* included in the received *measObjectToRemoveList* that is part of the current UE configuration in *VarMeasConfig*:
 - 2> remove the entry with the matching *measObjectId* from the *measObjectList* within the *VarMeasConfig*;
 - 2> remove all *measId* associated with this *measObjectId* from the *measIdList* within the *VarMeasConfig*, if any;
 - 2> if a *measId* is removed from the *measIdList*:
 - 3> remove the measurement reporting entry for this *measId* from the *VarMeasReportList*, if included;
 - 3> stop the periodical reporting timer or timer T321, whichever one is running, and reset the associated information (e.g. *timeToTrigger*) for this *measId*;

NOTE: The UE does not consider the message as erroneous if the *measObjectToRemoveList* includes any *measObjectId* value that is not part of the current UE configuration.

5.5.2.5 Measurement object addition/ modification

The UE shall:

- 1> for each *measObjectId* included in the received *measObjectToAddModList*:
 - 2> if an entry with the matching *measObjectId* exists in the *measObjectList* within the *VarMeasConfig*, for this entry:
 - 3> reconfigure the entry with the value received for this *measObject*, except for the fields *cellsToAddModList*, *blackCellsToAddModList*, *altTTT-CellsToAddModList*, *cellsToRemoveList*, *blackCellsToRemoveList*, *altTTT-CellsToRemoveList*, *measSubframePatternConfigNeigh* and *measDS-Config*;
 - 3> if the received *measObject* includes the *cellsToRemoveList*:
 - 4> for each *cellIndex* included in the *cellsToRemoveList*:
 - 5> remove the entry with the matching *cellIndex* from the *cellsToAddModList*;
 - 3> if the received *measObject* includes the *cellsToAddModList*:
 - 4> for each *cellIndex* value included in the *cellsToAddModList*:
 - 5> if an entry with the matching *cellIndex* exists in the *cellsToAddModList*:
 - 6> replace the entry with the value received for this *cellIndex*;
 - 5> else:

- 6> add a new entry for the received *cellIndex* to the *cellsToAddModList*;
- 3> if the received *measObject* includes the *blackCellsToRemoveList*:
 - 4> for each *cellIndex* included in the *blackCellsToRemoveList*:
 - 5> remove the entry with the matching *cellIndex* from the *blackCellsToAddModList*;

NOTE 1: For each *cellIndex* included in the *blackCellsToRemoveList* that concerns overlapping ranges of cells, a cell is removed from the black list of cells only if all cell indexes containing it are removed.

- 3> if the received *measObject* includes the *blackCellsToAddModList*:
 - 4> for each *cellIndex* included in the *blackCellsToAddModList*:
 - 5> if an entry with the matching *cellIndex* is included in the *blackCellsToAddModList*:
 - 6> replace the entry with the value received for this *cellIndex*;
 - 5> else:
 - 6> add a new entry for the received *cellIndex* to the *blackCellsToAddModList*;
 - 3> if the received *measObject* includes the *altTTT-CellsToRemoveList*:
 - 4> for each *cellIndex* included in the *altTTT-CellsToRemoveList*:
 - 5> remove the entry with the matching *cellIndex* from the *altTTT-CellsToAddModList*;

NOTE 2: For each *cellIndex* included in the *altTTT-CellsToRemoveList* that concerns overlapping ranges of cells, a cell is removed from the list of cells only if all cell indexes containing it are removed.

- 3> if the received *measObject* includes the *altTTT-CellsToAddModList*:
 - 4> for each *cellIndex* value included in the *altTTT-CellsToAddModList*:
 - 5> if an entry with the matching *cellIndex* exists in the *altTTT-CellsToAddModList*:
 - 6> replace the entry with the value received for this *cellIndex*;
 - 5> else:
 - 6> add a new entry for the received *cellIndex* to the *altTTT-CellsToAddModList*;
 - 3> if the received *measObject* includes *measSubframePatternConfigNeigh*:
 - 4> set *measSubframePatternConfigNeigh* within the *VarMeasConfig* to the value of the received field
 - 3> if the received *measObject* includes *measDS-Config*:
 - 4> if *measDS-Config* is set to *setup*:
 - 5> if the received *measDS-Config* includes the *measCSI-RS-ToRemoveList*:
 - 6> for each *measCSI-RS-Id* included in the *measCSI-RS-ToRemoveList*:
 - 7> remove the entry with the matching *measCSI-RS-Id* from the *measCSI-RS-ToAddModList*;
 - 5> if the received *measDS-Config* includes the *measCSI-RS-ToAddModList*, for each *measCSI-RS-Id* value included in the *measCSI-RS-ToAddModList*:
 - 6> if an entry with the matching *measCSI-RS-Id* exists in the *measCSI-RS-ToAddModList*:
 - 7> replace the entry with the value received for this *measCSI-RS-Id*;
 - 6> else:
 - 7> add a new entry for the received *measCSI-RS-Id* to the *measCSI-RS-ToAddModList*;

- 5> set other fields of the *measDS-Config* within the *VarMeasConfig* to the value of the received fields;
- 5> perform the discovery signals measurement timing configuration procedure as specified in 5.5.2.10;
- 4> else:
 - 5> release the discovery signals measurement configuration;
- 3> for each *measId* associated with this *measObjectId* in the *measIdList* within the *VarMeasConfig*, if any:
 - 4> remove the measurement reporting entry for this *measId* from the *VarMeasReportList*, if included;
 - 4> stop the periodical reporting timer or timer T321, whichever one is running, and reset the associated information (e.g. *timeToTrigger*) for this *measId*;
- 2> else:
 - 3> add a new entry for the received *measObject* to the *measObjectList* within *VarMeasConfig*;

NOTE 3: UE does not need to retain *cellForWhichToReportCGI* in the *measObject* after reporting *cgi-Info*.

5.5.2.6 Reporting configuration removal

The UE shall:

- 1> for each *reportConfigId* included in the received *reportConfigToRemoveList* that is part of the current UE configuration in *VarMeasConfig*:
 - 2> remove the entry with the matching *reportConfigId* from the *reportConfigList* within the *VarMeasConfig*;
 - 2> remove all *measId* associated with the *reportConfigId* from the *measIdList* within the *VarMeasConfig*, if any;
 - 2> if a *measId* is removed from the *measIdList*:
 - 3> remove the measurement reporting entry for this *measId* from the *VarMeasReportList*, if included;
 - 3> stop the periodical reporting timer or timer T321, whichever one is running, and reset the associated information (e.g. *timeToTrigger*) for this *measId*;

NOTE: The UE does not consider the message as erroneous if the *reportConfigToRemoveList* includes any *reportConfigId* value that is not part of the current UE configuration.

5.5.2.7 Reporting configuration addition/ modification

The UE shall:

- 1> for each *reportConfigId* included in the received *reportConfigToAddModList*:
 - 2> if an entry with the matching *reportConfigId* exists in the *reportConfigList* within the *VarMeasConfig*, for this entry:
 - 3> reconfigure the entry with the value received for this *reportConfig*;
 - 3> for each *measId* associated with this *reportConfigId* included in the *measIdList* within the *VarMeasConfig*, if any:
 - 4> remove the measurement reporting entry for this *measId* from in *VarMeasReportList*, if included;
 - 4> stop the periodical reporting timer or timer T321, whichever one is running, and reset the associated information (e.g. *timeToTrigger*) for this *measId*;
 - 2> else:
 - 3> add a new entry for the received *reportConfig* to the *reportConfigList* within the *VarMeasConfig*;

5.5.2.8 Quantity configuration

The UE shall:

- 1> for each RAT for which the received *quantityConfig* includes parameter(s):
 - 2> set the corresponding parameter(s) in *quantityConfig* within *VarMeasConfig* to the value of the received *quantityConfig* parameter(s);
- 1> for each *measId* included in the *measIdList* within *VarMeasConfig*:
 - 2> remove the measurement reporting entry for this *measId* from the *VarMeasReportList*, if included;
 - 2> stop the periodical reporting timer or timer T321, whichever one is running, and reset the associated information (e.g. *timeToTrigger*) for this *measId*;

5.5.2.9 Measurement gap configuration

The UE shall:

- 1> if *measGapConfig* is set to *setup*:
 - 2> if a measurement gap configuration is already setup, release the measurement gap configuration;
 - 2> setup the measurement gap configuration indicated by the *measGapConfig* in accordance with the received *gapOffset*, i.e., the first subframe of each gap occurs at an SFN and subframe meeting the following condition (SFN and subframe of MCG cells):

$$\text{SFN mod } T = \text{FLOOR}(\text{gapOffset}/10);$$

$$\text{subframe} = \text{gapOffset mod } 10;$$
 with $T = \text{MGRP}/10$ as defined in TS 36.133 [16];

NOTE: The UE applies a single gap, which timing is relative to the MCG cells, even when configured with DC.

- 1> else:
 - 2> release the measurement gap configuration;

5.5.2.10 Discovery signals measurement timing configuration

The UE shall setup the discovery signals measurement timing configuration (DMTC) in accordance with the received *dmtc-PeriodOffset*, i.e., the first subframe of each DMTC occasion occurs at an SFN and subframe of the PCell meeting the following condition:

- $$\text{SFN mod } T = \text{FLOOR}(\text{dmtc-Offset}/10);$$
- $$\text{subframe} = \text{dmtc-Offset mod } 10;$$
- with $T = \text{dmtc-Periodicity}/10$;

On the concerned frequency, the UE shall not consider discovery signals transmission in subframes outside the DMTC occasion.

5.5.3 Performing measurements

5.5.3.1 General

For all measurements the UE applies the layer 3 filtering as specified in 5.5.3.2, before using the measured results for evaluation of reporting criteria or for measurement reporting.

The UE shall:

- 1> whenever the UE has a *measConfig*, perform RSRP and RSRQ measurements for each serving cell as follows:

- 2> for the PCell, apply the time domain measurement resource restriction in accordance with *measSubframePatternPCell*, if configured;
- 2> if the UE supports CRS based discovery signals measurement:
 - 3> for each SCell in deactivated state, apply the discovery signals measurement timing configuration in accordance with *measDS-Config*, if configured within the *measObject* corresponding to the frequency of the SCell;
- 1> for each *measId* included in the *measIdList* within *VarMeasConfig*:
 - 2> if the *purpose* for the associated *reportConfig* is set to *reportCGI*:
 - 3> if *si-RequestForHO* is configured for the associated *reportConfig*:
 - 4> perform the corresponding measurements on the frequency and RAT indicated in the associated *measObject* using autonomous gaps as necessary;
 - 3> else:
 - 4> perform the corresponding measurements on the frequency and RAT indicated in the associated *measObject* using available idle periods or using autonomous gaps as necessary;

NOTE 1: If autonomous gaps are used to perform measurements, the UE is allowed to temporarily abort communication with all serving cell(s), i.e. create autonomous gaps to perform the corresponding measurements within the limits specified in TS 36.133 [16]. Otherwise, the UE only supports the measurements with the purpose set to *reportCGI* only if E-UTRAN has provided sufficient idle periods.

- 3> try to acquire the global cell identity of the cell indicated by the *cellForWhichToReportCGI* in the associated *measObject* by acquiring the relevant system information from the concerned cell;
- 3> if the cell indicated by the *cellForWhichToReportCGI* included in the associated *measObject* is an E-UTRAN cell:
 - 4> try to acquire the CSG identity, if the CSG identity is broadcast in the concerned cell;
 - 4> try to acquire the *trackingAreaCode* in the concerned cell;
 - 4> try to acquire the list of additional PLMN Identities, as included in the *plmn-IdentityList*, if multiple PLMN identities are broadcast in the concerned cell;

NOTE 2: The 'primary' PLMN is part of the global cell identity.

- 3> if the cell indicated by the *cellForWhichToReportCGI* included in the associated *measObject* is a UTRAN cell:
 - 4> try to acquire the LAC, the RAC and the list of additional PLMN Identities, if multiple PLMN identities are broadcast in the concerned cell;
 - 4> try to acquire the CSG identity, if the CSG identity is broadcast in the concerned cell;
- 3> if the cell indicated by the *cellForWhichToReportCGI* included in the associated *measObject* is a GERAN cell:
 - 4> try to acquire the RAC in the concerned cell;
- 3> if the cell indicated by the *cellForWhichToReportCGI* included in the associated *measObject* is a CDMA2000 cell and the *cdma2000-Type* included in the *measObject* is *typeHRPD*:
 - 4> try to acquire the Sector ID in the concerned cell;
- 3> if the cell indicated by the *cellForWhichToReportCGI* included in the associated *measObject* is a CDMA2000 cell and the *cdma2000-Type* included in the *measObject* is *type1XRTT*:
 - 4> try to acquire the BASE ID, SID and NID in the concerned cell;
- 2> else:

- 3> if a measurement gap configuration is setup; or
- 3> if the UE does not require measurement gaps to perform the concerned measurements:
 - 4> if *s-Measure* is not configured; or
 - 4> if *s-Measure* is configured and the PCell RSRP, after layer 3 filtering, is lower than this value; or
 - 4> if *measDS-Config* is configured in the associated *measObject*:
 - 5> if the UE supports CSI-RS based discovery signals measurement; and
 - 5> if the *eventId* in the associated *reportConfig* is set to *eventC1* or *eventC2*, or if *reportStrongestCSI-RSs* is included in the associated *reportConfig*:
 - 6> perform the corresponding measurements of CSI-RS resources on the frequency indicated in the concerned *measObject*, applying the discovery signals measurement timing configuration in accordance with *measDS-Config* in the concerned *measObject*;
 - 6> if *reportCRS-Meas* is included in the associated *reportConfig*, perform the corresponding measurements of neighbouring cells on the frequencies indicated in the concerned *measObject* as follows:
 - 7> for neighbouring cells on the primary frequency, apply the time domain measurement resource restriction in accordance with *measSubframePatternConfigNeigh*, if configured in the concerned *measObject*;
 - 7> apply the discovery signals measurement timing configuration in accordance with *measDS-Config* in the concerned *measObject*;
 - 5> else:
 - 6> perform the corresponding measurements of neighbouring cells on the frequencies and RATs indicated in the concerned *measObject* as follows:
 - 7> for neighbouring cells on the primary frequency, apply the time domain measurement resource restriction in accordance with *measSubframePatternConfigNeigh*, if configured in the concerned *measObject*;
 - 7> if the UE supports CRS based discovery signals measurement, apply the discovery signals measurement timing configuration in accordance with *measDS-Config*, if configured in the concerned *measObject*;
 - 4> if the *ue-RxTxTimeDiffPeriodical* is configured in the associated *reportConfig*:
 - 5> perform the UE Rx-Tx time difference measurements on the PCell;
- 2> perform the evaluation of reporting criteria as specified in 5.5.4;

NOTE 3: The *s-Measure* defines when the UE is required to perform measurements. The UE is however allowed to perform measurements also when the PCell RSRP exceeds *s-Measure*, e.g., to measure cells broadcasting a CSG identity following use of the autonomous search function as defined in TS 36.304 [4].

5.5.3.2 Layer 3 filtering

The UE shall:

- 1> for each measurement quantity that the UE performs measurements according to 5.5.3.1:

NOTE 1: This does not include quantities configured solely for UE Rx-Tx time difference measurements i.e. for those type of measurements the UE ignores the *triggerQuantity* and *reportQuantity*.

- 2> filter the measured result, before using for evaluation of reporting criteria or for measurement reporting, by the following formula:

$$F_n = (1 - a) \cdot F_{n-1} + a \cdot M_n$$

where

M_n is the latest received measurement result from the physical layer;

F_n is the updated filtered measurement result, that is used for evaluation of reporting criteria or for measurement reporting;

F_{n-1} is the old filtered measurement result, where F_0 is set to M_1 when the first measurement result from the physical layer is received; and

$a = 1/2^{(k/4)}$, where k is the *filterCoefficient* for the corresponding measurement quantity received by the *quantityConfig*;

- 2> adapt the filter such that the time characteristics of the filter are preserved at different input rates, observing that the *filterCoefficient* k assumes a sample rate equal to 200 ms;

NOTE 2: If k is set to 0, no layer 3 filtering is applicable.

NOTE 3: The filtering is performed in the same domain as used for evaluation of reporting criteria or for measurement reporting, i.e., logarithmic filtering for logarithmic measurements.

NOTE 4: The filter input rate is implementation dependent, to fulfil the performance requirements set in [16]. For further details about the physical layer measurements, see TS 36.133 [16].

5.5.4 Measurement report triggering

5.5.4.1 General

If security has been activated successfully, the UE shall:

- 1> for each *measId* included in the *measIdList* within *VarMeasConfig*:
 - 2> if the corresponding *reportConfig* includes a purpose set to *reportStrongestCellsForSON*:
 - 3> consider any neighbouring cell detected on the associated frequency to be applicable;
 - 2> else if the corresponding *reportConfig* includes a purpose set to *reportCGI*:
 - 3> consider any neighbouring cell detected on the associated frequency/ set of frequencies (GERAN) which has a physical cell identity matching the value of the *cellForWhichToReportCGI* included in the corresponding *measObject* within the *VarMeasConfig* to be applicable;
 - 2> else:
 - 3> if the corresponding *measObject* concerns E-UTRA:
 - 4> if the *ue-RxTxTimeDiffPeriodical* is configured in the corresponding *reportConfig*:
 - 5> consider only the PCell to be applicable;
 - 4> else if the *eventA1* or *eventA2* is configured in the corresponding *reportConfig*:
 - 5> consider only the serving cell to be applicable;
 - 4> else if *eventC1* or *eventC2* is configured in the corresponding *reportConfig*; or if *reportStrongestCSI-RSs* is included in the corresponding *reportConfig*:
 - 5> consider a CSI-RS resource on the associated frequency to be applicable when the concerned CSI-RS resource is included in the *measCSI-RS-ToAddModList* defined within the *VarMeasConfig* for this *measId*;
 - 4> else:
 - 5> consider any neighbouring cell detected on the associated frequency to be applicable when the concerned cell is not included in the *blackCellsToAddModList* defined within the *VarMeasConfig* for this *measId*;

- 5> for events involving a serving cell on one frequency and neighbours on another frequency, consider the serving cell on the other frequency as a neighbouring cell;
- 4> if the corresponding *reportConfig* includes *alternativeTimeToTrigger* and if the UE supports *alternativeTimeToTrigger*:
 - 5> use the value of *alternativeTimeToTrigger* as the time to trigger instead of the value of *timeToTrigger* in the corresponding *reportConfig* for cells included in the *altTTT-CellsToAddModList* of the corresponding *measObject*;
- 3> else if the corresponding *measObject* concerns UTRA or CDMA2000:
 - 4> consider a neighbouring cell on the associated frequency to be applicable when the concerned cell is included in the *cellsToAddModList* defined within the *VarMeasConfig* for this *measId* (i.e. the cell is included in the white-list);

NOTE 0: The UE may also consider a neighbouring cell on the associated UTRA frequency to be applicable when the concerned cell is included in the *csg-allowedReportingCells* within the *VarMeasConfig* for this *measId*, if configured in the corresponding *measObjectUTRA* (i.e. the cell is included in the range of physical cell identities for which reporting is allowed).

- 3> else if the corresponding *measObject* concerns GERAN:
 - 4> consider a neighbouring cell on the associated set of frequencies to be applicable when the concerned cell matches the *ncc-Permitted* defined within the *VarMeasConfig* for this *measId*;
- 2> if the *triggerType* is set to *event* and if the entry condition applicable for this event, i.e. the event corresponding with the *eventId* of the corresponding *reportConfig* within *VarMeasConfig*, is fulfilled for one or more applicable cells for all measurements after layer 3 filtering taken during *timeToTrigger* defined for this event within the *VarMeasConfig*, while the *VarMeasReportList* does not include an measurement reporting entry for this *measId* (a first cell triggers the event):
 - 3> include a measurement reporting entry within the *VarMeasReportList* for this *measId*;
 - 3> set the *numberOfReportsSent* defined within the *VarMeasReportList* for this *measId* to 0;
 - 3> include the concerned cell(s) in the *cellsTriggeredList* defined within the *VarMeasReportList* for this *measId*;
 - 3> if the UE supports T312 and if *useT312* is included for this event and if T310 is running:
 - 4> if T312 is not running:
 - 5> start timer T312 with the value configured in the corresponding *measObject*;
 - 3> initiate the measurement reporting procedure, as specified in 5.5.5;
- 2> if the *triggerType* is set to *event* and if the entry condition applicable for this event, i.e. the event corresponding with the *eventId* of the corresponding *reportConfig* within *VarMeasConfig*, is fulfilled for one or more applicable cells not included in the *cellsTriggeredList* for all measurements after layer 3 filtering taken during *timeToTrigger* defined for this event within the *VarMeasConfig* (a subsequent cell triggers the event):
 - 3> set the *numberOfReportsSent* defined within the *VarMeasReportList* for this *measId* to 0;
 - 3> include the concerned cell(s) in the *cellsTriggeredList* defined within the *VarMeasReportList* for this *measId*;
 - 3> if the UE supports T312 and if *useT312* is included for this event and if T310 is running:
 - 4> if T312 is not running:
 - 5> start timer T312 with the value configured in the corresponding *measObject*;
 - 3> initiate the measurement reporting procedure, as specified in 5.5.5;

- 2> if the *triggerType* is set to *event* and if the leaving condition applicable for this event is fulfilled for one or more of the cells included in the *cellsTriggeredList* defined within the *VarMeasReportList* for this *measId* for all measurements after layer 3 filtering taken during *timeToTrigger* defined within the *VarMeasConfig* for this event:
 - 3> remove the concerned cell(s) in the *cellsTriggeredList* defined within the *VarMeasReportList* for this *measId*;
 - 3> if the UE supports T312 and if *useT312* is included for this event and if T310 is running:
 - 4> if T312 is not running:
 - 5> start timer T312 with the value configured in the corresponding *measObject*;
 - 3> if *reportOnLeave* is set to *TRUE* for the corresponding reporting configuration or if *a6-ReportOnLeave* is set to *TRUE* for the corresponding reporting configuration:
 - 4> initiate the measurement reporting procedure, as specified in 5.5.5;
 - 3> if the *cellsTriggeredList* defined within the *VarMeasReportList* for this *measId* is empty:
 - 4> remove the measurement reporting entry within the *VarMeasReportList* for this *measId*;
 - 4> stop the periodical reporting timer for this *measId*, if running;
- 2> if the *triggerType* is set to *event* and if the entry condition applicable for this event, i.e. the event corresponding with the *eventId* of the corresponding *reportConfig* within *VarMeasConfig*, is fulfilled for one or more applicable CSI-RS resources for all measurements after layer 3 filtering taken during *timeToTrigger* defined for this event within the *VarMeasConfig*, while the *VarMeasReportList* does not include an measurement reporting entry for this *measId* (i.e. a first CSI-RS resource triggers the event):
 - 3> include a measurement reporting entry within the *VarMeasReportList* for this *measId*;
 - 3> set the *numberOfReportsSent* defined within the *VarMeasReportList* for this *measId* to 0;
 - 3> include the concerned CSI-RS resource(s) in the *csi-RS-TriggeredList* defined within the *VarMeasReportList* for this *measId*;
 - 3> initiate the measurement reporting procedure, as specified in 5.5.5;
- 2> if the *triggerType* is set to *event* and if the entry condition applicable for this event, i.e. the event corresponding with the *eventId* of the corresponding *reportConfig* within *VarMeasConfig*, is fulfilled for one or more applicable CSI-RS resources not included in the *csi-RS-TriggeredList* for all measurements after layer 3 filtering taken during *timeToTrigger* defined for this event within the *VarMeasConfig* (i.e. a subsequent CSI-RS resource triggers the event):
 - 3> set the *numberOfReportsSent* defined within the *VarMeasReportList* for this *measId* to 0;
 - 3> include the concerned CSI-RS resource(s) in the *csi-RS-TriggeredList* defined within the *VarMeasReportList* for this *measId*;
 - 3> initiate the measurement reporting procedure, as specified in 5.5.5;
- 2> if the *triggerType* is set to *event* and if the leaving condition applicable for this event is fulfilled for one or more of the CSI-RS resources included in the *csi-RS-TriggeredList* defined within the *VarMeasReportList* for this *measId* for all measurements after layer 3 filtering taken during *timeToTrigger* defined within the *VarMeasConfig* for this event:
 - 3> remove the concerned CSI-RS resource(s) in the *csi-RS-TriggeredList* defined within the *VarMeasReportList* for this *measId*;
 - 3> if *c1-ReportOnLeave* is set to *TRUE* for the corresponding reporting configuration or if *c2-ReportOnLeave* is set to *TRUE* for the corresponding reporting configuration:
 - 4> initiate the measurement reporting procedure, as specified in 5.5.5;
 - 3> if the *csi-RS-TriggeredList* defined within the *VarMeasReportList* for this *measId* is empty:

- 4> remove the measurement reporting entry within the *VarMeasReportList* for this *measId*;
- 4> stop the periodical reporting timer for this *measId*, if running;
- 2> if the *purpose* is included and set to *reportStrongestCells* or to *reportStrongestCellsForSON* and if a (first) measurement result is available:
 - 3> include a measurement reporting entry within the *VarMeasReportList* for this *measId*;
 - 3> set the *numberOfReportsSent* defined within the *VarMeasReportList* for this *measId* to 0;
 - 3> initiate the measurement reporting procedure, as specified in 5.5.5;

NOTE 1: If the *purpose* is set to *reportStrongestCells* and *reportStrongestCSI-RSs* is not included and *reportAmount* > 1, the UE initiates a first measurement report immediately after the quantity to be reported becomes available for the PCell. If the *purpose* is set to *reportStrongestCells* and *reportStrongestCSI-RSs* is not included and *reportAmount* = 1, the UE initiates a first measurement report immediately after the quantity to be reported becomes available for the PCell and for the strongest cell among the applicable cells. If the *purpose* is set to *reportStrongestCellsForSON*, the UE initiates a first measurement report when it has determined the strongest cells on the associated frequency.

- 2> upon expiry of the periodical reporting timer for this *measId*:
 - 3> initiate the measurement reporting procedure, as specified in 5.5.5;
- 2> if the *purpose* is included and set to *reportCGI* and if the UE acquired the information needed to set all fields of *cgi-Info* for the requested cell:
 - 3> include a measurement reporting entry within the *VarMeasReportList* for this *measId*;
 - 3> set the *numberOfReportsSent* defined within the *VarMeasReportList* for this *measId* to 0;
 - 3> stop timer T321;
 - 3> initiate the measurement reporting procedure, as specified in 5.5.5;
- 2> upon expiry of the T321 for this *measId*:
 - 3> include a measurement reporting entry within the *VarMeasReportList* for this *measId*;
 - 3> set the *numberOfReportsSent* defined within the *VarMeasReportList* for this *measId* to 0;
 - 3> initiate the measurement reporting procedure, as specified in 5.5.5;

NOTE 2: The UE does not stop the periodical reporting with *triggerType* set to *event* or to *periodical* while the corresponding measurement is not performed due to the PCell RSRP being equal to or better than *s-Measure* or due to the measurement gap not being setup.

NOTE 3: If the UE is configured with DRX, the UE may delay the measurement reporting for event triggered and periodical triggered measurements until the Active Time, which is defined in TS 36.321 [6].

5.5.4.2 Event A1 (Serving becomes better than threshold)

The UE shall:

- 1> consider the entering condition for this event to be satisfied when condition A1-1, as specified below, is fulfilled;
- 1> consider the leaving condition for this event to be satisfied when condition A1-2, as specified below, is fulfilled;
- 1> for this measurement, consider the primary or secondary cell that is configured on the frequency indicated in the associated *measObjectEUTRA* to be the serving cell;

Inequality A1-1 (Entering condition)

$$Ms - Hys > Thresh$$

Inequality A1-2 (Leaving condition)

$$Ms + Hys < Thresh$$

The variables in the formula are defined as follows:

Ms is the measurement result of the serving cell, not taking into account any offsets.

Hys is the hysteresis parameter for this event (i.e. *hysteresis* as defined within *reportConfigEUTRA* for this event).

Thresh is the threshold parameter for this event (i.e. *a1-Threshold* as defined within *reportConfigEUTRA* for this event).

Ms is expressed in dBm in case of RSRP, or in dB in case of RSRQ.

Hys is expressed in dB.

Thresh is expressed in the same unit as ***Ms***.

5.5.4.3 Event A2 (Serving becomes worse than threshold)

The UE shall:

- 1> consider the entering condition for this event to be satisfied when condition A2-1, as specified below, is fulfilled;
- 1> consider the leaving condition for this event to be satisfied when condition A2-2, as specified below, is fulfilled;
- 1> for this measurement, consider the primary or secondary cell that is configured on the frequency indicated in the associated *measObjectEUTRA* to be the serving cell;

Inequality A2-1 (Entering condition)

$$Ms + Hys < Thresh$$

Inequality A2-2 (Leaving condition)

$$Ms - Hys > Thresh$$

The variables in the formula are defined as follows:

Ms is the measurement result of the serving cell, not taking into account any offsets.

Hys is the hysteresis parameter for this event (i.e. *hysteresis* as defined within *reportConfigEUTRA* for this event).

Thresh is the threshold parameter for this event (i.e. *a2-Threshold* as defined within *reportConfigEUTRA* for this event).

Ms is expressed in dBm in case of RSRP, or in dB in case of RSRQ.

Hys is expressed in dB.

Thresh is expressed in the same unit as ***Ms***.

5.5.4.4 Event A3 (Neighbour becomes offset better than PCell/ PSCell)

The UE shall:

- 1> consider the entering condition for this event to be satisfied when condition A3-1, as specified below, is fulfilled;
- 1> consider the leaving condition for this event to be satisfied when condition A3-2, as specified below, is fulfilled;
- 1> if *usePSCell* of the corresponding *reportConfig* is set to *true*:
 - 2> use the PSCell for *Mp*, *Ofp* and *Ocp*;
- 1> else:
 - 2> use the PCell for *Mp*, *Ofp* and *Ocp*;

NOTE The cell(s) that triggers the event is on the frequency indicated in the associated *measObject* which may be different from the frequency used by the PCell/ PSCell.

Inequality A3-1 (Entering condition)

$$Mn + Ofn + Ocn - Hys > Mp + Ofp + Ocp + Off$$

Inequality A3-2 (Leaving condition)

$$Mn + Ofn + Ocn + Hys < Mp + Ofp + Ocp + Off$$

The variables in the formula are defined as follows:

Mn is the measurement result of the neighbouring cell, not taking into account any offsets.

Ofn is the frequency specific offset of the frequency of the neighbour cell (i.e. *offsetFreq* as defined within *measObjectEUTRA* corresponding to the frequency of the neighbour cell).

Ocn is the cell specific offset of the neighbour cell (i.e. *cellIndividualOffset* as defined within *measObjectEUTRA* corresponding to the frequency of the neighbour cell), and set to zero if not configured for the neighbour cell.

Mp is the measurement result of the PCell/ PSCell, not taking into account any offsets.

Ofp is the frequency specific offset of the frequency of the PCell/ PSCell (i.e. *offsetFreq* as defined within *measObjectEUTRA* corresponding to the frequency of the PCell/ PSCell).

Ocp is the cell specific offset of the PCell/ PSCell (i.e. *cellIndividualOffset* as defined within *measObjectEUTRA* corresponding to the frequency of the PCell/ PSCell), and is set to zero if not configured for the PCell/ PSCell.

Hys is the hysteresis parameter for this event (i.e. *hysteresis* as defined within *reportConfigEUTRA* for this event).

Off is the offset parameter for this event (i.e. *a3-Offset* as defined within *reportConfigEUTRA* for this event).

Mn, Mp are expressed in dBm in case of RSRP, or in dB in case of RSRQ.

Ofn, Ocn, Ofp, Ocp, Hys, Off are expressed in dB.

5.5.4.5 Event A4 (Neighbour becomes better than threshold)

The UE shall:

1> consider the entering condition for this event to be satisfied when condition A4-1, as specified below, is fulfilled;

1> consider the leaving condition for this event to be satisfied when condition A4-2, as specified below, is fulfilled;

Inequality A4-1 (Entering condition)

$$Mn + Ofn + Ocn - Hys > Thresh$$

Inequality A4-2 (Leaving condition)

$$Mn + Ofn + Ocn + Hys < Thresh$$

The variables in the formula are defined as follows:

Mn is the measurement result of the neighbouring cell, not taking into account any offsets.

Ofn is the frequency specific offset of the frequency of the neighbour cell (i.e. *offsetFreq* as defined within *measObjectEUTRA* corresponding to the frequency of the neighbour cell).

Ocn is the cell specific offset of the neighbour cell (i.e. *cellIndividualOffset* as defined within *measObjectEUTRA* corresponding to the frequency of the neighbour cell), and set to zero if not configured for the neighbour cell.

Hys is the hysteresis parameter for this event (i.e. *hysteresis* as defined within *reportConfigEUTRA* for this event).

Thresh is the threshold parameter for this event (i.e. *a4-Threshold* as defined within *reportConfigEUTRA* for this event).

Mn is expressed in dBm in case of RSRP, or in dB in case of RSRQ.

Ofn, Ocn, Hys are expressed in dB.

Thresh is expressed in the same unit as *Mn*.

5.5.4.6 Event A5 (PCell/ PSCell becomes worse than threshold1 and neighbour becomes better than threshold2)

The UE shall:

- 1> consider the entering condition for this event to be satisfied when both condition A5-1 and condition A5-2, as specified below, are fulfilled;
- 1> consider the leaving condition for this event to be satisfied when condition A5-3 or condition A5-4, i.e. at least one of the two, as specified below, is fulfilled;
- 1> if *usePSCell* of the corresponding *reportConfig* is set to *true*:
 - 2> use the PSCell for *Mp*;
- 1> else:
 - 2> use the PCell for *Mp*;

NOTE: The cell(s) that triggers the event is on the frequency indicated in the associated *measObject* which may be different from the frequency used by the PCell/ PSCell.

Inequality A5-1 (Entering condition 1)

$$Mp + Hys < Thresh1$$

Inequality A5-2 (Entering condition 2)

$$Mn + Ofn + Ocn - Hys > Thresh2$$

Inequality A5-3 (Leaving condition 1)

$$Mp - Hys > Thresh1$$

Inequality A5-4 (Leaving condition 2)

$$Mn + Ofn + Ocn + Hys < Thresh2$$

The variables in the formula are defined as follows:

Mp is the measurement result of the PCell/ PSCell, not taking into account any offsets.

Mn is the measurement result of the neighbouring cell, not taking into account any offsets.

Ofn is the frequency specific offset of the frequency of the neighbour cell (i.e. *offsetFreq* as defined within *measObjectEUTRA* corresponding to the frequency of the neighbour cell).

Ocn is the cell specific offset of the neighbour cell (i.e. *cellIndividualOffset* as defined within *measObjectEUTRA* corresponding to the frequency of the neighbour cell), and set to zero if not configured for the neighbour cell.

Hys is the hysteresis parameter for this event (i.e. *hysteresis* as defined within *reportConfigEUTRA* for this event).

Thresh1 is the threshold parameter for this event (i.e. *a5-Threshold1* as defined within *reportConfigEUTRA* for this event).

Thresh2 is the threshold parameter for this event (i.e. *a5-Threshold2* as defined within *reportConfigEUTRA* for this event).

Mn, Mp are expressed in dBm in case of RSRP, or in dB in case of RSRQ.

Ofn, Ocn, Hys are expressed in dB.

Thresh1 is expressed in the same unit as *Mp*.

Thresh2 is expressed in the same unit as *Mn*.

5.5.4.6a Event A6 (Neighbour becomes offset better than SCell)

The UE shall:

- 1> consider the entering condition for this event to be satisfied when condition A6-1, as specified below, is fulfilled;
- 1> consider the leaving condition for this event to be satisfied when condition A6-2, as specified below, is fulfilled;
- 1> for this measurement, consider the (secondary) cell that is configured on the frequency indicated in the associated *measObjectEUTRA* to be the serving cell;

NOTE: The neighbour(s) is on the same frequency as the SCell i.e. both are on the frequency indicated in the associated *measObject*.

Inequality A6-1 (Entering condition)

$$Mn + Ocn - Hys > Ms + Ocs + Off$$

Inequality A6-2 (Leaving condition)

$$Mn + Ocn + Hys < Ms + Ocs + Off$$

The variables in the formula are defined as follows:

Mn is the measurement result of the neighbouring cell, not taking into account any offsets.

Ocn is the cell specific offset of the neighbour cell (i.e. *cellIndividualOffset* as defined within *measObjectEUTRA* corresponding to the frequency of the neighbour cell), and set to zero if not configured for the neighbour cell.

Ms is the measurement result of the serving cell, not taking into account any offsets.

Ocs is the cell specific offset of the serving cell (i.e. *cellIndividualOffset* as defined within *measObjectEUTRA* corresponding to the serving frequency), and is set to zero if not configured for the serving cell.

Hys is the hysteresis parameter for this event (i.e. *hysteresis* as defined within *reportConfigEUTRA* for this event).

Off is the offset parameter for this event (i.e. *a6-Offset* as defined within *reportConfigEUTRA* for this event).

Mn, *Ms* are expressed in dBm in case of RSRP, or in dB in case of RSRQ.

Ocn, *Ocs*, *Hys*, *Off* are expressed in dB.

5.5.4.7 Event B1 (Inter RAT neighbour becomes better than threshold)

The UE shall:

- 1> for UTRA and CDMA2000, only trigger the event for cells included in the corresponding measurement object;
- 1> consider the entering condition for this event to be satisfied when condition B1-1, as specified below, is fulfilled;
- 1> consider the leaving condition for this event to be satisfied when condition B1-2, as specified below, is fulfilled;

Inequality B1-1 (Entering condition)

$$Mn + Ofn - Hys > Thresh$$

Inequality B1-2 (Leaving condition)

$$Mn + Ofn + Hys < Thresh$$

The variables in the formula are defined as follows:

Mn is the measurement result of the inter-RAT neighbour cell, not taking into account any offsets. For CDMA 2000 measurement result, *pilotStrength* is divided by -2.

Ofn is the frequency specific offset of the frequency of the inter-RAT neighbour cell (i.e. *offsetFreq* as defined within the *measObject* corresponding to the frequency of the neighbour inter-RAT cell).

Hys is the hysteresis parameter for this event (i.e. *hysteresis* as defined within *reportConfigInterRAT* for this event).

Thresh is the threshold parameter for this event (i.e. *b1-Threshold* as defined within *reportConfigInterRAT* for this event). For CDMA2000, *b1-Threshold* is divided by -2.

Mn is expressed in dBm or in dB, depending on the measurement quantity of the inter-RAT neighbour cell.

Ofn*, *Hys are expressed in dB.

Thresh is expressed in the same unit as ***Mn***.

5.5.4.8 Event B2 (PCell becomes worse than threshold1 and inter RAT neighbour becomes better than threshold2)

The UE shall:

- 1> for UTRA and CDMA2000, only trigger the event for cells included in the corresponding measurement object;
- 1> consider the entering condition for this event to be satisfied when both condition B2-1 and condition B2-2, as specified below, are fulfilled;
- 1> consider the leaving condition for this event to be satisfied when condition B2-3 or condition B2-4, i.e. at least one of the two, as specified below, is fulfilled;

Inequality B2-1 (Entering condition 1)

$$M_p + Hys < Thresh1$$

Inequality B2-2 (Entering condition 2)

$$M_n + Ofn - Hys > Thresh2$$

Inequality B2-3 (Leaving condition 1)

$$M_p - Hys > Thresh1$$

Inequality B2-4 (Leaving condition 2)

$$M_n + Ofn + Hys < Thresh2$$

The variables in the formula are defined as follows:

Mp is the measurement result of the PCell, not taking into account any offsets.

Mn is the measurement result of the inter-RAT neighbour cell, not taking into account any offsets. For CDMA2000 measurement result, *pilotStrength* is divided by -2.

Ofn is the frequency specific offset of the frequency of the inter-RAT neighbour cell (i.e. *offsetFreq* as defined within the *measObject* corresponding to the frequency of the inter-RAT neighbour cell).

Hys is the hysteresis parameter for this event (i.e. *hysteresis* as defined within *reportConfigInterRAT* for this event).

Thresh1 is the threshold parameter for this event (i.e. *b2-Threshold1* as defined within *reportConfigInterRAT* for this event).

Thresh2 is the threshold parameter for this event (i.e. *b2-Threshold2* as defined within *reportConfigInterRAT* for this event). For CDMA2000, *b2-Threshold2* is divided by -2.

Mp is expressed in dBm in case of RSRP, or in dB in case of RSRQ.

Mn is expressed in dBm or dB, depending on the measurement quantity of the inter-RAT neighbour cell.

Ofn, *Hys* are expressed in dB.

Thresh1 is expressed in the same unit as *Mp*.

Thresh2 is expressed in the same unit as *Mn*.

5.5.4.9 Event C1 (CSI-RS resource becomes better than threshold)

The UE shall:

1> consider the entering condition for this event to be satisfied when condition C1-1, as specified below, is fulfilled;

1> consider the leaving condition for this event to be satisfied when condition C1-2, as specified below, is fulfilled;

Inequality C1-1 (Entering condition)

$$Mcr + Ocr - Hys > Thresh$$

Inequality C1-2 (Leaving condition)

$$Mcr + Ocr + Hys < Thresh$$

The variables in the formula are defined as follows:

Mcr is the measurement result of the CSI-RS resource, not taking into account any offsets.

Ocr is the CSI-RS specific offset (i.e. *csi-RS-IndividualOffset* as defined within *measObjectEUTRA* corresponding to the frequency of the CSI-RS resource), and set to zero if not configured for the CSI-RS resource.

Hys is the hysteresis parameter for this event (i.e. *hysteresis* as defined within *reportConfigEUTRA* for this event).

Thresh is the threshold parameter for this event (i.e. *c1-Threshold* as defined within *reportConfigEUTRA* for this event).

Mcr, *Thresh* are expressed in dBm.

Ocr, *Hys* are expressed in dB.

5.5.4.10 Event C2 (CSI-RS resource becomes offset better than reference CSI-RS resource)

The UE shall:

1> consider the entering condition for this event to be satisfied when condition C2-1, as specified below, is fulfilled;

1> consider the leaving condition for this event to be satisfied when condition C2-2, as specified below, is fulfilled;

NOTE: The CSI-RS resource(s) that triggers the event is on the same frequency as the reference CSI-RS resource, i.e. both are on the frequency indicated in the associated *measObject*.

Inequality C2-1 (Entering condition)

$$Mcr + Ocr - Hys > Mref + Oref + Off$$

Inequality C2-2 (Leaving condition)

$$Mcr + Ocr + Hys < Mref + Oref + Off$$

The variables in the formula are defined as follows:

Mcr is the measurement result of the CSI-RS resource, not taking into account any offsets.

Ocr is the CSI-RS specific offset of the CSI-RS resource (i.e. *csi-RS-IndividualOffset* as defined within *measObjectEUTRA* corresponding to the frequency of the CSI-RS resource), and set to zero if not configured for the CSI-RS resource.

Mref is the measurement result of the reference CSI-RS resource (i.e. *c2-RefCSI-RS* as defined within *reportConfigEUTRA* for this event), not taking into account any offsets.

Oref is the CSI-RS specific offset of the reference CSI-RS resource (i.e. *csi-RS-IndividualOffset* as defined within *measObjectEUTRA* corresponding to the frequency of the reference CSI-RS resource), and is set to zero if not configured for the reference CSI-RS resource.

Hys is the hysteresis parameter for this event (i.e. *hysteresis* as defined within *reportConfigEUTRA* for this event).

Off is the offset parameter for this event (i.e. *c2-Offset* as defined within *reportConfigEUTRA* for this event).

Mcr, ***Mref*** are expressed in dBm.

Ocr, ***Oref***, ***Hys***, ***Off*** are expressed in dB.

5.5.5 Measurement reporting

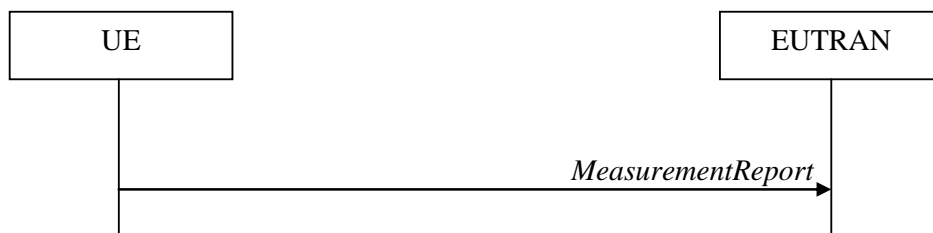

Figure 5.5.5-1: Measurement reporting

The purpose of this procedure is to transfer measurement results from the UE to E-UTRAN. The UE shall initiate this procedure only after successful security activation.

For the *measId* for which the measurement reporting procedure was triggered, the UE shall set the *measResults* within the *MeasurementReport* message as follows:

- 1> set the *measId* to the measurement identity that triggered the measurement reporting;
- 1> set the *measResultPCell* to include the quantities of the PCell;
- 1> set the *measResultServFreqList* to include for each SCell that is configured, if any, within *measResultSCell* the quantities of the concerned SCell, if available according to performance requirements in [16];
- 1> if the *reportConfig* associated with the *measId* that triggered the measurement reporting includes *reportAddNeighMeas*:
 - 2> for each serving frequency for which *measObjectId* is referenced in the *measIdList*, other than the frequency corresponding with the *measId* that triggered the measurement reporting:
 - 3> set the *measResultServFreqList* to include within *measResultBestNeighCell* the *physCellId* and the quantities of the best non-serving cell, based on RSRP, on the concerned serving frequency;
- 1> if there is at least one applicable neighbouring cell to report:
 - 2> set the *measResultNeighCells* to include the best neighbouring cells up to *maxReportCells* in accordance with the following:
 - 3> if the *triggerType* is set to *event*:
 - 4> include the cells included in the *cellsTriggeredList* as defined within the *VarMeasReportList* for this *measId*;
 - 3> else:
 - 4> include the applicable cells for which the new measurement results became available since the last periodical reporting or since the measurement was initiated or reset;

NOTE 1: The reliability of the report (i.e. the certainty it contains the strongest cells on the concerned frequency) depends on the measurement configuration i.e. the *reportInterval*. The related performance requirements are specified in TS 36.133 [16].

- 3> for each cell that is included in the *measResultNeighCells*, include the *physCellId*;
- 3> if the *triggerType* is set to *event*; or the *purpose* is set to *reportStrongestCells* or to *reportStrongestCellsForSON*:
 - 4> for each included cell, include the layer 3 filtered measured results in accordance with the *reportConfig* for this *measId*, ordered as follows:
 - 5> if the *measObject* associated with this *measId* concerns E-UTRA:
 - 6> set the *measResult* to include the quantity(ies) indicated in the *reportQuantity* within the concerned *reportConfig* in order of decreasing *triggerQuantity*, i.e. the best cell is included first;
 - 5> if the *measObject* associated with this *measId* concerns UTRA FDD and if *ReportConfigInterRAT* includes the *reportQuantityUTRA-FDD*:
 - 6> set the *measResult* to include the quantities indicated by the *reportQuantityUTRA-FDD* in order of decreasing *measQuantityUTRA-FDD* within the *quantityConfig*, i.e. the best cell is included first;
 - 5> if the *measObject* associated with this *measId* concerns UTRA FDD and if *ReportConfigInterRAT* does not include the *reportQuantityUTRA-FDD*; or
 - 5> if the *measObject* associated with this *measId* concerns UTRA TDD, GERAN or CDMA2000:
 - 6> set the *measResult* to the quantity as configured for the concerned RAT within the *quantityConfig* in order of either decreasing quantity for UTRA and GERAN or increasing quantity for CDMA2000 *pilotStrength*, i.e. the best cell is included first;
 - 3> else if the *purpose* is set to *reportCGI*:
 - 4> if the mandatory present fields of the *cgi-Info* for the cell indicated by the *cellForWhichToReportCGI* in the associated *measObject* have been obtained:
 - 5> if the cell broadcasts a CSG identity:
 - 6> include the *csg-Identity*;
 - 6> include the *csg-MemberStatus* and set it to *member* if the cell is a CSG member cell;
 - 5> if the *si-RequestForHO* is configured within the *reportConfig* associated with this *measId*:
 - 6> include the *cgi-Info* containing all the fields other than the *plmn-IdentityList* that have been successfully acquired;
 - 6> include, within the *cgi-Info*, the field *plmn-IdentityList* in accordance with the following:
 - 7> if the cell is a CSG member cell, determine the subset of the PLMN identities, starting from the second entry of PLMN identities in the broadcast information, that meet the following conditions:
 - a) equal to the RPLMN or an EPLMN; and
 - b) the CSG whitelist of the UE includes an entry comprising of the concerned PLMN identity and the CSG identity broadcast by the cell;
 - 7> if the subset of PLMN identities determined according to the previous includes at least one PLMN identity, include the *plmn-IdentityList* and set it to include this subset of the PLMN identities;
 - 7> if the cell is a CSG member cell, include the *primaryPLMN-Suitable* if the primary PLMN meets conditions a) and b) specified above;

5> else:

6> include the *cgi-Info* containing all the fields that have been successfully acquired and in accordance with the following:

7> include in the *plmn-IdentityList* the list of identities starting from the second entry of PLMN Identities in the broadcast information;

1> for the cells included according to the previous (i.e. covering the PCell, the SCells, the best non-serving cells on serving frequencies as well as neighbouring EUTRA cells) include results according to the extended RSRQ if corresponding results are available according to the associated performance requirements defined in 36.133 [16];

1> if there is at least one applicable CSI-RS resource to report:

2> set the *measResultCSI-RS-List* to include the best CSI-RS resources up to *maxReportCells* in accordance with the following:

3> if the *triggerType* is set to *event*:

4> include the CSI-RS resources included in the *csi-RS-TriggeredList* as defined within the *VarMeasReportList* for this *measId*;

3> else:

4> include the applicable CSI-RS resources for which the new measurement results became available since the last periodical reporting or since the measurement was initiated or reset;

NOTE 2: The reliability of the report (i.e. the certainty it contains the strongest CSI-RS resources on the concerned frequency) depends on the measurement configuration i.e. the *reportInterval*. The related performance requirements are specified in TS 36.133 [16].

3> for each CSI-RS resource that is included in the *measResultCSI-RS-List*:

4> include the *measCSI-RS-Id*;

4> include the layer 3 filtered measured results in accordance with the *reportConfig* for this *measId*, ordered as follow:

5> set the *csi-RSRP-Result* to include the quantity indicated in the *reportQuantity* within the concerned *reportConfig* in order of decreasing *triggerQuantityCSI-RS*, i.e. the best CSI-RS resource is included first;

4> if *reportCRS-Meas* is included within the associated *reportConfig*, and the cell indicated by *physCellId* of this CSI-RS resource is not a serving cell:

5> set the *measResultNeighCells* to include the cell indicated by *physCellId* of this CSI-RS resource, and include the *physCellId*;

5> set the *rsrpResult* to include the RSRP of the concerned cell, if available according to performance requirements in [16];

5> set the *rsrqResult* to include the RSRQ of the concerned cell, if available according to performance requirements in [16];

1> if the *ue-RxTxTimeDiffPeriodical* is configured within the corresponding *reportConfig* for this *measId*;

2> set the *ue-RxTxTimeDiffResult* to the measurement result provided by lower layers;

2> set the *currentSFN*;

1> if the *includeLocationInfo* is configured in the corresponding *reportConfig* for this *measId* and detailed location information that has not been reported is available, set the content of the *locationInfo* as follows:

2> include the *locationCoordinates*;

2> if available, include the *gnss-TOD-msec*;

- 1> increment the *numberOfReportsSent* as defined within the *VarMeasReportList* for this *measId* by 1;
- 1> stop the periodical reporting timer, if running;
- 1> if the *numberOfReportsSent* as defined within the *VarMeasReportList* for this *measId* is less than the *reportAmount* as defined within the corresponding *reportConfig* for this *measId*:
 - 2> start the periodical reporting timer with the value of *reportInterval* as defined within the corresponding *reportConfig* for this *measId*;
- 1> else:
 - 2> if the *triggerType* is set to *periodical*:
 - 3> remove the entry within the *VarMeasReportList* for this *measId*;
 - 3> remove this *measId* from the *measIdList* within *VarMeasConfig*;
- 1> if the measured results are for CDMA2000 HRPD:
 - 2> set the *preRegistrationStatusHRPD* to the UE's CDMA2000 upper layer's HRPD *preRegistrationStatus*;
- 1> if the measured results are for CDMA2000 1xRTT:
 - 2> set the *preRegistrationStatusHRPD* to *FALSE*;
- 1> submit the *MeasurementReport* message to lower layers for transmission, upon which the procedure ends;

5.5.6 Measurement related actions

5.5.6.1 Actions upon handover and re-establishment

E-UTRAN applies the handover procedure as follows:

- when performing the handover procedure, as specified in 5.3.5.4, ensure that a *measObjectId* corresponding to each handover target serving frequency is configured as a result of the procedures described in this sub-clause and in 5.3.5.4;
- when changing the band while the physical frequency remains unchanged, E-UTRAN releases the *measObject* corresponding to the source frequency and adds a *measObject* corresponding to the target frequency (i.e. it does not reconfigure the *measObject*);

E-UTRAN applies the re-establishment procedure as follows:

- when performing the connection re-establishment procedure, as specified in 5.3.7, ensure that a *measObjectId* corresponding each target serving frequency is configured as a result of the procedure described in this sub-clause and the subsequent connection reconfiguration procedure immediately following the re-establishment procedure;
- in the first reconfiguration following the re-establishment when changing the band while the physical frequency remains unchanged, E-UTRAN releases the *measObject* corresponding to the source frequency and adds a *measObject* corresponding to the target frequency (i.e. it does not reconfigure the *measObject*);

The UE shall:

- 1> for each *measId* included in the *measIdList* within *VarMeasConfig*:
 - 2> if the *triggerType* is set to *periodical*:
 - 3> remove this *measId* from the *measIdList* within *VarMeasConfig*;
- 1> if the procedure was triggered due to a handover or successful re-establishment and the procedure involves a change of primary frequency, update the *measId* values in the *measIdList* within *VarMeasConfig* as follows:
 - 2> if a *measObjectId* value corresponding to the target primary frequency exists in the *measObjectList* within *VarMeasConfig*:

- 3> for each *measId* value in the *measIdList*:
 - 4> if the *measId* value is linked to the *measObjectId* value corresponding to the source primary frequency:
 - 5> link this *measId* value to the *measObjectId* value corresponding to the target primary frequency;
 - 4> else if the *measId* value is linked to the *measObjectId* value corresponding to the target primary frequency:
 - 5> link this *measId* value to the *measObjectId* value corresponding to the source primary frequency;
- 2> else:
 - 3> remove all *measId* values that are linked to the *measObjectId* value corresponding to the source primary frequency;
- 1> remove all measurement reporting entries within *VarMeasReportList*;
- 1> stop the periodical reporting timer or timer T321, whichever one is running, as well as associated information (e.g. *timeToTrigger*) for all *measId*;
- 1> release the measurement gaps, if activated;

NOTE: If the UE requires measurement gaps to perform inter-frequency or inter-RAT measurements, the UE resumes the inter-frequency and inter-RAT measurements after the E-UTRAN has setup the measurement gaps.

5.5.6.2 Speed dependant scaling of measurement related parameters

The UE shall adjust the value of the following parameter configured by the E-UTRAN depending on the UE speed: *timeToTrigger*. The UE shall apply 3 different levels, which are selected as follows:

The UE shall:

- 1> perform mobility state detection using the mobility state detection as specified in TS 36.304 [4] with the following modifications:
 - 2> counting handovers instead of cell reselections;
 - 2> applying the parameter applicable for RRC_CONNECTED as included in *speedStatePars* within *VarMeasConfig*;
- 1> if high mobility state is detected:
 - 2> use the *timeToTrigger* value multiplied by *sf-High* within *VarMeasConfig*;
- 1> else if medium mobility state is detected:
 - 2> use the *timeToTrigger* value multiplied by *sf-Medium* within *VarMeasConfig*;
- 1> else:
 - 2> no scaling is applied;

5.5.7 Inter-frequency RSTD measurement indication

5.5.7.1 General

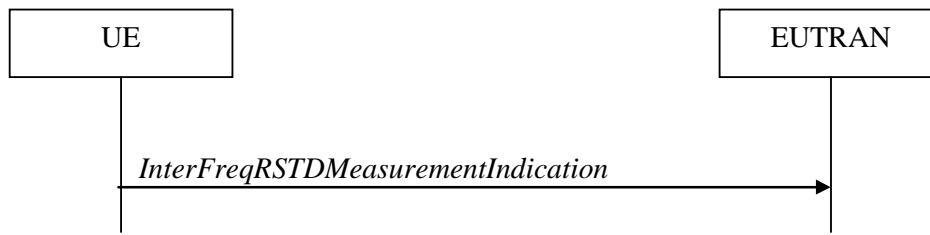

Figure 5.5.7.1-1: Inter-frequency RSTD measurement indication

The purpose of this procedure is to indicate to the network that the UE is going to start/stop OTDOA inter-frequency RSTD measurements which require measurement gaps as specified in [16, 8.1.2.6].

NOTE: It is a network decision to configure the measurement gap.

5.5.7.2 Initiation

The UE shall:

- 1> if and only if upper layers indicate to start performing inter-frequency RSTD measurements and the UE requires measurement gaps for these measurements while measurement gaps are either not configured or not sufficient:
 - 2> initiate the procedure to indicate start;

NOTE 1: The UE verifies the measurement gap situation only upon receiving the indication from upper layers. If at this point in time sufficient gaps are available, the UE does not initiate the procedure. Unless it receives a new indication from upper layers, the UE is only allowed to further repeat the procedure in the same PCell once per frequency if the provided measurement gaps are insufficient.

- 1> if and only if upper layers indicate to stop performing inter-frequency RSTD measurements:
 - 2> initiate the procedure to indicate stop;

NOTE 2: The UE may initiate the procedure to indicate stop even if it did not previously initiate the procedure to indicate start.

5.5.7.3 Actions related to transmission of *InterFreqRSTDMeasurementIndication* message

The UE shall set the contents of *InterFreqRSTDMeasurementIndication* message as follows:

- 1> set the *rstd-InterFreqIndication* as follows:
 - 2> if the procedure is initiated to indicate start of inter-frequency RSTD measurements:
 - 3> set the *rstd-InterFreqInfoList* according to the information received from upper layers;
 - 2> else if the procedure is initiated to indicate stop of inter-frequency RSTD measurements:
 - 3> set the *rstd-InterFreqIndication* to the value *stop*;
- 1> submit the *InterFreqRSTDMeasurementIndication* message to lower layers for transmission, upon which the procedure ends;

5.6 Other

5.6.1 DL information transfer

5.6.1.1 General

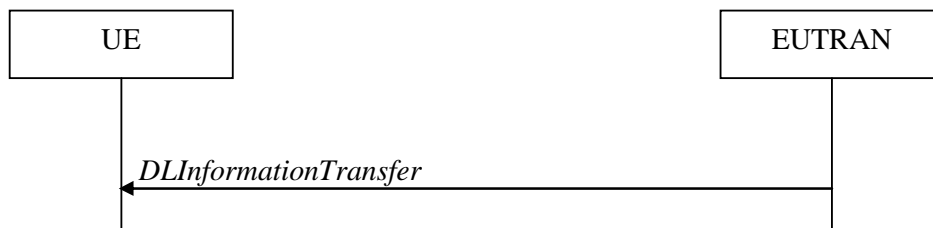

Figure 5.6.1.1-1: DL information transfer

The purpose of this procedure is to transfer NAS or (tunnelled) non-3GPP dedicated information from E-UTRAN to a UE in RRC_CONNECTED.

5.6.1.2 Initiation

E-UTRAN initiates the DL information transfer procedure whenever there is a need to transfer NAS or non-3GPP dedicated information. E-UTRAN initiates the DL information transfer procedure by sending the *DLInformationTransfer* message.

5.6.1.3 Reception of the *DLInformationTransfer* by the UE

Upon receiving *DLInformationTransfer* message, the UE shall:

- 1> if the *dedicatedInfoType* is set to *dedicatedInfoNAS*:
 - 2> forward the *dedicatedInfoNAS* to the NAS upper layers.
- 1> if the *dedicatedInfoType* is set to *dedicatedInfoCDMA2000-1XRTT* or to *dedicatedInfoCDMA2000-HRPD*:
 - 2> forward the *dedicatedInfoCDMA2000* to the CDMA2000 upper layers;

5.6.2 UL information transfer

5.6.2.1 General

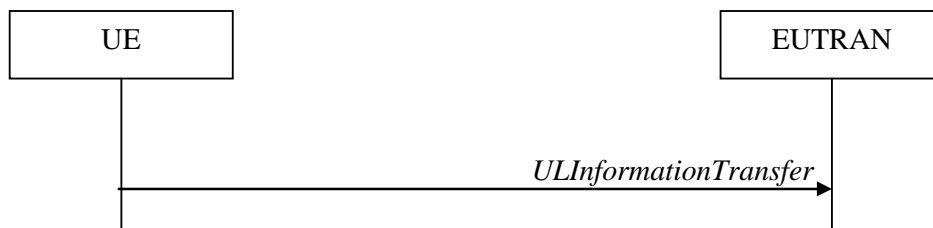

Figure 5.6.2.1-1: UL information transfer

The purpose of this procedure is to transfer NAS or (tunnelled) non-3GPP dedicated information from the UE to E-UTRAN.

5.6.2.2 Initiation

A UE in RRC_CONNECTED initiates the UL information transfer procedure whenever there is a need to transfer NAS or non-3GPP dedicated information, except at RRC connection establishment in which case the NAS information is piggybacked to the *RRCConnectionSetupComplete* message. The UE initiates the UL information transfer procedure by sending the *ULInformationTransfer* message. When CDMA2000 information has to be transferred, the UE shall initiate the procedure only if SRB2 is established.

5.6.2.3 Actions related to transmission of *ULInformationTransfer* message

The UE shall set the contents of the *ULInformationTransfer* message as follows:

- 1> if there is a need to transfer NAS information:
 - 2> set the *dedicatedInfoType* to include the *dedicatedInfoNAS*;
- 1> if there is a need to transfer CDMA2000 1XRTT information:
 - 2> set the *dedicatedInfoType* to include the *dedicatedInfoCDMA2000-1XRTT*;
- 1> if there is a need to transfer CDMA2000 HRPD information:
 - 2> set the *dedicatedInfoType* to include the *dedicatedInfoCDMA2000-HRPD*;
- 1> submit the *ULInformationTransfer* message to lower layers for transmission, upon which the procedure ends;

5.6.2.4 Failure to deliver *ULInformationTransfer* message

The UE shall:

- 1> if mobility (i.e. handover, RRC connection re-establishment) occurs before the successful delivery of *ULInformationTransfer* messages has been confirmed by lower layers:
 - 2> inform upper layers about the possible failure to deliver the information contained in the concerned *ULInformationTransfer* messages;

5.6.3 UE capability transfer

5.6.3.1 General

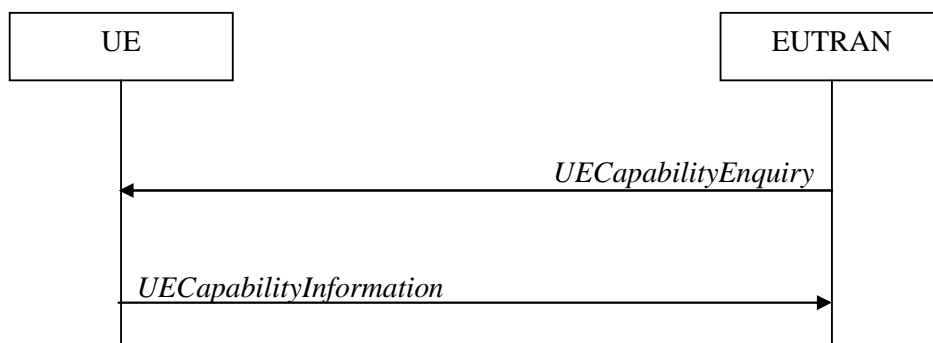

Figure 5.6.3.1-1: UE capability transfer

The purpose of this procedure is to transfer UE radio access capability information from the UE to E-UTRAN.

If the UE has changed its E-UTRAN radio access capabilities, the UE shall request higher layers to initiate the necessary NAS procedures (see TS 23.401 [41]) that would result in the update of UE radio access capabilities using a new RRC connection.

NOTE: Change of the UE's GERAN UE radio capabilities in RRC_IDLE is supported by use of Tracking Area Update.

5.6.3.2 Initiation

E-UTRAN initiates the procedure to a UE in RRC_CONNECTED when it needs (additional) UE radio access capability information.

5.6.3.3 Reception of the *UECapabilityEnquiry* by the UE

The UE shall:

- 1> set the contents of *UECapabilityInformation* message as follows:

- 2> if the *ue-CapabilityRequest* includes *eutra*:
- 3> include the *UE-EUTRA-Capability* within a *ue-CapabilityRAT-Container* and with the *rat-Type* set to *eutra*;
- 3> if the UE supports FDD and TDD:
- 4> set all fields of *UECapabilityInformation*, except field *fdd-Add-UE-EUTRA-Capabilities* and *tdd-Add-UE-EUTRA-Capabilities* (including their sub-fields), to include the values applicable for both FDD and TDD (i.e. functionality supported by both modes);
- 4> if (some of) the UE capability fields have a different value for FDD and TDD:
- 5> if for FDD, the UE supports additional functionality compared to what is indicated by the previous fields of *UECapabilityInformation*:
- 6> include field *fdd-Add-UE-EUTRA-Capabilities* and set it to include fields reflecting the additional functionality applicable for FDD;
- 5> if for TDD, the UE supports additional functionality compared to what is indicated by the previous fields of *UECapabilityInformation*:
- 6> include field *tdd-Add-UE-EUTRA-Capabilities* and set it to include fields reflecting the additional functionality applicable for TDD;

NOTE: The UE includes fields of *XDD-Add-UE-EUTRA-Capabilities* in accordance with the following:

- The field is included only if one or more of its sub-fields has a value that is different compared to the value signalled elsewhere within *UE-EUTRA-Capability*;
(this value signalled elsewhere is also referred to as the *Common value*, that is supported for both XDD modes)
 - For the fields that are included in *XDD-Add-UE-EUTRA-Capabilities*, the UE sets:
 - the sub-fields that are not allowed to be different the same as the *Common value*;
 - the sub-fields that are allowed to be different to a value indicating at least the same functionality as indicated by the *Common value*;
- 3> else (UE supports single xDD mode):
- 4> set all fields of *UECapabilityInformation*, except field *fdd-Add-UE-EUTRA-Capabilities* and *tdd-Add-UE-EUTRA-Capabilities* (including their sub-fields), to include the values applicable for the xDD mode supported by the UE;
- 3> if the *UECapabilityEnquiry* message includes *requestedFrequencyBands* and UE supports *requestedFrequencyBands*:
- 4> create a set of band combinations supported by the UE, including non-CA combinations, target for being included in *supportedBandCombination* while observing the following order (i.e. listed in order of decreasing priority):
- include all non-CA bands, regardless of whether UE supports carrier aggregation, only:
 - if the UE includes *ue-Category-v1020* (i.e. indicating category 6 to 8); or
 - if for at least one of the non-CA bands, the UE supports more MIMO layers with TM9 and TM10 than implied by the UE category; or
 - if the UE supports TM10 with one or more CSI processes;
 - include all 2DL+1UL CA band combinations, only consisting of bands included in *requestedFrequencyBands*;
 - include all other 2DL+1UL CA band combinations;
 - include all other CA band combinations, only consisting of bands included in *requestedFrequencyBands*, and prioritized in the order of *requestedFrequencyBands*, (i.e. first

include remaining band combinations containing the first-listed band, then include remaining band combinations containing the second-listed band, and so on);

4> include in *supportedBandCombination* as many of the target band combinations as possible, determined according to the above, while observing the priority order;

4> include in *supportedBandCombinationAdd* as many of the remaining target band combinations as possible, i.e. the target band combinations the UE was not able to include in *supportedBandCombination*, and limited to those consisting of bands included in *requestedFrequencyBands*, while observing the priority order;

4> indicate in *requestedBands* the same bands and in the same order as included in the received *requestedFrequencyBands*;

3> else

4> create a set of band combinations supported by the UE, including non-CA combinations, target for being included in *supportedBandCombination*:

- include all non-CA bands, regardless of whether UE supports carrier aggregation, only:
 - if the UE includes *ue-Category-v1020* (i.e. indicating category 6 to 8); or
 - if for at least one of the non-CA bands, the UE supports more MIMO layers with TM9 and TM10 than implied by the UE category; or
 - if the UE supports TM10 with one or more CSI processes;
- include all 2DL+1UL CA band combinations;
- include all other CA band combinations;

4> include in *supportedBandCombination* as many of the target band combinations as possible, determined according to the above;

4> if the number of non-CA and CA band combinations supported by UE exceeds the maximum number of band combinations of *supportedBandCombination*, the selection of subset of band combinations is up to UE implementation;

NOTE: If the *UECapabilityEnquiry* message does not include *requestedFrequencyBands*, UE does not include *supportedBandCombinationAdd*.

3> if the UE is a category 0 UE according to TS 36.306 [5]:

4> include *ue-RadioPagingInfo* including *ue-Category*;

2> if the *ue-CapabilityRequest* includes *geran-cs* and if the UE supports GERAN CS domain:

3> include the UE radio access capabilities for GERAN CS within a *ue-CapabilityRAT-Container* and with the *rat-Type* set to *geran-cs*;

2> if the *ue-CapabilityRequest* includes *geran-ps* and if the UE supports GERAN PS domain:

3> include the UE radio access capabilities for GERAN PS within a *ue-CapabilityRAT-Container* and with the *rat-Type* set to *geran-ps*;

2> if the *ue-CapabilityRequest* includes *utra* and if the UE supports UTRA:

3> include the UE radio access capabilities for UTRA within a *ue-CapabilityRAT-Container* and with the *rat-Type* set to *utra*;

2> if the *ue-CapabilityRequest* includes *cdma2000-1XRTT* and if the UE supports CDMA2000 1xRTT:

3> include the UE radio access capabilities for CDMA2000 within a *ue-CapabilityRAT-Container* and with the *rat-Type* set to *cdma2000-1XRTT*;

1> submit the *UECapabilityInformation* message to lower layers for transmission, upon which the procedure ends;

5.6.4 CSFB to 1x Parameter transfer

5.6.4.1 General

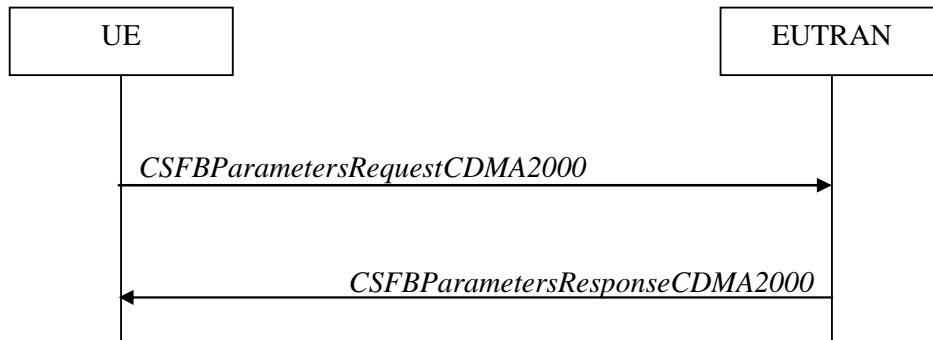

Figure 5.6.4.1-1: CSFB to 1x Parameter transfer

The purpose of this procedure is to transfer the CDMA2000 1xRTT parameters required to register the UE in the CDMA2000 1xRTT network for CSFB support.

5.6.4.2 Initiation

A UE in RRC_CONNECTED initiates the CSFB to 1x Parameter transfer procedure upon request from the CDMA2000 upper layers. The UE initiates the CSFB to 1x Parameter transfer procedure by sending the *CSFBParametersRequestCDMA2000* message.

5.6.4.3 Actions related to transmission of *CSFBParametersRequestCDMA2000* message

The UE shall:

- 1> submit the *CSFBParametersRequestCDMA2000* message to lower layers for transmission using the current configuration;

5.6.4.4 Reception of the *CSFBParametersResponseCDMA2000* message

Upon reception of the *CSFBParametersResponseCDMA2000* message, the UE shall:

- 1> forward the *rand* and the *mobilityParameters* to the CDMA2000 1xRTT upper layers;

5.6.5 UE Information

5.6.5.1 General

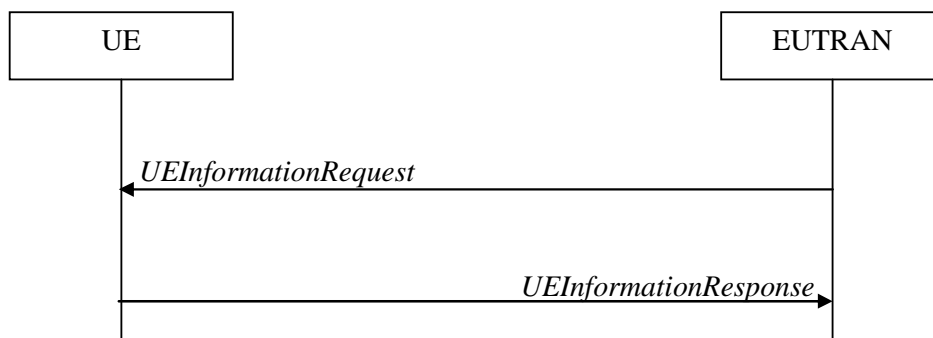

Figure 5.6.5.1-1: UE information procedure

The UE information procedure is used by E-UTRAN to request the UE to report information.

5.6.5.2 Initiation

E-UTRAN initiates the procedure by sending the *UEInformationRequest* message. E-UTRAN should initiate this procedure only after successful security activation.

5.6.5.3 Reception of the *UEInformationRequest* message

Upon receiving the *UEInformationRequest* message, the UE shall, only after successful security activation:

- 1> if *rach-ReportReq* is set to *true*, set the contents of the *rach-Report* in the *UEInformationResponse* message as follows:
 - 2> set the *numberOfPreamblesSent* to indicate the number of preambles sent by MAC for the last successfully completed random access procedure;
 - 2> if contention resolution was not successful as specified in TS 36.321 [6] for at least one of the transmitted preambles for the last successfully completed random access procedure:
 - 3> set the *contentionDetected* to *true*;
 - 2> else:
 - 3> set the *contentionDetected* to *false*;
- 1> if *rlf-ReportReq* is set to *true* and the UE has radio link failure information or handover failure information available in *VarRLF-Report* and if the RPLMN is included in *plmn-IdentityList* stored in *VarRLF-Report*:
 - 2> set *timeSinceFailure* in *VarRLF-Report* to the time that elapsed since the last radio link or handover failure in E-UTRA;
 - 2> set the *rlf-Report* in the *UEInformationResponse* message to the value of *rlf-Report* in *VarRLF-Report*;
 - 2> discard the *rlf-Report* from *VarRLF-Report* upon successful delivery of the *UEInformationResponse* message confirmed by lower layers;
- 1> if *connEstFailReportReq* is set to *true* and the UE has connection establishment failure information in *VarConnEstFailReport* and if the RPLMN is equal to *plmn-Identity* stored in *VarConnEstFailReport*:
 - 2> set *timeSinceFailure* in *VarConnEstFailReport* to the time that elapsed since the last connection establishment failure in E-UTRA;
 - 2> set the *connEstFailReport* in the *UEInformationResponse* message to the value of *connEstFailReport* in *VarConnEstFailReport*;
 - 2> discard the *connEstFailReport* from *VarConnEstFailReport* upon successful delivery of the *UEInformationResponse* message confirmed by lower layers;
- 1> if the *logMeasReportReq* is present and if the RPLMN is included in *plmn-IdentityList* stored in *VarLogMeasReport*:
 - 2> if *VarLogMeasReport* includes one or more logged measurement entries, set the contents of the *logMeasReport* in the *UEInformationResponse* message as follows:
 - 3> include the *absoluteTimeStamp* and set it to the value of *absoluteTimeInfo* in the *VarLogMeasReport*;
 - 3> include the *traceReference* and set it to the value of *traceReference* in the *VarLogMeasReport*;
 - 3> include the *traceRecordingSessionRef* and set it to the value of *traceRecordingSessionRef* in the *VarLogMeasReport*;
 - 3> include the *tce-Id* and set it to the value of *tce-Id* in the *VarLogMeasReport*;
 - 3> include the *logMeasInfoList* and set it to include one or more entries from *VarLogMeasReport* starting from the entries logged first;
 - 3> if the *VarLogMeasReport* includes one or more additional logged measurement entries that are not included in the *logMeasInfoList* within the *UEInformationResponse* message:

- 4> include the *logMeasAvailable*;
- 1> if *mobilityHistoryReportReq* is set to *true*:
 - 2> include the *mobilityHistoryReport* and set it to include entries from *VarMobilityHistoryReport*;
 - 2> include in the *mobilityHistoryReport* an entry for the current cell, possibly after removing the oldest entry if required, and set its fields as follows:
 - 3> set *visitedCellId* to the global cell identity of the current cell;
 - 3> set field *timeSpent* to the time spent in the current cell;
- 1> if the *logMeasReport* is included in the *UEInformationResponse*:
 - 2> submit the *UEInformationResponse* message to lower layers for transmission via SRB2;
 - 2> discard the logged measurement entries included in the *logMeasInfoList* from *VarLogMeasReport* upon successful delivery of the *UEInformationResponse* message confirmed by lower layers;
- 1> else:
 - 2> submit the *UEInformationResponse* message to lower layers for transmission via SRB1;

5.6.6 Logged Measurement Configuration

5.6.6.1 General

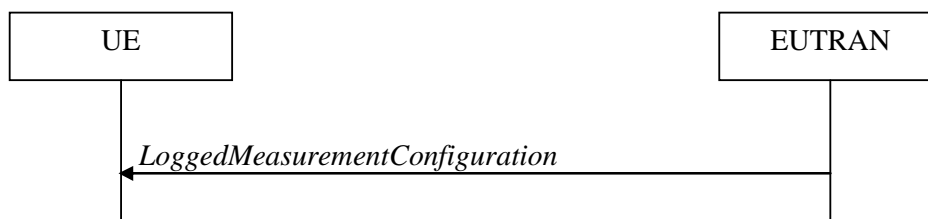

Figure 5.6.6.1-1: Logged measurement configuration

The purpose of this procedure is to configure the UE to perform logging of measurement results while in RRC_IDLE and to perform logging of measurement results for MBSFN in both RRC_IDLE and RRC_CONNECTED. The procedure applies to logged measurements capable UEs that are in RRC_CONNECTED.

NOTE E-UTRAN may retrieve stored logged measurement information by means of the UE Information procedure.

5.6.6.2 Initiation

E-UTRAN initiates the logged measurement configuration procedure to UE in RRC_CONNECTED by sending the *LoggedMeasurementConfiguration* message.

5.6.6.3 Reception of the *LoggedMeasurementConfiguration* by the UE

Upon receiving the *LoggedMeasurementConfiguration* message the UE shall:

- 1> discard the logged measurement configuration as well as the logged measurement information as specified in 5.6.7;
- 1> store the received *loggingDuration*, *loggingInterval* and *areaConfiguration*, if included, in *VarLogMeasConfig*;
- 1> if the *LoggedMeasurementConfiguration* message includes *plmn-IdentityList*:

2> set *plmn-IdentityList* in *VarLogMeasReport* to include the RPLMN as well as the PLMNs included in *plmn-IdentityList*;

1> else:

2> set *plmn-IdentityList* in *VarLogMeasReport* to include the RPLMN;

1> store the received *absoluteTimeInfo*, *traceReference*, *traceRecordingSessionRef* and *tce-Id* in *VarLogMeasReport*;

1> store the received *targetMBSFN-AreaList*, if included, in *VarLogMeasConfig*;

1> start timer T330 with the timer value set to the *loggingDuration*;

5.6.6.4 T330 expiry

Upon expiry of T330 the UE shall:

1> release *VarLogMeasConfig*;

The UE is allowed to discard stored logged measurements, i.e. to release *VarLogMeasReport*, 48 hours after T330 expiry.

5.6.7 Release of Logged Measurement Configuration

5.6.7.1 General

The purpose of this procedure is to release the logged measurement configuration as well as the logged measurement information.

5.6.7.2 Initiation

The UE shall initiate the procedure upon receiving a logged measurement configuration in another RAT. The UE shall also initiate the procedure upon power off or detach.

The UE shall:

1> stop timer T330, if running;

1> if stored, discard the logged measurement configuration as well as the logged measurement information, i.e. release the UE variables *VarLogMeasConfig* and *VarLogMeasReport*;

5.6.8 Measurements logging

5.6.8.1 General

This procedure specifies the logging of available measurements by a UE in RRC_IDLE that has a logged measurement configuration and the logging of available measurements by a UE in both RRC_IDLE and RRC_CONNECTED if *targetMBSFN-AreaList* is included in *VarLogMeasConfig*.

5.6.8.2 Initiation

While T330 is running, the UE shall:

1> perform the logging in accordance with the following:

2> if *targetMBSFN-AreaList* is included in *VarLogMeasConfig*:

3> if the UE is camping normally on an E-UTRA cell or is connected to E-UTRA; and

3> if the RPLMN is included in *plmn-IdentityList* stored in *VarLogMeasReport*; and

3> if the PCell (in RRC_CONNECTED) or cell where the UE is camping (in RRC_IDLE) is part of the area indicated by *areaConfiguration* if configured in *VarLogMeasConfig*;

4> for MBSFN areas, indicated in *targetMBSFN-AreaList*, from which the UE is receiving MBMS service:

5> perform MBSFN measurements in accordance with the performance requirements as specified in TS 36.133 [16];

NOTE 1: When configured to perform MBSFN measurement logging by *targetMBSFN-AreaList*, the UE is not required to receive additional MBSFN subframes, i.e. logging is based on the subframes corresponding to the MBMS services the UE is receiving.

5> perform logging at regular time intervals as defined by the *loggingInterval* in *VarLogMeasConfig*, but only for those intervals for which MBSFN measurement results are available as specified in TS 36.133 [16];

- 2> *else* if the UE is camping normally on an E-UTRA cell and if the RPLMN is included in *plmn-IdentityList* stored in *VarLogMeasReport* and, if the cell is part of the area indicated by *areaConfiguration* if configured in *VarLogMeasConfig*:
- 3> perform the logging at regular time intervals, as defined by the *loggingInterval* in *VarLogMeasConfig*;
- 2> when adding a logged measurement entry in *VarLogMeasReport*, include the fields in accordance with the following:
- 3> set the *relativeTimeStamp* to indicate the elapsed time since the moment at which the logged measurement configuration was received;
- 3> if detailed location information became available during the last logging interval, set the content of the *locationInfo* as follows:
- 4> include the *locationCoordinates*;
- 3> if *targetMBSFN-AreaList* is included in *VarLogMeasConfig*:
- 4> for each MBSFN area, for which the mandatory measurements result fields became available during the last logging interval:
- 5> set the *rsrpResultMBSFN*, *rsrqResultMBSFN* to include measurement results that became available during the last logging interval;
- 5> include the fields *signallingBLER-Result* or *dataBLER-MCH-ResultList* if the concerned BLER results are available,
- 5> set the *mbsfn-AreaId* and *carrierFrequency* to indicate the MBSFN area in which the UE is receiving MBSFN transmission;
- 4> if in RRC_CONNECTED:
- 5> set the *servCellIdentity* to indicate global cell identity of the PCell;
- 5> set the *measResultServCell* to include the layer 3 filtered measured results of the PCell;
- 5> if available, set the *measResultNeighCells* to include the layer 3 filtered measured results of SCell(s) and neighbouring cell(s) measurements that became available during the last logging interval, in order of decreasing RSRP, for at most the following number of cells: 6 intra-frequency and 3 inter-frequency cells per frequency and according to the following:
- 6> for each cell included, include the optional fields that are available;
- 5> if available, optionally set the *measResultNeighCells* to include the layer 3 filtered measured results of neighbouring cell(s) measurements that became available during the last logging interval, in order of decreasing RSCP(UTRA)/RSSI(GERAN)/PilotStrength(cdma2000), for at most the following number of cells: 3 inter-RAT cells per frequency (UTRA, cdma2000)/set of frequencies (GERAN), and according to the following:
- 6> for each cell included, include the optional fields that are available;

- 4> if in RRC_IDLE:
 - 5> set the *servCellIdentity* to indicate global cell identity of the serving cell;
 - 5> set the *measResultServCell* to include the quantities of the serving cell;
 - 5> if available, set the *measResultNeighCells*, in order of decreasing ranking-criterion as used for cell re-selection, to include neighbouring cell measurements that became available during the last logging interval for at most the following number of neighbouring cells: 6 intra-frequency and 3 inter-frequency neighbours per frequency and according to the following:
 - 6> for each neighbour cell included, include the optional fields that are available;
 - 5> if available, optionally set the *measResultNeighCells*, in order of decreasing ranking-criterion as used for cell re-selection, to include neighbouring cell measurements that became available during the last logging interval, for at most the following number of cells: 3 inter-RAT cells per frequency (UTRA, cdma2000)/set of frequencies (GERAN), and according to the following:
 - 6> for each cell included, include the optional fields that are available;
 - 4> for the cells included according to the previous (i.e. covering previous and current serving cells as well as neighbouring EUTRA cells) include results according to the extended RSRQ if corresponding results are available according to the associated performance requirements defined in TS 36.133 [16];
 - 4> for the cells included according to the previous (i.e. covering previous and current serving cells as well as neighbouring EUTRA cells) include RSRQ type if the result was based on measurements using a wider band or using all OFDM symbols;

NOTE 2: The UE includes the latest results in accordance with the performance requirements as specified in TS 36.133 [16]. E.g. RSRP and RSRQ results are available only if the UE has a sufficient number of results/ receives a sufficient number of subframes during the logging interval.

- 3> else:
 - 4> set the *servCellIdentity* to indicate global cell identity of the cell the UE is camping on;
 - 4> set the *measResultServCell* to include the quantities of the cell the UE is camping on;
 - 4> if available, set the *measResultNeighCells*, in order of decreasing ranking-criterion as used for cell re-selection, to include neighbouring cell measurements that became available during the last logging interval for at most the following number of neighbouring cells: 6 intra-frequency and 3 inter-frequency neighbours per frequency as well as 3 inter-RAT neighbours, per frequency/ set of frequencies (GERAN) per RAT and according to the following:
 - 5> for each neighbour cell included, include the optional fields that are available;
 - 4> for the cells included according to the previous (i.e. covering previous and current serving cells as well as neighbouring EUTRA cells) include results according to the extended RSRQ if corresponding results are available according to the associated performance requirements defined in TS 36.133 [16];
 - 4> for the cells included according to the previous (i.e. covering previous and current serving cells as well as neighbouring EUTRA cells) include RSRQ type if the result was based on measurements using a wider band or using all OFDM symbols;

NOTE 3: The UE includes the latest results of the available measurements as used for cell reselection evaluation in RRC_IDLE or as used for evaluation of reporting criteria or for measurement reporting according to 5.5.3 in RRC_CONNECTED, which are performed in accordance with the performance requirements as specified in TS 36.133 [16].

- 2> when the memory reserved for the logged measurement information becomes full, stop timer T330 and perform the same actions as performed upon expiry of T330, as specified in 5.6.6.4;

5.6.9 In-device coexistence indication

5.6.9.1 General

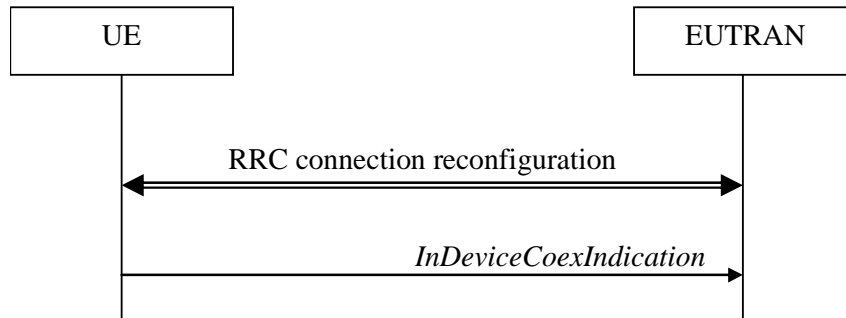

Figure 5.6.9.1-1: In-device coexistence indication

The purpose of this procedure is to inform E-UTRAN about (a change of) the In-Device Coexistence (IDC) problems experienced by the UE in RRC_CONNECTED, as described in TS 36.300 [9], and to provide the E-UTRAN with information in order to resolve them.

5.6.9.2 Initiation

A UE capable of providing IDC indications may initiate the procedure when it is configured to provide IDC indications and upon change of IDC problem information.

Upon initiating the procedure, the UE shall:

- 1> if configured to provide IDC indications:
 - 2> if the UE did not transmit an *InDeviceCoexIndication* message since it was configured to provide IDC indications:
 - 3> if on one or more frequencies for which a *measObjectEUTRA* is configured, the UE is experiencing IDC problems that it cannot solve by itself; or
 - 3> if configured to provide IDC indications for UL CA; and if on one or more supported UL CA combination comprising of carrier frequencies for which a measurement object is configured, the UE is experiencing IDC problems that it cannot solve by itself:
 - 4> initiate transmission of the *InDeviceCoexIndication* message in accordance with 5.6.9.3;
 - 2> else:
 - 3> if the set of frequencies, for which a *measObjectEUTRA* is configured and on which the UE is experiencing IDC problems that it cannot solve by itself, is different from the set indicated in the last transmitted *InDeviceCoexIndication* message; or
 - 3> if for one or more of the frequencies in the previously reported set of frequencies, the *interferenceDirection* is different from the value indicated in the last transmitted *InDeviceCoexIndication* message; or
 - 3> if the TDM assistance information is different from the assistance information included in the last transmitted *InDeviceCoexIndication* message; or
 - 3> if configured to provide IDC indications for UL CA; and if the *victimSystemType* is different from the value indicated in the last transmitted *InDeviceCoexIndication* message; or
 - 3> if configured to provide IDC indications for UL CA; and if the set of supported UL CA combinations on which the UE is experiencing IDC problems that it cannot solve by itself and that the UE includes in *affectedCarrierFreqCombList* according to 5.6.9.3, is different from the set indicated in the last transmitted *InDeviceCoexIndication* message:
 - 4> initiate transmission of the *InDeviceCoexIndication* message in accordance with 5.6.9.3;

NOTE 1: The term "IDC problems" refers to interference issues applicable across several subframes/slots where not necessarily all the subframes/slots are affected.

NOTE 2: For the frequencies on which a serving cell or serving cells is configured that is activated, IDC problems consist of interference issues that the UE cannot solve by itself, during either active data exchange or upcoming data activity which is expected in up to a few hundred milliseconds.

For frequencies on which a SCell or SCells is configured that is deactivated, reporting IDC problems indicates an anticipation that the activation of the SCell or SCells would result in interference issues that the UE would not be able to solve by itself.

For a non-serving frequency, reporting IDC problems indicates an anticipation that if the non-serving frequency or frequencies became a serving frequency or serving frequencies then this would result in interference issues that the UE would not be able to solve by itself.

5.6.9.3 Actions related to transmission of *InDeviceCoexIndication* message

The UE shall set the contents of the *InDeviceCoexIndication* message as follows:

- 1> if there is at least one E-UTRA carrier frequency, for which a measurement object is configured, that is affected by IDC problems:
 - 2> include the IE *affectedCarrierFreqList* with an entry for each affected E-UTRA carrier frequency for which a measurement object is configured;
 - 2> for each E-UTRA carrier frequency included in the IE *affectedCarrierFreqList*, include *interferenceDirection* and set it accordingly;
 - 2> include Time Domain Multiplexing (TDM) based assistance information:
 - 3> if the UE has DRX related assistance information that could be used to resolve the IDC problems:
 - 4> include *drx-CycleLength*, *drx-Offset* and *drx-ActiveTime*;
 - 3> else (the UE has desired subframe reservation patterns related assistance information that could be used to resolve the IDC problems):
 - 4> include *idc-SubframePatternList*;
 - 3> use the MCG as timing reference if TDM based assistance information regarding the SCG is included;
- 1> if the UE is configured to provide UL CA information and there is a supported UL CA combination comprising of carrier frequencies for which a measurement object is configured, that is affected by IDC problems:
 - 2> include *victimSystemType* in *ul-CA-AssistanceInfo*;
 - 2> if the UE sets *victimSystemType* to *wlan* or *Bluetooth*:
 - 3> include *affectedCarrierFreqCombList* in *ul-CA-AssistanceInfo* with an entry for each supported UL CA combination comprising of carrier frequencies for which a measurement object is configured, that is affected by IDC problems;
 - 2> else:
 - 3> optionally include *affectedCarrierFreqCombList* in *ul-CA-AssistanceInfo* with an entry for each supported UL CA combination comprising of carrier frequencies for which a measurement object is configured, that is affected by IDC problems;

NOTE 1: When sending an *InDeviceCoexIndication* message to inform E-UTRAN the IDC problems, the UE includes all assistance information (rather than providing e.g. the changed part(s) of the assistance information).

NOTE 2: Upon not anymore experiencing a particular IDC problem that the UE previously reported, the UE provides an IDC indication with the modified contents of the *InDeviceCoexIndication* message (e.g. by an empty message).

The UE shall submit the *InDeviceCoexIndication* message to lower layers for transmission.

5.6.10 UE Assistance Information

5.6.10.1 General

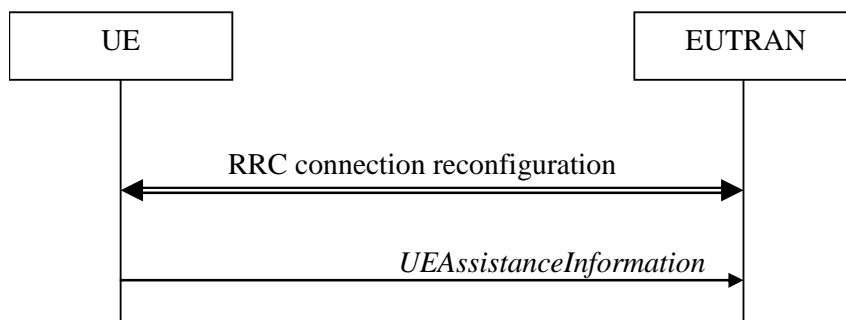

Figure 5.6.10.1-1: UE Assistance Information

The purpose of this procedure is to inform E-UTRAN of the UE's power saving preference. Upon configuring the UE to provide power preference indications E-UTRAN may consider that the UE does not prefer a configuration primarily optimised for power saving until the UE explicitly indicates otherwise.

5.6.10.2 Initiation

A UE capable of providing power preference indications in RRC_CONNECTED may initiate the procedure in several cases including upon being configured to provide power preference indications and upon change of power preference.

Upon initiating the procedure, the UE shall:

- 1> if configured to provide power preference indications:
 - 2> if the UE did not transmit a *UEAssistanceInformation* message since it was configured to provide power preference indications; or
 - 2> if the current power preference is different from the one indicated in the last transmission of the *UEAssistanceInformation* message and timer T340 is not running;
 - 3> initiate transmission of the *UEAssistanceInformation* message in accordance with 5.6.10.3;

5.6.10.3 Actions related to transmission of *UEAssistanceInformation* message

The UE shall set the contents of the *UEAssistanceInformation* message:

- 1> if the UE prefers a configuration primarily optimised for power saving:
 - 2> set *powerPrefIndication* to *lowPowerConsumption*;
- 1> else:
 - 2> start or restart timer T340 with the timer value set to the *powerPrefIndicationTimer*;
 - 2> set *powerPrefIndication* to *normal*;

The UE shall submit the *UEAssistanceInformation* message to lower layers for transmission.

5.6.11 Mobility history information

5.6.11.1 General

This procedure specifies how the mobility history information is stored by the UE, covering RRC_CONNECTED and RRC_IDLE.

5.6.11.2 Initiation

If the UE supports storage of mobility history information, the UE shall:

- 1> Upon change of cell, consisting of PCell in RRC_CONNECTED or serving cell in RRC_IDLE, to another E-UTRA or inter-RAT cell or when entering out of service:
 - 2> include an entry in variable *VarMobilityHistoryReport* possibly after removing the oldest entry, if necessary, according to following:
 - 3> if the global cell identity of the previous PCell/ serving cell is available:
 - 4> include the global cell identity of that cell in the field *visitedCellId* of the entry;
 - 3> else:
 - 4> include the physical cell identity and carrier frequency of that cell in the field *visitedCellId* of the entry;
 - 3> set the field *timeSpent* of the entry as the time spent in the previous PCell/ serving cell;
- 1> upon entering E-UTRA (in RRC_CONNECTED or RRC_IDLE) while previously out of service and/ or using another RAT:
 - 2> include an entry in variable *VarMobilityHistoryReport* possibly after removing the oldest entry, if necessary, according to following:
 - 3> set the field *timeSpent* of the entry as the time spent outside E-UTRA;

5.6.12 RAN-assisted WLAN interworking

5.6.12.1 General

The purpose of this procedure is to facilitate access network selection and traffic steering between E-UTRAN and WLAN.

If required by upper layers (see TS 24.312 [66]), the UE shall provide an up-to-date set of the applicable parameters provided by *wlan-OffloadConfigCommon* or *wlan-OffloadConfigDedicated* to upper layers, and inform upper layers when no parameters are configured. The parameter set from either *wlan-OffloadConfigCommon* or *wlan-OffloadConfigDedicated* is selected as specified in subclauses 5.2.2.24, 5.3.12, 5.6.12.2 and 5.6.12.4.

5.6.12.2 Dedicated WLAN offload configuration

The UE shall:

- 1> if the received *wlan-OffloadInfo* is set to *release*:
 - 2> release *wlan-OffloadConfigDedicated* and *t350*;
 - 2> if the *wlan-OffloadConfigCommon* corresponding to the RPLMN is broadcast by the cell:
 - 3> apply the *wlan-OffloadConfigCommon* corresponding to the RPLMN included in *SystemInformationBlockType17*;
- 1> else:
 - 2> apply the received *wlan-OffloadConfigDedicated*;

5.6.12.3 WLAN offload RAN evaluation

The UE shall:

- 1> if the UE is configured with either *wlan-OffloadConfigCommon* or *wlan-OffloadConfigDedicated*:
 - 2> provide measurement results required for the evaluation of the network selection and traffic steering rules as defined in TS 24.312 [66] to upper layers;
 - 2> evaluate the network selection and traffic steering rules as defined in TS 36.304 [4];

5.6.12.4 T350 expiry or stop

The UE shall:

- 1> if T350 expires or is stopped:
 - 2> release the *wlan-OffloadConfigDedicated* and *t350*;
 - 2> if the *wlan-OffloadConfigCommon* corresponding to the RPLMN is broadcast by the cell:
 - 3> apply the *wlan-OffloadConfigCommon* corresponding to the RPLMN included in *SystemInformationBlockType17*;

5.6.12.5 Cell selection/ re-selection while T350 is running

The UE shall:

- 1> if, while T350 is running, the UE selects/ reselects a cell which is not the PCell when the *wlan-OffloadDedicated* was configured:
 - 2> stop timer T350;
 - 2> perform the actions as specified in 5.6.12.4;

5.6.13 SCG failure information

5.6.13.1 General

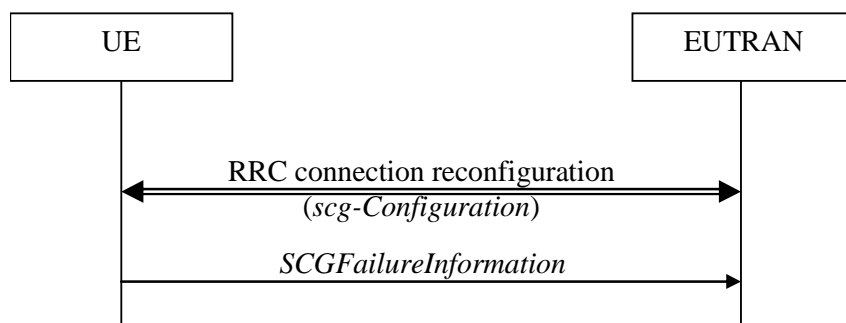

Figure 5.6.13.1-1: SCG failure information

The purpose of this procedure is to inform E-UTRAN about an SCG failure the UE has experienced i.e. SCG radio link failure, SCG change failure.

5.6.13.2 Initiation

A UE initiates the procedure to report SCG failures when SCG transmission is not suspended and when one of the following conditions is met:

- 1> upon detecting radio link failure for the SCG, in accordance with 5.3.11; or
- 1> upon SCG change failure, in accordance with 5.3.5.7a; or
- 1> upon stopping uplink transmission towards the PCell due to exceeding the maximum uplink transmission timing difference when *powerControlMode* is configured to 1, in accordance with subclause 7.17.2 of TS 36.133 [29];

Upon initiating the procedure, the UE shall:

- 1> suspend all SCG DRBs and suspend SCG transmission for split DRBs;
- 1> reset SCG-MAC;
- 1> stop T307;

1> initiate transmission of the *SCGFailureInformation* message in accordance with 5.6.13.3;

5.6.13.3 Actions related to transmission of *SCGFailureInformation* message

The UE shall set the contents of the *SCGFailureInformation* message as follows:

- 1> if the UE initiates transmission of the *SCGFailureInformation* message to provide SCG radio link failure information:
 - 2> include *failureType* and set it to the trigger for detecting SCG radio link failure;
- 1> else if the UE initiates transmission of the *SCGFailureInformation* message to provide SCG change failure information:
 - 2> include *failureType* and set it to *scg-ChangeFailure*;
- 1> else if the UE initiates transmission of the *SCGFailureInformation* message due to exceeding maximum uplink transmission timing difference:
 - 2> include *failureType* and set it to *maxUL-TimingDiff*;
- 1> set the *measResultServFreqList* to include for each SCG cell that is configured, if any, within *measResultSCell* the quantities of the concerned SCell, if available according to performance requirements in [16];
- 1> for each SCG serving frequency included in *measResultServFreqList*, include within *measResultBestNeighCell* the *physCellId* and the quantities of the best non-serving cell, based on RSRP, on the concerned serving frequency;
- 1> set the *measResultNeighCells* to include the best measured cells on non-serving E-UTRA frequencies, ordered such that the best cell is listed first, and based on measurements collected up to the moment the UE detected the failure, and set its fields as follows:
 - 2> if the UE was configured to perform measurements for one or more non-serving EUTRA frequencies and measurement results are available, include the *measResultListEUTRA*;
 - 2> for each neighbour cell included, include the optional fields that are available;

NOTE 2: The measured quantities are filtered by the L3 filter as configured in the mobility measurement configuration. The measurements are based on the time domain measurement resource restriction, if configured. Blacklisted cells are not required to be reported.

The UE shall submit the *SCGFailureInformation* message to lower layers for transmission.

5.7 Generic error handling

5.7.1 General

The generic error handling defined in the subsequent sub-clauses applies unless explicitly specified otherwise e.g. within the procedure specific error handling.

The UE shall consider a value as not comprehended when it is set:

- to an extended value that is not defined in the version of the transfer syntax supported by the UE.
- to a spare or reserved value unless the specification defines specific behaviour that the UE shall apply upon receiving the concerned spare/ reserved value.

The UE shall consider a field as not comprehended when it is defined:

- as spare or reserved unless the specification defines specific behaviour that the UE shall apply upon receiving the concerned spare/ reserved field.

5.7.2 ASN.1 violation or encoding error

The UE shall:

- 1> when receiving an RRC message on the BCCH, PCCH, CCCH, MCCH or SBCCH for which the abstract syntax is invalid [13]:
 - 2> ignore the message;

NOTE This section applies in case one or more fields is set to a value, other than a spare, reserved or extended value, not defined in this version of the transfer syntax. E.g. in the case the UE receives value 12 for a field defined as INTEGER (1..11). In cases like this, it may not be possible to reliably detect which field is in the error hence the error handling is at the message level.

5.7.3 Field set to a not comprehended value

The UE shall, when receiving an RRC message on any logical channel:

- 1> if the message includes a field that has a value that the UE does not comprehend:
 - 2> if a default value is defined for this field:
 - 3> treat the message while using the default value defined for this field;
 - 2> else if the concerned field is optional:
 - 3> treat the message as if the field were absent and in accordance with the need code for absence of the concerned field;
 - 2> else:
 - 3> treat the message as if the field were absent and in accordance with sub-clause 5.7.4;

5.7.4 Mandatory field missing

The UE shall:

- 1> if the message includes a field that is mandatory to include in the message (e.g. because conditions for mandatory presence are fulfilled) and that field is absent or treated as absent:
 - 2> if the RRC message was received on DCCH or CCCH:
 - 3> ignore the message;
 - 2> else:
 - 3> if the field concerns a (sub-field of) an entry of a list (i.e. a SEQUENCE OF):
 - 4> treat the list as if the entry including the missing or not comprehended field was not present;
 - 3> else if the field concerns a sub-field of another field, referred to as the 'parent' field i.e. the field that is one nesting level up compared to the erroneous field:
 - 4> consider the 'parent' field to be set to a not comprehended value;
 - 4> apply the generic error handling to the subsequent 'parent' field(s), until reaching the top nesting level i.e. the message level;
 - 3> else (field at message level):
 - 4> ignore the message;

NOTE 1: The error handling defined in these sub-clauses implies that the UE ignores a message with the message type or version set to a not comprehended value.

NOTE 2: The nested error handling for messages received on logical channels other than DCCH and CCCH applies for errors in extensions also, even for errors that can be regarded as invalid E-UTRAN operation e.g. E-UTRAN not observing conditional presence.

The following ASN.1 further clarifies the levels applicable in case of nested error handling for errors in extension fields.

```

-- /example/ ASN1START
-- Example with extension addition group
ItemInfoList ::=
    SEQUENCE (SIZE (1..max)) OF ItemInfo
ItemInfo ::=
    SEQUENCE {
        itemIdentity
            INTEGER (1..max),
        field1
            Field1,
        field2
            Field2
            OPTIONAL,
            -- Need ON
        ...
        [[ field3-r9
            Field3-r9
            OPTIONAL,
            -- Cond Cond1
            field4-r9
            Field4-r9
            OPTIONAL
            -- Need ON
        ]]
    }
-- Example with traditional non-critical extension (empty sequence)
BroadcastInfoBlock1 ::=
    SEQUENCE {
        itemIdentity
            INTEGER (1..max),
        field1
            Field1,
        field2
            Field2
            OPTIONAL,
            -- Need ON
        nonCriticalExtension
            BroadcastInfoBlock1-v940-IEs
            OPTIONAL
    }
BroadcastInfoBlock1-v940-IEs ::= SEQUENCE {
        field3-r9
            Field3-r9
            OPTIONAL,
            -- Cond Cond1
        field4-r9
            Field4-r9
            OPTIONAL,
            -- Need ON
        nonCriticalExtension
            SEQUENCE {}
            OPTIONAL
            -- Need OP
    }
-- ASN1STOP

```

The UE shall, apply the following principles regarding the levels applicable in case of nested error handling:

- an extension addition group is not regarded as a level on its own. E.g. in the ASN.1 extract in the previous, a error regarding the conditionality of *field3* would result in the entire *itemInfo* entry to be ignored (rather than just the extension addition group containing *field3* and *field4*)
- a traditional *nonCriticalExtension* is not regarded as a level on its own. E.g. in the ASN.1 extract in the previous, a error regarding the conditionality of *field3* would result in the entire *BroadcastInfoBlock1* to be ignored (rather than just the non critical extension containing *field3* and *field4*).

5.7.5 Not comprehended field

The UE shall, when receiving an RRC message on any logical channel:

- 1> if the message includes a field that the UE does not comprehend:
 - 2> treat the rest of the message as if the field was absent;

NOTE: This section does not apply to the case of an extension to the value range of a field. Such cases are addressed instead by the requirements in section 5.7.3.

5.8 MBMS

5.8.1 Introduction

5.8.1.1 General

In general the control information relevant only for UEs supporting MBMS is separated as much as possible from unicast control information. Most of the MBMS control information is provided on a logical channel specific for MBMS common control information: the MCCH. E-UTRA employs one MCCH logical channel per MBSFN area. In case the network configures multiple MBSFN areas, the UE acquires the MBMS control information from the MCCHs that are configured to identify if services it is interested to receive are ongoing. The action applicable when the UE is unable to simultaneously receive MBMS and unicast services is up to UE implementation. In this release of the specification, an MBMS capable UE is only required to support reception of a single MBMS service at a time, and reception of more than one MBMS service (also possibly on more than one MBSFN area) in parallel is left for UE

implementation. The MCCH carries the *MBSFNAreaConfiguration* message, which indicates the MBMS sessions that are ongoing as well as the (corresponding) radio resource configuration. The MCCH may also carry the *MBMSCountingRequest* message, when E-UTRAN wishes to count the number of UEs in RRC_CONNECTED that are receiving or interested to receive one or more specific MBMS services.

A limited amount of MBMS control information is provided on the BCCH. This primarily concerns the information needed to acquire the MCCH(s). This information is carried by means of a single MBMS specific *SystemInformationBlock: SystemInformationBlockType13*. An MBSFN area is identified solely by the *mbsfn-AreaId* in *SystemInformationBlockType13*. At mobility, the UE considers that the MBSFN area is continuous when the source cell and the target cell broadcast the same value in the *mbsfn-AreaId*.

5.8.1.2 Scheduling

The MCCH information is transmitted periodically, using a configurable repetition period. Scheduling information is not provided for MCCH i.e. both the time domain scheduling as well as the lower layer configuration are semi-statically configured, as defined within *SystemInformationBlockType13*.

For MBMS user data, which is carried by the MTCH logical channel, E-UTRAN periodically provides MCH scheduling information (MSI) at lower layers (MAC). This MCH information only concerns the time domain scheduling i.e. the frequency domain scheduling and the lower layer configuration are semi-statically configured. The periodicity of the MSI is configurable and defined by the MCH scheduling period.

5.8.1.3 MCCH information validity and notification of changes

Change of MCCH information only occurs at specific radio frames, i.e. the concept of a modification period is used. Within a modification period, the same MCCH information may be transmitted a number of times, as defined by its scheduling (which is based on a repetition period). The modification period boundaries are defined by SFN values for which $\text{SFN mod } m = 0$, where m is the number of radio frames comprising the modification period. The modification period is configured by means of *SystemInformationBlockType13*.

When the network changes (some of) the MCCH information, it notifies the UEs about the change during a first modification period. In the next modification period, the network transmits the updated MCCH information. These general principles are illustrated in figure 5.8.1.3-1, in which different colours indicate different MCCH information. Upon receiving a change notification, a UE interested to receive MBMS services acquires the new MCCH information immediately from the start of the next modification period. The UE applies the previously acquired MCCH information until the UE acquires the new MCCH information.

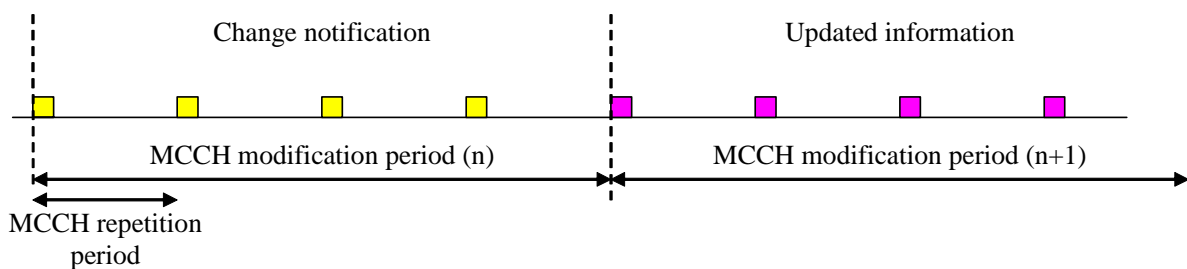

Figure 5.8.1.3-1: Change of MCCH Information

Indication of an MBMS specific RNTI, the M-RNTI (see TS 36.321 [6]), on PDCCH is used to inform UEs in RRC_IDLE and UEs in RRC_CONNECTED about an MCCH information change. When receiving an MCCH information change notification, the UE knows that the MCCH information will change at the next modification period boundary. The notification on PDCCH indicates which of the MCCHs will change, which is done by means of an 8-bit bitmap. Within this bitmap, the bit at the position indicated by the field *notificationIndicator* is used to indicate changes for that MBSFN area: if the bit is set to "1", the corresponding MCCH will change. No further details are provided e.g. regarding which MCCH information will change. The MCCH information change notification is used to inform the UE about a change of MCCH information upon session start or about the start of MBMS counting.

The MCCH information change notifications on PDCCH are transmitted periodically and are carried on MBSFN subframes only. These MCCH information change notification occasions are common for all MCCHs that are configured, and configurable by parameters included in *SystemInformationBlockType13*: a repetition coefficient, a radio frame offset and a subframe index. These common notification occasions are based on the MCCH with the shortest modification period.

NOTE 1: E-UTRAN may modify the MBMS configuration information provided on MCCH at the same time as updating the MBMS configuration information carried on BCCH i.e. at a coinciding BCCH and MCCH modification period. Upon detecting that a new MCCH is configured on BCCH, a UE interested to receive one or more MBMS services should acquire the MCCH, unless it knows that the services it is interested in are not provided by the corresponding MBSFN area.

A UE that is receiving an MBMS service shall acquire the MCCH information from the start of each modification period. A UE that is not receiving an MBMS service, as well as UEs that are receiving an MBMS service but potentially interested to receive other services not started yet in another MBSFN area, shall verify that the stored MCCH information remains valid by attempting to find the MCCH information change notification at least *notificationRepetitionCoeff* times during the modification period of the applicable MCCH(s), if no MCCH information change notification is received.

NOTE 2: In case the UE is aware which MCCH(s) E-UTRAN uses for the service(s) it is interested to receive, the UE may only need to monitor change notifications for a subset of the MCCHs that are configured, referred to as the 'applicable MCCH(s)' in the above.

5.8.2 MCCH information acquisition

5.8.2.1 General

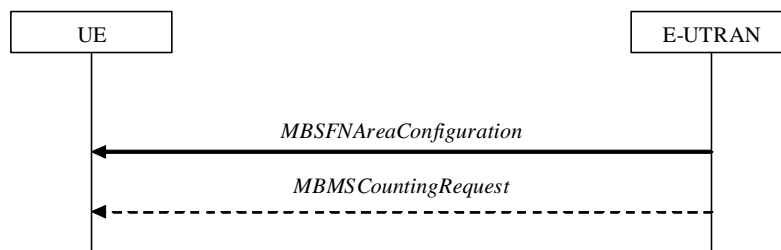

Figure 5.8.2.1-1: MCCH information acquisition

The UE applies the MCCH information acquisition procedure to acquire the MBMS control information that is broadcasted by the E-UTRAN. The procedure applies to MBMS capable UEs that are in RRC_IDLE or in RRC_CONNECTED.

5.8.2.2 Initiation

A UE interested to receive MBMS services shall apply the MCCH information acquisition procedure upon entering the corresponding MBSFN area (e.g. upon power on, following UE mobility) and upon receiving a notification that the MCCH information has changed. A UE that is receiving an MBMS service shall apply the MCCH information acquisition procedure to acquire the MCCH, that corresponds with the service that is being received, at the start of each modification period.

Unless explicitly stated otherwise in the procedural specification, the MCCH information acquisition procedure overwrites any stored MCCH information, i.e. delta configuration is not applicable for MCCH information and the UE discontinues using a field if it is absent in MCCH information unless explicitly specified otherwise.

5.8.2.3 MCCH information acquisition by the UE

An MBMS capable UE shall:

- 1> if the procedure is triggered by an MCCH information change notification:
 - 2> start acquiring the *MBSFNAreaConfiguration* message and the *MBMSCountingRequest* message if present, from the beginning of the modification period following the one in which the change notification was received;

NOTE 1: The UE continues using the previously received MCCH information until the new MCCH information has been acquired.

- 1> if the UE enters an MBSFN area:

2> acquire the *MBSFNAreaConfiguration* message and the *MBMSCountingRequest* message if present, at the next repetition period;

1> if the UE is receiving an MBMS service:

2> start acquiring the *MBSFNAreaConfiguration* message and the *MBMSCountingRequest* message if present, that both concern the MBSFN area of the service that is being received, from the beginning of each modification period;

5.8.2.4 Actions upon reception of the *MBSFNAreaConfiguration* message

No UE requirements related to the contents of this *MBSFNAreaConfiguration* apply other than those specified elsewhere e.g. within procedures using the concerned system information, the corresponding field descriptions.

5.8.2.5 Actions upon reception of the *MBMSCountingRequest* message

Upon receiving *MBMSCountingRequest* message, the UE shall perform the MBMS Counting procedure as specified in section 5.8.4.

5.8.3 MBMS PTM radio bearer configuration

5.8.3.1 General

The MBMS PTM radio bearer configuration procedure is used by the UE to configure RLC, MAC and the physical layer upon starting and/or stopping to receive an MRB. The procedure applies to UEs interested to receive one or more MBMS services.

NOTE: In case the UE is unable to receive an MBMS service due to capability limitations, upper layers may take appropriate action e.g. terminate a lower priority unicast service.

5.8.3.2 Initiation

The UE applies the MRB establishment procedure to start receiving a session of a service it has an interest in. The procedure may be initiated e.g. upon start of the MBMS session, upon (re-)entry of the corresponding MBSFN service area, upon becoming interested in the MBMS service, upon removal of UE capability limitations inhibiting reception of the concerned service.

The UE applies the MRB release procedure to stop receiving a session. The procedure may be initiated e.g. upon stop of the MBMS session, upon leaving the corresponding MBSFN service area, upon losing interest in the MBMS service, when capability limitations start inhibiting reception of the concerned service.

5.8.3.3 MRB establishment

Upon MRB establishment, the UE shall:

- 1> establish an RLC entity in accordance with the configuration specified in 9.1.1.4;
- 1> configure an MTCH logical channel in accordance with the received *logicalChannelIdentity*, applicable for the MRB, as included in the *MBSFNAreaConfiguration* message;
- 1> configure the physical layer in accordance with the *pmch-Config*, applicable for the MRB, as included in the *MBSFNAreaConfiguration* message;
- 1> inform upper layers about the establishment of the MRB by indicating the corresponding *tmgi* and *sessionId*;

5.8.3.4 MRB release

Upon MRB release, the UE shall:

- 1> release the RLC entity as well as the related MAC and physical layer configuration;
- 1> inform upper layers about the release of the MRB by indicating the corresponding *tmgi* and *sessionId*;

5.8.4 MBMS Counting Procedure

5.8.4.1 General

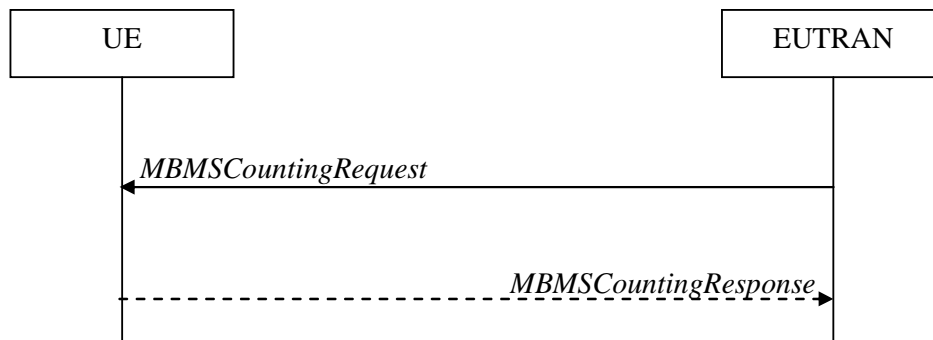

Figure 5.8.4.1-1: MBMS Counting procedure

The MBMS Counting procedure is used by the E-UTRAN to count the number of RRC_CONNECTED mode UEs which are receiving via an MRB or interested to receive via an MRB the specified MBMS services.

The UE determines interest in an MBMS service, that is identified by the TMGI, by interaction with upper layers.

5.8.4.2 Initiation

E-UTRAN initiates the procedure by sending an *MBMSCountingRequest* message.

5.8.4.3 Reception of the *MBMSCountingRequest* message by the UE

Upon receiving the *MBMSCountingRequest* message, the UE in RRC_CONNECTED mode shall:

- 1> if the *SystemInformationBlockType1*, that provided the scheduling information for the *systemInformationBlockType13* that included the configuration of the MCCH via which the *MBMSCountingRequest* message was received, contained the identity of the Registered PLMN; and
- 1> if the UE is receiving via an MRB or interested to receive via an MRB at least one of the services in the received *countingRequestList*:
 - 2> if more than one entry is included in the *mbsfn-AreaInfoList* received in the *SystemInformationBlockType13* that included the configuration of the MCCH via which the *MBMSCountingRequest* message was received:
 - 3> include the *mbsfn-AreaIndex* in the *MBMSCountingResponse* message and set it to the index of the entry in the *mbsfn-AreaInfoList* within the received *SystemInformationBlockType13* that corresponds with the MBSFN area used to transfer the received *MBMSCountingRequest* message;
 - 2> for each MBMS service included in the received *countingRequestList*:
 - 3> if the UE is receiving via an MRB or interested to receive via an MRB this MBMS service:
 - 4> include an entry in the *countingResponseList* within the *MBMSCountingResponse* message with *countingResponseService* set it to the index of the entry in the *countingRequestList* within the received *MBMSCountingRequest* that corresponds with the MBMS service the UE is receiving or interested to receive;
- 2> submit the *MBMSCountingResponse* message to lower layers for transmission upon which the procedure ends;

NOTE 1: UEs that are receiving an MBMS User Service [56] by means of a Unicast Bearer Service [57] (i.e. via a DRB), but are interested to receive the concerned MBMS User Service [56] via an MBMS Bearer Service (i.e. via an MRB), respond to the counting request.

NOTE 2: If ciphering is used at upper layers, the UE does not respond to the counting request if it can not decipher the MBMS service for which counting is performed (see TS 22.146 [62, 5.3]).

NOTE 3: The UE treats the *MBMSCountingRequest* messages received in each modification period independently. In the unlikely case E-UTRAN would repeat an *MBMSCountingRequest* (i.e. including the same services) in a subsequent modification period, the UE responds again. The UE provides at most one *MBMSCountingResponse* message to multiple transmission attempts of an *MBMSCountingRequest* messages in a given modification period.

5.8.5 MBMS interest indication

5.8.5.1 General

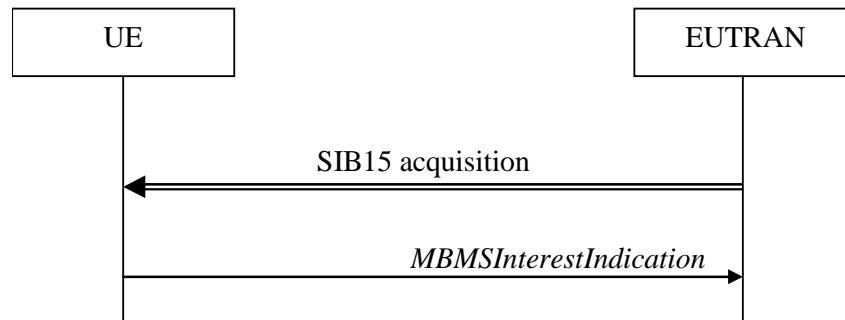

Figure 5.8.5.1-1: MBMS interest indication

The purpose of this procedure is to inform E-UTRAN that the UE is receiving or is interested to receive MBMS via an MRB, and if so, to inform E-UTRAN about the priority of MBMS versus unicast reception.

5.8.5.2 Initiation

An MBMS capable UE in RRC_CONNECTED may initiate the procedure in several cases including upon successful connection establishment, upon entering or leaving the service area, upon session start or stop, upon change of interest, upon change of priority between MBMS reception and unicast reception or upon change to a PCell broadcasting *SystemInformationBlockType15*.

Upon initiating the procedure, the UE shall:

- 1> if *SystemInformationBlockType15* is broadcast by the PCell:
 - 2> ensure having a valid version of *SystemInformationBlockType15* for the PCell;
- 2> if the UE did not transmit an *MBMSInterestIndication* message since last entering RRC_CONNECTED state; or
- 2> if since the last time the UE transmitted an *MBMSInterestIndication* message, the UE connected to a PCell not broadcasting *SystemInformationBlockType15*:
 - 3> if the set of MBMS frequencies of interest, determined in accordance with 5.8.5.3, is not empty:
 - 4> initiate transmission of the *MBMSInterestIndication* message in accordance with 5.8.5.4;
- 2> else:
 - 3> if the set of MBMS frequencies of interest, determined in accordance with 5.8.5.3, has changed since the last transmission of the *MBMSInterestIndication* message; or
 - 3> if the prioritisation of reception of all indicated MBMS frequencies compared to reception of any of the established unicast bearers has changed since the last transmission of the *MBMSInterestIndication* message:
 - 4> initiate transmission of the *MBMSInterestIndication* message in accordance with 5.8.5.4;

NOTE: The UE may send an *MBMSInterestIndication* even when it is able to receive the MBMS services it is interested in i.e. to avoid that the network allocates a configuration inhibiting MBMS reception.

5.8.5.3 Determine MBMS frequencies of interest

The UE shall:

1> consider a frequency to be part of the MBMS frequencies of interest if the following conditions are met:

2> at least one MBMS session the UE is receiving or interested to receive via an MRB is ongoing or about to start; and

NOTE 1: The UE may determine whether the session is ongoing from the start and stop time indicated in the User Service Description (USD), see 3GPP TS 36.300 [9] or 3GPP TS 26.346 [57].

2> for at least one of these MBMS sessions *SystemInformationBlockType15* acquired from the PCell includes for the concerned frequency one or more MBMS SAIs as indicated in the USD for this session; and

NOTE 2: The UE considers a frequency to be part of the MBMS frequencies of interest even though E-UTRAN may (temporarily) not employ an MRB for the concerned session. I.e. the UE does not verify if the session is indicated on MCCH

NOTE 3: The UE considers the frequencies of interest independently of any synchronization state, e.g. [9, Annex J.1]

2> the UE is capable of simultaneously receiving the set of MBMS frequencies of interest, regardless of whether a serving cell is configured on each of these frequencies or not; and

2> the *supportedBandCombination* the UE included in *UE-EUTRA-Capability* contains at least one band combination including the set of MBMS frequencies of interest;

NOTE 4: Indicating a frequency implies that the UE supports *SystemInformationBlockType13* acquisition for the concerned frequency i.e. the indication should be independent of whether a serving cell is configured on that frequency.

NOTE 5: When evaluating which frequencies it can receive simultaneously, the UE does not take into account the serving frequencies that are currently configured i.e. it only considers MBMS frequencies it is interested to receive.

NOTE 6: The set of MBMS frequencies of interest includes at most one frequency for a given physical frequency. The UE only considers a physical frequency to be part of the MBMS frequencies of interest if it supports at least one of the bands indicated for this physical frequency in *SystemInformationBlockType1* (for serving frequency) or *SystemInformationBlockType15* (for neighbouring frequencies). In this case, E-UTRAN may assume the UE supports MBMS reception on any of the bands supported by the UE (i.e. according to *supportedBandCombination*).

5.8.5.4 Actions related to transmission of *MBMSInterestIndication* message

The UE shall set the contents of the *MBMSInterestIndication* message as follows:

1> if the set of MBMS frequencies of interest, determined in accordance with 5.8.5.3, is not empty:

2> include *mbms-FreqList* and set it to include the MBMS frequencies of interest, using the EARFCN corresponding with *freqBandIndicator* included in *SystemInformationBlockType1* (for serving frequency), if applicable, and the EARFCN(s) as included in *SystemInformationBlockType15* (for neighbouring frequencies);

NOTE 1: The EARFCN included in *mbms-FreqList* is merely used to indicate a physical frequency the UE is interested to receive i.e. the UE may not support the band corresponding to the included EARFCN (but it does support at least one of the bands indicated in system information for the concerned physical frequency).

2> include *mbms-Priority* if the UE prioritises reception of all indicated MBMS frequencies above reception of any of the unicast bearers;

NOTE 2: If the UE prioritises MBMS reception and unicast data cannot be supported because of congestion on the MBMS carrier(s), E-UTRAN may initiate release of unicast bearers. It is up to E-UTRAN implementation whether all bearers or only GBR bearers are released. E-UTRAN does not initiate re-establishment of the released unicast bearers upon alleviation of the congestion.

The UE shall submit the *MBMSInterestIndication* message to lower layers for transmission.

5.9 RN procedures

5.9.1 RN reconfiguration

5.9.1.1 General

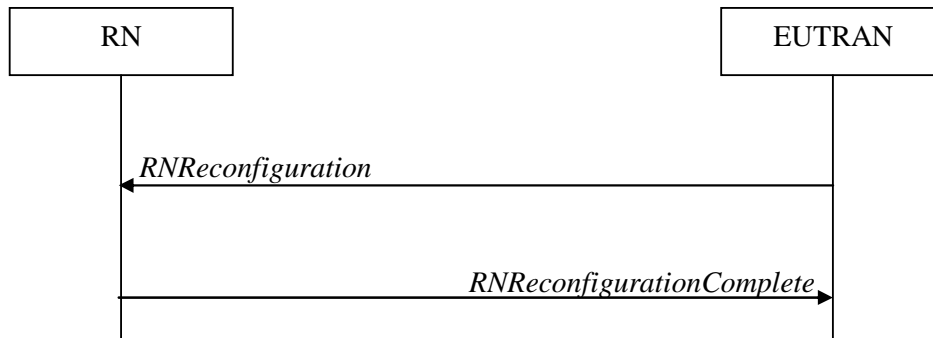

Figure 5.9.1.1-1: RN reconfiguration

The purpose of this procedure is to configure/reconfigure the RN subframe configuration and/or to update the system information relevant for the RN in RRC_CONNECTED.

5.9.1.2 Initiation

E-UTRAN may initiate the RN reconfiguration procedure to an RN in RRC_CONNECTED when AS security has been activated.

5.9.1.3 Reception of the *RNReconfiguration* by the RN

The RN shall:

- 1> if the *rn-SystemInfo* is included:
 - 2> if the *systemInformationBlockType1* is included:
 - 3> act upon the received *SystemInformationBlockType1* as specified in 5.2.2.7;
 - 2> if the *SystemInformationBlockType2* is included:
 - 3> act upon the received *SystemInformationBlockType2* as specified in 5.2.2.9;
- 1> if the *rn-SubframeConfig* is included:
 - 2> reconfigure lower layers in accordance with the received *subframeConfigPatternFDD* or *subframeConfigPatternTDD*;
 - 2> if the *rpdcch-Config* is included:
 - 3> reconfigure lower layers in accordance with the received *rpdcch-Config*;
- 1> submit the *RNReconfigurationComplete* message to lower layers for transmission, upon which the procedure ends;

5.10 Sidelink

5.10.1 Introduction

The sidelink communication/ discovery/ synchronisation resource configuration applies for the frequency at which it was received/ acquired. Moreover, for a UE configured with one or more SCells, the sidelink communication/ discovery/ synchronisation resource configuration provided by dedicated signalling applies for the PCell/ the primary frequency. Furthermore, the UE shall not use the sidelink communication/ discovery/ synchronisation transmission resources configured for one cell with the timing of another cell.

NOTE 1: Upper layers configure the UE to receive or transmit sidelink communication on a specific frequency, to monitor sidelink discovery announcements on one or more frequencies or to transmit sidelink discovery announcements on a specific frequency, but only if the UE is authorised to perform these particular ProSe related sidelink activities.

NOTE 2: It is up to UE implementation which actions to take (e.g. termination of unicast services, detach) when it is unable to perform the desired sidelink activities, e.g. due to UE capability limitations.

5.10.1a Conditions for sidelink operation

When it is specified that the UE shall perform a particular sidelink operation only if the conditions defined in this section are met, the UE shall perform the concerned sidelink operation only if:

- 1> if the UE's serving cell is suitable (RRC_IDLE or RRC_CONNECTED); and if either the selected cell on the frequency used for sidelink operation belongs to the registered or equivalent PLMN as specified in TS 24.334 [69] or the UE is out of coverage on the frequency used for sidelink operation as defined in TS 36.304 [4, 11.4]; or
- 1> if the UE is camped on a serving cell (RRC_IDLE) on which it fulfils the conditions to support sidelink communication in limited service state as specified in TS 23.303 [68, 4.5.6]; and if either the serving cell is on the frequency used for sidelink operation or the UE is out of coverage on the frequency used for sidelink operation as defined in TS 36.304 [4, 11.4]; or
- 1> if the UE has no serving cell (RRC_IDLE);

5.10.2 Sidelink UE information

5.10.2.1 General

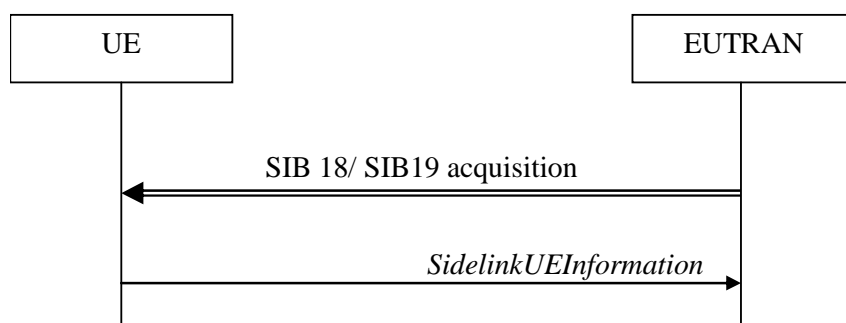

Figure 5.10.2-1: Sidelink UE information

The purpose of this procedure is to inform E-UTRAN that the UE is interested or no longer interested to receive sidelink communication or discovery, as well as to request assignment or release of transmission resources for sidelink communication or discovery announcements.

5.10.2.2 Initiation

A UE capable of sidelink communication or discovery that is in RRC_CONNECTED may initiate the procedure to indicate it is (interested in) receiving sidelink communication or discovery in several cases including upon successful connection establishment, upon change of interest, upon change to a PCell broadcasting *SystemInformationBlockType18* or *SystemInformationBlockType19*. A UE capable of sidelink communication or discovery may initiate the procedure to request assignment of dedicated resources for the concerned sidelink communication transmission or discovery announcements.

NOTE 1: A UE in RRC_IDLE that is configured to transmit sidelink communication/ discovery announcements, while *SystemInformationBlockType18/ SystemInformationBlockType19* does not include the resources for transmission (in normal conditions), initiates connection establishment in accordance with 5.3.3.1a.

Upon initiating the procedure, the UE shall:

1> if *SystemInformationBlockType18* is broadcast by the PCell:

2> ensure having a valid version of *SystemInformationBlockType18* for the PCell;

2> if configured by upper layers to receive sidelink communication:

3> if the UE did not transmit a *SidelinkUEInformation* message since last entering RRC_CONNECTED state; or

3> if since the last time the UE transmitted a *SidelinkUEInformation* message the UE connected to a PCell not broadcasting *SystemInformationBlockType18*; or

NOTE 2: After handover/ re-establishment from a source PCell not broadcasting *SystemInformationBlockType18* the UE repeats the same interest information that it provided previously as such a source PCell may not forward the interest information.

3> if the last transmission of the *SidelinkUEInformation* message did not include *commRxInterestedFreq*; or if the frequency configured by upper layers to receive sidelink communication on has changed since the last transmission of the *SidelinkUEInformation* message:

4> initiate transmission of the *SidelinkUEInformation* message to indicate the sidelink communication reception frequency of interest in accordance with 5.10.2.3;

2> else:

3> if the last transmission of the *SidelinkUEInformation* message included *commRxInterestedFreq*:

4> initiate transmission of the *SidelinkUEInformation* message to indicate it is no longer interested in sidelink communication reception in accordance with 5.10.2.3;

2> if configured by upper layers to transmit sidelink communication:

3> if the UE did not transmit a *SidelinkUEInformation* message since entering RRC_CONNECTED state; or

3> if since the last time the UE transmitted a *SidelinkUEInformation* message the UE connected to a PCell not broadcasting *SystemInformationBlockType18*; or

3> if the last transmission of the *SidelinkUEInformation* message did not include *commTxResourceReq*; or if the information carried by the *commTxResourceReq* has changed since the last transmission of the *SidelinkUEInformation* message:

4> initiate transmission of the *SidelinkUEInformation* message to indicate the sidelink communication transmission resources required by the UE in accordance with 5.10.2.3;

2> else:

3> if the last transmission of the *SidelinkUEInformation* message included *commTxResourceReq*:

4> initiate transmission of the *SidelinkUEInformation* message to indicate it does no longer require sidelink communication transmission resources in accordance with 5.10.2.3;

- 1> if *SystemInformationBlockType19* is broadcast by the PCell:
 - 2> ensure having a valid version of *SystemInformationBlockType19* for the PCell;
 - 2> if configured by upper layers to receive sidelink discovery announcements on a serving frequency or on one or more frequencies included in *discInterFreqList*, if included in *SystemInformationBlockType19*:
 - 3> if the UE did not transmit a *SidelinkUEInformation* message since last entering RRC_CONNECTED state; or
 - 3> if since the last time the UE transmitted a *SidelinkUEInformation* message the UE connected to a PCell not broadcasting *SystemInformationBlockType19*; or
 - 3> if the last transmission of the *SidelinkUEInformation* message did not include *discRxInterest*:
 - 4> initiate transmission of the *SidelinkUEInformation* message to indicate it is interested in sidelink discovery reception in accordance with 5.10.2.3;
 - 2> else:
 - 3> if the last transmission of the *SidelinkUEInformation* message included *discRxInterest*:
 - 4> initiate transmission of the *SidelinkUEInformation* message to indicate it is no longer interested in sidelink discovery reception in accordance with 5.10.2.3;
 - 2> if the UE is configured by upper layers to transmit sidelink discovery announcements:
 - 3> if the UE did not transmit a *SidelinkUEInformation* message since entering RRC_CONNECTED state; or
 - 3> if since the last time the UE transmitted a *SidelinkUEInformation* message the UE connected to a PCell not broadcasting *SystemInformationBlockType19*; or
 - 3> if the last transmission of the *SidelinkUEInformation* message did not include *discTxResourceReq*; or if the sidelink discovery announcement resources required by the UE have changed (i.e. resulting in a change of *discTxResourceReq*) since the last transmission of the *SidelinkUEInformation* message:
 - 4> initiate transmission of the *SidelinkUEInformation* message to indicate the sidelink discovery announcement resources required by the UE in accordance with 5.10.2.3;
 - 2> else:
 - 3> if the last transmission of the *SidelinkUEInformation* message included *discTxResourceReq*:
 - 4> initiate transmission of the *SidelinkUEInformation* message to indicate it does no longer require sidelink discovery announcement resources in accordance with 5.10.2.3;

5.10.2.3 Actions related to transmission of *SidelinkUEInformation* message

The UE shall set the contents of the *SidelinkUEInformation* message as follows:

- 1> if *SystemInformationBlockType18* is broadcast by the PCell:
 - 2> if configured by upper layers to receive sidelink communication:
 - 3> include *commRxInterestedFreq* and set it to the sidelink communication frequency;
 - 2> if configured by upper layers to transmit sidelink communication:
 - 3> include *commTxResourceReq* and set its fields as follows:
 - 4> set *carrierFreq* to indicate the sidelink communication frequency i.e. the same value as indicated in *commRxInterestedFreq* if included;
 - 4> set *destinationInfoList* to include the sidelink communication transmission destination(s) for which it requests E-UTRAN to assign dedicated resources;
- 1> if *SystemInformationBlockType19* is broadcast by the PCell:

- 2> if configured by upper layers to receive sidelink discovery announcements on a serving frequency or one or more frequencies included in *discInterFreqList*, if included in *SystemInformationBlockType19*:
 - 3> include *discRxInterest*;
- 2> if the UE is configured by upper layers to transmit sidelink discovery announcements:
 - 3> include *discTxResourceReq* and set it to indicate the number of discovery messages for sidelink discovery announcement(s) for which it requests E-UTRAN to assign dedicated resources;

The UE shall submit the *SidelinkUEInformation* message to lower layers for transmission.

5.10.3 Sidelink communication monitoring

A UE capable of sidelink communication that is configured by upper layers to receive sidelink communication shall:

- 1> if the conditions for sidelink operation as defined in 5.10.1a are met:
 - 2> if in coverage on the frequency used for sidelink communication, as defined in TS 36.304 [4, 11.4]:
 - 3> if the cell chosen for sidelink communication reception broadcasts *SystemInformationBlockType18* including *commRxPool*:
 - 4> configure lower layers to monitor sidelink control information and the corresponding data using the pool of resources indicated by *commRxPool*;

NOTE 1: If *commRxPool* includes one or more entries including *rxParametersNCell*, the UE may only monitor such entries if the associated PSS/SSS or SLSSIDs is detected. When monitoring such pool(s), the UE applies the timing of the concerned PSS/SSS or SLSS.

- 2> else (i.e. out of coverage on the sidelink carrier):
 - 3> configure lower layers to monitor sidelink control information and the corresponding data using the pool of resources that were preconfigured (i.e. *preconfigComm* in *SL-Preconfiguration* defined in 9.3);

NOTE 2: The UE may monitor in accordance with the timing of the selected SyncRef UE, or if the UE does not have a selected SyncRef UE, based on the UE's own timing.

5.10.4 Sidelink communication transmission

A UE capable of sidelink communication that is configured by upper layers to transmit sidelink communication and has related data to be transmitted shall:

- 1> if the conditions for sidelink operation as defined in 5.10.1a are met:
 - 2> if in coverage on the frequency used for sidelink communication, as defined in TS 36.304 [4, 11.4]:
 - 3> if the UE is in RRC_CONNECTED and uses the PCell for sidelink communication:
 - 4> if the UE is configured, by the current PCell/ the PCell in which physical layer problems or radio link failure was detected, with *commTxResources* set to *scheduled*:
 - 5> if T310 or T311 is running; and if the PCell at which the UE detected physical layer problems or radio link failure broadcasts *SystemInformationBlockType18* including *commTxPoolExceptional*; or
 - 5> if T301 is running and the cell on which the UE initiated connection re-establishment broadcasts *SystemInformationBlockType18* including *commTxPoolExceptional*;
 - 6> configure lower layers to transmit the sidelink control information and the corresponding data using the pool of resources indicated by the first entry in *commTxPoolExceptional*;
 - 5> else:
 - 6> configure lower layers to request E-UTRAN to assign transmission resources for sidelink communication;
 - 4> else if the UE is configured with *commTxPoolNormalDedicated*:
 - 5> configure lower layers to transmit the sidelink control information and the corresponding data using the pool of resources indicated by the first entry in *commTxPoolNormalDedicated*;
 - 3> else (i.e. sidelink communication in RRC_IDLE or on cell other than PCell in RRC_CONNECTED):
 - 4> if the cell chosen for sidelink communication transmission broadcasts *SystemInformationBlockType18*:
 - 5> if *SystemInformationBlockType18* includes *commTxPoolNormalCommon*:
 - 6> configure lower layers to transmit the sidelink control information and the corresponding data using the pool of resources indicated by the first entry in *commTxPoolNormalCommon*;
 - 5> else:
 - 6> if the last connection establishment was initiated to request sidelink communication transmission resources and resulted in T300 expiry; and
 - 6> if the cell on which the UE initiated connection establishment broadcasts *SystemInformationBlockType18* including *commTxPoolExceptional*:
 - 7> from the moment T300 expired, as specified in 5.3.3.6, until receiving an *RRCConnectionReconfiguration* including *sl-CommConfig* or until receiving an *RRCConnectionRelease* or an *RRCConnectionReject*;
 - 8> configure lower layers to transmit the sidelink control information and the corresponding data using the pool of resources indicated by the first entry in *commTxPoolExceptional*;
 - 2> else (i.e. out of coverage on sidelink carrier):
 - 3> configure lower layers to transmit the sidelink control information and the corresponding data using the pool of resources that were preconfigured i.e. indicated by the first entry in *preconfigComm* in *SL-Preconfiguration* defined in 9.3 and in accordance with the timing of the selected SyncRef UE, or if the UE does not have a selected SyncRef UE, based on the UEs own timing;

5.10.5 Sidelink discovery monitoring

A UE capable of sidelink discovery that is configured by upper layers to monitor sidelink discovery announcements shall:

- 1> for each frequency the UE is configured to monitor sidelink discovery announcements on, prioritising the frequencies included in *discInterFreqList*, if included in *SystemInformationBlockType19*:
- 2> configure lower layers to monitor sidelink discovery announcements using the pool of resources indicated by *discRxPool* in *SystemInformationBlockType19* without affecting normal operation i.e. receive during idle periods or by using a spare receiver;

NOTE 1: The requirement not to affect normal UE operation also applies for the acquisition of sidelink discovery related system and synchronisation information from inter-frequency cells.

NOTE 2: The UE is not required to monitor all pools simultaneously.

NOTE 3: It is up to UE implementation to decide whether a cell is sufficiently good to be used to monitor sidelink discovery announcements.

NOTE 4: If *discRxPool* includes one or more entries including *rxParameters*, the UE may only monitor such entries if the associated SLSSIDs are detected. When monitoring such pool(s) the UE applies the timing of the corresponding SLSS.

5.10.6 Sidelink discovery announcement

A UE capable of sidelink discovery that is configured by upper layers to transmit sidelink discovery announcements shall:

NOTE 1: In case the configured resources are insufficient it is up to UE implementation to decide which sidelink discovery announcements to transmit.

- 1> if the UE's serving cell (RRC_IDLE) or PCell (RRC_CONNECTED) is suitable as defined in TS 36.304 [4]:
 - 2> if the UE is in RRC_CONNECTED (i.e. PCell is used for sidelink discovery announcement):
 - 3> if the UE is configured with *discTxResources* set to *scheduled*:
 - 4> configure lower layers to transmit the sidelink discovery announcement using the assigned resources indicated by *scheduled* in *discTxResources*;
 - 3> else if the UE is configured with *discTxPoolDedicated* (i.e. *discTxResources* set to *ue-Selected*):
 - 4> if *poolSelection* within *poolToAddModList* is set to *rsrpBased*:
 - 5> select an entry of *poolToAddModList* for which the RSRP measurement of the PCell, after applying the layer 3 filter defined by *quantityConfig* as specified in 5.5.3.2, is in-between *threshLow* and *threshHigh*;
 - 4> else:
 - 5> randomly select, using a uniform distribution, an entry of *poolToAddModList*;
 - 4> configure lower layers to transmit the sidelink discovery announcement using the selected pool of resources;
 - 2> else if T300 is not running (i.e. UE in RRC_IDLE, announcing via serving cell):
 - 3> if *SystemInformationBlockType19* of the serving cell includes *discTxPoolCommon*:
 - 4> if *poolSelection* is set to *rsrpBased*:
 - 5> select an entry of *discTxPoolCommon* for which RSRP measurement of the serving cell is in-between *threshLow* and *threshHigh*;
 - 4> else:

- 5> randomly select, using a uniform distribution, an entry of *discTxPoolCommon*;
- 4> configure lower layers to transmit the sidelink discovery announcement using the selected pool of resources;

NOTE 2: When performing resource pool selection based on RSRP, the UE uses the latest results of the available measurements used for cell reselection evaluation in RRC_IDLE/ for measurement report triggering evaluation in RRC_CONNECTED, which are performed in accordance with the performance requirements specified in TS 36.133 [16].

5.10.7 Sidelink synchronisation information transmission

5.10.7.1 General

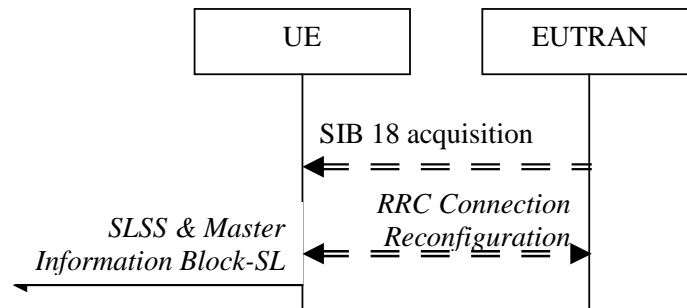

Figure 5.10.7.1-1: Synchronisation information transmission for sidelink communication, in (partial) coverage

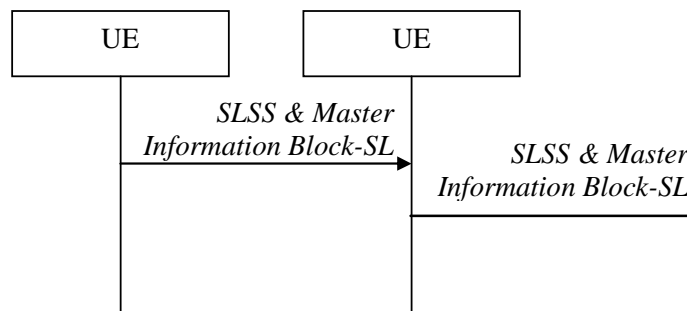

Figure 5.10.7.1-2: Synchronisation information transmission for sidelink communication, out of coverage

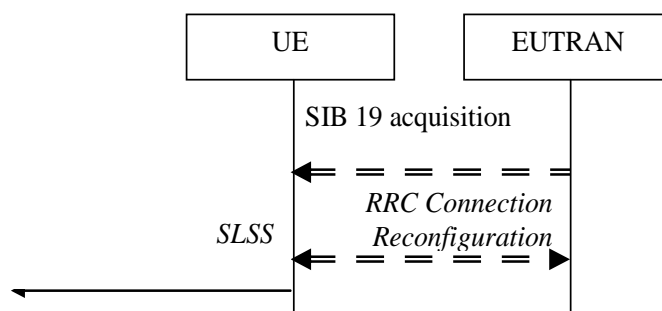

Figure 5.10.7.1-3: Synchronisation information transmission for sidelink discovery

The purpose of this procedure is to provide synchronisation information to a UE. The synchronisation information concerns a Sidelink Synchronisation Signal (SLSS) for sidelink discovery, while it concerns an SLSS, timing information and some additional configuration parameters (i.e. the *MasterInformationBlock-SL* message) for sidelink communication. A UE transmits synchronisation information either when E-UTRAN configures it to do so by dedicated signalling (i.e. network based), or when not configured by dedicated signalling (i.e. UE based) and E-UTRAN broadcasts (in coverage) or pre-configures a threshold (out of coverage).

The synchronisation information transmitted by the UE may be derived from information/ signals received from E-UTRAN (in coverage) or received from a UE acting as synchronisation reference for the transmitting UE. In the remainder, the UE acting as synchronisation reference is referred to as SyncRef UE.

5.10.7.2 Initiation

A UE capable of SLSS transmission shall, when transmitting sidelink discovery announcements in accordance with 5.10.6 and when the following conditions are met:

- 1> if the UE's serving cell (RRC_IDLE) or PCell (RRC_CONNECTED) is suitable as defined in TS 36.304 [4];
 - 2> if in RRC_CONNECTED; and if *networkControlledSyncTx* is configured and set to *on*; or
 - 2> if *networkControlledSyncTx* is not configured; and *syncTxThreshIC* is included in *SystemInformationBlockType19*; and the RSRP measurement of the serving cell (RRC_IDLE) or PCell (RRC_CONNECTED) is below the value of *syncTxThreshIC*;
 - 3> transmit SLSS in accordance with 5.10.7.3 and TS 36.211 [21], unless the UE uses the selected subframe for regular uplink transmission;

A UE capable of sidelink communication that is configured by upper layers to transmit sidelink communication shall, irrespective of whether or not it has data to transmit:

- 1> if the conditions for sidelink operation as defined in 5.10.1a are met:
 - 2> if in RRC_CONNECTED; and if *networkControlledSyncTx* is configured and set to *on*:
 - 3> transmit SLSS in accordance with 5.10.7.3 and TS 36.211 [21];
 - 3> transmit the *MasterInformationBlock-SL* message, in the same subframe as SLSS, and in accordance with 5.10.7.4;

A UE shall, when transmitting sidelink communication in accordance with 5.10.4 and when the following conditions are met:

- 1> if in coverage on the frequency used for sidelink communication, as defined in TS 36.304 [4, 11.4]:
 - 2> if the UE is in RRC_CONNECTED; and *networkControlledSyncTx* is not configured; and *syncTxThreshIC* is included in *SystemInformationBlockType18*; and the RSRP measurement of the cell chosen for sidelink communication transmission is below the value of *syncTxThreshIC*; or
 - 2> if the UE is in RRC_IDLE; and *syncTxThreshIC* is included in *SystemInformationBlockType18*; and the RSRP measurement of the cell chosen for sidelink communication transmission is below the value of *syncTxThreshIC*:
 - 3> transmit SLSS in accordance with 5.10.7.3 and TS 36.211 [21];
 - 3> transmit the *MasterInformationBlock-SL* message, in the same subframe as SLSS, and in accordance with 5.10.7.4;
- 1> else (i.e. out of coverage):
 - 2> if *syncTxThreshOoC* is included in the preconfigured sidelink parameters (i.e. *SL-Preconfiguration* defined in 9.3); and the UE has no selected SyncRef UE or the S-RSRP measurement result of the selected SyncRef UE is below the value of *syncTxThreshOoC*:
 - 3> transmit SLSS in accordance with 5.10.7.3 and TS 36.211 [21];
 - 3> transmit the *MasterInformationBlock-SL* message, in the same subframe as SLSS, and in accordance with 5.10.7.4;

5.10.7.3 Transmission of SLSS

The UE shall select the SLSSID and the subframe in which to transmit SLSS as follows:

- 1> if triggered by sidelink discovery announcement:

- 2> select the SLSSID included in the entry of *discSyncConfig* included in the received *SystemInformationBlockType19*, that includes *txParameters*;
- 2> use *syncOffsetIndicator* corresponding to the selected SLSSID;
- 2> for each pool used for the transmission of discovery announcements (each corresponding to the selected SLSSID):
 - 3> if a subframe indicated by *syncOffsetIndicator* corresponds to the first subframe of the discovery transmission pool;
 - 4> select the concerned subframe;
 - 3> else
 - 4> select the subframe indicated by *syncOffsetIndicator* that precedes and which, in time domain, is nearest to the first subframe of the discovery transmission pool;
- 1> if triggered by sidelink communication:
 - 2> if in coverage on the frequency used for sidelink communication, as defined in TS 36.304 [4, 11.4]:
 - 3> select the SLSSID included in the entry of *commSyncConfig* that is included in the received *SystemInformationBlockType18* and includes *txParameters*;
 - 3> use *syncOffsetIndicator* corresponding to the selected SLSSID;
 - 3> if in RRC_CONNECTED; and if *networkControlledSyncTx* is configured and set to *on*:
 - 4> select the subframe(s) indicated by *syncOffsetIndicator*;
 - 3> else (when transmitting communication):
 - 4> select the subframe(s) indicated by *syncOffsetIndicator* within the SC period in which the UE intends to transmit sidelink control information or data;
 - 2> else (i.e. out of coverage on sidelink carrier):
 - 3> select the synchronisation reference UE (i.e. SyncRef UE) as defined in 5.10.8;
 - 3> if the UE has a selected SyncRef UE and *inCoverage* in the *MasterInformationBlock-SL* message received from this UE is set to *TRUE*; or
 - 3> if the UE has a selected SyncRef UE and *inCoverage* in the *MasterInformationBlock-SL* message received from this UE is set to *FALSE* while the SLSS from this UE is part of the set defined for out of coverage, see TS 36.211 [21]:
 - 4> select the same SLSSID as the SLSSID of the selected SyncRef UE;
 - 4> select the subframe in which to transmit the SLSS according to the *syncOffsetIndicator1* or *syncOffsetIndicator2* included in the preconfigured sidelink parameters (i.e. *preconfigSync* in *SL-Preconfiguration* defined in 9.3), such that the subframe timing is different from the SLSS of the selected SyncRef UE;
 - 3> else if the UE has a selected SyncRef UE:
 - 4> select the SLSSID from the set defined for out of coverage having an index that is 168 more than the index of the SLSSID of the selected SyncRef UE, see TS 36.211 [21];
 - 4> select the subframe in which to transmit the SLSS according to *syncOffsetIndicator1* or *syncOffsetIndicator2* included in the preconfigured sidelink parameters (i.e. *preconfigSync* in *SL-Preconfiguration* defined in 9.3), such that the subframe timing is different from the SLSS of the selected SyncRef UE;
 - 3> else (i.e. no SyncRef UE selected):

- 4> randomly select, using a uniform distribution, an SLSSID from the set of sequences defined for out of coverage, see TS 36.211 [21];
- 4> select the subframe in which to transmit the SLSS according to the *syncOffsetIndicator1* or *syncOffsetIndicator2* (arbitrary selection between these) included in the preconfigured sidelink parameters (i.e. *preconfigSync* in *SL-Preconfiguration* defined in 9.3);

5.10.7.4 Transmission of *MasterInformationBlock-SL* message

The UE shall set the contents of the *MasterInformationBlock-SL* message as follows:

- 1> if in coverage on the frequency used for sidelink communication, as defined in TS 36.304 [4, 11.4]:
 - 2> set *inCoverage* to *TRUE*;
 - 2> set *sl-Bandwidth* to the value of *ul-Bandwidth* as included in the received *SystemInformationBlockType2* of the cell chosen for sidelink communication;
 - 2> if *tdd-Config* is included in the received *SystemInformationBlockType1*:
 - 3> set *subframeAssignmentSL* to the value representing the same meaning as of *subframeAssignment* that is included in *tdd-Config* in the received *SystemInformationBlockType1*;
 - 2> else:
 - 3> set *subframeAssignmentSL* to *none*;
 - 2> if *syncInfoReserved* is included in an entry of *commSyncConfig* from the received *SystemInformationBlockType18*:
 - 3> set *reserved* to the value of *syncInfoReserved* in the received *SystemInformationBlockType18*;
 - 2> else:
 - 3> set all bits in *reserved* to 0;
- 1> else if the UE has a selected SyncRef UE (as defined in 5.10.8):
 - 2> set *inCoverage* to *FALSE*;
 - 2> set *sl-Bandwidth*, *subframeAssignmentSL* and *reserved* to the value of the corresponding field included in the received *MasterInformationBlock-SL*;
- 1> else (i.e. no SyncRef UE selected):
 - 2> set *inCoverage* to *FALSE*;
 - 2> set *sl-Bandwidth*, *subframeAssignmentSL* and *reserved* to the value of the corresponding field included in the preconfigured sidelink parameters (i.e. *preconfigGeneral* in *SL-Preconfiguration* defined in 9.3);
- 1> set *directFrameNumber* and *directSubframeNumber* according to the subframe used to transmit the SLSS, as specified in 5.10.7.3;
- 1> submit the *MasterInformationBlock-SL* message to lower layers for transmission upon which the procedure ends;

5.10.7.5 Void

5.10.8 Sidelink synchronisation reference

5.10.8.1 General

The purpose of this procedure is to select a synchronisation reference and used a.o. when transmitting sidelink communication or synchronisation information.

5.10.8.2 Selection and reselection of synchronisation reference UE (SyncRef UE)

The UE shall:

- 1> if out of coverage on the frequency used for sidelink communication, as defined in TS 36.304 [4, 11.4]:
 - 2> perform a full search (i.e. covering all subframes and all possible SLSSIDs) to detect candidate SLSS, in accordance with TS 36.133 [16]
 - 2> when evaluating the one or more detected SLSSIDs, apply layer 3 filtering as specified in 5.5.3.2 using the preconfigured *filterCoefficient* as defined in 9.3, before using the S-RSRP measurement results;
 - 2> if the UE has selected a SyncRef UE:
 - 3> if the S-RSRP of the strongest candidate SyncRef UE exceeds the minimum requirement TS 36.133 [16] by *syncRefMinHyst* and the strongest candidate SyncRef UE belongs to the same priority group as the current SyncRef UE and the S-RSRP of the strongest candidate SyncRef UE exceeds the S-RSRP of the current SyncRef UE by *syncRefDiffHyst*; or
 - 3> if the S-RSRP of the candidate SyncRef UE exceeds the minimum requirement TS 36.133 [16] by *syncRefMinHyst* and the candidate SyncRef UE belongs to a higher priority group than the current SyncRef UE; or
 - 3> if the S-RSRP of the current SyncRef UE is less than the minimum requirement TS 36.133 [16]:
 - 4> consider no SyncRef UE to be selected;
 - 2> if the UE has not selected a SyncRef UE,
 - 3> if the UE detects one or more SLSSIDs for which the S-RSRP exceeds the minimum requirement defined in TS 36.133 [16] by *syncRefMinHyst* and for which the UE received the corresponding *MasterInformationBlock-SL* message (candidate SyncRef UEs), select a SyncRef UE according to the following priority order:
 - 4> UEs of which *inCoverage*, included in the *MasterInformationBlock-SL* message received from this UE, is set to *TRUE*, starting with the UE with the highest S-RSRP result (priority group 1);
 - 4> UE which SLSSID is part of the set defined for in coverage, starting with the UE with the highest S-RSRP result (priority group 2);
 - 4> Other UEs, starting with the UE with the highest S-RSRP result (priority group 3);

5.10.9 Sidelink common control information

5.10.9.1 General

The sidelink common control information is carried by a single message, the *MasterInformationBlock-SL* (MIB-SL) message. The MIB-SL includes timing information as well as some configuration parameters and is transmitted via SL-BCH.

The MIB-SL uses a fixed schedule with a periodicity of 40 ms without repetitions. In particular, the MIB-SL is scheduled in subframes indicated by *syncOffsetIndicator* i.e. for which $(10 \cdot \text{DFN} + \text{subframe number}) \bmod 40 = \text{syncOffsetIndicator}$.

The sidelink common control information may change at any transmission i.e. neither a modification period nor a change notification mechanism is used.

A UE configured to receive or transmit sidelink communication shall:

- 1> if the UE has a selected SyncRef UE, as specified in 5.10.8.2:
 - 2> ensure having a valid version of the *MasterInformationBlock-SL* message of that SyncRefUE:

5.10.9.2 Actions related to reception of *MasterInformationBlock-SL* message

Upon receiving *MasterInformationBlock-SL*, the UE shall:

- 1> apply the values of *sl-Bandwidth*, *subframeAssignmentSL*, *directFrameNumber* and *directSubframeNumber* included in the received *MasterInformationBlock-SL* message;

6 Protocol data units, formats and parameters (tabular & ASN.1)

6.1 General

The contents of each RRC message is specified in sub-clause 6.2 using ASN.1 to specify the message syntax and using tables when needed to provide further detailed information about the fields specified in the message syntax. The syntax of the information elements that are defined as stand-alone abstract types is further specified in a similar manner in sub-clause 6.3.

The need for fields to be present in a message or an abstract type, i.e., the ASN.1 fields that are specified as OPTIONAL in the abstract notation (ASN.1), is specified by means of comment text tags attached to the OPTIONAL statement in the abstract syntax. All comment text tags are available for use in the downlink direction only. The meaning of each tag is specified in table 6.1-1.

Table 6.1-1: Meaning of abbreviations used to specify the need for fields to be present

Abbreviation	Meaning
Cond <i>conditionTag</i> (Used in downlink only)	<i>Conditionally present</i> A field for which the need is specified by means of conditions. For each <i>conditionTag</i> , the need is specified in a tabular form following the ASN.1 segment. In case, according to the conditions, a field is not present, the UE takes no action and where applicable shall continue to use the existing value (and/ or the associated functionality) unless explicitly stated otherwise (e.g. in the conditional presence table or in the description of the field itself).
Need OP (Used in downlink only)	<i>Optionally present</i> A field that is optional to signal. For downlink messages, the UE is not required to take any special action on absence of the IE beyond what is specified in the procedural text or the field description table following the ASN.1 segment. The UE behaviour on absence should be captured either in the procedural text or in the field description.
Need ON (Used in downlink only)	<i>Optionally present, No action</i> A field that is optional to signal. If the message is received by the UE, and in case the information element is absent, the UE takes no action and where applicable shall continue to use the existing value (and/ or the associated functionality).
Need OR (Used in downlink only)	<i>Optionally present, Release</i> A field that is optional to signal. If the message is received by the UE, and in case the information element is absent, the UE shall discontinue/ stop using/ delete any existing value (and/ or the associated functionality).

Any field with Need ON in system information shall be interpreted as Need OR.

Need codes may not be specified for a parent extension field/ extension group, used in downlink, which includes one or more child extension fields. Upon absence of such a parent extension field/ extension group, the UE shall:

- For each individual child extension field, including extensions that are mandatory to include in the optional group, act in accordance with the need code that is defined for the extension;
- Apply this behaviour not only for child extension fields included directly within the optional parent extension field/ extension group, but also for extension fields defined at further nesting levels as long as for none of the fields in-between the concerned extension field and the parent extension field a need code is specified;

NOTE 1: The above applies for groups of non critical extensions using double brackets (referred to as extension groups), as well as non-critical extensions at the end of a message or at the end of a structure contained in a BIT STRING or OCTET STRING (referred to as parent extension fields).

Need codes, conditions and ASN.1 defaults specified for a particular (child) field only apply in case the (parent) field including the particular field is present. This rule does not apply for optional parent extension fields/ extension groups without need codes,

NOTE 2: The previous rule implies that E-UTRAN has to include such a parent extension field to release a child field that is either:

- Optional with need OR, or

- Conditional while the UE releases the child field when absent.

The handling of need codes as specified in the previous is illustrated by means of an example, as shown in the following ASN.1.

```
-- /example/ ASN1START
RRCMessage-r8-IEs ::= SEQUENCE {
    field1          InformationElement1,
    field2          InformationElement2          OPTIONAL,  -- Need ON
    nonCriticalExtension
    RRCMessage-v8a0-IEs
    OPTIONAL
}

RRCMessage-v8a0-IEs ::= SEQUENCE {
    field3          InformationElement3          OPTIONAL,  -- Need ON
    nonCriticalExtension
    RRCMessage-v940-IEs
    OPTIONAL
}

RRCMessage-v940-IEs ::= SEQUENCE {
    field4          InformationElement4          OPTIONAL,  -- Need OR
    nonCriticalExtension
    SEQUENCE {}
    OPTIONAL
}

InformationElement1 ::= SEQUENCE {
    field11         InformationElement11         OPTIONAL,  -- Need ON
    field12         InformationElement12         OPTIONAL,  -- Need OR
    ...,
    [[ field13      InformationElement13         OPTIONAL,  -- Need OR
    field14         InformationElement14         OPTIONAL,  -- Need ON
    ]]
}

InformationElement2 ::= SEQUENCE {
    field21         InformationElement11         OPTIONAL,  -- Need OR
    ...
}

-- ASN1STOP
```

The handling of need codes as specified in the previous implies that:

- if *field2* in *RRCMessage-r8-IEs* is absent, the UE does not modify *field21*;
- if *field2* in *RRCMessage-r8-IEs* is present but does not include *field21*, the UE releases *field21*;
- if the extension group containing *field13* is absent, the UE releases *field13* and does not modify *field14*;
- if *nonCriticalExtension* defined by IE *RRCMessage-v8a0-IEs* is absent, the UE does not modify *field3* and releases *field4*;

6.2 RRC messages

NOTE: The messages included in this section reflect the current status of the discussions. Additional messages may be included at a later stage.

6.2.1 General message structure

– EUTRA-RRC-Definitions

This ASN.1 segment is the start of the E-UTRA RRC PDU definitions.

```
-- ASN1START
EUTRA-RRC-Definitions DEFINITIONS AUTOMATIC TAGS ::=
BEGIN
-- ASN1STOP
```

– *BCCH-BCH-Message*

The *BCCH-BCH-Message* class is the set of RRC messages that may be sent from the E-UTRAN to the UE via BCH on the BCCH logical channel.

```
-- ASN1START
BCCH-BCH-Message ::= SEQUENCE {
    message          BCCH-BCH-MessageType
}
BCCH-BCH-MessageType ::=
    MasterInformationBlock
-- ASN1STOP
```

– *BCCH-DL-SCH-Message*

The *BCCH-DL-SCH-Message* class is the set of RRC messages that may be sent from the E-UTRAN to the UE via DL-SCH on the BCCH logical channel.

```
-- ASN1START
BCCH-DL-SCH-Message ::= SEQUENCE {
    message          BCCH-DL-SCH-MessageType
}
BCCH-DL-SCH-MessageType ::= CHOICE {
    c1              CHOICE {
        systemInformation          SystemInformation,
        systemInformationBlockType1 SystemInformationBlockType1
    },
    messageClassExtension SEQUENCE {}
}
-- ASN1STOP
```

– *MCCH-Message*

The *MCCH-Message* class is the set of RRC messages that may be sent from the E-UTRAN to the UE on the MCCH logical channel.

```
-- ASN1START
MCCH-Message ::= SEQUENCE {
    message          MCCH-MessageType
}
MCCH-MessageType ::= CHOICE {
    c1              CHOICE {
        mbsfnAreaConfiguration-r9 MBSFNAreaConfiguration-r9
    },
    later          CHOICE {
        c2          CHOICE {
            mbmsCountingRequest-r10 MBMSCountingRequest-r10
        },
        messageClassExtension SEQUENCE {}
    }
}
-- ASN1STOP
```

– *PCCH-Message*

The *PCCH-Message* class is the set of RRC messages that may be sent from the E-UTRAN to the UE on the PCCH logical channel.

```
-- ASN1START
PCCH-Message ::= SEQUENCE {
    message          PCCH-MessageType
}
```



```

}
PCCCH-MessageType ::= CHOICE {
  c1 CHOICE {
    paging Paging
  },
  messageClassExtension SEQUENCE {}
}
-- ASN1STOP

```

– DL-CCCH-Message

The *DL-CCCH-Message* class is the set of RRC messages that may be sent from the E-UTRAN to the UE on the downlink CCCH logical channel.

```

-- ASN1START
DL-CCCH-Message ::= SEQUENCE {
  message DL-CCCH-MessageType
}
DL-CCCH-MessageType ::= CHOICE {
  c1 CHOICE {
    rrcConnectionReestablishment RRCConnectionReestablishment,
    rrcConnectionReestablishmentReject RRCConnectionReestablishmentReject,
    rrcConnectionReject RRCConnectionReject,
    rrcConnectionSetup RRCConnectionSetup
  },
  messageClassExtension SEQUENCE {}
}
-- ASN1STOP

```

– DL-DCCH-Message

The *DL-DCCH-Message* class is the set of RRC messages that may be sent from the E-UTRAN to the UE or from the E-UTRAN to the RN on the downlink DCCH logical channel.

```

-- ASN1START
DL-DCCH-Message ::= SEQUENCE {
  message DL-DCCH-MessageType
}
DL-DCCH-MessageType ::= CHOICE {
  c1 CHOICE {
    csfbParametersResponseCDMA2000 CSFBParametersResponseCDMA2000,
    dlInformationTransfer DLInformationTransfer,
    handoverFromEUTRAPreparationRequest HandoverFromEUTRAPreparationRequest,
    mobilityFromEUTRACCommand MobilityFromEUTRACCommand,
    rrcConnectionReconfiguration RRCConnectionReconfiguration,
    rrcConnectionRelease RRCConnectionRelease,
    securityModeCommand SecurityModeCommand,
    ueCapabilityEnquiry UECapabilityEnquiry,
    counterCheck CounterCheck,
    ueInformationRequest-r9 UEInformationRequest-r9,
    loggedMeasurementConfiguration-r10 LoggedMeasurementConfiguration-r10,
    rnReconfiguration-r10 RNReconfiguration-r10,
    spare4 NULL,
    spare3 NULL, spare2 NULL, spare1 NULL
  },
  messageClassExtension SEQUENCE {}
}
-- ASN1STOP

```

– UL-CCCH-Message

The *UL-CCCH-Message* class is the set of RRC messages that may be sent from the UE to the E-UTRAN on the uplink CCCH logical channel.

```

-- ASN1START
UL-CCCH-Message ::= SEQUENCE {
    message          UL-CCCH-MessageType
}
UL-CCCH-MessageType ::= CHOICE {
    c1              CHOICE {
        rrcConnectionReestablishmentRequest  RRCConnectionReestablishmentRequest,
        rrcConnectionRequest                RRCConnectionRequest
    },
    messageClassExtension  SEQUENCE {}
}
-- ASN1STOP

```

– *UL-DCCH-Message*

The *UL-DCCH-Message* class is the set of RRC messages that may be sent from the UE to the E-UTRAN or from the RN to the E-UTRAN on the uplink DCCH logical channel.

```

-- ASN1START
UL-DCCH-Message ::= SEQUENCE {
    message          UL-DCCH-MessageType
}
UL-DCCH-MessageType ::= CHOICE {
    c1              CHOICE {
        csfbParametersRequestCDMA2000      CSFBParametersRequestCDMA2000,
        measurementReport                  MeasurementReport,
        rrcConnectionReconfigurationComplete  RRCConnectionReconfigurationComplete,
        rrcConnectionReestablishmentComplete  RRCConnectionReestablishmentComplete,
        rrcConnectionSetupComplete          RRCConnectionSetupComplete,
        securityModeComplete                SecurityModeComplete,
        securityModeFailure                  SecurityModeFailure,
        ueCapabilityInformation              UECapabilityInformation,
        ulHandoverPreparationTransfer        ULHandoverPreparationTransfer,
        ulInformationTransfer                ULInformationTransfer,
        counterCheckResponse                 CounterCheckResponse,
        ueInformationResponse-r9             UEInformationResponse-r9,
        proximityIndication-r9                ProximityIndication-r9,
        rnReconfigurationComplete-r10        RNReconfigurationComplete-r10,
        mbmsCountingResponse-r10             MBMSCountingResponse-r10,
        interFreqRSTDMeasurementIndication-r10  InterFreqRSTDMeasurementIndication-r10
    },
    messageClassExtension  CHOICE {
        c2              CHOICE {
            ueAssistanceInformation-r11      UEAssistanceInformation-r11,
            inDeviceCoexIndication-r11        InDeviceCoexIndication-r11,
            mbmsInterestIndication-r11        MBMSInterestIndication-r11,
            scgFailureInformation-r12         SCGFailureInformation-r12,
            sidelinkUEInformation-r12         SidelinkUEInformation-r12,
            spare11 NULL, spare10 NULL,
            spare9 NULL, spare8 NULL, spare7 NULL,
            spare6 NULL, spare5 NULL, spare4 NULL,
            spare3 NULL, spare2 NULL, spare1 NULL
        },
        messageClassExtensionFuture-r11 SEQUENCE {}
    }
}
-- ASN1STOP

```

6.2.2 Message definitions

– CounterCheck

The *CounterCheck* message is used by the E-UTRAN to indicate the current COUNT MSB values associated to each DRB and to request the UE to compare these to its COUNT MSB values and to report the comparison results to E-UTRAN.

Signalling radio bearer: SRB1

RLC-SAP: AM

Logical channel: DCCH

Direction: E-UTRAN to UE

CounterCheck message

```
-- ASN1START
CounterCheck ::= SEQUENCE {
    rrc-TransactionIdentifier RRC-TransactionIdentifier,
    criticalExtensions CHOICE {
        c1 CHOICE {
            counterCheck-r8 CounterCheck-r8-IEs,
            spare3 NULL, spare2 NULL, spare1 NULL
        },
        criticalExtensionsFuture SEQUENCE {}
    }
}

CounterCheck-r8-IEs ::= SEQUENCE {
    drb-CountMSB-InfoList DRB-CountMSB-InfoList,
    nonCriticalExtension CounterCheck-v8a0-IEs OPTIONAL
}

CounterCheck-v8a0-IEs ::= SEQUENCE {
    lateNonCriticalExtension OCTET STRING OPTIONAL,
    nonCriticalExtension SEQUENCE {} OPTIONAL
}

DRB-CountMSB-InfoList ::= SEQUENCE (SIZE (1..maxDRB)) OF DRB-CountMSB-Info

DRB-CountMSB-Info ::= SEQUENCE {
    drb-Identity DRB-Identity,
    countMSB-Uplink INTEGER(0..33554431),
    countMSB-Downlink INTEGER(0..33554431)
}
-- ASN1STOP
```

CounterCheck field descriptions

count-MSB-Downlink

Indicates the value of 25 MSBs from downlink COUNT associated to this DRB.

count-MSB-Uplink

Indicates the value of 25 MSBs from uplink COUNT associated to this DRB.

drb-CountMSB-InfoList

Indicates the MSBs of the COUNT values of the DRBs.

– CounterCheckResponse

The *CounterCheckResponse* message is used by the UE to respond to a *CounterCheck* message.

Signalling radio bearer: SRB1

RLC-SAP: AM

Logical channel: DCCH

Direction: UE to E-UTRAN

CounterCheckResponse message

```
-- ASN1START
CounterCheckResponse ::=          SEQUENCE {
    rrc-TransactionIdentifier      RRC-TransactionIdentifier,
    criticalExtensions             CHOICE {
        counterCheckResponse-r8   CounterCheckResponse-r8-IEs,
        criticalExtensionsFuture   SEQUENCE {}
    }
}

CounterCheckResponse-r8-IEs ::= SEQUENCE {
    drb-CountInfoList             DRB-CountInfoList,
    nonCriticalExtension          CounterCheckResponse-v8a0-IEs    OPTIONAL
}

CounterCheckResponse-v8a0-IEs ::= SEQUENCE {
    lateNonCriticalExtension      OCTET STRING                    OPTIONAL,
    nonCriticalExtension          SEQUENCE {}                     OPTIONAL
}

DRB-CountInfoList ::=          SEQUENCE (SIZE (0..maxDRB)) OF DRB-CountInfo

DRB-CountInfo ::=          SEQUENCE {
    drb-Identity                 DRB-Identity,
    count-Uplink                 INTEGER(0..4294967295),
    count-Downlink               INTEGER(0..4294967295)
}
-- ASN1STOP
```

CounterCheckResponse field descriptions

count-Downlink

Indicates the value of downlink COUNT associated to this DRB.

count-Uplink

Indicates the value of uplink COUNT associated to this DRB.

drb-CountInfoList

Indicates the COUNT values of the DRBs.

– CSFBParametersRequestCDMA2000

The *CSFBParametersRequestCDMA2000* message is used by the UE to obtain the CDMA2000 1xRTT Parameters from the network. The UE needs these parameters to generate the CDMA2000 1xRTT Registration message used to register with the CDMA2000 1xRTT Network which is required to support CSFB to CDMA2000 1xRTT.

Signalling radio bearer: SRB1

RLC-SAP: AM

Logical channel: DCCH

Direction: UE to E-UTRAN

CSFBParametersRequestCDMA2000 message

```
-- ASN1START
```

```

CSFBParametersRequestCDMA2000 ::= SEQUENCE {
    criticalExtensions          CHOICE {
        csfbParametersRequestCDMA2000-r8      CSFBParametersRequestCDMA2000-r8-IEs,
        criticalExtensionsFuture              SEQUENCE {}
    }
}

CSFBParametersRequestCDMA2000-r8-IEs ::= SEQUENCE {
    nonCriticalExtension          CSFBParametersRequestCDMA2000-v8a0-IEs OPTIONAL
}

CSFBParametersRequestCDMA2000-v8a0-IEs ::= SEQUENCE {
    lateNonCriticalExtension      OCTET STRING          OPTIONAL,
    nonCriticalExtension          SEQUENCE {}            OPTIONAL
}

-- ASN1STOP

```

– *CSFBParametersResponseCDMA2000*

The *CSFBParametersResponseCDMA2000* message is used to provide the CDMA2000 1xRTT Parameters to the UE so the UE can register with the CDMA2000 1xRTT Network to support CSFB to CDMA2000 1xRTT.

Signalling radio bearer: SRB1

RLC-SAP: AM

Logical channel: DCCH

Direction: E-UTRAN to UE

CSFBParametersResponseCDMA2000 message

```

-- ASN1START

CSFBParametersResponseCDMA2000 ::= SEQUENCE {
    rrc-TransactionIdentifier      RRC-TransactionIdentifier,
    criticalExtensions              CHOICE {
        csfbParametersResponseCDMA2000-r8      CSFBParametersResponseCDMA2000-r8-IEs,
        criticalExtensionsFuture              SEQUENCE {}
    }
}

CSFBParametersResponseCDMA2000-r8-IEs ::= SEQUENCE {
    rand                            RAND-CDMA2000,
    mobilityParameters              MobilityParametersCDMA2000,
    nonCriticalExtension            CSFBParametersResponseCDMA2000-v8a0-IEs OPTIONAL
}

CSFBParametersResponseCDMA2000-v8a0-IEs ::= SEQUENCE {
    lateNonCriticalExtension        OCTET STRING          OPTIONAL,
    nonCriticalExtension            SEQUENCE {}            OPTIONAL
}

-- ASN1STOP

```

– *DLInformationTransfer*

The *DLInformationTransfer* message is used for the downlink transfer of NAS or non-3GPP dedicated information.

Signalling radio bearer: SRB2 or SRB1 (only if SRB2 not established yet. If SRB2 is suspended, E-UTRAN does not send this message until SRB2 is resumed.)

RLC-SAP: AM

Logical channel: DCCH

Direction: E-UTRAN to UE

DLInformationTransfer message

```

-- ASN1START
DLInformationTransfer ::= SEQUENCE {
    rrc-TransactionIdentifier RRC-TransactionIdentifier,
    criticalExtensions CHOICE {
        cl CHOICE {
            dlInformationTransfer-r8 DLInformationTransfer-r8-IEs,
            spare3 NULL, spare2 NULL, spare1 NULL
        },
        criticalExtensionsFuture SEQUENCE {}
    }
}

DLInformationTransfer-r8-IEs ::= SEQUENCE {
    dedicatedInfoType CHOICE {
        dedicatedInfoNAS DedicatedInfoNAS,
        dedicatedInfoCDMA2000-1XRTT DedicatedInfoCDMA2000,
        dedicatedInfoCDMA2000-HRPD DedicatedInfoCDMA2000
    },
    nonCriticalExtension DLInformationTransfer-v8a0-IEs OPTIONAL
}

DLInformationTransfer-v8a0-IEs ::= SEQUENCE {
    lateNonCriticalExtension OCTET STRING OPTIONAL,
    nonCriticalExtension SEQUENCE {} OPTIONAL
}
-- ASN1STOP

```

HandoverFromEUTRAPreparationRequest (CDMA2000)

The *HandoverFromEUTRAPreparationRequest* message is used to trigger the handover preparation procedure with a CDMA2000 RAT. This message is also used to trigger a tunneled preparation procedure with a CDMA2000 1xRTT RAT to obtain traffic channel resources for the enhanced CS fallback to CDMA2000 1xRTT, which may also involve a concurrent preparation for handover to CDMA2000 HRPD. Also, this message is used to trigger the dual Rx/Tx redirection procedure with a CDMA2000 1xRTT RAT.

Signalling radio bearer: SRB1

RLC-SAP: AM

Logical channel: DCCH

Direction: E-UTRAN to UE

HandoverFromEUTRAPreparationRequest message

```

-- ASN1START
HandoverFromEUTRAPreparationRequest ::= SEQUENCE {
    rrc-TransactionIdentifier RRC-TransactionIdentifier,
    criticalExtensions CHOICE {
        cl CHOICE {
            handoverFromEUTRAPreparationRequest-r8 HandoverFromEUTRAPreparationRequest-r8-IEs,
            spare3 NULL, spare2 NULL, spare1 NULL
        },
        criticalExtensionsFuture SEQUENCE {}
    }
}

HandoverFromEUTRAPreparationRequest-r8-IEs ::= SEQUENCE {
    cdma2000-Type CDMA2000-Type,
    rand RAND-CDMA2000 OPTIONAL, -- Cond cdma2000-Type
    mobilityParameters MobilityParametersCDMA2000 OPTIONAL, -- Cond cdma2000-Type
    nonCriticalExtension HandoverFromEUTRAPreparationRequest-v890-IEs OPTIONAL
}

HandoverFromEUTRAPreparationRequest-v890-IEs ::= SEQUENCE {
    lateNonCriticalExtension OCTET STRING OPTIONAL,
    nonCriticalExtension HandoverFromEUTRAPreparationRequest-v920-IEs OPTIONAL
}

```

```

HandoverFromEUTRAPreparationRequest-v920-IEs ::= SEQUENCE {
    concurrPrepCDMA2000-HRPD-r9          BOOLEAN          OPTIONAL, -- Cond cdma2000-Type
    nonCriticalExtension                  HandoverFromEUTRAPreparationRequest-v1020-IEs  OPTIONAL
}

HandoverFromEUTRAPreparationRequest-v1020-IEs ::= SEQUENCE {
    dualRxTxRedirectIndicator-r10        ENUMERATED {true}    OPTIONAL, -- Cond cdma2000-1XRTT
    redirectCarrierCDMA2000-1XRTT-r10   CarrierFreqCDMA2000  OPTIONAL, -- Cond dualRxTxRedirect
    nonCriticalExtension                  SEQUENCE {}          OPTIONAL
}

-- ASN1STOP

```

HandoverFromEUTRAPreparationRequest field descriptions

concurrPrepCDMA2000-HRPD

Value TRUE indicates that upper layers should initiate concurrent preparation for handover to CDMA2000 HRPD in addition to preparation for enhanced CS fallback to CDMA2000 1xRTT.

dualRxTxRedirectIndicator

Value TRUE indicates that the second radio of the dual Rx/Tx UE is being redirected to CDMA2000 1xRTT [51].

redirectCarrierCDMA2000-1XRTT

Used to indicate the CDMA2000 1xRTT carrier frequency where the UE is being redirected to.

Conditional presence	Explanation
<i>cdma2000-1XRTT</i>	The field is optionally present, need ON, if the <i>cdma2000-Type = type1XRTT</i> ; otherwise it is not present.
<i>cdma2000-Type</i>	The field is mandatory present if the <i>cdma2000-Type = type1XRTT</i> ; otherwise it is not present.
<i>dualRxTxRedirect</i>	The field is optionally present, need ON, if <i>dualRxTxRedirectIndicator</i> is present; otherwise it is not present.

– *InDeviceCoexIndication*

The *InDeviceCoexIndication* message is used to inform E-UTRAN about IDC problems which can not be solved by the UE itself, as well as to provide information that may assist E-UTRAN when resolving these problems.

Signalling radio bearer: SRB1

RLC-SAP: AM

Logical channel: DCCH

Direction: UE to E-UTRAN

***InDeviceCoexIndication* message**

```

-- ASN1START

InDeviceCoexIndication-r11 ::= SEQUENCE {
    criticalExtensions          CHOICE {
        c1                     CHOICE {
            inDeviceCoexIndication-r11          InDeviceCoexIndication-r11-IEs,
            spare3 NULL, spare2 NULL, spare1 NULL
        },
        criticalExtensionsFuture          SEQUENCE {}
    }
}

InDeviceCoexIndication-r11-IEs ::= SEQUENCE {
    affectedCarrierFreqList-r11          AffectedCarrierFreqList-r11          OPTIONAL,
    tdm-AssistanceInfo-r11              TDM-AssistanceInfo-r11              OPTIONAL,
    lateNonCriticalExtension             OCTET STRING                      OPTIONAL,
    nonCriticalExtension                 InDeviceCoexIndication-v11d0-IEs    OPTIONAL
}

InDeviceCoexIndication-v11d0-IEs ::= SEQUENCE {
    ul-CA-AssistanceInfo-r11            SEQUENCE {
        affectedCarrierFreqCombList-r11          AffectedCarrierFreqCombList-r11          OPTIONAL,
        victimSystemType-r11                    VictimSystemType-r11
    }
}

```

```

    }
    nonCriticalExtension          SEQUENCE {}
  }
  OPTIONAL,
  OPTIONAL

AffectedCarrierFreqList-r11 ::= SEQUENCE (SIZE (1..maxFreqIDC-r11)) OF AffectedCarrierFreq-r11

AffectedCarrierFreq-r11 ::= SEQUENCE {
  carrierFreq-r11                MeasObjectId,
  interferenceDirection-r11      ENUMERATED {eutra, other, both, spare}
}

AffectedCarrierFreqCombList-r11 ::= SEQUENCE (SIZE (1..maxCombIDC-r11)) OF AffectedCarrierFreqComb-r11

AffectedCarrierFreqComb-r11 ::= SEQUENCE (SIZE (2..maxServCell-r10)) OF MeasObjectId

TDM-AssistanceInfo-r11 ::= CHOICE {
  drx-AssistanceInfo-r11        SEQUENCE {
    drx-CycleLength-r11          ENUMERATED {sf40, sf64, sf80, sf128, sf160,
                                              sf256, spare2, spare1},
    drx-Offset-r11              INTEGER (0..255)    OPTIONAL,
    drx-ActiveTime-r11          ENUMERATED {sf20, sf30, sf40, sf60, sf80,
                                              sf100, spare2, spare1}
  },
  idc-SubframePatternList-r11   IDC-SubframePatternList-r11,
  ...
}

IDC-SubframePatternList-r11 ::= SEQUENCE (SIZE (1..maxSubframePatternIDC-r11)) OF IDC-SubframePattern-r11

IDC-SubframePattern-r11 ::= CHOICE {
  subframePatternFDD-r11        BIT STRING (SIZE (4)),
  subframePatternTDD-r11       CHOICE {
    subframeConfig0-r11         BIT STRING (SIZE (70)),
    subframeConfig1-5-r11      BIT STRING (SIZE (10)),
    subframeConfig6-r11        BIT STRING (SIZE (60))
  },
  ...
}

VictimSystemType-r11 ::= SEQUENCE {
  gps-r11                       ENUMERATED {true}                OPTIONAL,
  glonass-r11                   ENUMERATED {true}                OPTIONAL,
  bds-r11                       ENUMERATED {true}                OPTIONAL,
  galileo-r11                   ENUMERATED {true}                OPTIONAL,
  wlan-r11                      ENUMERATED {true}                OPTIONAL,
  bluetooth-r11                 ENUMERATED {true}                OPTIONAL
}

-- ASN1STOP

```

<i>InDeviceCoexIndication</i> field descriptions
<p><i>affectedCarrierFreqCombList</i> Indicates a list of E-UTRA carrier frequencies that are affected by IDC problems due to Inter-Modulation Distortion and harmonics from E-UTRA when configured with UL CA.</p>
<p><i>affectedCarrierFreqList</i> List of E-UTRA carrier frequencies affected by IDC problems.</p>
<p><i>drx-ActiveTime</i> Indicates the desired active time that the E-UTRAN is recommended to configure. Value in number of subframes. Value <i>sf20</i> corresponds to 20 subframes, <i>sf30</i> corresponds to 30 subframes and so on.</p>
<p><i>drx-CycleLength</i> Indicates the desired DRX cycle length that the E-UTRAN is recommended to configure. Value in number of subframes. Value <i>sf40</i> corresponds to 40 subframes, <i>sf64</i> corresponds to 64 subframes and so on.</p>
<p><i>drx-Offset</i> Indicates the desired DRX starting offset that the E-UTRAN is recommended to configure. The UE shall set the value of <i>drx-Offset</i> smaller than the value of <i>drx-CycleLength</i>. The starting frame and subframe satisfy the relation: $[(SFN * 10) + \text{subframe number}] \bmod (drx-CycleLength) = drx-Offset$.</p>
<p><i>idc-SubframePatternList</i> A list of one or more subframe patterns indicating which HARQ process E-UTRAN is requested to abstain from using. Value 0 indicates that E-UTRAN is requested to abstain from using the subframe. For FDD, the radio frame in which the pattern starts (i.e. the radio frame in which the first/leftmost bit of the <i>subframePatternFDD</i> corresponds to subframe #0) occurs when $SFN \bmod 2 = 0$. For TDD, the first/leftmost bit corresponds to the subframe #0 of the radio frame satisfying $SFN \bmod x = 0$, where x is the size of the bit string divided by 10. The UE shall indicate a subframe pattern that follows HARQ time line, as specified in TS 36.213 [23], i.e. if a subframe is set to 1 in the subframe pattern, also the corresponding subframes carrying the potential UL grant [23, 8.0], the UL HARQ retransmission [23, 8.0] and the DL/UL HARQ feedback [23, 7.3, 8.3 and 9.1.2] shall be set to 1.</p>
<p><i>interferenceDirection</i> Indicates the direction of IDC interference. Value <i>eutra</i> indicates that only E-UTRA is victim of IDC interference, value <i>other</i> indicates that only another radio is victim of IDC interference and value <i>both</i> indicates that both E-UTRA and another radio are victims of IDC interference. The other radio refers to either the ISM radio or GNSS (see 3GPP TR 36.816 [63]).</p>
<p><i>victimSystemType</i> Indicate the list of victim system types to which IDC interference is caused from E-UTRA when configured with UL CA. Value <i>gps</i>, <i>glonass</i>, <i>bds</i> and <i>galileo</i> indicates the type of GNSS. Value <i>wlan</i> indicates WLAN and value <i>bluetooth</i> indicates Bluetooth.</p>

– *InterFreqRSTDMeasurementIndication*

The *InterFreqRSTDMeasurementIndication* message is used to indicate that the UE is going to either start or stop OTDOA inter-frequency RSTD measurement which requires measurement gaps as specified in TS 36.133 [16, 8.1.2.6].

Signalling radio bearer: SRB1

RLC-SAP: AM

Logical channel: DCCH

Direction: UE to E-UTRAN

InterFreqRSTDMeasurementIndication message

```
-- ASN1START
InterFreqRSTDMeasurementIndication-r10 ::= SEQUENCE {
    criticalExtensions      CHOICE {
        c1                  CHOICE {
            interFreqRSTDMeasurementIndication-r10  InterFreqRSTDMeasurementIndication-r10-IEs,
            spare3 NULL, spare2 NULL, spare1 NULL
        },
        criticalExtensionsFuture SEQUENCE {}
    }
}

InterFreqRSTDMeasurementIndication-r10-IEs ::= SEQUENCE {
    rstd-InterFreqIndication-r10 CHOICE {
        start SEQUENCE {
            rstd-InterFreqInfoList-r10 RSTD-InterFreqInfoList-r10
        },
        stop NULL
    }
},
```

```

lateNonCriticalExtension      OCTET STRING      OPTIONAL,
nonCriticalExtension          SEQUENCE {}         OPTIONAL
}

RSTD-InterFreqInfoList-r10 ::= SEQUENCE (SIZE(1..maxRSTD-Freq-r10)) OF RSTD-InterFreqInfo-r10

RSTD-InterFreqInfo-r10 ::= SEQUENCE {
  carrierFreq-r10              ARFCN-ValueEUTRA,
  measPRS-Offset-r10           INTEGER (0..39),
  ...
  [[ carrierFreq-v1090          ARFCN-ValueEUTRA-v9e0      OPTIONAL
  ]]
}

-- ASN1STOP

```

InterFreqRSTDMeasurementIndication field descriptions
<p>carrierFreq The EARFCN value of the carrier received from upper layers for which the UE needs to perform the inter-frequency RSTD measurements. If the UE includes <i>carrierFreq-v1090</i>, it shall set <i>carrierFreq-r10</i> to <i>maxEARFCN</i>.</p>
<p>measPRS-Offset Indicates the requested gap offset for performing inter-frequency RSTD measurements. It is the smallest subframe offset from the beginning of subframe 0 of SFN=0 of the serving cell of the requested gap for measuring PRS positioning occasions in the carrier frequency <i>carrierFreq</i> for which the UE needs to perform the inter-frequency RSTD measurements. The PRS positioning occasion information is received from upper layers. The value of <i>measPRS-Offset</i> is obtained by mapping the starting subframe of the PRS positioning occasion in the measured cell onto the corresponding subframe in the serving cell and is calculated as the serving cell's number of subframes from SFN=0 mod 40. The UE shall take into account any additional time required by the UE to start PRS measurements on the other carrier when it does this mapping for determining the <i>measPRS-Offset</i>. NOTE: Figure 6.2.2-1 illustrates the <i>measPRS-Offset</i> field.</p>
<p>rstd-InterFreqIndication Indicates the inter-frequency RSTD measurement action, i.e. the UE is going to start or stop inter-frequency RSTD measurement.</p>

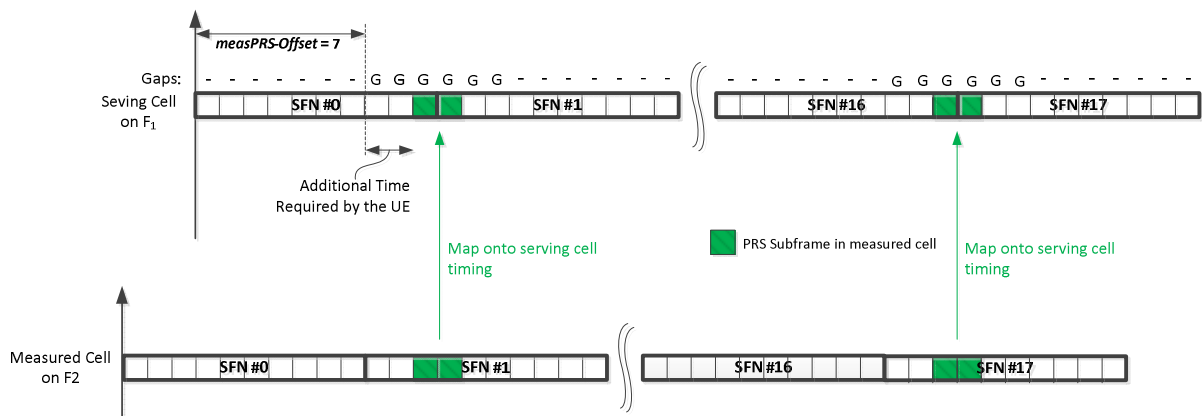

Figure 6.2.2-1 (informative): Exemplary calculation of *measPRS-Offset* field.

– **LoggedMeasurementConfiguration**

The *LoggedMeasurementConfiguration* message is used by E-UTRAN to configure the UE to perform logging of measurement results while in RRC_IDLE or to perform logging of measurement results for MBSFN while in both RRC_IDLE and RRC_CONNECTED. It is used to transfer the logged measurement configuration for network performance optimisation, see TS 37.320 [60].

Signalling radio bearer: SRB1

RLC-SAP: AM

Logical channel: DCCH

Direction: E-UTRAN to UE

LoggedMeasurementConfiguration message

```

-- ASN1START
LoggedMeasurementConfiguration-r10 ::= SEQUENCE {
    criticalExtensions          CHOICE {
        c1                     CHOICE {
            loggedMeasurementConfiguration-r10    LoggedMeasurementConfiguration-r10-IEs,
            spare3 NULL, spare2 NULL, spare1 NULL
        },
        criticalExtensionsFuture          SEQUENCE {}
    }
}

LoggedMeasurementConfiguration-r10-IEs ::= SEQUENCE {
    traceReference-r10          TraceReference-r10,
    traceRecordingSessionRef-r10    OCTET STRING (SIZE (2)),
    tce-Id-r10                  OCTET STRING (SIZE (1)),
    absoluteTimeInfo-r10        AbsoluteTimeInfo-r10,
    areaConfiguration-r10        AreaConfiguration-r10          OPTIONAL, -- Need OR
    loggingDuration-r10          LoggingDuration-r10,
    loggingInterval-r10          LoggingInterval-r10,
    nonCriticalExtension          LoggedMeasurementConfiguration-v1080-IEs    OPTIONAL
}

LoggedMeasurementConfiguration-v1080-IEs ::= SEQUENCE {
    lateNonCriticalExtension-r10    OCTET STRING          OPTIONAL,
    nonCriticalExtension            LoggedMeasurementConfiguration-v1130-IEs    OPTIONAL
}

LoggedMeasurementConfiguration-v1130-IEs ::= SEQUENCE {
    plmn-IdentityList-r11          PLMN-IdentityList3-r11    OPTIONAL, -- Need OR
    areaConfiguration-v1130        AreaConfiguration-v1130    OPTIONAL, -- Need OR
    nonCriticalExtension            LoggedMeasurementConfiguration-v1250-IEs    OPTIONAL
}

LoggedMeasurementConfiguration-v1250-IEs ::= SEQUENCE {
    targetMBSFN-AreaList-r12        TargetMBSFN-AreaList-r12    OPTIONAL, -- Need OP
    nonCriticalExtension            SEQUENCE {}                  OPTIONAL
}

TargetMBSFN-AreaList-r12 ::=          SEQUENCE (SIZE (0..maxMBSFN-Area)) OF TargetMBSFN-Area-r12

TargetMBSFN-Area-r12 ::=          SEQUENCE {
    mbsfn-AreaId-r12                MBSFN-AreaId-r12          OPTIONAL, -- Need OR
    carrierFreq-r12                ARFCN-ValueEUTRA-r9,
    ...
}
-- ASN1STOP

```

LoggedMeasurementConfiguration field descriptions
absoluteTimeInfo Indicates the absolute time in the current cell.
areaConfiguration Used to restrict the area in which the UE performs measurement logging to cells broadcasting either one of the included cell identities or one of the included tracking area codes/ identities.
plmn-IdentityList Indicates a set of PLMNs defining when the UE performs measurement logging as well as the associated status indication and information retrieval i.e. the UE performs these actions when the RPLMN is part of this set of PLMNs.
targetMBSFN-AreaList Used to indicate logging of MBSFN measurements and further restrict the area and frequencies for which the UE performs measurement logging for MBSFN. If both MBSFN area id and carrier frequency are present, a specific MBSFN area is indicated. If only carrier frequency is present, all MBSFN areas on that carrier frequency are indicated. If there is no entry in the list, any MBSFN area is indicated.
tce-Id Parameter Trace Collection Entity Id: See TS 32.422 [58].
traceRecordingSessionRef Parameter Trace Recording Session Reference: See TS 32.422 [58]

– *MasterInformationBlock*

The *MasterInformationBlock* includes the system information transmitted on BCH.

Signalling radio bearer: N/A

RLC-SAP: TM

Logical channel: BCCH

Direction: E-UTRAN to UE

MasterInformationBlock

```
-- ASN1START
MasterInformationBlock ::=
    dl-Bandwidth
    phich-Config
    systemFrameNumber
    spare
}
SEQUENCE {
    ENUMERATED {
        n6, n15, n25, n50, n75, n100},
    PHICH-Config,
    BIT STRING (SIZE (8)),
    BIT STRING (SIZE (10))
}
-- ASN1STOP
```

MasterInformationBlock field descriptions
dl-Bandwidth Parameter: transmission bandwidth configuration, N_{RB} in downlink, see TS 36.101 [42, table 5.6-1]. n6 corresponds to 6 resource blocks, n15 to 15 resource blocks and so on.
systemFrameNumber Defines the 8 most significant bits of the SFN. As indicated in TS 36.211 [21, 6.6.1], the 2 least significant bits of the SFN are acquired implicitly in the P-BCH decoding, i.e. timing of 40ms P-BCH TTI indicates 2 least significant bits (within 40ms P-BCH TTI, the first radio frame: 00, the second radio frame: 01, the third radio frame: 10, the last radio frame: 11). One value applies for all serving cells of a Cell Group (i.e. MCG or SCG). The associated functionality is common (i.e. not performed independently for each cell).

– *MBMSCountingRequest*

The *MBMSCountingRequest* message is used by E-UTRAN to count the UEs that are receiving or interested to receive specific MBMS services.

Signalling radio bearer: N/A

RLC-SAP: UM

Logical channel: MCCH

Direction: E-UTRAN to UE

MBMSCountingRequest message

```
-- ASN1START
MBMSCountingRequest-r10 ::= SEQUENCE {
    countingRequestList-r10      CountingRequestList-r10,
    lateNonCriticalExtension     OCTET STRING                OPTIONAL,
    nonCriticalExtension         SEQUENCE {}                          OPTIONAL
}

CountingRequestList-r10 ::= SEQUENCE (SIZE (1..maxServiceCount)) OF CountingRequestInfo-r10

CountingRequestInfo-r10 ::= SEQUENCE {
    tmgi-r10                    TMGI-r9,
    ...
}
-- ASN1STOP
```

MBMSCountingResponse

The *MBMSCountingResponse* message is used by the UE to respond to an *MBMSCountingRequest* message.

Signalling radio bearer: SRB1

RLC-SAP: AM

Logical channel: DCCH

Direction: UE to E-UTRAN

MBMSCountingResponse message

```
-- ASN1START
MBMSCountingResponse-r10 ::= SEQUENCE {
    criticalExtensions          CHOICE {
        c1                      CHOICE {
            countingResponse-r10 MBMSCountingResponse-r10-IEs,
            spare3 NULL, spare2 NULL, spare1 NULL
        },
        criticalExtensionsFuture SEQUENCE {}
    }
}

MBMSCountingResponse-r10-IEs ::= SEQUENCE {
    mbsfn-AreaIndex-r10      INTEGER (0..maxMBSFN-Area-1)                OPTIONAL,
    countingResponseList-r10 CountingResponseList-r10                OPTIONAL,
    lateNonCriticalExtension OCTET STRING                            OPTIONAL,
    nonCriticalExtension     SEQUENCE {}                              OPTIONAL
}

CountingResponseList-r10 ::= SEQUENCE (SIZE (1..maxServiceCount)) OF CountingResponseInfo-r10

CountingResponseInfo-r10 ::= SEQUENCE {
    countingResponseService-r10 INTEGER (0..maxServiceCount-1),
    ...
}
-- ASN1STOP
```

MBMSCountingResponse field descriptions
<p>countingResponseList List of MBMS services which the UE is receiving or interested to receive. Value 0 for field <i>countingResponseService</i> corresponds to the first entry in <i>countingRequestList</i> within <i>MBMSCountingRequest</i>, value 1 corresponds to the second entry in this list and so on.</p>
<p>mbsfn-AreaIndex Index of the entry in field <i>mbsfn-AreaInfoList</i> within <i>SystemInformationBlockType13</i>. Value 0 corresponds to the first entry in <i>mbsfn-AreaInfoList</i> within <i>SystemInformationBlockType13</i>, value 1 corresponds to the second entry in this list and so on.</p>

– *MBMSInterestIndication*

The *MBMSInterestIndication* message is used to inform E-UTRAN that the UE is receiving/ interested to receive or no longer receiving/ interested to receive MBMS via an MRB.

Signalling radio bearer: SRB1

RLC-SAP: AM

Logical channel: DCCH

Direction: UE to E-UTRAN

MBMSInterestIndication message

```

-- ASN1START
MBMSInterestIndication-r11 ::= SEQUENCE {
    criticalExtensions          CHOICE {
        c1                     CHOICE {
            interestIndication-r11 MBMSInterestIndication-r11-IEs,
            spare3 NULL, spare2 NULL, spare1 NULL
        },
        criticalExtensionsFuture SEQUENCE {}
    }
}

MBMSInterestIndication-r11-IEs ::= SEQUENCE {
    mbms-FreqList-r11          CarrierFreqListMBMS-r11          OPTIONAL,
    mbms-Priority-r11          ENUMERATED {true}                OPTIONAL,
    lateNonCriticalExtension   OCTET STRING                    OPTIONAL,
    nonCriticalExtension       SEQUENCE {}                      OPTIONAL
}
-- ASN1STOP

```

MBMSInterestIndication field descriptions
<p>mbms-FreqList List of MBMS frequencies on which the UE is receiving or interested to receive MBMS via an MRB.</p>
<p>mbms-Priority Indicates whether the UE prioritises MBMS reception above unicast reception. The field is present (i.e. value <i>true</i>), if the UE prioritises reception of all listed MBMS frequencies above reception of any of the unicast bearers. Otherwise the field is absent.</p>

– *MBSFNAreaConfiguration*

The *MBSFNAreaConfiguration* message contains the MBMS control information applicable for an MBSFN area. For each MBSFN area included in *SystemInformationBlockType13* E-UTRAN configures an MCCH (i.e. the MCCH identifies the MBSFN area) and signals the *MBSFNAreaConfiguration* message.

Signalling radio bearer: N/A

RLC-SAP: UM

Logical channel: MCCH

Direction: E-UTRAN to UE

MBSFNAreaConfiguration message

```

-- ASN1START
MBSFNAreaConfiguration-r9 ::= SEQUENCE {
    commonSF-Alloc-r9          CommonSF-AllocPatternList-r9,
    commonSF-AllocPeriod-r9   ENUMERATED {
        rf4, rf8, rf16, rf32, rf64, rf128, rf256},
    pmch-InfoList-r9          PMCH-InfoList-r9,
    nonCriticalExtension       MBSFNAreaConfiguration-v930-IEs OPTIONAL
}

MBSFNAreaConfiguration-v930-IEs ::= SEQUENCE {
    lateNonCriticalExtension   OCTET STRING OPTIONAL,
    nonCriticalExtension       MBSFNAreaConfiguration-v1250-IEs OPTIONAL
}

MBSFNAreaConfiguration-v1250-IEs ::= SEQUENCE {
    pmch-InfoListExt-r12      PMCH-InfoListExt-r12 OPTIONAL, -- Need OR
    nonCriticalExtension       SEQUENCE {} OPTIONAL
}

CommonSF-AllocPatternList-r9 ::= SEQUENCE (SIZE (1..maxMBSFN-Allocations)) OF MBSFN-
SubframeConfig
-- ASN1STOP

```

MBSFNAreaConfiguration field descriptions**commonSF-Alloc**

Indicates the subframes allocated to the MBSFN area. E-UTRAN always sets this field to cover at least the subframes configured by *SystemInformationBlockType13* for this MCCH, regardless of whether any MBMS sessions are ongoing.

commonSF-AllocPeriod

Indicates the period during which resources corresponding with field *commonSF-Alloc* are divided between the (P)MCH that are configured for this MBSFN area. The subframe allocation patterns, as defined by *commonSF-Alloc*, repeat continuously during this period. Value rf4 corresponds to 4 radio frames, rf8 corresponds to 8 radio frames and so on. The *commonSF-AllocPeriod* starts in the radio frames for which: SFN mod *commonSF-AllocPeriod* = 0.

pmch-InfoList

EUTRAN may include *pmch-InfoListExt* even if *pmch-InfoList* does not include *maxPMCH-PerMBSFN* entries. EUTRAN configures at most *maxPMCH-PerMBSFN* entries i.e. across *pmch-InfoList* and *pmch-InfoListExt*.

MeasurementReport

The *MeasurementReport* message is used for the indication of measurement results.

Signalling radio bearer: SRB1

RLC-SAP: AM

Logical channel: DCCH

Direction: UE to E-UTRAN

MeasurementReport message

```

-- ASN1START
MeasurementReport ::= SEQUENCE {
    criticalExtensions        CHOICE {
        c1                    CHOICE {
            measurementReport-r8          MeasurementReport-r8-IEs,
            spare7 NULL,
            spare6 NULL, spare5 NULL, spare4 NULL,
            spare3 NULL, spare2 NULL, spare1 NULL
        },
        criticalExtensionsFuture          SEQUENCE {}
    }
}

MeasurementReport-r8-IEs ::= SEQUENCE {
    measResults              MeasResults,
    nonCriticalExtension     MeasurementReport-v8a0-IEs OPTIONAL
}

```

```

}
MeasurementReport-v8a0-IEs ::= SEQUENCE {
    lateNonCriticalExtension    OCTET STRING                OPTIONAL,
    nonCriticalExtension        SEQUENCE {}                        OPTIONAL
}
-- ASN1STOP

```

– *MobilityFromEUTRACommand*

The *MobilityFromEUTRACommand* message is used to command handover or a cell change from E-UTRA to another RAT (3GPP or non-3GPP), or enhanced CS fallback to CDMA2000 1xRTT.

Signalling radio bearer: SRB1

RLC-SAP: AM

Logical channel: DCCH

Direction: E-UTRAN to UE

***MobilityFromEUTRACommand* message**

```

-- ASN1START
MobilityFromEUTRACommand ::= SEQUENCE {
    rrc-TransactionIdentifier    RRC-TransactionIdentifier,
    criticalExtensions            CHOICE {
        c1                       CHOICE {
            mobilityFromEUTRACommand-r8    MobilityFromEUTRACommand-r8-IEs,
            mobilityFromEUTRACommand-r9    MobilityFromEUTRACommand-r9-IEs,
            spare2 NULL, spare1          NULL
        },
        criticalExtensionsFuture    SEQUENCE {}
    }
}

MobilityFromEUTRACommand-r8-IEs ::= SEQUENCE {
    cs-FallbackIndicator        BOOLEAN,
    purpose                     CHOICE {
        handover                Handover,
        cellChangeOrder        CellChangeOrder
    },
    nonCriticalExtension        MobilityFromEUTRACommand-v8a0-IEs    OPTIONAL
}

MobilityFromEUTRACommand-v8a0-IEs ::= SEQUENCE {
    lateNonCriticalExtension    OCTET STRING                OPTIONAL,
    nonCriticalExtension        MobilityFromEUTRACommand-v8d0-IEs    OPTIONAL
}

MobilityFromEUTRACommand-v8d0-IEs ::= SEQUENCE {
    bandIndicator              BandIndicatorGERAN                OPTIONAL, -- Cond GERAN
    nonCriticalExtension        SEQUENCE {}                        OPTIONAL
}

MobilityFromEUTRACommand-r9-IEs ::= SEQUENCE {
    cs-FallbackIndicator        BOOLEAN,
    purpose                     CHOICE {
        handover                Handover,
        cellChangeOrder        CellChangeOrder,
        e-CSFB-r9              E-CSFB-r9,
        ...
    },
    nonCriticalExtension        MobilityFromEUTRACommand-v930-IEs    OPTIONAL
}

MobilityFromEUTRACommand-v930-IEs ::= SEQUENCE {
    lateNonCriticalExtension    OCTET STRING                OPTIONAL,
    nonCriticalExtension        MobilityFromEUTRACommand-v960-IEs    OPTIONAL
}

MobilityFromEUTRACommand-v960-IEs ::= SEQUENCE {
    bandIndicator              BandIndicatorGERAN                OPTIONAL, -- Cond GERAN
}

```



```

    nonCriticalExtension          SEQUENCE {}                OPTIONAL
}

Handover ::=
    targetRAT-Type                SEQUENCE {
        ENUMERATED {
            utra, geran, cdma2000-1XRTT, cdma2000-HRPD,
            spare4, spare3, spare2, spare1, ...},

        targetRAT-MessageContainer OCTET STRING,
        nas-SecurityParamFromEUTRA OCTET STRING (SIZE (1))    OPTIONAL,    -- Cond UTRAGERAN
        systemInformation           SI-OrPSI-GERAN             OPTIONAL     -- Cond PSHO
    }

CellChangeOrder ::=
    t304                            SEQUENCE {
        ENUMERATED {
            ms100, ms200, ms500, ms1000,
            ms2000, ms4000, ms8000, spare1},

        targetRAT-Type
            geran
                CHOICE {
                    SEQUENCE {
                        physCellId      PhysCellIdGERAN,
                        carrierFreq     CarrierFreqGERAN,
                        networkControlOrder BIT STRING (SIZE (2))    OPTIONAL,    -- Need OP
                        systemInformation SI-OrPSI-GERAN             OPTIONAL     -- Need OP
                    },
                    ...
                }
    }

SI-OrPSI-GERAN ::=
    si                               CHOICE {
        SystemInfoListGERAN,
        psi                           SystemInfoListGERAN
    }

E-CSFB-r9 ::=
    messageContCDMA2000-1XRTT-r9     OCTET STRING          OPTIONAL,    -- Need ON
    mobilityCDMA2000-HRPD-r9         ENUMERATED {
        handover, redirection
    }                                OPTIONAL,    -- Need OP
    messageContCDMA2000-HRPD-r9     OCTET STRING          OPTIONAL,    -- Cond concHO
    redirectCarrierCDMA2000-HRPD-r9 CarrierFreqCDMA2000 OPTIONAL    -- Cond concRedir
}

-- ASN1STOP

```

MobilityFromEUTRACommand field descriptions	
bandIndicator	Indicates how to interpret the ARFCN of the BCCH carrier.
carrierFreq	contains the carrier frequency of the target GERAN cell.
cs-FallbackIndicator	Value <i>true</i> indicates that the CS Fallback procedure to UTRAN or GERAN is triggered.
messageContCDMA2000-1XRTT	This field contains a message specified in CDMA2000 1xRTT standard that either tells the UE to move to specific 1xRTT target cell(s) or indicates a failure to allocate resources for the enhanced CS fallback to CDMA2000 1xRTT.
messageContCDMA2000-HRPD	This field contains a message specified in CDMA2000 HRPD standard that either tells the UE to move to specific HRPD target cell(s) or indicates a failure to allocate resources for the handover to CDMA2000 HRPD.
mobilityCDMA2000-HRPD	This field indicates whether or not mobility to CDMA2000 HRPD is to be performed by the UE and it also indicates the type of mobility to CDMA2000 HRPD that is to be performed; If this field is not present the UE shall perform only the enhanced CS fallback to CDMA2000 1xRTT.
nas-SecurityParamFromEUTRA	Used to deliver the key synchronisation and Key freshness for the E-UTRAN to UTRAN handovers as specified in TS 33.401. The content of the parameter is defined in TS24.301.
networkControlOrder	Parameter NETWORK_CONTROL_ORDER in TS 44.060 [36].
purpose	Indicates which type of mobility procedure the UE is requested to perform. EUTRAN always applies value <i>e-CSFB</i> in case of enhanced CS fallback to CDMA2000 (e.g. also when that procedure results in handover to CDMA2000 1XRTT only, in handover to CDMA2000 HRPD only or in redirection to CDMA2000 HRPD only),
redirectCarrierCDMA2000-HRPD	The <i>redirectCarrierCDMA2000-HRPD</i> indicates a CDMA2000 carrier frequency and is used to redirect the UE to a HRPD carrier frequency.
SystemInfoListGERAN	If <i>purpose = CellChangeOrder</i> and if the field is not present, the UE has to acquire SI/PSI from the GERAN cell.
t304	Timer T304 as described in section 7.3. Value <i>ms100</i> corresponds with 100 ms, <i>ms200</i> corresponds with 200 ms and so on.
targetRAT-Type	Indicates the target RAT type.
targetRAT-MessageContainer	The field contains a message specified in another standard, as indicated by the <i>targetRAT-Type</i> , and carries information about the target cell identifier(s) and radio parameters relevant for the target radio access technology. NOTE 1. A complete message is included, as specified in the other standard.

Conditional presence	Explanation
<i>concHO</i>	The field is mandatory present if the <i>mobilityCDMA2000-HRPD</i> is set to " <i>handover</i> "; otherwise the field is optional present, need ON.
<i>concRedir</i>	The field is mandatory present if the <i>mobilityCDMA2000-HRPD</i> is set to " <i>redirection</i> "; otherwise the field is not present.
<i>GERAN</i>	The field should be present if the <i>purpose</i> is set to " <i>handover</i> " and the <i>targetRAT-Type</i> is set to " <i>geran</i> "; otherwise the field is not present
<i>PSHO</i>	The field is mandatory present in case of PS handover toward GERAN; otherwise the field is optionally present, but not used by the UE
<i>UTRAGERAN</i>	The field is mandatory present if the <i>targetRAT-Type</i> is set to " <i>utra</i> " or " <i>geran</i> "; otherwise the field is not present

NOTE 1: The correspondence between the value of the *targetRAT-Type*, the standard to apply and the message contained within the *targetRAT-MessageContainer* is shown in the table below:

targetRAT-Type	Standard to apply	targetRAT-MessageContainer
<i>cdma2000-1XRTT</i>	C.S0001 or later, C.S0007 or later, C.S0008 or later	
<i>cdma2000-HRPD</i>	C.S0024 or later	
<i>geran</i>	GSM TS 04.18, version 8.5.0 or later, or 3GPP TS 44.018 (clause 9.1.15)	HANDOVER COMMAND
	3GPP TS 44.060, version 6.13.0 or later (clause 11.2.43)	PS HANDOVER COMMAND
	3GPP TS 44.060, version 7.6.0 or later (clause 11.2.46)	DTM HANDOVER COMMAND
<i>utra</i>	3GPP TS 25.331 (clause 10.2.16a)	HANDOVER TO UTRAN COMMAND

Paging

The *Paging* message is used for the notification of one or more UEs.

Signalling radio bearer: N/A

RLC-SAP: TM

Logical channel: PCCH

Direction: E-UTRAN to UE

Paging message

```

-- ASN1START
Paging ::=
    SEQUENCE {
        pagingRecordList          PagingRecordList          OPTIONAL, -- Need ON
        systemInfoModification    ENUMERATED {true}          OPTIONAL, -- Need ON
        etws-Indication           ENUMERATED {true}          OPTIONAL, -- Need ON
        nonCriticalExtension       Paging-v890-IEs             OPTIONAL
    }

Paging-v890-IEs ::=
    SEQUENCE {
        lateNonCriticalExtension   OCTET STRING          OPTIONAL,
        nonCriticalExtension       Paging-v920-IEs             OPTIONAL
    }

Paging-v920-IEs ::=
    SEQUENCE {
        cmas-Indication-r9        ENUMERATED {true}          OPTIONAL, -- Need ON
        nonCriticalExtension       Paging-v1130-IEs         OPTIONAL
    }

Paging-v1130-IEs ::=
    SEQUENCE {
        eab-ParamModification-r11 ENUMERATED {true}          OPTIONAL, -- Need ON
        nonCriticalExtension       SEQUENCE {}              OPTIONAL
    }

PagingRecordList ::=
    SEQUENCE (SIZE (1..maxPageRec)) OF PagingRecord

PagingRecord ::=
    SEQUENCE {
        ue-Identity               PagingUE-Identity,
        cn-Domain                 ENUMERATED {ps, cs},
        ...
    }

PagingUE-Identity ::=
    CHOICE {
        s-TMSI                    S-TMSI,
        imsi                      IMSI,
        ...
    }

IMSI ::=
    SEQUENCE (SIZE (6..21)) OF IMSI-Digit

IMSI-Digit ::=
    INTEGER (0..9)
-- ASN1STOP

```

<i>Paging field descriptions</i>
cmas-Indication If present: indication of a CMAS notification.
cn-Domain Indicates the origin of paging.
eab-ParamModification If present: indication of an EAB parameters (SIB14) modification.
etws-Indication If present: indication of an ETWS primary notification and/ or ETWS secondary notification.
imsi The International Mobile Subscriber Identity, a globally unique permanent subscriber identity, see TS 23.003 [27]. The first element contains the first IMSI digit, the second element contains the second IMSI digit and so on.
systemInfoModification If present: indication of a BCCH modification other than SIB10, SIB11, SIB12 and SIB14.
ue-Identity Provides the NAS identity of the UE that is being paged.

– *ProximityIndication*

The *ProximityIndication* message is used to indicate that the UE is entering or leaving the proximity of one or more CSG member cell(s).

Signalling radio bearer: SRB1

RLC-SAP: AM

Logical channel: DCCH

Direction: UE to E-UTRAN

ProximityIndication message

```
-- ASN1START
ProximityIndication-r9 ::= SEQUENCE {
    criticalExtensions          CHOICE {
        c1                      CHOICE {
            proximityIndication-r9
            spare3 NULL, spare2 NULL, spare1 NULL
        },
        criticalExtensionsFuture SEQUENCE {}
    }
}

ProximityIndication-r9-IEs ::= SEQUENCE {
    type-r9                    ENUMERATED {entering, leaving},
    carrierFreq-r9             CHOICE {
        eutra-r9                ARFCN-ValueEUTRA,
        utra-r9                 ARFCN-ValueUTRA,
        ...,
        eutra2-v9e0             ARFCN-ValueEUTRA-v9e0
    },
    nonCriticalExtension       ProximityIndication-v930-IEs
    OPTIONAL
}

ProximityIndication-v930-IEs ::= SEQUENCE {
    lateNonCriticalExtension   OCTET STRING                OPTIONAL,
    nonCriticalExtension       SEQUENCE {}                OPTIONAL
}
-- ASN1STOP
```

ProximityIndication field descriptions
<p>carrierFreq Indicates the RAT and frequency of the CSG member cell(s), for which the proximity indication is sent. For E-UTRA and UTRA frequencies, the UE shall set the ARFCN according to a band it previously considered suitable for accessing (one of) the CSG member cell(s), for which the proximity indication is sent.</p>
<p>type Used to indicate whether the UE is entering or leaving the proximity of CSG member cell(s).</p>

– *RNReconfiguration*

The *RNReconfiguration* is a command to modify the RN subframe configuration and/or to convey changed system information.

Signalling radio bearer: SRB1

RLC-SAP: AM

Logical channel: DCCH

Direction: E-UTRAN to RN

RNReconfiguration message

```

-- ASN1START
RNReconfiguration-r10 ::= SEQUENCE {
    rrc-TransactionIdentifier RRC-TransactionIdentifier,
    criticalExtensions CHOICE {
        c1 CHOICE {
            rnReconfiguration-r10 RNReconfiguration-r10-IEs,
            spare3 NULL, spare2 NULL, spare1 NULL
        },
        criticalExtensionsFuture SEQUENCE {}
    }
}

RNReconfiguration-r10-IEs ::= SEQUENCE {
    rn-SystemInfo-r10 RN-SystemInfo-r10 OPTIONAL, -- Need ON
    rn-SubframeConfig-r10 RN-SubframeConfig-r10 OPTIONAL, -- Need ON
    lateNonCriticalExtension OCTET STRING OPTIONAL,
    nonCriticalExtension SEQUENCE {} OPTIONAL
}

RN-SystemInfo-r10 ::= SEQUENCE {
    systemInformationBlockType1-r10 OCTET STRING (CONTAINING SystemInformationBlockType1)
    OPTIONAL, -- Need ON
    systemInformationBlockType2-r10 SystemInformationBlockType2 OPTIONAL, -- Need ON
    ...
}
-- ASN1STOP

```

– *RNReconfigurationComplete*

The *RNReconfigurationComplete* message is used to confirm the successful completion of an RN reconfiguration.

Signalling radio bearer: SRB1

RLC-SAP: AM

Logical channel: DCCH

Direction: RN to E-UTRAN

RNReconfigurationComplete message

```

-- ASN1START
RNReconfigurationComplete-r10 ::= SEQUENCE {
    rrc-TransactionIdentifier RRC-TransactionIdentifier,

```

```

criticalExtensions CHOICE {
  c1 CHOICE {
    rnReconfigurationComplete-r10 RNReconfigurationComplete-r10-IEs,
    spare3 NULL, spare2 NULL, spare1 NULL
  },
  criticalExtensionsFuture SEQUENCE {}
}
}

RNReconfigurationComplete-r10-IEs ::= SEQUENCE {
  lateNonCriticalExtension OCTET STRING OPTIONAL,
  nonCriticalExtension SEQUENCE {} OPTIONAL
}

-- ASN1STOP

```

– *RRCConnectionReconfiguration*

The *RRCConnectionReconfiguration* message is the command to modify an RRC connection. It may convey information for measurement configuration, mobility control, radio resource configuration (including RBs, MAC main configuration and physical channel configuration) including any associated dedicated NAS information and security configuration.

Signalling radio bearer: SRB1

RLC-SAP: AM

Logical channel: DCCH

Direction: E-UTRAN to UE

RRCConnectionReconfiguration message

```

-- ASN1START

RRCConnectionReconfiguration ::= SEQUENCE {
  rrc-TransactionIdentifier RRC-TransactionIdentifier,
  criticalExtensions CHOICE {
    c1 CHOICE {
      rrcConnectionReconfiguration-r8 RRCConnectionReconfiguration-r8-IEs,
      spare7 NULL,
      spare6 NULL, spare5 NULL, spare4 NULL,
      spare3 NULL, spare2 NULL, spare1 NULL
    },
    criticalExtensionsFuture SEQUENCE {}
  }
}

RRCConnectionReconfiguration-r8-IEs ::= SEQUENCE {
  measConfig MeasConfig OPTIONAL, -- Need ON
  mobilityControlInfo MobilityControlInfo OPTIONAL, -- Cond HO
  dedicatedInfoNASList SEQUENCE (SIZE(1..maxDRB)) OF
    DedicatedInfoNAS OPTIONAL, -- Cond nonHO
  radioResourceConfigDedicated RadioResourceConfigDedicated OPTIONAL, -- Cond HO-toEUTRA
  securityConfigHO SecurityConfigHO OPTIONAL, -- Cond HO
  nonCriticalExtension RRCConnectionReconfiguration-v890-IEs OPTIONAL
}

RRCConnectionReconfiguration-v890-IEs ::= SEQUENCE {
  lateNonCriticalExtension OCTET STRING (CONTAINING RRCConnectionReconfiguration-v8m0-
IEs) OPTIONAL,
  nonCriticalExtension RRCConnectionReconfiguration-v920-IEs OPTIONAL
}

-- Late non-critical extensions:
RRCConnectionReconfiguration-v8m0-IEs ::= SEQUENCE {
  -- Following field is only for pre REL-10 late non-critical extensions
  lateNonCriticalExtension OCTET STRING OPTIONAL,
  nonCriticalExtension RRCConnectionReconfiguration-v10i0-IEs OPTIONAL
}

RRCConnectionReconfiguration-v10i0-IEs ::= SEQUENCE {
  antennaInfoDedicatedPCell-v10i0 AntennaInfoDedicated-v10i0 OPTIONAL, -- Need ON
  nonCriticalExtension RRCConnectionReconfiguration-v10i0-IEs OPTIONAL
}

```

```

}
RRCCONNECTIONRECONFIGURATION-V1010-IEs ::= SEQUENCE {
    mobilityControlInfo-v1010      MobilityControlInfo-v1010      OPTIONAL,
    sCellToAddModList-v1010        SCellToAddModList-v1010      OPTIONAL, -- Need ON
    -- Following field is only for late non-critical extensions from REL-10 to REL-11
    lateNonCriticalExtension        OCTET STRING                      OPTIONAL,
    nonCriticalExtension            RRCCONNECTIONRECONFIGURATION-V12F0-IEs OPTIONAL
}
RRCCONNECTIONRECONFIGURATION-V12F0-IEs ::= SEQUENCE {
    scg-Configuration-v12f0        SCG-Configuration-v12f0 OPTIONAL, -- Cond nonFullConfig
    -- Following field is only for late non-critical extensions from REL-12
    lateNonCriticalExtension        OCTET STRING                      OPTIONAL,
    -- Following field is not used in this release (i.e. only for late non-critical extensions from
REL-13 onwards)
    nonCriticalExtension            SEQUENCE {}                      OPTIONAL
}

-- Regular non-critical extensions:
RRCCONNECTIONRECONFIGURATION-V920-IEs ::= SEQUENCE {
    otherConfig-r9                 OtherConfig-r9                OPTIONAL, -- Need ON
    fullConfig-r9                  ENUMERATED {true}             OPTIONAL, -- Cond HO-Reestab
    nonCriticalExtension            RRCCONNECTIONRECONFIGURATION-V1020-IEs OPTIONAL
}

RRCCONNECTIONRECONFIGURATION-V1020-IEs ::= SEQUENCE {
    sCellToReleaseList-r10         SCellToReleaseList-r10        OPTIONAL, -- Need ON
    sCellToAddModList-r10         SCellToAddModList-r10        OPTIONAL, -- Need ON
    nonCriticalExtension            RRCCONNECTIONRECONFIGURATION-V1130-IEs OPTIONAL
}

RRCCONNECTIONRECONFIGURATION-V1130-IEs ::= SEQUENCE {
    systemInformationBlockType1Dedicated-r11 OCTET STRING (CONTAINING SystemInformationBlockType1)
                                                                OPTIONAL, -- Need ON
    nonCriticalExtension            RRCCONNECTIONRECONFIGURATION-V1250-IEs OPTIONAL
}

RRCCONNECTIONRECONFIGURATION-V1250-IEs ::= SEQUENCE {
    wlan-OffloadInfo-r12           CHOICE {
        release                     NULL,
        setup                        SEQUENCE {
            wlan-OffloadConfigDedicated-r12 WLAN-OffloadConfig-r12,
            t350-r12                 ENUMERATED {min5, min10, min20, min30, min60,
                                                                min120, min180, spare1} OPTIONAL -- Need OR
        }
    }
    scg-Configuration-r12          SCG-Configuration-r12        OPTIONAL, -- Need ON
    nonFullConfig
    sl-SyncTxControl-r12           SL-SyncTxControl-r12         OPTIONAL, -- Need ON
    sl-DiscConfig-r12              SL-DiscConfig-r12           OPTIONAL, -- Need ON
    sl-CommConfig-r12              SL-CommConfig-r12           OPTIONAL, -- Need ON
    nonCriticalExtension            SEQUENCE {}                      OPTIONAL
}

SL-SyncTxControl-r12 ::= SEQUENCE {
    networkControlledSyncTx-r12    ENUMERATED {on, off}         OPTIONAL -- Need OP
}

PSCellToAddMod-r12 ::= SEQUENCE {
    sCellIndex-r12                 SCellIndex-r10,
    cellIdentification-r12         SEQUENCE {
        physCellId-r12              PhysCellId,
        dl-CarrierFreq-r12          ARFCN-ValueEUTRA-r9
    }
    radioResourceConfigCommonPSCell-r12 RadioResourceConfigCommonPSCell-r12 OPTIONAL, -- Cond SCellAdd
    SCellAdd
    radioResourceConfigDedicatedPSCell-r12 RadioResourceConfigDedicatedPSCell-r12 OPTIONAL, --
Cond SCellAdd2
    ...
    [[ antennaInfoDedicatedPSCell-v1280 AntennaInfoDedicated-v10i0 OPTIONAL -- Need ON
    ]]
}

PSCellToAddMod-v12f0 ::= SEQUENCE {
    radioResourceConfigCommonPSCell-r12 RadioResourceConfigCommonPSCell-v12f0 OPTIONAL
}

PowerCoordinationInfo-r12 ::= SEQUENCE {

```

```

    p-MeNB-r12                INTEGER (1..16),
    p-SeNB-r12                INTEGER (1..16),
    powerControlMode-r12      INTEGER (1..2)
}

SCellToAddModList-r10 ::= SEQUENCE (SIZE (1..maxSCell-r10)) OF SCellToAddMod-r10

SCellToAddModList-v1010 ::= SEQUENCE (SIZE (1..maxSCell-r10)) OF SCellToAddMod-v1010

SCellToAddMod-r10 ::= SEQUENCE {
    sCellIndex-r10            SCellIndex-r10,
    cellIdentification-r10    SEQUENCE {
        physCellId-r10        PhysCellId,
        dl-CarrierFreq-r10    ARFCN-ValueEUTRA
    }
    radioResourceConfigCommonSCell-r10 RadioResourceConfigCommonSCell-r10 OPTIONAL, -- Cond SCellAdd
}
SCellAdd
    radioResourceConfigDedicatedSCell-r10 RadioResourceConfigDedicatedSCell-r10 OPTIONAL, --
Cond SCellAdd2
    ...
    [[ dl-CarrierFreq-v1090            ARFCN-ValueEUTRA-v9e0 OPTIONAL -- Cond EARFCN-max
]],
    [[ antennaInfoDedicatedSCell-v10i0 AntennaInfoDedicated-v10i0 OPTIONAL -- Need ON
]]
}

SCellToAddMod-v1010 ::= SEQUENCE {
    radioResourceConfigCommonSCell-v1010 RadioResourceConfigCommonSCell-v1010 OPTIONAL
}

SCellToReleaseList-r10 ::= SEQUENCE (SIZE (1..maxSCell-r10)) OF SCellIndex-r10

SCG-Configuration-r12 ::= CHOICE {
    release NULL,
    setup SEQUENCE {
        scg-ConfigPartMCG-r12 SEQUENCE {
            scg-Counter-r12 INTEGER (0.. 65535) OPTIONAL, -- Need ON
            powerCoordinationInfo-r12 PowerCoordinationInfo-r12 OPTIONAL, -- Need ON
            ...
        }
        scg-ConfigPartSCG-r12 SCG-ConfigPartSCG-r12 OPTIONAL, -- Need ON
    }
}

SCG-Configuration-v12f0 ::= CHOICE {
    release NULL,
    setup SEQUENCE {
        scg-ConfigPartSCG-v12f0 SCG-ConfigPartSCG-v12f0 OPTIONAL -- Need ON
    }
}

SCG-ConfigPartSCG-r12 ::= SEQUENCE {
    radioResourceConfigDedicatedSCG-r12 RadioResourceConfigDedicatedSCG-r12 OPTIONAL, -- Need ON
    sCellToReleaseListSCG-r12 SCellToReleaseList-r10 OPTIONAL, -- Need ON
    pSCellToAddMod-r12 PSCellToAddMod-r12 OPTIONAL, -- Need ON
    sCellToAddModListSCG-r12 SCellToAddModList-r10 OPTIONAL, -- Need ON
    mobilityControlInfoSCG-r12 MobilityControlInfoSCG-r12 OPTIONAL, -- Need ON
    ...
}

SCG-ConfigPartSCG-v12f0 ::= SEQUENCE {
    pSCellToAddMod-v12f0 PSCellToAddMod-v12f0 OPTIONAL, -- Need ON
    sCellToAddModListSCG-v12f0 SCellToAddModList-v1010 OPTIONAL -- Need ON
}

SecurityConfigHO ::= SEQUENCE {
    handoverType CHOICE {
        intraLTE SEQUENCE {
            securityAlgorithmConfig SecurityAlgorithmConfig OPTIONAL, -- Cond
fullConfig
            keyChangeIndicator BOOLEAN,
            nextHopChainingCount NextHopChainingCount
        },
        interRAT SEQUENCE {
            securityAlgorithmConfig SecurityAlgorithmConfig,
            nas-SecurityParamToEUTRA OCTET STRING (SIZE(6))
        }
    }
},
}

```



```

}
...
-- ASN1STOP

```

RRCConnectionReconfiguration field descriptions
<p>dedicatedInfoNASList This field is used to transfer UE specific NAS layer information between the network and the UE. The RRC layer is transparent for each PDU in the list.</p>
<p>fullConfig Indicates the full configuration option is applicable for the RRC Connection Reconfiguration message.</p>
<p>keyChangeIndicator true is used only in an intra-cell handover when a K_{eNB} key is derived from a K_{ASME} key taken into use through the latest successful NAS SMC procedure, as described in TS 33.401 [32] for K_{eNB} re-keying. false is used in an intra-LTE handover when the new K_{eNB} key is obtained from the current K_{eNB} key or from the NH as described in TS 33.401 [32].</p>
<p>nas-securityParamToEUTRA This field is used to transfer UE specific NAS layer information between the network and the UE. The RRC layer is transparent for this field, although it affects activation of AS- security after inter-RAT handover to E-UTRA. The content is defined in TS 24.301.</p>
<p>networkControlledSyncTx This field indicates whether the UE shall transmit synchronisation information (i.e. become synchronisation source). Value <i>On</i> indicates the UE to transmit synchronisation information while value <i>Off</i> indicates the UE to not transmit such information.</p>
<p>nextHopChainingCount Parameter NCC: See TS 33.401 [32]</p>
<p>p-MeNB Indicates the guaranteed power for the MeNB, as specified in 36.213 [23]. The value N corresponds to N-1 in TS 36.213 [23].</p>
<p>powerControlMode Indicates the power control mode used in DC. Value 1 corresponds to DC power control mode 1 and value 2 indicates DC power control mode 2, as specified in 36.213 [23].</p>
<p>p-SeNB Indicates the guaranteed power for the SeNB as specified in 36.213 [23, Table 5.1.4.2-1]. The value N corresponds to N-1 in TS 36.213 [23].</p>
<p>sCellIndex In case of DC, the <i>sCellIndex</i> is unique within the scope of the UE i.e. an SCG cell can not use the same value as used for an MCG cell.</p>
<p>sCellToAddModList, sCellToAddModListExt Indicates the SCell to be added or modified. Field <i>sCellToAddModList</i> is used to add the first 4 SCells with <i>sCellIndex-r10</i> while <i>sCellToAddModListExt</i> is used to add the rest. If E-UTRAN includes <i>sCellToAddModList-v1010</i> it includes the same number of entries, and listed in the same order, as in <i>sCellToAddModList-r10</i>.</p>
<p>sCellToAddModListSCG, sCellToAddModListSCG-Ext Indicates the SCG cell to be added or modified. The field is used for SCG cells other than the PSCell (which is added/modified by field <i>pSCellToAddMod</i>). If E-UTRAN includes <i>sCellToAddModListSCG-v1010</i> it includes the same number of entries, and listed in the same order, as in <i>sCellToAddModListSCG-r12</i>.</p>
<p>sCellToReleaseListSCG Indicates the SCG cell to be released. The field is also used to release the PSCell e.g. upon change of PSCell, upon system information change for the PSCell.</p>
<p>scg-Counter A counter used upon initial configuration of SCG security as well as upon refresh of S-K_{eNB}. E-UTRAN includes the field upon SCG change when one or more SCG DRBs are configured. Otherwise E-UTRAN does not include the field.</p>
<p>t350 Timer T350 as described in section 7.3. Value <i>minN</i> corresponds to N minutes.</p>

Conditional presence	Explanation
<i>EARFCN-max</i>	The field is mandatory present if <i>dl-CarrierFreq-r10</i> is included and set to <i>maxEARFCN</i> . Otherwise the field is not present.
<i>fullConfig</i>	This field is mandatory present for handover within E-UTRA when the <i>fullConfig</i> is included; otherwise it is optionally present, Need OP.
<i>HO</i>	The field is mandatory present in case of handover within E-UTRA or to E-UTRA; otherwise the field is not present.
<i>HO-Reestab</i>	This field is optionally present, need ON, in case of handover within E-UTRA or upon the first reconfiguration after RRC connection re-establishment; otherwise the field is not present.
<i>HO-toEUTRA</i>	The field is mandatory present in case of handover to E-UTRA or for reconfigurations when <i>fullConfig</i> is included; otherwise the field is optionally present, need ON.
<i>nonFullConfig</i>	The field is not present when the <i>fullConfig</i> is included or in case of handover to E-UTRA; otherwise it is optional present, need ON.
<i>nonHO</i>	The field is not present in case of handover within E-UTRA or to E-UTRA; otherwise it is optional present, need ON.
<i>SCellAdd</i>	The field is mandatory present upon SCell addition; otherwise it is not present.
<i>SCellAdd2</i>	The field is mandatory present upon SCell addition; otherwise it is optionally present, need ON.

– *RRCCONNECTIONRECONFIGURATIONCOMPLETE*

The *RRCCONNECTIONRECONFIGURATIONCOMPLETE* message is used to confirm the successful completion of an RRC connection reconfiguration.

Signalling radio bearer: SRB1

RLC-SAP: AM

Logical channel: DCCH

Direction: UE to E-UTRAN

***RRCCONNECTIONRECONFIGURATIONCOMPLETE* message**

```
-- ASN1START
RRCCONNECTIONRECONFIGURATIONCOMPLETE ::= SEQUENCE {
    rrc-TransactionIdentifier      RRC-TransactionIdentifier,
    criticalExtensions             CHOICE {
        rrcConnectionReconfigurationComplete-r8
        criticalExtensionsFuture   SEQUENCE {}
    }
}

RRCCONNECTIONRECONFIGURATIONCOMPLETE-r8-IEs ::= SEQUENCE {
    nonCriticalExtension          RRCCONNECTIONRECONFIGURATIONCOMPLETE-v8a0-IEs  OPTIONAL
}

RRCCONNECTIONRECONFIGURATIONCOMPLETE-v8a0-IEs ::= SEQUENCE {
    lateNonCriticalExtension      OCTET STRING                               OPTIONAL,
    nonCriticalExtension          RRCCONNECTIONRECONFIGURATIONCOMPLETE-v1020-IEs  OPTIONAL
}

RRCCONNECTIONRECONFIGURATIONCOMPLETE-v1020-IEs ::= SEQUENCE {
    rlf-InfoAvailable-r10        ENUMERATED {true}                               OPTIONAL,
    logMeasAvailable-r10         ENUMERATED {true}                               OPTIONAL,
    nonCriticalExtension          RRCCONNECTIONRECONFIGURATIONCOMPLETE-v1130-IEs  OPTIONAL
}

RRCCONNECTIONRECONFIGURATIONCOMPLETE-v1130-IEs ::= SEQUENCE {
    connEstFailInfoAvailable-r11  ENUMERATED {true}                               OPTIONAL,
    nonCriticalExtension          RRCCONNECTIONRECONFIGURATIONCOMPLETE-v1250-IEs  OPTIONAL
}

RRCCONNECTIONRECONFIGURATIONCOMPLETE-v1250-IEs ::= SEQUENCE {
    logMeasAvailableMBSFN-r12     ENUMERATED {true}                               OPTIONAL,
    nonCriticalExtension          SEQUENCE {}                               OPTIONAL
}
```

```
-- ASN1STOP
```

– *RRConnectionReestablishment*

The *RRConnectionReestablishment* message is used to re-establish SRB1.

Signalling radio bearer: SRB0

RLC-SAP: TM

Logical channel: CCCH

Direction: E-UTRAN to UE

RRConnectionReestablishment message

```
-- ASN1START
```

```
RRConnectionReestablishment ::= SEQUENCE {
  rrc-TransactionIdentifier      RRC-TransactionIdentifier,
  criticalExtensions              CHOICE {
    c1                            CHOICE {
      rrcConnectionReestablishment-r8      RRConnectionReestablishment-r8-IEs,
      spare7 NULL,
      spare6 NULL, spare5 NULL, spare4      NULL,
      spare3 NULL, spare2 NULL, spare1      NULL
    },
    criticalExtensionsFuture            SEQUENCE {}
  }
}

RRConnectionReestablishment-r8-IEs ::= SEQUENCE {
  radioResourceConfigDedicated      RadioResourceConfigDedicated,
  nextHopChainingCount              NextHopChainingCount,
  nonCriticalExtension                RRConnectionReestablishment-v8a0-IEs  OPTIONAL
}

RRConnectionReestablishment-v8a0-IEs ::= SEQUENCE {
  lateNonCriticalExtension            OCTET STRING                        OPTIONAL,
  nonCriticalExtension                SEQUENCE {}                        OPTIONAL
}

-- ASN1STOP
```

– *RRConnectionReestablishmentComplete*

The *RRConnectionReestablishmentComplete* message is used to confirm the successful completion of an RRC connection reestablishment.

Signalling radio bearer: SRB1

RLC-SAP: AM

Logical channel: DCCH

Direction: UE to E-UTRAN

RRConnectionReestablishmentComplete message

```
-- ASN1START
```

```
RRConnectionReestablishmentComplete ::= SEQUENCE {
  rrc-TransactionIdentifier      RRC-TransactionIdentifier,
  criticalExtensions              CHOICE {
    rrcConnectionReestablishmentComplete-r8      RRConnectionReestablishmentComplete-r8-IEs,
    criticalExtensionsFuture            SEQUENCE {}
  }
}

RRConnectionReestablishmentComplete-r8-IEs ::= SEQUENCE {
```

```

    nonCriticalExtension                RRCCConnectionReestablishmentComplete-v920-IEs  OPTIONAL
  }
RRCCConnectionReestablishmentComplete-v920-IEs ::= SEQUENCE {
    rlf-InfoAvailable-r9                ENUMERATED {true}                        OPTIONAL,
    nonCriticalExtension                RRCCConnectionReestablishmentComplete-v8a0-IEs  OPTIONAL
  }
RRCCConnectionReestablishmentComplete-v8a0-IEs ::= SEQUENCE {
    lateNonCriticalExtension            OCTET STRING                            OPTIONAL,
    nonCriticalExtension                RRCCConnectionReestablishmentComplete-v1020-IEs  OPTIONAL
  }
RRCCConnectionReestablishmentComplete-v1020-IEs ::= SEQUENCE {
    logMeasAvailable-r10               ENUMERATED {true}                        OPTIONAL,
    nonCriticalExtension                RRCCConnectionReestablishmentComplete-v1130-IEs  OPTIONAL
  }
RRCCConnectionReestablishmentComplete-v1130-IEs ::= SEQUENCE {
    connEstFailInfoAvailable-r11       ENUMERATED {true}                        OPTIONAL,
    nonCriticalExtension                RRCCConnectionReestablishmentComplete-v1250-IEs  OPTIONAL
  }
RRCCConnectionReestablishmentComplete-v1250-IEs ::= SEQUENCE {
    logMeasAvailableMBSFN-r12         ENUMERATED {true}                        OPTIONAL,
    nonCriticalExtension                SEQUENCE {}                            OPTIONAL
  }
-- ASN1STOP

```

<i>RRCCConnectionReestablishmentComplete</i> field descriptions
<p><i>rlf-InfoAvailable</i> This field is used to indicate the availability of radio link failure or handover failure related measurements</p>

– ***RRCCConnectionReestablishmentReject***

The *RRCCConnectionReestablishmentReject* message is used to indicate the rejection of an RRC connection reestablishment request.

Signalling radio bearer: SRB0

RLC-SAP: TM

Logical channel: CCCH

Direction: E-UTRAN to UE

***RRCCConnectionReestablishmentReject* message**

```

-- ASN1START
RRCCConnectionReestablishmentReject ::= SEQUENCE {
    criticalExtensions                CHOICE {
        rrcConnectionReestablishmentReject-r8
        criticalExtensionsFuture      SEQUENCE {}
    }
  }
RRCCConnectionReestablishmentReject-r8-IEs ::= SEQUENCE {
    nonCriticalExtension              RRCCConnectionReestablishmentReject-v8a0-IEs  OPTIONAL
  }
RRCCConnectionReestablishmentReject-v8a0-IEs ::= SEQUENCE {
    lateNonCriticalExtension          OCTET STRING                            OPTIONAL,
    nonCriticalExtension              SEQUENCE {}                            OPTIONAL
  }
-- ASN1STOP

```

– ***RRCConnectionReestablishmentRequest***

The *RRCConnectionReestablishmentRequest* message is used to request the reestablishment of an RRC connection.

Signalling radio bearer: SRB0

RLC-SAP: TM

Logical channel: CCCH

Direction: UE to E-UTRAN

RRCConnectionReestablishmentRequest message

```
-- ASN1START
RRCConnectionReestablishmentRequest ::= SEQUENCE {
    criticalExtensions          CHOICE {
        rrcConnectionReestablishmentRequest-r8
        criticalExtensionsFuture SEQUENCE {}
    }
}
RRCConnectionReestablishmentRequest-r8-IEs ::= SEQUENCE {
    ue-Identity          ReestabUE-Identity,
    reestablishmentCause ReestablishmentCause,
    spare                BIT STRING (SIZE (2))
}
ReestabUE-Identity ::= SEQUENCE {
    c-RNTI          C-RNTI,
    physCellId     PhysCellId,
    shortMAC-I     ShortMAC-I
}
ReestablishmentCause ::= ENUMERATED {
    reconfigurationFailure, handoverFailure,
    otherFailure, spare1
}
-- ASN1STOP
```

RRCConnectionReestablishmentRequest field descriptions

<i>physCellId</i>	The Physical Cell Identity of the PCell the UE was connected to prior to the failure.
<i>reestablishmentCause</i>	Indicates the failure cause that triggered the re-establishment procedure.
<i>ue-Identity</i>	UE identity included to retrieve UE context and to facilitate contention resolution by lower layers.

– ***RRCConnectionReject***

The *RRCConnectionReject* message is used to reject the RRC connection establishment.

Signalling radio bearer: SRB0

RLC-SAP: TM

Logical channel: CCCH

Direction: E-UTRAN to UE

RRCConnectionReject message

```
-- ASN1START
RRCConnectionReject ::= SEQUENCE {
    criticalExtensions          CHOICE {
        c1 CHOICE {
            rrcConnectionReject-r8
            RRCConnectionReject-r8-IEs,
        }
    }
}
```

```

        spare3 NULL, spare2 NULL, spare1 NULL
    },
    criticalExtensionsFuture          SEQUENCE {}
}
}
}

RRCConnectionReject-r8-IEs ::= SEQUENCE {
    waitTime                        INTEGER (1..16),
    nonCriticalExtension            RRCConnectionReject-v8a0-IEs          OPTIONAL
}

RRCConnectionReject-v8a0-IEs ::= SEQUENCE {
    lateNonCriticalExtension        OCTET STRING                        OPTIONAL,
    nonCriticalExtension            RRCConnectionReject-v1020-IEs      OPTIONAL
}

RRCConnectionReject-v1020-IEs ::= SEQUENCE {
    extendedWaitTime-r10            INTEGER (1..1800)                  OPTIONAL, -- Need ON
    nonCriticalExtension            RRCConnectionReject-v1130-IEs      OPTIONAL
}

RRCConnectionReject-v1130-IEs ::= SEQUENCE {
    deprioritisationReq-r11         SEQUENCE {
        deprioritisationType-r11    ENUMERATED {frequency, e-utra},
        deprioritisationTimer-r11   ENUMERATED {min5, min10, min15, min30}
    }                                OPTIONAL, -- Need ON
    nonCriticalExtension            SEQUENCE {}                          OPTIONAL
}

-- ASN1STOP

```

***RRCConnectionReject* field descriptions**

deprioritisationReq

Indicates whether the current frequency or RAT is to be de-prioritised. The UE shall be able to store a de-prioritisation request for up to 8 frequencies (applicable when receiving another frequency specific de-prioritisation request before T325 expiry).

deprioritisationTimer

Indicates the period for which either the current carrier frequency or E-UTRA is de-prioritised. Value *minN* corresponds to N minutes.

extendedWaitTime

Value in seconds for the wait time for Delay Tolerant access requests.

waitTime

Wait time value in seconds.

RRCConnectionRelease

The *RRCConnectionRelease* message is used to command the release of an RRC connection.

Signalling radio bearer: SRB1

RLC-SAP: AM

Logical channel: DCCH

Direction: E-UTRAN to UE

***RRCConnectionRelease* message**

```

-- ASN1START

RRCConnectionRelease ::= SEQUENCE {
    rrc-TransactionIdentifier        RRC-TransactionIdentifier,
    criticalExtensions               CHOICE {
        c1                           CHOICE {
            rrcConnectionRelease-r8   RRCConnectionRelease-r8-IEs,
            spare3 NULL, spare2 NULL, spare1 NULL
        },
        criticalExtensionsFuture       SEQUENCE {}
    }
}

RRCConnectionRelease-r8-IEs ::= SEQUENCE {

```

```

    releaseCause                ReleaseCause,
    redirectedCarrierInfo        RedirectedCarrierInfo        OPTIONAL, -- Need ON
    idleModeMobilityControlInfo  IdleModeMobilityControlInfo  OPTIONAL, -- Need OP
    nonCriticalExtension         RRCConnectionRelease-v890-IEs  OPTIONAL
}

RRCConnectionRelease-v890-IEs ::= SEQUENCE {
    lateNonCriticalExtension      OCTET STRING (CONTAINING RRCConnectionRelease-v9e0-IEs)
    OPTIONAL,
    nonCriticalExtension         RRCConnectionRelease-v920-IEs  OPTIONAL
}

-- Late non critical extensions
RRCConnectionRelease-v9e0-IEs ::= SEQUENCE {
    redirectedCarrierInfo-v9e0    RedirectedCarrierInfo-v9e0        OPTIONAL, -- Cond
NoRedirect-r8
    idleModeMobilityControlInfo-v9e0  IdleModeMobilityControlInfo-v9e0  OPTIONAL, -- Cond
IdleInfoEUTRA
    nonCriticalExtension           SEQUENCE {}                          OPTIONAL
}

-- Regular non critical extensions
RRCConnectionRelease-v920-IEs ::= SEQUENCE {
    cellInfoList-r9              CHOICE {
        geran-r9                  CellInfoListGERAN-r9,
        utra-FDD-r9               CellInfoListUTRA-FDD-r9,
        utra-TDD-r9               CellInfoListUTRA-TDD-r9,
        ...,
        utra-TDD-r10              CellInfoListUTRA-TDD-r10
    }
    OPTIONAL, -- Cond Redirection
    nonCriticalExtension         RRCConnectionRelease-v1020-IEs  OPTIONAL
}

RRCConnectionRelease-v1020-IEs ::= SEQUENCE {
    extendedWaitTime-r10         INTEGER (1..1800)                OPTIONAL, -- Need ON
    nonCriticalExtension         SEQUENCE {}                          OPTIONAL
}

ReleaseCause ::=
    ENUMERATED {loadBalancingTAUrequired,
                other, cs-FallbackHighPriority-v1020, spare1}

RedirectedCarrierInfo ::=
    CHOICE {
        eutra                     ARFCN-ValueEUTRA,
        geran                     CarrierFreqsGERAN,
        utra-FDD                  ARFCN-ValueUTRA,
        utra-TDD                  ARFCN-ValueUTRA,
        cdma2000-HRPD             CarrierFreqCDMA2000,
        cdma2000-1xRTT           CarrierFreqCDMA2000,
        ...,
        utra-TDD-r10             CarrierFreqListUTRA-TDD-r10
    }

RedirectedCarrierInfo-v9e0 ::=
    SEQUENCE {
        eutra-v9e0                ARFCN-ValueEUTRA-v9e0
    }

CarrierFreqListUTRA-TDD-r10 ::=
    SEQUENCE (SIZE (1..maxFreqUTRA-TDD-r10)) OF ARFCN-ValueUTRA

IdleModeMobilityControlInfo ::=
    SEQUENCE {
        freqPriorityListEUTRA      FreqPriorityListEUTRA            OPTIONAL, -- Need ON
        freqPriorityListGERAN      FreqPriorityListGERAN           OPTIONAL, -- Need ON
        freqPriorityListUTRA-FDD    FreqPriorityListUTRA-FDD        OPTIONAL, -- Need ON
        freqPriorityListUTRA-TDD    FreqPriorityListUTRA-TDD        OPTIONAL, -- Need ON
        bandClassPriorityListHRPD   BandClassPriorityListHRPD        OPTIONAL, -- Need ON
        bandClassPriorityList1XRTT  BandClassPriorityList1XRTT       OPTIONAL, -- Need ON
        t320                       ENUMERATED {
                min5, min10, min20, min30, min60, min120, min180,
                spare1}
                OPTIONAL, -- Need OR
        ...,
        [[ freqPriorityListExtEUTRA-r12  FreqPriorityListExtEUTRA-r12  OPTIONAL --
Need ON
        ]]
    }

IdleModeMobilityControlInfo-v9e0 ::=
    SEQUENCE {
        freqPriorityListEUTRA-v9e0  SEQUENCE (SIZE (1..maxFreq)) OF FreqPriorityEUTRA-v9e0
    }

```

```

FreqPriorityListEUTRA ::= SEQUENCE (SIZE (1..maxFreq)) OF FreqPriorityEUTRA
FreqPriorityListExtEUTRA-r12 ::= SEQUENCE (SIZE (1..maxFreq)) OF FreqPriorityEUTRA-r12
FreqPriorityEUTRA ::= SEQUENCE {
    carrierFreq ARFCN-ValueEUTRA,
    cellReselectionPriority CellReselectionPriority
}
FreqPriorityEUTRA-v9e0 ::= SEQUENCE {
    carrierFreq-v9e0 ARFCN-ValueEUTRA-v9e0 OPTIONAL -- Cond EARFCN-max
}
FreqPriorityEUTRA-r12 ::= SEQUENCE {
    carrierFreq-r12 ARFCN-ValueEUTRA-r9,
    cellReselectionPriority-r12 CellReselectionPriority
}
FreqsPriorityListGERAN ::= SEQUENCE (SIZE (1..maxGNFG)) OF FreqsPriorityGERAN
FreqsPriorityGERAN ::= SEQUENCE {
    carrierFreqs CarrierFreqsGERAN,
    cellReselectionPriority CellReselectionPriority
}
FreqPriorityListUTRA-FDD ::= SEQUENCE (SIZE (1..maxUTRA-FDD-Carrier)) OF FreqPriorityUTRA-FDD
FreqPriorityUTRA-FDD ::= SEQUENCE {
    carrierFreq ARFCN-ValueUTRA,
    cellReselectionPriority CellReselectionPriority
}
FreqPriorityListUTRA-TDD ::= SEQUENCE (SIZE (1..maxUTRA-TDD-Carrier)) OF FreqPriorityUTRA-TDD
FreqPriorityUTRA-TDD ::= SEQUENCE {
    carrierFreq ARFCN-ValueUTRA,
    cellReselectionPriority CellReselectionPriority
}
BandClassPriorityListHRPD ::= SEQUENCE (SIZE (1..maxCDMA-BandClass)) OF BandClassPriorityHRPD
BandClassPriorityHRPD ::= SEQUENCE {
    bandClass BandclassCDMA2000,
    cellReselectionPriority CellReselectionPriority
}
BandClassPriorityListLXRTT ::= SEQUENCE (SIZE (1..maxCDMA-BandClass)) OF BandClassPriorityLXRTT
BandClassPriorityLXRTT ::= SEQUENCE {
    bandClass BandclassCDMA2000,
    cellReselectionPriority CellReselectionPriority
}
CellInfoListGERAN-r9 ::= SEQUENCE (SIZE (1..maxCellInfoGERAN-r9)) OF CellInfoGERAN-r9
CellInfoGERAN-r9 ::= SEQUENCE {
    physCellId-r9 PhysCellIdGERAN,
    carrierFreq-r9 CarrierFreqGERAN,
    systemInformation-r9 SystemInfoListGERAN
}
CellInfoListUTRA-FDD-r9 ::= SEQUENCE (SIZE (1..maxCellInfoUTRA-r9)) OF CellInfoUTRA-FDD-r9
CellInfoUTRA-FDD-r9 ::= SEQUENCE {
    physCellId-r9 PhysCellIdUTRA-FDD,
    utra-BCCH-Container-r9 OCTET STRING
}
CellInfoListUTRA-TDD-r9 ::= SEQUENCE (SIZE (1..maxCellInfoUTRA-r9)) OF CellInfoUTRA-TDD-r9
CellInfoUTRA-TDD-r9 ::= SEQUENCE {
    physCellId-r9 PhysCellIdUTRA-TDD,
    utra-BCCH-Container-r9 OCTET STRING
}
CellInfoListUTRA-TDD-r10 ::= SEQUENCE (SIZE (1..maxCellInfoUTRA-r9)) OF CellInfoUTRA-TDD-r10
CellInfoUTRA-TDD-r10 ::= SEQUENCE {

```



```

physCellId-r10          PhysCellIdUTRA-TDD,
carrierFreq-r10        ARFCN-ValueUTRA,
utra-BCCH-Container-r10 OCTET STRING
}
-- ASN1STOP

```

***RRCConnectionRelease* field descriptions**

<i>carrierFreq</i> or <i>bandClass</i>	The carrier frequency (UTRA and E-UTRA) and band class (HRPD and 1xRTT) for which the associated <i>cellReselectionPriority</i> is applied.
<i>carrierFreqs</i>	The list of GERAN carrier frequencies organised into one group of GERAN carrier frequencies.
<i>cellInfoList</i>	Used to provide system information of one or more cells on the redirected inter-RAT carrier frequency. The system information can be used if, upon redirection, the UE selects an inter-RAT cell indicated by the <i>physCellId</i> and <i>carrierFreq</i> (GERAN and UTRA TDD) or by the <i>physCellId</i> (other RATs). The choice shall match the <i>redirectedCarrierInfo</i> . In particular, E-UTRAN only applies value <i>utra-TDD-r10</i> in case <i>redirectedCarrierInfo</i> is set to <i>utra-TDD-r10</i> .
<i>extendedWaitTime</i>	Value in seconds for the wait time for Delay Tolerant access requests.
<i>freqPriorityListX</i>	Provides a cell reselection priority for each frequency, by means of separate lists for each RAT (including E-UTRA). The UE shall be able to store at least 3 occurrences of <i>FreqsPriorityGERAN</i> . If E-UTRAN includes <i>freqPriorityListEUTRA-v9e0</i> it includes the same number of entries, and listed in the same order, as in <i>freqPriorityListEUTRA</i> (i.e. without suffix). Field <i>freqPriorityListExt</i> includes additional neighbouring inter-frequencies, i.e. extending the size of the inter-frequency carrier list using the general principles specified in 5.1.2. EUTRAN only includes <i>freqPriorityListExtEUTRA</i> if <i>freqPriorityListEUTRA</i> (i.e. without suffix) includes <i>maxFreq</i> entries.
<i>idleModeMobilityControllInfo</i>	Provides dedicated cell reselection priorities. Used for cell reselection as specified in TS 36.304 [4]. For E-UTRA and UTRA frequencies, a UE that supports multi-band cells for the concerned RAT considers the dedicated priorities to be common for all overlapping bands (i.e. regardless of the ARFCN that is used).
<i>redirectedCarrierInfo</i>	The <i>redirectedCarrierInfo</i> indicates a carrier frequency (downlink for FDD) and is used to redirect the UE to an E-UTRA or an inter-RAT carrier frequency, by means of the cell selection upon leaving RRC_CONNECTED as specified in TS 36.304 [4].
<i>releaseCause</i>	The <i>releaseCause</i> is used to indicate the reason for releasing the RRC Connection. The cause value <i>cs-FallbackHighPriority</i> is only applicable when <i>redirectedCarrierInfo</i> is present with the value set to <i>utra-FDD</i> , <i>utra-TDD</i> or <i>utra-TDD-r10</i> . E-UTRAN should not set the <i>releaseCause</i> to <i>loadBalancingTAURequired</i> or to <i>cs-FallbackHighPriority</i> if the <i>extendedWaitTime</i> is present.
<i>systemInformation</i>	Container for system information of the GERAN cell i.e. one or more System Information (SI) messages as defined in TS 44.018 [45, table 9.1.1].
<i>t320</i>	Timer T320 as described in section 7.3. Value minN corresponds to N minutes.
<i>utra-BCCH-Container</i>	Contains System Information Container message as defined in TS 25.331 [19].

Conditional presence	Explanation
<i>EARFCN-max</i>	The field is mandatory present if the corresponding <i>carrierFreq</i> (i.e. without suffix) is set to <i>maxEARFCN</i> . Otherwise the field is not present.
<i>IdleInfoEUTRA</i>	The field is optionally present, need OP, if the <i>IdleModeMobilityControllInfo</i> (i.e. without suffix) is included and includes <i>freqPriorityListEUTRA</i> ; otherwise the field is not present.
<i>NoRedirect-r8</i>	The field is optionally present, need OP, if the <i>redirectedCarrierInfo</i> (i.e. without suffix) is not included; otherwise the field is not present.
<i>Redirection</i>	The field is optionally present, need ON, if the <i>redirectedCarrierInfo</i> is included and set to <i>geran</i> , <i>utra-FDD</i> , <i>utra-TDD</i> or <i>utra-TDD-r10</i> ; otherwise the field is not present.

– ***RRCConnectionRequest***

The *RRCConnectionRequest* message is used to request the establishment of an RRC connection.

Signalling radio bearer: SRB0

RLC-SAP: TM

Logical channel: CCCH

Direction: UE to E-UTRAN

RRCConnectionRequest message

```
-- ASN1START
RRCConnectionRequest ::=
    SEQUENCE {
        criticalExtensions      CHOICE {
            rrcConnectionRequest-r8          RRCConnectionRequest-r8-IEs,
            criticalExtensionsFuture          SEQUENCE {}
        }
    }

RRCConnectionRequest-r8-IEs ::=
    SEQUENCE {
        ue-Identity              InitialUE-Identity,
        establishmentCause       EstablishmentCause,
        spare                     BIT STRING (SIZE (1))
    }

InitialUE-Identity ::=
    CHOICE {
        s-TMSI                    S-TMSI,
        randomValue                BIT STRING (SIZE (40))
    }

EstablishmentCause ::=
    ENUMERATED {
        emergency, highPriorityAccess, mt-Access, mo-Signalling,
        mo-Data, delayTolerantAccess-v1020, mo-VoiceCall-v1280,
        spare1}
-- ASN1STOP
```

RRCConnectionRequest field descriptions

establishmentCause

Provides the establishment cause for the RRC connection request as provided by the upper layers. W.r.t. the cause value names: highPriorityAccess concerns AC11..AC15, 'mt' stands for 'Mobile Terminating' and 'mo' for 'Mobile Originating'.

randomValue

Integer value in the range 0 to $2^{40} - 1$.

ue-Identity

UE identity included to facilitate contention resolution by lower layers.

RRCConnectionSetup

The *RRCConnectionSetup* message is used to establish SRB1.

Signalling radio bearer: SRB0

RLC-SAP: TM

Logical channel: CCCH

Direction: E-UTRAN to UE

RRCConnectionSetup message

```
-- ASN1START
RRCConnectionSetup ::=
    SEQUENCE {
        rrc-TransactionIdentifier      RRC-TransactionIdentifier,
        criticalExtensions              CHOICE {
            c1                          CHOICE {
                rrcConnectionSetup-r8          RRCConnectionSetup-r8-IEs,
                spare7 NULL,
                spare6 NULL, spare5 NULL, spare4 NULL,
                spare3 NULL, spare2 NULL, spare1 NULL
            }
        }
    }
-- ASN1STOP
```

```

    },
    criticalExtensionsFuture          SEQUENCE {}
  }
}

RRCConnectionSetup-r8-IEs ::= SEQUENCE {
  radioResourceConfigDedicated      RadioResourceConfigDedicated,
  nonCriticalExtension                RRCConnectionSetup-v8a0-IEs          OPTIONAL
}

RRCConnectionSetup-v8a0-IEs ::= SEQUENCE {
  lateNonCriticalExtension            OCTET STRING                      OPTIONAL,
  nonCriticalExtension                SEQUENCE {}                       OPTIONAL
}

-- ASN1STOP

```

– *RRCConnectionSetupComplete*

The *RRCConnectionSetupComplete* message is used to confirm the successful completion of an RRC connection establishment.

Signalling radio bearer: SRB1

RLC-SAP: AM

Logical channel: DCCH

Direction: UE to E-UTRAN

RRCConnectionSetupComplete message

```

-- ASN1START

RRCConnectionSetupComplete ::= SEQUENCE {
  rrc-TransactionIdentifier          RRC-TransactionIdentifier,
  criticalExtensions                  CHOICE {
    c1                                CHOICE {
      rrcConnectionSetupComplete-r8  RRCConnectionSetupComplete-r8-IEs,
      spare3 NULL, spare2 NULL, spare1 NULL
    },
    criticalExtensionsFuture          SEQUENCE {}
  }
}

RRCConnectionSetupComplete-r8-IEs ::= SEQUENCE {
  selectedPLMN-Identity              INTEGER (1..maxPLMN-r11),
  registeredMME                      RegisteredMME                      OPTIONAL,
  dedicatedInfoNAS                   DedicatedInfoNAS,
  nonCriticalExtension                RRCConnectionSetupComplete-v8a0-IEs OPTIONAL
}

RRCConnectionSetupComplete-v8a0-IEs ::= SEQUENCE {
  lateNonCriticalExtension            OCTET STRING                      OPTIONAL,
  nonCriticalExtension                RRCConnectionSetupComplete-v1020-IEs OPTIONAL
}

RRCConnectionSetupComplete-v1020-IEs ::= SEQUENCE {
  gummei-Type-r10                    ENUMERATED {native, mapped}          OPTIONAL,
  rlf-InfoAvailable-r10              ENUMERATED {true}                    OPTIONAL,
  logMeasAvailable-r10              ENUMERATED {true}                    OPTIONAL,
  rn-SubframeConfigReq-r10          ENUMERATED {required, notRequired} OPTIONAL,
  nonCriticalExtension                RRCConnectionSetupComplete-v1130-IEs OPTIONAL
}

RRCConnectionSetupComplete-v1130-IEs ::= SEQUENCE {
  connEstFailInfoAvailable-r11       ENUMERATED {true}                    OPTIONAL,
  nonCriticalExtension                RRCConnectionSetupComplete-v1250-IEs OPTIONAL
}

RRCConnectionSetupComplete-v1250-IEs ::= SEQUENCE {
  mobilityState-r12                  ENUMERATED {normal, medium, high, spare} OPTIONAL,
  mobilityHistoryAvail-r12           ENUMERATED {true}                    OPTIONAL,
  logMeasAvailableMBSFN-r12         ENUMERATED {true}                    OPTIONAL,
  nonCriticalExtension                SEQUENCE {}                       OPTIONAL
}

```

```

}
RegisteredMME ::=
    plmn-Identity          SEQUENCE {
    plmn-Identity          PLMN-Identity          OPTIONAL,
    mmegi                  BIT STRING (SIZE (16)),
    mmec                   MMEC
    }
-- ASN1STOP

```

***RRCConnectionSetupComplete* field descriptions**

gummei-Type

This field is used to indicate whether the GUMMEI included is native (assigned by EPC) or mapped (from 2G/3G identifiers).

mmegi

Provides the Group Identity of the registered MME within the PLMN, as provided by upper layers, see TS 23.003 [27].

mobilityState

This field indicates the UE mobility state (as defined in TS 36.304 [4, 5.2.4.3]) just prior to UE going into RRC_CONNECTED state. The UE indicates the value of *medium* and *high* when being in Medium-mobility and High-mobility states respectively. Otherwise the UE indicates the value *normal*.

registeredMME

This field is used to transfer the GUMMEI of the MME where the UE is registered, as provided by upper layers.

rn-SubframeConfigReq

If present, this field indicates that the connection establishment is for an RN and whether a subframe configuration is requested or not.

selectedPLMN-Identity

Index of the PLMN selected by the UE from the *plmn-IdentityList* included in SIB1. 1 if the 1st PLMN is selected from the *plmn-IdentityList* included in SIB1, 2 if the 2nd PLMN is selected from the *plmn-IdentityList* included in SIB1 and so on.

SCGFailureInformation

The *SCGFailureInformation* message is used to provide information regarding failures detected by the UE.

Signalling radio bearer: SRB1

RLC-SAP: AM

Logical channel: DCCH

Direction: UE to E-UTRAN

***SCGFailureInformation* message**

```

-- ASN1START
SCGFailureInformation-r12 ::= SEQUENCE {
    criticalExtensions          CHOICE {
        c1                      CHOICE {
            scgFailureInformation-r12
            spare3 NULL, spare2 NULL, spare1 NULL
        },
        criticalExtensionsFuture SEQUENCE {}
    }
}

SCGFailureInformation-r12-IEs ::= SEQUENCE {
    failureReportSCG-r12      FailureReportSCG-r12          OPTIONAL,
    nonCriticalExtension       SCGFailureInformation-v1310-IEs OPTIONAL
}

-- Backported from REL-13
SCGFailureInformation-v1310-IEs ::= SEQUENCE {
    lateNonCriticalExtension   OCTET STRING (CONTAINING SCGFailureInformation-v12d0-IEs)
    OPTIONAL,
    nonCriticalExtension       SEQUENCE {}                  OPTIONAL
}

-- Late non-critical extensions:
SCGFailureInformation-v12d0-IEs ::= SEQUENCE {

```

```

failureReportSCG-v12d0      FailureReportSCG-v12d0      OPTIONAL,
nonCriticalExtension        SEQUENCE {}              OPTIONAL
}
-- Regular non-critical extensions:
FailureReportSCG-r12 ::= SEQUENCE {
  failureType-r12           ENUMERATED {t313-Expiry, randomAccessProblem,
                                       rlc-MaxNumRetx, scg-ChangeFailure },
  measResultServFreqList-r12 MeasResultServFreqList-r10  OPTIONAL,
  measResultNeighCells-r12  MeasResultList2EUTRA-r9    OPTIONAL,
  ...,
  [[ failureType-v1290      ENUMERATED {maxUL-TimingDiff-v1290} OPTIONAL
  ]]
}
FailureReportSCG-v12d0 ::= SEQUENCE {
  measResultNeighCells-v12d0 MeasResultList2EUTRA-v9e0  OPTIONAL
}
-- ASN1STOP

```

– *SecurityModeCommand*

The *SecurityModeCommand* message is used to command the activation of AS security.

Signalling radio bearer: SRB1

RLC-SAP: AM

Logical channel: DCCH

Direction: E-UTRAN to UE

SecurityModeCommand message

```

-- ASN1START
SecurityModeCommand ::= SEQUENCE {
  rrc-TransactionIdentifier RRC-TransactionIdentifier,
  criticalExtensions        CHOICE {
    c1                       CHOICE {
      securityModeCommand-r8 SecurityModeCommand-r8-IEs,
      spare3 NULL, spare2 NULL, spare1 NULL
    },
    criticalExtensionsFuture SEQUENCE {}
  }
}
SecurityModeCommand-r8-IEs ::= SEQUENCE {
  securityConfigSMC SecurityConfigSMC,
  nonCriticalExtension SecurityModeCommand-v8a0-IEs OPTIONAL
}
SecurityModeCommand-v8a0-IEs ::= SEQUENCE {
  lateNonCriticalExtension OCTET STRING OPTIONAL,
  nonCriticalExtension     SEQUENCE {}    OPTIONAL
}
SecurityConfigSMC ::= SEQUENCE {
  securityAlgorithmConfig SecurityAlgorithmConfig,
  ...
}
-- ASN1STOP

```

– *SecurityModeComplete*

The *SecurityModeComplete* message is used to confirm the successful completion of a security mode command.

Signalling radio bearer: SRB1

RLC-SAP: AM

Logical channel: DCCH

Direction: UE to E-UTRAN

SecurityModeComplete message

```

-- ASN1START
SecurityModeComplete ::= SEQUENCE {
    rrc-TransactionIdentifier RRC-TransactionIdentifier,
    criticalExtensions CHOICE {
        securityModeComplete-r8 SecurityModeComplete-r8-IEs,
        criticalExtensionsFuture SEQUENCE {}
    }
}

SecurityModeComplete-r8-IEs ::= SEQUENCE {
    nonCriticalExtension SecurityModeComplete-v8a0-IEs
    OPTIONAL
}

SecurityModeComplete-v8a0-IEs ::= SEQUENCE {
    lateNonCriticalExtension OCTET STRING OPTIONAL,
    nonCriticalExtension SEQUENCE {} OPTIONAL
}
-- ASN1STOP

```

SecurityModeFailure

The *SecurityModeFailure* message is used to indicate an unsuccessful completion of a security mode command.

Signalling radio bearer: SRB1

RLC-SAP: AM

Logical channel: DCCH

Direction: UE to E-UTRAN

SecurityModeFailure message

```

-- ASN1START
SecurityModeFailure ::= SEQUENCE {
    rrc-TransactionIdentifier RRC-TransactionIdentifier,
    criticalExtensions CHOICE {
        securityModeFailure-r8 SecurityModeFailure-r8-IEs,
        criticalExtensionsFuture SEQUENCE {}
    }
}

SecurityModeFailure-r8-IEs ::= SEQUENCE {
    nonCriticalExtension SecurityModeFailure-v8a0-IEs
    OPTIONAL
}

SecurityModeFailure-v8a0-IEs ::= SEQUENCE {
    lateNonCriticalExtension OCTET STRING OPTIONAL,
    nonCriticalExtension SEQUENCE {} OPTIONAL
}
-- ASN1STOP

```

SidelinkUEInformation

The *SidelinkUEInformation* message is used for the indication of sidelink information to the eNB.

Signalling radio bearer: SRB1

RLC-SAP: AM

Logical channel: DCCH

Direction: UE to E-UTRAN

SidelinkUEInformation message

```

-- ASN1START
SidelinkUEInformation-r12 ::= SEQUENCE {
  criticalExtensions          CHOICE {
    c1                       CHOICE {
      sidelinkUEInformation-r12 SidelinkUEInformation-r12-IEs,
      spare3 NULL, spare2 NULL, spare1 NULL
    },
    criticalExtensionsFuture    SEQUENCE {}
  }
}

SidelinkUEInformation-r12-IEs ::= SEQUENCE {
  commRxInterestedFreq-r12    ARFCN-ValueEUTRA-r9          OPTIONAL,
  commTxResourceReq-r12       SL-CommTxResourceReq-r12     OPTIONAL,
  discRxInterest-r12          ENUMERATED {true}             OPTIONAL,
  discTxResourceReq-r12       INTEGER (1..63)                OPTIONAL,
  lateNonCriticalExtension     OCTET STRING                  OPTIONAL,
  nonCriticalExtension         SEQUENCE {}                   OPTIONAL
}

SL-CommTxResourceReq-r12 ::= SEQUENCE {
  carrierFreq-r12             ARFCN-ValueEUTRA-r9          OPTIONAL,
  destinationInfoList-r12     SL-DestinationInfoList-r12
}

SL-DestinationInfoList-r12 ::= SEQUENCE (SIZE (1..maxSL-Dest-r12)) OF SL-DestinationIdentity-r12

SL-DestinationIdentity-r12 ::= BIT STRING (SIZE (24))
-- ASN1STOP

```

SidelinkUEInformation field descriptions

<i>commRxInterestedFreq</i>	Indicates the frequency on which the UE is interested to receive sidelink communication.
<i>commTxResourceReq</i>	Indicates the frequency on which the UE is interested to transmit sidelink communication as well as the sidelink communication transmission destination(s) for which the UE requests E-UTRAN to assign dedicated resources.
<i>destinationInfoList</i>	Indicates the destination which is identified by the ProSe Layer-2 Group ID as specified in TS 23.303 [68].
<i>discRxInterest</i>	Indicates that the UE is interested to monitor sidelink discovery announcements.
<i>discTxResourceReq</i>	Indicates the number of separate discovery message(s) the UE wants to transmit every discovery period. This field concerns the resources the UE requires every discovery period for transmitting sidelink discovery announcement(s).

SystemInformation

The *SystemInformation* message is used to convey one or more System Information Blocks. All the SIBs included are transmitted with the same periodicity.

Signalling radio bearer: N/A

RLC-SAP: TM

Logical channel: BCCH

Direction: E-UTRAN to UE

SystemInformation message

```
-- ASN1START
SystemInformation ::=
    criticalExtensions
        systemInformation-r8
        criticalExtensionsFuture
    }
}
SystemInformation-r8-IEs ::=
    sib-TypeAndInfo
        sib2
        sib3
        sib4
        sib5
        sib6
        sib7
        sib8
        sib9
        sib10
        sib11
        . . .
        sib12-v920
        sib13-v920
        sib14-v1130
        sib15-v1130
        sib16-v1130
        sib17-v1250
        sib18-v1250
        sib19-v1250
    },
    nonCriticalExtension
}
SystemInformation-v8a0-IEs ::= SEQUENCE {
    lateNonCriticalExtension
    nonCriticalExtension
}
-- ASN1STOP
```

SystemInformationBlockType1

SystemInformationBlockType1 contains information relevant when evaluating if a UE is allowed to access a cell and defines the scheduling of other system information.

Signalling radio bearer: N/A

RLC-SAP: TM

Logical channel: BCCH

Direction: E-UTRAN to UE

SystemInformationBlockType1 message

```
-- ASN1START
SystemInformationBlockType1 ::=
    cellAccessRelatedInfo
    plmn-IdentityList
    trackingAreaCode
    cellIdentity
    cellBarred
}
-- ASN1STOP
```



```

        intraFreqReselection      ENUMERATED {allowed, notAllowed},
        csg-Indication            BOOLEAN,
        csg-Identity              CSG-Identity          OPTIONAL    -- Need OR
    },
    cellSelectionInfo            SEQUENCE {
        q-RxLevMin                Q-RxLevMin,
        q-RxLevMinOffset          INTEGER (1..8)          OPTIONAL    -- Need OP
    },
    p-Max                        P-Max                  OPTIONAL,    -- Need OP
    freqBandIndicator            FreqBandIndicator,
    schedulingInfoList           SchedulingInfoList,
    tdd-Config                   TDD-Config          OPTIONAL,    -- Cond TDD
    si-WindowLength             ENUMERATED {
        ms1, ms2, ms5, ms10, ms15, ms20,
        ms40},
    systemInfoValueTag           INTEGER (0..31),
    nonCriticalExtension          SystemInformationBlockType1-v890-IEs  OPTIONAL
}

SystemInformationBlockType1-v890-IEs ::= SEQUENCE {
    lateNonCriticalExtension     OCTET STRING (CONTAINING SystemInformationBlockType1-v8h0-
    IEs)                          OPTIONAL,
    nonCriticalExtension          SystemInformationBlockType1-v920-IEs  OPTIONAL
}

-- Late non critical extensions
SystemInformationBlockType1-v8h0-IEs ::= SEQUENCE {
    multiBandInfoList           MultiBandInfoList          OPTIONAL,    -- Need OR
    nonCriticalExtension         SystemInformationBlockType1-v9e0-IEs  OPTIONAL
}

SystemInformationBlockType1-v9e0-IEs ::= SEQUENCE {
    freqBandIndicator-v9e0      FreqBandIndicator-v9e0      OPTIONAL,    -- Cond FBI-max
    multiBandInfoList-v9e0      MultiBandInfoList-v9e0      OPTIONAL,    -- Cond mFBI-max
    nonCriticalExtension         SystemInformationBlockType1-v10j0-IEs  OPTIONAL
}

SystemInformationBlockType1-v10j0-IEs ::= SEQUENCE {
    freqBandInfo-r10            NS-PmaxList-r10              OPTIONAL,    -- Need OR
    multiBandInfoList-v10j0     MultiBandInfoList-v10j0     OPTIONAL,    -- Need OR
    nonCriticalExtension         SystemInformationBlockType1-v10l0-IEs  OPTIONAL
}

SystemInformationBlockType1-v10l0-IEs ::= SEQUENCE {
    freqBandInfo-v10l0          NS-PmaxList-v10l0              OPTIONAL,    -- Need OR
    multiBandInfoList-v10l0     MultiBandInfoList-v10l0     OPTIONAL,    -- Need OR
    nonCriticalExtension         SEQUENCE {}                  OPTIONAL
}

-- Regular non critical extensions
SystemInformationBlockType1-v920-IEs ::= SEQUENCE {
    ims-EmergencySupport-r9      ENUMERATED {true}            OPTIONAL,    -- Need OR
    cellSelectionInfo-v920       CellSelectionInfo-v920      OPTIONAL,    -- Cond RSRQ
    nonCriticalExtension          SystemInformationBlockType1-v1130-IEs  OPTIONAL
}

SystemInformationBlockType1-v1130-IEs ::= SEQUENCE {
    tdd-Config-v1130            TDD-Config-v1130            OPTIONAL,    -- Cond TDD-OR
    cellSelectionInfo-v1130      CellSelectionInfo-v1130      OPTIONAL,    -- Cond WB-RSRQ
    nonCriticalExtension          SystemInformationBlockType1-v1250-IEs  OPTIONAL
}

SystemInformationBlockType1-v1250-IEs ::= SEQUENCE {
    cellAccessRelatedInfo-v1250 SEQUENCE {
        category0Allowed-r12     ENUMERATED {true}            OPTIONAL    -- Need OP
    },
    cellSelectionInfo-v1250      CellSelectionInfo-v1250      OPTIONAL,    -- Cond RSRQ2
    freqBandIndicatorPriority-r12 ENUMERATED {true}            OPTIONAL,    -- Cond mFBI
    nonCriticalExtension          SEQUENCE {}                  OPTIONAL
}

PLMN-IdentityList ::= SEQUENCE (SIZE (1..maxPLMN-r11)) OF PLMN-IdentityInfo

PLMN-IdentityInfo ::= SEQUENCE {
    plmn-Identity                PLMN-Identity,
    cellReservedForOperatorUse    ENUMERATED {reserved, notReserved}
}

```

```
SchedulingInfoList ::= SEQUENCE (SIZE (1..maxSI-Message)) OF SchedulingInfo

SchedulingInfo ::= SEQUENCE {
    si-Periodicity          ENUMERATED {
                            rf8, rf16, rf32, rf64, rf128, rf256, rf512},
    sib-MappingInfo        SIB-MappingInfo
}

SIB-MappingInfo ::= SEQUENCE (SIZE (0..maxSIB-1)) OF SIB-Type

SIB-Type ::=
    ENUMERATED {
        sibType3, sibType4, sibType5, sibType6,
        sibType7, sibType8, sibType9, sibType10,
        sibType11, sibType12-v920, sibType13-v920,
        sibType14-v1130, sibType15-v1130,
        sibType16-v1130, sibType17-v1250, sibType18-v1250,
        ..., sibType19-v1250}

CellSelectionInfo-v920 ::=
    SEQUENCE {
        q-QualMin-r9          Q-QualMin-r9,
        q-QualMinOffset-r9   INTEGER (1..8)                OPTIONAL    -- Need OP
    }

CellSelectionInfo-v1130 ::=
    SEQUENCE {
        q-QualMinWB-r11      Q-QualMin-r9
    }

CellSelectionInfo-v1250 ::=
    SEQUENCE {
        q-QualMinRSRQ-OnAllSymbols-r12  Q-QualMin-r9
    }

-- ASN1STOP
```

SystemInformationBlockType1 field descriptions
<p>category0Allowed The presence of this field indicates category 0 UEs are allowed to access the cell.</p>
<p>cellBarred barred means the cell is barred, as defined in TS 36.304 [4].</p>
<p>cellReservedForOperatorUse As defined in TS 36.304 [4].</p>
<p>csg-Identity Identity of the Closed Subscriber Group the cell belongs to.</p>
<p>csg-Indication If set to TRUE the UE is only allowed to access the cell if it is a CSG member cell, if selected during manual CSG selection or to obtain limited service, see TS 36.304 [4].</p>
<p>freqBandIndicatorPriority If the field is present and supported by the UE, the UE shall prioritize the frequency bands in the <i>multiBandInfoList</i> IE in decreasing priority order. Only if the UE does not support any of the frequency band in <i>multiBandInfoList</i>, the UE shall use the value in <i>freqBandIndicator</i> IE. Otherwise, the UE applies frequency band according to the rules defined in <i>multiBandInfoList</i>.</p>
<p>freqBandInfo A list of <i>additionalPmax</i> and <i>additionalSpectrumEmission</i> values as defined in TS 36.101 [42, table 6.2.4-1] for the frequency band in <i>freqBandIndicator</i>.</p>
<p>ims-EmergencySupport Indicates whether the cell supports IMS emergency bearer services for UEs in limited service mode. If absent, IMS emergency call is not supported by the network in the cell for UEs in limited service mode.</p>
<p>intraFreqReselection Used to control cell reselection to intra-frequency cells when the highest ranked cell is barred, or treated as barred by the UE, as specified in TS 36.304 [4].</p>
<p>multiBandInfoList A list of additional frequency band indicators, as defined in TS 36.101 [42, table 5.5-1] that the cell belongs to. If the UE supports the frequency band in the <i>freqBandIndicator</i> IE it shall apply that frequency band. Otherwise, the UE shall apply the first listed band which it supports in the <i>multiBandInfoList</i> IE. If E-UTRAN includes <i>multiBandInfoList-v9e0</i> it includes the same number of entries, and listed in the same order, as in <i>multiBandInfoList</i> (i.e. without suffix). See Annex D for more descriptions. The UE shall ignore the rule defined in this field description if <i>freqBandIndicatorPriority</i> is present and supported by the UE.</p>
<p>multiBandInfoList-v10j0 A list of <i>additionalPmax</i> and <i>additionalSpectrumEmission</i> values as defined in TS 36.101 [42, table 6.2.4-1] for the frequency bands in <i>multiBandInfoList</i> (i.e. without suffix) and <i>multiBandInfoList-v9e0</i>. If E-UTRAN includes <i>multiBandInfoList-v10j0</i>, it includes the same number of entries, and listed in the same order, as in <i>multiBandInfoList</i> (i.e. without suffix). If E-UTRAN includes <i>multiBandInfoList-v10i0</i> it includes the same number of entries, and listed in the same order, as in <i>multiBandInfoList-v10j0</i>.</p>
<p>plmn-IdentityList List of PLMN identities. The first listed <i>PLMN-Identity</i> is the primary PLMN.</p>
<p>p-Max Value applicable for the cell. If absent the UE applies the maximum power according to the UE capability.</p>
<p>q-QualMin Parameter "Q_{qualmin}" in TS 36.304 [4]. If <i>cellSelectionInfo-v920</i> is not present, the UE applies the (default) value of negative infinity for Q_{qualmin}. NOTE 1.</p>
<p>q-QualMinRSRQ-OnAllSymbols If this field is present and supported by the UE, the UE shall, when performing RSRQ measurements, perform RSRQ measurement on all OFDM symbols in accordance with TS 36.214 [48]. NOTE 1.</p>
<p>q-QualMinOffset Parameter "Q_{qualminoffset}" in TS 36.304 [4]. Actual value Q_{qualminoffset} = IE value [dB]. If <i>cellSelectionInfo-v920</i> is not present or the field is not present, the UE applies the (default) value of 0 dB for Q_{qualminoffset}. Affects the minimum required quality level in the cell.</p>
<p>q-QualMinWB If this field is present and supported by the UE, the UE shall, when performing RSRQ measurements, use a wider bandwidth in accordance with TS 36.133 [16]. NOTE 1.</p>
<p>q-RxLevMinOffset Parameter Q_{rxlevminoffset} in TS 36.304 [4]. Actual value Q_{rxlevminoffset} = IE value * 2 [dB]. If absent, the UE applies the (default) value of 0 dB for Q_{rxlevminoffset}. Affects the minimum required Rx level in the cell.</p>
<p>sib-MappingInfo List of the SIBs mapped to this <i>SystemInformation</i> message. There is no mapping information of SIB2; it is always present in the first <i>SystemInformation</i> message listed in the <i>schedulingInfoList</i> list.</p>
<p>si-Periodicity Periodicity of the SI-message in radio frames, such that rf8 denotes 8 radio frames, rf16 denotes 16 radio frames, and so on.</p>

SystemInformationBlockType1 field descriptions
category0Allowed The presence of this field indicates category 0 UEs are allowed to access the cell.
si-WindowLength Common SI scheduling window for all SIs. Unit in milliseconds, where ms1 denotes 1 millisecond, ms2 denotes 2 milliseconds and so on.
systemInfoValueTag Common for all SIBs other than MIB, SIB1, SIB10, SIB11, SIB12 and SIB14. Change of MIB and SIB1 is detected by acquisition of the corresponding message.
trackingAreaCode A <i>trackingAreaCode</i> that is common for all the PLMNs listed.

NOTE 1: The value the UE applies for parameter " Q_{qualmin} " in TS 36.304 [4] depends on the $q\text{-QualMin}$ fields signalled by E-UTRAN and supported by the UE. In case multiple candidate options are available, the UE shall select the highest priority candidate option according to the priority order indicated by the following table (top row is highest priority).

q-QualMinRSRQ-OnAllSymbols	q-QualMinWB	Value of parameter "Q_{qualmin}" in TS 36.304 [4]
Included	Included	$q\text{-QualMinRSRQ-OnAllSymbols} - (q\text{-QualMin} - q\text{-QualMinWB})$
Included	Not included	$q\text{-QualMinRSRQ-OnAllSymbols}$
Not included	Included	$q\text{-QualMinWB}$
Not included	Not included	$q\text{-QualMin}$

Conditional presence	Explanation
<i>FBI-max</i>	The field is mandatory present if <i>freqBandIndicator</i> (i.e. without suffix) is set to <i>maxFBI</i> . Otherwise the field is not present.
<i>mFBI</i>	The field is optional present, Need OR, if <i>multiBandInfoList</i> is present. Otherwise the field is not present.
<i>mFBI-max</i>	The field is mandatory present if one or more entries in <i>multiBandInfoList</i> (i.e. without suffix, introduced in -v8h0) is set to <i>maxFBI</i> . Otherwise the field is not present.
<i>RSRQ</i>	The field is mandatory present if SIB3 is being broadcast and <i>threshServingLowQ</i> is present in SIB3; otherwise optionally present, Need OP.
<i>RSRQ2</i>	The field is mandatory present if <i>q-QualMinRSRQ-OnAllSymbols</i> is present in SIB3; otherwise it is not present and the UE shall delete any existing value for this field.
<i>TDD</i>	This field is mandatory present for TDD; it is not present for FDD and the UE shall delete any existing value for this field.
<i>TDD-OR</i>	The field is optional present for TDD, need OR; it is not present for FDD.
<i>WB-RSRQ</i>	The field is optionally present, need OP if the measurement bandwidth indicated by <i>allowedMeasBandwidth</i> in <i>systemInformationBlockType3</i> is 50 resource blocks or larger; otherwise it is not present.

– UEAssistanceInformation

The *UEAssistanceInformation* message is used for the indication of UE assistance information to the eNB.

Signalling radio bearer: SRB1

RLC-SAP: AM

Logical channel: DCCH

Direction: UE to E-UTRAN

UEAssistanceInformation message

```
-- ASN1START
UEAssistanceInformation-r11 ::=
    SEQUENCE {
        criticalExtensions
            CHOICE {
                c1
                    CHOICE {
                        ueAssistanceInformation-r11
                        UEAssistanceInformation-r11-IEs,
                        spare3 NULL, spare2 NULL, spare1 NULL
                    }
            },
        criticalExtensionsFuture
            SEQUENCE {}
    }
-- ASN1END
```

```

}
}
UEAssistanceInformation-r11-IEs ::= SEQUENCE {
    powerPrefIndication-r11      ENUMERATED {normal, lowPowerConsumption} OPTIONAL,
    lateNonCriticalExtension      OCTET STRING                OPTIONAL,
    nonCriticalExtension          SEQUENCE {}                OPTIONAL
}
-- ASN1STOP

```

UEAssistanceInformation field descriptions

powerPrefIndication

Value *lowPowerConsumption* indicates the UE prefers a configuration that is primarily optimised for power saving. Otherwise the value is set to *normal*.

– **UECapabilityEnquiry**

The *UECapabilityEnquiry* message is used to request the transfer of UE radio access capabilities for E-UTRA as well as for other RATs.

Signalling radio bearer: SRB1

RLC-SAP: AM

Logical channel: DCCH

Direction: E-UTRAN to UE

UECapabilityEnquiry message

```

-- ASN1START
UECapabilityEnquiry ::= SEQUENCE {
    rrc-TransactionIdentifier      RRC-TransactionIdentifier,
    criticalExtensions             CHOICE {
        c1                        CHOICE {
            ueCapabilityEnquiry-r8      UECapabilityEnquiry-r8-IEs,
            spare3 NULL, spare2 NULL, spare1 NULL
        },
        criticalExtensionsFuture      SEQUENCE {}
    }
}

UECapabilityEnquiry-r8-IEs ::= SEQUENCE {
    ue-CapabilityRequest          UE-CapabilityRequest,
    nonCriticalExtension          UECapabilityEnquiry-v8a0-IEs      OPTIONAL
}

UECapabilityEnquiry-v8a0-IEs ::= SEQUENCE {
    lateNonCriticalExtension      OCTET STRING                OPTIONAL,
    nonCriticalExtension          UECapabilityEnquiry-v1180-IEs
    OPTIONAL
}

UECapabilityEnquiry-v1180-IEs ::= SEQUENCE {
    requestedFrequencyBands-r11   SEQUENCE (SIZE (1..16)) OF FreqBandIndicator-r11
    OPTIONAL,
    nonCriticalExtension          SEQUENCE {}                OPTIONAL
}

UE-CapabilityRequest ::= SEQUENCE (SIZE (1..maxRAT-Capabilities)) OF RAT-Type
-- ASN1STOP

```

<i>UECapabilityEnquiry</i> field descriptions
<p><i>ue-CapabilityRequest</i> List of the RATs for which the UE is requested to transfer the UE radio access capabilities i.e. E-UTRA, UTRA, GERAN-CS, GERAN-PS, CDMA2000.</p>
<p><i>requestedFrequencyBands</i> List of frequency bands for which the UE is requested to provide supported CA band combinations and non CA bands.</p>

– *UECapabilityInformation*

The *UECapabilityInformation* message is used to transfer of UE radio access capabilities requested by the E-UTRAN.

Signalling radio bearer: SRB1

RLC-SAP: AM

Logical channel: DCCH

Direction: UE to E-UTRAN

***UECapabilityInformation* message**

```

-- ASN1START
UECapabilityInformation ::= SEQUENCE {
    rrc-TransactionIdentifier RRC-TransactionIdentifier,
    criticalExtensions CHOICE {
        cl CHOICE {
            ueCapabilityInformation-r8 UECapabilityInformation-r8-IEs,
            spare7 NULL,
            spare6 NULL, spare5 NULL, spare4 NULL,
            spare3 NULL, spare2 NULL, spare1 NULL
        },
        criticalExtensionsFuture SEQUENCE {}
    }
}

UECapabilityInformation-r8-IEs ::= SEQUENCE {
    ue-CapabilityRAT-ContainerList UE-CapabilityRAT-ContainerList,
    nonCriticalExtension UECapabilityInformation-v8a0-IEs OPTIONAL
}

UECapabilityInformation-v8a0-IEs ::= SEQUENCE {
    lateNonCriticalExtension OCTET STRING OPTIONAL,
    nonCriticalExtension UECapabilityInformation-v1250-IEs OPTIONAL
}

UECapabilityInformation-v1250-IEs ::= SEQUENCE {
    ue-RadioPagingInfo-r12 UE-RadioPagingInfo-r12 OPTIONAL,
    nonCriticalExtension SEQUENCE {} OPTIONAL
}
-- ASN1STOP

```

<i>UECapabilityInformation</i> field descriptions
<p><i>ue-RadioPagingInfo</i> This field contains information used for paging of category 0 UEs.</p>

– *UEInformationRequest*

The *UEInformationRequest* is the command used by E-UTRAN to retrieve information from the UE.

Signalling radio bearer: SRB1

RLC-SAP: AM

Logical channel: DCCH

Direction: E-UTRAN to UE

UEInformationRequest message

```

-- ASN1START
UEInformationRequest-r9 ::= SEQUENCE {
  rrc-TransactionIdentifier RRC-TransactionIdentifier,
  criticalExtensions CHOICE {
    cl CHOICE {
      ueInformationRequest-r9 UEInformationRequest-r9-IEs,
      spare3 NULL, spare2 NULL, spare1 NULL
    },
    criticalExtensionsFuture SEQUENCE {}
  }
}

UEInformationRequest-r9-IEs ::= SEQUENCE {
  rach-ReportReq-r9 BOOLEAN,
  rlf-ReportReq-r9 BOOLEAN,
  nonCriticalExtension UEInformationRequest-v930-IEs OPTIONAL
}

UEInformationRequest-v930-IEs ::= SEQUENCE {
  lateNonCriticalExtension OCTET STRING OPTIONAL,
  nonCriticalExtension UEInformationRequest-v1020-IEs OPTIONAL
}

UEInformationRequest-v1020-IEs ::= SEQUENCE {
  logMeasReportReq-r10 ENUMERATED {true} OPTIONAL, -- Need ON
  nonCriticalExtension UEInformationRequest-v1130-IEs OPTIONAL
}

UEInformationRequest-v1130-IEs ::= SEQUENCE {
  connEstFailReportReq-r11 ENUMERATED {true} OPTIONAL, -- Need ON
  nonCriticalExtension UEInformationRequest-v1250-IEs OPTIONAL
}

UEInformationRequest-v1250-IEs ::= SEQUENCE {
  mobilityHistoryReportReq-r12 ENUMERATED {true} OPTIONAL, -- Need ON
  nonCriticalExtension SEQUENCE {} OPTIONAL
}
-- ASN1STOP

```

UEInformationRequest field descriptions**rach-ReportReq**

This field is used to indicate whether the UE shall report information about the random access procedure.

– **UEInformationResponse**

The *UEInformationResponse* message is used by the UE to transfer the information requested by the E-UTRAN.

Signalling radio bearer: SRB1 or SRB2 (when logged measurement information is included)

RLC-SAP: AM

Logical channel: DCCH

Direction: UE to E-UTRAN

UEInformationResponse message

```

-- ASN1START
UEInformationResponse-r9 ::= SEQUENCE {
  rrc-TransactionIdentifier RRC-TransactionIdentifier,
  criticalExtensions CHOICE {
    cl CHOICE {
      ueInformationResponse-r9 UEInformationResponse-r9-IEs,
      spare3 NULL, spare2 NULL, spare1 NULL
    },
    criticalExtensionsFuture SEQUENCE {}
  }
}

```

```

UEInformationResponse-r9-IEs ::= SEQUENCE {
  rach-Report-r9          SEQUENCE {
    numberOfPreamblesSent-r9  NumberOfPreamblesSent-r11,
    contentionDetected-r9      BOOLEAN
  },
  rlf-Report-r9          RLF-Report-r9          OPTIONAL,
  nonCriticalExtension    UEInformationResponse-v930-IEs  OPTIONAL
}

-- Late non critical extensions
UEInformationResponse-v9e0-IEs ::= SEQUENCE {
  rlf-Report-v9e0        RLF-Report-v9e0          OPTIONAL,
  nonCriticalExtension    SEQUENCE {}              OPTIONAL
}

-- Regular non critical extensions
UEInformationResponse-v930-IEs ::= SEQUENCE {
  lateNonCriticalExtension OCTET STRING (CONTAINING UEInformationResponse-v9e0-IEs)
  OPTIONAL,
  nonCriticalExtension      UEInformationResponse-v1020-IEs  OPTIONAL
}

UEInformationResponse-v1020-IEs ::= SEQUENCE {
  logMeasReport-r10      LogMeasReport-r10          OPTIONAL,
  nonCriticalExtension    UEInformationResponse-v1130-IEs  OPTIONAL
}

UEInformationResponse-v1130-IEs ::= SEQUENCE {
  connEstFailReport-r11  ConnEstFailReport-r11    OPTIONAL,
  nonCriticalExtension    UEInformationResponse-v1250-IEs  OPTIONAL
}

UEInformationResponse-v1250-IEs ::= SEQUENCE {
  mobilityHistoryReport-r12  MobilityHistoryReport-r12  OPTIONAL,
  nonCriticalExtension        SEQUENCE {}              OPTIONAL
}

RLF-Report-r9 ::= SEQUENCE {
  measResultLastServCell-r9 SEQUENCE {
    rsrpResult-r9      RSRP-Range,
    rsrqResult-r9      RSRQ-Range          OPTIONAL
  },
  measResultNeighCells-r9 SEQUENCE {
    measResultListEUTRA-r9  MeasResultList2EUTRA-r9    OPTIONAL,
    measResultListUTRA-r9   MeasResultList2UTRA-r9     OPTIONAL,
    measResultListGERAN-r9   MeasResultListGERAN          OPTIONAL,
    measResultsCDMA2000-r9   MeasResultList2CDMA2000-r9  OPTIONAL
  } OPTIONAL,
  ...
  [[ locationInfo-r10      LocationInfo-r10          OPTIONAL,
    failedPCellId-r10      CHOICE {
      cellGlobalId-r10    CellGlobalIdEUTRA,
      pci-arfcn-r10       SEQUENCE {
        physCellId-r10    PhysCellId,
        carrierFreq-r10   ARFCN-ValueEUTRA
      }
    } OPTIONAL,
    reestablishmentCellId-r10 CellGlobalIdEUTRA          OPTIONAL,
    timeConnFailure-r10     INTEGER (0..1023)          OPTIONAL,
    connectionFailureType-r10 ENUMERATED {rlf, hof}          OPTIONAL,
    previousPCellId-r10     CellGlobalIdEUTRA          OPTIONAL
  ]],
  [[ failedPCellId-v1090    SEQUENCE {
    carrierFreq-v1090      ARFCN-ValueEUTRA-v9e0
  } OPTIONAL
  ]],
  [[ basicFields-r11       SEQUENCE {
    c-RNTI-r11            C-RNTI,
    rlf-Cause-r11         ENUMERATED {
      t310-Expiry, randomAccessProblem,
      rlc-MaxNumRetx, t312-Expiry-r12},
    timeSinceFailure-r11  TimeSinceFailure-r11          OPTIONAL,
    previousUTRA-CellId-r11 SEQUENCE {
      carrierFreq-r11     ARFCN-ValueUTRA,
      physCellId-r11     CHOICE {
        fdd-r11          PhysCellIdUTRA-FDD,

```



```

        tdd-r11                PhysCellIdUTRA-TDD
    },
    cellGlobalId-r11           CellGlobalIdUTRA                OPTIONAL,
}                               OPTIONAL,
selectedUTRA-CellId-r11      SEQUENCE {
    carrierFreq-r11           ARFCN-ValueUTRA,
    physCellId-r11           CHOICE {
        fdd-r11              PhysCellIdUTRA-FDD,
        tdd-r11              PhysCellIdUTRA-TDD
    }
}                               OPTIONAL
]],
[[ failedPCellId-v1250        SEQUENCE {
    tac-FailedPCell-r12       TrackingAreaCode
}                               OPTIONAL,
measResultLastServCell-v1250 RSRQ-Range-v1250                OPTIONAL,
lastServCellRSRQ-Type-r12    RSRQ-Type-r12                OPTIONAL,
measResultListEUTRA-v1250    MeasResultList2EUTRA-v1250  OPTIONAL
]]
}

RLF-Report-v9e0 ::=          SEQUENCE {
    measResultListEUTRA-v9e0  MeasResultList2EUTRA-v9e0
}

MeasResultList2EUTRA-r9 ::=  SEQUENCE (SIZE (1..maxFreq)) OF MeasResult2EUTRA-r9
MeasResultList2EUTRA-v9e0 ::= SEQUENCE (SIZE (1..maxFreq)) OF MeasResult2EUTRA-v9e0
MeasResultList2EUTRA-v1250 ::= SEQUENCE (SIZE (1..maxFreq)) OF MeasResult2EUTRA-v1250

MeasResult2EUTRA-r9 ::=      SEQUENCE {
    carrierFreq-r9           ARFCN-ValueEUTRA,
    measResultList-r9        MeasResultListEUTRA
}

MeasResult2EUTRA-v9e0 ::=    SEQUENCE {
    carrierFreq-v9e0         ARFCN-ValueEUTRA-v9e0        OPTIONAL
}

MeasResult2EUTRA-v1250 ::=   SEQUENCE {
    rsrq-Type-r12           RSRQ-Type-r12                OPTIONAL
}

MeasResultList2UTRA-r9 ::=   SEQUENCE (SIZE (1..maxFreq)) OF MeasResult2UTRA-r9
MeasResult2UTRA-r9 ::=       SEQUENCE {
    carrierFreq-r9           ARFCN-ValueUTRA,
    measResultList-r9        MeasResultListUTRA
}

MeasResultList2CDMA2000-r9 ::= SEQUENCE (SIZE (1..maxFreq)) OF MeasResult2CDMA2000-r9
MeasResult2CDMA2000-r9 ::=   SEQUENCE {
    carrierFreq-r9           CarrierFreqCDMA2000,
    measResultList-r9        MeasResultsCDMA2000
}

LogMeasReport-r10 ::=        SEQUENCE {
    absoluteTimeStamp-r10     AbsoluteTimeInfo-r10,
    traceReference-r10        TraceReference-r10,
    traceRecordingSessionRef-r10 OCTET STRING (SIZE (2)),
    tce-Id-r10                OCTET STRING (SIZE (1)),
    logMeasInfoList-r10       LogMeasInfoList-r10,
    logMeasAvailable-r10      ENUMERATED {true}                OPTIONAL,
    ...
}

LogMeasInfoList-r10 ::=      SEQUENCE (SIZE (1..maxLogMeasReport-r10)) OF LogMeasInfo-r10
LogMeasInfo-r10 ::=          SEQUENCE {
    locationInfo-r10          LocationInfo-r10                OPTIONAL,
    relativeTimeStamp-r10     INTEGER (0..7200),
    servCellIdentity-r10      CellGlobalIdEUTRA,
    measResultServCell-r10    SEQUENCE {
        rsrpResult-r10        RSRP-Range,
        rsrqResult-r10        RSRQ-Range
    }
}

```

```

    },
    measResultNeighCells-r10          SEQUENCE {
        measResultListEUTRA-r10      MeasResultList2EUTRA-r9    OPTIONAL,
        measResultListUTRA-r10       MeasResultList2UTRA-r9     OPTIONAL,
        measResultListGERAN-r10      MeasResultList2GERAN-r10  OPTIONAL,
        measResultListCDMA2000-r10   MeasResultList2CDMA2000-r9 OPTIONAL
    }
    OPTIONAL,
    ...
    [[ measResultListEUTRA-v1090     MeasResultList2EUTRA-v9e0  OPTIONAL
    ]],
    [[ measResultListMBSFN-r12       MeasResultListMBSFN-r12  OPTIONAL,
    measResultServCell-v1250        RSRQ-Range-v1250         OPTIONAL,
    servCellRSRQ-Type-r12           RSRQ-Type-r12            OPTIONAL,
    measResultListEUTRA-v1250       MeasResultList2EUTRA-v1250 OPTIONAL
    ]]
}

MeasResultListMBSFN-r12 ::=          SEQUENCE (SIZE (1..maxMBSFN-Area)) OF MeasResultMBSFN-r12

MeasResultMBSFN-r12 ::=             SEQUENCE {
    mbsfn-Area-r12                   SEQUENCE {
        mbsfn-AreaId-r12             MBSFN-AreaId-r12,
        carrierFreq-r12              ARFCN-ValueEUTRA-r9
    },
    rsrpResultMBSFN-r12              RSRP-Range,
    rsrqResultMBSFN-r12              MBSFN-RSRQ-Range-r12,
    signallingBLER-Result-r12        BLER-Result-r12          OPTIONAL,
    dataBLER-MCH-ResultList-r12     DataBLER-MCH-ResultList-r12 OPTIONAL,
    ...
}

DataBLER-MCH-ResultList-r12 ::=     SEQUENCE (SIZE (1..maxPMCH-PerMBSFN)) OF DataBLER-MCH-
Result-r12

DataBLER-MCH-Result-r12 ::=         SEQUENCE {
    mch-Index-r12                    INTEGER (1..maxPMCH-PerMBSFN),
    dataBLER-Result-r12              BLER-Result-r12
}

BLER-Result-r12 ::=                 SEQUENCE {
    bler-r12                          BLER-Range-r12,
    blocksReceived-r12                SEQUENCE {
        n-r12                         BIT STRING (SIZE (3)),
        m-r12                         BIT STRING (SIZE (8))
    }
}

BLER-Range-r12 ::=                  INTEGER(0..31)

MeasResultList2GERAN-r10 ::=        SEQUENCE (SIZE (1..maxCellListGERAN)) OF MeasResultListGERAN

ConnEstFailReport-r11 ::=           SEQUENCE {
    failedCellId-r11                  CellGlobalIdEUTRA,
    locationInfo-r11                  LocationInfo-r10          OPTIONAL,
    measResultFailedCell-r11          SEQUENCE {
        rsrpResult-r11                RSRP-Range,
        rsrqResult-r11                RSRQ-Range              OPTIONAL
    },
    measResultNeighCells-r11          SEQUENCE {
        measResultListEUTRA-r11       MeasResultList2EUTRA-r9    OPTIONAL,
        measResultListUTRA-r11        MeasResultList2UTRA-r9     OPTIONAL,
        measResultListGERAN-r11       MeasResultListGERAN      OPTIONAL,
        measResultsCDMA2000-r11       MeasResultList2CDMA2000-r9 OPTIONAL
    }
    OPTIONAL,
    numberOfPreamblesSent-r11         NumberOfPreamblesSent-r11,
    contentionDetected-r11             BOOLEAN,
    maxTxPowerReached-r11              BOOLEAN,
    timeSinceFailure-r11               TimeSinceFailure-r11,
    measResultListEUTRA-v1130         MeasResultList2EUTRA-v9e0  OPTIONAL,
    ...
    [[ measResultFailedCell-v1250     RSRQ-Range-v1250         OPTIONAL,
    failedCellRSRQ-Type-r12           RSRQ-Type-r12            OPTIONAL,
    measResultListEUTRA-v1250       MeasResultList2EUTRA-v1250 OPTIONAL
    ]]
}

NumberOfPreamblesSent-r11 ::=        INTEGER (1..200)

```

```
TimeSinceFailure-r11 ::=                INTEGER (0..172800)
MobilityHistoryReport-r12 ::=  VisitedCellInfoList-r12
-- ASN1STOP
```

UEInformationResponse field descriptions
<p>absoluteTimeStamp Indicates the absolute time when the logged measurement configuration logging is provided, as indicated by E-UTRAN within <i>absoluteTimeInfo</i>.</p>
<p>bler Indicates the measured BLER value. The coding of BLER value is defined in TS 36.133 [16].</p>
<p>blocksReceived Indicates total number of MCH blocks, which were received by the UE and used for the corresponding BLER calculation, within the measurement period as defined in TS 36.133 [16].</p>
<p>carrierFreq In case the UE includes <i>carrierFreq-v9e0</i> and/ or <i>carrierFreq-v1090</i>, the UE shall set the corresponding entry of <i>carrierFreq-r9</i> and/ or <i>carrierFreq-r10</i> respectively to <i>maxEARFCN</i>. For E-UTRA and UTRA frequencies, the UE sets the ARFCN according to the band used when obtaining the concerned measurement results.</p>
<p>connectionFailureType This field is used to indicate whether the connection failure is due to radio link failure or handover failure.</p>
<p>contentionDetected This field is used to indicate that contention was detected for at least one of the transmitted preambles, see TS 36.321 [6].</p>
<p>c-RNTI This field indicates the C-RNTI used in the PCell upon detecting radio link failure or the C-RNTI used in the source PCell upon handover failure.</p>
<p>dataBLER-MCH-ResultList Includes a BLER result per MCH on subframes using <i>dataMCS</i>, with the applicable MCH(s) listed in the same order as in <i>pmch-InfoList</i> within <i>MBSFNAreaConfiguration</i>.</p>
<p>failedCellId This field is used to indicate the cell in which connection establishment failed.</p>
<p>failedPCellId This field is used to indicate the PCell in which RLF is detected or the target PCell of the failed handover. The UE sets the EARFCN according to the band used for transmission/ reception when the failure occurred.</p>
<p>maxTxPowerReached This field is used to indicate whether or not the maximum power level was used for the last transmitted preamble, see TS 36.321 [6].</p>
<p>mch-Index Indicates the MCH by referring to the entry as listed in <i>pmch-InfoList</i> within <i>MBSFNAreaConfiguration</i>.</p>
<p>measResultFailedCell This field refers to the last measurement results taken in the cell, where connection establishment failure happened.</p>
<p>measResultLastServCell This field refers to the last measurement results taken in the PCell, where radio link failure or handover failure happened.</p>
<p>measResultListEUTRA If <i>measResultListEUTRA-v9e0</i>, <i>measResultListEUTRA-v1090</i> or <i>measResultListEUTRA-v1130</i> is included, the UE shall include the same number of entries, and listed in the same order, as in <i>measResultListEUTRA-r9</i>, <i>measResultListEUTRA-r10</i> and/ or <i>measResultListEUTRA-r11</i> respectively.</p>
<p>measResultListEUTRA-v1250 If included in <i>RLF-Report-r9</i> the UE shall include the same number of entries, and listed in the same order, as in <i>measResultListEUTRA-r9</i>; If included in <i>LogMeasInfo-r10</i> the UE shall include the same number of entries, and listed in the same order, as in <i>measResultListEUTRA-r10</i>; If included in <i>ConnEstFailReport-r11</i> the UE shall include the same number of entries, and listed in the same order, as in <i>measResultListEUTRA-r11</i>;</p>
<p>mobilityHistoryReport This field is used to indicate the time of stay in 16 most recently visited E-UTRA cells or of stay out of E-UTRA.</p>
<p>numberOfPreamblesSent This field is used to indicate the number of RACH preambles that were transmitted. Corresponds to parameter <i>PREAMBLE_TRANSMISSION_COUNTER</i> in TS 36.321 [6].</p>
<p>previousPCellId This field is used to indicate the source PCell of the last handover (source PCell when the last <i>RRC-Connection-Reconfiguration</i> message including <i>mobilityControlInfo</i> was received).</p>
<p>previousUTRA-CellId This field is used to indicate the source UTRA cell of the last successful handover to E-UTRAN, when RLF occurred at the target PCell. The UE sets the ARFCN according to the band used for transmission/ reception on the concerned cell.</p>
<p>reestablishmentCellId This field is used to indicate the cell in which the re-establishment attempt was made after connection failure.</p>
<p>relativeTimeStamp Indicates the time of logging measurement results, measured relative to the <i>absoluteTimeStamp</i>. Value in seconds.</p>

UEInformationResponse field descriptions
<p>rlf-Cause This field is used to indicate the cause of the last radio link failure that was detected. In case of handover failure information reporting (i.e., the <i>connectionFailureType</i> is set to 'hof'), the UE is allowed to set this field to any value.</p>
<p>selectedUTRA-CellId This field is used to indicate the UTRA cell that the UE selects after RLF is detected, while T311 is running. The UE sets the ARFCN according to the band selected for transmission/ reception on the concerned cell.</p>
<p>signallingBLER-Result Includes a BLER result of MBSFN subframes using <i>signallingMCS</i>.</p>
<p>tac-FailedPCell This field is used to indicate the Tracking Area Code of the PCell in which RLF is detected.</p>
<p>tce-Id Parameter Trace Collection Entity Id: See TS 32.422 [58].</p>
<p>timeConnFailure This field is used to indicate the time elapsed since the last HO initialization until connection failure. Actual value = IE value * 100ms. The maximum value 1023 means 102.3s or longer.</p>
<p>timeSinceFailure This field is used to indicate the time that elapsed since the connection (establishment) failure. Value in seconds. The maximum value 172800 means 172800s or longer.</p>
<p>traceRecordingSessionRef Parameter Trace Recording Session Reference: See TS 32.422 [58].</p>

– *ULHandoverPreparationTransfer (CDMA2000)*

The *ULHandoverPreparationTransfer* message is used for the uplink transfer of handover related CDMA2000 information when requested by the higher layers.

Signalling radio bearer: SRB1

RLC-SAP: AM

Logical channel: DCCH

Direction: UE to E-UTRAN

ULHandoverPreparationTransfer message

```

-- ASN1START
ULHandoverPreparationTransfer ::= SEQUENCE {
    criticalExtensions          CHOICE {
        c1                     CHOICE {
            ulHandoverPreparationTransfer-r8          ULHandoverPreparationTransfer-r8-IEs,
            spare3 NULL, spare2 NULL, spare1 NULL
        },
        criticalExtensionsFuture          SEQUENCE {}
    }
}

ULHandoverPreparationTransfer-r8-IEs ::= SEQUENCE {
    cdma2000-Type          CDMA2000-Type,
    meid                   BIT STRING (SIZE (56)) OPTIONAL,
    dedicatedInfo          DedicatedInfoCDMA2000,
    nonCriticalExtension    ULHandoverPreparationTransfer-v8a0-IEs OPTIONAL
}

ULHandoverPreparationTransfer-v8a0-IEs ::= SEQUENCE {
    lateNonCriticalExtension    OCTET STRING          OPTIONAL,
    nonCriticalExtension        SEQUENCE {}          OPTIONAL
}
-- ASN1STOP

```

<i>ULHandoverPreparationTransfer</i> field descriptions
<p>meid The 56 bit mobile identification number provided by the CDMA2000 Upper layers.</p>

– *ULInformationTransfer*

The *ULInformationTransfer* message is used for the uplink transfer of NAS or non-3GPP dedicated information.

Signalling radio bearer: SRB2 or SRB1 (only if SRB2 not established yet). If SRB2 is suspended, the UE does not send this message until SRB2 is resumed

RLC-SAP: AM

Logical channel: DCCH

Direction: UE to E-UTRAN

ULInformationTransfer message

```
-- ASN1START
ULInformationTransfer ::= SEQUENCE {
    criticalExtensions CHOICE {
        c1 CHOICE {
            ulInformationTransfer-r8 ULInformationTransfer-r8-IEs,
            spare3 NULL, spare2 NULL, spare1 NULL
        },
        criticalExtensionsFuture SEQUENCE {}
    }
}

ULInformationTransfer-r8-IEs ::= SEQUENCE {
    dedicatedInfoType CHOICE {
        dedicatedInfoNAS DedicatedInfoNAS,
        dedicatedInfoCDMA2000-1XRTT DedicatedInfoCDMA2000,
        dedicatedInfoCDMA2000-HRPD DedicatedInfoCDMA2000
    },
    nonCriticalExtension OPTIONAL ULInformationTransfer-v8a0-IEs
}

ULInformationTransfer-v8a0-IEs ::= SEQUENCE {
    lateNonCriticalExtension OCTET STRING OPTIONAL,
    nonCriticalExtension SEQUENCE {} OPTIONAL
}
-- ASN1STOP
```

6.3 RRC information elements

6.3.1 System information blocks

– *SystemInformationBlockType2*

The IE *SystemInformationBlockType2* contains radio resource configuration information that is common for all UEs.

NOTE: UE timers and constants related to functionality for which parameters are provided in another SIB are included in the corresponding SIB.

SystemInformationBlockType2 information element

```
-- ASN1START
SystemInformationBlockType2 ::= SEQUENCE {
    ac-BarringInfo SEQUENCE {
        ac-BarringForEmergency BOOLEAN,
        ac-BarringForMO-Signalling AC-BarringConfig OPTIONAL, -- Need OP
        ac-BarringForMO-Data AC-BarringConfig OPTIONAL, -- Need OP
    }
    radioResourceConfigCommon RadioResourceConfigCommonSIB,
    ue-TimersAndConstants UE-TimersAndConstants,
    freqInfo SEQUENCE {
        ul-CarrierFreq ARFCN-ValueEUTRA OPTIONAL, -- Need OP
        ul-Bandwidth ENUMERATED {n6, n15, n25, n50, n75, n100} OPTIONAL, -- Need OP
    }
}
-- ASN1STOP
```

```

        additionalSpectrumEmission          AdditionalSpectrumEmission
    },
    mbsfn-SubframeConfigList              MBSFN-SubframeConfigList          OPTIONAL, -- Need OR
    timeAlignmentTimerCommon              TimeAlignmentTimer,
    . . . ,
    lateNonCriticalExtension               OCTET STRING (CONTAINING SystemInformationBlockType2-v8h0-IEs)
        OPTIONAL,
    [[ ssac-BarringForMMTEL-Voice-r9       AC-BarringConfig                    OPTIONAL, -- Need OP
     ssac-BarringForMMTEL-Video-r9        AC-BarringConfig                    OPTIONAL  -- Need OP
    ]],
    [[ ac-BarringForCSFB-r10               AC-BarringConfig                    OPTIONAL  -- Need OP
    ]],
    [[ ac-BarringSkipForMMTELVoice-r12     ENUMERATED {true}                   OPTIONAL, -- Need OP
     ac-BarringSkipForMMTELVideo-r12     ENUMERATED {true}                   OPTIONAL, -- Need OP
     ac-BarringSkipForSMS-r12            ENUMERATED {true}                   OPTIONAL, -- Need OP
     ac-BarringPerPLMN-List-r12          AC-BarringPerPLMN-List-r12         OPTIONAL  -- Need OP
    ]],
    [[ voiceServiceCauseIndication-r12     ENUMERATED {true}                   OPTIONAL  -- Need OP
    ]]
}

SystemInformationBlockType2-v8h0-IEs ::= SEQUENCE {
    multiBandInfoList                    SEQUENCE (SIZE (1..maxMultiBands)) OF AdditionalSpectrumEmission
    OPTIONAL, -- Need OR
    nonCriticalExtension                  SystemInformationBlockType2-v9e0-IEs  OPTIONAL
}

SystemInformationBlockType2-v9e0-IEs ::= SEQUENCE {
    ul-CarrierFreq-v9e0                   ARFCN-ValueEUTRA-v9e0                OPTIONAL, -- Cond ul-FreqMax
    nonCriticalExtension                  SystemInformationBlockType2-v9i0-IEs  OPTIONAL
}

SystemInformationBlockType2-v9i0-IEs ::= SEQUENCE {
-- Following field is for any non-critical extensions from REL-9
    nonCriticalExtension                  OCTET STRING (CONTAINING SystemInformationBlockType2-v10m0-IEs)
        OPTIONAL,
    dummy                                SEQUENCE {} OPTIONAL
}

SystemInformationBlockType2-v10m0-IEs ::= SEQUENCE {
    freqInfo-v1010                        SEQUENCE {
        additionalSpectrumEmission-v1010  AdditionalSpectrumEmission-v1010
        OPTIONAL,
    }
    multiBandInfoList-v1010              SEQUENCE (SIZE (1..maxMultiBands)) OF
        AdditionalSpectrumEmission-v1010  OPTIONAL,
-- Following field is for non-critical extensions from REL-10
    nonCriticalExtension                  SEQUENCE {} OPTIONAL
}

AC-BarringConfig ::= SEQUENCE {
    ac-BarringFactor                      ENUMERATED {
        p00, p05, p10, p15, p20, p25, p30, p40,
        p50, p60, p70, p75, p80, p85, p90, p95},
    ac-BarringTime                        ENUMERATED {s4, s8, s16, s32, s64, s128, s256, s512},
    ac-BarringForSpecialAC                BIT STRING (SIZE(5))
}

MBSFN-SubframeConfigList ::= SEQUENCE (SIZE (1..maxMBSFN-Allocations)) OF MBSFN-SubframeConfig

AC-BarringPerPLMN-List-r12 ::= SEQUENCE (SIZE (1.. maxPLMN-r11)) OF AC-BarringPerPLMN-r12

AC-BarringPerPLMN-r12 ::= SEQUENCE {
    plmn-IdentityIndex-r12                INTEGER (1..maxPLMN-r11),
    ac-BarringInfo-r12                    SEQUENCE {
        ac-BarringForEmergency-r12        BOOLEAN,
        ac-BarringForMO-Signalling-r12    AC-BarringConfig  OPTIONAL, -- Need OP
        ac-BarringForMO-Data-r12          AC-BarringConfig  OPTIONAL, -- Need OP
    }
    ac-BarringSkipForMMTELVoice-r12      ENUMERATED {true}  OPTIONAL, -- Need OP
    ac-BarringSkipForMMTELVideo-r12      ENUMERATED {true}  OPTIONAL, -- Need OP
    ac-BarringSkipForSMS-r12              ENUMERATED {true}  OPTIONAL, -- Need OP
    ac-BarringForCSFB-r12                 AC-BarringConfig  OPTIONAL, -- Need OP
    ssac-BarringForMMTEL-Voice-r12        AC-BarringConfig  OPTIONAL, -- Need OP
    ssac-BarringForMMTEL-Video-r12        AC-BarringConfig  OPTIONAL  -- Need OP
}

-- ASN1STOP

```

SystemInformationBlockType2 field descriptions	
ac-BarringFactor	If the random number drawn by the UE is lower than this value, access is allowed. Otherwise the access is barred. The values are interpreted in the range [0,1): p00 = 0, p05 = 0.05, p10 = 0.10, ..., p95 = 0.95. Values other than p00 can only be set if all bits of the corresponding <i>ac-BarringForSpecialAC</i> are set to 0.
ac-BarringForCSFB	Access class barring for mobile originating CS fallback.
ac-BarringForEmergency	Access class barring for AC 10.
ac-BarringForMO-Data	Access class barring for mobile originating calls.
ac-BarringForMO-Signalling	Access class barring for mobile originating signalling.
ac-BarringForSpecialAC	Access class barring for AC 11-15. The first/ leftmost bit is for AC 11, the second bit is for AC 12, and so on.
ac-BarringTime	Mean access barring time value in seconds.
additionalSpectrumEmission	The UE requirements related to IE <i>AdditionalSpectrumEmission</i> are defined in TS 36.101 [42, table 6.2.4.1].
dummy	This field is not used in the specification. If received it shall be ignored by the UE.
mbsfn-SubframeConfigList	Defines the subframes that are reserved for MBSFN in downlink.
multiBandInfoList	A list of <i>additionalSpectrumEmission</i> i.e. one for each additional frequency band included in <i>multiBandInfoList</i> in <i>SystemInformationBlockType1</i> , listed in the same order. If E-UTRAN includes <i>multiBandInfoList-v1010</i> it includes the same number of entries, and listed in the same order, as in <i>multiBandInfoList</i> .
plmn-IdentityIndex	Index of the PLMN in <i>plmn-IdentityList</i> included in SIB1. Value 1 indicates the PLMN listed 1st in <i>plmn-IdentityList</i> included in SIB1. Value 2 indicates the PLMN listed 2nd in <i>plmn-IdentityList</i> included in SIB1 and so on.
ssac-BarringForMMTEL-Video	Service specific access class barring for MMTEL video originating calls.
ssac-BarringForMMTEL-Voice	Service specific access class barring for MMTEL voice originating calls.
ul-Bandwidth	Parameter: transmission bandwidth configuration, N_{RB} , in uplink, see TS 36.101 [42, table 5.6-1]. Value n_6 corresponds to 6 resource blocks, n_{15} to 15 resource blocks and so on. If for FDD this parameter is absent, the uplink bandwidth is equal to the downlink bandwidth. For TDD this parameter is absent and it is equal to the downlink bandwidth.
ul-CarrierFreq	For FDD: If absent, the (default) value determined from the default TX-RX frequency separation defined in TS 36.101 [42, table 5.7.3-1] applies. For TDD: This parameter is absent and it is equal to the downlink frequency.
voiceServiceCauseIndication	Indicates whether UE is requested to use the establishment cause <i>mo-VoiceCall</i> for mobile originating MMTEL voice calls.

Conditional presence	Explanation
<i>ul-FreqMax</i>	The field is mandatory present if <i>ul-CarrierFreq</i> (i.e. without suffix) is present and set to <i>maxEARFCN</i> . Otherwise the field is not present.

– SystemInformationBlockType3

The IE *SystemInformationBlockType3* contains cell re-selection information common for intra-frequency, inter-frequency and/ or inter-RAT cell re-selection (i.e. applicable for more than one type of cell re-selection but not necessarily all) as well as intra-frequency cell re-selection information other than neighbouring cell related.

SystemInformationBlockType3 information element

```
-- ASN1START
SystemInformationBlockType3 ::= SEQUENCE {
    cellReselectionInfoCommon SEQUENCE {
        q-Hyst ENUMERATED {
```



```

        dB0, dB1, dB2, dB3, dB4, dB5, dB6, dB8, dB10,
        dB12, dB14, dB16, dB18, dB20, dB22, dB24},
    speedStateReselectionPars          SEQUENCE {
        mobilityStateParameters        MobilityStateParameters,
        q-HystSF                        SEQUENCE {
            sf-Medium                   ENUMERATED {
                dB-6, dB-4, dB-2, dB0},
            sf-High                     ENUMERATED {
                dB-6, dB-4, dB-2, dB0}
        }
    }
},
cellReselectionServingFreqInfo       SEQUENCE {
    s-NonIntraSearch                   ReselectionThreshold          OPTIONAL,    -- Need OP
    threshServingLow                   ReselectionThreshold,
    cellReselectionPriority             CellReselectionPriority
},
intraFreqCellReselectionInfo         SEQUENCE {
    q-RxLevMin                         Q-RxLevMin,
    p-Max                              P-Max                        OPTIONAL,    -- Need OP
    s-IntraSearch                       ReselectionThreshold          OPTIONAL,    -- Need OP
    allowedMeasBandwidth                AllowedMeasBandwidth          OPTIONAL,    -- Need OP
    presenceAntennaPort1               PresenceAntennaPort1,
    neighCellConfig                    NeighCellConfig,
    t-ReselectionEUTRA                 T-Reselection,
    t-ReselectionEUTRA-SF             SpeedStateScaleFactors        OPTIONAL,    -- Need OP
},
...,
lateNonCriticalExtension              OCTET STRING (CONTAINING SystemInformationBlockType3-
v10j0-IEs) OPTIONAL,
[[ s-IntraSearch-v920                 SEQUENCE {
    s-IntraSearchP-r9                 ReselectionThreshold,
    s-IntraSearchQ-r9                 ReselectionThresholdQ-r9
}
    s-NonIntraSearch-v920             SEQUENCE {
    s-NonIntraSearchP-r9              ReselectionThreshold,
    s-NonIntraSearchQ-r9              ReselectionThresholdQ-r9
}
    q-QualMin-r9                      Q-QualMin-r9                 OPTIONAL,    -- Need OP
    threshServingLowQ-r9              ReselectionThresholdQ-r9     OPTIONAL,    -- Need OP
]],
[[ q-QualMinWB-r11                   Q-QualMin-r9                 OPTIONAL,    -- Cond WB-RSRQ
]],
[[ q-QualMinRSRQ-OnAllSymbols-r12     Q-QualMin-r9                 OPTIONAL,    --
Cond RSRQ
]]
}

-- Late non critical extensions
SystemInformationBlockType3-v10j0-IEs ::= SEQUENCE {
    freqBandInfo-r10                  NS-PmaxList-r10              OPTIONAL,    -- Need OR
    multiBandInfoList-v10j0          MultiBandInfoList-v10j0     OPTIONAL,    -- Need OR
    nonCriticalExtension              SystemInformationBlockType3-v10j0-IEs OPTIONAL
}

SystemInformationBlockType3-v1010-IEs ::= SEQUENCE {
    freqBandInfo-v1010                NS-PmaxList-v1010           OPTIONAL,    -- Need OR
    multiBandInfoList-v1010          MultiBandInfoList-v1010     OPTIONAL,    -- Need OR
    nonCriticalExtension              SEQUENCE {                  OPTIONAL
}

-- ASN1STOP

```

SystemInformationBlockType3 field descriptions
<p>allowedMeasBandwidth If absent, the value corresponding to the downlink bandwidth indicated by the <i>dl-Bandwidth</i> included in <i>MasterInformationBlock</i> applies.</p>
<p>cellReselectionInfoCommon Cell re-selection information common for cells.</p>
<p>cellReselectionServingFreqInfo Information common for Cell re-selection to inter-frequency and inter-RAT cells.</p>
<p>freqBandInfo A list of <i>additionalPmax</i> and <i>additionalSpectrumEmission</i> values as defined in TS 36.101 [42, table 6.2.4-1] applicable for the intra-frequency neighbouring E-UTRA cells if the UE selects the frequency band from <i>freqBandIndicator</i> in <i>SystemInformationBlockType1</i>. If E-UTRAN includes <i>freqBandInfo-v1010</i> it includes the same number of entries, and listed in the same order, as in <i>freqBandInfo-r10</i>.</p>
<p>intraFreqcellReselectionInfo Cell re-selection information common for intra-frequency cells.</p>
<p>multiBandInfoList-v10j0 A list of <i>additionalPmax</i> and <i>additionalSpectrumEmission</i> values as defined in TS 36.101 [42, table 6.2.4-1] applicable for the intra-frequency neighbouring E-UTRA cells if the UE selects the frequency bands in <i>multiBandInfoList</i> (i.e. without suffix) or <i>multiBandInfoList-v9e0</i>. If E-UTRAN includes <i>multiBandInfoList-v10j0</i>, it includes the same number of entries, and listed in the same order, as in <i>multiBandInfoList</i> (i.e. without suffix). If E-UTRAN includes <i>multiBandInfoList-v1010</i> it includes the same number of entries, and listed in the same order, as in <i>multiBandInfoList-v10j0</i>.</p>
<p>p-Max Value applicable for the intra-frequency neighbouring E-UTRA cells. If absent the UE applies the maximum power according to the UE capability.</p>
<p>q-Hyst Parameter Q_{hyst} in 36.304 [4], Value in dB. Value dB1 corresponds to 1 dB, dB2 corresponds to 2 dB and so on.</p>
<p>q-HystSF Parameter "Speed dependent ScalingFactor for Q_{hyst}" in TS 36.304 [4]. The sf-Medium and sf-High concern the additional hysteresis to be applied, in Medium and High Mobility state respectively, to Q_{hyst} as defined in TS 36.304 [4]. In dB. Value dB-6 corresponds to -6dB, dB-4 corresponds to -4dB and so on.</p>
<p>q-QualMin Parameter "$Q_{qualmin}$" in TS 36.304 [4], applicable for intra-frequency neighbour cells. If the field is not present, the UE applies the (default) value of negative infinity for $Q_{qualmin}$. NOTE 1.</p>
<p>q-QualMinRSRQ-OnAllSymbols If this field is present and supported by the UE, the UE shall, when performing RSRQ measurements, perform RSRQ measurement on all OFDM symbols in accordance with TS 36.214 [48]. NOTE 1.</p>
<p>q-QualMinWB If this field is present and supported by the UE, the UE shall, when performing RSRQ measurements, use a wider bandwidth in accordance with TS 36.133 [16]. NOTE 1.</p>
<p>q-RxLevMin Parameter "$Q_{rxlevmin}$" in TS 36.304 [4], applicable for intra-frequency neighbour cells.</p>
<p>s-IntraSearch Parameter "$S_{intraSearchP}$" in TS 36.304 [4]. If the field <i>s-IntraSearchP</i> is present, the UE applies the value of <i>s-IntraSearchP</i> instead. Otherwise if neither <i>s-IntraSearch</i> nor <i>s-IntraSearchP</i> is present, the UE applies the (default) value of infinity for $S_{intraSearchP}$.</p>
<p>s-IntraSearchP Parameter "$S_{intraSearchP}$" in TS 36.304 [4]. See descriptions under <i>s-IntraSearch</i>.</p>
<p>s-IntraSearchQ Parameter "$S_{intraSearchQ}$" in TS 36.304 [4]. If the field is not present, the UE applies the (default) value of 0 dB for $S_{intraSearchQ}$.</p>
<p>s-NonIntraSearch Parameter "$S_{nonIntraSearchP}$" in TS 36.304 [4]. If the field <i>s-NonIntraSearchP</i> is present, the UE applies the value of <i>s-NonIntraSearchP</i> instead. Otherwise if neither <i>s-NonIntraSearch</i> nor <i>s-NonIntraSearchP</i> is present, the UE applies the (default) value of infinity for $S_{nonIntraSearchP}$.</p>
<p>s-NonIntraSearchP Parameter "$S_{nonIntraSearchP}$" in TS 36.304 [4]. See descriptions under <i>s-NonIntraSearch</i>.</p>
<p>s-NonIntraSearchQ Parameter "$S_{nonIntraSearchQ}$" in TS 36.304 [4]. If the field is not present, the UE applies the (default) value of 0 dB for $S_{nonIntraSearchQ}$.</p>
<p>speedStateReselectionPars Speed dependent reselection parameters, see TS 36.304 [4]. If this field is absent, i.e. <i>mobilityStateParameters</i> is also not present, UE behaviour is specified in TS 36.304 [4].</p>
<p>threshServingLow Parameter "$Thresh_{Serving, LowP}$" in TS 36.304 [4].</p>
<p>threshServingLowQ Parameter "$Thresh_{Serving, LowQ}$" in TS 36.304 [4].</p>

SystemInformationBlockType3 field descriptions
t-ReselectionEUTRA Parameter "Treseselection _{EUTRA} " in TS 36.304 [4].
t-ReselectionEUTRA-SF Parameter "Speed dependent ScalingFactor for Treseselection _{EUTRA} " in TS 36.304 [4]. If the field is not present, the UE behaviour is specified in TS 36.304 [4].

NOTE 1: The value the UE applies for parameter " $Q_{qualmin}$ " in TS 36.304 [4] depends on the q -QualMin fields signalled by E-UTRAN and supported by the UE. In case multiple candidate options are available, the UE shall select the highest priority candidate option according to the priority order indicated by the following table (top row is highest priority).

q-QualMinRSRQ-OnAllSymbols	q-QualMinWB	Value of parameter "$Q_{qualmin}$" in TS 36.304 [4]
Included	Included	q -QualMinRSRQ-OnAllSymbols – (q -QualMin – q -QualMinWB)
Included	Not included	q -QualMinRSRQ-OnAllSymbols
Not included	Included	q -QualMinWB
Not included	Not included	q -QualMin

Conditional presence	Explanation
RSRQ	The field is optionally present, Need OR, if <i>threshServingLowQ</i> is present in SIB3; otherwise it is not present.
WB-RSRQ	The field is optionally present, need OP if the measurement bandwidth indicated by <i>allowedMeasBandwidth</i> is 50 resource blocks or larger; otherwise it is not present.

SystemInformationBlockType4

The IE *SystemInformationBlockType4* contains neighbouring cell related information relevant only for intra-frequency cell re-selection. The IE includes cells with specific re-selection parameters as well as blacklisted cells.

SystemInformationBlockType4 information element

```
-- ASN1START
SystemInformationBlockType4 ::= SEQUENCE {
    intraFreqNeighCellList      IntraFreqNeighCellList      OPTIONAL, -- Need OR
    intraFreqBlackCellList     IntraFreqBlackCellList     OPTIONAL, -- Need OR
    csg-PhysCellIdRange        PhysCellIdRange           OPTIONAL, -- Cond CSG
    ...,
    lateNonCriticalExtension    OCTET STRING              OPTIONAL
}
IntraFreqNeighCellList ::= SEQUENCE (SIZE (1..maxCellIntra)) OF IntraFreqNeighCellInfo
IntraFreqNeighCellInfo ::= SEQUENCE {
    physCellId                 PhysCellId,
    q-OffsetCell                Q-OffsetRange,
    ...
}
IntraFreqBlackCellList ::= SEQUENCE (SIZE (1..maxCellBlack)) OF PhysCellIdRange
-- ASN1STOP
```

SystemInformationBlockType4 field descriptions
<p>csg-PhysCellIdRange Set of physical cell identities reserved for CSG cells on the frequency on which this field was received. The received <i>csg-PhysCellIdRange</i> applies if less than 24 hours has elapsed since it was received and the UE is camped on a cell of the same primary PLMN where this field was received. The 3 hour validity restriction (section 5.2.1.3) does not apply to this field. The UE shall not apply any stored <i>csg-PhysCellIdRange</i> when it is in <i>any cell selection</i> state defined in TS 36.304 [4].</p>
<p>intraFreqBlackCellList List of blacklisted intra-frequency neighbouring cells.</p>
<p>intraFreqNeighbCellList List of intra-frequency neighbouring cells with specific cell re-selection parameters.</p>
<p>q-OffsetCell Parameter "Qoffset_{s,n}" in TS 36.304 [4].</p>

Conditional presence	Explanation
CSG	This field is optional, need OP, for non-CSG cells, and mandatory for CSG cells.

SystemInformationBlockType5

The IE *SystemInformationBlockType5* contains information relevant only for inter-frequency cell re-selection i.e. information about other E-UTRA frequencies and inter-frequency neighbouring cells relevant for cell re-selection. The IE includes cell re-selection parameters common for a frequency as well as cell specific re-selection parameters.

SystemInformationBlockType5 information element

```

-- ASN1START
SystemInformationBlockType5 ::= SEQUENCE {
    interFreqCarrierFreqList      InterFreqCarrierFreqList,
    . . . ,
    lateNonCriticalExtension      OCTET STRING      (CONTAINING SystemInformationBlockType5-
v8h0-IEs)                        OPTIONAL,
    [[ interFreqCarrierFreqList-v1250 InterFreqCarrierFreqList-v1250      OPTIONAL, -- Need OR
    interFreqCarrierFreqListExt-r12 InterFreqCarrierFreqListExt-r12      OPTIONAL -- Need OR
    ]],
    [[ interFreqCarrierFreqListExt-v1280 InterFreqCarrierFreqListExt-v1280  OPTIONAL -- Need
OR
    ]]
}

SystemInformationBlockType5-v8h0-IEs ::= SEQUENCE {
    interFreqCarrierFreqList-v8h0 SEQUENCE (SIZE (1..maxFreq)) OF InterFreqCarrierFreqInfo-v8h0
    OPTIONAL, -- Need OP
    nonCriticalExtension          SystemInformationBlockType5-v9e0-IEs
    OPTIONAL
}

SystemInformationBlockType5-v9e0-IEs ::= SEQUENCE {
    interFreqCarrierFreqList-v9e0 SEQUENCE (SIZE (1..maxFreq)) OF InterFreqCarrierFreqInfo-v9e0
    OPTIONAL, -- Need OR
    nonCriticalExtension          SystemInformationBlockType5-v10j0-IEs  OPTIONAL
}

SystemInformationBlockType5-v10j0-IEs ::= SEQUENCE {
    interFreqCarrierFreqList-v10j0 SEQUENCE (SIZE (1..maxFreq)) OF InterFreqCarrierFreqInfo-v10j0
    OPTIONAL, -- Need OR
    nonCriticalExtension          SystemInformationBlockType5-v10l0-IEs
    OPTIONAL
}

SystemInformationBlockType5-v10l0-IEs ::= SEQUENCE {
    interFreqCarrierFreqList-v10l0 SEQUENCE (SIZE (1..maxFreq)) OF InterFreqCarrierFreqInfo-v10l0
    OPTIONAL, -- Need OR
    nonCriticalExtension          SEQUENCE { }                        OPTIONAL
}

InterFreqCarrierFreqList ::= SEQUENCE (SIZE (1..maxFreq)) OF InterFreqCarrierFreqInfo
InterFreqCarrierFreqList-v1250 ::= SEQUENCE (SIZE (1.. maxFreq)) OF InterFreqCarrierFreqInfo-v1250
InterFreqCarrierFreqListExt-r12 ::= SEQUENCE (SIZE (1.. maxFreq)) OF InterFreqCarrierFreqInfo-r12

```

```

InterFreqCarrierFreqListExt-v1280 ::= SEQUENCE (SIZE (1.. maxFreq)) OF InterFreqCarrierFreqInfo-
v10j0

InterFreqCarrierFreqInfo ::= SEQUENCE {
  dl-CarrierFreq          ARFCN-ValueEUTRA,
  q-RxLevMin             Q-RxLevMin,
  p-Max                  P-Max                      OPTIONAL,      -- Need OP
  t-ReselectionEUTRA     T-Reselection,
  t-ReselectionEUTRA-SF SpeedStateScaleFactors  OPTIONAL,      -- Need OP
  threshX-High           ReselectionThreshold,
  threshX-Low            ReselectionThreshold,
  allowedMeasBandwidth   AllowedMeasBandwidth,
  presenceAntennaPort1   PresenceAntennaPort1,
  cellReselectionPriority CellReselectionPriority  OPTIONAL,      -- Need OP
  neighCellConfig        NeighCellConfig,
  q-OffsetFreq           Q-OffsetRange          DEFAULT dB0,
  interFreqNeighCellList InterFreqNeighCellList  OPTIONAL,      -- Need OR
  interFreqBlackCellList InterFreqBlackCellList  OPTIONAL,      -- Need OR
  ...,
  [[ q-QualMin-r9         Q-QualMin-r9          OPTIONAL,      -- Need OP
    threshX-Q-r9         SEQUENCE {
      threshX-HighQ-r9   ReselectionThresholdQ-r9,
      threshX-LowQ-r9    ReselectionThresholdQ-r9
    }
  ]],
  [[ q-QualMinWB-r11     Q-QualMin-r9          OPTIONAL      -- Cond WB-RSRQ
  ]]
}

InterFreqCarrierFreqInfo-v8h0 ::= SEQUENCE {
  multiBandInfoList      MultiBandInfoList          OPTIONAL      -- Need OR
}

InterFreqCarrierFreqInfo-v9e0 ::= SEQUENCE {
  dl-CarrierFreq-v9e0    ARFCN-ValueEUTRA-v9e0  OPTIONAL,      -- Cond dl-FreqMax
  multiBandInfoList-v9e0 MultiBandInfoList-v9e0  OPTIONAL      -- Need OR
}

InterFreqCarrierFreqInfo-v10j0 ::= SEQUENCE {
  freqBandInfo-r10       NS-PmaxList-r10          OPTIONAL,      -- Need OR
  multiBandInfoList-v10j0 MultiBandInfoList-v10j0  OPTIONAL      -- Need OR
}

InterFreqCarrierFreqInfo-v10l0 ::= SEQUENCE {
  freqBandInfo-v10l0     NS-PmaxList-v10l0          OPTIONAL,      -- Need OR
  multiBandInfoList-v10l0 MultiBandInfoList-v10l0  OPTIONAL      -- Need OR
}

InterFreqCarrierFreqInfo-v1250 ::= SEQUENCE {
  reducedMeasPerformance-r12 ENUMERATED {true}    OPTIONAL,      -- Need OP
  q-QualMinRSRQ-OnAllSymbols-r12 Q-QualMin-r9          OPTIONAL      -- Cond RSRQ2
}

InterFreqCarrierFreqInfo-r12 ::= SEQUENCE {
  dl-CarrierFreq-r12     ARFCN-ValueEUTRA-r9,
  q-RxLevMin-r12         Q-RxLevMin,
  p-Max-r12              P-Max                      OPTIONAL,      -- Need OP
  t-ReselectionEUTRA-r12 T-Reselection,
  t-ReselectionEUTRA-SF-r12 SpeedStateScaleFactors  OPTIONAL,      -- Need OP
  threshX-High-r12       ReselectionThreshold,
  threshX-Low-r12        ReselectionThreshold,
  allowedMeasBandwidth-r12 AllowedMeasBandwidth,
  presenceAntennaPort1-r12 PresenceAntennaPort1,
  cellReselectionPriority-r12 CellReselectionPriority  OPTIONAL,      -- Need OP
  neighCellConfig-r12    NeighCellConfig,
  q-OffsetFreq-r12       Q-OffsetRange          DEFAULT dB0,
  interFreqNeighCellList-r12 InterFreqNeighCellList  OPTIONAL,      -- Need OR
  interFreqBlackCellList-r12 InterFreqBlackCellList  OPTIONAL,      -- Need OR
  q-QualMin-r12          Q-QualMin-r9          OPTIONAL,      -- Need OP
  threshX-Q-r12         SEQUENCE {
    threshX-HighQ-r12    ReselectionThresholdQ-r9,
    threshX-LowQ-r12     ReselectionThresholdQ-r9
  }
  ]],
  q-QualMinWB-r12       Q-QualMin-r9          OPTIONAL,      -- Cond WB-RSRQ
  multiBandInfoList-r12 MultiBandInfoList-r11  OPTIONAL,      -- Need OR
  reducedMeasPerformance-r12 ENUMERATED {true}    OPTIONAL,      -- Need OP
  q-QualMinRSRQ-OnAllSymbols-r12 Q-QualMin-r9          OPTIONAL,      -- Cond RSRQ2
  ...
}

```

```
}  
InterFreqNeighCellList ::= SEQUENCE (SIZE (1..maxCellInter)) OF InterFreqNeighCellInfo  
InterFreqNeighCellInfo ::= SEQUENCE {  
    physCellId PhysCellId,  
    q-OffsetCell Q-OffsetRange  
}  
InterFreqBlackCellList ::= SEQUENCE (SIZE (1..maxCellBlack)) OF PhysCellIdRange  
-- ASN1STOP
```

SystemInformationBlockType5 field descriptions
<p>freqBandInfo A list of <i>additionalPmax</i> and <i>additionalSpectrumEmission</i> values as defined in TS 36.101 [42, table 6.2.4-1] for the frequency band represented by <i>dl-CarrierFreq</i> for which cell reselection parameters are common. If E-UTRAN includes <i>freqBandInfo-v10I0</i> it includes the same number of entries, and listed in the same order, as in <i>freqBandInfo-r10</i>.</p>
<p>interFreqBlackCellList List of blacklisted inter-frequency neighbouring cells.</p>
<p>interFreqCarrierFreqList List of neighbouring inter-frequencies. E-UTRAN does not configure more than one entry for the same physical frequency regardless of the E-ARFCN used to indicate this. If E-UTRAN includes <i>interFreqCarrierFreqList-v8h0</i>, <i>interFreqCarrierFreqList-v9e0</i> and/or <i>InterFreqCarrierFreqList-v1250</i>, it includes the same number of entries, and listed in the same order, as in <i>interFreqCarrierFreqList</i> (i.e. without suffix). See Annex D for more descriptions.</p>
<p>interFreqCarrierFreqListExt List of additional neighbouring inter-frequencies, i.e. extending the size of the inter-frequency carrier list using the general principles specified in 5.1.2. E-UTRAN does not configure more than one entry for the same physical frequency regardless of the E-ARFCN used to indicate this. E-UTRAN may include <i>interFreqCarrierFreqListExt</i> even if <i>interFreqCarrierFreqList</i> (i.e. without suffix) does not include <i>maxFreq</i> entries.</p>
<p>interFreqNeighCellList List of inter-frequency neighbouring cells with specific cell re-selection parameters.</p>
<p>multiBandInfoList Indicates the list of frequency bands in addition to the band represented by <i>dl-CarrierFreq</i> for which cell reselection parameters are common. E-UTRAN indicates at most <i>maxMultiBands</i> frequency bands (i.e. the total number of entries across both <i>multiBandInfoList</i> and <i>multiBandInfoList-v9e0</i> is below this limit).</p>
<p>multiBandInfoList-v10j0 A list of <i>additionalPmax</i> and <i>additionalSpectrumEmission</i> values as defined in TS 36.101 [42, table 6.2.4-1] for the frequency bands in <i>multiBandInfoList</i> (i.e. without suffix) and <i>multiBandInfoList-v9e0</i>. If E-UTRAN includes <i>multiBandInfoList-v10j0</i>, it includes the same number of entries, and listed in the same order, as in <i>multiBandInfoList</i> (i.e. without suffix). If E-UTRAN includes <i>multiBandInfoList-v10I0</i> it includes the same number of entries, and listed in the same order, as in <i>multiBandInfoList-v10j0</i>.</p>
<p>p-Max Value applicable for the neighbouring E-UTRA cells on this carrier frequency. If absent the UE applies the maximum power according to the UE capability.</p>
<p>q-OffsetCell Parameter "Qoffset_{s,n}" in TS 36.304 [4].</p>
<p>q-OffsetFreq Parameter "Qoffset_{frequency}" in TS 36.304 [4].</p>
<p>q-QualMin Parameter "Q_{qualmin}" in TS 36.304 [4]. If the field is not present, the UE applies the (default) value of negative infinity for Q_{qualmin}. NOTE 1.</p>
<p>q-QualMinRSRQ-OnAllSymbols If this field is present and supported by the UE, the UE shall, when performing RSRQ measurements, perform RSRQ measurement on all OFDM symbols in accordance with TS 36.214 [48]. NOTE 1.</p>
<p>q-QualMinWB If this field is present and supported by the UE, the UE shall, when performing RSRQ measurements, use a wider bandwidth in accordance with TS 36.133 [16]. NOTE 1.</p>
<p>reducedMeasPerformance Value <i>TRUE</i> indicates that the neighbouring inter-frequency is configured for reduced measurement performance, see TS 36.133 [16]. If the field is not included, the neighbouring inter-frequency is configured for normal measurement performance, see TS 36.133 [16].</p>
<p>threshX-High Parameter "Thresh_{X, HighP}" in TS 36.304 [4].</p>
<p>threshX-HighQ Parameter "Thresh_{X, HighQ}" in TS 36.304 [4].</p>
<p>threshX-Low Parameter "Thresh_{X, LowP}" in TS 36.304 [4].</p>
<p>threshX-LowQ Parameter "Thresh_{X, LowQ}" in TS 36.304 [4].</p>
<p>t-ReselectionEUTRA Parameter "T_{reselectionEUTRA}" in TS 36.304 [4].</p>
<p>t-ReselectionEUTRA-SF Parameter "Speed dependent ScalingFactor for T_{reselectionEUTRA}" in TS 36.304 [4]. If the field is not present, the UE behaviour is specified in TS 36.304 [4].</p>

NOTE 1: The value the UE applies for parameter " Q_{qualmin} " in TS 36.304 [4] depends on the $q\text{-QualMin}$ fields signalled by E-UTRAN and supported by the UE. In case multiple candidate options are available, the UE shall select the highest priority candidate option according to the priority order indicated by the following table (top row is highest priority).

q-QualMinRSRQ-OnAllSymbols	q-QualMinWB	Value of parameter " Q_{qualmin} " in TS 36.304 [4]
Included	Included	$q\text{-QualMinRSRQ-OnAllSymbols} - (q\text{-QualMin} - q\text{-QualMinWB})$
Included	Not included	$q\text{-QualMinRSRQ-OnAllSymbols}$
Not included	Included	$q\text{-QualMinWB}$
Not included	Not included	$q\text{-QualMin}$

Conditional presence	Explanation
<i>dl-FreqMax</i>	The field is mandatory present if, for the corresponding entry in <i>InterFreqCarrierFreqList</i> (i.e. without suffix), <i>dl-CarrierFreq</i> (i.e. without suffix) is set to <i>maxEARFCN</i> . Otherwise the field is not present.
<i>RSRQ</i>	The field is mandatory present if <i>threshServingLowQ</i> is present in <i>systemInformationBlockType3</i> ; otherwise it is not present.
<i>RSRQ2</i>	The field is mandatory present for all EUTRA carriers listed in SIB5 if <i>q-QualMinRSRQ-OnAllSymbols</i> is present in SIB3; otherwise it is not present and the UE shall delete any existing value for this field.
<i>WB-RSRQ</i>	The field is optionally present, need OP if the measurement bandwidth indicated by <i>allowedMeasBandwidth</i> is 50 resource blocks or larger; otherwise it is not present.

SystemInformationBlockType6

The IE *SystemInformationBlockType6* contains information relevant only for inter-RAT cell re-selection i.e. information about UTRA frequencies and UTRA neighbouring cells relevant for cell re-selection. The IE includes cell re-selection parameters common for a frequency.

SystemInformationBlockType6 information element

```
-- ASN1START
SystemInformationBlockType6 ::= SEQUENCE {
    carrierFreqListUTRA-FDD      CarrierFreqListUTRA-FDD      OPTIONAL,      -- Need OR
    carrierFreqListUTRA-TDD      CarrierFreqListUTRA-TDD      OPTIONAL,      -- Need OR
    t-ReselectionUTRA            T-Reselection,
    t-ReselectionUTRA-SF         SpeedStateScaleFactors      OPTIONAL,      -- Need OP
    . . .
    lateNonCriticalExtension      OCTET STRING      (CONTAINING SystemInformationBlockType6-
v8h0-IEs)                       OPTIONAL,
    [[ carrierFreqListUTRA-FDD-v1250 SEQUENCE (SIZE (1..maxUTRA-FDD-Carrier)) OF
        CarrierFreqInfoUTRA-v1250      OPTIONAL,      -- Cond UTRA-FDD
        carrierFreqListUTRA-TDD-v1250 SEQUENCE (SIZE (1..maxUTRA-TDD-Carrier)) OF
        CarrierFreqInfoUTRA-v1250      OPTIONAL,      -- Cond UTRA-TDD
        carrierFreqListUTRA-FDD-Ext-r12 CarrierFreqListUTRA-FDD-Ext-r12 OPTIONAL,      -- Cond UTRA-FDD
        carrierFreqListUTRA-TDD-Ext-r12 CarrierFreqListUTRA-TDD-Ext-r12 OPTIONAL      -- Cond
UTRA-TDD
    ]]
}

SystemInformationBlockType6-v8h0-IEs ::= SEQUENCE {
    carrierFreqListUTRA-FDD-v8h0 SEQUENCE (SIZE (1..maxUTRA-FDD-Carrier)) OF CarrierFreqInfoUTRA-
FDD-v8h0 OPTIONAL,      -- Cond UTRA-FDD
    nonCriticalExtension
SEQUENCE {}              OPTIONAL
}

CarrierFreqInfoUTRA-v1250 ::= SEQUENCE {
    reducedMeasPerformance-r12      ENUMERATED {true}      OPTIONAL      -- Need OP
}

CarrierFreqListUTRA-FDD ::= SEQUENCE (SIZE (1..maxUTRA-FDD-Carrier)) OF CarrierFreqUTRA-FDD

CarrierFreqUTRA-FDD ::= SEQUENCE {
    carrierFreq      ARFCN-ValueUTRA,
    cellReselectionPriority      CellReselectionPriority      OPTIONAL,      -- Need OP
    threshX-High      ReselectionThreshold,
    threshX-Low      ReselectionThreshold,
}
```



```

q-RxLevMin          INTEGER (-60..-13),
p-MaxUTRA           INTEGER (-50..33),
q-QualMin           INTEGER (-24..0),
...
[[ threshX-Q-r9      SEQUENCE {
    threshX-HighQ-r9  ReselectionThresholdQ-r9,
    threshX-LowQ-r9   ReselectionThresholdQ-r9
  }
]]
}
}
}
CarrierFreqInfoUTRA-FDD-v8h0 ::= SEQUENCE {
  multiBandInfoList SEQUENCE (SIZE (1..maxMultiBands)) OF FreqBandIndicator-
UTRA-FDD            OPTIONAL -- Need OR
}

CarrierFreqListUTRA-FDD-Ext-r12 ::= SEQUENCE (SIZE (1..maxUTRA-FDD-Carrier)) OF
CarrierFreqUTRA-FDD-Ext-r12

CarrierFreqUTRA-FDD-Ext-r12 ::= SEQUENCE {
  carrierFreq-r12      ARFCN-ValueUTRA,
  cellReselectionPriority-r12 CellReselectionPriority OPTIONAL, -- Need OP
  threshX-High-r12    ReselectionThreshold,
  threshX-Low-r12     ReselectionThreshold,
  q-RxLevMin-r12      INTEGER (-60..-13),
  p-MaxUTRA-r12       INTEGER (-50..33),
  q-QualMin-r12       INTEGER (-24..0),
  threshX-Q-r12       SEQUENCE {
    threshX-HighQ-r12  ReselectionThresholdQ-r9,
    threshX-LowQ-r12   ReselectionThresholdQ-r9
  }
}
multiBandInfoList-r12 SEQUENCE (SIZE (1..maxMultiBands)) OF FreqBandIndicator-
UTRA-FDD              OPTIONAL, -- Need OR
reducedMeasPerformance-r12 ENUMERATED {true} OPTIONAL, -- Need OP
...
}

CarrierFreqListUTRA-TDD ::= SEQUENCE (SIZE (1..maxUTRA-TDD-Carrier)) OF CarrierFreqUTRA-TDD

CarrierFreqUTRA-TDD ::= SEQUENCE {
  carrierFreq      ARFCN-ValueUTRA,
  cellReselectionPriority-r12 CellReselectionPriority OPTIONAL, -- Need OP
  threshX-High     ReselectionThreshold,
  threshX-Low      ReselectionThreshold,
  q-RxLevMin       INTEGER (-60..-13),
  p-MaxUTRA        INTEGER (-50..33),
  ...
}

CarrierFreqListUTRA-TDD-Ext-r12 ::= SEQUENCE (SIZE (1..maxUTRA-TDD-Carrier)) OF
CarrierFreqUTRA-TDD-r12

CarrierFreqUTRA-TDD-r12 ::= SEQUENCE {
  carrierFreq-r12      ARFCN-ValueUTRA,
  cellReselectionPriority-r12 CellReselectionPriority OPTIONAL, -- Need OP
  threshX-High-r12    ReselectionThreshold,
  threshX-Low-r12     ReselectionThreshold,
  q-RxLevMin-r12      INTEGER (-60..-13),
  p-MaxUTRA-r12       INTEGER (-50..33),
  reducedMeasPerformance-r12 ENUMERATED {true} OPTIONAL, -- Need OP
  ...
}

FreqBandIndicator-UTRA-FDD ::= INTEGER (1..86)

-- ASN1STOP

```

SystemInformationBlockType6 field descriptions	
carrierFreqListUTRA-FDD	List of carrier frequencies of UTRA FDD. E-UTRAN does not configure more than one entry for the same physical frequency regardless of the ARFCN used to indicate this. If E-UTRAN includes <i>carrierFreqListUTRA-FDD-v8h0</i> and/or <i>carrierFreqListUTRA-FDD-v1250</i> , it includes the same number of entries, and listed in the same order, as in <i>carrierFreqListUTRA-FDD</i> (i.e. without suffix). See Annex D for more descriptions.
carrierFreqListUTRA-FDD-Ext	List of additional carrier frequencies of UTRA FDD. E-UTRAN does not configure more than one entry for the same physical frequency regardless of the ARFCN used to indicate this. EUTRAN may include <i>carrierFreqListUTRA-FDD-Ext</i> even if <i>carrierFreqListUTRA-FDD</i> (i.e without suffix) does not include <i>maxUTRA-FDD-Carrier</i> entries.
carrierFreqListUTRA-TDD	List of carrier frequencies of UTRA TDD. E-UTRAN does not configure more than one entry for the same physical frequency regardless of the ARFCN used to indicate this. If E-UTRAN includes <i>carrierFreqListUTRA-TDD-v1250</i> , it includes the same number of entries, and listed in the same order, as in <i>carrierFreqListUTRA-TDD</i> (i.e. without suffix).
carrierFreqListUTRA-TDD-Ext	List of additional carrier frequencies of UTRA TDD. E-UTRAN does not configure more than one entry for the same physical frequency regardless of the ARFCN used to indicate this. EUTRAN may include <i>carrierFreqListUTRA-TDD-Ext</i> even if <i>carrierFreqListUTRA-TDD</i> (i.e without suffix) does not include <i>maxUTRA-TDD-Carrier</i> entries.
multiBandInfoList	Indicates the list of frequency bands in addition to the band represented by <i>carrierFreq</i> in the <i>CarrierFreqUTRA-FDD</i> for which UTRA cell reselection parameters are common.
p-MaxUTRA	The maximum allowed transmission power on the (uplink) carrier frequency, see TS 25.304 [40]. In dBm
q-QualMin	Parameter "Q _{qualmin} " in TS 25.304 [40]. Actual value = IE value [dB].
q-RxLevMin	Parameter "Q _{rxlevmin} " in TS 25.304 [40]. Actual value = IE value * 2+1 [dBm].
reducedMeasPerformance	Value <i>TRUE</i> indicates that the UTRA carrier frequency is configured for reduced measurement performance, see TS 36.133 [16]. If the field is not included, the UTRA carrier frequency is configured for normal measurement performance, see TS 36.133 [16].
t-ReselectionUTRA	Parameter "T _{reselctionUTRAN} " in TS 36.304 [4].
t-ReselectionUTRA-SF	Parameter "Speed dependent ScalingFactor for T _{reselctionUTRA} " in TS 36.304 [4]. If the field is not present, the UE behaviour is specified in TS 36.304 [4].
threshX-High	Parameter "Thresh _{X, HighP} " in TS 36.304 [4].
threshX-HighQ	Parameter "Thresh _{X, HighQ} " in TS 36.304 [4].
threshX-Low	Parameter "Thresh _{X, LowP} " in TS 36.304 [4].
threshX-LowQ	Parameter "Thresh _{X, LowQ} " in TS 36.304 [4].

Conditional presence	Explanation
RSRQ	The field is mandatory present if the <i>threshServingLowQ</i> is present in <i>systemInformationBlockType3</i> , otherwise it is not present.
UTRA-FDD	The field is optionally present, need OR, if the <i>carrierFreqListUTRA-FDD</i> is present. Otherwise it is not present.
UTRA-TDD	The field is optionally present, need OR, if the <i>carrierFreqListUTRA-TDD</i> is present. Otherwise it is not present.

– SystemInformationBlockType7

The IE *SystemInformationBlockType7* contains information relevant only for inter-RAT cell re-selection i.e. information about GERAN frequencies relevant for cell re-selection. The IE includes cell re-selection parameters for each frequency.

SystemInformationBlockType7 information element

```
-- ASN1START
SystemInformationBlockType7 ::= SEQUENCE {
    t-ReselectionGERAN          T-Reselection,
    t-ReselectionGERAN-SF      SpeedStateScaleFactors          OPTIONAL, -- Need OR
}
```

```

carrierFreqsInfoList          CarrierFreqsInfoListGERAN          OPTIONAL,  -- Need OR
...
lateNonCriticalExtension      OCTET STRING                OPTIONAL
}

CarrierFreqsInfoListGERAN ::=          SEQUENCE (SIZE (1..maxGNFG)) OF CarrierFreqsInfoGERAN

CarrierFreqsInfoGERAN ::=          SEQUENCE {
  carrierFreqs                CarrierFreqsGERAN,
  commonInfo                   SEQUENCE {
    cellReselectionPriority    CellReselectionPriority          OPTIONAL,  -- Need OP
    ncc-Permitted              BIT STRING (SIZE (8)),
    q-RxLevMin                 INTEGER (0..45),
    p-MaxGERAN                 INTEGER (0..39)                  OPTIONAL,  -- Need OP
    threshX-High               ReselectionThreshold,
    threshX-Low                ReselectionThreshold
  },
  ...
}
-- ASN1STOP

```

SystemInformationBlockType7 field descriptions

carrierFreqs	The list of GERAN carrier frequencies organised into one group of GERAN carrier frequencies.
carrierFreqsInfoList	Provides a list of neighbouring GERAN carrier frequencies, which may be monitored for neighbouring GERAN cells. The GERAN carrier frequencies are organised in groups and the cell reselection parameters are provided per group of GERAN carrier frequencies.
commonInfo	Defines the set of cell reselection parameters for the group of GERAN carrier frequencies.
ncc-Permitted	Field encoded as a bit map, where bit N is set to "0" if a BCCH carrier with NCC = N-1 is not permitted for monitoring and set to "1" if the BCCH carrier with NCC = N-1 is permitted for monitoring; N = 1 to 8; bit 1 of the bitmap is the leading bit of the bit string.
p-MaxGERAN	Maximum allowed transmission power for GERAN on an uplink carrier frequency, see TS 45.008 [28]. Value in dBm. Applicable for the neighbouring GERAN cells on this carrier frequency. If <i>pmaxGERAN</i> is absent, the maximum power according to the UE capability is used.
q-RxLevMin	Parameter " $Q_{rxlevmin}$ " in TS 36.304 [1], minimum required RX level in the GSM cell. The actual value of $Q_{rxlevmin}$ in dBm = (IE value * 2) - 115.
threshX-High	Parameter " $Thresh_{X, HighP}$ " in TS 36.304 [4].
threshX-Low	Parameter " $Thresh_{X, LowP}$ " in TS 36.304 [4].
t-ReselectionGERAN	Parameter " $Treselection_{GERAN}$ " in TS 36.304 [4].
t-ReselectionGERAN-SF	Parameter "Speed dependent ScalingFactor for $Treselection_{GERAN}$ " in TS 36.304 [4]. If the field is not present, the UE behaviour is specified in TS 36.304 [4].

SystemInformationBlockType8

The IE *SystemInformationBlockType8* contains information relevant only for inter-RAT cell re-selection i.e. information about CDMA2000 frequencies and CDMA2000 neighbouring cells relevant for cell re-selection. The IE includes cell re-selection parameters common for a frequency as well as cell specific re-selection parameters.

SystemInformationBlockType8 information element

```

-- ASN1START
SystemInformationBlockType8 ::=          SEQUENCE {
  systemTimeInfo              SystemTimeInfoCDMA2000          OPTIONAL,  -- Need OR
  searchWindowSize            INTEGER (0..15)                  OPTIONAL,  -- Need OR
  parametersHRPD              SEQUENCE {
    preRegistrationInfoHRPD    PreRegistrationInfoHRPD,
    cellReselectionParametersHRPD CellReselectionParametersCDMA2000  OPTIONAL -- Need OR
  }
}
-- ASN1STOP

```

```

parameters1XRTT          SEQUENCE {
  csfb-RegistrationParam1XRTT    CSFB-RegistrationParam1XRTT    OPTIONAL, -- Need OP
  longCodeState1XRTT            BIT STRING (SIZE (42))        OPTIONAL, -- Need OR
  cellReselectionParameters1XRTT CellReselectionParametersCDMA2000 OPTIONAL -- Need OR
}
...,
lateNonCriticalExtension      OCTET STRING                OPTIONAL,
[[ csfb-SupportForDualRxUEs-r9  BOOLEAN                    OPTIONAL, -- Need OR
  cellReselectionParametersHRPD-v920 CellReselectionParametersCDMA2000-v920 OPTIONAL, --
Cond NCL-HRPD
  cellReselectionParameters1XRTT-v920 CellReselectionParametersCDMA2000-v920 OPTIONAL, --
Cond NCL-1XRTT
  csfb-RegistrationParam1XRTT-v920    CSFB-RegistrationParam1XRTT-v920    OPTIONAL, --
Cond REG-1XRTT
  ac-BarringConfig1XRTT-r9            AC-BarringConfig1XRTT-r9        OPTIONAL -- Cond REG-
1XRTT
  ]],
[[ csfb-DualRxTxSupport-r10        ENUMERATED {true}              OPTIONAL -- Cond REG-
1XRTT
  ]],
[[ sib8-PerPLMN-List-r11           SIB8-PerPLMN-List-r11         OPTIONAL -- Need OR
  ]]
}

CellReselectionParametersCDMA2000 ::= SEQUENCE {
  bandClassList                BandClassListCDMA2000,
  neighCellList                NeighCellListCDMA2000,
  t-ReselectionCDMA2000        T-Reselection,
  t-ReselectionCDMA2000-SF     SpeedStateScaleFactors        OPTIONAL -- Need OP
}

CellReselectionParametersCDMA2000-r11 ::= SEQUENCE {
  bandClassList                BandClassListCDMA2000,
  neighCellList-r11            SEQUENCE (SIZE (1..16)) OF NeighCellCDMA2000-r11,
  t-ReselectionCDMA2000        T-Reselection,
  t-ReselectionCDMA2000-SF     SpeedStateScaleFactors        OPTIONAL -- Need OP
}

CellReselectionParametersCDMA2000-v920 ::= SEQUENCE {
  neighCellList-v920          NeighCellListCDMA2000-v920
}

NeighCellListCDMA2000 ::= SEQUENCE (SIZE (1..16)) OF NeighCellCDMA2000

NeighCellCDMA2000 ::= SEQUENCE {
  bandClass                    BandclassCDMA2000,
  neighCellsPerFreqList       NeighCellsPerBandclassListCDMA2000
}

NeighCellCDMA2000-r11 ::= SEQUENCE {
  bandClass                    BandclassCDMA2000,
  neighFreqInfoList-r11        SEQUENCE (SIZE (1..16)) OF NeighCellsPerBandclassCDMA2000-
r11
}

NeighCellsPerBandclassListCDMA2000 ::= SEQUENCE (SIZE (1..16)) OF NeighCellsPerBandclassCDMA2000

NeighCellsPerBandclassCDMA2000 ::= SEQUENCE {
  arfcn                        ARFCN-ValueCDMA2000,
  physCellIdList              PhysCellIdListCDMA2000
}

NeighCellsPerBandclassCDMA2000-r11 ::= SEQUENCE {
  arfcn                        ARFCN-ValueCDMA2000,
  physCellIdList-r11          SEQUENCE (SIZE (1..40)) OF PhysCellIdCDMA2000
}

NeighCellListCDMA2000-v920 ::= SEQUENCE (SIZE (1..16)) OF NeighCellCDMA2000-v920

NeighCellCDMA2000-v920 ::= SEQUENCE {
  neighCellsPerFreqList-v920  NeighCellsPerBandclassListCDMA2000-v920
}

NeighCellsPerBandclassListCDMA2000-v920 ::= SEQUENCE (SIZE (1..16)) OF
NeighCellsPerBandclassCDMA2000-v920

NeighCellsPerBandclassCDMA2000-v920 ::= SEQUENCE {
  physCellIdList-v920         PhysCellIdListCDMA2000-v920
}

```

```

}
PhysCellIdListCDMA2000 ::= SEQUENCE (SIZE (1..16)) OF PhysCellIdCDMA2000
PhysCellIdListCDMA2000-v920 ::= SEQUENCE (SIZE (0..24)) OF PhysCellIdCDMA2000
BandClassListCDMA2000 ::= SEQUENCE (SIZE (1..maxCDMA-BandClass)) OF BandClassInfoCDMA2000
BandClassInfoCDMA2000 ::= SEQUENCE {
    bandClass BandclassCDMA2000,
    cellReselectionPriority CellReselectionPriority OPTIONAL, -- Need OP
    threshX-High INTEGER (0..63),
    threshX-Low INTEGER (0..63),
    ...
}
AC-BarringConfig1XRTT-r9 ::= SEQUENCE {
    ac-Barring0to9-r9 INTEGER (0..63),
    ac-Barring10-r9 INTEGER (0..7),
    ac-Barring11-r9 INTEGER (0..7),
    ac-Barring12-r9 INTEGER (0..7),
    ac-Barring13-r9 INTEGER (0..7),
    ac-Barring14-r9 INTEGER (0..7),
    ac-Barring15-r9 INTEGER (0..7),
    ac-BarringMsg-r9 INTEGER (0..7),
    ac-BarringReg-r9 INTEGER (0..7),
    ac-BarringEmg-r9 INTEGER (0..7)
}
SIB8-PerPLMN-List-r11 ::= SEQUENCE (SIZE (1..maxPLMN-r11)) OF SIB8-PerPLMN-r11
SIB8-PerPLMN-r11 ::= SEQUENCE {
    plmn-Identity-r11 INTEGER (1..maxPLMN-r11),
    parametersCDMA2000-r11 CHOICE {
        explicitValue ParametersCDMA2000-r11,
        defaultValue NULL
    }
}
ParametersCDMA2000-r11 ::= SEQUENCE {
    systemTimeInfo-r11 CHOICE {
        explicitValue SystemTimeInfoCDMA2000,
        defaultValue NULL
    } OPTIONAL, -- Need OR
    searchWindowSize-r11 INTEGER (0..15),
    parametersHRPD-r11 SEQUENCE {
        preRegistrationInfoHRPD-r11 PreRegistrationInfoHRPD,
        cellReselectionParametersHRPD-r11 CellReselectionParametersCDMA2000-r11 OPTIONAL -- Need
OR
    } OPTIONAL, -- Need OR
    parameters1XRTT-r11 SEQUENCE {
        csfb-RegistrationParam1XRTT-r11 CSFB-RegistrationParam1XRTT OPTIONAL, -- Need OP
        csfb-RegistrationParam1XRTT-Ext-r11 CSFB-RegistrationParam1XRTT-v920 OPTIONAL, -- Cond
REG-1XRTT-PerPLMN
        longCodeState1XRTT-r11 BIT STRING (SIZE (42)) OPTIONAL, -- Cond PerPLMN-LC
        cellReselectionParameters1XRTT-r11 CellReselectionParametersCDMA2000-r11 OPTIONAL, --
Need OR
        ac-BarringConfig1XRTT-r11 AC-BarringConfig1XRTT-r9 OPTIONAL, -- Cond
REG-1XRTT-PerPLMN
        csfb-SupportForDualRxUEs-r11 BOOLEAN OPTIONAL, -- Need OR
        csfb-DualRxTxSupport-r11 ENUMERATED {true} OPTIONAL -- Cond REG-1XRTT-
PerPLMN
    } OPTIONAL, -- Need OR
    ...
}
-- ASN1STOP

```

SystemInformationBlockType8 field descriptions
<p>ac-BarringConfig1XRTT Contains the access class barring parameters the UE uses to calculate the access class barring factor, see C.S0097 [53].</p>
<p>ac-Barring0to9 Parameter used for calculating the access class barring factor for access overload classes 0 through 9. It is the parameter "PSIST" in C.S0004 [34] for access overload classes 0 through 9.</p>
<p>ac-BarringEmg Parameter used for calculating the access class barring factor for emergency calls and emergency message transmissions for access overload classes 0 through 9. It is the parameter "PSIST_EMG" in C.S0004 [34].</p>
<p>ac-BarringMsg Parameter used for modifying the access class barring factor for message transmissions. It is the parameter "MSG_PSIST" in C.S0004 [34].</p>
<p>ac-BarringN Parameter used for calculating the access class barring factor for access overload class N (N = 10 to 15). It is the parameter "PSIST" in C.S0004 [34] for access overload class N.</p>
<p>ac-BarringReg Parameter used for modifying the access class barring factor for autonomous registrations. It is the parameter "REG_PSIST" in C.S0004 [34].</p>
<p>bandClass Identifies the Frequency Band in which the Carrier can be found. Details can be found in C.S0057 [24, Table 1.5].</p>
<p>bandClassList List of CDMA2000 frequency bands.</p>
<p>cellReselectionParameters1XRTT Cell reselection parameters applicable only to CDMA2000 1xRTT system.</p>
<p>cellReselectionParameters1XRTT-Ext Cell reselection parameters applicable for cell reselection to CDMA2000 1XRTT system.</p>
<p>cellReselectionParameters1XRTT-v920 Cell reselection parameters applicable for cell reselection to CDMA2000 1XRTT system. The field is not present if <i>cellReselectionParameters1XRTT</i> is not present; otherwise it is optionally present.</p>
<p>cellReselectionParametersHRPD Cell reselection parameters applicable for cell reselection to CDMA2000 HRPD system</p>
<p>cellReselectionParametersHRPD-Ext Cell reselection parameters applicable for cell reselection to CDMA2000 HRPD system.</p>
<p>cellReselectionParametersHRPD-v920 Cell reselection parameters applicable for cell reselection to CDMA2000 HRPD system. The field is not present if <i>cellReselectionParametersHRPD</i> is not present; otherwise it is optionally present.</p>
<p>csfb-DualRxTxSupport Value TRUE indicates that the network supports dual Rx/Tx enhanced 1xCSFB, which enables UEs capable of dual Rx/Tx enhanced 1xCSFB to switch off their 1xRTT receiver/transmitter while camped in E-UTRAN [51].</p>
<p>csfb-RegistrationParam1XRTT Contains the parameters the UE will use to determine if it should perform a CDMA2000 1xRTT Registration/Re-Registration. This field is included if either CSFB or enhanced CS fallback to CDMA2000 1xRTT is supported.</p>
<p>csfb-SupportForDualRxUEs Value TRUE indicates that the network supports dual Rx CSFB [51].</p>
<p>longCodeState1XRTT The state of long code generation registers in CDMA2000 1XRTT system as defined in C.S0002 [12, Section 1.3] at $\lceil t/10 \rceil \times 10 + 320$ ms, where <i>t</i> equals to the <i>cdma-SystemTime</i>. This field is required for reporting CGI for 1xRTT, SRVCC handover and enhanced CS fallback to CDMA2000 1xRTT operation. Otherwise this IE is not needed. This field is excluded when estimating changes in system information, i.e. changes of <i>longCodeState1XRTT</i> should neither result in system information change notifications nor in a modification of <i>systemInfoValueTag</i> in SIB1.</p>
<p>neighCellList List of CDMA2000 neighbouring cells. The total number of neighbouring cells in <i>neighCellList</i> for each RAT (1XRTT or HRPD) is limited to 32.</p>
<p>neighCellList-v920 Extended List of CDMA2000 neighbouring cells. The combined total number of CDMA2000 neighbouring cells in both <i>neighCellList</i> and <i>neighCellList-v920</i> is limited to 32 for HRPD and 40 for 1xRTT.</p>

SystemInformationBlockType8 field descriptions
<p>neighCellsPerFreqList List of carrier frequencies and neighbour cell ids in each frequency within a CDMA2000 Band, see C.S0002 [12] or C.S0024 [26].</p>
<p>neighCellsPerFreqList-v920 Extended list of neighbour cell ids, in the same CDMA2000 Frequency Band as the corresponding instance in "NeighCellListCDMA2000".</p>
<p>parameters1XRTT Parameters applicable for interworking with CDMA2000 1XRTT system.</p>
<p>parametersCDMA2000 Provides the corresponding SIB8 parameters for the CDMA2000 network associated with the PLMN indicated in <i>plmn-Identity</i>. A choice is used to indicate whether for this PLMN the parameters are signalled explicitly or set to the (default) values common for all PLMNs i.e. the values not included in <i>sib8-PerPLMN-List</i>.</p>
<p>parametersHRPD Parameters applicable only for interworking with CDMA2000 HRPD systems.</p>
<p>physCellIdList Identifies the list of CDMA2000 cell ids, see C.S0002 [12] or C.S0024 [26].</p>
<p>physCellIdList-v920 Extended list of CDMA2000 cell ids, in the same CDMA2000 ARFCN as the corresponding instance in "NeighCellsPerBandclassCDMA2000".</p>
<p>plmn-Identity Indicates the PLMN associated with this CDMA2000 network. Value 1 indicates the PLMN listed 1st in <i>plmn-IdentityList</i> included in SIB1, value 2 indicates the PLMN listed 2nd in <i>plmn-IdentityList</i> included in SIB1 and so on. A PLMN which identity is not indicated in the <i>sib8-PerPLMN-List</i>, does not support inter-working with CDMA2000.</p>
<p>preRegistrationInfoHRPD The CDMA2000 HRPD Pre-Registration Information tells the UE if it should pre-register with the CDMA2000 HRPD network and identifies the Pre-registration zone to the UE.</p>
<p>searchWindowSize The search window size is a CDMA2000 parameter to be used to assist in searching for the neighbouring pilots. For values see C.S0005 [25, Table 2.6.6.2.1-1] and C.S0024 [26, Table 8.7.6.2-4]. This field is required for a UE with <i>rx-ConfigHRPD= single</i> and/ or <i>rx-Config1XRTT= single</i> to perform handover, cell re-selection, UE measurement based redirection and enhanced 1xRTT CS fallback from E-UTRAN to CDMA2000 according to this specification and TS 36.304 [4].</p>
<p>sib8-PerPLMN-List This field provides the values for the interworking CDMA2000 networks corresponding, if any, to the UE's RPLMN.</p>
<p>systemTimeInfo Information on CDMA2000 system time. This field is required for a UE with <i>rx-ConfigHRPD= single</i> and/ or <i>rx-Config1XRTT= single</i> to perform handover, cell re-selection, UE measurement based redirection and enhanced 1xRTT CS fallback from E-UTRAN to CDMA2000 according to this specification and TS 36.304 [4]. This field is excluded when estimating changes in system information, i.e. changes of <i>systemTimeInfo</i> should neither result in system information change notifications nor in a modification of <i>systemInfoValueTag</i> in SIB1. For the field included in <i>ParametersCDMA2000</i>, a choice is used to indicate whether for this PLMN the parameters are signalled explicitly or set to the (default) value common for all PLMNs i.e. the value not included in <i>sib8-PerPLMN-List</i>.</p>
<p>threshX-High Parameter "Thresh_{X, HighP}" in TS 36.304 [4]. This specifies the high threshold used in reselection towards this CDMA2000 band class expressed as an unsigned binary number equal to FLOOR (-2 x 10 x log₁₀ E_c/I₀) in units of 0.5 dB, as defined in C.S0005 [25].</p>
<p>threshX-Low Parameter "Thresh_{X, LowP}" in TS 36.304 [4]. This specifies the low threshold used in reselection towards this CDMA2000 band class expressed as an unsigned binary number equal to FLOOR (-2 x 10 x log₁₀ E_c/I₀) in units of 0.5 dB, as defined in C.S0005 [25].</p>
<p>t-ReselectionCDMA2000 Parameter "Treselction_{CDMA_HRPD}" or "Treselction_{CDMA_1xRTT}" in TS 36.304 [4].</p>
<p>t-ReselectionCDMA2000-SF Parameter "Speed dependent ScalingFactor for Treselction_{CDMA-HRPD}" or Treselction_{CDMA-1xRTT}" in TS 36.304 [4]. If the field is not present, the UE behaviour is specified in TS 36.304 [4].</p>

Conditional presence	Explanation
<i>NCL-1XRTT</i>	The field is optional present, need OR, if <i>cellReselectionParameters1xRTT</i> is present; otherwise it is not present.
<i>NCL-HRPD</i>	The field is optional present, need OR, if <i>cellReselectionParametersHRPD</i> is present; otherwise it is not present.
<i>PerPLMN-LC</i>	The field is optional present, need OR, when <i>systemTimeInfo</i> is included in <i>SIB8PerPLMN</i> for this CDMA2000 network; otherwise it is not present.
<i>REG-1XRTT</i>	The field is optional present, need OR, if <i>csfb-RegistrationParam1XRTT</i> is present; otherwise it is not present.
<i>REG-1XRTT-PerPLMN</i>	The field is optional present, need OR, if <i>csfb-RegistrationParam1XRTT</i> is included in <i>SIB8PerPLMN</i> for this CDMA2000 network; otherwise it is not present.

– *SystemInformationBlockType9*

The IE *SystemInformationBlockType9* contains a home eNB name (HNB Name).

***SystemInformationBlockType9* information element**

```
-- ASN1START
SystemInformationBlockType9 ::= SEQUENCE {
    hnb-Name                OCTET STRING (SIZE(1..48))    OPTIONAL,    -- Need OR
    . . . ,
    lateNonCriticalExtension OCTET STRING                OPTIONAL
}
-- ASN1STOP
```

***SystemInformationBlockType9* field descriptions**

hnb-Name

Carries the name of the home eNB, coded in UTF-8 with variable number of bytes per character, see TS 22.011 [10].

– *SystemInformationBlockType10*

The IE *SystemInformationBlockType10* contains an ETWS primary notification.

***SystemInformationBlockType10* information element**

```
-- ASN1START
SystemInformationBlockType10 ::= SEQUENCE {
    messageIdentifier        BIT STRING (SIZE (16)),
    serialNumber             BIT STRING (SIZE (16)),
    warningType              OCTET STRING (SIZE (2)),
    dummy                    OCTET STRING (SIZE (50))    OPTIONAL,    -- Need OP
    . . . ,
    lateNonCriticalExtension OCTET STRING                OPTIONAL
}
-- ASN1STOP
```

SystemInformationBlockType10 field descriptions
<p>messageIdentifier</p> <p>Identifies the source and type of ETWS notification. The leading bit (which is equivalent to the leading bit of the equivalent IE defined in TS 36.413 [39, 9.2.1.44]) contains bit 7 of the first octet of the equivalent IE, defined in and encoded according to TS 23.041 [37, 9.4.3.2.1], while the trailing bit contains bit 0 of the second octet of the same equivalent IE.</p>
<p>serialNumber</p> <p>Identifies variations of an ETWS notification. The leading bit (which is equivalent to the leading bit of the equivalent IE defined in TS 36.413 [39, 9.2.1.45]) contains bit 7 of the first octet of the equivalent IE, defined in and encoded according to TS 23.041 [37, 9.4.3.2.2], while the trailing bit contains bit 0 of the second octet of the same equivalent IE.</p>
<p>dummy</p> <p>This field is not used in the specification. If received it shall be ignored by the UE.</p>
<p>warningType</p> <p>Identifies the warning type of the ETWS primary notification and provides information on emergency user alert and UE popup. The first octet (which is equivalent to the first octet of the equivalent IE defined in TS 36.413 [39, 9.2.1.50]) contains the first octet of the equivalent IE defined in and encoded according to TS 23.041 [37, 9.3.24], and so on.</p>

– SystemInformationBlockType11

The IE *SystemInformationBlockType11* contains an ETWS secondary notification.

SystemInformationBlockType11 information element

```

-- ASN1START
SystemInformationBlockType11 ::= SEQUENCE {
    messageIdentifier          BIT STRING (SIZE (16)),
    serialNumber              BIT STRING (SIZE (16)),
    warningMessageSegmentType ENUMERATED {notLastSegment, lastSegment},
    warningMessageSegmentNumber INTEGER (0..63),
    warningMessageSegment     OCTET STRING,
    dataCodingScheme          OCTET STRING (SIZE (1))          OPTIONAL,  -- Cond Segment1
    . . . ,
    lateNonCriticalExtension  OCTET STRING                    OPTIONAL
}
-- ASN1STOP

```

SystemInformationBlockType11 field descriptions
<p>dataCodingScheme</p> <p>Identifies the alphabet/coding and the language applied variations of an ETWS notification. The octet (which is equivalent to the octet of the equivalent IE defined in TS 36.413 [39, 9.2.1.52]) contains the octet of the equivalent IE defined in TS 23.041 [37, 9.4.3.2.3] and encoded according to TS 23.038 [38].</p>
<p>messageIdentifier</p> <p>Identifies the source and type of ETWS notification. The leading bit (which is equivalent to the leading bit of the equivalent IE defined in TS 36.413 [39, 9.2.1.44]) contains bit 7 of the first octet of the equivalent IE, defined in and encoded according to TS 23.041 [37, 9.4.3.2.1], while the trailing bit contains bit 0 of second octet of the same equivalent IE.</p>
<p>serialNumber</p> <p>Identifies variations of an ETWS notification. The leading bit (which is equivalent to the leading bit of the equivalent IE defined in TS 36.413 [39, 9.2.1.45]) contains bit 7 of the first octet of the equivalent IE, defined in and encoded according to TS 23.041 [37, 9.4.3.2.2], while the trailing bit contains bit 0 of second octet of the same equivalent IE.</p>
<p>warningMessageSegment</p> <p>Carries a segment of the <i>Warning Message Contents</i> IE defined in TS 36.413 [39, 9.2.1.53]. The first octet of the <i>Warning Message Contents</i> IE is equivalent to the first octet of the <i>CB data</i> IE defined in and encoded according to TS 23.041 [37, 9.4.2.2.5] and so on.</p>
<p>warningMessageSegmentNumber</p> <p>Segment number of the ETWS warning message segment contained in the SIB. A segment number of zero corresponds to the first segment, one corresponds to the second segment, and so on.</p>
<p>warningMessageSegmentType</p> <p>Indicates whether the included ETWS warning message segment is the last segment or not.</p>

Conditional presence	Explanation
<i>Segment1</i>	The field is mandatory present in the first segment of SIB11, otherwise it is not present.

– SystemInformationBlockType12

The IE *SystemInformationBlockType12* contains a CMAS notification.

SystemInformationBlockType12 information element

```
-- ASN1START
SystemInformationBlockType12-r9 ::= SEQUENCE {
  messageIdentifier-r9          BIT STRING (SIZE (16)),
  serialNumber-r9              BIT STRING (SIZE (16)),
  warningMessageSegmentType-r9 ENUMERATED {notLastSegment, lastSegment},
  warningMessageSegmentNumber-r9 INTEGER (0..63),
  warningMessageSegment-r9     OCTET STRING,
  dataCodingScheme-r9          OCTET STRING (SIZE (1))          OPTIONAL,  -- Cond Segment1
  lateNonCriticalExtension      OCTET STRING                    OPTIONAL,
  ...
}
-- ASN1STOP
```

SystemInformationBlockType12 field descriptions

<i>dataCodingScheme</i>	Identifies the alphabet/coding and the language applied variations of a CMAS notification. The octet (which is equivalent to the octet of the equivalent IE defined in TS 36.413 [39, 9.2.1.52]) contains the octet of the equivalent IE defined in TS 23.041 [37, 9.4.3.2.3] and encoded according to TS 23.038 [38].
<i>messageIdentifier</i>	Identifies the source and type of CMAS notification. The leading bit (which is equivalent to the leading bit of the equivalent IE defined in TS 36.413 [39, 9.2.1.44]) contains bit 7 of the first octet of the equivalent IE, defined in and encoded according to TS 23.041 [37, 9.4.3.2.1], while the trailing bit contains bit 0 of second octet of the same equivalent IE.
<i>serialNumber</i>	Identifies variations of a CMAS notification. The leading bit (which is equivalent to the leading bit of the equivalent IE defined in TS 36.413 [39, 9.2.1.45]) contains bit 7 of the first octet of the equivalent IE, defined in and encoded according to TS 23.041 [37, 9.4.3.2.2], while the trailing bit contains bit 0 of second octet of the same equivalent IE.
<i>warningMessageSegment</i>	Carries a segment of the <i>Warning Message Contents</i> IE defined in TS 36.413 [39]. The first octet of the <i>Warning Message Contents</i> IE is equivalent to the first octet of the <i>CB data</i> IE defined in and encoded according to TS 23.041 [37, 9.4.2.2.5] and so on.
<i>warningMessageSegmentNumber</i>	Segment number of the CMAS warning message segment contained in the SIB. A segment number of zero corresponds to the first segment, one corresponds to the second segment, and so on.
<i>warningMessageSegmentType</i>	Indicates whether the included CMAS warning message segment is the last segment or not.

Conditional presence	Explanation
<i>Segment1</i>	The field is mandatory present in the first segment of SIB12, otherwise it is not present.

– SystemInformationBlockType13

The IE *SystemInformationBlockType13* contains the information required to acquire the MBMS control information associated with one or more MBSFN areas.

SystemInformationBlockType13 information element

```
-- ASN1START
SystemInformationBlockType13-r9 ::= SEQUENCE {
  mbsfn-AreaInfoList-r9        MBSFN-AreaInfoList-r9,
  notificationConfig-r9        MBMS-NotificationConfig-r9,
  lateNonCriticalExtension      OCTET STRING                    OPTIONAL,
  ...
}
-- ASN1STOP
```

```
-- ASN1STOP
```

– SystemInformationBlockType14

The IE *SystemInformationBlockType14* contains the EAB parameters.

SystemInformationBlockType14 information element

```
-- ASN1START
SystemInformationBlockType14-r11 ::= SEQUENCE {
  eab-Param-r11 CHOICE {
    eab-Common-r11 EAB-Config-r11,
    eab-PerPLMN-List-r11 SEQUENCE (SIZE (1..maxPLMN-r11)) OF EAB-ConfigPLMN-
r11
  }
  lateNonCriticalExtension OPTIONAL, -- Need OR
  ... OCTET STRING OPTIONAL,
}
EAB-ConfigPLMN-r11 ::= SEQUENCE {
  eab-Config-r11 EAB-Config-r11 OPTIONAL -- Need OR
}
EAB-Config-r11 ::= SEQUENCE {
  eab-Category-r11 ENUMERATED {a, b, c},
  eab-BarringBitmap-r11 BIT STRING (SIZE (10))
}
-- ASN1STOP
```

SystemInformationBlockType14 field descriptions

eab-BarringBitmap

Extended access class barring for AC 0-9. The first/ leftmost bit is for AC 0, the second bit is for AC 1, and so on.

eab-Category

Indicates the category of UEs for which EAB applies. Value *a* corresponds to all UEs, value *b* corresponds to the UEs that are neither in their HPLMN nor in a PLMN that is equivalent to it, and value *c* corresponds to the UEs that are neither in the PLMN listed as most preferred PLMN of the country where the UEs are roaming in the operator-defined PLMN selector list on the USIM, nor in their HPLMN nor in a PLMN that is equivalent to their HPLMN, see TS 22.011 [10].

eab-Common

The EAB parameters applicable for all PLMN(s).

eab-PerPLMN-List

The EAB parameters per PLMN, listed in the same order as the PLMN(s) occur in *plmn-IdentityList* in *SystemInformationBlockType1*.

– SystemInformationBlockType15

The IE *SystemInformationBlockType15* contains the MBMS Service Area Identities (SAI) of the current and/ or neighbouring carrier frequencies.

SystemInformationBlockType15 information element

```
-- ASN1START
SystemInformationBlockType15-r11 ::= SEQUENCE {
  mbms-SAI-IntraFreq-r11 MBMS-SAI-List-r11 OPTIONAL, -- Need OR
  mbms-SAI-InterFreqList-r11 MBMS-SAI-InterFreqList-r11 OPTIONAL, -- Need OR
  lateNonCriticalExtension OCTET STRING OPTIONAL,
  ...
  [[ mbms-SAI-InterFreqList-v1140 MBMS-SAI-InterFreqList-v1140 OPTIONAL -- Cond
InterFreq
]]
}
MBMS-SAI-List-r11 ::= SEQUENCE (SIZE (1..maxSAI-MBMS-r11)) OF MBMS-SAI-r11
MBMS-SAI-r11 ::= INTEGER (0..65535)
MBMS-SAI-InterFreqList-r11 ::= SEQUENCE (SIZE (1..maxFreq)) OF MBMS-SAI-InterFreq-r11
```

```

MBMS-SAI-InterFreqList-v1140 ::= SEQUENCE (SIZE (1..maxFreq)) OF MBMS-SAI-InterFreq-v1140
MBMS-SAI-InterFreq-r11 ::= SEQUENCE {
    dl-CarrierFreq-r11
    mbms-SAI-List-r11
}
MBMS-SAI-InterFreq-v1140 ::= SEQUENCE {
    multiBandInfoList-r11 MultiBandInfoList-r11 OPTIONAL -- Need OR
}
-- ASN1STOP

```

SystemInformationBlockType15 field descriptions

mbms-SAI-InterFreqList

Contains a list of neighboring frequencies including additional bands, if any, that provide MBMS services and the corresponding MBMS SAIs.

mbms-SAI-IntraFreq

Contains the list of MBMS SAIs for the current frequency. A duplicate MBMS SAI indicates that this and all following SAIs are not offered by this cell but only by neighbour cells on the current frequency. For MBMS service continuity, the UE shall use all MBMS SAIs listed in *mbms-SAI-IntraFreq* to derive the MBMS frequencies of interest.

mbms-SAI-List

Contains a list of MBMS SAIs for a specific frequency.

multiBandInfoList

A list of additional frequency bands applicable for the cells participating in the MBSFN transmission.

Conditional presence	Explanation
<i>InterFreq</i>	The field is optionally present, need OR, if the <i>mbms-SAI-InterFreqList-r11</i> is present. Otherwise it is not present.

SystemInformationBlockType16

The IE *SystemInformationBlockType16* contains information related to GPS time and Coordinated Universal Time (UTC). The UE may use the parameters provided in this system information block to obtain the UTC, the GPS and the local time.

NOTE: The UE may use the time information for numerous purposes, possibly involving upper layers e.g. to assist GPS initialisation, to synchronise the UE clock (a.o. to determine MBMS session start/ stop).

SystemInformationBlockType16 information element

```

-- ASN1START
SystemInformationBlockType16-r11 ::= SEQUENCE {
    timeInfo-r11 SEQUENCE {
        timeInfoUTC-r11 INTEGER (0..549755813887),
        dayLightSavingTime-r11 BIT STRING (SIZE (2)) OPTIONAL, -- Need OR
        leapSeconds-r11 INTEGER (-127..128) OPTIONAL, -- Need OR
        localTimeOffset-r11 INTEGER (-63..64) OPTIONAL, -- Need OR
    }
    lateNonCriticalExtension OCTET STRING OPTIONAL,
    ...
}
-- ASN1STOP

```

SystemInformationBlockType16 field descriptions
<p>dayLightSavingTime</p> <p>It indicates if and how daylight saving time (DST) is applied to obtain the local time. The semantics is the same as the semantics of the <i>Daylight Saving Time</i> IE in TS 24.301 [35] and TS 24.008 [49]. The first/leftmost bit of the bit string contains the b2 of octet 3, i.e. the value part of the <i>Daylight Saving Time</i> IE, and the second bit of the bit string contains b1 of octet 3.</p>
<p>leapSeconds</p> <p>Number of leap seconds offset between GPS Time and UTC. UTC and GPS time are related i.e. GPS time -<i>leapSeconds</i> = UTC time.</p>
<p>localTimeOffset</p> <p>Offset between UTC and local time in units of 15 minutes. Actual value = IE value * 15 minutes. Local time of the day is calculated as UTC time + <i>localTimeOffset</i>.</p>
<p>timeInfoUTC</p> <p>Coordinated Universal Time corresponding to the SFN boundary at or immediately after the ending boundary of the SI-window in which <i>SystemInformationBlockType16</i> is transmitted. The field counts the number of UTC seconds in 10 ms units since 00:00:00 on Gregorian calendar date 1 January, 1900 (midnight between Sunday, December 31, 1899 and Monday, January 1, 1900). NOTE 1.</p> <p>This field is excluded when estimating changes in system information, i.e. changes of <i>timeInfoUTC</i> should neither result in system information change notifications nor in a modification of <i>systemInfoValueTag</i> in SIB1.</p>

NOTE 1: The UE may use this field together with the leapSeconds field to obtain GPS time as follows: GPS Time (in seconds) = timeInfoUTC (in seconds) - 2,524,953,600 (seconds) + leapSeconds, where 2,524,953,600 is the number of seconds between 00:00:00 on Gregorian calendar date 1 January, 1900 and 00:00:00 on Gregorian calendar date 6 January, 1980 (start of GPS time).

SystemInformationBlockType17

The IE *SystemInformationBlockType17* contains information relevant for traffic steering between E-UTRAN and WLAN.

SystemInformationBlockType17 information element

```

-- ASN1START
SystemInformationBlockType17-r12 ::= SEQUENCE {
    wlan-OffloadInfoPerPLMN-List-r12 SEQUENCE (SIZE (1..maxPLMN-r11)) OF
        wlan-OffloadInfoPerPLMN-r12 OPTIONAL, -- Need OR
    lateNonCriticalExtension OCTET STRING OPTIONAL,
    ...
}
WLAN-OffloadInfoPerPLMN-r12 ::= SEQUENCE {
    wlan-OffloadConfigCommon-r12 WLAN-OffloadConfig-r12 OPTIONAL, -- Need OR
    wlan-Id-List-r12 WLAN-Id-List-r12 OPTIONAL, -- Need OR
    ...
}
WLAN-Id-List-r12 ::= SEQUENCE (SIZE (1..maxWLAN-Id-r12)) OF WLAN-Identifiers-r12
WLAN-Identifiers-r12 ::= SEQUENCE {
    ssid-r12 OCTET STRING (SIZE (1..32)) OPTIONAL, -- Need OR
    bssid-r12 OCTET STRING (SIZE (6)) OPTIONAL, -- Need OR
    hessid-r12 OCTET STRING (SIZE (6)) OPTIONAL, -- Need OR
    ...
}
-- ASN1STOP

```

SystemInformationBlockType17 field descriptions
<p>bssid</p> <p>Basic Service Set Identifier (BSSID) defined in IEEE 802.11-2012 [67].</p>
<p>hessid</p> <p>Homogenous Extended Service Set Identifier (HESSID) defined in IEEE 802.11-2012 [67].</p>
<p>ssid</p> <p>Service Set Identifier (SSID) defined in IEEE 802.11-2012 [67].</p>

SystemInformationBlockType17 field descriptions**wlan-OffloadInfoPerPLMN-List**

The WLAN offload configuration per PLMN includes the same number of entries, listed in the same order as the PLMN(s) in *plmn-IdentityList* in *SystemInformationBlockType1*.

SystemInformationBlockType18

The IE *SystemInformationBlockType18* indicates E-UTRAN supports the Sidelink UE information procedure and may contain sidelink communication related resource configuration information.

SystemInformationBlockType18 information element

```
-- ASN1START
SystemInformationBlockType18-r12 ::= SEQUENCE {
  commConfig-r12          SEQUENCE {
    commRxPool-r12        SL-CommRxPoolList-r12,
    commTxPoolNormalCommon-r12  SL-CommTxPoolList-r12          OPTIONAL, -- Need OR
    commTxPoolExceptional-r12  SL-CommTxPoolList-r12          OPTIONAL, -- Need OR
    commSyncConfig-r12     SL-SyncConfigList-r12              OPTIONAL, -- Need OR
  }
  lateNonCriticalExtension OCTET STRING                      OPTIONAL,
  ...
}
-- ASN1STOP
```

SystemInformationBlockType18 field descriptions**commRxPool**

Indicates the resources by which the UE is allowed to receive sidelink communication while in RRC_IDLE and while in RRC_CONNECTED.

commSyncConfig

Indicates the configuration by which the UE is allowed to receive and transmit synchronisation information. E-UTRAN configures *commSyncConfig* including *txParameters* when configuring UEs by dedicated signalling to transmit synchronisation information.

commTxPoolExceptional

Indicates the resources by which the UE is allowed to transmit sidelink communication in exceptional conditions, as specified in 5.10.4.

commTxPoolNormalCommon

Indicates the resources by which the UE is allowed to transmit sidelink communication while in RRC_IDLE or when in RRC_CONNECTED while transmitting sidelink via a frequency other than the primary.

SystemInformationBlockType19

The IE *SystemInformationBlockType19* indicates E-UTRAN supports the sidelink UE information procedure and may contain sidelink discovery related resource configuration information.

SystemInformationBlockType19 information element

```
-- ASN1START
SystemInformationBlockType19-r12 ::= SEQUENCE {
  discConfig-r12          SEQUENCE {
    discRxPool-r12        SL-DiscRxPoolList-r12,
    discTxPoolCommon-r12  SL-DiscTxPoolList-r12          OPTIONAL, -- Need OR
    discTxPowerInfo-r12   SL-DiscTxPowerInfoList-r12     OPTIONAL, -- Cond Tx
    discSyncConfig-r12     SL-SyncConfigList-r12          OPTIONAL, -- Need OR
  }
  discInterFreqList-r12   SL-CarrierFreqInfoList-r12     OPTIONAL, -- Need OR
  lateNonCriticalExtension OCTET STRING                      OPTIONAL,
  ...
}
SL-CarrierFreqInfoList-r12 ::= SEQUENCE (SIZE (1..maxFreq)) OF SL-CarrierFreqInfo-r12
SL-CarrierFreqInfo-r12 ::= SEQUENCE {
  carrierFreq-r12        ARFCN-ValueEUTRA-r9,
  plmn-IdentityList-r12  PLMN-IdentityList4-r12          OPTIONAL, -- Need OP
}
-- ASN1STOP
```

```

PLMN-IdentityList4-r12 ::= SEQUENCE (SIZE (1..maxPLMN-r11)) OF PLMN-IdentityInfo2-r12
PLMN-IdentityInfo2-r12 ::= CHOICE {
    plmn-Index-r12          INTEGER (1..maxPLMN-r11),
    plmnIdentity-r12       PLMN-Identity
}
-- ASN1STOP

```

SystemInformationBlockType19 field descriptions

discInterFreqList	Indicates the neighbouring frequencies on which sidelink discovery announcement is supported.
discRxPool	Indicates the resources by which the UE is allowed to receive sidelink discovery announcements while in RRC_IDLE and while in RRC_CONNECTED.
discSyncConfig	Indicates the configuration by which the UE is allowed to receive and transmit synchronisation information. E-UTRAN configures <i>discSyncConfig</i> including <i>txParameters</i> when configuring UEs by dedicated signalling to transmit synchronisation information.
discTxPoolCommon	Indicates the resources by which the UE is allowed to transmit sidelink discovery announcements while in RRC_IDLE.
plmn-IdentityList	List of PLMN identities for the neighbouring frequency indicated by <i>carrierFreq</i> . Absence of the field indicates the same PLMN identities as listed in <i>plmn-IdentityList</i> (without suffix) in <i>SystemInformationBlockType1</i> .
plmn-Index	Index of the corresponding entry in field <i>plmn-IdentityList</i> (without suffix) within <i>SystemInformationBlockType1</i> .

Conditional presence	Explanation
Tx	The field is mandatory present if <i>discTxPoolCommon</i> is included. Otherwise the field is optional present, need OR.

6.3.2 Radio resource control information elements

– AntennaInfo

The IE *AntennaInfoCommon* and the *AntennaInfoDedicated* are used to specify the common and the UE specific antenna configuration respectively.

AntennaInfo information elements

```

-- ASN1START
AntennaInfoCommon ::= SEQUENCE {
    antennaPortsCount    ENUMERATED {an1, an2, an4, spare1}
}
AntennaInfoDedicated ::= SEQUENCE {
    transmissionMode     ENUMERATED {
        tm1, tm2, tm3, tm4, tm5, tm6,
        tm7, tm8-v920},
    codebookSubsetRestriction CHOICE {
        n2TxAntenna-tm3    BIT STRING (SIZE (2)),
        n4TxAntenna-tm3    BIT STRING (SIZE (4)),
        n2TxAntenna-tm4    BIT STRING (SIZE (6)),
        n4TxAntenna-tm4    BIT STRING (SIZE (64)),
        n2TxAntenna-tm5    BIT STRING (SIZE (4)),
        n4TxAntenna-tm5    BIT STRING (SIZE (16)),
        n2TxAntenna-tm6    BIT STRING (SIZE (4)),
        n4TxAntenna-tm6    BIT STRING (SIZE (16))
    } OPTIONAL, -- Cond TM
    ue-TransmitAntennaSelection CHOICE{
        release            NULL,
        setup              ENUMERATED {closedLoop, openLoop}
    }
}
AntennaInfoDedicated-v920 ::= SEQUENCE {
    codebookSubsetRestriction-v920 CHOICE {

```

```

        n2TxAntenna-tm8-r9          BIT STRING (SIZE (6)),
        n4TxAntenna-tm8-r9          BIT STRING (SIZE (32))
    }                                OPTIONAL                                -- Cond TM8
}

AntennaInfoDedicated-r10 ::=      SEQUENCE {
    transmissionMode-r10            ENUMERATED {
        tm1, tm2, tm3, tm4, tm5, tm6, tm7, tm8-v920,
        tm9-v1020, tm10-v1130, spare6, spare5, spare4,
        spare3, spare2, spare1},
    codebookSubsetRestriction-r10  BIT STRING                                OPTIONAL,          -- Cond TMX
    ue-TransmitAntennaSelection    CHOICE{
        release                      NULL,
        setup                        ENUMERATED {closedLoop, openLoop}
    }
}

AntennaInfoDedicated-v10i0 ::=    SEQUENCE {
    maxLayersMIMO-r10              ENUMERATED {twoLayers, fourLayers, eightLayers}  OPTIONAL  --
Need OR
}

AntennaInfoDedicated-v1250 ::=    SEQUENCE {
    alternativeCodebookEnabledFor4TX-r12  BOOLEAN
}

-- ASN1STOP

```

AntennaInfo field descriptions

alternativeCodebookEnabledFor4TX

Indicates whether code book in TS 36.213 [23] Table 7.2.4-0A to Table 7.2.4-0D is being used for deriving CSI feedback and reporting. E-UTRAN only configures the field if the UE is configured with a) *tm8* with 4 CRS ports, *tm9* or *tm10* with 4 CSI-RS ports and b) PMI/RI reporting.

antennaPortsCount

Parameter represents the number of cell specific antenna ports where an1 corresponds to 1, an2 to 2 antenna ports etc. see TS 36.211 [21, 6.2.1].

codebookSubsetRestriction

Parameter: *codebookSubsetRestriction*, see TS 36.213 [23, 7.2] and TS 36.211 [21, 6.3.4.2.3]. The number of bits in the *codebookSubsetRestriction* for applicable transmission modes is defined in TS 36.213 [23, Table 7.2-1b]. If the UE is configured with *transmissionMode* *tm8*, E-UTRAN configures the field *codebookSubsetRestriction* if PMI/RI reporting is configured. If the UE is configured with *transmissionMode* *tm9*, E-UTRAN configures the field *codebookSubsetRestriction* if PMI/RI reporting is configured and if the number of CSI-RS ports is greater than 1. E-UTRAN does not configure the field *codebookSubsetRestriction* in other cases where the UE is configured with *transmissionMode* *tm8* or *tm9*.

maxLayersMIMO

Indicates the maximum number of layers for spatial multiplexing used to determine the rank indication bit width and Kc determination of the soft buffer size for the corresponding serving cell according to TS 36.212 [22]. EUTRAN configures this field only when *transmissionMode* is set to *tm3*, *tm4*, *tm9* or *tm10* for the corresponding serving cell. When configuring the field for a serving cell which *transmissionMode* is set to *tm3* or *tm4*, EUTRAN only configures value *fourLayers*: For a serving cell which *transmissionMode* is set to *tm9* or *tm10*, EUTRAN only configures the field only if *intraBandContiguousCC-InfoList* is indicated for the band and the band combination of the corresponding serving cell or the UE supports *maxLayersMIMO-Indication*.

transmissionMode

Points to one of Transmission modes defined in TS 36.213 [23, 7.1] where *tm1* refers to transmission mode 1, *tm2* to transmission mode 2 etc.

ue-TransmitAntennaSelection

For value *setup* the field indicates whether UE transmit antenna selection control is closed-loop or open-loop as described in TS 36.213 [23, 8.7]. EUTRAN configures the same value for all serving cells.

Conditional presence	Explanation
<i>TM</i>	The field is mandatory present if the <i>transmissionMode</i> is set to <i>tm3</i> , <i>tm4</i> , <i>tm5</i> or <i>tm6</i> . Otherwise the field is not present and the UE shall delete any existing value for this field.
<i>TM8</i>	The field is optional present, need OR, if <i>AntennaInfoDedicated</i> is included and <i>transmissionMode</i> is set to <i>tm8</i> . If <i>AntennaInfoDedicated</i> is included and <i>transmissionMode</i> is set to a value other than <i>tm8</i> , the field is not present and the UE shall delete any existing value for this field. Otherwise the field is not present.
<i>TMX</i>	The field is mandatory present if the <i>transmissionMode-r10</i> is set to <i>tm3</i> , <i>tm4</i> , <i>tm5</i> or <i>tm6</i> . The field is optionally present, need OR, if the <i>transmissionMode-r10</i> is set to <i>tm8</i> or <i>tm9</i> . Otherwise the field is not present and the UE shall delete any existing value for this field.

– *AntennaInfoUL*

The IE *AntennaInfoUL* is used to specify the UL antenna configuration.

AntennaInfoUL information elements

```
-- ASN1START
AntennaInfoUL-r10 ::= SEQUENCE {
    transmissionModeUL-r10      ENUMERATED {tm1, tm2, spare6, spare5,
                                             spare4, spare3, spare2, spare1} OPTIONAL, --
Need OR
    fourAntennaPortActivated-r10  ENUMERATED {setup}          OPTIONAL          -- Need OR
}
-- ASN1STOP
```

AntennaInfoUL field descriptions

fourAntennaPortActivated

Parameter indicates if four antenna ports are used. See TS 36.213 [23, 8.2]. E-UTRAN optionally configures *fourAntennaPortActivated* only if *transmissionModeUL* is set to *tm2*.

transmissionModeUL

Points to one of UL Transmission modes defined in TS 36.213 [23, 8.0] where *tm1* refers to transmission mode 1, *tm2* to transmission mode 2 etc.

– *CQI-ReportConfig*

The IE *CQI-ReportConfig* is used to specify the CQI reporting configuration.

CQI-ReportConfig information elements

```
-- ASN1START
CQI-ReportConfig ::= SEQUENCE {
    cqi-ReportModeAperiodic      CQI-ReportModeAperiodic OPTIONAL,          -- Need OR
    nomPDSCH-RS-EPRE-Offset      INTEGER (-1..6),
    cqi-ReportPeriodic           CQI-ReportPeriodic      OPTIONAL          -- Need ON
}

CQI-ReportConfig-v920 ::= SEQUENCE {
    cqi-Mask-r9                  ENUMERATED {setup}          OPTIONAL,          -- Cond cqi-Setup
    pmi-RI-Report-r9             ENUMERATED {setup}          OPTIONAL          -- Cond PMIRI
}

CQI-ReportConfig-r10 ::= SEQUENCE {
    cqi-ReportAperiodic-r10      CQI-ReportAperiodic-r10      OPTIONAL,          -- Need ON
    nomPDSCH-RS-EPRE-Offset      INTEGER (-1..6),
    cqi-ReportPeriodic-r10       CQI-ReportPeriodic-r10       OPTIONAL,          -- Need ON
    pmi-RI-Report-r9             ENUMERATED {setup}          OPTIONAL,          -- Cond
PMIRIPCell
    csi-SubframePatternConfig-r10 CHOICE {
        release
        setup
            SEQUENCE {
                csi-MeasSubframeSet1-r10 MeasSubframePattern-r10,
                csi-MeasSubframeSet2-r10 MeasSubframePattern-r10
            }
    }
}
-- ASN1STOP
```

```

CQI-ReportConfig-v1130 ::= SEQUENCE {
    cqi-ReportPeriodic-v1130          CQI-ReportPeriodic-v1130,
    cqi-ReportBoth-r11                CQI-ReportBoth-r11
}

CQI-ReportConfig-v1250 ::= SEQUENCE {
    csi-SubframePatternConfig-r12     CHOICE {
        release                        NULL,
        setup                          SEQUENCE {
            csi-MeasSubframeSets-r12  BIT STRING (SIZE (10))
        }
    }
    cqi-ReportBoth-v1250              CQI-ReportBoth-v1250          OPTIONAL, -- Need ON
    cqi-ReportAperiodic-v1250        CQI-ReportAperiodic-v1250    OPTIONAL, -- Need ON
    altCQI-Table-r12                 ENUMERATED {
        allSubframes, csi-SubframeSet1,
        csi-SubframeSet2, spare1}    OPTIONAL          -- Need OP
}

CQI-ReportConfigSCell-r10 ::= SEQUENCE {
    cqi-ReportModeAperiodic-r10      CQI-ReportModeAperiodic    OPTIONAL, -- Need OR
    nomPDSCH-RS-EPRE-Offset-r10     INTEGER (-1..6),
    cqi-ReportPeriodicSCell-r10      CQI-ReportPeriodic-r10     OPTIONAL, -- Need ON
    pmi-RI-Report-r10                ENUMERATED {setup}        OPTIONAL  -- Cond
}
PMIRISCell
}

CQI-ReportPeriodic ::= CHOICE {
    release                        NULL,
    setup                          SEQUENCE {
        cqi-PUCCH-ResourceIndex     INTEGER (0..1185),
        cqi-pmi-ConfigIndex          INTEGER (0..1023),
        cqi-FormatIndicatorPeriodic CHOICE {
            widebandCQI             NULL,
            subbandCQI              SEQUENCE {
                k                    INTEGER (1..4)
            }
        },
        ri-ConfigIndex              INTEGER (0..1023)    OPTIONAL, -- Need OR
        simultaneousAckNackAndCQI   BOOLEAN
    }
}

CQI-ReportPeriodic-r10 ::= CHOICE {
    release                        NULL,
    setup                          SEQUENCE {
        cqi-PUCCH-ResourceIndex-r10 INTEGER (0..1184),
        cqi-PUCCH-ResourceIndexP1-r10 INTEGER (0..1184)          OPTIONAL, -- Need OR
        cqi-pmi-ConfigIndex         INTEGER (0..1023),
        cqi-FormatIndicatorPeriodic-r10 CHOICE {
            widebandCQI-r10         SEQUENCE {
                csi-ReportMode-r10  ENUMERATED {submode1, submode2}    OPTIONAL  -- Need OR
            },
            subbandCQI-r10          SEQUENCE {
                k                    INTEGER (1..4),
                periodicityFactor-r10 ENUMERATED {n2, n4}
            }
        },
        ri-ConfigIndex              INTEGER (0..1023)          OPTIONAL, -- Need OR
        simultaneousAckNackAndCQI   BOOLEAN,
        cqi-Mask-r9                 ENUMERATED {setup}         OPTIONAL, -- Need OR
        csi-ConfigIndex-r10         CHOICE {
            release                  NULL,
            setup                    SEQUENCE {
                cqi-pmi-ConfigIndex2-r10 INTEGER (0..1023),
                ri-ConfigIndex2-r10    INTEGER (0..1023)          OPTIONAL  -- Need OR
            }
        }
    }
    OPTIONAL          -- Need ON
}

CQI-ReportPeriodic-v1130 ::= SEQUENCE {
    simultaneousAckNackAndCQI-Format3-r11 ENUMERATED {setup}    OPTIONAL, -- Need OR
    cqi-ReportPeriodicProcExtToReleaseList-r11 CQI-ReportPeriodicProcExtToReleaseList-r11
    OPTIONAL, -- Need ON
    cqi-ReportPeriodicProcExtToAddModList-r11 CQI-ReportPeriodicProcExtToAddModList-r11
    OPTIONAL
    -- Need ON
}

```

```

}

CQI-ReportPeriodicProcExtToAddModList-r11 ::= SEQUENCE (SIZE (1..maxCQI-ProcExt-r11)) OF CQI-
ReportPeriodicProcExt-r11

CQI-ReportPeriodicProcExtToReleaseList-r11 ::= SEQUENCE (SIZE (1..maxCQI-ProcExt-r11)) OF CQI-
ReportPeriodicProcExtId-r11

CQI-ReportPeriodicProcExt-r11 ::= SEQUENCE {
  cqi-ReportPeriodicProcExtId-r11 CQI-ReportPeriodicProcExtId-r11,
  cqi-pmi-ConfigIndex-r11 INTEGER (0..1023),
  cqi-FormatIndicatorPeriodic-r11 CHOICE {
    widebandCQI-r11 SEQUENCE {
      csi-ReportMode-r11 ENUMERATED {submode1, submode2} OPTIONAL -- Need OR
    },
    subbandCQI-r11 SEQUENCE {
      k INTEGER (1..4),
      periodicityFactor-r11 ENUMERATED {n2, n4}
    }
  },
  ri-ConfigIndex-r11 INTEGER (0..1023) OPTIONAL, -- Need OR
  csi-ConfigIndex-r11 CHOICE {
    release NULL,
    setup SEQUENCE {
      cqi-pmi-ConfigIndex2-r11 INTEGER (0..1023),
      ri-ConfigIndex2-r11 INTEGER (0..1023) OPTIONAL -- Need OR
    }
  }
} OPTIONAL, -- Need ON
...
}

CQI-ReportAperiodic-r10 ::= CHOICE {
  release NULL,
  setup SEQUENCE {
    cqi-ReportModeAperiodic-r10 CQI-ReportModeAperiodic,
    aperiodicCSI-Trigger-r10 SEQUENCE {
      trigger1-r10 BIT STRING (SIZE (8)),
      trigger2-r10 BIT STRING (SIZE (8))
    }
  }
} OPTIONAL -- Need OR
}

CQI-ReportAperiodic-v1250 ::= CHOICE {
  release NULL,
  setup SEQUENCE {
    aperiodicCSI-Trigger-v1250 SEQUENCE {
      trigger-SubframeSetIndicator-r12 ENUMERATED {s1, s2},
      trigger1-SubframeSetIndicator-r12 BIT STRING (SIZE (8)),
      trigger2-SubframeSetIndicator-r12 BIT STRING (SIZE (8))
    }
  }
}

CQI-ReportAperiodicProc-r11 ::= SEQUENCE {
  cqi-ReportModeAperiodic-r11 CQI-ReportModeAperiodic,
  trigger01-r11 BOOLEAN,
  trigger10-r11 BOOLEAN,
  trigger11-r11 BOOLEAN
}

CQI-ReportModeAperiodic ::= ENUMERATED {
  rm12, rm20, rm22, rm30, rm31,
  rm32-v1250, spare2, spare1
}

CQI-ReportBoth-r11 ::= SEQUENCE {
  csi-IM-ConfigToReleaseList-r11 CSI-IM-ConfigToReleaseList-r11 OPTIONAL, -- Need ON
  csi-IM-ConfigToAddModList-r11 CSI-IM-ConfigToAddModList-r11 OPTIONAL, -- Need ON
  csi-ProcessToReleaseList-r11 CSI-ProcessToReleaseList-r11 OPTIONAL, -- Need ON
  csi-ProcessToAddModList-r11 CSI-ProcessToAddModList-r11 OPTIONAL, -- Need ON
}

CQI-ReportBoth-v1250 ::= SEQUENCE {
  csi-IM-ConfigToReleaseListExt-r12 CSI-IM-ConfigId-v1250 OPTIONAL, -- Need ON
  csi-IM-ConfigToAddModListExt-r12 CSI-IM-ConfigExt-r12 OPTIONAL, -- Need ON
}

CSI-IM-ConfigToAddModList-r11 ::= SEQUENCE (SIZE (1..maxCSI-IM-r11)) OF CSI-IM-Config-r11

```

```
CSI-IM-ConfigToReleaseList-r11 ::= SEQUENCE (SIZE (1..maxCSI-IM-r11)) OF CSI-IM-ConfigId-r11
CSI-ProcessToAddModList-r11 ::= SEQUENCE (SIZE (1..maxCSI-Proc-r11)) OF CSI-Process-r11
CSI-ProcessToReleaseList-r11 ::= SEQUENCE (SIZE (1..maxCSI-Proc-r11)) OF CSI-ProcessId-r11
CQI-ReportBothProc-r11 ::= SEQUENCE {
    ri-Ref-CSI-ProcessId-r11 CSI-ProcessId-r11 OPTIONAL, -- Need OR
    pmi-RI-Report-r11 ENUMERATED {setup} OPTIONAL -- Need OR
}
-- ASN1STOP
```

CQI-ReportConfig field descriptions
<p>altCQI-Table Indicates the applicability of the alternative CQI table (i.e. Table 7.2.3-2 in TS 36.213 [23]) for both aperiodic and periodic CSI reporting for the concerned serving cell. Value <i>allSubframes</i> means the alternative CQI table applies to all the subframes and CSI processes, if configured, and value <i>csi-SubframeSet1</i> means the alternative CQI table applies to CSI subframe set1, and value <i>csi-SubframeSet2</i> means the alternative CQI table applies to CSI subframe set2. EUTRAN sets the value to <i>csi-SubframeSet1</i> or <i>csi-SubframeSet2</i> only if <i>transmissionMode</i> is set in range <i>tm1</i> to <i>tm9</i> and <i>csi-SubframePatternConfig-r10</i> is configured for the concerned serving cell and different CQI tables apply to the two CSI subframe sets; otherwise EUTRAN sets the value to <i>allSubframes</i>. If this field is not present, the UE shall use Table 7.2.3-1 in TS 36.213 [23] for all subframes and CSI processes, if configured.</p>
<p>aperiodicCSI-Trigger Indicates for which serving cell(s) the aperiodic CSI report is triggered when one or more SCells are configured. <i>trigger1</i> corresponds to the CSI request field 10 and <i>trigger2</i> corresponds to the CSI request field 11, see TS 36.213 [23, table 7.2.1-1A]. The leftmost bit, bit 0 in the bit string corresponds to the cell with <i>ServCellIndex=0</i> and bit 1 in the bit string corresponds to the cell with <i>ServCellIndex=1</i> etc. Each bit has either value 0 (means no aperiodic CSI report is triggered) or value 1 (means the aperiodic CSI report is triggered). At most 5 bits can be set to value 1 in the bit string. E-UTRAN configures value 1 only for cells configured with <i>transmissionMode</i> set in range <i>tm1</i> to <i>tm9</i>. One value applies for all serving cells configured with <i>transmissionMode</i> set in range <i>tm1</i> to <i>tm9</i> (the associated functionality is common i.e. not performed independently for each cell).</p>
<p>cqi-Mask Limits CQI/PMI/PTI/RI reports to the on-duration period of the DRX cycle, see TS 36.321 [6]. One value applies for all CSI processes and all serving cells (the associated functionality is common i.e. not performed independently for each cell).</p>
<p>cqi-FormatIndicatorPeriodic Parameter: <i>PUCCH CQI Feedback Type</i>, see TS 36.213 [23, table 7.2.2-1]. Depending on <i>transmissionMode</i>, reporting mode is implicitly given from the table.</p>
<p>cqi-pmi-ConfigIndex Parameter: <i>CQI/PMI Periodicity and Offset Configuration Index I_{CQI/PMI}</i>, see TS 36.213 [23, tables 7.2.2-1A and 7.2.2-1C]. If subframe patterns for CSI (CQI/PMI/PTI/RI) reporting are configured (i.e. <i>csi-SubframePatternConfig</i> is configured), the parameter applies to the subframe pattern corresponding to <i>csi-MeasSubframeSet1</i> or corresponding to the CSI subframe set 1 indicated by <i>csi-MeasSubframeSets-r12</i>.</p>
<p>cqi-pmi-ConfigIndex2 Parameter: <i>CQI/PMI Periodicity and Offset Configuration Index I_{CQI/PMI}</i>, see TS 36.213 [23, tables 7.2.2-1A and 7.2.2-1C]. The parameter applies to the subframe pattern corresponding to <i>csi-MeasSubframeSet2</i> or corresponding to the CSI subframe set 2 indicated by <i>csi-MeasSubframeSets-r12</i>.</p>
<p>cqi-PUCCH-ResourceIndex, cqi-PUCCH-ResourceIndexP1 Parameter $n_{\text{PUCCH}}^{(2,p)}$ for antenna port P0 and for antenna port P1 respectively, see TS 36.213 [23, 7.2]. E-UTRAN does not apply value 1185. One value applies for all CSI processes.</p>
<p>cqi-ReportAperiodic E-UTRAN does not configure <i>CQI-ReportAperiodic</i> when transmission mode 10 is configured for all serving cells. E-UTRAN configures <i>cqi-ReportAperiodic-v1250</i> only if <i>cqi-ReportAperiodic-r10</i> and <i>csi-MeasSubframeSets-r12</i> are configured.</p>
<p>cqi-ReportModeAperiodic Parameter: <i>reporting mode</i>. Value <i>rm12</i> corresponds to Mode 1-2, <i>rm20</i> corresponds to Mode 2-0, <i>rm22</i> corresponds to Mode 2-2 etc. PUSCH reporting modes are described in TS 36.213 [23, 7.2.1]. The UE shall ignore <i>cqi-ReportModeAperiodic-r10</i> when transmission mode 10 is configured for the serving cell on this carrier frequency. The UE shall ignore <i>cqi-ReportModeAperiodic-r10</i> configured for the PCell/ PSCell when the transmission bandwidth of the PCell/PSCell in downlink is 6 resource blocks.</p>
<p>CQI-ReportPeriodicProcExt A set of periodic CQI related parameters for which E-UTRAN may configure different values for each CSI process. For a serving frequency E-UTRAN configures one or more <i>CQI-ReportPeriodicProcExt</i> only when transmission mode 10 is configured for the serving cell on this carrier frequency.</p>
<p>csi-ConfigIndex E-UTRAN configures <i>csi-ConfigIndex</i> only for PCell and only if <i>csi-SubframePatternConfig</i> is configured. The UE shall release <i>csi-ConfigIndex</i> if <i>csi-SubframePatternConfig</i> is released.</p>
<p>csi-IM-ConfigToAddModList For a serving frequency E-UTRAN configures one or more <i>CSI-IM-Config</i> only when transmission mode 10 is configured for the serving cell on this carrier frequency.</p>
<p>csi-MeasSubframeSets Indicates the two CSI subframe sets. Value 0 means the subframe belongs to CSI subframe set 1 and value 1 means the subframe belongs to CSI subframe set 2. CSI subframe set 1 refers to $C_{\text{CSI},0}$ in TS 36.213 [23, 7.2] and CSI subframe set 2 refers to $C_{\text{CSI},1}$ in TS 36.213 [23, 7.2]. EUTRAN does not configure <i>csi-MeasSubframeSet1-r10</i> and <i>csi-MeasSubframeSet2-r10</i> if either <i>csi-MeasSubframeSets-r12</i> for PCell or <i>eimta-MainConfigPCell-r12</i> is configured.</p>
<p>csi-MeasSubframeSet1, csi-MeasSubframeSet2 Indicates the CSI measurement subframe sets. <i>csi-MeasSubframeSet1</i> refers to $C_{\text{CSI},0}$ in TS 36.213 [23, 7.2] and <i>csi-MeasSubframeSet2</i> refers to $C_{\text{CSI},1}$ in TS 36.213 [23, 7.2]. E-UTRAN only configures the two CSI measurement subframe sets for the PCell.</p>

CQI-ReportConfig field descriptions
<p>csi-ProcessToAddModList For a serving frequency E-UTRAN configures one or more <i>CSI-Process</i> only when transmission mode 10 is configured for the serving cell on this carrier frequency.</p>
<p>csi-ReportMode Parameter: <i>PUCCH_format1-1_CSI_reporting_mode</i>, see TS 36.213 [23, 7.2.2].</p>
<p>K Parameter: <i>K</i>, see TS 36.213 [23, 7.2.2].</p>
<p>nomPDSCH-RS-EPRE-Offset Parameter: Δ_{offset} see TS 36.213 [23, 7.2.3]. Actual value = IE value * 2 [dB].</p>
<p>periodicityFactor Parameter: <i>H'</i>, see TS 36.213 [23, 7.2.2].</p>
<p>pmi-RI-Report See TS 36.213 [23, 7.2]. The presence of this field means PMI/RI reporting is configured; otherwise the PMI/RI reporting is not configured. EUTRAN configures this field only when <i>transmissionMode</i> is set to <i>tm8</i>, <i>tm9</i> or <i>tm10</i>. The UE shall ignore <i>pmi-RI-Report-r9</i>/<i>pmi-RI-Report-r10</i> when transmission mode 10 is configured for the serving cell on this carrier frequency.</p>
<p>ri-ConfigIndex Parameter: <i>RI Config Index I_{RI}</i>, see TS 36.213 [23, 7.2.2-1B]. If subframe patterns for CSI (CQI/PMI/PTI/RI) reporting are configured (i.e. <i>csi-SubframePatternConfig</i> is configured), the parameter applies to the subframe pattern corresponding to <i>csi-MeasSubframeSet1</i>.</p>
<p>ri-ConfigIndex2 Parameter: <i>RI Config Index I_{RI}</i>, see TS 36.213 [23, 7.2.2-1B]. The parameter applies to the subframe pattern corresponding to <i>_csi-MeasSubframeSet2</i> or corresponding to the CSI subframe set 2 indicated by <i>csi-MeasSubframeSets-r12</i>. E-UTRAN configures <i>ri-ConfigIndex2</i> only if <i>ri-ConfigIndex</i> is configured.</p>
<p>ri-Ref-CSI-ProcessId CSI process whose RI value the UE inherits when reporting RI, in the same subframe, for CSI reporting. E-UTRAN ensures that the CSI process that inherits the RI value is configured in accordance with the conditions specified in 36.213 [23, 7.2.1, 7.2.2].</p>
<p>simultaneousAckNackAndCQI Parameter: <i>Simultaneous-AN-and-CQI</i>, see TS 36.213 [23, 10.1]. TRUE indicates that simultaneous transmission of ACK/NACK and CQI is allowed. One value applies for all CSI processes. For SCells except for the PSCell this field is not applicable and the UE shall ignore the value.</p>
<p>simultaneousAckNackAndCQI-Format3 Indicates that the UE shall perform simultaneous transmission of HARQ A/N and periodic CQI report multiplexing on PUCCH format 3, see TS 36.213 [23, 7.2, 10.1.1]. E-UTRAN configures this information only when <i>pucch-Format</i> is set to <i>format3</i>. One value applies for all CSI processes. For SCells except for the PSCell this field is not applicable and the UE shall ignore the value.</p>
<p>trigger01 Indicates whether or not reporting for this CSI-process or reporting for this CSI-process corresponding to a CSI subframe set is triggered by CSI request field set to 01, for a CSI request applicable for the serving cell on the same frequency as the CSI process, see TS 36.213 [23, table 7.2.1-1B].</p>
<p>trigger10, trigger11 Indicates whether or not reporting for this CSI-process or reporting for this CSI-process corresponding to a CSI subframe set is triggered by CSI request field set to 10 or 11, see TS 36.213 [23, table 7.2.1-1B]. EUTRAN configures at most 5 CSI processes, across all serving frequencies within each CG, to be triggered by a CSI request field set to value 10. The same restriction applies for value 11. In case E-UTRAN simultaneously triggers CSI requests for more than 5 CSI processes some limitations apply, see TS 36.213 [23].</p>
<p>trigger-SubframeSetIndicator For a serving cell configured with <i>csi-MeasSubframeSets-r12</i>, indicates for which CSI subframe set the aperiodic CSI report is triggered for the serving cell if the aperiodic CSI is triggered by the CSI request field 01, see TS 36.213 [23, table 7.2.1-1C]. Value <i>s1</i> corresponds to CSI subframe set 1 and value <i>s2</i> corresponds to CSI subframe set 2.</p>
<p>trigger1-SubframeSetIndicator Indicates for which CSI subframe set the aperiodic CSI report is triggered when aperiodic CSI is triggered by the CSI request field 10, see TS 36.213 [23, table 7.2.1-1C]. The leftmost bit, bit 0 in the bit string corresponds to the cell with <i>ServCellIndex</i>=0 and bit 1 in the bit string corresponds to the cell with <i>ServCellIndex</i>=1 etc. Each bit has either value 0 (means that aperiodic CSI report is triggered for CSI subframe set 1) or value 1 (means that aperiodic CSI report is triggered for CSI subframe set 2).</p>
<p>trigger2-SubframeSetIndicator Indicates for which CSI subframe set the aperiodic CSI report is triggered when aperiodic CSI is triggered by the CSI request field 11, see TS 36.213 [23, table 7.2.1-1C]. The leftmost bit, bit 0 in the bit string corresponds to the cell with <i>ServCellIndex</i>=0 and bit 1 in the bit string corresponds to the cell with <i>ServCellIndex</i>=1 etc. Each bit has either value 0 (means that aperiodic CSI report is triggered for CSI subframe set 1) or value 1 (means that aperiodic CSI report is triggered for CSI subframe set 2).</p>

Conditional presence	Explanation
<i>cqi-Setup</i>	This field is not present for an Scell except for the PSCell, while it is conditionally present for the PCell and the PSCell according to the following. The field is optional present, need OR, if the <i>cqi-ReportPeriodic</i> in the <i>cqi-ReportConfig</i> is set to <i>setup</i> . If the field <i>cqi-ReportPeriodic</i> is present and set to <i>release</i> , the field is not present and the UE shall delete any existing value for this field. Otherwise the field is not present.
<i>PMIRI</i>	The field is optional present, need OR, if <i>cqi-ReportPeriodic</i> is included and set to <i>setup</i> , or <i>cqi-ReportModeAperiodic</i> is included. If the field <i>cqi-ReportPeriodic</i> is present and set to <i>release</i> and <i>cqi-ReportModeAperiodic</i> is absent, the field is not present and the UE shall delete any existing value for this field. Otherwise the field is not present.
<i>PMIRIPCell</i>	The field is optional present, need OR, if <i>cqi-ReportPeriodic</i> is included in the <i>CQI-ReportConfig-r10</i> and set to <i>setup</i> , or <i>cqi-ReportAperiodic</i> is included in the <i>CQI-ReportConfig-r10</i> and set to <i>setup</i> . If the field <i>cqi-ReportPeriodic</i> is present in the <i>CQI-ReportConfig-r10</i> and set to <i>release</i> and <i>cqi-ReportAperiodic</i> is included in the <i>CQI-ReportConfig-r10</i> and set to <i>release</i> , the field is not present and the UE shall delete any existing value for this field. Otherwise the field is not present.
<i>PMIRISCell</i>	The field is optional present, need OR, if <i>cqi-ReportPeriodicSCell</i> is included and set to <i>setup</i> , or <i>cqi-ReportModeAperiodic-r10</i> is included in the <i>CQI-ReportConfigSCell</i> . If the field <i>cqi-ReportPeriodicSCell</i> is present and set to <i>release</i> and <i>cqi-ReportModeAperiodic-r10</i> is absent in the <i>CQI-ReportConfigSCell</i> , the field is not present and the UE shall delete any existing value for this field. Otherwise the field is not present.

– *CQI-ReportPeriodicProcExtId*

The IE *CQI-ReportPeriodicProcExtId* is used to identify a periodic CQI reporting configuration that E-UTRAN may configure in addition to the configuration specified by the IE *CQI-ReportPeriodic-r10*. These additional configurations are specified by the IE *CQI-ReportPeriodicProcExt-r11*. The identity is unique within the scope of a carrier frequency.

***CQI-ReportPeriodicProcExtId* information elements**

```
-- ASN1START
CQI-ReportPeriodicProcExtId-r11 ::= INTEGER (1..maxCQI-ProcExt-r11)
-- ASN1STOP
```

– *CrossCarrierSchedulingConfig*

The IE *CrossCarrierSchedulingConfig* is used to specify the configuration when the cross carrier scheduling is used in a cell.

***CrossCarrierSchedulingConfig* information elements**

```
-- ASN1START
CrossCarrierSchedulingConfig-r10 ::= SEQUENCE {
  schedulingCellInfo-r10 CHOICE {
    own-r10 SEQUENCE { -- No cross carrier
      scheduling cif-Presence-r10 BOOLEAN
    },
    other-r10 SEQUENCE { -- Cross carrier
      scheduling schedulingCellId-r10 ServCellIndex-r10,
        pdsch-Start-r10 INTEGER (1..4)
    }
  }
}
-- ASN1STOP
```

CrossCarrierSchedulingConfig field descriptions
<p>cif-Presence The field is used to indicate whether carrier indicator field is present (value TRUE) or not (value FALSE) in PDCCH/EPDCCH DCI formats, see TS 36.212 [22, 5.3.3.1].</p>
<p>pdsch-Start The starting OFDM symbol of PDSCH for the concerned SCell, see TS 36.213 [23, 7.1.6.4]. Values 1, 2, 3 are applicable when <i>dl-Bandwidth</i> for the concerned SCell is greater than 10 resource blocks, values 2, 3, 4 are applicable when <i>dl-Bandwidth</i> for the concerned SCell is less than or equal to 10 resource blocks, see TS 36.211 [21, Table 6,7-1].</p>
<p>schedulingCellId Indicates which cell signals the downlink allocations and uplink grants, if applicable, for the concerned SCell. In case the UE is configured with DC, the scheduling cell is part of the same cell group (i.e. MCG or SCG) as the scheduled cell.</p>

– CSI-IM-Config

The IE *CSI-IM-Config* is the CSI Interference Measurement (IM) configuration that E-UTRAN may configure on a serving frequency, see TS 36.213 [23, 7.2.6].

CSI-IM-Config information elements

```

-- ASN1START
CSI-IM-Config-r11 ::=          SEQUENCE {
    csi-IM-ConfigId-r11        CSI-IM-ConfigId-r11,
    resourceConfig-r11         INTEGER (0..31),
    subframeConfig-r11         INTEGER (0..154),
    ...
}
CSI-IM-ConfigExt-r12 ::=      SEQUENCE {
    csi-IM-ConfigId-v1250      CSI-IM-ConfigId-v1250,
    resourceConfig-r12         INTEGER (0..31),
    subframeConfig-r12         INTEGER (0..154),
    ...
}
-- ASN1STOP

```

CSI-IM-Config field descriptions
<p>resourceConfig Parameter: CSI reference signal configuration, see TS 36.213 [23, 7.2.6] and TS 36.211 [21, table 6.10.5.2-1 and 6.10.5.2-2] for 4 REs.</p>
<p>subframeConfig Parameter: $I_{\text{CSI-RS}}$, see TS 36.213 [23, 7.2.6] and TS 36.211 [21, table 6.10.5.3-1].</p>

– CSI-IM-ConfigId

The IE *CSI-IM-ConfigId* is used to identify a CSI-IM configuration that is configured by the IE *CSI-IM-Config*. The identity is unique within the scope of a carrier frequency.

CSI-IM-ConfigId information elements

```

-- ASN1START
CSI-IM-ConfigId-r11 ::=      INTEGER (1..maxCSI-IM-r11)
CSI-IM-ConfigId-r12 ::=      INTEGER (1..maxCSI-IM-r12)
CSI-IM-ConfigId-v1250 ::=    INTEGER (maxCSI-IM-r12)
-- ASN1STOP

```

– CSI-Process

The IE *CSI-Process* is the CSI process configuration that E-UTRAN may configure on a serving frequency.

CSI-Process information elements

```

-- ASN1START
CSI-Process-r11 ::= SEQUENCE {
  csi-ProcessId-r11          CSI-ProcessId-r11,
  csi-RS-ConfigNZPId-r11   CSI-RS-ConfigNZPId-r11,
  csi-IM-ConfigId-r11      CSI-IM-ConfigId-r11,
  p-C-AndCBSRList-r11 SEQUENCE (SIZE (1..2)) OF P-C-AndCBSR-r11,
  cqi-ReportBothProc-r11   CQI-ReportBothProc-r11          OPTIONAL,      -- Need OR
  cqi-ReportPeriodicProcId-r11 INTEGER (0..maxCQI-ProcExt-r11) OPTIONAL,      -- Need OR
  cqi-ReportAperiodicProc-r11 CQI-ReportAperiodicProc-r11  OPTIONAL,      -- Need OR
  ...,
  [[ alternativeCodebookEnabledFor4TXProc-r12 ENUMERATED {true} OPTIONAL,      -- Need ON
    csi-IM-ConfigIdList-r12 CHOICE {
      release NULL,
      setup SEQUENCE (SIZE (1..2)) OF CSI-IM-ConfigId-r12
    } OPTIONAL,      -- Need ON
    cqi-ReportAperiodicProc2-r12 CHOICE {
      release NULL,
      setup CQI-ReportAperiodicProc-r11
    } OPTIONAL      -- Need ON
  ]]
}

P-C-AndCBSR-r11 ::= SEQUENCE {
  p-C-r11 INTEGER (-8..15),
  codebookSubsetRestriction-r11 BIT STRING
}
-- ASN1STOP

```

CSI-Process field descriptions
<p>alternativeCodebookEnabledFor4TXProc Indicates whether code book in TS 36.213 [23] Table 7.2.4-0A to Table 7.2.4-0D is being used for deriving CSI feedback and reporting for a CSI process. E-UTRAN may configure the field only if the number of CSI-RS ports for non-zero power transmission CSI-RS configuration is 4.</p>
<p>cqi-ReportAperiodicProc If <i>csi-MeasSubframeSets-r12</i> is configured for the same frequency as the CSI process, <i>cqi-ReportAperiodicProc</i> applies for CSI subframe set 1. If <i>csi-MeasSubframeSet1-r10</i> or <i>csi-MeasSubframeSet2-r10</i> are configured for the same frequency as the CSI process, <i>cqi-ReportAperiodicProc</i> applies for CSI subframe set 1 or CSI subframe set 2. Otherwise, <i>cqi-ReportAperiodicProc</i> applies for all subframes</p>
<p>cqi-ReportAperiodicProc2 <i>cqi-ReportAperiodicProc2</i> is configured only if <i>csi-MeasSubframeSets-r12</i> is configured for the same frequency as the CSI process. <i>cqi-ReportAperiodicProc2</i> is for CSI subframe set 2. E-UTRAN shall set <i>cqi-ReportModeAperiodic-r11</i> in <i>cqi-ReportAperiodicProc2</i> the same as in <i>cqi-ReportAperiodicProc</i>.</p>
<p>cqi-ReportBothProc Includes CQI configuration parameters applicable for both aperiodic and periodic CSI reporting, for which CSI process specific values may be configured. E-UTRAN configures the field if and only if <i>cqi-ReportPeriodicProclD</i> is included and/ or if <i>cqi-ReportAperiodicProc</i> is included.</p>
<p>cqi-ReportPeriodicProclD Refers to a periodic CQI reporting configuration that is configured for the same frequency as the CSI process. Value 0 refers to the set of parameters defined by the REL-10 CQI reporting configuration fields, while the other values refer to the additional configurations E-UTRAN assigns by <i>CQI-ReportPeriodicProcExt-r11</i> (and as covered by <i>CQI-ReportPeriodicProcExtId</i>).</p>
<p>csi-IM-ConfigId Refers to a CSI-IM configuration that is configured for the same frequency as the CSI process.</p>
<p>csi-IM-ConfigIdList Refers to one or two CSI-IM configurations that are configured for the same frequency as the CSI process. <i>csi-IM-ConfigIdList</i> can include 2 entries only if <i>csi-MeasSubframeSets-r12</i> is configured for the same frequency as the CSI process. UE shall ignore <i>csi-IM-ConfigId-r11</i> if <i>csi-IM-ConfigIdList-r12</i> is configured.</p>
<p>csi-RS-ConfigNZPId Refers to a CSI RS configuration using non-zero power transmission that is configured for the same frequency as the CSI process.</p>
<p>p-C Parameter: P_c, see TS 36.213 [23, 7.2.5].</p>
<p>p-C-AndCBSRList A <i>p-C-AndCBSRList</i> including 2 entries indicates that the subframe patterns configured for CSI (CQI/PMI/PTI/RI) reporting (i.e. as defined by field <i>csi-MeasSubframeSet1</i> and <i>csi-MeasSubframeSet2</i>, or as defined by <i>csi-MeasSubframeSets-r12</i>) are to be used for this CSI process, while a single entry indicates that the subframe patterns are not to be used for this CSI process. E-UTRAN does not include 2 entries in <i>p-C-AndCBSRList</i> with <i>csi-MeasSubframeSet1</i> and <i>csi-MeasSubframeSet2</i> for CSI processes concerning a secondary frequency. E-UTRAN includes 2 entries in <i>p-C-AndCBSRList</i> when configuring both <i>cqi-pmi-ConfigIndex</i> and <i>cqi-pmi-ConfigIndex2</i>.</p>

– CSI-ProcessId

The IE *CSI-ProcessId* is used to identify a CSI process that is configured by the IE *CSI-Process*. The identity is unique within the scope of a carrier frequency.

CSI-ProcessId information elements

```
-- ASN1START
CSI-ProcessId-r11 ::=          INTEGER (1..maxCSI-Proc-r11)
-- ASN1STOP
```

– CSI-RS-Config

The IE *CSI-RS-Config* is used to specify the CSI (Channel-State Information) reference signal configuration.

CSI-RS-Config information elements

```
-- ASN1START
CSI-RS-Config-r10 ::=          SEQUENCE {
    csi-RS-r10                  CHOICE {
        release                 NULL,

```

```

        setup                    SEQUENCE {
            antennaPortsCount-r10    ENUMERATED {an1, an2, an4, an8},
            resourceConfig-r10       INTEGER (0..31),
            subframeConfig-r10       INTEGER (0..154),
            p-C-r10                  INTEGER (-8..15)
        }
    }
    zeroTxPowerCSI-RS-r10          ZeroTxPowerCSI-RS-Conf-r12    OPTIONAL,      -- Need ON
    }                               OPTIONAL                    -- Need ON
}

CSI-RS-Config-v1250 ::= SEQUENCE {
    zeroTxPowerCSI-RS2-r12        ZeroTxPowerCSI-RS-Conf-r12    OPTIONAL,      -- Need ON
    ds-ZeroTxPowerCSI-RS-r12     CHOICE {
        release                    NULL,
        setup                      SEQUENCE {
            zeroTxPowerCSI-RS-List-r12 SEQUENCE (SIZE (1..maxDS-ZTP-CSI-RS-r12)) OF
ZeroTxPowerCSI-RS-r12
        }
    }
}
}                               OPTIONAL                    -- Need
ON
}

ZeroTxPowerCSI-RS-Conf-r12 ::= CHOICE {
    release                        NULL,
    setup                          ZeroTxPowerCSI-RS-r12
}

ZeroTxPowerCSI-RS-r12 ::= SEQUENCE {
    zeroTxPowerResourceConfigList-r12 BIT STRING (SIZE (16)),
    zeroTxPowerSubframeConfig-r12     INTEGER (0..154)
}

-- ASN1STOP

```

CSI-RS-Config field descriptions	
antennaPortsCount	Parameter represents the number of antenna ports used for transmission of CSI reference signals where value an1 corresponds to 1 antenna port, an2 to 2 antenna ports and so on, see TS 36.211 [21, 6.10.5].
ds-ZeroTxPowerCSI-RS	Parameter for additional <i>zeroTxPowerCSI-RS</i> for a serving cell, concerning the CSI-RS included in discovery signals.
zeroTxPowerCSI-RS2	Parameter for additional <i>zeroTxPowerCSI-RS</i> for a serving cell. E-UTRAN configures the field only if <i>csi-MeasSubframeSets-r12</i> and <i>TM 1 – 9</i> are configured for the serving cell.
p-C	Parameter: P_c , see TS 36.213 [23, 7.2.5].
resourceConfig	Parameter: CSI reference signal configuration, see TS 36.211 [21, table 6.10.5.2-1 and 6.10.5.2-2].
subframeConfig	Parameter: I_{CSI-RS} , see TS 36.211 [21, table 6.10.5.3-1].
zeroTxPowerResourceConfigList	Parameter: <i>ZeroPowerCSI-RS</i> , see TS 36.213 [23, 7.2.7].
zeroTxPowerSubframeConfig	Parameter: I_{CSI-RS} , see TS 36.211 [21, table 6.10.5.3-1].

– *CSI-RS-ConfigNZIP*

The IE *CSI-RS-ConfigNZIP* is the CSI-RS resource configuration using non-zero power transmission that E-UTRAN may configure on a serving frequency.

CSI-RS-ConfigNZIP information elements

```

-- ASN1START

CSI-RS-ConfigNZIP-r11 ::= SEQUENCE {
    csi-RS-ConfigNZIPId-r11      CSI-RS-ConfigNZIPId-r11,
    antennaPortsCount-r11       ENUMERATED {an1, an2, an4, an8},
    resourceConfig-r11          INTEGER (0..31),
    subframeConfig-r11          INTEGER (0..154),
    scramblingIdentity-r11      INTEGER (0..503),
    qcl-CRS-Info-r11            SEQUENCE {

```

```

    qcl-ScramblingIdentity-r11      INTEGER (0..503),
    crs-PortsCount-r11             ENUMERATED {n1, n2, n4, spare1},
    mbsfn-SubframeConfigList-r11  CHOICE {
        release                     NULL,
        setup                       SEQUENCE {
            subframeConfigList      MBSFN-SubframeConfigList
        }
    }
}
...
}
-- ASN1STOP
OPTIONAL -- Need ON
OPTIONAL -- Need OR

```

CSI-RS-ConfigNZP field descriptions

antennaPortsCount

Parameter represents the number of antenna ports used for transmission of CSI reference signals where an1 corresponds to 1, an2 to 2 antenna ports etc. see TS 36.211 [21, 6.10.5].

qcl-CRS-Info

Indicates CRS antenna ports that is quasi co-located with the CSI-RS antenna ports, see TS 36.213 [23, 7.2.5]. EUTRAN configures this field if and only if the UE is configured with *qcl-Operation* set to *typeB*.

resourceConfig

Parameter: CSI reference signal configuration, see TS 36.211 [21, table 6.10.5.2-1 and 6.10.5.2-2].

subframeConfig

Parameter: $I_{\text{CSI-RS}}$, see TS 36.211 [21, table 6.10.5.3-1].

scramblingIdentity

Parameter: Pseudo-random sequence generator parameter, n_{ID} , see TS 36.213 [23, 7.2.5].

CSI-RS-ConfigNZPId

The IE *CSI-RS-ConfigNZPId* is used to identify a CSI-RS resource configuration using non-zero transmission power, as configured by the IE *CSI-RS-ConfigNZP*. The identity is unique within the scope of a carrier frequency.

CSI-RS-ConfigNZPId information elements

```

-- ASN1START
CSI-RS-ConfigNZPId-r11 ::=          INTEGER (1..maxCSI-RS-NZP-r11)
-- ASN1STOP

```

CSI-RS-ConfigZP

The IE *CSI-RS-ConfigZP* is the CSI-RS resource configuration, for which UE assumes zero transmission power, that E-UTRAN may configure on a serving frequency.

CSI-RS-ConfigZP information elements

```

-- ASN1START
CSI-RS-ConfigZP-r11 ::=          SEQUENCE {
    csi-RS-ConfigZPId-r11        CSI-RS-ConfigZPId-r11,
    resourceConfigList-r11       BIT STRING (SIZE (16)),
    subframeConfig-r11           INTEGER (0..154),
    ...
}
-- ASN1STOP

```

CSI-RS-ConfigZP field descriptions

resourceConfigList

Parameter: *ZeroPowerCSI-RS*, see TS 36.213 [23, 7.2.7].

subframeConfig

Parameter: $I_{\text{CSI-RS}}$, see TS 36.211 [21, table 6.10.5.3-1].

– *CSI-RS-ConfigZPId*

The IE *CSI-RS-ConfigZPId* is used to identify a CSI-RS resource configuration for which UE assumes zero transmission power, as configured by the IE *CSI-RS-ConfigZP*. The identity is unique within the scope of a carrier frequency.

CSI-RS-ConfigZPId information elements

```
-- ASN1START
CSI-RS-ConfigZPId-r11 ::=                INTEGER (1..maxCSI-RS-ZP-r11)
-- ASN1STOP
```

– *DMRS-Config*

The IE *DMRS-Config* is the DMRS configuration that E-UTRAN may configure on a serving frequency.

DMRS-Config information elements

```
-- ASN1START
DMRS-Config-r11 ::=      CHOICE {
  release                NULL,
  setup                  SEQUENCE {
    scramblingIdentity-r11    INTEGER (0..503),
    scramblingIdentity2-r11   INTEGER (0..503)
  }
}
-- ASN1STOP
```

DMRS-Config field descriptions

scramblingIdentity*, *scramblingIdentity2

Parameter: $n_{ID}^{DMRS,i}$, see TS 36.211 [21, 6.10.3.1].

– *DRB-Identity*

The IE *DRB-Identity* is used to identify a DRB used by a UE.

DRB-Identity information elements

```
-- ASN1START
DRB-Identity ::=                INTEGER (1..32)
-- ASN1STOP
```

– *EPDCCH-Config*

The IE *EPDCCH-Config* specifies the subframes and resource blocks for EPDCCH monitoring that E-UTRAN may configure for a serving cell.

EPDCCH-Config information element

```
-- ASN1START
EPDCCH-Config-r11 ::=      SEQUENCE{
  config-r11              CHOICE {
    release                NULL,
    setup                  SEQUENCE {
      subframePatternConfig-r11  CHOICE {
        release            NULL,
        setup              SEQUENCE {
          subframePattern-r11    MeasSubframePattern-r10
        }
      }
    }
  }
}
OPTIONAL, -- Need ON
```

```

        startSymbol-r11          INTEGER (1..4)          OPTIONAL, -- Need OP
        setConfigToReleaseList-r11 EPDCCH-SetConfigToReleaseList-r11 OPTIONAL, -- Need ON
        setConfigToAddModList-r11 EPDCCH-SetConfigToAddModList-r11  OPTIONAL -- Need ON
    }
}

EPDCCH-SetConfigToAddModList-r11 ::= SEQUENCE (SIZE(1..maxEPDCCH-Set-r11)) OF EPDCCH-SetConfig-
r11

EPDCCH-SetConfigToReleaseList-r11 ::= SEQUENCE (SIZE(1..maxEPDCCH-Set-r11)) OF EPDCCH-SetConfigId-
r11

EPDCCH-SetConfig-r11 ::= SEQUENCE {
    setConfigId-r11          EPDCCH-SetConfigId-r11,
    transmissionType-r11    ENUMERATED {localised, distributed},
    resourceBlockAssignment-r11 SEQUENCE{
        numberPRB-Pairs-r11    ENUMERATED {n2, n4, n8},
        resourceBlockAssignment-r11 BIT STRING (SIZE(4..38))
    },
    dmrs-ScramblingSequenceInt-r11 INTEGER (0..503),
    pucch-ResourceStartOffset-r11 INTEGER (0..2047),
    re-MappingQCL-ConfigId-r11 PDSCH-RE-MappingQCL-ConfigId-r11  OPTIONAL, -- Need OR
    ...,
    [[ csi-RS-ConfigZPID2-r12    CHOICE {
        release                NULL,
        setup                  CSI-RS-ConfigZPID-r11
    }
    ]]
}

EPDCCH-SetConfigId-r11 ::= INTEGER (0..1)

-- ASN1STOP

```

EPDCCH-Config field descriptions
<p>csi-RS-ConfigZPId2 Indicates the rate matching parameters in addition to those indicated by <i>re-MappingQCL-ConfigId</i>. E-UTRAN configures this field only when tm10 is configured.</p>
<p>dmrs-ScramblingSequenceInt The DMRS scrambling sequence initialization parameter $n_{ID,i}^{EPDCCH}$ defined in TS 36.211 [21, 6.10.3A.1].</p>
<p>EPDCCH-SetConfig Provides EPDCCH configuration set. See TS 36.213 [23, 9.1.4]. E-UTRAN configures at least one <i>EPDCCH-SetConfig</i> when <i>EPDCCH-Config</i> is configured.</p>
<p>numberPRB-Pairs Indicates the number of physical resource-block pairs used for the EPDCCH set. Value n2 corresponds to 2 physical resource-block pairs; n4 corresponds to 4 physical resource-block pairs and so on. Value n8 is not supported if <i>dl-Bandwidth</i> is set to 6 resource blocks.</p>
<p>pucch-ResourceStartOffset PUCCH format 1a, 1b and 3 resource starting offset for the EPDCCH set. See TS 36.213 [23, 10.1].</p>
<p>re-MappingQCL-ConfigId Indicates the starting OFDM symbol, the related rate matching parameters and quasi co-location assumption for EPDCCH when the UE is configured with tm10. This field provides the identity of a configured <i>PDSCH-RE-MappingQCL-Config</i>. E-UTRAN configures this field only when tm10 is configured.</p>
<p>resourceBlockAssignment Indicates the index to a specific combination of physical resource-block pair for EPDCCH set. See TS 36.213 [23, 9.1.4.4]. The size of <i>resourceBlockAssignment</i> is specified in TS 36.213 [23, 9.1.4.4] and based on <i>numberPRB-Pairs</i> and the signalled value of <i>dl-Bandwidth</i>.</p>
<p>setConfigId Indicates the identity of the EPDCCH configuration set.</p>
<p>startSymbol Indicates the OFDM starting symbol for any EPDCCH and PDSCH scheduled by EPDCCH on the same cell, see TS 36.213 [23, 9.1.4.1]. If not present, the UE shall release the configuration and shall derive the starting OFDM symbol of EPDCCH and PDSCH scheduled by EPDCCH from PCFICH. Values 1, 2, and 3 are applicable for <i>dl-Bandwidth</i> greater than 10 resource blocks. Values 2, 3, and 4 are applicable otherwise. E-UTRAN does not configure the field for UEs configured with tm10.</p>
<p>subframePatternConfig Configures the subframes which the UE shall monitor the UE-specific search space on EPDCCH, except for pre-defined rules in TS 36.213 [23, 9.1.4]. If the field is not configured when EPDCCH is configured, the UE shall monitor the UE-specific search space on EPDCCH in all subframes except for pre-defined rules in TS 36.213 [23, 9.1.4].</p>
<p>transmissionType Indicates whether distributed or localized EPDCCH transmission mode is used as defined in TS 36.211 [21, 6.8A.1].</p>

– *EIMTA-MainConfig*

The IE *EIMTA-MainConfig* is used to specify the eIMTA-RNTI used for eIMTA and the subframes used for monitoring PDCCH with eIMTA-RNTI. The IE *EIMTA-MainConfigServCell* is used to specify the eIMTA related parameters applicable for the concerned serving cell.

***EIMTA-MainConfig* information element**

```

-- ASN1START
EIMTA-MainConfig-r12 ::= CHOICE {
  release      NULL,
  setup        SEQUENCE {
    eimta-RNTI-r12      C-RNTI,
    eimta-CommandPeriodicity-r12  ENUMERATED {sf10, sf20, sf40, sf80},
    eimta-CommandSubframeSet-r12  BIT STRING (SIZE(10))
  }
}

EIMTA-MainConfigServCell-r12 ::= CHOICE {
  release      NULL,
  setup        SEQUENCE {
    eimta-UL-DL-ConfigIndex-r12      INTEGER (1..5),
    eimta-HARQ-ReferenceConfig-r12    ENUMERATED {sa2, sa4, sa5},
    mbsfn-SubframeConfigList-v1250    CHOICE {
      release      NULL,
      setup        SEQUENCE {
        subframeConfigList-r12        MBSFN-SubframeConfigList
      }
    }
  }
}
-- ASN1END

```

```
-- ASN1STOP
```

EIMTA-MainConfig field descriptions	
<i>eimta-CommandPeriodicity</i>	Configures the periodicity to monitor PDCCH with eIMTA-RNTI, see TS 36.213 [23, 13.1]. Value sf10 corresponds to 10 subframes, sf20 corresponds to 20 subframes and so on.
<i>eimta-CommandSubframeSet</i>	Configures the subframe(s) to monitor PDCCH with eIMTA-RNTI within the periodicity configured by <i>eimta-CommandPeriodicity</i> . The 10 bits correspond to all subframes in the last radio frame within each periodicity. The left most bit is for subframe 0 and so on. Each bit can be of value 0 or 1. The value of 1 means that the corresponding subframe is configured for monitoring PDCCH with eIMTA-RNTI, and the value of 0 means otherwise. In case of TDD as PCell, only the downlink and the special subframes indicated by the UL/ DL configuration in SIB1 can be configured for monitoring PDCCH with eIMTA-RNTI. In case of FDD as PCell, any of the ten subframes can be configured for monitoring PDCCH with eIMTA-RNTI.
<i>eimta-HARQ-ReferenceConfig</i>	Indicates UL/ DL configuration used as the DL HARQ reference configuration for this serving cell. Value sa2 corresponds to Configuration2, sa4 to Configuration4 etc, as specified in TS 36.211 [21, table 4.2-2]. E-UTRAN configures the same value for all serving cells residing on same frequency band.
<i>eimta-UL-DL-ConfigIndex</i>	Index of <i>l</i> , see TS 36.212 [22, 5.3.3.1.4]. E-UTRAN configures the same value for all serving cells residing on same frequency band.
<i>mbsfn-SubframeConfigList</i>	Configure the MBSFN subframes for the UE on this serving cell. An uplink subframe indicated by the DL/UL subframe configuration in SIB1 can be configured as MBSFN subframe.

– *LogicalChannelConfig*

The IE *LogicalChannelConfig* is used to configure the logical channel parameters.

***LogicalChannelConfig* information element**

```
-- ASN1START
LogicalChannelConfig ::=
    ul-SpecificParameters
        priority
        prioritisedBitRate
        bucketSizeDuration
        logicalChannelGroup
    } OPTIONAL,
    ...,
    [[ logicalChannelSR-Mask-r9
    ]],
    [[ logicalChannelSR-Prohibit-r12
    ]]
}
-- ASN1STOP
```

LogicalChannelConfig field descriptions	
bucketSizeDuration	Bucket Size Duration for logical channel prioritization in TS 36.321 [6]. Value in milliseconds. Value ms50 corresponds to 50 ms, ms100 corresponds to 100 ms and so on.
logicalChannelGroup	Mapping of logical channel to logical channel group for BSR reporting in TS 36.321 [6].
logicalChannelSR-Mask	Controlling SR triggering on a logical channel basis when an uplink grant is configured. See TS 36.321 [6].
logicalChannelSR-Prohibit	Value <i>TRUE</i> indicates that the <i>logicalChannelSR-ProhibitTimer</i> is enabled for the logical channel. E-UTRAN only (optionally) configures the field (i.e. indicates value <i>TRUE</i>) if <i>logicalChannelSR-ProhibitTimer</i> is configured. See TS 36.321 [6].
prioritisedBitRate	Prioritized Bit Rate for logical channel prioritization in TS 36.321 [6]. Value in kilobytes/second. Value kbps0 corresponds to 0 kB/second, kbps8 corresponds to 8 kB/second, kbps16 corresponds to 16 kB/second and so on. Infinity is the only applicable value for SRB1 and SRB2
priority	Logical channel priority in TS 36.321 [6]. Value is an integer.

Conditional presence	Explanation
<i>SRmask</i>	The field is optionally present if <i>ul-SpecificParameters</i> is present, need OR; otherwise it is not present.
<i>UL</i>	The field is mandatory present for UL logical channels; otherwise it is not present.

– MAC-MainConfig

The IE *MAC-MainConfig* is used to specify the MAC main configuration for signalling and data radio bearers. All MAC main configuration parameters can be configured independently per Cell Group (i.e. MCG or SCG), unless explicitly specified otherwise.

MAC-MainConfig information element

```
-- ASN1START
MAC-MainConfig ::=
    ul-SCH-Config
        maxHARQ-Tx
        periodicBSR-Timer
        retxBSR-Timer
        ttiBundling
    }
    drx-Config
    timeAlignmentTimerDedicated
    phr-Config
        release
        setup
        periodicPHR-Timer
        prohibitPHR-Timer
        dl-PathlossChange
    }
    sr-ProhibitTimer-r9
    mac-MainConfig-v1020
        sCellDeactivationTimer-r10
        extendedBSR-Sizes-r10
        extendedPHR-r10
    }
    stag-ToReleaseList-r11
    stag-ToAddModList-r11
    drx-Config-v1130
```

```
SEQUENCE {
    SEQUENCE {
        ENUMERATED {
            n1, n2, n3, n4, n5, n6, n7, n8,
            n10, n12, n16, n20, n24, n28,
            spare2, spare1} OPTIONAL, -- Need ON
        PeriodicBSR-Timer-r12 OPTIONAL, -- Need ON
        RetxBSR-Timer-r12,
        BOOLEAN
    } OPTIONAL, -- Need ON
    DRX-Config
    TimeAlignmentTimer,
    CHOICE {
        NULL,
        SEQUENCE {
            ENUMERATED {sf10, sf20, sf50, sf100, sf200,
                sf500, sf1000, infinity},
            ENUMERATED {sf0, sf10, sf20, sf50, sf100,
                sf200, sf500, sf1000},
            ENUMERATED {dB1, dB3, dB6, infinity}
        }
    } OPTIONAL, -- Need ON
    INTEGER (0..7) OPTIONAL -- Need ON
    SEQUENCE {
        ENUMERATED {
            rf2, rf4, rf8, rf16, rf32, rf64, rf128,
            spare} OPTIONAL, -- Need OP
        ENUMERATED {setup} OPTIONAL, -- Need OR
        ENUMERATED {setup} OPTIONAL -- Need OR
    } OPTIONAL -- Need ON
    STAG-ToReleaseList-r11 OPTIONAL, -- Need ON
    STAG-ToAddModList-r11 OPTIONAL, -- Need ON
    DRX-Config-v1130 OPTIONAL -- Need ON
}
```

```

]],
[[ e-HARQ-Pattern-r12                BOOLEAN                OPTIONAL,  -- Need ON
   dualConnectivityPHR                CHOICE {
     release                            NULL,
     setup                               SEQUENCE {
       phr-ModeOtherCG-r12              ENUMERATED {real, virtual}
     }
   }
   logicalChannelSR-Config-r12        CHOICE {
     release                            NULL,
     setup                               SEQUENCE {
       logicalChannelSR-ProhibitTimer-r12  ENUMERATED {sf20, sf40, sf64, sf128, sf512,
sf1024, sf2560, spare1}
     }
   }
]]
}

MAC-MainConfigSCell-r11 ::=          SEQUENCE {
  stag-Id-r11                          STAG-Id-r11          OPTIONAL,  -- Need OP
  ...
}

DRX-Config ::=                       CHOICE {
  release                               NULL,
  setup                                SEQUENCE {
    onDurationTimer                     ENUMERATED {
      psf1, psf2, psf3, psf4, psf5, psf6,
      psf8, psf10, psf20, psf30, psf40,
      psf50, psf60, psf80, psf100,
      psf200},
    drx-InactivityTimer                 ENUMERATED {
      psf1, psf2, psf3, psf4, psf5, psf6,
      psf8, psf10, psf20, psf30, psf40,
      psf50, psf60, psf80, psf100,
      psf200, psf300, psf500, psf750,
      psf1280, psf1920, psf2560, psf0-v1020,
      spare9, spare8, spare7, spare6,
      spare5, spare4, spare3, spare2,
      spare1},
    drx-RetransmissionTimer             ENUMERATED {
      psf1, psf2, psf4, psf6, psf8, psf16,
      psf24, psf33},
    longDRX-CycleStartOffset            CHOICE {
      sf10                               INTEGER(0..9),
      sf20                               INTEGER(0..19),
      sf32                               INTEGER(0..31),
      sf40                               INTEGER(0..39),
      sf64                               INTEGER(0..63),
      sf80                               INTEGER(0..79),
      sf128                              INTEGER(0..127),
      sf160                              INTEGER(0..159),
      sf256                              INTEGER(0..255),
      sf320                              INTEGER(0..319),
      sf512                              INTEGER(0..511),
      sf640                              INTEGER(0..639),
      sf1024                             INTEGER(0..1023),
      sf1280                             INTEGER(0..1279),
      sf2048                             INTEGER(0..2047),
      sf2560                             INTEGER(0..2559)
    },
    shortDRX                             SEQUENCE {
      shortDRX-Cycle                     ENUMERATED {
        sf2, sf5, sf8, sf10, sf16, sf20,
        sf32, sf40, sf64, sf80, sf128, sf160,
        sf256, sf320, sf512, sf640},
      drxShortCycleTimer                 INTEGER (1..16)
    }
  }
}

DRX-Config-v1130 ::=                 SEQUENCE {
  drx-RetransmissionTimer-v1130         ENUMERATED {psf0-v1130} OPTIONAL,  --Need OR
  longDRX-CycleStartOffset-v1130        CHOICE {
    sf60-v1130                           INTEGER(0..59),
    sf70-v1130                           INTEGER(0..69)
  }
  shortDRX-Cycle-v1130                  ENUMERATED {sf4-v1130} OPTIONAL,  --Need OR
}

```

```
}
PeriodicBSR-Timer-r12 ::=          ENUMERATED {
                                     sf5, sf10, sf16, sf20, sf32, sf40, sf64, sf80,
                                     sf128, sf160, sf320, sf640, sf1280, sf2560,
                                     infinity, spare1}
RetxBSR-Timer-r12 ::=             ENUMERATED {
                                     sf320, sf640, sf1280, sf2560, sf5120,
                                     sf10240, spare2, spare1}
STAG-ToReleaseList-r11 ::= SEQUENCE (SIZE (1..maxSTAG-r11)) OF STAG-Id-r11
STAG-ToAddModList-r11 ::= SEQUENCE (SIZE (1..maxSTAG-r11)) OF STAG-ToAddMod-r11
STAG-ToAddMod-r11 ::= SEQUENCE {
    stag-Id-r11                STAG-Id-r11,
    timeAlignmentTimerSTAG-r11 TimeAlignmentTimer,
    ...
}
STAG-Id-r11 ::=                INTEGER (1..maxSTAG-r11)
-- ASN1STOP
```

MAC-MainConfig field descriptions
<p>dl-PathlossChange DL Pathloss Change and the change of the required power backoff due to power management (as allowed by P-MPRc [42]) for PHR reporting in TS 36.321 [6]. Value in dB. Value dB1 corresponds to 1 dB, dB3 corresponds to 3 dB and so on. The same value applies for each serving cell (although the associated functionality is performed independently for each cell).</p>
<p>drx-Config Used to configure DRX as specified in TS 36.321 [6]. E-UTRAN configures the values in <i>DRX-Config-v1130</i> only if the UE indicates support for IDC indication. E-UTRAN configures <i>drx-Config-v1130</i> only if <i>drx-Config</i> (without suffix) is configured.</p>
<p>drx-InactivityTimer Timer for DRX in TS 36.321 [6]. Value in number of PDCCH sub-frames. Value psf1 corresponds to 1 PDCCH sub-frame, psf2 corresponds to 2 PDCCH sub-frames and so on.</p>
<p>drx-RetransmissionTimer Timer for DRX in TS 36.321 [6]. Value in number of PDCCH sub-frames. Value psf1 corresponds to 1 PDCCH sub-frame, psf2 corresponds to 2 PDCCH sub-frames and so on. In case <i>drx-RetransmissionTimer-v1130</i> is signalled, the UE shall ignore <i>drx-RetransmissionTimer</i> (i.e. without suffix).</p>
<p>drxShortCycleTimer Timer for DRX in TS 36.321 [6]. Value in multiples of shortDRX-Cycle. A value of 1 corresponds to shortDRX-Cycle, a value of 2 corresponds to 2 * shortDRX-Cycle and so on.</p>
<p>dualConnectivityPHR Indicates if power headroom shall be reported using Dual Connectivity Power Headroom Report MAC Control Element defined in TS 36.321 [6] (value <i>setup</i>). If PHR functionality and dual connectivity are configured, E-UTRAN always configures the value <i>setup</i> for this field and configures <i>phr-Config</i> and <i>dualConnectivityPHR</i> for both CGs.</p>
<p>e-HARQ-Pattern TRUE indicates that enhanced HARQ pattern for TTI bundling is enabled for FDD. E-UTRAN enables this field only when <i>ttiBundling</i> is set to <i>TRUE</i>.</p>
<p>extendedBSR-Sizes If value <i>setup</i> is configured, the BSR index indicates extended BSR size levels as defined in TS 36.321 [6, Table 6.1.3.1-2].</p>
<p>extendedPHR Indicates if power headroom shall be reported using the Extended Power Headroom Report MAC control element defined in TS 36.321 [6] (value <i>setup</i>). E-UTRAN always configures the value <i>setup</i> if more than one Serving Cell with uplink is configured and if dual connectivity is not configured. E-UTRAN configures <i>extendedPHR</i> only if <i>phr-Config</i> is configured. The UE shall release <i>extendedPHR</i> if <i>phr-Config</i> is released.</p>
<p>logicalChannelSR-ProhibitTimer Timer used to delay the transmission of an SR for logical channels enabled by <i>logicalChannelSR-Prohibit</i>. Value sf20 corresponds to 20 subframes, sf40 corresponds to 40 subframes, and so on. See TS 36.321 [6].</p>
<p>longDRX-CycleStartOffset <i>longDRX-Cycle</i> and <i>drxStartOffset</i> in TS 36.321 [6]. The value of <i>longDRX-Cycle</i> is in number of sub-frames. Value sf10 corresponds to 10 sub-frames, sf20 corresponds to 20 sub-frames and so on. If <i>shortDRX-Cycle</i> is configured, the value of <i>longDRX-Cycle</i> shall be a multiple of the <i>shortDRX-Cycle</i> value. The value of <i>drxStartOffset</i> value is in number of sub-frames. In case <i>longDRX-CycleStartOffset-v1130</i> is signalled, the UE shall ignore <i>longDRX-CycleStartOffset</i> (i.e. without suffix).</p>
<p>maxHARQ-Tx Maximum number of transmissions for UL HARQ in TS 36.321 [6].</p>
<p>onDurationTimer Timer for DRX in TS 36.321 [6]. Value in number of PDCCH sub-frames. Value psf1 corresponds to 1 PDCCH sub-frame, psf2 corresponds to 2 PDCCH sub-frames and so on.</p>
<p>periodicBSR-Timer Timer for BSR reporting in TS 36.321 [6]. Value in number of sub-frames. Value sf10 corresponds to 10 sub-frames, sf20 corresponds to 20 sub-frames and so on.</p>
<p>periodicPHR-Timer Timer for PHR reporting in TS 36.321 [6]. Value in number of sub-frames. Value sf10 corresponds to 10 subframes, sf20 corresponds to 20 subframes and so on.</p>
<p>phr-ModeOtherCG Indicates the mode (i.e. <i>real</i> or <i>virtual</i>) used for the PHR of the activated cells that are part of the other Cell Group (i.e. MCG or SCG), when DC is configured.</p>
<p>prohibitPHR-Timer Timer for PHR reporting in TS 36.321 [6]. Value in number of sub-frames. Value sf0 corresponds to 0 subframes, sf100 corresponds to 100 subframes and so on.</p>
<p>retxBSR-Timer Timer for BSR reporting in TS 36.321 [6]. Value in number of sub-frames. Value sf640 corresponds to 640 sub-frames, sf1280 corresponds to 1280 sub-frames and so on.</p>

MAC-MainConfig field descriptions
<p>sCellDeactivationTimer SCell deactivation timer in TS 36.321 [6]. Value in number of radio frames. Value rf4 corresponds to 4 radio frames, value rf8 corresponds to 8 radio frames and so on. E-UTRAN only configures the field if the UE is configured with one or more SCells other than the PSCell. If the field is absent, the UE shall delete any existing value for this field and assume the value to be set to <i>infinity</i>. The same value applies for each SCell of a Cell Group (i.e. MCG or SCG) (although the associated functionality is performed independently for each SCell).</p>
<p>shortDRX-Cycle Short DRX cycle in TS 36.321 [6]. Value in number of sub-frames. Value sf2 corresponds to 2 sub-frames, sf5 corresponds to 5 subframes and so on. In case <i>shortDRX-Cycle-v1130</i> is signalled, the UE shall ignore <i>shortDRX-Cycle</i> (i.e. without suffix).</p>
<p>sr-ProhibitTimer Timer for SR transmission on PUCCH in TS 36.321 [6]. Value in number of SR period(s). Value 0 means no timer for SR transmission on PUCCH is configured. Value 1 corresponds to one SR period, Value 2 corresponds to 2*SR periods and so on. SR period is defined in TS 36.213 [23, table 10.1.5-1].</p>
<p>stag-Id Indicates the TAG of an SCell, see TS 36.321 [6]. Uniquely identifies the TAG within the scope of a Cell Group (i.e. MCG or SCG). If the field is not configured for an SCell (e.g. absent in <i>MAC-MainConfigSCell</i>), the SCell is part of the PTAG.</p>
<p>stag-ToAddModList, stag-ToReleaseList Used to configure one or more STAGs. E-UTRAN ensures that a STAG contains at least one SCell with configured uplink. If, due to SCell release a reconfiguration would result in an 'empty' TAG, E-UTRAN includes release of the concerned TAG.</p>
<p>timeAlignmentTimerSTAG Indicates the value of the time alignment timer for an STAG, see TS 36.321 [6].</p>
<p>tTiBundling TRUE indicates that TTI bundling TS 36.321 [6] is enabled while FALSE indicates that TTI bundling is disabled. TTI bundling can be enabled for FDD and for TDD only for configurations 0, 1 and 6. The functionality is performed independently per Cell Group (i.e. MCG or SCG), but E-UTRAN does not configure TTI bundling for the SCG. For a TDD PCell, E-UTRAN does not simultaneously enable TTI bundling and semi-persistent scheduling in this release of specification. Furthermore, for a Cell Group, E-UTRAN does not simultaneously configure TTI bundling and SCells with configured uplink, and E-UTRAN does not simultaneously configure TTI bundling and eIMTA.</p>

– PDCP-Config

The IE *PDCP-Config* is used to set the configurable PDCP parameters for data radio bearers.

PDCP-Config information element

```

-- ASN1START
PDCP-Config ::=
    discardTimer          SEQUENCE {
        ENUMERATED {
            ms50, ms100, ms150, ms300, ms500,
            ms750, ms1500, infinity
        }
    }
    rlc-AM                SEQUENCE {
        statusReportRequired    BOOLEAN
    }
    rlc-UM                SEQUENCE {
        pdcp-SN-Size            ENUMERATED {len7bits, len12bits}
    }
    headerCompression    CHOICE {
        notUsed                NULL,
        rohc                    SEQUENCE {
            maxCID              INTEGER (1..16383)
            profiles             SEQUENCE {
                profile0x0001    BOOLEAN,
                profile0x0002    BOOLEAN,
                profile0x0003    BOOLEAN,
                profile0x0004    BOOLEAN,
                profile0x0006    BOOLEAN,
                profile0x0101    BOOLEAN,
                profile0x0102    BOOLEAN,
                profile0x0103    BOOLEAN,
                profile0x0104    BOOLEAN
            }
        }
    }
    ...
},
...
}
...

```

```

[[ rn-IntegrityProtection-r10      ENUMERATED {enabled}    OPTIONAL  -- Cond RN
]],
[[ pdcp-SN-Size-v1130             ENUMERATED {len15bits}  OPTIONAL  -- Cond Rlc-AM2
]],
[[ ul-DataSplitDRB-ViaSCG-r12     BOOLEAN                OPTIONAL, -- Need ON
   t-Reordering-r12               ENUMERATED {
ms0, ms20, ms40, ms60, ms80, ms100, ms120, ms140,
ms160, ms180, ms200, ms220, ms240, ms260, ms280, ms300,
ms500, ms750, spare14, spare13, spare12, spare11, spare10,
spare9, spare8, spare7, spare6, spare5, spare4, spare3,
spare2, spare1}          OPTIONAL  -- Cond SetupS
]]
}
-- ASN1STOP

```

PDCP-Config field descriptions

discardTimer

Indicates the discard timer value specified in TS 36.323 [8]. Value in milliseconds. Value ms50 means 50 ms, ms100 means 100 ms and so on.

headerCompression

E-UTRAN does not reconfigure header compression for an MCG DRB except for upon handover and upon the first reconfiguration after RRC connection re-establishment. E-UTRAN does not reconfigure header compression for a SCG DRB except for upon SCG change involving PDCP re-establishment. For split DRBs E-UTRAN configures only *notUsed*.

maxCID

Indicates the value of the MAX_CID parameter as specified in TS 36.323 [8]. The total value of MAX_CIDs across all bearers for the UE should be less than or equal to the value of *maxNumberROHC-ContextSessions* parameter as indicated by the UE.

pdcp-SN-Size

Indicates the PDCP Sequence Number length in bits. For RLC UM: value *len7bits* means that the 7-bit PDCP SN format is used and *len12bits* means that the 12-bit PDCP SN format is used. For RLC AM: value *len15bits* means that the 15-bit PDCP SN format is used, otherwise if the field is not included upon setup of the PDCP entity 12-bit PDCP SN format is used, as specified in TS 36.323 [8].

profiles

The profiles used by both compressor and decompressor in both UE and E-UTRAN. The field indicates which of the ROHC profiles specified in TS 36.323 [8] are supported, i.e. value *true* indicates that the profile is supported. Profile 0x0000 shall always be supported when the use of ROHC is configured. If support of two ROHC profile identifiers with the same 8 LSB's is signalled, only the profile corresponding to the highest value shall be applied. E-UTRAN does not configure ROHC while *t-Reordering* is configured (i.e. for split DRBs or upon reconfiguration from split to MCG DRB).

t-Reordering

Indicates the value of the reordering timer, as specified in TS 36.323 [8]. Value in milliseconds. Value ms0 means 0 ms, ms20 means 20 ms and so on.

rn-IntegrityProtection

Indicates that integrity protection or verification shall be applied for all subsequent packets received and sent by the RN on the DRB.

statusReportRequired

Indicates whether or not the UE shall send a PDCP Status Report upon re-establishment of the PDCP entity and upon PDCP data recovery as specified in TS 36.323 [8].

ul-DataSplitDRB-ViaSCG

Indicates whether the UE shall send PDCP PDUs via SCG. E-UTRAN only configures the field (i.e. indicates value *TRUE*) for split DRBs.

Conditional presence	Explanation
<i>Rlc-AM</i>	The field is mandatory present upon setup of a PDCP entity for a radio bearer configured with RLC AM. The field is optional, need ON, in case of reconfiguration of a PDCP entity at handover, at the first reconfiguration after RRC re-establishment or at SCG change involving PDCP re-establishment or PDCP data recovery for a radio bearer configured with RLC AM. Otherwise the field is not present.
<i>Rlc-AM2</i>	The field is optionally present, need OP, upon setup of a PDCP entity for a radio bearer configured with RLC AM. Otherwise the field is not present.
<i>Rlc-UM</i>	The field is mandatory present upon setup of a PDCP entity for a radio bearer configured with RLC UM. It is optionally present, Need ON, upon handover within E-UTRA, upon the first reconfiguration after re-establishment and upon SCG change involving PDCP re-establishment. Otherwise the field is not present.
<i>RN</i>	The field is optionally present when signalled to the RN, need OR. Otherwise the field is not present.
<i>Setup</i>	The field is mandatory present in case of radio bearer setup. Otherwise the field is optionally present, need ON.
<i>SetupS</i>	The field is mandatory present in case of setup of or reconfiguration to a split DRB. The field is optionally present upon reconfiguration of a split DRB or upon DRB type change from split to MCG DRB, need ON. Otherwise the field is not present.

PDSCH-Config

The IE *PDSCH-ConfigCommon* and the IE *PDSCH-ConfigDedicated* are used to specify the common and the UE specific PDSCH configuration respectively.

PDSCH-Config information element

```
-- ASN1START
PDSCH-ConfigCommon ::= SEQUENCE {
    referenceSignalPower      INTEGER (-60..50),
    p-b                       INTEGER (0..3)
}

PDSCH-ConfigDedicated ::= SEQUENCE {
    p-a                       ENUMERATED {
        dB-6, dB-4dot77, dB-3, dB-1dot77,
        dB0, dB1, dB2, dB3}
}

PDSCH-ConfigDedicated-v1130 ::= SEQUENCE {
    dmrs-ConfigPDSCH-r11     DMRS-Config-r11                OPTIONAL, -- Need ON
    qcl-Operation             ENUMERATED {typeA, typeB}         OPTIONAL, -- Need OR
    re-MappingQCLConfigToReleaseList-r11 RE-MappingQCLConfigToReleaseList-r11 OPTIONAL, --
Need ON
    re-MappingQCLConfigToAddModList-r11 RE-MappingQCLConfigToAddModList-r11  OPTIONAL --
Need ON
}

RE-MappingQCLConfigToAddModList-r11 ::= SEQUENCE (SIZE (1..maxRE-MapQCL-r11)) OF PDSCH-RE-
MappingQCL-Config-r11

RE-MappingQCLConfigToReleaseList-r11 ::= SEQUENCE (SIZE (1..maxRE-MapQCL-r11)) OF PDSCH-RE-
MappingQCL-ConfigId-r11

PDSCH-RE-MappingQCL-Config-r11 ::= SEQUENCE {
    pdsch-RE-MappingQCL-ConfigId-r11 PDSCH-RE-MappingQCL-ConfigId-r11,
    optionalSetOfFields-r11           SEQUENCE {
        crs-PortsCount-r11             ENUMERATED {n1, n2, n4, spare1},
        crs-FreqShift-r11              INTEGER (0..5),
        mbsfn-SubframeConfigList-r11 CHOICE {
            release                     NULL,
            setup                       SEQUENCE {
                subframeConfigList     MBSFN-SubframeConfigList
            }
        }
    }
    pdsch-Start-r11                   ENUMERATED {reserved, n1, n2, n3, n4, assigned}
}
OPTIONAL, -- Need ON
}
OPTIONAL, -- Need OP
csi-RS-ConfigZPID-r11               CSI-RS-ConfigZPID-r11,
qcl-CSI-RS-ConfigNZPID-r11         CSI-RS-ConfigNZPID-r11
OPTIONAL, -- Need OR
...
}
```

```

PDSCH-ConfigDedicated-v1280 ::= SEQUENCE {
    tbsIndexAlt-r12          ENUMERATED {a26, a33}          OPTIONAL  -- Need OR
}
-- ASN1STOP

```

PDSCH-Config field descriptions

optionalSetOfFields
If absent, the UE releases the configuration provided previously, if any, and applies the values from the serving cell configured on the same frequency.
p-a
Parameter: P_A , see TS 36.213 [23, 5.2]. Value dB-6 corresponds to -6 dB, dB-4dot77 corresponds to -4.77 dB etc.
p-b
Parameter: P_B , see TS 36.213 [23, Table 5.2-1].
pdsch-Start
The starting OFDM symbol of PDSCH for the concerned serving cell, see TS 36.213 [23, 7.1.6.4]. Values 1, 2, 3 are applicable when <i>dl-Bandwidth</i> for the concerned serving cell is greater than 10 resource blocks, values 2, 3, 4 are applicable when <i>dl-Bandwidth</i> for the concerned serving cell is less than or equal to 10 resource blocks, see TS 36.211 [21, Table 6.7-1]. Value <i>n1</i> corresponds to 1, value <i>n2</i> corresponds to 2 and so on.
qcl-CSI-RS-ConfigNZPId
Indicates the CSI-RS resource that is quasi co-located with the PDSCH antenna ports, see TS 36.213 [23, 7.1.9]. E-UTRAN configures this field if and only if the UE is configured with <i>qcl-Operation</i> set to <i>typeB</i> .
qcl-Operation
Indicates the quasi co-location behaviour to be used by the UE, type A and type B, as described in TS 36.213 [23, 7.1.10].
referenceSignalPower
Parameter: <i>Reference-signal power</i> , which provides the downlink reference-signal EPRE, see TS 36.213 [23, 5.2]. The actual value in dBm.
re-MappingQCLConfigToAddModList, re-MappingQCLConfigToReleaseList
For a serving frequency E-UTRAN configures at least one <i>PDSCH-RE-MappingQCL-Config</i> when transmission mode 10 is configured for the serving cell on this carrier frequency. Otherwise it does not configure this IE.
tbsIndexAlt
Indicates the applicability of the alternative TBS index for the I_{TBS} 26 and 33 (see TS 36.213 [23, Table 7.1.7.2.1-1]) to all subframes scheduled by DCI format 2C or 2D. Value <i>a26</i> refers to the alternative TBS index I_{TBS} 26A, and value <i>a33</i> refers to the alternative TBS index I_{TBS} 33A. If this field is not configured, the UE shall use I_{TBS} 26 and 33 specified in Table 7.1.7.2.1-1 in TS 36.213 [23] for all subframes instead.

– **PDSCH-RE-MappingQCL-ConfigId**

The IE *PDSCH-RE-MappingQCL-ConfigId* is used to identify a set of PDSCH parameters related to resource element mapping and quasi co-location, as configured by the IE *PDSCH-RE-MappingQCL-Config*. The identity is unique within the scope of a carrier frequency.

PDSCH-RE-MappingQCL-ConfigId information elements

```

-- ASN1START
PDSCH-RE-MappingQCL-ConfigId-r11 ::= INTEGER (1..maxRE-MapQCL-r11)
-- ASN1STOP

```

– **PHICH-Config**

The IE *PHICH-Config* is used to specify the PHICH configuration.

PHICH-Config information element

```

-- ASN1START
PHICH-Config ::= SEQUENCE {
    phich-Duration          ENUMERATED {normal, extended},
    phich-Resource          ENUMERATED {oneSixth, half, one, two}
}
-- ASN1STOP

```

PHICH-Config field descriptions	
phich-Duration	Parameter: <i>PHICH-Duration</i> , see TS 36.211 [21, Table 6.9.3-1].
phich-Resource	Parameter: <i>Ng</i> , see TS 36.211 [21, 6.9]. Value oneSixth corresponds to 1/6, half corresponds to 1/2 and so on.

– *PhysicalConfigDedicated*

The IE *PhysicalConfigDedicated* is used to specify the UE specific physical channel configuration.

***PhysicalConfigDedicated* information element**

```

-- ASN1START
PhysicalConfigDedicated ::= SEQUENCE {
    pdsch-ConfigDedicated      PDSCH-ConfigDedicated      OPTIONAL,      -- Need ON
    pucch-ConfigDedicated      PUCCH-ConfigDedicated      OPTIONAL,      -- Need ON
    pusch-ConfigDedicated      PUSCH-ConfigDedicated      OPTIONAL,      -- Need ON
    uplinkPowerControlDedicated UplinkPowerControlDedicated OPTIONAL,      -- Need ON
    tpc-PDCCH-ConfigPUCCH      TPC-PDCCH-Config          OPTIONAL,      -- Need ON
    tpc-PDCCH-ConfigPUSCH      TPC-PDCCH-Config          OPTIONAL,      -- Need ON
    cqi-ReportConfig           CQI-ReportConfig          OPTIONAL,      -- Cond CQI-
r8
    soundingRS-UL-ConfigDedicated SoundingRS-UL-ConfigDedicated OPTIONAL,      -- Need ON
    antennaInfo                CHOICE {
        explicitValue          AntennaInfoDedicated,
        defaultValue           NULL
    } OPTIONAL,      -- Cond AI-r8
    schedulingRequestConfig     SchedulingRequestConfig    OPTIONAL,      -- Need ON
    ...,
r8
    [[ cqi-ReportConfig-v920     CQI-ReportConfig-v920     OPTIONAL,      -- Cond CQI-
r8
    antennaInfo-v920            AntennaInfoDedicated-v920 OPTIONAL      -- Cond AI-
r8
]],
    [[ antennaInfo-r10          CHOICE {
        explicitValue-r10      AntennaInfoDedicated-r10,
        defaultValue           NULL
    } OPTIONAL,      -- Cond AI-r10
    antennaInfoUL-r10          AntennaInfoUL-r10         OPTIONAL,      -- Need ON
    cif-Presence-r10           BOOLEAN                    OPTIONAL,      -- Need ON
    cqi-ReportConfig-r10       CQI-ReportConfig-r10     OPTIONAL,      -- Cond CQI-
r10
    csi-RS-Config-r10          CSI-RS-Config-r10         OPTIONAL,      -- Need ON
    pucch-ConfigDedicated-v1020 PUCCH-ConfigDedicated-v1020 OPTIONAL,      -- Need ON
    pusch-ConfigDedicated-v1020 PUSCH-ConfigDedicated-v1020 OPTIONAL,      -- Need ON
    schedulingRequestConfig-v1020 SchedulingRequestConfig-v1020 OPTIONAL,      -- Need ON
    soundingRS-UL-ConfigDedicated-v1020 SoundingRS-UL-ConfigDedicated-v1020 OPTIONAL,      -- Need ON
    soundingRS-UL-ConfigDedicatedAperiodic-r10 SoundingRS-UL-ConfigDedicatedAperiodic-r10 OPTIONAL,      -- Need ON
    uplinkPowerControlDedicated-v1020 UplinkPowerControlDedicated-v1020 OPTIONAL      -- Need
ON
    ]],
    [[ additionalSpectrumEmissionCA-r10 CHOICE {
        release                NULL,
        setup                  SEQUENCE {
            additionalSpectrumEmissionPCell-r10 AdditionalSpectrumEmission
        }
    } OPTIONAL      -- Need ON
    ]],
    [[ -- DL configuration as well as configuration applicable for DL and UL
ON
    csi-RS-ConfigNZPTToReleaseList-r11 CSI-RS-ConfigNZPTToReleaseList-r11 OPTIONAL,      -- Need
ON
    csi-RS-ConfigNZPTToAddModList-r11 CSI-RS-ConfigNZPTToAddModList-r11 OPTIONAL,      -- Need
ON
    csi-RS-ConfigZPTToReleaseList-r11 CSI-RS-ConfigZPTToReleaseList-r11 OPTIONAL,      -- Need
ON
    csi-RS-ConfigZPTToAddModList-r11 CSI-RS-ConfigZPTToAddModList-r11 OPTIONAL,      -- Need ON
    epdcch-Config-r11           EPDCCH-Config-r11         OPTIONAL,      -- Need ON
    pdsch-ConfigDedicated-v1130 PDSCH-ConfigDedicated-v1130 OPTIONAL,      -- Need ON
-- UL configuration
    cqi-ReportConfig-v1130      CQI-ReportConfig-v1130     OPTIONAL,      -- Need ON

```

```

    pucch-ConfigDedicated-v1130      PUCCH-ConfigDedicated-v1130      OPTIONAL, -- Need ON
    pusch-ConfigDedicated-v1130      PUSCH-ConfigDedicated-v1130      OPTIONAL, -- Need ON
    uplinkPowerControlDedicated-v1130 UplinkPowerControlDedicated-v1130 OPTIONAL -- Need
ON
  ]],
  [[ antennaInfo-v1250                AntennaInfoDedicated-v1250        OPTIONAL, -- Cond AI-
r10
    eimta-MainConfig-r12              EIMTA-MainConfig-r12              OPTIONAL, -- Need ON
    eimta-MainConfigPCell-r12        EIMTA-MainConfigServCell-r12     OPTIONAL, -- Need
ON
    pucch-ConfigDedicated-v1250      PUCCH-ConfigDedicated-v1250      OPTIONAL, -- Need ON
    cqi-ReportConfigPCell-v1250      CQI-ReportConfig-v1250            OPTIONAL, -- Need ON
    uplinkPowerControlDedicated-v1250 UplinkPowerControlDedicated-v1250 OPTIONAL, -- Need
ON
    pusch-ConfigDedicated-v1250      PUSCH-ConfigDedicated-v1250      OPTIONAL, -- Need ON
    csi-RS-Config-v1250              CSI-RS-Config-v1250              OPTIONAL, -- Need ON
  ]],
  [[ pdsch-ConfigDedicated-v1280      PDSCH-ConfigDedicated-v1280      OPTIONAL, -- Need ON
  ]]
}

PhysicalConfigDedicatedSCell-r10 ::= SEQUENCE {
  -- DL configuration as well as configuration applicable for DL and UL
  nonUL-Configuration-r10            SEQUENCE {
    antennaInfo-r10                  AntennaInfoDedicated-r10         OPTIONAL, -- Need ON
    crossCarrierSchedulingConfig-r10 CrossCarrierSchedulingConfig-r10  OPTIONAL, --
Need ON
    csi-RS-Config-r10                CSI-RS-Config-r10                OPTIONAL, -- Need ON
    pdsch-ConfigDedicated-r10        PDSCH-ConfigDedicated            OPTIONAL, -- Need ON
  }
  -- UL configuration
  ul-Configuration-r10              SEQUENCE {
    antennaInfoUL-r10                AntennaInfoUL-r10                OPTIONAL, -- Need ON
    pusch-ConfigDedicatedSCell-r10   PUSCH-ConfigDedicatedSCell-r10   OPTIONAL, --
Need ON
    uplinkPowerControlDedicatedSCell-r10 UplinkPowerControlDedicatedSCell-r10 OPTIONAL, --
Need ON
    cqi-ReportConfigSCell-r10        CQI-ReportConfigSCell-r10        OPTIONAL, -- Need ON
    soundingRS-UL-ConfigDedicated-r10 SoundingRS-UL-ConfigDedicated    OPTIONAL, -- Need
ON
    soundingRS-UL-ConfigDedicated-v1020 SoundingRS-UL-ConfigDedicated-v1020 OPTIONAL, -- Need ON
    soundingRS-UL-ConfigDedicatedAperiodic-r10 SoundingRS-UL-ConfigDedicatedAperiodic-r10 OPTIONAL -- Need ON
  }
  ...
  [[ -- DL configuration as well as configuration applicable for DL and UL
    csi-RS-ConfigNZPTToReleaseList-r11 CSI-RS-ConfigNZPTToReleaseList-r11 OPTIONAL, -- Need
ON
    csi-RS-ConfigNZPTToAddModList-r11 CSI-RS-ConfigNZPTToAddModList-r11 OPTIONAL, -- Need
ON
    csi-RS-ConfigZPTToReleaseList-r11 CSI-RS-ConfigZPTToReleaseList-r11 OPTIONAL, -- Need
ON
    csi-RS-ConfigZPTToAddModList-r11 CSI-RS-ConfigZPTToAddModList-r11 OPTIONAL, -- Need ON
    epdcch-Config-r11                EPDCCH-Config-r11                OPTIONAL, -- Need ON
    pdsch-ConfigDedicated-v1130      PDSCH-ConfigDedicated-v1130      OPTIONAL, -- Need ON
  -- UL configuration
    cqi-ReportConfig-v1130           CQI-ReportConfig-v1130           OPTIONAL, -- Need ON
    pusch-ConfigDedicated-v1130      PUSCH-ConfigDedicated-v1130      OPTIONAL, -- Need ON
    uplinkPowerControlDedicatedSCell-v1130 UplinkPowerControlDedicated-v1130 OPTIONAL --
Need ON
  ]],
  [[ antennaInfo-v1250                AntennaInfoDedicated-v1250        OPTIONAL, -- Need ON
    eimta-MainConfigSCell-r12        EIMTA-MainConfigServCell-r12     OPTIONAL, -- Need ON
    cqi-ReportConfigSCell-v1250      CQI-ReportConfig-v1250            OPTIONAL, -- Need ON
    uplinkPowerControlDedicatedSCell-v1250 UplinkPowerControlDedicated-v1250 OPTIONAL, --
Need ON
    csi-RS-Config-v1250              CSI-RS-Config-v1250              OPTIONAL, -- Need ON
  ]],
  [[ pdsch-ConfigDedicated-v1280      PDSCH-ConfigDedicated-v1280      OPTIONAL, -- Need ON
  ]]
}

CSI-RS-ConfigNZPTToAddModList-r11 ::= SEQUENCE (SIZE (1..maxCSI-RS-NZP-r11)) OF CSI-RS-ConfigNZP-
r11

CSI-RS-ConfigNZPTToReleaseList-r11 ::= SEQUENCE (SIZE (1..maxCSI-RS-NZP-r11)) OF CSI-RS-
ConfigNZPID-r11

```

```

CSI-RS-ConfigZPTToAddModList-r11 ::= SEQUENCE (SIZE (1..maxCSI-RS-ZP-r11)) OF CSI-RS-ConfigZP-r11
CSI-RS-ConfigZPToReleaseList-r11 ::= SEQUENCE (SIZE (1..maxCSI-RS-ZP-r11)) OF CSI-RS-ConfigZPId-r11
-- ASN1STOP

```

PhysicalConfigDedicated field descriptions	
additionalSpectrumEmissionPCell	E-UTRAN does not configure this field in this release of the specification.
antennaInfo	A choice is used to indicate whether the <i>antennaInfo</i> is signalled explicitly or set to the default antenna configuration as specified in section 9.2.4.
csi-RS-Config	For a serving frequency E-UTRAN does not configure <i>csi-RS-Config</i> (includes <i>zeroTxPowerCSI-RS</i>) when transmission mode 10 is configured for the serving cell on this carrier frequency.
csi-RS-ConfigNZPTToAddModList	For a serving frequency E-UTRAN configures one or more <i>CSI-RS-ConfigNZP</i> only when transmission mode 10 is configured for the serving cell on this carrier frequency. EUTRAN configures a maximum of one <i>CSI-RS-ConfigNZP</i> for a serving frequency on which the UE supports only one CSI process (i.e. <i>supportedCSI-Proc</i> is indicated as n1).
csi-RS-ConfigZPTToAddModList	For a serving frequency E-UTRAN configures one or more <i>CSI-RS-ConfigZP</i> only when transmission mode 10 is configured for the serving cell on this carrier frequency.
eimta-MainConfigPCell, eimta-MainConfigSCell	If E-UTRAN configures <i>eimta-MainConfigPCell</i> or <i>eimta-MainConfigSCell</i> for one serving cell in a frequency band, E-UTRAN configures <i>eimta-MainConfigPCell</i> or <i>eimta-MainConfigSCell</i> for all serving cells residing on the frequency band. E-UTRAN configures <i>eimta-MainConfigPCell</i> or <i>eimta-MainConfigSCell</i> only if <i>eimta-MainConfig</i> is configured.
epdcch-Config	indicates the <i>EPDCCH-Config</i> for the cell. E-UTRAN does not configure <i>EPDCCH-Config</i> for an SCell that is configured with value <i>other</i> for <i>schedulingCellInfo</i> in <i>CrossCarrierSchedulingConfig</i> .
pdsch-ConfigDedicated-v1130	For a serving frequency E-UTRAN configures <i>pdsch-ConfigDedicated-v1130</i> only when transmission mode 10 is configured for the serving cell on this carrier frequency.
pdsch-ConfigDedicated-v1280	For a serving frequency E-UTRAN configures <i>pdsch-ConfigDedicated-v1280</i> only when transmission mode 9 or 10 is configured for the serving cell on this carrier frequency.
pusch-ConfigDedicated-v1250	E-UTRAN configures <i>pusch-ConfigDedicated-v1250</i> only if <i>tpc-SubframeSet</i> is configured.
tpc-PDCCH-ConfigPUCCH	PDCCH configuration for power control of PUCCH using format 3/3A, see TS 36.212 [22].
tpc-PDCCH-ConfigPUSCH	PDCCH configuration for power control of PUSCH using format 3/3A, see TS 36.212 [22].
uplinkPowerControlDedicated	E-UTRAN configures <i>uplinkPowerControlDedicated-v1130</i> only if <i>uplinkPowerControlDedicated</i> (without suffix) is configured.
uplinkPowerControlDedicatedSCell	E-UTRAN configures <i>uplinkPowerControlDedicatedSCell-v1130</i> only if <i>uplinkPowerControlDedicatedSCell-r10</i> is configured for this serving cell.

Conditional presence	Explanation
<i>AI-r8</i>	The field is optionally present, need ON, if <i>antennaInfoDedicated-r10</i> is absent. Otherwise the field is not present
<i>AI-r10</i>	The field is optionally present, need ON, if <i>antennaInfoDedicated</i> is absent. Otherwise the field is not present
<i>CommonUL</i>	The field is mandatory present if <i>ul-Configuration</i> of <i>RadioResourceConfigCommonSCell-r10</i> is present; otherwise it is optional, need ON.
<i>CQI-r8</i>	The field is optionally present, need ON, if <i>cqi-ReportConfig-r10</i> is absent. Otherwise the field is not present
<i>CQI-r10</i>	The field is optionally present, need ON, if <i>cqi-ReportConfig</i> is absent. Otherwise the field is not present
<i>SCellAdd</i>	The field is mandatory present if <i>cellIdentification</i> is present; otherwise it is optional, need ON.

NOTE 1: During handover, the UE performs a MAC reset, which involves reverting to the default CQI/ SRS/ SR configuration in accordance with subclause 5.3.13 and TS 36.321 [6, 5.9 & 5.2]. Hence, for these parts of the dedicated radio resource configuration, the default configuration (rather than the configuration used in the source PCell) is used as the basis for the delta signalling that is included in the message used to perform handover.

NOTE 2: Since delta signalling is not supported for the common SCell configuration, E-UTRAN can only add or release the uplink of an SCell by releasing and adding the concerned SCell.

– *P-Max*

The IE *P-Max* is used to limit the UE's uplink transmission power on a carrier frequency and is used to calculate the parameter *Pcompensation* defined in TS 36.304 [4]. Corresponds to parameter P_{EMAX} or $P_{EMAX,c}$ in TS 36.101 [42]. The UE transmit power on one serving cell shall not exceed the configured maximum UE output power of the serving cell determined by this value as specified in TS 36.101 [42, 6.2.5 or 6.2.5A] or, when transmitting sidelink discovery announcements within the coverage of the concerned cell, as specified in TS 36.101 [42, 6.2.5D].

***P-Max* information element**

```
-- ASN1START
P-Max ::=
    INTEGER (-30..33)
-- ASN1STOP
```

– *PRACH-Config*

The IE *PRACH-ConfigSIB* and IE *PRACH-Config* are used to specify the PRACH configuration in the system information and in the mobility control information, respectively.

***PRACH-Config* information elements**

```
-- ASN1START
PRACH-ConfigSIB ::=
    SEQUENCE {
        rootSequenceIndex
            INTEGER (0..837),
        prach-ConfigInfo
    }
PRACH-Config ::=
    SEQUENCE {
        rootSequenceIndex
            INTEGER (0..837),
        prach-ConfigInfo
    } OPTIONAL -- Need ON
PRACH-ConfigSCell-r10 ::=
    SEQUENCE {
        prach-ConfigIndex-r10
            INTEGER (0..63)
    }
PRACH-ConfigInfo ::=
    SEQUENCE {
        prach-ConfigIndex
            INTEGER (0..63),
        highSpeedFlag
            BOOLEAN,
        zeroCorrelationZoneConfig
            INTEGER (0..15),
        prach-FreqOffset
            INTEGER (0..94)
    }
-- ASN1STOP
```

PRACH-Config field descriptions
highSpeedFlag Parameter: High-speed-flag, see TS 36.211, [21, 5.7.2]. TRUE corresponds to Restricted set and FALSE to Unrestricted set.
prach-ConfigIndex Parameter: <i>prach-ConfigurationIndex</i> , see TS 36.211 [21, 5.7.1].
prach-FreqOffset Parameter: <i>prach-FrequencyOffset</i> , see TS 36.211, [21, 5.7.1]. For TDD the value range is dependent on the value of <i>prach-ConfigIndex</i> .
rootSequenceIndex Parameter: <i>RACH_ROOT_SEQUENCE</i> , see TS 36.211 [21, 5.7.1].
zeroCorrelationZoneConfig Parameter: Ncs configuration, see TS 36.211, [21, 5.7.2: table 5.7.2-2] for preamble format 0..3 and TS 36.211, [21, 5.7.2: table 5.7.2-3] for preamble format 4.

– PresenceAntennaPort1

The IE *PresenceAntennaPort1* is used to indicate whether all the neighbouring cells use Antenna Port 1. When set to *TRUE*, the UE may assume that at least two cell-specific antenna ports are used in all neighbouring cells.

PresenceAntennaPort1 information element

```
-- ASN1START
PresenceAntennaPort1 ::=          BOOLEAN
-- ASN1STOP
```

– PUCCH-Config

The IE *PUCCH-ConfigCommon* and IE *PUCCH-ConfigDedicated* are used to specify the common and the UE specific PUCCH configuration respectively.

PUCCH-Config information elements

```
-- ASN1START
PUCCH-ConfigCommon ::=          SEQUENCE {
    deltaPUCCH-Shift              ENUMERATED {ds1, ds2, ds3},
    nRB-CQI                       INTEGER (0..98),
    nCS-AN                        INTEGER (0..7),
    n1PUCCH-AN                    INTEGER (0..2047)
}

PUCCH-ConfigDedicated ::=       SEQUENCE {
    ackNackRepetition             CHOICE {
        release                    NULL,
        setup                      SEQUENCE {
            repetitionFactor        ENUMERATED {n2, n4, n6, spare1},
            n1PUCCH-AN-Rep          INTEGER (0..2047)
        }
    },
    tdd-AckNackFeedbackMode       ENUMERATED {bundling, multiplexing} OPTIONAL -- Cond TDD
}

PUCCH-ConfigDedicated-v1020 ::= SEQUENCE {
    pucch-Format-r10              CHOICE {
        format3-r10                SEQUENCE {
            n3PUCCH-AN-List-r10    SEQUENCE (SIZE (1..4)) OF INTEGER (0..549) OPTIONAL, -- Need ON
            twoAntennaPortActivatedPUCCH-Format3-r10 CHOICE {
                release            NULL,
                setup              SEQUENCE {
                    n3PUCCH-AN-ListP1-r10 SEQUENCE (SIZE (1..4)) OF INTEGER (0..549)
                }
            }
        } OPTIONAL -- Need ON
    },
    channelSelection-r10          SEQUENCE {
        n1PUCCH-AN-CS-r10         CHOICE {
            release                NULL,
            setup                  SEQUENCE {
                n1PUCCH-AN-CS-List-r10 SEQUENCE (SIZE (1..2)) OF N1PUCCH-AN-CS-r10
            }
        }
    }
}
-- ASN1STOP
```

```

    }
  }
}
twoAntennaPortActivatedPUCCH-Format1a1b-r10    ENUMERATED {true}    OPTIONAL, -- Need OR
simultaneousPUCCH-PUSCH-r10                  ENUMERATED {true}    OPTIONAL, -- Need OR
n1PUCCH-AN-RepP1-r10                          INTEGER (0..2047)    OPTIONAL  -- Need OR
}

PUCCH-ConfigDedicated-v1130 ::= SEQUENCE {
  n1PUCCH-AN-CS-v1130          CHOICE {
    release                     NULL,
    setup                       SEQUENCE {
      n1PUCCH-AN-CS-ListP1-r11 SEQUENCE (SIZE (2..4)) OF INTEGER (0..2047)
    }
  }
  nPUCCH-Param-r11            CHOICE {
    release                     NULL,
    setup                       SEQUENCE {
      nPUCCH-Identity-r11      INTEGER (0..503),
      n1PUCCH-AN-r11           INTEGER (0..2047)
    }
  }
}
OPTIONAL, -- Need ON

PUCCH-ConfigDedicated-v1250 ::= SEQUENCE {
  nkaPUCCH-Param-r12          CHOICE {
    release                     NULL,
    setup                       SEQUENCE {
      nkaPUCCH-AN-r12          INTEGER (0..2047)
    }
  }
}

N1PUCCH-AN-CS-r10 ::= SEQUENCE (SIZE (1..4)) OF INTEGER (0..2047)

-- ASN1STOP

```

PUCCH-Config field descriptions	
ackNackRepetition	Parameter indicates whether ACK/NACK repetition is configured, see TS 36.213 [23, 10.1].
deltaPUCCH-Shift	Parameter: $\Delta_{\text{shift}}^{\text{PUCCH}}$, see 36.211 [21, 5.4.1], where ds1 corresponds to value 1 ds2 to 2 etc.
n1PUCCH-AN	Parameter: $N_{\text{PUCCH}}^{(1)}$, see TS 36.213 [23, 10.1]. <i>n1PUCCH-AN-r11</i> indicates UE-specific PUCCH AN resource offset, see TS 36.213 [23, 10.1].
n1PUCCH-AN-CS-List	Parameter: $n_{\text{PUCCH},j}^{(1)}$ for antenna port p_0 for PUCCH format 1b with channel selection, see TS 36.213 [23, 10.1.2.2.1, 10.1.3.2.1].
n1PUCCH-AN-CS-ListP1	Parameter: $n_{\text{PUCCH},j}^{(1,\tilde{p}_1)}$ for antenna port p_1 for PUCCH format 1b with channel selection, see TS 36.213 [23, 10.1]. E-UTRAN configures this field only when <i>pucch-Format</i> is set to <i>channelSelection</i> .
n1PUCCH-AN-Rep, n1PUCCH-AN-RepP1	Parameter: $n_{\text{PUCCH,ANRep}}^{(1,p)}$ for antenna port P0 and for antenna port P1 respectively, see TS 36.213 [23, 10.1].
n3PUCCH-AN-List, n3PUCCH-AN-ListP1	Parameter: $n_{\text{PUCCH}}^{(3,p)}$ for antenna port P0 and for antenna port P1 respectively, see TS 36.213 [23, 10.1].
nCS-An	Parameter: $N_{\text{cs}}^{(1)}$ see TS 36.211 [21, 5.4].
nkaPUCCH-AN	Parameter: $N_{\text{PUCCH}}^{\text{KA}}$, see TS 36.213 [23, 10.1.3]. <i>nkaPUCCH-AN-r12</i> indicates PUCCH format 1a/1b starting offset for the subframe set K^A , see TS 36.213 [23, 10.1.3]. E-UTRAN configures <i>nkaPUCCH-AN</i> only if <i>eimta-MainConfig</i> is configured.
nPUCCH-Identity	Parameter: $n_{\text{ID}}^{\text{PUCCH}}$, see TS 36.211 [21, 5.5.1.5].
nRB-CQI	Parameter: $N_{\text{RB}}^{(2)}$, see TS 36.211 [21, 5.4].
pucch-Format	Parameter indicates one of the PUCCH formats for transmission of HARQ-ACK, see TS 36.213 [23, 10.1]. For TDD, if the UE is configured with PCell only, the <i>channelSelection</i> indicates the transmission of HARQ-ACK multiplexing as defined in Tables 10.1.3-5, 10.1.3-6, and 10.1.3-7 in TS 36.213 [23] for PUCCH, and in 7.3 in TS 36.213 [23] for PUSCH.
repetitionFactor	Parameter N_{ANRep} see TS 36.213 [23, 10.1] where n2 corresponds to repetition factor 2, n4 to 4.
simultaneousPUCCH-PUSCH	Parameter indicates whether simultaneous PUCCH and PUSCH transmissions is configured, see TS 36.213 [23, 10.1 and 5.1.1]. E-UTRAN configures this field for the PCell, only when the <i>nonContiguousUL-RA-WithinCC-Info</i> is set to <i>supported</i> in the band on which PCell is configured. Likewise, E-UTRAN configures this field for the PSCell, only when the <i>nonContiguousUL-RA-WithinCC-Info</i> is set to <i>supported</i> in the band on which PSCell is configured.
tdd-AckNackFeedbackMode	Parameter indicates one of the TDD ACK/NACK feedback modes used, see TS 36.213 [23, 7.3 and 10.1.3]. The value bundling corresponds to use of ACK/NACK bundling whereas, the value multiplexing corresponds to ACK/NACK multiplexing as defined in Tables 10.1.3-2, 10.1.3-3, and 10.1.3-4 in TS 36.213 [23]. The same value applies to both ACK/NACK feedback modes on PUCCH as well as on PUSCH.
twoAntennaPortActivatedPUCCH-Format1a1b	Indicates whether two antenna ports are configured for PUCCH format 1a/1b for HARQ-ACK, see TS 36.213 [23, 10.1]. The field also applies for PUCCH format 1a/1b transmission when <i>format3</i> is configured, see TS 36.213 [23, 10.1.2.2.2, 10.1.3.2.2].
twoAntennaPortActivatedPUCCH-Format3	Indicates whether two antenna ports are configured for PUCCH format 3 for HARQ-ACK, see TS 36.213 [23, 10.1].

Conditional presence	Explanation
TDD	The field is mandatory present for TDD if the <i>pucch-Format</i> is not present. If the <i>pucch-Format</i> is present, the field is not present and the UE shall delete any existing value for this field. It is not present for FDD and the UE shall delete any existing value for this field.

PUSCH-Config

The IE *PUSCH-ConfigCommon* is used to specify the common PUSCH configuration and the reference signal configuration for PUSCH and PUCCH. The IE *PUSCH-ConfigDedicated* is used to specify the UE specific PUSCH configuration.

PUSCH-Config information element

```

-- ASN1START
PUSCH-ConfigCommon ::=          SEQUENCE {
    pusch-ConfigBasic            SEQUENCE {
        n-SB                     INTEGER (1..4),
        hoppingMode              ENUMERATED {interSubFrame, intraAndInterSubFrame},
        pusch-HoppingOffset      INTEGER (0..98),
        enable64QAM              BOOLEAN
    },
    ul-ReferenceSignalsPUSCH     UL-ReferenceSignalsPUSCH
}

PUSCH-ConfigCommon-v1270 ::=    SEQUENCE {
    enable64QAM-v1270            ENUMERATED {true}
}

PUSCH-ConfigDedicated ::=      SEQUENCE {
    betaOffset-ACK-Index         INTEGER (0..15),
    betaOffset-RI-Index         INTEGER (0..15),
    betaOffset-CQI-Index        INTEGER (0..15)
}

PUSCH-ConfigDedicated-v1020 ::= SEQUENCE {
    betaOffsetMC-r10            SEQUENCE {
        betaOffset-ACK-Index-MC-r10  INTEGER (0..15),
        betaOffset-RI-Index-MC-r10   INTEGER (0..15),
        betaOffset-CQI-Index-MC-r10  INTEGER (0..15)
    }
    groupHoppingDisabled-r10     ENUMERATED {true}
    dmrs-WithOCC-Activated-r10   ENUMERATED {true}
}
OPTIONAL, -- Need OR
OPTIONAL, -- Need OR
OPTIONAL  -- Need OR

PUSCH-ConfigDedicated-v1130 ::= SEQUENCE {
    pusch-DMRS-r11              CHOICE {
        release                  NULL,
        setup                    SEQUENCE {
            nPUSCH-Identity-r11   INTEGER (0..509),
            nDMRS-CSH-Identity-r11 INTEGER (0..509)
        }
    }
}

PUSCH-ConfigDedicated-v1250 ::= SEQUENCE {
    uciOnPUSCH                  CHOICE {
        release                  NULL,
        setup                    SEQUENCE {
            betaOffset-ACK-Index-SubframeSet2-r12  INTEGER (0..15),
            betaOffset-RI-Index-SubframeSet2-r12   INTEGER (0..15),
            betaOffset-CQI-Index-SubframeSet2-r12  INTEGER (0..15),
            betaOffsetMC-r12                       SEQUENCE {
                betaOffset-ACK-Index-MC-SubframeSet2-r12  INTEGER (0..15),
                betaOffset-RI-Index-MC-SubframeSet2-r12   INTEGER (0..15),
                betaOffset-CQI-Index-MC-SubframeSet2-r12  INTEGER (0..15)
            }
        }
    }
}
OPTIONAL -- Need OR

PUSCH-ConfigDedicatedSCell-r10 ::= SEQUENCE {
    groupHoppingDisabled-r10     ENUMERATED {true}
    dmrs-WithOCC-Activated-r10   ENUMERATED {true}
}
OPTIONAL, -- Need OR
OPTIONAL  -- Need OR

UL-ReferenceSignalsPUSCH ::=    SEQUENCE {
    groupHoppingEnabled          BOOLEAN,
    groupAssignmentPUSCH         INTEGER (0..29),
    sequenceHoppingEnabled       BOOLEAN,
    cyclicShift                  INTEGER (0..7)
}

```

-- ASN1STOP

PUSCH-Config field descriptions
<p>betaOffset-ACK-Index, betaOffset-ACK-Index-MC</p> <p>Parameter: $I_{offset}^{HARQ-ACK}$, for single- and multiple-codeword respectively, see TS 36.213 [23, Table 8.6.3-1]. One value applies for all serving cells with an uplink in a cell group (MCG or SCG) and not configured with uplink power control subframe sets. The same value also applies for subframe set 1 of all serving cells with an uplink in that cell group and configured with uplink power control subframe sets (the associated functionality is common i.e. not performed independently for each cell).</p>
<p>betaOffset-ACK-Index-SubframeSet2, betaOffset-ACK-Index-MC-SubframeSet2</p> <p>Parameter: $I_{offset}^{HARQ-ACK}$, for single- and multiple-codeword respectively, see TS 36.213 [23, Table 8.6.3-1]. One value applies for subframe set 2 of all serving cells with an uplink in a cell group (MCG or SCG) and configured with uplink power control subframe sets (the associated functionality is common i.e. not performed independently for each cell configured with uplink power control subframe sets).</p>
<p>betaOffset-CQI-Index, betaOffset-CQI-Index-MC</p> <p>Parameter: I_{offset}^{CQI}, for single- and multiple-codeword respectively, see TS 36.213 [23, Table 8.6.3-3]. One value applies for all serving cells with an uplink in a cell group (MCG or SCG) and not configured with uplink power control subframe sets. The same value also applies for subframe set 1 of all serving cells with an uplink in that cell group and configured with uplink power control subframe sets (the associated functionality is common i.e. not performed independently for each cell).</p>
<p>betaOffset-CQI-Index-SubframeSet2, betaOffset-CQI-Index-MC-SubframeSet2</p> <p>Parameter: I_{offset}^{CQI}, for single- and multiple-codeword respectively, see TS 36.213 [23, Table 8.6.3-3]. One value applies for subframe set 2 of all serving cells with an uplink in a cell group (MCG or SCG) and configured with uplink power control subframe sets (the associated functionality is common i.e. not performed independently for each cell configured with uplink power control subframe sets).</p>
<p>betaOffset-RI-Index, betaOffset-RI-Index-MC</p> <p>Parameter: I_{offset}^{RI}, for single- and multiple-codeword respectively, see TS 36.213 [23, Table 8.6.3-2]. One value applies for all serving cells with an uplink in a cell group (MCG or SCG) and not configured with uplink power control subframe sets. The same value also applies for subframe set 1 of all serving cells with an uplink in that cell group and configured with uplink power control subframe sets (the associated functionality is common i.e. not performed independently for each cell).</p>
<p>betaOffset-RI-Index-SubframeSet2, betaOffset-RI-Index-MC-SubframeSet2</p> <p>Parameter: I_{offset}^{RI}, for single- and multiple-codeword respectively, see TS 36.213 [23, Table 8.6.3-2]. One value applies for subframe set 2 of all serving cells with an uplink in a cell group (MCG or SCG) and configured with uplink power control subframe sets (the associated functionality is common i.e. not performed independently for each cell configured with uplink power control subframe sets).</p>
<p>cyclicShift</p> <p>Parameters: <i>cyclicShift</i>, see TS 36.211 [21, Table 5.5.2.1.1-2].</p>
<p>dmrs-WithOCC-Activated</p> <p>Parameter: <i>Activate-DMRS-with OCC</i>, see TS 36.211 [21, 5.5.2.1].</p>
<p>enable64QAM</p> <p>See TS 36.213 [23, 8.6.1]. If <i>enable64QAM</i> (without suffix) is set to TRUE, it indicates that 64QAM is allowed for UE categories 5 and 8 indicated in <i>ue-Category</i> while FALSE indicates that 64QAM is not allowed. If <i>enable64QAM-v1270</i> is set to TRUE, it indicates that 64QAM is allowed for UL categories 5 and 13 indicated in <i>ue-CategoryUL</i>. E-UTRAN configures <i>enable64QAM-v1270</i> only when <i>enable64QAM</i> (without suffix) is set to TRUE.</p>
<p>groupAssignmentPUSCH</p> <p>Parameter: ΔSS See TS 36.211 [21, 5.5.1.3].</p>
<p>groupHoppingDisabled</p> <p>Parameter: <i>Disable-sequence-group-hopping</i>, see TS 36.211 [21, 5.5.1.3].</p>
<p>groupHoppingEnabled</p> <p>Parameter: <i>Group-hopping-enabled</i>, see TS 36.211 [21, 5.5.1.3].</p>
<p>hoppingMode</p> <p>Parameter: <i>Hopping-mode</i>, see TS 36.211 [21, 5.3.4].</p>
<p>nDMRS-CSH-Identity</p> <p>Parameter: $N_{ID}^{csh_DMRS}$, see TS 36.211 [21, 5.5.2.1.1].</p>
<p>nPUSCH-Identity</p> <p>Parameter: n_{ID}^{PUSCH}, see TS 36.211 [21, 5.5.1.5].</p>
<p>n-SB</p> <p>Parameter: N_{sb} see TS 36.211 [21, 5.3.4].</p>
<p>pusch-hoppingOffset</p> <p>Parameter: N_{RB}^{HO}, see TS 36.211 [21, 5.3.4].</p>

PUSCH-Config field descriptions
sequenceHoppingEnabled Parameter: <i>Sequence-hopping-enabled</i> , see TS 36.211 [21, 5.5.1.4].
ul-ReferenceSignalsPUSCH Used to specify parameters needed for the transmission on PUSCH (or PUCCH).

RACH-ConfigCommon

The IE *RACH-ConfigCommon* is used to specify the generic random access parameters.

RACH-ConfigCommon information element

```

-- ASN1START
RACH-ConfigCommon ::= SEQUENCE {
  preambleInfo SEQUENCE {
    numberOfRA-Preambles ENUMERATED {
      n4, n8, n12, n16, n20, n24, n28,
      n32, n36, n40, n44, n48, n52, n56,
      n60, n64},
    preamblesGroupAConfig SEQUENCE {
      sizeOfRA-PreamblesGroupA ENUMERATED {
        n4, n8, n12, n16, n20, n24, n28,
        n32, n36, n40, n44, n48, n52, n56,
        n60},
      messageSizeGroupA ENUMERATED {b56, b144, b208, b256},
      messagePowerOffsetGroupB ENUMERATED {
        minusinfinity, dB0, dB5, dB8, dB10, dB12,
        dB15, dB18},
      ...
    } OPTIONAL -- Need OP
  },
  powerRampingParameters PowerRampingParameters,
  ra-SupervisionInfo SEQUENCE {
    preambleTransMax PreambleTransMax,
    ra-ResponseWindowSize ENUMERATED {
      sf2, sf3, sf4, sf5, sf6, sf7,
      sf8, sf10},
    mac-ContentionResolutionTimer ENUMERATED {
      sf8, sf16, sf24, sf32, sf40, sf48,
      sf56, sf64}
  },
  maxHARQ-Msg3Tx INTEGER (1..8),
  ...
}

RACH-ConfigCommon-v1250 ::= SEQUENCE {
  txFailParams-r12 SEQUENCE {
    connEstFailCount-r12 ENUMERATED {n1, n2, n3, n4},
    connEstFailOffsetValidity-r12 ENUMERATED {s30, s60, s120, s240,
      s300, s420, s600, s900},
    connEstFailOffset-r12 INTEGER (0..15) OPTIONAL -- Need OP
  }
}

RACH-ConfigCommonSCell-r11 ::= SEQUENCE {
  powerRampingParameters-r11 PowerRampingParameters,
  ra-SupervisionInfo-r11 SEQUENCE {
    preambleTransMax-r11 PreambleTransMax
  },
  ...
}

PowerRampingParameters ::= SEQUENCE {
  powerRampingStep ENUMERATED {dB0, dB2, dB4, dB6},
  preambleInitialReceivedTargetPower ENUMERATED {
    dBm-120, dBm-118, dBm-116, dBm-114, dBm-112,
    dBm-110, dBm-108, dBm-106, dBm-104, dBm-102,
    dBm-100, dBm-98, dBm-96, dBm-94,
    dBm-92, dBm-90}
}

PreambleTransMax ::= ENUMERATED {
  n3, n4, n5, n6, n7, n8, n10, n20, n50,
  n100, n200}

```

```
-- ASN1STOP
```

RACH-ConfigCommon field descriptions
<p>connEstFailCount Number of times that the UE detects T300 expiry on the same cell before applying <i>connEstFailOffset</i>.</p>
<p>connEstFailOffset Parameter "Qoffset_{temp}" in TS 36.304 [4]. If the field is not present the value of infinity shall be used for "Qoffset_{temp}".</p>
<p>connEstFailOffsetValidity Amount of time that the UE applies <i>connEstFailOffset</i> before removing the offset from evaluation of the cell. Value s30 corresponds to 30 seconds, s60 corresponds to 60 seconds, and so on.</p>
<p>mac-ContentionResolutionTimer Timer for contention resolution in TS 36.321 [6]. Value in subframes. Value sf8 corresponds to 8 subframes, sf16 corresponds to 16 subframes and so on.</p>
<p>maxHARQ-Msg3Tx Maximum number of Msg3 HARQ transmissions in TS 36.321 [6], used for contention based random access. Value is an integer.</p>
<p>messagePowerOffsetGroupB Threshold for preamble selection in TS 36.321 [6]. Value in dB. Value minusinfinity corresponds to -infinity. Value dB0 corresponds to 0 dB, dB5 corresponds to 5 dB and so on.</p>
<p>messageSizeGroupA Threshold for preamble selection in TS 36.321 [6]. Value in bits. Value b56 corresponds to 56 bits, b144 corresponds to 144 bits and so on.</p>
<p>numberOfRA-Preambles Number of non-dedicated random access preambles in TS 36.321 [6]. Value is an integer. Value n4 corresponds to 4, n8 corresponds to 8 and so on.</p>
<p>powerRampingStep Power ramping factor in TS 36.321 [6]. Value in dB. Value dB0 corresponds to 0 dB, dB2 corresponds to 2 dB and so on.</p>
<p>preambleInitialReceivedTargetPower Initial preamble power in TS 36.321 [6]. Value in dBm. Value dBm-120 corresponds to -120 dBm, dBm-118 corresponds to -118 dBm and so on.</p>
<p>preamblesGroupAConfig Provides the configuration for preamble grouping in TS 36.321 [6]. If the field is not signalled, the size of the random access preambles group A [6] is equal to <i>numberOfRA-Preambles</i>.</p>
<p>preambleTransMax Maximum number of preamble transmission in TS 36.321 [6]. Value is an integer. Value n3 corresponds to 3, n4 corresponds to 4 and so on.</p>
<p>ra-ResponseWindowSize Duration of the RA response window in TS 36.321 [6]. Value in subframes. Value sf2 corresponds to 2 subframes, sf3 corresponds to 3 subframes and so on. The same value applies for each serving cell (although the associated functionality is performed independently for each cell).</p>
<p>sizeOfRA-PreamblesGroupA Size of the random access preambles group A in TS 36.321 [6]. Value is an integer. Value n4 corresponds to 4, n8 corresponds to 8 and so on.</p>

– RACH-ConfigDedicated

The IE *RACH-ConfigDedicated* is used to specify the dedicated random access parameters.

RACH-ConfigDedicated information element

```
-- ASN1START
RACH-ConfigDedicated ::= SEQUENCE {
    ra-PreambleIndex          INTEGER (0..63),
    ra-PRACH-MaskIndex       INTEGER (0..15)
}
-- ASN1STOP
```

RACH-ConfigDedicated field descriptions
<i>ra-PRACH-MaskIndex</i> Explicitly signalled PRACH Mask Index for RA Resource selection in TS 36.321 [6].
<i>ra-PreambleIndex</i> Explicitly signalled Random Access Preamble for RA Resource selection in TS 36.321 [6].

– RadioResourceConfigCommon

The IE *RadioResourceConfigCommonSIB* and IE *RadioResourceConfigCommon* are used to specify common radio resource configurations in the system information and in the mobility control information, respectively, e.g., the random access parameters and the static physical layer parameters.

RadioResourceConfigCommon information element

```
-- ASN1START

RadioResourceConfigCommonSIB ::= SEQUENCE {
    rach-ConfigCommon          RACH-ConfigCommon,
    bccch-Config               BCCH-Config,
    pcch-Config                PCCH-Config,
    prach-Config               PRACH-ConfigSIB,
    pdsch-ConfigCommon         PDSCH-ConfigCommon,
    pusch-ConfigCommon         PUSCH-ConfigCommon,
    pucch-ConfigCommon         PUCCH-ConfigCommon,
    soundingRS-UL-ConfigCommon SoundingRS-UL-ConfigCommon,
    uplinkPowerControlCommon   UplinkPowerControlCommon,
    ul-CyclicPrefixLength      UL-CyclicPrefixLength,
    ...,
    [[ uplinkPowerControlCommon-v1020 UplinkPowerControlCommon-v1020 OPTIONAL -- Need OR
    ]],
    [[ rach-ConfigCommon-v1250        RACH-ConfigCommon-v1250    OPTIONAL -- Need OR
    ]],
    [[ pusch-ConfigCommon-v1270       PUSCH-ConfigCommon-v1270  OPTIONAL -- Need OR
    ]]
}

RadioResourceConfigCommon ::= SEQUENCE {
    rach-ConfigCommon          RACH-ConfigCommon          OPTIONAL, -- Need ON
    prach-Config               PRACH-Config,
    pdsch-ConfigCommon         PDSCH-ConfigCommon          OPTIONAL, -- Need ON
    pusch-ConfigCommon         PUSCH-ConfigCommon,
    phich-Config               PHICH-Config              OPTIONAL, -- Need ON
    pucch-ConfigCommon         PUCCH-ConfigCommon          OPTIONAL, -- Need ON
    soundingRS-UL-ConfigCommon SoundingRS-UL-ConfigCommon OPTIONAL, -- Need ON
    uplinkPowerControlCommon   UplinkPowerControlCommon  OPTIONAL, -- Need ON
    antennaInfoCommon          AntennaInfoCommon          OPTIONAL, -- Need ON
    p-Max                       P-Max                      OPTIONAL, -- Need OP
    tdd-Config                  TDD-Config              OPTIONAL, -- Cond TDD
    ul-CyclicPrefixLength      UL-CyclicPrefixLength,
    ...,
    [[ uplinkPowerControlCommon-v1020 UplinkPowerControlCommon-v1020 OPTIONAL -- Need ON
    ]],
    [[ tdd-Config-v1130              TDD-Config-v1130          OPTIONAL -- Cond TDD3
    ]],
    [[ pusch-ConfigCommon-v1270       PUSCH-ConfigCommon-v1270  OPTIONAL -- Need OR
    ]]
}

RadioResourceConfigCommonPSCell-r12 ::= SEQUENCE {
    basicFields-r12            RadioResourceConfigCommonSCell-r10,
    pucch-ConfigCommon-r12     PUCCH-ConfigCommon,
    rach-ConfigCommon-r12      RACH-ConfigCommon,
    uplinkPowerControlCommonPSCell-r12 UplinkPowerControlCommonPSCell-r12,
    ...
}

RadioResourceConfigCommonPSCell-v12f0 ::= SEQUENCE {
    basicFields-v12f0          RadioResourceConfigCommonSCell-v1010
}

RadioResourceConfigCommonSCell-r10 ::= SEQUENCE {
    -- DL configuration as well as configuration applicable for DL and UL
    nonUL-Configuration-r10    SEQUENCE {
        -- 1: Cell characteristics
        dl-Bandwidth-r10        ENUMERATED {n6, n15, n25, n50, n75, n100},
    }
}
```

```

-- 2: Physical configuration, general
antennaInfoCommon-r10      AntennaInfoCommon,
mbsfn-SubframeConfigList-r10  MBSFN-SubframeConfigList  OPTIONAL,  -- Need OR
-- 3: Physical configuration, control
pich-Config-r10           PHICH-Config,
-- 4: Physical configuration, physical channels
pdsch-ConfigCommon-r10    PDSCH-ConfigCommon,
tdd-Config-r10            TDD-Config          OPTIONAL  -- Cond
TDDSCell
},
-- UL configuration
ul-Configuration-r10      SEQUENCE {
  ul-FreqInfo-r10         SEQUENCE {
    ul-CarrierFreq-r10    ARFCN-ValueEUTRA          OPTIONAL,  -- Need OP
    ul-Bandwidth-r10      ENUMERATED {n6, n15,
                                     n25, n50, n75, n100}  OPTIONAL,  -- Need OP
    additionalSpectrumEmissionSCell-r10  AdditionalSpectrumEmission
  },
  p-Max-r10               P-Max          OPTIONAL,  -- Need OP
  uplinkPowerControlCommonSCell-r10  UplinkPowerControlCommonSCell-r10,
  -- A special version of IE UplinkPowerControlCommon may be introduced
  -- 3: Physical configuration, control
  soundingRS-UL-ConfigCommon-r10  SoundingRS-UL-ConfigCommon,
  ul-CyclicPrefixLength-r10        UL-CyclicPrefixLength,
  -- 4: Physical configuration, physical channels
  prach-ConfigSCell-r10            PRACH-ConfigSCell-r10  OPTIONAL,  -- Cond TDD-
OR-NoR11
  pusch-ConfigCommon-r10          PUSCH-ConfigCommon          OPTIONAL,  -- Need OR
}
...,
[[ ul-CarrierFreq-v1090          ARFCN-ValueEUTRA-v9e0          OPTIONAL  -- Need OP
]],
[[ rach-ConfigCommonSCell-r11    RACH-ConfigCommonSCell-r11  OPTIONAL,  -- Cond
ULSCell
  prach-ConfigSCell-r11          PRACH-Config          OPTIONAL,  -- Cond UL
  tdd-Config-v1130               TDD-Config-v1130          OPTIONAL,  -- Cond TDD2
  uplinkPowerControlCommonSCell-v1130  UplinkPowerControlCommonSCell-v1130  OPTIONAL  -- Cond UL
]],
[[ pusch-ConfigCommon-v1270      PUSCH-ConfigCommon-v1270      OPTIONAL  -- Need OR
]]
}

RadioResourceConfigCommonSCell-v1010 ::= SEQUENCE {
  -- UL configuration
  ul-Configuration-v1010          SEQUENCE {
    additionalSpectrumEmissionSCell-v1010  AdditionalSpectrumEmission-v1010
  }
}

BCCH-Config ::= SEQUENCE {
  modificationPeriodCoeff        ENUMERATED {n2, n4, n8, n16}
}

PCCH-Config ::= SEQUENCE {
  defaultPagingCycle             ENUMERATED {
    rf32, rf64, rf128, rf256},
  nB                             ENUMERATED {
    fourT, twoT, oneT, halfT, quarterT, oneEighthT,
    oneSixteenthT, oneThirtySecondT}
}

UL-CyclicPrefixLength ::= ENUMERATED {len1, len2}

-- ASN1STOP

```

RadioResourceConfigCommon field descriptions	
additionalSpectrumEmissionSCell	The UE requirements related to <i>additionalSpectrumEmissionSCell</i> are defined in TS 36.101 [42]. E-UTRAN configures the same value in <i>additionalSpectrumEmissionSCell</i> for all SCell(s) of the same band with UL configured. The <i>additionalSpectrumEmissionSCell</i> is applicable for all serving cells (including PCell) of the same band with UL configured.
defaultPagingCycle	Default paging cycle, used to derive 'T' in TS 36.304 [4]. Value rf32 corresponds to 32 radio frames, rf64 corresponds to 64 radio frames and so on.
modificationPeriodCoeff	Actual modification period, expressed in number of radio frames= <i>modificationPeriodCoeff</i> * <i>defaultPagingCycle</i> . n2 corresponds to value 2, n4 corresponds to value 4, n8 corresponds to value 8 and n16 corresponds to value 16.
nB	Parameter: nB is used as one of parameters to derive the Paging Frame and Paging Occasion according to TS 36.304 [4]. Value in multiples of 'T' as defined in TS 36.304 [4]. A value of fourT corresponds to 4 * T, a value of twoT corresponds to 2 * T and so on.
p-Max	Pmax to be used in the target cell. If absent the UE applies the maximum power according to the UE capability.
ul-Bandwidth	Parameter: transmission bandwidth configuration, N _{RB} , in uplink, see TS 36.101 [42, table 5.6-1]. Value n6 corresponds to 6 resource blocks, n15 to 15 resource blocks and so on. If for FDD this parameter is absent, the uplink bandwidth is equal to the downlink bandwidth. For TDD this parameter is absent and it is equal to the downlink bandwidth.
ul-CarrierFreq	For FDD: If absent, the (default) value determined from the default TX-RX frequency separation defined in TS 36.101 [42, table 5.7.3-1] applies. For TDD: This parameter is absent and it is equal to the downlink frequency.
UL-CyclicPrefixLength	Parameter: Uplink cyclic prefix length see 36.211 [21, 5.2.1] where len1 corresponds to normal cyclic prefix and len2 corresponds to extended cyclic prefix.

Conditional presence	Explanation
<i>TDD</i>	The field is optional for TDD, Need ON; it is not present for FDD and the UE shall delete any existing value for this field.
<i>TDD2</i>	If <i>tdd-Config-r10</i> is present, the field is optional, Need OR. Otherwise the field is not present and the UE shall delete any existing value for this field.
<i>TDD3</i>	If <i>tdd-Config</i> is present, the field is optional, Need OR. Otherwise the field is not present and the UE shall delete any existing value for this field.
<i>TDD-OR-NoR11</i>	If <i>prach-ConfigSCell-r11</i> is absent, the field is optional for TDD, Need OR. Otherwise the field is not present and the UE shall delete any existing value for this field.
<i>TDDSCell</i>	This field is mandatory present for TDD; it is not present for FDD and the UE shall delete any existing value for this field.
<i>UL</i>	If the SCell is part of the STAG or concerns the PSCell and if <i>ul-Configuration</i> is included, the field is optional, Need OR. Otherwise the field is not present and the UE shall delete any existing value for this field.
<i>ULSCell</i>	For the PSCell (IE is included in <i>RadioResourceConfigCommonPSCell</i>) the field is absent. Otherwise, if the SCell is part of the STAG and if <i>ul-Configuration</i> is included, the field is optional, Need OR. Otherwise the field is not present and the UE shall delete any existing value for this field.

– *RadioResourceConfigDedicated*

The IE *RadioResourceConfigDedicated* is used to setup/modify/release RBs, to modify the MAC main configuration, to modify the SPS configuration and to modify dedicated physical configuration.

***RadioResourceConfigDedicated* information element**

```

-- ASN1START
RadioResourceConfigDedicated ::=
    SEQUENCE {
        srb-ToAddModList          SRB-ToAddModList          OPTIONAL,    -- Cond HO-Conn
        drb-ToAddModList          DRB-ToAddModList          OPTIONAL,    -- Cond HO-
toEUTRA
        drb-ToReleaseList         DRB-ToReleaseList        OPTIONAL,    -- Need ON
        mac-MainConfig            CHOICE {
            explicitValue         MAC-MainConfig,
            defaultValue          NULL
        }
    }

```

```

} OPTIONAL, -- Cond HO-
toEUTRA2
  sps-Config SPS-Config OPTIONAL, -- Need ON
  physicalConfigDedicated PhysicalConfigDedicated OPTIONAL, -- Need ON
  ...,
  [[ rlf-TimersAndConstants-r9 RLF-TimersAndConstants-r9 OPTIONAL -- Need ON
  ]],
  [[ measSubframePatternPCell-r10 MeasSubframePatternPCell-r10 OPTIONAL -- Need ON
  ]],
  [[ neighCellsCRS-Info-r11 NeighCellsCRS-Info-r11 OPTIONAL -- Need ON
  ]],
  [[ naics-Info-r12 NAICS-AssistanceInfo-r12 OPTIONAL -- Need ON
  ]]}

RadioResourceConfigDedicatedPSCell-r12 ::= SEQUENCE {
  -- UE specific configuration extensions applicable for an PSCell
  physicalConfigDedicatedPSCell-r12 PhysicalConfigDedicated OPTIONAL, -- Need ON
  sps-Config-r12 SPS-Config OPTIONAL, -- Need ON
  naics-Info-r12 NAICS-AssistanceInfo-r12 OPTIONAL, -- Need ON
  ...
}

RadioResourceConfigDedicatedSCG-r12 ::= SEQUENCE {
  drb-ToAddModListSCG-r12 DRB-ToAddModListSCG-r12 OPTIONAL, -- Need ON
  mac-MainConfigSCG-r12 MAC-MainConfig OPTIONAL, -- Need ON
  rlf-TimersAndConstantsSCG-r12 RLF-TimersAndConstantsSCG-r12 OPTIONAL, -- Need ON
  ...
}

RadioResourceConfigDedicatedSCell-r10 ::= SEQUENCE {
  -- UE specific configuration extensions applicable for an SCell
  physicalConfigDedicatedSCell-r10 PhysicalConfigDedicatedSCell-r10 OPTIONAL, -- Need
ON
  ...,
  [[ mac-MainConfigSCell-r11 MAC-MainConfigSCell-r11 OPTIONAL -- Cond SCellAdd
  ]],
  [[ naics-Info-r12 NAICS-AssistanceInfo-r12 OPTIONAL -- Need ON
  ]]}

SRB-ToAddModList ::= SEQUENCE (SIZE (1..2)) OF SRB-ToAddMod

SRB-ToAddMod ::= SEQUENCE {
  srb-Identity INTEGER (1..2),
  rlc-Config CHOICE {
    explicitValue RLC-Config,
    defaultValue NULL
  } OPTIONAL, -- Cond Setup
  logicalChannelConfig CHOICE {
    explicitValue LogicalChannelConfig,
    defaultValue NULL
  } OPTIONAL, -- Cond Setup
  ...
}

DRB-ToAddModList ::= SEQUENCE (SIZE (1..maxDRB)) OF DRB-ToAddMod

DRB-ToAddModListSCG-r12 ::= SEQUENCE (SIZE (1..maxDRB)) OF DRB-ToAddModSCG-r12

DRB-ToAddMod ::= SEQUENCE {
  eps-BearerIdentity INTEGER (0..15) OPTIONAL, -- Cond DRB-Setup
  drb-Identity DRB-Identity,
  pdcp-Config PDCP-Config OPTIONAL, -- Cond PDCP
  rlc-Config RLC-Config OPTIONAL, -- Cond SetupM
  logicalChannelIdentity INTEGER (3..10) OPTIONAL, -- Cond DRB-SetupM
  logicalChannelConfig LogicalChannelConfig OPTIONAL, -- Cond SetupM
  ...,
  [[ drb-TypeChange-r12 ENUMERATED {toMCG} OPTIONAL, -- Need OP
  rlc-Config-v1250 RLC-Config-v1250 OPTIONAL -- Need ON
  ]]}

DRB-ToAddModSCG-r12 ::= SEQUENCE {
  drb-Identity-r12 DRB-Identity,
  drb-Type-r12 CHOICE {
    split-r12 NULL,
    scg-r12 SEQUENCE {
      eps-BearerIdentity-r12 INTEGER (0..15) OPTIONAL, -- Cond DRB-Setup

```



```

    pdcP-Config-r12                PDCP-Config    OPTIONAL    -- Cond PDCP-S
  }
}
rlc-ConfigSCG-r12                 RLC-Config    OPTIONAL,   -- Cond SetupS2
rlc-Config-v1250                  RLC-Config-v1250  OPTIONAL,   -- Cond SetupS
logicalChannelIdentitySCG-r12     INTEGER (3..10)  OPTIONAL,   -- Need ON
logicalChannelConfigSCG-r12       LogicalChannelConfig  OPTIONAL,   -- Cond DRB-SetupS
...
}
DRB-ToReleaseList ::=              SEQUENCE (SIZE (1..maxDRB)) OF DRB-Identity
MeasSubframePatternPCell-r10 ::=   CHOICE {
  release                          NULL,
  setup                            MeasSubframePattern-r10
}
NeighCellsCRS-Info-r11 ::=         CHOICE {
  release                          NULL,
  setup                            CRS-AssistanceInfoList-r11
}
CRS-AssistanceInfoList-r11 ::=     SEQUENCE (SIZE (1..maxCellReport)) OF CRS-AssistanceInfo-r11
CRS-AssistanceInfo-r11 ::=         SEQUENCE {
  physCellId-r11                  PhysCellId,
  antennaPortsCount-r11           ENUMERATED {an1, an2, an4, spare1},
  mbsfn-SubframeConfigList-r11    MBSFN-SubframeConfigList,
  ...
}
NAICS-AssistanceInfo-r12 ::=       CHOICE {
  release                          NULL,
  setup                            SEQUENCE {
    neighCellsToReleaseList-r12    NeighCellsToReleaseList-r12    OPTIONAL,   -- Need ON
    neighCellsToAddModList-r12     NeighCellsToAddModList-r12     OPTIONAL,   -- Need ON
    servCellp-a-r12                P-a                            OPTIONAL,   -- Need ON
  }
}
NeighCellsToReleaseList-r12 ::=     SEQUENCE (SIZE (1..maxNeighCell-r12)) OF PhysCellId
NeighCellsToAddModList-r12 ::=     SEQUENCE (SIZE (1..maxNeighCell-r12)) OF NeighCellsInfo-r12
NeighCellsInfo-r12 ::=             SEQUENCE {
  physCellId-r12                  PhysCellId,
  p-b-r12                         INTEGER (0..3),
  crs-PortsCount-r12              ENUMERATED {n1, n2, n4, spare},
  mbsfn-SubframeConfig-r12        MBSFN-SubframeConfigList        OPTIONAL,   -- Need ON
  p-aList-r12                     SEQUENCE (SIZE (1..maxP-a-PerNeighCell-r12)) OF P-a,
  transmissionModeList-r12        BIT STRING (SIZE(8)),
  resAllocGranularity-r12         INTEGER (1..4),
  ...
}
P-a ::= ENUMERATED {               dB-6, dB-4dot77, dB-3, dB-1dot77,
                                dB0, dB1, dB2, dB3}
-- ASN1STOP

```

RadioResourceConfigDedicated field descriptions
<p>crs-PortsCount Parameter represents the number of antenna ports for cell-specific reference signal used by the signaled neighboring cell where n1 corresponds to 1 antenna port, n2 to 2 antenna ports etc. see TS 36.211 [21, 6.10.1].</p>
<p>drb-Identity In case of DC, the DRB identity is unique within the scope of the UE i.e. an SCG DRB can not use the same value as used for an MCG or split DRB. For a split DRB the same identity is used for the MCG- and SCG parts of the configuration.</p>
<p>drb-ToAddModListSCG When an SCG is configured, E-UTRAN configures at least one SCG or split DRB.</p>
<p>drb-Type This field indicates whether the DRB is split or SCG DRB. E-UTRAN does not configure split and SCG DRBs simultaneously for the UE.</p>
<p>drb-TypeChange Indicates that a split/SCG DRB is reconfigured to an MCG DRB (i.e. E-UTRAN only signals the field in case the DRB type changes).</p>
<p>logicalChannelConfig For SRBs a choice is used to indicate whether the logical channel configuration is signalled explicitly or set to the default logical channel configuration for SRB1 as specified in 9.2.1.1 or for SRB2 as specified in 9.2.1.2.</p>
<p>logicalChannelIdentity The logical channel identity for both UL and DL.</p>
<p>mac-MainConfig Although the ASN.1 includes a choice that is used to indicate whether the mac-MainConfig is signalled explicitly or set to the default MAC main configuration as specified in 9.2.2, EUTRAN does not apply "defaultValue".</p>
<p>mbsfn-SubframeConfig Defines the MBSFN subframe configuration used by the signaled neighboring cell. If absent, UE assumes no MBSFN configuration for the neighboring cell.</p>
<p>measSubframePatternPCell Time domain measurement resource restriction pattern for the PCell measurements (RSRP, RSRQ and the radio link monitoring).</p>
<p>neighCellsCRS-Info This field contains assistance information, concerning the primary frequency, used by the UE to mitigate interference from CRS while performing RRM/RLM/CSI measurement or data demodulation. When the received CRS assistance information is for a cell with CRS colliding with that of the CRS of the cell to measure, the UE may use the CRS assistance information to mitigate CRS interference (as specified in TS 36.101 [42]) on the subframes indicated by <i>measSubframePatternPCell</i>, <i>measSubframePatternConfigNeigh</i>, <i>csi-MeasSubframeSet1</i> if configured, and the CSI subframe set 1 if <i>csi-MeasSubframeSets-r12</i> is configured. Furthermore, the UE may use CRS assistance information to mitigate CRS interference from the cells in the IE for the demodulation purpose as specified in TS 36.101 [42]. EUTRAN does not configure <i>neighCellsCRS-Info-r11</i> if <i>eimta-MainConfigPCell-r12</i> is configured.</p>
<p>neighCellsToAddModList This field contains assistance information used by the UE to cancel and suppress interference of a neighbouring cell. If this field is present for a neighbouring cell, the UE assumes that the transmission parameters listed in the sub-fields are used by the neighbouring cell. If this field is present for a neighbouring cell, the UE assumes the neighbour cell is subframe and SFN synchronized to the serving cell, has the same system bandwidth, UL/DL and special subframe configuration, and cyclic prefix length as the serving cell.</p>
<p>p-aList Indicates the restricted subset of power offset for QPSK, 16QAM, and 64QAM PDSCH transmissions for the neighbouring cell by using the parameter P_A, see TS 36.213 [23, 5.2]. Value dB-6 corresponds to -6 dB, dB-4dot77 corresponds to -4.77 dB etc.</p>
<p>p-b Parameter: P_B, indicates the cell-specific ratio used by the signaled neighboring cell, see TS 36.213 [23, Table 5.2-1].</p>
<p>physicalConfigDedicated The default dedicated physical configuration is specified in 9.2.4.</p>
<p>resAllocGranularity Indicates the resource allocation and precoding granularity in PRB pair level of the signaled neighboring cell, see TS 36.213 [23, 7.1.6].</p>
<p>rlc-Config For SRBs a choice is used to indicate whether the RLC configuration is signalled explicitly or set to the values defined in the default RLC configuration for SRB1 in 9.2.1.1 or for SRB2 in 9.2.1.2. RLC AM is the only applicable RLC mode for SRB1 and SRB2. E-UTRAN does not reconfigure the RLC mode of DRBs except when a full configuration option is used, and may reconfigure the UM RLC SN field size and the AM RLC LI field size only upon handover within E-UTRA or upon the first reconfiguration after RRC connection re-establishment or upon SCG Change for SCG and split DRBs.</p>
<p>servCellp-a Indicates the power offset for QPSK C-RNTI based PDSCH transmissions used by the serving cell, see 36.213 [23, 5.2]. Value dB-6 corresponds to -6 dB, dB-4dot77 corresponds to -4.77 dB etc.</p>

RadioResourceConfigDedicated field descriptions
<p>sps-Config The default SPS configuration is specified in 9.2.3. Except for handover or releasing SPS for MCG, E-UTRAN does not reconfigure <i>sps-Config</i> for MCG when there is a configured downlink assignment or a configured uplink grant for MCG (see TS 36.321 [6]). Except for SCG change or releasing SPS for SCG, E-UTRAN does not reconfigure <i>sps-Config</i> for SCG when there is a configured downlink assignment or a configured uplink grant for SCG (see TS 36.321 [6]).</p>
<p>srb-Identity Value 1 is applicable for SRB1 only. Value 2 is applicable for SRB2 only.</p>
<p>transmissionModeList Indicates a subset of transmission mode 1, 2, 3, 4, 6, 8, 9, 10, for the signaled neighboring cell for which <i>NeighCellsInfo</i> applies. When TM10 is signaled, other signaled transmission parameters in <i>NeighCellsInfo</i> are not applicable to up to 8 layer transmission scheme of TM10. E-UTRAN may indicate TM9 when TM10 with QCL type A and DMRS scrambling with $n_{ID}^{(i)} = N_{ID}^{cell}$ in TS 36.211 [21, 6.10.3.1] is used in the signalled neighbour cell and TM9 or TM10 with QCL type A and DMRS scrambling with $n_{ID}^{(i)} = N_{ID}^{cell}$ in TS 36.211 [21, 6.10.3.1] is used in the serving cell. UE behaviour with NAICS when TM10 is used is only defined when QCL type A and DMRS scrambling with $n_{ID}^{(i)} = N_{ID}^{cell}$ in TS 36.211 [21, 6.10.3.1] is used for the serving cell and all signalled neighbour cells. The first/ leftmost bit is for transmission mode 1, the second bit is for transmission mode 2, and so on.</p>

Conditional presence	Explanation
<i>DRB-Setup</i>	The field is mandatory present if the corresponding DRB is being set up; otherwise it is not present.
<i>DRB-SetupM</i>	The field is mandatory present upon setup of MCG or split DRB; The field is optionally present, Need ON, upon change from SCG to MCG DRB; otherwise it is not present.
<i>DRB-SetupS</i>	The field is mandatory present upon setup of SCG or split DRB, or upon change from MCG to split DRB; The field is optionally present, Need ON, upon change from MCG to SCG DRB; otherwise it is not present.
<i>HO-Conn</i>	The field is mandatory present in case of handover to E-UTRA or when the <i>fullConfig</i> is included in the <i>RRCConnectionReconfiguration</i> message or in case of RRC connection establishment; otherwise the field is optionally present, need ON. Upon connection establishment/ re-establishment only SRB1 is applicable.
<i>HO-toEUTRA</i>	The field is mandatory present in case of handover to E-UTRA or when the <i>fullConfig</i> is included in the <i>RRCConnectionReconfiguration</i> message; In case of RRC connection establishment and RRC connection re-establishment the field is not present; otherwise the field is optionally present, need ON.
<i>HO-toEUTRA2</i>	The field is mandatory present in case of handover to E-UTRA or when the <i>fullConfig</i> is included in the <i>RRCConnectionReconfiguration</i> message; otherwise the field is optionally present, need ON.
<i>PDCP</i>	The field is mandatory present if the corresponding DRB is being setup; the field is optionally present, need ON, upon reconfiguration of the corresponding split DRB, upon the corresponding DRB type change from split to MCG bearer, upon the corresponding DRB type change from MCG to split bearer, upon handover within E-UTRA and upon the first reconfiguration after re-establishment but in all these cases only when <i>fullConfig</i> is not included in the <i>RRCConnectionReconfiguration</i> message; otherwise it is not present.
<i>PDCP-S</i>	The field is mandatory present if the corresponding DRB is being setup; the field is optionally present, need ON, upon SCG change; otherwise it is not present.
<i>RLC-Setup</i>	This field is optionally present if the corresponding DRB is being setup, need ON; otherwise it is not present.
<i>SCellAdd</i>	The field is optionally present, need ON, upon SCell addition; otherwise it is not present.
<i>Setup</i>	The field is mandatory present if the corresponding SRB/DRB is being setup; otherwise the field is optionally present, need ON.
<i>SetupM</i>	The field is mandatory present upon setup of an MCG or split DRB; otherwise the field is optionally present, need ON.
<i>SetupS</i>	The field is mandatory present upon setup of an SCG or split DRB, as well as upon change from MCG to split DRB; otherwise the field is optionally present, need ON.
<i>SetupS2</i>	The field is mandatory present upon setup of an SCG or split DRB, as well as upon change from MCG to split or SCG DRB. For an SCG DRB the field is optionally present, need ON. Otherwise the field is not present.

– RLC-Config

The IE *RLC-Config* is used to specify the RLC configuration of SRBs and DRBs.

RLC-Config information element

```
-- ASN1START
RLC-Config ::= CHOICE {
    am SEQUENCE {
        ul-AM-RLC UL-AM-RLC,
        dl-AM-RLC DL-AM-RLC
    },
    um-Bi-Directional SEQUENCE {
        ul-UM-RLC UL-UM-RLC,
        dl-UM-RLC DL-UM-RLC
    },
    um-Uni-Directional-UL SEQUENCE {
        ul-UM-RLC UL-UM-RLC
    },
    um-Uni-Directional-DL SEQUENCE {
        dl-UM-RLC DL-UM-RLC
    },
    ...
}

RLC-Config-v1250 ::= SEQUENCE {
    ul-extended-RLC-LI-Field-r12 BOOLEAN,
    dl-extended-RLC-LI-Field-r12 BOOLEAN
}

UL-AM-RLC ::= SEQUENCE {
    t-PollRetransmit T-PollRetransmit,
    pollPDU PollPDU,
    pollByte PollByte,
    maxRetxThreshold ENUMERATED {
        t1, t2, t3, t4, t6, t8, t16, t32}
}

DL-AM-RLC ::= SEQUENCE {
    t-Reordering T-Reordering,
    t-StatusProhibit T-StatusProhibit
}

UL-UM-RLC ::= SEQUENCE {
    sn-FieldLength SN-FieldLength
}

DL-UM-RLC ::= SEQUENCE {
    sn-FieldLength SN-FieldLength,
    t-Reordering T-Reordering
}

SN-FieldLength ::= ENUMERATED {size5, size10}

T-PollRetransmit ::= ENUMERATED {
    ms5, ms10, ms15, ms20, ms25, ms30, ms35,
    ms40, ms45, ms50, ms55, ms60, ms65, ms70,
    ms75, ms80, ms85, ms90, ms95, ms100, ms105,
    ms110, ms115, ms120, ms125, ms130, ms135,
    ms140, ms145, ms150, ms155, ms160, ms165,
    ms170, ms175, ms180, ms185, ms190, ms195,
    ms200, ms205, ms210, ms215, ms220, ms225,
    ms230, ms235, ms240, ms245, ms250, ms300,
    ms350, ms400, ms450, ms500, spare9, spare8,
    spare7, spare6, spare5, spare4, spare3,
    spare2, spare1}

PollPDU ::= ENUMERATED {
    p4, p8, p16, p32, p64, p128, p256, pInfinity}

PollByte ::= ENUMERATED {
    kB25, kB50, kB75, kB100, kB125, kB250, kB375,
    kB500, kB750, kB1000, kB1250, kB1500, kB2000,
    kB3000, kBInfinity, spare1}

T-Reordering ::= ENUMERATED {
```

```

ms0, ms5, ms10, ms15, ms20, ms25, ms30, ms35,
ms40, ms45, ms50, ms55, ms60, ms65, ms70,
ms75, ms80, ms85, ms90, ms95, ms100, ms110,
ms120, ms130, ms140, ms150, ms160, ms170,
ms180, ms190, ms200, spare1}

T-StatusProhibit ::=
    ENUMERATED {
        ms0, ms5, ms10, ms15, ms20, ms25, ms30, ms35,
        ms40, ms45, ms50, ms55, ms60, ms65, ms70,
        ms75, ms80, ms85, ms90, ms95, ms100, ms105,
        ms110, ms115, ms120, ms125, ms130, ms135,
        ms140, ms145, ms150, ms155, ms160, ms165,
        ms170, ms175, ms180, ms185, ms190, ms195,
        ms200, ms205, ms210, ms215, ms220, ms225,
        ms230, ms235, ms240, ms245, ms250, ms300,
        ms350, ms400, ms450, ms500, spare8, spare7,
        spare6, spare5, spare4, spare3, spare2,
        spare1}

-- ASN1STOP

```

RLC-Config field descriptions

<i>dl-extended-RLC-LI-Field, ul-extended-RLC-LI-Field</i>
Indicates the RLC LI field size. Value <i>TRUE</i> means that 15 bit LI length shall be used, otherwise 11 bit LI length shall be used; see TS 36.322 [7]. E-UTRAN enables this field only when <i>RLC-Config</i> (without suffix) is set to <i>am</i> .
<i>maxRetxThreshold</i>
Parameter for RLC AM in TS 36.322 [7]. Value t1 corresponds to 1 retransmission, t2 to 2 retransmissions and so on.
<i>pollByte</i>
Parameter for RLC AM in TS 36.322 [7]. Value kB25 corresponds to 25 kBytes, kB50 to 50 kBytes and so on. kBInfinity corresponds to an infinite amount of kBytes.
<i>pollPDU</i>
Parameter for RLC AM in TS 36.322 [7]. Value p4 corresponds to 4 PDUs, p8 to 8 PDUs and so on. pInfinity corresponds to an infinite number of PDUs.
<i>sn-FieldLength</i>
Indicates the UM RLC SN field size, see TS 36.322 [7], in bits. Value size5 means 5 bits, size10 means 10 bits.
<i>t-PollRetransmit</i>
Timer for RLC AM in TS 36.322 [7], in milliseconds. Value ms5 means 5ms, ms10 means 10ms and so on.
<i>t-Reordering</i>
Timer for reordering in TS 36.322 [7], in milliseconds. Value ms0 means 0ms, ms5 means 5ms and so on.
<i>t-StatusProhibit</i>
Timer for status reporting in TS 36.322 [7], in milliseconds. Value ms0 means 0ms, ms5 means 5ms and so on.

RLF-TimersAndConstants

The IE *RLF-TimersAndConstants* contains UE specific timers and constants applicable for UEs in RRC_CONNECTED.

RLF-TimersAndConstants information element

```

-- ASN1START

RLF-TimersAndConstants-r9 ::=
    CHOICE {
        release
        setup
            t301-r9
            t310-r9
            n310-r9
            t311-r9
            n311-r9
            ...
    }

RLF-TimersAndConstantsSCG-r12 ::=
    CHOICE {

```

```

release          NULL,
setup           SEQUENCE {
  t313-r12      ENUMERATED {
    ms0, ms50, ms100, ms200, ms500, ms1000, ms2000},
  n313-r12      ENUMERATED {
    n1, n2, n3, n4, n6, n8, n10, n20},
  n314-r12      ENUMERATED {
    n1, n2, n3, n4, n5, n6, n8, n10},
  ...
}
}
-- ASN1STOP

```

RLF-TimersAndConstants field descriptions

n3xy

Constants are described in section 7.4. n1 corresponds with 1, n2 corresponds with 2 and so on.

t3xy

Timers are described in section 7.3. Value ms0 corresponds with 0 ms, ms50 corresponds with 50 ms and so on.

RN-SubframeConfig

The IE *RN-SubframeConfig* is used to specify the subframe configuration for an RN.

RN-SubframeConfig information element

```

-- ASN1START
RN-SubframeConfig-r10 ::= SEQUENCE {
  subframeConfigPattern-r10 CHOICE {
    subframeConfigPatternFDD-r10 BIT STRING (SIZE(8)),
    subframeConfigPatternTDD-r10 INTEGER (0..31)
  } OPTIONAL, -- Need ON
  rpdccch-Config-r10 SEQUENCE {
    resourceAllocationType-r10 ENUMERATED {type0, type1, type2Localized, type2Distributed,
      spare4, spare3, spare2, spare1},
    resourceBlockAssignment-r10 CHOICE {
      type01-r10 CHOICE {
        nrb6-r10 BIT STRING (SIZE(6)),
        nrb15-r10 BIT STRING (SIZE(8)),
        nrb25-r10 BIT STRING (SIZE(13)),
        nrb50-r10 BIT STRING (SIZE(17)),
        nrb75-r10 BIT STRING (SIZE(19)),
        nrb100-r10 BIT STRING (SIZE(25))
      },
      type2-r10 CHOICE {
        nrb6-r10 BIT STRING (SIZE(5)),
        nrb15-r10 BIT STRING (SIZE(7)),
        nrb25-r10 BIT STRING (SIZE(9)),
        nrb50-r10 BIT STRING (SIZE(11)),
        nrb75-r10 BIT STRING (SIZE(12)),
        nrb100-r10 BIT STRING (SIZE(13))
      },
      ...
    },
    demodulationRS-r10 CHOICE {
      interleaving-r10 ENUMERATED {crs},
      noInterleaving-r10 ENUMERATED {crs, dmrs}
    },
    pdsch-Start-r10 INTEGER (1..3),
    pucch-Config-r10 CHOICE {
      tdd CHOICE {
        channelSelectionMultiplexingBundling SEQUENCE {
          n1PUCCH-AN-List-r10 SEQUENCE (SIZE (1..4)) OF INTEGER (0..2047)
        },
        fallbackForFormat3 SEQUENCE {
          n1PUCCH-AN-P0-r10 INTEGER (0..2047),
          n1PUCCH-AN-P1-r10 INTEGER (0..2047) OPTIONAL -- Need OR
        }
      },
      fdd SEQUENCE {
        n1PUCCH-AN-P0-r10 INTEGER (0..2047),
        n1PUCCH-AN-P1-r10 INTEGER (0..2047) OPTIONAL -- Need OR
      }
    }
  }
}
-- ASN1STOP

```

```

    },
    ...
}
...
}
-- ASN1STOP

```

OPTIONAL, -- Need ON

RN-SubframeConfig field descriptions
<p>demodulationRS Indicates which reference signals are used for R-PDCCH demodulation according to TS 36.216 [55, 7.4.1]. Value interleaving corresponds to cross-interleaving and value noInterleaving corresponds to no cross-interleaving according to TS 36.216 [55, 7.4.2 and 7.4.3].</p>
<p>n1PUCCH-AN-List Parameter: $n_{\text{PUCCH},i}^{(1)}$, see TS 36.216, [55, 7.5.1]. This parameter is only applicable for TDD. Configures PUCCH HARQ-ACK resources if the RN is configured to use HARQ-ACK channel selection, HARQ-ACK multiplexing or HARQ-ACK bundling.</p>
<p>n1PUCCH-AN-P0, n1PUCCH-AN-P1 Parameter: $n_{\text{PUCCH}}^{(1,p)}$, for antenna port P0 and for antenna port P1 respectively, see TS 36.216, [55, 7.5.1] for FDD and [55, 7.5.2] for TDD.</p>
<p>pdsch-Start Parameter: <i>DL-StartSymbol</i>, see TS 36.216 [55, Table 5.4-1].</p>
<p>resourceAllocationType Represents the resource allocation used: type 0, type 1 or type 2 according to TS 36.213 [23, 7.1.6]. Value type0 corresponds to type 0, value type1 corresponds to type 1, value type2Localized corresponds to type 2 with localized virtual resource blocks and type2Distributed corresponds to type 2 with distributed virtual resource blocks.</p>
<p>resourceBlockAssignment Indicates the resource block assignment bits according to TS 36.213 [23, 7.1.6]. Value type01 corresponds to type 0 and type 1, and the value type2 corresponds to type 2. Value nrb6 corresponds to a downlink system bandwidth of 6 resource blocks, value nrb15 corresponds to a downlink system bandwidth of 15 resource blocks, and so on.</p>
<p>subframeConfigPatternFDD Parameter: <i>SubframeConfigurationFDD</i>, see TS 36.216 [55, Table 5.2-1]. Defines the DL subframe configuration for eNB-to-RN transmission, i.e. those subframes in which the eNB may indicate downlink assignments for the RN. The radio frame in which the pattern starts (i.e. the radio frame in which the first bit of the <i>subframeConfigPatternFDD</i> corresponds to subframe #0) occurs when $\text{SFN mod } 4 = 0$.</p>
<p>subframeConfigPatternTDD Parameter: <i>SubframeConfigurationTDD</i>, see TS 36.216 [55, Table 5.2-2]. Defines the DL and UL subframe configuration for eNB-RN transmission.</p>

SchedulingRequestConfig

The IE *SchedulingRequestConfig* is used to specify the Scheduling Request related parameters

SchedulingRequestConfig information element

```

-- ASN1START
SchedulingRequestConfig ::= CHOICE {
  release      NULL,
  setup       SEQUENCE {
    sr-PUCCH-ResourceIndex  INTEGER (0..2047),
    sr-ConfigIndex          INTEGER (0..157),
    dsr-TransMax            ENUMERATED {
      n4, n8, n16, n32, n64, spare3, spare2, spare1}
  }
}
SchedulingRequestConfig-v1020 ::= SEQUENCE {
  sr-PUCCH-ResourceIndexP1-r10  INTEGER (0..2047)
}
-- ASN1STOP

```

OPTIONAL -- Need OR

<i>SchedulingRequestConfig</i> field descriptions
<p><i>dsr-TransMax</i> Parameter for SR transmission in TS 36.321 [6, 5.4.4]. The value n4 corresponds to 4 transmissions, n8 corresponds to 8 transmissions and so on.</p>
<p><i>sr-ConfigIndex</i> Parameter I_{SR}. See TS 36.213 [23,10.1]. The values 156 and 157 are not applicable for Release 8.</p>
<p><i>sr-PUCCH-ResourceIndex, sr-PUCCH-ResourceIndexP1</i> Parameter: $n_{PUCCH,SRI}^{(1,p)}$ for antenna port P0 and for antenna port P1 respectively, see TS 36.213 [23, 10.1]. E-UTRAN configures <i>sr-PUCCH-ResourceIndexP1</i> only if <i>sr-PUCCHResourceIndex</i> is configured.</p>

SoundingRS-UL-Config

The IE *SoundingRS-UL-Config* is used to specify the uplink Sounding RS configuration for periodic and aperiodic sounding.

SoundingRS-UL-Config information element

```
-- ASN1START

SoundingRS-UL-ConfigCommon ::= CHOICE {
  release      NULL,
  setup       SEQUENCE {
    srs-BandwidthConfig      ENUMERATED {bw0, bw1, bw2, bw3, bw4, bw5, bw6, bw7},
    srs-SubframeConfig      ENUMERATED {
      sc0, sc1, sc2, sc3, sc4, sc5, sc6, sc7,
      sc8, sc9, sc10, sc11, sc12, sc13, sc14, sc15},
    ackNackSRS-SimultaneousTransmission BOOLEAN,
    srs-MaxUpPts            ENUMERATED {true}          OPTIONAL    -- Cond TDD
  }
}

SoundingRS-UL-ConfigDedicated ::= CHOICE{
  release      NULL,
  setup       SEQUENCE {
    srs-Bandwidth      ENUMERATED {bw0, bw1, bw2, bw3},
    srs-HoppingBandwidth      ENUMERATED {hbw0, hbw1, hbw2, hbw3},
    freqDomainPosition      INTEGER (0..23),
    duration              BOOLEAN,
    srs-ConfigIndex      INTEGER (0..1023),
    transmissionComb      INTEGER (0..1),
    cyclicShift          ENUMERATED {cs0, cs1, cs2, cs3, cs4, cs5, cs6, cs7}
  }
}

SoundingRS-UL-ConfigDedicated-v1020 ::= SEQUENCE {
  srs-AntennaPort-r10      SRS-AntennaPort
}

SoundingRS-UL-ConfigDedicatedAperiodic-r10 ::= CHOICE{
  release      NULL,
  setup       SEQUENCE {
    srs-ConfigIndexAp-r10      INTEGER (0..31),
    srs-ConfigApDCI-Format4-r10      SEQUENCE (SIZE (1..3)) OF SRS-ConfigAp-r10  OPTIONAL,--
  }
}

Need ON
  srs-ActivateAp-r10      CHOICE {
    release      NULL,
    setup       SEQUENCE {
      srs-ConfigApDCI-Format0-r10      SRS-ConfigAp-r10,
      srs-ConfigApDCI-Format1a2b2c-r10      SRS-ConfigAp-r10,
      ...
    }
  }
}

OPTIONAL    -- Need ON

}

SRS-ConfigAp-r10 ::= SEQUENCE {
  srs-AntennaPortAp-r10      SRS-AntennaPort,
  srs-BandwidthAp-r10      ENUMERATED {bw0, bw1, bw2, bw3},
  freqDomainPositionAp-r10      INTEGER (0..23),
  transmissionCombAp-r10      INTEGER (0..1),
  cyclicShiftAp-r10          ENUMERATED {cs0, cs1, cs2, cs3, cs4, cs5, cs6, cs7}
}
-- ASN1END
```



```
SRS-AntennaPort ::= ENUMERATED {an1, an2, an4, spare1}
-- ASN1STOP
```

SoundingRS-UL-Config field descriptions	
ackNackSRS-SimultaneousTransmission	Parameter: <i>Simultaneous-AN-and-SRS</i> , see TS 36.213 [23, 8.2]. For SCells this field is not applicable and the UE shall ignore the value.
cyclicShift, cyclicShiftAp	Parameter: n_{SRS} for periodic and aperiodic sounding reference signal transmission respectively. See TS 36.211 [21, 5.5.3.1], where cs_0 corresponds to 0 etc.
duration	Parameter: Duration for periodic sounding reference signal transmission. See TS 36.213 [21, 8.2]. FALSE corresponds to "single" and value TRUE to "indefinite".
freqDomainPosition, freqDomainPositionAp	Parameter: n_{RRC} for periodic and aperiodic sounding reference signal transmission respectively, see TS 36.211 [21, 5.5.3.2].
srs-AntennaPort, srs-AntennaPortAp	Indicates the number of antenna ports used for periodic and aperiodic sounding reference signal transmission respectively, see TS 36.211 [21, 5.5.3]. UE shall release <i>srs-AntennaPort</i> if <i>SoundingRS-UL-ConfigDedicated</i> is released.
srs-Bandwidth, srs-BandwidthAp	Parameter: B_{SRS} for periodic and aperiodic sounding reference signal transmission respectively, see TS 36.211 [21, tables 5.5.3.2-1, 5.5.3.2-2, 5.5.3.2-3 and 5.5.3.2-4].
srs-BandwidthConfig	Parameter: SRS Bandwidth Configuration. See TS 36.211, [21, table 5.5.3.2-1, 5.5.3.2-2, 5.5.3.2-3 and 5.5.3.2-4]. Actual configuration depends on UL bandwidth. bw_0 corresponds to value 0, bw_1 to value 1 and so on.
srs-ConfigApDCI-Format0 / srs-ConfigApDCI-Format1a2b2c / srs-ConfigApDCI-Format4	Parameters indicate the resource configurations for aperiodic sounding reference signal transmissions triggered by DCI formats 0, 1A, 2B, 2C, 4. See TS 36.213 [23, 8.2].
srs-ConfigIndex, srs-ConfigIndexAp	Parameter: i_{SRS} for periodic and aperiodic sounding reference signal transmission respectively. See TS 36.213 [23, table 8.2-1 and table 8.2-2] for periodic and TS 36.213 [23, table 8.2-4 and table 8.2-5] for aperiodic SRS transmission.
srs-HoppingBandwidth	Parameter: SRS hopping bandwidth $b_{\text{hop}} \in \{0,1,2,3\}$ for periodic sounding reference signal transmission, see TS 36.211 [21, 5.5.3.2] where hbw_0 corresponds to value 0, hbw_1 to value 1 and so on.
srs-MaxUpPts	Parameter: <i>srsMaxUpPts</i> , see TS 36.211 [21, 5.5.3.2]. If this field is present, reconfiguration of $m_{\text{SRS},0}^{\text{max}}$ applies for UpPts, otherwise reconfiguration does not apply.
srs-SubframeConfig	Parameter: SRS SubframeConfiguration. See TS 36.211, [21, table 5.5.3.3-1] applies for FDD whereas TS 36.211, [21, table 5.5.3.3-2] applies for TDD. sc_0 corresponds to value 0, sc_1 to value 1 and so on.
transmissionComb, transmissionCombAp	Parameter: $\bar{k}_{\text{TC}} \in \{0,1\}$ for periodic and aperiodic sounding reference signal transmission respectively, see TS 36.211 [21, 5.5.3.2].

Conditional presence	Explanation
<i>TDD</i>	This field is optional present for TDD, need OR; it is not present for FDD and the UE shall delete any existing value for this field.

– SPS-Config

The IE *SPS-Config* is used to specify the semi-persistent scheduling configuration.

SPS-Config information element

```
-- ASN1START
SPS-Config ::= SEQUENCE {
    semiPersistSchedC-RNTI          C-RNTI          OPTIONAL,
    -- Need OR
```

```

sps-ConfigDL          SPS-ConfigDL          OPTIONAL,          -- Need ON
sps-ConfigUL          SPS-ConfigUL          OPTIONAL          -- Need ON
}

SPS-ConfigDL ::= CHOICE{
  release              NULL,
  setup                SEQUENCE {
    semiPersistSchedIntervalDL  ENUMERATED {
      sf10, sf20, sf32, sf40, sf64, sf80,
      sf128, sf160, sf320, sf640, spare6,
      spare5, spare4, spare3, spare2,
      spare1},
    numberOfConfSPS-Processes    INTEGER (1..8),
    n1PUCCH-AN-PersistentList    N1PUCCH-AN-PersistentList,
    ...,
    [[ twoAntennaPortActivated-r10 CHOICE {
      release              NULL,
      setup                SEQUENCE {
        n1PUCCH-AN-PersistentListPl-r10 N1PUCCH-AN-PersistentList
      }
    }
  ]]
}
OPTIONAL          -- Need ON

SPS-ConfigUL ::= CHOICE {
  release              NULL,
  setup                SEQUENCE {
    semiPersistSchedIntervalUL  ENUMERATED {
      sf10, sf20, sf32, sf40, sf64, sf80,
      sf128, sf160, sf320, sf640, spare6,
      spare5, spare4, spare3, spare2,
      spare1},
    implicitReleaseAfter        ENUMERATED {e2, e3, e4, e8},
    p0-Persistent                SEQUENCE {
      p0-NominalPUSCH-Persistent    INTEGER (-126..24),
      p0-UE-PUSCH-Persistent        INTEGER (-8..7)
    }
    OPTIONAL,
    twoIntervalsConfig          ENUMERATED {true}
    OPTIONAL,
    ...,
    [[ p0-PersistentSubframeSet2-r12 CHOICE {
      release              NULL,
      setup                SEQUENCE {
        p0-NominalPUSCH-PersistentSubframeSet2-r12    INTEGER (-126..24),
        p0-UE-PUSCH-PersistentSubframeSet2-r12        INTEGER (-8..7)
      }
    }
  ]]
}
OPTIONAL          -- Need ON

N1PUCCH-AN-PersistentList ::= SEQUENCE (SIZE (1..4)) OF INTEGER (0..2047)

-- ASN1STOP

```

SPS-Config field descriptions
<p>implicitReleaseAfter Number of empty transmissions before implicit release, see TS 36.321 [6, 5.10.2]. Value e2 corresponds to 2 transmissions, e3 corresponds to 3 transmissions and so on.</p>
<p>n1PUCCH-AN-PersistentList, n1PUCCH-AN-PersistentListP1 List of parameter: $n_{\text{PUCCH}}^{(1,p)}$ for antenna port P0 and for antenna port P1 respectively, see TS 36.213 [23, 10.1]. Field <i>n1-PUCCH-AN-PersistentListP1</i> is applicable only if the <i>twoAntennaPortActivatedPUCCH-Format1a1b</i> in <i>PUCCH-ConfigDedicated-v1020</i> is set to <i>true</i>. Otherwise the field is not configured.</p>
<p>numberOfConfSPS-Processes The number of configured HARQ processes for Semi-Persistent Scheduling, see TS 36.321 [6].</p>
<p>p0-NominalPUSCH-Persistent Parameter: $P_{\text{O_NOMINAL_PUSCH}}(0)$. See TS 36.213 [23, 5.1.1.1], unit dBm step 1. This field is applicable for persistent scheduling, only. If choice setup is used and <i>p0-Persistent</i> is absent, apply the value of <i>p0-NominalPUSCH</i> for <i>p0-NominalPUSCH-Persistent</i>. If uplink power control subframe sets are configured by <i>tpc-SubframeSet</i>, this field applies for uplink power control subframe set 1.</p>
<p>p0-NominalPUSCH-PersistentSubframeSet2 Parameter: $P_{\text{O_NOMINAL_PUSCH}}(0)$. See TS 36.213 [23, 5.1.1.1], unit dBm step 1. This field is applicable for persistent scheduling, only. If <i>p0-PersistentSubframeSet2-r12</i> is not configured, apply the value of <i>p0-NominalPUSCH-SubframeSet2-r12</i> for <i>p0-NominalPUSCH-PersistentSubframeSet2</i>. E-UTRAN configures this field only if uplink power control subframe sets are configured by <i>tpc-SubframeSet</i>, in which case this field applies for uplink power control subframe set 2.</p>
<p>p0-UE-PUSCH-Persistent Parameter: $P_{\text{O_UE_PUSCH}}(0)$. See TS 36.213 [23, 5.1.1.1], unit dB. This field is applicable for persistent scheduling, only. If choice setup is used and <i>p0-Persistent</i> is absent, apply the value of <i>p0-UE-PUSCH</i> for <i>p0-UE-PUSCH-Persistent</i>. If uplink power control subframe sets are configured by <i>tpc-SubframeSet</i>, this field applies for uplink power control subframe set 1.</p>
<p>p0-UE-PUSCH-PersistentSubframeSet2 Parameter: $P_{\text{O_UE_PUSCH}}(0)$. See TS 36.213 [23, 5.1.1.1], unit dB. This field is applicable for persistent scheduling, only. If <i>p0-PersistentSubframeSet2-r12</i> is not configured, apply the value of <i>p0-UE-PUSCH-SubframeSet2</i> for <i>p0-UE-PUSCH-PersistentSubframeSet2</i>. E-UTRAN configures this field only if uplink power control subframe sets are configured by <i>tpc-SubframeSet</i>, in which case this field applies for uplink power control subframe set 2.</p>
<p>semiPersistSchedC-RNTI Semi-persistent Scheduling C-RNTI, see TS 36.321 [6].</p>
<p>semiPersistSchedIntervalDL Semi-persistent scheduling interval in downlink, see TS 36.321 [6]. Value in number of sub-frames. Value sf10 corresponds to 10 sub-frames, sf20 corresponds to 20 sub-frames and so on. For TDD, the UE shall round this parameter down to the nearest integer (of 10 sub-frames), e.g. sf10 corresponds to 10 sub-frames, sf32 corresponds to 30 sub-frames, sf128 corresponds to 120 sub-frames.</p>
<p>semiPersistSchedIntervalUL Semi-persistent scheduling interval in uplink, see TS 36.321 [6]. Value in number of sub-frames. Value sf10 corresponds to 10 sub-frames, sf20 corresponds to 20 sub-frames and so on. For TDD, the UE shall round this parameter down to the nearest integer (of 10 sub-frames), e.g. sf10 corresponds to 10 sub-frames, sf32 corresponds to 30 sub-frames, sf128 corresponds to 120 sub-frames.</p>
<p>twoIntervalsConfig Trigger of two-intervals-Semi-Persistent Scheduling in uplink. See TS 36.321 [6, 5.10]. If this field is present, two-intervals-SPS is enabled for uplink. Otherwise, two-intervals-SPS is disabled.</p>

Conditional presence	Explanation
<i>TDD</i>	This field is optional present for TDD, need OR; it is not present for FDD and the UE shall delete any existing value for this field.

TDD-Config

The IE *TDD-Config* is used to specify the TDD specific physical channel configuration.

TDD-Config information element

```

-- ASN1START
TDD-Config ::=
    subframeAssignment          SEQUENCE {
                                ENUMERATED {
                                    sa0, sa1, sa2, sa3, sa4, sa5, sa6},
                                specialSubframePatterns
                                ENUMERATED {
                                    ssp0, ssp1, ssp2, ssp3, ssp4, ssp5, ssp6, ssp7,

```

```

}
ssp8}
TDD-Config-v1130 ::= SEQUENCE {
  specialSubframePatterns-v1130 ENUMERATED {ssp7,ssp9}
}
TDD-ConfigSL-r12 ::= SEQUENCE {
  subframeAssignmentSL-r12 ENUMERATED {
    none, sa0, sa1, sa2, sa3, sa4, sa5, sa6}
}
-- ASN1STOP

```

TDD-Config field descriptions

specialSubframePatterns

Indicates Configuration as in TS 36.211 [21, table 4.2-1] where *ssp0* points to Configuration 0, *ssp1* to Configuration 1 etc. Value *ssp7* points to Configuration 7 for extended cyclic prefix and value *ssp9* points to Configuration 9 for normal cyclic prefix. E-UTRAN signals *ssp7* only when setting *specialSubframePatterns* (without suffix i.e. the version defined in REL-8) to *ssp4*. E-UTRAN signals value *ssp9* only when setting *specialSubframePatterns* (without suffix) to *ssp5*. If *specialSubframePatterns-v1130* is present, the UE shall ignore *specialSubframePatterns* (without suffix).

subframeAssignment

Indicates DL/UL subframe configuration where *sa0* points to Configuration 0, *sa1* to Configuration 1 etc. as specified in TS 36.211 [21, table 4.2-2]. E-UTRAN configures the same value for serving cells residing on same frequency band.

subframeAssignmentSL

Indicates UL/ DL subframe configuration where *sa0* points to Configuration 0, *sa1* to Configuration 1 etc. as specified in TS 36.211 [21, table 4.2-2]. The value *none* means that no TDD specific physical channel configuration is applicable (i.e. the carrier on which *MasterInformationBlock-SL* is transmitted is an FDD UL carrier).

– *TimeAlignmentTimer*

The IE *TimeAlignmentTimer* is used to control how long the UE considers the serving cells belonging to the associated TAG to be uplink time aligned. Corresponds to the Timer for time alignment in TS 36.321 [6]. Value in number of sub-frames. Value *sf500* corresponds to 500 sub-frames, *sf750* corresponds to 750 sub-frames and so on.

TimeAlignmentTimer information element

```

-- ASN1START
TimeAlignmentTimer ::= ENUMERATED {
  sf500, sf750, sf1280, sf1920, sf2560, sf5120,
  sf10240, infinity}
-- ASN1STOP

```

– *TPC-PDCCH-Config*

The IE *TPC-PDCCH-Config* is used to specify the RNTIs and indexes for PUCCH and PUSCH power control according to TS 36.212 [22]. The power control function can either be setup or released with the IE.

TPC-PDCCH-Config information element

```

-- ASN1START
TPC-PDCCH-Config ::= CHOICE {
  release NULL,
  setup SEQUENCE {
    tpc-RNTI BIT STRING (SIZE (16)),
    tpc-Index TPC-Index
  }
}
TPC-Index ::= CHOICE {
  indexOfSize3 INTEGER (1..15),
  indexOfSize3A INTEGER (1..31)
}
-- ASN1STOP

```

TPC-PDCCH-Config field descriptions
<i>indexOfFormat3</i> Index of N when DCI format 3 is used. See TS 36.212 [22, 5.3.3.1.6].
<i>IndexOfFormat3A</i> Index of M when DCI format 3A is used. See TS 36.212 [22, 5.3.3.1.7].
<i>tpc-Index</i> Index of N or M, see TS 36.212 [22, 5.3.3.1.6 and 5.3.3.1.7], where N or M is dependent on the used DCI format (i.e. format 3 or 3a).
<i>tpc-RNTI</i> RNTI for power control using DCI format 3/3A, see TS 36.212 [22].

UplinkPowerControl

The IE *UplinkPowerControlCommon* and IE *UplinkPowerControlDedicated* are used to specify parameters for uplink power control in the system information and in the dedicated signalling, respectively.

UplinkPowerControl information elements

```

-- ASN1START
UplinkPowerControlCommon ::= SEQUENCE {
    p0-NominalPUSCH          INTEGER (-126..24),
    alpha                    Alpha-r12,
    p0-NominalPUCCH          INTEGER (-127..-96),
    deltaFList-PUCCH         DeltaFList-PUCCH,
    deltaPreambleMsg3        INTEGER (-1..6)
}

UplinkPowerControlCommon-v1020 ::= SEQUENCE {
    deltaF-PUCCH-Format3-r10  ENUMERATED {deltaF-1, deltaF0, deltaF1, deltaF2,
                                                deltaF3, deltaF4, deltaF5, deltaF6},
    deltaF-PUCCH-Format1bCS-r10  ENUMERATED {deltaF1, deltaF2, spare2, spare1}
}

UplinkPowerControlCommonPSCell-r12 ::= SEQUENCE {
-- For uplink power control the additional/
deltaF-PUCCH-Format3-r12      ENUMERATED {deltaF-1, deltaF0, deltaF1, deltaF2,
                                                deltaF3, deltaF4, deltaF5, deltaF6},
    deltaF-PUCCH-Format1bCS-r12  ENUMERATED {deltaF1, deltaF2, spare2, spare1},
    p0-NominalPUCCH-r12          INTEGER (-127..-96),
    deltaFList-PUCCH-r12         DeltaFList-PUCCH
}

UplinkPowerControlCommonSCell-r10 ::= SEQUENCE {
    p0-NominalPUSCH-r10         INTEGER (-126..24),
    alpha-r10                   Alpha-r12
}

UplinkPowerControlCommonSCell-v1130 ::= SEQUENCE {
    deltaPreambleMsg3-r11       INTEGER (-1..6)
}

UplinkPowerControlDedicated ::= SEQUENCE {
    p0-UE-PUSCH                 INTEGER (-8..7),
    deltaMCS-Enabled             ENUMERATED {en0, en1},
    accumulationEnabled         BOOLEAN,
    p0-UE-PUCCH                 INTEGER (-8..7),
    pSRS-Offset                 INTEGER (0..15),
    filterCoefficient            FilterCoefficient           DEFAULT fc4
}

UplinkPowerControlDedicated-v1020 ::= SEQUENCE {
    deltaTxD-OffsetListPUCCH-r10  DeltaTxD-OffsetListPUCCH-r10  OPTIONAL,  -- Need OR
    pSRS-OffsetAp-r10             INTEGER (0..15)                OPTIONAL  -- Need OR
}

UplinkPowerControlDedicated-v1130 ::= SEQUENCE {
    pSRS-Offset-v1130             INTEGER (16..31)                OPTIONAL,  -- Need OR
    pSRS-OffsetAp-v1130          INTEGER (16..31)                OPTIONAL,  -- Need OR
    deltaTxD-OffsetListPUCCH-v1130  DeltaTxD-OffsetListPUCCH-v1130  OPTIONAL  -- Need OR
}

UplinkPowerControlDedicated-v1250 ::= SEQUENCE {
    set2PowerControlParameter     CHOICE {

```

```

        release                NULL,
        setup                   SEQUENCE {
            tpc-SubframeSet-r12  BIT STRING (SIZE(10)),
            p0-NominalPUSCH-SubframeSet2-r12  INTEGER (-126..24),
            alpha-SubframeSet2-r12  Alpha-r12,
            p0-UE-PUSCH-SubframeSet2-r12  INTEGER (-8..7)
        }
    }
}

UplinkPowerControlDedicatedSCell-r10 ::= SEQUENCE {
    p0-UE-PUSCH-r10            INTEGER (-8..7),
    deltaMCS-Enabled-r10       ENUMERATED {en0, en1},
    accumulationEnabled-r10    BOOLEAN,
    pSRS-Offset-r10            INTEGER (0..15),
    pSRS-OffsetAp-r10          INTEGER (0..15)                OPTIONAL, -- Need OR
    filterCoefficient-r10     FilterCoefficient             DEFAULT fc4,
    pathlossReferenceLinking-r10  ENUMERATED {pCell, sCell}
}

Alpha-r12 ::= ENUMERATED {a10, a104, a105, a106, a107, a108, a109, a11}

DeltaFList-PUCCH ::= SEQUENCE {
    deltaF-PUCCH-Format1       ENUMERATED {deltaF-2, deltaF0, deltaF2},
    deltaF-PUCCH-Format1b      ENUMERATED {deltaF1, deltaF3, deltaF5},
    deltaF-PUCCH-Format2       ENUMERATED {deltaF-2, deltaF0, deltaF1, deltaF2},
    deltaF-PUCCH-Format2a      ENUMERATED {deltaF-2, deltaF0, deltaF2},
    deltaF-PUCCH-Format2b      ENUMERATED {deltaF-2, deltaF0, deltaF2}
}

DeltaTxD-OffsetListPUCCH-r10 ::= SEQUENCE {
    deltaTxD-OffsetPUCCH-Format1-r10  ENUMERATED {dB0, dB-2},
    deltaTxD-OffsetPUCCH-Format1a1b-r10  ENUMERATED {dB0, dB-2},
    deltaTxD-OffsetPUCCH-Format2a2b-r10  ENUMERATED {dB0, dB-2},
    deltaTxD-OffsetPUCCH-Format3-r10  ENUMERATED {dB0, dB-2},
    ...
}

DeltaTxD-OffsetListPUCCH-v1130 ::= SEQUENCE {
    deltaTxD-OffsetPUCCH-Format1bCS-r11  ENUMERATED {dB0, dB-1}
}
-- ASN1STOP

```

UplinkPowerControl field descriptions
<p>accumulationEnabled Parameter: Accumulation-enabled, see TS 36.213 [23, 5.1.1.1]. TRUE corresponds to "enabled" whereas FALSE corresponds to "disabled".</p>
<p>alpha Parameter: α See TS 36.213 [23, 5.1.1.1] where al0 corresponds to 0, al04 corresponds to value 0.4, al05 to 0.5, al06 to 0.6, al07 to 0.7, al08 to 0.8, al09 to 0.9 and al1 corresponds to 1. This field applies for uplink power control subframe set 1 if uplink power control subframe sets are configured by <i>tpc-SubframeSet</i>.</p>
<p>alpha-SubframeSet2 Parameter: α. See TS 36.213 [23, 5.1.1.1] where al0 corresponds to 0, al04 corresponds to value 0.4, al05 to 0.5, al06 to 0.6, al07 to 0.7, al08 to 0.8, al09 to 0.9 and al1 corresponds to 1. This field applies for uplink power control subframe set 2 if uplink power control subframe sets are configured by <i>tpc-SubframeSet</i>.</p>
<p>deltaF-PUCCH-FormatX Parameter: $\Delta_{F_PUCCH}(F)$ for the PUCCH formats 1, 1b, 2, 2a, 2b, 3 and 1b with channel selection. See TS 36.213 [23, 5.1.2] where deltaF-2 corresponds to -2 dB, deltaF0 corresponds to 0 dB and so on.</p>
<p>deltaMCS-Enabled Parameter: K_s See TS 36.213 [23, 5.1.1.1]. en0 corresponds to value 0 corresponding to state "disabled". en1 corresponds to value 1.25 corresponding to "enabled".</p>
<p>deltaPreambleMsg3 Parameter: $\Delta_{PREAMBLE_Msg3}$ see TS 36.213 [23, 5.1.1.1]. Actual value = IE value * 2 [dB].</p>
<p>deltaTxD-OffsetPUCCH-FormatX Parameter: $\Delta_{TxD}(F')$ for the PUCCH formats 1, 1a/1b, 1b with channel selection, 2/2a/2b and 3 when two antenna ports are configured for PUCCH transmission. See TS 36.213 [23, 5.1.2.1] where dB0 corresponds to 0 dB, dB-1 corresponds to -1 dB, dB-2 corresponds to -2 dB. EUTRAN configures the field <i>deltaTxD-OffsetPUCCH-Format1bCS-r11</i> for the PCell and/or the PSCell only.</p>
<p>filterCoefficient Specifies the filtering coefficient for RSRP measurements used to calculate path loss, as specified in TS 36.213 [23, 5.1.1.1]. The same filtering mechanism applies as for <i>quantityConfig</i> described in 5.5.3.2.</p>
<p>p0-NominalPUCCH Parameter: $P_{O_NOMINAL_PUCCH}$ See TS 36.213 [23, 5.1.2.1], unit dBm.</p>
<p>p0-NominalPUSCH Parameter: $P_{O_NOMINAL_PUSCH}(1)$ See TS 36.213 [23, 5.1.1.1], unit dBm. This field is applicable for non-persistent scheduling only. This field applies for uplink power control subframe set 1 if uplink power control subframe sets are configured by <i>tpc-SubframeSet</i>.</p>
<p>p0-NominalPUSCH-SubframeSet2 Parameter: $P_{O_NOMINAL_PUSCH}(1)$. See TS 36.213 [23, 5.1.1.1], unit dBm. This field is applicable for non-persistent scheduling only. This field applies for uplink power control subframe set 2 if uplink power control subframe sets are configured by <i>tpc-SubframeSet</i>.</p>
<p>p0-UE-PUCCH Parameter: $P_{O_UE_PUCCH}$ See TS 36.213 [23, 5.1.2.1]. Unit dB</p>
<p>p0-UE-PUSCH Parameter: $P_{O_UE_PUSCH}(1)$ See TS 36.213 [23, 5.1.1.1], unit dB. This field is applicable for non-persistent scheduling, only. This field applies for uplink power control subframe set 1 if uplink power control subframe sets are configured by <i>tpc-SubframeSet</i>.</p>
<p>p0-UE-PUSCH-SubframeSet2 Parameter: $P_{O_UE_PUSCH}(1)$ See TS 36.213 [23, 5.1.1.1], unit dB. This field is applicable for non-persistent scheduling, only. This field applies for uplink power control subframe set 2 if uplink power control subframe sets are configured by <i>tpc-SubframeSet</i>.</p>
<p>pathlossReferenceLinking Indicates whether the UE shall apply as pathloss reference either the downlink of the PCell or of the SCell that corresponds with this uplink (i.e. according to the <i>cellIdentification</i> within the field <i>sCellToAddMod</i>). For SCells part of an STAG E-UTRAN sets the value to sCell.</p>
<p>pSRS-Offset, pSRS-OffsetAp Parameter: P_{SRS_OFFSET} for periodic and aperiodic sounding reference signal transmission respectively. See TS 36.213 [23, 5.1.3.1]. For $K_s=1.25$, the actual parameter value is pSRS-Offset value - 3. For $K_s=0$, the actual parameter value is $-10.5 + 1.5 * pSRS-Offset$ value. If <i>pSRS-Offset-v1130</i> is included, the UE ignores <i>pSRS-Offset</i> (i.e., without suffix). Likewise, if <i>pSRS-OffsetAp-v1130</i> is included, the UE ignores <i>pSRS-OffsetAp-r10</i>. For $K_s=0$, E-UTRAN does not set values larger than 26.</p>

UplinkPowerControl field descriptions**tpc-SubframeSet**

Indicates the uplink subframes (including UpPTS in special subframes) of the uplink power control subframe sets. Value 0 means the subframe belongs to uplink power control subframe set 1, and value 1 means the subframe belongs to uplink power control subframe set 2.

6.3.3 Security control information elements

– *NextHopChainingCount*

The IE *NextHopChainingCount* is used to update the K_{eNB} key and corresponds to parameter NCC: See TS 33.401 [32, 7.2.8.4].

NextHopChainingCount information element

```
-- ASN1START
NextHopChainingCount ::=
    INTEGER (0..7)
-- ASN1STOP
```

– *SecurityAlgorithmConfig*

The IE *SecurityAlgorithmConfig* is used to configure AS integrity protection algorithm (SRBs) and AS ciphering algorithm (SRBs and DRBs). For RNs, the IE *SecurityAlgorithmConfig* is also used to configure AS integrity protection algorithm for DRBs between the RN and the E-UTRAN.

SecurityAlgorithmConfig information element

```
-- ASN1START
SecurityAlgorithmConfig ::=
    SEQUENCE {
        cipheringAlgorithm
            CipheringAlgorithm-r12,
        integrityProtAlgorithm
            ENUMERATED {
                eia0-v920, eia1, eia2, eia3-v1130, spare4, spare3,
                spare2, spare1, ...}
    }
CipheringAlgorithm-r12 ::=
    ENUMERATED {
        eea0, eea1, eea2, eea3-v1130, spare4, spare3,
        spare2, spare1, ...}
-- ASN1STOP
```

SecurityAlgorithmConfig field descriptions***cipheringAlgorithm***

Indicates the ciphering algorithm to be used for SRBs and DRBs, as specified in TS 33.401 [32, 5.1.3.2].

integrityProtAlgorithm

Indicates the integrity protection algorithm to be used for SRBs, as specified in TS 33.401 [32, 5.1.4.2]. For RNs, also indicates the integrity protection algorithm to be used for integrity protection-enabled DRB(s).

– *ShortMAC-I*

The IE *ShortMAC-I* is used to identify and verify the UE at RRC connection re-establishment. The 16 least significant bits of the MAC-I calculated using the security configuration of the source PCell, as specified in 5.3.7.4.

ShortMAC-I information element

```
-- ASN1START
ShortMAC-I ::=
    BIT STRING (SIZE (16))
-- ASN1STOP
```

6.3.4 Mobility control information elements

– *AdditionalSpectrumEmission*

If an extension is signalled using the extended value range (as defined by IE *AdditionalSpectrumEmission-v1010*), the corresponding original field, using the value range as defined by IE *AdditionalSpectrumEmission* i.e. without suffix) shall be set to value 32, if signalled. UE supporting an LTE band assigned NS values larger than 32 as defined in TS 36.101 [42, 6.2.4], needs to support extension signaling (as defined by IE *AdditionalSpectrumEmission-v1010*).

***AdditionalSpectrumEmission* information element**

```
-- ASN1START
AdditionalSpectrumEmission ::=      INTEGER (1..32)
AdditionalSpectrumEmission-v1010 ::=  INTEGER (33..288)
-- ASN1STOP
```

– *ARFCN-ValueCDMA2000*

The IE *ARFCN-ValueCDMA2000* used to indicate the CDMA2000 carrier frequency within a CDMA2000 band, see C.S0002 [12].

***ARFCN-ValueCDMA2000* information element**

```
-- ASN1START
ARFCN-ValueCDMA2000 ::=      INTEGER (0..2047)
-- ASN1STOP
```

– *ARFCN-ValueEUTRA*

The IE *ARFCN-ValueEUTRA* is used to indicate the ARFCN applicable for a downlink, uplink or bi-directional (TDD) E-UTRA carrier frequency, as defined in TS 36.101 [42]. If an extension is signalled using the extended value range (as defined by IE *ARFCN-ValueEUTRA-v9e0*), the UE shall only consider this extension (and hence ignore the corresponding original field, using the value range as defined by IE *ARFCN-ValueEUTRA* i.e. without suffix, if signalled). In dedicated signalling, E-UTRAN only provides an EARFCN corresponding to an E-UTRA band supported by the UE.

***ARFCN-ValueEUTRA* information element**

```
-- ASN1START
ARFCN-ValueEUTRA ::=      INTEGER (0..maxEARFCN)
ARFCN-ValueEUTRA-v9e0 ::=  INTEGER (maxEARFCN-Plus1..maxEARFCN2)
ARFCN-ValueEUTRA-r9 ::=    INTEGER (0..maxEARFCN2)
-- ASN1STOP
```

NOTE: For fields using the original value range, as defined by IE *ARFCN-ValueEUTRA* i.e. without suffix, value *maxEARFCN* indicates that the E-UTRA carrier frequency is indicated by means of an extension. In such a case, UEs not supporting the extension consider the field to be set to a not supported value.

– *ARFCN-ValueGERAN*

The IE *ARFCN-ValueGERAN* is used to specify the ARFCN value applicable for a GERAN BCCH carrier frequency, see TS 45.005 [20].

ARFCN-ValueGERAN information element

```
-- ASN1START
ARFCN-ValueGERAN ::=          INTEGER (0..1023)
-- ASN1STOP
```

ARFCN-ValueUTRA

The IE *ARFCN-ValueUTRA* is used to indicate the ARFCN applicable for a downlink (Nd, FDD) or bi-directional (Nt, TDD) UTRA carrier frequency, as defined in TS 25.331 [19].

ARFCN-ValueUTRA information element

```
-- ASN1START
ARFCN-ValueUTRA ::=          INTEGER (0..16383)
-- ASN1STOP
```

BandclassCDMA2000

The IE *BandclassCDMA2000* is used to define the CDMA2000 band in which the CDMA2000 carrier frequency can be found, as defined in C.S0057 [24, table 1.5-1].

BandclassCDMA2000 information element

```
-- ASN1START
BandclassCDMA2000 ::=          ENUMERATED {
                                bc0, bc1, bc2, bc3, bc4, bc5, bc6, bc7, bc8,
                                bc9, bc10, bc11, bc12, bc13, bc14, bc15, bc16,
                                bc17, bc18-v9a0, bc19-v9a0, bc20-v9a0, bc21-v9a0,
                                spare10, spare9, spare8, spare7, spare6, spare5, spare4,
                                spare3, spare2, spare1, ...}
-- ASN1STOP
```

BandIndicatorGERAN

The IE *BandIndicatorGERAN* indicates how to interpret an associated GERAN carrier ARFCN, see TS 45.005 [20]. More specifically, the IE indicates the GERAN frequency band in case the ARFCN value can concern either a DCS 1800 or a PCS 1900 carrier frequency. For ARFCN values not associated with one of these bands, the indicator has no meaning.

BandIndicatorGERAN information element

```
-- ASN1START
BandIndicatorGERAN ::=          ENUMERATED {dcs1800, pcs1900}
-- ASN1STOP
```

CarrierFreqCDMA2000

The IE *CarrierFreqCDMA2000* used to provide the CDMA2000 carrier information.

CarrierFreqCDMA2000 information element

```
-- ASN1START
CarrierFreqCDMA2000 ::=          SEQUENCE {
    bandClass          BandclassCDMA2000,
    arfcn              ARFCN-ValueCDMA2000
}
-- ASN1STOP
```

– *CarrierFreqGERAN*

The IE *CarrierFreqGERAN* is used to provide an unambiguous carrier frequency description of a GERAN cell.

***CarrierFreqGERAN* information element**

```
-- ASN1START
CarrierFreqGERAN ::=          SEQUENCE {
    arfcn                      ARFCN-ValueGERAN,
    bandIndicator              BandIndicatorGERAN
}
-- ASN1STOP
```

***CarrierFreqGERAN* field descriptions**

arfcn

GERAN ARFCN of BCCH carrier.

bandIndicator

Indicates how to interpret the ARFCN of the BCCH carrier.

– *CarrierFreqsGERAN*

The IE *CarrierFreqListGERAN* is used to provide one or more GERAN ARFCN values, as defined in TS 44.005 [43], which represents a list of GERAN BCCH carrier frequencies.

***CarrierFreqsGERAN* information element**

```
-- ASN1START
CarrierFreqsGERAN ::=          SEQUENCE {
    startingARFCN              ARFCN-ValueGERAN,
    bandIndicator              BandIndicatorGERAN,
    followingARFCNs            CHOICE {
        explicitListOfARFCNs   ExplicitListOfARFCNs,
        equallySpacedARFCNs    SEQUENCE {
            arfcn-Spacing       INTEGER (1..8),
            numberOfFollowingARFCNs  INTEGER (0..31)
        },
        variableBitMapOfARFCNs OCTET STRING (SIZE (1..16))
    }
}
ExplicitListOfARFCNs ::=      SEQUENCE (SIZE (0..31)) OF ARFCN-ValueGERAN
-- ASN1STOP
```

CarrierFreqsGERAN field descriptions
arfcn-Spacing Space, d, between a set of equally spaced ARFCN values.
bandIndicator Indicates how to interpret the ARFCN of the BCCH carrier.
explicitListOfARFCNs The remaining ARFCN values in the set are explicitly listed one by one.
followingARFCNs Field containing a representation of the remaining ARFCN values in the set.
numberOfFollowingARFCNs The number, n, of the remaining equally spaced ARFCN values in the set. The complete set of (n+1) ARFCN values is defined as: {s, ((s + d) mod 1024), ((s + 2*d) mod 1024) ... ((s + n*d) mod 1024)}.
startingARFCN The first ARFCN value, s, in the set.
variableBitMapOfARFCNs Bitmap field representing the remaining ARFCN values in the set. The leading bit of the first octet in the bitmap corresponds to the ARFCN = ((s + 1) mod 1024), the next bit to the ARFCN = ((s + 2) mod 1024), and so on. If the bitmap consist of N octets, the trailing bit of octet N corresponds to ARFCN = ((s + 8*N) mod 1024). The complete set of ARFCN values consists of ARFCN = s and the ARFCN values, where the corresponding bit in the bitmap is set to "1".

– **CarrierFreqListMBMS**

The IE *CarrierFreqListMBMS* is used to indicate the E-UTRA ARFCN values of the one or more MBMS frequencies the UE is interested to receive.

CarrierFreqListMBMS information element

```
-- ASN1START
CarrierFreqListMBMS-r11 ::= SEQUENCE (SIZE (1..maxFreqMBMS-r11)) OF ARFCN-ValueEUTRA-r9
-- ASN1STOP
```

– **CDMA2000-Type**

The IE *CDMA2000-Type* is used to describe the type of CDMA2000 network.

CDMA2000-Type information element

```
-- ASN1START
CDMA2000-Type ::= ENUMERATED {type1XRTT, typeHRPD}
-- ASN1STOP
```

– **CellIdentity**

The IE *CellIdentity* is used to unambiguously identify a cell within a PLMN.

CellIdentity information element

```
-- ASN1START
CellIdentity ::= BIT STRING (SIZE (28))
-- ASN1STOP
```

– **CellIndexList**

The IE *CellIndexList* concerns a list of cell indices, which may be used for different purposes.

CellIndexList information element

```
-- ASN1START
```

```

CellIndexList ::= SEQUENCE (SIZE (1..maxCellMeas)) OF CellIndex
CellIndex ::= INTEGER (1..maxCellMeas)
-- ASN1STOP

```

– *CellReselectionPriority*

The IE *CellReselectionPriority* concerns the absolute priority of the concerned carrier frequency/ set of frequencies (GERAN)/ bandclass (CDMA2000), as used by the cell reselection procedure. Corresponds with parameter "priority" in TS 36.304 [4]. Value 0 means: lowest priority. The UE behaviour for the case the field is absent, if applicable, is specified in TS 36.304 [4].

CellReselectionPriority information element

```

-- ASN1START
CellReselectionPriority ::= INTEGER (0..7)
-- ASN1STOP

```

– *CSFB-RegistrationParam1XRTT*

The IE *CSFB-RegistrationParam1XRTT* is used to indicate whether or not the UE shall perform a CDMA2000 1xRTT pre-registration if the UE does not have a valid / current pre-registration.

```

-- ASN1START
CSFB-RegistrationParam1XRTT ::= SEQUENCE {
    sid BIT STRING (SIZE (15)),
    nid BIT STRING (SIZE (16)),
    multipleSID BOOLEAN,
    multipleNID BOOLEAN,
    homeReg BOOLEAN,
    foreignSIDReg BOOLEAN,
    foreignNIDReg BOOLEAN,
    parameterReg BOOLEAN,
    powerUpReg BOOLEAN,
    registrationPeriod BIT STRING (SIZE (7)),
    registrationZone BIT STRING (SIZE (12)),
    totalZone BIT STRING (SIZE (3)),
    zoneTimer BIT STRING (SIZE (3))
}
CSFB-RegistrationParam1XRTT-v920 ::= SEQUENCE {
    powerDownReg-r9 ENUMERATED {true}
}
-- ASN1STOP

```

CSFB-RegistrationParam1XRTT field descriptions	
foreignNIDReg	The CDMA2000 1xRTT NID roamer registration indicator.
foreignSIDReg	The CDMA2000 1xRTT SID roamer registration indicator.
homeReg	The CDMA2000 1xRTT Home registration indicator.
multipleNID	The CDMA2000 1xRTT Multiple NID storage indicator.
multipleSID	The CDMA2000 1xRTT Multiple SID storage indicator.
nid	Used along with the <i>sid</i> as a pair to control when the UE should Register or Re-Register with the CDMA2000 1xRTT network.
parameterReg	The CDMA2000 1xRTT Parameter-change registration indicator.
powerDownReg	The CDMA2000 1xRTT Power-down registration indicator. If set to TRUE, the UE that has a valid / current CDMA2000 1xRTT pre-registration will perform a CDMA2000 1xRTT power down registration when it is switched off.
powerUpReg	The CDMA2000 1xRTT Power-up registration indicator.
registrationPeriod	The CDMA2000 1xRTT Registration period.
registrationZone	The CDMA2000 1xRTT Registration zone.
sid	Used along with the <i>nid</i> as a pair to control when the UE should Register or Re-Register with the CDMA2000 1xRTT network.
totalZone	The CDMA2000 1xRTT Number of registration zones to be retained.
zoneTimer	The CDMA2000 1xRTT Zone timer length.

– *CellGlobalIdEUTRA*

The IE *CellGlobalIdEUTRA* specifies the Evolved Cell Global Identifier (ECGI), the globally unique identity of a cell in E-UTRA.

CellGlobalIdEUTRA information element

```
-- ASN1START
CellGlobalIdEUTRA ::=
    SEQUENCE {
        plmn-Identity
        cellIdentity
    }
-- ASN1STOP
```

CellGlobalIdEUTRA field descriptions	
cellIdentity	Identity of the cell within the context of the PLMN.
plmn-Identity	Identifies the PLMN of the cell as given by the first PLMN entry in the <i>plmn-IdentityList</i> in <i>SystemInformationBlockType1</i> .

– *CellGlobalIdUTRA*

The IE *CellGlobalIdUTRA* specifies the global UTRAN Cell Identifier, the globally unique identity of a cell in UTRA.

CellGlobalIdUTRA information element

```
-- ASN1START
CellGlobalIdUTRA ::=
    SEQUENCE {
        plmn-Identity
        PLMN-Identity,
```

```

    cellIdentity                BIT STRING (SIZE (28))
}
-- ASN1STOP

```

CellGlobalIdUTRA field descriptions

cellIdentity

UTRA Cell Identifier which is unique within the context of the identified PLMN as defined in TS 25.331 [19].

plmn-Identity

Identifies the PLMN of the cell as given by the common PLMN broadcast in the MIB, as defined in TS 25.331 [19].

– *CellGlobalIdGERAN*

The IE *CellGlobalIdGERAN* specifies the Cell Global Identification (CGI), the globally unique identity of a cell in GERAN.

CellGlobalIdGERAN information element

```

-- ASN1START
CellGlobalIdGERAN ::=
    plmn-Identity          PLMN-Identity,
    locationAreaCode      BIT STRING (SIZE (16)),
    cellIdentity          BIT STRING (SIZE (16))
}
-- ASN1STOP

```

CellGlobalIdGERAN field descriptions

cellIdentity

Cell Identifier which is unique within the context of the GERAN location area as defined in TS 23.003 [27].

locationAreaCode

A fixed length code identifying the location area within a PLMN as defined in TS 23.003 [27].

plmn-Identity

Identifies the PLMN of the cell, as defined in TS 23.003 [27].

– *CellGlobalIdCDMA2000*

The IE *CellGlobalIdCDMA2000* specifies the Cell Global Identification (CGI), the globally unique identity of a cell in CDMA2000.

CellGlobalIdCDMA2000 information element

```

-- ASN1START
CellGlobalIdCDMA2000 ::=
    cellGlobalId1XRRT      BIT STRING (SIZE (47)),
    cellGlobalIdHRPD       BIT STRING (SIZE (128))
}
-- ASN1STOP

```

CellGlobalIdCDMA2000 field descriptions

cellGlobalId1XRRT

Unique identifier for a CDMA2000 1xRTT cell, corresponds to BASEID, SID and NID parameters (in that order) defined in C.S0005 [25].

cellGlobalIdHRPD

Unique identifier for a CDMA2000 HRPD cell, corresponds to SECTOR ID parameter defined in C.S0024 [26, 14.9].

– *CSG-Identity*

The IE *CSG-Identity* is used to identify a Closed Subscriber Group.

CSG-Identity information element

```
-- ASN1START
CSG-Identity ::=                               BIT STRING (SIZE (27))
-- ASN1STOP
```

– **FreqBandIndicator**

The IE *FreqBandIndicator* indicates the E-UTRA operating band as defined in TS 36.101 [42, table 5.5-1]. If an extension is signalled using the extended value range (as defined by IE *FreqBandIndicator-v9e0*), the UE shall only consider this extension (and hence ignore the corresponding original field, using the value range as defined by IE *FreqBandIndicator* i.e. without suffix, if signalled).

FreqBandIndicator information element

```
-- ASN1START
FreqBandIndicator ::=                         INTEGER (1..maxFBI)
FreqBandIndicator-v9e0 ::=                   INTEGER (maxFBI-Plus1..maxFBI2)
FreqBandIndicator-r11 ::=                    INTEGER (1..maxFBI2)
-- ASN1STOP
```

NOTE: For fields using the original value range, as defined by IE *FreqBandIndicator* i.e. without suffix, value *maxFBI* indicates that the frequency band is indicated by means of an extension. In such a case, UEs not supporting the extension consider the field to be set to a not supported value.

– **MobilityControlInfo**

The IE *MobilityControlInfo* includes parameters relevant for network controlled mobility to/within E-UTRA.

MobilityControlInfo information element

```
-- ASN1START
MobilityControlInfo ::= SEQUENCE {
    targetPhysCellId          PhysCellId,
    carrierFreq                CarrierFreqEUTRA                OPTIONAL,  -- Cond HO-
toEUTRA2
    carrierBandwidth          CarrierBandwidthEUTRA            OPTIONAL,  -- Cond HO-
toEUTRA
    additionalSpectrumEmission AdditionalSpectrumEmission    OPTIONAL,  -- Cond HO-
toEUTRA
    t304                       ENUMERATED {
        ms50, ms100, ms150, ms200, ms500, ms1000,
        ms2000, spare1},
    newUE-Identity            C-RNTI,
    radioResourceConfigCommon RadioResourceConfigCommon,
    rach-ConfigDedicated      RACH-ConfigDedicated        OPTIONAL,  -- Need OP
    . . . ,
    [[ carrierFreq-v9e0        CarrierFreqEUTRA-v9e0        OPTIONAL  -- Need ON
    ]],
    [[ drb-ContinueROHC-r11    ENUMERATED {true}            OPTIONAL  -- Cond HO
    ]]
}

MobilityControlInfo-v1010 ::= SEQUENCE {
    additionalSpectrumEmission-v1010 AdditionalSpectrumEmission-v1010 OPTIONAL  -- Need ON
}

MobilityControlInfoSCG-r12 ::= SEQUENCE {
    t307-r12                   ENUMERATED {
        ms50, ms100, ms150, ms200, ms500, ms1000,
        ms2000, spare1},
    ue-IdentitySCG-r12         C-RNTI                OPTIONAL,  -- Cond SCGEst,
    rach-ConfigDedicated-r12   RACH-ConfigDedicated  OPTIONAL,  -- Need OP
}
```



```

    cipheringAlgorithmSCG-r12      CipheringAlgorithm-r12      OPTIONAL,  -- Need ON
    ...
}
CarrierBandwidthEUTRA ::=
    dl-Bandwidth                SEQUENCE {
                                ENUMERATED {
                                    n6, n15, n25, n50, n75, n100, spare10,
                                    spare9, spare8, spare7, spare6, spare5,
                                    spare4, spare3, spare2, spare1},
                                ul-Bandwidth                ENUMERATED {
                                    n6, n15, n25, n50, n75, n100, spare10,
                                    spare9, spare8, spare7, spare6, spare5,
                                    spare4, spare3, spare2, spare1} OPTIONAL -- Need OP
                                }
}
CarrierFreqEUTRA ::=
    dl-CarrierFreq              ARFCN-ValueEUTRA,
    ul-CarrierFreq              ARFCN-ValueEUTRA                OPTIONAL  -- Cond FDD
}
CarrierFreqEUTRA-v9e0 ::=
    dl-CarrierFreq-v9e0        ARFCN-ValueEUTRA-r9,
    ul-CarrierFreq-v9e0        ARFCN-ValueEUTRA-r9                OPTIONAL  -- Cond FDD
}
-- ASN1STOP

```

MobilityControlInfo field descriptions

additionalSpectrumEmission

For a UE with no SCCells configured for UL in the same band as the PCell, the UE shall apply the value for the PCell instead of the corresponding value from *SystemInformationBlockType2* or *SystemInformationBlockType1*. For a UE with SCCell(s) configured for UL in the same band as the PCell, the UE shall, in case all SCCells configured for UL in that band are released after handover completion, apply the value for the PCell instead of the corresponding value from *SystemInformationBlockType2* or *SystemInformationBlockType1*. The UE requirements related to IE *AdditionalSpectrumEmission* are defined in TS 36.101 [42, table 6.2.4.1].

carrierBandwidth

Provides the parameters *Downlink bandwidth*, and *Uplink bandwidth*, see TS 36.101 [42].

carrierFreq

Provides the EARFCN to be used by the UE in the target cell.

cipheringAlgorithmSCG

Indicates the ciphering algorithm to be used for SCG DRBs. E-UTRAN includes the field upon SCG change when one or more SCG DRBs are configured. Otherwise E-UTRAN does not include the field.

dl-Bandwidth

Parameter: *Downlink bandwidth*, see TS 36.101 [42].

drb-ContinueROHC

This field indicates whether to continue or reset, for this handover, the header compression protocol context for the RLC UM bearers configured with the header compression protocol. Presence of the field indicates that the header compression protocol context continues while absence indicates that the header compression protocol context is reset. E-UTRAN includes the field only in case of a handover within the same eNB.

rach-ConfigDedicated

The dedicated random access parameters. If absent the UE applies contention based random access as specified in TS 36.321 [6].

t304

Timer T304 as described in section 7.3. ms50 corresponds with 50 ms, ms100 corresponds with 100 ms and so on.

t307

Timer T307 as described in section 7.3. ms50 corresponds with 50 ms, ms100 corresponds with 100 ms and so on.

ul-Bandwidth

Parameter: *Uplink bandwidth*, see TS 36.101 [42, table 5.6-1]. For TDD, the parameter is absent and it is equal to downlink bandwidth. If absent for FDD, apply the same value as applies for the downlink bandwidth.

Conditional presence	Explanation
<i>FDD</i>	The field is mandatory with default value (the default duplex distance defined for the concerned band, as specified in TS 36.101 [42]) in case of "FDD"; otherwise the field is not present.
<i>HO</i>	This field is optionally present, need OP, in case of handover within E-UTRA when the <i>fullConfig</i> is not included; otherwise the field is not present.
<i>HO-toEUTRA</i>	The field is mandatory present in case of inter-RAT handover to E-UTRA; otherwise the field is optionally present, need ON.
<i>HO-toEUTRA2</i>	The field is absent if <i>carrierFreq-v9e0</i> is present. Otherwise it is mandatory present in case of inter-RAT handover to E-UTRA and optionally present, need ON, in all other cases.
<i>SCGEst</i>	This field is mandatory present in case of SCG establishment; otherwise the field is optionally present, need ON.

– *MobilityParametersCDMA2000 (1xRTT)*

The *MobilityParametersCDMA2000* contains the parameters provided to the UE for handover and (enhanced) CSFB to 1xRTT support, as defined in C.S0097 [53].

***MobilityParametersCDMA2000* information element**

```
-- ASN1START
MobilityParametersCDMA2000 ::= OCTET STRING
-- ASN1STOP
```

– *MobilityStateParameters*

The IE *MobilityStateParameters* contains parameters to determine UE mobility state.

***MobilityStateParameters* information element**

```
-- ASN1START
MobilityStateParameters ::= SEQUENCE {
    t-Evaluation      ENUMERATED {
        s30, s60, s120, s180, s240, spare3, spare2, spare1},
    t-HystNormal      ENUMERATED {
        s30, s60, s120, s180, s240, spare3, spare2, spare1},
    n-CellChangeMedium INTEGER (1..16),
    n-CellChangeHigh  INTEGER (1..16)
}
-- ASN1STOP
```

***MobilityStateParameters* field descriptions**

n-CellChangeHigh

The number of cell changes to enter high mobility state. Corresponds to N_{CR_H} in TS 36.304 [4].

n-CellChangeMedium

The number of cell changes to enter medium mobility state. Corresponds to N_{CR_M} in TS 36.304 [4].

t-Evaluation

The duration for evaluating criteria to enter mobility states. Corresponds to T_{CRmax} in TS 36.304 [4]. Value in seconds, s30 corresponds to 30 s and so on.

t-HystNormal

The additional duration for evaluating criteria to enter normal mobility state. Corresponds to $T_{CRmaxHyst}$ in TS 36.304 [4]. Value in seconds, s30 corresponds to 30 s and so on.

– *MultiBandInfoList*

***MultiBandInfoList* information element**

```
-- ASN1START
MultiBandInfoList ::= SEQUENCE (SIZE (1..maxMultiBands)) OF FreqBandIndicator
```

```

MultiBandInfoList-v9e0 ::= SEQUENCE (SIZE (1..maxMultiBands)) OF MultiBandInfo-v9e0
MultiBandInfoList-v10j0 ::= SEQUENCE (SIZE (1..maxMultiBands)) OF NS-PmaxList-r10
MultiBandInfoList-v10l0 ::= SEQUENCE (SIZE (1..maxMultiBands)) OF NS-PmaxList-v10l0
MultiBandInfoList-r11 ::= SEQUENCE (SIZE (1..maxMultiBands)) OF FreqBandIndicator-r11
MultiBandInfo-v9e0 ::= SEQUENCE {
    freqBandIndicator-v9e0          FreqBandIndicator-v9e0          OPTIONAL    -- Need OP
}
-- ASN1STOP

```

– NS-PmaxList

The IE *NS-PmaxList* concerns a list of *additionalPmax* and *additionalSpectrumEmission* as defined in TS 36.101 [42, table 6.2.4-1] for a given frequency band. E-UTRAN does not include the same value of *additionalSpectrumEmission* in *SystemInformationType2* within this list.

NS-PmaxList information element

```

-- ASN1START
NS-PmaxList-r10 ::= SEQUENCE (SIZE (1..maxNS-Pmax-r10)) OF NS-PmaxValue-r10
NS-PmaxList-v10l0 ::= SEQUENCE (SIZE (1..maxNS-Pmax-r10)) OF NS-PmaxValue-v10l0
NS-PmaxValue-r10 ::= SEQUENCE {
    additionalPmax-r10                P-Max                OPTIONAL,    -- Need OP
    additionalSpectrumEmission        AdditionalSpectrumEmission
}
NS-PmaxValue-v10l0 ::= SEQUENCE {
    additionalSpectrumEmission-v10l0  AdditionalSpectrumEmission-v10l0  OPTIONAL    -- Need OP
}
-- ASN1STOP

```

– PhysCellId

The IE *PhysCellId* is used to indicate the physical layer identity of the cell, as defined in TS 36.211 [21].

PhysCellId information element

```

-- ASN1START
PhysCellId ::= INTEGER (0..503)
-- ASN1STOP

```

– PhysCellIdRange

The IE *PhysCellIdRange* is used to encode either a single or a range of physical cell identities. The range is encoded by using a *start* value and by indicating the number of consecutive physical cell identities (including *start*) in the range. For fields comprising multiple occurrences of *PhysCellIdRange*, E-UTRAN may configure overlapping ranges of physical cell identities.

PhysCellIdRange information element

```

-- ASN1START
PhysCellIdRange ::= SEQUENCE {
    start          PhysCellId,
    range          ENUMERATED {
        n4, n8, n12, n16, n24, n32, n48, n64, n84,
        n96, n128, n168, n252, n504, spare2,
        spare1}          OPTIONAL    -- Need OP
}

```

```
-- ASN1STOP
```

PhysCellIdRange field descriptions

range

Indicates the number of physical cell identities in the range (including *start*). Value n4 corresponds with 4, n8 corresponds with 8 and so on. The UE shall apply value 1 in case the field is absent, in which case only the physical cell identity value indicated by *start* applies.

start

Indicates the lowest physical cell identity in the range.

PhysCellIdRangeUTRA-FDDList

The IE *PhysCellIdRangeUTRA-FDDList* is used to encode one or more of *PhysCellIdRangeUTRA-FDD*. While the IE *PhysCellIdRangeUTRA-FDD* is used to encode either a single physical layer identity or a range of physical layer identities, i.e. primary scrambling codes. Each range is encoded by using a *start* value and by indicating the number of consecutive physical cell identities (including *start*) in the range.

PhysCellIdRangeUTRA-FDDList information element

```
-- ASN1START
PhysCellIdRangeUTRA-FDDList-r9 ::= SEQUENCE (SIZE (1..maxPhysCellIdRange-r9)) OF
PhysCellIdRangeUTRA-FDD-r9
PhysCellIdRangeUTRA-FDD-r9 ::= SEQUENCE {
    start-r9 PhysCellIdUTRA-FDD,
    range-r9 INTEGER (2..512) OPTIONAL -- Need OP
}
-- ASN1STOP
```

PhysCellIdRangeUTRA-FDDList field descriptions

range

Indicates the number of primary scrambling codes in the range (including *start*). The UE shall apply value 1 in case the field is absent, in which case only the primary scrambling code value indicated by *start* applies.

start

Indicates the lowest primary scrambling code in the range.

PhysCellIdCDMA2000

The IE *PhysCellIdCDMA2000* identifies the PNOffset that represents the "Physical cell identity" in CDMA2000.

PhysCellIdCDMA2000 information element

```
-- ASN1START
PhysCellIdCDMA2000 ::= INTEGER (0..maxPNOffset)
-- ASN1STOP
```

PhysCellIdGERAN

The IE *PhysCellIdGERAN* contains the Base Station Identity Code (BSIC).

PhysCellIdGERAN information element

```
-- ASN1START
PhysCellIdGERAN ::= SEQUENCE {
    networkColourCode BIT STRING (SIZE (3)),
    baseStationColourCode BIT STRING (SIZE (3))
}
-- ASN1STOP
```

<i>PhysCellIdGERAN</i> field descriptions
baseStationColourCode Base station Colour Code as defined in TS 23.003 [27].
networkColourCode Network Colour Code as defined in TS 23.003 [27].

– *PhysCellIdUTRA-FDD*

The IE *PhysCellIdUTRA-FDD* is used to indicate the physical layer identity of the cell, i.e. the primary scrambling code, as defined in TS 25.331 [19].

***PhysCellIdUTRA-FDD* information element**

```
-- ASN1START
PhysCellIdUTRA-FDD ::=                INTEGER (0..511)
-- ASN1STOP
```

– *PhysCellIdUTRA-TDD*

The IE *PhysCellIdUTRA-TDD* is used to indicate the physical layer identity of the cell, i.e. the cell parameters ID (TDD), as specified in TS 25.331 [19]. Also corresponds to the Initial Cell Parameter Assignment in TS 25.223 [46].

***PhysCellIdUTRA-TDD* information element**

```
-- ASN1START
PhysCellIdUTRA-TDD ::=                INTEGER (0..127)
-- ASN1STOP
```

– *PLMN-Identity*

The IE *PLMN-Identity* identifies a Public Land Mobile Network. Further information regarding how to set the IE are specified in TS 23.003 [27].

***PLMN-Identity* information element**

```
-- ASN1START
PLMN-Identity ::=                     SEQUENCE {
    mcc                                MCC                                OPTIONAL,                -- Cond MCC
    mnc                                MNC
}
MCC ::=                               SEQUENCE (SIZE (3)) OF
    MCC-MNC-Digit
MNC ::=                               SEQUENCE (SIZE (2..3)) OF
    MCC-MNC-Digit
MCC-MNC-Digit ::=                    INTEGER (0..9)
-- ASN1STOP
```

<i>PLMN-Identity</i> field descriptions
mcc The first element contains the first MCC digit, the second element the second MCC digit and so on. If the field is absent, it takes the same value as the mcc of the immediately preceding IE <i>PLMN-Identity</i> . See TS 23.003 [27].
mnc The first element contains the first MNC digit, the second element the second MNC digit and so on. See TS 23.003 [27].

Conditional presence	Explanation
MCC	This IE is mandatory when <i>PLMN-Identity</i> is included in <i>CellGlobalIdEUTRA</i> , in <i>CellGlobalIdUTRA</i> , in <i>CellGlobalIdGERAN</i> or in <i>RegisteredMME</i> . This IE is also mandatory in the first occurrence of the IE <i>PLMN-Identity</i> within the IE <i>PLMN-IdentityList</i> . Otherwise it is optional, need OP.

– *PLMN-IdentityList3*

Includes a list of PLMN identities.

***PLMN-IdentityList3* information element**

```
-- ASN1START
PLMN-IdentityList3-r11 ::=          SEQUENCE (SIZE (1..16)) OF PLMN-Identity
-- ASN1STOP
```

– *PreRegistrationInfoHRPD*

```
-- ASN1START
PreRegistrationInfoHRPD ::=          SEQUENCE {
    preRegistrationAllowed             BOOLEAN,
    preRegistrationZoneId             PreRegistrationZoneIdHRPD  OPTIONAL, -- cond PreRegAllowed
    secondaryPreRegistrationZoneIdList SecondaryPreRegistrationZoneIdListHRPD  OPTIONAL -- Need OR
}
SecondaryPreRegistrationZoneIdListHRPD ::= SEQUENCE (SIZE (1..2)) OF PreRegistrationZoneIdHRPD
PreRegistrationZoneIdHRPD ::=          INTEGER (0..255)
-- ASN1STOP
```

***PreRegistrationInfoHRPD* field descriptions**

preRegistrationAllowed

TRUE indicates that a UE shall perform a CDMA2000 HRPD pre-registration if the UE does not have a valid / current pre-registration. FALSE indicates that the UE is not allowed to perform CDMA2000 HRPD pre-registration in the current cell.

preRegistrationZoneId

ColorCode (see C.S0024 [26], C.S0087 [44]) of the CDMA2000 Reference Cell corresponding to the HRPD sector under the HRPD AN that is configured for this LTE cell. It is used to control when the UE should register or re-register.

secondaryPreRegistrationZoneIdList

List of SecondaryColorCodes (see C.S0024 [26], C.S0087 [44]) of the CDMA2000 Reference Cell corresponding to the HRPD sector under the HRPD AN that is configured for this LTE cell. They are used to control when the UE should re-register.

Conditional presence	Explanation
<i>PreRegAllowed</i>	<i>The field is mandatory in case the preRegistrationAllowed is set to true. Otherwise the field is not present and the UE shall delete any existing value for this field.</i>

– *Q-QualMin*

The IE *Q-QualMin* is used to indicate for cell selection/ re-selection the required minimum received RSRQ level in the (E-UTRA) cell. Corresponds to parameter $Q_{qualmin}$ in 36.304 [4]. Actual value $Q_{qualmin} = \text{IE value [dB]}$.

***Q-QualMin* information element**

```
-- ASN1START
Q-QualMin-r9 ::=          INTEGER (-34..-3)
-- ASN1STOP
```

– *Q-RxLevMin*

The IE *Q-RxLevMin* is used to indicate for cell selection/ re-selection the required minimum received RSRP level in the (E-UTRA) cell. Corresponds to parameter $Q_{rxlevmin}$ in 36.304 [4]. Actual value $Q_{rxlevmin} = \text{IE value} * 2$ [dBm].

Q-RxLevMin information element

```
-- ASN1START
Q-RxLevMin ::=                INTEGER (-70..-22)
-- ASN1STOP
```

– *Q-OffsetRange*

The IE *Q-OffsetRange* is used to indicate a cell, CSI-RS resource or frequency specific offset to be applied when evaluating candidates for cell re-selection or when evaluating triggering conditions for measurement reporting. The value in dB. Value dB-24 corresponds to -24 dB, dB-22 corresponds to -22 dB and so on.

Q-OffsetRange information element

```
-- ASN1START
Q-OffsetRange ::=            ENUMERATED {
                                dB-24, dB-22, dB-20, dB-18, dB-16, dB-14,
                                dB-12, dB-10, dB-8, dB-6, dB-5, dB-4, dB-3,
                                dB-2, dB-1, dB0, dB1, dB2, dB3, dB4, dB5,
                                dB6, dB8, dB10, dB12, dB14, dB16, dB18,
                                dB20, dB22, dB24}
-- ASN1STOP
```

– *Q-OffsetRangeInterRAT*

The IE *Q-OffsetRangeInterRAT* is used to indicate a frequency specific offset to be applied when evaluating triggering conditions for measurement reporting. The value in dB.

Q-OffsetRangeInterRAT information element

```
-- ASN1START
Q-OffsetRangeInterRAT ::=    INTEGER (-15..15)
-- ASN1STOP
```

– *ReselectionThreshold*

The IE *ReselectionThreshold* is used to indicate an Rx level threshold for cell reselection. Actual value of threshold = IE value * 2 [dB].

ReselectionThreshold information element

```
-- ASN1START
ReselectionThreshold ::=    INTEGER (0..31)
-- ASN1STOP
```

– *ReselectionThresholdQ*

The IE *ReselectionThresholdQ* is used to indicate a quality level threshold for cell reselection. Actual value of threshold = IE value [dB].

ReselectionThresholdQ information element

```
-- ASN1START
```

```

ReselectionThresholdQ-r9 ::=                INTEGER (0..31)
-- ASN1STOP

```

– *SCellIndex*

The IE *SCellIndex* concerns a short identity, used to identify an SCell.

SCellIndex information element

```

-- ASN1START
SCellIndex-r10 ::=                          INTEGER (1..7)
-- ASN1STOP

```

– *ServCellIndex*

The IE *ServCellIndex* concerns a short identity, used to identify a serving cell (i.e. the PCell or an SCell). Value 0 applies for the PCell, while the *SCellIndex* that has previously been assigned applies for SCells.

ServCellIndex information element

```

-- ASN1START
ServCellIndex-r10 ::=                       INTEGER (0..7)
-- ASN1STOP

```

– *SpeedStateScaleFactors*

The IE *SpeedStateScaleFactors* concerns factors, to be applied when the UE is in medium or high speed state, used for scaling a mobility control related parameter.

SpeedStateScaleFactors information element

```

-- ASN1START
SpeedStateScaleFactors ::=                  SEQUENCE {
  sf-Medium      ENUMERATED {oDot25, oDot5, oDot75, lDot0},
  sf-High        ENUMERATED {oDot25, oDot5, oDot75, lDot0}
}
-- ASN1STOP

```

SpeedStateScaleFactors field descriptions

sf-High

The concerned mobility control related parameter is multiplied with this factor if the UE is in High Mobility state as defined in TS 36.304 [4]. Value oDot25 corresponds to 0.25, oDot5 corresponds to 0.5 , oDot75 corresponds to 0.75 and so on.

sf-Medium

The concerned mobility control related parameter is multiplied with this factor if the UE is in Medium Mobility state as defined in TS 36.304 [4]. Value oDot25 corresponds to 0.25, oDot5 corresponds to 0.5 , oDot75 corresponds to 0.75 and so on.

– *SystemInfoListGERAN*

The IE *SystemInfoListGERAN* contains system information of a GERAN cell.

SystemInfoListGERAN information element

```

-- ASN1START
SystemInfoListGERAN ::=                    SEQUENCE (SIZE (1..maxGERAN-SI)) OF
                                             OCTET STRING (SIZE (1..23))
-- ASN1STOP

```

-- ASN1STOP

SystemInfoListGERAN field descriptions
<p>SystemInfoListGERAN Each OCTET STRING contains one System Information (SI) message as defined in TS 44.018 [45, table 9.1.1] excluding the L2 Pseudo Length, the RR management Protocol Discriminator and the Skip Indicator or a complete Packet System Information (PSI) message as defined in TS 44.060 [36, table 11.2.1].</p>

– **SystemTimeInfoCDMA2000**

The IE *SystemTimeInfoCDMA2000* informs the UE about the absolute time in the current cell. The UE uses this absolute time knowledge to derive the CDMA2000 Physical cell identity, expressed as PNOffset, of neighbour CDMA2000 cells.

NOTE: The UE needs the CDMA2000 system time with a certain level of accuracy for performing measurements as well as for communicating with the CDMA2000 network (HRPD or 1xRTT).

SystemTimeInfoCDMA2000 information element

```

-- ASN1START
SystemTimeInfoCDMA2000 ::=          SEQUENCE {
    cdma-EUTRA-Synchronisation      BOOLEAN,
    cdma-SystemTime                  CHOICE {
        synchronousSystemTime        BIT STRING (SIZE (39)),
        asynchronousSystemTime       BIT STRING (SIZE (49))
    }
}
-- ASN1STOP
    
```

SystemTimeInfoCDMA2000 field descriptions
<p>asynchronousSystemTime The CDMA2000 system time corresponding to the SFN boundary at or after the ending boundary of the SI-Window in which <i>SystemInformationBlockType8</i> is transmitted. E-UTRAN includes this field if the E-UTRA frame boundary is not aligned to the start of CDMA2000 system time. This field size is 49 bits and the unit is 8 CDMA chips based on 1.2288 Mcps.</p>
<p>cdma-EUTRA-Synchronisation TRUE indicates that there is no drift in the timing between E-UTRA and CDMA2000. FALSE indicates that the timing between E-UTRA and CDMA2000 can drift. NOTE 1</p>
<p>synchronousSystemTime CDMA2000 system time corresponding to the SFN boundary at or after the ending boundary of the SI-window in which <i>SystemInformationBlockType8</i> is transmitted. E-UTRAN includes this field if the E-UTRA frame boundary is aligned to the start of CDMA2000 system time. This field size is 39 bits and the unit is 10 ms based on a 1.2288 Mcps chip rate.</p>

NOTE 1: The following table shows the recommended combinations of the *cdma-EUTRA-Synchronisation* field and the choice of *cdma-SystemTime* included by E-UTRAN for FDD and TDD:

FDD/TDD	cdma-EUTRA-Synchronisation	synchronousSystemTime	asynchronousSystemTime
FDD	FALSE	Not Recommended	Recommended
FDD	TRUE	Recommended	Recommended
TDD	FALSE	Not Recommended	Recommended
TDD	TRUE	Recommended	Recommended

– **TrackingAreaCode**

The IE *TrackingAreaCode* is used to identify a tracking area within the scope of a PLMN, see TS 24.301 [35].

TrackingAreaCode information element

```
-- ASN1START
TrackingAreaCode ::=                BIT STRING (SIZE (16))
-- ASN1STOP
```

– **T-Reselection**

The IE *T-Reselection* concerns the cell reselection timer $T_{\text{reselction}_{\text{RAT}}}$ for E-UTRA, UTRA, GERAN or CDMA2000. Value in seconds.

T-Reselection information element

```
-- ASN1START
T-Reselection ::=                    INTEGER (0..7)
-- ASN1STOP
```

6.3.5 Measurement information elements– **AllowedMeasBandwidth**

The IE *AllowedMeasBandwidth* is used to indicate the maximum allowed measurement bandwidth on a carrier frequency as defined by the parameter Transmission Bandwidth Configuration "N_{RB}" TS 36.104 [47]. The values mbw6, mbw15, mbw25, mbw50, mbw75, mbw100 indicate 6, 15, 25, 50, 75 and 100 resource blocks respectively.

AllowedMeasBandwidth information element

```
-- ASN1START
AllowedMeasBandwidth ::=             ENUMERATED {mbw6, mbw15, mbw25, mbw50, mbw75, mbw100}
-- ASN1STOP
```

– **CSI-RSRP-Range**

The IE *CSI-RSRP-Range* specifies the value range used in CSI-RSRP measurements and thresholds. Integer value for CSI-RSRP measurements according to mapping table in TS 36.133 [16].

CSI-RSRP-Range information element

```
-- ASN1START
CSI-RSRP-Range-r12 ::=               INTEGER(0..97)
-- ASN1STOP
```

– **Hysteresis**

The IE *Hysteresis* is a parameter used within the entry and leave condition of an event triggered reporting condition. The actual value is IE value * 0.5 dB.

Hysteresis information element

```
-- ASN1START
Hysteresis ::=                       INTEGER (0..30)
-- ASN1STOP
```

– LocationInfo

The IE *LocationInfo* is used to transfer detailed location information available at the UE to correlate measurements and UE position information.

LocationInfo information element

```
-- ASN1START
LocationInfo-r10 ::= SEQUENCE {
    locationCoordinates-r10 CHOICE {
        ellipsoid-Point-r10 OCTET STRING,
        ellipsoidPointWithAltitude-r10 OCTET STRING,
        ...,
        ellipsoidPointWithUncertaintyCircle-r11 OCTET STRING,
        ellipsoidPointWithUncertaintyEllipse-r11 OCTET STRING,
        ellipsoidPointWithAltitudeAndUncertaintyEllipsoid-r11 OCTET STRING,
        ellipsoidArc-r11 OCTET STRING,
        polygon-r11 OCTET STRING
    },
    horizontalVelocity-r10 OCTET STRING OPTIONAL,
    gnss-TOD-msec-r10 OCTET STRING OPTIONAL,
    ...
}
-- ASN1STOP
```

LocationInfo field descriptions

ellipsoidArc	Parameter <i>EllipsoidArc</i> defined in TS36.355 [54]. The first/leftmost bit of the first octet contains the most significant bit.
ellipsoid-Point	Parameter <i>Ellipsoid-Point</i> defined in TS36.355 [54]. The first/leftmost bit of the first octet contains the most significant bit.
ellipsoidPointWithAltitude	Parameter <i>EllipsoidPointWithAltitude</i> defined in TS36.355 [54]. The first/leftmost bit of the first octet contains the most significant bit.
ellipsoidPointWithAltitudeAndUncertaintyEllipsoid	Parameter <i>EllipsoidPointWithAltitudeAndUncertaintyEllipsoid</i> defined in TS36.355 [54]. The first/leftmost bit of the first octet contains the most significant bit.
ellipsoidPointWithUncertaintyCircle	Parameter <i>Ellipsoid-PointWithUncertaintyCircle</i> defined in TS36.355 [54]. The first/leftmost bit of the first octet contains the most significant bit.
ellipsoidPointWithUncertaintyEllipse	Parameter <i>EllipsoidPointWithUncertaintyEllipse</i> defined in TS36.355 [54]. The first/leftmost bit of the first octet contains the most significant bit.
gnss-TOD-msec	Parameter <i>Gnss-TOD-msec</i> defined in TS36.355 [54]. The first/leftmost bit of the first octet contains the most significant bit.
horizontalVelocity	Parameter <i>HorizontalVelocity</i> defined in TS36.355 [54]. The first/leftmost bit of the first octet contains the most significant bit.
polygon	Parameter <i>Polygon</i> defined in TS36.355 [54]. The first/leftmost bit of the first octet contains the most significant bit.

– MBSFN-RSRQ-Range

The IE *MBSFN-RSRQ-Range* specifies the value range used in MBSFN RSRQ measurements. Integer value for MBSFN RSRQ measurements according to mapping table in TS 36.133 [16].

MBSFN-RSRQ-Range information element

```
-- ASN1START
MBSFN-RSRQ-Range-r12 ::= INTEGER(0..31)
-- ASN1STOP
```

– *MeasConfig*

The IE *MeasConfig* specifies measurements to be performed by the UE, and covers intra-frequency, inter-frequency and inter-RAT mobility as well as configuration of measurement gaps.

***MeasConfig* information element**

```
-- ASN1START

MeasConfig ::=
    SEQUENCE {
        -- Measurement objects
        measObjectToRemoveList      MeasObjectToRemoveList      OPTIONAL, -- Need ON
        measObjectToAddModList     MeasObjectToAddModList     OPTIONAL, -- Need ON
        -- Reporting configurations
        reportConfigToRemoveList   ReportConfigToRemoveList   OPTIONAL, -- Need ON
        reportConfigToAddModList   ReportConfigToAddModList   OPTIONAL, -- Need ON
        -- Measurement identities
        measIdToRemoveList         MeasIdToRemoveList         OPTIONAL, -- Need ON
        measIdToAddModList         MeasIdToAddModList         OPTIONAL, -- Need ON
        -- Other parameters
        quantityConfig             QuantityConfig             OPTIONAL, -- Need ON
        measGapConfig              MeasGapConfig              OPTIONAL, -- Need ON
        s-Measure                   RSRP-Range                 OPTIONAL, -- Need ON
        preRegistrationInfoHRPD     PreRegistrationInfoHRPD    OPTIONAL, -- Need OP
        speedStatePars              CHOICE {
            release                 NULL,
            setup                    SEQUENCE {
                mobilityStateParameters  MobilityStateParameters,
                timeToTrigger-SF         SpeedStateScaleFactors
            }
        }
        OPTIONAL, -- Need ON
        ...,
        [[ measObjectToAddModList-v9e0  MeasObjectToAddModList-v9e0  OPTIONAL  -- Need ON
        ]],
        [[ allowInterruptions-r11        BOOLEAN                        OPTIONAL  -- Need ON
        ]],
        [[ measScaleFactor-r12           CHOICE {
            release                 NULL,
            setup                    MeasScaleFactor-r12
        }
        OPTIONAL, -- Need ON
        measIdToRemoveListExt-r12       MeasIdToRemoveListExt-r12    OPTIONAL, -- Need ON
        measIdToAddModListExt-r12       MeasIdToAddModListExt-r12    OPTIONAL, -- Need ON
        measRSRQ-OnAllSymbols-r12      BOOLEAN                        OPTIONAL, -- Need ON
        ]],
    }

MeasIdToRemoveList ::=
    SEQUENCE (SIZE (1..maxMeasId)) OF MeasId

MeasIdToRemoveListExt-r12 ::=
    SEQUENCE (SIZE (1..maxMeasId)) OF MeasId-v1250

MeasObjectToRemoveList ::=
    SEQUENCE (SIZE (1..maxObjectId)) OF MeasObjectId

ReportConfigToRemoveList ::=
    SEQUENCE (SIZE (1..maxReportConfigId)) OF ReportConfigId

-- ASN1STOP
```

MeasConfig field descriptions
<p>allowInterruptions Value TRUE indicates that the UE is allowed to cause interruptions to serving cells when performing measurements of deactivated SCell carriers for <i>measCycleSCell</i> of less than 640ms, as specified in TS 36.133 [16]. E-UTRAN enables this field only when an SCell is configured.</p>
<p>measGapConfig Used to setup and release measurement gaps.</p>
<p>measIdToRemoveList List of measurement identities to remove. Field <i>measIdToRemoveListExt</i> includes additional measurement identities i.e. extends the size of the measurement identity list using the general principles specified in 5.1.2.</p>
<p>measObjectToAddModList If E-UTRAN includes <i>measObjectToAddModList-v9e0</i> it includes the same number of entries, and listed in the same order, as in <i>measObjectToAddModList</i> (i.e. without suffix).</p>
<p>measObjectToRemoveList List of measurement objects to remove.</p>
<p>measRSRQ-OnAllSymbols Value TRUE indicates that the UE shall, when performing RSRQ measurements, perform RSRQ measurement on all OFDM symbols in accordance with TS 36.214 [48]. If <i>widebandRSRQ-Meas</i> is enabled for the frequency in <i>MeasObjectEUTRA</i>, the UE shall, when performing RSRQ measurements, perform RSRQ measurement on all OFDM symbols with wider bandwidth for concerned frequency in accordance with TS 36.214 [48].</p>
<p>measScaleFactor Even if <i>reducedMeasPerformance</i> is not included in any <i>measObjectEUTRA</i> or <i>measObjectUTRA</i>, E-UTRAN may configure this field. The UE behavior is specified in TS 36.133 [16].</p>
<p>PreRegistrationInfoHRPD The CDMA2000 HRPD Pre-Registration Information tells the UE if it should pre-register with the CDMA2000 HRPD network and identifies the Pre-registration zone to the UE.</p>
<p>reportConfigToRemoveList List of measurement reporting configurations to remove.</p>
<p>s-Measure PCell quality threshold controlling whether or not the UE is required to perform measurements of intra-frequency, inter-frequency and inter-RAT neighbouring cells. Value "0" indicates to disable <i>s-Measure</i>.</p>
<p>timeToTrigger-SF The <i>timeToTrigger</i> in <i>ReportConfigEUTRA</i> and in <i>ReportConfigInterRAT</i> are multiplied with the scaling factor applicable for the UE's speed state.</p>

– MeasDS-Config

The IE *MeasDS-Config* specifies information applicable for discovery signals measurement.

MeasDS-Config information elements

```

-- ASN1START
MeasDS-Config-r12 ::= CHOICE {
    release          NULL,
    setup           SEQUENCE {
        dmtc-PeriodOffset-r12 CHOICE {
            ms40-r12          INTEGER(0..39),
            ms80-r12          INTEGER(0..79),
            ms160-r12         INTEGER(0..159),
            ...
        },
        ds-OccasionDuration-r12 CHOICE {
            durationFDD-r12   INTEGER(1..maxDS-Duration-r12),
            durationTDD-r12   INTEGER(2..maxDS-Duration-r12)
        },
        measCSI-RS-ToRemoveList-r12 MeasCSI-RS-ToRemoveList-r12 OPTIONAL, -- Need ON
        measCSI-RS-ToAddModList-r12 MeasCSI-RS-ToAddModList-r12 OPTIONAL, -- Need ON
        ...
    }
}

MeasCSI-RS-ToRemoveList-r12 ::= SEQUENCE (SIZE (1..maxCSI-RS-Meas-r12)) OF MeasCSI-RS-Id-r12
MeasCSI-RS-ToAddModList-r12 ::= SEQUENCE (SIZE (1..maxCSI-RS-Meas-r12)) OF MeasCSI-RS-Config-r12
MeasCSI-RS-Id-r12 ::= INTEGER (1..maxCSI-RS-Meas-r12)
MeasCSI-RS-Config-r12 ::= SEQUENCE {
    measCSI-RS-Id-r12 MeasCSI-RS-Id-r12,

```

```

physCellId-r12          INTEGER (0..503),
scramblingIdentity-r12  INTEGER (0..503),
resourceConfig-r12     INTEGER (0..31),
subframeOffset-r12     INTEGER (0..4),
csi-RS-IndividualOffset-r12  Q-OffsetRange,
...
}
-- ASN1STOP

```

MeasDS-Config field descriptions

csi-RS-IndividualOffset

CSI-RS individual offset applicable to a specific CSI-RS resource. Value dB-24 corresponds to -24 dB, dB-22 corresponds to -22 dB and so on.

dmtc-PeriodOffset

Indicates the discovery signals measurement timing configuration (DMTC) periodicity (*dmtc-Periodicity*) and offset (*dmtc-Offset*) for this frequency. For DMTC periodicity, value ms40 corresponds to 40ms, ms80 corresponds to 80ms and so on. The value of DMTC offset is in number of subframe(s). The duration of a DMTC occasion is 6ms.

ds-OccasionDuration

Indicates the duration of discovery signal occasion for this frequency. Discovery signal occasion duration is common for all cells transmitting discovery signals on one frequency.

measCSI-RS-ToAddModList

List of CSI-RS resources to add/ modify in the CSI-RS resource list for discovery signals measurement.

measCSI-RS-ToRemoveList

List of CSI-RS resources to remove from the CSI-RS resource list for discovery signals measurement.

physCellId

Indicates the physical cell identity where UE may assume that the CSI-RS and the PSS/SSS/CRS corresponding to the indicated physical cell identity are quasi co-located with respect to average delay and doppler shift.

resourceConfig

Parameter: CSI reference signal configuration, see TS 36.211 [21, table 6.10.5.2-1 and 6.10.5.2-2].

scramblingIdentity

Parameter: Pseudo-random sequence generator parameter, n_{ID} , see TS 36.213 [23, 7.2.5].

subframeOffset

Indicates the subframe offset between SSS of the cell indicated by physCellId and the CSI-RS resource in a discovery signal occasion.

MeasGapConfig

The IE *MeasGapConfig* specifies the measurement gap configuration and controls setup/ release of measurement gaps.

MeasGapConfig information element

```

-- ASN1START
MeasGapConfig ::=
    CHOICE {
        release      NULL,
        setup        SEQUENCE {
            gapOffset CHOICE {
                gp0    INTEGER (0..39),
                gp1    INTEGER (0..79),
                ...
            }
        }
    }
-- ASN1STOP

```

MeasGapConfig field descriptions

gapOffset

Value *gapOffset* of *gp0* corresponds to gap offset of Gap Pattern Id "0" with MGRP = 40ms, *gapOffset* of *gp1* corresponds to gap offset of Gap Pattern Id "1" with MGRP = 80ms. Also used to specify the measurement gap pattern to be applied, as defined in TS 36.133 [16].

– *MeasId*

The IE *MeasId* is used to identify a measurement configuration, i.e., linking of a measurement object and a reporting configuration.

***MeasId* information element**

```
-- ASN1START
MeasId ::= INTEGER (1..maxMeasId)
MeasId-v1250 ::= INTEGER (maxMeasId-Plus1..maxMeasId-r12)
-- ASN1STOP
```

– *MeasIdToAddModList*

The IE *MeasIdToAddModList* concerns a list of measurement identities to add or modify, with for each entry the *measId*, the associated *measObjectId* and the associated *reportConfigId*. Field *measIdToAddModListExt* includes additional measurement identities i.e. extends the size of the measurement identity list using the general principles specified in 5.1.2.

***MeasIdToAddModList* information element**

```
-- ASN1START
MeasIdToAddModList ::= SEQUENCE (SIZE (1..maxMeasId)) OF MeasIdToAddMod
MeasIdToAddModListExt-r12 ::= SEQUENCE (SIZE (1..maxMeasId)) OF MeasIdToAddModExt-r12
MeasIdToAddMod ::= SEQUENCE {
    measId MeasId,
    measObjectId MeasObjectId,
    reportConfigId ReportConfigId
}
MeasIdToAddModExt-r12 ::= SEQUENCE {
    measId-v1250 MeasId-v1250,
    measObjectId-r12 MeasObjectId,
    reportConfigId-r12 ReportConfigId
}
-- ASN1STOP
```

– *MeasObjectCDMA2000*

The IE *MeasObjectCDMA2000* specifies information applicable for inter-RAT CDMA2000 neighbouring cells.

***MeasObjectCDMA2000* information element**

```
-- ASN1START
MeasObjectCDMA2000 ::= SEQUENCE {
    cdma2000-Type CDMA2000-Type,
    carrierFreq CarrierFreqCDMA2000,
    searchWindowSize INTEGER (0..15) OPTIONAL, -- Need ON
    offsetFreq Q-OffsetRangeInterRAT DEFAULT 0,
    cellsToRemoveList CellIndexList OPTIONAL, -- Need ON
    cellsToAddModList CellsToAddModListCDMA2000 OPTIONAL, -- Need ON
    cellForWhichToReportCGI PhysCellIdCDMA2000 OPTIONAL, -- Need ON
    ...
}
CellsToAddModListCDMA2000 ::= SEQUENCE (SIZE (1..maxCellMeas)) OF CellsToAddModCDMA2000
CellsToAddModCDMA2000 ::= SEQUENCE {
    cellIndex INTEGER (1..maxCellMeas),
    physCellId PhysCellIdCDMA2000
}
-- ASN1STOP
```

MeasObjectCDMA2000 field descriptions	
carrierInfo	Identifies CDMA2000 carrier frequency for which this configuration is valid.
cdma2000-Type	The type of CDMA2000 network: CDMA2000 1xRTT or CDMA2000 HRPD.
cellIndex	Entry index in the neighbouring cell list.
cellsToAddModList	List of cells to add/ modify in the neighbouring cell list.
cellsToRemoveList	List of cells to remove from the neighbouring cell list.
physCellId	CDMA2000 Physical cell identity of a cell in neighbouring cell list expressed as PNOffset.
searchWindowSize	Provides the search window size to be used by the UE for the neighbouring pilot, see C.S0005 [25].

– MeasObjectEUTRA

The IE *MeasObjectEUTRA* specifies information applicable for intra-frequency or inter-frequency E-UTRA cells.

MeasObjectEUTRA information element

```

-- ASN1START
MeasObjectEUTRA ::=
    SEQUENCE {
        carrierFreq                ARFCN-ValueEUTRA,
        allowedMeasBandwidth        AllowedMeasBandwidth,
        presenceAntennaPort1        PresenceAntennaPort1,
        neighCellConfig             NeighCellConfig,
        offsetFreq                  Q-OffsetRange                DEFAULT dB0,
        -- Cell list
        cellsToRemoveList           CellIndexList                OPTIONAL,        -- Need ON
        cellsToAddModList           CellsToAddModList            OPTIONAL,        -- Need ON
        -- Black list
        blackCellsToRemoveList       CellIndexList                OPTIONAL,        -- Need ON
        blackCellsToAddModList       BlackCellsToAddModList    OPTIONAL,        -- Need ON
        cellForWhichToReportCGI     PhysCellId                OPTIONAL,        -- Need ON
        . . .
        [[measCycleSCell-r10         MeasCycleSCell-r10        OPTIONAL,        -- Need ON
          measSubframePatternConfigNeigh-r10 MeasSubframePatternConfigNeigh-r10 OPTIONAL
          -- Need ON
        ]],
        [[widebandRSRQ-Meas-r11      BOOLEAN OPTIONAL        -- Cond WB-RSRQ
        ]],
        [[ altTTT-CellsToRemoveList-r12 CellIndexList            OPTIONAL,        -- Need ON
          altTTT-CellsToAddModList-r12 AltTTT-CellsToAddModList-r12 OPTIONAL,        -- Need ON
          t312-r12                    CHOICE {
              release                  NULL,
              setup                     ENUMERATED {ms0, ms50, ms100, ms200,
              ms300, ms400, ms500, ms1000}
          }
          OPTIONAL,        -- Need ON
          reducedMeasPerformance-r12   BOOLEAN                OPTIONAL,        -- Need ON
          measDS-Config-r12            MeasDS-Config-r12      OPTIONAL,        -- Need ON
        ]],
    }

MeasObjectEUTRA-v9e0 ::=
    SEQUENCE {
        carrierFreq-v9e0             ARFCN-ValueEUTRA-v9e0
    }

CellsToAddModList ::=
    SEQUENCE (SIZE (1..maxCellMeas)) OF CellsToAddMod

CellsToAddMod ::= SEQUENCE {
    cellIndex                       INTEGER (1..maxCellMeas),
    physCellId                       PhysCellId,
    cellIndividualOffset             Q-OffsetRange
}

BlackCellsToAddModList ::=
    SEQUENCE (SIZE (1..maxCellMeas)) OF BlackCellsToAddMod

BlackCellsToAddMod ::= SEQUENCE {

```



```
    cellIndex                INTEGER (1..maxCellMeas),
    physCellIdRange          PhysCellIdRange
  }
MeasCycleSCell-r10 ::=      ENUMERATED {sf160, sf256, sf320, sf512,
                                       sf640, sf1024, sf1280, spare1}
MeasSubframePatternConfigNeigh-r10 ::= CHOICE {
  release                    NULL,
  setup                      SEQUENCE {
    measSubframePatternNeigh-r10 MeasSubframePattern-r10,
    measSubframeCellList-r10     MeasSubframeCellList-r10    OPTIONAL    -- Cond
  }
  always
}
MeasSubframeCellList-r10 ::= SEQUENCE (SIZE (1..maxCellMeas)) OF PhysCellIdRange
AltTTT-CellsToAddModList-r12 ::= SEQUENCE (SIZE (1..maxCellMeas)) OF AltTTT-CellsToAddMod-r12
AltTTT-CellsToAddMod-r12 ::= SEQUENCE {
  cellIndex-r12              INTEGER (1..maxCellMeas),
  physCellIdRange-r12        PhysCellIdRange
}
-- ASN1STOP
```

MeasObjectEUTRA field descriptions	
altTTT-CellsToAddModList	List of cells to add/ modify in the cell list for which the alternative time to trigger specified by <i>alternativeTimeToTrigger</i> in <i>reportConfigEUTRA</i> , if configured, applies.
altTTT-CellsToRemoveList	List of cells to remove from the list of cells for alternative time to trigger.
blackCellsToAddModList	List of cells to add/ modify in the black list of cells.
blackCellsToRemoveList	List of cells to remove from the black list of cells.
carrierFreq	Identifies E-UTRA carrier frequency for which this configuration is valid. E-UTRAN does not configure more than one measurement object for the same physical frequency regardless of the E-ARFCN used to indicate this.
cellIndex	Entry index in the cell list. An entry may concern a range of cells, in which case this value applies to the entire range.
cellIndividualOffset	Cell individual offset applicable to a specific cell. Value dB-24 corresponds to -24 dB, dB-22 corresponds to -22 dB and so on.
cellsToAddModList	List of cells to add/ modify in the cell list.
cellsToRemoveList	List of cells to remove from the cell list.
measCycleSCell	The parameter is used only when an SCell is configured on the frequency indicated by the <i>measObject</i> and is in deactivated state, see TS 36.133 [16, 8.3.3]. E-UTRAN configures the parameter whenever an SCell is configured on the frequency indicated by the <i>measObject</i> , but the field may also be signalled when an SCell is not configured. Value <i>sf160</i> corresponds to 160 sub-frames, <i>sf256</i> corresponds to 256 sub-frames and so on.
measDS-Config	Parameters applicable to discovery signals measurement on the carrier frequency indicated by <i>carrierFreq</i> .
measSubframeCellList	List of cells for which <i>measSubframePatternNeigh</i> is applied.
measSubframePatternNeigh	Time domain measurement resource restriction pattern applicable to neighbour cell RSRP and RSRQ measurements on the carrier frequency indicated by <i>carrierFreq</i> . For cells in <i>measSubframeCellList</i> the UE shall assume that the subframes indicated by <i>measSubframePatternNeigh</i> are non-MBSFN subframes, and have the same special subframe configuration as PCell.
offsetFreq	Offset value applicable to the carrier frequency. Value dB-24 corresponds to -24 dB, dB-22 corresponds to -22 dB and so on.
physCellId	Physical cell identity of a cell in the cell list.
physCellIdRange	Physical cell identity or a range of physical cell identities.
reducedMeasPerformance	If set to <i>TRUE</i> , the EUTRA carrier frequency is configured for reduced measurement performance, otherwise it is configured for normal measurement performance, see TS 36.133 [16].
t312	The value of timer T312. Value <i>ms0</i> represents 0 ms, <i>ms50</i> represents 50 ms and so on.
widebandRSRQ-Meas	If this field is set to <i>TRUE</i> , the UE shall, when performing RSRQ measurements, use a wider bandwidth in accordance with TS 36.133 [16].

Conditional presence	Explanation
<i>always</i>	The field is mandatory present.
<i>WB-RSRQ</i>	The field is optionally present, need ON, if the measurement bandwidth indicated by <i>allowedMeasBandwidth</i> is 50 resource blocks or larger; otherwise it is not present and the UE shall delete any existing value for this field, if configured.

– *MeasObjectGERAN*

The IE *MeasObjectGERAN* specifies information applicable for inter-RAT GERAN neighbouring frequencies.

***MeasObjectGERAN* information element**

-- ASN1START

```

MeasObjectGERAN ::=
    SEQUENCE {
        carrierFreqs          CarrierFreqsGERAN,
        offsetFreq            Q-OffsetRangeInterRAT          DEFAULT 0,
        ncc-Permitted         BIT STRING(SIZE (8))           DEFAULT '11111111'B,
        cellForWhichToReportCGI PhysCellIdGERAN              OPTIONAL, -- Need ON
        ...
    }
-- ASN1STOP

```

MeasObjectGERAN field descriptions

ncc-Permitted

Field encoded as a bit map, where bit N is set to "0" if a BCCH carrier with NCC = N-1 is not permitted for monitoring and set to "1" if a BCCH carrier with NCC = N-1 is permitted for monitoring; N = 1 to 8; bit 1 of the bitmap is the leading bit of the bit string.

carrierFreqs

If E-UTRAN includes *cellForWhichToReportCGI*, it includes only one GERAN ARFCN value in *carrierFreqs*.

– **MeasObjectId**

The IE *MeasObjectId* used to identify a measurement object configuration.

MeasObjectId information element

```

-- ASN1START
MeasObjectId ::=
    INTEGER (1..maxObjectId)
-- ASN1STOP

```

– **MeasObjectToAddModList**

The IE *MeasObjectToAddModList* concerns a list of measurement objects to add or modify

MeasObjectToAddModList information element

```

-- ASN1START
MeasObjectToAddModList ::=
    SEQUENCE (SIZE (1..maxObjectId)) OF MeasObjectToAddMod
MeasObjectToAddModList-v9e0 ::=
    SEQUENCE (SIZE (1..maxObjectId)) OF MeasObjectToAddMod-v9e0
MeasObjectToAddMod ::= SEQUENCE {
    measObjectId          MeasObjectId,
    measObject            CHOICE {
        measObjectEUTRA    MeasObjectEUTRA,
        measObjectUTRA     MeasObjectUTRA,
        measObjectGERAN    MeasObjectGERAN,
        measObjectCDMA2000 MeasObjectCDMA2000,
        ...
    }
}
MeasObjectToAddMod-v9e0 ::= SEQUENCE {
    measObjectEUTRA-v9e0 MeasObjectEUTRA-v9e0 OPTIONAL -- Cond eutra
}
-- ASN1STOP

```

Conditional presence	Explanation
<i>eutra</i>	The field is optional present, need OR, if for the corresponding entry in <i>MeasObjectToAddModList</i> field <i>measObject</i> is set to <i>measObjectEUTRA</i> and its sub-field <i>carrierFreq</i> is set to <i>maxEARFCN</i> . Otherwise the field is not present and the UE shall delete any existing value for this field.

– *MeasObjectUTRA*

The IE *MeasObjectUTRA* specifies information applicable for inter-RAT UTRA neighbouring cells.

***MeasObjectUTRA* information element**

```

-- ASN1START
MeasObjectUTRA ::= SEQUENCE {
    carrierFreq          ARFCN-ValueUTRA,
    offsetFreq          Q-OffsetRangeInterRAT          DEFAULT 0,
    cellsToRemoveList   CellIndexList                OPTIONAL,          -- Need ON
    cellsToAddModList   CHOICE {
        cellsToAddModListUTRA-FDD   CellsToAddModListUTRA-FDD,
        cellsToAddModListUTRA-TDD   CellsToAddModListUTRA-TDD
    }                OPTIONAL,          -- Need ON
    cellForWhichToReportCGI CHOICE {
        utra-FDD                    PhysCellIdUTRA-FDD,
        utra-TDD                    PhysCellIdUTRA-TDD
    }                OPTIONAL,          -- Need ON
    ...,
    [[ csg-allowedReportingCells-v930   CSG-AllowedReportingCells-r9   OPTIONAL          --
Need ON
]],
    [[ reducedMeasPerformance-r12      BOOLEAN                OPTIONAL          -- Need ON
]],
}

CellsToAddModListUTRA-FDD ::= SEQUENCE (SIZE (1..maxCellMeas)) OF CellsToAddModUTRA-FDD

CellsToAddModUTRA-FDD ::= SEQUENCE {
    cellIndex          INTEGER (1..maxCellMeas),
    physCellId        PhysCellIdUTRA-FDD
}

CellsToAddModListUTRA-TDD ::= SEQUENCE (SIZE (1..maxCellMeas)) OF CellsToAddModUTRA-TDD

CellsToAddModUTRA-TDD ::= SEQUENCE {
    cellIndex          INTEGER (1..maxCellMeas),
    physCellId        PhysCellIdUTRA-TDD
}

CSG-AllowedReportingCells-r9 ::= SEQUENCE {
    physCellIdRangeUTRA-FDDList-r9   PhysCellIdRangeUTRA-FDDList-r9   OPTIONAL          -- Need OR
}
-- ASN1STOP

```

***MeasObjectUTRA* field descriptions**

<i>carrierFreq</i>	Identifies UTRA carrier frequency for which this configuration is valid. E-UTRAN does not configure more than one measurement object for the same physical frequency regardless of the ARFCN used to indicate this.
<i>cellIndex</i>	Entry index in the neighbouring cell list.
<i>cellsToAddModListUTRA-FDD</i>	List of UTRA FDD cells to add/ modify in the neighbouring cell list.
<i>cellsToAddModListUTRA-TDD</i>	List of UTRA TDD cells to add/modify in the neighbouring cell list.
<i>cellsToRemoveList</i>	List of cells to remove from the neighbouring cell list.
<i>csg-allowedReportingCells</i>	One or more ranges of physical cell identities for which UTRA-FDD reporting is allowed.
<i>reducedMeasPerformance</i>	If set to <i>TRUE</i> the UTRA carrier frequency is configured for reduced measurement performance, otherwise it is configured for normal measurement performance, see TS 36.133 [16].

– *MeasResults*

The IE *MeasResults* covers measured results for intra-frequency, inter-frequency and inter- RAT mobility.

MeasResults information element

```

-- ASN1START
MeasResults ::=
    SEQUENCE {
        measId
            MeasId,
        measResultPCell
            SEQUENCE {
                rsrpResult
                    RSRP-Range,
                rsrqResult
                    RSRQ-Range
            },
        measResultNeighCells
            CHOICE {
                measResultListEUTRA
                    MeasResultListEUTRA,
                measResultListUTRA
                    MeasResultListUTRA,
                measResultListGERAN
                    MeasResultListGERAN,
                measResultsCDMA2000
                    MeasResultsCDMA2000,
                ...
            }
        OPTIONAL,
        ...
        [[ measResultForECID-r9
            MeasResultForECID-r9
        ]],
        [[ locationInfo-r10
            LocationInfo-r10
        ]],
        [[ measResultServFreqList-r10
            MeasResultServFreqList-r10
        ]],
        [[ measId-v1250
            MeasId-v1250
        ]],
        [[ measResultPCell-v1250
            RSRP-Range-v1250
        ]],
        [[ measResultCSI-RS-List-r12
            MeasResultCSI-RS-List-r12
        ]],
        ...
    }

MeasResultListEUTRA ::= SEQUENCE (SIZE (1..maxCellReport)) OF MeasResultEUTRA

MeasResultEUTRA ::= SEQUENCE {
    physCellId
        PhysCellId,
    cgi-Info
        SEQUENCE {
            cellGlobalId
                CellGlobalIdEUTRA,
            trackingAreaCode
                TrackingAreaCode,
            plmn-IdentityList
                PLMN-IdentityList2
        }
        OPTIONAL,
    measResult
        SEQUENCE {
            rsrpResult
                RSRP-Range
            rsrqResult
                RSRQ-Range
            ...
            [[ additionalSI-Info-r9
                AdditionalSI-Info-r9
            ]],
            [[ primaryPLMN-Suitable-r12
                ENUMERATED {true}
            ]],
            [[ measResult-v1250
                RSRQ-Range-v1250
            ]],
            ...
        }

MeasResultServFreqList-r10 ::= SEQUENCE (SIZE (1..maxServCell-r10)) OF MeasResultServFreq-r10

MeasResultServFreq-r10 ::= SEQUENCE {
    servFreqId-r10
        ServCellIndex-r10,
    measResultSCell-r10
        SEQUENCE {
            rsrpResultSCell-r10
                RSRP-Range,
            rsrqResultSCell-r10
                RSRQ-Range
        }
        OPTIONAL,
    measResultBestNeighCell-r10
        SEQUENCE {
            physCellId-r10
                PhysCellId,
            rsrpResultNCell-r10
                RSRP-Range,
            rsrqResultNCell-r10
                RSRQ-Range
        }
        OPTIONAL,
    ...
    [[ measResultSCell-v1250
        RSRQ-Range-v1250
    ]],
    [[ measResultBestNeighCell-v1250
        RSRQ-Range-v1250
    ]],
    ...
}

MeasResultCSI-RS-List-r12 ::= SEQUENCE (SIZE (1..maxCellReport)) OF MeasResultCSI-RS-r12

MeasResultCSI-RS-r12 ::= SEQUENCE {
    measCSI-RS-Id-r12
        MeasCSI-RS-Id-r12,
    csi-RSRP-Result-r12
        CSI-RSRP-Range-r12,
    ...
}

MeasResultListUTRA ::= SEQUENCE (SIZE (1..maxCellReport)) OF MeasResultUTRA

```

```

MeasResultUTRA ::= SEQUENCE {
    physCellId          CHOICE {
        fdd
        tdd
    },
    cgi-Info            SEQUENCE {
        cellGlobalId    CellGlobalIdUTRA,
        locationAreaCode BIT STRING (SIZE (16)) OPTIONAL,
        routingAreaCode BIT STRING (SIZE (8))   OPTIONAL,
        plmn-IdentityList PLMN-IdentityList2   OPTIONAL
    }
    measResult          SEQUENCE {
        utra-RSCP        INTEGER (-5..91)      OPTIONAL,
        utra-EcN0        INTEGER (0..49)        OPTIONAL,
        ...
        [[ additionalSI-Info-r9 AdditionalSI-Info-r9 OPTIONAL
        ]],
        [[ primaryPLMN-Suitable-r12 ENUMERATED {true} OPTIONAL
        ]]
    }
}

MeasResultListGERAN ::= SEQUENCE (SIZE (1..maxCellReport)) OF MeasResultGERAN

MeasResultGERAN ::= SEQUENCE {
    carrierFreq          CarrierFreqGERAN,
    physCellId          PhysCellIdGERAN,
    cgi-Info            SEQUENCE {
        cellGlobalId    CellGlobalIdGERAN,
        routingAreaCode BIT STRING (SIZE (8))   OPTIONAL
    }
    measResult          SEQUENCE {
        rssi             INTEGER (0..63),
        ...
    }
}

MeasResultsCDMA2000 ::= SEQUENCE {
    preRegistrationStatusHRPD BOOLEAN,
    measResultListCDMA2000   MeasResultListCDMA2000
}

MeasResultListCDMA2000 ::= SEQUENCE (SIZE (1..maxCellReport)) OF MeasResultCDMA2000

MeasResultCDMA2000 ::= SEQUENCE {
    physCellId          PhysCellIdCDMA2000,
    cgi-Info            SEQUENCE {
        cellGlobalId    CellGlobalIdCDMA2000   OPTIONAL,
    }
    measResult          SEQUENCE {
        pilotPnPhase    INTEGER (0..32767)     OPTIONAL,
        pilotStrength    INTEGER (0..63),
        ...
    }
}

MeasResultForECID-r9 ::= SEQUENCE {
    ue-RxTxTimeDiffResult-r9 INTEGER (0..4095),
    currentSFN-r9           BIT STRING (SIZE (10))
}

PLMN-IdentityList2 ::= SEQUENCE (SIZE (1..5)) OF PLMN-Identity

AdditionalSI-Info-r9 ::= SEQUENCE {
    csg-MemberStatus-r9    ENUMERATED {member}   OPTIONAL,
    csg-Identity-r9        CSG-Identity           OPTIONAL
}

-- ASN1STOP

```

MeasResults field descriptions
<p>csg-MemberStatus Indicates whether or not the UE is a member of the CSG of the neighbour cell.</p>
<p>currentSFN Indicates the current system frame number when receiving the UE Rx-Tx time difference measurement results from lower layer.</p>
<p>locationAreaCode A fixed length code identifying the location area within a PLMN, as defined in TS 23.003 [27].</p>
<p>measId Identifies the measurement identity for which the reporting is being performed. If the <i>measId-v1250</i> is included, the <i>measId</i> (i.e. without a suffix) is ignored by eNB.</p>
<p>measResult Measured result of an E-UTRA cell; Measured result of a UTRA cell; Measured result of a GERAN cell or frequency; or Measured result of a CDMA2000 cell. Measured result of UE Rx-Tx time difference.</p>
<p>measResultCSI-RS-List Measured results of the CSI-RS resources in discovery signals measurement.</p>
<p>measResultListCDMA2000 List of measured results for the maximum number of reported best cells for a CDMA2000 measurement identity.</p>
<p>measResultListEUTRA List of measured results for the maximum number of reported best cells for an E-UTRA measurement identity.</p>
<p>measResultListGERAN List of measured results for the maximum number of reported best cells or frequencies for a GERAN measurement identity.</p>
<p>measResultListUTRA List of measured results for the maximum number of reported best cells for a UTRA measurement identity.</p>
<p>measResultPCell Measured result of the PCell.</p>
<p>measResultsCDMA2000 Contains the CDMA2000 HRPD pre-registration status and the list of CDMA2000 measurements.</p>
<p>MeasResultServFreqList Measured results of the serving frequencies: the measurement result of each SCell, if any, and of the best neighbouring cell on each serving frequency.</p>
<p>pilotPnPhase Indicates the arrival time of a CDMA2000 pilot, measured relative to the UE's time reference in units of PN chips, see C.S0005 [25]. This information is used in either SRVCC handover or enhanced 1xRTT CS fallback procedure to CDMA2000 1xRTT.</p>
<p>pilotStrength CDMA2000 Pilot Strength, the ratio of pilot power to total power in the signal bandwidth of a CDMA2000 Forward Channel. See C.S0005 [25] for CDMA2000 1xRTT and C.S0024 [26] for CDMA2000 HRPD.</p>
<p>plmn-IdentityList The list of PLMN Identity read from broadcast information when the multiple PLMN Identities are broadcast.</p>
<p>preRegistrationStatusHRPD Set to TRUE if the UE is currently pre-registered with CDMA2000 HRPD. Otherwise set to FALSE. This can be ignored by the eNB for CDMA2000 1xRTT.</p>

<i>MeasResults</i> field descriptions
<p>routingAreaCode The RAC identity read from broadcast information, as defined in TS 23.003 [27].</p>
<p>rsrpResult Measured RSRP result of an E-UTRA cell. The rsrpResult is only reported if configured by the eNB.</p>
<p>rsrqResult Measured RSRQ result of an E-UTRA cell. The rsrqResult is only reported if configured by the eNB.</p>
<p>rssI GERAN Carrier RSSI. RXLEV is mapped to a value between 0 and 63, TS 45.008 [28]. When mapping the RXLEV value to the RSSI bit string, the first/leftmost bit of the bit string contains the most significant bit.</p>
<p>ue-RxTxTimeDiffResult UE Rx-Tx time difference measurement result of the PCell, provided by lower layers. According to UE Rx-Tx time difference report mapping in TS 36.133 [16].</p>
<p>utra-EcN0 According to CPICH_Ec/No in TS 25.133 [29] for FDD. Fourteen spare values. The field is not present for TDD.</p>
<p>utra-RSCP According to CPICH_RSCP in TS 25.133 [29] for FDD and P-CCPCH_RSCP in TS 25.123 [30] for TDD. Thirty-one spare values.</p>

– *MeasScaleFactor*

The IE *MeasScaleFactor* specifies the factor for scaling the measurement performance requirements in TS 36.133 [16].

***MeasScaleFactor* information element**

```
-- ASN1START
MeasScaleFactor-r12 ::=          ENUMERATED {sf-EUTRA-cf1, sf-EUTRA-cf2}
-- ASN1STOP
```

NOTE: If the *reducedMeasPerformance* is not included in any *measObjectEUTRA* or *measObjectUTRA* and the *measScaleFactor* is included in the *measConfig*, E-UTRAN can configure any of the values for the *measScaleFactor* as specified in TS 36.133 [16].

– *QuantityConfig*

The IE *QuantityConfig* specifies the measurement quantities and layer 3 filtering coefficients for E-UTRA and inter-RAT measurements.

***QuantityConfig* information element**

```
-- ASN1START
QuantityConfig ::=
    SEQUENCE {
        quantityConfigEUTRA          QuantityConfigEUTRA          OPTIONAL,  -- Need ON
        quantityConfigUTRA           QuantityConfigUTRA           OPTIONAL,  -- Need ON
        quantityConfigGERAN          QuantityConfigGERAN          OPTIONAL,  -- Need ON
        quantityConfigCDMA2000       QuantityConfigCDMA2000       OPTIONAL,  -- Need ON
        . . . ,
        [[ quantityConfigUTRA-v1020   QuantityConfigUTRA-v1020   OPTIONAL  -- Need ON
        ]],
        [[ quantityConfigEUTRA-v1250  QuantityConfigEUTRA-v1250  OPTIONAL  -- Need ON
        ]]
    }

QuantityConfigEUTRA ::=
    SEQUENCE {
        filterCoefficientRSRP        FilterCoefficient          DEFAULT fc4,
        filterCoefficientRSRQ        FilterCoefficient          DEFAULT fc4
    }

QuantityConfigEUTRA-v1250 ::=
    SEQUENCE {
        filterCoefficientCSI-RSRP-r12 FilterCoefficient          OPTIONAL  -- Need
OR
```



```

}
QuantityConfigUTRA ::=
    SEQUENCE {
        measQuantityUTRA-FDD      ENUMERATED {cpich-RSCP, cpich-EcN0},
        measQuantityUTRA-TDD      ENUMERATED {pccpch-RSCP},
        filterCoefficient          FilterCoefficient          DEFAULT fc4
    }
QuantityConfigUTRA-v1020 ::=
    SEQUENCE {
        filterCoefficient2-FDD-r10 FilterCoefficient          DEFAULT fc4
    }
QuantityConfigGERAN ::=
    SEQUENCE {
        measQuantityGERAN          ENUMERATED {rssi},
        filterCoefficient          FilterCoefficient          DEFAULT fc2
    }
QuantityConfigCDMA2000 ::=
    SEQUENCE {
        measQuantityCDMA2000       ENUMERATED {pilotStrength, pilotPnPhaseAndPilotStrength}
    }
-- ASN1STOP

```

QuantityConfig field descriptions

filterCoefficient2-FDD	Specifies the filtering coefficient used for the UTRAN FDD measurement quantity, which is not included in <i>measQuantityUTRA-FDD</i> , when <i>reportQuantityUTRA-FDD</i> is present in <i>ReportConfigInterRAT</i> .
filterCoefficientCSI-RSRP	Specifies the filtering coefficient used for CSI-RSRP.
filterCoefficientRSRP	Specifies the filtering coefficient used for RSRP.
filterCoefficientRSRQ	Specifies the filtering coefficient used for RSRQ.
measQuantityCDMA2000	Measurement quantity used for CDMA2000 measurements. <i>pilotPnPhaseAndPilotStrength</i> is only applicable for <i>MeasObjectCDMA2000</i> of <i>cdma2000-Type = type1XRTT</i> .
measQuantityGERAN	Measurement quantity used for GERAN measurements.
measQuantityUTRA	Measurement quantity used for UTRA measurements.
quantityConfigCDMA2000	Specifies quantity configurations for CDMA2000 measurements.
quantityConfigEUTRA	Specifies filter configurations for E-UTRA measurements.
quantityConfigGERAN	Specifies quantity and filter configurations for GERAN measurements.
quantityConfigUTRA	Specifies quantity and filter configurations for UTRA measurements. Field <i>quantityConfigUTRA-v1020</i> is applicable only when <i>reportQuantityUTRA-FDD</i> is configured.

ReportConfigEUTRA

The IE *ReportConfigEUTRA* specifies criteria for triggering of an E-UTRA measurement reporting event. The E-UTRA measurement reporting events concerning CRS are labelled AN with N equal to 1, 2 and so on.

- Event A1: Serving becomes better than absolute threshold;
- Event A2: Serving becomes worse than absolute threshold;
- Event A3: Neighbour becomes amount of offset better than PCell/ PSCell;
- Event A4: Neighbour becomes better than absolute threshold;
- Event A5: PCell/ PSCell becomes worse than absolute threshold1 AND Neighbour becomes better than another absolute threshold2.
- Event A6: Neighbour becomes amount of offset better than SCell.

The E-UTRA measurement reporting events concerning CSI-RS are labelled *CN* with *N* equal to 1 and 2.

- Event C1: CSI-RS resource becomes better than absolute threshold;
- Event C2: CSI-RS resource becomes amount of offset better than reference CSI-RS resource.

ReportConfigEUTRA information element

```

-- ASN1START
ReportConfigEUTRA ::=
  triggerType
  event
  eventId
    eventA1
      a1-Threshold
    },
    eventA2
      a2-Threshold
    },
    eventA3
      a3-Offset
      reportOnLeave
    },
    eventA4
      a4-Threshold
    },
    eventA5
      a5-Threshold1
      a5-Threshold2
    },
    ...,
    eventA6-r10
      a6-Offset-r10
      a6-ReportOnLeave-r10
    },
    eventC1-r12
      c1-Threshold-r12
      c1-ReportOnLeave-r12
    },
    eventC2-r12
      c2-RefCSI-RS-r12
      c2-Offset-r12
      c2-ReportOnLeave-r12
  },
  hysteresis
  timeToTrigger
},
periodical
purpose
}
},
triggerQuantity
reportQuantity
maxReportCells
reportInterval
reportAmount
...,
[[ si-RequestForHO-r9
ue-RxTxTimeDiffPeriodical-r9
SEQUENCE {
  CHOICE {
    SEQUENCE {
      CHOICE {
        SEQUENCE {
          ThresholdEUTRA
        }
        SEQUENCE {
          ThresholdEUTRA
        }
        SEQUENCE {
          INTEGER (-30..30),
          BOOLEAN
        }
        SEQUENCE {
          ThresholdEUTRA
        }
        SEQUENCE {
          ThresholdEUTRA,
          ThresholdEUTRA
        }
        SEQUENCE {
          INTEGER (-30..30),
          BOOLEAN
        }
        SEQUENCE {
          ThresholdEUTRA-v1250,
          BOOLEAN
        }
        SEQUENCE {
          MeasCSI-RS-Id-r12,
          INTEGER (-30..30),
          BOOLEAN
        }
      }
    },
    Hysteresis,
    TimeToTrigger
  },
  SEQUENCE {
    ENUMERATED {
      reportStrongestCells, reportCGI
    }
  }
},
ENUMERATED {rsrp, rsrq},
ENUMERATED {sameAsTriggerQuantity, both},
INTEGER (1..maxCellReport),
ReportInterval,
ENUMERATED {r1, r2, r4, r8, r16, r32, r64, infinity},
ENUMERATED {setup} OPTIONAL, -- Cond reportCGI
ENUMERATED {setup} OPTIONAL -- Need OR

```

```

]],
[[ includeLocationInfo-r10          ENUMERATED {true}          OPTIONAL,  -- Need OR
   reportAddNeighMeas-r10          ENUMERATED {setup}        OPTIONAL,  -- Need OR
]],
[[ alternativeTimeToTrigger-r12     CHOICE {
   release                          NULL,
   setup                            TimeToTrigger
   }                                OPTIONAL,  -- Need ON
 useT312-r12                        BOOLEAN                OPTIONAL,  -- Need ON
 usePSCell-r12                      BOOLEAN                OPTIONAL,  -- Need ON
 aN-Threshold1-v1250               RSRQ-RangeConfig-r12    OPTIONAL,  -- Need ON
 a5-Threshold2-v1250               RSRQ-RangeConfig-r12    OPTIONAL,  -- Need ON
 reportStrongestCSI-RSs-r12        BOOLEAN                OPTIONAL,  -- Need ON
 reportCRS-Meas-r12                BOOLEAN                OPTIONAL,  -- Need ON
 triggerQuantityCSI-RS-r12        BOOLEAN                OPTIONAL,  -- Need ON
]]
}

RSRQ-RangeConfig-r12 ::=
  CHOICE {
    release
    setup
  }

ThresholdEUTRA ::=
  CHOICE{
    threshold-RSRP
    threshold-RSRQ
  }

ThresholdEUTRA-v1250 ::=
  CSI-RSRP-Range-r12

-- ASN1STOP

```

ReportConfigEUTRA field descriptions
<p>a3-Offset/ a6-Offset/ c2-Offset Offset value to be used in EUTRA measurement report triggering condition for event a3/ a6/ c2. The actual value is IE value * 0.5 dB.</p>
<p>alternativeTimeToTrigger Indicates the time to trigger applicable for cells specified in <i>altTTT-CellsToAddModList</i> of the associated measurement object, if configured</p>
<p>aN-ThresholdM/ cN-ThresholdM Threshold to be used in EUTRA measurement report triggering condition for event number aN/ cN. If multiple thresholds are defined for event number aN/ cN, the thresholds are differentiated by M.</p>
<p>c1-ReportOnLeave/ c2-ReportOnLeave Indicates whether or not the UE shall initiate the measurement reporting procedure when the leaving condition is met for a CSI-RS resource in <i>csi-RS-TriggeredList</i>, as specified in 5.5.4.1.</p>
<p>c2-RefCSI-RS Identity of the CSI-RS resource from the <i>measCSI-RS-ToAddModList</i> of the associated <i>measObject</i>, to be used as the reference CSI-RS resource in EUTRA measurement report triggering condition for event c2.</p>
<p>eventId Choice of E-UTRA event triggered reporting criteria. EUTRAN may set this field to <i>eventC1</i> or <i>eventC2</i> only if <i>measDS-Config</i> is configured in the associated <i>measObject</i> with one or more CSI-RS resources.</p>
<p>maxReportCells Max number of cells, excluding the serving cell, to include in the measurement report concerning CRS, and max number of CSI-RS resources to include in the measurement report concerning CSI-RS.</p>
<p>reportAmount Number of measurement reports applicable for <i>triggerType event</i> as well as for <i>triggerType periodical</i>. In case <i>purpose</i> is set to <i>reportCGI</i> only value 1 applies.</p>
<p>reportCRS-Meas Indicates that UE shall include <i>rsrp</i>, <i>rsrq</i> together with <i>csi-rsrp</i> in the measurement report, if possible.</p>
<p>reportOnLeave/ a6-ReportOnLeave Indicates whether or not the UE shall initiate the measurement reporting procedure when the leaving condition is met for a cell in <i>cellsTriggeredList</i>, as specified in 5.5.4.1.</p>
<p>reportQuantity The quantities to be included in the measurement report. The value both means that both the <i>rsrp</i> and <i>rsrq</i> quantities are to be included in the measurement report. In case <i>triggerQuantityCSI-RS</i> is included, only value <i>sameAsTriggerQuantity</i> applies.</p>
<p>reportStrongestCSI-RSs Indicates that periodical CSI-RS measurement report is performed. EUTRAN configures value <i>TRUE</i> only if <i>measDS-Config</i> is configured in the associated <i>measObject</i> with one or more CSI-RS resources.</p>
<p>si-RequestForHO The field applies to the <i>reportCGI</i> functionality, and when the field is included, the UE is allowed to use autonomous gaps in acquiring system information from the neighbour cell, applies a different value for T321, and includes different fields in the measurement report.</p>
<p>ThresholdEUTRA For RSRP: RSRP based threshold for event evaluation. The actual value is IE value – 140 dBm. For RSRQ: RSRQ based threshold for event evaluation. The actual value is (IE value – 40)/2 dB. For CSI-RSRP: CSI-RSRP based threshold for event evaluation. The actual value is IE value – 140 dBm. EUTRAN configures the same threshold quantity for all the thresholds of an event.</p>
<p>timeToTrigger Time during which specific criteria for the event needs to be met in order to trigger a measurement report.</p>
<p>triggerQuantity The quantity used to evaluate the triggering condition for the event concerning CRS. EUTRAN sets the value according to the quantity of the <i>ThresholdEUTRA</i> for this event. The values <i>rsrp</i> and <i>rsrq</i> correspond to Reference Signal Received Power (RSRP) and Reference Signal Received Quality (RSRQ), see TS 36.214 [48].</p>
<p>triggerQuantityCSI-RS The quantity used to evaluate the triggering condition for the event concerning CSI-RS. The value <i>TRUE</i> corresponds to CSI Reference Signal Received Power (CSI-RSRP), see TS 36.214 [48]. E-UTRAN configures value <i>TRUE</i> if and only if the measurement reporting event concerns CSI-RS.</p>
<p>ue-RxTxTimeDiffPeriodical If this field is present, the UE shall perform UE Rx-Tx time difference measurement reporting and ignore the fields <i>triggerQuantity</i>, <i>reportQuantity</i> and <i>maxReportCells</i>. If the field is present, the only applicable values for the corresponding <i>triggerType</i> and <i>purpose</i> are <i>periodical</i> and <i>reportStrongestCells</i> respectively.</p>
<p>usePSCell If this field is set to <i>TRUE</i> the UE shall use the PSCell instead of the PCell. E-UTRAN configures value <i>TRUE</i> only <i>TRU</i> events A3 and A5, see 5.5.4.4 and 5.5.4.6.</p>
<p>useT312 If value <i>TRUE</i> is configured, the UE shall use the timer T312 with the value <i>t312</i> as specified in the corresponding <i>measObject</i>. If the corresponding <i>measObject</i> does not include the timer T312 then the timer T312 is considered as not configured. E-UTRAN configures value <i>TRUE</i> only if <i>triggerType</i> is set to <i>event</i>.</p>

Conditional presence	Explanation
<i>reportCGI</i>	The field is optional, need OR, in case <i>purpose</i> is included and set to <i>reportCGI</i> ; otherwise the field is not present and the UE shall delete any existing value for this field.

– *ReportConfigId*

The IE *ReportConfigId* is used to identify a measurement reporting configuration.

***ReportConfigId* information element**

```
-- ASN1START
ReportConfigId ::=                INTEGER (1..maxReportConfigId)
-- ASN1STOP
```

– *ReportConfigInterRAT*

The IE *ReportConfigInterRAT* specifies criteria for triggering of an inter-RAT measurement reporting event. The inter-RAT measurement reporting events are labelled *BN* with *N* equal to 1, 2 and so on.

Event B1: Neighbour becomes better than absolute threshold;

Event B2: PCell becomes worse than absolute threshold1 AND Neighbour becomes better than another absolute threshold2.

The b1 and b2 event thresholds for CDMA2000 are the CDMA2000 pilot detection thresholds are expressed as an unsigned binary number equal to $[-2 \times 10 \log_{10} E_c/I_0]$ in units of 0.5dB, see C.S0005 [25] for details.

***ReportConfigInterRAT* information element**

```
-- ASN1START
ReportConfigInterRAT ::=
  triggerType                CHOICE {
    event                     SEQUENCE {
      eventId                 CHOICE {
        eventB1              SEQUENCE {
          b1-Threshold       CHOICE {
            b1-ThresholdUTRA      ThresholdUTRA,
            b1-ThresholdGERAN     ThresholdGERAN,
            b1-ThresholdCDMA2000  ThresholdCDMA2000
          }
        },
        eventB2              SEQUENCE {
          b2-Threshold1       ThresholdEUTRA,
          b2-Threshold2       CHOICE {
            b2-Threshold2UTRA     ThresholdUTRA,
            b2-Threshold2GERAN    ThresholdGERAN,
            b2-Threshold2CDMA2000 ThresholdCDMA2000
          }
        },
        ...
      },
      hysteresis              Hysteresis,
      timeToTrigger           TimeToTrigger
    },
    periodical                SEQUENCE {
      purpose                 ENUMERATED {
        reportStrongestCells,
        reportStrongestCellsForSON,
        reportCGI
      }
    }
  },
  maxReportCells              INTEGER (1..maxCellReport),
  reportInterval              ReportInterval,
  reportAmount                ENUMERATED {r1, r2, r4, r8, r16, r32, r64, infinity},
  ...,
  [{" si-RequestForHO-r9      ENUMERATED {setup}          OPTIONAL -- Cond reportCGI
```

```

]] ,
[[ reportQuantityUTRA-FDD-r10          ENUMERATED {both}          OPTIONAL  -- Need OR
]] ,
[[ includeLocationInfo-r11            BOOLEAN                    OPTIONAL  -- Need ON
]] ,
[[ b2-Threshold1-v1250                CHOICE {
    release                            NULL,
    setup                              RSRQ-Range-v1250
  }
]]
}

ThresholdUTRA ::=
    CHOICE {
        utra-RSCP                       INTEGER (-5..91),
        utra-EcN0                       INTEGER (0..49)
    }

ThresholdGERAN ::=
    INTEGER (0..63)

ThresholdCDMA2000 ::=
    INTEGER (0..63)

-- ASN1STOP

```

ReportConfigInterRAT field descriptions

bN-ThresholdM	Threshold to be used in inter RAT measurement report triggering condition for event number bN. If multiple thresholds are defined for event number bN, the thresholds are differentiated by M.
eventId	Choice of inter-RAT event triggered reporting criteria.
maxReportCells	Max number of cells, excluding the serving cell, to include in the measurement report. In case <i>purpose</i> is set to <i>reportStrongestCellsForSON</i> only value 1 applies.
Purpose	<i>reportStrongestCellsForSON</i> applies only in case <i>reportConfig</i> is linked to a <i>measObject</i> set to <i>measObjectUTRA</i> or <i>measObjectCDMA2000</i> .
reportAmount	Number of measurement reports applicable for <i>triggerType event</i> as well as for <i>triggerType periodical</i> . In case <i>purpose</i> is set to <i>reportCGI</i> or <i>reportStrongestCellsForSON</i> only value 1 applies.
reportQuantityUTRA-FDD	The quantities to be included in the UTRA measurement report. The value <i>both</i> means that both the cpich RSCP and cpich EcN0 quantities are to be included in the measurement report.
si-RequestForHO	The field applies to the <i>reportCGI</i> functionality, and when the field is included, the UE is allowed to use autonomous gaps in acquiring system information from the neighbour cell, applies a different value for T321, and includes different fields in the measurement report.
ThresholdGERAN	The actual value is IE value – 110 dBm.
ThresholdUTRA	<i>utra-RSCP</i> corresponds to CPICH_RSCP in TS 25.133 [29] for FDD and P-CCPCH_RSCP in TS 25.123 [30] for TDD. <i>utra-EcN0</i> corresponds to CPICH_Ec/No in TS 25.133 [29] for FDD, and is not applicable for TDD. For <i>utra-RSCP</i> : The actual value is IE value – 115 dBm. For <i>utra-EcN0</i> : The actual value is (IE value – 49)/2 dB.
timeToTrigger	Time during which specific criteria for the event needs to be met in order to trigger a measurement report.

Conditional presence	Explanation
<i>reportCGI</i>	The field is optional, need OR, in case <i>purpose</i> is included and set to <i>reportCGI</i> ; otherwise the field is not present and the UE shall delete any existing value for this field.

ReportConfigToAddModList

The IE *ReportConfigToAddModList* concerns a list of reporting configurations to add or modify

ReportConfigToAddModList information element

```

-- ASN1START
ReportConfigToAddModList ::=
    SEQUENCE (SIZE (1..maxReportConfigId)) OF ReportConfigToAddMod

```

```

ReportConfigToAddMod ::= SEQUENCE {
    reportConfigId          ReportConfigId,
    reportConfig            CHOICE {
        reportConfigEUTRA  ReportConfigEUTRA,
        reportConfigInterRAT ReportConfigInterRAT
    }
}
-- ASN1STOP

```

– *ReportInterval*

The *ReportInterval* indicates the interval between periodical reports. The *ReportInterval* is applicable if the UE performs periodical reporting (i.e. when *reportAmount* exceeds 1), for *triggerType event* as well as for *triggerType periodical*. Value ms120 corresponds with 120 ms, ms240 corresponds with 240 ms and so on, while value min1 corresponds with 1 min, min6 corresponds with 6 min and so on.

ReportInterval information element

```

-- ASN1START
ReportInterval ::= ENUMERATED {
    ms120, ms240, ms480, ms640, ms1024, ms2048, ms5120, ms10240,
    min1, min6, min12, min30, min60, spare3, spare2, spare1}
-- ASN1STOP

```

– *RSRP-Range*

The IE *RSRP-Range* specifies the value range used in RSRP measurements and thresholds. Integer value for RSRP measurements according to mapping table in TS 36.133 [16].

RSRP-Range information element

```

-- ASN1START
RSRP-Range ::= INTEGER(0..97)
RSRP-RangeSL-r12 ::= INTEGER(0..13)
RSRP-RangeSL2-r12 ::= INTEGER(0..7)
RSRP-RangeSL3-r12 ::= INTEGER(0..11)
-- ASN1STOP

```

RSRP-Range field descriptions

RSRP-RangeSL

Value 0 corresponds to -infinity, value 1 to -115dBm, value 2 to -110dBm, and so on (i.e. in steps of 5dBm) until value 12, which corresponds to -60dBm, while value 13 corresponds to +infinity.

RSRP-RangeSL2

Value 0 corresponds to -infinity, value 1 to -110dBm, value 2 to -100dBm, and so on (i.e. in steps of 10dBm) until value 6, which corresponds to -60dBm, while value 7 corresponds to +infinity.

RSRP-RangeSL3

Value 0 corresponds to -110dBm, value 1 to -105dBm, value 2 to -100dBm, and so on (i.e. in steps of 5dBm) until value 10, which corresponds to -60dBm, while value 11 corresponds to +infinity.

– *RSRQ-Range*

The IE *RSRQ-Range* specifies the value range used in RSRQ measurements and thresholds. Integer value for RSRQ measurements is according to mapping table in TS 36.133 [16]. A given field using *RSRQ-Range-v1250* shall only be signalled if the corresponding original field (using *RSRQ-Range* i.e. without suffix) is set to value 0 or 34. Only a UE indicating support of *extendedRSRQ-LowerRange-r12* or *rsrq-OnAllSymbols-r12* may report *RSRQ-Range-v1250*, and

this may be done without explicit configuration from the E-UTRAN. If received, the UE shall use the value indicated by the *RSRQ-Range-v1250* and ignore the value signalled by *RSRQ-Range* (without the suffix).

***RSRQ-Range* information element**

```
-- ASN1START
RSRQ-Range ::= INTEGER(0..34)
RSRQ-Range-v1250 ::= INTEGER(-30..46)
-- ASN1STOP
```

– ***RSRQ-Type***

The IE *RSRQ-Type* specifies the RSRQ value type used in RSRQ measurements, see TS 36.214 [48].

***RSRQ-Type* information element**

```
-- ASN1START
RSRQ-Type-r12 ::= SEQUENCE {
    allSymbols-r12    BOOLEAN,
    wideBand-r12     BOOLEAN
}
-- ASN1STOP
```

***RSRQ-Type* field descriptions**

allSymbols

Value TRUE indicates use of all OFDM symbols when performing RSRQ measurements.

wideBand

Value TRUE indicates use of a wider bandwidth when performing RSRQ measurements.

– ***TimeToTrigger***

The IE *TimeToTrigger* specifies the value range used for time to trigger parameter, which concerns the time during which specific criteria for the event needs to be met in order to trigger a measurement report. Value ms0 corresponds to 0 ms, ms40 corresponds to 40 ms, and so on.

***TimeToTrigger* information element**

```
-- ASN1START
TimeToTrigger ::= ENUMERATED {
    ms0, ms40, ms64, ms80, ms100, ms128, ms160, ms256,
    ms320, ms480, ms512, ms640, ms1024, ms1280, ms2560,
    ms5120}
-- ASN1STOP
```

6.3.6 Other information elements

– ***AbsoluteTimeInfo***

The IE *AbsoluteTimeInfo* indicates an absolute time in a format YY-MM-DD HH:MM:SS and using BCD encoding. The first/ leftmost bit of the bit string contains the most significant bit of the most significant digit of the year and so on.

***AbsoluteTimeInfo* information element**

```
-- ASN1START
AbsoluteTimeInfo-r10 ::= BIT STRING (SIZE (48))
-- ASN1STOP
```



```
-- ASN1STOP
```

– *AreaConfiguration*

The *AreaConfiguration* indicates area for which UE is requested to perform measurement logging. If not configured, measurement logging is not restricted to specific cells or tracking areas but applies as long as the RPLMN is contained in *plmn-IdentityList* stored in *VarLogMeasReport*.

AreaConfiguration information element

```
-- ASN1START
AreaConfiguration-r10 ::= CHOICE {
    cellGlobalIdList-r10      CellGlobalIdList-r10,
    trackingAreaCodeList-r10  TrackingAreaCodeList-r10
}
AreaConfiguration-v1130 ::= SEQUENCE {
    trackingAreaCodeList-v1130  TrackingAreaCodeList-v1130
}
CellGlobalIdList-r10 ::= SEQUENCE (SIZE (1..32)) OF CellGlobalIdEUTRA
TrackingAreaCodeList-r10 ::= SEQUENCE (SIZE (1..8)) OF TrackingAreaCode
TrackingAreaCodeList-v1130 ::= SEQUENCE {
    plmn-Identity-perTAC-List-r11 SEQUENCE (SIZE (1..8)) OF PLMN-Identity
}
-- ASN1STOP
```

AreaConfiguration field descriptions

plmn-Identity-perTAC-List

Includes the PLMN identity for each of the TA codes included in *trackingAreaCodeList*. The PLMN identity listed first in *plmn-Identity-perTAC-List* corresponds with the TA code listed first in *trackingAreaCodeList* and so on.

– *C-RNTI*

The IE *C-RNTI* identifies a UE having a RRC connection within a cell.

C-RNTI information element

```
-- ASN1START
C-RNTI ::= BIT STRING (SIZE (16))
-- ASN1STOP
```

– *DedicatedInfoCDMA2000*

The *DedicatedInfoCDMA2000* is used to transfer UE specific CDMA2000 information between the network and the UE. The RRC layer is transparent for this information.

DedicatedInfoCDMA2000 information element

```
-- ASN1START
DedicatedInfoCDMA2000 ::= OCTET STRING
-- ASN1STOP
```

– *DedicatedInfoNAS*

The IE *DedicatedInfoNAS* is used to transfer UE specific NAS layer information between the network and the UE. The RRC layer is transparent for this information.

DedicatedInfoNAS information element

```
-- ASN1START
DedicatedInfoNAS ::= OCTET STRING
-- ASN1STOP
```

– **FilterCoefficient**

The IE *FilterCoefficient* specifies the measurement filtering coefficient. Value *fc0* corresponds to $k = 0$, *fc1* corresponds to $k = 1$, and so on.

FilterCoefficient information element

```
-- ASN1START
FilterCoefficient ::= ENUMERATED {
    fc0, fc1, fc2, fc3, fc4, fc5,
    fc6, fc7, fc8, fc9, fc11, fc13,
    fc15, fc17, fc19, spare1, ...}
-- ASN1STOP
```

– **LoggingDuration**

The *LoggingDuration* indicates the duration for which UE is requested to perform measurement logging. Value *min10* corresponds to 10 minutes, value *min20* corresponds to 20 minutes and so on.

LoggingDuration information element

```
-- ASN1START
LoggingDuration-r10 ::= ENUMERATED {
    min10, min20, min40, min60, min90, min120, spare2, spare1}
-- ASN1STOP
```

– **LoggingInterval**

The *LoggingInterval* indicates the periodicity for logging measurement results. Value *ms1280* corresponds to 1.28s, value *ms2560* corresponds to 2.56s and so on.

LoggingInterval information element

```
-- ASN1START
LoggingInterval-r10 ::= ENUMERATED {
    ms1280, ms2560, ms5120, ms10240, ms20480,
    ms30720, ms40960, ms61440}
-- ASN1STOP
```

– **MeasSubframePattern**

The IE *MeasSubframePattern* is used to specify a subframe pattern. The first/leftmost bit corresponds to the subframe #0 of the radio frame satisfying $\text{SFN mod } x = 0$, where SFN is that of PCell and x is the size of the bit string divided by 10. "1" denotes that the corresponding subframe is used.

MeasSubframePattern information element

```
-- ASN1START
MeasSubframePattern-r10 ::= CHOICE {
    subframePatternFDD-r10 BIT STRING (SIZE (40)),
    subframePatternTDD-r10 CHOICE {
        subframeConfig1-5-r10 BIT STRING (SIZE (20)),
        subframeConfig0-r10 BIT STRING (SIZE (70))
    }
}
-- ASN1STOP
```

```

        subframeConfig6-r10          BIT STRING (SIZE (60)),
        ...
    },
    ...
}
-- ASN1STOP

```

– MMEC

The IE *MMEC* identifies an MME within the scope of an MME Group within a PLMN, see TS 23.003 [27].

MMEC information element

```

-- ASN1START
MMEC ::=                               BIT STRING (SIZE (8))
-- ASN1STOP

```

– NeighCellConfig

The IE *NeighCellConfig* is used to provide the information related to MBSFN and TDD UL/DL configuration of neighbour cells.

NeighCellConfig information element

```

-- ASN1START
NeighCellConfig ::=                    BIT STRING (SIZE (2))
-- ASN1STOP

```

NeighCellConfig field descriptions

neighCellConfig

Provides information related to MBSFN and TDD UL/DL configuration of neighbour cells of this frequency

00: Not all neighbour cells have the same MBSFN subframe allocation as the serving cell on this frequency, if configured, and as the PCell otherwise

10: The MBSFN subframe allocations of all neighbour cells are identical to or subsets of that in the serving cell on this frequency, if configured, and of that in the PCell otherwise

01: No MBSFN subframes are present in all neighbour cells

11: Different UL/DL allocation in neighbouring cells for TDD compared to the serving cell on this frequency, if configured, and compared to the PCell otherwise

For TDD, 00, 10 and 01 are only used for same UL/DL allocation in neighbouring cells compared to the serving cell on this frequency, if configured, and compared to the PCell otherwise.

– OtherConfig

The IE *OtherConfig* contains configuration related to other configuration

OtherConfig information element

```

-- ASN1START
OtherConfig-r9 ::= SEQUENCE {
    reportProximityConfig-r9          ReportProximityConfig-r9          OPTIONAL,  -- Need ON
    ...
    [[
        idc-Config-r11                IDC-Config-r11                OPTIONAL,  -- Need ON
        powerPrefIndicationConfig-r11 PowerPrefIndicationConfig-r11 OPTIONAL,  -- Need ON
        obtainLocationConfig-r11      ObtainLocationConfig-r11      OPTIONAL,  -- Need ON
    ]]
}
IDC-Config-r11 ::= SEQUENCE {
    idc-Indication-r11                ENUMERATED {setup}          OPTIONAL,  -- Need OR

```

```

autonomousDenialParameters-r11 SEQUENCE {
    autonomousDenialSubframes-r11 ENUMERATED {n2, n5, n10, n15,
        n20, n30, spare2, spare1},
    autonomousDenialValidity-r11 ENUMERATED {
        sf200, sf500, sf1000, sf2000,
        spare4, spare3, spare2, spare1}
} OPTIONAL, -- Need OR
...
[[ idc-Indication-UL-CA-r11 ENUMERATED {setup} OPTIONAL -- Cond idc-Ind
]]
}

ObtainLocationConfig-r11 ::= SEQUENCE {
    obtainLocation-r11 ENUMERATED {setup} OPTIONAL -- Need OR
}

PowerPrefIndicationConfig-r11 ::= CHOICE{
    release NULL,
    setup SEQUENCE{
        powerPrefIndicationTimer-r11 ENUMERATED {s0, s0dot5, s1, s2, s5, s10, s20,
            s30, s60, s90, s120, s300, s600, spare3,
            spare2, spare1}
    }
}

ReportProximityConfig-r9 ::= SEQUENCE {
    proximityIndicationEUTRA-r9 ENUMERATED {enabled} OPTIONAL, -- Need OR
    proximityIndicationUTRA-r9 ENUMERATED {enabled} OPTIONAL -- Need OR
}

-- ASN1STOP

```

OtherConfig field descriptions

autonomousDenialSubframes

Indicates the maximum number of the UL subframes for which the UE is allowed to deny any UL transmission. Value n2 corresponds to 2 subframes, n5 to 5 subframes and so on. E-UTRAN does not configure autonomous denial for frequencies on which SCG cells are configured.

autonomousDenialValidity

Indicates the validity period over which the UL autonomous denial subframes shall be counted. Value sf200 corresponds to 200 subframes, sf500 corresponds to 500 subframes and so on.

idc-Indication

The field is used to indicate whether the UE is configured to initiate transmission of the *InDeviceCoexIndication* message to the network.

idc-Indication-UL-CA

The field is used to indicate whether the UE is configured to provide IDC indications for UL CA using the *InDeviceCoexIndication* message.

obtainLocation

Requests the UE to attempt to have detailed location information available using GNSS. E-UTRAN configures the field only if *includeLocationInfo* is configured for one or more measurements.

powerPrefIndicationTimer

Prohibit timer for Power Preference Indication reporting. Value in seconds. Value s0 means prohibit timer is set to 0 second or not set, value s0dot5 means prohibit timer is set to 0.5 second, value s1 means prohibit timer is set to 1 second and so on.

reportProximityConfig

Indicates, for each of the applicable RATs (EUTRA, UTRA), whether or not proximity indication is enabled for CSG member cell(s) of the concerned RAT. Note.

NOTE: Enabling/ disabling of proximity indication includes enabling/ disabling of the related functionality e.g. autonomous search in connected mode.

Conditional presence	Explanation
<i>idc-Ind</i>	The field is optionally present if <i>idc-Indication</i> is present, need OR. Otherwise the field is not present.

– **RAND-CDMA2000 (1xRTT)**

The *RAND-CDMA2000* concerns a random value, generated by the eNB, to be passed to the CDMA2000 upper layers.

RAND-CDMA2000 information element

```
-- ASN1START
RAND-CDMA2000 ::=
-- ASN1STOP
```

RAT-Type

The IE *RAT-Type* is used to indicate the radio access technology (RAT), including E-UTRA, of the requested/transferred UE capabilities.

RAT-Type information element

```
-- ASN1START
RAT-Type ::=
-- ASN1STOP
```

RRC-TransactionIdentifier

The IE *RRC-TransactionIdentifier* is used, together with the message type, for the identification of an RRC procedure (transaction).

RRC-TransactionIdentifier information element

```
-- ASN1START
RRC-TransactionIdentifier ::=
-- ASN1STOP
```

S-TMSI

The IE *S-TMSI* contains an S-Temporary Mobile Subscriber Identity, a temporary UE identity provided by the EPC which uniquely identifies the UE within the tracking area, see TS 23.003 [27].

S-TMSI information element

```
-- ASN1START
S-TMSI ::=
-- ASN1STOP
```

S-TMSI field descriptions**m-TMSI**

The first/leftmost bit of the bit string contains the most significant bit of the M-TMSI.

TraceReference

The *TraceReference* contains parameter Trace Reference as defined in TS 32.422 [58].

TraceReference information element

```
-- ASN1START
TraceReference-r10 ::=
-- ASN1STOP
```

```

    traceId-r10                OCTET STRING (SIZE (3))
  }
-- ASN1STOP

```

– *UE-CapabilityRAT-ContainerList*

The IE *UE-CapabilityRAT-ContainerList* contains list of containers, one for each RAT for which UE capabilities are transferred, if any.

***UE-CapabilityRAT-ContainerList* information element**

```

-- ASN1START
UE-CapabilityRAT-ContainerList ::= SEQUENCE (SIZE (0..maxRAT-Capabilities)) OF UE-CapabilityRAT-
Container
UE-CapabilityRAT-Container ::= SEQUENCE {
    rat-Type                RAT-Type,
    ueCapabilityRAT-Container OCTET STRING
}
-- ASN1STOP

```

***UECapabilityRAT-ContainerList* field descriptions**

ueCapabilityRAT-Container

Container for the UE capabilities of the indicated RAT. The encoding is defined in the specification of each RAT:

For E-UTRA: the encoding of UE capabilities is defined in IE *UE-EUTRA-Capability*.

For UTRA: the octet string contains the INTER RAT HANDOVER INFO message defined in TS 25.331 [19].

For GERAN CS: the octet string contains the concatenated string of the Mobile Station Classmark 2 and Mobile Station Classmark 3. The first 5 octets correspond to Mobile Station Classmark 2 and the following octets correspond to Mobile Station Classmark 3. The Mobile Station Classmark 2 is formatted as 'TLV' and is coded in the same way as the *Mobile Station Classmark 2* information element in TS 24.008 [49]. The first octet is the *Mobile station classmark 2 IEI* and its value shall be set to 33H. The second octet is the *Length of mobile station classmark 2* and its value shall be set to 3. The octet 3 contains the first octet of the value part of the *Mobile Station Classmark 2* information element, the octet 4 contains the second octet of the value part of the *Mobile Station Classmark 2* information element and so on. For each of these octets, the first/ leftmost/ most significant bit of the octet contains b8 of the corresponding octet of the Mobile Station Classmark 2. The Mobile Station Classmark 3 is formatted as 'V' and is coded in the same way as the value part in the *Mobile station classmark 3* information element in TS 24.008 [49]. The sixth octet of this octet string contains octet 1 of the value part of *Mobile station classmark 3*, the seventh of octet of this octet string contains octet 2 of the value part of *Mobile station classmark 3* and so on. Note.

For GERAN PS: the encoding of UE capabilities is formatted as 'V' and is coded in the same way as the value part in the *MS Radio Access Capability* information element in TS 24.008 [49].

For CDMA2000-1XRTT: the octet string contains the A21 Mobile Subscription Information and the encoding of this is defined in A.S0008 [33]. The A21 Mobile Subscription Information contains the supported CDMA2000 1xRTT band class and band sub-class information.

NOTE: The value part is specified by means of CSN.1, which encoding results in a bit string, to which final padding may be appended up to the next octet boundary TS 24.008 [49]. The first/ leftmost bit of the CSN.1 bit string is placed in the first/ leftmost/ most significant bit of the first octet. This continues until the last bit of the CSN.1 bit string, which is placed in the last/ rightmost/ least significant bit of the last octet.

– *UE-EUTRA-Capability*

The IE *UE-EUTRA-Capability* is used to convey the E-UTRA UE Radio Access Capability Parameters, see TS 36.306 [5], and the Feature Group Indicators for mandatory features (defined in Annexes B.1 and C.1) to the network. The IE *UE-EUTRA-Capability* is transferred in E-UTRA or in another RAT.

***UE-EUTRA-Capability* information element**

```

-- ASN1START
UE-EUTRA-Capability ::= SEQUENCE {
    accessStratumRelease      AccessStratumRelease,
    ue-Category               INTEGER (1..5),
    pdcp-Parameters          PDCP-Parameters,
    phyLayerParameters       PhyLayerParameters,
    rf-Parameters            RF-Parameters,
}

```

```

measParameters          MeasParameters,
featureGroupIndicators  BIT STRING (SIZE (32))          OPTIONAL,
interRAT-Parameters     SEQUENCE {
  ultraFDD              IRAT-ParametersUTRA-FDD          OPTIONAL,
  ultraTDD128           IRAT-ParametersUTRA-TDD128        OPTIONAL,
  ultraTDD384           IRAT-ParametersUTRA-TDD384        OPTIONAL,
  ultraTDD768           IRAT-ParametersUTRA-TDD768        OPTIONAL,
  geran                 IRAT-ParametersGERAN             OPTIONAL,
  cdma2000-HRPD         IRAT-ParametersCDMA2000-HRPD      OPTIONAL,
  cdma2000-1xRTT       IRAT-ParametersCDMA2000-1XRTT     OPTIONAL,
},
nonCriticalExtension    UE-EUTRA-Capability-v920-IEs     OPTIONAL
}

-- Late non critical extensions
UE-EUTRA-Capability-v9a0-IEs ::= SEQUENCE {
  featureGroupIndRel9Add-r9  BIT STRING (SIZE (32))          OPTIONAL,
  fdd-Add-UE-EUTRA-Capabilities-r9  UE-EUTRA-CapabilityAddXDD-Mode-r9  OPTIONAL,
  tdd-Add-UE-EUTRA-Capabilities-r9  UE-EUTRA-CapabilityAddXDD-Mode-r9  OPTIONAL,
  nonCriticalExtension        UE-EUTRA-Capability-v9c0-IEs     OPTIONAL
}

UE-EUTRA-Capability-v9c0-IEs ::= SEQUENCE {
  interRAT-ParametersUTRA-v9c0  IRAT-ParametersUTRA-v9c0          OPTIONAL,
  nonCriticalExtension            UE-EUTRA-Capability-v9d0-IEs     OPTIONAL
}

UE-EUTRA-Capability-v9d0-IEs ::= SEQUENCE {
  phyLayerParameters-v9d0       PhyLayerParameters-v9d0          OPTIONAL,
  nonCriticalExtension            UE-EUTRA-Capability-v9e0-IEs     OPTIONAL
}

UE-EUTRA-Capability-v9e0-IEs ::= SEQUENCE {
  rf-Parameters-v9e0            RF-Parameters-v9e0                OPTIONAL,
  nonCriticalExtension            UE-EUTRA-Capability-v9h0-IEs     OPTIONAL
}

UE-EUTRA-Capability-v9h0-IEs ::= SEQUENCE {
  interRAT-ParametersUTRA-v9h0  IRAT-ParametersUTRA-v9h0          OPTIONAL,
  -- Following field is only to be used for late REL-9 extensions
  lateNonCriticalExtension       OCTET STRING                    OPTIONAL,
  nonCriticalExtension            UE-EUTRA-Capability-v10c0-IEs     OPTIONAL
}

UE-EUTRA-Capability-v10c0-IEs ::= SEQUENCE {
  otdoa-PositioningCapabilities-r10  OTDOA-PositioningCapabilities-r10  OPTIONAL,
  nonCriticalExtension                UE-EUTRA-Capability-v10f0-IEs     OPTIONAL
}

UE-EUTRA-Capability-v10f0-IEs ::= SEQUENCE {
  rf-Parameters-v10f0            RF-Parameters-v10f0                OPTIONAL,
  nonCriticalExtension            UE-EUTRA-Capability-v10i0-IEs     OPTIONAL
}

UE-EUTRA-Capability-v10i0-IEs ::= SEQUENCE {
  rf-Parameters-v10i0            RF-Parameters-v10i0                OPTIONAL,
  -- Following field is only to be used for late REL-10 extensions
  lateNonCriticalExtension        OCTET STRING (CONTAINING UE-EUTRA-Capability-v10j0-IEs)
  OPTIONAL,
  nonCriticalExtension            UE-EUTRA-Capability-v11d0-IEs     OPTIONAL
}

UE-EUTRA-Capability-v10j0-IEs ::= SEQUENCE {
  rf-Parameters-v10j0            RF-Parameters-v10j0                OPTIONAL,
  nonCriticalExtension            SEQUENCE {}                      OPTIONAL
}

UE-EUTRA-Capability-v11d0-IEs ::= SEQUENCE {
  rf-Parameters-v11d0            RF-Parameters-v11d0                OPTIONAL,
  otherParameters-v11d0          Other-Parameters-v11d0            OPTIONAL,
  nonCriticalExtension            UE-EUTRA-Capability-v11x0-IEs     OPTIONAL
}

UE-EUTRA-Capability-v11x0-IEs ::= SEQUENCE {
  -- Following field is only to be used for late REL-11 extensions
  lateNonCriticalExtension        OCTET STRING                    OPTIONAL,
  nonCriticalExtension            UE-EUTRA-Capability-v12b0-IEs     OPTIONAL
}

```

```

UE-EUTRA-Capability-v12b0-IEs ::= SEQUENCE {
    rf-Parameters-v12b0                RF-Parameters-v12b0                OPTIONAL,
    -- Following field is only to be used for late REL-12 extensions
    nonCriticalExtension                SEQUENCE {}                    OPTIONAL
}

-- Regular non critical extensions
UE-EUTRA-Capability-v920-IEs ::= SEQUENCE {
    phyLayerParameters-v920            PhyLayerParameters-v920,
    interRAT-ParametersGERAN-v920     IRAT-ParametersGERAN-v920,
    interRAT-ParametersUTRA-v920      IRAT-ParametersUTRA-v920        OPTIONAL,
    interRAT-ParametersCDMA2000-v920  IRAT-ParametersCDMA2000-1XRTT-v920 OPTIONAL,
    deviceType-r9                      ENUMERATED {noBenFromBatConsumpOpt} OPTIONAL,
    csg-ProximityIndicationParameters-r9 CSG-ProximityIndicationParameters-r9,
    neighCellSI-AcquisitionParameters-r9 NeighCellSI-AcquisitionParameters-r9,
    son-Parameters-r9                  SON-Parameters-r9,
    nonCriticalExtension                UE-EUTRA-Capability-v940-IEs    OPTIONAL
}

UE-EUTRA-Capability-v940-IEs ::= SEQUENCE {
    lateNonCriticalExtension           OCTET STRING (CONTAINING UE-EUTRA-Capability-v9a0-IEs)
                                       OPTIONAL,
    nonCriticalExtension                UE-EUTRA-Capability-v1020-IEs   OPTIONAL
}

UE-EUTRA-Capability-v1020-IEs ::= SEQUENCE {
    ue-Category-v1020                 INTEGER (6..8)                   OPTIONAL,
    phyLayerParameters-v1020           PhyLayerParameters-v1020        OPTIONAL,
    rf-Parameters-v1020                RF-Parameters-v1020             OPTIONAL,
    measParameters-v1020               MeasParameters-v1020            OPTIONAL,
    featureGroupIndRel10-r10           BIT STRING (SIZE (32))          OPTIONAL,
    interRAT-ParametersCDMA2000-v1020 IRAT-ParametersCDMA2000-1XRTT-v1020 OPTIONAL,
    ue-BasedNetwPerfMeasParameters-r10 UE-BasedNetwPerfMeasParameters-r10 OPTIONAL,
    interRAT-ParametersUTRA-TDD-v1020 IRAT-ParametersUTRA-TDD-v1020   OPTIONAL,
    nonCriticalExtension                UE-EUTRA-Capability-v1060-IEs   OPTIONAL
}

UE-EUTRA-Capability-v1060-IEs ::= SEQUENCE {
    fdd-Add-UE-EUTRA-Capabilities-v1060 UE-EUTRA-CapabilityAddXDD-Mode-v1060 OPTIONAL,
    tdd-Add-UE-EUTRA-Capabilities-v1060 UE-EUTRA-CapabilityAddXDD-Mode-v1060 OPTIONAL,
    rf-Parameters-v1060                RF-Parameters-v1060             OPTIONAL,
    nonCriticalExtension                UE-EUTRA-Capability-v1090-IEs   OPTIONAL
}

UE-EUTRA-Capability-v1090-IEs ::= SEQUENCE {
    rf-Parameters-v1090                RF-Parameters-v1090             OPTIONAL,
    nonCriticalExtension                UE-EUTRA-Capability-v1130-IEs   OPTIONAL
}

UE-EUTRA-Capability-v1130-IEs ::= SEQUENCE {
    pdcp-Parameters-v1130              PDCP-Parameters-v1130,
    phyLayerParameters-v1130           PhyLayerParameters-v1130        OPTIONAL,
    rf-Parameters-v1130                RF-Parameters-v1130,
    measParameters-v1130               MeasParameters-v1130,
    interRAT-ParametersCDMA2000-v1130 IRAT-ParametersCDMA2000-v1130,
    otherParameters-r11                Other-Parameters-r11,
    fdd-Add-UE-EUTRA-Capabilities-v1130 UE-EUTRA-CapabilityAddXDD-Mode-v1130 OPTIONAL,
    tdd-Add-UE-EUTRA-Capabilities-v1130 UE-EUTRA-CapabilityAddXDD-Mode-v1130 OPTIONAL,
    nonCriticalExtension                UE-EUTRA-Capability-v1170-IEs   OPTIONAL
}

UE-EUTRA-Capability-v1170-IEs ::= SEQUENCE {
    phyLayerParameters-v1170           PhyLayerParameters-v1170        OPTIONAL,
    ue-Category-v1170                  INTEGER (9..10)                  OPTIONAL,
    nonCriticalExtension                UE-EUTRA-Capability-v1180-IEs   OPTIONAL
}

UE-EUTRA-Capability-v1180-IEs ::= SEQUENCE {
    rf-Parameters-v1180                RF-Parameters-v1180             OPTIONAL,
    mbms-Parameters-r11                MBMS-Parameters-r11             OPTIONAL,
    fdd-Add-UE-EUTRA-Capabilities-v1180 UE-EUTRA-CapabilityAddXDD-Mode-v1180 OPTIONAL,
    tdd-Add-UE-EUTRA-Capabilities-v1180 UE-EUTRA-CapabilityAddXDD-Mode-v1180 OPTIONAL,
    nonCriticalExtension                UE-EUTRA-Capability-v11a0-IEs   OPTIONAL
}

UE-EUTRA-Capability-v11a0-IEs ::= SEQUENCE {
    ue-Category-v11a0                  INTEGER (11..12)                  OPTIONAL,

```



```

measParameters-v11a0      MeasParameters-v11a0      OPTIONAL,
nonCriticalExtension      UE-EUTRA-Capability-v1250-IEs    OPTIONAL
}

UE-EUTRA-Capability-v1250-IEs ::= SEQUENCE {
  phyLayerParameters-v1250      PhyLayerParameters-v1250      OPTIONAL,
  rf-Parameters-v1250          RF-Parameters-v1250          OPTIONAL,
  rlc-Parameters-r12          RLC-Parameters-r12          OPTIONAL,
  ue-BasedNetwPerfMeasParameters-v1250  UE-BasedNetwPerfMeasParameters-v1250  OPTIONAL,
  ue-CategoryDL-r12          INTEGER (0..14)          OPTIONAL,
  ue-CategoryUL-r12          INTEGER (0..13)          OPTIONAL,
  wlan-IW-Parameters-r12      WLAN-IW-Parameters-r12      OPTIONAL,
  measParameters-v1250        MeasParameters-v1250        OPTIONAL,
  dc-Parameters-r12          DC-Parameters-r12          OPTIONAL,
  mbms-Parameters-v1250      MBMS-Parameters-v1250      OPTIONAL,
  mac-Parameters-r12          MAC-Parameters-r12          OPTIONAL,
  fdd-Add-UE-EUTRA-Capabilities-v1250  UE-EUTRA-CapabilityAddXDD-Mode-v1250  OPTIONAL,
  tdd-Add-UE-EUTRA-Capabilities-v1250  UE-EUTRA-CapabilityAddXDD-Mode-v1250  OPTIONAL,
  sl-Parameters-r12          SL-Parameters-r12          OPTIONAL,
  nonCriticalExtension        UE-EUTRA-Capability-v1260-IEs    OPTIONAL
}

UE-EUTRA-Capability-v1260-IEs ::= SEQUENCE {
  ue-CategoryDL-v1260        INTEGER (15..16)          OPTIONAL,
  nonCriticalExtension        UE-EUTRA-Capability-v1270-IEs    OPTIONAL
}

UE-EUTRA-Capability-v1270-IEs ::= SEQUENCE {
  rf-Parameters-v1270        RF-Parameters-v1270          OPTIONAL,
  nonCriticalExtension        UE-EUTRA-Capability-v1280-IEs    OPTIONAL
}

UE-EUTRA-Capability-v1280-IEs ::= SEQUENCE {
  phyLayerParameters-v1280    PhyLayerParameters-v1280    OPTIONAL,
  nonCriticalExtension        SEQUENCE {}          OPTIONAL
}

UE-EUTRA-CapabilityAddXDD-Mode-r9 ::= SEQUENCE {
  phyLayerParameters-r9      PhyLayerParameters          OPTIONAL,
  featureGroupIndicators-r9  BIT STRING (SIZE (32))    OPTIONAL,
  featureGroupIndRel9Add-r9  BIT STRING (SIZE (32))    OPTIONAL,
  interRAT-ParametersGERAN-r9  IRAT-ParametersGERAN      OPTIONAL,
  interRAT-ParametersUTRA-r9   IRAT-ParametersUTRA-v920   OPTIONAL,
  interRAT-ParametersCDMA2000-r9  IRAT-ParametersCDMA2000-1XRTT-v920  OPTIONAL,
  neighCellSI-AcquisitionParameters-r9  NeighCellSI-AcquisitionParameters-r9  OPTIONAL,
  ...
}

UE-EUTRA-CapabilityAddXDD-Mode-v1060 ::= SEQUENCE {
  phyLayerParameters-v1060    PhyLayerParameters-v1060    OPTIONAL,
  featureGroupIndRel10-v1060  BIT STRING (SIZE (32))    OPTIONAL,
  interRAT-ParametersCDMA2000-v1060  IRAT-ParametersCDMA2000-1XRTT-v1020  OPTIONAL,
  interRAT-ParametersUTRA-TDD-v1060  IRAT-ParametersUTRA-TDD-v1020  OPTIONAL,
  ...
  [[ 'otdoa-PositioningCapabilities-r10  OTDOA-PositioningCapabilities-r10  OPTIONAL
  ]]
}

UE-EUTRA-CapabilityAddXDD-Mode-v1130 ::= SEQUENCE {
  phyLayerParameters-v1130    PhyLayerParameters-v1130    OPTIONAL,
  measParameters-v1130        MeasParameters-v1130        OPTIONAL,
  otherParameters-r11        Other-Parameters-r11        OPTIONAL,
  ...
}

UE-EUTRA-CapabilityAddXDD-Mode-v1180 ::= SEQUENCE {
  mbms-Parameters-r11        MBMS-Parameters-r11
}

UE-EUTRA-CapabilityAddXDD-Mode-v1250 ::= SEQUENCE {
  phyLayerParameters-v1250    PhyLayerParameters-v1250    OPTIONAL,
  measParameters-v1250        MeasParameters-v1250        OPTIONAL
}

AccessStratumRelease ::= ENUMERATED {
  rel8, rel9, rel10, rel11, rel12, spare3,
  spare2, spare1, ...}

```

```

DC-Parameters-r12 ::= SEQUENCE {
    drb-TypeSplit-r12          ENUMERATED {supported}          OPTIONAL,
    drb-TypeSCG-r12           ENUMERATED {supported}          OPTIONAL
}

MAC-Parameters-r12 ::= SEQUENCE {
    logicalChannelSR-ProhibitTimer-r12  ENUMERATED {supported}          OPTIONAL,
    longDRX-Command-r12                 ENUMERATED {supported}          OPTIONAL
}

RLC-Parameters-r12 ::= SEQUENCE {
    extended-RLC-LI-Field-r12           ENUMERATED {supported}
}

PDCP-Parameters ::= SEQUENCE {
    supportedROHC-Profiles              SEQUENCE {
        profile0x0001                   BOOLEAN,
        profile0x0002                   BOOLEAN,
        profile0x0003                   BOOLEAN,
        profile0x0004                   BOOLEAN,
        profile0x0006                   BOOLEAN,
        profile0x0101                   BOOLEAN,
        profile0x0102                   BOOLEAN,
        profile0x0103                   BOOLEAN,
        profile0x0104                   BOOLEAN
    },
    maxNumberROHC-ContextSessions       ENUMERATED {
        cs2, cs4, cs8, cs12, cs16, cs24, cs32,
        cs48, cs64, cs128, cs256, cs512, cs1024,
        cs16384, spare2, spare1}          DEFAULT cs16,
    ...
}

PDCP-Parameters-v1130 ::= SEQUENCE {
    pdcP-SN-Extension-r11               ENUMERATED {supported}          OPTIONAL,
    supportRohcContextContinue-r11      ENUMERATED {supported}          OPTIONAL
}

PhyLayerParameters ::= SEQUENCE {
    ue-TxAntennaSelectionSupported      BOOLEAN,
    ue-SpecificRefSigsSupported         BOOLEAN
}

PhyLayerParameters-v920 ::= SEQUENCE {
    enhancedDualLayerFDD-r9             ENUMERATED {supported}          OPTIONAL,
    enhancedDualLayerTDD-r9            ENUMERATED {supported}          OPTIONAL
}

PhyLayerParameters-v9d0 ::= SEQUENCE {
    tm5-FDD-r9                          ENUMERATED {supported}          OPTIONAL,
    tm5-TDD-r9                          ENUMERATED {supported}          OPTIONAL
}

PhyLayerParameters-v1020 ::= SEQUENCE {
    twoAntennaPortsForPUCCH-r10         ENUMERATED {supported}          OPTIONAL,
    tm9-With-8Tx-FDD-r10               ENUMERATED {supported}          OPTIONAL,
    pmi-Disabling-r10                  ENUMERATED {supported}          OPTIONAL,
    crossCarrierScheduling-r10          ENUMERATED {supported}          OPTIONAL,
    simultaneousPUCCH-PUSCH-r10        ENUMERATED {supported}          OPTIONAL,
    multiClusterPUSCH-WithinCC-r10      ENUMERATED {supported}          OPTIONAL,
    nonContiguousUL-RA-WithinCC-List-r10 NonContiguousUL-RA-WithinCC-List-r10 OPTIONAL
}

PhyLayerParameters-v1130 ::= SEQUENCE {
    crs-InterfHandl-r11                ENUMERATED {supported}          OPTIONAL,
    ePDCCH-r11                         ENUMERATED {supported}          OPTIONAL,
    multiACK-CSI-Reporting-r11          ENUMERATED {supported}          OPTIONAL,
    ss-CCH-InterfHandl-r11             ENUMERATED {supported}          OPTIONAL,
    tdd-SpecialSubframe-r11            ENUMERATED {supported}          OPTIONAL,
    txDiv-PUCCH1b-ChSelect-r11         ENUMERATED {supported}          OPTIONAL,
    ul-CoMP-r11                        ENUMERATED {supported}          OPTIONAL
}

PhyLayerParameters-v1170 ::= SEQUENCE {
    interBandTDD-CA-WithDifferentConfig-r11 BIT STRING (SIZE (2))          OPTIONAL
}

PhyLayerParameters-v1250 ::= SEQUENCE {

```

e-HARQ-Pattern-FDD-r12	ENUMERATED {supported}	OPTIONAL,
enhanced-4TxCodebook-r12	ENUMERATED {supported}	OPTIONAL,
tdd-FDD-CA-PCellDuplex-r12	BIT STRING (SIZE (2))	OPTIONAL,
phy-TDD-ReConfig-TDD-PCell-r12	ENUMERATED {supported}	OPTIONAL,
phy-TDD-ReConfig-FDD-PCell-r12	ENUMERATED {supported}	OPTIONAL,
pusch-FeedbackMode-r12	ENUMERATED {supported}	OPTIONAL,
pusch-SRS-PowerControl-SubframeSet-r12	ENUMERATED {supported}	OPTIONAL,
csi-SubframeSet-r12	ENUMERATED {supported}	OPTIONAL,
noResourceRestrictionForTTIBundling-r12	ENUMERATED {supported}	OPTIONAL,
discoverySignalsInDeactSCell-r12	ENUMERATED {supported}	OPTIONAL,
naics-Capability-List-r12	NAICS-Capability-List-r12	OPTIONAL
}		
PhyLayerParameters-v1280 ::=	SEQUENCE {	
alternativeTBS-Indices-r12	ENUMERATED {supported}	OPTIONAL
}		
NonContiguousUL-RA-WithinCC-List-r10 ::=	SEQUENCE (SIZE (1..maxBands)) OF NonContiguousUL-RA-WithinCC-r10	
NonContiguousUL-RA-WithinCC-r10 ::=	SEQUENCE {	
nonContiguousUL-RA-WithinCC-Info-r10	ENUMERATED {supported}	OPTIONAL
}		
RF-Parameters ::=	SEQUENCE {	
supportedBandListEUTRA	SupportedBandListEUTRA	
}		
RF-Parameters-v9e0 ::=	SEQUENCE {	
supportedBandListEUTRA-v9e0	SupportedBandListEUTRA-v9e0	OPTIONAL
}		
RF-Parameters-v1020 ::=	SEQUENCE {	
supportedBandCombination-r10	SupportedBandCombination-r10	
}		
RF-Parameters-v1060 ::=	SEQUENCE {	
supportedBandCombinationExt-r10	SupportedBandCombinationExt-r10	
}		
RF-Parameters-v1090 ::=	SEQUENCE {	
supportedBandCombination-v1090	SupportedBandCombination-v1090	OPTIONAL
}		
RF-Parameters-v10f0 ::=	SEQUENCE {	
modifiedMPR-Behavior-r10	BIT STRING (SIZE (32))	OPTIONAL
}		
RF-Parameters-v10i0 ::=	SEQUENCE {	
supportedBandCombination-v10i0	SupportedBandCombination-v10i0	OPTIONAL
}		
RF-Parameters-v10j0 ::=	SEQUENCE {	
multiNS-Pmax-r10	ENUMERATED {supported}	OPTIONAL
}		
RF-Parameters-v1130 ::=	SEQUENCE {	
supportedBandCombination-v1130	SupportedBandCombination-v1130	OPTIONAL
}		
RF-Parameters-v1180 ::=	SEQUENCE {	
freqBandRetrieval-r11	ENUMERATED {supported}	OPTIONAL,
requestedBands-r11	SEQUENCE (SIZE (1.. maxBands)) OF FreqBandIndicator-r11	
OPTIONAL,		
supportedBandCombinationAdd-r11	SupportedBandCombinationAdd-r11	OPTIONAL
}		
RF-Parameters-v11d0 ::=	SEQUENCE {	
supportedBandCombinationAdd-v11d0	SupportedBandCombinationAdd-v11d0	OPTIONAL
}		
RF-Parameters-v1250 ::=	SEQUENCE {	
supportedBandListEUTRA-v1250	SupportedBandListEUTRA-v1250	OPTIONAL,
supportedBandCombination-v1250	SupportedBandCombination-v1250	OPTIONAL,
supportedBandCombinationAdd-v1250	SupportedBandCombinationAdd-v1250	OPTIONAL,
freqBandPriorityAdjustment-r12	ENUMERATED {supported}	OPTIONAL
}		

```

RF-Parameters-v1270 ::= SEQUENCE {
    supportedBandCombination-v1270 SupportedBandCombination-v1270 OPTIONAL,
    supportedBandCombinationAdd-v1270 SupportedBandCombinationAdd-v1270 OPTIONAL
}

RF-Parameters-v12b0 ::= SEQUENCE {
    maxLayersMIMO-Indication-r12 ENUMERATED {supported} OPTIONAL
}

SupportedBandCombination-r10 ::= SEQUENCE (SIZE (1..maxBandComb-r10)) OF BandCombinationParameters-
r10

SupportedBandCombinationExt-r10 ::= SEQUENCE (SIZE (1..maxBandComb-r10)) OF
BandCombinationParametersExt-r10

SupportedBandCombination-v1090 ::= SEQUENCE (SIZE (1..maxBandComb-r10)) OF
BandCombinationParameters-v1090

SupportedBandCombination-v10i0 ::= SEQUENCE (SIZE (1..maxBandComb-r10)) OF
BandCombinationParameters-v10i0

SupportedBandCombination-v1130 ::= SEQUENCE (SIZE (1..maxBandComb-r10)) OF
BandCombinationParameters-v1130

SupportedBandCombination-v1250 ::= SEQUENCE (SIZE (1..maxBandComb-r10)) OF
BandCombinationParameters-v1250

SupportedBandCombination-v1270 ::= SEQUENCE (SIZE (1..maxBandComb-r10)) OF
BandCombinationParameters-v1270

SupportedBandCombinationAdd-r11 ::= SEQUENCE (SIZE (1..maxBandComb-r11)) OF
BandCombinationParameters-r11

SupportedBandCombinationAdd-v11d0 ::= SEQUENCE (SIZE (1..maxBandComb-r11)) OF
BandCombinationParameters-v10i0

SupportedBandCombinationAdd-v1250 ::= SEQUENCE (SIZE (1..maxBandComb-r11)) OF
BandCombinationParameters-v1250

SupportedBandCombinationAdd-v1270 ::= SEQUENCE (SIZE (1..maxBandComb-r11)) OF
BandCombinationParameters-v1270

BandCombinationParameters-r10 ::= SEQUENCE (SIZE (1..maxSimultaneousBands-r10)) OF BandParameters-
r10

BandCombinationParametersExt-r10 ::= SEQUENCE {
    supportedBandwidthCombinationSet-r10 SupportedBandwidthCombinationSet-r10 OPTIONAL
}

BandCombinationParameters-v1090 ::= SEQUENCE (SIZE (1..maxSimultaneousBands-r10)) OF BandParameters-
v1090

BandCombinationParameters-v10i0 ::= SEQUENCE {
    bandParameterList-v10i0 SEQUENCE (SIZE (1..maxSimultaneousBands-r10)) OF
    BandParameters-v10i0 OPTIONAL
}

BandCombinationParameters-v1130 ::= SEQUENCE {
    multipleTimingAdvance-r11 ENUMERATED {supported} OPTIONAL,
    simultaneousRx-Tx-r11 ENUMERATED {supported} OPTIONAL,
    bandParameterList-r11 SEQUENCE (SIZE (1..maxSimultaneousBands-r10)) OF BandParameters-
v1130 OPTIONAL,
    ...
}

BandCombinationParameters-r11 ::= SEQUENCE {
    bandParameterList-r11 SEQUENCE (SIZE (1..maxSimultaneousBands-r10)) OF
    BandParameters-r11,
    supportedBandwidthCombinationSet-r11 SupportedBandwidthCombinationSet-r10 OPTIONAL,
    multipleTimingAdvance-r11 ENUMERATED {supported} OPTIONAL,
    simultaneousRx-Tx-r11 ENUMERATED {supported} OPTIONAL,
    bandInfoEUTRA-r11 BandInfoEUTRA,
    ...
}

BandCombinationParameters-v1250 ::= SEQUENCE {
    dc-Support-r12 SEQUENCE {
        asynchronous-r12 ENUMERATED {supported} OPTIONAL,

```

```

        supportedCellGrouping-r12      CHOICE {
            threeEntries-r12           BIT STRING (SIZE(3)),
            fourEntries-r12            BIT STRING (SIZE(7)),
            fiveEntries-r12            BIT STRING (SIZE(15))
        }
    }
    supportedNAICS-2CRS-AP-r12        BIT STRING (SIZE (1..maxNAICS-Entries-r12))  OPTIONAL,
    commSupportedBandsPerBC-r12       BIT STRING (SIZE (1.. maxBands))          OPTIONAL,
    ...
}

BandCombinationParameters-v1270 ::= SEQUENCE {
    bandParameterList-v1270           SEQUENCE (SIZE (1..maxSimultaneousBands-r10)) OF
    BandParameters-v1270              OPTIONAL
}

SupportedBandwidthCombinationSet-r10 ::= BIT STRING (SIZE (1..maxBandwidthCombSet-r10))

BandParameters-r10 ::= SEQUENCE {
    bandEUTRA-r10                     FreqBandIndicator,
    bandParametersUL-r10               BandParametersUL-r10          OPTIONAL,
    bandParametersDL-r10               BandParametersDL-r10          OPTIONAL
}

BandParameters-v1090 ::= SEQUENCE {
    bandEUTRA-v1090                   FreqBandIndicator-v9e0          OPTIONAL,
    ...
}

BandParameters-v10i0 ::= SEQUENCE {
    bandParametersDL-v10i0             SEQUENCE (SIZE (1..maxBandwidthClass-r10)) OF CA-MIMO-ParametersDL-
    v10i0
}

BandParameters-v1130 ::= SEQUENCE {
    supportedCSI-Proc-r11              ENUMERATED {n1, n3, n4}
}

BandParameters-r11 ::= SEQUENCE {
    bandEUTRA-r11                     FreqBandIndicator-r11,
    bandParametersUL-r11               BandParametersUL-r10          OPTIONAL,
    bandParametersDL-r11               BandParametersDL-r10          OPTIONAL,
    supportedCSI-Proc-r11              ENUMERATED {n1, n3, n4}          OPTIONAL
}

BandParameters-v1270 ::= SEQUENCE {
    bandParametersDL-v1270             SEQUENCE (SIZE (1..maxBandwidthClass-r10)) OF CA-MIMO-
    ParametersDL-v1270
}

BandParametersUL-r10 ::= SEQUENCE (SIZE (1..maxBandwidthClass-r10)) OF CA-MIMO-ParametersUL-r10

CA-MIMO-ParametersUL-r10 ::= SEQUENCE {
    ca-BandwidthClassUL-r10           CA-BandwidthClass-r10,
    supportedMIMO-CapabilityUL-r10    MIMO-CapabilityUL-r10          OPTIONAL
}

BandParametersDL-r10 ::= SEQUENCE (SIZE (1..maxBandwidthClass-r10)) OF CA-MIMO-ParametersDL-r10

CA-MIMO-ParametersDL-r10 ::= SEQUENCE {
    ca-BandwidthClassDL-r10           CA-BandwidthClass-r10,
    supportedMIMO-CapabilityDL-r10    MIMO-CapabilityDL-r10          OPTIONAL
}

CA-MIMO-ParametersDL-v10i0 ::= SEQUENCE {
    fourLayerTM3-TM4-r10              ENUMERATED {supported}          OPTIONAL
}

CA-MIMO-ParametersDL-v1270 ::= SEQUENCE {
    intraBandContiguousCC-InfoList-r12 SEQUENCE (SIZE (1..maxServCell-r10)) OF
    IntraBandContiguousCC-Info-r12
}

IntraBandContiguousCC-Info-r12 ::= SEQUENCE {
    fourLayerTM3-TM4-perCC-r12        ENUMERATED {supported}          OPTIONAL,
    supportedMIMO-CapabilityDL-r12    MIMO-CapabilityDL-r10          OPTIONAL,
    supportedCSI-Proc-r12              ENUMERATED {n1, n3, n4}          OPTIONAL
}

```

```

CA-BandwidthClass-r10 ::= ENUMERATED {a, b, c, d, e, f, ...}
MIMO-CapabilityUL-r10 ::= ENUMERATED {twoLayers, fourLayers}
MIMO-CapabilityDL-r10 ::= ENUMERATED {twoLayers, fourLayers, eightLayers}
SupportedBandListEUTRA ::= SEQUENCE (SIZE (1..maxBands)) OF SupportedBandEUTRA
SupportedBandListEUTRA-v9e0 ::= SEQUENCE (SIZE (1..maxBands)) OF SupportedBandEUTRA-v9e0
SupportedBandListEUTRA-v1250 ::= SEQUENCE (SIZE (1..maxBands)) OF SupportedBandEUTRA-v1250
SupportedBandEUTRA ::= SEQUENCE {
    bandEUTRA
    halfDuplex
}
SupportedBandEUTRA-v9e0 ::= SEQUENCE {
    bandEUTRA-v9e0
    FreqBandIndicator-v9e0 OPTIONAL
}
SupportedBandEUTRA-v1250 ::= SEQUENCE {
    dl-256QAM-r12
    ul-64QAM-r12
    ENUMERATED {supported} OPTIONAL,
    ENUMERATED {supported} OPTIONAL
}
MeasParameters ::= SEQUENCE {
    bandListEUTRA
    BandListEUTRA
}
MeasParameters-v1020 ::= SEQUENCE {
    bandCombinationListEUTRA-r10
    BandCombinationListEUTRA-r10
}
MeasParameters-v1130 ::= SEQUENCE {
    rsrqMeasWideband-r11
    ENUMERATED {supported} OPTIONAL
}
MeasParameters-v11a0 ::= SEQUENCE {
    benefitsFromInterruption-r11
    ENUMERATED {true} OPTIONAL
}
MeasParameters-v1250 ::= SEQUENCE {
    timerT312-r12
    alternativeTimeToTrigger-r12
    incMonEUTRA-r12
    incMonUTRA-r12
    extendedMaxMeasId-r12
    extendedRSRQ-LowerRange-r12
    rsrq-OnAllSymbols-r12
    crs-DiscoverySignalsMeas-r12
    csi-RS-DiscoverySignalsMeas-r12
    ENUMERATED {supported} OPTIONAL,
    ENUMERATED {supported} OPTIONAL,
    ENUMERATED {supported} OPTIONAL,
    ENUMERATED {supported} OPTIONAL,
    ENUMERATED {supported} OPTIONAL,
    ENUMERATED {supported} OPTIONAL,
    ENUMERATED {supported} OPTIONAL,
    ENUMERATED {supported} OPTIONAL,
    ENUMERATED {supported} OPTIONAL
}
BandListEUTRA ::= SEQUENCE (SIZE (1..maxBands)) OF BandInfoEUTRA
BandCombinationListEUTRA-r10 ::= SEQUENCE (SIZE (1..maxBandComb-r10)) OF BandInfoEUTRA
BandInfoEUTRA ::= SEQUENCE {
    interFreqBandList
    interRAT-BandList
    InterFreqBandList,
    InterRAT-BandList OPTIONAL
}
InterFreqBandList ::= SEQUENCE (SIZE (1..maxBands)) OF InterFreqBandInfo
InterFreqBandInfo ::= SEQUENCE {
    interFreqNeedForGaps
    BOOLEAN
}
InterRAT-BandList ::= SEQUENCE (SIZE (1..maxBands)) OF InterRAT-BandInfo
InterRAT-BandInfo ::= SEQUENCE {
    interRAT-NeedForGaps
    BOOLEAN
}
IRAT-ParametersUTRA-FDD ::= SEQUENCE {
    supportedBandListUTRA-FDD
    SupportedBandListUTRA-FDD
}

```

```

}
IRAT-ParametersUTRA-v920 ::= SEQUENCE {
    e-RedirectionUTRA-r9      ENUMERATED {supported}
}
IRAT-ParametersUTRA-v9c0 ::= SEQUENCE {
    voiceOverPS-HS-UTRA-FDD-r9      ENUMERATED {supported}      OPTIONAL,
    voiceOverPS-HS-UTRA-TDD128-r9   ENUMERATED {supported}      OPTIONAL,
    srvcc-FromUTRA-FDD-ToUTRA-FDD-r9 ENUMERATED {supported}      OPTIONAL,
    srvcc-FromUTRA-FDD-ToGERAN-r9   ENUMERATED {supported}      OPTIONAL,
    srvcc-FromUTRA-TDD128-ToUTRA-TDD128-r9 ENUMERATED {supported}      OPTIONAL,
    srvcc-FromUTRA-TDD128-ToGERAN-r9 ENUMERATED {supported}      OPTIONAL
}
IRAT-ParametersUTRA-v9h0 ::= SEQUENCE {
    mfbI-UTRA-r9                ENUMERATED {supported}
}
SupportedBandListUTRA-FDD ::= SEQUENCE (SIZE (1..maxBands)) OF SupportedBandUTRA-FDD
SupportedBandUTRA-FDD ::= ENUMERATED {
    bandI, bandII, bandIII, bandIV, bandV, bandVI,
    bandVII, bandVIII, bandIX, bandX, bandXI,
    bandXII, bandXIII, bandXIV, bandXV, bandXVI, ...,
    bandXVII-8a0, bandXVIII-8a0, bandXIX-8a0, bandXX-8a0,
    bandXXI-8a0, bandXXII-8a0, bandXXIII-8a0, bandXXIV-8a0,
    bandXXV-8a0, bandXXVI-8a0, bandXXVII-8a0, bandXXVIII-8a0,
    bandXXIX-8a0, bandXXX-8a0, bandXXXI-8a0, bandXXXII-8a0}
IRAT-ParametersUTRA-TDD128 ::= SEQUENCE {
    supportedBandListUTRA-TDD128 SupportedBandListUTRA-TDD128
}
SupportedBandListUTRA-TDD128 ::= SEQUENCE (SIZE (1..maxBands)) OF SupportedBandUTRA-TDD128
SupportedBandUTRA-TDD128 ::= ENUMERATED {
    a, b, c, d, e, f, g, h, i, j, k, l, m, n,
    o, p, ...}
IRAT-ParametersUTRA-TDD384 ::= SEQUENCE {
    supportedBandListUTRA-TDD384 SupportedBandListUTRA-TDD384
}
SupportedBandListUTRA-TDD384 ::= SEQUENCE (SIZE (1..maxBands)) OF SupportedBandUTRA-TDD384
SupportedBandUTRA-TDD384 ::= ENUMERATED {
    a, b, c, d, e, f, g, h, i, j, k, l, m, n,
    o, p, ...}
IRAT-ParametersUTRA-TDD768 ::= SEQUENCE {
    supportedBandListUTRA-TDD768 SupportedBandListUTRA-TDD768
}
SupportedBandListUTRA-TDD768 ::= SEQUENCE (SIZE (1..maxBands)) OF SupportedBandUTRA-TDD768
SupportedBandUTRA-TDD768 ::= ENUMERATED {
    a, b, c, d, e, f, g, h, i, j, k, l, m, n,
    o, p, ...}
IRAT-ParametersUTRA-TDD-v1020 ::= SEQUENCE {
    e-RedirectionUTRA-TDD-r10      ENUMERATED {supported}
}
IRAT-ParametersGERAN ::= SEQUENCE {
    supportedBandListGERAN          SupportedBandListGERAN,
    interRAT-PS-HO-ToGERAN         BOOLEAN
}
IRAT-ParametersGERAN-v920 ::= SEQUENCE {
    dtm-r9                          ENUMERATED {supported}      OPTIONAL,
    e-RedirectionGERAN-r9           ENUMERATED {supported}      OPTIONAL
}
SupportedBandListGERAN ::= SEQUENCE (SIZE (1..maxBands)) OF SupportedBandGERAN
SupportedBandGERAN ::= ENUMERATED {
    gsm450, gsm480, gsm710, gsm750, gsm810, gsm850,

```

```

gsm900P, gsm900E, gsm900R, gsm1800, gsm1900,
spare5, spare4, spare3, spare2, spare1, ...}

IRAT-ParametersCDMA2000-HRPD ::= SEQUENCE {
    supportedBandListHRPD SupportedBandListHRPD,
    tx-ConfigHRPD ENUMERATED {single, dual},
    rx-ConfigHRPD ENUMERATED {single, dual}
}

SupportedBandListHRPD ::= SEQUENCE (SIZE (1..maxCDMA-BandClass)) OF BandclassCDMA2000

IRAT-ParametersCDMA2000-1XRTT ::= SEQUENCE {
    supportedBandList1XRTT SupportedBandList1XRTT,
    tx-Config1XRTT ENUMERATED {single, dual},
    rx-Config1XRTT ENUMERATED {single, dual}
}

IRAT-ParametersCDMA2000-1XRTT-v920 ::= SEQUENCE {
    e-CSFB-1XRTT-r9 ENUMERATED {supported},
    e-CSFB-ConcPS-Mob1XRTT-r9 ENUMERATED {supported} OPTIONAL
}

IRAT-ParametersCDMA2000-1XRTT-v1020 ::= SEQUENCE {
    e-CSFB-dual-1XRTT-r10 ENUMERATED {supported}
}

IRAT-ParametersCDMA2000-v1130 ::= SEQUENCE {
    cdma2000-NW-Sharing-r11 ENUMERATED {supported} OPTIONAL
}

SupportedBandList1XRTT ::= SEQUENCE (SIZE (1..maxCDMA-BandClass)) OF BandclassCDMA2000

CSG-ProximityIndicationParameters-r9 ::= SEQUENCE {
    intraFreqProximityIndication-r9 ENUMERATED {supported} OPTIONAL,
    interFreqProximityIndication-r9 ENUMERATED {supported} OPTIONAL,
    utran-ProximityIndication-r9 ENUMERATED {supported} OPTIONAL
}

NeighCellSI-AcquisitionParameters-r9 ::= SEQUENCE {
    intraFreqSI-AcquisitionForHO-r9 ENUMERATED {supported} OPTIONAL,
    interFreqSI-AcquisitionForHO-r9 ENUMERATED {supported} OPTIONAL,
    utran-SI-AcquisitionForHO-r9 ENUMERATED {supported} OPTIONAL
}

SON-Parameters-r9 ::= SEQUENCE {
    rach-Report-r9 ENUMERATED {supported} OPTIONAL
}

UE-BasedNetwPerfMeasParameters-r10 ::= SEQUENCE {
    loggedMeasurementsIdle-r10 ENUMERATED {supported} OPTIONAL,
    standaloneGNSS-Location-r10 ENUMERATED {supported} OPTIONAL
}

UE-BasedNetwPerfMeasParameters-v1250 ::= SEQUENCE {
    loggedMBSFNMeasurements-r12 ENUMERATED {supported}
}

OTDOA-PositioningCapabilities-r10 ::= SEQUENCE {
    otdoa-UE-Assisted-r10 ENUMERATED {supported},
    interFreqRSTD-Measurement-r10 ENUMERATED {supported} OPTIONAL
}

Other-Parameters-r11 ::= SEQUENCE {
    inDeviceCoexInd-r11 ENUMERATED {supported} OPTIONAL,
    powerPrefInd-r11 ENUMERATED {supported} OPTIONAL,
    ue-Rx-TxTimeDiffMeasurements-r11 ENUMERATED {supported} OPTIONAL
}

Other-Parameters-v11d0 ::= SEQUENCE {
    inDeviceCoexInd-UL-CA-r11 ENUMERATED {supported} OPTIONAL
}

MBMS-Parameters-r11 ::= SEQUENCE {
    mbms-SCell-r11 ENUMERATED {supported} OPTIONAL,
    mbms-NonServingCell-r11 ENUMERATED {supported} OPTIONAL
}

MBMS-Parameters-v1250 ::= SEQUENCE {

```



```

    mbms-AsyncDC-r12                ENUMERATED {supported}    OPTIONAL
  }
WLAN-IW-Parameters-r12 ::= SEQUENCE {
    wlan-IW-RAN-Rules-r12            ENUMERATED {supported}    OPTIONAL,
    wlan-IW-ANDSF-Policies-r12      ENUMERATED {supported}    OPTIONAL
}
NAICS-Capability-List-r12 ::= SEQUENCE (SIZE (1..maxNAICS-Entries-r12)) OF NAICS-Capability-Entry-
r12
NAICS-Capability-Entry-r12 ::= SEQUENCE {
    numberOfNAICS-CapableCC-r12      INTEGER(1..5),
    numberOfAggregatedPRB-r12        ENUMERATED {
        n50, n75, n100, n125, n150, n175,
        n200, n225, n250, n275, n300, n350,
        n400, n450, n500, spare},
    ...
}
SL-Parameters-r12 ::= SEQUENCE {
    commSimultaneousTx-r12            ENUMERATED {supported}    OPTIONAL,
    commSupportedBands-r12            FreqBandIndicatorListEUTRA-r12 OPTIONAL,
    discSupportedBands-r12            SupportedBandInfoList-r12  OPTIONAL,
    discScheduledResourceAlloc-r12    ENUMERATED {supported}    OPTIONAL,
    disc-UE-SelectedResourceAlloc-r12 ENUMERATED {supported}    OPTIONAL,
    disc-SLSS-r12                     ENUMERATED {supported}    OPTIONAL,
    discSupportedProc-r12             ENUMERATED {n50, n400}    OPTIONAL
}
SupportedBandInfoList-r12 ::= SEQUENCE (SIZE (1..maxBands)) OF SupportedBandInfo-r12
SupportedBandInfo-r12 ::= SEQUENCE {
    support-r12                       ENUMERATED {supported}    OPTIONAL
}
FreqBandIndicatorListEUTRA-r12 ::= SEQUENCE (SIZE (1..maxBands)) OF FreqBandIndicator-r11
-- ASN1STOP

```

UE-EUTRA-Capability field descriptions	FDD/ TDD diff
accessStratumRelease Set to rel12 in this version of the specification.	-
alternativeTBS-Indices Indicates whether the UE supports alternative TBS indices for t_{TBS} 26 and 33 as specified in TS 36.213 [23].	-
alternativeTimeToTrigger Indicates whether the UE supports alternativeTimeToTrigger.	No
bandCombinationListEUTRA One entry corresponding to each supported band combination listed in the same order as in <i>supportedBandCombination</i> .	-
BandCombinationParameters-v1090, BandCombinationParameters-v10i0, BandCombinationParameters-v1270 If included, the UE shall include the same number of entries, and listed in the same order, as in <i>BandCombinationParameters-r10</i> .	-
BandCombinationParameters-v1130 The field is applicable to each supported CA bandwidth class combination (i.e. CA configuration in TS 36.101 [42, Section 5.6A.1]) indicated in the corresponding band combination. If included, the UE shall include the same number of entries, and listed in the same order, as in <i>BandCombinationParameters-r10</i> .	-
bandEUTRA E-UTRA band as defined in TS 36.101 [42]. In case the UE includes <i>bandEUTRA-v9e0</i> or <i>bandEUTRA-v1090</i> , the UE shall set the corresponding entry of <i>bandEUTRA</i> (i.e. without suffix) or <i>bandEUTRA-r10</i> respectively to <i>maxFBI</i> .	-
bandListEUTRA One entry corresponding to each supported E-UTRA band listed in the same order as in <i>supportedBandListEUTRA</i> .	-
bandParametersUL, bandParametersDL Indicates the supported parameters for the band. Each of <i>CA-MIMO-ParametersUL</i> and <i>CA-MIMO-ParametersDL</i> can be included only once for one band in a single band combination entry.	-
benefitsFromInterruption Indicates whether the UE power consumption would benefit from being allowed to cause interruptions to serving cells when performing measurements of deactivated SCell carriers for <i>measCycleSCell</i> of less than 640ms, as specified in TS 36.133 [16].	No
CA-BandwidthClass The CA bandwidth class supported by the UE as defined in TS 36.101 [42, Table 5.6A-1]. The UE explicitly includes all the supported CA bandwidth class combinations in the band combination signalling. Support for one CA bandwidth class does not implicitly indicate support for another CA bandwidth class.	-
cdma2000-NW-Sharing Indicates whether the UE supports network sharing for CDMA2000.	-
commSimultaneousTx Indicates whether the UE supports simultaneous transmission of EUTRA and sidelink communication (on different carriers) in all bands for which the UE indicated sidelink support in a band combination (using <i>commSupportedBandsPerBC</i>).	-
commSupportedBands Indicates the bands on which the UE supports sidelink communication, by an independent list of bands i.e. separate from the list of supported E UTRA band, as indicated in <i>supportedBandListEUTRA</i> .	-
commSupportedBandsPerBC Indicates, for a particular band combination, the bands on which the UE supports simultaneous reception of EUTRA and sidelink communication. If the UE indicates support simultaneous transmission (using <i>commSimultaneousTx</i>), it also indicates, for a particular band combination, the bands on which the UE supports simultaneous transmission of EUTRA and sidelink communication. The first bit refers to the first band included in <i>commSupportedBands</i> , with value 1 indicating sidelink is supported.	-
crossCarrierScheduling	Yes
crs-DiscoverySignalsMeas Indicates whether the UE supports CRS based discovery signals measurement, and PDSCH/EPDCCH RE mapping with zero power CSI-RS configured for discovery signals.	FFS
crs-InterfHandl Indicates whether the UE supports CRS interference handling.	Yes
csi-RS-DiscoverySignalsMeas Indicates whether the UE supports CSI-RS based discovery signals measurement. If this field is included, the UE shall also include <i>crs-DiscoverySignalsMeas</i> .	FFS

UE-EUTRA-Capability field descriptions	FDD/ TDD diff
csi-SubframeSet Indicates whether the UE supports REL-12 DL CSI subframe set configuration, REL-12 DL CSI subframe set dependent CSI measurement/feedback, configuration of up to 2 CSI-IM resources for a CSI process with no more than 4 CSI-IM resources for all CSI processes of one frequency if the UE supports tm10, configuration of two ZP-CSI-RS for tm1 to tm9, PDSCH RE mapping with two ZP-CSI-RS configurations, and EPDCCH RE mapping with two ZP-CSI-RS configurations if the UE supports EPDCCH. This field is only applicable for UEs supporting TDD.	Yes
dc-Support Including this field indicates that the UE supports synchronous DC and power control mode 1. Including this field for a band combination entry comprising of single band entry indicates that the UE supports intra-band contiguous DC. Including this field for a band combination entry comprising of two or more band entries, indicates that the UE supports DC for these bands and that the serving cells corresponding to a band entry shall belong to one cell group (i.e. MCG or SCG). Including field <i>asynchronous</i> indicates that the UE supports asynchronous DC and power control mode 2. Including this field for a TDD/FDD band combination indicates that the UE supports TDD/FDD DC for this band combination.	-
deviceType UE may set the value to " <i>noBenFromBatConsumpOpt</i> " when it does not foresee to particularly benefit from NW-based battery consumption optimisation. Absence of this value means that the device does benefit from NW-based battery consumption optimisation.	-
discoverySignalsInDeactSCell Indicates whether the UE supports the behaviour on DL signals and physical channels when SCell is deactivated and discovery signals measurement is configured as specified in TS 36.211 [17, 6.11A]. This field is included only if UE supports carrier aggregation and includes <i>crs-DiscoverySignalsMeas</i> .	FFS
discScheduledResourceAlloc Indicates whether the UE supports transmission of discovery announcements based on network scheduled resource allocation.	-
disc-UE-SelectedResourceAlloc Indicates whether the UE supports transmission of discovery announcements based on UE autonomous resource selection.	-
disc-SLSS Indicates whether the UE supports Sidelink Synchronization Signal (SLSS) transmission and reception for sidelink discovery.	-
discSupportedBands Indicates the bands on which the UE supports sidelink discovery. One entry corresponding to each supported E UTRA band, listed in the same order as in <i>supportedBandListEUTRA</i> .	-
discSupportedProc Indicates the number of processes supported by the UE for sidelink discovery.	-
dl-256QAM Indicates whether the UE supports 256QAM in DL on the band.	-
dtm Indicates whether the UE supports DTM in GERAN.	-
e-CSFB-1XRTT Indicates whether the UE supports enhanced CS fallback to CDMA2000 1xRTT or not.	Yes
e-CSFB-ConcPS-Mob1XRTT Indicates whether the UE supports concurrent enhanced CS fallback to CDMA2000 1xRTT and PS handover/ redirection to CDMA2000 HRPD.	Yes
e-CSFB-dual-1XRTT Indicates whether the UE supports enhanced CS fallback to CDMA2000 1xRTT for dual Rx/Tx configuration. This bit can only be set to supported if <i>tx-Config1XRTT</i> and <i>rx-Config1XRTT</i> are both set to dual.	Yes
e-HARQ-Pattern-FDD Indicates whether the UE supports enhanced HARQ pattern for TTI bundling operation for FDD.	Yes
Enhanced-4TxCodebook Indicates whether the UE supports enhanced 4Tx codebook.	No
enhancedDualLayerTDD Indicates whether the UE supports enhanced dual layer (PDSCH transmission mode 8) for TDD or not.	-
ePDCCH Indicates whether the UE can receive DCI on UE specific search space on Enhanced PDCCH.	Yes
e-RedirectionUTRA	Yes

UE-EUTRA-Capability field descriptions	FDD/ TDD diff
e-RedirectionUTRA-TDD Indicates whether the UE supports enhanced redirection to UTRA TDD to multiple carrier frequencies both with and without using related SIB provided by <i>RRCConnectionRelease</i> or not.	Yes
extendedMaxMeasId Indicates whether the UE supports extended number of measurement identities as defined by <i>maxMeasId-r12</i> .	No
extended-RLC-LI-Field Indicates whether the UE supports 15 bit RLC length indicator.	-
extendedRSRQ-LowerRange Indicates whether the UE supports the extended RSRQ lower value range from -34dB to -19.5dB in measurement configuration and reporting as specified in TS 36.133 [16].	No
featureGroupIndicators, featureGroupIndRel9Add, featureGroupIndRel10 The definitions of the bits in the bit string are described in Annex B.1 (for <i>featureGroupIndicators</i> and <i>featureGroupIndRel9Add</i>) and in Annex C.1.(for <i>featureGroupIndRel10</i>)	Yes
fourLayerTM3-TM4 Indicates whether the UE supports 4-layer spatial multiplexing for TM3 and TM4.	-
fourLayerTM3-TM4-perCC Indicates whether the UE supports 4-layer spatial multiplexing for TM3 and TM4 for the component carrier.	-
freqBandPriorityAdjustment Indicates whether the UE supports the prioritization of frequency bands in <i>multiBandInfoList</i> over the band in <i>freqBandIndicator</i> as defined by <i>freqBandIndicatorPriority-r12</i> .	-
freqBandRetrieval Indicates whether the UE supports reception of <i>requestedFrequencyBands</i> .	-
halfDuplex If <i>halfDuplex</i> is set to true, only half duplex operation is supported for the band, otherwise full duplex operation is supported.	-
incMonEUTRA Indicates whether the UE supports increased number of E-UTRA carrier monitoring in RRC_IDLE and RRC_CONNECTED, as specified in TS 36.133 [16].	No
incMonUTRA Indicates whether the UE supports increased number of UTRA carrier monitoring in RRC_IDLE and RRC_CONNECTED, as specified in TS 36.133 [16].	No
inDeviceCoexInd Indicates whether the UE supports in-device coexistence indication as well as autonomous denial functionality.	Yes
inDeviceCoexInd-UL-CA Indicates whether the UE supports UL CA related in-device coexistence indication. This field can be included only if <i>inDeviceCoexInd</i> is included. The UE supports <i>inDeviceCoexInd-UL-CA</i> in the same duplexing modes as it supports <i>inDeviceCoexInd</i> .	-
interBandTDD-CA-WithDifferentConfig Indicates whether the UE supports inter-band TDD carrier aggregation with different UL/DL configuration combinations. The first bit indicates UE supports the configuration combination of SCell DL subframes are a subset of PCell and PSCell by SIB1 configuration and the configuration combination of SCell DL subframes are a superset of PCell and PSCell by SIB1 configuration; the second bit indicates UE supports the configuration combination of SCell DL subframes are neither superset nor subset of PCell and PSCell by SIB1 configuration. This field is included only if UE supports inter-band TDD carrier aggregation.	-
interFreqBandList One entry corresponding to each supported E-UTRA band listed in the same order as in <i>supportedBandListEUTRA</i> .	-
interFreqNeedForGaps Indicates need for measurement gaps when operating on the E-UTRA band given by the entry in <i>bandListEUTRA</i> or on the E-UTRA band combination given by the entry in <i>bandCombinationListEUTRA</i> and measuring on the E-UTRA band given by the entry in <i>interFreqBandList</i> .	-
interFreqProximityIndication Indicates whether the UE supports proximity indication for inter-frequency E-UTRAN CSG member cells.	-
interFreqRSTD-Measurement Indicates whether the UE supports inter-frequency RSTD measurements for OTDOA positioning [54].	Yes

UE-EUTRA-Capability field descriptions	FDD/ TDD diff
interFreqSI-AcquisitionForHO Indicates whether the UE supports, upon configuration of si-RequestForHO by the network, acquisition and reporting of relevant information using autonomous gaps by reading the SI from a neighbouring inter-frequency cell.	Yes
interRAT-BandList One entry corresponding to each supported band of another RAT listed in the same order as in the <i>interRAT-Parameters</i> .	-
interRAT-NeedForGaps Indicates need for DL measurement gaps when operating on the E-UTRA band given by the entry in <i>bandListEUTRA</i> or on the E-UTRA band combination given by the entry in <i>bandCombinationListEUTRA</i> and measuring on the inter-RAT band given by the entry in the <i>interRAT-BandList</i> .	-
interRAT-PS-HO-ToGERAN Indicates whether the UE supports inter-RAT PS handover to GERAN or not.	Yes
intraBandContiguousCC-InfoList Indicates, per serving carrier of which the corresponding bandwidth class includes multiple serving carriers (i.e. bandwidth class B, C, D and so on), the maximum number of supported layers for spatial multiplexing in DL and the maximum number of CSI processes supported. The number of entries is equal to the number of component carriers in the corresponding bandwidth class. The UE shall support the setting indicated in each entry of the list regardless of the order of entries in the list. The UE shall include the field only if it supports 4-layer spatial multiplexing in transmission mode 3/4 for a subset of component carriers in the corresponding bandwidth class, or if the maximum number of supported layers for at least one component carrier is higher than <i>supportedMIMO-CapabilityDL-r10</i> in the corresponding bandwidth class, or if the number of CSI processes for at least one component carrier is higher than <i>supportedCSI-Proc-r11</i> in the corresponding band. This field may also be included for bandwidth class A but in such a case without including any sub-fields in <i>IntraBandContiguousCC-Info-r12</i> (see NOTE 6).	-
intraFreqProximityIndication Indicates whether the UE supports proximity indication for intra-frequency E-UTRAN CSG member cells.	-
intraFreqSI-AcquisitionForHO Indicates whether the UE supports, upon configuration of si-RequestForHO by the network, acquisition and reporting of relevant information using autonomous gaps by reading the SI from a neighbouring intra-frequency cell.	Yes
loggedMBSFNMeasurements Indicates whether the UE supports logged measurements for MBSFN. A UE indicating support for logged measurements for MBSFN shall also indicate support for logged measurements in Idle mode.	-
loggedMeasurementsIdle Indicates whether the UE supports logged measurements in Idle mode.	-
logicalChannelSR-ProhibitTimer Indicates whether the UE supports the <i>logicalChannelSR-ProhibitTimer</i> as defined in TS 36.321 [6].	-
longDRX-Command Indicates whether the UE supports Long DRX Command MAC Control Element.	-
maxLayersMIMO-Indication Indicates whether the UE supports the network configuration of <i>maxLayersMIMO</i> . If the UE supports <i>fourLayerTM3-TM4</i> or <i>intraBandContiguousCC-InfoList</i> , UE supports the configuration of <i>maxLayersMIMO</i> for these two cases regardless of indicating <i>maxLayersMIMO-Indication</i> .	-
maxNumberROHC-ContextSessions Set to the maximum number of concurrently active ROHC contexts supported by the UE, excluding context sessions that leave all headers uncompressed. cs2 corresponds with 2 (context sessions), cs4 corresponds with 4 and so on. The network ignores this field if the UE supports none of the ROHC profiles in <i>supportedROHC-Profiles</i> .	-
mbms-AsyncDC Indicates whether the UE in RRC_CONNECTED supports MBMS reception on a frequency indicated in an <i>MBMSInterestIndication</i> message, where (according to <i>supportedBandCombination</i>) the carriers that are or can be configured as serving cells in the MCG and the SCG are not synchronized. If this field is included, the UE shall also include <i>mbms-SCell</i> and <i>mbms-NonServingCell</i> . The field indicates that the UE supports the feature for xDD if <i>mbms-SCell</i> and <i>mbms-NonServingCell</i> are supported for xDD.	-

UE-EUTRA-Capability field descriptions	FDD/ TDD diff
mbms-SCell Indicates whether the UE in RRC_CONNECTED supports MBMS reception on a frequency indicated in an <i>MBMSInterestIndication</i> message, when an SCell is configured on that frequency (regardless of whether the SCell is activated or deactivated).	Yes
mbms-NonServingCell Indicates whether the UE in RRC_CONNECTED supports MBMS reception on a frequency indicated in an <i>MBMSInterestIndication</i> message, where (according to <i>supportedBandCombination</i> and to network synchronization properties) a serving cell may be additionally configured. If this field is included, the UE shall also include the <i>mbms-SCell</i> field.	Yes
mfb-UTRA It indicates if the UE supports the signalling requirements of multiple radio frequency bands in a UTRA FDD cell, as defined in TS 25.307 [65].	-
MIMO-CapabilityDL The number of supported layers for spatial multiplexing in DL. The field may be absent for category 0 and category 1 UE in which case the number of supported layers is 1.	-
MIMO-CapabilityUL The number of supported layers for spatial multiplexing in UL. Absence of the field means that the number of supported layers is 1.	-
modifiedMPR-Behavior Field encoded as a bit map, where at least one bit N is set to "1" if UE supports modified MPR/A-MPR behaviour N, see TS 36.101 [42]. All remaining bits of the field are set to "0". The leading / leftmost bit (bit 0) corresponds to modified MPR/A-MPR behaviour 0, the next bit corresponds to modified MPR/A-MPR behaviour 1 and so on. Absence of this field means that UE does not support any modified MPR/A-MPR behaviour.	-
multiACK-CSlreporting Indicates whether the UE supports multi-cell HARQ ACK and periodic CSI reporting and SR on PUCCH format 3.	Yes
multiClusterPUSCH-WithinCC	Yes
multiNS-Pmax Indicates whether the UE supports the mechanisms defined for cells broadcasting <i>NS-PmaxList</i> .	-
multipleTimingAdvance Indicates whether the UE supports multiple timing advances for each band combination listed in <i>supportedBandCombination</i> . If the band combination comprised of more than one band entry (i.e., inter-band or intra-band non-contiguous band combination), the field indicates that the same or different timing advances on different band entries are supported. If the band combination comprised of one band entry (i.e., intra-band contiguous band combination), the field indicates that the same or different timing advances across component carriers of the band entry are supported.	-
naics-Capability-List Indicates that UE supports NAICS, i.e. receiving assistance information from serving cell and using it to cancel or suppress interference of neighbouring cell(s) for at least one band combination. If not present, UE does not support NAICS for any band combination. The field <i>numberOfNAICS-CapableCC</i> indicates the number of component carriers where the NAICS processing is supported and the field <i>numberOfAggregatedPRB</i> indicates the maximum aggregated bandwidth across these of component carriers (expressed as a number of PRBs) with the restriction that NAICS is only supported over the full carrier bandwidth. The UE shall indicate the combination of { <i>numberOfNAICS-CapableCC</i> , <i>numberOfNAICS-CapableCC</i> } for every supported <i>numberOfNAICS-CapableCC</i> , e.g. if a UE supports {x CC, y PRBs} and {x-n CC, y-m PRBs} where $n \geq 1$ and $m \geq 0$, the UE shall indicate both. <ul style="list-style-type: none"> - For <i>numberOfNAICS-CapableCC</i> = 1, UE signals one value for <i>numberOfAggregatedPRB</i> from the range {50, 75, 100}; - For <i>numberOfNAICS-CapableCC</i> = 2, UE signals one value for <i>numberOfAggregatedPRB</i> from the range {50, 75, 100, 125, 150, 175, 200}; - For <i>numberOfNAICS-CapableCC</i> = 3, UE signals one value for <i>numberOfAggregatedPRB</i> from the range {50, 75, 100, 125, 150, 175, 200, 225, 250, 275, 300}; - For <i>numberOfNAICS-CapableCC</i> = 4, UE signals one value for <i>numberOfAggregatedPRB</i> from the range {50, 100, 150, 200, 250, 300, 350, 400}; - For <i>numberOfNAICS-CapableCC</i> = 5, UE signals one value for <i>numberOfAggregatedPRB</i> from the range {50, 100, 150, 200, 250, 300, 350, 400, 450, 500}. 	No
NonContiguousUL-RA-WithinCC-List One entry corresponding to each supported E-UTRA band listed in the same order as in <i>supportedBandListEUTRA</i> .	No

UE-EUTRA-Capability field descriptions	FDD/ TDD diff
noResourceRestrictionForTTIBundling Indicates whether the UE supports TTI bundling operation without resource allocation restriction.	No
otdoa-UE-Assisted Indicates whether the UE supports UE-assisted OTDOA positioning [54].	Yes
pdcp-SN-Extension Indicates whether the UE supports 15 bit length of PDCP sequence number.	-
phy-TDD-ReConfig-FDD-PCell Indicates whether the UE supports TDD UL/DL reconfiguration for TDD serving cell(s) via monitoring PDCCH with eIMTA-RNTI on a FDD PCell, and HARQ feedback according to UL and DL HARQ reference configurations. This bit can only be set to supported only if the UE supports FDD PCell and <i>phy-TDD-ReConfig-TDD-PCell</i> is set to supported.	No
phy-TDD-ReConfig-TDD-PCell Indicates whether the UE supports TDD UL/DL reconfiguration for TDD serving cell(s) via monitoring PDCCH with eIMTA-RNTI on a TDD PCell, and HARQ feedback according to UL and DL HARQ reference configurations, and PUCCH format 3.	Yes
pmi-Disabling	Yes
powerPrefInd Indicates whether the UE supports power preference indication.	No
pusch-FeedbackMode Indicates whether the UE supports PUSCH feedback mode 3-2.	No
pusch-SRS-PowerControl-SubframeSet Indicates whether the UE supports subframe set dependent UL power control for PUSCH and SRS. This field is only applicable for UEs supporting TDD.	Yes
rach-Report Indicates whether the UE supports delivery of rachReport.	-
requestedBands Indicates the frequency bands requested by E-UTRAN.	-
rsrqMeasWideband Indicates whether the UE can perform RSRQ measurements with wider bandwidth.	Yes
rsrq-OnAllSymbols Indicates whether the UE can perform RSRQ measurement on all OFDM symbols and also support the extended RSRQ upper value range from -3dB to 2.5dB in measurement configuration and reporting as specified in TS 36.133 [16].	No
simultaneousPUCCH-PUSCH	Yes
simultaneousRx-Tx Indicates whether the UE supports simultaneous reception and transmission on different bands for each band combination listed in <i>supportedBandCombination</i> . This field is only applicable for inter-band TDD band combinations. A UE indicating support of <i>simultaneousRx-Tx</i> and <i>dc-Support-r12</i> shall support different UL/DL configurations between PCell and PSCell.	-
srvcc-FromUTRA-FDD-ToGERAN Indicates whether UE supports SRVCC handover from UTRA FDD PS HS to GERAN CS.	-
srvcc-FromUTRA-FDD-ToUTRA-FDD Indicates whether UE supports SRVCC handover from UTRA FDD PS HS to UTRA FDD CS.	-
srvcc-FromUTRA-TDD128-ToGERAN Indicates whether UE supports SRVCC handover from UTRA TDD 1.28Mcps PS HS to GERAN CS.	-
srvcc-FromUTRA-TDD128-ToUTRA-TDD128 Indicates whether UE supports SRVCC handover from UTRA TDD 1.28Mcps PS HS to UTRA TDD 1.28Mcps CS.	-
ss-CCH-InterfHandl Indicates whether the UE supports synchronisation signal and common channel interference handling.	Yes
standaloneGNSS-Location Indicates whether the UE is equipped with a standalone GNSS receiver that may be used to provide detailed location information in RRC measurement report and logged measurements.	-
supportedBandCombination Includes the supported CA band combinations, if any, and may include all the supported non-CA bands.	-
supportedBandCombinationAdd-r11 Includes additional supported CA band combinations in case maximum number of CA band combinations of <i>supportedBandCombination</i> is exceeded.	-
SupportedBandCombinationAdd-v11d0, SupportedBandCombinationAdd-v1250, SupportedBandCombinationAdd-v1270 If included, the UE shall include the same number of entries, and listed in the same order, as in <i>SupportedBandCombinationAdd-r11</i> .	-

UE-EUTRA-Capability field descriptions	FDD/ TDD diff
<p>SupportedBandCombinationExt, SupportedBandCombination-v1090, SupportedBandCombination-v10i0, SupportedBandCombination-v1130, SupportedBandCombination-v1250, SupportedBandCombination-v1270 If included, the UE shall include the same number of entries, and listed in the same order, as in <i>supportedBandCombination-r10</i>.</p>	-
<p>SupportedBandGERAN GERAN band as defined in TS 45.005 [20].</p>	No
<p>SupportedBandList1XRTT One entry corresponding to each supported CDMA2000 1xRTT band class.</p>	-
<p>SupportedBandListEUTRA Includes the supported E-UTRA bands. This field shall include all bands which are indicated in <i>BandCombinationParameters</i>.</p>	-
<p>SupportedBandListEUTRA-v9e0, SupportedBandListEUTRA-v1250 If included, the UE shall include the same number of entries, and listed in the same order, as in <i>supportedBandListEUTRA</i> (i.e. without suffix).</p>	-
<p>SupportedBandListGERAN</p>	No
<p>SupportedBandListHRPD One entry corresponding to each supported CDMA2000 HRPD band class.</p>	-
<p>SupportedBandUTRA-FDD UTRA band as defined in TS 25.101 [17].</p>	-
<p>SupportedBandUTRA-TDD128 UTRA band as defined in TS 25.102 [18].</p>	-
<p>SupportedBandUTRA-TDD384 UTRA band as defined in TS 25.102 [18].</p>	-
<p>SupportedBandUTRA-TDD768 UTRA band as defined in TS 25.102 [18].</p>	-
<p>supportedBandwidthCombinationSet The <i>supportedBandwidthCombinationSet</i> indicated for a band combination is applicable to all bandwidth classes indicated by the UE in this band combination. Field encoded as a bit map, where bit N is set to "1" if UE support Bandwidth Combination Set N for this band combination, see 36.101 [42]. The leading / leftmost bit (bit 0) corresponds to the Bandwidth Combination Set 0, the next bit corresponds to the Bandwidth Combination Set 1 and so on. The UE shall neither include the field for a non-CA band combination, nor for a CA band combination for which the UE only supports Bandwidth Combination Set 0.</p>	-
<p>supportedCellGrouping This field indicates for which mapping of serving cells to cell groups (i.e. MCG or SCG) the UE supports asynchronous DC. This field is only present for a band combination with more than two band entries where the UE supports asynchronous DC. If this field is not present but asynchronous operation is supported, the UE supports all possible mappings of serving cells to cell groups for the band combination. The bitmap size is selected based on the number of entries in the combinations, i.e., in case of three entries, the bitmap corresponding to <i>threeEntries</i> is selected and so on. A bit in the bit string set to 1 indicates that the UE supports asynchronous DC for the cell grouping option represented by the concerned bit position. Each bit position represents a different cell grouping option, as illustrated by a table, see NOTE 5. A cell grouping option is represented by a number of bits, each representing a particular band entry in the band combination with the left-most bit referring to the band listed first in the band combination, etc. Value 0 indicates that the carriers of the corresponding band entry are mapped to a first cell group, while value 1 indicates that the carriers of the corresponding band entry are mapped to a second cell group. It is noted that the mapping table does not include entries with all bits set to the same value (0 or 1) as this does not represent a DC scenario (i.e. indicating that the UE supports that all carriers of the corresponding band entry are in one cell group).</p>	-
<p>supportedCSI-Proc Indicates the maximum number of CSI processes supported on a component carrier within a band. Value n1 corresponds to 1 CSI process, value n3 corresponds to 3 CSI processes, and value n4 corresponds to 4 CSI processes. If this field is included, the UE shall include the same number of entries listed in the same order as in <i>BandParameters</i>. If the UE supports at least 1 CSI process on any component carrier, then the UE shall include this field in all bands in all band combinations.</p>	-

UE-EUTRA-Capability field descriptions	FDD/ TDD diff
<p>supportedNAICS-2CRS-AP If included, the UE supports NAICS for the band combination. The UE shall include a bitmap of the same length, and in the same order, as in <i>naics-Capability-List</i>, to indicate 2 CRS AP NAICS capability of the band combination. The first/ leftmost bit points to the first entry of <i>naics-Capability-List</i>, the second bit points to the second entry of <i>naics-Capability-List</i>, and so on. For band combinations with a single component carrier, UE is only allowed to indicate $\{numberOfNAICS-CapableCC, numberOfAggregatedPRB\} = \{1, 100\}$ if NAICS is supported.</p>	-
<p>supportRohcContextContinue Indicates whether the UE supports ROHC context continuation operation where the UE does not reset the current ROHC context upon handover.</p>	-
<p>tdd-SpecialSubframe Indicates whether the UE supports TDD special subframe defined in TS 36.211 [21].</p>	Yes
<p>tdd-FDD-CA-PCellDuplex The presence of this field indicates that the UE supports TDD/FDD CA in any supported band combination including at least one FDD band with <i>bandParametersUL</i> and at least one TDD band with <i>bandParametersUL</i>. The first bit is set to "1" if UE supports the TDD PCell. The second bit is set to "1" if UE supports FDD PCell. This field is included only if the UE supports band combination including at least one FDD band with <i>bandParametersUL</i> and at least one TDD band with <i>bandParametersUL</i>. If this field is included, the UE shall set at least one of the bits as "1". If this field is included with DC, then it is applicable within a CG, and the presence of this field indicates the capability of the UE to support TDD/FDD CA with at least one FDD band and at least one TDD band in the same CG, with the value indicating the support for TDD/FDD PCell (PSCell).</p>	No
<p>timerT312 Indicates whether the UE supports T312.</p>	No
<p>tm5-FDD Indicates whether the UE supports the PDSCH transmission mode 5 in FDD.</p>	-
<p>tm5-TDD Indicates whether the UE supports the PDSCH transmission mode 5 in TDD.</p>	-
<p>tm9-With-8Tx-FDD</p>	Yes
<p>twoAntennaPortsForPUCCH</p>	No
<p>txDiv-PUCCH1b-ChSelect Indicates whether the UE supports transmit diversity for PUCCH format 1b with channel selection.</p>	Yes
<p>ue-Category UE category as defined in TS 36.306 [5]. Set to values 1 to 12 in this version of the specification.</p>	-
<p>ue-CategoryDL UE DL category as defined in TS 36.306 [5]. For ASN.1 compatibility, a UE indicating DL category 0 shall also indicate any of the categories (1..5) in <i>ue-Category</i> (without suffix), which is ignored by the eNB. The field <i>ue-CategoryDL</i> is set to values 0, 4, 6, 7, 9 to 16 in this version of the specification.</p>	-
<p>ue-CategoryUL UE UL category as defined in TS 36.306 [5]. The field <i>ue-CategoryUL-r12</i> is set to values 0, 3, 5, 7, 8 and 13 in this version of the specification.</p>	-
<p>ue-Rx-TxTimeDiffMeasurements Indicates whether the UE supports Rx - Tx time difference measurements.</p>	No
<p>ue-SpecificRefSigsSupported</p>	No
<p>ue-TxAntennaSelectionSupported TRUE indicates that the UE is capable of supporting UE transmit antenna selection as described in TS 36.213 [23, 8.7].</p>	Yes
<p>ul-CoMP Indicates whether the UE supports UL Coordinated Multi-Point operation.</p>	No
<p>utran-ProximityIndication Indicates whether the UE supports proximity indication for UTRAN CSG member cells.</p>	-
<p>ul-64QAM Indicates whether the UE supports 64QAM in UL on the band. This field is only present when the field <i>ue-CategoryUL</i> is set to 5, 8 or 13. If the field is present for one band, the field shall be present for all bands including downlink only bands.</p>	-
<p>utran-SI-AcquisitionForHO Indicates whether the UE supports, upon configuration of <i>si-RequestForHO</i> by the network, acquisition and reporting of relevant information using autonomous gaps by reading the SI from a neighbouring UMTS cell.</p>	Yes

UE-EUTRA-Capability field descriptions	FDD/ TDD diff
voiceOverPS-HS-UTRA-FDD Indicates whether UE supports IMS voice according to GSMA IR.58 profile in UTRA FDD.	-
voiceOverPS-HS-UTRA-TDD128 Indicates whether UE supports IMS voice in UTRA TDD 1.28Mcps.	-
wlan-IW-RAN-Rules Indicates whether the UE supports RAN-assisted WLAN interworking based on access network selection and traffic steering rules.	-
wlan-IW-ANDSF-Policies Indicates whether the UE supports RAN-assisted WLAN interworking based on ANDSF policies.	-

NOTE 1: The IE *UE-EUTRA-Capability* does not include AS security capability information, since these are the same as the security capabilities that are signalled by NAS. Consequently AS need not provide "man-in-the-middle" protection for the security capabilities.

NOTE 2: The column FDD/ TDD diff indicates if the UE is allowed to signal, as part of the additional capabilities for an XDD mode i.e. within *UE-EUTRA-CapabilityAddXDD-Mode-xNM*, a different value compared to the value signalled elsewhere within *UE-EUTRA-Capability* (i.e. the common value, supported for both XDD modes). A '-' is used to indicate that it is not possible to signal different values (used for fields for which the field description is provided for other reasons). Annex E specifies for which TDD and FDD serving cells a UE supporting TDD/FDD CA shall support a capability for which it indicates support within the capability signalling.

NOTE 3: The *BandCombinationParameters* for the same band combination can be included more than once.

NOTE 4: UE CA and measurement capabilities indicate the combinations of frequencies that can be configured as serving frequencies.

NOTE 5: The grouping of the cells to the first and second cell group, as indicated by *supportedCellGrouping*, is shown in the table below. The leading / leftmost bit of *supportedCellGrouping* corresponds to the Bit String Position 1.

Nr of Band Entries:	5	4	3
Length of Bit-String:	15	7	3
Bit String Position	Cell grouping option (0= first cell group, 1= second cell group)		
1	00001	0001	001
2	00010	0010	010
3	00011	0011	011
4	00100	0100	
5	00101	0101	
6	00110	0110	
7	00111	0111	
8	01000		
9	01001		
10	01010		
11	01011		
12	01100		
13	01101		
14	01110		
15	01111		

NOTE 6: UE includes the *intraBandContiguousCC-InfoList-r12* also for bandwidth class A because of the presence conditions in *BandCombinationParameters-v1270*. For example, if UE supports CA_1A_41D band combination, if UE includes the field *intraBandContiguousCC-InfoList-r12* for band 41, the UE includes *intraBandContiguousCC-InfoList-r12* also for band 1.

– *UE-RadioPagingInfo*

The *UE-RadioPagingInfo* IE contains information needed for paging of category 0 UE.

UE-RadioPagingInfo information element

```
-- ASN1START
UE-RadioPagingInfo-r12 ::=
    SEQUENCE {
        ue-Category-v1250
            INTEGER (0)          OPTIONAL,
        ...
    }
-- ASN1STOP
```

– *UE-TimersAndConstants*

The IE *UE-TimersAndConstants* contains timers and constants used by the UE in either RRC_CONNECTED or RRC_IDLE.

UE-TimersAndConstants information element

```
-- ASN1START
UE-TimersAndConstants ::=
    SEQUENCE {
        t300
            ENUMERATED {
                ms100, ms200, ms300, ms400, ms600, ms1000, ms1500,
                ms2000},
        t301
            ENUMERATED {
                ms100, ms200, ms300, ms400, ms600, ms1000, ms1500,
                ms2000},
        t310
            ENUMERATED {
                ms0, ms50, ms100, ms200, ms500, ms1000, ms2000},
        n310
            ENUMERATED {
                n1, n2, n3, n4, n6, n8, n10, n20},
        t311
            ENUMERATED {
                ms1000, ms3000, ms5000, ms10000, ms15000,
                ms20000, ms30000},
        n311
            ENUMERATED {
                n1, n2, n3, n4, n5, n6, n8, n10},
        ...
    }
-- ASN1STOP
```

UE-TimersAndConstants field descriptions

n3xy

Constants are described in section 7.4. n1 corresponds with 1, n2 corresponds with 2 and so on.

t3xy

Timers are described in section 7.3. Value ms0 corresponds with 0 ms, ms50 corresponds with 50 ms and so on.

– *VisitedCellInfoList*

The IE *VisitedCellInfoList* includes the mobility history information of maximum of 16 most recently visited cells or time spent outside E-UTRA. The most recently visited cell is stored first in the list. The list includes cells visited in RRC_IDLE and RRC_CONNECTED states.

VisitedCellInfoList information element

```
-- ASN1START
```

```

VisitedCellInfoList-r12 ::= SEQUENCE (SIZE (1..maxCellHistory-r12)) OF VisitedCellInfo-r12
VisitedCellInfo-r12 ::=
    SEQUENCE {
        visitedCellId-r12          CHOICE {
            cellGlobalId-r12      CellGlobalIdEUTRA,
            pci-arfcn-r12          SEQUENCE {
                physCellId-r12    PhysCellId,
                carrierFreq-r12    ARFCN-ValueEUTRA-r9
            }
        }
        timeSpent-r12              INTEGER (0..4095),
        ...
    }
-- ASN1STOP

```

VisitedCellInfoList field descriptions

timeSpent

This field indicates the duration of stay in the cell or outside E-UTRA approximated to the closest second. If the duration of stay exceeds 4095s, the UE shall set it to 4095s.

– WLAN-OffloadConfig

The IE *WLAN-OffloadConfig* includes information for traffic steering between E-UTRAN and WLAN. The fields are applicable to both RAN-assisted WLAN interworking based on access network selection and traffic steering rules and RAN-assisted WLAN interworking based on ANDSF policies unless stated otherwise in the field description.

WLAN-OffloadConfig information element

```

-- ASN1START
WLAN-OffloadConfig-r12 ::=
    SEQUENCE {
        thresholdRSRP-r12          SEQUENCE {
            thresholdRSRP-Low-r12  RSRP-Range,
            thresholdRSRP-High-r12 RSRP-Range
        }
        thresholdRSRQ-r12          SEQUENCE {
            thresholdRSRQ-Low-r12  RSRQ-Range,
            thresholdRSRQ-High-r12 RSRQ-Range
        }
        thresholdRSRQ-OnAllSymbolsWithWB-r12 SEQUENCE {
            thresholdRSRQ-OnAllSymbolsWithWB-Low-r12 RSRQ-Range,
            thresholdRSRQ-OnAllSymbolsWithWB-High-r12 RSRQ-Range
        }
        thresholdRSRQ-OnAllSymbols-r12 SEQUENCE {
            thresholdRSRQ-OnAllSymbolsLow-r12 RSRQ-Range,
            thresholdRSRQ-OnAllSymbolsHigh-r12 RSRQ-Range
        }
        thresholdRSRQ-WB-r12 SEQUENCE {
            thresholdRSRQ-WB-Low-r12 RSRQ-Range,
            thresholdRSRQ-WB-High-r12 RSRQ-Range
        }
        thresholdChannelUtilization-r12 SEQUENCE {
            thresholdChannelUtilizationLow-r12 INTEGER (0..255),
            thresholdChannelUtilizationHigh-r12 INTEGER (0..255)
        }
        thresholdBackhaul-Bandwidth-r12 SEQUENCE {
            thresholdBackhaulDL-BandwidthLow-r12 WLAN-backhaulRate-r12,
            thresholdBackhaulDL-BandwidthHigh-r12 WLAN-backhaulRate-r12,
            thresholdBackhaulUL-BandwidthLow-r12 WLAN-backhaulRate-r12,
            thresholdBackhaulUL-BandwidthHigh-r12 WLAN-backhaulRate-r12
        }
        thresholdBeaconRSSI-r12 SEQUENCE {
            thresholdBeaconRSSI-Low-r12 INTEGER (0..255),
            thresholdBeaconRSSI-High-r12 INTEGER (0..255)
        }
        offloadPreferenceIndicator-r12 BIT STRING (SIZE (16))
        t-SteeringWLAN-r12 T-Reselection
        ...
    }
WLAN-backhaulRate-r12 ::=
    ENUMERATED
    {r0, r4, r8, r16, r32, r64, r128, r256, r512,

```

```

r131072,
r1024, r2048, r4096, r8192, r16384, r32768, r65536,
r262144, r524288, r1048576, r2097152, r4194304, r8388608,
r16777216, r33554432, r67108864, r134217728, r268435456,
r536870912, r1073741824, r2147483648, r4294967296}
-- ASN1STOP

```

WLAN-OffloadConfig field descriptions
<p>offloadPreferenceIndicator Indicates the offload preference indicator. Parameter: OPI in TS 24.312 [66]. Only applicable to RAN-assisted WLAN interworking based on ANDSF policies.</p>
<p>thresholdBackhaulDLBandwidth-High Indicates the backhaul available downlink bandwidth threshold used by the UE for traffic steering to WLAN. Parameter: ThreshBackhRateDLWLAN, High in TS 36.304 [4]. Value in kilobits/second. Value rN corresponds to N kbps.</p>
<p>thresholdBackhaulDLBandwidth-Low Indicates the backhaul available downlink bandwidth threshold used by the UE for traffic steering to E-UTRAN. Parameter: ThreshBackhRateDLWLAN, Low in TS 36.304 [4]. Value in kilobits/second. Value rN corresponds to N kbps.</p>
<p>thresholdBackhaulULBandwidth-High Indicates the backhaul available uplink bandwidth threshold used by the UE for traffic steering to WLAN. Parameter: ThreshBackhRateULWLAN, High in TS 36.304 [4]. Value in kilobits/second. Value rN corresponds to N kbps.</p>
<p>thresholdBackhaulULBandwidth-Low Indicates the backhaul available uplink bandwidth threshold used by the UE for traffic steering to E-UTRAN. Parameter: ThreshBackhRateULWLAN, Low in TS 36.304 [4]. Value in kilobits/second. Value rN corresponds to N kbps.</p>
<p>thresholdBeaconRSSI-High Indicates the Beacon RSSI threshold used by the UE for traffic steering to WLAN. Parameter: ThreshBeaconRSSIWLAN, High in TS 36.304 [4]. Value 0 corresponds to -128dBm, 1 corresponds to -127dBm and so on.</p>
<p>thresholdBeaconRSSI-Low Indicates the Beacon RSSI threshold used by the UE for traffic steering to E-UTRAN. Parameter: ThreshBeaconRSSIWLAN, Low in TS 36.304 [4]. Value 0 corresponds to -128dBm, 1 corresponds to -127dBm and so on.</p>
<p>thresholdChannelUtilization-High Indicates the WLAN channel utilization (BSS load) threshold used by the UE for traffic steering to E-UTRAN. Parameter: ThreshChUtilWLAN, High in TS 36.304 [4].</p>
<p>thresholdChannelUtilization-Low Indicates the WLAN channel utilization (BSS load) threshold used by the UE for traffic steering to WLAN. Parameter: ThreshChUtilWLAN, Low in TS 36.304 [4].</p>
<p>thresholdRSRP-High Indicates the RSRP threshold (in dBm) used by the UE for traffic steering to E-UTRAN. Parameter: ThreshServingOffloadWLAN, HighP in TS 36.304 [4].</p>
<p>thresholdRSRP-Low Indicates the RSRP threshold (in dBm) used by the UE for traffic steering to WLAN. Parameter: ThreshServingOffloadWLAN, LowP in TS 36.304 [4].</p>
<p>thresholdRSRQ-High, thresholdRSRQ-OnAllSymbolsHigh, thresholdRSRQ-WB-High, thresholdRSRQ-OnAllSymbolsWithWB-High Indicates the RSRQ threshold (in dB) used by the UE for traffic steering to E-UTRAN. Parameter: ThreshServingOffloadWLAN, HighQ in TS 36.304 [4]. The UE shall only apply one of threshold values of <i>thresholdRSRQ-OnAllSymbolsWithWB-High</i>, <i>thresholdRSRQ-OnAllSymbolsHigh</i>, <i>thresholdRSRQ-WB-High</i> and <i>thresholdRSRQ-High</i> as present in <i>wlan-OffloadConfigCommon</i> and forward this to upper layer. NOTE 1.</p>
<p>thresholdRSRQ-Low, thresholdRSRQ-OnAllSymbolsLow, thresholdRSRQ-WB-Low, thresholdRSRQ-OnAllSymbolsWithWB-Low Indicates the RSRQ threshold (in dB) used by the UE for traffic steering to WLAN. Parameter: ThreshServingOffloadWLAN, LowQ in TS 36.304 [4]. The UE shall only apply one of threshold values of <i>thresholdRSRQ-OnAllSymbolsWithWB-Low</i>, <i>thresholdRSRQ-OnAllSymbolsLow</i>, <i>thresholdRSRQ-WB-Low</i> and <i>thresholdRSRQ-Low</i> as present in <i>wlan-OffloadConfigCommon</i> and forward this to upper layer. NOTE 1.</p>
<p>t-SteeringWLAN Indicates the timer value during which the rules should be fulfilled before starting traffic steering between E-UTRAN and WLAN. Parameter: TsteeringWLAN in TS 36.304 [4]. Only applicable to RAN-assisted WLAN interworking based on access network selection and traffic steering rules.</p>

NOTE 1: Within SIB17, E-UTRAN includes the fields corresponding to same RSRQ types as included in SIB1. E.g. if E-UTRAN includes *q-QualMinRSRQ-OnAllSymbols* in SIB1 it also includes *thresholdRSRQ-OnAllSymbols* in SIB17. Within the *RRConnectionReconfiguration* message E-UTRAN only includes *thresholdRSRQ*, setting the value according to the RSRQ type used for E-UTRAN. The UE shall apply the RSRQ fields (RSRQ threshold, high and low) corresponding to one RSRQ type i.e. the same as it applies for E-UTRAN.

6.3.7 MBMS information elements

– *MBMS-NotificationConfig*

The IE *MBMS-NotificationConfig* specifies the MBMS notification related configuration parameters, that are applicable for all MBSFN areas.

MBMS-NotificationConfig information element

```
-- ASN1START
MBMS-NotificationConfig-r9 ::=          SEQUENCE {
  notificationRepetitionCoeff-r9        ENUMERATED {n2, n4},
  notificationOffset-r9                  INTEGER (0..10),
  notificationSF-Index-r9                INTEGER (1..6)
}
-- ASN1STOP
```

MBMS-NotificationConfig field descriptions

notificationOffset

Indicates, together with the *notificationRepetitionCoeff*, the radio frames in which the MCCH information change notification is scheduled i.e. the MCCH information change notification is scheduled in radio frames for which: $SFN \bmod \text{notificationRepetitionPeriod} = \text{notificationOffset}$.

notificationRepetitionCoeff

Actual change notification repetition period common for all MCCHs that are configured= shortest modification period/ *notificationRepetitionCoeff*. The 'shortest modification period' corresponds with the lowest value of *mcch-ModificationPeriod* of all MCCHs that are configured. Value n2 corresponds to coefficient 2, and so on.

notificationSF-Index

Indicates the subframe used to transmit MCCH change notifications on PDCCH.
 FDD: Value 1, 2, 3, 4, 5 and 6 correspond with subframe #1, #2, #3 #6, #7, and #8 respectively.
 TDD: Value 1, 2, 3, 4, and 5 correspond with subframe #3, #4, #7, #8, and #9 respectively.

– *MBSFN-AreaId*

The IE *MBSFN-AreaId* identifies an MBSFN area by means of a locally unique value at lower layers i.e. it concerns parameter N_{ID}^{MBSFN} in TS 36.211 [21, 6.10.2.1].

MBSFN-AreaId information element

```
-- ASN1START
MBSFN-AreaId-r12 ::=                      INTEGER (0..255)
-- ASN1STOP
```

– *MBSFN-AreaInfoList*

The IE *MBSFN-AreaInfoList* contains the information required to acquire the MBMS control information associated with one or more MBSFN areas.

MBSFN-AreaInfoList information element

```
-- ASN1START
MBSFN-AreaInfoList-r9 ::=                SEQUENCE (SIZE(1..maxMBSFN-Area)) OF MBSFN-AreaInfo-r9
MBSFN-AreaInfo-r9 ::=                    SEQUENCE {
  mbsfn-AreaId-r9                        MBSFN-AreaId-r12,
  non-MBSFNregionLength                  ENUMERATED {s1, s2},
  notificationIndicator-r9               INTEGER (0..7),
}
```

```

mcch-Config-r9          SEQUENCE {
  mcch-RepetitionPeriod-r9  ENUMERATED {rf32, rf64, rf128, rf256},
  mcch-Offset-r9           INTEGER (0..10),
  mcch-ModificationPeriod-r9  ENUMERATED {rf512, rf1024},
  sf-AllocInfo-r9         BIT STRING (SIZE(6)),
  signallingMCS-r9        ENUMERATED {n2, n7, n13, n19}
},
...
}
-- ASN1STOP

```

MBSFN-AreaInfoList field descriptions

mcch-ModificationPeriod

Defines periodically appearing boundaries, i.e. radio frames for which $\text{SFN mod } mcch\text{-ModificationPeriod} = 0$. The contents of different transmissions of MCCH information can only be different if there is at least one such boundary in-between them.

mcch-Offset

Indicates, together with the *mcch-RepetitionPeriod*, the radio frames in which MCCH is scheduled i.e. MCCH is scheduled in radio frames for which: $\text{SFN mod } mcch\text{-RepetitionPeriod} = mcch\text{-Offset}$.

mcch-RepetitionPeriod

Defines the interval between transmissions of MCCH information, in radio frames, Value rf32 corresponds to 32 radio frames, rf64 corresponds to 64 radio frames and so on.

non-MBSFNregionLength

Indicates how many symbols from the beginning of the subframe constitute the non-MBSFN region. This value applies in all subframes of the MBSFN area used for PMCH transmissions as indicated in the MSI. The values s1 and s2 correspond with 1 and 2 symbols, respectively: see TS 36.211 [21, Table 6.7-1].

notificationIndicator

Indicates which PDCCCH bit is used to notify the UE about change of the MCCH applicable for this MBSFN area. Value 0 corresponds with the least significant bit as defined in TS 36.212 [22, Section 5.3.3.1] and so on.

sf-AllocInfo

Indicates the subframes of the radio frames indicated by the *mcch-RepetitionPeriod* and the *mcch-Offset*, that may carry MCCH. Value "1" indicates that the corresponding subframe is allocated. The following mapping applies:
 FDD: The first/ leftmost bit defines the allocation for subframe #1 of the radio frame indicated by *mcch-RepetitionPeriod* and *mcch-Offset*, the second bit for #2, the third bit for #3, the fourth bit for #6, the fifth bit for #7 and the sixth bit for #8.
 TDD: The first/leftmost bit defines the allocation for subframe #3 of the radio frame indicated by *mcch-RepetitionPeriod* and *mcch-Offset*, the second bit for #4, third bit for #7, fourth bit for #8, fifth bit for #9. Uplink subframes are not allocated. The last bit is not used.

signallingMCS

Indicates the Modulation and Coding Scheme (MCS) applicable for the subframes indicated by the field *sf-AllocInfo* and for each (P)MCH that is configured for this MBSFN area, for the first subframe allocated to the (P)MCH within each MCH scheduling period (which may contain the MCH scheduling information provided by MAC). Value n2 corresponds with the value 2 for parameter I_{MCS} in TS 36.213 [23, Table 7.1.7.1-1], and so on.

MBSFN-SubframeConfig

The IE *MBSFN-SubframeConfig* defines subframes that are reserved for MBSFN in downlink.

MBSFN-SubframeConfig information element

```

-- ASN1START
MBSFN-SubframeConfig ::=
  radioframeAllocationPeriod  ENUMERATED {n1, n2, n4, n8, n16, n32},
  radioframeAllocationOffset  INTEGER (0..7),
  subframeAllocation          CHOICE {
    oneFrame                  BIT STRING (SIZE(6)),
    fourFrames                BIT STRING (SIZE(24))
  }
}
-- ASN1STOP

```

MBSFN-SubframeConfig field descriptions
<p>fourFrames A bit-map indicating MBSFN subframe allocation in four consecutive radio frames, "1" denotes that the corresponding subframe is allocated for MBSFN. The bitmap is interpreted as follows: FDD: Starting from the first radioframe and from the first/leftmost bit in the bitmap, the allocation applies to subframes #1, #2, #3, #6, #7, and #8 in the sequence of the four radio-frames. TDD: Starting from the first radioframe and from the first/leftmost bit in the bitmap, the allocation applies to subframes #3, #4, #7, #8, and #9 in the sequence of the four radio-frames. The last four bits are not used. E-UTRAN allocates uplink subframes only if <i>eimta-MainConfig</i> is configured.</p>
<p>oneFrame "1" denotes that the corresponding subframe is allocated for MBSFN. The following mapping applies: FDD: The first/leftmost bit defines the MBSFN allocation for subframe #1, the second bit for #2, third bit for #3, fourth bit for #6, fifth bit for #7, sixth bit for #8. TDD: The first/leftmost bit defines the allocation for subframe #3, the second bit for #4, third bit for #7, fourth bit for #8, fifth bit for #9. E-UTRAN allocates uplink subframes only if <i>eimta-MainConfig</i> is configured. The last bit is not used.</p>
<p>radioFrameAllocationPeriod, radioFrameAllocationOffset Radio-frames that contain MBSFN subframes occur when equation $SFN \bmod radioFrameAllocationPeriod = radioFrameAllocationOffset$ is satisfied. Value <i>n1</i> for <i>radioFrameAllocationPeriod</i> denotes value 1, <i>n2</i> denotes value 2, and so on. When <i>fourFrames</i> is used for <i>subframeAllocation</i>, the equation defines the first radio frame referred to in the description below. Values <i>n1</i> and <i>n2</i> are not applicable when <i>fourFrames</i> is used.</p>
<p>subframeAllocation Defines the subframes that are allocated for MBSFN within the radio frame allocation period defined by the <i>radioFrameAllocationPeriod</i> and the <i>radioFrameAllocationOffset</i>.</p>

– PMCH-InfoList

The IE *PMCH-InfoList* specifies configuration of all PMCHs of an MBSFN area, while IE *PMCH-InfoListExt* includes additional PMCHs, i.e. extends the PMCH list using the general principles specified in 5.1.2. The information provided for an individual PMCH includes the configuration parameters of the sessions that are carried by the concerned PMCH. For all PMCH that E-UTRAN includes in *PMCH-InfoList*, the list of ongoing sessions has at least one entry.

PMCH-InfoList information element

```
-- ASN1START
PMCH-InfoList-r9 ::= SEQUENCE (SIZE (0..maxPMCH-PerMBSFN)) OF PMCH-Info-r9
PMCH-InfoListExt-r12 ::= SEQUENCE (SIZE (0..maxPMCH-PerMBSFN)) OF PMCH-InfoExt-r12
PMCH-Info-r9 ::= SEQUENCE {
    pmch-Config-r9          PMCH-Config-r9,
    mbms-SessionInfoList-r9 MBMS-SessionInfoList-r9,
    ...
}
PMCH-InfoExt-r12 ::= SEQUENCE {
    pmch-Config-r12        PMCH-Config-r12,
    mbms-SessionInfoList-r12 MBMS-SessionInfoList-r9,
    ...
}
MBMS-SessionInfoList-r9 ::= SEQUENCE (SIZE (0..maxSessionPerPMCH)) OF MBMS-SessionInfo-r9
MBMS-SessionInfo-r9 ::= SEQUENCE {
    tmgi-r9                TMGI-r9,
    sessionId-r9           OCTET STRING (SIZE (1)) OPTIONAL, -- Need OR
    logicalChannelIdentity-r9 INTEGER (0..maxSessionPerPMCH-1),
    ...
}
PMCH-Config-r9 ::= SEQUENCE {
    sf-AllocEnd-r9        INTEGER (0..1535),
    dataMCS-r9           INTEGER (0..28),
    mch-SchedulingPeriod-r9 ENUMERATED {
        rf8, rf16, rf32, rf64, rf128, rf256, rf512, rf1024},
    ...
}
PMCH-Config-r12 ::= SEQUENCE {
    sf-AllocEnd-r12      INTEGER (0..1535),
    dataMCS-r12         CHOICE {
        normal-r12      INTEGER (0..28),
```



```

    higherOrder-r12                INTEGER (0..27)
  },
  mch-SchedulingPeriod-r12        ENUMERATED {
    rf4, rf8, rf16, rf32, rf64, rf128, rf256, rf512, rf1024},
  ...
}
TMGI-r9 ::=
  plmn-Id-r9                      CHOICE {
    plmn-Index-r9                  INTEGER (1..maxPLMN-r11),
    explicitValue-r9              PLMN-Identity
  },
  serviceId-r9                    OCTET STRING (SIZE (3))
}
-- ASN1STOP

```

PMCH-InfoList field descriptions

dataMCS

Indicates the value for parameter I_{MCS} in TS 36.213 [23], which defines the Modulation and Coding Scheme (MCS) applicable for the subframes of this (P)MCH as indicated by the field *commonSF-Alloc*. Value *normal* corresponds to Table 7.1.7.1-1 and value *higherOrder* corresponds to Table 7.1.7.1-1A. The MCS does however neither apply to the subframes that may carry MCCH i.e. the subframes indicated by the field *sf-AllocInfo* within *SystemInformationBlockType13* nor for the first subframe allocated to this (P)MCH within each MCH scheduling period (which may contain the MCH scheduling information provided by MAC).

mch-SchedulingPeriod

Indicates the MCH scheduling period i.e. the periodicity used for providing MCH scheduling information at lower layers (MAC) applicable for an MCH. Value *rf8* corresponds to 8 radio frames, *rf16* corresponds to 16 radio frames and so on. The *mch-SchedulingPeriod* starts in the radio frames for which: $SFN \bmod mch-SchedulingPeriod = 0$. E-UTRAN configures *mch-SchedulingPeriod* of the (P)MCH listed first in *PMCH-InfoList* to be smaller than or equal to *mcch-RepetitionPeriod*.

plmn-Index

Index of the entry in field *plmn-IdentityList* within *SystemInformationBlockType1*.

sessionId

Indicates the optional MBMS Session Identity, which together with TMGI identifies a transmission or a possible retransmission of a specific MBMS session: see TS 29.061 [51, Sections 20.5, 17.7.11, 17.7.15]. The field is included whenever upper layers have assigned a session identity i.e. one is available for the MBMS session in E-UTRAN.

serviceId

Uniquely identifies the identity of an MBMS service within a PLMN. The field contains octet 3- 5 of the IE Temporary Mobile Group Identity (TMGI) as defined in TS 24.008 [49]. The first octet contains the third octet of the TMGI, the second octet contains the fourth octet of the TMGI and so on.

sf-AllocEnd

Indicates the last subframe allocated to this (P)MCH within a period identified by field *commonSF-AllocPeriod*. The subframes allocated to (P)MCH corresponding with the n^{th} entry in *pmch-InfoList* are the subsequent subframes starting from either the next subframe after the subframe identified by *sf-AllocEnd* of the $(n-1)^{\text{th}}$ listed (P)MCH or, for $n=1$, the first subframe defined by field *commonSF-Alloc*, through the subframe identified by *sf-AllocEnd* of the n^{th} listed (P)MCH. Value 0 corresponds with the first subframe defined by field *commonSF-Alloc*.

6.3.8 Sidelink information elements

– SL-CommConfig

The IE *SL-CommConfig* specifies the dedicated configuration information for sidelink communication. In particular it concerns the transmission resource configuration for sidelink communication on the primary frequency.

SL-CommConfig information element

```

-- ASN1START
SL-CommConfig-r12 ::=
  commTxResources-r12             SEQUENCE {
    release                       CHOICE {
    setup                          CHOICE {
      scheduled-r12              SEQUENCE {
        sl-RNTI-r12              C-RNTI,
        mac-MainConfig-r12      MAC-MainConfigSL-r12,
        sc-CommTxConfig-r12     SL-CommResourcePool-r12,

```

```

mcs-r12 INTEGER (0..28) OPTIONAL -- Need
OP
},
ue-Selected-r12 SEQUENCE {
-- Pool for normal usage
commTxPoolNormalDedicated-r12 SEQUENCE {
poolToReleaseList-r12 SL-TxPoolToReleaseList-r12 OPTIONAL, -- Need
ON
poolToAddModList-r12 SL-CommTxPoolToAddModList-r12 OPTIONAL -- Need
ON
}
}
}
}
}
OPTIONAL, -- Need ON
...
}
}

SL-CommTxPoolToAddModList-r12 ::= SEQUENCE (SIZE (1..maxSL-TxPool-r12)) OF SL-
CommTxPoolToAddMod-r12

SL-CommTxPoolToAddMod-r12 ::= SEQUENCE {
poolIdentity-r12 SL-TxPoolIdentity-r12,
pool-r12 SL-CommResourcePool-r12
}

MAC-MainConfigSL-r12 ::= SEQUENCE {
periodic-BSR-TimerSL PeriodicBSR-Timer-r12 OPTIONAL, -- Need ON
retx-BSR-TimerSL RetxBSR-Timer-r12
}

-- ASN1STOP

```

SL-CommConfig field descriptions

commTxPoolNormalDedicated	Indicates a pool of transmission resources the UE is allowed to use while in RRC_CONNECTED.
mcs	Indicates the Modulation and Coding Scheme as defined in TS 36.212 [23, 14.2.1]. If not configured, the selection of Modulation and Coding Scheme is up to UE implementation.
sc-CommTxConfig	Indicates a pool of resources for SC when E-UTRAN schedules Tx resources (i.e. when indices included in DCI format 5 indicate the actual data resources to be used as specified in TS 36.212 [22, 5.3.3.1.9]).
scheduled	Indicates the configuration for the case E-UTRAN schedules the transmission resources based on sidelink specific BSR from the UE.
ue-Selected	Indicates the configuration for the case the UE selects the transmission resources from a pool of resources configured by E-UTRAN.

SL-CommResourcePool

The IE *SL-CommResourcePool* specifies the configuration information for an individual pool of resources for sidelink communication. The IE covers the configuration of both the sidelink control information and the data.

SL-CommResourcePool information element

```

-- ASN1START

SL-CommTxPoolList-r12 ::= SEQUENCE (SIZE (1..maxSL-TxPool-r12)) OF SL-CommResourcePool-r12
SL-CommRxPoolList-r12 ::= SEQUENCE (SIZE (1..maxSL-RxPool-r12)) OF SL-CommResourcePool-r12

SL-CommResourcePool-r12 ::= SEQUENCE {
sc-CP-Len-r12 SL-CP-Len-r12,
sc-Period-r12 SL-PeriodComm-r12,
sc-TF-ResourceConfig-r12 SL-TF-ResourceConfig-r12,
data-CP-Len-r12 SL-CP-Len-r12,
dataHoppingConfig-r12 SL-HoppingConfigComm-r12,
ue-SelectedResourceConfig-r12 SEQUENCE {
data-TF-ResourceConfig-r12 SL-TF-ResourceConfig-r12,
trpt-Subset-r12 SL-TRPT-Subset-r12 OPTIONAL -- Need OP
}
}
rxParametersNCell-r12 SEQUENCE {

```

```

    tdd-Config-r12                TDD-Config                OPTIONAL,  -- Need OP
    syncConfigIndex-r12           INTEGER (0..15)                OPTIONAL,  -- Need OR
  }
  txParameters-r12               SEQUENCE {
    sc-TxParameters-r12          SL-TxParameters-r12,
    dataTxParameters-r12        SL-TxParameters-r12
  }
  ...
}
SL-TRPT-Subset-r12 ::=          BIT STRING (SIZE (3..5))
-- ASN1STOP

```

SL-CommResourcePool field descriptions

sc-Period

Indicates the period over which resources are allocated in a cell for SC and over which scheduled and UE selected data transmissions occur, see PSCCH period in TS 36.213 [23]. Value in number of subframes. Value sf40 corresponds to 40 subframes, sf80 corresponds to 80 subframes and so on. E-UTRAN configures values sf40, sf80, sf160 and sf320 for FDD and for TDD config 1 to 5, values sf70, sf140 and sf280 for TDD config 0, and finally values sf60, sf120 and sf240 for TDD config 6.

syncConfigIndex

Indicates the synchronisation configuration that is associated with a reception pool, by means of an index to the corresponding entry of *commSyncConfig* in *SystemInformationBlockType18*.

tdd-Config

TDD configuration associated with the reception pool of the cell indicated by *syncConfigIndex*. Absence of the field indicates the same duplex mode as the cell providing this field and the same UL/DL configuration as indicated by *subframeAssignment* in *SystemInformationBlockType1* in case of TDD.

trpt-Subset

Indicates the subset of T-RPT available (see TS 36.213 [23, 14.1.1.1.1]). Consists of a bitmap which is used to indicate the set of available 'k' values to be used for sidelink communication (see TS 36.213 [23, 14.1.1.3]). If T-RPT subset configuration is not signaled/ preconfigured then UE assumes the whole T-RPT set is available.

Conditional presence	Explanation
Tx	The field is mandatory present when included in <i>commTxPoolNormalDedicated</i> , <i>commTxPoolNormalCommon</i> or <i>commTxPoolExceptional</i> . Otherwise the field is not present.

– SL-CP-Len

The IE *SL-CP-Len* indicates the cyclic prefix length, see TS 36.211 [21].

SL-CP-Len information element

```

-- ASN1START
SL-CP-Len-r12 ::=          ENUMERATED {normal, extended}
-- ASN1STOP

```

– SL-DiscConfig

The IE *SL-DiscConfig* specifies the dedicated configuration information for sidelink discovery.

SL-DiscConfig information element

```

-- ASN1START
SL-DiscConfig-r12 ::=
  discTxResources-r12
  release
  setup
    scheduled-r12
      discTxConfig-r12
      discTF-IndexList-r12
      discHoppingConfig-r12
  SEQUENCE {
    CHOICE {
      NULL,
      CHOICE {
        SEQUENCE {
          SL-DiscResourcePool-r12 OPTIONAL, -- Need ON
          SL-TF-IndexPairList-r12  OPTIONAL, -- Need ON
          SL-HoppingConfigDisc-r12
        }
      }
    }
  }
  OPTIONAL -- Need ON

```

```

    },
    ue-Selected-r12
        discTxPoolDedicated-r12
            poolToReleaseList-r12
                SEQUENCE {
                    SEQUENCE {
                        SL-TxPoolToReleaseList-r12 OPTIONAL, -- Need
ON
                        poolToAddModList-r12
                            SL-DiscTxPoolToAddModList-r12 OPTIONAL -- Need
ON
                    }
                }
            }
        }
    },
    ...
    [[ discTF-IndexList-v1260
        release
            CHOICE {
                NULL,
                setup
                    SEQUENCE {
                        discTF-IndexList-r12b
                            SL-TF-IndexPairList-r12b
                    }
            }
        ] ]
    }
}

SL-DiscTxPoolToAddModList-r12 ::= SEQUENCE (SIZE (1..maxSL-TxPool-r12)) OF SL-
DiscTxPoolToAddMod-r12

SL-DiscTxPoolToAddMod-r12 ::= SEQUENCE {
    poolIdentity-r12 SL-TxPoolIdentity-r12,
    pool-r12 SL-DiscResourcePool-r12
}

SL-TF-IndexPairList-r12 ::= SEQUENCE (SIZE (1..maxSL-TF-IndexPair-r12)) OF SL-TF-IndexPair-r12

SL-TF-IndexPair-r12 ::= SEQUENCE {
    discSF-Index-r12 INTEGER (1.. 200) OPTIONAL, -- Need ON
    discPRB-Index-r12 INTEGER (1.. 50) OPTIONAL -- Need ON
}

SL-TF-IndexPairList-r12b ::= SEQUENCE (SIZE (1..maxSL-TF-IndexPair-r12)) OF SL-TF-IndexPair-
r12b

SL-TF-IndexPair-r12b ::= SEQUENCE {
    discSF-Index-r12b INTEGER (0..209) OPTIONAL, -- Need ON
    discPRB-Index-r12b INTEGER (0..49) OPTIONAL -- Need ON
}
-- ASN1STOP

```

SL-DiscConfig field descriptions

discTF-IndexList

Indicates a list of time-frequency resource indices pair where each pair of indices corresponds to one discovery message. E-UTRAN only configures *discTF-IndexList-r12b* when configuring the UE with scheduled SL discovery Tx resources. When receiving *discTF-IndexList-r12b*, the UE shall only consider this field (and hence ignore *discTF-IndexList-r12*, if included or previously configured).

discTxConfig

Indicates the resources configuration used when E-UTRAN schedules Tx resources (i.e. the fields *discSF-Index* and *discPRB-Index* indicate the actual resources to be used).

discTxResources

Indicates the resources assigned to the UE for discovery announcements, which can either be a pool from which the UE may select or a set of resources specifically assigned for use by the UE.

SL-TF-IndexPair

A pair of indices, one for the time domain and one for the frequency domain, indicating the start of resources within the pool covered by *discTxConfig*, see TS 36.211 [21, 9.5.6] for one discovery message. The upper limits of *discSF-Index* and *discPRB-Index* are defined in TS 36.213 [23, 14.3.1].

– SL-DiscResourcePool

The IE *SL-DiscResourcePool* specifies the configuration information for an individual pool of resources for sidelink discovery.

SL-DiscResourcePool information element

```
-- ASN1START
```

```

SL-DiscTxPoolList-r12 ::= SEQUENCE (SIZE (1..maxSL-TxPool-r12)) OF SL-DiscResourcePool-r12
SL-DiscRxPoolList-r12 ::= SEQUENCE (SIZE (1..maxSL-RxPool-r12)) OF SL-DiscResourcePool-r12
SL-DiscResourcePool-r12 ::= SEQUENCE {
  cp-Len-r12 SL-CP-Len-r12,
  discPeriod-r12 ENUMERATED {rf32, rf64, rf128,
    rf256, rf512, rf1024, spare2, spare},
  numRetx-r12 INTEGER (0..3),
  numRepetition-r12 INTEGER (1..50),
  tf-ResourceConfig-r12 SL-TF-ResourceConfig-r12,
  txParameters-r12 SEQUENCE {
    txParametersGeneral-r12 SL-TxParameters-r12,
    ue-SelectedResourceConfig-r12 SEQUENCE {
      poolSelection-r12 CHOICE {
        rsrpBased-r12 SL-PoolSelectionConfig-r12,
        random-r12 NULL
      },
      txProbability-r12 ENUMERATED {p25, p50, p75, p100}
    }
  }
  }
  rxParameters-r12 SEQUENCE {
    tdd-Config-r12 TDD-Config OPTIONAL, -- Need OR
    syncConfigIndex-r12 INTEGER (0..15) OPTIONAL, -- Cond Tx
    ... OPTIONAL, -- Need OR
  }
}

SL-PoolSelectionConfig-r12 ::= SEQUENCE {
  threshLow-r12 RSRP-RangeSL2-r12,
  threshHigh-r12 RSRP-RangeSL2-r12
}

-- ASN1STOP

```

SL-DiscResourcePool field descriptions

discPeriod

Indicates the period over which resources are allocated in a cell for discovery message transmission/reception, see PSDCH period in TS 36.213 [23]. Value in number of radio frames. Value rf32 corresponds to 32 radio frames, rf64 corresponds to 64 radio frames and so on.

numRepetition

Indicates the number of times *subframeBitmap* is repeated for mapping to subframes that occurs within a *discPeriod*. The highest value E-UTRAN uses is value 5 for FDD and TDD configuration 0, value 13 for TDD configuration 1, value 25 for TDD configuration 2, value 17 for TDD configuration 3, value 25 for TDD configuration 4, value 50 for TDD configuration 5 and value 7 for TDD configuration 6. E-UTRAN configures *numRepetition* and *subframeBitmap* such that the mapped subframes do not exceed the *discPeriod*.

poolSelection

Indicates the mechanism for selecting a (transmission) pool when multiple candidates are provided. E-UTRAN configures the same value (i.e. a pool selection method) for all candidate pools within one pool list (*discTxPoolCommon* or *discTxPoolDedicated*) but the pool selection method in different pool lists may or may not be the same.

syncConfigIndex

Indicates the synchronisation configuration that is associated with a reception pool, by means of an index to the corresponding entry of *discSyncConfig* in *SystemInformationBlockType19*.

threshLow, threshHigh

Specifies the thresholds used to select a resource pool in RSRP based pool selection. The E-UTRAN should configure *threshLow* and *threshHigh* such that the UE selects only one resource pool upon RSRP based pool selection.

txProbability

Indicates the probability of transmitting announcement in a discovery period when configured with a pool of resources, see TS 36.321 [6].

Conditional presence	Explanation
Tx	The field is mandatory present when included in <i>discTxPoolDedicated</i> or <i>discTxPoolCommon</i> . Otherwise the field is not present.

– **SL-DiscTxPowerInfo**

The IE *SL-DiscTxPowerInfo* specifies power control parameters for one or more power classes.

SL-DiscTxPowerInfo information element

```
-- ASN1START
SL-DiscTxPowerInfoList-r12 ::= SEQUENCE (SIZE (maxSL-DiscPowerClass-r12)) OF SL-DiscTxPowerInfo-r12
SL-DiscTxPowerInfo-r12 ::= SEQUENCE {
    discMaxTxPower-r12 P-Max,
    ...
}
-- ASN1STOP
```

SL-DiscTxPowerInfo field descriptions

discMaxTxPower

Indicates the P-Max parameter used to calculate the maximum transmit power a UE configured with the concerned range class, see TS 24.333 [70, 4.2.11]. The first entry in *SL-DiscTxPowerInfoList* corresponds to UE range class 'short', the second entry corresponds to 'medium' and the third entry corresponds to 'long'.

– **SL-HoppingConfig**

The IE *SL-HoppingConfig* indicates the hopping configuration used for sidelink.

SL-HoppingConfig information element

```
-- ASN1START
SL-HoppingConfigComm-r12 ::= SEQUENCE {
    hoppingParameter-r12 INTEGER (0..504),
    numSubbands-r12 ENUMERATED {ns1, ns2, ns4},
    rb-Offset-r12 INTEGER (0..110)
}
SL-HoppingConfigDisc-r12 ::= SEQUENCE {
    a-r12 INTEGER (1..200),
    b-r12 INTEGER (1..10),
    c-r12 ENUMERATED {n1, n5}
}
-- ASN1STOP
```

SL-HoppingConfig field descriptions

a

Per cell parameter: $N_{PSDCH}^{(1)}$ see TS 36.213 [23, 14.3.1].

b

Per UE parameter: $N_{PSDCH}^{(2)}$ see TS 36.213 [23, 14.3.1].

c

Per cell parameter: $N_{PSDCH}^{(3)}$ see TS36.213 [23, 14.3.1]

hoppingParameter

Affects the hopping performed as specified in TS 36.213 [23, 14.1.1.2 and 14.1.1.4]. In case value 504 is received, the value used by the UE is 510.

numSubbands

Parameter: N_{sb} see TS 36.211 [21, 9.3.6].

rb-Offset

Parameter: N_{RB}^{HO} , see TS 36.211 [21, 9.3.6].

– *SL-OffsetIndicator*

The IE *SL-OffsetIndicator* indicates the offset of the pool of resources relative to SFN 0 of the cell from which it was obtained or, when out of coverage, relative to DFN 0.

***SL-OffsetIndicator* information element**

```
-- ASN1START
SL-OffsetIndicator-r12 ::=          CHOICE {
    small-r12                       INTEGER (0..319),
    large-r12                       INTEGER (0..10239)
}
SL-OffsetIndicatorSync-r12 ::=     INTEGER (0..39)
-- ASN1STOP
```

***SL-OffsetIndicator* field descriptions**

SL-OffsetIndicator

In *sc-TF-ResourceConfig*, it indicates the offset of the first period of pool of resources within a SFN cycle. For *data-TF-ResourceConfig*, it corresponds to the *offsetIndicator* as defined in TS 36.213 [23, 14.1.3].

SL-OffsetIndicatorSync

Synchronisation resources are present in those SFN and subframes which satisfy the relation: $(\text{SFN} \cdot 10 + \text{Subframe Number}) \bmod 40 = \text{SL-OffsetIndicatorSync}$.

– *SL-PeriodComm*

The IE *SL-PeriodComm* indicates the period over which resources allocated in a cell for sidelink communication.

***SL-PeriodComm* information element**

```
-- ASN1START
SL-PeriodComm-r12 ::=              ENUMERATED {sf40, sf60, sf70, sf80, sf120, sf140,
                                             sf160, sf240, sf280, sf320, spare6, spare5,
                                             spare4, spare3, spare2, spare}
-- ASN1STOP
```

– *SLSSID*

The IE *SLSSID* identifies a cell and is used by the receiving UE to detect asynchronous neighbouring cells, and by transmitting UEs to extend the synchronisation signals beyond the cell's coverage area.

***SLSSID* information element**

```
-- ASN1START
SLSSID-r12 ::=                     INTEGER (0..167)
-- ASN1STOP
```

– *SL-SyncConfig*

The IE *SL-SyncConfig* specifies the configuration information concerning reception of synchronisation signals from neighbouring cells as well as concerning the transmission of synchronisation signals for sidelink communication and sidelink discovery.

***SL-SyncConfig* information element**

```
-- ASN1START
SL-SyncConfigList-r12 ::=          SEQUENCE (SIZE (1..maxSL-SyncConfig-r12)) OF SL-SyncConfig-r12
SL-SyncConfig-r12 ::=              SEQUENCE {
    syncCP-Len-r12                  SL-CP-Len-r12,
```

```

syncOffsetIndicator-r12          SL-OffsetIndicatorSync-r12,
slssid-r12                       SLSSID-r12,
txParameters-r12                 SEQUENCE {
    syncTxParameters-r12        SL-TxParameters-r12,
    syncTxThreshIC-r12         RSRP-RangeSL-r12,
    syncInfoReserved-r12       BIT STRING (SIZE (19)) OPTIONAL -- Need OR
}
rxParamsNCell-r12                SEQUENCE {
    physCellId-r12              PhysCellId,
    discSyncWindow-r12          ENUMERATED {w1, w2}
}
...
}
-- ASN1STOP

```

SL-SyncConfig field descriptions
<p>discSyncWindow Indicates the synchronization window over which the UE expects that SLSS or discovery resources indicated by the pool configuration (see TS 36.213 [23, 14.4]). The value <i>w1</i> denotes 5 milliseconds. The value <i>w2</i> denotes the length corresponding to normal cyclic prefix divided by 2.</p>
<p>syncInfoReserved Reserved for future use.</p>
<p>syncOffsetIndicator E-UTRAN should ensure <i>syncOffsetIndicator</i> is set to the same value as <i>syncOffsetIndicator1</i> or <i>syncOffsetIndicator2</i> in <i>preconfigSync</i> within <i>SL-Preconfiguration</i>, if configured.</p>
<p>syncTxThreshIC Indicates the threshold used while in coverage. In case the RSRP measurement of the cell chosen for transmission of sidelink communication/ discovery announcements, is below the level indicated by this field, the UE may transmit SLSS (i.e. become synchronisation reference) when performing the corresponding sidelink transmission..</p>
<p>txParameters Includes parameters relevant only for transmission. E-UTRAN includes the field in one entry per list, as included in <i>commSyncConfig</i> or <i>discSyncConfig</i>.</p>

– SL-TF-ResourceConfig

The IE *SL-TF-ResourceConfig* specifies a set of time/ frequency resources used for sidelink.

SL-TF-ResourceConfig information element

```
-- ASN1START
SL-TF-ResourceConfig-r12 ::=          SEQUENCE      {
    prb-Num-r12                INTEGER (1..100),
    prb-Start-r12              INTEGER (0..99),
    prb-End-r12                INTEGER (0..99),
    offsetIndicator-r12        SL-OffsetIndicator-r12,
    subframeBitmap-r12        SubframeBitmapSL-r12
}

SubframeBitmapSL-r12 ::=          CHOICE {
    bs4-r12                    BIT STRING (SIZE (4)),
    bs8-r12                    BIT STRING (SIZE (8)),
    bs12-r12                   BIT STRING (SIZE (12)),
    bs16-r12                   BIT STRING (SIZE (16)),
    bs30-r12                   BIT STRING (SIZE (30)),
    bs40-r12                   BIT STRING (SIZE (40)),
    bs42-r12                   BIT STRING (SIZE (42))
}
-- ASN1STOP
```

SL-TF-ResourceConfig field descriptions
<p>prb-Start, prb-End, prb-Num Sidelink transmissions on a sub-frame can occur on PRB with index greater than or equal to <i>prb-Start</i> and less than <i>prb-Start + prb-Num</i>, and on PRB with index greater than <i>prb-End - prb-Num</i> and less than or equal to <i>prb-End</i>. Even for neighbouring cells, <i>prb-Start</i> and <i>prb-End</i>, are relative to PRB #0 of the cell from which it was obtained. See TS36.213 [23, 14.1.3, 14.2.3, 14.3.3].</p>
<p>subframeBitmap Indicates the subframe bitmap indicating resources used for sidelink. E-UTRAN configures value <i>bs40</i> for FDD and the following values for TDD: value <i>bs42</i> for configuration0, value <i>bs16</i> for configuration1, value <i>bs8</i> for configuration2, value <i>bs12</i> for configuration3, value <i>bs8</i> for configuration4, value <i>bs4</i> for configuration5 and value <i>bs30</i> for configuration6.</p>

– SL-TxParameters

The IE *SL-TxParameters* identifies a set of parameters configured for sidelink transmission, used for communication, discovery and synchronisation.

SL-TxParameters information element

```
-- ASN1START
SL-TxParameters-r12 ::=          SEQUENCE      {
```

```

    alpha-r12          Alpha-r12,
    p0-r12            P0-SL-r12
}
P0-SL-r12 ::=
-- ASN1STOP

```

SL-TxParameters field descriptions

alpha

Parameter(s): $\alpha_{PSSCH,1}$, $\alpha_{PSSCH,2}$, $\alpha_{PSCCH,1}$, $\alpha_{PSCCH,2}$, $\alpha_{PSDCH,1}$, α_{PSSS} See TS 36.213 [23, 14.1.1.5, 14.2.1.2, 14.3.1, 14.4] where al0 corresponds to 0, al04 corresponds to value 0.4, al05 to 0.5, al06 to 0.6, al07 to 0.7, al08 to 0.8, al09 to 0.9 and al1 corresponds to 1. This field applies for sidelink power control.

p0

Parameter: $P_{O_PSSCH,1}$, $P_{O_PSSCH,2}$, $P_{O_PSCCH,1}$, $P_{O_PSCCH,2}$, $P_{O_PSDCH,1}$, P_{O_PSSS} see TS 36.213 [23, 14.1.1.5, 14.2.1.2, 14.3.1, 14.4], unit dBm.

– **SL-TxPoolIdentity**

The IE *SL-TxPoolIdentity* identifies an individual pool entry configured for sidelink transmission, used for communication and discovery.

SL-TxPoolIdentity information element

```

-- ASN1START
SL-TxPoolIdentity-r12 ::=
-- ASN1STOP

```

– **SL-TxPoolToReleaseList**

The IE *SL-TxPoolToReleaseList* is used to release one or more individual pool entries used for sidelink transmission, for communication and discovery.

SL-TxPoolToReleaseList information element

```

-- ASN1START
SL-TxPoolToReleaseList-r12 ::= SEQUENCE (SIZE (1..maxSL-TxPool-r12)) OF SL-TxPoolIdentity-r12
-- ASN1STOP

```

6.4 RRC multiplicity and type constraint values

– Multiplicity and type constraint definitions

```

-- ASN1START
maxBandComb-r10      INTEGER ::= 128 -- Maximum number of band combinations.
maxBandComb-r11     INTEGER ::= 256 -- Maximum number of additional band combinations.
maxBands             INTEGER ::= 64  -- Maximum number of bands listed in EUTRA UE caps
maxBandwidthClass-r10 INTEGER ::= 16  -- Maximum number of supported CA BW classes per band
maxBandwidthCombSet-r10 INTEGER ::= 32 -- Maximum number of bandwidth combination sets per
-- supported band combination
maxCDMA-BandClass   INTEGER ::= 32  -- Maximum value of the CDMA band classes
maxCellBlack        INTEGER ::= 16  -- Maximum number of blacklisted physical cell identity
-- ranges listed in SIB type 4 and 5
maxCellHistory-r12  INTEGER ::= 16  -- Maximum number of visited EUTRA cells reported
maxCellInfoGERAN-r9  INTEGER ::= 32  -- Maximum number of GERAN cells for which system in-
-- formation can be provided as redirection assistance
maxCellInfoUTRA-r9  INTEGER ::= 16  -- Maximum number of UTRA cells for which system
-- information can be provided as redirection
-- assistance
maxCombIDC-r11     INTEGER ::= 128  -- Maximum number of reported UL CA combinations
maxCSI-IM-r11      INTEGER ::= 3    -- Maximum number of CSI-IM configurations

```

maxCSI-IM-r12	INTEGER ::= 4	-- (per carrier frequency) -- Maximum number of CSI-IM configurations -- (per carrier frequency)
maxCSI-Proc-r11	INTEGER ::= 4	-- Maximum number of CSI processes (per carrier -- frequency)
maxCSI-RS-NZP-r11	INTEGER ::= 3	-- Maximum number of CSI RS resource -- configurations using non-zero Tx power -- (per carrier frequency)
maxCSI-RS-ZP-r11	INTEGER ::= 4	-- Maximum number of CSI RS resource -- configurations using zero Tx power(per carrier -- frequency)
maxCQI-ProcExt-r11	INTEGER ::= 3	-- Maximum number of additional periodic CQI -- configurations (per carrier frequency)
maxFreqUTRA-TDD-r10	INTEGER ::= 6	-- Maximum number of UTRA TDD carrier frequencies for -- which system information can be provided as -- redirection assistance
maxCellInter	INTEGER ::= 16	-- Maximum number of neighbouring inter-frequency -- cells listed in SIB type 5
maxCellIntra	INTEGER ::= 16	-- Maximum number of neighbouring intra-frequency -- cells listed in SIB type 4
maxCellListGERAN	INTEGER ::= 3	-- Maximum number of lists of GERAN cells
maxCellMeas	INTEGER ::= 32	-- Maximum number of entries in each of the -- cell lists in a measurement object
maxCellReport	INTEGER ::= 8	-- Maximum number of reported cells/CSI-RS resources
maxCSI-RS-Meas-r12	INTEGER ::= 96	-- Maximum number of entries in the CSI-RS list -- in a measurement object
maxDRB	INTEGER ::= 11	-- Maximum number of Data Radio Bearers
maxDS-Duration-r12	INTEGER ::= 5	-- Maximum number of subframes in a discovery signals -- occasion
maxDS-ZTP-CSI-RS-r12	INTEGER ::= 5	-- Maximum number of zero transmission power CSI-RS for -- a serving cell concerning discovery signals
maxEARFCN	INTEGER ::= 65535	-- Maximum value of EUTRA carrier frequency
maxEARFCN-Plus1	INTEGER ::= 65536	-- Lowest value extended EARFCN range
maxEARFCN2	INTEGER ::= 262143	-- Highest value extended EARFCN range
maxEPDCCH-Set-r11	INTEGER ::= 2	-- Maximum number of EPDCCH sets
maxFBI	INTEGER ::= 64	-- Maximum value of fequency band indicator
maxFBI-Plus1	INTEGER ::= 65	-- Lowest value extended FBI range
maxFBI2	INTEGER ::= 256	-- Highest value extended FBI range
maxFreq	INTEGER ::= 8	-- Maximum number of carrier frequencies
maxFreqIDC-r11	INTEGER ::= 32	-- Maximum number of carrier frequencies that are -- affected by the IDC problems
maxFreqMBMS-r11	INTEGER ::= 5	-- Maximum number of carrier frequencies for which an -- MBMS capable UE may indicate an interest
maxGERAN-SI	INTEGER ::= 10	-- Maximum number of GERAN SI blocks that can be -- provided as part of NACC information
maxGNFG	INTEGER ::= 16	-- Maximum number of GERAN neighbour freq groups
maxLogMeasReport-r10	INTEGER ::= 520	-- Maximum number of logged measurement entries -- that can be reported by the UE in one message
maxMBSFN-Allocations	INTEGER ::= 8	-- Maximum number of MBSFN frame allocations with -- different offset
maxMBSFN-Area	INTEGER ::= 8	
maxMBSFN-Area-1	INTEGER ::= 7	
maxMeasId	INTEGER ::= 32	
maxMeasId-Plus1	INTEGER ::= 33	
maxMeasId-r12	INTEGER ::= 64	
maxMultiBands	INTEGER ::= 8	-- Maximum number of additional frequency bands -- that a cell belongs to
maxNS-Pmax-r10	INTEGER ::= 8	-- Maximum number of NS and P-Max values per band
maxNAICS-Entries-r12	INTEGER ::= 8	-- Maximum number of supported NAICS combination(s)
maxNeighCell-r12	INTEGER ::= 8	-- Maximum number of neighbouring cells in NAICS -- configuration (per carrier frequency)
maxObjectId	INTEGER ::= 32	
maxP-a-PerNeighCell-r12	INTEGER ::= 3	-- Maximum number of power offsets for a neighbour cell -- in NAICS configuration
maxPageRec	INTEGER ::= 16	--
maxPhysCellIdRange-r9	INTEGER ::= 4	-- Maximum number of physical cell identity ranges
maxPLMN-r11	INTEGER ::= 6	-- Maximum number of PLMNs
maxPNOffset	INTEGER ::= 511	-- Maximum number of CDMA2000 PNOFFsets
maxPMCH-PerMBSFN	INTEGER ::= 15	
maxRAT-Capabilities	INTEGER ::= 8	-- Maximum number of interworking RATs (incl EUTRA)
maxRE-MapQCL-r11	INTEGER ::= 4	-- Maximum number of PDSCH RE Mapping configurations -- (per carrier frequency)
maxReportConfigId	INTEGER ::= 32	
maxRSTD-Freq-r10	INTEGER ::= 3	-- Maximum number of frequency layers for RSTD -- measurement
maxSAI-MBMS-r11	INTEGER ::= 64	-- Maximum number of MBMS service area identities -- broadcast per carrier frequency
maxSCell-r10	INTEGER ::= 4	-- Maximum number of SCells

```

maxSL-Dest-r12          INTEGER ::= 16 -- Maximum number of sidelink destinations
maxSL-DiscPowerClass-r12  INTEGER ::= 3 -- Maximum number of sidelink power classes
maxSL-RxPool-r12        INTEGER ::= 16 -- Maximum number of individual sidelink Rx resource
pools
maxSL-SyncConfig-r12     INTEGER ::= 16 -- Maximum number of sidelink Sync configurations
maxSL-TF-IndexPair-r12  INTEGER ::= 64 -- Maximum number of sidelink Time Freq resource index
-- pairs
maxSL-TxPool-r12        INTEGER ::= 4 -- Maximum number of individual sidelink Tx resource
pools
maxSTAG-r11              INTEGER ::= 3 -- Maximum number of STAGs
maxServCell-r10          INTEGER ::= 5 -- Maximum number of Serving cells
maxServiceCount          INTEGER ::= 16 -- Maximum number of MBMS services that can be included
-- in an MBMS counting request and response
maxServiceCount-1       INTEGER ::= 15
maxSessionPerPMCH        INTEGER ::= 29
maxSessionPerPMCH-1     INTEGER ::= 28
maxSIB                   INTEGER ::= 32 -- Maximum number of SIBs
maxSIB-1                 INTEGER ::= 31
maxSI-Message            INTEGER ::= 32 -- Maximum number of SI messages
maxSimultaneousBands-r10 INTEGER ::= 64 -- Maximum number of simultaneously aggregated bands
maxSubframePatternIDC-r11 INTEGER ::= 8 -- Maximum number of subframe reservation patterns
-- that the UE can simultaneously recommend to the
-- E-UTRAN for use.
maxUTRA-FDD-Carrier      INTEGER ::= 16 -- Maximum number of UTRA FDD carrier frequencies
maxUTRA-TDD-Carrier      INTEGER ::= 16 -- Maximum number of UTRA TDD carrier frequencies
maxWLAN-Id-r12           INTEGER ::= 16 -- Maximum number of WLAN identifiers

```

```
-- ASN1STOP
```

NOTE: The value of maxDRB aligns with SA2.

– End of EUTRA-RRC-Definitions

```
-- ASN1START
```

```
END
```

```
-- ASN1STOP
```

6.5 PC5 RRC messages

NOTE: The messages included in this section reflect the current status of the discussions. Additional messages may be included at a later stage.

6.5.1 General message structure

– PC5-RRC-Definitions

This ASN.1 segment is the start of the PC5 RRC PDU definitions.

```
-- ASN1START
```

```
PC5-RRC-Definitions DEFINITIONS AUTOMATIC TAGS ::=
```

```
BEGIN
```

```
IMPORTS
```

```
    TDD-ConfigSL-r12
```

```
FROM EUTRA-RRC-Definitions;
```

```
-- ASN1STOP
```

– SBCCH-SL-BCH-Message

The *SBCCH-SL-BCH-Message* class is the set of RRC messages that may be sent from the UE to the UE via SL-BCH on the SBCCH logical channel.

```
-- ASN1START
```

```
SBCCH-SL-BCH-Message ::= SEQUENCE {
    message                SBCCH-SL-BCH-MessageType
}
```

```
SBCCH-SL-BCH-MessageType ::= MasterInformationBlock-SL
-- ASN1STOP
```

6.5.2 Message definitions

– *MasterInformationBlock-SL*

The *MasterInformationBlock-SL* includes the information transmitted by a UE transmitting SLSS, i.e. acting as synchronisation reference, via SL-BCH.

Signalling radio bearer: N/A

RLC-SAP: TM

Logical channel: SBCCH

Direction: UE to UE

MasterInformationBlock-SL

```
-- ASN1START
MasterInformationBlock-SL ::= SEQUENCE {
    sl-Bandwidth-r12          ENUMERATED {
        n6, n15, n25, n50, n75, n100},
    tdd-ConfigSL-r12        TDD-ConfigSL-r12,
    directFrameNumber-r12   BIT STRING (SIZE (10)),
    directSubframeNumber-r12 INTEGER (0..9),
    inCoverage-r12         BOOLEAN,
    reserved-r12           BIT STRING (SIZE (19))
}
-- ASN1STOP
```

***MasterInformationBlock-SL* field descriptions**

directFrameNumber

Indicates the frame number in which SLSS and SL-BCH are transmitted. The subframe in the frame corresponding to *directFrameNumber* is indicated by *directSubframeNumber*.

inCoverage

Value *TRUE* indicates that the UE transmitting the *MasterInformationBlock-SL* is in E-UTRAN coverage.

sl-Bandwidth

Parameter: transmission bandwidth configuration. n6 corresponds to 6 resource blocks, n15 to 15 resource blocks and so on.

– End of *PC5-RRC-Definitions*

```
-- ASN1START
END
-- ASN1STOP
```

7 Variables and constants

7.1 UE variables

NOTE: To facilitate the specification of the UE behavioural requirements, UE variables are represented using ASN.1. Unless explicitly specified otherwise, it is however up to UE implementation how to store the variables. The optionality of the IEs in ASN.1 is used only to indicate that the values may not always be available.

– EUTRA-UE-Variables

This ASN.1 segment is the start of the E-UTRA UE variable definitions.

```
-- ASN1START
EUTRA-UE-Variables DEFINITIONS AUTOMATIC TAGS ::=
BEGIN

IMPORTS
    AbsoluteTimeInfo-r10,
    AreaConfiguration-r10,
    AreaConfiguration-v1130,
    CarrierFreqGERAN,
    CellIdentity,
    ConnEstFailReport-r11,
    SpeedStateScaleFactors,
    C-RNTI,
    LoggingDuration-r10,
    LoggingInterval-r10,
    LogMeasInfo-r10,
    MeasCSI-RS-Id-r12,
    MeasId,
    MeasId-v1250,
    MeasIdToAddModList,
    MeasIdToAddModListExt-r12,
    MeasObjectToAddModList,
    MeasObjectToAddModList-v9e0,
    MeasScaleFactor-r12,
    MobilityStateParameters,
    NeighCellConfig,
    PhysCellId,
    PhysCellIdCDMA2000,
    PhysCellIdGERAN,
    PhysCellIdUTRA-FDD,
    PhysCellIdUTRA-TDD,
    PLMN-Identity,
    PLMN-IdentityList3-r11,
    QuantityConfig,
    ReportConfigToAddModList,
    RLF-Report-r9,
    TargetMBSFN-AreaList-r12,
    TraceReference-r10,
    VisitedCellInfoList-r12,
    maxCellMeas,
    maxCSI-RS-Meas-r12,
    maxMeasId,
    maxMeasId-r12
FROM EUTRA-RRC-Definitions;

-- ASN1STOP
```

– VarConnEstFailReport

The UE variable *VarConnEstFailReport* includes the connection establishment failure information.

VarConnEstFailReport UE variable

```
-- ASN1START
VarConnEstFailReport-r11 ::= SEQUENCE {
    connEstFailReport-r11 ConnEstFailReport-r11,
    plmn-Identity-r11      PLMN-Identity
}
-- ASN1STOP
```

– VarLogMeasConfig

The UE variable *VarLogMeasConfig* includes the configuration of the logging of measurements to be performed by the UE while in RRC_IDLE, covering intra-frequency, inter-frequency, inter-RAT mobility and MBSFN related

measurements. If MBSFN logging is configured, the UE performs logging of measurements while in both RRC_IDLE and RRC_CONNECTED. Otherwise, the UE performs logging of measurements only while in RRC_IDLE.

***VarLogMeasConfig* UE variable**

```
-- ASN1START
VarLogMeasConfig-r10 ::=
    areaConfiguration-r10      SEQUENCE {
    loggingDuration-r10        AreaConfiguration-r10      OPTIONAL,
    loggingInterval-r10       LoggingDuration-r10,
    }                          LoggingInterval-r10

VarLogMeasConfig-r11 ::=
    areaConfiguration-r10      SEQUENCE {
    areaConfiguration-v1130    AreaConfiguration-r10      OPTIONAL,
    loggingDuration-r10        AreaConfiguration-v1130    OPTIONAL,
    loggingInterval-r10       LoggingDuration-r10,
    }                          LoggingInterval-r10

VarLogMeasConfig-r12 ::=
    areaConfiguration-r10      SEQUENCE {
    areaConfiguration-v1130    AreaConfiguration-r10      OPTIONAL,
    loggingDuration-r10        AreaConfiguration-v1130    OPTIONAL,
    loggingInterval-r10       LoggingDuration-r10,
    targetMBSFN-AreaList-r12  LoggingInterval-r10,
    }                          TargetMBSFN-AreaList-r12  OPTIONAL
-- ASN1STOP
```

VarLogMeasReport

The UE variable *VarLogMeasReport* includes the logged measurements information.

***VarLogMeasReport* UE variable**

```
-- ASN1START
VarLogMeasReport-r10 ::=
    traceReference-r10        SEQUENCE {
    traceRecordingSessionRef-r10 OCTET STRING (SIZE (2)),
    tce-Id-r10                 OCTET STRING (SIZE (1)),
    plmn-Identity-r10          PLMN-Identity,
    absoluteTimeInfo-r10       AbsoluteTimeInfo-r10,
    logMeasInfoList-r10        LogMeasInfoList2-r10
    }

VarLogMeasReport-r11 ::=
    traceReference-r10        SEQUENCE {
    traceRecordingSessionRef-r10 OCTET STRING (SIZE (2)),
    tce-Id-r10                 OCTET STRING (SIZE (1)),
    plmn-IdentityList-r11      PLMN-IdentityList3-r11,
    absoluteTimeInfo-r10       AbsoluteTimeInfo-r10,
    logMeasInfoList-r10        LogMeasInfoList2-r10
    }

LogMeasInfoList2-r10 ::=
    SEQUENCE (SIZE (1..maxLogMeas-r10)) OF LogMeasInfo-r10
-- ASN1STOP
```

VarMeasConfig

The UE variable *VarMeasConfig* includes the accumulated configuration of the measurements to be performed by the UE, covering intra-frequency, inter-frequency and inter-RAT mobility related measurements.

NOTE: The amount of measurement configuration information, which a UE is required to store, is specified in subclause 11.1. If the number of frequencies configured for a particular RAT exceeds the minimum performance requirements specified in [16], it is up to UE implementation which frequencies of that RAT are measured. If the total number of frequencies for all RATs provided to the UE in the measurement configuration exceeds the minimum performance requirements specified in [16], it is up to UE implementation which frequencies/RATs are measured.

VarMeasConfig UE variable

```

-- ASN1START
VarMeasConfig ::=
    SEQUENCE {
        -- Measurement identities
        measIdList                MeasIdToAddModList                OPTIONAL,
        measIdListExt-r12         MeasIdToAddModListExt-r12        OPTIONAL,
        -- Measurement objects
        measObjectList            MeasObjectToAddModList            OPTIONAL,
        measObjectList-v9e0       MeasObjectToAddModList-v9e0      OPTIONAL,
        -- Reporting configurations
        reportConfigList          ReportConfigToAddModList          OPTIONAL,
        -- Other parameters
        quantityConfig            QuantityConfig                    OPTIONAL,
        measScaleFactor-r12       MeasScaleFactor-r12              OPTIONAL,
        s-Measure                  INTEGER (-140..-44)                OPTIONAL,
        speedStatePars            CHOICE {
            release                NULL,
            setup                  SEQUENCE {
                mobilityStateParameters    MobilityStateParameters,
                timeToTrigger-SF          SpeedStateScaleFactors
            }
        }
        allowInterruptions-r11    BOOLEAN                            OPTIONAL
    }
-- ASN1STOP

```

VarMeasReportList

The UE variable *VarMeasReportList* includes information about the measurements for which the triggering conditions have been met.

VarMeasReportList UE variable

```

-- ASN1START
VarMeasReportList ::=
    SEQUENCE (SIZE (1..maxMeasId)) OF VarMeasReport
VarMeasReportList-r12 ::=
    SEQUENCE (SIZE (1..maxMeasId-r12)) OF VarMeasReport

VarMeasReport ::=
    SEQUENCE {
        -- List of measurement that have been triggered
        measId                MeasId,
        measId-v1250          MeasId-v1250                OPTIONAL,
        cellsTriggeredList    CellsTriggeredList            OPTIONAL,
        csi-RS-TriggeredList-r12    CSI-RS-TriggeredList-r12    OPTIONAL,
        numberOfReportsSent    INTEGER
    }

CellsTriggeredList ::=
    SEQUENCE (SIZE (1..maxCellMeas)) OF CHOICE {
        physCellIdEUTRA        PhysCellId,
        physCellIdUTRA         CHOICE {
            fdd                 PhysCellIdUTRA-FDD,
            tdd                 PhysCellIdUTRA-TDD
        },
        physCellIdGERAN        SEQUENCE {
            carrierFreq         CarrierFreqGERAN,
            physCellId          PhysCellIdGERAN
        },
        physCellIdCDMA2000     PhysCellIdCDMA2000
    }

CSI-RS-TriggeredList-r12 ::=
    SEQUENCE (SIZE (1..maxCSI-RS-Meas-r12)) OF MeasCSI-RS-Id-r12
-- ASN1STOP

```

VarMobilityHistoryReport

The UE variable *VarMobilityHistoryReport* includes the mobility history information.

```

-- ASN1START
VarMobilityHistoryReport-r12 ::= VisitedCellInfoList-r12

```



```
-- ASN1STOP
```

– *VarRLF-Report*

The UE variable *VarRLF-Report* includes the radio link failure information or handover failure information.

***VarRLF-Report* UE variable**

```
-- ASN1START
VarRLF-Report-r10 ::=          SEQUENCE {
    rlf-Report-r10             RLF-Report-r9,
    plmn-Identity-r10         PLMN-Identity
}
VarRLF-Report-r11 ::=          SEQUENCE {
    rlf-Report-r10             RLF-Report-r9,
    plmn-IdentityList-r11     PLMN-IdentityList3-r11
}
-- ASN1STOP
```

– *VarShortMAC-Input*

The UE variable *VarShortMAC-Input* specifies the input used to generate the shortMAC-I.

***VarShortMAC-Input* UE variable**

```
-- ASN1START
VarShortMAC-Input ::=          SEQUENCE {
    cellIdentity               CellIdentity,
    physCellId                 PhysCellId,
    c-RNTI                      C-RNTI
}
-- ASN1STOP
```

***VarShortMAC-Input* field descriptions**

cellIdentity

Set to CellIdentity of the current cell.

c-RNTI

Set to C-RNTI that the UE had in the PCell it was connected to prior to the failure.

physCellId

Set to the physical cell identity of the PCell the UE was connected to prior to the failure.

– Multiplicity and type constraint definitions

This section includes multiplicity and type constraints applicable (only) for UE variables.

```
-- ASN1START
maxLogMeas-r10          INTEGER ::= 4060 -- Maximum number of logged measurement entries
                        -- that can be stored by the UE
-- ASN1STOP
```

– End of *EUTRA-UE-Variables*

```
-- ASN1START
END
-- ASN1STOP
```

7.2 Counters

Counter	Reset	Incremented	When reaching max value

7.3 Timers (Informative)

Timer	Start	Stop	At expiry
T300	Transmission of <i>RRCCONNECTIONREQUEST</i>	Reception of <i>RRCCONNECTIONSETUP</i> or <i>RRCCONNECTIONREJECT</i> message, cell re-selection and upon abortion of connection establishment by upper layers	Perform the actions as specified in 5.3.3.6
T301	Transmission of <i>RRCCONNECTIONREESTABLISHMENTREQUEST</i>	Reception of <i>RRCCONNECTIONREESTABLISHMENT</i> or <i>RRCCONNECTIONREESTABLISHMENTREJECT</i> message as well as when the selected cell becomes unsuitable	Go to RRC_IDLE
T302	Reception of <i>RRCCONNECTIONREJECT</i> while performing RRC connection establishment	Upon entering RRC_CONNECTED and upon cell re-selection	Inform upper layers about barring alleviation as specified in 5.3.3.7
T303	Access barred while performing RRC connection establishment for mobile originating calls	Upon entering RRC_CONNECTED and upon cell re-selection	Inform upper layers about barring alleviation as specified in 5.3.3.7
T304	Reception of <i>RRCCONNECTIONRECONFIGURATION</i> message including the <i>MOBILITYCONTROLINFO</i> or reception of <i>MOBILITYFROMEUTRACOMMAND</i> message including <i>CELLCHANGEORDER</i>	Criterion for successful completion of handover within E-UTRA, handover to E-UTRA or cell change order is met (the criterion is specified in the target RAT in case of inter-RAT)	In case of cell change order from E-UTRA or intra E-UTRA handover, initiate the RRC connection re-establishment procedure; In case of handover to E-UTRA, perform the actions defined in the specifications applicable for the source RAT.
T305	Access barred while performing RRC connection establishment for mobile originating signalling	Upon entering RRC_CONNECTED and upon cell re-selection	Inform upper layers about barring alleviation as specified in 5.3.3.7
T306	Access barred while performing RRC connection establishment for mobile originating CS fallback.	Upon entering RRC_CONNECTED and upon cell re-selection	Inform upper layers about barring alleviation as specified in 5.3.3.7
T307	Reception of <i>RRCCONNECTIONRECONFIGURATION</i> message including <i>MOBILITYCONTROLINFOSCG</i>	Successful completion of random access on the PSCell, upon initiating re-establishment and upon SCG release	Inform E-UTRAN about the SCG change failure by initiating the SCG failure information procedure as specified in 5.6.13.
T310	Upon detecting physical layer problems for the PCell i.e. upon receiving N310 consecutive out-of-sync indications from lower layers	Upon receiving N311 consecutive in-sync indications from lower layers for the PCell, upon triggering the handover procedure and upon initiating the connection re-establishment procedure	If security is not activated: go to RRC_IDLE else: initiate the connection re-establishment procedure
T311	Upon initiating the RRC connection re-establishment procedure	Selection of a suitable E-UTRA cell or a cell using another RAT.	Enter RRC_IDLE
T312	Upon triggering a measurement report for a measurement identity for which T312 has been configured, while T310 is running	Upon receiving N311 consecutive in-sync indications from lower layers, upon triggering the handover procedure, upon initiating the connection re-establishment procedure, and upon the expiry of T310	If security is not activated: go to RRC_IDLE else: initiate the connection re-establishment procedure

Timer	Start	Stop	At expiry
T313	Upon detecting physical layer problems for the PSCell i.e. upon receiving N313 consecutive out-of-sync indications from lower layers	Upon receiving N314 consecutive in-sync indications from lower layers for the PSCell, upon initiating the connection re-establishment procedure, upon SCG release and upon receiving <i>RRCCoalitionReconfiguration</i> including <i>MobilityControlInfoSCG</i>	Inform E-UTRAN about the SCG radio link failure by initiating the SCG failure information procedure as specified in 5.6.13.
T320	Upon receiving <i>t320</i> or upon cell (re)selection to E-UTRA from another RAT with validity time configured for dedicated priorities (in which case the remaining validity time is applied).	Upon entering RRC_CONNECTED, when PLMN selection is performed on request by NAS, or upon cell (re)selection to another RAT (in which case the timer is carried on to the other RAT).	Discard the cell reselection priority information provided by dedicated signalling.
T321	Upon receiving <i>measConfig</i> including a <i>reportConfig</i> with the <i>purpose</i> set to <i>reportCGI</i>	Upon acquiring the information needed to set all fields of <i>cellGlobalId</i> for the requested cell, upon receiving <i>measConfig</i> that includes removal of the <i>reportConfig</i> with the <i>purpose</i> set to <i>reportCGI</i>	Initiate the measurement reporting procedure, stop performing the related measurements and remove the corresponding <i>measId</i>
T325	Timer (re)started upon receiving <i>RRCCoalitionReject</i> message with <i>deprioritisationTimer</i> .		Stop deprioritisation of all frequencies or E-UTRA signalled by <i>RRCCoalitionReject</i> .
T330	Upon receiving <i>LoggedMeasurementConfiguration</i> message	Upon log volume exceeding the suitable UE memory, upon initiating the release of <i>LoggedMeasurementConfiguration</i> procedure	Perform the actions specified in 5.6.6.4
T340	Upon transmitting <i>UEAssistanceInformation</i> message with <i>powerPrefIndication</i> set to <i>normal</i>	Upon initiating the connection re-establishment procedure	No action.
T350	Upon entering RRC_IDLE if <i>t350</i> has been received in wlan-OffloadInfo.	Upon entering RRC_CONNECTED, or upon cell reselection.	Perform the actions specified in 5.6.12.4.

7.4 Constants

Constant	Usage
N310	Maximum number of consecutive "out-of-sync" indications for the PCell received from lower layers
N311	Maximum number of consecutive "in-sync" indications for the PCell received from lower layers
N313	Maximum number of consecutive "out-of-sync" indications for the PSCell received from lower layers
N314	Maximum number of consecutive "in-sync" indications for the PSCell received from lower layers

8 Protocol data unit abstract syntax

8.1 General

The RRC PDU contents in clause 6, clause 9.3.2 and clause 10 are described using abstract syntax notation one (ASN.1) as specified in ITU-T Rec. X.680 [13] and X.681 [14]. Transfer syntax for RRC PDUs is derived from their ASN.1 definitions by use of Packed Encoding Rules, unaligned as specified in ITU-T Rec. X.691 [15].

The following encoding rules apply in addition to what has been specified in X.691:

- When a bit string value is placed in a bit-field as specified in 15.6 to 15.11 in X.691, the leading bit of the bit string value shall be placed in the leading bit of the bit-field, and the trailing bit of the bit string value shall be placed in the trailing bit of the bit-field.

NOTE: The terms 'leading bit' and 'trailing bit' are defined in ITU-T Rec. X.680. When using the 'bstring' notation, the leading bit of the bit string value is on the left, and the trailing bit of the bit string value is on the right.

- When decoding types constrained with the ASN.1 Contents Constraint ("CONTAINING"), automatic decoding of the contained type should not be performed because errors in the decoding of the contained type should not cause the decoding of the entire RRC message PDU to fail. It is recommended that the decoder first decodes the outer PDU type that contains the OCTET STRING or BIT STRING with the Contents Constraint, and then decodes the contained type that is nested within the OCTET STRING or BIT STRING as a separate step.
- When decoding a) RRC message PDUs, b) BIT STRING constrained with a Contents Constraint, or c) OCTET STRING constrained with a Contents Constraint, PER decoders are required to never report an error if there are extraneous zero or non-zero bits at the end of the encoded RRC message PDU, BIT STRING or OCTET STRING.

8.2 Structure of encoded RRC messages

An RRC PDU, which is the bit string that is exchanged between peer entities/ across the radio interface contains the basic production as defined in X.691.

RRC PDUs shall be mapped to and from PDCP SDUs (in case of DCCH) or RLC SDUs (in case of PCCH, BCCH, CCCH or MCCH) upon transmission and reception as follows:

- when delivering an RRC PDU as an PDCP SDU to the PDCP layer for transmission, the first bit of the RRC PDU shall be represented as the first bit in the PDCP SDU and onwards; and
- when delivering an RRC PDU as an RLC SDU to the RLC layer for transmission, the first bit of the RRC PDU shall be represented as the first bit in the RLC SDU and onwards; and
- upon reception of an PDCP SDU from the PDCP layer, the first bit of the PDCP SDU shall represent the first bit of the RRC PDU and onwards; and
- upon reception of an RLC SDU from the RLC layer, the first bit of the RLC SDU shall represent the first bit of the RRC PDU and onwards.

8.3 Basic production

The 'basic production' is obtained by applying UNALIGNED PER to the abstract syntax value (the ASN.1 description) as specified in X.691. It always contains a multiple of 8 bits.

8.4 Extension

The following rules apply with respect to the use of protocol extensions:

- A transmitter compliant with this version of the specification shall, unless explicitly indicated otherwise on a PDU type basis, set the extension part empty. Transmitters compliant with a later version may send non-empty extensions;

- A transmitter compliant with this version of the specification shall set spare bits to zero;

8.5 Padding

If the encoded RRC message does not fill a transport block, the RRC layer shall add padding bits. This applies to PCCH and BCCH.

Padding bits shall be set to 0 and the number of padding bits is a multiple of 8.

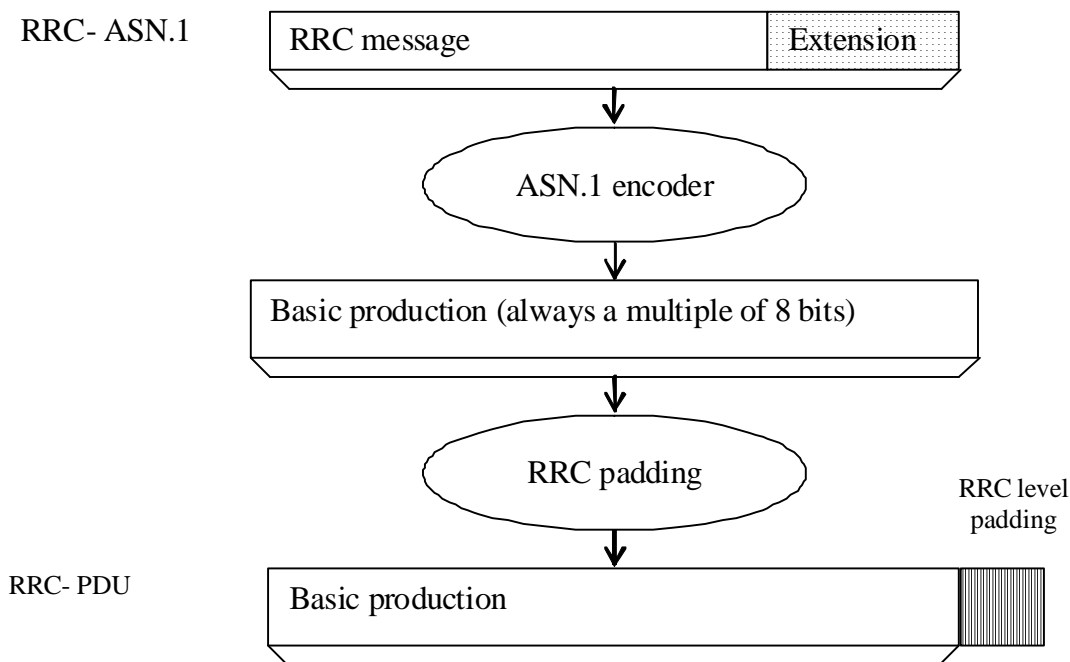

Figure 8.5-1: RRC level padding

9 Specified and default radio configurations

Specified and default configurations are configurations of which the details are specified in the standard. Specified configurations are fixed while default configurations can be modified using dedicated signalling.

9.1 Specified configurations

9.1.1 Logical channel configurations

9.1.1.1 BCCH configuration

Parameters

Name	Value	Semantics description	Ver
PDCP configuration	N/A		
RLC configuration	TM		
MAC configuration	TM		

NOTE: RRC will perform padding, if required due to the granularity of the TF signalling, as defined in 8.5.

9.1.1.2 CCCH configuration

Parameters

Name	Value	Semantics description	Ver
PDCP configuration	N/A		
RLC configuration	TM		

Name	Value	Semantics description	Ver
MAC configuration		Normal MAC headers are used	
Logical channel configuration			
<i>priority</i>	1	Highest priority	
<i>prioritisedBitRate</i>	infinity		
<i>bucketSizeDuration</i>	N/A		
<i>logicalChannelGroup</i>	0		
<i>logicalChannelSR-Mask-r9</i>	release		v920

9.1.1.3 PCCH configuration

Parameters

Name	Value	Semantics description	Ver
PDCP configuration	N/A		
RLC configuration	TM		
MAC configuration	TM		

NOTE: RRC will perform padding, if required due to the granularity of the TF signalling, as defined in 8.5.

9.1.1.4 MCCH and MTCH configuration

Parameters

Name	Value	Semantics description	Ver
PDCP configuration	N/A		
RLC configuration	UM		
<i>Sn-FieldLength</i>	size5		
<i>t-Reordering</i>	0		

9.1.1.5 SBCCH configuration

Parameters

Name	Value	Semantics description	Ver
PDCP configuration	N/A		
RLC configuration	TM		
MAC configuration	TM		

NOTE: RRC will perform padding, if required due to the granularity of the TF signalling, as defined in 8.5.

9.1.1.6 STCH configuration

Parameters

Name	Value	Semantics description	Ver
PDCP configuration			
discardTimer	Undefined	Up to UE implementation	
pdcp-SN-Size	16		
maxCID	15		
profiles			
RLC configuration		Uni-directional UM RLC UM window size is set to 0	
<i>sn-FieldLength</i>	5		
logicalChannelIdentity	Undefined	Selected by the transmitting UE, up to UE implementation	
Logical channel configuration			
priority	Undefined	Selected by the transmitting UE, up to UE implementation	
prioritisedBitRate	Undefined	Selected by the transmitting UE, up to UE implementation	

Name	Value	Semantics description	Ver
bucketSizeDuration	Undefined	Selected by the transmitting UE, up to UE implementation	
logicalChannelGroup	3		
MAC configuration			

9.1.2 SRB configurations

9.1.2.1 SRB1

Parameters

Name	Value	Semantics description	Ver
RLC configuration			
<i>logicalChannelIdentity</i>	1		

9.1.2.2 SRB2

Parameters

Name	Value	Semantics description	Ver
RLC configuration			
<i>logicalChannelIdentity</i>	2		

9.2 Default radio configurations

The following sections only list default values for REL-8 parameters included in protocol version v8.5.0. For all fields introduced in a later protocol version, the default value is "released" unless explicitly specified otherwise. If UE is to apply default configuration while it is configured with some critically extended fields, the UE shall apply the original version with only default values. For the following fields, introduced in a protocol version later than v8.5.0, the default corresponds with "value not applicable":

- *codeBookSubsetRestriction-v920*;
- *pmi-RI-Report*;

NOTE 1: Value "N/A" indicates that the UE does not apply a specific value (i.e. upon switching to a default configuration, E-UTRAN can not assume the UE keeps the previously configured value). This implies that E-UTRAN needs to configure a value before invoking the related functionality.

NOTE 2: In general, the signalling should preferably support a "release" option for fields introduced after v8.5.0. The "value not applicable" should be used restrictively, mainly limited to for fields which value is relevant only if another field is set to a value other than its default.

9.2.1 SRB configurations

9.2.1.1 SRB1

Parameters

Name	Value	Semantics description	Ver
RLC configuration CHOICE	am		
<i>ul-RLC-Config</i>			
> <i>t-PollRetransmit</i>	ms45		
> <i>pollPDU</i>	infinity		
> <i>pollByte</i>	infinity		
> <i>maxRetxThreshold</i>	t4		
<i>dl-RLC-Config</i>			
> <i>t-Reordering</i>	ms35		
> <i>t-StatusProhibit</i>	ms0		
Logical channel configuration			
<i>priority</i>	1	Highest priority	

Name	Value	Semantics description	Ver
<i>prioritisedBitRate</i>	infinity		
<i>bucketSizeDuration</i>	N/A		
<i>logicalChannelGroup</i>	0		

9.2.1.2 SRB2

Parameters

Name	Value	Semantics description	Ver
RLC configuration CHOICE	am		
<i>ul-RLC-Config</i>			
> <i>t-PollRetransmit</i>	ms45		
> <i>pollPDU</i>	infinity		
> <i>pollByte</i>	infinity		
> <i>maxRetxThreshold</i>	t4		
<i>dl-RLC-Config</i>			
> <i>t-Reordering</i>	ms35		
> <i>t-StatusProhibit</i>	ms0		
Logical channel configuration			
<i>priority</i>	3		
<i>prioritisedBitRate</i>	infinity		
<i>bucketSizeDuration</i>	N/A		
<i>logicalChannelGroup</i>	0		

9.2.2 Default MAC main configuration

Parameters

Name	Value	Semantics description	Ver
MAC main configuration			
<i>maxHARQ-tx</i>	n5		
<i>periodicBSR-Timer</i>	infinity		
<i>retxBSR-Timer</i>	sf2560		
<i>ttiBundling</i>	FALSE		
<i>drx-Config</i>	release		
<i>phr-Config</i>	release		

9.2.3 Default semi-persistent scheduling configuration

SPS-Config			
> <i>sps-ConfigDL</i>	release		
> <i>sps-ConfigUL</i>	release		

9.2.4 Default physical channel configuration

Parameters

Name	Value	Semantics description	Ver
<i>PDSCH-ConfigDedicated</i>			
> <i>p-a</i>	dB0		
<i>PUCCH-ConfigDedicated</i>			
> <i>tdt-AckNackFeedbackMode</i>	bundling	Only valid for TDD mode	
> <i>ackNackRepetition</i>	release		
<i>PUSCH-ConfigDedicated</i>			
> <i>betaOffset-ACK-Index</i>	10		
> <i>betaOffset-RI-Index</i>	12		
> <i>betaOffset-CQI-Index</i>	15		
<i>UplinkPowerControlDedicated</i>			
> <i>p0-UE-PUSCH</i>	0		
> <i>deltaMCS-Enabled</i>	en0 (disabled)		
> <i>accumulationEnabled</i>	TRUE		

Name	Value	Semantics description	Ver
>p0-UE-PUCCH	0		
>pSRS-Offset	7		
>filterCoefficient	fc4		
tpc-pdcch-ConfigPUCCH	release		
tpc-pdcch-ConfigPUSCH	release		
CQI-ReportConfig			
>CQI-ReportPeriodic	release		
>cgi-ReportModeAperiodic	N/A		
>nomPDSCH-RS-EPRE-Offset	N/A		
SoundingRS-UL-ConfigDedicated	release		
AntennaInfoDedicated			
>transmissionMode	tm1, tm2	If the number of PBCH antenna ports is one, tm1 is used as default; otherwise tm2 is used as default	
>codebookSubsetRestriction	N/A		
>ue-TransmitAntennaSelection	release		
SchedulingRequestConfig	release		

9.2.5 Default values timers and constants

Parameters

Name	Value	Semantics description	Ver
t310	ms1000		
n310	n1		
t311	ms1000		
n311	n1		

9.3 Sidelink pre-configured parameters

9.3.1 Specified parameters

This section only list parameters which value is specified in the standard.

Parameters

Name	Value	Semantics description	Ver
preconfigSync			
>syncTxParameters			
>>alpha	0		
preconfigComm			
>sc-TxParameters			
>>alpha	0		
>dataTxParameters			
>>alpha	0		

9.3.2 Pre-configurable parameters

This ASN.1 segment is the start of the E-UTRA definitions of pre-configured sidelink parameters.

NOTE 1: Upper layers are assumed to provide a set of pre-configured parameters that are valid at the current UE location if any, see TS 24.334 [69, 10.2].

```
-- ASN1START
EUTRA-Sidelink-Preconf DEFINITIONS AUTOMATIC TAGS ::=
BEGIN

IMPORTS
    AdditionalSpectrumEmission,
    ARFCN-ValueEUTRA-r9,
```

```

FilterCoefficient,
maxSL-TxPool-r12,
P-Max,
SL-CP-Len-r12,
SL-HoppingConfigComm-r12,
SL-OffsetIndicatorSync-r12,
SL-PeriodComm-r12,
RSRP-RangeSL3-r12,
SL-TF-ResourceConfig-r12,
SL-TRPT-Subset-r12,
P0-SL-r12,
TDD-ConfigSL-r12
FROM EUTRA-RRC-Definitions;

-- ASN1STOP

```

– *SL-Preconfiguration*

The IE *SL-Preconfiguration* includes the sidelink pre-configured parameters.

***SL-Preconfiguration* information elements**

```

-- ASN1START

SL-Preconfiguration-r12 ::= SEQUENCE {
    preconfigGeneral-r12          SL-PreconfigGeneral-r12,
    preconfigSync-r12            SL-PreconfigSync-r12,
    preconfigComm-r12            SL-PreconfigCommPoolList4-r12,
    ...
}

SL-PreconfigGeneral-r12 ::= SEQUENCE {
    -- PDCP configuration
    rohc-Profiles-r12            SEQUENCE {
        profile0x0001-r12        BOOLEAN,
        profile0x0002-r12        BOOLEAN,
        profile0x0004-r12        BOOLEAN,
        profile0x0006-r12        BOOLEAN,
        profile0x0101-r12        BOOLEAN,
        profile0x0102-r12        BOOLEAN,
        profile0x0104-r12        BOOLEAN
    },
    -- Physical configuration
    carrierFreq-r12              ARFCN-ValueEUTRA-r9,
    maxTxPower-r12               P-Max,
    additionalSpectrumEmission-r12 AdditionalSpectrumEmission,
    sl-bandwidth-r12             ENUMERATED {n6, n15, n25, n50, n75, n100},
    tdd-ConfigSL-r12             TDD-ConfigSL-r12,
    reserved-r12                 BIT STRING (SIZE (19)),
    ...
}

SL-PreconfigSync-r12 ::= SEQUENCE {
    syncCP-Len-r12               SL-CP-Len-r12,
    syncOffsetIndicator1-r12      SL-OffsetIndicatorSync-r12,
    syncOffsetIndicator2-r12      SL-OffsetIndicatorSync-r12,
    syncTxParameters-r12         P0-SL-r12,
    syncTxThreshOoC-r12          RSRP-RangeSL3-r12,
    filterCoefficient-r12        FilterCoefficient,
    syncRefMinHyst-r12           ENUMERATED {dB0, dB3, dB6, dB9, dB12},
    syncRefDiffHyst-r12          ENUMERATED {dB0, dB3, dB6, dB9, dB12, dBInf},
    ...
}

SL-PreconfigCommPoolList4-r12 ::= SEQUENCE (SIZE (1..maxSL-TxPool-r12)) OF SL-PreconfigCommPool-
r12

SL-PreconfigCommPool-r12 ::= SEQUENCE {
    -- This IE is same as SL-CommResourcePool with rxParametersNCell absent
    sc-CP-Len-r12                SL-CP-Len-r12,
    sc-Period-r12                SL-PeriodComm-r12,
    sc-TF-ResourceConfig-r12     SL-TF-ResourceConfig-r12,
    sc-TxParameters-r12          P0-SL-r12,
    data-CP-Len-r12              SL-CP-Len-r12,
    data-TF-ResourceConfig-r12   SL-TF-ResourceConfig-r12,

```

```

dataHoppingConfig-r12          SL-HoppingConfigComm-r12,
dataTxParameters-r12         P0-SL-r12,
trpt-Subset-r12              SL-TRPT-Subset-r12,
...
}
END
-- ASN1STOP

```

SL-Preconfiguration field descriptions

carrierFreq

Indicates the carrier frequency for sidelink operation. In case of FDD it is uplink carrier frequency and the corresponding downlink frequency can be determined from the default TX-RX frequency separation defined in TS 36.101 [42, table 5.7.3-1].

preconfigComm

Indicates a list of resource pools. The first resource pool in the list is used for both reception and transmission of sidelink communication. The other resource pools, if present, are only used for reception of sidelink communication.

syncRefDiffHyst

Hysteresis when evaluating a SyncRef UE using relative comparison. Value *dB0* corresponds to 0 dB, *dB3* to 3 dB and so on, value *dBinf* corresponds to infinite dB.

syncRefMinHyst

Hysteresis when evaluating a SyncRef UE using absolute comparison. Value *dB0* corresponds to 0 dB, *dB3* to 3 dB and so on.

NOTE 1: The network may configure one or more of the reception only resource pools in *preconfigComm* to cover reception from in coverage UEs using scheduled resource allocation. For such a resource pool the network should set all bits of *subframeBitmap* to 1 and *offsetIndicator* to indicate the subframe immediately following the sidelink control information.

NOTE 2: The network should ensure that the resources defined by the first entry in *preconfigComm* (used for transmission by an out of coverage UE) do not overlap with those of the pool(s) covering scheduled transmissions by in coverage UEs. Furthermore, the network should ensure that for none of the entries in *preconfigComm* the resources defined by *sc-TF-ResourceConfig* overlap.

10 Radio information related interactions between network nodes

10.1 General

This section specifies RRC messages that are transferred between network nodes. These RRC messages may be transferred to or from the UE via another Radio Access Technology. Consequently, these messages have similar characteristics as the RRC messages that are transferred across the E-UTRA radio interface, i.e. the same transfer syntax and protocol extension mechanisms apply.

10.2 Inter-node RRC messages

10.2.1 General

This section specifies RRC messages that are sent either across the X2- or the S1-interface, either to or from the eNB, i.e. a single 'logical channel' is used for all RRC messages transferred across network nodes. The information could originate from or be destined for another RAT.

– EUTRA-InterNodeDefinitions

This ASN.1 segment is the start of the E-UTRA inter-node PDU definitions.

```

-- ASN1START
EUTRA-InterNodeDefinitions DEFINITIONS AUTOMATIC TAGS ::=
BEGIN

```

```

IMPORTS
  AntennaInfoCommon,
  AntennaInfoDedicated-v10i0,
  ARFCN-ValueEUTRA,
  ARFCN-ValueEUTRA-v9e0,
  ARFCN-ValueEUTRA-r9,
  CellIdentity,
  C-RNTI,
  DL-DCCH-Message,
  DRB-Identity,
  DRB-ToReleaseList,
  InDeviceCoexIndication-r11,
  MasterInformationBlock,
  maxFreq,
  maxDRB,
  maxSCell-r10,
  maxServCell-r10,
  MBMSInterestIndication-r11,
  MeasConfig,
  MeasGapConfig,
  OtherConfig-r9,
  PhysCellId,
  P-Max,
  PowerCoordinationInfo-r12,
  SidelinkUEInformation-r12,
  SL-CommConfig-r12,
  SL-DiscConfig-r12,
  RadioResourceConfigDedicated,
  RSRP-Range,
  RSRQ-Range,
  RSRQ-Range-v1250,
  SCellToAddModList-r10,
  SCG-ConfigPartSCG-r12,
  SecurityAlgorithmConfig,
  SCellIndex-r10,
  SCellToReleaseList-r10,
  ServCellIndex-r10,
  ShortMAC-I,
  SystemInformationBlockType1,
  SystemInformationBlockType1-v890-IEs,
  SystemInformationBlockType2,
  UEAssistanceInformation-r11,
  UECapabilityInformation,
  UE-CapabilityRAT-ContainerList,
  UE-RadioPagingInfo-r12,
  WLAN-OffloadConfig-r12
FROM EUTRA-RRC-Definitions;

-- ASN1STOP

```

10.2.2 Message definitions

– *HandoverCommand*

This message is used to transfer the handover command generated by the target eNB.

Direction: target eNB to source eNB/ source RAN

***HandoverCommand* message**

```

-- ASN1START
HandoverCommand ::=
  criticalExtensions
    c1
      handoverCommand-r8
      spare7 NULL,
      spare6 NULL, spare5 NULL, spare4 NULL,
      spare3 NULL, spare2 NULL, spare1 NULL
    },
  criticalExtensionsFuture
    SEQUENCE {}
  }
}

```

```

HandoverCommand-r8-IEs ::= SEQUENCE {
    handoverCommandMessage OCTET STRING (CONTAINING DL-DCCH-Message),
    nonCriticalExtension SEQUENCE {} OPTIONAL
}
-- ASN1STOP

```

HandoverCommand field descriptions

handoverCommandMessage

Contains the entire DL-DCCH-Message including the *RRConnectionReconfiguration* message used to perform handover within E-UTRAN or handover to E-UTRAN, generated (entirely) by the target eNB.

NOTE: The source BSC, in case of inter-RAT handover from GERAN to E-UTRAN, expects that the HandoverCommand message includes DL-DCCH-Message only. Thus, criticalExtensionsFuture, spare1-spare7 and nonCriticalExtension should not be used regardless whether the source RAT is E-UTRAN, UTRAN or GERAN.

– **HandoverPreparationInformation**

This message is used to transfer the E-UTRA RRC information used by the target eNB during handover preparation, including UE capability information.

Direction: source eNB/ source RAN to target eNB

HandoverPreparationInformation message

```

-- ASN1START
HandoverPreparationInformation ::= SEQUENCE {
    criticalExtensions CHOICE {
        c1 CHOICE {
            handoverPreparationInformation-r8 HandoverPreparationInformation-r8-IEs,
            spare7 NULL,
            spare6 NULL, spare5 NULL, spare4 NULL,
            spare3 NULL, spare2 NULL, spare1 NULL
        },
        criticalExtensionsFuture SEQUENCE {}
    }
}

HandoverPreparationInformation-r8-IEs ::= SEQUENCE {
    ue-RadioAccessCapabilityInfo UE-CapabilityRAT-ContainerList,
    as-Config AS-Config OPTIONAL, -- Cond HO
    rrm-Config RRM-Config OPTIONAL,
    as-Context AS-Context OPTIONAL, -- Cond HO
    nonCriticalExtension HandoverPreparationInformation-v920-IEs OPTIONAL
}

HandoverPreparationInformation-v920-IEs ::= SEQUENCE {
    ue-ConfigRelease-r9 ENUMERATED {
        rel9, rel10, rel11, rel12, v10j0, v11e0,
        v1280, spare1, ...} OPTIONAL, -- Cond HO2
    nonCriticalExtension HandoverPreparationInformation-v9d0-IEs OPTIONAL
}

HandoverPreparationInformation-v9d0-IEs ::= SEQUENCE {
    lateNonCriticalExtension OCTET STRING (CONTAINING HandoverPreparationInformation-
v9j0-IEs) OPTIONAL,
    nonCriticalExtension HandoverPreparationInformation-v9e0-IEs OPTIONAL
}

-- Late non-critical extensions:
HandoverPreparationInformation-v9j0-IEs ::= SEQUENCE {
    -- Following field is only for pre REL-10 late non-critical extensions
    lateNonCriticalExtension OCTET STRING OPTIONAL,
    nonCriticalExtension HandoverPreparationInformation-v10j0-IEs OPTIONAL
}

HandoverPreparationInformation-v10j0-IEs ::= SEQUENCE {
    as-Config-v10j0 AS-Config-v10j0 OPTIONAL,
    -- Following field is only for late non-critical extensions from REL-10

```

```

    nonCriticalExtension          SEQUENCE {}          OPTIONAL
  }

-- Regular non-critical extensions:
HandoverPreparationInformation-v9e0-IEs ::= SEQUENCE {
    as-Config-v9e0              AS-Config-v9e0          OPTIONAL,    -- Cond HO2
    nonCriticalExtension        HandoverPreparationInformation-v1130-IEs  OPTIONAL
}

HandoverPreparationInformation-v1130-IEs ::= SEQUENCE {
    as-Context-v1130           AS-Context-v1130          OPTIONAL,    -- Cond HO2
    nonCriticalExtension        HandoverPreparationInformation-v1250-IEs
    OPTIONAL
}

HandoverPreparationInformation-v1250-IEs ::= SEQUENCE {
    ue-SupportedEARFCN-r12     ARFCN-ValueEUTRA-r9          OPTIONAL,    -- Cond HO3
    as-Config-v1250            AS-Config-v1250          OPTIONAL,    -- Cond HO2
    nonCriticalExtension        SEQUENCE {}          OPTIONAL
}

-- ASN1STOP

```

HandoverPreparationInformation field descriptions

as-Config

The radio resource configuration. Applicable in case of intra-E-UTRA handover. If the target receives an incomplete *MeasConfig* and *RadioResourceConfigDedicated* in the *as-Config*, the target eNB may decide to apply the full configuration option based on the *ue-ConfigRelease*.

as-Context

Local E-UTRAN context required by the target eNB.

rrm-Config

Local E-UTRAN context used depending on the target node's implementation, which is mainly used for the RRM purpose.

ue-ConfigRelease

Indicates the RRC protocol release or version applicable for the current UE configuration. This could be used by target eNB to decide if the full configuration approach should be used. If this field is not present, the target assumes that the current UE configuration is based on the release 8 version of RRC protocol. NOTE 1.

ue-RadioAccessCapabilityInfo

NOTE 2

ue-SupportedEARFCN

Includes UE supported EARFCN of the handover target E-UTRA cell if the target E-UTRA cell belongs to multiple frequency bands.

NOTE 1: The source typically sets the *ue-ConfigRelease* to the release corresponding with the current dedicated radio configuration. The source may however also consider the common radio resource configuration e.g. in case interoperability problems would appear if the UE temporary continues extensions of this part of the configuration in a target PCell not supporting them.

NOTE 2: The following table indicates per source RAT whether RAT capabilities are included or not.

Source RAT	E-UTRA capabilities	UTRA capabilities	GERAN capabilities
UTRAN	Included	May be included, ignored by eNB if received	May be included
GERAN CS	Excluded	May be included, ignored by eNB if received	Included
GERAN PS	Excluded	May be included, ignored by eNB if received	Included
E-UTRAN	Included	May be included	May be included

Conditional presence	Explanation
HO	The field is mandatory present in case of handover within E-UTRA; otherwise the field is not present.
HO2	The field is optional present in case of handover within E-UTRA; otherwise the field is not present.
HO3	The field is optional present in case of handover from GERAN to E-UTRA, otherwise the field is not present.

– SCG-Config

This message is used to transfer the SCG radio configuration generated by the SeNB.

Direction: Secondary eNB to master eNB

SCG-Config message

```
-- ASN1START
SCG-Config-r12 ::=
    SEQUENCE {
        criticalExtensions
            CHOICE {
                c1
                    CHOICE {
                        scg-Config-r12
                        spare7 NULL,
                        spare6 NULL, spare5 NULL, spare4 NULL,
                        spare3 NULL, spare2 NULL, spare1 NULL
                    },
                criticalExtensionsFuture
                    SEQUENCE {}
            }
    }

SCG-Config-r12-IEs ::=
    SEQUENCE {
        scg-RadioConfig-r12
            SCG-ConfigPartSCG-r12
            OPTIONAL,
        nonCriticalExtension
            SEQUENCE {}
            OPTIONAL
    }
-- ASN1STOP
```

SCG-Config field descriptions

scg-RadioConfig-r12

Includes the change of the dedicated SCG configuration and, upon addition of an SCG cell, the common SCG configuration.

The SeNB only includes a new SCG cell in response to a request from MeNB, but may include release of an SCG cell release or release of the SCG part of an SCG/Split DRB without prior request from MeNB. The SeNB does not use this field to initiate release of the SCG.

– SCG-ConfigInfo

This message is used by MeNB to request the SeNB to perform certain actions e.g. to establish, modify or release an SCG, and it may include additional information e.g. to assist the SeNB with assigning the SCG configuration.

Direction: Master eNB to secondary eNB

SCG-ConfigInfo message

```
-- ASN1START
SCG-ConfigInfo-r12 ::=
    SEQUENCE {
        criticalExtensions
            CHOICE {
                c1
                    CHOICE {
                        scg-ConfigInfo-r12
                        spare7 NULL,
                        spare6 NULL, spare5 NULL, spare4 NULL,
                        spare3 NULL, spare2 NULL, spare1 NULL
                    },
                criticalExtensionsFuture
                    SEQUENCE {}
            }
    }

SCG-ConfigInfo-r12-IEs ::=
    SEQUENCE {
```

```

radioResourceConfigDedMCG-r12      RadioResourceConfigDedicated      OPTIONAL,
sCellToAddModListMCG-r12           SCellToAddModList-r10              OPTIONAL,
measGapConfig-r12                  MeasGapConfig                      OPTIONAL,
powerCoordinationInfo-r12          PowerCoordinationInfo-r12          OPTIONAL,
scg-RadioConfig-r12                SCG-ConfigPartSCG-r12             OPTIONAL,
eutra-CapabilityInfo-r12           OCTET STRING (CONTAINING UECapabilityInformation)  OPTIONAL,
scg-ConfigRestrictInfo-r12        SCG-ConfigRestrictInfo-r12        OPTIONAL,
mbmsInterestIndication-r12        OCTET STRING (CONTAINING
                                     MBMSInterestIndication-r11)  OPTIONAL,
measResultServCellListSCG-r12     MeasResultServCellListSCG-r12     OPTIONAL,
drb-ToAddModListSCG-r12           DRB-InfoListSCG-r12               OPTIONAL,
drb-ToReleaseListSCG-r12          DRB-ToReleaseList                 OPTIONAL,
sCellToAddModListSCG-r12          SCellToAddModListSCG-r12          OPTIONAL,
sCellToReleaseListSCG-r12         SCellToReleaseList-r10            OPTIONAL,
p-Max-r12                          P-Max                              OPTIONAL,
nonCriticalExtension                SEQUENCE {}                       OPTIONAL
}

DRB-InfoListSCG-r12 ::=            SEQUENCE (SIZE (1..maxDRB)) OF DRB-InfoSCG-r12

DRB-InfoSCG-r12 ::=                SEQUENCE {
  eps-BearerIdentity-r12           INTEGER (0..15)                   OPTIONAL,  -- Cond DRB-Setup
  drb-Identity-r12                 DRB-Identity,                    OPTIONAL,
  drb-Type-r12                     ENUMERATED {split, scg}          OPTIONAL,  -- Cond DRB-Setup
  ...
}

SCellToAddModListSCG-r12 ::=      SEQUENCE (SIZE (1..maxSCell-r10)) OF Cell-ToAddMod-r12

Cell-ToAddMod-r12 ::=              SEQUENCE {
  sCellIndex-r12                   SCellIndex-r10,
  cellIdentification-r12           SEQUENCE {
    physCellId-r12                 PhysCellId,
    dl-CarrierFreq-r12             ARFCN-ValueEUTRA-r9
  }
  measResultCellToAdd-r12          SEQUENCE {
    rsrpResult-r12                 RSRP-Range,
    rsrqResult-r12                 RSRQ-Range
  }
  ...
}
OPTIONAL,  -- Cond SCellAdd
OPTIONAL,  -- Cond SCellAdd2

MeasResultServCellListSCG-r12 ::= SEQUENCE (SIZE (1..maxServCell-r10)) OF MeasResultServCellSCG-
r12

MeasResultServCellSCG-r12 ::=      SEQUENCE {
  servCellId-r12                   ServCellIndex-r10,
  measResultSCell-r12              SEQUENCE {
    rsrpResultSCell-r12            RSRP-Range,
    rsrqResultSCell-r12            RSRQ-Range
  },
  ...
}

SCG-ConfigRestrictInfo-r12 ::=    SEQUENCE {
  maxSCH-TB-BitsDL-r12             INTEGER (1..100),
  maxSCH-TB-BitsUL-r12             INTEGER (1..100)
}

-- ASN1STOP

```

SCG-ConfigInfo field descriptions
drb-ToAddModListSCG Includes DRBs the SeNB is requested to establish or modify (DRB type change).
drb-ToReleaseListSCG Includes DRBs the SeNB is requested to release.
maxSCH-TB-BitsXL Indicates the maximum DL-SCH/UL-SCH TB bits that may be scheduled in a TTI. Specified as a percentage of the value defined for the applicable UE category.
measGapConfig Includes the current measurement gap configuration.
measResultServCellListSCG Includes measurement results of SCG (serving) cells.
radioResourceConfigDedMCG Includes the current dedicated MCG radio resource configuration.
sCellToAddModListMCG Includes the current MCG SCell configuration.
sCellToAddModListSCG Includes SCG cells the SeNB is requested to establish. Measurement results may be provided for these cells.
sCellToReleaseListSCG Includes SCG cells the SeNB is requested to release.
scg-RadioConfig Includes the current dedicated SCG configuration.
scg-ConfigRestrictInfo Includes fields for which MeNB explicitly indicates the restriction to be observed by SeNB.
p-Max Cell specific value i.e. as broadcast by PCell.

Conditional presence	Explanation
<i>DRB-Setup</i>	The field is mandatory present in case DRB establishment is requested; otherwise the field is not present.
<i>SCellAdd</i>	The field is mandatory present in case SCG cell establishment is requested; otherwise the field is not present.
<i>SCellAdd2</i>	The field is optional present in case SCG cell establishment is requested; otherwise the field is not present.

– *UERadioAccessCapabilityInformation*

This message is used to transfer UE radio access capability information, covering both upload to and download from the EPC.

Direction: eNB to/ from EPC

***UERadioAccessCapabilityInformation* message**

```

-- ASN1START
UERadioAccessCapabilityInformation ::= SEQUENCE {
    criticalExtensions          CHOICE {
        c1                     CHOICE {
            ueRadioAccessCapabilityInformation-r8
                                UERadioAccessCapabilityInformation-r8-IEs,
            spare7 NULL,
            spare6 NULL, spare5 NULL, spare4 NULL,
            spare3 NULL, spare2 NULL, spare1 NULL
        },
        criticalExtensionsFuture SEQUENCE {}
    }
}

UERadioAccessCapabilityInformation-r8-IEs ::= SEQUENCE {
    ue-RadioAccessCapabilityInfo OCTET STRING (CONTAINING UECapabilityInformation),
    nonCriticalExtension         SEQUENCE {} OPTIONAL
}
-- ASN1STOP

```

UERadioAccessCapabilityInformation field descriptions**ue-RadioAccessCapabilityInfo**

Including E-UTRA, GERAN, and CDMA2000-1xRTT Bandclass radio access capabilities (separated). UTRA radio access capabilities are not included.

UERadioPagingInformation

This message is used to transfer radio paging information required for a category 0 UE, covering both upload to and download from the EPC.

Direction: eNB to/ from EPC

UERadioPagingInformation message

```
-- ASN1START
UERadioPagingInformation ::= SEQUENCE {
    criticalExtensions          CHOICE {
        c1                     CHOICE {
            ueRadioPagingInformation-r12          UERadioPagingInformation-r12-IEs,
            spare7 NULL,
            spare6 NULL, spare5 NULL, spare4 NULL,
            spare3 NULL, spare2 NULL, spare1 NULL
        },
        criticalExtensionsFuture          SEQUENCE {}
    }
}

UERadioPagingInformation-r12-IEs ::= SEQUENCE {
    ue-RadioPagingInfo-r12          OCTET STRING (CONTAINING UE-RadioPagingInfo-r12),
    nonCriticalExtension            SEQUENCE {} OPTIONAL
}
-- ASN1STOP
```

10.3 Inter-node RRC information element definitions

AS-Config

The *AS-Config* IE contains information about RRC configuration information in the source eNB which can be utilized by target eNB to determine the need to change the RRC configuration during the handover preparation phase. The information can also be used after the handover is successfully performed or during the RRC connection re-establishment.

AS-Config information element

```
-- ASN1START
AS-Config ::= SEQUENCE {
    sourceMeasConfig          MeasConfig,
    sourceRadioResourceConfig          RadioResourceConfigDedicated,
    sourceSecurityAlgorithmConfig          SecurityAlgorithmConfig,
    sourceUE-Identity          C-RNTI,
    sourceMasterInformationBlock          MasterInformationBlock,
    sourceSystemInformationBlockType1          SystemInformationBlockType1(WITH COMPONENTS
        {..., nonCriticalExtension ABSENT}),
    sourceSystemInformationBlockType2          SystemInformationBlockType2,
    antennaInfoCommon          AntennaInfoCommon,
    sourceDl-CarrierFreq          ARFCN-ValueEUTRA,
    ...,
    [[ sourceSystemInformationBlockType1Ext          OCTET STRING (CONTAINING
        SystemInformationBlockType1-v890-IEs) OPTIONAL,
        sourceOtherConfig-r9          OtherConfig-r9
    -- sourceOtherConfig-r9 should have been optional. A target eNB compliant with this transfer
    -- syntax should support receiving an AS-Config not including this extension addition group
    -- e.g. from a legacy source eNB
    ]],
    [[ sourceSCellConfigList-r10          SCellToAddModList-r10          OPTIONAL
    ]],
    [[ sourceConfigSCG-r12          SCG-Config-r12          OPTIONAL
    ]]
```

```

]]
}
AS-Config-v9e0 ::= SEQUENCE {
    sourceDL-CarrierFreq-v9e0 ARFCN-ValueEUTRA-v9e0
}
AS-Config-v10j0 ::= SEQUENCE {
    antennaInfoDedicatedPCell-v10i0 AntennaInfoDedicated-v10i0 OPTIONAL
}
AS-Config-v1250 ::= SEQUENCE {
    sourceWlan-OffloadConfig-r12 WLAN-OffloadConfig-r12 OPTIONAL,
    sourceSL-CommConfig-r12 SL-CommConfig-r12 OPTIONAL,
    sourceSL-DiscConfig-r12 SL-DiscConfig-r12 OPTIONAL
}
-- ASN1STOP

```

NOTE: The *AS-Config* re-uses information elements primarily created to cover the radio interface signalling requirements. Consequently, the information elements may include some parameters that are not relevant for the target eNB e.g. the SFN as included in the *MasterInformationBlock*.

AS-Config field descriptions
antennaInfoCommon This field provides information about the number of antenna ports in the source PCell.
sourceDL-CarrierFreq Provides the parameter Downlink EARFCN in the source PCell, see TS 36.101 [42]. If the source eNB provides <i>AS-Config-v9e0</i> , it sets <i>sourceDL-CarrierFreq</i> (i.e. without suffix) to <i>maxEARFCN</i> .
sourceOtherConfig Provides other configuration in the source PCell.
sourceMasterInformationBlock <i>MasterInformationBlock</i> transmitted in the source PCell.
sourceMeasConfig Measurement configuration in the source cell. The measurement configuration for all measurements existing in the source eNB when handover is triggered shall be included. See 10.5.
sourceSL-CommConfig This field covers the sidelink communication configuration.
sourceSL-DiscConfig This field covers the sidelink discovery configuration.
sourceRadioResourceConfig Radio configuration in the source PCell. The radio resource configuration for all radio bearers existing in the source PCell when handover is triggered shall be included. See 10.5.
sourceSCellConfigList Radio resource configuration (common and dedicated) of the SCells configured in the source eNB.
sourceSecurityAlgorithmConfig This field provides the AS integrity protection (SRBs) and AS ciphering (SRBs and DRBs) algorithm configuration used in the source PCell.
sourceSystemInformationBlockType1 <i>SystemInformationBlockType1</i> transmitted in the source PCell.
sourceSystemInformationBlockType2 <i>SystemInformationBlockType2</i> transmitted in the source PCell.

– AS-Context

The IE *AS-Context* is used to transfer local E-UTRAN context required by the target eNB.

AS-Context information element

```

-- ASN1START
AS-Context ::= SEQUENCE {
    reestablishmentInfo ReestablishmentInfo OPTIONAL -- Cond HO
}
AS-Context-v1130 ::= SEQUENCE {

```

```

idc-Indication-r11          OCTET STRING (CONTAINING
                             InDeviceCoexIndication-r11) OPTIONAL, -- Cond HO2
mbmsInterestIndication-r11 OCTET STRING (CONTAINING
                             MBMSInterestIndication-r11) OPTIONAL, -- Cond HO2
powerPrefIndication-r11    OCTET STRING (CONTAINING
                             UEAssistanceInformation-r11)   OPTIONAL, -- Cond HO2
...
[[ sidelinkUEInformation-r12 OCTET STRING (CONTAINING
                             SidelinkUEInformation-r12)   OPTIONAL  -- Cond HO2
]]
}
-- ASN1STOP

```

AS-Context field descriptions

idc-Indication

Including information used for handling the IDC problems.

reestablishmentInfo

Including information needed for the RRC connection re-establishment.

Conditional presence	Explanation
<i>HO</i>	The field is mandatory present in case of handover within E-UTRA; otherwise the field is not present.
<i>HO2</i>	The field is optional present in case of handover within E-UTRA; otherwise the field is not present.

ReestablishmentInfo

The *ReestablishmentInfo* IE contains information needed for the RRC connection re-establishment.

ReestablishmentInfo information element

```

-- ASN1START
ReestablishmentInfo ::=          SEQUENCE {
    sourcePhysCellId             PhysCellId,
    targetCellShortMAC-I         ShortMAC-I,
    additionalReestabInfoList    AdditionalReestabInfoList           OPTIONAL,
    ...
}
AdditionalReestabInfoList ::=    SEQUENCE ( SIZE (1..maxReestabInfo) ) OF AdditionalReestabInfo
AdditionalReestabInfo ::=        SEQUENCE{
    cellIdentity                 CellIdentity,
    key-eNodeB-Star              Key-eNodeB-Star,
    shortMAC-I                   ShortMAC-I
}
Key-eNodeB-Star ::=             BIT STRING (SIZE (256))
-- ASN1STOP

```

ReestablishmentInfo field descriptions

additionalReestabInfoList

Contains a list of shortMAC-I and KeNB* for cells under control of the target eNB, required for potential re-establishment by the UE in these cells to succeed.

Key-eNodeB-Star

Parameter KeNB*: See TS 33.401 [32, 7.2.8.4]. If the cell identified by *cellIdentity* belongs to multiple frequency bands, the source eNB selects the DL-EARFCN for the KeNB* calculation using the same logic as UE uses when selecting the DL-EARFCN in IDLE as defined in section 6.2.2. This parameter is only used for X2 handover, and for S1 handover, it shall be ignored by target eNB.

sourcePhyCellId

The physical cell identity of the source PCell, used to determine the UE context in the target eNB at re-establishment.

targetCellShortMAC-I

The ShortMAC-I for the handover target PCell, in order for potential re-establishment to succeed.

– RRM-Config

The *RRM-Config* IE contains information about UE specific RRM information before the handover which can be utilized by target eNB.

RRM-Config information element

```
-- ASN1START
RRM-Config ::=
  ue-InactiveTime
  SEQUENCE {
    ENUMERATED {
      s1, s2, s3, s5, s7, s10, s15, s20,
      s25, s30, s40, s50, min1, min1s20c, min1s40,
      min2, min2s30, min3, min3s30, min4, min5, min6,
      min7, min8, min9, min10, min12, min14, min17, min20,
      min24, min28, min33, min38, min44, min50, hr1,
      hr1min30, hr2, hr2min30, hr3, hr3min30, hr4, hr5, hr6,
      hr8, hr10, hr13, hr16, hr20, day1, day1hr12, day2,
      day2hr12, day3, day4, day5, day7, day10, day14, day19,
      day24, day30, dayMoreThan30} OPTIONAL,
    ...,
    [[ candidateCellInfoList-r10 CandidateCellInfoList-r10 OPTIONAL
    ]]
  }
CandidateCellInfoList-r10 ::= SEQUENCE (SIZE (1..maxFreq)) OF CandidateCellInfo-r10
CandidateCellInfo-r10 ::= SEQUENCE {
  -- cellIdentification
  physCellId-r10 PhysCellId,
  dl-CarrierFreq-r10 ARFCN-ValueEUTRA,
  -- available measurement results
  rsrpResult-r10 RSRP-Range OPTIONAL,
  rsrqResult-r10 RSRQ-Range OPTIONAL,
  ...,
  [[ dl-CarrierFreq-v1090 ARFCN-ValueEUTRA-v9e0 OPTIONAL
  ]],
  [[ rsrqResult-v1250 RSRQ-Range-v1250 OPTIONAL
  ]]
}
-- ASN1STOP
```

RRM-Config field descriptions

candidateCellInfoList

A list of the best cells on each frequency for which measurement information was available, in order of decreasing RSRP.

dl-CarrierFreq

The source includes *dl-CarrierFreq-v1090* if and only if *dl-CarrierFreq-r10* is set to *maxEARFCN*.

ue-InactiveTime

Duration while UE has not received or transmitted any user data. Thus the timer is still running in case e.g., UE measures the neighbour cells for the HO purpose. Value *s1* corresponds to 1 second, *s2* corresponds to 2 seconds and so on. Value *min1* corresponds to 1 minute, value *min1s20* corresponds to 1 minute and 20 seconds, value *min1s40* corresponds to 1 minute and 40 seconds and so on. Value *hr1* corresponds to 1 hour, *hr1min30* corresponds to 1 hour and 30 minutes and so on.

10.4 Inter-node RRC multiplicity and type constraint values

– Multiplicity and type constraints definitions

```
-- ASN1START
maxReestabInfo INTEGER ::= 32 -- Maximum number of KeNB* and shortMAC-I forwarded
-- at handover for re-establishment preparation
-- ASN1STOP
```

– End of *EUTRA-InterNodeDefinitions*

```
-- ASN1START
END
-- ASN1STOP
```

10.5 Mandatory information in *AS-Config*

The *AS-Config* transferred between source eNB and target-eNB shall include all IEs necessary to describe the AS context. The conditional presence in section 6 is only applicable for eNB to UE communication.

The "need" or "cond" statements are not applied in case of sending the IEs from source eNB to target eNB. Some information elements shall be included regardless of the "need" or "cond" e.g. *discardTimer*. The *AS-Config* re-uses information elements primarily created to cover the radio interface signalling requirements. The information elements may include some parameters that are not relevant for the target eNB e.g. the SFN as included in the *MasterInformationBlock*.

All the fields in the *AS-Config* as defined in 10.3 that are introduced after v9.2.0 and that are optional for eNB to UE communication shall be included, if the functionality is configured. The fields in the *AS-Config* that are defined before and including v9.2.0 shall be included as specified in the following.

Within the *sourceRadioResourceConfig*, *sourceMeasConfig* and *sourceOtherConfig*, the source eNB shall include fields that are optional for eNB to UE communication, if the functionality is configured unless explicitly specified otherwise in the following:

- in accordance with a condition that is explicitly stated to be applicable; or
- a default value is defined for the concerned field; and the configured value is the same as the default value that is defined; or
- the need of the field is OP and the current UE configuration corresponds with the behaviour defined for absence of the field;

The following fields, if the functionality is configured, are not mandatory for the source eNB to include in the *AS-Config* since delta signalling by the target eNB for these fields is not supported:

- *semiPersistSchedC-RNTI*
- *measGapConfig*

For the measurement configuration, a corresponding operation as 5.5.6.1 and 5.5.2.2a is executed by target eNB.

11 UE capability related constraints and performance requirements

11.1 UE capability related constraints

The following table lists constraints regarding the UE capabilities that E-UTRAN is assumed to take into account.

Parameter	Description	Value
#DRBs	The number of DRBs that a UE shall support	8
#RLC-AM	The number of RLC AM entities that a UE shall support	10
#minCellperMeasObjectEUTRA	The minimum number of neighbour cells (excluding black list cells) that a UE shall be able to store within a MeasObjectEUTRA. NOTE.	32
#minBlackCellRangesperMeasObjectEUTRA	The minimum number of blacklist cell PCI ranges that a UE shall be able to store within a MeasObjectEUTRA	32
#minCellperMeasObjectUTRA	The minimum number of neighbour cells that a UE shall be able to store within a MeasObjectUTRA. NOTE.	32
#minCellperMeasObjectGERAN	The minimum number of neighbour cells that a UE shall be able to store within a measObjectGERAN. NOTE.	32
#minCellperMeasObjectCDMA2000	The minimum number of neighbour cells that a UE shall be able to store within a measObjectCDMA2000. NOTE.	32
#minCellTotal	The minimum number of neighbour cells (excluding black list cells) that UE shall be able to store in total in all measurement objects configured	256
NOTE:	In case of CGI reporting, the limit regarding the cells E-UTRAN can configure includes the cell for which the UE is requested to report CGI i.e. the amount of neighbour cells that can be included is at most (# minCellperMeasObjectRAT - 1), where RAT represents EUTRA/UTRA/GERAN/CDMA2000 respectively.	

11.2 Processing delay requirements for RRC procedures

The UE performance requirements for RRC procedures are specified in the following table, by means of a value N:

N = the number of 1ms subframes from the end of reception of the E-UTRAN -> UE message on the UE physical layer up to when the UE shall be ready for the reception of uplink grant for the UE -> E-UTRAN response message with no access delay other than the TTI-alignment (e.g. excluding delays caused by scheduling, the random access procedure or physical layer synchronisation).

NOTE: No processing delay requirements are specified for RN-specific procedures.

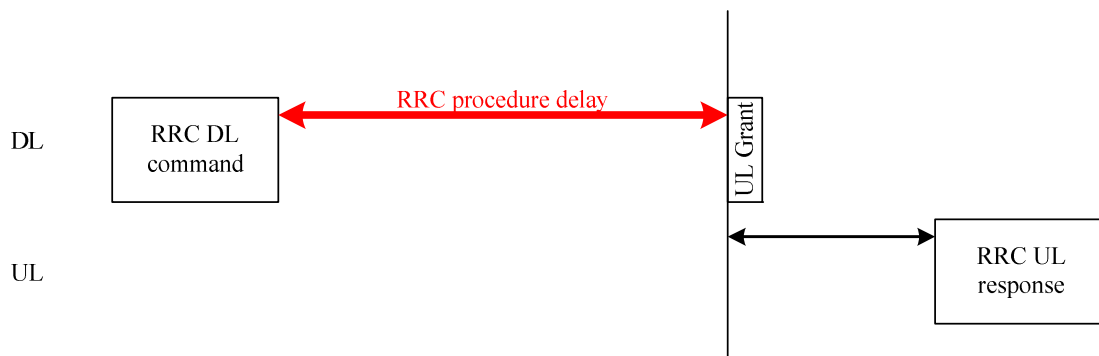

Figure 11.2-1: Illustration of RRC procedure delay

Procedure title:	E-UTRAN -> UE	UE -> E-UTRAN	N	Notes
RRC Connection Control Procedures				
RRC connection establishment	<i>RRCCConnectionSetup</i>	<i>RRCCConnectionSetupComplete</i>	15	
RRC connection release	<i>RRCCConnectionRelease</i>		NA	
RRC connection re-configuration (radio resource configuration)	<i>RRCCConnectionReconfiguration</i>	<i>RRCCConnectionReconfigurationComplete</i>	15	
RRC connection re-configuration (measurement configuration)	<i>RRCCConnectionReconfiguration</i>	<i>RRCCConnectionReconfigurationComplete</i>	15	
RRC connection re-configuration (intra-LTE mobility)	<i>RRCCConnectionReconfiguration</i>	<i>RRCCConnectionReconfigurationComplete</i>	15	
RRC connection reconfiguration (SCell addition/release)	<i>RRCCConnectionReconfiguration</i>	<i>RRCCConnectionReconfigurationComplete</i>	20	
RRC connection reconfiguration (SCG establishment/ release, SCG cell addition/ release)	<i>RRCCConnectionReconfiguration</i>	<i>RRCCConnectionReconfigurationComplete</i>	20	
RRC connection re-establishment	<i>RRCCConnectionReestablishment</i>	<i>RRCCConnectionReestablishmentComplete</i>	15	
Initial security activation	<i>SecurityModeCommand</i>	<i>SecurityModeCommandComplete/SecurityModeCommandFailure</i>	10	
Initial security activation + RRC connection re-configuration (RB establishment)	<i>SecurityModeCommand, RRCCConnectionReconfiguration</i>	<i>RRCCConnectionReconfigurationComplete</i>	20	The two DL messages are transmitted in the same TTI
Paging	<i>Paging</i>		NA	
Inter RAT mobility				
Handover to E-UTRA	<i>RRCCConnectionReconfiguration (sent by other RAT)</i>	<i>RRCCConnectionReconfigurationComplete</i>	NA	The performance of this procedure is specified in [50] in case of handover from GSM and [29], [30] in case of handover from UTRA.
Handover from E-UTRA	<i>MobilityFromEUTRACommand</i>		NA	The performance of this procedure is specified in [16]
Handover from E-UTRA to CDMA2000	<i>HandoverFromEUTRAPreparationRequest (CDMA2000)</i>		NA	Used to trigger the handover preparation procedure with a CDMA2000 RAT. The performance of this procedure is specified in [16]
Measurement procedures				
Measurement Reporting		<i>MeasurementReport</i>	NA	
Other procedures				
UE capability transfer	<i>UECapabilityEnquiry</i>	<i>UECapabilityInformation</i>	10	
Counter check	<i>CounterCheck</i>	<i>CounterCheckResponse</i>	10	
Proximity indication		<i>ProximityIndication</i>	NA	

Procedure title:	E-UTRAN -> UE	UE -> E-UTRAN	N	Notes
UE information	<i>UEInformationRequest</i>	<i>UEInformationResponse</i>	15	
MBMS counting	<i>MBMSCountingRequest</i>	<i>MBMSCountingResponse</i>	NA	
MBMS interest indication		<i>MBMSInterestIndication</i>	NA	
In-device coexistence indication		<i>InDeviceCoexIndication</i>	NA	
UE assistance information		<i>UEAssistanceInformation</i>	NA	
SCG failure information		<i>SCGFailureInformation</i>	NA	
Sidelink UE information		<i>SidelinkUEInformation</i>	NA	

11.3 Void

Annex A (informative): Guidelines, mainly on use of ASN.1

Editor's note No agreements have been reached concerning the extension of RRC PDUs so far. Any statements in this section about the protocol extension mechanism should be considered as FFS.

A.1 Introduction

The following clauses contain guidelines for the specification of RRC protocol data units (PDUs) with ASN.1.

A.2 Procedural specification

A.2.1 General principles

The procedural specification provides an overall high level description regarding the UE behaviour in a particular scenario.

It should be noted that most of the UE behaviour associated with the reception of a particular field is covered by the applicable parts of the PDU specification. The procedural specification may also include specific details of the UE behaviour upon reception of a field, but typically this should be done only for cases that are not easy to capture in the PDU section e.g. general actions, more complicated actions depending on the value of multiple fields.

Likewise, the procedural specification need not specify the UE requirements regarding the setting of fields within the messages that are sent to E-UTRAN i.e. this may also be covered by the PDU specification.

A.2.2 More detailed aspects

The following more detailed conventions should be used:

- Bullets:
 - Capitals should be used in the same manner as in other parts of the procedural text i.e. in most cases no capital applies since the bullets are part of the sentence starting with 'The UE shall:'
 - All bullets, including the last one in a sub-clause, should end with a semi-colon i.e. an ';'.
 - Conditions
 - Whenever multiple conditions apply, a semi-colon should be used at the end of each conditions with the exception of the last one, i.e. as in 'if cond1; or cond2:'
-

A.3 PDU specification

A.3.1 General principles

A.3.1.1 ASN.1 sections

The RRC PDU contents are formally and completely described using abstract syntax notation (ASN.1), see X.680 [13], X.681 (02/2002) [14].

The complete ASN.1 code is divided into a number of ASN.1 sections in the specifications. In order to facilitate the extraction of the complete ASN.1 code from the specification, each ASN.1 section begins with a text paragraph consisting entirely of an *ASN.1 start tag*, which consists of a double hyphen followed by a single space and the text string "ASN1START" (in all upper case letters). Each ASN.1 section ends with a text paragraph consisting entirely of an *ASN.1 stop tag*, which consists of a double hyphen followed by a single space and the text "ASN1STOP" (in all upper case letters):

```
-- ASN1START
```

```
-- ASN1STOP
```

The text paragraphs containing the ASN.1 start and stop tags should not contain any ASN.1 code significant for the complete description of the RRC PDU contents. The complete ASN.1 code may be extracted by copying all the text paragraphs between an ASN.1 start tag and the following ASN.1 stop tag in the order they appear, throughout the specification.

NOTE: A typical procedure for extraction of the complete ASN.1 code consists of a first step where the entire RRC PDU contents description (ultimately the entire specification) is saved into a plain text (ASCII) file format, followed by a second step where the actual extraction takes place, based on the occurrence of the ASN.1 start and stop tags.

A.3.1.2 ASN.1 identifier naming conventions

The naming of identifiers (i.e., the ASN.1 field and type identifiers) should be based on the following guidelines:

- Message (PDU) identifiers should be ordinary mixed case without hyphenation. These identifiers, e.g., the *RRCConnectionModificationCommand*, should be used for reference in the procedure text. Abbreviated forms of these identifiers should not be used.
- Type identifiers other than PDU identifiers should be ordinary mixed case, with hyphenation used to set off acronyms only where an adjacent letter is a capital, e.g., *EstablishmentCause*, *SelectedPLMN* (not *Selected-PLMN*, since the "d" in "Selected" is lowercase), *InitialUE-Identity* and *MeasSFN-SFN-TimeDifference*.
- Field identifiers shall start with a lowercase letter and use mixed case thereafter, e.g., *establishmentCause*. If a field identifier begins with an acronym (which would normally be in upper case), the entire acronym is lowercase (*plmn-Identity*, not *pLMN-Identity*). The acronym is set off with a hyphen (*ue-Identity*, not *ueIdentity*), in order to facilitate a consistent search pattern with corresponding type identifiers.
- Identifiers that are likely to be keywords of some language, especially widely used languages, such as C++ or Java, should be avoided to the extent possible.
- Identifiers, other than PDU identifiers, longer than 25 characters should be avoided where possible. It is recommended to use abbreviations, which should be done in a consistent manner i.e. use 'Meas' instead of 'Measurement' for all occurrences. Examples of typical abbreviations are given in table A.3.1.2.1-1 below.
- *For future extension:* When an extension is introduced a suffix is added to the identifier of the concerned ASN.1 field and/ or type. A suffix of the form "-rX" is used, with X indicating the release, for ASN.1 fields or types introduced in a later release (i.e. a release later than the original/ first release of the protocol) as well as for ASN.1 fields or types for which a revision is introduced in a later release replacing a previous version, e.g., *Foo-r9* for the Rel-9 version of the ASN.1 type *Foo*. A suffix of the form "-rXb" is used for the first revision of a field that it appears in the same release (X) as the original version of the field, "-rXc" for a second intra-release revision and so on. A suffix of the form "-vXYZ" is used for ASN.1 fields or types that only are an extension of a corresponding earlier field or type (see sub-clause A.4), e.g., *AnElement-v10b0* for the extension of the ASN.1 type *AnElement* introduced in version 10.11.0 of the specification. A number 0..9, 10, 11, etc. is used to represent the first part of the version number, indicating the release of the protocol. Lower case letters *a*, *b*, *c*, etc. are used to represent the second (and third) part of the version number if they are greater than 9. In the procedural specification, in field descriptions as well as in headings suffices are not used, unless there is a clear need to distinguish the extension from the original field.
- More generally, in case there is a need to distinguish different variants of an ASN.1 field or IE, a suffix should be added at the end of the identifiers e.g. *MeasObjectUTRA*, *ConfigCommon*. When there is no particular need to distinguish the fields (e.g. because the field is included in different IEs), a common field identifier name may be used. This may be attractive e.g. in case the procedural specification is the same for the different variants.

Table A.3.1.2-1: Examples of typical abbreviations used in ASN.1 identifiers

Abbreviation	Abbreviated word
Comm	Communication
Conf	Confirmation
Config	Configuration
Disc	Discovery
DL	Downlink
Ext	Extension
Freq	Frequency
Id	Identity
Ind	Indication
Info	Information
Meas	Measurement
Neigh	Neighbour(ing)
Param(s)	Parameter(s)
Persist	Persistent
Phys	Physical
Proc	Process
Reestab	Reestablishment
Req	Request
Rx	Reception
Sched	Scheduling
Sync	Synchronisation
Thresh	Threshold
Tx/ Transm	Transmission
UL	Uplink

NOTE: The table A.3.1.2.1-1 is not exhaustive. Additional abbreviations may be used in ASN.1 identifiers when needed.

A.3.1.3 Text references using ASN.1 identifiers

A text reference into the RRC PDU contents description from other parts of the specification is made using the ASN.1 field or type identifier of the referenced element. The ASN.1 field and type identifiers used in text references should be in the *italic font style*. The "do not check spelling and grammar" attribute in Word should be set. Quotation marks (i.e., " ") should not be used around the ASN.1 field or type identifier.

A reference to an RRC PDU type should be made using the corresponding ASN.1 type identifier followed by the word "message", e.g., a reference to the *RRCCConnectionRelease* message.

A reference to a specific part of an RRC PDU, or to a specific part of any other ASN.1 type, should be made using the corresponding ASN.1 field identifier followed by the word "field", e.g., a reference to the *prioritisedBitRate* field in the example below.

```
-- /example/ ASN1START
LogicalChannelConfig ::=
    ul-SpecificParameters
        priority
        prioritisedBitRate
        bucketSizeDuration
        logicalChannelGroup
    } OPTIONAL
SEQUENCE {
    SEQUENCE {
        Priority,
        PrioritisedBitRate,
        BucketSizeDuration,
        INTEGER (0..3)
    }
}
-- ASN1STOP
```

NOTE: All the ASN.1 start tags in the ASN.1 sections, used as examples in this annex to the specification, are deliberately distorted, in order not to include them when the ASN.1 description of the RRC PDU contents is extracted from the specification.

A reference to a specific type of information element should be made using the corresponding ASN.1 type identifier preceded by the acronym "IE", e.g., a reference to the IE *LogicalChannelConfig* in the example above.

References to a specific type of information element should only be used when those are generic, i.e., without regard to the particular context wherein the specific type of information element is used. If the reference is related to a particular context, e.g., an RRC PDU type (message) wherein the information element is used, the corresponding field identifier in that context should be used in the text reference.

A reference to a specific value of an ASN.1 field should be made using the corresponding ASN.1 value without using quotation marks around the ASN.1 value, e.g., 'if the *status* field is set to value *true*'.

A.3.2 High-level message structure

Within each logical channel type, the associated RRC PDU (message) types are alternatives within a CHOICE, as shown in the example below.

```
-- /example/ ASN1START

DL-DCCH-Message ::= SEQUENCE {
    message          DL-DCCH-MessageType
}

DL-DCCH-MessageType ::= CHOICE {
    c1               CHOICE {
        dlInformationTransfer                DLInformationTransfer,
        handoverFromEUTRAPreparationRequest HandoverFromEUTRAPreparationRequest,
        mobilityFromEUTRACCommand          MobilityFromEUTRACCommand,
        rrcConnectionReconfiguration       RRCConnectionReconfiguration,
        rrcConnectionRelease               RRCConnectionRelease,
        securityModeCommand                SecurityModeCommand,
        ueCapabilityEnquiry                 UECapabilityEnquiry,
        spare1 NULL
    },
    messageClassExtension SEQUENCE {}
}

-- ASN1STOP
```

A nested two-level CHOICE structure is used, where the alternative PDU types are alternatives within the inner level *c1* CHOICE.

Spare alternatives (i.e., *spare1* in this case) may be included within the *c1* CHOICE to facilitate future extension. The number of such spare alternatives should not extend the total number of alternatives beyond an integer-power-of-two number of alternatives (i.e., eight in this case).

Further extension of the number of alternative PDU types is facilitated using the *messageClassExtension* alternative in the outer level CHOICE.

A.3.3 Message definition

Each PDU (message) type is specified in an ASN.1 section similar to the one shown in the example below.

```
-- /example/ ASN1START

RRCConnectionReconfiguration ::= SEQUENCE {
    rrc-TransactionIdentifier      RRC-TransactionIdentifier,
    criticalExtensions             CHOICE {
        c1                       CHOICE {
            rrcConnectionReconfiguration-r8 RRCConnectionReconfiguration-r8-IEs,
            spare3 NULL, spare2 NULL, spare1 NULL
        },
        criticalExtensionsFuture SEQUENCE {}
    }
}

RRCConnectionReconfiguration-r8-IEs ::= SEQUENCE {
    -- Enter the IEs here.
    ...
}

-- ASN1STOP
```

Hooks for *critical* and *non-critical* extension should normally be included in the PDU type specification. How these hooks are used is further described in sub-clause A.4.

Critical extensions are characterised by a redefinition of the PDU contents and need to be governed by a mechanism for protocol version agreement between the encoder and the decoder of the PDU, such that the encoder is prevented from sending a critically extended version of the PDU type, which is not comprehended by the decoder.

Critical extension of a PDU type is facilitated by a two-level CHOICE structure, where the alternative PDU contents are alternatives within the inner level *c1* CHOICE. Spare alternatives (i.e., *spare3* down to *spare1* in this case) may be included within the *c1* CHOICE. The number of spare alternatives to be included in the original PDU specification should be decided case by case, based on the expected rate of critical extension in the future releases of the protocol.

Further critical extension, when the spare alternatives from the original specifications are used up, is facilitated using the *criticalExtensionsFuture* in the outer level CHOICE.

In PDU types where critical extension is not expected in the future releases of the protocol, the inner level *c1* CHOICE and the spare alternatives may be excluded, as shown in the example below.

```
-- /example/ ASN1START
RRCConnectionReconfigurationComplete ::= SEQUENCE {
    rrc-TransactionIdentifier      RRC-TransactionIdentifier,
    criticalExtensions             CHOICE {
        rrcConnectionReconfigurationComplete-r8
        criticalExtensionsFuture   RRCConnectionReconfigurationComplete-r8-IEs,
    }
}
RRCConnectionReconfigurationComplete-r8-IEs ::= SEQUENCE {
    -- Enter the IEs here. --
    ...
}
-- ASN1STOP
```

Non-critical extensions are characterised by the addition of new information to the original specification of the PDU type. If not comprehended, a non-critical extension may be skipped by the decoder, whilst the decoder is still able to complete the decoding of the comprehended parts of the PDU contents.

Non-critical extensions at locations other than the end of the message or other than at the end of a field contained in a BIT or OCTET STRING are facilitated by use of the ASN.1 extension marker "...". The original specification of a PDU type should normally include the extension marker at the end of the sequence of information elements contained.

Non-critical extensions at the end of the message or at the end of a field that is contained in a BIT or OCTET STRING are facilitated by use of an empty sequence that is marked OPTIONAL e.g. as shown in the following example:

```
-- /example/ ASN1START
RRCMessage-r8-IEs ::=
    SEQUENCE {
        field1          InformationElement1,
        field2          InformationElement2,
        nonCriticalExtension SEQUENCE {} OPTIONAL
    }
-- ASN1STOP
```

The ASN.1 section specifying the contents of a PDU type may be followed by a *field description* table where a further description of, e.g., the semantic properties of the fields may be included. The general format of this table is shown in the example below. The field description table is absent in case there are no fields for which further description needs to be provided e.g. because the PDU does not include any fields, or because an IE is defined for each field while there is nothing specific regarding the use of this IE that needs to be specified.

%PDU-TypeIdentifier% field descriptions
%field identifier% Field description.
%field identifier% Field description.

The field description table has one column. The header row shall contain the ASN.1 type identifier of the PDU type.

The following rows are used to provide field descriptions. Each row shall include a first paragraph with a *field identifier* (in ***bold and italic*** font style) referring to the part of the PDU to which it applies. The following paragraphs at the same row may include (in regular font style), e.g., semantic description, references to other specifications and/ or specification of value units, which are relevant for the particular part of the PDU.

The parts of the PDU contents that do not require a field description shall be omitted from the field description table.

A.3.4 Information elements

Each IE (information element) type is specified in an ASN.1 section similar to the one shown in the example below.

```
-- /example/ ASN1START

PRACH-ConfigSIB ::=          SEQUENCE {
    rootSequenceIndex        INTEGER (0..1023),
    prach-ConfigInfo
}

PRACH-Config ::=            SEQUENCE {
    rootSequenceIndex        INTEGER (0..1023),
    prach-ConfigInfo        PRACH-ConfigInfo OPTIONAL -- Need ON
}

PRACH-ConfigInfo ::=       SEQUENCE {
    prach-ConfigIndex        ENUMERATED {ffs},
    highSpeedFlag            ENUMERATED {ffs},
    zeroCorrelationZoneConfig ENUMERATED {ffs}
}

-- ASN1STOP
```

IEs should be introduced whenever there are multiple fields for which the same set of values apply. IEs may also be defined for other reasons e.g. to break down a ASN.1 definition in to smaller pieces.

A group of closely related IE type definitions, like the IEs *PRACH-ConfigSIB* and *PRACH-Config* in this example, are preferably placed together in a common ASN.1 section. The IE type identifiers should in this case have a common base, defined as the *generic type identifier*. It may be complemented by a suffix to distinguish the different variants. The "*PRACH-Config*" is the generic type identifier in this example, and the "*SIB*" suffix is added to distinguish the variant. The sub-clause heading and generic references to a group of closely related IEs defined in this way should use the generic type identifier.

The same principle should apply if a new version, or an extension version, of an existing IE is created for *critical* or *non-critical* extension of the protocol (see sub-clause A.4). The new version, or the extension version, of the IE is included in the same ASN.1 section defining the original. A suffix is added to the type identifier, using the naming conventions defined in sub-clause A.3.1.2, indicating the release or version of the where the new version, or extension version, was introduced.

Local IE type definitions, like the IE *PRACH-ConfigInfo* in the example above, may be included in the ASN.1 section and be referenced in the other IE types defined in the same ASN.1 section. The use of locally defined IE types should be encouraged, as a tool to break up large and complex IE type definitions. It can improve the readability of the code. There may also be a benefit for the software implementation of the protocol end-points, as these IE types are typically provided by the ASN.1 compiler as independent data elements, to be used in the software implementation.

An IE type defined in a local context, like the IE *PRACH-ConfigInfo*, should not be referenced directly from other ASN.1 sections in the RRC specification. An IE type which is referenced in more than one ASN.1 section should be defined in a separate sub-clause, with a separate heading and a separate ASN.1 section (possibly as one in a set of closely related IE types, like the IEs *PRACH-ConfigSIB* and *PRACH-Config* in the example above). Such IE types are also referred to as 'global IEs'.

NOTE: Referring to an IE type, that is defined as a local IE type in the context of another ASN.1 section, does not generate an ASN.1 compilation error. Nevertheless, using a locally defined IE type in that way makes the IE type definition difficult to find, as it would not be visible at an outline level of the specification. It should be avoided.

The ASN.1 section specifying the contents of one or more IE types, like in the example above, may be followed by a *field description table*, where a further description of, e.g., the semantic properties of the fields of the information

elements may be included. This table may be absent, similar as indicated in sub-clause A.3.3 for the specification of the PDU type. The general format of the *field description* table is the same as shown in sub-clause A.3.3 for the specification of the PDU type.

A.3.5 Fields with optional presence

A field with optional presence may be declared with the keyword `DEFAULT`. It identifies a default value to be assumed, if the sender does not include a value for that field in the encoding:

```
-- /example/ ASN1START
PreambleInfo ::=
    numberOfRA-Preambles      SEQUENCE {
                                INTEGER (1..64)          DEFAULT 1,
                                ...
    }
-- ASN1STOP
```

Alternatively, a field with optional presence may be declared with the keyword `OPTIONAL`. It identifies a field for which a value can be omitted. The omission carries semantics, which is different from any normal value of the field:

```
-- /example/ ASN1START
PRACH-Config ::=
    rootSequenceIndex          SEQUENCE {
                                INTEGER (0..1023),
                                prach-ConfigInfo          PRACH-ConfigInfo          OPTIONAL -- Need ON
    }
-- ASN1STOP
```

The semantics of an optionally present field, in the case it is omitted, should be indicated at the end of the paragraph including the keyword `OPTIONAL`, using a short comment text with a need statement. The need statement includes the keyword "Need", followed by one of the predefined semantics tags (OP, ON or OR) defined in sub-clause 6.1. If the semantics tag `OP` is used, the semantics of the absent field are further specified either in the field description table following the ASN.1 section, or in procedure text.

A.3.6 Fields with conditional presence

A field with conditional presence is declared with the keyword `OPTIONAL`. In addition, a short comment text shall be included at the end of the paragraph including the keyword `OPTIONAL`. The comment text includes the keyword "Cond", followed by a condition tag associated with the field ("UL" in this example):

```
-- /example/ ASN1START
LogicalChannelConfig ::=
    ul-SpecificParameters      SEQUENCE {
                                SEQUENCE {
                                    priority          INTEGER (0),
                                    ...
                                }          OPTIONAL -- Cond UL
    }
-- ASN1STOP
```

When conditionally present fields are included in an ASN.1 section, the field description table after the ASN.1 section shall be followed by a *conditional presence* table. The conditional presence table specifies the conditions for including the fields with conditional presence in the particular ASN.1 section.

Conditional presence	Explanation
UL	Specification of the conditions for including the field associated with the condition tag = "UL". Semantics in case of optional presence under certain conditions may also be specified.

The conditional presence table has two columns. The first column (heading: "Conditional presence") contains the condition tag (in *italic* font style), which links the fields with a condition tag in the ASN.1 section to an entry in the table. The second column (heading: "Explanation") contains a text specification of the conditions and requirements for

the presence of the field. The second column may also include semantics, in case of an optional presence of the field, under certain conditions i.e. using the same predefined tags as defined for optional fields in A.3.5.

Conditional presence should primarily be used when presence of a field depends on the presence and/ or value of other fields within the same message. If the presence of a field depends on whether another feature/ function has been configured, while this function can be configured independently e.g. by another message and/ or at another point in time, the relation is best reflected by means of a statement in the field description table.

If the ASN.1 section does not include any fields with conditional presence, the conditional presence table shall not be included.

Whenever a field is only applicable in specific cases e.g. TDD, use of conditional presence should be considered.

A.3.7 Guidelines on use of lists with elements of SEQUENCE type

Where an information element has the form of a list (the SEQUENCE OF construct in ASN.1) with the type of the list elements being a SEQUENCE data type, an information element shall be defined for the list elements even if it would not otherwise be needed.

For example, a list of PLMN identities with reservation flags is defined as in the following example:

```
-- /example/ ASN1START
PLMN-IdentityInfoList ::=                SEQUENCE (SIZE (1..6)) OF PLMN-IdentityInfo
PLMN-IdentityInfo ::=                   SEQUENCE {
    plmn-Identity                        PLMN-Identity,
    cellReservedForOperatorUse           ENUMERATED {reserved, notReserved}
}
-- ASN1STOP
```

rather than as in the following (bad) example, which may cause generated code to contain types with unpredictable names:

```
-- /bad example/ ASN1START
PLMN-IdentityList ::=                   SEQUENCE (SIZE (1..6)) OF SEQUENCE {
    plmn-Identity                        PLMN-Identity,
    cellReservedForOperatorUse           ENUMERATED {reserved, notReserved}
}
-- ASN1STOP
```

A.4 Extension of the PDU specifications

A.4.1 General principles to ensure compatibility

It is essential that extension of the protocol does not affect interoperability i.e. it is essential that implementations based on different versions of the RRC protocol are able to interoperate. In particular, this requirement applies for the following kind of protocol extensions:

- Introduction of new PDU types (i.e. these should not cause unexpected behaviour or damage).
- Introduction of additional fields in an extensible PDUs (i.e. it should be possible to ignore uncomprehended extensions without affecting the handling of the other parts of the message).
- Introduction of additional values of an extensible field of PDUs. If used, the behaviour upon reception of an uncomprehended value should be defined.

It should be noted that the PDU extension mechanism may depend on the logical channel used to transfer the message e.g. for some PDUs an implementation may be aware of the protocol version of the peer in which case selective ignoring of extensions may not be required.

The non-critical extension mechanism is the primary mechanism for introducing protocol extensions i.e. the critical extension mechanism is used merely when there is a need to introduce a 'clean' message version. Such a need appears when the last message version includes a large number of non-critical extensions, which results in issues like readability, overhead associated with the extension markers. The critical extension mechanism may also be considered when it is complicated to accommodate the extensions by means of non-critical extension mechanisms.

A.4.2 Critical extension of messages and fields

The mechanisms to critically extend a message are defined in A.3.3. There are both "outer branch" and "inner branch" mechanisms available. The "outer branch" consists of a CHOICE having the name *criticalExtensions*, with two values, *c1* and *criticalExtensionsFuture*. The *criticalExtensionsFuture* branch consists of an empty SEQUENCE, while the *c1* branch contains the "inner branch" mechanism.

The "inner branch" structure is a CHOICE with values of the form "*MessageName-rX-IEs*" (e.g., "*RRCConnectionReconfiguration-r8-IEs*") or "*spareX*", with the spare values having type NULL. The "-rX-IEs" structures contain the *complete* structure of the message IEs for the appropriate release; i.e., the critical extension branch for the Rel-10 version of a message includes all Rel-8 and Rel-9 fields (that are not obviated in the later version), rather than containing only the additional Rel-10 fields.

The following guidelines may be used when deciding which mechanism to introduce for a particular message, i.e. only an 'outer branch', or an 'outer branch' in combination with an 'inner branch' including a certain number of spares:

- For certain messages, e.g. initial uplink messages, messages transmitted on a broadcast channel, critical extension may not be applicable.
- An outer branch may be sufficient for messages not including any fields.
- The number of spares within inner branch should reflect the likelihood that the message will be critically extended in future releases (since each release with a critical extension for the message consumes one of the spare values). The estimation of the critical extension likelihood may be based on the number, size and changeability of the fields included in the message.
- In messages where an inner branch extension mechanism is available, all spare values of the inner branch should be used before any critical extensions are added using the outer branch.

The following example illustrates the use of the critical extension mechanism by showing the ASN.1 of the original and of a later release

```
-- /example/ ASN1START                                -- Original release
RRCMessage ::=                                       SEQUENCE {
  rrc-TransactionIdentifier      RRC-TransactionIdentifier,
  criticalExtensions              CHOICE {
    c1                            CHOICE {
      rrcMessage-r8              RRCMessage-r8-IEs,
      spare3 NULL, spare2 NULL, spare1 NULL
    },
    criticalExtensionsFuture      SEQUENCE {}
  }
}
-- ASN1STOP
```

```
-- /example/ ASN1START                                -- Later release
RRCMessage ::=                                       SEQUENCE {
  rrc-TransactionIdentifier      RRC-TransactionIdentifier,
  criticalExtensions              CHOICE {
    c1                            CHOICE {
      rrcMessage-r8              RRCMessage-r8-IEs,
      rrcMessage-r10             RRCMessage-r10-IEs,
      rrcMessage-r11             RRCMessage-r11-IEs,
      rrcMessage-r14             RRCMessage-r14-IEs
    },
    later                          CHOICE {
      c2                          CHOICE {
        rrcMessage-r16           RRCMessage-r16-IEs,
        spare7 NULL, spare6 NULL, spare5 NULL, spare4 NULL,
        spare3 NULL, spare2 NULL, spare1 NULL
      }
    }
  }
}
```

```

    },
    criticalExtensionsFuture          SEQUENCE {}
  }
}
-- ASN1STOP

```

It is important to note that critical extensions may also be used at the level of individual fields i.e. a field may be replaced by a critically extended version. When sending the extended version, the original version may also be included (e.g. original field is mandatory, EUTRAN is unaware if UE supports the extended version). In such cases, a UE supporting both versions may be required to ignore the original field. The following example illustrates the use of the critical extension mechanism by showing the ASN.1 of the original and of a later release

```

-- /example/ ASN1START          -- Original release
RRCMessage ::=
  rrc-TransactionIdentifier      SEQUENCE {
  criticalExtensions             CHOICE {
    c1                           CHOICE{
      rrcMessage-r8              RRCMessage-r8-IEs,
      spare3 NULL, spare2 NULL, spare1 NULL
    },
    criticalExtensionsFuture      SEQUENCE {}
  }
}

RRCMessage-rN-IEs ::= SEQUENCE {
  field1-rN                     ENUMERATED {
    value1, value2, value3, value4} OPTIONAL, -- Need ON
  field2-rN                     InformationElement2-rN    OPTIONAL, -- Need ON
  nonCriticalExtension           RRCConnectionReconfiguration-vMxy-IEs  OPTIONAL
}

RRCConnectionReconfiguration-vMxy-IEs ::= SEQUENCE {
  field2-rM                     InformationElement2-rM      OPTIONAL, -- Cond NoField2rN
  nonCriticalExtension           SEQUENCE {}                 OPTIONAL
}
-- ASN1STOP

```

Conditional presence	Explanation
<i>NoField2rN</i>	The field is optionally present, need ON, if <i>field2-rN</i> is absent. Otherwise the field is not present

Finally, it is noted that a critical extension may be introduced in the same release as the one in which the original field was introduced e.g. to correct an essential ASN.1 error. In such cases a UE capability may be introduced, to assist E-UTRAN in deciding whether or not to use the critically extension.

A.4.3 Non-critical extension of messages

A.4.3.1 General principles

The mechanisms to extend a message in a non-critical manner are defined in A.3.3. W.r.t. the use of extension markers, the following additional guidelines apply:

- When further non-critical extensions are added to a message that has been critically extended, the inclusion of these non-critical extensions in earlier critical branches of the message should be avoided when possible.
- The extension marker ("...") is the primary non-critical extension mechanism that is used unless a length determinant is not required. Examples of cases where a length determinant is not required:
 - at the end of a message,
 - at the end of a structure contained in a BIT STRING or OCTET STRING

- When an extension marker is available, non-critical extensions are preferably placed at the location (e.g. the IE) where the concerned parameter belongs from a logical/ functional perspective (referred to as the '*default extension location*')
- It is desirable to aggregate extensions of the same release or version of the specification into a group, which should be placed at the lowest possible level.
- In specific cases it may be preferable to place extensions elsewhere (referred to as the '*actual extension location*') e.g. when it is possible to aggregate several extensions in a group. In such a case, the group should be placed at the lowest suitable level in the message. <TBD: ref to separate example>
- In case placement at the default extension location affects earlier critical branches of the message, locating the extension at a following higher level in the message should be considered.
- In case an extension is not placed at the default extension location, an IE should be defined. The IE's ASN.1 definition should be placed in the same ASN.1 section as the default extension location. In case there are intermediate levels in-between the actual and the default extension location, an IE may be defined for each level. Intermediate levels are primarily introduced for readability and overview. Hence intermediate levels need not always be introduced e.g. they may not be needed when the default and the actual extension location are within the same ASN.1 section. <TBD: ref to separate example>

A.4.3.2 Further guidelines

Further to the general principles defined in the previous section, the following additional guidelines apply regarding the use of extension markers:

- Extension markers within SEQUENCE
 - Extension markers are primarily, but not exclusively, introduced at the higher nesting levels
 - Extension markers are introduced for a SEQUENCE comprising several fields as well as for information elements whose extension would result in complex structures without it (e.g. re-introducing another list)
 - Extension markers are introduced to make it possible to maintain important information structures e.g. parameters relevant for one particular RAT
 - Extension markers are also used for size critical messages (i.e. messages on BCCH, PCCH and CCCH), although introduced somewhat more carefully
 - The extension fields introduced (or frozen) in a specific version of the specification are grouped together using double brackets.
- Extension markers within ENUMERATED
 - Spare values are used until the number of values reaches the next power of 2, while the extension marker caters for extension beyond that limit
 - A suffix of the form "vXYZ" is used for the identifier of each new value, e.g. "value-vXYZ".
- Extension markers within CHOICE:
 - Extension markers are introduced when extension is foreseen and when comprehension is not required by the receiver i.e. behaviour is defined for the case where the receiver cannot comprehend the extended value (e.g. ignoring an optional CHOICE field). It should be noted that defining the behaviour of a receiver upon receiving a not comprehended choice value is not required if the sender is aware whether or not the receiver supports the extended value.
 - A suffix of the form "vXYZ" is used for the identifier of each new choice value, e.g. "choice-vXYZ".

Non-critical extensions at the end of a message/ of a field contained in an OCTET or BIT STRING:

- When a nonCriticalExtension is actually used, a "Need" statement should not be provided for the field, which always is a group including at least one extension and a field facilitating further possible extensions. For simplicity, it is recommended not to provide a "Need" statement when the field is not actually used either.

Further, more general, guidelines:

- In case a need statement is not provided for a group, a "Need" statement is provided for all individual extension fields within the group i.e. including for fields that are not marked as OPTIONAL. The latter is to clarify the action upon absence of the whole group.

A.4.3.3 Typical example of evolution of IE with local extensions

The following example illustrates the use of the extension marker for a number of elementary cases (sequence, enumerated, choice). The example also illustrates how the IE may be revised in case the critical extension mechanism is used.

NOTE In case there is a need to support further extensions of release n while the ASN.1 of release (n+1) has been frozen, without requiring the release n receiver to support decoding of release (n+1) extensions, more advanced mechanisms are needed e.g. including multiple extension markers.

```
-- /example/ ASN1START

InformationElement1 ::=          SEQUENCE {
  field1                        ENUMERATED {
                                value1, value2, value3, value4-v880,
                                ..., value5-v960 },
  field2                        CHOICE {
    field2a                     BOOLEAN,
    field2b                     InformationElement2b,
    ...,
    field2c-v960                InformationElement2c-r9
  },
  ...,
  [[ field3-r9                  InformationElement3-r9          OPTIONAL      -- Need OR
  ]],
  [[ field3-v9a0                InformationElement3-v9a0        OPTIONAL,      -- Need OR
  field4-r9                    InformationElement4              OPTIONAL      -- Need OR
  ]]
}

InformationElement1-r10 ::=      SEQUENCE {
  field1                        ENUMERATED {
                                value1, value2, value3, value4-v880,
                                value5-v960, value6-v1170, spare2, spare1, ... },
  field2                        CHOICE {
    field2a                     BOOLEAN,
    field2b                     InformationElement2b,
    field2c-v960                InformationElement2c-r9,
    ...,
    field2d-v12b0               INTEGER (0..63)
  },
  field3-r9                    InformationElement3-r10          OPTIONAL,    -- Need OR
  field4-r9                    InformationElement4              OPTIONAL,    -- Need OR
  field5-r10                   BOOLEAN,
  field6-r10                   InformationElement6-r10          OPTIONAL,    -- Need OR
  ...,
  [[ field3-v1170                InformationElement3-v1170      OPTIONAL      -- Need OR
  ]]
}

-- ASN1STOP
```

Some remarks regarding the extensions of *InformationElement1* as shown in the above example:

- The *InformationElement1* is initially extended with a number of non-critical extensions. In release 10 however, a critical extension is introduced for the message using this IE. Consequently, a new version of the IE *InformationElement1* (i.e. *InformationElement1-r10*) is defined in which the earlier non-critical extensions are incorporated by means of a revision of the original field.
- The *value4-v880* is replacing a spare value defined in the original protocol version for *field1*. Likewise *value6-v1170* replaces *spare3* that was originally defined in the r10 version of *field1*.
- Within the critically extended release 10 version of *InformationElement1*, the names of the original fields/ IEs are not changed, unless there is a real need to distinguish them from other fields/ IEs. E.g. the *field1* and *InformationElement4* were defined in the original protocol version (release 8) and hence not tagged. Moreover, the *field3-r9* is introduced in release 9 and not re-tagged; although, the *InformationElement3* is also critically extended and therefore tagged *InformationElement3-r10* in the release 10 version of *InformationElement1*.

A.4.3.4 Typical examples of non critical extension at the end of a message

The following example illustrates the use of non-critical extensions at the end of the message or at the end of a field that is contained in a BIT or OCTET STRING i.e. when an empty sequence is used.

```
-- /example/ ASN1START
RRCMessage-r8-IEs ::=          SEQUENCE {
    field1                    InformationElement1,
    field2                    InformationElement2,
    field3                    InformationElement3          OPTIONAL,    -- Need ON
    nonCriticalExtension      RRCMessage-v860-IEs        OPTIONAL
}
RRCMessage-v860-IEs ::=       SEQUENCE {
    field4-v860               InformationElement4          OPTIONAL,    -- Need OP
    field5-v860               BOOLEAN                    OPTIONAL,    -- Cond C54
    nonCriticalExtension      RRCMessage-v940-IEs        OPTIONAL
}
RRCMessage-v940-IEs ::=       SEQUENCE {
    field6-v940               InformationElement6-r9        OPTIONAL,    -- Need OR
    nonCriticalExtensions     SEQUENCE {}                OPTIONAL
}
-- ASN1STOP
```

Some remarks regarding the extensions shown in the above example:

- The *InformationElement4* is introduced in the original version of the protocol (release 8) and hence no suffix is used.

A.4.3.5 Examples of non-critical extensions not placed at the default extension location

The following example illustrates the use of non-critical extensions in case an extension is not placed at the default extension location.

– *ParentIE-WithEM*

The IE *ParentIE-WithEM* is an example of a high level IE including the extension marker (EM). The root encoding of this IE includes two lower level IEs *ChildIE1-WithoutEM* and *ChildIE2-WithoutEM* which not include the extension marker. Consequently, non-critical extensions of the Child-IEs have to be included at the level of the Parent-IE.

The example illustrates how the two extension IEs *ChildIE1-WithoutEM-vNx0* and *ChildIE2-WithoutEM-vNx0* (both in release N) are used to connect non-critical extensions with a default extension location in the lower level IEs to the actual extension location in this IE.

***ParentIE-WithEM* information element**

```
-- /example/ ASN1START
ParentIE-WithEM ::=          SEQUENCE {
    -- Root encoding, including:
    childIE1-WithoutEM        ChildIE1-WithoutEM          OPTIONAL,    -- Need ON
    childIE2-WithoutEM        ChildIE2-WithoutEM          OPTIONAL,    -- Need ON
    ...,
    [[ childIE1-WithoutEM-vNx0 ChildIE1-WithoutEM-vNx0    OPTIONAL,    -- Need ON
      childIE2-WithoutEM-vNx0 ChildIE2-WithoutEM-vNx0    OPTIONAL,    -- Need ON
    ]]
}
-- ASN1STOP
```

Some remarks regarding the extensions shown in the above example:

- The fields *childIEx-WithoutEM-vNx0* may not really need to be optional (depends on what is defined at the next lower level).

- In general, especially when there are several nesting levels, fields should be marked as optional only when there is a clear reason.

– *ChildIE1-WithoutEM*

The IE *ChildIE1-WithoutEM* is an example of a lower level IE, used to control certain radio configurations including a configurable feature which can be setup or released using the local IE *ChIE1-ConfigurableFeature*. The example illustrates how the new field *chIE1-NewField* is added in release N to the configuration of the configurable feature. The example is based on the following assumptions:

- when initially configuring as well as when modifying the new field, the original fields of the configurable feature have to be provided also i.e. as if the extended ones were present within the setup branch of this feature.
- when the configurable feature is released, the new field should be released also.
- when omitting the original fields of the configurable feature the UE continues using the existing values (which is used to optimise the signalling for features that typically continue unchanged upon handover).
- when omitting the new field of the configurable feature the UE releases the existing values and discontinues the associated functionality (which may be used to support release of unsupported functionality upon handover to an eNB supporting an earlier protocol version).

The above assumptions, which affect the use of conditions and need codes, may not always apply. Hence, the example should not be re-used blindly.

***ChildIE1-WithoutEM* information elements**

```
-- /example/ ASN1START

ChildIE1-WithoutEM ::=          SEQUENCE {
  -- Root encoding, including:
  chIE1-ConfigurableFeature     ChIE1-ConfigurableFeature     OPTIONAL          -- Need ON
}

ChildIE1-WithoutEM-vNx0 ::=    SEQUENCE {
  chIE1-ConfigurableFeature-vNx0 ChIE1-ConfigurableFeature-vNx0 OPTIONAL          -- Cond ConfigF
}

ChIE1-ConfigurableFeature ::=  CHOICE {
  release                        NULL,
  setup                          SEQUENCE {
    -- Root encoding
  }
}

ChIE1-ConfigurableFeature-vNx0 ::= SEQUENCE {
  chIE1-NewField-rN             INTEGER (0..31)
}

-- ASN1STOP
```

Conditional presence	Explanation
<i>ConfigF</i>	The field is optional present, need OR, in case of <i>chIE1-ConfigurableFeature</i> is included and set to "setup"; otherwise the field is not present and the UE shall delete any existing value for this field.

– *ChildIE2-WithoutEM*

The IE *ChildIE2-WithoutEM* is an example of a lower level IE, typically used to control certain radio configurations. The example illustrates how the new field *chIE1-NewField* is added in release N to the configuration of the configurable feature.

***ChildIE2-WithoutEM* information element**

```
-- /example/ ASN1START
```

```

ChildIE2-WithoutEM ::= CHOICE {
  release          NULL,
  setup           SEQUENCE {
    -- Root encoding
  }
}

ChildIE2-WithoutEM-vNx0 ::= SEQUENCE {
  chIE2-NewField-rN          INTEGER (0..31)          OPTIONAL  -- Cond ConfigF
}

-- ASN1STOP

```

Conditional presence	Explanation
<i>ConfigF</i>	The field is optional present, need OR, in case of <i>chIE2-ConfigurableFeature</i> is included and set to "setup"; otherwise the field is not present and the UE shall delete any existing value for this field.

A.5 Guidelines regarding inclusion of transaction identifiers in RRC messages

The following rules provide guidance on which messages should include a Transaction identifier

- 1: DL messages on CCCH that move UE to RRC-Idle should not include the RRC transaction identifier.
- 2: All network initiated DL messages by default should include the RRC transaction identifier.
- 3: All UL messages that are direct response to a DL message with an RRC Transaction identifier should include the RRC Transaction identifier.
- 4: All UL messages that require a direct DL response message should include an RRC transaction identifier.
- 5: All UL messages that are not in response to a DL message nor require a corresponding response from the network should not include the RRC Transaction identifier.

A.6 Protection of RRC messages (informative)

The following list provides information which messages can be sent (unprotected) prior to security activation and which messages can be sent unprotected after security activation. Those messages indicated "-" in "P" column should never be sent unprotected by eNB or UE. Further requirements are defined in the procedural text.

P...Messages that can be sent (unprotected) prior to security activation

A - I...Messages that can be sent without integrity protection after security activation

A - C...Messages that can be sent unciphered after security activation

NA... Message can never be sent after security activation

Message	P	A-I	A-C	Comment
CSFBParametersRequestCDMA2000	+	-	-	
CSFBParametersResponseCDMA2000	+	-	-	
CounterCheck	-	-	-	
CounterCheckResponse	-	-	-	
DLInformationTransfer	+	-	-	
HandoverFromEUTRAPreparationRequest (CDMA2000)	-	-	-	
InDeviceCoexIndication	-	-	-	
InterFreqRSTDMeasurementIndication	-	-	-	
LoggedMeasurementsConfiguration	-	-	-	
MasterInformationBlock	+	+	+	
MBMSCountingRequest	+	+	+	
MBMSCountingResponse	-	-	-	
MBMSInterestIndication	+	-	-	
MBSFNAreaConfiguration	+	+	+	
MeasurementReport	-	-	-	RAN2 agreed that measurement configuration may be sent prior to security activation. But: In order to protect privacy of UEs MEASUREMENT REPORT is only be sent from the UE after successful security activation.
MobilityFromEUTRACCommand	-	-	-	
Paging	+	+	+	
SidelinkUEInformation	+	-	-	
ProximityIndication	-	-	-	
RNReconfiguration	-	-	-	
RNReconfigurationComplete	-	-	-	
RRCCoalitionReconfiguration	+	-	-	The message shall not be sent unprotected before security activation if it is used to perform handover or to establish SRB2 and DRBs
RRCCoalitionReconfigurationComplete	+	-	-	Unprotected, if sent as response to RRCCoalitionReconfiguration which was sent before security activation
RRCCoalitionReestablishment	-	+	+	This message is not protected by PDCP operation.
RRCCoalitionReestablishmentComplete	-	-	-	
RRCCoalitionReestablishmentReject	-	+	+	One reason to send this may be that the security context has been lost, therefore sent as unprotected.
RRCCoalitionReestablishmentRequest	-	-	+	This message is not protected by PDCP operation. However a short MAC-I is included.
RRCCoalitionReject	+	NA	NA	
RRCCoalitionRelease	+	-	-	Justification for P: If the RRC connection only for signalling not requiring DRBs or ciphered messages, or the signalling connection has to be released prematurely, this message is sent as unprotected.
RRCCoalitionRequest	+	NA	NA	
RRCCoalitionSetup	+	NA	NA	
RRCCoalitionSetupComplete	+	NA	NA	
SecurityModeCommand	+	NA	NA	Integrity protection applied, but no ciphering (integrity verification done after the message received by RRC)
SecurityModeComplete	-	NA	NA	Integrity protection applied, but no ciphering. Ciphering is applied after completing the procedure.
SecurityModeFailure	+	NA	NA	Neither integrity protection nor ciphering applied.
SystemInformation	+	+	+	

Message	P	A-I	A-C	Comment
SystemInformationBlockType1	+	+	+	
UEAssistanceInformation	-	-	-	
UECapabilityEnquiry	+	-	-	
UECapabilityInformation	+	-	-	
SCGFailureInformation	-	-	-	
UEInformationRequest	-	-	-	
UEInformationResponse	-	-	-	In order to protect privacy of UEs UEInformationResponse is only be sent from the UE after successful security activation
ULHandoverPreparationTransfer (CDMA2000)	-	-	-	This message should follow HandoverFromEUTRAPreparationRequest
ULInformationTransfer	+	-	-	

A.7 Miscellaneous

The following miscellaneous conventions should be used:

- References: Whenever another specification is referenced, the specification number and optionally the relevant subclause, table or figure, should be indicated in addition to the pointer to the References section e.g. as follows: 'see TS 36.212 [22, 5.3.3.1.6]'.
- UE capabilities: TS 36.306 [6] specifies that E-UTRAN should in general respect the UE's capabilities. Hence there is no need to include statement clarifying that E-UTRAN, when setting the value of a certain configuration field, shall respect the related UE capabilities unless there is a particular need e.g. particularly complicated cases.

Annex B (normative): Release 8 and 9 AS feature handling

B.1 Feature group indicators

This annex contains the definitions of the bits in fields *featureGroupIndicators* (in Table B.1-1) and *featureGroupIndRel9Add* (in Table B.1-1a).

In this release of the protocol, the UE shall include the fields *featureGroupIndicators* in the IE *UE-EUTRA-Capability* and *featureGroupIndRel9Add* in the IE *UE-EUTRA-Capability-v9a0*. All the functionalities defined within the field *featureGroupIndicators* defined in Table B.1-1 or Table B.1-1a are mandatory for the UE, if the related capability (frequency band, RAT, SR-VCC or Inter-RAT ANR) is also supported. For a specific indicator, if all functionalities for a feature group listed in Table B.1-1 have been implemented and tested, the UE shall set the indicator as one (1), else (i.e. if any one of the functionalities in a feature group listed in Table B.1-1 or Table B.1-1a, which have not been implemented or tested), the UE shall set the indicator as zero (0).

The UE shall set all indicators that correspond to RATs not supported by the UE as zero (0).

The UE shall set all indicators, which do not have a definition in Table B.1-1 or Table B.1-1a, as zero (0).

If the optional fields *featureGroupIndicators* or *featureGroupIndRel9Add* are not included by a UE of a future release, the network may assume that all features pertaining to the RATs supported by the UE, respectively listed in Table B.1-1 or Table B.1-1a and deployed in the network, have been implemented and tested by the UE.

In Table B.1-1, a 'VoLTE capable UE' corresponds to a UE which is IMS voice capable.

The indexing in Table B.1-1a starts from index 33, which is the leftmost bit in the field *featureGroupIndRel9Add*.

Table B.1-1: Definitions of feature group indicators

Index of indicator (bit number)	Definition (description of the supported functionality, if indicator set to one)	Notes	If indicated "Yes" the feature shall be implemented and successfully tested for this version of the specification	FDD/ TDD diff
1 (leftmost bit)	<ul style="list-style-type: none"> - Intra-subframe frequency hopping for PUSCH scheduled by UL grant - DCI format 3a (TPC commands for PUCCH and PUSCH with single bit power adjustments) - Aperiodic CQI/PMI/RI reporting on PUSCH: Mode 2-0 – UE selected subband CQI without PMI - Aperiodic CQI/PMI/RI reporting on PUSCH: Mode 2-2 – UE selected subband CQI with multiple PMI 			Yes
2	<ul style="list-style-type: none"> - Simultaneous CQI and ACK/NACK on PUCCH, i.e. PUCCH format 2a and 2b - Absolute TPC command for PUSCH - Resource allocation type 1 for PDSCH - Periodic CQI/PMI/RI reporting on PUCCH: Mode 2-0 – UE selected subband CQI without PMI - Periodic CQI/PMI/RI reporting on PUCCH: Mode 2-1 – UE selected subband CQI with single PMI 			Yes
3	<ul style="list-style-type: none"> - 5bit RLC UM SN - 7bit PDCP SN 	- can only be set to 1 if the UE has set bit number 7 to 1.	Yes, if UE supports VoLTE. Yes, if UE supports SRVCC to EUTRAN from GERAN.	No

4	- Short DRX cycle	- can only be set to 1 if the UE has set bit number 5 to 1.		Yes
---	-------------------	---	--	-----

5	- Long DRX cycle - DRX command MAC control element		Yes	No
6	- Prioritised bit rate		Yes	No
7	- RLC UM	- can only be set to 0 if the UE does not support VoLTE	Yes, if UE supports VoLTE. Yes, if UE supports SRVCC to EUTRAN from GERAN.	No
8	- EUTRA RRC_CONNECTED to UTRA FDD or UTRA TDD CELL_DCH PS handover, if the UE supports either only UTRAN FDD or only UTRAN TDD - EUTRA RRC_CONNECTED to UTRA FDD CELL_DCH PS handover, if the UE supports both UTRAN FDD and UTRAN TDD	- can only be set to 1 if the UE has set bit number 22 to 1	Yes for FDD, if UE supports UTRA FDD	Yes
9	- EUTRA RRC_CONNECTED to GERAN GSM_Dedicated handover	- related to SR-VCC - can only be set to 1 if the UE has set bit number 23 to 1	Yes, if UE supports SRVCC to EUTRAN from GERAN.	Yes
10	- EUTRA RRC_CONNECTED to GERAN (Packet_) Idle by Cell Change Order - EUTRA RRC_CONNECTED to GERAN (Packet_) Idle by Cell Change Order with NACC (Network Assisted Cell Change)			Yes
11	- EUTRA RRC_CONNECTED to CDMA2000 1xRTT CS Active handover	- related to SR-VCC - can only be set to 1 if the UE has set bit number 24 to 1		Yes
12	- EUTRA RRC_CONNECTED to CDMA2000 HRPD Active handover	- can only be set to 1 if the UE has set bit number 26 to 1		Yes
13	- Inter-frequency handover (within FDD or TDD)	- can only be set to 1 if the UE has set bit number 25 to 1	Yes, unless UE only supports band 13	No
14	- Measurement reporting event: Event A4 – Neighbour > threshold - Measurement reporting event: Event A5 – Serving < threshold1 & Neighbour > threshold2		Yes	No
15	- Measurement reporting event: Event B1 – Neighbour > threshold for UTRAN FDD or UTRAN TDD, if the UE supports either only UTRAN FDD or only UTRAN TDD and has set bit number 22 to 1 - Measurement reporting event: Event B1 – Neighbour > threshold for UTRAN FDD or UTRAN TDD, if the UE supports both UTRAN FDD and UTRAN TDD and has set bit number 22 or 39 to 1, respectively - Measurement reporting event: Event B1 – Neighbour > threshold for GERAN, 1xRTT or HRPD, if the UE has set bit number 23, 24 or 26 to 1, respectively	- can only be set to 1 if the UE has set at least one of the bit number 22, 23, 24, 26 or 39 to 1. - even if the UE sets bits 41, it shall still set bit 15 to 1 if measurement reporting event B1 is tested for all RATs supported by UE	Yes for FDD, if UE supports only UTRAN FDD and does not support UTRAN TDD or GERAN or 1xRTT or HRPD	Yes

16	<p>- Intra-frequency periodical measurement reporting where <i>triggerType</i> is set to <i>periodical</i> and <i>purpose</i> is set to <i>reportStrongestCells</i></p> <p>- Inter-frequency periodical measurement reporting where <i>triggerType</i> is set to <i>periodical</i> and <i>purpose</i> is set to <i>reportStrongestCells</i>, if the UE has set bit number 25 to 1</p> <p>- Inter-RAT periodical measurement reporting where <i>triggerType</i> is set to <i>periodical</i> and <i>purpose</i> is set to <i>reportStrongestCells</i> for UTRAN FDD or UTRAN TDD, if the UE supports either only UTRAN FDD or only UTRAN TDD and has set bit number 22 to 1</p> <p>- Inter-RAT periodical measurement reporting where <i>triggerType</i> is set to <i>periodical</i> and <i>purpose</i> is set to <i>reportStrongestCells</i> for UTRAN FDD or UTRAN TDD, if the UE supports both UTRAN FDD and UTRAN TDD and has set bit number 22 or 39 to 1, respectively</p> <p>- Inter-RAT periodical measurement reporting where <i>triggerType</i> is set to <i>periodical</i> and <i>purpose</i> is set to <i>reportStrongestCells</i> for GERAN, 1xRTT or HRPD, if the UE has set bit number 23, 24 or 26 to 1, respectively.</p> <p>NOTE: Event triggered periodical reporting (i.e., with <i>triggerType</i> set to <i>event</i> and with <i>reportAmount</i> > 1) is a mandatory functionality of event triggered reporting and therefore not the subject of this bit.</p>		Yes	No
17	<p>Intra-frequency ANR features including:</p> <p>- Intra-frequency periodical measurement reporting where <i>triggerType</i> is set to <i>periodical</i> and <i>purpose</i> is set to <i>reportStrongestCells</i></p> <p>- Intra-frequency periodical measurement reporting where <i>triggerType</i> is set to <i>periodical</i> and <i>purpose</i> is set to <i>reportCGI</i></p>	- can only be set to 1 if the UE has set bit number 5 to 1.	Yes	No
18	<p>Inter-frequency ANR features including:</p> <p>- Inter-frequency periodical measurement reporting where <i>triggerType</i> is set to <i>periodical</i> and <i>purpose</i> is set to <i>reportStrongestCells</i></p> <p>- Inter-frequency periodical measurement reporting where <i>triggerType</i> is set to <i>periodical</i> and <i>purpose</i> is set to <i>reportCGI</i></p>	- can only be set to 1 if the UE has set bit number 5 and bit number 25 to 1.	Yes, unless UE only supports band 13	No

19	<p>Inter-RAT ANR features including:</p> <ul style="list-style-type: none"> - Inter-RAT periodical measurement reporting where <i>triggerType</i> is set to <i>periodical</i> and <i>purpose</i> is set to <i>reportStrongestCells</i> for GERAN, if the UE has set bit number 23 to 1 - Inter-RAT periodical measurement reporting where <i>triggerType</i> is set to <i>periodical</i> and <i>purpose</i> is set to <i>reportStrongestCellsForSON</i> for UTRAN FDD or UTRAN TDD, if the UE supports either only UTRAN FDD or only UTRAN TDD and has set bit number 22 to 1 - Inter-RAT periodical measurement reporting where <i>triggerType</i> is set to <i>periodical</i> and <i>purpose</i> is set to <i>reportStrongestCellsForSON</i> for UTRAN FDD or UTRAN TDD, if the UE supports both UTRAN FDD and UTRAN TDD and has set bit number 22 or 39 to 1, respectively - Inter-RAT periodical measurement reporting where <i>triggerType</i> is set to <i>periodical</i> and <i>purpose</i> is set to <i>reportStrongestCellsForSON</i> for 1xRTT or HRPD, if the UE has set bit number 24 or 26 to 1, respectively - Inter-RAT periodical measurement reporting where <i>triggerType</i> is set to <i>periodical</i> and <i>purpose</i> is set to <i>reportCGI</i> for UTRAN FDD or UTRAN TDD, if the UE supports either only UTRAN FDD or only UTRAN TDD and has set bit number 22 to 1 - Inter-RAT periodical measurement reporting where <i>triggerType</i> is set to <i>periodical</i> and <i>purpose</i> is set to <i>reportCGI</i> for UTRAN FDD or UTRAN TDD, if the UE supports both UTRAN FDD and UTRAN TDD and has set bit number 22 or 39 to 1, respectively - Inter-RAT periodical measurement reporting where <i>triggerType</i> is set to <i>periodical</i> and <i>purpose</i> is set to <i>reportCGI</i> for GERAN, 1xRTT or HRPD, if the UE has set bit number 23, 24 or 26 to 1, respectively 	<ul style="list-style-type: none"> - can only be set to 1 if the UE has set bit number 5 to 1 and the UE has set at least one of the bit number 22, 23, 24 or 26 to 1. - even if the UE sets bits 33 to 37, it shall still set bit 19 to 1 if inter-RAT ANR features are tested for all RATs for which inter-RAT measurement reporting is indicated as tested 		Yes
20	<p>If bit number 7 is set to 0:</p> <ul style="list-style-type: none"> - SRB1 and SRB2 for DCCH + 8x AM DRB <p>If bit number 7 is set to 1:</p> <ul style="list-style-type: none"> - SRB1 and SRB2 for DCCH + 8x AM DRB - SRB1 and SRB2 for DCCH + 5x AM DRB + 3x UM DRB <p>NOTE: UE which indicate support for a DRB combination also support all subsets of the DRB combination. Therefore, release of DRB(s) never results in an unsupported DRB combination.</p>	<ul style="list-style-type: none"> - Regardless of what bit number 7 and bit number 20 is set to, UE shall support at least SRB1 and SRB2 for DCCH + 4x AM DRB - Regardless of what bit number 20 is set to, if bit number 7 is set to 1, UE shall support at least SRB1 and SRB2 for DCCH + 4x AM DRB + 1x UM DRB 	Yes	No

21	- Predefined intra- and inter-subframe frequency hopping for PUSCH with $N_{sb} > 1$ - Predefined inter-subframe frequency hopping for PUSCH with $N_{sb} > 1$			No
22	- UTRAN FDD or UTRAN TDD measurements, reporting and measurement reporting event B2 in E-UTRA connected mode, if the UE supports either only UTRAN FDD or only UTRAN TDD - UTRAN FDD measurements, reporting and measurement reporting event B2 in E-UTRA connected mode, if the UE supports both UTRAN FDD and UTRAN TDD		Yes for FDD, if UE supports UTRA FDD	Yes
23	- GERAN measurements, reporting and measurement reporting event B2 in E-UTRA connected mode			Yes
24	- 1xRTT measurements, reporting and measurement reporting event B2 in E-UTRA connected mode		Yes for FDD, if UE supports enhanced 1xRTT CSFB for FDD Yes for TDD, if UE supports enhanced 1xRTT CSFB for TDD	Yes
25	- Inter-frequency measurements and reporting in E-UTRA connected mode NOTE: The UE setting this bit to 1 and indicating support for FDD and TDD frequency bands in the UE capability signalling implements and is tested for FDD measurements while the UE is in TDD, and for TDD measurements while the UE is in FDD.		Yes, unless UE only supports band 13	No
26	- HRPD measurements, reporting and measurement reporting event B2 in E-UTRA connected mode		Yes for FDD, if UE supports HRPD	Yes
27	- EUTRA RRC_CONNECTED to UTRA FDD or UTRA TDD CELL_DCH CS handover, if the UE supports either only UTRAN FDD or only UTRAN TDD - EUTRA RRC_CONNECTED to UTRA FDD CELL_DCH CS handover, if the UE supports both UTRAN FDD and UTRAN TDD	- related to SR-VCC - can only be set to 1 if the UE has set bit number 8 to 1 and supports SR-VCC from EUTRA defined in TS 24.008 [49]	Yes for FDD, if UE supports VoLTE and UTRA FDD	Yes
28	- TTI bundling		Yes for FDD	Yes
29	- Semi-Persistent Scheduling			Yes
30	- Handover between FDD and TDD	- can only be set to 1 if the UE has set bit number 13 to 1		No
31	- Indicates whether the UE supports the mechanisms defined for cells broadcasting multi band information i.e. comprehending <i>multiBandInfoList</i> , disregarding in RRC_CONNECTED the related system information fields and understanding the EARFCN signalling for all bands, that overlap with the bands supported by the UE, and that are defined in the earliest version of TS 36.101 [42] that includes all UE supported bands.		Yes	No
32	Undefined			

NOTE: The column FDD/ TDD diff indicates if the UE is allowed to signal different values for FDD and TDD.

Table B.1-1a: Definitions of feature group indicators

Index of indicator (bit number)	Definition (description of the supported functionality, if indicator set to one)	Notes	If indicated "Yes" the feature shall be implemented and successfully tested for this version of the specification	FDD/ TDD diff
33 (leftmost bit)	Inter-RAT ANR features for UTRAN FDD including: - Inter-RAT periodical measurement reporting where <i>triggerType</i> is set to <i>periodical</i> and <i>purpose</i> is set to <i>reportStrongestCellsForSON</i> - Inter-RAT periodical measurement reporting where <i>triggerType</i> is set to <i>periodical</i> and <i>purpose</i> is set to <i>reportCGI</i>	- can only be set to 1 if the UE has set bit number 5 and bit number 22 to 1.		Yes
34	Inter-RAT ANR features for GERAN including: - Inter-RAT periodical measurement reporting where <i>triggerType</i> is set to <i>periodical</i> and <i>purpose</i> is set to <i>reportStrongestCells</i> - Inter-RAT periodical measurement reporting where <i>triggerType</i> is set to <i>periodical</i> and <i>purpose</i> is set to <i>reportCGI</i>	- can only be set to 1 if the UE has set bit number 5 and bit number 23 to 1.		Yes
35	Inter-RAT ANR features for 1xRTT including: - Inter-RAT periodical measurement reporting where <i>triggerType</i> is set to <i>periodical</i> and <i>purpose</i> is set to <i>reportStrongestCellsForSON</i> - Inter-RAT periodical measurement reporting where <i>triggerType</i> is set to <i>periodical</i> and <i>purpose</i> is set to <i>reportCGI</i>	- can only be set to 1 if the UE has set bit number 5 and bit number 24 to 1.		Yes
36	Inter-RAT ANR features for HRPD including: - Inter-RAT periodical measurement reporting where <i>triggerType</i> is set to <i>periodical</i> and <i>purpose</i> is set to <i>reportStrongestCellsForSON</i> - Inter-RAT periodical measurement reporting where <i>triggerType</i> is set to <i>periodical</i> and <i>purpose</i> is set to <i>reportCGI</i>	- can only be set to 1 if the UE has set bit number 5 and bit number 26 to 1.		Yes
37	Inter-RAT ANR features for UTRAN TDD including: - Inter-RAT periodical measurement reporting where <i>triggerType</i> is set to <i>periodical</i> and <i>purpose</i> is set to <i>reportStrongestCellsForSON</i> - Inter-RAT periodical measurement reporting where <i>triggerType</i> is set to <i>periodical</i> and <i>purpose</i> is set to <i>reportCGI</i>	- can only be set to 1 if the UE has set bit number 5 and at least one of the bit number 22 (for UEs supporting only UTRA TDD) or the bit number 39 to 1.		Yes
38	- EUTRA RRC_CONNECTED to UTRA TDD CELL_DCH PS handover, if the UE supports both UTRAN FDD and UTRAN TDD	- can only be set to 1 if the UE has set bit number 39 to 1		Yes
39	- UTRAN TDD measurements, reporting and measurement reporting event B2 in E-UTRA connected mode, if the UE supports both UTRAN FDD and UTRAN TDD			Yes

40	- EUTRA RRC_CONNECTED to UTRA TDD CELL_DCH CS handover, if the UE supports both UTRAN FDD and UTRAN TDD	- related to SR-VCC - can only be set to 1 if the UE has set bit number 38 to 1		Yes
41	Measurement reporting event: Event B1 – Neighbour > threshold for UTRAN FDD, if the UE supports UTRAN FDD and has set bit number 22 to 1		Yes for FDD, unless UE has set bit number 15 to 1	Yes
42	Undefined			
43	Undefined			
44	Undefined			
45	Undefined			
46	Undefined			
47	Undefined			
48	Undefined			
49	Undefined			
50	Undefined			
51	Undefined			
52	Undefined			
53	Undefined			
54	Undefined			
55	Undefined			
56	Undefined			
57	Undefined			
58	Undefined			
59	Undefined			
60	Undefined			
61	Undefined			
62	Undefined			
63	Undefined			
64	Undefined			

NOTE: The column FDD/ TDD diff indicates if the UE is allowed to signal different values for FDD and TDD. Annex E specifies for which TDD and FDD serving cells a UE supporting TDD/FDD CA shall support a feature for which it indicates support within the FGI signalling.

Clarification for mobility from EUTRAN and inter-frequency handover within EUTRAN

There are several feature groups related to mobility from E-UTRAN and inter-frequency handover within EUTRAN. The description of these features is based on the assumption that we have 5 main "functions" related to mobility from E-UTRAN:

- A. Support of measurements and cell reselection procedure in idle mode
- B. Support of RRC release with redirection procedure in connected mode
- C. Support of Network Assisted Cell Change in connected mode
- D. Support of measurements and reporting in connected mode
- E. Support of handover procedure in connected mode

All functions can be applied for mobility to Inter-frequency to EUTRAN, GERAN, UTRAN, CDMA2000 HRPD and CDMA2000 1xRTT except for function C) which is only applicable for mobility to GERAN. Table B.1-2 below summarises the mobility functions that are supported based on the UE capability signaling (band support) and the setting of the feature group support indicators.

Table B.1-2: Mobility from E-UTRAN

Feature	GERAN	UTRAN	HRPD	1xRTT	EUTRAN
A. Measurements and cell reselection procedure in E-UTRA idle mode	Supported if GERAN band support is indicated	Supported if UTRAN band support is indicated	Supported if CDMA2000 HRPD band support is indicated	Supported if CDMA2000 1xRTT band support is indicated	Supported for supported bands
B. RRC release with blind redirection procedure in E-UTRA connected mode	Supported if GERAN band support is indicated	Supported if UTRAN band support is indicated	Supported if CDMA2000 HRPD band support is indicated	Supported if CDMA2000 1xRTT band support is indicated	Supported for supported bands
C. Cell Change Order (with or without) Network Assisted Cell Change) in E-UTRA connected mode	Group 10	N.A.	N.A	N.A	N.A.
D. Inter-frequency/RAT measurements, reporting and measurement reporting event B2 (for inter-RAT) in E-UTRA connected mode	Group 23	Group 22/39	Group 26	Group 24	Group 25
E. Inter-frequency/RAT handover procedure in E-UTRA connected mode	Group 9 (GSM_connected handover) Separate UE capability bit defined in TS 36.306 for PS handover	Group 8/38 (PS handover) or Group 27/40 (SRVCC handover)	Group 12	Group 11	Group 13 (within FDD or TDD) Group 30 (between FDD and TDD)

In case measurements and reporting function is not supported by UE, the network may still issue the mobility procedures redirection (B) and CCO (C) in a blind fashion.

B.2 CSG support

In this release of the protocol, it is mandatory for the UE to support a minimum set of CSG functionality consisting of:

- Identifying whether a cell is CSG or not;
- Ignoring CSG cells in cell selection/reselection.

Additional CSG functionality in AS, i.e. the requirement to detect and camp on CSG cells when the "CSG whitelist" is available or when manual CSG selection is triggered by the user, are related to the corresponding NAS features. This additional AS functionality consists of:

- Manual CSG selection;
- Autonomous CSG search;
- Implicit priority handling for cell reselection with CSG cells.

It is possible that this additional CSG functionality in AS is not supported or tested in early UE implementations.

Note that since the above AS features relate to idle mode operations, the capability support is not signalled to the network. For these reasons, no "feature group indicator" is assigned to this feature to indicate early support in Rel-8.

Annex C (normative): Release 10 AS feature handling

C.1 Feature group indicators

This annex contains the definitions of the bits in field *featureGroupIndRel10*.

In this release of the protocol, the UE shall include the field *featureGroupIndRel10* in the IE *UE-EUTRA-Capability-v1020-IEs*. All the functionalities defined within the field *featureGroupIndRel10* defined in Table C.1-1 are mandatory for the UE, if the related capability (spatial multiplexing in UL, PDSCH transmission mode 9, carrier aggregation, handover to EUTRA, or RAT) is also supported. For a specific indicator, if all functionalities for a feature group listed in Table C.1-1 have been implemented and tested, the UE shall set the indicator as one (1), else (i.e. if any one of the functionalities in a feature group listed in Table C.1-1 have not been implemented or tested), the UE shall set the indicator as zero (0).

The UE shall set all indicators that correspond to RATs not supported by the UE as zero (0).

The UE shall set all indicators, which do not have a definition in Table C.1-1, as zero (0).

If the optional field *featureGroupIndRel10* is not included by a UE of a future release, the network may assume that all features, listed in Table C.1-1 and deployed in the network, have been implemented and tested by the UE.

The indexing in Table C.1-1 starts from index 101, which is the leftmost bit in the field *featureGroupIndRel10*.

Table C.1-1: Definitions of feature group indicators

Index of indicator	Definition (description of the supported functionality, if indicator set to one)	Notes	If indicated "Yes" the feature shall be implemented and successfully tested for this version of the specification	FDD/TDD diff
101 (leftmost bit)	- DMRS with OCC (orthogonal cover code) and SGH (sequence group hopping) disabling	- if the UE supports two or more layers for spatial multiplexing in UL, this bit shall be set to 1. - If a category 0 UE does not support this feature, this bit shall be set to 0.		No
102	- Trigger type 1 SRS (aperiodic SRS) transmission (Up to X ports) NOTE: X = number of supported layers on given band			Yes
103	- PDSCH transmission mode 9 when up to 4 CSI reference signal ports are configured	- for Category 8 UEs, this bit shall be set to 1.		Yes
104	- PDSCH transmission mode 9 for TDD when 8 CSI reference signal ports are configured	- if the UE does not support TDD, this bit is irrelevant (capability signalling exists for FDD for this feature), and this bit shall be set to 0. - for Category 8 UEs, this bit shall be set to 1.		No
105	- Periodic CQI/PMI/RI reporting on PUCCH: Mode 2-0 – UE selected subband CQI without PMI, when PDSCH transmission mode 9 is configured - Periodic CQI/PMI/RI reporting on PUCCH: Mode 2-1 – UE selected subband CQI with single PMI, when PDSCH transmission mode 9 and up to 4 CSI reference signal ports are configured	- this bit can be set to 1 only if indices 2 (Table B.1-1) and 103 are set to 1. - For UEs capable of TDD-FDD CA, this bit can be set to 1 for both FDD and TDD if index 2 is set to 1 for both FDD and TDD, and index 103 is set to 1 for at least one of FDD and TDD duplex modes.		Yes

106	- Periodic CQI/PMI/RI/PTI reporting on PUCCH: Mode 2-1 – UE selected subband CQI with single PMI, when PDSCH transmission mode 9 and 8 CSI reference signal ports are configured	- this bit can be set to 1 only if the UE supports PDSCH transmission mode 9 with 8 CSI reference signal ports (i.e., for TDD, if index 104 is set to 1, and for FDD, if <i>tm9-With-8Tx-FDD-r10</i> is set to 'supported') and if index 2 (Table B.1-1) is set to 1. - For UEs capable of TDD-FDD CA, this bit can be set to 1 for both FDD and TDD if at least one of index 104 and <i>tm9-With-8Tx-FDD-r10</i> is set to 1/'supported', and if index 2 is set to 1 for both FDD and TDD.		Yes
107	- Aperiodic CQI/PMI/RI reporting on PUSCH: Mode 2-0 – UE selected subband CQI without PMI, when PDSCH transmission mode 9 is configured - Aperiodic CQI/PMI/RI reporting on PUSCH: Mode 2-2 – UE selected subband CQI with multiple PMI, when PDSCH transmission mode 9 and up to 4 CSI reference signal ports are configured	- this bit can be set to 1 only if indices 1 (Table B.1-1) and 103 are set to 1. - For UEs capable of TDD-FDD CA, this bit can be set to 1 for both FDD and TDD if index 1 is set to 1 for both FDD and TDD, and index 103 is set to 1 for at least one of FDD and TDD duplex modes.		Yes
108	- Aperiodic CQI/PMI/RI reporting on PUSCH: Mode 2-2 – UE selected subband CQI with multiple PMI, when PDSCH transmission mode 9 and 8 CSI reference signal ports are configured	- this bit can be set to 1 only if the UE supports PDSCH transmission mode 9 with 8 CSI reference signal ports (i.e., for TDD, if index 104 is set to 1, and for FDD, if <i>tm9-With-8Tx-FDD-r10</i> is set to 'supported') and if index 1 (Table B.1-1) is set to 1. - For UEs capable of TDD-FDD CA, this bit can be set to 1 for both FDD and TDD if at least one of index 104 and <i>tm9-With-8Tx-FDD-r10</i> is set to 1/'supported', and if index 1 is set to 1 for both FDD and TDD.		Yes
109	- Periodic CQI/PMI/RI reporting on PUCCH Mode 1-1, submode 1	- this bit can be set to 1 only if the UE supports PDSCH transmission mode 9 with 8 CSI reference signal ports (i.e., for TDD, if index 104 is set to 1, and for FDD, if <i>tm9-With-8Tx-FDD-r10</i> is set to 'supported'). - For UEs capable of TDD-FDD CA, this bit can be set to 1 for both FDD and TDD if at least one of index 104 and <i>tm9-With-8Tx-FDD-r10</i> is set to 1/'supported'.		Yes

110	- Periodic CQI/PMI/RI reporting on PUCCH Mode 1-1, submode 2	- this bit can be set to 1 only if the UE supports PDSCH transmission mode 9 with 8 CSI reference signal ports (i.e., for TDD, if index 104 is set to 1, and for FDD, if <i>tm9-With-8Tx-FDD-r10</i> is set to 'supported'). - For UEs capable of TDD-FDD CA, this bit can be set to 1 for both FDD and TDD if at least one of index 104 and <i>tm9-With-8Tx-FDD-r10</i> is set to 1/'supported'.		Yes
111	- Measurement reporting trigger Event A6	- this bit can be set to 1 only if the UE supports carrier aggregation.		Yes
112	- SCell addition within the Handover to EUTRA procedure	- this bit can be set to 1 only if the UE supports carrier aggregation and the Handover to EUTRA procedure.		Yes
113	- Trigger type 0 SRS (periodic SRS) transmission on X Serving Cells NOTE: X = number of supported component carriers in a given band combination	- this bit can be set to 1 only if the UE supports carrier aggregation in UL.		Yes
114	- Reporting of both UTRA CPICH RSCP and Ec/N0 in a Measurement Report	- this bit can be set to 1 only if index 22 (Table B.1-1) is set to 1.		No
115	- time domain ICIC RLM/RRM measurement subframe restriction for the serving cell - time domain ICIC RRM measurement subframe restriction for neighbour cells - time domain ICIC CSI measurement subframe restriction			Yes
116	- Relative transmit phase continuity for spatial multiplexing in UL	- this bit can be set to 1 only if the UE supports two or more layers for spatial multiplexing in UL.		Yes
117	Undefined			
118	Undefined			
119	Undefined			
120	Undefined			
121	Undefined			
122	Undefined			
123	Undefined			
124	Undefined			
125	Undefined			
126	Undefined			
127	Undefined			
128	Undefined			
129	Undefined			
130	Undefined			
131	Undefined			
132	Undefined			

NOTE: The column FDD/ TDD diff indicates if the UE is allowed to signal different values for FDD and TDD. Annex E specifies for which TDD and FDD serving cells a UE supporting TDD/FDD CA shall support a feature for which it indicates support within the FGI signalling.

Annex D (informative): Descriptive background information

D.1 Signalling of Multiple Frequency Band Indicators (Multiple FBI)

D.1.1 Mapping between frequency band indicator and multiple frequency band indicator

This subclause describes the use of the Multiple Frequency Band Indicator (MFBI) lists and the E-UTRA frequency bands in *SystemInformationBlockType1* by means of an example as shown in Figure D.1.1-1. In this example:

- E-UTRAN cell belongs to band B90 and also bands B6, B7, B91, and B92.
- The *freqBandIndicatorPriority* field is not present in *SystemInformationBlockType1*.
- E-UTRAN uses B64 to indicate the presence of B90 in *freqBandIndicator-v9e0*.
- For the MFBI list of this cell, E-UTRAN uses B64 in *MultiBandInfoList* to indicate the position and priority of the bands in *MultiBandInfoList-v9e0*.
- The UE, after reading *SystemInformationBlockType1*, generates an MFBI list with priority of B91, B6, B92, and B7. If the UE supports the frequency band in the *freqBandIndicator-v9e0* IE it applies that frequency band. Otherwise, the UE applies the first listed band in the MFBI list which it supports.

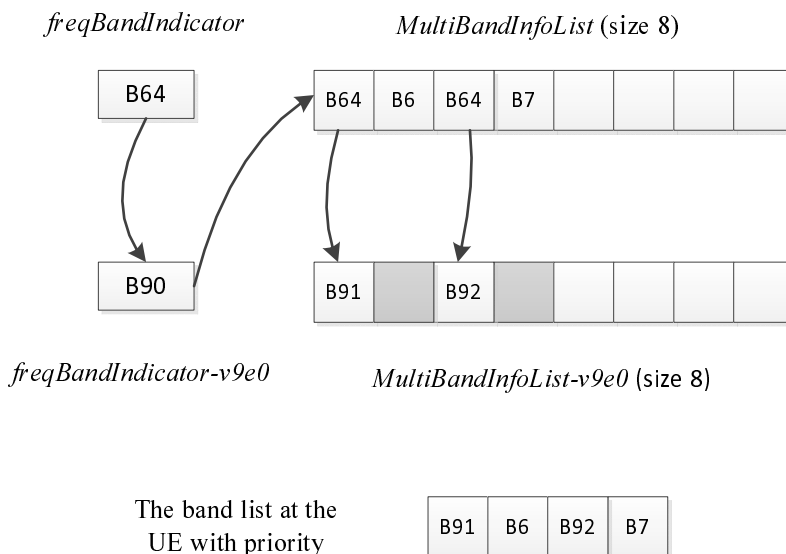

Figure D.1.1-1: Mapping of frequency bands to *MultiBandInfoList*/*MultiBandInfoList-v9e0*

D.1.2 Mapping between inter-frequency neighbour list and multiple frequency band indicator

This subclause describes the use of the Multiple Frequency Band Indicator (MFBI) lists and the E-UTRA frequencies signalled in *SystemInformationBlockType5* by means of an example as shown in Figure D.1.2-1. In this example:

- E-UTRAN includes 4 frequencies (EARFCNs): the bands associated with f1 and f4 belong to bands lower than 64; the bands associated with f2 and f3 belong to bands larger than 64. The reserved EARFCN value of 65535 is used to indicate the presence of *ARFCN-ValueEUTRA-v9e0*.

- The band associated with f1 has two overlapping bands, B1 and B2 (lower than 64); the band associated with f2 has one overlapping band, B91; the band associated with f3 has four overlapping bands B3, B4, B92, and B93; the band associated with f4 does not have overlapping bands.
- E-UTRAN includes 4 lists in both *interFreqCarrierFreqList-v8h0* and *interFreqCarrierFreqList-v9e0* and ensure the order of the lists is matching. Each list corresponds to one EARFCN and contains up to 8 bands. The first list corresponds to f1, the second list corresponds to f2, and so on. The grey lists mean not including *MultiBandInfoList* or *MultiBandInfoList-v9e0*, i.e. the corresponding EARFCN does not have any overlapping frequency bands in *MultiBandInfoList* or *MultiBandInfoList-v9e0*.



Figure D.1.2-1: Mapping of EARFCNs to *MultiBandInfoList/MultiBandInfoList-v9e0*

D.1.3 Mapping between UTRA FDD frequency list and multiple frequency band indicator

This subclause describes the use of the Multiple Frequency Band Indicator (MFBI) lists and the UTRA FDD frequencies signalled in *SystemInformationBlockType6* by means of an example as shown in Figure D.1.3-1. In this example:

- E-UTRAN includes 4 UTRA FDD frequencies (UARFCNs).
- The bands associated with f1 and f4 have no overlapping bands. The band associated with f2 has two overlapping bands, B1 and B2. The band associated with f3 has one overlapping band, B3.
- E-UTRAN includes 4 lists in *carrierFreqListUTRA-FDD-v8h0* with the first and fourth entry not including *MultiBandInfoList*.

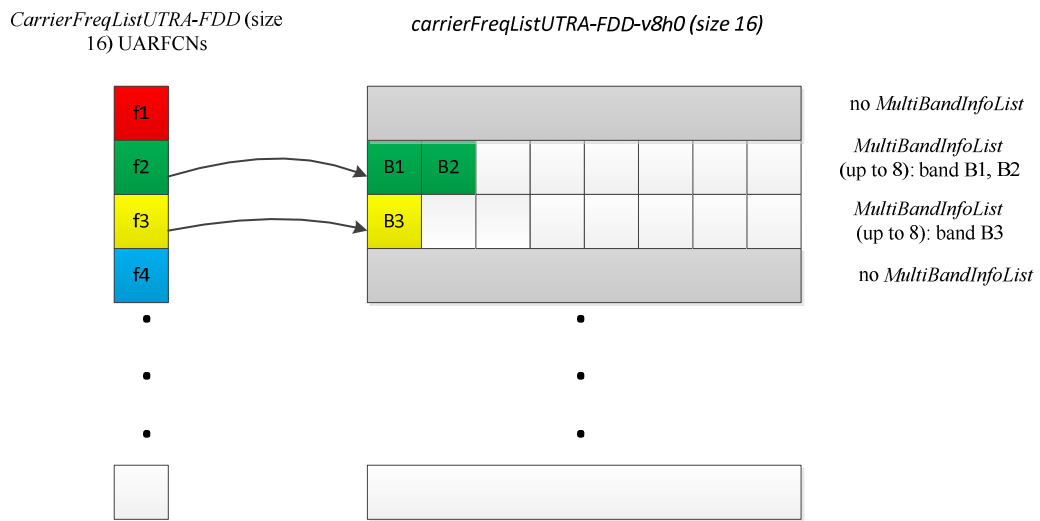

Figure D.1.3-1: Mapping of UARFCNs to *MultiBandInfoList*

Annex E (normative): TDD/FDD differentiation of FGIs/capabilities in TDD-FDD CA

Annex E specifies for which TDD and FDD serving cells a UE supporting TDD/FDD CA shall support a feature/capability for which it indicates support within the FGI/capability signalling.

A UE that indicates support for TDD/ FDD CA:

- For the fields for which the UE is allowed to indicate different support for FDD and TDD, the UE shall support the feature on the PCell and/or SCell(s), as specified in tables E-1, E-2 and E-3 in accordance to the following rules:
 - PCell: the UE shall support the feature for the PCell, if the UE indicates support of the feature for the PCell duplex mode;
 - SCell: the UE shall support the feature for SCell(s), if the UE indicates support of the feature for the SCell duplex mode;
 - Per serving cell: the UE shall support the feature for a serving cell if the UE indicates support of the feature for the serving cell's duplex mode;
 - All serving cells: UE shall support the feature if the UE indicates support of the feature for both TDD and FDD duplex modes;
- For the fields where the UE is not allowed to indicate different support for FDD and TDD, the UE shall support the feature for PCell and SCell(s) if the UE indicates support of the feature via the common FGI/capability bit.

Table E-1: Rel-8/9 FGIs for which FDD/TDD differentiation is allowed (from Annex B)

Index of indicator	Classification
1	Per serving cell
2	All serving cells
4	All serving cells
8	PCell
9	PCell
10	PCell
11	PCell
12	PCell
15	PCell
19	PCell
22	PCell
23	PCell
24	PCell
26	PCell
27	PCell
28	PCell
29	PCell
33	PCell
34	PCell
35	PCell
36	PCell
37	PCell
38	PCell
39	PCell
40	PCell
41	PCell

Table E-2: Rel-10 FGLs for which FDD/TDD differentiation is allowed (from Annex C)

Index of indicator	Classification
102	Per serving cell
103	Per serving cell
105	All serving cells
106	All serving cells
107	All serving cells
108	All serving cells
109	All serving cells
110	All serving cells
111	SCell
112	PCell
113	Per serving cell
115	PCell
116	Per serving cell

Table E-3: Rel-12 UE-EUTRA capabilities for which FDD/TDD differentiation is allowed

UE-EUTRA-Capability	Classification
crossCarrierScheduling	All serving cells
e-CSFB-1XRTT	PCell
e-CSFB-ConcPS-Mob1XRTT	PCell
e-CSFB-dual-1XRTT	PCell
ePDCCH	Per serving cell
e-RedirectionUTRA	PCell
e-RedirectionUTRA-TDD	PCell
inDeviceCoexInd	All serving cells
interFreqRSTD-Measurement	PCell
interFreqSI-AcquisitionForHO	PCell
interRAT-PS-HO-ToGERAN	PCell
intraFreqSI-AcquisitionForHO	PCell
mbms-Scell	SCell
mbms-NonServingCell	SCell
multiACK-CSlreporting	PCell
multiClusterPUSCH-WithinCC	Per serving cell
otdoa-UE-Assisted	PCell
pmi-Disabling	Per serving cell
rsrqMeasWideband	Per serving cell
simultaneousPUCCH-PUSCH	All serving cells
ss-CCH-InterfHandl	PCell
txDiv-PUCCH1b-ChSelect	PCell
ue-TxAntennaSelectionSupported	Per serving cell
utran-SI-AcquisitionForHO	PCell

Annex F (informative): Change history

Change history							
Date	TSG #	TSG Doc.	CR	Rev	Cat	Subject/Comment	New version
12/2007	RP-38	RP-070920	-			Approved at TSG-RAN #38 and placed under Change Control	8.0.0
03/2008	RP-39	RP-080163	0001	4		CR to 36.331 with Miscellaneous corrections	8.1.0
03/2008	RP-39	RP-080164	0002	2		CR to 36.331 to convert RRC to agreed ASN.1 format	8.1.0
05/2008	RP-40	RP-080361	0003	1		CR to 36.331 on Miscellaneous clarifications/ corrections	8.2.0
09/2008	RP-41	RP-080693	0005	-		CR on Miscellaneous corrections and clarifications	8.3.0
12/2008	RP-42	RP-081021	0006	-		Miscellaneous corrections and clarifications	8.4.0
03/2009	RP-43	RP-090131	0007	-		Correction to the Counter Check procedure	8.5.0
	RP-43	RP-090131	0008	-		CR to 36.331-UE Actions on Receiving SIB11	8.5.0
	RP-43	RP-090131	0009	1		Spare usage on BCCH	8.5.0
	RP-43	RP-090131	0010	-		Issues in handling optional IE upon absence in GERAN NCL	8.5.0
	RP-43	RP-090131	0011	-		CR to 36.331 on Removal of useless RLC re-establishment at RB release	8.5.0
	RP-43	RP-090131	0012	1		Clarification to RRC level padding at PCCH and BCCH	8.5.0
	RP-43	RP-090131	0013	-		Removal of Inter-RAT message	8.5.0
	RP-43	RP-090131	0014	-		Padding of the SRB-ID for security input	8.5.0
	RP-43	RP-090131	0015	-		Validity of ETWS SIB	8.5.0
	RP-43	RP-090131	0016	1		Configuration of the Two-Intervals-SPS	8.5.0
	RP-43	RP-090131	0017	-		Corrections on Scaling Factor Values of Qhyst	8.5.0
	RP-43	RP-090131	0018	1		Optionality of srsMaxUpts	8.5.0
	RP-43	RP-090131	0019	-		CR for discussion on field name for common and dedicated IE	8.5.0
	RP-43	RP-090131	0020	-		Corrections to Connected mode mobility	8.5.0
	RP-43	RP-090131	0021	-		Clarification regarding the measurement reporting procedure	8.5.0
	RP-43	RP-090131	0022	1		Corrections on s-Measure	8.5.0
	RP-43	RP-090131	0023	1		R1 of CR0023 (R2-091029) on combination of SPS and TTI bundling for TDD	8.5.0
	RP-43	RP-090131	0024	-		L3 filtering for path loss measurements	8.5.0
	RP-43	RP-090131	0025	1		S-measure handling for reportCGI	8.5.0
	RP-43	RP-090131	0026	1		Measurement configuration clean up	8.5.0
	RP-43	RP-090131	0027	-		Alignment of measurement quantities for UTRA	8.5.0
	RP-43	RP-090131	0028	-		CR to 36.331 on L1 parameters ranges alignment	8.5.0
	RP-43	RP-090131	0029	-		Default configuration for transmissionMode	8.5.0
	RP-43	RP-090131	0030	-		CR to 36.331 on RRC Parameters for MAC, RLC and PDCP	8.5.0
	RP-43	RP-090131	0031	1		CR to 36.331 - Clarification on Configured PRACH Freq Offset	8.5.0
	RP-43	RP-090131	0032	-		Clarification on TTI bundling configuration	8.5.0
	RP-43	RP-090131	0033	1		Update of R2-091039 on Inter-RAT UE Capability	8.5.0
	RP-43	RP-090133	0034	-		Feature Group Support Indicators	8.5.0
	RP-43	RP-090131	0036	-		Corrections to RLF detection	8.5.0
	RP-43	RP-090131	0037	-		Indication of Dedicated Priority	8.5.0
	RP-43	RP-090131	0038	2		Security Clean up	8.5.0
	RP-43	RP-090131	0039	-		Correction of TTT value range	8.5.0
	RP-43	RP-090131	0040	-		Correction on CDMA measurement result IE	8.5.0
	RP-43	RP-090131	0041	1		Clarification of Measurement Reporting	8.5.0
	RP-43	RP-090131	0042	-		Spare values in DL and UL Bandwidth in MIB and SIB2	8.5.0
	RP-43	RP-090131	0044	1		Clarifications to System Information Block Type 8	8.5.0
	RP-43	RP-090131	0045	-		Reception of ETWS secondary notification	8.5.0
	RP-43	RP-090131	0046	1		Validity time for ETWS message Id and Sequence No	8.5.0
	RP-43	RP-090131	0047	-		CR for Timers and constants values used during handover to E-UTRA	8.5.0
	RP-43	RP-090131	0048	-		Inter-RAT Security Clarification	8.5.0
	RP-43	RP-090131	0049	-		CR to 36.331 on consistent naming of 1xRTT identifiers	8.5.0
	RP-43	RP-090131	0050	-		Capturing RRC behavior regarding NAS local release	8.5.0
	RP-43	RP-090131	0051	-		Report CGI before T321 expiry and UE null reporting	8.5.0
	RP-43	RP-090131	0052	-		System Information and 3 hour validity	8.5.0
	RP-43	RP-090131	0053	1		Inter-Node AS Signalling	8.5.0
	RP-43	RP-090131	0054	-		Set of values for the parameter "messagePowerOffsetGroupB"	8.5.0
	RP-43	RP-090131	0055	-		CR to paging reception for ETWS capable UEs in RRC_CONNECTED	8.5.0
	RP-43	RP-090131	0056	1		CR for CSG related items in 36.331	8.5.0
	RP-43	RP-090131	0057	1		SRS common configuration	8.5.0
	RP-43	RP-090131	0058	-		RRC processing delay	8.5.0
	RP-43	RP-090131	0059	-		CR for HNB Name	8.5.0
	RP-43	RP-090131	0060	3		Handover to EUTRA delta configuration	8.5.0
	RP-43	RP-090131	0063	-		Delivery of Message Identifier and Serial Number to upper layers for ETWS	8.5.0
	RP-43	RP-090131	0066	-		Clarification on the maximum size of cell lists	8.5.0
	RP-43	RP-090131	0067	-		Missing RRC messages in 'Protection of RRC messages'	8.5.0
	RP-43	RP-090131	0069	1		Clarification on NAS Security Container	8.5.0
	RP-43	RP-090131	0071	-		Extension of range of CQI/PMI configuration index	8.5.0
	RP-43	RP-090131	0072	1		Access barring alleviation in RRC connection establishment	8.5.0
	RP-43	RP-090367	0077	6		Corrections to feature group support indicators	8.5.0
	RP-43	RP-090131	0078	-		CR from email discussion to capture DRX and TTT handling	8.5.0
	RP-43	RP-090131	0079	1		Need Code handling on BCCH messages	8.5.0
	RP-43	RP-090131	0080	-		Unification of T300 and T301 and removal of miscellaneous FFSS	8.5.0

	RP-43	RP-090131	0084	1	Proposed CR modifying the code-point definitions of neighbourCellConfiguration	8.5.0
	RP-43	RP-090131	0087	2	Remove Redundant Optionality in SIB8	8.5.0
	RP-43	RP-090131	0089	-	Corrections to the generic error handling	8.5.0
	RP-43	RP-090131	0090	-	Configurability of T301	8.5.0
	RP-43	RP-090131	0091	1	Correction related to TTT	8.5.0
	RP-43	RP-090131	0095	-	CR for 36.331 on SPS-config	8.5.0
	RP-43	RP-090131	0096	2	CR for Deactivation of periodical measurement	8.5.0
	RP-43	RP-090131	0099	2	SMC and reconfiguration	8.5.0
	RP-43	RP-090131	0101	-	TDD handover	8.5.0
	RP-43	RP-090131	0102	-	Corrections to system information acquisition	8.5.0
	RP-43	RP-090131	0106	-	Some Corrections and Clarifications to 36.331	8.5.0
	RP-43	RP-090131	0109	-	Clarification on the Maximum number of ROHC context sessions parameter	8.5.0
	RP-43	RP-090131	0110	-	Transmission of rrm-Config at Inter-RAT Handover	8.5.0
	RP-43	RP-090131	0111	1	Use of SameRefSignalsInNeighbor parameter	8.5.0
	RP-43	RP-090131	0112	-	Default serving cell offset for measurement event A3	8.5.0
	RP-43	RP-090131	0114	-	dl-EARFCN missing in HandoverPreparationInformation	8.5.0
	RP-43	RP-090131	0115	-	Cleanup of references to 36.101	8.5.0
	RP-43	RP-090131	0117	-	Correction to the value range of UE-Categories	8.5.0
	RP-43	RP-090131	0122	1	Correction on RRC connection re-establishment	8.5.0
	RP-43	RP-090131	0124	-	Performing Measurements to report CGI for CDMA2000	8.5.0
	RP-43	RP-090131	0125	-	CDMA2000-SystemTimeInfo in VarMeasurementConfiguration	8.5.0
	RP-43	RP-090131	0126	-	UE Capability Information for CDMA2000 1xRTT	8.5.0
	RP-43	RP-090131	0127	-	CDMA2000 related editorial changes	8.5.0
	RP-43	RP-090131	0128	-	Draft CR to 36.331 on State mismatch recovery at re-establishment	8.5.0
	RP-43	RP-090131	0129	1	Draft CR to 36.331 on Renaming of AC barring related IEs	8.5.0
	RP-43	RP-090131	0130	2	Draft CR to 36.331 on Inheriting of dedicated priorities at inter-RAT reselection	8.5.0
	RP-43	RP-090131	0135	-	Proposed CR to 36.331 Description alignment for paging parameter, nB	8.5.0
	RP-43	RP-090131	0139	2	Miscellaneous corrections and clarifications resulting from ASN.1 review	8.5.0
	RP-43	RP-090131	0141	1	Correction regarding Redirection Information fo GERAN	8.5.0
	RP-43	RP-090131	0142	-	Further ASN.1 review related issues	8.5.0
	RP-43	RP-090131	0143	-	Periodic measurements	8.5.0
	RP-43	RP-090131	0144	1	Further analysis on code point "OFF" for ri-ConfigIndex	8.5.0
	RP-43	RP-090131	0145	1	Adding and deleting same measurement or configuration in one message	8.5.0
	RP-43	RP-090131	0147	-	Corrections to IE dataCodingScheme in SIB11	8.5.0
	RP-43	RP-090131	0148	-	Clarification on Mobility from E-UTRA	8.5.0
	RP-43	RP-090131	0149	-	36.331 CR related to "not applicable"	8.5.0
	RP-43	RP-090131	0150	1	UE radio capability transfer	8.5.0
	RP-43	RP-090131	0151	-	CR to 36.331 on value of CDMA band classes	8.5.0
	RP-43	RP-090131	0152	-	Corrections to DRB modification	8.5.0
	RP-43	RP-090131	0153	-	Correction to presence condition for pdcp-config	8.5.0
	RP-43	RP-090131	0155	-	TDD HARQ-ACK feedback mode	8.5.0
	RP-43	RP-090275	0157	-	Corrections regarding use of carrierFreq for CDMA (SIB8) and GERAN (measObject)	8.5.0
	RP-43	RP-090321	0156	1	Sending of GERAN SI/PSI information at Inter-RAT Handover	8.5.0
	RP-43	RP-090339	0158	-	Clarification of CSG support	8.5.0
06/2009	RP-44	RP-090516	0159	-	Octet alignment of VarShortMAC-Input	8.6.0
	RP-44	RP-090516	0160	3	Minor corrections to the feature grouping	8.6.0
	RP-44	RP-090516	0161	-	Security clarification	8.6.0
	RP-44	RP-090516	0162	1	Sending of GERAN SI/PSI information at Inter-RAT Handover	8.6.0
	RP-44	RP-090516	0163	1	Correction of UE measurement model	8.6.0
	RP-44	RP-090516	0164	-	Restricting the reconfiguration of UM RLC SN field size	8.6.0
	RP-44	RP-090516	0165	1	36.331 CR on Clarification on cell change order from GERAN to E-UTRAN	8.6.0
	RP-44	RP-090516	0166	-	36.331 CR - Handling of expired TAT and failed D-SR	8.6.0
	RP-44	RP-090516	0167	1	Proposed CR to 36.331 Clarification on mandatory information in AS-Config	8.6.0
	RP-44	RP-090516	0168	2	Miscellaneous small corrections	8.6.0
	RP-44	RP-090516	0173	-	Clarification on the basis of delta signalling	8.6.0
	RP-44	RP-090516	0177	-	CR on Alignment of CCCH and DCCH handling of missing mandatory field	8.6.0
	RP-44	RP-090516	0180	2	Handling of Measurement Context During HO Preparation	8.6.0
	RP-44	RP-090516	0181	-	Clarification of key-eNodeB-Star in AdditionalReestabInfo	8.6.0
	RP-44	RP-090516	0182	1	UE Capability Transfer	8.6.0
	RP-44	RP-090516	0186	1	Clarification regarding mobility from E-UTRA in-between SMC and SRB2/DRB setup	8.6.0
	RP-44	RP-090516	0188	1	Correction and completion of specification conventions	8.6.0
	RP-44	RP-090516	0195	2	RB combination in feature group indicator	8.6.0
	RP-44	RP-090516	0196	1	CR for need code for fields in mobilityControllInfo	8.6.0
	RP-44	RP-090497	0197	-	Alignment of pusch-HoppingOffset with 36.211	8.6.0
	RP-44	RP-090570	0198	-	Explicit srb-Identity values for SRB1 and SRB2	8.6.0
	RP-44	RP-090516	0199	-	Removing use of defaultValue for mac-MainConfig	8.6.0
09/2009	RP-45	RP-090906	0200	-	Proposed update of the feature grouping	8.7.0

	RP-45	RP-090906	0201	-	Clarification on measurement object configuration for serving frequency	8.7.0
	RP-45	RP-090906	0202	-	Correction regarding SRVCC	8.7.0
	RP-45	RP-090906	0203	-	Indication of DRB Release during HO	8.7.0
	RP-45	RP-090906	0204	1	Correction regarding application of dedicated resource configuration upon handover	8.7.0
	RP-45	RP-090906	0205	-	REL-9 protocol extensions in RRC	8.7.0
	RP-45	RP-090906	0206	-	In-order delivery of NAS PDUs at RRC connection reconfiguration	8.7.0
	RP-45	RP-090906	0207	-	Correction on Threshold of Measurement Event	8.7.0
	RP-45	RP-090906	0210	-	Clarification on dedicated resource of RA procedure	8.7.0
	RP-45	RP-090906	0213	1	Cell barring when MasterInformationBlock or SystemInformationBlock1 is missing	8.7.0
	RP-45	RP-090915	0218	-	Security threat with duplicate detection for ETWS	8.7.0
	RP-45	RP-090906	0224	-	Clarification on supported handover types in feature grouping	8.7.0
	RP-45	RP-090906	0250	1	Handling of unsupported / non-comprehended frequency band and emission requirement	8.7.0
	RP-45	RP-090906	0251	-	RB combinations in feature group indicator 20	8.7.0
09/2009	RP-45	RP-090934	0220	1	Introduction of Per-QCI radio link failure timers (option 1)	9.0.0
	RP-45	RP-090926	0222	-	Null integrity protection algorithm	9.0.0
	RP-45	RP-090926	0223	-	Emergency Support Indicator in BCCH	9.0.0
	RP-45	RP-090934	0230	2	CR to 36.331 for Enhanced CSFB to 1xRTT with concurrent PS handover	9.0.0
	RP-45	RP-090934	0243	-	REL-9 on Miscellaneous editorial corrections	9.0.0
	RP-45	RP-090934	0247	-	Periodic CQI/PMI/RI masking	9.0.0
	RP-45	RP-090933	0252	-	Introduction of CMAS	9.0.0
12/2009	RP-46	RP-091346	0253	1	(Rel-9)-clarification on the description of redirectedCarrierInfo	9.1.0
	RP-46	RP-091346	0254	1	Adding references to RRC processing delay for inter-RAT mobility messages	9.1.0
	RP-46	RP-091314	0256	-	Alignment of srs-Bandwidth with 36.211	9.1.0
	RP-46	RP-091341	0257	5	Baseline CR capturing eMBMS agreements	9.1.0
	RP-46	RP-091343	0258	3	Capturing agreements on inbound mobility	9.1.0
	RP-46	RP-091314	0260	-	Clarification of preRegistrationZoneID/secondaryPreRegistrationZoneID	9.1.0
	RP-46	RP-091346	0261	-	Clarification on NCC for IRAT HO	9.1.0
	RP-46	RP-091314	0263	-	Clarification on P-max	9.1.0
	RP-46	RP-091314	0265	1	Clarification on the definition of maxCellMeas	9.1.0
	RP-46	RP-091346	0266	-	Correction of q-RxLevMin reference in SIB7	9.1.0
	RP-46	RP-091346	0267	-	Correction on SPS-Config field descriptions	9.1.0
	RP-46	RP-091346	0268	1	correction on the definition of CellsTriggeredList	9.1.0
	RP-46	RP-091345	0269	-	Correction relating to CMAS UE capability	9.1.0
	RP-46	RP-091314	0271	1	Feature grouping bit for SRVCC handover	9.1.0
	RP-46	RP-091314	0272	1	Correction and completion of extension guidelines	9.1.0
	RP-46	RP-091344	0273	-	RACH optimization Stage-3	9.1.0
	RP-46	RP-091345	0274	-	Stage 3 correction for CMAS	9.1.0
	RP-46	RP-091346	0276	1	SR prohibit mechanism for UL SPS	9.1.0
	RP-46	RP-091346	0277	-	Parameters used for enhanced 1xRTT CS fallback	9.1.0
	RP-46	RP-091346	0281	-	Correction on UTRAN UE Capability transfer	9.1.0
	RP-46	RP-091346	0285	-	Maximum number of CDMA2000 neighbors in SIB8	9.1.0
	RP-46	RP-091340	0288	1	Introduction of UE Rx-Tx Time Difference measurement	9.1.0
	RP-46	RP-091346	0297	-	Introduction of SR prohibit timer	9.1.0
	RP-46	RP-091346	0298	-	Remove FFSs from RAN2 specifications	9.1.0
	RP-46	RP-091343	0301	1	Renaming Allowed CSG List (36.331 Rel-9)	9.1.0
	RP-46	RP-091346	0305	-	Re-introduction of message segment discard time	9.1.0
	RP-46	RP-091346	0306	1	Application of ASN.1 extension guidelines	9.1.0
	RP-46	RP-091346	0309	1	Support for Dual Radio 1xCSFB	9.1.0
	RP-46	RP-091346	0311	-	Shorter SR periodicity	9.1.0
	RP-46	RP-091342	0316	-	CR to 36.331 for Introduction of Dual Layer Transmission	9.1.0
	RP-46	RP-091343	0318	1	Draft CR to 36.331 on Network ordered SI reporting	9.1.0
	RP-46	RP-091346	0322	-	UE e1xcfb capabilities correction	9.1.0
	RP-46	RP-091331	0327	1	Clarification on coding of ETWS related IEs	9.1.0
03/2010	RP-47	RP-100285	0331	-	Clarification of CGI reporting	9.2.0
	RP-47	RP-100305	0332	-	Clarification on MCCH change notification	9.2.0
	RP-47	RP-100308	0333	-	Clarification on measurement for serving cell only	9.2.0
	RP-47	RP-100306	0334	-	Clarification on proximity indication configuraiton in handover to E-UTRA	9.2.0
	RP-47	RP-100308	0335	-	Clarification on radio resource configuration in handover to E-UTRA procedure	9.2.0
	RP-47	RP-100308	0336	-	Clarification on UE maximum transmission power	9.2.0
	RP-47	RP-100308	0337	-	Correction to field descriptions of UE-EUTRA-Capability	9.2.0
	RP-47	RP-100305	0338	-	Correction to MBMS scheduling terminology	9.2.0
	RP-47	RP-100308	0339	-	Corrections to SIB8	9.2.0
	RP-47	RP-100306	0340	-	CR 36.331 R9 for Unifying SI reading for ANR and inbound mobility	9.2.0
	RP-47	RP-100308	0341	1	CR to 36.331 for 1xRTT pre-registration information in SIB8	9.2.0
	RP-47	RP-100305	0342	-	CR to 36.331 on corrections for MBMS	9.2.0
	RP-47	RP-100306	0343	1	CR to 36.331 on CSG identity reporting	9.2.0
	RP-47	RP-100308	0344	2	CR to 36.331 on Optionality of Rel-9 UE features	9.2.0
	RP-47	RP-100308	0345	1	CR to 36.331 on Service Specific Acces Control (SSAC)	9.2.0

	RP-47	RP-100308	0346	-		Introduction of power-limited device indication in UE capability.	9.2.0
	RP-47	RP-100305	0347	-		Missing agreement in MCCH change notification.	9.2.0
	RP-47	RP-100305	0348	1		Corrections related to MCCH change notification and value ranges	9.2.0
	RP-47	RP-100306	0349	2		Prohibit timer for proximity indication	9.2.0
	RP-47	RP-100306	0350	1		Proximity Indication after handover and re-establishment	9.2.0
	RP-47	RP-100305	0351	-		Specifying the exact mapping of notificationIndicator in SIB13 to PDCCH bits	9.2.0
	RP-47	RP-100308	0352	-		Corrections out of ASN.1 review scope	9.2.0
	RP-47	RP-100308	0353	-		CR on clarification of system information change	9.2.0
	RP-47	RP-100285	0358	-		Measurement Result CDMA2000 Cell	9.2.0
	RP-47	RP-100304	0361	-		Correction on the range of UE Rx-Tx time difference measurement result	9.2.0
	RP-47	RP-100305	0362	-		Small clarifications regarding MBMS	9.2.0
	RP-47	RP-100308	0363	-		Introduction of REL-9 indication within field accessStratumRelease	9.2.0
	RP-47	RP-100306	0364	-		Extending mobility description to cover inbound mobility	9.2.0
	RP-47	RP-100308	0365	1		Clarification regarding enhanced CSFB to 1XRTT	9.2.0
	RP-47	RP-100308	0368	-		Handling of dedicated RLF timers	9.2.0
	RP-47	RP-100305	0370	1		Clarification on UE's behavior of receiving MBMS service	9.2.0
	RP-47	RP-100305	0371	-		MBMS Service ID and Session ID	9.2.0
	RP-47	RP-100305	0372	1		Inclusion of non-MBSFN region length in SIB13	9.2.0
	RP-47	RP-100309	0374	1		CR to 36.331 for e1xCSFB access class barring parameters in SIB8	9.2.0
	RP-47	RP-100308	0375	-		Multiple 1xRTT/HRPD target cells in MobilityFromEUTRACCommand	9.2.0
	RP-47	RP-100308	0376	-		Independent support indicators for Dual-Rx CSFB and S102 in SIB8	9.2.0
	RP-47	RP-100285	0378	-		Clarification on DRX StartOffset for TDD	9.2.0
	RP-47	RP-100308	0379	1		Miscellaneous corrections from REL-9 ASN.1 review	9.2.0
	RP-47	RP-100308	0381	-		Need codes and missing conventions	9.2.0
	RP-47	RP-100308	0383	1		Introduction of Full Configuration Handover for handling earlier eNB releases	9.2.0
	RP-47	RP-100308	0385	-		Clarification to SFN reference in RRC	9.2.0
	RP-47	RP-100308	0390	-		RSRP and RSRQ based Thresholds	9.2.0
	RP-47	RP-100189	0392	3		Redirection enhancements to GERAN	9.2.0
	RP-47	RP-100308	0398	-		Cell reselection enhancements CR for 36.331	9.2.0
	RP-47	RP-100307	0401	3		CR on UE-originated RLF reporting for MRO SON use case	9.2.0
	RP-47	RP-100309	0402	3		CR to 36.331 on Redirection enhancements to UTRAN	9.2.0
	RP-47	RP-100306	0403	2		Proximity status indication handling at mobility	9.2.0
	RP-47	RP-100305	0404	-		Upper layer aspect of MBSFN area id	9.2.0
	RP-47	RP-100308	0405	-		Redirection for enhanced 1xRTT CS fallback with concurrent PSHO	9.2.0
	RP-47	RP-100301	0406	-		Avoiding interleaving transmission of CMAS notifications	9.2.0
	RP-47	RP-100308	0407	1		Introduction of UE GERAN DTM capability indicator	9.2.0
	RP-47	RP-100381	0408	2		Introducing provisions for late ASN.1 corrections	9.2.0
	RP-47	RP-100245	0411	-		Correction/ alignment of REL-9 UE capability signalling	9.2.0
06/2010	RP-48	RP-100553	0412	-		Clarification for mapping between warning message and CB-data	9.3.0
	RP-48	RP-100556	0413	-		Clarification of radio link failure related actions	9.3.0
	RP-48	RP-100554	0414	-		Clarification on UE actions upon leaving RRC_CONNECTED	9.3.0
	RP-48	RP-100553	0415	-		Correction on CMAS system information	9.3.0
	RP-48	RP-100554	0416	1		Corrections to MBMS	9.3.0
	RP-48	RP-100536	0418	-		Decoding of unknown future extensions	9.3.0
	RP-48	RP-100556	0419	1		Miscellaneous small corrections and clarifications	9.3.0
	RP-48	RP-100551	0420	-		Prohibit timer for proximity indication	9.3.0
	RP-48	RP-100556	0421	-		RLF report for MRO correction	9.3.0
	RP-48	RP-100546	0423	1		Missing UTRA bands in IRAT-ParametersUTRA-FDD	9.3.0
	RP-48	RP-100556	0424	-		Correction on handling of dedicated RLF timers	9.3.0
	RP-48	RP-100556	0431	1		Protection of RRC messages	9.3.0
	RP-48	RP-100556	0433	-		Handling missing Essential system information	9.3.0
	RP-48	RP-100551	0434	1		Clarification on UMTS CSG detected cell reporting in LTE	9.3.0
	RP-48	RP-100556	0436	-		Introducing provisions for late corrections	9.3.0
	RP-48	RP-100556	0437	-		Clarification regarding / alignment of REL-9 UE capabilities	9.3.0
09/2010	RP-49	RP-100845	0440	-		Correction to 3GPP2 reference for interworking with cdma2000 1x	9.4.0
	RP-49	RP-100851	0441	-		Clarification on UL handover preparation transfer	9.4.0
	RP-49	RP-100851	0442	1		Clarifications regarding fullConfiguration	9.4.0
	RP-49	RP-100851	0443	-		Clarifications regarding handover to E-UTRAN	9.4.0
	RP-49	RP-100854	0444	-		Correction on the table of conditionally mandatory Release 9 features	9.4.0
	RP-49	RP-100851	0445	-		Corrections to TS36.331 on MeasConfig IE	9.4.0
	RP-49	RP-100853	0446	2		CR to 36.331 on clarification for MBMS PTM RBs	9.4.0
	RP-49	RP-100851	0447	-		Introduction of late corrections container for E-UTRA UE capabilities	9.4.0
	RP-49	RP-100851	0448	-		Renaming of containers for late non-critical extensions	9.4.0
	RP-49	RP-100851	0452	-		Clarifications Regarding Redirection from LTE	9.4.0
	RP-49	RP-100845	0456	-		Description of multi-user MIMO functionality in feature group indicator table	9.4.0
	RP-49	RP-100845	0458	-		Correct the PEMAX_H to PEMAX	9.4.0
	RP-49	RP-100851	0460	-		Clarification for feature group indicator bit 11	9.4.0
	RP-49	RP-100851	0465	1		Clarification of FGI setting for inter-RAT features not supported by the UE	9.4.0
	RP-49	RP-101008	0475	1		FGI settings in Rel-9	9.4.0
12/2010	RP-50	RP-101197	0483	-		Clarification on Meaning of FGI Bits	9.5.0
	RP-50	RP-101197	0485	-		Clarification regarding reconfiguration of the quantityConfig	9.5.0

	RP-50	RP-101210	0486	1		Corrections to the presence of IE regarding DRX and CQI	9.5.0
	RP-50	RP-101210	0493	-		The field descriptions of MeasObjectEUTRA	9.5.0
	RP-50	RP-101197	0498	1		Clarification of FGI settings non ANR periodical measurement reporting	9.5.0
	RP-50	RP-101209	0500	-		Corrections to RLF Report	9.5.0
	RP-50	RP-101206	0519	1		T321 timer fix	9.5.0
	RP-50	RP-101197	0524	-		Restriction of AC barring parameter setting	9.5.0
	RP-50	RP-101210	0525	-		Removal of SEQUENCE OF SEQUENCE in UEInformationResponse	9.5.0
	RP-50	RP-101197	0526	1		Clarification regarding default configuration value N/A	9.5.0
	RP-50	RP-101431	0532	-		Splitting FGI bit 3	9.5.0
	RP-50	RP-101183	0476	4		36.331 CR on Introduction of Minimization of Drive Tests	10.0.0
	RP-50	RP-101293	0477	4		AC-Barring for Mobile Originating CSFB call	10.0.0
	RP-50	RP-101214	0478	-		Addition of UE-EUTRA-Capability descriptions	10.0.0
	RP-50	RP-101214	0481	-		Clarification on Default Configuration for CQI-ReportConfig	10.0.0
	RP-50	RP-101215	0487	-		CR to 36.331 adding e1xCSFB support for dual Rx/Tx UE	10.0.0
	RP-50	RP-101227	0488	1		Introduction of Carrier Aggregation and UL/ DL MIMO	10.0.0
	RP-50	RP-101228	0489	1		Introduction of relays in RRC	10.0.0
	RP-50	RP-101214	0490	1		Priority indication for CSFB with re-direction	10.0.0
	RP-50	RP-101214	0491	-		SIB Size Limitations	10.0.0
	RP-50	RP-101214	0513	-		Combined Quantity Report for IRAT measurement of UTRAN	10.0.0
	RP-50	RP-101214	0527	1		UE power saving and Local release	10.0.0
	RP-50	RP-101429	0530	1		Inclusion of new UE categories in Rel-10	10.0.0
03/2011	RP-51	RP-110282	0533	-		36331_CRxxx_Protection of Logged Measurements Configuration	10.1.0
	RP-51	RP-110294	0534	1		Stage-3 CR for MBMS enhancement	10.1.0
	RP-51	RP-110282	0535	-		Clean up MDT-related text	10.1.0
	RP-51	RP-110282	0536	-		Clear MDT configuration and logs when the UE is not registered	10.1.0
	RP-51	RP-110280	0537	-		Correction to the field description of nB	10.1.0
	RP-51	RP-110289	0538	-		CR on impact on UP with remove&add approach_2	10.1.0
	RP-51	RP-110282	0539	-		CR to 36.331 on corrections for MDT	10.1.0
	RP-51	RP-110290	0543	-		Introduction of CA/MIMO capability signalling and measurement capability signalling in CA	10.1.0
	RP-51	RP-110282	0544	-		MDT PDU related clarifications	10.1.0
	RP-51	RP-110282	0545	-		Correction on release of logged measurement configuration while in another RAT	10.1.0
	RP-51	RP-110289	0546	-		Miscellaneous Corrections for CA Running RRC CR	10.1.0
	RP-51	RP-110280	0547	1		Miscellaneous small clarifications and corrections	10.1.0
	RP-51	RP-110293	0548	4		Necessary changes for RLF reporting enhancements	10.1.0
	RP-51	RP-110282	0549	1		Memory size for logged measurements capable UE	10.1.0
	RP-51	RP-110289	0550	-		Parameters confusion of non-CA and CA configurations	10.1.0
	RP-51	RP-110272	0553	-		Presence condition for cellSelectionInfo-v920 in SIB1	10.1.0
	RP-51	RP-110282	0554	1		Removal of MDT configuration at T330 expiry	10.1.0
	RP-51	RP-110289	0556	1		Signalling aspects of existing LTE-A parameters	10.1.0
	RP-51	RP-110280	0557	1		Some Corrections on measurement	10.1.0
	RP-51	RP-110291	0558	-		Stored system information for RNs	10.1.0
	RP-51	RP-110291	0559	-		Support of Integrity Protection for Relay	10.1.0
	RP-51	RP-110290	0561	2		Updates of L1 parameters for CA and UL/DL MIMO	10.1.0
	RP-51	RP-110291	0571	1		Note for Dedicated SIB for RNs	10.1.0
	RP-51	RP-110272	0579	-		Correction to cs-fallbackIndicator field description	10.1.0
	RP-51	RP-110289	0580	-		Clarification to the default configuration of sCellDeactivationTimer	10.1.0
	RP-51	RP-110289	0581	-		Miscellaneous corrections to TS 36.331 on Carrier Aggregation	10.1.0
	RP-51	RP-110280	0584	-		Correction of configuration description in SIB2	10.1.0
	RP-51	RP-110265	0587	-		Clarification of band indicator in handover from E-UTRAN to GERAN	10.1.0
	RP-51	RP-110285	0588	1		36331_CRxxx Support of Delay Tolerant access requests	10.1.0
	RP-51	RP-110292	0590	-		Update of R2-110807 on CSI measurement resource restriction for time domain ICIC	10.1.0
	RP-51	RP-110292	0591	-		Update of R2-110821 on RRM/RLM resource restriction for time domain ICIC	10.1.0
	RP-51	RP-110290	0592	-		Corrections on UE capability related parameters	10.1.0
	RP-51	RP-110282	0596	-		Validity time for location information in Immediate MDT	10.1.0
	RP-51	RP-110280	0597	-		CR to 36.331 adding UE capability indicator for dual Rx/Tx e1xCSFB	10.1.0
	RP-51	RP-110289	0598	-		Miscellaneous corrections to CA	10.1.0
	RP-51	RP-110280	0599	-		Further correction to combined measurement report of UTRAN	10.1.0
	RP-51	RP-110280	0600	-		Correction to the reference of ETWS	10.1.0
	RP-51	RP-110269	0602	1		Introduction of OTDOA inter-freq RSTD measurement indication procedure	10.1.0
	RP-51	RP-110280	0603	-		Correction of use of RRCConnectionReestablishment message for contention resolution	10.1.0
	RP-51	RP-110282	0604	-		CR to 36.331 on MDT neighbour cell measurements logging	10.1.0
	RP-51	RP-110272	0609	-		Minor ASN.1 corrections for the UEInformationResponse message	10.1.0
	RP-51	RP-110280	0613	-		Clarification regarding dedicated RLF timers and constants	10.1.0
	RP-51	RP-110282	0615	-		Release of Logged Measurement Configuration	10.1.0
	RP-51	RP-110280	0616	-		Some corrections on TS 36.331	10.1.0
	RP-51	RP-110280	0623	-		AC barring procedure clean up	10.1.0
	RP-51	RP-110282	0624	-		Counter proposal to R2-110826 on UE capabilities for MDT	10.1.0
	RP-51	RP-110280	0628	1		UE information report for RACH	10.1.0

	RP-51	RP-110289	0629	2		Measurement on the deactivated SCells	10.1.0
	RP-51	RP-110282	0632	1		Trace configuration parameters for Logged MDT	10.1.0
	RP-51	RP-110282	0635	-		Clarification on stop condition for timer T3330	10.1.0
	RP-51	RP-110282	0637	-		User consent for MDT	10.1.0
	RP-51	RP-110280	0638	-		Correction on the range of CQI resource index	10.1.0
	RP-51	RP-110272	0640	1		Small corrections to ETWS & CMAS system information	10.1.0
	RP-51	RP-110290	0641	1		UE capability signaling structure w.r.t carrier aggregation, MIMO and measurement gap	10.1.0
	RP-51	RP-110289	0642	1		Normal PHR and the multiple uplink carriers	10.1.0
	RP-51	RP-110280	0643	1		Corrections to TS36.331 on SIB2 handling	10.1.0
	RP-51	RP-110280	0644	1		Adding a Power Management indication in PHR	10.1.0
	RP-51	RP-110289	0646	1		Clarification for CA and TTI bundling in RRC	10.1.0
	RP-51	RP-110443	0648	1		Updates to FGI settings	10.1.0
06/2011	RP-52	RP-110836	0651	-		Add MBMS counting procedure to processing delay requirement for RRC procedure Section 11.2	10.2.0
	RP-52	RP-110830	0653	-		Add pre Rel-10 procedures to processing delay requirement for RRC procedure Section 11.2	10.2.0
	RP-52	RP-110847	0654	1		Addition of a specific reference for physical configuration fields	10.2.0
	RP-52	RP-110839	0656	-		Clarification of inter-frequency RSTD measurement indication procedure	10.2.0
	RP-52	RP-110830	0658	-		Clarification of optionality of UE features without capability	10.2.0
	RP-52	RP-110839	0660	-		Clarification on the definition of maxCellBlack	10.2.0
	RP-52	RP-110839	0661	-		Clarification on upper layer requested connection release	10.2.0
	RP-52	RP-110850	0662	3		Clarification regarding eCIC measurements	10.2.0
	RP-52	RP-110839	0663	-		CR for s-measure handling	10.2.0
	RP-52	RP-110851	0664	1		CR on clarification of RLF Report in Carrier Aggregation	10.2.0
	RP-52	RP-110830	0669	-		FGI bit for handover between LTE FDD/TDD	10.2.0
	RP-52	RP-110847	0670	2		Further updates on L1 parameters	10.2.0
	RP-52	RP-110839	0671	2		General error handling for extension fields	10.2.0
	RP-52	RP-110851	0672	2		Additional information for RLF report	10.2.0
	RP-52	RP-110843	0673	-		Introduction of TCE ID for logged MDT	10.2.0
	RP-52	RP-110670	0674	4		Miscellaneous corrections (related to review in preparation for ASN.1 freeze)	10.2.0
	RP-52	RP-110843	0675	-		PLMN check for MDT logging	10.2.0
	RP-52	RP-110839	0677	-		UE actions upon leaving RRC_CONNECTED	10.2.0
	RP-52	RP-110847	0678	-		Clarification on bandEUTRA-r10 and supportedBandListEUTRA	10.2.0
	RP-52	RP-110837	0679	-		Updated value range for the Extended Wait Timer	10.2.0
	RP-52	RP-110839	0680	1		Value range of DRX-InactivityTimer	10.2.0
	RP-52	RP-110828	0693	1		Correction for SR-VCC and QCI usage	10.2.0
	RP-52	RP-110847	0694	-		Restructuring of CQI-ReportConfig-r10	10.2.0
	RP-52	RP-110839	0695	2		Correction on DL allocations in MBSFN subframes	10.2.0
	RP-52	RP-110850	0700	-		Reference SFN for MeasSubframePattern	10.2.0
	RP-52	RP-110846	0701	-		Clarifications to CA related field descriptions	10.2.0
	RP-52	RP-110847	0702	-		Corrections to codebookSubsetRestriction and SRS parameters	10.2.0
	RP-52	RP-110834	0704	-		Corrections to the handling of ri-ConfigIndex for TM9	10.2.0
	RP-52	RP-110715	0710	2		UE capabilities for Rel-10 LTE features with eCIC measurement restrictions as FGI (Alt.1)	10.2.0
	RP-52	RP-110839	0713	-		CR to 36.331 on redirected ultra-TDD carrier frequency	10.2.0
	RP-52	RP-110839	0714	-		Explicit AS signalling for mapped PTMSI/GUTI	10.2.0
	RP-52	RP-110847	0718	-		Counter proposal for Updates of mandatory information in AS-Config	10.2.0
	RP-52	RP-110839	0719	-		CR for Reconfiguration of discardTimer in PDCP-Config	10.2.0
	RP-52	RP-110847	0723	-		On the missing multiplicity of UE capability parameters	10.2.0
	RP-52	RP-110830	0735	-		Radio frame alignment of CSA and MSP	10.2.0
	RP-52	RP-110847	0740	-		Reconfiguration involving critically extended IEs (using fullFieldConfig i.e. option 2)	10.2.0
	RP-52	RP-110839	0744	-		Counter proposal to R2-112753 on CR to remove CSG Identity validity limited to CSG cell	10.2.0
	RP-52	RP-110839	0746	1		Increase of prioritisedBitRate	10.2.0
	RP-52	RP-110847	0747	-		CA and MIMO Capabilities in LTE Rel-10	10.2.0
09/2011	RP-53	RP-111297	0752	-		TS36.331 Correction	10.3.0
	RP-53	RP-111297	0754	-		maxNumberROHC-ContextSessions when no ROHC profile is supported	10.3.0
	RP-53	RP-111280	0757	-		Correction to Subframe Allocation End in PMCH-Info	10.3.0
	RP-53	RP-111288	0761	-		Correction on PUCCH configuration for Un interface	10.3.0
	RP-53	RP-111297	0762	-		Miscellaneous corrections to 36.331	10.3.0
	RP-53	RP-111278	0764	2		36.331 correction on CSG identity validity to allow introduction of CSG RAN sharing	10.3.0
	RP-53	RP-111283	0770	2		AdditionalSpectrumEmissions in CA	10.3.0
	RP-53	RP-111297	0773	-		CR to 36.331 on Small correction of PHR parameter	10.3.0
	RP-53	RP-111283	0775	2		Clarifications to P-max on CA	10.3.0
	RP-53	RP-111280	0784	-		Clarification on for which subframes signalling MCS applies	10.3.0
	RP-53	RP-111283	0792	-		Corrections in RRC	10.3.0
	RP-53	RP-111297	0793	-		Replace the tables with exception list in 10.5 AS-Config	10.3.0
	RP-53	RP-111297	0796	-		Corrections to the field descriptions	10.3.0
	RP-53	RP-111283	0798	-		Configuration of simultaneous PUCCH&PUSCH	10.3.0
	RP-53	RP-111297	0806	-		Corrections to release of csi-SubframePatternConfig and cqi-Mask	10.3.0

	RP-53	RP-111272	0810	-		GERAN SI format for cell change order&PS handover& enhanced redirection to GERAN	10.3.0
	RP-53	RP-111283	0811	-		Corrections to PUCCH-Config field descriptions	10.3.0
12/2011	RP-54	RP-111711	0812	1		Clarification of PCI range for CSG cells	10.4.0
	RP-54	RP-111716	0813	-		Clarifications to Default Radio Configurations	10.4.0
	RP-54	RP-111716	0814	1		Corrections to enhancedDualLayerTDD	10.4.0
	RP-54	RP-111716	0815	-		Miscellaneous small corrections	10.4.0
	RP-54	RP-111716	0816	1		Correction on notation of SRS transmission comb	10.4.0
	RP-54	RP-111706	0823	1		36.331 CR SPS reconfiguration	10.4.0
	RP-54	RP-111716	0827	2		Clarification of list sizes in measurement configuration stored by UE	10.4.0
	RP-54	RP-111706	0835	-		Clarification of the event B1 and ANR related FGI bits	10.4.0
	RP-54	RP-111714	0840	1		Clarification on MBSFN and measurement resource restrictions	10.4.0
	RP-54	RP-111706	0845	-		Clarification on parallel message transmission upon connection re-establishment	10.4.0
03/2012	RP-55	RP-120326	0855	1		Limiting MBMS counting responses to within the PLMN	10.5.0
	RP-55	RP-120321	0857	-		CR to 36.331 on cdma2000 band classes and references	10.5.0
	RP-55	RP-120326	0862	1		Clarification on MBSFN and measurement resource restrictions	10.5.0
	RP-55	RP-120325	0871	-		On SIB10/11 Reception Timing	10.5.0
	RP-55	RP-120326	0875	1		Clarification on MBMS counting for uncipherable services	10.5.0
	RP-55	RP-120325	0876	-		Minor correction regarding limited service access on non-CSG-member cell	10.5.0
	RP-55	RP-120326	0894	-		Time to keep RLF Reporting logs	10.5.0
	RP-55	RP-120356	0895	1		Introducing means to signal different FDD/TDD Capabilities/FGIs for Dual-xDD UE	10.5.0
	RP-55	RP-120321	0899	-		Clarification on SRB2 resumption upon connection re-establishment (parallel message transmission)	10.5.0
	RP-55	RP-120321	0900	1		Duplicated ASN.1 naming correction	10.5.0
06/2012	RP-56	RP-120805	0909	-		SPS Reconfiguration	10.6.0
	RP-56	RP-120805	0912	1		Change in Scheduling Information for ETWS	10.6.0
	RP-56	RP-120807	0914	-		Clarification of mch-SchedulingPeriod configuration	10.6.0
	RP-56	RP-120808	0916	1		Change in Scheduling Information for CMAS	10.6.0
	RP-56	RP-120814	0919	1		Introducing means to signal different REL-10 FDD/TDD Capabilities/FGIs for Dual-xDD UE	10.6.0
	RP-56	RP-120812	0920	1		Clarification on setting of dedicated NS value for CA by E-UTRAN	10.6.0
	RP-56	RP-120808	0931	-		T321 value for UTRA SI acquisition	10.6.0
	RP-56	RP-120813	0957	1		Korean Public Alert System (KPAS) in relation to CMAS	10.6.0
	RP-56	RP-120812	0969	1		Introduction of supported bandwidth combinations for CA	10.6.0
	RP-56	RP-120734	0970	1		Introduction of multiple frequency band indicator	10.6.0
	RP-56	RP-120825	0934	-		Introduction of a new security algorithm ZUC	11.0.0
	RP-56	RP-120813	0973	1		EU-Alert in relation to CMAS	11.0.0
09/2012	RP-57	RP-121371	0982	1		Introduction of EAB	11.1.0
	RP-57	RP-121381	0990	-		Additional special subframe configuration related correction	11.1.0
	RP-57	RP-121423	1000	4		36.331 CR introducing In-Device Coexistence (IDC)	11.1.0
	RP-57	RP-121359	1008	-		Voice support Capabilities	11.1.0
	RP-57	RP-121361	1013	-		Differentiating UTRAN modes in FGIs	11.1.0
	RP-57	RP-121368	1022	1		Introduction of absolute priority based measurements and reselection in CELL_FACH State in 36.331	11.1.0
	RP-57	RP-121370	1024	-		Introducing MDT enhancements for REL-11	11.1.0
	RP-57	RP-121349	1025	2		Introducing Carrier aggregation enhancements for REL-11	11.1.0
	RP-57	RP-121375	1026	-		Introducing MBMS enhancements for REL-11	11.1.0
	RP-57	RP-121376	1052	2		Signaling support for CRS interference management in eICIC	11.1.0
	RP-57	RP-121395	1055	-		CR on scell measurement cycle	11.1.0
	RP-57	RP-121395	1056	-		CR on measurement report	11.1.0
	RP-57	RP-121378	1057	3		Introduction of 'Power preference indication'	11.1.0
	RP-57	RP-121280	1060	-		Correction for PUCCH/SRS Release	11.1.0
12/2012	RP-58	RP-121933	1063	-		Correction related to differentiating UTRAN modes in FGIs	11.2.0
	RP-58	RP-121936	1065	-		Processing delay for RRCConnectionReconfiguration	11.2.0
	RP-58	RP-121953	1066	2		Addition of the stage-3 agreements on IDC	11.2.0
	RP-58	RP-121951	1067	3		Carrier Aggregation Enhancement RAN1 parameters	11.2.0
	RP-58	RP-121957	1068	1		Clarification of SR period	11.2.0
	RP-58	RP-121957	1069	1		Clarification on HandoverCommand message	11.2.0
	RP-58	RP-121957	1070	-		Clarification on mobility related issues	11.2.0
	RP-58	RP-121946	1071	1		Correction of the signaling for Uncertainty and Confidence	11.2.0
	RP-58	RP-121940	1072	2		Corrections to MBMS Service Continuity	11.2.0
	RP-58	RP-121940	1073	-		CR to 36.331 on SIB15 acquisition	11.2.0
	RP-58	RP-121957	1074	1		Handling of 1xCsFB failure	11.2.0
	RP-58	RP-121957	1075	-		Miscellaneous corrections	11.2.0
	RP-58	RP-121958	1076	1		RAN overload control using RRC connection Rejection	11.2.0
	RP-58	RP-121954	1077	-		RRC support for CoMP in UL	11.2.0
	RP-58	RP-121951	1078	-		Some clarification to Carrier aggregation enhancements	11.2.0
	RP-58	RP-121939	1079	1		Validity of EAB SIB and acquisition of SIB1	11.2.0
	RP-58	RP-121922	1085	-		Clarification for Multiple Frequency Band Indicators feature	11.2.0
	RP-58	RP-121924	1089	1		Moving the TM5 capability	11.2.0

	RP-58	RP-121959	1093	1		CR to 36.331 on introducing ROHC context continue for intra-ENB handover	11.2.0
	RP-58	RP-121946	1100	-		Correction on MDT multi-PLMN support	11.2.0
	RP-58	RP-121953	1102	-		Clarification and alignment of handling of other configuration	11.2.0
	RP-58	RP-121970	1103	6		Introducing support for Coordinated Multi-Point (CoMP) operation	11.2.0
	RP-58	RP-121922	1105	2		Introducing further UE aspects regarding multi band cells	11.2.0
	RP-58	RP-121947	1120	-		CR to 36.331 on additional information in RLF report for inter-RAT MRO	11.2.0
	RP-58	RP-121952	1125	1		Correction on Power preference indication	11.2.0
	RP-58	RP-121950	1127	1		SIB1 provisioning via dedicated signalling	11.2.0
	RP-58	RP-121936	1128	2		Measurement reporting of Scells	11.2.0
	RP-58	RP-121956	1129	1		Introduction of EPDCCH parameters in TS 36.331	11.2.0
	RP-58	RP-121961	1130	2		Introduction of Rel-11 UE capabilities	11.2.0
	RP-58	RP-121958	1131	-		Introduction of wideband RSRQ measurements	11.2.0
	RP-58	RP-121958	1146	-		Introduction of network sharing for CDMA2000 inter-working	11.2.0
	RP-58	RP-121960	1157	-		Broadcast of Time Info by Using a New SIB	11.2.0
	RP-58	RP-121957	1175	-		GERAN measurement object at ANR	11.2.0
03/2013	RP-59	RP-130246	1182	2		Miscellaneous corrections from review preceeding ASN.1 freeze	11.3.0
	RP-59	RP-130243	1186	2		DL COMP capability related correction	11.3.0
	RP-59	RP-130231	1193	1		Mandatory supporting of B1 measurement to UMTS FDD (FGI bit 15)	11.3.0
	RP-59	RP-130241	1197	-		Clarification on MBMS Service Continuity	11.3.0
	RP-59	RP-130241	1198	-		IDC Problem Reporting	11.3.0
	RP-59	RP-130247	1210	-		Corrections on definition of CSG member cell	11.3.0
	RP-59	RP-130237	1211	-		Extension of FBI and EARFCN	11.3.0
	RP-59	RP-130228	1220	-		Invalidation of ETWS with security feature	11.3.0
	RP-59	RP-130225	1224	-		Invalid measurement configuration with different (E)ARFCN	11.3.0
	RP-59	RP-130241	1231	2		PPI and IDC indication upon handover	11.3.0
	RP-59	RP-130227	1235	1		Correcting further UE aspects regarding multi band cells	11.3.0
	RP-59	RP-130248	1236	1		Behaviour in case of excessive dedicated priority information	11.3.0
	RP-59	RP-130225	1241	-		Clarification on EARFCN signalling in Mobility control info	11.3.0
	RP-59	RP-130241	1244	-		IDC-SubframePattern length for FDD	11.3.0
	RP-59	RP-130249	1252	-		Introduction of wideband RSRQ measurements in RRC_IDLE	11.3.0
	RP-59	RP-130240	1255	-		Optional support of RLF report for inter-RAT MRO	11.3.0
	RP-59	RP-130233	1258	2		The presence of bandcombination for non-CA capable UEs	11.3.0
	RP-59	RP-130248	1259	-		Correction for event A5	11.3.0
	RP-59	RP-130332	1265	-		Mandating the settings of FGI bit 14, 27 and 28 to true	11.3.0
06/2013	RP-60	RP-130805	1267	-		Clarification on the redirection to UTRA-TDD frequency in case of CSFB High Priority	11.4.0
	RP-60	RP-130804	1269	1		Correction of wrong reference	11.4.0
	RP-60	RP-130809	1270	-		Clarification to support of deprioritisation feature	11.4.0
	RP-60	RP-130809	1271	-		Clarification on KASME key usage	11.4.0
	RP-60	RP-130808	1272	-		Correction on multi-TA capability	11.4.0
	RP-60	RP-130808	1273	-		MBMS interest indication upon handover/ re-establishment	11.4.0
	RP-60	RP-130808	1274	-		Conditions RI reference inheriting CSI process (DL CoMP)	11.4.0
	RP-60	RP-130808	1275	-		Clarification on NZP CSI-RS resource configuration for UE supporting 1 CSI process	11.4.0
	RP-60	RP-130808	1276	-		Corrections to field description of pdsch-Start-r11	11.4.0
	RP-60	RP-130809	1277	-		Need code corrections in Rel-11 RRC	11.4.0
	RP-60	RP-130808	1278	-		Miscellaneous small corrections	11.4.0
	RP-60	RP-130809	1279	1		FDD/TDD diff column correction for FGI31	11.4.0
	RP-60	RP-130804	1282	-		measCycleSCell upon SCell configuration	11.4.0
	RP-60	RP-130809	1294	-		Clarification on RRC Connection Reconfiguration with Critical Extension	11.4.0
	RP-60	RP-130802	1298	-		Security key generation in case of MFBI	11.4.0
	RP-60	RP-130804	1303	1		Clarification on inclusion of non-CA band combinations	11.4.0
	RP-60	RP-130809	1308	-		CR on ROHC parameter configuration in Rel-11 RRC	11.4.0
	RP-60	RP-130804	1315	2		Clarification on UE CA capability	11.4.0
	RP-60	RP-130809	1321	-		Updating 3GPP2 specification references	11.4.0
	RP-60	RP-130805	1323	-		Clarification on the configuration of the extended PHR	11.4.0
	RP-60	RP-130805	1324	-		Clarifications on SystemTimeInfoCDMA2000 IE	11.4.0
	RP-60	RP-130808	1325	-		MFBI impact on MBMS service continuity	11.4.0
	RP-60	RP-130819	1329	1		MFBI aspects for dedicated signalling	11.4.0
09/2013	RP-61	RP-131311	1335	-		Clarification on PhysCellIdRange	11.5.0
	RP-61	RP-131311	1339	1		Correction on the first subframe of the measurement gap	11.5.0
	RP-61	RP-131319	1340	1		Correction for MFBI in SIB15 and SIB6	11.5.0
	RP-61	RP-131319	1343	-		Clarification of MFBI impact on MBMS service continuity	11.5.0
	RP-61	RP-131238	1344	2		Clarification of UE action for otherwise in conditions	11.5.0
	RP-61	RP-131311	1348	-		Corrections to the 3GPP2 specification references in 36.331	11.5.0
	RP-61	RP-131318	1353	-		Clarifications regarding the usage of "rlf-Cause" in case of handover failure	11.5.0
12/2013	RP-62	RP-131986	1366	-		Introduction of capability bit for UTRA MFBI	11.6.0
	RP-62	RP-131984	1368	1		Addition of inter-frequency RSTD measurement capability indicator for OTDOA	11.6.0
	RP-62	RP-131989	1370	-		Clarification on supportedBand	11.6.0
	RP-62	RP-132003	1371	-		Capturing mandatory/optional agreements on Rel-11 UE features	11.6.0
	RP-62	RP-131995	1372	-		Clarification on otherwise behaviour	11.6.0

	RP-62	RP-131995	1373	-		Corrections of the 3GPP2 references in TS 36.331	11.6.0
	RP-62	RP-131991	1374	-		measResultLastServCell for SON-HOF report	11.6.0
	RP-62	RP-131729	1375	1		Clarification to timeInfoUTC field in SIB16	11.6.0
	RP-62	RP-131991	1389	-		Clarification on eRedirection to UMTS TDD with multiple UMTS TDD frequencies	11.6.0
	RP-62	RP-131995	1390	-		Delta signalling for critical extension	11.6.0
	RP-62	RP-132005	1391	-		Capability signalling for CSI processes	11.6.0
	RP-62	RP-131991	1395	1		Clarifications on Measurement	11.6.0
	RP-62	RP-131984	1397	-		Correction to InterFreqRSTDMeasurementIndication field descriptions	11.6.0
	RP-62	RP-131984	1404	-		Correction of Inter-frequency RSTD indication for multiple frequencies	11.6.0
	RP-62	RP-131993	1405	1		Enabling SRVCC from GERAN without forwarding UE-EUTRA-Capability	11.6.0
	RP-62	RP-131995	1409	1		System information and change monitoring procedure	11.6.0
	RP-62	RP-131991	1410	1		Correction on presence of codebookSubsetRestriction-r10	11.6.0
	RP-62	RP-131998	1376	-		Introducing UE support for inbound mobility to a shared CSG cell	12.0.0
	RP-62	RP-132002	1378	2		Introduction of support of further DL MIMO enhancement	12.0.0
	RP-62	RP-131988	1379	-		CR for SSAC in CONNECTED	12.0.0
	RP-62	RP-132002	1406	-		Update of CMAS reference to E-UTRAN specific sections in TS23.041	12.0.0
03/2014	RP-63	RP-140359	1424	1		CR on introduction of Cell-specific time-to-trigger	12.1.0
	RP-63	RP-140346	1435	-		UE autonomous modification of cellsTriggered upon serving cell addition/release	12.1.0
	RP-63	RP-140359	1436	1		Introduction of T312	12.1.0
	RP-63	RP-140362	1439	1		Introduction of UE-supported EARFCN list in handover preparation information for MFBI	12.1.0
	RP-63	RP-140352	1442	-		Correction of Connection Establishment Failure Report	12.1.0
	RP-63	RP-140356	1450	1		Clarification on the presence of TDD special subframe	12.1.0
	RP-63	RP-140359	1453	-		Introduction of UE mobility history reporting (option 2)	12.1.0
	RP-63	RP-140340	1455	1		Clarification regarding need codes, conditions and ASN.1 defaults for extension fields	12.1.0
	RP-63	RP-140340	1456	-		ASN.1 issue with inter-node signalling (AS-Config)	12.1.0
	RP-63	RP-140357	1457	1		Clarification for the SIB occurrence in a single SI message	12.1.0
	RP-63	RP-140364	1462	-		New UE categories for DL 450Mbps class	12.1.0
	RP-63	RP-140354	1463	-		IoT indication for inter-band TDD CA with different UL/DL configuration	12.1.0
06/2014	RP-64	RP-140869	1471	-		Removal of comment line from EUTRA-UE-Variables imports	12.2.0
	RP-64	RP-140871	1475	-		Correction on measObjectList in VarMeasConfig	12.2.0
	RP-64	RP-140879	1477	-		Minor correction inbound mobility to shared CSG cell	12.2.0
	RP-64	RP-140873	1478	-		Clarification on precedence of SCell SI provided dedicately	12.2.0
	RP-64	RP-140887	1479	-		Support of the enhancement for TTI bundling for FDD	12.2.0
	RP-64	RP-140885	1490	-		Corrections on timer T312	12.2.0
	RP-64	RP-140885	1486	-		Correction to the description of physCellIdRange in MeasObjectEUTRA	12.2.0
	RP-64	RP-140885	1506	-		Corrections to UE mobility history information	12.2.0
	RP-64	RP-140873	1489	-		ACK/NACK feedback mode on PUSCH	12.2.0
	RP-64	RP-140878	1556	-		SIB15 enhancement for service availability information	12.2.0
	RP-64	RP-140888	1557	-		Introduction of FDD/TDD CA UE capability	12.2.0
	RP-64	RP-140871	1545	-		Clarification of E-UTRA MFBI signalling	12.2.0
	RP-64	RP-140892	1520	1		Extended RLC LI field	12.2.0
	RP-64	RP-140873	1517	1		Network-requested CA Band Combination Capability Signalling	12.2.0
	RP-64	RP-140873	1554	1		Allowing TDD/FDD split for FGI111 and FGI112	12.2.0
	RP-64	RP-140871	1551	1		Inter-RAT ANR capability signalling in FGI33 when UE supports UTRA TDD only	12.2.0
	RP-64	RP-140884	1495	1		Introduction of TDD eIMTA	12.2.0
	RP-64	RP-140885	1499	1		Minor Corrections to T312	12.2.0
	RP-64	RP-140892	1510	1		Introduction of RRC Connection Establishment failure temporary Qoffset handling	12.2.0
	RP-64	RP-140849	1555	2		Introduction of UE capability for eMBMS reception on SCell and Non-Serving Cell	12.2.0
09/2014	RP-65	RP-141494	1632	-		FDD&TDD split for CA	12.3.0
	RP-65	RP-141505	1599	-		UE capabilities for Hetnet mobility in TS 36.331	12.3.0
	RP-65	RP-141499	1584	-		Introduction of UE eIMTA capabilities	12.3.0
	RP-65	RP-141511	1567	-		Corrections to extended RLC LI field	12.3.0
	RP-65	RP-141511	1603	-		TAI reporting of last serving cell	12.3.0
	RP-65	RP-141498	1630	1		Correction to Network-requested CA Band Combination Capability Signalling	12.3.0
	RP-65	RP-141496	1577	1		Clarification on double indication of SAI in SIB15	12.3.0
	RP-65	RP-141496	1597	-		Clarification on MBMSCountingResponse	12.3.0
	RP-65	RP-141496	1623	-		Clarification on the setting of SupportedBandCombination-v1130	12.3.0
	RP-65	RP-141489	1574	1		Correction of E-UTRAN UE capabilities description in HandoverPreparationInformation message field descriptions	12.3.0
	RP-65	RP-141507	1570	-		Introducing MBSFN measurement by extension of logged measurements	12.3.0
	RP-65	RP-141510	1572	1		Introduction of ACB skip for MMTEL voice/video and SMS	12.3.0
	RP-65	RP-141496	1615	1		Clarification on determining MBMS frequencies of interest in MBMSInterestIndication	12.3.0
	RP-65	RP-141506	1579	1		Introduction of signaling support for low complexity UEs	12.3.0
	RP-65	RP-141499	1601	1		Rel-12 ASN.1 correction	12.3.0
	RP-65	RP-141511	1560	1		Introduction of shorter MCH scheduling period	12.3.0

	RP-65	RP-141493	1611	-		Clarification for time-domain resource restriction pattern applicable to neighbour cell RSRQ measurements	12.3.0
	RP-65	RP-141511	1559	2		Correction to stop condition for "Chiba offset"	12.3.0
	RP-65	RP-141115	1636	-		Mandating the FGI bit 31 to true	12.3.0
	RP-65	RP-141618	1566	2		Connected mode procedures and RRC signaling of WLAN/3GPP Radio Interworking for LTE	12.3.0
12/2014	RP-66	RP-142122	1643	-		Clarification on WLAN interworking	12.4.0
	RP-66	RP-142122	1644	-		Correction on handling of dedicated parameters during re-establishment	12.4.0
	RP-66	RP-142122	1645	-		Corrections to WLAN/3GPP Radio Interworking for LTE	12.4.0
	RP-66	RP-142122	1646	-		Reduction of possible values for WLAN backhaul rate thresholds in LTE	12.4.0
	RP-66	RP-142140	1648	-		PDCP SN size change during HO for RLC-UM mode bearers	12.4.0
	RP-66	RP-142124	1651	-		Support of TTI bundling without resource allocation restriction for LTE coverage enhancements for Rel-12	12.4.0
	RP-66	RP-142123	1652	-		Corrections to eMTC capabilities	12.4.0
	RP-66	RP-142140	1653	-		ACB, ACB-skip, CSFB and SSAC signalling per PLMN	12.4.0
	RP-66	RP-142122	1642	1		Minor corrections regarding WLAN interworking	12.4.0
	RP-66	RP-142115	1659	-		Correction of remaining TBD for Rel-10 FGIs	12.4.0
	RP-66	RP-142117	1663	-		New UE categories for DL 600Mbps	12.4.0
	RP-66	RP-142135	1687	-		Introduction of Dual Connectivity	12.4.0
	RP-66	RP-142140	1697	1		Prohibit timer for SR	12.4.0
	RP-66	RP-142133	1666	-		Support of 256QAM in TS 36.331 (per band 256QAM capability report)	12.4.0
	RP-66	RP-142128	1690	1		Introduction of increased number of frequencies to monitor	12.4.0
	RP-66	RP-142140	1696	2		Introduction of extended RSRQ value range and new RSRQ definition	12.4.0
	RP-66	RP-142115	1650	1		Introduction of signalling for serving cell interruptions	12.4.0
	RP-66	RP-142123	1655	-		Correction for p0-Persistent-SubframeSet2 Handling	12.4.0
	RP-66	RP-142134	1681	-		Introduction of missing Rel-12 UE capabilities	12.4.0
	RP-66	RP-142140	1647	1		Extended RLC LI field correction	12.4.0
	RP-66	RP-142140	1656	-		Outstanding Need OP for non-critical extension removal	12.4.0
	RP-66	RP-142140	1669	2		Clarification on statusReportRequired handling	12.4.0
	RP-66	RP-142131	1698	2		MCH BLER and RSRQ update for MBSFN MDT	12.4.0
	RP-66	RP-142130	1699	1		Optionality support of UE mandatory features for Category 0 UEs	12.4.0
	RP-66	RP-142123	1661	-		Further Clarifications on eMTC and eCIC	12.4.0
	RP-66	RP-142113	1686	1		UE capability for modified MPR behavior	12.4.0
	RP-66	RP-142132	1664	1		Support of Discovery Signals measurement in TS 36.331	12.4.0
	RP-66	RP-142139	1670	2		RRC Parameters for NAICS	12.4.0
	RP-66	RP-141979	1700	-		UE capability signaling for WLAN/3GPP radio interworking	12.4.0
	RP-66	-	-	-		MCC editorial update	12.4.1
03/2015	RP-67	RP-150373	1737	-		Clarification on the setting of measScaleFactor without reducedMeasPerformance	12.5.0
	RP-67	RP-150371	1747	-		Clarification on Measurement Configuration handling	12.5.0
	RP-67	RP-150371	1765	-		Clarification to usage of field deltaTxD-OffsetPUCCH-Format1bCS-r11 in dedicated uplink power control parameter signalling	12.5.0
	RP-67	RP-150370	1751	-		Clarification on CSI measurement subframe set	12.5.0
	RP-67	RP-150368	1795	-		The absence of supportedMIMO-CapabilityUL-r10	12.5.0
	RP-67	RP-150370	1798	-		Presence of codebookSubsetRestriction	12.5.0
	RP-67	RP-150377	1768	2		Miscellaneous changes resulting from review for REL-12 ASN.1 freeze	12.5.0
	RP-67	RP-150374	1770	2		Introduction of ProSe	12.5.0
06/2015	RP-68	RP-150921	1800	-		Correction field description of networkControlledSyncTx	12.6.0
	RP-68	RP-150921	1801	-		Clarification on SCG reconfiguration	12.6.0
	RP-68	RP-150921	1802	-		Correction for aperiodic CSI trigger	12.6.0
	RP-68	RP-150920	1804	-		Correction on handling of wlan-OffloadConfigDedicated upon leaving RRC_CONNECTED	12.6.0
	RP-68	RP-150921	1805	-		Reconfiguration of SPS	12.6.0
	RP-68	RP-150916	1809	-		CR on Aperiodic CSI Reporting for 1.4MHz cell	12.6.0
	RP-68	RP-150921	1815	-		Clarification on PDCP reconfiguration	12.6.0
	RP-68	RP-150921	1816	-		Correction to SCG change	12.6.0
	RP-68	RP-150921	1817	-		Minor corrections for PSCell configuration in DC	12.6.0
	RP-68	RP-150921	1818	-		CR on ROHC for split bearer	12.6.0
	RP-68	RP-150921	1819	-		Clarification on FDD/TDD differentiation of FGIs/capabilities in TDD-FDD CA	12.6.0
	RP-68	RP-150921	1803	1		Correction to SCG and split bearer configuration	12.6.0
	RP-68	RP-150921	1810	1		Clarifications on use of preconfigComm for direct communication	12.6.0
	RP-68	RP-150921	1811	1		Miscellaneous corrections (a.o. Sidelink)	12.6.0
	RP-68	RP-150921	1813	1		Conditions for establishing RRC Connection for sidelink transmission	12.6.0
	RP-68	RP-150921	1814	1		Correction on field description on SL-TF-ResourceConfig	12.6.0
	RP-68	RP-150917	1806	1		Mandatory present of supportedMIMO-CapabilityDL-r10	12.6.0
	RP-68	RP-150923	1853	-		Clarification on Cell barring for downlink only bands	12.6.0
	RP-68	RP-150917	1852	-		Clarification regarding no MBMS sessions ongoing	12.6.0
	RP-68	RP-150917	1827	1		Correction to additionalSpectrumEmission	12.6.0
	RP-68	RP-150923	1820	4		Clarification on extended RSRQ range support	12.6.0
	RP-68	RP-150917	1838	-		Restriction to CA capability signalling	12.6.0
	RP-68	RP-150921	1823	-		Clarification on PUCCH and SRS	12.6.0
	RP-68	RP-150926	1849	-		Introduction of new DL UE categories 15&16	12.6.0

	RP-68	RP-150923	1824	-		Clean-up corrections to TS 36.331	12.6.0
	RP-68	RP-150918	1846	1		Correction to IDC signalling	12.6.0
	RP-68	RP-150921	1822	1		Change of LCID upon DC-specific DRB reconfiguration	12.6.0
	RP-68	RP-150921	1832	1		Correction to PHR format	12.6.0
	RP-68	RP-150921	1842	1		Correction on conditions for sidelink operation	12.6.0
	RP-68	RP-150811	1834	2		Correction on the SL-TF-IndexPair values for ProSe Direct Discovery	12.6.0
09/2015	RP-69	RP-151443	1866	-		Correction on UE band combination capability	12.7.0
	RP-69	RP-151438	1869	-		Correction on Restriction to CA capability signalling	12.7.0
	RP-69	RP-151443	1884	-		The support of UL64QAM	12.7.0
	RP-69	RP-151442	1889	-		Small corrections concerning RadioResourceConfig	12.7.0
	RP-69	RP-151441	1900	-		Sidelink discovery related corrections	12.7.0
	RP-69	RP-151440	1905	2		Clarification of Beacon RSSI Encoding	12.7.0
	RP-69	RP-151439	1911	1		CR for IDC signalling enhancement for UL CA	12.7.0
	RP-69	RP-151440	1880	2		Clarification on cell selection sequence upon leaving RRC_CONNECTED	12.7.0
	RP-69	RP-151438	1908	-		Correction to additionalSpectrumEmission - Option 1	12.7.0
	RP-69	RP-151439	1879	1		Correction on the reference of EPDCCH	12.7.0
	RP-69	RP-151441	1891	1		Introducing general handling and guidelines concerning critical extensions within a release	12.7.0
	RP-69	RP-151443	1909	1		Applicability of longCodeState1XRTT for 1xRTT IRAT ANR	12.7.0
	RP-69	RP-151441	1912	1		Sidelink terminology alignment in TS 36.331	12.7.0
	RP-69	RP-151442	1906	2		Clarification for NAICS capability signalling	12.7.0
	RP-69	RP-151467	1861	2		Additional MIMO/CSI capability for intra-band contiguous CA	12.7.0
	RP-69	RP-151466	1887	2		Signalling for 4-layer MIMO with TM3 and TM4	12.7.0
	RP-69	RP-151625	1914	2		Allowing NAICS with TM10	12.7.0
12/2015	RP-70	RP-152053	1916	-		Correction on SCG release	12.8.0
	RP-70	RP-152053	1932	-		Clarification to SCG RLF timers and constants reconfiguration	12.8.0
	RP-70	RP-152053	1933	-		Correction to triggerQuantityCSI-RS	12.8.0
	RP-70	RP-152053	1946	-		Correction to NAICS field descriptions	12.8.0
	RP-70	RP-152055	1947	-		Correction of need code definition terminology	12.8.0
	RP-70	RP-152050	1964	-		Clarification on FDD/TDD difference for UL CA IDC indication	12.8.0
	RP-70	RP-152046	1975	-		Correction to SystemTimeInfoCDMA2000 IE	12.8.0
	RP-70	RP-152053	1928	1		highPriorityAccess for MMTEL voice, MMTEL video and SMS	12.8.0
	RP-70	RP-152053	1986	1		Correction to the support of Mobility State reporting	12.8.0
	RP-70	RP-152046	1971	1		MaxLayerMIMO in HandoverPreparationInformation	12.8.0
	RP-70	RP-152046	1987	-		Correction to ASN.1 field names for 4-layer TM3/4	12.8.0
	RP-70	RP-152053	1969	1		Correction on measurement identity autonomous removal in dual connectivity	12.8.0
	RP-70	RP-152053	1979	1		Clarification on tdd-FDD-CA-PCellDuplex	12.8.0
	RP-70	RP-152049	1919	2		Alternative new maximum transport block sizes for DL 64QAM and 256QAM in TM9/10	12.8.0
	RP-70	RP-152050	1934	1		Some general RRC issues	12.8.0
	RP-70	RP-152055	1965	1		Correction on capability rsrq-OnAllSymbols	12.8.0
	RP-70	RP-152056	1931	2		Addition of establishment cause for mobile-originating VoLTE calls and network indication in SIB2	12.8.0
	RP-70	RP-152048	1927	2		CR to correct UE messages to be sent only after security activation	12.8.0
	RP-70	RP-152053	1973	3		Clarification of MCG	12.8.0
	RP-70	RP-152113	1923	4		Enabling multiple NS and P-Max operation per cell	12.8.0
03/2016	RP-71	RP-160467	2021	1		Correction on the RRC signalling configuration for 4Tx MIMO	12.9.0
	RP-71	RP-160462	2038	1		Applicability of longCodeState1XRTT	12.9.0
	RP-71	RP-160467	2052	-		Correction to SL-DiscConfig	12.9.0
	RP-71	RP-160467	2064	1		Maximum UL timing difference for DC	12.9.0
	RP-71	RP-160467	2067	1		T321 for Category 0 UE	12.9.0
	RP-71	RP-160467	2073	1		Procedural clarification on PSCell change involving PSCell release	12.9.0
	RP-71	RP-160467	2080	2		Clarification on NAICS subset capability	12.9.0
	RP-71	RP-160467	2089	-		Clarification on the leftmost bit for the supportedCellGrouping	12.9.0
	RP-71	RP-160467	2093	-		Clarification on the value range of guaranteed power for the MeNB and SeNB	12.9.0
	RP-71	RP-160465	2099	-		In-Device Coexistence for UL CA change of victim system	12.9.0
06/2016	RP-72	RP-161073	2124	-		drb-identity change in full configuration	12.10.0
	RP-72	RP-161078	2128	-		Corrections for SL resource configuration during handover	12.10.0
	RP-72	RP-161078	2129	-		Addition of S-RSRP abbreviation	12.10.0
	RP-72	RP-161077	2139	-		Clarification regarding IDC indication upon change of UL CA affecting GNSS	12.10.0
	RP-72	RP-161078	2153	-		Correction on condition nonFullConfig in dual connectivity	12.10.0
	RP-72	RP-161078	2219	-		Clarification on the presence of ul-64QAM-r12 for DL-only bands	12.10.0
09/2016	RP-73	RP-161751	2267	3		Clarification to intra-band contiguous CA capabilities	12.11.0
	RP-73	RP-161751	2343	1		Indication of the maxLayersMIMO	12.11.0
12/2016	RP-74	RP-162311	2379	-		FDD&TDD diff for mbms-AsyncDC	12.12.0
	RP-74	RP-162309	2433	1		Correction of NOTE 3 in UE-EUTRA-Capability related to multiple CA-MIMO-ParametersDL/UL	12.12.0
	RP-74	RP-162311	2439	1		Clarification on reporting of the plmn-IdentityList	12.12.0
	RP-74	RP-162311	2464	1		Corrections on sidelink pre-configurations and default configurations	12.12.0
	RP-74	RP-162311	2467	-		Corrections on system information acquisition for Sidelink discovery	12.12.0

	RP-74	RP-162350	2514	1		timeInfoUTC in SIB16	12.12.0
	RP-74	RP-162309	2550	-		Clarification on prioritization of multiple Pmax values	12.12.0
03/2017	RP-75	RP-170650	2583	1	F	Addition of extended EARFCNs in SCGFailureInformation message	12.13.0
06/2017	RP-76	RP-171248	2793	1	B	Entry-Level UE Support UL 64QAM	12.14.0
	RP-76	RP-171242	2957	-	F	Setting of FGI 107 and 108 in case of TDD-FDD CA	12.14.0
09/2017	RP-77	RP-171916	3000	2	A	additionalSpectrumEmission extension	12.15.0
	RP-77	RP-171918	3017	-	F	Correction in PUSCH Config description	12.15.0
	RP-77	RP-171918	3060	2	F	Adding abstract syntax notation one chapter of sidelink pre-configuration.	12.15.0
09/2017						Removed a Rel-13 extension (txParamsAddNeighFreq-v13xy) from Rel-12 specification	12.15.1
12/2017	RP-78	RP-172622	3188	-	F	DCI monitoring subframes for eIMTA	12.16.0
06/2018	RP-80	RP-181230	3289	2	A	Removal of the FDD/TDD diff restriction for crs-InterfHandl IE	12.17.0
	RP-80	RP-181231	3362	3	F	Correction on UE capabilities	12.17.0
	RP-80	RP-181413	3403	2	A	Corrections to additionalSpectrumEmission extension	12.17.0

History

Document history		
V12.3.0	September 2014	Publication
V12.4.1	February 2015	Publication
V12.5.0	April 2015	Publication
V12.6.0	July 2015	Publication
V12.7.0	October 2015	Publication
V12.8.0	January 2016	Publication
V12.9.0	April 2016	Publication
V12.10.0	August 2016	Publication
V12.11.0	December 2016	Publication
V12.12.0	January 2017	Publication
V12.13.0	April 2017	Publication
V12.14.0	July 2017	Publication
V12.15.1	October 2017	Publication
V12.16.0	January 2018	Publication
V12.17.0	July 2018	Publication