

ETSI TS 136 331 V14.13.0 (2020-01)



**LTE;
Evolved Universal Terrestrial Radio Access (E-UTRA);
Radio Resource Control (RRC);
Protocol specification
(3GPP TS 36.331 version 14.13.0 Release 14)**



ReferenceRTS/TSGR-0236331ved0

KeywordsLTE

ETSI

650 Route des Lucioles
F-06921 Sophia Antipolis Cedex - FRANCE

Tel.: +33 4 92 94 42 00 Fax: +33 4 93 65 47 16

Siret N° 348 623 562 00017 - NAF 742 C
Association à but non lucratif enregistrée à la
Sous-Préfecture de Grasse (06) N° 7803/88

Important notice

The present document can be downloaded from:

<http://www.etsi.org/standards-search>

The present document may be made available in electronic versions and/or in print. The content of any electronic and/or print versions of the present document shall not be modified without the prior written authorization of ETSI. In case of any existing or perceived difference in contents between such versions and/or in print, the prevailing version of an ETSI deliverable is the one made publicly available in PDF format at www.etsi.org/deliver.

Users of the present document should be aware that the document may be subject to revision or change of status.

Information on the current status of this and other ETSI documents is available at

<https://portal.etsi.org/TB/ETSIDeliverableStatus.aspx>

If you find errors in the present document, please send your comment to one of the following services:

<https://portal.etsi.org/People/CommitteeSupportStaff.aspx>

Copyright Notification

No part may be reproduced or utilized in any form or by any means, electronic or mechanical, including photocopying and microfilm except as authorized by written permission of ETSI.

The content of the PDF version shall not be modified without the written authorization of ETSI.

The copyright and the foregoing restriction extend to reproduction in all media.

© ETSI 2020.

All rights reserved.

DECT™, **PLUGTESTS™**, **UMTS™** and the ETSI logo are trademarks of ETSI registered for the benefit of its Members.

3GPP™ and **LTE™** are trademarks of ETSI registered for the benefit of its Members and of the 3GPP Organizational Partners.

oneM2M™ logo is a trademark of ETSI registered for the benefit of its Members and of the oneM2M Partners.

GSM® and the GSM logo are trademarks registered and owned by the GSM Association.

Intellectual Property Rights

Essential patents

IPRs essential or potentially essential to normative deliverables may have been declared to ETSI. The information pertaining to these essential IPRs, if any, is publicly available for **ETSI members and non-members**, and can be found in ETSI SR 000 314: "*Intellectual Property Rights (IPRs); Essential, or potentially Essential, IPRs notified to ETSI in respect of ETSI standards*", which is available from the ETSI Secretariat. Latest updates are available on the ETSI Web server (<https://ipr.etsi.org/>).

Pursuant to the ETSI IPR Policy, no investigation, including IPR searches, has been carried out by ETSI. No guarantee can be given as to the existence of other IPRs not referenced in ETSI SR 000 314 (or the updates on the ETSI Web server) which are, or may be, or may become, essential to the present document.

Trademarks

The present document may include trademarks and/or tradenames which are asserted and/or registered by their owners. ETSI claims no ownership of these except for any which are indicated as being the property of ETSI, and conveys no right to use or reproduce any trademark and/or tradename. Mention of those trademarks in the present document does not constitute an endorsement by ETSI of products, services or organizations associated with those trademarks.

Legal Notice

This Technical Specification (TS) has been produced by ETSI 3rd Generation Partnership Project (3GPP).

The present document may refer to technical specifications or reports using their 3GPP identities. These shall be interpreted as being references to the corresponding ETSI deliverables.

The cross reference between 3GPP and ETSI identities can be found under <http://webapp.etsi.org/key/queryform.asp>.

Modal verbs terminology

In the present document "**shall**", "**shall not**", "**should**", "**should not**", "**may**", "**need not**", "**will**", "**will not**", "**can**" and "**cannot**" are to be interpreted as described in clause 3.2 of the [ETSI Drafting Rules](#) (Verbal forms for the expression of provisions).

"**must**" and "**must not**" are **NOT** allowed in ETSI deliverables except when used in direct citation.

Contents

Intellectual Property Rights	2
Legal Notice	2
Modal verbs terminology.....	2
Foreword.....	20
1 Scope	21
2 References	21
3 Definitions, symbols and abbreviations	24
3.1 Definitions	24
3.2 Abbreviations	26
4 General	29
4.1 Introduction	29
4.2 Architecture	30
4.2.1 UE states and state transitions including inter RAT	30
4.2.2 Signalling radio bearers	32
4.3 Services	33
4.3.1 Services provided to upper layers	33
4.3.2 Services expected from lower layers	33
4.4 Functions	33
4.5 Data available for transmission for NB-IoT	34
5 Procedures	35
5.1 General	35
5.1.1 Introduction.....	35
5.1.2 General requirements.....	35
5.2 System information	36
5.2.1 Introduction.....	36
5.2.1.1 General	36
5.2.1.2 Scheduling.....	37
5.2.1.2a Scheduling for NB-IoT	38
5.2.1.3 System information validity and notification of changes	38
5.2.1.4 Indication of ETWS notification	40
5.2.1.5 Indication of CMAS notification.....	40
5.2.1.6 Notification of EAB parameters change	41
5.2.1.7 Access Barring parameters change in NB-IoT	41
5.2.2 System information acquisition	41
5.2.2.1 General	41
5.2.2.2 Initiation.....	41
5.2.2.3 System information required by the UE.....	42
5.2.2.4 System information acquisition by the UE.....	42
5.2.2.5 Essential system information missing	46
5.2.2.6 Actions upon reception of the <i>MasterInformationBlock</i> message.....	46
5.2.2.7 Actions upon reception of the <i>SystemInformationBlockType1</i> message	47
5.2.2.8 Actions upon reception of <i>SystemInformation</i> messages	48
5.2.2.9 Actions upon reception of <i>SystemInformationBlockType2</i>	49
5.2.2.10 Actions upon reception of <i>SystemInformationBlockType3</i>	50
5.2.2.11 Actions upon reception of <i>SystemInformationBlockType4</i>	51
5.2.2.12 Actions upon reception of <i>SystemInformationBlockType5</i>	51
5.2.2.13 Actions upon reception of <i>SystemInformationBlockType6</i>	52
5.2.2.14 Actions upon reception of <i>SystemInformationBlockType7</i>	52
5.2.2.15 Actions upon reception of <i>SystemInformationBlockType8</i>	52
5.2.2.16 Actions upon reception of <i>SystemInformationBlockType9</i>	53
5.2.2.17 Actions upon reception of <i>SystemInformationBlockType10</i>	53
5.2.2.18 Actions upon reception of <i>SystemInformationBlockType11</i>	53
5.2.2.19 Actions upon reception of <i>SystemInformationBlockType12</i>	54

5.2.2.20	Actions upon reception of <i>SystemInformationBlockType13</i>	54
5.2.2.21	Actions upon reception of <i>SystemInformationBlockType14</i>	54
5.2.2.22	Actions upon reception of <i>SystemInformationBlockType15</i>	55
5.2.2.23	Actions upon reception of <i>SystemInformationBlockType16</i>	55
5.2.2.24	Actions upon reception of <i>SystemInformationBlockType17</i>	55
5.2.2.25	Actions upon reception of <i>SystemInformationBlockType18</i>	55
5.2.2.26	Actions upon reception of <i>SystemInformationBlockType19</i>	55
5.2.2.27	Actions upon reception of <i>SystemInformationBlockType20</i>	56
5.2.2.28	Actions upon reception of <i>SystemInformationBlockType21</i>	56
5.2.2.29	Actions upon reception of <i>SystemInformationBlockType22-NB</i>	56
5.2.3	Acquisition of an SI message	56
5.2.3a	Acquisition of an SI message by BL UE or UE in CE or a NB-IoT UE	57
5.2.3b	Acquisition of an SI message from MBMS-dedicated cell	57
5.3	Connection control	58
5.3.1	Introduction	58
5.3.1.1	RRC connection control	58
5.3.1.2	Security	59
5.3.1.2a	RN security	60
5.3.1.3	Connected mode mobility	60
5.3.1.4	Connection control in NB-IoT	61
5.3.2	Paging	62
5.3.2.1	General	62
5.3.2.2	Initiation	62
5.3.2.3	Reception of the <i>Paging</i> message by the UE	63
5.3.3	RRC connection establishment	64
5.3.3.1	General	64
5.3.3.1a	Conditions for establishing RRC Connection for sidelink communication/ discovery/ V2X sidelink communication	65
5.3.3.2	Initiation	67
5.3.3.3	Actions related to transmission of <i>RRCCConnectionRequest</i> message	71
5.3.3.3a	Actions related to transmission of <i>RRCCConnectionResumeRequest</i> message	72
5.3.3.4	Reception of the <i>RRCCConnectionSetup</i> by the UE	73
5.3.3.4a	Reception of the <i>RRCCConnectionResume</i> by the UE	75
5.3.3.5	Cell re-selection while T300, T302, T303, T305, T306, or T308 is running	77
5.3.3.6	T300 expiry	78
5.3.3.7	T302, T303, T305, T306, or T308 expiry or stop	79
5.3.3.8	Reception of the <i>RRCCConnectionReject</i> by the UE	80
5.3.3.9	Abortion of RRC connection establishment	81
5.3.3.10	Handling of SSAC related parameters	81
5.3.3.11	Access barring check	82
5.3.3.12	EAB check	82
5.3.3.13	Access barring check for ACDC	83
5.3.3.14	Access Barring check for NB-IoT	84
5.3.3.15	Failure to deliver NAS information in <i>RRCCConnectionSetupComplete</i> message	85
5.3.4	Initial security activation	85
5.3.4.1	General	85
5.3.4.2	Initiation	86
5.3.4.3	Reception of the <i>SecurityModeCommand</i> by the UE	86
5.3.5	RRC connection reconfiguration	87
5.3.5.1	General	87
5.3.5.2	Initiation	87
5.3.5.3	Reception of an <i>RRCCConnectionReconfiguration</i> not including the <i>mobilityControlInfo</i> by the UE	88
5.3.5.4	Reception of an <i>RRCCConnectionReconfiguration</i> including the <i>mobilityControlInfo</i> by the UE (handover)	89
5.3.5.5	Reconfiguration failure	94
5.3.5.6	T304 expiry (handover failure)	94
5.3.5.7	Void	95
5.3.5.7a	T307 expiry (SCG change failure)	95
5.3.5.8	Radio Configuration involving full configuration option	96
5.3.6	Counter check	97
5.3.6.1	General	97

5.3.6.2	Initiation.....	97
5.3.6.3	Reception of the <i>CounterCheck</i> message by the UE.....	97
5.3.7	RRC connection re-establishment.....	98
5.3.7.1	General.....	98
5.3.7.2	Initiation.....	99
5.3.7.3	Actions following cell selection while T311 is running.....	100
5.3.7.4	Actions related to transmission of <i>RRCConnectionReestablishmentRequest</i> message.....	100
5.3.7.5	Reception of the <i>RRCConnectionReestablishment</i> by the UE.....	101
5.3.7.6	T311 expiry.....	104
5.3.7.7	T301 expiry or selected cell no longer suitable.....	104
5.3.7.8	Reception of <i>RRCConnectionReestablishmentReject</i> by the UE.....	104
5.3.8	RRC connection release.....	104
5.3.8.1	General.....	104
5.3.8.2	Initiation.....	105
5.3.8.3	Reception of the <i>RRCConnectionRelease</i> by the UE.....	105
5.3.8.4	T320 expiry.....	106
5.3.8.5	T322 expiry or stop.....	106
5.3.8.6	UE actions upon receiving the expiry of <i>DataInactivityTimer</i>	106
5.3.9	RRC connection release requested by upper layers.....	106
5.3.9.1	General.....	106
5.3.9.2	Initiation.....	106
5.3.10	Radio resource configuration.....	107
5.3.10.0	General.....	107
5.3.10.1	SRB addition/ modification.....	107
5.3.10.2	DRB release.....	108
5.3.10.3	DRB addition/ modification.....	108
5.3.10.3a1	DC specific DRB addition or reconfiguration.....	109
5.3.10.3a2	LWA specific DRB addition or reconfiguration.....	111
5.3.10.3a3	LWIP specific DRB addition or reconfiguration.....	112
5.3.10.3a	SCell release.....	113
5.3.10.3b	SCell addition/ modification.....	113
5.3.10.3c	PSCell addition or modification.....	113
5.3.10.4	MAC main reconfiguration.....	114
5.3.10.5	Semi-persistent scheduling reconfiguration.....	114
5.3.10.6	Physical channel reconfiguration.....	114
5.3.10.7	Radio Link Failure Timers and Constants reconfiguration.....	115
5.3.10.8	Time domain measurement resource restriction for serving cell.....	116
5.3.10.9	Other configuration.....	116
5.3.10.10	SCG reconfiguration.....	118
5.3.10.11	SCG dedicated resource configuration.....	120
5.3.10.12	Reconfiguration SCG or split DRB by <i>drb-ToAddModList</i>	120
5.3.10.13	Neighbour cell information reconfiguration.....	120
5.3.10.14	Void.....	121
5.3.10.15	Sidelink dedicated configuration.....	121
5.3.10.15a	V2X sidelink Communication dedicated configuration.....	122
5.3.10.16	T370 expiry.....	123
5.3.11	Radio link failure related actions.....	123
5.3.11.1	Detection of physical layer problems in RRC_CONNECTED.....	123
5.3.11.1a	Early detection of physical layer problems in RRC_CONNECTED.....	123
5.3.11.1b	Detection of physical layer improvements in RRC_CONNECTED.....	123
5.3.11.2	Recovery of physical layer problems.....	123
5.3.11.2a	Recovery of early detection of physical layer problems.....	124
5.3.11.2b	Cancellation of physical layer improvements in RRC_CONNECTED.....	124
5.3.11.3	Detection of radio link failure.....	124
5.3.11.3a	Detection of early-out-of-sync event.....	126
5.3.11.3b	Detection of early-in-sync event.....	126
5.3.12	UE actions upon leaving RRC_CONNECTED.....	126
5.3.13	UE actions upon PUCCH/ SRS release request.....	127
5.3.14	Proximity indication.....	128
5.3.14.1	General.....	128
5.3.14.2	Initiation.....	128
5.3.14.3	Actions related to transmission of <i>ProximityIndication</i> message.....	128

5.3.15	Void	129
5.4	Inter-RAT mobility.....	129
5.4.1	Introduction.....	129
5.4.2	Handover to E-UTRA.....	129
5.4.2.1	General	129
5.4.2.2	Initiation.....	129
5.4.2.3	Reception of the <i>RRCCONNECTIONRECONFIGURATION</i> by the UE.....	130
5.4.2.4	Reconfiguration failure	131
5.4.2.5	T304 expiry (handover to E-UTRA failure).....	132
5.4.3	Mobility from E-UTRA	132
5.4.3.1	General	132
5.4.3.2	Initiation.....	133
5.4.3.3	Reception of the <i>MOBILITYFROMEUTRACOMMAND</i> by the UE	133
5.4.3.4	Successful completion of the mobility from E-UTRA.....	134
5.4.3.5	Mobility from E-UTRA failure.....	134
5.4.4	Handover from E-UTRA preparation request (CDMA2000)	135
5.4.4.1	General	135
5.4.4.2	Initiation.....	135
5.4.4.3	Reception of the <i>HANDOVERFROMEUTRAPREPARATIONREQUEST</i> by the UE	135
5.4.5	UL handover preparation transfer (CDMA2000)	136
5.4.5.1	General	136
5.4.5.2	Initiation.....	136
5.4.5.3	Actions related to transmission of the <i>ULHANDOVERPREPARATIONTRANSFER</i> message.....	136
5.4.5.4	Failure to deliver the <i>ULHANDOVERPREPARATIONTRANSFER</i> message.....	136
5.4.6	Inter-RAT cell change order to E-UTRAN.....	136
5.4.6.1	General	136
5.4.6.2	Initiation.....	137
5.4.6.3	UE fails to complete an inter-RAT cell change order	137
5.5	Measurements.....	137
5.5.1	Introduction.....	137
5.5.2	Measurement configuration	139
5.5.2.1	General	139
5.5.2.2	Measurement identity removal.....	140
5.5.2.2a	Measurement identity autonomous removal	140
5.5.2.3	Measurement identity addition/ modification	141
5.5.2.4	Measurement object removal	141
5.5.2.5	Measurement object addition/ modification.....	142
5.5.2.6	Reporting configuration removal	144
5.5.2.7	Reporting configuration addition/ modification.....	145
5.5.2.8	Quantity configuration	145
5.5.2.9	Measurement gap configuration.....	145
5.5.2.10	Discovery signals measurement timing configuration	147
5.5.2.11	RSSI measurement timing configuration	147
5.5.2.12	Measurement gap sharing configuration	147
5.5.3	Performing measurements	147
5.5.3.1	General	147
5.5.3.2	Layer 3 filtering	151
5.5.4	Measurement report triggering	151
5.5.4.1	General	151
5.5.4.2	Event A1 (Serving becomes better than threshold)	156
5.5.4.3	Event A2 (Serving becomes worse than threshold)	157
5.5.4.4	Event A3 (Neighbour becomes offset better than PCell/ PSCell)	157
5.5.4.5	Event A4 (Neighbour becomes better than threshold)	158
5.5.4.6	Event A5 (PCell/ PSCell becomes worse than threshold1 and neighbour becomes better than threshold2)	159
5.5.4.6a	Event A6 (Neighbour becomes offset better than SCell)	160
5.5.4.7	Event B1 (Inter RAT neighbour becomes better than threshold).....	160
5.5.4.8	Event B2 (PCell becomes worse than threshold1 and inter RAT neighbour becomes better than threshold2)	161
5.5.4.9	Event C1 (CSI-RS resource becomes better than threshold).....	162
5.5.4.10	Event C2 (CSI-RS resource becomes offset better than reference CSI-RS resource).....	162
5.5.4.11	Event W1 (WLAN becomes better than a threshold).....	163

5.5.4.12	Event W2 (All WLAN inside WLAN mobility set becomes worse than threshold1 and a WLAN outside WLAN mobility set becomes better than threshold2)	163
5.5.4.13	Event W3 (All WLAN inside WLAN mobility set becomes worse than a threshold)	164
5.5.4.14	Event V1 (The channel busy ratio is above a threshold)	165
5.5.4.15	Event V2 (The channel busy ratio is below a threshold)	165
5.5.5	Measurement reporting	166
5.5.6	Measurement related actions	171
5.5.6.1	Actions upon handover and re-establishment	171
5.5.6.2	Speed dependant scaling of measurement related parameters	172
5.5.7	Inter-frequency RSTD measurement indication	172
5.5.7.1	General	172
5.5.7.2	Initiation	172
5.5.7.3	Actions related to transmission of <i>InterFreqRSTDMeasurementIndication</i> message	173
5.6	Other	173
5.6.0	General	173
5.6.1	DL information transfer	174
5.6.1.1	General	174
5.6.1.2	Initiation	174
5.6.1.3	Reception of the <i>DLInformationTransfer</i> by the UE	174
5.6.2	UL information transfer	174
5.6.2.1	General	174
5.6.2.2	Initiation	174
5.6.2.3	Actions related to transmission of <i>ULInformationTransfer</i> message	175
5.6.2.4	Failure to deliver <i>ULInformationTransfer</i> message	175
5.6.3	UE capability transfer	175
5.6.3.1	General	175
5.6.3.2	Initiation	176
5.6.3.3	Reception of the <i>UECapabilityEnquiry</i> by the UE	176
5.6.4	CSFB to 1x Parameter transfer	179
5.6.4.1	General	179
5.6.4.2	Initiation	180
5.6.4.3	Actions related to transmission of <i>CSFBParametersRequestCDMA2000</i> message	180
5.6.4.4	Reception of the <i>CSFBParametersResponseCDMA2000</i> message	180
5.6.5	UE Information	180
5.6.5.1	General	180
5.6.5.2	Initiation	180
5.6.5.3	Reception of the <i>UEInformationRequest</i> message	180
5.6.6	Logged Measurement Configuration	182
5.6.6.1	General	182
5.6.6.2	Initiation	182
5.6.6.3	Reception of the <i>LoggedMeasurementConfiguration</i> by the UE	182
5.6.6.4	T330 expiry	182
5.6.7	Release of Logged Measurement Configuration	183
5.6.7.1	General	183
5.6.7.2	Initiation	183
5.6.8	Measurements logging	183
5.6.8.1	General	183
5.6.8.2	Initiation	183
5.6.9	In-device coexistence indication	186
5.6.9.1	General	186
5.6.9.2	Initiation	186
5.6.9.3	Actions related to transmission of <i>InDeviceCoexIndication</i> message	187
5.6.10	UE Assistance Information	188
5.6.10.1	General	188
5.6.10.2	Initiation	188
5.6.10.3	Actions related to transmission of <i>UEAssistanceInformation</i> message	189
5.6.11	Mobility history information	191
5.6.11.1	General	191
5.6.11.2	Initiation	191
5.6.12	RAN-assisted WLAN interworking	191
5.6.12.1	General	191
5.6.12.2	Dedicated WLAN offload configuration	192

5.6.12.3	WLAN offload RAN evaluation	192
5.6.12.4	T350 expiry or stop	192
5.6.12.5	Cell selection/ re-selection while T350 is running	192
5.6.13	SCG failure information	193
5.6.13.1	General	193
5.6.13.2	Initiation	193
5.6.13.3	Actions related to transmission of <i>SCGFailureInformation</i> message	193
5.6.14	LTE-WLAN Aggregation	194
5.6.14.1	Introduction	194
5.6.14.2	Reception of LWA configuration	194
5.6.14.3	Release of LWA configuration	195
5.6.15	WLAN connection management	195
5.6.15.1	Introduction	195
5.6.15.2	WLAN connection status reporting	195
5.6.15.2.1	General	195
5.6.15.2.2	Initiation	196
5.6.15.2.3	Actions related to transmission of <i>WLANConnectionStatusReport</i> message	196
5.6.15.3	T351 Expiry (WLAN connection attempt timeout)	196
5.6.15.4	WLAN status monitoring	196
5.6.16	RAN controlled LTE-WLAN interworking	197
5.6.16.1	General	197
5.6.16.2	WLAN traffic steering command	197
5.6.17	LTE-WLAN aggregation with IPsec tunnel	198
5.6.17.1	General	198
5.6.17.2	LWIP reconfiguration	198
5.6.17.3	LWIP release	199
5.6.18	Void	199
5.7	Generic error handling	199
5.7.1	General	199
5.7.2	ASN.1 violation or encoding error	199
5.7.3	Field set to a not comprehended value	200
5.7.4	Mandatory field missing	200
5.7.5	Not comprehended field	201
5.8	MBMS	201
5.8.1	Introduction	201
5.8.1.1	General	201
5.8.1.2	Scheduling	202
5.8.1.3	MCCH information validity and notification of changes	202
5.8.2	MCCH information acquisition	203
5.8.2.1	General	203
5.8.2.2	Initiation	203
5.8.2.3	MCCH information acquisition by the UE	203
5.8.2.4	Actions upon reception of the <i>MBSFNAreaConfiguration</i> message	204
5.8.2.5	Actions upon reception of the <i>MBMScountingRequest</i> message	204
5.8.3	MBMS PTM radio bearer configuration	204
5.8.3.1	General	204
5.8.3.2	Initiation	204
5.8.3.3	MRB establishment	204
5.8.3.4	MRB release	205
5.8.4	MBMS Counting Procedure	205
5.8.4.1	General	205
5.8.4.2	Initiation	205
5.8.4.3	Reception of the <i>MBMScountingRequest</i> message by the UE	205
5.8.5	MBMS interest indication	206
5.8.5.1	General	206
5.8.5.2	Initiation	206
5.8.5.3	Determine MBMS frequencies of interest	207
5.8.5.4	Actions related to transmission of <i>MBMSInterestIndication</i> message	208
5.8a	SC-PTM	208
5.8a.1	Introduction	208
5.8a.1.1	General	208
5.8a.1.2	SC-MCCH scheduling	209

5.8a.1.3	SC-MCCH information validity and notification of changes.....	209
5.8a.1.4	Procedures.....	210
5.8a.2	SC-MCCH information acquisition.....	210
5.8a.2.1	General.....	210
5.8a.2.2	Initiation.....	210
5.8a.2.3	SC-MCCH information acquisition by the UE.....	210
5.8a.2.4	Actions upon reception of the <i>SCPTMConfiguration</i> message.....	211
5.8a.3	SC-PTM radio bearer configuration.....	211
5.8a.3.1	General.....	211
5.8a.3.2	Initiation.....	211
5.8a.3.3	SC-MRB establishment.....	211
5.8a.3.4	SC-MRB release.....	211
5.9	RN procedures.....	212
5.9.1	RN reconfiguration.....	212
5.9.1.1	General.....	212
5.9.1.2	Initiation.....	212
5.9.1.3	Reception of the <i>RNReconfiguration</i> by the RN.....	212
5.10	Sidelink.....	213
5.10.1	Introduction.....	213
5.10.1a	Conditions for sidelink communication operation.....	213
5.10.1d	Conditions for V2X sidelink communication operation.....	214
5.10.2	Sidelink UE information.....	214
5.10.2.1	General.....	214
5.10.2.2	Initiation.....	215
5.10.2.3	Actions related to transmission of <i>SidelinkUEInformation</i> message.....	220
5.10.3	Sidelink communication monitoring.....	222
5.10.4	Sidelink communication transmission.....	224
5.10.5	Sidelink discovery monitoring.....	225
5.10.6	Sidelink discovery announcement.....	226
5.10.6a	Sidelink discovery announcement pool selection.....	229
5.10.6b	Sidelink discovery announcement reference carrier selection.....	229
5.10.7	Sidelink synchronisation information transmission.....	230
5.10.7.1	General.....	230
5.10.7.2	Initiation.....	231
5.10.7.3	Transmission of SLSS.....	232
5.10.7.4	Transmission of <i>MasterInformationBlock-SL</i> or <i>MasterInformationBlock-SL-V2X</i> message.....	235
5.10.7.5	Void.....	236
5.10.8	Sidelink synchronisation reference.....	236
5.10.8.1	General.....	236
5.10.8.2	Selection and reselection of synchronisation reference.....	236
5.10.9	Sidelink common control information.....	238
5.10.9.1	General.....	238
5.10.9.2	Actions related to reception of <i>MasterInformationBlock-SL/ MasterInformationBlock-SL-V2X</i> message.....	239
5.10.10	Sidelink relay UE operation.....	239
5.10.10.1	General.....	239
5.10.10.2	AS-conditions for relay related sidelink communication transmission by sidelink relay UE.....	239
5.10.10.3	AS-conditions for relay PS related sidelink discovery transmission by sidelink relay UE.....	239
5.10.10.4	Sidelink relay UE threshold conditions.....	240
5.10.11	Sidelink remote UE operation.....	240
5.10.11.1	General.....	240
5.10.11.2	AS-conditions for relay related sidelink communication transmission by sidelink remote UE.....	240
5.10.11.3	AS-conditions for relay PS related sidelink discovery transmission by sidelink remote UE.....	241
5.10.11.4	Selection and reselection of sidelink relay UE.....	241
5.10.11.5	Sidelink remote UE threshold conditions.....	241
5.10.12	V2X sidelink communication monitoring.....	242
5.10.13	V2X sidelink communication transmission.....	242
5.10.13.1	Transmission of V2X sidelink communication.....	242
5.10.13.1a	Transmission of P2X related V2X sidelink communication.....	245
5.10.13.2	V2X sidelink communication transmission pool selection.....	245
5.10.13.3	V2X sidelink communication transmission reference cell selection.....	247
5.10.14	DFN derivation from GNSS.....	247

6	Protocol data units, formats and parameters (tabular & ASN.1)	248
6.1	General	248
6.2	RRC messages	249
6.2.1	General message structure	250
-	<i>EUTRA-RRC-Definitions</i>	250
-	<i>BCCH-BCH-Message</i>	250
-	<i>BCCH-BCH-Message-MBMS</i>	250
-	<i>BCCH-DL-SCH-Message</i>	250
-	<i>BCCH-DL-SCH-Message-BR</i>	251
-	<i>BCCH-DL-SCH-Message-MBMS</i>	251
-	<i>MCCH-Message</i>	251
-	<i>PCCH-Message</i>	252
-	<i>DL-CCCH-Message</i>	252
-	<i>DL-DCCH-Message</i>	252
-	<i>UL-CCCH-Message</i>	253
-	<i>UL-DCCH-Message</i>	253
-	<i>SC-MCCH-Message</i>	254
6.2.2	Message definitions	254
-	<i>CounterCheck</i>	254
-	<i>CounterCheckResponse</i>	255
-	<i>CSFBParametersRequestCDMA2000</i>	256
-	<i>CSFBParametersResponseCDMA2000</i>	256
-	<i>DLInformationTransfer</i>	257
-	<i>HandoverFromEUTRAPreparationRequest (CDMA2000)</i>	257
-	<i>InDeviceCoexIndication</i>	259
-	<i>InterFreqRSTDMeasurementIndication</i>	261
-	<i>LoggedMeasurementConfiguration</i>	263
-	<i>MasterInformationBlock</i>	264
-	<i>MasterInformationBlock-MBMS</i>	265
-	<i>MBMSCountingRequest</i>	265
-	<i>MBMSCountingResponse</i>	266
-	<i>MBMSInterestIndication</i>	267
-	<i>MBSFNAreaConfiguration</i>	267
-	<i>MeasurementReport</i>	268
-	<i>MobilityFromEUTRACommand</i>	269
-	<i>Paging</i>	272
-	<i>ProximityIndication</i>	273
-	<i>RNReconfiguration</i>	274
-	<i>RNReconfigurationComplete</i>	274
-	<i>RRCCConnectionReconfiguration</i>	275
-	<i>RRCCConnectionReconfigurationComplete</i>	281
-	<i>RRCCConnectionReestablishment</i>	282
-	<i>RRCCConnectionReestablishmentComplete</i>	283
-	<i>RRCCConnectionReestablishmentReject</i>	284
-	<i>RRCCConnectionReestablishmentRequest</i>	284
-	<i>RRCCConnectionReject</i>	285
-	<i>RRCCConnectionRelease</i>	286
-	<i>RRCCConnectionRequest</i>	290
-	<i>RRCCConnectionResume</i>	290
-	<i>RRCCConnectionResumeComplete</i>	291
-	<i>RRCCConnectionResumeRequest</i>	292
-	<i>RRCCConnectionSetup</i>	293
-	<i>RRCCConnectionSetupComplete</i>	293
-	<i>SCGFailureInformation</i>	295
-	<i>SCPTMConfiguration</i>	296
-	<i>SCPTMConfiguration-BR</i>	297
-	<i>SecurityModeCommand</i>	297
-	<i>SecurityModeComplete</i>	298
-	<i>SecurityModeFailure</i>	298
-	<i>SidelinkUEInformation</i>	299
-	<i>SystemInformation</i>	302
-	<i>SystemInformationBlockType1</i>	302

-	<i>SystemInformationBlockType1-MBMS</i>	309
-	<i>UEAssistanceInformation</i>	311
-	<i>UECapabilityEnquiry</i>	313
-	<i>UECapabilityInformation</i>	315
-	<i>UEInformationRequest</i>	316
-	<i>UEInformationResponse</i>	316
-	<i>ULHandoverPreparationTransfer (CDMA2000)</i>	322
-	<i>ULInformationTransfer</i>	323
-	<i>WLANConnectionStatusReport</i>	323
6.3	RRC information elements	324
6.3.1	System information blocks	324
-	<i>SystemInformationBlockType2</i>	324
-	<i>SystemInformationBlockType3</i>	328
-	<i>SystemInformationBlockType4</i>	332
-	<i>SystemInformationBlockType5</i>	333
-	<i>SystemInformationBlockType6</i>	338
-	<i>SystemInformationBlockType7</i>	341
-	<i>SystemInformationBlockType8</i>	342
-	<i>SystemInformationBlockType9</i>	346
-	<i>SystemInformationBlockType10</i>	346
-	<i>SystemInformationBlockType11</i>	347
-	<i>SystemInformationBlockType12</i>	348
-	<i>SystemInformationBlockType13</i>	348
-	<i>SystemInformationBlockType14</i>	349
-	<i>SystemInformationBlockType15</i>	349
-	<i>SystemInformationBlockType16</i>	351
-	<i>SystemInformationBlockType17</i>	351
-	<i>SystemInformationBlockType18</i>	352
-	<i>SystemInformationBlockType19</i>	353
-	<i>SystemInformationBlockType20</i>	356
-	<i>SystemInformationBlockType21</i>	359
6.3.2	Radio resource control information elements	360
-	<i>AntennaInfo</i>	360
-	<i>AntennaInfoUL</i>	362
-	<i>CQI-ReportAperiodic</i>	363
-	<i>CQI-ReportBoth</i>	366
-	<i>CQI-ReportConfig</i>	367
-	<i>CQI-ReportPeriodic</i>	369
-	<i>CQI-ReportPeriodicProcExtId</i>	372
-	<i>CrossCarrierSchedulingConfig</i>	372
-	<i>CSI-IM-Config</i>	373
-	<i>CSI-IM-ConfigId</i>	374
-	<i>CSI-Process</i>	374
-	<i>CSI-ProcessId</i>	375
-	<i>CSI-RS-Config</i>	376
-	<i>CSI-RS-ConfigBeamformed</i>	377
-	<i>CSI-RS-ConfigEMIMO</i>	378
-	<i>CSI-RS-ConfigNonPrecoded</i>	379
-	<i>CSI-RS-ConfigNZP</i>	380
-	<i>CSI-RS-ConfigNZPId</i>	381
-	<i>CSI-RS-ConfigZP</i>	382
-	<i>CSI-RS-ConfigZPId</i>	382
-	<i>DataInactivityTimer</i>	382
-	<i>DMRS-Config</i>	383
-	<i>DRB-Identity</i>	383
-	<i>EPDCCH-Config</i>	383
-	<i>EIMTA-MainConfig</i>	385
-	<i>LogicalChannelConfig</i>	386
-	<i>LWA-Configuration</i>	387
-	<i>LWIP-Configuration</i>	388
-	<i>MAC-MainConfig</i>	388
-	<i>P-C-AndCBSR</i>	394

-	<i>PDCCH-ConfigSCell</i>	395
-	<i>PDCP-Config</i>	396
-	<i>PDSCH-Config</i>	399
-	<i>PDSCH-RE-MappingQCL-ConfigId</i>	401
-	<i>PerCC-GapIndicationList</i>	402
-	<i>PHICH-Config</i>	402
-	<i>PhysicalConfigDedicated</i>	402
-	<i>P-Max</i>	410
-	<i>PRACH-Config</i>	411
-	<i>PresenceAntennaPort1</i>	414
-	<i>PUCCH-Config</i>	414
-	<i>PUSCH-Config</i>	419
-	<i>RACH-ConfigCommon</i>	425
-	<i>RACH-ConfigDedicated</i>	427
-	<i>RadioResourceConfigCommon</i>	427
-	<i>RadioResourceConfigDedicated</i>	432
-	<i>RCLWI-Configuration</i>	438
-	<i>RLC-Config</i>	439
-	<i>RLF-TimersAndConstants</i>	441
-	<i>RN-SubframeConfig</i>	442
-	<i>SchedulingRequestConfig</i>	443
-	<i>SoundingRS-UL-Config</i>	444
-	<i>SPS-Config</i>	447
-	<i>SRS-TPC-PDCCH-Config</i>	451
-	<i>TDD-Config</i>	452
-	<i>TimeAlignmentTimer</i>	453
-	<i>TPC-PDCCH-Config</i>	453
-	<i>TunnelConfigLWIP</i>	454
-	<i>UplinkPowerControl</i>	454
-	<i>WLAN-Id-List</i>	458
-	<i>WLAN-MobilityConfig</i>	458
6.3.3	Security control information elements	459
-	<i>NextHopChainingCount</i>	459
-	<i>SecurityAlgorithmConfig</i>	459
-	<i>ShortMAC-I</i>	459
6.3.4	Mobility control information elements	460
-	<i>AdditionalSpectrumEmission</i>	460
-	<i>ARFCN-ValueCDMA2000</i>	460
-	<i>ARFCN-ValueEUTRA</i>	460
-	<i>ARFCN-ValueGERAN</i>	461
-	<i>ARFCN-ValueUTRA</i>	461
-	<i>BandclassCDMA2000</i>	461
-	<i>BandIndicatorGERAN</i>	461
-	<i>CarrierFreqCDMA2000</i>	461
-	<i>CarrierFreqGERAN</i>	462
-	<i>CarrierFreqsGERAN</i>	462
-	<i>CarrierFreqListMBMS</i>	463
-	<i>CDMA2000-Type</i>	463
-	<i>CellIdentity</i>	463
-	<i>CellIndexList</i>	463
-	<i>CellReselectionPriority</i>	464
-	<i>CellSelectionInfoCE</i>	464
-	<i>CellSelectionInfoCE1</i>	464
-	<i>CellReselectionSubPriority</i>	465
-	<i>CSFB-RegistrationParam1XRTT</i>	465
-	<i>CellGlobalIdEUTRA</i>	466
-	<i>CellGlobalIdUTRA</i>	466
-	<i>CellGlobalIdGERAN</i>	467
-	<i>CellGlobalIdCDMA2000</i>	467
-	<i>CellSelectionInfoNFreq</i>	468
-	<i>CSG-Identity</i>	468
-	<i>FreqBandIndicator</i>	468

-	<i>MobilityControlInfo</i>	468
-	<i>MobilityParametersCDMA2000 (1xRTT)</i>	472
-	<i>MobilityStateParameters</i>	473
-	<i>MultiBandInfoList</i>	473
-	<i>NS-PmaxList</i>	473
-	<i>PhysCellId</i>	474
-	<i>PhysCellIdRange</i>	474
-	<i>PhysCellIdRangeUTRA-FDDList</i>	475
-	<i>PhysCellIdCDMA2000</i>	475
-	<i>PhysCellIdGERAN</i>	475
-	<i>PhysCellIdUTRA-FDD</i>	476
-	<i>PhysCellIdUTRA-TDD</i>	476
-	<i>PLMN-Identity</i>	476
-	<i>PLMN-IdentityList3</i>	477
-	<i>PreRegistrationInfoHRPD</i>	477
-	<i>Q-QualMin</i>	477
-	<i>Q-RxLevMin</i>	477
-	<i>Q-OffsetRange</i>	478
-	<i>Q-OffsetRangeInterRAT</i>	478
-	<i>ReselectionThreshold</i>	478
-	<i>ReselectionThresholdQ</i>	478
-	<i>SCellIndex</i>	479
-	<i>ServCellIndex</i>	479
-	<i>SpeedStateScaleFactors</i>	479
-	<i>SystemInfoListGERAN</i>	479
-	<i>SystemTimeInfoCDMA2000</i>	480
-	<i>TrackingAreaCode</i>	481
-	<i>T-Reselection</i>	481
-	<i>T-ReselectionEUTRA-CE</i>	481
6.3.5	Measurement information elements	481
-	<i>AllowedMeasBandwidth</i>	481
-	<i>CSI-RSRP-Range</i>	481
-	<i>Hysteresis</i>	482
-	<i>LocationInfo</i>	482
-	<i>MBSFN-RSRQ-Range</i>	483
-	<i>MeasConfig</i>	483
-	<i>MeasDS-Config</i>	485
-	<i>MeasGapConfig</i>	486
-	<i>MeasGapConfigPerCC-List</i>	487
-	<i>MeasGapSharingConfig</i>	488
-	<i>MeasId</i>	488
-	<i>MeasIdToAddModList</i>	488
-	<i>MeasObjectCDMA2000</i>	489
-	<i>MeasObjectEUTRA</i>	490
-	<i>MeasObjectGERAN</i>	493
-	<i>MeasObjectId</i>	493
-	<i>MeasObjectToAddModList</i>	494
-	<i>MeasObjectUTRA</i>	494
-	<i>MeasObjectWLAN</i>	495
-	<i>MeasResults</i>	496
-	<i>MeasScaleFactor</i>	502
-	<i>QuantityConfig</i>	502
-	<i>ReportConfigEUTRA</i>	504
-	<i>ReportConfigId</i>	507
-	<i>ReportConfigInterRAT</i>	507
-	<i>ReportConfigToAddModList</i>	510
-	<i>ReportInterval</i>	511
-	<i>RSRP-Range</i>	511
-	<i>RSRQ-Range</i>	512
-	<i>RSRQ-Type</i>	512
-	<i>RS-SINR-Range</i>	513
-	<i>RSSI-Range-r13</i>	513

–	<i>TimeToTrigger</i>	513
–	<i>UL-DelayConfig</i>	513
–	<i>WLAN-CarrierInfo</i>	514
–	<i>WLAN-RSSI-Range</i>	514
–	<i>WLAN-Status</i>	514
–	<i>WLAN-SuspendConfig</i>	515
6.3.6	Other information elements	515
–	<i>AbsoluteTimeInfo</i>	515
–	<i>AreaConfiguration</i>	515
–	<i>C-RNTI</i>	516
–	<i>DedicatedInfoCDMA2000</i>	516
–	<i>DedicatedInfoNAS</i>	516
–	<i>FilterCoefficient</i>	517
–	<i>LoggingDuration</i>	517
–	<i>LoggingInterval</i>	517
–	<i>MeasSubframePattern</i>	517
–	<i>MMEC</i>	518
–	<i>NeighCellConfig</i>	518
–	<i>OtherConfig</i>	518
–	<i>RAND-CDMA2000 (1xRTT)</i>	520
–	<i>RAT-Type</i>	521
–	<i>ResumeIdentity</i>	521
–	<i>RRC-TransactionIdentifier</i>	521
–	<i>S-TMSI</i>	521
–	<i>TraceReference</i>	522
–	<i>UE-CapabilityRAT-ContainerList</i>	522
–	<i>UE-EUTRA-Capability</i>	523
–	<i>UE-RadioPagingInfo</i>	568
–	<i>UE-TimersAndConstants</i>	569
–	<i>VisitedCellInfoList</i>	570
–	<i>WLAN-OffloadConfig</i>	570
6.3.7	MBMS information elements	573
–	<i>MBMS-NotificationConfig</i>	573
–	<i>MBMS-ServiceList</i>	573
–	<i>MBSFN-AreaId</i>	573
–	<i>MBSFN-AreaInfoList</i>	574
–	<i>MBSFN-SubframeConfig</i>	575
–	<i>PMCH-InfoList</i>	576
6.3.7a	SC-PTM information elements	578
–	<i>SC-MTCH-InfoList</i>	578
–	<i>SC-MTCH-InfoList-BR</i>	579
–	<i>SCPTM-NeighbourCellList</i>	581
6.3.8	Sidelink information elements	582
–	<i>SL-AnchorCarrierFreqList-V2X</i>	582
–	<i>SL-CBR-CommonTxConfigList</i>	582
–	<i>SL-CBR-PPPP-TxConfigList</i>	583
–	<i>SL-CommConfig</i>	584
–	<i>SL-CommResourcePool</i>	585
–	<i>SL-CommTxPoolSensingConfig</i>	588
–	<i>SL-CP-Len</i>	589
–	<i>SL-DiscConfig</i>	589
–	<i>SL-DiscResourcePool</i>	592
–	<i>SL-DiscSysInfoReport</i>	593
–	<i>SL-DiscTxPowerInfo</i>	594
–	<i>SL-GapConfig</i>	594
–	<i>SL-GapRequest</i>	595
–	<i>SL-HoppingConfig</i>	595
–	<i>SL-InterFreqInfoListV2X</i>	596
–	<i>SL-V2X-UE-ConfigList</i>	597
–	<i>SL-OffsetIndicator</i>	598
–	<i>SL-P2X-ResourceSelectionConfig</i>	599
–	<i>SL-PeriodComm</i>	599

–	<i>SL-Priority</i>	599
–	<i>SL-PSSCH-TxConfigList</i>	599
–	<i>SL-RestrictResourceReservationPeriodList</i>	600
–	<i>SLSSID</i>	601
–	<i>SL-SyncAllowed</i>	601
–	<i>SL-SyncConfig</i>	601
–	<i>SL-TF-ResourceConfig</i>	603
–	<i>SL-TxPower</i>	604
–	<i>SL-TypeTxSync</i>	604
–	<i>SL-ThresPSSCH-RSRP-List</i>	604
–	<i>SL-TxParameters</i>	605
–	<i>SL-TxPoolIdentity</i>	605
–	<i>SL-TxPoolToReleaseList</i>	605
–	<i>SL-V2X-ConfigDedicated</i>	606
–	<i>SL-ZoneConfig</i>	607
6.4	RRC multiplicity and type constraint values	608
–	Multiplicity and type constraint definitions	608
–	End of EUTRA-RRC-Definitions	611
6.5	PC5 RRC messages	611
6.5.1	General message structure	611
–	<i>PC5-RRC-Definitions</i>	611
–	<i>SBCCH-SL-BCH-Message</i>	611
–	<i>SBCCH-SL-BCH-Message-V2X</i>	611
6.5.2	Message definitions	612
–	<i>MasterInformationBlock-SL</i>	612
–	<i>MasterInformationBlock-SL-V2X</i>	612
–	End of <i>PC5-RRC-Definitions</i>	613
6.6	Direct Indication Information	613
6.6a	Direct Indication FeMBMS	613
6.7	NB-IoT RRC messages	614
6.7.1	General NB-IoT message structure	614
–	<i>BCCH-BCH-Message-NB</i>	615
–	<i>BCCH-DL-SCH-Message-NB</i>	615
–	<i>PCCH-Message-NB</i>	615
–	<i>DL-CCCH-Message-NB</i>	615
–	<i>DL-DCCH-Message-NB</i>	616
–	<i>UL-CCCH-Message-NB</i>	616
–	<i>SC-MCCH-Message-NB</i>	617
–	<i>UL-DCCH-Message-NB</i>	617
6.7.2	NB-IoT Message definitions	617
–	<i>DLInformationTransfer-NB</i>	617
–	<i>MasterInformationBlock-NB</i>	618
–	<i>Paging-NB</i>	619
–	<i>RRCCConnectionReconfiguration-NB</i>	620
–	<i>RRCCConnectionReconfigurationComplete-NB</i>	621
–	<i>RRCCConnectionReestablishment-NB</i>	621
–	<i>RRCCConnectionReestablishmentComplete-NB</i>	622
–	<i>RRCCConnectionReestablishmentRequest-NB</i>	622
–	<i>RRCCConnectionReject-NB</i>	623
–	<i>RRCCConnectionRelease-NB</i>	624
–	<i>RRCCConnectionRequest-NB</i>	625
–	<i>RRCCConnectionResume-NB</i>	626
–	<i>RRCCConnectionResumeComplete-NB</i>	627
–	<i>RRCCConnectionResumeRequest-NB</i>	627
–	<i>RRCCConnectionSetup-NB</i>	628
–	<i>RRCCConnectionSetupComplete-NB</i>	629
–	<i>SCPTMConfiguration-NB</i>	630
–	<i>SystemInformation-NB</i>	630
–	<i>SystemInformationBlockType1-NB</i>	631
–	<i>UECapabilityEnquiry-NB</i>	635
–	<i>UECapabilityInformation-NB</i>	636
–	<i>ULInformationTransfer-NB</i>	636

6.7.3	NB-IoT information elements	637
6.7.3.1	NB-IoT System information blocks	637
-	<i>SystemInformationBlockType2-NB</i>	637
-	<i>SystemInformationBlockType3-NB</i>	638
-	<i>SystemInformationBlockType4-NB</i>	639
-	<i>SystemInformationBlockType5-NB</i>	640
-	<i>SystemInformationBlockType14-NB</i>	641
-	<i>SystemInformationBlockType15-NB</i>	642
-	<i>SystemInformationBlockType16-NB</i>	643
-	<i>SystemInformationBlockType20-NB</i>	643
-	<i>SystemInformationBlockType22-NB</i>	644
6.7.3.2	NB-IoT Radio resource control information elements	646
-	<i>CarrierConfigDedicated-NB</i>	646
-	<i>CarrierFreq-NB</i>	648
-	<i>DL-Bitmap-NB</i>	649
-	<i>DL-CarrierConfigCommon-NB</i>	649
-	<i>DL-GapConfig-NB</i>	650
-	<i>LogicalChannelConfig-NB</i>	651
-	<i>MAC-MainConfig-NB</i>	651
-	<i>NPDCCH-ConfigDedicated-NB</i>	653
-	<i>NPDSCH-ConfigCommon-NB</i>	654
-	<i>NPRACH-ConfigSIB-NB</i>	654
-	<i>NPUSCH-Config-NB</i>	657
-	<i>PDCCP-Config-NB</i>	658
-	<i>PhysicalConfigDedicated-NB</i>	659
-	<i>RACH-ConfigCommon-NB</i>	660
-	<i>RadioResourceConfigCommonSIB-NB</i>	661
-	<i>RadioResourceConfigDedicated-NB</i>	662
-	<i>RLC-Config-NB</i>	663
-	<i>RLF-TimersAndConstants-NB</i>	664
-	<i>UplinkPowerControl-NB</i>	664
6.7.3.3	NB-IoT Security control information elements	665
6.7.3.4	NB-IoT Mobility control information elements	665
-	<i>AdditionalBandInfoList-NB</i>	665
-	<i>FreqBandIndicator-NB</i>	665
-	<i>MultiBandInfoList-NB</i>	665
-	<i>NS-PmaxList-NB</i>	666
-	<i>T-Reselection-NB</i>	666
6.7.3.5	NB-IoT Measurement information elements	666
-	<i>CQI-NPDCCH-NB</i>	666
-	<i>CQI-NPDCCH-Short-NB</i>	667
-	<i>MeasResultServCell-NB</i>	667
6.7.3.6	NB-IoT Other information elements	668
-	<i>EstablishmentCause-NB</i>	668
-	<i>UE-Capability-NB</i>	668
-	<i>UE-RadioPagingInfo-NB</i>	670
-	<i>UE-TimersAndConstants-NB</i>	671
6.7.3.7	NB-IoT MBMS information elements	671
6.7.3.7a	NB-IoT SC-PTM information elements	672
-	<i>SC-MTCH-InfoList-NB</i>	672
-	<i>SCPTM-NeighbourCellList-NB</i>	673
6.7.4	NB-IoT RRC multiplicity and type constraint values	674
-	Multiplicity and type constraint definitions	674
-	End of NBIOT-RRC-Definitions	674
6.7.5	Direct Indication Information	674
7	Variables and constants	674
7.1	UE variables	674
-	<i>EUTRA-UE-Variables</i>	675
-	<i>VarConnEstFailReport</i>	675
-	<i>VarLogMeasConfig</i>	676
-	<i>VarLogMeasReport</i>	676

–	<i>VarMeasConfig</i>	677
–	<i>VarMeasReportList</i>	677
–	<i>VarMobilityHistoryReport</i>	678
–	<i>VarRLF-Report</i>	678
–	<i>VarShortMAC-Input</i>	678
–	<i>VarShortResumeMAC-Input</i>	679
–	<i>VarWLAN-MobilityConfig</i>	679
–	<i>VarWLAN-Status</i>	679
–	Multiplicity and type constraint definitions	680
–	End of <i>EUTRA-UE-Variables</i>	680
7.1a	NB-IoT UE variables	680
–	<i>NBIOT-UE-Variables</i>	680
–	End of <i>NBIOT-UE-Variables</i>	680
7.2	Counters	681
7.3	Timers	682
7.3.1	Timers (Informative)	682
7.3.2	Timer handling	685
7.4	Constants	686
8	Protocol data unit abstract syntax	686
8.1	General	686
8.2	Structure of encoded RRC messages	686
8.3	Basic production	687
8.4	Extension	687
8.5	Padding	687
9	Specified and default radio configurations	687
9.1	Specified configurations	688
9.1.1	Logical channel configurations	688
9.1.1.1	BCCH configuration	688
9.1.1.2	CCCH configuration	688
9.1.1.3	PCCH configuration	688
9.1.1.4	MCCH and MTCH configuration	688
9.1.1.5	SBCCH configuration	689
9.1.1.6	STCH configuration	689
9.1.1.7	SC-MCCH and SC-MTCH configuration	689
9.1.1.8	BR-BCCH configuration	690
9.1.2	SRB configurations	690
9.1.2.1	SRB1	690
9.1.2.1a	SRB1bis	690
9.1.2.2	SRB2	690
9.2	Default radio configurations	690
9.2.1	SRB configurations	691
9.2.1.1	SRB1	691
9.2.1.2	SRB2	691
9.2.2	Default MAC main configuration	692
9.2.3	Default semi-persistent scheduling configuration	692
9.2.4	Default physical channel configuration	692
9.2.5	Default values timers and constants	694
9.3	Sidelink pre-configured parameters	694
9.3.1	Specified parameters	694
9.3.2	Pre-configurable parameters	694
–	<i>SL-Preconfiguration</i>	695
–	<i>SL-V2X-Preconfiguration</i>	697
10	Radio information related interactions between network nodes	701
10.1	General	701
10.2	Inter-node RRC messages	701
10.2.1	General	701
–	<i>EUTRA-InterNodeDefinitions</i>	701
10.2.2	Message definitions	702
–	<i>HandoverCommand</i>	702
–	<i>HandoverPreparationInformation</i>	703

–	SCG-Config	705
–	SCG-ConfigInfo	706
–	UEPagingCoverageInformation	708
–	UERadioAccessCapabilityInformation	709
–	UERadioPagingInformation	709
10.3	Inter-node RRC information element definitions	710
–	AS-Config	710
–	AS-Context	712
–	ReestablishmentInfo	713
–	RRM-Config	713
10.4	Inter-node RRC multiplicity and type constraint values	714
–	Multiplicity and type constraints definitions	714
–	End of EUTRA-InterNodeDefinitions	714
10.5	Mandatory information in AS-Config	715
10.6	Inter-node NB-IoT messages	715
10.6.1	General	715
–	NB-IoT-InterNodeDefinitions	715
10.6.2	Message definitions	716
–	HandoverPreparationInformation-NB	716
–	UEPagingCoverageInformation-NB	717
–	UERadioAccessCapabilityInformation-NB	717
–	UERadioPagingInformation-NB	718
10.7	Inter-node NB-IoT RRC information element definitions	718
–	AS-Config-NB	718
–	AS-Context-NB	719
–	ReestablishmentInfo-NB	719
–	RRM-Config-NB	719
10.8	Inter-node RRC multiplicity and type constraint values	720
–	Multiplicity and type constraints definitions	720
–	End of NB-IoT-InterNodeDefinitions	720
10.9	Mandatory information in AS-Config-NB	720
11	UE capability related constraints and performance requirements	721
11.1	UE capability related constraints	721
11.2	Processing delay requirements for RRC procedures	721
11.3	Void	724
Annex A (informative): Guidelines, mainly on use of ASN.1		725
A.1	Introduction	725
A.2	Procedural specification	725
A.2.1	General principles	725
A.2.2	More detailed aspects	725
A.3	PDU specification	725
A.3.1	General principles	725
A.3.1.1	ASN.1 sections	725
A.3.1.2	ASN.1 identifier naming conventions	726
A.3.1.3	Text references using ASN.1 identifiers	727
A.3.2	High-level message structure	728
A.3.3	Message definition	728
A.3.4	Information elements	730
A.3.5	Fields with optional presence	731
A.3.6	Fields with conditional presence	731
A.3.7	Guidelines on use of lists with elements of SEQUENCE type	732
A.4	Extension of the PDU specifications	733
A.4.1	General principles to ensure compatibility	733
A.4.2	Critical extension of messages and fields	733
A.4.3	Non-critical extension of messages	735
A.4.3.1	General principles	735
A.4.3.2	Further guidelines	735
A.4.3.3	Typical example of evolution of IE with local extensions	736
A.4.3.4	Typical examples of non critical extension at the end of a message	737
A.4.3.5	Examples of non-critical extensions not placed at the default extension location	737

–	<i>ParentIE-WithEM</i>	738
–	<i>ChildIE1-WithoutEM</i>	738
–	<i>ChildIE2-WithoutEM</i>	739
A.5	Guidelines regarding inclusion of transaction identifiers in RRC messages	739
A.6	Protection of RRC messages (informative)	740
A.7	Miscellaneous	742
Annex B (normative): Release 8 and 9 AS feature handling		743
B.1	Feature group indicators	743
B.2	CSG support	753
Annex C (normative): Release 10 AS feature handling		754
C.1	Feature group indicators	754
Annex D (informative): Descriptive background information		758
D.1	Signalling of Multiple Frequency Band Indicators (Multiple FBI)	758
D.1.1	Mapping between frequency band indicator and multiple frequency band indicator	758
D.1.2	Mapping between inter-frequency neighbour list and multiple frequency band indicator	758
D.1.3	Mapping between UTRA FDD frequency list and multiple frequency band indicator	759
Annex E (normative): TDD/FDD differentiation of FGIs/capabilities in TDD-FDD CA		761
Annex F (normative): UE requirements on ASN.1 comprehension		763
Annex G (informative): Change history		764
History		784

Foreword

This Technical Specification has been produced by the 3rd Generation Partnership Project (3GPP).

The contents of the present document are subject to continuing work within the TSG and may change following formal TSG approval. Should the TSG modify the contents of the present document, it will be re-released by the TSG with an identifying change of release date and an increase in version number as follows:

Version x.y.z

where:

- x the first digit:
 - 1 presented to TSG for information;
 - 2 presented to TSG for approval;
 - 3 or greater indicates TSG approved document under change control.
- y the second digit is incremented for all changes of substance, i.e. technical enhancements, corrections, updates, etc.
- z the third digit is incremented when editorial only changes have been incorporated in the document.

1 Scope

The present document specifies the Radio Resource Control protocol for the radio interface between UE and E-UTRAN as well as for the radio interface between RN and E-UTRAN.

The scope of the present document also includes:

- the radio related information transported in a transparent container between source eNB and target eNB upon inter eNB handover;
- the radio related information transported in a transparent container between a source or target eNB and another system upon inter RAT handover.

2 References

The following documents contain provisions which, through reference in this text, constitute provisions of the present document.

- References are either specific (identified by date of publication, edition number, version number, etc.) or non-specific.
- For a specific reference, subsequent revisions do not apply.
- For a non-specific reference, the latest version applies. In the case of a reference to a 3GPP document (including a GSM document), a non-specific reference implicitly refers to the latest version of that document *in the same Release as the present document*.

- [1] 3GPP TR 21.905: "Vocabulary for 3GPP Specifications".
- [2] Void.
- [3] 3GPP TS 36.302: "Evolved Universal Terrestrial Radio Access (E-UTRA); Services provided by the physical layer".
- [4] 3GPP TS 36.304: "Evolved Universal Terrestrial Radio Access (E-UTRA); UE Procedures in Idle Mode".
- [5] 3GPP TS 36.306 "Evolved Universal Terrestrial Radio Access (E-UTRA); UE Radio Access Capabilities".
- [6] 3GPP TS 36.321: "Evolved Universal Terrestrial Radio Access (E-UTRA); Medium Access Control (MAC) protocol specification".
- [7] 3GPP TS 36.322: "Evolved Universal Terrestrial Radio Access (E-UTRA); Radio Link Control (RLC) protocol specification".
- [8] 3GPP TS 36.323: "Evolved Universal Terrestrial Radio Access (E-UTRA); Packet Data Convergence Protocol (PDCP) Specification".
- [9] 3GPP TS 36.300: "Evolved Universal Terrestrial Radio Access (E-UTRA) and Evolved Universal Terrestrial Radio Access (E-UTRAN); Overall description; Stage 2".
- [10] 3GPP TS 22.011: "Service accessibility".
- [11] 3GPP TS 23.122: "Non-Access-Stratum (NAS) functions related to Mobile Station (MS) in idle mode".
- [12] 3GPP2 C.S0002-F v1.0: "Physical Layer Standard for cdma2000 Spread Spectrum Systems".
- [13] ITU-T Recommendation X.680 (07/2002) "Information Technology - Abstract Syntax Notation One (ASN.1): Specification of basic notation" (Same as the ISO/IEC International Standard 8824-1).

- [14] ITU-T Recommendation X.681 (07/2002) "Information Technology - Abstract Syntax Notation One (ASN.1): Information object specification" (Same as the ISO/IEC International Standard 8824-2).
- [15] ITU-T Recommendation X.691 (07/2002) "Information technology - ASN.1 encoding rules: Specification of Packed Encoding Rules (PER)" (Same as the ISO/IEC International Standard 8825-2).
- [16] 3GPP TS 36.133: "Evolved Universal Terrestrial Radio Access (E-UTRA); Requirements for support of radio resource management".
- [17] 3GPP TS 25.101: "Universal Terrestrial Radio Access (UTRA); User Equipment (UE) radio transmission and reception (FDD)".
- [18] 3GPP TS 25.102: "Universal Terrestrial Radio Access (UTRA); User Equipment (UE) radio transmission and reception (TDD)".
- [19] 3GPP TS 25.331: "Universal Terrestrial Radio Access (UTRA); Radio Resource Control (RRC); Protocol specification".
- [20] 3GPP TS 45.005: "Radio transmission and reception".
- [21] 3GPP TS 36.211: "Evolved Universal Terrestrial Radio Access (E-UTRA); Physical Channels and Modulation".
- [22] 3GPP TS 36.212: "Evolved Universal Terrestrial Radio Access (E-UTRA); Multiplexing and channel coding".
- [23] 3GPP TS 36.213: "Evolved Universal Terrestrial Radio Access (E-UTRA); Physical layer procedures".
- [24] 3GPP2 C.S0057-E v1.0: "Band Class Specification for cdma2000 Spread Spectrum Systems".
- [25] 3GPP2 C.S0005-F v1.0: "Upper Layer (Layer 3) Signaling Standard for cdma2000 Spread Spectrum Systems".
- [26] 3GPP2 C.S0024-C v2.0: "cdma2000 High Rate Packet Data Air Interface Specification".
- [27] 3GPP TS 23.003: "Numbering, addressing and identification".
- [28] 3GPP TS 45.008: "Radio subsystem link control".
- [29] 3GPP TS 25.133: "Requirements for Support of Radio Resource Management (FDD)".
- [30] 3GPP TS 25.123: "Requirements for Support of Radio Resource Management (TDD)".
- [31] 3GPP TS 36.401: "Evolved Universal Terrestrial Radio Access (E-UTRA); Architecture description".
- [32] 3GPP TS 33.401: "3GPP System Architecture Evolution (SAE); Security architecture".
- [33] 3GPP2 A.S0008-C v4.0: "Interoperability Specification (IOS) for High Rate Packet Data (HRPD) Radio Access Network Interfaces with Session Control in the Access Network"
- [34] 3GPP2 C.S0004-F v1.0: "Signaling Link Access Control (LAC) Standard for cdma2000 Spread Spectrum Systems"
- [35] 3GPP TS 24.301: "Non-Access-Stratum (NAS) protocol for Evolved Packet System (EPS); Stage 3".
- [36] 3GPP TS 44.060: "General Packet Radio Service (GPRS); Mobile Station (MS) - Base Station System (BSS) interface; Radio Link Control/Medium Access Control (RLC/MAC) protocol".
- [37] 3GPP TS 23.041: "Technical realization of Cell Broadcast Service (CBS)".
- [38] 3GPP TS 23.038: "Alphabets and Language".

- [39] 3GPP TS 36.413: "Evolved Universal Terrestrial Radio Access (E-UTRAN); S1 Application Protocol (S1 AP)".
- [40] 3GPP TS 25.304: "Universal Terrestrial Radio Access (UTRAN); User Equipment (UE) procedures in idle mode and procedures for cell reselection in connected mode".
- [41] 3GPP TS 23.401: "General Packet Radio Service (GPRS) enhancements for Evolved Universal Terrestrial Radio Access Network (E-UTRAN) access".
- [42] 3GPP TS 36.101: "Evolved Universal Terrestrial Radio Access (E-UTRA); User Equipment (UE) radio transmission and reception".
- [43] 3GPP TS 45.005: "GSM/EDGE Radio transmission and reception".
- [44] 3GPP2 C.S0087-A v2.0: "E-UTRAN - cdma2000 HRPD Connectivity and Interworking Air Interface Specification"
- [45] 3GPP TS 44.018: "Mobile radio interface layer 3 specification; Radio Resource Control (RRC) protocol".
- [46] 3GPP TS 25.223: "Spreading and modulation (TDD)".
- [47] 3GPP TS 36.104: "Evolved Universal Terrestrial Radio Access (E-UTRA); Base Station (BS) radio transmission and reception".
- [48] 3GPP TS 36.214: "Evolved Universal Terrestrial Radio Access (E-UTRA); Physical layer - Measurements".
- [49] 3GPP TS 24.008: "Mobile radio interface layer 3 specification; Core network protocols; Stage 3".
- [50] 3GPP TS 45.010: "Radio subsystem synchronization".
- [51] 3GPP TS 23.272: "Circuit Switched Fallback in Evolved Packet System; Stage 2".
- [52] 3GPP TS 29.061: "Interworking between the Public Land Mobile Network (PLMN) supporting packet based services and Packet Data Networks (PDN)".
- [53] 3GPP2 C.S0097-0 v3.0: "E-UTRAN - cdma2000 1x Connectivity and Interworking Air Interface Specification".
- [54] 3GPP TS 36.355: "LTE Positioning Protocol (LPP)".
- [55] 3GPP TS 36.216: "Evolved Universal Terrestrial Radio Access (E-UTRA); Physical layer for relaying operation".
- [56] 3GPP TS 23.246: "Multimedia Broadcast/Multicast Service (MBMS); Architecture and functional description".
- [57] 3GPP TS 26.346: "Multimedia Broadcast/Multicast Service (MBMS); Protocols and codecs".
- [58] 3GPP TS 32.422: "Telecommunication management; Subscriber and equipment trace; Trace control and configuration management".
- [59] 3GPP TS 22.368: "Service Requirements for Machine Type Communications; Stage 1".
- [60] 3GPP TS 37.320: "Universal Terrestrial Radio Access (UTRA) and Evolved Universal Terrestrial Radio Access (E-UTRA); Radio measurement collection for Minimization of Drive Tests (MDT); Overall description; Stage 2".
- [61] 3GPP TS 23.216: "Single Radio Voice Call Continuity (SRVCC); Stage 2".
- [62] 3GPP TS 22.146: "Multimedia Broadcast/Multicast Service (MBMS); Stage 1".
- [63] 3GPP TR 36.816: "Evolved Universal Terrestrial Radio Access (E-UTRA); Study on signalling and procedure for interference avoidance for in-device coexistence".
- [64] IS-GPS-200F: "Navstar GPS Space Segment/Navigation User Segment Interfaces".

- [65] 3GPP TS 25.307: "Requirement on User Equipments (UEs) supporting a release-independent frequency band".
- [66] 3GPP TS 24.312: "Access Network Discovery and Selection Function (ANDSF) Management Object (MO)".
- [67] IEEE 802.11-2012, Part 11: Wireless LAN Medium Access Control (MAC) and Physical Layer (PHY) specifications, IEEE Std.
- [68] 3GPP TS 23.303: "Proximity-based services (ProSe); Stage 2".
- [69] 3GPP TS 24.334: "Proximity-services (ProSe) User Equipment (UE) to ProSe function protocol aspects; Stage 3".
- [70] 3GPP TS 24.333: "Proximity-services (ProSe) Management Objects (MO)".
- [71] 3GPP TS 36.314: "Evolved Universal Terrestrial Radio Access (E-UTRA); Layer 2-Measurements".
- [72] 3GPP TS 24.105: "Application specific Congestion control for Data Communication (ACDC) Management Object (MO)".
- [73] 3GPP TS 23.179: "Functional architecture and information flows to support mission critical communication services; Stage 2".
- [74] 3GPP TS 24.302: "Access to the 3GPP Evolved Packet Core (EPC) via non-3GPP access networks".
- [75] 3GPP TS 23.402: "Architecture enhancements for non-3GPP accesses; Stage-2".
- [76] Wi-Fi Alliance® Technical Committee, Hotspot 2.0 Technical Task Group Hotspot 2.0 (Release 2) Technical Specification Version 3.11.
- [77] 3GPP TS 22.101: "Service aspects; Service principles".
- [78] 3GPP TS 23.285: "Technical Specification Group Services and System Aspects; Architecture enhancements for V2X services".
- [79] 3GPP TS 36.307: "Evolved Universal Terrestrial Radio Access (E-UTRA); Requirements on User Equipments (UEs) supporting a release-independent frequency band".
- [80] Military Standard WGS84 Metric MIL-STD-2401 (11 January 1994): "Military Standard Department of Defence World Geodetic System (WGS)".

3 Definitions, symbols and abbreviations

3.1 Definitions

For the purposes of the present document, the terms and definitions given in TR 21.905 [1] and the following apply. A term defined in the present document takes precedence over the definition of the same term, if any, in TR 21.905 [1].

Anchor carrier: In NB-IoT, a carrier where the UE assumes that NPSS/NSSS/NPBCH/SIB-NB are transmitted.

Bandwidth Reduced: Refers to operation in downlink and uplink with a limited channel bandwidth of 6 PRBs.

Cellular IoT EPS Optimisation: Provides improved support of small data transfer, as defined in TS 24.301 [35].

Commercial Mobile Alert System: Public Warning System that delivers *Warning Notifications* provided by *Warning Notification Providers* to CMAS capable UEs.

Common access barring parameters: The common access barring parameters refer to the access class barring parameters that are broadcast in *SystemInformationBlockType2* outside the list of PLMN specific parameters (i.e. in *ac-BarringPerPLMN-List*).

Control plane CIoT EPS optimisation: Enables support of efficient transport of user data (IP, non-IP or SMS) over control plane via the MME without triggering data radio bearer establishment, as defined in TS 24.301 [35].

CSG member cell: A cell broadcasting the identity of the selected PLMN, registered PLMN or equivalent PLMN and for which the CSG whitelist of the UE includes an entry comprising cell's CSG ID and the respective PLMN identity.

Dual Connectivity: A UE in RRC_CONNECTED is configured with Dual Connectivity when configured with a Master and a Secondary Cell Group.

EU-Alert: Public Warning System that delivers Warning Notifications provided by Warning Notification Providers using the same AS mechanisms as defined for CMAS.

Field: The individual contents of an information element are referred as fields.

Floor: Mathematical function used to 'round down' i.e. to the nearest integer having a lower or equal value.

Information element: A structural element containing a single or multiple fields is referred as information element.

Korean Public Alert System (KPAS): Public Warning System that delivers Warning Notifications provided by Warning Notification Providers using the same AS mechanisms as defined for CMAS.

Master Cell Group: For a UE not configured with DC, the MCG comprises all serving cells. For a UE configured with DC, the MCG concerns a subset of the serving cells comprising of the PCell and zero or more secondary cells.

MBMS service: MBMS bearer service as defined in TS 23.246 [56] (i.e. provided via an MRB or an SC-MRB).

NB-IoT: NB-IoT allows access to network services via E-UTRA with a channel bandwidth limited to 200 kHz.

NB-IoT UE: A UE that uses NB-IoT.

NCSG: Network controlled small gap as defined in TS 36.133 [16].

Non-anchor carrier: In NB-IoT, a carrier where the UE does not assume that NPSS/NSSS/NPBCH/SIB-NB are transmitted.

Primary Cell: The cell, operating on the primary frequency, in which the UE either performs the initial connection establishment procedure or initiates the connection re-establishment procedure, or the cell indicated as the primary cell in the handover procedure.

Primary Secondary Cell: The SCG cell in which the UE is instructed to perform random access or initial PUSCH transmission if random access procedure is skipped when performing the SCG change procedure.

Primary Timing Advance Group: Timing Advance Group containing the PCell or the PSCell.

PUCCH SCell: An SCell configured with PUCCH.

Secondary Cell: A cell, operating on a secondary frequency, which may be configured once an RRC connection is established and which may be used to provide additional radio resources.

Secondary Cell Group: For a UE configured with DC, the subset of serving cells not part of the MCG, i.e. comprising of the PSCell and zero or more other secondary cells.

Secondary Timing Advance Group: Timing Advance Group neither containing the PCell nor the PSCell. A secondary timing advance group contains at least one cell with configured uplink.

Serving Cell: For a UE in RRC_CONNECTED not configured with CA/ DC there is only one serving cell comprising of the primary cell. For a UE in RRC_CONNECTED configured with CA/ DC the term 'serving cells' is used to denote the set of one or more cells comprising of the primary cell and all secondary cells.

Sidelink: UE to UE interface for sidelink communication, V2X sidelink communication and sidelink discovery. The sidelink corresponds to the PC5 interface as defined in TS 23.303 [68].

Sidelink communication: AS functionality enabling ProSe Direct Communication as defined in TS 23.303 [68], between two or more nearby UEs, using E-UTRA technology but not traversing any network node. In this version, the terminology "sidelink communication" without "V2X" prefix only concerns PS unless specifically stated otherwise.

Sidelink discovery: AS functionality enabling ProSe Direct Discovery as defined in TS 23.303 [68], using E-UTRA technology but not traversing any network node.

Sidelink operation: Includes sidelink communication, V2X sidelink communication and sidelink discovery.

UE in CE: Refers to a UE that is capable of using coverage enhancement, and requires coverage enhancement mode to access a cell or is configured in a coverage enhancement mode.

User plane CIoT EPS optimisation: Enables support for change from EMM-IDLE mode to EMM-CONNECTED mode without the need for using the Service Request procedure, as defined in TS 24.301 [35].

Timing Advance Group: A group of serving cells that is configured by RRC and that, for the cells with an UL configured, use the same timing reference cell and the same Timing Advance value. A Timing Advance Group only includes cells of the same cell group i.e. it either includes MCG cells or SCG cells.

V2X Sidelink communication: AS functionality enabling V2X Communication as defined in TS 23.285 [78], between nearby UEs, using E-UTRA technology but not traversing any network node.

3.2 Abbreviations

For the purposes of the present document, the abbreviations given in TR 21.905 [1], TS 36.300 [9] and the following apply. An abbreviation defined in the present document takes precedence over the definition of the same abbreviation, if any, in TR 21.905 [1] or TS 36.300 [9].

1xRTT	CDMA2000 1x Radio Transmission Technology
AB	Access Barring
ACDC	Application specific Congestion control for Data Communication
ACK	Acknowledgement
AM	Acknowledged Mode
ANDSF	Access Network Discovery and Selection Function
ARQ	Automatic Repeat Request
AS	Access Stratum
ASN.1	Abstract Syntax Notation One
BCCH	Broadcast Control Channel
BCD	Binary Coded Decimal
BCH	Broadcast Channel
BL	Bandwidth reduced Low complexity
BLER	Block Error Rate
BR	Bandwidth Reduced
BR-BCCH	Bandwidth Reduced Broadcast Control Channel
CA	Carrier Aggregation
CBR	Channel Busy Ratio
CCCH	Common Control Channel
CCO	Cell Change Order
CE	Coverage Enhancement
CG	Cell Group
CIoT	Cellular IoT
CMAS	Commercial Mobile Alert Service
CP	Control Plane
C-RNTI	Cell RNTI
CRS	Cell-specific Reference Signal
CSFB	CS fallback
CSG	Closed Subscriber Group
CSI	Channel State Information
DC	Dual Connectivity
DCCH	Dedicated Control Channel
DCI	Downlink Control Information
DCN	Dedicated Core Networks
DFN	Direct Frame Number
DL	Downlink
DL-SCH	Downlink Shared Channel
DRB	(user) Data Radio Bearer

DRX	Discontinuous Reception
DTCH	Dedicated Traffic Channel
EAB	Extended Access Barring
eDRX	Extended DRX
EHPLMN	Equivalent Home Public Land Mobile Network
eIMTA	Enhanced Interference Management and Traffic Adaptation
ENB	Evolved Node B
EPC	Evolved Packet Core
EPDCCH	Enhanced Physical Downlink Control Channel
EPS	Evolved Packet System
ETWS	Earthquake and Tsunami Warning System
E-UTRA	Evolved Universal Terrestrial Radio Access
E-UTRAN	Evolved Universal Terrestrial Radio Access Network
FDD	Frequency Division Duplex
FFS	For Further Study
GERAN	GSM/EDGE Radio Access Network
GNSS	Global Navigation Satellite System
G-RNTI	Group RNTI
GSM	Global System for Mobile Communications
HARQ	Hybrid Automatic Repeat Request
HFN	Hyper Frame Number
HPLMN	Home Public Land Mobile Network
HRPD	CDMA2000 High Rate Packet Data
H-SFN	Hyper SFN
IDC	In-Device Coexistence
IE	Information element
IMEI	International Mobile Equipment Identity
IMSI	International Mobile Subscriber Identity
IoT	Internet of Things
ISM	Industrial, Scientific and Medical
kB	Kilobyte (1000 bytes)
L1	Layer 1
L2	Layer 2
L3	Layer 3
LAA	Licensed-Assisted Access
LWA	LTE-WLAN Aggregation
LWAAP	LTE-WLAN Aggregation Adaptation Protocol
LWIP	LTE-WLAN Radio Level Integration with IPsec Tunnel
MAC	Medium Access Control
MBMS	Multimedia Broadcast Multicast Service
MBSFN	Multimedia Broadcast multicast service Single Frequency Network
MCG	Master Cell Group
MCPTT	Mission Critical Push To Talk
MDT	Minimization of Drive Tests
MIB	Master Information Block
MO	Mobile Originating
MPDCCH	MTC Physical Downlink Control Channel
MRB	MBMS Point to Multipoint Radio Bearer
MRO	Mobility Robustness Optimisation
MSI	MCH Scheduling Information
MT	Mobile Terminating
MUST	MultiUser Superposition Transmission
N/A	Not Applicable
NACC	Network Assisted Cell Change
NAICS	Network Assisted Interference Cancellation/Suppression
NAS	Non Access Stratum
NB-IoT	NarrowBand Internet of Things
NPBCH	Narrowband Physical Broadcast channel
NPDCCH	Narrowband Physical Downlink Control channel
NPDSCH	Narrowband Physical Downlink Shared channel
NPRACH	Narrowband Physical Random Access channel
NPSS	Narrowband Primary Synchronization Signal

NPUSCH	Narrowband Physical Uplink Shared channel
NRS	Narrowband Reference Signal
NSSS	Narrowband Secondary Synchronization Signal
P2X	Pedestrian-to-Everything
PCCH	Paging Control Channel
PCell	Primary Cell
PDCCH	Physical Downlink Control Channel
PDCP	Packet Data Convergence Protocol
PDU	Protocol Data Unit
PLMN	Public Land Mobile Network
PMK	Pairwise Master Key
ProSe	Proximity based Services
PS	Public Safety (in context of sidelink), Packet Switched (otherwise)
PSCell	Primary Secondary Cell
PSK	Pre-Shared Key
PTAG	Primary Timing Advance Group
PUCCH	Physical Uplink Control Channel
QCI	QoS Class Identifier
QoS	Quality of Service
RACH	Random Access CHannel
RAI	Release Assistance Indication
RAT	Radio Access Technology
RB	Radio Bearer
RCLWI	RAN Controlled LTE-WLAN Integration
RLC	Radio Link Control
RMTC	RSSI Measurement Timing Configuration
RN	Relay Node
RNTI	Radio Network Temporary Identifier
ROHC	RObust Header Compression
RPLMN	Registered Public Land Mobile Network
RRC	Radio Resource Control
RSCP	Received Signal Code Power
RSRP	Reference Signal Received Power
RSRQ	Reference Signal Received Quality
RSSI	Received Signal Strength Indicator
SAE	System Architecture Evolution
SAP	Service Access Point
SC	Sidelink Control
SCell	Secondary Cell
SCG	Secondary Cell Group
SC-MRB	Single Cell MRB
SC-RNTI	Single Cell RNTI
SD-RSRP	Sidelink Discovery Reference Signal Received Power
SFN	System Frame Number
SI	System Information
SIB	System Information Block
SI-RNTI	System Information RNTI
SL	Sidelink
SLSS	Sidelink Synchronisation Signal
SMC	Security Mode Control
SPS	Semi-Persistent Scheduling
SR	Scheduling Request
SRB	Signalling Radio Bearer
S-RSRP	Sidelink Reference Signal Received Power
SSAC	Service Specific Access Control
SSTD	SFN and Subframe Timing Difference
STAG	Secondary Timing Advance Group
S-TMSI	SAE Temporary Mobile Station Identifier
TA	Tracking Area
TAG	Timing Advance Group
TDD	Time Division Duplex
TDM	Time Division Multiplexing

TM	Transparent Mode
TPC-RNTI	Transmit Power Control RNTI
T-RPT	Time Resource Pattern of Transmission
TTT	Time To Trigger
UE	User Equipment
UICC	Universal Integrated Circuit Card
UL	Uplink
UL-SCH	Uplink Shared Channel
UM	Unacknowledged Mode
UP	User Plane
UTC	Coordinated Universal Time
UTRAN	Universal Terrestrial Radio Access Network
V2X	Vehicle-to-Everything
VoLTE	Voice over Long Term Evolution
WLAN	Wireless Local Area Network
WT	WLAN Termination

In the ASN.1, lower case may be used for some (parts) of the above abbreviations e.g. c-RNTI.

4 General

4.1 Introduction

In this specification, (parts of) procedures and messages specified for the UE equally apply to the RN for functionality necessary for the RN. There are also (parts of) procedures and messages which are only applicable to the RN in its communication with the E-UTRAN, in which case the specification denotes the RN instead of the UE. Such RN-specific aspects are not applicable to the UE.

NB-IoT is a non backward compatible variant of E-UTRAN supporting a reduced set of functionality. In this specification, (parts of) procedures and messages specified for the UE equally apply to the UE in NB-IoT. There are also some features and related procedures and messages that are not supported by UEs in NB-IoT.

In particular, the following features are not supported in NB-IoT and corresponding procedures and messages do not apply to the UE in NB-IoT:

- Connected mode mobility (Handover and measurement reporting);
- Inter-RAT cell reselection or inter-RAT mobility in connected mode;
- CSG;
- Relay Node (RN);
- Carrier Aggregation (CA);
- Dual connectivity (DC);
- GBR (QoS);
- ACB, EAB, SSAC and ACDC;
- MBMS, except for MBMS via SC-PTM in Idle mode;
- Self-configuration and self-optimisation;
- Measurement logging and reporting for network performance optimisation;
- Public warning systems e.g. CMAS, ETWS and PWS;
- Real time services (including emergency call);
- CS services and CS fallback;

- In-device coexistence;
- RAN assisted WLAN interworking;
- Network-assisted interference cancellation/suppression;
- Sidelink (including direct communication and direct discovery).

NOTE: In regard to mobility, NB-IoT is a separate RAT from E-UTRAN.

In this specification, there are also (parts of) procedures and messages which are only applicable to UEs in NB-IoT, in which case this is stated explicitly.

This specification is organised as follows:

- clause 4.2 describes the RRC protocol model;
- clause 4.3 specifies the services provided to upper layers as well as the services expected from lower layers;
- clause 4.4 lists the RRC functions;
- clause 5 specifies RRC procedures, including UE state transitions;
- clause 6 specifies the RRC message in a mixed format (i.e. tabular & ASN.1 together);
- clause 7 specifies the variables (including protocol timers and constants) and counters to be used by the UE;
- clause 8 specifies the encoding of the RRC messages;
- clause 9 specifies the specified and default radio configurations;
- clause 10 specifies the RRC messages transferred across network nodes;
- clause 11 specifies the UE capability related constraints and performance requirements.

4.2 Architecture

4.2.1 UE states and state transitions including inter RAT

A UE is in `RRC_CONNECTED` when an RRC connection has been established. If this is not the case, i.e. no RRC connection is established, the UE is in `RRC_IDLE` state. The RRC states can further be characterised as follows:

- **RRC_IDLE:**
 - A UE specific DRX may be configured by upper layers (not applicable for NB-IoT);
 - UE controlled mobility;
 - The UE:
 - Monitors a Paging channel to detect incoming calls, system information change, for ETWS capable UEs, ETWS notification, and for CMAS capable UEs, CMAS notification;
 - Performs neighbouring cell measurements and cell (re-)selection;
 - Acquires system information.
 - Performs logging of available measurements together with location and time for logged measurement configured UEs.
- **RRC_CONNECTED:**
 - Transfer of unicast data to/from UE.
 - At lower layers, the UE may be configured with a UE specific DRX.

- For UEs supporting CA, use of one or more SCells, aggregated with the PCell, for increased bandwidth;
- For UEs supporting DC, use of one SCG, aggregated with the MCG, for increased bandwidth;
- Network controlled mobility, i.e. handover and cell change order with optional network assistance (NACC) to GERAN (not applicable for NB-IoT);
- The UE:
 - Monitors a Paging channel and/ or System Information Block Type 1 contents to detect system information change, for ETWS capable UEs, ETWS notification, and for CMAS capable UEs, CMAS notification (not applicable for NB-IoT);
 - Monitors control channels associated with the shared data channel to determine if data is scheduled for it;
 - Provides channel quality and feedback information (not applicable for NB-IoT);
 - Performs neighbouring cell measurements and measurement reporting (not applicable for NB-IoT);
 - Acquires system information (not applicable for NB-IoT).

The following figure not only provides an overview of the RRC states in E-UTRA, but also illustrates the mobility support between E-UTRAN, UTRAN and GERAN.

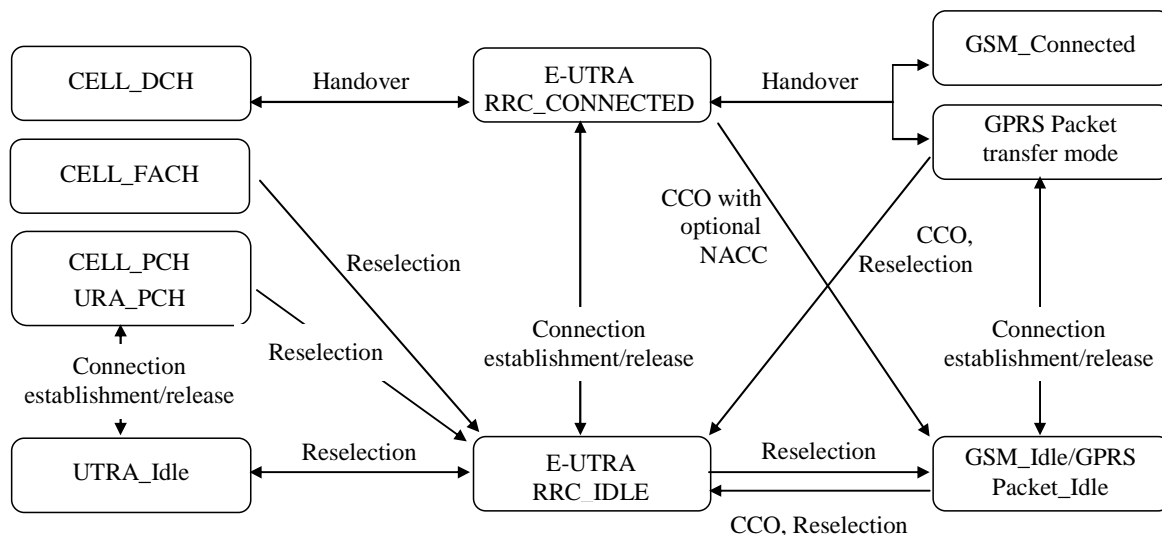

Figure 4.2.1-1: E-UTRA states and inter RAT mobility procedures, 3GPP

The following figure illustrates the mobility support between E-UTRAN, CDMA2000 1xRTT and CDMA2000 HRPD. The details of the CDMA2000 state models are out of the scope of this specification.

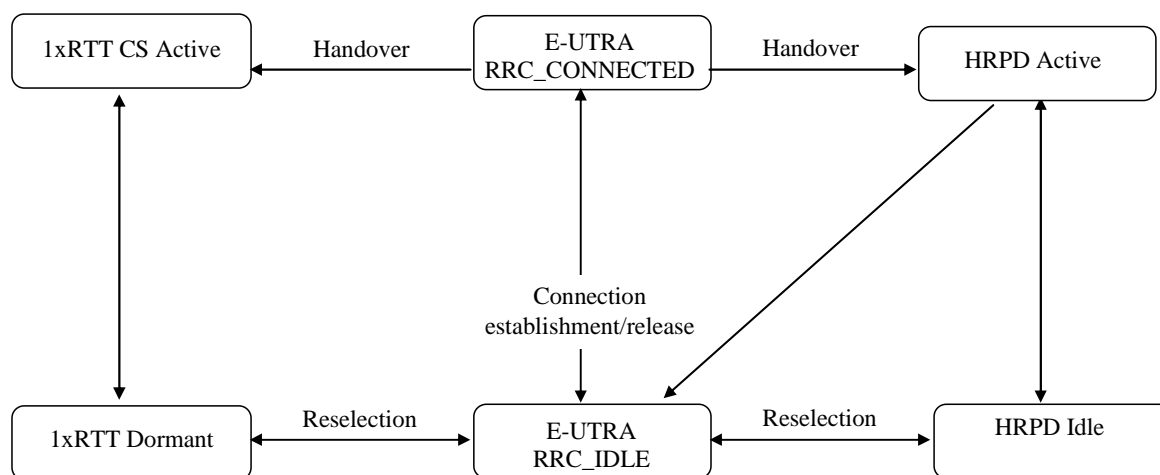

Figure 4.2.1-2: Mobility procedures between E-UTRA and CDMA2000

The inter-RAT handover procedure(s) supports the case of signalling, conversational services, non-conversational services and combinations of these.

In addition to the state transitions shown in Figure 4.2.1-1 and Figure 4.2.1-2, there is support for connection release with redirection information from E-UTRA RRC_CONNECTED to GERAN, UTRAN and CDMA2000 (HRPD Idle/ 1xRTT Dormant mode).

For NB-IoT, mobility between E-UTRA and UTRAN, GERAN and between E-UTRA and CDMA2000 1xRTT and CDMA2000 HRPD is not supported at AS level and hence only the E-UTRA states depicted in Figure 4.2.1-1 are applicable.

4.2.2 Signalling radio bearers

"Signalling Radio Bearers" (SRBs) are defined as Radio Bearers (RB) that are used only for the transmission of RRC and NAS messages. More specifically, the following SRBs are defined:

- SRB0 is for RRC messages using the CCCH logical channel;
- SRB1 is for RRC messages (which may include a piggybacked NAS message) as well as for NAS messages prior to the establishment of SRB2, all using DCCH logical channel;
- For NB-IoT, SRB1bis is for RRC messages (which may include a piggybacked NAS message) as well as for NAS messages prior to the activation of security, all using DCCH logical channel;
- SRB2 is for RRC messages which include logged measurement information as well as for NAS messages, all using DCCH logical channel. SRB2 has a lower-priority than SRB1 and is always configured by E-UTRAN after security activation. SRB2 is not applicable for NB-IoT.

In downlink piggybacking of NAS messages is used only for one dependant (i.e. with joint success/ failure) procedure: bearer establishment/ modification/ release. In uplink NAS message piggybacking is used only for transferring the initial NAS message during connection setup.

NOTE: The NAS messages transferred via SRB2 are also contained in RRC messages, which however do not include any RRC protocol control information.

Once security is activated, all RRC messages on SRB1 and SRB2, including those containing NAS or non-3GPP messages, are integrity protected and ciphered by PDCP. NAS independently applies integrity protection and ciphering to the NAS messages.

For a UE configured with DC, all RRC messages, regardless of the SRB used and both in downlink and uplink, are transferred via the MCG.

4.3 Services

4.3.1 Services provided to upper layers

The RRC protocol offers the following services to upper layers:

- Broadcast of common control information;
- Notification of UEs in RRC_IDLE, e.g. about a terminating call, for ETWS, for CMAS;
- Transfer of dedicated control information, i.e. information for one specific UE.

4.3.2 Services expected from lower layers

In brief, the following are the main services that RRC expects from lower layers:

- PDCP: integrity protection and ciphering;
- RLC: reliable and in-sequence transfer of information, without introducing duplicates and with support for segmentation and concatenation.

Further details about the services provided by Packet Data Convergence Protocol layer (e.g. integrity and ciphering) are provided in TS 36.323 [8]. The services provided by Radio Link Control layer (e.g. the RLC modes) are specified in TS 36.322 [7]. Further details about the services provided by Medium Access Control layer (e.g. the logical channels) are provided in TS 36.321 [6]. The services provided by physical layer (e.g. the transport channels) are specified in TS 36.302 [3].

4.4 Functions

The RRC protocol includes the following main functions:

- Broadcast of system information:
 - Including NAS common information;
 - Information applicable for UEs in RRC_IDLE, e.g. cell (re-)selection parameters, neighbouring cell information and information (also) applicable for UEs in RRC_CONNECTED, e.g. common channel configuration information.
 - Including ETWS notification, CMAS notification (not applicable for NB-IoT);
- RRC connection control:
 - Paging;
 - Establishment/ modification/ suspension / resumption / release of RRC connection, including e.g. assignment/ modification of UE identity (C-RNTI), establishment/ modification/ release of SRB1, SRB1bis and SRB2, access class barring;
 - Initial security activation, i.e. initial configuration of AS integrity protection (SRBs) and AS ciphering (SRBs, DRBs);
 - For RNs, configuration of AS integrity protection for DRBs;
 - RRC connection mobility including e.g. intra-frequency and inter-frequency handover, associated security handling, i.e. key/ algorithm change, specification of RRC context information transferred between network nodes;

NOTE 1: In NB-IoT, only key change (but no re-keying) at RRC Connection Resumption and RRC context information transfer are applicable.

- Establishment/ modification/ release of RBs carrying user data (DRBs);

- Radio configuration control including e.g. assignment/ modification of ARQ configuration, HARQ configuration, DRX configuration;
- For RNs, RN-specific radio configuration control for the radio interface between RN and E-UTRAN;
- In case of CA, cell management including e.g. change of PCell, addition/ modification/ release of SCell(s) and addition/modification/release of STAG(s);
- In case of DC, cell management including e.g. change of PSCell, addition/ modification/ release of SCG cell(s) and addition/modification/release of SCG TAG(s).
- QoS control including assignment/ modification of semi-persistent scheduling (SPS) configuration information for DL and UL, assignment/ modification of parameters for UL rate control in the UE, i.e. allocation of a priority and a prioritised bit rate (PBR) for each RB (not applicable for NB-IoT);
- Recovery from radio link failure;
- In case of LWA, RCLWI and LWIP, WLAN mobility set management including e.g. addition/ modification/ release of WLAN(s) from the WLAN mobility set;
- Inter-RAT mobility including e.g. security activation, transfer of RRC context information (not applicable for NB-IoT);
- Measurement configuration and reporting (not applicable for NB-IoT):
 - Establishment/ modification/ release of measurements (e.g. intra-frequency, inter-frequency and inter- RAT measurements);
 - Setup and release of measurement gaps;
 - Measurement reporting;
- Other functions including e.g. transfer of dedicated NAS information and non-3GPP dedicated information, transfer of UE radio access capability information, support for E-UTRAN sharing (multiple PLMN identities);
- Generic protocol error handling;
- Support of self-configuration and self-optimisation (not applicable for NB-IoT);
- Support of measurement logging and reporting for network performance optimisation [60] (not applicable for NB-IoT);

NOTE 2: Random access is specified entirely in the MAC including initial transmission power estimation.

4.5 Data available for transmission for NB-IoT

For the purpose of MAC Data Volume and Power Headroom reporting, the NB-IoT UE shall consider the following as data available for transmission in the RRC layer:

- For SDUs to be submitted to lower layers:
 - the SDU itself, if the SDU has not yet been processed by RRC, or
 - the PDU if the SDU has been processed by RRC; or
- The data available for transmission in upper layers not submitted to the RRC layer.

5 Procedures

5.1 General

5.1.1 Introduction

The procedural requirements are structured according to the main functional areas: system information (5.2), connection control (5.3), inter-RAT mobility (5.4) and measurements (5.5). In addition, clause 5.6 covers other aspects e.g. NAS dedicated information transfer, UE capability transfer, clause 5.7 specifies the generic error handling, clause 5.8 covers MBMS (i.e. MBMS service reception via MRB), clause 5.8a covers SC-PTM (i.e. MBMS service reception via SC-MRB), clause 5.9 covers RN-specific procedures and clause 5.10 covers sidelink.

For NB-IoT, only a subset of the above procedural requirements applies: system information (5.2), connection control (5.3), some part of other aspects (5.6), general error handling (5.7), and SC-PTM (5.8a). Clauses inter-RAT mobility (5.4), measurements (5.5), MBMS (5.8), RN procedures (5.9) and Sidelink (5.10) are not applicable in NB-IoT.

5.1.2 General requirements

The UE shall:

- 1> process the received messages in order of reception by RRC, i.e. the processing of a message shall be completed before starting the processing of a subsequent message;

NOTE 1: E-UTRAN may initiate a subsequent procedure prior to receiving the UE's response of a previously initiated procedure.

- 1> within a clause execute the steps according to the order specified in the procedural description;
- 1> consider the term 'radio bearer' (RB) to cover SRBs and DRBs but not MRBs or SC-MRBs unless explicitly stated otherwise;
- 1> set the *rrc-TransactionIdentifier* in the response message, if included, to the same value as included in the message received from E-UTRAN that triggered the response message;
- 1> upon receiving a choice value set to *setup*:
 - 2> apply the corresponding received configuration and start using the associated resources, unless explicitly specified otherwise;

- 1> upon receiving a choice value set to *release*:

- 2> clear the corresponding configuration and stop using the associated resources;

NOTE 1a: Following receipt of choice value set to release, the UE considers the field as if it was never configured.

- 1> upon handover to E-UTRA; or

- 1> upon receiving an *RRCConnectionReconfiguration* message including the *fullConfig*:

- 2> apply the Conditions in the ASN.1 for inclusion of the fields for the DRB/PDCP/RLC setup during the reconfiguration of the DRBs included in the *drb-ToAddModList*;

NOTE 2: At each point in time, the UE keeps a single value for each field except for during handover when the UE temporarily stores the previous configuration so it can revert back upon handover failure. In other words: when the UE reconfigures a field, the existing value is released except for during handover.

NOTE 3: Although not explicitly stated, the UE initially considers all functionality to be deactivated/ released until it is explicitly stated that the functionality is setup/ activated. Correspondingly, the UE initially considers lists to be empty e.g. the list of radio bearers, the list of measurements.

- 1> upon receiving an extension field comprising the entries in addition to the ones carried by the original field (regardless of whether E-UTRAN may signal more entries in total); apply the following generic behaviour if explicitly stated to be applicable:
 - 2> create a combined list by concatenating the additional entries included in the extension field to the original field while maintaining the order among both the original and the additional entries;
 - 2> for the combined list, created according to the previous, apply the same behaviour as defined for the original field;

NOTE 4: A field comprising a list of entries normally includes 'list' in the field name. The typical way to extend (the size of) such a list is to introduce a field comprising the additional entries, which should include 'listExt' in the name of the field/ IE. E.g. *field1List-RAT*, *field1ListExt-RAT*.

5.2 System information

5.2.1 Introduction

5.2.1.1 General

System information is divided into the *MasterInformationBlock* (MIB) and a number of *SystemInformationBlocks* (SIBs). The MIB includes a limited number of most essential and most frequently transmitted parameters that are needed to acquire other information from the cell, and is transmitted on BCH. SIBs other than *SystemInformationBlockType1* are carried in *SystemInformation* (SI) messages and mapping of SIBs to SI messages is flexibly configurable by *schedulingInfoList* included in *SystemInformationBlockType1*, with restrictions that: each SIB is contained only in a single SI message, and at most once in that message; only SIBs having the same scheduling requirement (periodicity) can be mapped to the same SI message; *SystemInformationBlockType2* is always mapped to the SI message that corresponds to the first entry in the list of SI messages in *schedulingInfoList*. There may be multiple SI messages transmitted with the same periodicity. *SystemInformationBlockType1* and all SI messages are transmitted on DL-SCH.

The Bandwidth reduced Low Complexity (BL) UEs and UEs in Coverage Enhancement (CE) apply Bandwidth Reduced (BR) version of the SIB or SI messages. A UE considers itself in enhanced coverage as specified in TS 36.304 [4]. In this and subsequent clauses, anything applicable for a particular SIB or SI message equally applies to the corresponding BR version unless explicitly stated otherwise.

For NB-IoT, a reduced set of system information block with similar functionality but different content is defined; the UE applies the NB-IoT (NB) version of the MIB and the SIBs. These are denoted *MasterInformationBlock-NB* and *SystemInformationBlockTypeX-NB* in this specification. All other system information blocks (without NB suffix) are not applicable to NB-IoT; this is not further stated in the corresponding text.

NOTE 1: The physical layer imposes a limit to the maximum size a SIB can take. When DCI format 1C is used the maximum allowed by the physical layer is 1736 bits (217 bytes) while for format 1A the limit is 2216 bits (277 bytes), see TS 36.212 [22] and TS 36.213 [23]. For BL UEs and UEs in CE, the maximum SIB and SI message size is 936 bits, see TS 36.213 [23]. For NB-IoT, the maximum SIB and SI message size is 680 bits, see TS 36.213 [23].

In addition to broadcasting, E-UTRAN may provide *SystemInformationBlockType1* and/or *SystemInformationBlockType2*, including the same parameter values, via dedicated signalling i.e., within an *RRCConnectionReconfiguration* message.

The UE applies the system information acquisition and change monitoring procedures for the PCell, except when being a BL UE or a UE in CE or a NB-IoT UE in RRC_CONNECTED mode while T311 is not running. For an SCell, E-UTRAN provides, via dedicated signalling, all system information relevant for operation in RRC_CONNECTED when adding the SCell. However, a UE that is configured with DC shall acquire the *MasterInformationBlock* of the PCell but use it only to determine the SFN timing of the SCG, which may be different from the MCG. Upon change of the relevant system information of a configured SCell, E-UTRAN releases and subsequently adds the concerned SCell, which may be done with a single *RRCConnectionReconfiguration* message. If the UE is receiving or interested to receive an MBMS service in a cell, the UE shall apply the system information acquisition and change monitoring procedure to acquire parameters relevant for MBMS operation and apply the parameters acquired from system information only for MBMS operation for this cell.

NOTE 2: E-UTRAN may configure via dedicated signalling different parameter values than the ones broadcast in the concerned SCell.

In MBMS-dedicated cell, non-MBSFN subframes are used for providing *MasterInformationBlock-MBMS* (MIB-MBMS) and *SystemInformationBlockType1-MBMS*. SIBs other than *SystemInformationBlockType1-MBMS* are carried in *SystemInformation-MBMS* message which is also provided on non-MBSFN subframes.

An RN configured with an RN subframe configuration does not need to apply the system information acquisition and change monitoring procedures. Upon change of any system information relevant to an RN, E-UTRAN provides the system information blocks containing the relevant system information to an RN configured with an RN subframe configuration via dedicated signalling using the *RNReconfiguration* message. For RNs configured with an RN subframe configuration, the system information contained in this dedicated signalling replaces any corresponding stored system information and takes precedence over any corresponding system information acquired through the system information acquisition procedure. The dedicated system information remains valid until overridden.

NOTE 3: E-UTRAN may configure an RN, via dedicated signalling, with different parameter values than the ones broadcast in the concerned cell.

5.2.1.2 Scheduling

The MIB uses a fixed schedule with a periodicity of 40 ms and repetitions made within 40 ms. The first transmission of the MIB is scheduled in subframe #0 of radio frames for which the SFN mod 4 = 0, and repetitions are scheduled in subframe #0 of all other radio frames. For TDD/FDD system with a bandwidth larger than 1.4 MHz that supports BL UEs or UEs in CE, MIB transmission may additionally be repeated in subframe#0 of the same radio frame, and in subframe#9 of the previous radio frame for FDD and subframe #5 of the same radio frame for TDD.

NOTE: The UE may assume the scheduling of MIB repetitions does not change. E-UTRAN may indicate in *MobilityControlInfo* whether optional MIB repetitions are enabled or not.

The MIB-MBMS uses a fixed schedule with a periodicity of 160 ms and repetitions made within 160 ms. The first transmission of the MIB-MBMS is scheduled in subframe #0 of radio frames for which the SFN mod 16 = 0, and repetitions are scheduled in subframe #0 of all other radio frames for which the SFN mod 4 = 0.

The *SystemInformationBlockType1* uses a fixed schedule with a periodicity of 80 ms and repetitions made within 80 ms. The first transmission of *SystemInformationBlockType1* is scheduled in subframe #5 of radio frames for which the SFN mod 8 = 0, and repetitions are scheduled in subframe #5 of all other radio frames for which SFN mod 2 = 0.

For BL UEs or UEs in CE, MIB is applied which may be provided with additional repetitions, while for SIB1 and further SI messages, separate messages are used which are scheduled independently and with content that may differ. The separate instance of SIB1 is named as *SystemInformationBlockType1-BR*. The *SystemInformationBlockType1-BR* uses a schedule with a periodicity of 80ms. TBS for *SystemInformationBlockType1-BR* and the repetitions made within 80ms are indicated via *schedulingInfoSIB1-BR* in MIB or optionally in the *RRCConnectionReconfiguration* message including the *MobilityControlInfo*.

The *SystemInformationBlockType1-MBMS* uses fixed schedule with a periodicity of 160 ms. The first transmission of *SystemInformationBlockType1-MBMS* is scheduled in subframe #0 of radio frames for which the SFN mod 16 = 0, and repetitions are scheduled in subframe #0 of all other radio frames for which SFN mod 8 = 0. Additionally, the *SystemInformationBlockType1-MBMS* and other system informations blocks may be scheduled in additional non-MBSFN subframes indicated in *MasterInformationBlock-MBMS*.

The SI messages are transmitted within periodically occurring time domain windows (referred to as SI-windows) using dynamic scheduling. Each SI message is associated with a SI-window and the SI-windows of different SI messages do not overlap. That is, within one SI-window only the corresponding SI is transmitted. The length of the SI-window is common for all SI messages, and is configurable. Within the SI-window, the corresponding SI message can be transmitted a number of times in any subframe other than MBSFN subframes, uplink subframes in TDD, and subframe #5 of radio frames for which SFN mod 2 = 0. The UE acquires the detailed time-domain scheduling (and other information, e.g. frequency-domain scheduling, used transport format) from decoding SI-RNTI on PDCCH (see TS 36.321 [6]). For a BL UE or a UE in CE, the detailed time/frequency domain scheduling information for the SI messages is provided in *SystemInformationBlockType1-BR*.

For UEs other than BL UE or UEs in CE SI-RNTI is used to address *SystemInformationBlockType1* as well as all SI messages. On MBMS-dedicated cell and on FeMBMS/Unicast-mixed cell, SI-RNTI with value in accordance with TS 36.321 [6] is used to address all SI messages whereas SI-RNTI with value in accordance with TS 36.321 [6] is used to address *SystemInformationBlockType1-MBMS*.

SystemInformationBlockType1 configures the SI-window length and the transmission periodicity for the SI messages.

5.2.1.2a Scheduling for NB-IoT

The *MasterInformationBlock-NB* (MIB-NB) uses a fixed schedule with a periodicity of 640 ms and repetitions made within 640 ms. The first transmission of the MIB-NB is scheduled in subframe #0 of radio frames for which the SFN mod 64 = 0 and repetitions are scheduled in subframe #0 of all other radio frames. The transmissions are arranged in 8 independently decodable blocks of 80 ms duration.

The *SystemInformationBlockType1-NB* (SIB1-NB) uses a fixed schedule with a periodicity of 2560 ms. SIB1-NB transmission occurs in subframe #4 of every other frame in 16 continuous frames. The starting frame for the first transmission of the SIB1-NB is derived from the cell PCID and the number of repetitions within the 2560 ms period and repetitions are made, equally spaced, within the 2560 ms period (see TS 36.213 [23]). TBS for *SystemInformationBlockType1-NB* and the repetitions made within the 2560 ms are indicated by *schedulingInfoSIB1* field in the MIB-NB.

The SI messages are transmitted within periodically occurring time domain windows (referred to as SI-windows) using scheduling information provided in *SystemInformationBlockType1-NB*. Each SI message is associated with a SI-window and the SI-windows of different SI messages do not overlap. That is, within one SI-window only the corresponding SI is transmitted. The length of the SI-window is common for all SI messages, and is configurable.

Within the SI-window, the corresponding SI message can be transmitted a number of times over 2 or 8 consecutive NB-IoT downlink subframes depending on TBS. The UE acquires the detailed time/frequency domain scheduling information and other information, e.g. used transport format for the SI messages from *schedulingInfoList* field in *SystemInformationBlockType1-NB*. The UE is not required to accumulate several SI messages in parallel but may need to accumulate a SI message across multiple SI windows, depending on coverage condition.

SystemInformationBlockType1-NB configures the SI-window length and the transmission periodicity for all SI messages.

5.2.1.3 System information validity and notification of changes

Change of system information (other than for ETWS, CMAS and EAB parameters and other than for AB parameters for NB-IoT) only occurs at specific radio frames, i.e. the concept of a modification period is used. System information may be transmitted a number of times with the same content within a modification period, as defined by its scheduling. The modification period boundaries are defined by SFN values for which SFN mod $m=0$, where m is the number of radio frames comprising the modification period. The modification period is configured by system information. If H-SFN is provided in *SystemInformationBlockType1-BR*, modification period boundaries for BL UEs and UEs in CE are defined by SFN values for which $(H-SFN * 1024 + SFN) \bmod m=0$. For NB-IoT, H-SFN is always provided and the modification period boundaries are defined by SFN values for which $(H-SFN * 1024 + SFN) \bmod m=0$.

To enable system information update notification for RRC_IDLE UEs configured to use a DRX cycle longer than the modification period, an eDRX acquisition period is defined. The boundaries of the eDRX acquisition period are determined by H-SFN values for which H-SFN mod 256 = 0. For NB-IoT, the boundaries of the eDRX acquisition period are determined by H-SFN values for which H-SFN mod 1024 = 0.

NOTE 1: If the UE in RRC_IDLE is configured to use extended DRX cycle, e.g., in the order of several minutes or longer, in case the eNB is reset the UE SFN may not be synchronized to the new eNB SFN. The UE is expected to recover, e.g., acquire MIB within a reasonable time, to avoid repeated paging failures.

When the network changes (some of the) system information, it first notifies the UEs about this change, i.e. this may be done throughout a modification period. In the next modification period, the network transmits the updated system information. These general principles are illustrated in figure 5.2.1.3-1, in which different colours indicate different system information. Upon receiving a change notification, the UE not configured to use a DRX cycle that is longer than the modification period acquires the new system information immediately from the start of the next modification period. Upon receiving a change notification applicable to eDRX, a UE in RRC_IDLE configured to use a DRX cycle that is longer than the modification period acquires the updated system information immediately from the start of the next eDRX acquisition period. The UE applies the previously acquired system information until the UE acquires the new system information. The possible boundaries of modification for *SystemInformationBlockType1-BR* are defined by SFN values for which SFN mod 512 = 0 except for notification of ETWS/CMAS for which the eNB may change *SystemInformationBlockType1-BR* content at any time. For NB-IoT, the possible boundaries of modification for *SystemInformationBlockType1-NB* are defined by SFN values for which $(H-SFN * 1024 + SFN) \bmod 4096 = 0$.

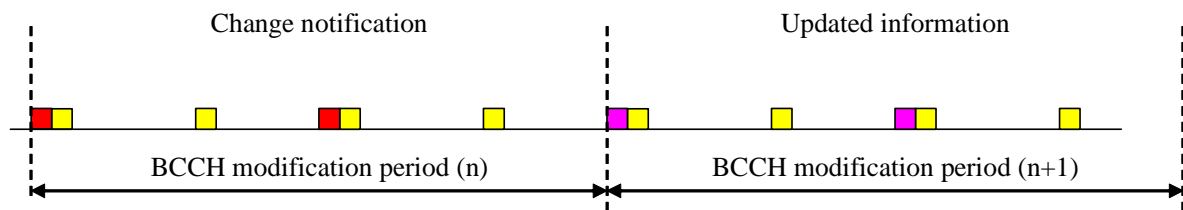

Figure 5.2.1.3-1: Change of system Information

The *Paging* message is used to inform UEs in RRC_IDLE and UEs in RRC_CONNECTED about a system information change. If the UE is in RRC_CONNECTED or is not configured to use a DRX cycle longer than the modification period in RRC_IDLE, and receives a *Paging* message including the *systemInfoModification*, it knows that the system information will change at the next modification period boundary. A UE in RRC_IDLE that is configured to use a DRX cycle longer than the modification period, and receives in an eDRX acquisition period at least one *Paging* message including the *systemInfoModification-eDRX*, shall acquire the updated system information at the next eDRX acquisition period boundary. Although the UE may be informed about changes in system information, no further details are provided e.g. regarding which system information will change, except if *systemInfoValueTagSI* is received by BL UEs or UEs in CE.

In RRC_CONNECTED, BL UEs or UEs in CE or NB-IoT UEs are not required to acquire system information except when T311 is running or upon handover where the UE is only required to acquire the *MasterInformationBlock* in the target PCell. In RRC_IDLE, E-UTRAN may notify BL UEs or UEs in CE or NB-IoT UEs about SI update, and except for NB-IoT, ETWS and CMAS notification and EAB modification, using Direct Indication information, as specified in 6.6 (or 6.7.5 in NB-IoT) and TS 36.212 [22].

NOTE 2: Upon system information change essential for BL UEs, UEs in CE, or NB-IoT UEs in RRC_CONNECTED, E-UTRAN may initiate connection release.

SystemInformationBlockType1 (or *MasterInformationBlock-NB* in NB-IoT) includes a value tag *systemInfoValueTag*, that indicates if a change has occurred in the SI messages. UEs may use *systemInfoValueTag*, e.g. upon return from out of coverage, to verify if the previously stored SI messages are still valid. Additionally, for other than BL UEs or UEs in CE or NB-IoT UEs, the UE considers stored system information to be invalid after 3 hours from the moment it was successfully confirmed as valid, unless specified otherwise. BL UE or UE in CE considers stored system information to be invalid after 24 hours from the moment it was successfully confirmed as valid, unless the UE is configured by parameter *si-ValidityTime* to consider stored system information to be invalid 3 hours after validity confirmation. NB-IoT UE considers stored system information to be invalid after 24 hours from the moment it was successfully confirmed as valid. If a BL UE, UE in CE or NB-IoT UE in RRC_CONNECTED state considers the stored system information invalid, the UE shall continue using the stored system information while in RRC_CONNECTED state in the serving cell.

For BL UEs or UEs in CE or NB-IoT UEs, the change of specific SI message can additionally be indicated by a SI message specific value tag *systemInfoValueTagSI*. If *systemInfoValueTag* included in the *SystemInformationBlockType1-BR* (or *MasterInformationBlock-NB* in NB-IoT) is different from the one of the stored system information and if *systemInfoValueTagSI* is included in the *SystemInformationBlockType1-BR* (or *SystemInformationBlockType1-NB* in NB-IoT) for a specific SI message and is different from the stored one, the UE shall consider this specific SI message to be invalid. If only *systemInfoValueTag* is included and is different from the stored one, the BL UE or UE in CE should consider any stored system information except *SystemInformationBlockType10*, *SystemInformationBlockType11*, *SystemInformationBlockType12* and *SystemInformationBlockType14* to be invalid; the NB-IoT UE should consider any stored system information except *SystemInformationBlockType14-NB* to be invalid.

On MBMS-dedicated cell and on FeMBMS/Unicast-mixed cell, the change of system information and ETWS/CMAS notification is indicated by using Direct Indication FeMBMS defined in 6.6a. The modification periodicity follows MCCH modification periodicity as defined in 5.8.1.3.

E-UTRAN may not update *systemInfoValueTag* upon change of some system information e.g. ETWS information, CMAS information, regularly changing parameters like time information (*SystemInformationBlockType8*, *SystemInformationBlockType16*, *hyperSFN-MSB* in *SystemInformationBlockType1-NB*), EAB and AB parameters. Similarly, E-UTRAN may not include the *systemInfoModification* within the *Paging* message upon change of some system information.

The UE that is not configured to use a DRX cycle longer than the modification period verifies that stored system information remains valid by either checking *systemInfoValueTag* in *SystemInformationBlockType1* (or *MasterInformationBlock-NB* in NB-IoT) after the modification period boundary, or attempting to find the *systemInfoModification* indication at least *modificationPeriodCoeff* times during the modification period in case no paging is received, in every modification period. If no paging message is received by the UE during a modification period, the UE may assume that no change of system information will occur at the next modification period boundary. If UE in RRC_CONNECTED, during a modification period, receives one paging message, it may deduce from the presence/ absence of *systemInfoModification* whether a change of system information other than ETWS information, CMAS information and EAB parameters will occur in the next modification period or not.

When the RRC_IDLE UE is configured with a DRX cycle that is longer than the modification period, and at least one modification period boundary has passed since the UE last verified validity of stored system information, the UE verifies that stored system information remains valid by checking the *systemInfoValueTag* before establishing or resuming an RRC connection.

ETWS and/or CMAS capable UEs in RRC_CONNECTED, other than BL UEs and UEs in CE, shall attempt to read paging at least once every *defaultPagingCycle* to check whether ETWS and/or CMAS notification is present or not.

5.2.1.4 Indication of ETWS notification

ETWS primary notification and/ or ETWS secondary notification can occur at any point in time. The *Paging* message is used to inform ETWS capable UEs in RRC_IDLE and UEs in RRC_CONNECTED about presence of an ETWS primary notification and/ or ETWS secondary notification. If the UE receives a *Paging* message including the *etws-Indication*, it shall start receiving the ETWS primary notification and/ or ETWS secondary notification according to *schedulingInfoList* contained in *SystemInformationBlockType1*. If the UE receives *Paging* message including the *etws-Indication* while it is acquiring ETWS notification(s), the UE shall continue acquiring ETWS notification(s) based on the previously acquired *schedulingInfoList* until it re-acquires *schedulingInfoList* in *SystemInformationBlockType1*.

NOTE: The UE is not required to periodically check *schedulingInfoList* contained in *SystemInformationBlockType1*, but *Paging* message including the *etws-Indication* triggers the UE to re-acquire *schedulingInfoList* contained in *SystemInformationBlockType1* for scheduling changes for *SystemInformationBlockType10* and *SystemInformationBlockType11*. The UE may or may not receive a *Paging* message including the *etws-Indication* and/ or *systemInfoModification* when ETWS is no longer scheduled.

ETWS primary notification is contained in *SystemInformationBlockType10* and ETWS secondary notification is contained in *SystemInformationBlockType11*. Segmentation can be applied for the delivery of a secondary notification. The segmentation is fixed for transmission of a given secondary notification within a cell (i.e. the same segment size for a given segment with the same *messageIdentifier*, *serialNumber* and *warningMessageSegmentNumber*). An ETWS secondary notification corresponds to a single *CB data* IE as defined according to TS 23.041 [37].

5.2.1.5 Indication of CMAS notification

CMAS notification can occur at any point in time. The *Paging* message is used to inform CMAS capable UEs in RRC_IDLE and UEs in RRC_CONNECTED about presence of one or more CMAS notifications. If the UE receives a *Paging* message including the *cmas-Indication*, it shall start receiving the CMAS notifications according to *schedulingInfoList* contained in *SystemInformationBlockType1*. If the UE receives *Paging* message including the *cmas-Indication* while it is acquiring CMAS notification(s), the UE shall continue acquiring CMAS notification(s) based on the previously acquired *schedulingInfoList* until it re-acquires *schedulingInfoList* in *SystemInformationBlockType1*.

NOTE: The UE is not required to periodically check *schedulingInfoList* contained in *SystemInformationBlockType1*, but *Paging* message including the *cmas-Indication* triggers the UE to re-acquire *schedulingInfoList* contained in *SystemInformationBlockType1* for scheduling changes for *SystemInformationBlockType12*. The UE may or may not receive a *Paging* message including the *cmas-Indication* and/ or *systemInfoModification* when *SystemInformationBlockType12* is no longer scheduled.

CMAS notification is contained in *SystemInformationBlockType12*. Segmentation can be applied for the delivery of a CMAS notification. The segmentation is fixed for transmission of a given CMAS notification within a cell (i.e. the same segment size for a given segment with the same *messageIdentifier*, *serialNumber* and *warningMessageSegmentNumber*). E-UTRAN does not interleave transmissions of CMAS notifications, i.e. all segments of a given CMAS notification transmission are transmitted prior to those of another CMAS notification. A CMAS notification corresponds to a single *CB data* IE as defined according to TS 23.041 [37].

5.2.1.6 Notification of EAB parameters change

Change of EAB parameters can occur at any point in time. The EAB parameters are contained in *SystemInformationBlockType14*. The *Paging* message is used to inform EAB capable UEs in RRC_IDLE about a change of EAB parameters or that *SystemInformationBlockType14* is no longer scheduled. If the UE receives a *Paging* message including the *eab-ParamModification*, it shall acquire *SystemInformationBlockType14* according to *schedulingInfoList* contained in *SystemInformationBlockType1*. If the UE receives a *Paging* message including the *eab-ParamModification* while it is acquiring *SystemInformationBlockType14*, the UE shall continue acquiring *SystemInformationBlockType14* based on the previously acquired *schedulingInfoList* until it re-acquires *schedulingInfoList* in *SystemInformationBlockType1*.

NOTE: The EAB capable UE is not expected to periodically check *schedulingInfoList* contained in *SystemInformationBlockType1*.

5.2.1.7 Access Barring parameters change in NB-IoT

Change of Access Barring (AB) parameters can occur at any point in time. The AB parameters are contained in *SystemInformationBlockType14-NB*. Update of the AB parameters does not impact the *systemInfoValueTag* in the *MasterInformationBlock-NB* or the *systemInfoValueTagSI* in *SystemInformationBlockType1-NB*.

A NB-IoT UE checks *ab-Enabled* indication in the *MasterInformationBlock-NB* to know whether access barring is enabled. If access barring is enabled the UE shall not initiate the RRC connection establishment / resume for all access causes except mobile terminating calls until the UE has a valid version of *SystemInformationBlockType14-NB*.

5.2.2 System information acquisition

5.2.2.1 General

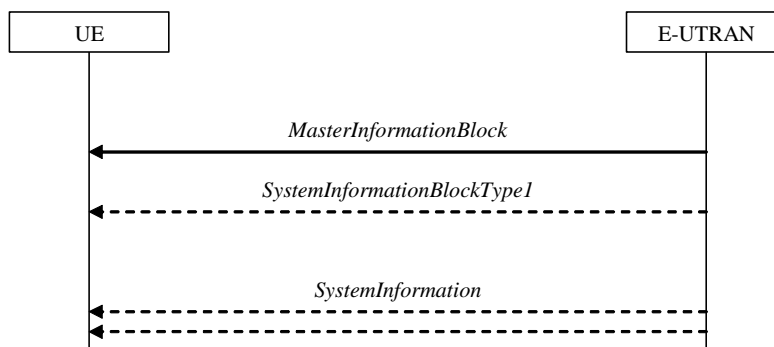

Figure 5.2.2.1-1: System information acquisition, normal

The UE applies the system information acquisition procedure to acquire the AS- and NAS- system information that is broadcasted by the E-UTRAN. The procedure applies to UEs in RRC_IDLE and UEs in RRC_CONNECTED.

For BL UE, UE in CE and NB-IoT UE, specific conditions apply, as specified below.

5.2.2.2 Initiation

The UE shall apply the system information acquisition procedure upon selecting (e.g. upon power on) and upon re-selecting a cell, after handover completion, after entering E-UTRA from another RAT, upon return from out of coverage, upon receiving a notification that the system information has changed, upon receiving an indication about the presence of an ETWS notification, upon receiving an indication about the presence of a CMAS notification, upon receiving a notification that the EAB parameters have changed, upon receiving a request from CDMA2000 upper layers and upon exceeding the maximum validity duration. Unless explicitly stated otherwise in the procedural specification, the system information acquisition procedure overwrites any stored system information, i.e. delta configuration is not applicable for system information and the UE discontinues using a field if it is absent in system information unless explicitly specified otherwise.

In RRC_CONNECTED, BL UEs and UEs in CE are required to acquire system information when T311 is running or upon handover where the UE is only required to acquire the *MasterInformationBlock* in the target PCell.

NOTE: Upon handover, E-UTRAN provides system information required by the UE in RRC_CONNECTED except MIB with RRC signalling, i.e. *systemInformationBlockType1Dedicated* and *mobilityControlInfo*.

5.2.2.3 System information required by the UE

The UE shall:

- 1> ensure having a valid version, as defined below, of (at least) the following system information, also referred to as the 'required' system information:
 - 2> if in RRC_IDLE:
 - 3> if the UE is a NB-IoT UE:
 - 4> the *MasterInformationBlock-NB* and *SystemInformationBlockType1-NB* as well as *SystemInformationBlockType2-NB* through *SystemInformationBlockType5-NB*, *SystemInformationBlockType22-NB*;
 - 3> else:
 - 4> the *MasterInformationBlock* and *SystemInformationBlockType1* (or *SystemInformationBlockType1-BR* depending on whether the UE is a BL UE or the UE in CE) as well as *SystemInformationBlockType2* through *SystemInformationBlockType8* (depending on support of the concerned RATs), *SystemInformationBlockType17* (depending on support of RAN-assisted WLAN interworking);
 - 2> if in RRC_CONNECTED; and
 - 2> the UE is not a BL UE; and
 - 2> the UE is not in CE; and
 - 2> the UE is not a NB-IoT UE:
 - 3> the *MasterInformationBlock*, *SystemInformationBlockType1* and *SystemInformationBlockType2* as well as *SystemInformationBlockType8* (depending on support of CDMA2000), *SystemInformationBlockType17* (depending on support of RAN-assisted WLAN interworking);
 - 2> if in RRC_CONNECTED and T311 is running; and
 - 2> the UE is a BL UE or the UE is in CE or the UE is a NB-IoT UE;
 - 3> the *MasterInformationBlock* (or *MasterInformationBlock-NB* in NB-IoT), *SystemInformationBlockType1-BR* (or *SystemInformationBlockType1-NB* in NB-IoT) and *SystemInformationBlockType2* (or *SystemInformationBlockType2-NB* in NB-IoT), and for NB-IoT *SystemInformationBlockType22-NB*;
- 1> delete any stored system information after 3 hours or 24 hours from the moment it was confirmed to be valid as defined in 5.2.1.3, unless specified otherwise;
- 1> consider any stored system information except *SystemInformationBlockType10*, *SystemInformationBlockType11*, *systemInformationBlockType12* and *systemInformationBlockType14* (*systemInformationBlockType14-NB* in NB-IoT) to be invalid if *systemInfoValueTag* included in the *SystemInformationBlockType1* (*MasterInformationBlock-NB* in NB-IoT) is different from the one of the stored system information and in case of NB-IoT UEs, BL UEs and UEs in CE, *systemInfoValueTagSI* is not broadcasted. Otherwise consider system information validity as defined in 5.2.1.3;

5.2.2.4 System information acquisition by the UE

The UE shall:

- 1> apply the specified BCCH configuration defined in 9.1.1.1 or BR-BCCH configuration defined in 9.1.1.8;
- 1> if the procedure is triggered by a system information change notification:
 - 2> if the UE uses an idle DRX cycle longer than the modification period:

3> start acquiring the required system information, as defined in 5.2.2.3, from the next eDRX acquisition period boundary;

2> else

3> start acquiring the required system information, as defined in 5.2.2.3, from the beginning of the modification period following the one in which the change notification was received;

NOTE 1: The UE continues using the previously received system information until the new system information has been acquired.

1> if the UE is in RRC_IDLE and enters a cell for which the UE does not have stored a valid version of the system information required in RRC_IDLE, as defined in 5.2.2.3:

2> acquire, using the system information acquisition procedure as defined in 5.2.3, the system information required in RRC_IDLE, as defined in 5.2.2.3;

1> following successful handover completion to a PCell for which the UE does not have stored a valid version of the system information required in RRC_CONNECTED, as defined in 5.2.2.3:

2> acquire, using the system information acquisition procedure as defined in 5.2.3, the system information required in RRC_CONNECTED, as defined in 5.2.2.3;

2> upon acquiring the concerned system information:

3> discard the corresponding radio resource configuration information included in the *radioResourceConfigCommon* previously received in a dedicated message, if any;

1> following a request from CDMA2000 upper layers:

2> acquire *SystemInformationBlockType8*, as defined in 5.2.3;

1> neither initiate the RRC connection establishment/resume procedure nor initiate transmission of the *RRCConnectionReestablishmentRequest* message until the UE has a valid version of the *MasterInformationBlock* (*MasterInformationBlock-NB* in NB-IoT) and *SystemInformationBlockType1* (*SystemInformationBlockType1-NB* in NB-IoT) messages as well as *SystemInformationBlockType2* (*SystemInformationBlockType2-NB* in NB-IoT), and for NB-IoT, *SystemInformationBlockType22-NB*;

1> not initiate the RRC connection establishment/resume procedure subject to EAB until the UE has a valid version of *SystemInformationBlockType14*, if broadcast;

1> if the UE is ETWS capable:

2> upon entering a cell during RRC_IDLE, following successful handover or upon connection re-establishment:

3> discard any previously buffered *warningMessageSegment*;

3> clear, if any, the current values of *messageIdentifier* and *serialNumber* for *SystemInformationBlockType11*;

2> when the UE acquires *SystemInformationBlockType1* following ETWS indication, upon entering a cell during RRC_IDLE, following successful handover or upon connection re-establishment:

3> if *schedulingInfoList* indicates that *SystemInformationBlockType10* is present:

4> if the UE is in CE:

5> start acquiring *SystemInformationBlockType10*;

4> else

5> start acquiring *SystemInformationBlockType10* immediately;

3> if *schedulingInfoList* indicates that *SystemInformationBlockType11* is present:

4> start acquiring *SystemInformationBlockType11* immediately;

NOTE 2: UEs shall start acquiring *SystemInformationBlockType10* and *SystemInformationBlockType11* as described above even when *systemInfoValueTag* in *SystemInformationBlockType1* has not changed.

1> if the UE is CMAS capable:

2> upon entering a cell during RRC_IDLE, following successful handover or upon connection re-establishment:

3> discard any previously buffered *warningMessageSegment*;

3> clear, if any, stored values of *messageIdentifier* and *serialNumber* for *SystemInformationBlockType12* associated with the discarded *warningMessageSegment*;

2> when the UE acquires *SystemInformationBlockType1* following CMAS indication, upon entering a cell during RRC_IDLE, following successful handover and upon connection re-establishment:

3> if *schedulingInfoList* indicates that *SystemInformationBlockType12* is present:

4> acquire *SystemInformationBlockType12*;

NOTE 3: UEs shall start acquiring *SystemInformationBlockType12* as described above even when *systemInfoValueTag* in *SystemInformationBlockType1* has not changed.

1> if the UE is interested to receive MBMS services:

2> if the UE is capable of MBMS reception as specified in 5.8:

3> if *schedulingInfoList* indicates that *SystemInformationBlockType13* is present and the UE does not have stored a valid version of this system information block:

4> acquire *SystemInformationBlockType13*;

3> else if *SystemInformationBlockType13* is present in *SystemInformationBlockType1-MBMS* and the UE does not have stored a valid version of this system information block:

4> acquire *SystemInformationBlockType13* from *SystemInformationBlockType1-MBMS*;

2> if the UE is capable of SC-PTM reception as specified in 5.8a:

3> if *schedulingInfoList* indicates that *SystemInformationBlockType20* (*SystemInformationBlockType20-NB* in NB-IoT) is present and the UE does not have stored a valid version of this system information block:

4> acquire *SystemInformationBlockType20* (*SystemInformationBlockType20-NB* in NB-IoT);

2> if the UE is capable of MBMS Service Continuity:

3> if *schedulingInfoList* indicates that *SystemInformationBlockType15* (*SystemInformationBlockType15-NB* in NB-IoT) is present and the UE does not have stored a valid version of this system information block:

4> acquire *SystemInformationBlockType15* (*SystemInformationBlockType15-NB* in NB-IoT);

1> if the UE is EAB capable:

2> when the UE does not have stored a valid version of *SystemInformationBlockType14* upon entering RRC_IDLE, or when the UE acquires *SystemInformationBlockType1* following EAB parameters change notification, or upon entering a cell during RRC_IDLE, or before establishing an RRC connection if using eDRX with DRX cycle longer than the modification period:

3> if *schedulingInfoList* indicates that *SystemInformationBlockType14* is present:

4> start acquiring *SystemInformationBlockType14* immediately;

3> else:

4> discard *SystemInformationBlockType14*, if previously received;

NOTE 4: EAB capable UEs start acquiring *SystemInformationBlockType14* as described above even when *systemInfoValueTag* in *SystemInformationBlockType1* has not changed.

NOTE 5: EAB capable UEs maintain an up to date *SystemInformationBlockType14* in RRC_IDLE.

- 1> if the UE is capable of sidelink communication and is configured by upper layers to receive or transmit sidelink communication:
 - 2> if the cell used for sidelink communication meets the S-criteria as defined in TS 36.304 [4]; and
 - 2> if *schedulingInfoList* indicates that *SystemInformationBlockType18* is present and the UE does not have stored a valid version of this system information block:
 - 3> acquire *SystemInformationBlockType18*;
- 1> if the UE is capable of sidelink discovery and is configured by upper layers to receive or transmit sidelink discovery announcements on the primary frequency:
 - 2> if *schedulingInfoList* of the serving cell/ PCell indicates that *SystemInformationBlockType19* is present and the UE does not have stored a valid version of this system information block:
 - 3> acquire *SystemInformationBlockType19*;
- 1> if the UE is capable of sidelink discovery and, for each of the one or more frequencies included in *discInterFreqList*, if included in *SystemInformationBlockType19* and for which the UE is configured by upper layers to receive sidelink discovery announcements on:
 - 2> if *SystemInformationBlockType19* of the serving cell/ PCell does not provide the corresponding reception resources; and
 - 2> if *schedulingInfoList* of the cell on the concerned frequency indicates that *SystemInformationBlockType19* is present and the UE does not have stored a valid version of this system information block:
 - 3> acquire *SystemInformationBlockType19*;
- 1> if the UE is capable of sidelink discovery and, for each of the one or more frequencies included in *discInterFreqList*, if included in *SystemInformationBlockType19* and for which the UE is configured by upper layers to transmit sidelink discovery announcements on:
 - 2> if *SystemInformationBlockType19* of the serving cell/ PCell includes *discTxResourcesInterFreq* which is set to *acquireSI-FromCarrier*; and
 - 2> if *schedulingInfoList* of the cell on the concerned frequency indicates that *SystemInformationBlockType19* is present and the UE does not have stored a valid version of this system information block:
 - 3> acquire *SystemInformationBlockType19*;
- 1> if the UE is a NB-IoT UE and if *ab-Enabled* included in *MasterInformationBlock-NB* is set to *TRUE*:
 - 2> not initiate the RRC connection establishment/resume procedure for all access causes except mobile terminating calls until the UE has acquired the *SystemInformationBlockType14-NB*;
- 1> if the UE is capable of V2X sidelink communication and is configured by upper layers to receive or transmit V2X sidelink communication on a frequency:
 - 2> if *schedulingInfoList* on the serving cell/PCell indicates that *SystemInformationBlockType21* is present and the UE does not have stored valid version of this system information block;
 - 3> acquire *SystemInformationBlockType21* from serving cell/PCell;
- 1> if the UE is capable of V2X sidelink communication and is configured by upper layers to receive V2X sidelink communication on a frequency, which is not primary frequency:
 - 2> if *SystemInformationBlockType21* of the serving cell/ PCell does not provide reception resource pool for V2X sidelink communication for the concerned frequency; and
 - 2> if the cell used for V2X sidelink communication on the concerned frequency meets the S-criteria as defined in TS 36.304 [4]; and

- 2> if *schedulingInfoList* on the concerned frequency indicates that *SystemInformationBlockType21* is present and the UE does not have stored a valid version of this system information block:
 - 3> acquire *SystemInformationBlockType21* from the concerned frequency;
- 1> if the UE is capable of V2X sidelink communication and is configured by upper layers to transmit V2X sidelink communication on a frequency, which is not primary frequency and is not included in *v2x-InterFreqInfoList* in *SystemInformationBlockType21* of the serving cell/PCell:
 - 2> if the cell used for V2X sidelink communication on the concerned frequency meets the S-criteria as defined in TS 36.304 [4]; and
 - 2> if *schedulingInfoList* on the concerned frequency indicates that *SystemInformationBlockType21* is present and the UE does not have stored a valid version of this system information block:
 - 3> acquire *SystemInformationBlockType21* from the concerned frequency;

The UE may apply the received SIBs immediately, i.e. the UE does not need to delay using a SIB until all SI messages have been received. The UE may delay applying the received SIBs until completing lower layer procedures associated with a received or a UE originated RRC message, e.g. an ongoing random access procedure.

NOTE 6: While attempting to acquire a particular SIB, if the UE detects from *schedulingInfoList* that it is no longer present, the UE should stop trying to acquire the particular SIB.

5.2.2.5 Essential system information missing

The UE shall:

- 1> if in RRC_IDLE or in RRC_CONNECTED while T311 is running:
 - 2> if the UE is unable to acquire the *MasterInformationBlock* (*MasterInformationBlock-NB* in NB-IoT); or
 - 2> if the UE is neither a BL UE nor in CE nor in NB-IoT and the UE is unable to acquire the *SystemInformationBlockType1*; or
 - 2> if the BL UE or UE in CE is unable to acquire *SystemInformationBlockType1-BR* or *SystemInformationBlockType1-BR* is not scheduled; or
 - 2> if the NB-IoT UE is unable to acquire the *SystemInformationBlockType1-NB*:
 - 3> consider the cell as barred in accordance with TS 36.304 [4]; and
 - 3> perform barring as if *intraFreqReselection* is set to *allowed*, and as if the *csg-Indication* is set to *FALSE*;
 - 2> else if the UE is unable to acquire the *SystemInformationBlockType2* (or *SystemInformationBlockType2-NB* in NB-IoT) and for NB-IoT, *SystemInformationBlockType22-NB* if scheduled:
 - 3> treat the cell as barred in accordance with TS 36.304 [4];

5.2.2.6 Actions upon reception of the *MasterInformationBlock* message

Upon receiving the *MasterInformationBlock* message the UE shall:

- 1> apply the radio resource configuration included in the *phich-Config*;
- 1> if the UE is in RRC_IDLE or if the UE is in RRC_CONNECTED while T311 is running:
 - 2> if the UE has no valid system information stored according to 5.2.2.3 for the concerned cell:
 - 3> apply the received value of *dl-Bandwidth* to the *ul-Bandwidth* until *SystemInformationBlockType2* is received;

Upon receiving the *MasterInformationBlock-NB* message the UE shall:

- 1> apply the radio resource configuration included in accordance with the *operationModeInfo*.

No UE requirements related to the contents of *MasterInformationBlock-MBMS* apply other than those specified elsewhere e.g. within procedures using the concerned system information, and/ or within the corresponding field descriptions.

5.2.2.7 Actions upon reception of the *SystemInformationBlockType1* message

Upon receiving the *SystemInformationBlockType1* or *SystemInformationBlockType1-BR* either via broadcast or via dedicated signalling, the UE shall:

- 1> if the *cellAccessRelatedInfoList* contains an entry with the *PLMN-Identity* of the selected PLMN:
 - 2> in the remainder of the procedures use *plmn-IdentityList*, *trackingAreaCode*, and *cellIdentity* for the cell as received in the corresponding *cellAccessRelatedInfoList* containing the selected PLMN;
- 1> if in RRC_IDLE or in RRC_CONNECTED while T311 is running; and
- 1> if the UE is a category 0 UE according to TS 36.306 [5]; and
- 1> if *category0Allowed* is not included in *SystemInformationBlockType1*:
 - 2> consider the cell as barred in accordance with TS 36.304 [4];
- 1> if in RRC_CONNECTED while T311 is not running, and the UE supports multi-band cells as defined by bit 31 in *featureGroupIndicators*:
 - 2> disregard the *freqBandIndicator* and *multiBandInfoList*, if received, while in RRC_CONNECTED;
 - 2> forward the *cellIdentity* to upper layers;
 - 2> forward the *trackingAreaCode* to upper layers;
- 1> else:
 - 2> if the frequency band indicated in the *freqBandIndicator* is part of the frequency bands supported by the UE and it is not a downlink only band; or
 - 2> if the UE supports *multiBandInfoList*, and if one or more of the frequency bands indicated in the *multiBandInfoList* are part of the frequency bands supported by the UE and they are not downlink only bands:
 - 3> forward the *cellIdentity* to upper layers;
 - 3> forward the *trackingAreaCode* to upper layers;
 - 3> forward the *ims-EmergencySupport* to upper layers, if present;
 - 3> forward the *eCallOverIMS-Support* to upper layers, if present;
 - 3> if, for the frequency band selected by the UE (from *freqBandIndicator* or *multiBandInfoList*), the *freqBandInfo* or the *multiBandInfoList-v10j0* is present and the UE capable of *multiNS-Pmax* supports at least one *additionalSpectrumEmission* in the *NS-PmaxList* within the *freqBandInfo* or *multiBandInfoList-v10j0*:
 - 4> apply the first listed *additionalSpectrumEmission* which it supports among the values included in *NS-PmaxList* within *freqBandInfo* or *multiBandInfoList-v10j0*;
 - 4> if the *additionalPmax* is present in the same entry of the selected *additionalSpectrumEmission* within *NS-PmaxList*:
 - 5> apply the *additionalPmax*;
 - 4> else:
 - 5> apply the *p-Max*;
 - 3> else:

- 4> apply the *additionalSpectrumEmission* in *SystemInformationBlockType2* and the *p-Max*;
- 2> else:
 - 3> consider the cell as barred in accordance with TS 36.304 [4]; and
 - 3> perform barring as if *intraFreqReselection* is set to *notAllowed*, and as if the *csg-Indication* is set to *FALSE*;

Upon receiving the *SystemInformationBlockType1-NB*, the UE shall:

- 1> if the frequency band indicated in the *freqBandIndicator* is part of the frequency bands supported by the UE; or
- 1> if one or more of the frequency bands indicated in the *multiBandInfoList* are part of the frequency bands supported by the UE:
 - 2> forward the *cellIdentity* to upper layers;
 - 2> forward the *trackingAreaCode* to upper layers;
 - 2> if *attachWithoutPDN-Connectivity* is received for the selected PLMN:
 - 3> forward the *attachWithoutPDN-Connectivity* to upper layers;
 - 2> else
 - 3> indicate to upper layers that *attachWithoutPDN-Connectivity* is not present;
 - 2> if, for the frequency band selected by the UE (from *freqBandIndicator* or *multiBandInfoList*), the *freqBandInfo* is present and the UE capable of *multiNS-Pmax* supports at least one *additionalSpectrumEmission* in the *NS-PmaxList* within the *freqBandInfo*:
 - 3> apply the first listed *additionalSpectrumEmission* which it supports among the values included in *NS-PmaxList* within *freqBandInfo*;
 - 3> if the *additionalPmax* is present in the same entry of the selected *additionalSpectrumEmission* within *NS-PmaxList*:
 - 4> apply the *additionalPmax*;
 - 3> else:
 - 4> apply the *p-Max*;
- 2> else:
 - 3> apply the *additionalSpectrumEmission* in *SystemInformationBlockType2-NB* and the *p-Max*;
- 1> else:
 - 2> consider the cell as barred in accordance with TS 36.304 [4]; and
 - 2> perform barring as if *intraFreqReselection* is set to *notAllowed*.

No UE requirements related to the contents of *SystemInformationBlockType1-MBMS* apply other than those specified elsewhere e.g. within procedures using the concerned system information, and/ or within the corresponding field descriptions.

5.2.2.8 Actions upon reception of *SystemInformation* messages

No UE requirements related to the contents of the *SystemInformation* messages apply other than those specified elsewhere e.g. within procedures using the concerned system information, and/ or within the corresponding field descriptions.

5.2.2.9 Actions upon reception of *SystemInformationBlockType2*

Upon receiving *SystemInformationBlockType2*, the UE shall:

- 1> apply the configuration included in the *radioResourceConfigCommon*;
- 1> if upper layers indicate that a (UE specific) paging cycle is configured:
 - 2> apply the shortest of the (UE specific) paging cycle and the *defaultPagingCycle* included in the *radioResourceConfigCommon*;
- 1> if the *mbsfn-SubframeConfigList* is included:
 - 2> consider that DL assignments may occur in the MBSFN subframes indicated in the *mbsfn-SubframeConfigList* under the conditions specified in [23, 7.1];
- 1> apply the specified PCCH configuration defined in 9.1.1.3;
- 1> not apply the *timeAlignmentTimerCommon*;
- 1> if in RRC_CONNECTED and UE is configured with RLF timers and constants values received within *rlf-TimersAndConstants*:
 - 2> not update its values of the timers and constants in *ue-TimersAndConstants* except for the value of timer T300;
- 1> if in RRC_CONNECTED while T311 is not running; and the UE supports multi-band cells as defined by bit 31 in *featureGroupIndicators* or *multipleNS-Pmax*:
 - 2> disregard the *additionalSpectrumEmission* and *ul-CarrierFreq*, if received, while in RRC_CONNECTED;
- 1> if *attachWithoutPDN-Connectivity* is received for the selected PLMN:
 - 2> forward *attachWithoutPDN-Connectivity* to upper layers;
- 1> else
 - 2> indicate to upper layers that *attachWithoutPDN-Connectivity* is not present;
- 1> if *cp-CIoT-EPS-Optimisation* is received for the selected PLMN:
 - 2> forward *cp-CIoT-EPS-Optimisation* to upper layers;
- 1> else
 - 2> indicate to upper layers that *cp-CIoT-EPS-Optimisation* is not present;
- 1> if *up-CIoT-EPS-Optimisation* is received for the selected PLMN:
 - 2> forward *up-CIoT-EPS-Optimisation* to upper layers;
- 1> else
 - 2> indicate to upper layers that *up-CIoT-EPS-Optimisation* is not present;

Upon receiving *SystemInformationBlockType2-NB*, the UE shall:

- 1> apply the configuration included in the *radioResourceConfigCommon*;
- 1> apply the *defaultPagingCycle* included in the *radioResourceConfigCommon*;
- 1> if *SystemInformationBlockType22-NB* is scheduled:
 - 2> read and act on information sent in *SystemInformationBlockType22-NB*;
- 1> apply the specified PCCH configuration defined in 9.1.1.3.

- 1> if in RRC_CONNECTED and UE is configured with RLF timers and constants values received within *rlf-TimersAndConstants*:
 - 2> not update its values of the timers and constants in *ue-TimersAndConstants* except for the value of timer T300;

5.2.2.10 Actions upon reception of *SystemInformationBlockType3*

Upon receiving *SystemInformationBlockType3*, the UE shall:

- 1> if in RRC_IDLE, the *redistributionServingInfo* is included and the UE is redistribution capable:
 - 2> perform E-UTRAN inter-frequency redistribution procedure as specified in TS 36.304 [4, 5.2.4.10];
- 1> if in RRC_IDLE, or in RRC_CONNECTED while T311 is running:
 - 2> if, for the frequency band selected by the UE (from the procedure in Clause 5.2.2.7) to represent the serving cell's carrier frequency, the *freqBandInfo* or the *multiBandInfoList-v10j0* is present in *SystemInformationBlockType3* and the UE capable of *multiNS-Pmax* supports at least one *additionalSpectrumEmission* in the NS-PmaxList within the *freqBandInfo* or *multiBandInfoList-v10j0*:
 - 3> apply the first listed *additionalSpectrumEmission* which it supports among the values included in NS-PmaxList within *freqBandInfo* or *multiBandInfoList-v10j0*;
 - 3> if the *additionalPmax* is present in the same entry of the selected *additionalSpectrumEmission* within NS-PmaxList:
 - 4> apply the *additionalPmax*;
 - 3> else:
 - 4> apply the *p-Max*;
 - 2> else:
 - 3> apply the *p-Max*;

Upon receiving *SystemInformationBlockType3-NB*, the UE shall:

- 1> if in RRC_IDLE, or in RRC_CONNECTED while T311 is running:
 - 2> if, for the frequency band selected by the UE (from the procedure in clause 5.2.2.7) to represent the serving cell's carrier frequency, the *freqBandInfo* or the *multiBandInfoList* is present in *SystemInformationBlockType3-NB* and the UE capable of *multiNS-Pmax* supports at least one *additionalSpectrumEmission* in the NS-PmaxList within the *freqBandInfo* or the *multiBandInfoList*:
 - 3> apply the first listed *additionalSpectrumEmission* which it supports among the values included in NS-PmaxList within *freqBandInfo* or *multiBandInfoList*;
 - 3> if the *additionalPmax* is present in the same entry of the selected *additionalSpectrumEmission* within NS-PmaxList:
 - 4> apply the *additionalPmax*;
 - 3> else:
 - 4> apply the *p-Max*;
 - 2> else:
 - 3> apply the *p-Max*;

5.2.2.11 Actions upon reception of *SystemInformationBlockType4*

No UE requirements related to the contents of this *SystemInformationBlock* (*SystemInformationBlockType4* or *SystemInformationBlockType4-NB*) apply other than those specified elsewhere e.g. within procedures using the concerned system information, and/ or within the corresponding field descriptions.

5.2.2.12 Actions upon reception of *SystemInformationBlockType5*

Upon receiving *SystemInformationBlockType5*, the UE shall:

- 1> if in RRC_IDLE, the *redistributionInterFreqInfo* is included and the UE is redistribution capable:
 - 2> perform E-UTRAN inter-frequency redistribution procedure as specified in TS 36.304 [4, 5.2.4.10];
- 1> if in RRC_IDLE, or in RRC_CONNECTED while T311 is running:
 - 2> if the frequency band selected by the UE to represent a non-serving E UTRA carrier frequency is not a downlink only band:
 - 3> if, for the selected frequency band, the *freqBandInfo* or the *multiBandInfoList-v10j0* is present and the UE capable of *multiNS-Pmax* supports at least one *additionalSpectrumEmission* in the *NS-PmaxList* within *freqBandInfo* or *multiBandInfoList-v10j0*:
 - 4> apply the first listed *additionalSpectrumEmission* which it supports among the values included in *NS-PmaxList* within *freqBandInfo* or *multiBandInfoList-v10j0*;
 - 4> if the *additionalPmax* is present in the same entry of the selected *additionalSpectrumEmission* within *NS-PmaxList*:
 - 5> apply the *additionalPmax*;
 - 4> else:
 - 5> apply the *p-Max*;
 - 3> else:
 - 4> apply the *p-Max*;

Upon receiving *SystemInformationBlockType5-NB*, the UE shall:

- 1> if in RRC_IDLE, or in RRC_CONNECTED while T311 is running:
 - 2> if, for the frequency band selected by the UE (from *multiBandInfoList*) to represent a non-serving NB-IoT carrier frequency, the *freqBandInfo* is present and the UE capable of *multiNS-Pmax* supports at least one *additionalSpectrumEmission* in the *NS-PmaxList* within the *freqBandInfo*:
 - 3> apply the first listed *additionalSpectrumEmission* which it supports among the values included in *NS-PmaxList* within *freqBandInfo*;
 - 3> if the *additionalPmax* is present in the same entry of the selected *additionalSpectrumEmission* within *NS-PmaxList*:
 - 4> apply the *additionalPmax*;
 - 3> else:
 - 4> apply the *p-Max*;
 - 2> else:
 - 3> apply the *p-Max*;

5.2.2.13 Actions upon reception of *SystemInformationBlockType6*

No UE requirements related to the contents of this *SystemInformationBlock* apply other than those specified elsewhere e.g. within procedures using the concerned system information, and/ or within the corresponding field descriptions.

5.2.2.14 Actions upon reception of *SystemInformationBlockType7*

No UE requirements related to the contents of this *SystemInformationBlock* apply other than those specified elsewhere e.g. within procedures using the concerned system information, and/ or within the corresponding field descriptions.

5.2.2.15 Actions upon reception of *SystemInformationBlockType8*

Upon receiving *SystemInformationBlockType8*, the UE shall:

- 1> if *sib8-PerPLMN-List* is included and the UE is capable of network sharing for CDMA2000:
 - 2> apply the CDMA2000 parameters below corresponding to the RPLMN;
- 1> if the *systemTimeInfo* is included:
 - 2> forward the *systemTimeInfo* to CDMA2000 upper layers;
- 1> if the UE is in RRC_IDLE and if *searchWindowSize* is included:
 - 2> forward the *searchWindowSize* to CDMA2000 upper layers;
- 1> if *parametersHRPD* is included:
 - 2> forward the *preRegistrationInfoHRPD* to CDMA2000 upper layers only if the UE has not received the *preRegistrationInfoHRPD* within an *RRCCONNECTIONRECONFIGURATION* message after entering this cell;
 - 2> if the *cellReselectionParametersHRPD* is included:
 - 3> forward the *neighCellList* to the CDMA2000 upper layers;
- 1> if the *parametersIXRTT* is included:
 - 2> if the *csfb-RegistrationParamIXRTT* is included:
 - 3> forward the *csfb-RegistrationParamIXRTT* to the CDMA2000 upper layers which will use this information to determine if a CS registration/re-registration towards CDMA2000 1xRTT in the EUTRA cell is required;
 - 2> else:
 - 3> indicate to CDMA2000 upper layers that CSFB Registration to CDMA2000 1xRTT is not allowed;
 - 2> if the *longCodeStateIXRTT* is included:
 - 3> forward the *longCodeStateIXRTT* to CDMA2000 upper layers;
 - 2> if the *cellReselectionParametersIXRTT* is included:
 - 3> forward the *neighCellList* to the CDMA2000 upper layers;
 - 2> if the *csfb-SupportForDualRxUEs* is included:
 - 3> forward *csfb-SupportForDualRxUEs* to the CDMA2000 upper layers;
 - 2> else:
 - 3> forward *csfb-SupportForDualRxUEs*, with its value set to *FALSE*, to the CDMA2000 upper layers;
 - 2> if *ac-BarringConfigIXRTT* is included:
 - 3> forward *ac-BarringConfigIXRTT* to the CDMA2000 upper layers;

2> if the *csfb-DualRxTxSupport* is included:

3> forward *csfb-DualRxTxSupport* to the CDMA2000 upper layers;

2> else:

3> forward *csfb-DualRxTxSupport*, with its value set to *FALSE*, to the CDMA2000 upper layers;

5.2.2.16 Actions upon reception of *SystemInformationBlockType9*

Upon receiving *SystemInformationBlockType9*, the UE shall:

1> if *hnb-Name* is included, forward the *hnb-Name* to upper layers;

5.2.2.17 Actions upon reception of *SystemInformationBlockType10*

Upon receiving *SystemInformationBlockType10*, the UE shall:

1> forward the received *warningType*, *messageIdentifier* and *serialNumber* to upper layers;

5.2.2.18 Actions upon reception of *SystemInformationBlockType11*

Upon receiving *SystemInformationBlockType11*, the UE shall:

1> if there is no current value for *messageIdentifier* and *serialNumber* for *SystemInformationBlockType11*; or

1> if either the received value of *messageIdentifier* or of *serialNumber* or of both are different from the current values of *messageIdentifier* and *serialNumber* for *SystemInformationBlockType11*:

2> use the received values of *messageIdentifier* and *serialNumber* for *SystemInformationBlockType11* as the current values of *messageIdentifier* and *serialNumber* for *SystemInformationBlockType11*;

2> discard any previously buffered *warningMessageSegment*;

2> if all segments of a warning message have been received:

3> assemble the warning message from the received *warningMessageSegment*;

3> forward the received warning message, *messageIdentifier*, *serialNumber* and *dataCodingScheme* to upper layers;

3> stop reception of *SystemInformationBlockType11*;

3> discard the current values of *messageIdentifier* and *serialNumber* for *SystemInformationBlockType11*;

2> else:

3> store the received *warningMessageSegment*;

3> continue reception of *SystemInformationBlockType11*;

1> else if all segments of a warning message have been received:

2> assemble the warning message from the received *warningMessageSegment*;

2> forward the received complete warning message, *messageIdentifier*, *serialNumber* and *dataCodingScheme* to upper layers;

2> stop reception of *SystemInformationBlockType11*;

2> discard the current values of *messageIdentifier* and *serialNumber* for *SystemInformationBlockType11*;

1> else:

2> store the received *warningMessageSegment*;

2> continue reception of *SystemInformationBlockType11*;

The UE should discard any stored *warningMessageSegment* and the current value of *messageIdentifier* and *serialNumber* for *SystemInformationBlockType11* if the complete warning message has not been assembled within a period of 3 hours.

5.2.2.19 Actions upon reception of *SystemInformationBlockType12*

Upon receiving *SystemInformationBlockType12*, the UE shall:

- 1> if the *SystemInformationBlockType12* contains a complete warning message:
 - 2> forward the received warning message, *messageIdentifier*, *serialNumber* and *dataCodingScheme* to upper layers;
 - 2> continue reception of *SystemInformationBlockType12*;
- 1> else:
 - 2> if the received values of *messageIdentifier* and *serialNumber* are the same (each value is the same) as a pair for which a warning message is currently being assembled:
 - 3> store the received *warningMessageSegment*;
 - 3> if all segments of a warning message have been received:
 - 4> assemble the warning message from the received *warningMessageSegment*;
 - 4> forward the received warning message, *messageIdentifier*, *serialNumber* and *dataCodingScheme* to upper layers;
 - 4> stop assembling a warning message for this *messageIdentifier* and *serialNumber* and delete all stored information held for it;
 - 3> continue reception of *SystemInformationBlockType12*;
 - 2> else if the received values of *messageIdentifier* and/or *serialNumber* are not the same as any of the pairs for which a warning message is currently being assembled:
 - 3> start assembling a warning message for this *messageIdentifier* and *serialNumber* pair;
 - 3> store the received *warningMessageSegment*;
 - 3> continue reception of *SystemInformationBlockType12*;

The UE should discard *warningMessageSegment* and the associated values of *messageIdentifier* and *serialNumber* for *SystemInformationBlockType12* if the complete warning message has not been assembled within a period of 3 hours.

NOTE: The number of warning messages that a UE can re-assemble simultaneously is a function of UE implementation.

5.2.2.20 Actions upon reception of *SystemInformationBlockType13*

No UE requirements related to the contents of this *SystemInformationBlock* apply other than those specified elsewhere e.g. within procedures using the concerned system information, and/ or within the corresponding field descriptions.

5.2.2.21 Actions upon reception of *SystemInformationBlockType14*

No UE requirements related to the contents of this *SystemInformationBlock* (*SystemInformationBlockType14* or *SystemInformationBlockType14-NB*) apply other than those specified elsewhere e.g. within procedures using the concerned system information, and/ or within the corresponding field descriptions.

5.2.2.22 Actions upon reception of *SystemInformationBlockType15*

No UE requirements related to the contents of this *SystemInformationBlock* (*SystemInformationBlockType15* or *SystemInformationBlockType15-NB*) apply other than those specified elsewhere e.g. within procedures using the concerned system information, and/ or within the corresponding field descriptions.

5.2.2.23 Actions upon reception of *SystemInformationBlockType16*

No UE requirements related to the contents of this *SystemInformationBlock* (*SystemInformationBlockType16* or *SystemInformationBlockType16-NB*) apply other than those specified elsewhere e.g. within procedures using the concerned system information, and/ or within the corresponding field descriptions.

5.2.2.24 Actions upon reception of *SystemInformationBlockType17*

Upon receiving *SystemInformationBlockType17*, the UE shall:

- 1> if *wlan-OffloadConfigCommon* corresponding to the RPLMN is included:
 - 2> if the UE is not configured with *rclwi-Configuration* with *command* set to *steerToWLAN*:
 - 3> apply the *wlan-Id-List* corresponding to the RPLMN;
 - 2> if not configured with the *wlan-OffloadConfigDedicated*:
 - 3> apply the *wlan-OffloadConfigCommon* corresponding to the RPLMN;

5.2.2.25 Actions upon reception of *SystemInformationBlockType18*

Upon receiving *SystemInformationBlockType18*, the UE shall:

- 1> if *SystemInformationBlockType18* message includes the *commConfig*:
 - 2> if configured to receive sidelink communication:
 - 3> from the next SC period, as defined by *sc-Period*, use the resource pool indicated by *commRxPool* for sidelink communication monitoring, as specified in 5.10.3;
 - 2> if configured to transmit sidelink communication:
 - 3> from the next SC period, as defined by *sc-Period*, use the resource pool indicated by *commTxPoolNormalCommon*, *commTxPoolNormalCommonExt* or by *commTxPoolExceptional* for sidelink communication transmission, as specified in 5.10.4;

5.2.2.26 Actions upon reception of *SystemInformationBlockType19*

Upon receiving *SystemInformationBlockType19*, the UE shall:

- 1> if *SystemInformationBlockType19* message includes the *discConfig* or *discConfigPS*:
 - 2> from the next discovery period, as defined by *discPeriod*, use the resources indicated by *discRxPool*, *discRxResourcesInterFreq* or *discRxPoolPS* for sidelink discovery monitoring, as specified in 5.10.5;
 - 2> if *SystemInformationBlockType19* message includes the *discTxPoolCommon* or *discTxPoolPS-Common*; and the UE is in RRC_IDLE:
 - 3> from the next discovery period, as defined by *discPeriod*, use the resources indicated by *discTxPoolCommon* or *discTxPoolPS-Common* for sidelink discovery announcement, as specified in 5.10.6;
 - 2> if the *SystemInformationBlockType19* message includes the *discTxPowerInfo*:
 - 3> use the power information included in *discTxPowerInfo* for sidelink discovery transmission on the serving frequency, as specified in TS 36.213 [23];

- 1> if *SystemInformationBlockType19* message includes the *discConfigRelay*:
- 2> if the *SystemInformationBlockType19* message includes the *txPowerInfo*:
 - 3> use the power information included in *txPowerInfo* for sidelink discovery transmission on the corresponding non-serving frequency, as specified in TS 36.213 [23];

5.2.2.27 Actions upon reception of *SystemInformationBlockType20*

No UE requirements related to the contents of this *SystemInformationBlock* (*SystemInformationBlockType20* or *SystemInformationBlockType20-NB*) apply other than those specified elsewhere e.g. within procedures using the concerned system information, and/ or within the corresponding field descriptions.

5.2.2.28 Actions upon reception of *SystemInformationBlockType21*

Upon receiving *SystemInformationBlockType21*, the UE shall:

- 1> if *SystemInformationBlockType21* message includes *sl-V2X-ConfigCommon*:
 - 2> if configured to receive V2X sidelink communication:
 - 3> use the resource pool indicated by *v2x-CommRxPool* in *sl-V2X-ConfigCommon* for V2X sidelink communication monitoring, as specified in 5.10.12;
 - 2> if configured to transmit V2X sidelink communication:
 - 3> use the resource pool indicated by *v2x-CommTxPoolNormalCommon*, *p2x-CommTxPoolNormalCommon*, *v2x-CommTxPoolNormal*, *p2x-CommTxPoolNormal* or by *v2x-CommTxPoolExceptional* for V2X sidelink communication transmission, as specified in 5.10.13;
 - 3> perform CBR measurement on the transmission resource pool(s) indicated by *v2x-CommTxPoolNormalCommon*, *v2x-CommTxPoolNormal* and *v2x-CommTxPoolExceptional* for V2X sidelink communication transmission, as specified in 5.5.3;

5.2.2.29 Actions upon reception of *SystemInformationBlockType22-NB*

No UE requirements related to the contents of this *SystemInformationBlock* apply other than those specified elsewhere e.g. within procedures using the concerned system information, and/ or within the corresponding field descriptions.

5.2.3 Acquisition of an SI message

When acquiring an SI message, the UE shall:

- 1> determine the start of the SI-window for the concerned SI message as follows:
 - 2> for the concerned SI message, determine the number n which corresponds to the order of entry in the list of SI messages configured by *schedulingInfoList* in *SystemInformationBlockType1*;
 - 2> determine the integer value $x = (n - 1) * w$, where w is the *si-WindowLength*;
 - 2> the SI-window starts at the subframe $\#a$, where $a = x \bmod 10$, in the radio frame for which $\text{SFN} \bmod T = \text{FLOOR}(x/10)$, where T is the *si-Periodicity* of the concerned SI message;

NOTE: E-UTRAN should configure an SI-window of 1 ms only if all SIs are scheduled before subframe #5 in radio frames for which $\text{SFN} \bmod 2 = 0$.

- 1> receive DL-SCH using the SI-RNTI from the start of the SI-window and continue until the end of the SI-window whose absolute length in time is given by *si-WindowLength*, or until the SI message was received, excluding the following subframes:
 - 2> subframe #5 in radio frames for which $\text{SFN} \bmod 2 = 0$;
 - 2> any MBSFN subframes;

- 2> any uplink subframes in TDD;
- 1> if the SI message was not received by the end of the SI-window, repeat reception at the next SI-window occasion for the concerned SI message;

5.2.3a Acquisition of an SI message by BL UE or UE in CE or a NB-IoT UE

When acquiring an SI message, the BL UE or UE in CE or NB-IoT UE shall:

- 1> determine the start of the SI-window for the concerned SI message as follows:
 - 2> for the concerned SI message, determine the number n which corresponds to the order of entry in the list of SI messages configured by *schedulingInfoList* in *SystemInformationBlockType1-BR* (or *SystemInformationBlockType1-NB* in NB-IoT);
 - 2> determine the integer value $x = (n - 1) * w$, where w is the *si-WindowLength-BR* (or *si-WindowLength* in NB-IoT);
 - 2> if the UE is a NB-IoT UE:
 - 3> the SI-window starts at the subframe #0 in the radio frame for which $(H-SFN * 1024 + SFN) \bmod T = \text{FLOOR}(x/10) + \text{Offset}$, where T is the *si-Periodicity* of the concerned SI message and, *Offset* is the offset of the start of the SI-Window (*si-RadioFrameOffset*);
 - 2> else:
 - 3> the SI-window starts at the subframe #0 in the radio frame for which $SFN \bmod T = \text{FLOOR}(x/10)$, where T is the *si-Periodicity* of the concerned SI message;
 - 1> if the UE is a NB-IoT UE:
 - 2> receive and accumulate SI message transmissions on DL-SCH from the start of the SI-window and continue until the end of the SI-window whose absolute length in time is given by *si-WindowLength*, starting from the radio frames as provided in *si-RepetitionPattern* and in subframes as provided in *downlinkBitmap*, or until successful decoding of the accumulated SI message transmissions excluding the subframes used for transmission of NPSS, NSSS, *MasterInformationBlock-NB* and *SystemInformationBlockType1-NB*. If there are not enough subframes for one SI message transmission in the radio frames as provided in *si-RepetitionPattern*, the UE shall continue to receive the SI message transmission in the radio frames following the radio frame indicated in *si-RepetitionPattern*;
 - 1> else:
 - 2> receive and accumulate SI message transmissions on DL-SCH on narrowband provided by *si-Narrowband*, from the start of the SI-window and continue until the end of the SI-window whose absolute length in time is given by *si-WindowLength-BR*, only in radio frames as provided in *si-RepetitionPattern* and subframes as provided in *fdd-DownlinkOrTddSubframeBitmapBR* in *bandwidthReducedAccessRelatedInfo*, or until successful decoding of the accumulated SI message transmissions;
 - 1> if the SI message was not possible to decode from the accumulated SI message transmissions by the end of the SI-window, continue reception and accumulation of SI message transmissions on DL-SCH in the next SI-window occasion for the concerned SI message;

5.2.3b Acquisition of an SI message from MBMS-dedicated cell

When acquiring an SI message, the UE shall:

- 1> determine the start of the SI-window for the concerned SI message as follows:
 - 2> for the concerned SI message, determine the number n which corresponds to the order of entry in the list of SI messages configured by *schedulingInfoList* in *SystemInformationBlockType1-MBMS*;
 - 2> determine the integer value $x = (n - 1) * w$, where w is the *si-WindowLength*;

- 2> the SI-window starts always at the subframe # a , where $a = x \bmod 10$, in the radio frame for which $\text{SFN} \bmod T = \text{FLOOR}(x/10)$, where T is the *si-Periodicity* of the concerned SI message;
- 1> receive DL-SCH using SI-RNTI with value in accordance with 36.321 [6] from the start of the SI-window and continue until the end of the SI-window whose absolute length in time is given by *si-WindowLength*, or until the SI message was received, excluding the following subframes:
 - 2> any MBSFN subframes;
- 1> if the SI message was not received by the end of the SI-window, repeat reception at the next SI-window occasion for the concerned SI message;

5.3 Connection control

5.3.1 Introduction

5.3.1.1 RRC connection control

RRC connection establishment involves the establishment of SRB1. E-UTRAN completes RRC connection establishment prior to completing the establishment of the S1 connection, i.e. prior to receiving the UE context information from the EPC. Consequently, AS security is not activated during the initial phase of the RRC connection. During this initial phase of the RRC connection, the E-UTRAN may configure the UE to perform measurement reporting, but the UE only sends the corresponding measurement reports after successful security activation. However, the UE only accepts a handover message when security has been activated.

NOTE: In case the serving frequency broadcasts multiple overlapping bands, E-UTRAN can only configure measurements after having obtained the UE capabilities, as the measurement configuration needs to be set according to the band selected by the UE.

Upon receiving the UE context from the EPC, E-UTRAN activates security (both ciphering and integrity protection) using the initial security activation procedure. The RRC messages to activate security (command and successful response) are integrity protected, while ciphering is started only after completion of the procedure. That is, the response to the message used to activate security is not ciphered, while the subsequent messages (e.g. used to establish SRB2 and DRBs) are both integrity protected and ciphered.

After having initiated the initial security activation procedure, E-UTRAN initiates the establishment of SRB2 and DRBs, i.e. E-UTRAN may do this prior to receiving the confirmation of the initial security activation from the UE. In any case, E-UTRAN will apply both ciphering and integrity protection for the RRC connection reconfiguration messages used to establish SRB2 and DRBs. E-UTRAN should release the RRC connection if the initial security activation and/ or the radio bearer establishment fails (i.e. security activation and DRB establishment are triggered by a joint S1-procedure, which does not support partial success).

For SRB2 and DRBs, security is always activated from the start, i.e. the E-UTRAN does not establish these bearers prior to activating security.

For some radio configuration fields, a critical extension has been defined. A switch from the original version of the field to the critically extended version is allowed using any connection reconfiguration. The UE reverts to the original version of some critically extended fields upon handover and re-establishment as specified elsewhere in this specification. Otherwise, switching a field from the critically extended version to the original version is only possible using the handover or re-establishment procedure with the full configuration option. This also applies for fields that are critically extended within a release (i.e. original and extended version defined in same release).

After having initiated the initial security activation procedure, E-UTRAN may configure a UE that supports CA, with one or more SCells in addition to the PCell that was initially configured during connection establishment. The PCell is used to provide the security inputs and upper layer system information (i.e. the NAS mobility information e.g. TAI). SCells are used to provide additional downlink and optionally uplink radio resources. When not configured with DC all SCells the UE is configured with, if any, are part of the MCG. When configured with DC however, some of the SCells are part of a SCG. In this case, user data carried by a DRB may either be transferred via MCG (i.e. MCG-DRB), via SCG (SCG-DRB) or via both MCG and SCG in DL while E-UTRAN configures the CG used in UL (split DRB). An RRC connection reconfiguration message may be used to change the DRB type from MCG-DRB to SCG-DRB or to split DRB, as well as from SCG-DRB or split DRB to MCG-DRB.

SCG change is a synchronous SCG reconfiguration procedure (i.e. involving RA to the PSCell) including reset/ re-establishment of layer 2 and, if SCG DRBs are configured, refresh of security. The procedure is used in a number of different scenarios e.g. SCG establishment, PSCell change, Key refresh, change of DRB type. The UE performs the SCG change related actions upon receiving an *RRCConnectionReconfiguration* message including *mobilityControlInfoSCG*, see 5.3.10.10.

The release of the RRC connection normally is initiated by E-UTRAN. The procedure may be used to re-direct the UE to an E-UTRA frequency or an inter-RAT carrier frequency. Only in exceptional cases, as specified within this specification, TS 36.300 [9], TS 36.304 [4] or TS 24.301 [35], may the UE abort the RRC connection, i.e. move to RRC_IDLE without notifying E-UTRAN.

The suspension of the RRC connection is initiated by E-UTRAN. When the RRC connection is suspended, the UE stores the UE AS context and the *resumeIdentity*, and transitions to RRC_IDLE state. The RRC message to suspend the RRC connection is integrity protected and ciphered. Suspension can only be performed when at least 1 DRB is successfully established.

The resumption of a suspended RRC connection is initiated by upper layers when the UE has a stored UE AS context, RRC connection resume is permitted by E-UTRAN and the UE needs to transit from RRC_IDLE state to RRC_CONNECTED state. When the RRC connection is resumed, RRC configures the UE according to the RRC connection resume procedure based on the stored UE AS context and any RRC configuration received from E-UTRAN. The RRC connection resume procedure re-activates security and re-establishes SRB(s) and DRB(s). The request to resume the RRC connection includes the *resumeIdentity*. The request is not ciphered, but protected with a message authentication code.

In response to a request to resume the RRC connection, E-UTRAN may resume the suspended RRC connection, reject the request to resume and instruct the UE to either keep or discard the stored context, or setup a new RRC connection.

5.3.1.2 Security

AS security comprises of the integrity protection of RRC signalling (SRBs) as well as the ciphering of RRC signalling (SRBs) and user data (DRBs).

RRC handles the configuration of the security parameters which are part of the AS configuration: the integrity protection algorithm, the ciphering algorithm and two parameters, namely the *keyChangeIndicator* and the *nextHopChainingCount*, which are used by the UE to determine the AS security keys upon handover, connection re-establishment and/ or connection resume.

The integrity protection algorithm is common for signalling radio bearers SRB1 and SRB2. The ciphering algorithm is common for all radio bearers (i.e. SRB1, SRB2 and DRBs). Neither integrity protection nor ciphering applies for SRB0.

RRC integrity and ciphering are always activated together, i.e. in one message/ procedure. RRC integrity and ciphering are never de-activated. However, it is possible to switch to a 'NULL' ciphering algorithm (eea0).

The 'NULL' integrity protection algorithm (eia0) is used only for the UE in limited service mode [32, TS33.401]. In case the 'NULL' integrity protection algorithm is used, 'NULL' ciphering algorithm is also used.

NOTE 1: Lower layers discard RRC messages for which the integrity check has failed and indicate the integrity verification check failure to RRC.

The AS applies three different security keys: one for the integrity protection of RRC signalling (K_{RRCint}), one for the ciphering of RRC signalling (K_{RRCenc}) and one for the ciphering of user data (K_{UPenc}). All three AS keys are derived from the K_{eNB} key. The K_{eNB} is based on the K_{ASME} key, which is handled by upper layers.

Upon connection establishment new AS keys are derived. No AS-parameters are exchanged to serve as inputs for the derivation of the new AS keys at connection establishment.

The integrity and ciphering of the RRC message used to perform handover is based on the security configuration used prior to the handover and is performed by the source eNB.

The integrity and ciphering algorithms can only be changed upon handover. The four AS keys (K_{eNB} , K_{RRCint} , K_{RRCenc} and K_{UPenc}) change upon every handover, connection re-establishment and connection resume. The *keyChangeIndicator* is used upon handover and indicates whether the UE should use the keys associated with the K_{ASME} key taken into use with the latest successful NAS SMC procedure. The *nextHopChainingCount* parameter is used upon handover, connection re-establishment and connection resume by the UE when deriving the new K_{eNB} that is used to generate

K_{RRcInt} , K_{RRcEnc} and K_{UPenc} (see TS 33.401 [32]). An intra cell handover procedure may be used to change the keys in RRC_CONNECTED.

For each radio bearer an independent counter (COUNT, as specified in TS 36.323 [8]) is maintained for each direction. For each DRB, the COUNT is used as input for ciphering. For each SRB, the COUNT is used as input for both ciphering and integrity protection. It is not allowed to use the same COUNT value more than once for a given security key. At connection resume the COUNT is reset. In order to limit the signalling overhead, individual messages/ packets include a short sequence number (PDCP SN, as specified in TS 36.323 [8]). In addition, an overflow counter mechanism is used: the hyper frame number (TX_HFN and RX_HFN, as specified in TS 36.323 [8]). The HFN needs to be synchronized between the UE and the eNB. The eNB is responsible for avoiding reuse of the COUNT with the same RB identity and with the same K_{eNB} , e.g. due to the transfer of large volumes of data, release and establishment of new RBs. In order to avoid such re-use, the eNB may e.g. use different RB identities for successive RB establishments, trigger an intra cell handover or an RRC_CONNECTED to RRC_IDLE to RRC_CONNECTED transition.

For each SRB, the value provided by RRC to lower layers to derive the 5-bit BEARER parameter used as input for ciphering and for integrity protection is the value of the corresponding *srb-Identity* with the MSBs padded with zeroes.

In case of DC, a separate K_{eNB} is used for SCG-DRBs (S- K_{eNB}). This key is derived from the key used for the MCG (K_{eNB}) and an SCG counter that is used to ensure freshness. To refresh the S- K_{eNB} e.g. when the COUNT will wrap around, E-UTRAN employs an SCG change, i.e. an *RRCCConnectionReconfiguration* message including *mobilityControlInfoSCG*. When performing handover, while at least one SCG-DRB remains configured, both K_{eNB} and S- K_{eNB} are refreshed. In such case E-UTRAN performs handover with SCG change i.e. an *RRCCConnectionReconfiguration* message including both *mobilityControlInfo* and *mobilityControlInfoSCG*. The ciphering algorithm is common for all radio bearers within a CG but may be different between MCG and SCG. The ciphering algorithm for SCG DRBs can only be changed upon SCG change.

5.3.1.2a RN security

For RNs, AS security follows the procedures in 5.3.1.2. Furthermore, E-UTRAN may configure per DRB whether or not integrity protection is used. The use of integrity protection may be configured only upon DRB establishment and reconfigured only upon handover or upon the first reconfiguration following RRC connection re-establishment.

To provide integrity protection on DRBs between the RN and the E-UTRAN, the K_{UPint} key is derived from the K_{eNB} key as described in TS33.401 [32]. The same integrity protection algorithm used for SRBs also applies to the DRBs. The K_{UPint} changes at every handover and RRC connection re-establishment and is based on an updated K_{eNB} which is derived by taking into account the *nextHopChainingCount*. The COUNT value maintained for DRB ciphering is also used for integrity protection, if the integrity protection is configured for the DRB.

5.3.1.3 Connected mode mobility

In RRC_CONNECTED, the network controls UE mobility, i.e. the network decides when the UE shall connect to which E-UTRA cell(s), or inter-RAT cell. For network controlled mobility in RRC_CONNECTED, the PCell can be changed using an *RRCCConnectionReconfiguration* message including the *mobilityControlInfo* (handover), whereas the SCell(s) can be changed using the *RRCCConnectionReconfiguration* message either with or without the *mobilityControlInfo*.

An SCG can be established, reconfigured or released by using an *RRCCConnectionReconfiguration* message with or without the *mobilityControlInfo*. In case Random Access to the PSCell or initial PUSCH transmission to the PSCell if *rach-SkipSCG* is configured is required upon SCG reconfiguration, E-UTRAN employs the SCG change procedure (i.e. an *RRCCConnectionReconfiguration* message including the *mobilityControlInfoSCG*). The PSCell can only be changed using the SCG change procedure and by release and addition of the PSCell.

The network triggers the handover procedure e.g. based on radio conditions, load. To facilitate this, the network may configure the UE to perform measurement reporting (possibly including the configuration of measurement gaps). The network may also initiate handover blindly, i.e. without having received measurement reports from the UE.

Before sending the handover message to the UE, the source eNB prepares one or more target cells. The source eNB selects the target PCell. The source eNB may also provide the target eNB with a list of best cells on each frequency for which measurement information is available, in order of decreasing RSRP. The source eNB may also include available measurement information for the cells provided in the list. The target eNB decides which SCells are configured for use after handover, which may include cells other than the ones indicated by the source eNB. If an SCG is configured, handover involves either SCG release or SCG change. In case the UE was configured with DC, the target eNB indicates in the handover message whether the UE shall release the entire SCG configuration. Upon connection re-establishment,

the UE releases the entire SCG configuration except for the DRB configuration, while E-UTRAN in the first reconfiguration message following the re-establishment either releases the DRB(s) or reconfigures the DRB(s) to MCG DRB(s).

The target eNB generates the message used to perform the handover, i.e. the message including the AS-configuration to be used in the target cell(s). The source eNB transparently (i.e. does not alter values/ content) forwards the handover message/ information received from the target to the UE. When appropriate, the source eNB may initiate data forwarding for (a subset of) the DRBs.

After receiving the handover message, the UE attempts to access the target PCell at the first available RACH occasion according to Random Access resource selection defined in TS 36.321 [6], i.e. the handover is asynchronous, or at the first available PUSCH occasion if *rach-Skip* is configured. Consequently, when allocating a dedicated preamble for the random access in the target PCell, E-UTRA shall ensure it is available from the first RACH occasion the UE may use. The first available PUSCH occasion is provided by *ul-ConfigInfo*, if configured, otherwise UE shall monitor the PDCCH of target eNB. Upon successful completion of the handover, the UE sends a message used to confirm the handover.

If the target eNB does not support the release of RRC protocol which the source eNB used to configure the UE, the target eNB may be unable to comprehend the UE configuration provided by the source eNB. In this case, the target eNB should use the full configuration option to reconfigure the UE for Handover and Re-establishment. Full configuration option includes an initialization of the radio configuration, which makes the procedure independent of the configuration used in the source cell(s) with the exception that the security algorithms are continued for the RRC re-establishment.

After the successful completion of handover, PDCP SDUs may be re-transmitted in the target cell(s). This only applies for DRBs using RLC-AM mode and for handovers not involving full configuration option. The further details are specified in TS 36.323 [8]. After the successful completion of handover not involving full configuration option, the SN and the HFN are reset except for the DRBs using RLC-AM mode (for which both SN and HFN continue). For reconfigurations involving the full configuration option, the PDCP entities are newly established (SN and HFN do not continue) for all DRBs irrespective of the RLC mode. The further details are specified in TS 36.323 [8].

One UE behaviour to be performed upon handover is specified, i.e. this is regardless of the handover procedures used within the network (e.g. whether the handover includes X2 or S1 signalling procedures).

The source eNB should, for some time, maintain a context to enable the UE to return in case of handover failure. After having detected handover failure, the UE attempts to resume the RRC connection either in the source PCell or in another cell using the RRC re-establishment procedure. This connection resumption succeeds only if the accessed cell is prepared, i.e. concerns a cell of the source eNB or of another eNB towards which handover preparation has been performed. The cell in which the re-establishment procedure succeeds becomes the PCell while SCells and STAGs, if configured, are released.

Normal measurement and mobility procedures are used to support handover to cells broadcasting a CSG identity. In addition, E-UTRAN may configure the UE to report that it is entering or leaving the proximity of cell(s) included in its CSG whitelist. Furthermore, E-UTRAN may request the UE to provide additional information broadcast by the handover candidate cell e.g. global cell identity, CSG identity, CSG membership status.

NOTE: E-UTRAN may use the 'proximity report' to configure measurements as well as to decide whether or not to request additional information broadcast by the handover candidate cell. The additional information is used to verify whether or not the UE is authorised to access the target PCell and may also be needed to identify handover candidate cell (*PCI confusion* i.e. when the physical layer identity that is included in the measurement report does not uniquely identify the cell).

5.3.1.4 Connection control in NB-IoT

In NB-IoT, during the RRC connection establishment procedure, SRB1bis is established implicitly with SRB1. SRB1bis uses the logical channel identity defined in 9.1.2a, with the same configuration as SRB1 but no PDCP entity. SRB1bis is used until security is activated. The RRC messages to activate security (command and successful response) are sent over SRB1 being integrity protected and ciphering is started after completion of the procedure. In case of unsuccessful security activation, the failure message is sent over SRB1 and subsequent messages are sent over SRB1bis. Once security is activated, new RRC messages shall be transmitted using SRB1. A NB-IoT UE that only supports the Control Plane CIoT EPS optimisation (see TS 24.301 [35]) only establishes SRB1bis.

A NB-IoT UE only supports 0, 1 or 2 DRBs, depending on its capability. A NB-IoT UE that only supports the Control Plane CIoT EPS optimisation (see TS 24.301 [35]) does not need to support any DRBs and associated procedures.

Table 5.3.1.4-1 lists the procedures that are applicable for NB-IoT. All other procedures are not applicable; this is not further stated in the corresponding procedures.

Table 5.3.1.4-1: Connection control procedures applicable to a NB-IoT UE

Clause	Procedures
5.3.2	Paging
5.3.3	RRC connection establishment
	RRC connection resume (see NOTE)
5.3.4	Initial security activation (see NOTE)
5.3.5	RRC connection reconfiguration (see NOTE)
5.3.7	RRC connection re-establishment
5.3.8	RRC connection release
5.3.9	RRC connection release requested by upper layers
5.3.10	Radio resource configuration
5.3.11	Radio link failure related actions
5.3.12	UE actions upon leaving RRC_CONNECTED

NOTE: Not applicable for a UE that only supports the Control Plane CIoT EPS optimisation (see TS 24.301 [35]).

5.3.2 Paging

5.3.2.1 General



Figure 5.3.2.1-1: Paging

The purpose of this procedure is:

- to transmit paging information to a UE in RRC_IDLE and/ or;
- to inform UEs in RRC_IDLE, and UEs in RRC_CONNECTED other than NB-IoT UEs, BL UEs and UEs in CE, about a system information change and/ or;
- to inform UEs in RRC_IDLE other than NB-IoT UEs, and UEs in RRC_CONNECTED other than NB-IoT UEs, BL UEs and UEs in CE, about an ETWS primary notification and/ or ETWS secondary notification and/ or;
- to inform UEs in RRC_IDLE other than NB-IoT UEs, and UEs in RRC_CONNECTED other than NB-IoT UEs, BL UEs and UEs in CE, about a CMAS notification and/ or;
- to inform UEs other than NB-IoT UEs in RRC_IDLE about an EAB parameters modification and/ or;
- to inform UEs other than NB-IoT UEs in RRC_IDLE to perform E-UTRAN inter-frequency redistribution procedure.

The paging information is provided to upper layers, which in response may initiate RRC connection establishment, e.g. to receive an incoming call.

5.3.2.2 Initiation

E-UTRAN initiates the paging procedure by transmitting the *Paging* message at the UE's paging occasion as specified in TS 36.304 [4]. E-UTRAN may address multiple UEs within a *Paging* message by including one *PagingRecord* for

each UE. E-UTRAN may also indicate a change of system information, and/ or provide an ETWS notification or a CMAS notification in the *Paging* message.

5.3.2.3 Reception of the *Paging* message by the UE

Upon receiving the *Paging* message, the UE shall:

- 1> if in RRC_IDLE, for each of the *PagingRecord*, if any, included in the *Paging* message:
 - 2> if the *ue-Identity* included in the *PagingRecord* matches one of the UE identities allocated by upper layers:
 - 3> forward the *ue-Identity* and, except for NB-IoT, the *cn-Domain* to the upper layers;
- 1> if the UE is not configured with a DRX cycle longer than the modification period and the *systemInfoModification* is included; or
- 1> if the UE is configured with a DRX cycle longer than the modification period and the *systemInfoModification-eDRX* is included:
 - 2> re-acquire the required system information using the system information acquisition procedure as specified in 5.2.2.
- 1> if the *etws-Indication* is included and the UE is ETWS capable:
 - 2> re-acquire *SystemInformationBlockType1* immediately, i.e., without waiting until the next system information modification period boundary;
 - 2> if the *schedulingInfoList* indicates that *SystemInformationBlockType10* is present:
 - 3> acquire *SystemInformationBlockType10*;

NOTE: If the UE is in CE, it is up to UE implementation when to start acquiring *SystemInformationBlockType10*.

- 2> if the *schedulingInfoList* indicates that *SystemInformationBlockType11* is present:
 - 3> acquire *SystemInformationBlockType11*;
- 1> if the *cmas-Indication* is included and the UE is CMAS capable:
 - 2> re-acquire *SystemInformationBlockType1* immediately, i.e., without waiting until the next system information modification period boundary as specified in 5.2.1.5;
 - 2> if the *schedulingInfoList* indicates that *SystemInformationBlockType12* is present:
 - 3> acquire *SystemInformationBlockType12*;
- 1> if in RRC_IDLE, the *eab-ParamModification* is included and the UE is EAB capable:
 - 2> consider previously stored *SystemInformationBlockType14* as invalid;
 - 2> re-acquire *SystemInformationBlockType1* immediately, i.e., without waiting until the next system information modification period boundary as specified in 5.2.1.6;
 - 2> re-acquire *SystemInformationBlockType14* using the system information acquisition procedure as specified in 5.2.2.4;
- 1> if in RRC_IDLE, the *redistributionIndication* is included and the UE is redistribution capable:
 - 2> Perform E-UTRAN inter-frequency redistribution procedure as specified in TS 36.304 (5.2.4.10, [4]);

5.3.3 RRC connection establishment

5.3.3.1 General

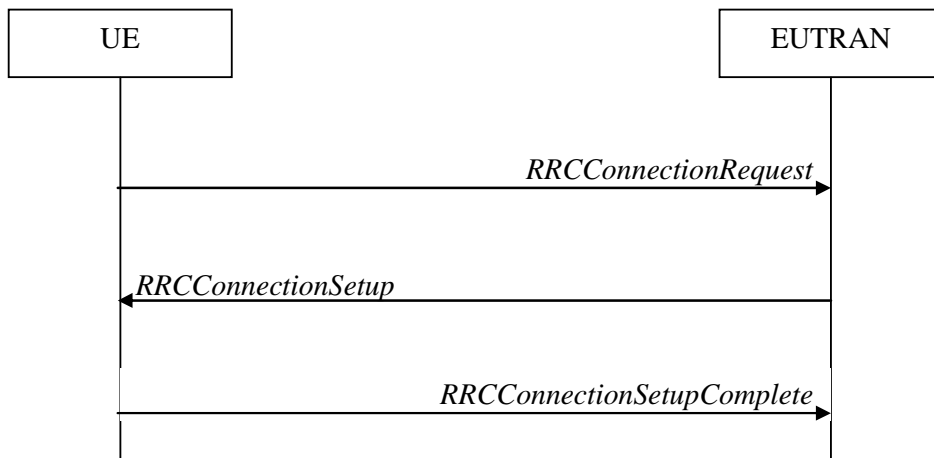

Figure 5.3.3.1-1: RRC connection establishment, successful

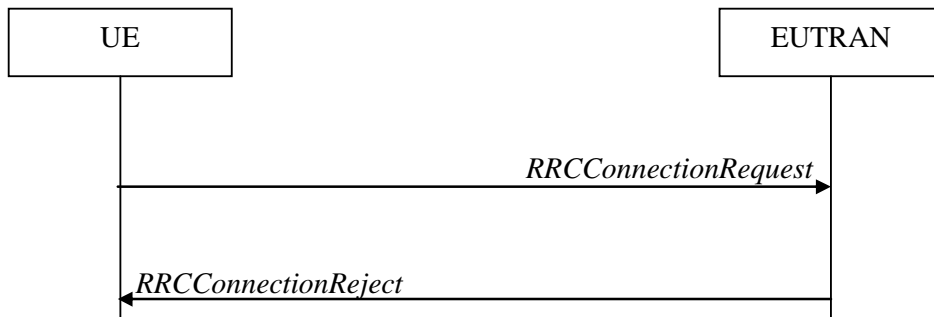

Figure 5.3.3.1-2: RRC connection establishment, network reject

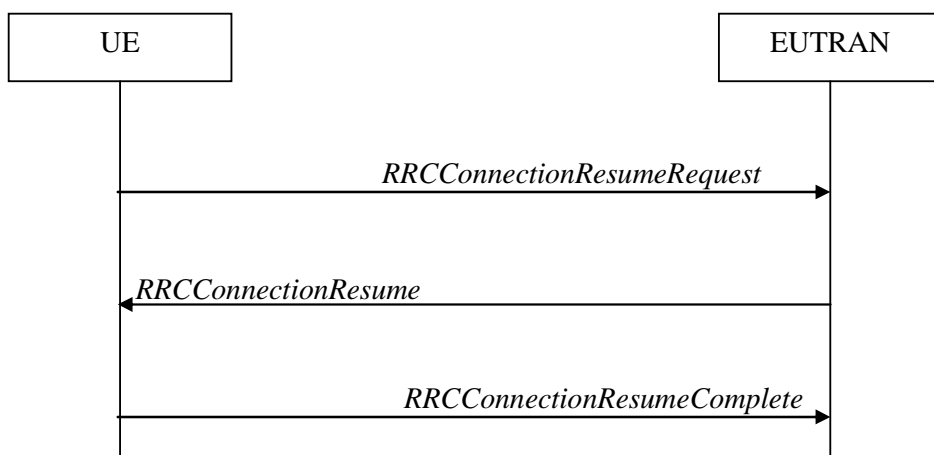

Figure 5.3.3.1-3: RRC connection resume, successful

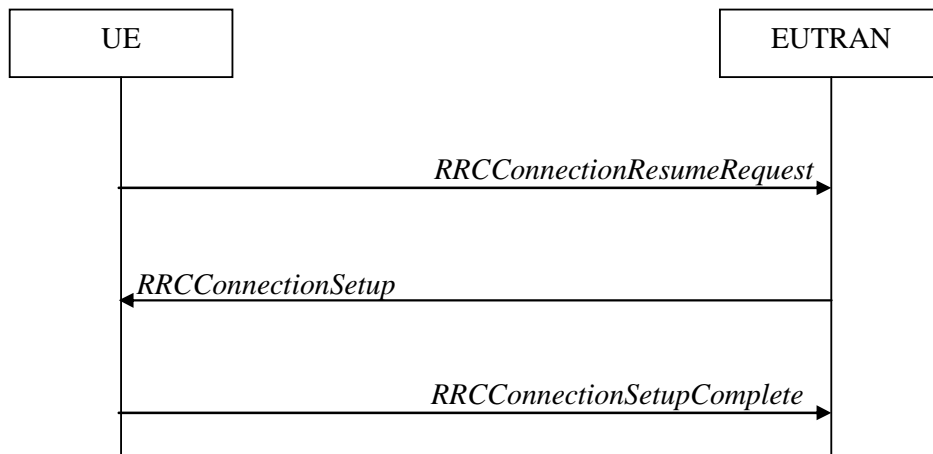

Figure 5.3.3.1-4: RRC connection resume fallback to RRC connection establishment, successful

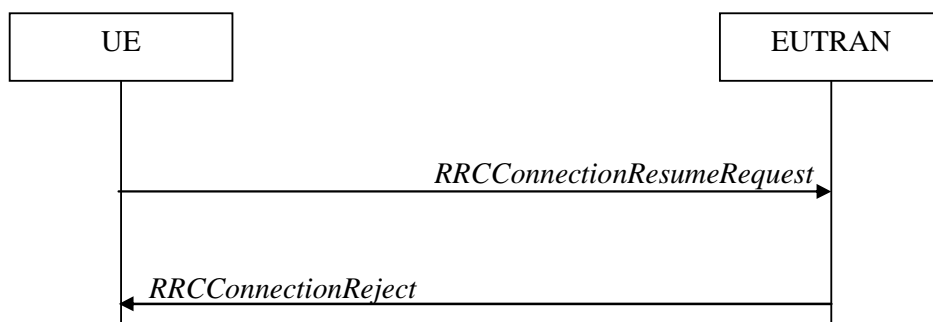

Figure 5.3.3.1-5: RRC connection resume, network reject or release

The purpose of this procedure is to establish or resume an RRC connection. RRC connection establishment involves SRB1 (and SRB1bis for NB-IoT) establishment. The procedure is also used to transfer the initial NAS dedicated information/ message from the UE to E-UTRAN.

E-UTRAN applies the procedure as follows:

- When establishing an RRC connection:
 - to establish SRB1 and, for NB-IoT, SRB1bis;
- When resuming an RRC connection:
 - to restore the AS configuration from a stored context including resuming SRB(s) and DRB(s).

5.3.3.1a Conditions for establishing RRC Connection for sidelink communication/ discovery/ V2X sidelink communication

For sidelink communication an RRC connection is initiated only in the following case:

- 1> if configured by upper layers to transmit non-relay related sidelink communication and related data is available for transmission:
 - 2> if *SystemInformationBlockType18* is broadcast by the cell on which the UE camps; and if the valid version of *SystemInformationBlockType18* does not include *commTxPoolNormalCommon*;
- 1> if configured by upper layers to transmit relay related sidelink communication:
 - 2> if the UE is acting as sidelink relay UE; and if *SystemInformationBlockType18* is broadcast by the cell on which the UE camps; or
 - 2> if the UE has a selected sidelink relay UE; and if the sidelink remote UE threshold conditions as specified in 5.10.11.5 are met and if *SystemInformationBlockType18* is broadcast by the cell on which the UE camps; and

if the valid version of *SystemInformationBlockType18* does not include *commTxPoolNormalCommon* or *commTxAllowRelayCommon*;

For V2X sidelink communication an RRC connection is initiated only in the following case:

- 1> if configured by upper layers to transmit non-P2X related V2X sidelink communication and related data is available for transmission:
 - 2> if the frequency on which the UE is configured to transmit non-P2X related V2X sidelink communication concerns the camped frequency; and if *SystemInformationBlockType21* is broadcast by the cell on which the UE camps; and if the valid version of *SystemInformationBlockType21* includes *sl-V2X-ConfigCommon*; and *sl-V2X-ConfigCommon* does not include *v2x-CommTxPoolNormalCommon*; or
 - 2> if the frequency on which the UE is configured to transmit non-P2X related V2X sidelink communication is included in *v2x-InterFreqInfoList* within *SystemInformationBlockType21* broadcast by the cell on which the UE camps; and if the valid version of *SystemInformationBlockType21* does not include *v2x-CommTxPoolNormal* for the concerned frequency;
- 1> if configured by upper layers to transmit P2X related V2X sidelink communication and related data is available for transmission:
 - 2> if the frequency on which the UE is configured to transmit P2X related V2X sidelink communication concerns the camped frequency; and if *SystemInformationBlockType21* is broadcast by the cell on which the UE camps; and if the valid version of *SystemInformationBlockType21* includes *sl-V2X-ConfigCommon*; and *sl-V2X-ConfigCommon* does not include *p2x-CommTxPoolNormalCommon*; or
 - 2> if the frequency on which the UE is configured to transmit P2X related V2X sidelink communication is included in *v2x-InterFreqInfoList* within *SystemInformationBlockType21* broadcast by the cell on which the UE camps; and if the valid version of *SystemInformationBlockType21* does not include *p2x-CommTxPoolNormal* for the concerned frequency;

For sidelink discovery an RRC connection is initiated only in the following case:

- 1> if configured by upper layers to transmit non-PS related sidelink discovery announcements:
 - 2> if the frequency on which the UE is configured to transmit non-PS related sidelink discovery announcements concerns the camped frequency; and *SystemInformationBlockType19* of the cell on which the UE camps does not include *discTxPoolCommon-r12*; or
 - 2> if the frequency on which the UE is configured to transmit non-PS related sidelink discovery announcements is included in *discInterFreqList* in *SystemInformationBlockType19* broadcast by the cell on which the UE camps, with *discTxResourcesInterFreq* included within *discResourcesNonPS* and set to *requestDedicated*;
- 1> if configured by upper layers to transmit non-relay PS related sidelink discovery announcements:
 - 2> if the frequency on which the UE is configured to transmit non-relay PS related sidelink discovery announcements concerns the camped frequency; and *SystemInformationBlockType19* of the cell on which the UE camps includes *discConfigPS* but does not include *discTxPoolPS-Common*; or
 - 2> if the frequency on which the UE is configured to transmit non-relay PS related sidelink discovery announcements (e.g. group member discovery) is included in *discInterFreqList* in *SystemInformationBlockType19* broadcast by the cell on which the UE camps, with *discTxResourcesInterFreq* within *discResourcesPS* included and set to *requestDedicated*;
- 1> if configured by upper layers to transmit relay PS related sidelink discovery announcements:
 - 2> if the UE is acting as sidelink relay UE; and if the sidelink relay UE threshold conditions as specified in 5.10.10.4 are met; or
 - 2> if the UE is selecting a sidelink relay UE / has a selected sidelink relay UE; and if the sidelink remote UE threshold conditions as specified in 5.10.11.5 are met:
 - 3> if the frequency on which the UE is configured to transmit relay PS related sidelink discovery announcements concerns the camped frequency; and *SystemInformationBlockType19* of the cell on which the UE camps includes *discConfigRelay* and *discConfigPS* but does not include *discTxPoolPS-Common*;

NOTE: Upper layers initiate an RRC connection. The interaction with NAS is left to UE implementation.

5.3.3.2 Initiation

The UE initiates the procedure when upper layers request establishment or resume of an RRC connection while the UE is in RRC_IDLE.

Except for NB-IoT, upon initiation of the procedure, the UE shall:

- 1> if *SystemInformationBlockType2* includes *ac-BarringPerPLMN-List* and the *ac-BarringPerPLMN-List* contains an *AC-BarringPerPLMN* entry with the *plmn-IdentityIndex* corresponding to the PLMN selected by upper layers (see TS 23.122 [11], TS 24.301 [35]):
 - 2> select the *AC-BarringPerPLMN* entry with the *plmn-IdentityIndex* corresponding to the PLMN selected by upper layers;
 - 2> in the remainder of this procedure, use the selected *AC-BarringPerPLMN* entry (i.e. presence or absence of access barring parameters in this entry) irrespective of the common access barring parameters included in *SystemInformationBlockType2*;
- 1> else
 - 2> in the remainder of this procedure use the common access barring parameters (i.e. presence or absence of these parameters) included in *SystemInformationBlockType2*;
- 1> if *SystemInformationBlockType2* contains *acdc-BarringPerPLMN-List* and the *acdc-BarringPerPLMN-List* contains an *ACDC-BarringPerPLMN* entry with the *plmn-IdentityIndex* corresponding to the PLMN selected by upper layers (see TS 23.122 [11], TS 24.301 [35]):
 - 2> select the *ACDC-BarringPerPLMN* entry with the *plmn-IdentityIndex* corresponding to the PLMN selected by upper layers;
 - 2> in the remainder of this procedure, use the selected *ACDC-BarringPerPLMN* entry for ACDC barring check (i.e. presence or absence of access barring parameters in this entry) irrespective of the *acdc-BarringForCommon* parameters included in *SystemInformationBlockType2*;
- 1> else:
 - 2> in the remainder of this procedure use the *acdc-BarringForCommon* (i.e. presence or absence of these parameters) included in *SystemInformationBlockType2* for ACDC barring check;
- 1> if upper layers indicate that the RRC connection is subject to EAB (see TS 24.301 [35]):
 - 2> if the result of the EAB check, as specified in 5.3.3.12, is that access to the cell is barred:
 - 3> inform upper layers about the failure to establish the RRC connection or failure to resume the RRC connection with suspend indication and that EAB is applicable, upon which the procedure ends;
- 1> if upper layers indicate that the RRC connection is subject to ACDC (see TS 24.301 [35]), *SystemInformationBlockType2* contains *BarringPerACDC-CategoryList*, and *acdc-HPLMNonly* indicates that ACDC is applicable for the UE:
 - 2> if the *BarringPerACDC-CategoryList* contains a *BarringPerACDC-Category* entry corresponding to the ACDC category selected by upper layers:
 - 3> select the *BarringPerACDC-Category* entry corresponding to the ACDC category selected by upper layers;
 - 2> else:
 - 3> select the last *BarringPerACDC-Category* entry in the *BarringPerACDC-CategoryList*;
 - 2> stop timer T308, if running;
 - 2> perform access barring check as specified in 5.3.3.13, using T308 as "Tbarring" and *acdc-BarringConfig* in the *BarringPerACDC-Category* as "ACDC barring parameter";

- 2> if access to the cell is barred:
 - 3> inform upper layers about the failure to establish the RRC connection or failure to resume the RRC connection with suspend indication and that access barring is applicable due to ACDC, upon which the procedure ends;
- 1> else if the UE is establishing the RRC connection for mobile terminating calls:
 - 2> if timer T302 is running:
 - 3> inform upper layers about the failure to establish the RRC connection or failure to resume the RRC connection with suspend indication and that access barring for mobile terminating calls is applicable, upon which the procedure ends;
- 1> else if the UE is establishing the RRC connection for emergency calls:
 - 2> if *SystemInformationBlockType2* includes the *ac-BarringInfo*:
 - 3> if the *ac-BarringForEmergency* is set to *TRUE*:
 - 4> if the UE has one or more Access Classes, as stored on the USIM, with a value in the range 11..15, which is valid for the UE to use according to TS 22.011 [10] and TS 23.122 [11]:
 - 5> if the *ac-BarringInfo* includes *ac-BarringForMO-Data*, and for all of these valid Access Classes for the UE, the corresponding bit in the *ac-BarringForSpecialAC* contained in *ac-BarringForMO-Data* is set to *one*:
 - 6> consider access to the cell as barred;
 - 4> else:
 - 5> consider access to the cell as barred;
- 2> if access to the cell is barred:
 - 3> inform upper layers about the failure to establish the RRC connection or failure to resume the RRC connection with suspend indication, upon which the procedure ends;
- 1> else if the UE is establishing the RRC connection for mobile originating calls:
 - 2> perform access barring check as specified in 5.3.3.11, using T303 as "Tbarring" and *ac-BarringForMO-Data* as "AC barring parameter";
 - 2> if access to the cell is barred:
 - 3> if *SystemInformationBlockType2* includes *ac-BarringForCSFB* or the UE does not support CS fallback:
 - 4> inform upper layers about the failure to establish the RRC connection or failure to resume the RRC connection with suspend indication and that access barring for mobile originating calls is applicable, upon which the procedure ends;
 - 3> else (*SystemInformationBlockType2* does not include *ac-BarringForCSFB* and the UE supports CS fallback):
 - 4> if timer T306 is not running, start T306 with the timer value of T303;
 - 4> inform upper layers about the failure to establish the RRC connection or failure to resume the RRC connection with suspend indication and that access barring for mobile originating calls and mobile originating CS fallback is applicable, upon which the procedure ends;
- 1> else if the UE is establishing the RRC connection for mobile originating signalling:
 - 2> perform access barring check as specified in 5.3.3.11, using T305 as "Tbarring" and *ac-BarringForMO-Signalling* as "AC barring parameter";

- 2> if access to the cell is barred:
 - 3> inform upper layers about the failure to establish the RRC connection or failure to resume the RRC connection with suspend indication and that access barring for mobile originating signalling is applicable, upon which the procedure ends;
- 1> else if the UE is establishing the RRC connection for mobile originating CS fallback:
 - 2> if *SystemInformationBlockType2* includes *ac-BarringForCSFB*:
 - 3> perform access barring check as specified in 5.3.3.11, using T306 as "Tbarring" and *ac-BarringForCSFB* as "AC barring parameter";
 - 3> if access to the cell is barred:
 - 4> inform upper layers about the failure to establish the RRC connection or failure to resume the RRC connection with suspend indication and that access barring for mobile originating CS fallback is applicable, due to *ac-BarringForCSFB*, upon which the procedure ends;
 - 2> else:
 - 3> perform access barring check as specified in 5.3.3.11, using T306 as "Tbarring" and *ac-BarringForMO-Data* as "AC barring parameter";
 - 3> if access to the cell is barred:
 - 4> if timer T303 is not running, start T303 with the timer value of T306;
 - 4> inform upper layers about the failure to establish the RRC connection or failure to resume the RRC connection with suspend indication and that access barring for mobile originating CS fallback and mobile originating calls is applicable, due to *ac-BarringForMO-Data*, upon which the procedure ends;
- 1> else if the UE is establishing the RRC connection for mobile originating MMTEL voice, mobile originating MMTEL video, mobile originating SMSoIP or mobile originating SMS:
 - 2> if the UE is establishing the RRC connection for mobile originating MMTEL voice and *SystemInformationBlockType2* includes *ac-BarringSkipForMMTELVoice*; or
 - 2> if the UE is establishing the RRC connection for mobile originating MMTEL video and *SystemInformationBlockType2* includes *ac-BarringSkipForMMTELVideo*; or
 - 2> if the UE is establishing the RRC connection for mobile originating SMSoIP or SMS and *SystemInformationBlockType2* includes *ac-BarringSkipForSMS*:
 - 3> consider access to the cell as not barred;
 - 2> else:
 - 3> if *establishmentCause* received from higher layers is set to *mo-Signalling* (including the case that *mo-Signalling* is replaced by *highPriorityAccess* according to TS 24.301 [35] or by *mo-VoiceCall* according to the clause 5.3.3.3):
 - 4> perform access barring check as specified in 5.3.3.11, using T305 as "Tbarring" and *ac-BarringForMO-Signalling* as "AC barring parameter";
 - 4> if access to the cell is barred:
 - 5> inform upper layers about the failure to establish the RRC connection or failure to resume the RRC connection with suspend indication and that access barring for mobile originating signalling is applicable, upon which the procedure ends;
 - 3> if *establishmentCause* received from higher layers is set to *mo-Data* (including the case that *mo-Data* is replaced by *highPriorityAccess* according to TS 24.301 [35] or by *mo-VoiceCall* according to the clause 5.3.3.3):
 - 4> perform access barring check as specified in 5.3.3.11, using T303 as "Tbarring" and *ac-BarringForMO-Data* as "AC barring parameter";

- 4> if access to the cell is barred:
 - 5> if *SystemInformationBlockType2* includes *ac-BarringForCSFB* or the UE does not support CS fallback:
 - 6> inform upper layers about the failure to establish the RRC connection or failure to resume the RRC connection with suspend indication and that access barring for mobile originating calls is applicable, upon which the procedure ends;
 - 5> else (*SystemInformationBlockType2* does not include *ac-BarringForCSFB* and the UE supports CS fallback):
 - 6> if timer T306 is not running, start T306 with the timer value of T303;
 - 6> inform upper layers about the failure to establish the RRC connection or failure to resume the RRC connection with suspend indication and that access barring for mobile originating calls and mobile originating CS fallback is applicable, upon which the procedure ends;
- 1> if the UE is resuming an RRC connection:
 - 2> release the MCG SCell(s), if configured, in accordance with 5.3.10.3a;
 - 2> release *powerPrefIndicationConfig*, if configured and stop timer T340, if running;
 - 2> release *reportProximityConfig* and clear any associated proximity status reporting timer;
 - 2> release *obtainLocationConfig*, if configured;
 - 2> release *idc-Config*, if configured;
 - 2> release *sps-AssistanceInfoReport*, if configured;
 - 2> release *measSubframePatternPCell*, if configured;
 - 2> release the entire SCG configuration, if configured, except for the DRB configuration (as configured by *drb-ToAddModListSCG*);
 - 2> release *naics-Info* for the PCell, if configured;
 - 2> release the LWA configuration, if configured, as described in 5.6.14.3;
 - 2> release the LWIP configuration, if configured, as described in 5.6.17.3;
 - 2> release *bw-PreferenceIndicationTimer*, if configured and stop timer T341, if running;
 - 2> release *delayBudgetReportingConfig*, if configured and stop timer T342, if running;
- 1> apply the default physical channel configuration as specified in 9.2.4;
- 1> apply the default semi-persistent scheduling configuration as specified in 9.2.3;
- 1> apply the default MAC main configuration as specified in 9.2.2;
- 1> apply the CCCH configuration as specified in 9.1.1.2;
- 1> apply the *timeAlignmentTimerCommon* included in *SystemInformationBlockType2*;
- 1> start timer T300;
- 1> if the UE is resuming an RRC connection:
 - 2> initiate transmission of the *RRCCConnectionResumeRequest* message in accordance with 5.3.3.3a;
- 1> else:
 - 2> if stored, discard the UE AS context and *resumeIdentity*;
 - 2> initiate transmission of the *RRCCConnectionRequest* message in accordance with 5.3.3.3;

NOTE 2: Upon initiating the connection establishment procedure, the UE is not required to ensure it maintains up to date system information applicable only for UEs in RRC_IDLE state. However, the UE needs to perform system information acquisition upon cell re-selection.

For NB-IoT, upon initiation of the procedure, the UE shall:

- 1> if the UE is establishing or resuming the RRC connection for mobile originating exception data; or
- 1> if the UE is establishing or resuming the RRC connection for mobile originating data; or
- 1> if the UE is establishing or resuming the RRC connection for delay tolerant access; or
- 1> if the UE is establishing or resuming the RRC connection for mobile originating signalling;
 - 2> perform access barring check as specified in 5.3.3.14;
 - 2> if access to the cell is barred:
 - 3> inform upper layers about the failure to establish the RRC connection or failure to resume the RRC connection with suspend indication and that access barring is applicable, upon which the procedure ends;
- 1> apply the default physical channel configuration as specified in 9.2.4;
- 1> apply the default MAC main configuration as specified in 9.2.2;
- 1> apply the CCCH configuration as specified in 9.1.1.2;
- 1> start timer T300;
- 1> if the UE is establishing an RRC connection:
 - 2> if stored, discard the UE AS context and *resumeIdentity*;
 - 2> initiate transmission of the *RRCConnectionRequest* message in accordance with 5.3.3.3;
- 1> else if the UE is resuming an RRC connection:
 - 2> initiate transmission of the *RRCConnectionResumeRequest* message in accordance with 5.3.3.3a;

NOTE 3: Upon initiating the connection establishment or resumption procedure, the UE is not required to ensure it maintains up to date system information applicable only for UEs in RRC_IDLE state. However, the UE needs to perform system information acquisition upon cell re-selection.

5.3.3.3 Actions related to transmission of *RRCConnectionRequest* message

The UE shall set the contents of *RRCConnectionRequest* message as follows:

- 1> set the *ue-Identity* as follows:
 - 2> if upper layers provide an S-TMSI:
 - 3> set the *ue-Identity* to the value received from upper layers;
 - 2> else:
 - 3> draw a random value in the range $0 \dots 2^{40}-1$ and set the *ue-Identity* to this value;

NOTE 1: Upper layers provide the S-TMSI if the UE is registered in the TA of the current cell.

- 1> if the UE supports *mo-VoiceCall* establishment cause and UE is establishing the RRC connection for mobile originating MMTEL voice and *SystemInformationBlockType2* includes *voiceServiceCauseIndication* and the establishment cause received from upper layers is not the *highPriorityAccess* value:
 - 2> set the *establishmentCause* to *mo-VoiceCall*;
- 1> else if the UE supports *mo-VoiceCall* establishment cause for mobile originating MMTEL video and UE is establishing the RRC connection for mobile originating MMTEL video and *SystemInformationBlockType2*

includes *videoServiceCauseIndication* and the establishment cause received from upper layers is not the *highPriorityAccess* value:

2> set the *establishmentCause* to *mo-VoiceCall*;

1> else:

2> set the *establishmentCause* in accordance with the information received from upper layers;

1> if the UE is a NB-IoT UE:

2> if the UE supports multi-tone transmission, include *multiToneSupport*;

2> if the UE supports multi-carrier operation, include *multiCarrierSupport*;

2> if the UE supports DL channel quality reporting and *cqi-Reporting* is present in *SystemInformationBlockType2-NB*:

3> set the *cqi-NPDCCH* to include the latest results of the downlink channel quality measurements of the serving cell as specified in TS 36.133 [16];

NOTE 2: The downlink channel quality measurements may use measurement period T1 or T2, as defined in TS 36.133 [16]. In case period T2 is used the RRC-MAC interactions are left to UE implementation.

2> if the UE supports MAC PDU containing the UE contention resolution identity MAC control element without RRC response message, set *earlyContentionResolution* to TRUE.

The UE shall submit the *RRCConnectionRequest* message to lower layers for transmission.

The UE shall continue cell re-selection related measurements as well as cell re-selection evaluation. If the conditions for cell re-selection are fulfilled, the UE shall perform cell re-selection as specified in 5.3.3.5.

5.3.3.3a Actions related to transmission of *RRCConnectionResumeRequest* message

The UE shall set the contents of *RRCConnectionResumeRequest* message as follows:

1> if the UE is a NB-IoT UE; or

1> if field *useFullResumeID* is signalled in *SystemInformationBlockType2*:

2> set the *resumeID* to the stored *resumeIdentity*;

1> else:

2> set the *truncatedResumeID* to include bits in bit position 9 to 20 and 29 to 40 from the left in the stored *resumeIdentity*.

1> if the UE supports *mo-VoiceCall* establishment cause and UE is resuming the RRC connection for mobile originating MMTEL voice and *SystemInformationBlockType2* includes *voiceServiceCauseIndication* and the establishment cause received from upper layers is not the *highPriorityAccess* value:

2> set the *resumeCause* to *mo-VoiceCall*;

1> else if the UE supports *mo-VoiceCall* establishment cause for mobile originating MMTEL video and UE is resuming the RRC connection for mobile originating MMTEL video and *SystemInformationBlockType2* includes *videoServiceCauseIndication* and the establishment cause received from upper layers is not the *highPriorityAccess* value:

2> set the *resumeCause* to *mo-VoiceCall*;

1> else:

2> set the *resumeCause* in accordance with the information received from upper layers;

1> set the *shortResumeMAC-I* to the 16 least significant bits of the MAC-I calculated:

- 2> over the ASN.1 encoded as per clause 8 (i.e., a multiple of 8 bits) *VarShortResumeMAC-Input* (or *VarShortResumeMAC-Input-NB* in NB-IoT);
- 2> with the K_{RRCint} key and the previously configured integrity protection algorithm; and
- 2> with all input bits for COUNT, BEARER and DIRECTION set to binary ones;
- 1> if the UE is a NB-IoT UE:
 - 2> if the UE supports DL channel quality reporting and *cqi-Reporting* is present in *SystemInformationBlockType2-NB*:
 - 3> set the *cqi-NPDCCH* to include the latest results of the downlink channel quality measurements of the serving cell as specified in TS 36.133 [16];

NOTE 1: The downlink channel quality measurements may use measurement period T1 or T2, as defined in TS 36.133 [16]. In case period T2 is used the RRC-MAC interactions are left to UE implementation.

- 2> if the UE supports MAC PDU containing the UE contention resolution identity MAC control element without RRC response message, set *earlyContentionResolution* to TRUE.
- 1> restore the RRC configuration and security context from the stored UE AS context;
- 1> restore the PDCP state and re-establish PDCP entities for SRB1;
- 1> resume SRB1;

NOTE 2: Until successful connection resumption, the default physical layer configuration and the default MAC Main configuration are applied for the transmission of SRB0 and SRB1, and SRB1 is used only for the transfer of *RRCConnectionResume* message.

The UE shall submit the *RRCConnectionResumeRequest* message to lower layers for transmission.

The UE shall continue cell re-selection related measurements as well as cell re-selection evaluation. If the conditions for cell re-selection are fulfilled, the UE shall perform cell re-selection as specified in 5.3.3.5.

5.3.3.4 Reception of the *RRCConnectionSetup* by the UE

NOTE 1: Prior to this, lower layer signalling is used to allocate a C-RNTI. For further details see TS 36.321 [6];

The UE shall:

- 1> if the *RRCConnectionSetup* is received in response to an *RRCConnectionResumeRequest*:
 - 2> release all radio resources, including release of the RLC entity, the MAC configuration and the associated PDCP entity for all established or suspended RBs, except for SRB0;
 - 2> discard the stored UE AS context and *resumeIdentity*;
 - 2> indicate to upper layers that the RRC connection resume has been fallbacked;
- 1> perform the radio resource configuration procedure in accordance with the received *radioResourceConfigDedicated* and as specified in 5.3.10;
- 1> if stored, discard the cell reselection priority information provided by the *idleModeMobilityControlInfo* or inherited from another RAT;
- 1> if stored, discard the dedicated offset provided by the *redirectedCarrierOffsetDedicated*;
- 1> stop timer T300;
- 1> stop timer T302, if running;
- 1> stop timer T303, if running;
- 1> stop timer T305, if running;

- 1> stop timer T306, if running;
- 1> stop timer T308, if running;
- 1> perform the actions as specified in 5.3.3.7;
- 1> stop timer T320, if running;
- 1> stop timer T350, if running;
- 1> perform the actions as specified in 5.6.12.4;
- 1> release *rclwi-Configuration*, if configured, as specified in 5.6.16.2;
- 1> stop timer T360, if running;
- 1> stop timer T322, if running;
- 1> enter RRC_CONNECTED;
- 1> stop the cell re-selection procedure;
- 1> consider the current cell to be the PCell;
- 1> set the content of *RRCCConnectionSetupComplete* message as follows:
 - 2> if the *RRCCConnectionSetup* is received in response to an *RRCCConnectionResumeRequest*:
 - 3> if upper layers provide an S-TMSI:
 - 4> set the *s-TMSI* to the value received from upper layers;
 - 2> set the *selectedPLMN-Identity* to the PLMN selected by upper layers (see TS 23.122 [11], TS 24.301 [35]) from the PLMN(s) included in the *plmn-IdentityList* in *SystemInformationBlockType1* (or *SystemInformationBlockType1-NB* in NB-IoT);
 - 2> if upper layers provide the 'Registered MME', include and set the *registeredMME* as follows:
 - 3> if the PLMN identity of the 'Registered MME' is different from the PLMN selected by the upper layers:
 - 4> include the *plmnIdentity* in the *registeredMME* and set it to the value of the PLMN identity in the 'Registered MME' received from upper layers;
 - 3> set the *mmegi* and the *mmec* to the value received from upper layers;
 - 2> if upper layers provided the 'Registered MME':
 - 3> include and set the *gummei-Type* to the value provided by the upper layers;
 - 2> if the UE supports CIoT EPS optimisation(s):
 - 3> include *attachWithoutPDN-Connectivity* if received from upper layers;
 - 3> include *up-CIoT-EPS-Optimisation* if received from upper layers;
 - 3> except for NB-IoT, include *cp-CIoT-EPS-Optimisation* if received from upper layers;
 - 2> if connecting as an RN:
 - 3> include the *rn-SubframeConfigReq*;
 - 2> set the *dedicatedInfoNAS* to include the information received from upper layers;
 - 2> except for NB-IoT:
 - 3> if the UE has radio link failure or handover failure information available in *VarRLF-Report* and if the RPLMN is included in *plmn-IdentityList* stored in *VarRLF-Report*:
 - 4> include *rlf-InfoAvailable*;

- 3> if the UE has MBSFN logged measurements available for E-UTRA and if the RPLMN is included in *plmn-IdentityList* stored in *VarLogMeasReport*:
 - 4> include *logMeasAvailableMBSFN*;
- 3> else if the UE has logged measurements available for E-UTRA and if the RPLMN is included in *plmn-IdentityList* stored in *VarLogMeasReport*:
 - 4> include *logMeasAvailable*;
- 3> if the UE has connection establishment failure information available in *VarConnEstFailReport* and if the RPLMN is equal to *plmn-Identity* stored in *VarConnEstFailReport*:
 - 4> include *connEstFailInfoAvailable*;
- 3> include the *mobilityState* and set it to the mobility state (as specified in TS 36.304 [4]) of the UE just prior to entering RRC_CONNECTED state;
- 3> if the UE supports storage of mobility history information and the UE has mobility history information available in *VarMobilityHistoryReport*:
 - 4> include the *mobilityHistoryAvail*;
- 2> for NB-IoT:
 - 3> if the UE supports serving cell idle mode measurements reporting and *servingCellMeasInfo* is present in *SystemInformationBlockType2-NB*:
 - 4> set the *measResultServCell* to include the measurements of the serving cell;

NOTE 2: The UE includes the latest results of the serving cell measurements as used for cell selection/ reselection evaluation, which are performed in accordance with the performance requirements as specified in TS 36.133 [16].

- 2> include *dcn-ID* if a DCN-ID value (see TS 23.401 [41]) is received from upper layers;
- 2> if UE needs UL gaps during continuous uplink transmission:
 - 3> include *ue-CE-NeedULGaps*;
- 2> submit the *RRCCConnectionSetupComplete* message to lower layers for transmission, upon which the procedure ends;

5.3.3.4a Reception of the *RRCCConnectionResume* by the UE

The UE shall:

- 1> stop timer T300;
- 1> restore the PDCP state and re-establish PDCP entities for SRB2 and all DRBs;
- 1> if *drb-ContinueROHC* is included:
 - 2> indicate to lower layers that stored UE AS context is used and that *drb-ContinueROHC* is configured;
 - 2> continue the header compression protocol context for the DRBs configured with the header compression protocol;
- 1> else:
 - 2> indicate to lower layers that stored UE AS context is used;
 - 2> reset the header compression protocol context for the DRBs configured with the header compression protocol;
- 1> discard the stored UE AS context and *resumeIdentity*;

- 1> perform the radio resource configuration procedure in accordance with the received *radioResourceConfigDedicated* and as specified in 5.3.10;

NOTE 1: When performing the radio resource configuration procedure, for the physical layer configuration and the MAC Main configuration, the restored RRC configuration from the stored UE AS context is used as basis for the reconfiguration.

- 1> resume SRB2 and all DRBs;
- 1> if stored, discard the cell reselection priority information provided by the *idleModeMobilityControlInfo* or inherited from another RAT;
- 1> if stored, discard the dedicated offset provided by the *redirectedCarrierOffsetDedicated*;
- 1> if the *RRCConnectionResume* message includes the *measConfig*:
 - 2> perform the measurement configuration procedure as specified in 5.5.2;
- 1> stop timer T302, if running;
- 1> stop timer T303, if running;
- 1> stop timer T305, if running;
- 1> stop timer T306, if running;
- 1> stop timer T308, if running;
- 1> perform the actions as specified in 5.3.3.7;
- 1> stop timer T320, if running;
- 1> stop timer T350, if running;
- 1> perform the actions as specified in 5.6.12.4;
- 1> stop timer T360, if running;
- 1> stop timer T322, if running;
- 1> update the K_{eNB} key based on the K_{ASME} key to which the current K_{eNB} is associated, using the *nextHopChainingCount* value indicated in the *RRCConnectionResume* message, as specified in TS 33.401 [32];
- 1> store the *nextHopChainingCount* value;
- 1> derive the K_{RRCint} key associated with the previously configured integrity algorithm, as specified in TS 33.401 [32];
- 1> request lower layers to verify the integrity protection of the *RRCConnectionResume* message, using the previously configured algorithm and the K_{RRCint} key;
- 1> if the integrity protection check of the *RRCConnectionResume* message fails:
 - 2> perform the actions upon leaving RRC_CONNECTED as specified in 5.3.12, with release cause 'other', upon which the procedure ends;
- 1> derive the K_{RRCenc} key and the K_{UPenc} key associated with the previously configured ciphering algorithm, as specified in TS 33.401 [32];
- 1> configure lower layers to resume integrity protection using the previously configured algorithm and the K_{RRCint} key immediately, i.e., integrity protection shall be applied to all subsequent messages received and sent by the UE;
- 1> configure lower layers to resume ciphering and to apply the ciphering algorithm, the K_{RRCenc} key and the K_{UPenc} key, i.e. the ciphering configuration shall be applied to all subsequent messages received and sent by the UE;
- 1> enter RRC_CONNECTED;

- 1> indicate to upper layers that the suspended RRC connection has been resumed;
 - 1> stop the cell re-selection procedure;
 - 1> consider the current cell to be the PCell;
 - 1> set the content of *RRCConnectionResumeComplete* message as follows:
 - 2> set the *selectedPLMN-Identity* to the PLMN selected by upper layers (see TS 23.122 [11], TS 24.301 [35]) from the PLMN(s) included in the *plmn-IdentityList* in *SystemInformationBlockType1*;
 - 2> set the *dedicatedInfoNAS* to include the information received from upper layers;
 - 2> except for NB-IoT:
 - 3> if the UE has radio link failure or handover failure information available in *VarRLF-Report* and if the RPLMN is included in *plmn-IdentityList* stored in *VarRLF-Report*:
 - 4> include *rlf-InfoAvailable*;
 - 3> if the UE has MBSFN logged measurements available for E-UTRA and if the RPLMN is included in *plmn-IdentityList* stored in *VarLogMeasReport*:
 - 4> include *logMeasAvailableMBSFN*;
 - 3> else if the UE has logged measurements available for E-UTRA and if the RPLMN is included in *plmn-IdentityList* stored in *VarLogMeasReport*:
 - 4> include *logMeasAvailable*;
 - 3> if the UE has connection establishment failure information available in *VarConnEstFailReport* and if the RPLMN is equal to *plmn-Identity* stored in *VarConnEstFailReport*:
 - 4> include *connEstFailInfoAvailable*;
 - 3> include the *mobilityState* and set it to the mobility state (as specified in TS 36.304 [4]) of the UE just prior to entering RRC_CONNECTED state;
 - 3> if the UE supports storage of mobility history information and the UE has mobility history information available in *VarMobilityHistoryReport*:
 - 4> include *mobilityHistoryAvail*;
 - 2> for NB-IoT:
 - 3> if the UE supports serving cell idle mode measurements reporting and *servingCellMeasInfo* is present in *SystemInformationBlockType2-NB*:
 - 4> set the *measResultServCell* to include the measurements of the serving cell;
- NOTE 2: The UE includes the latest results of the serving cell measurements as used for cell selection/ reselection evaluation, which are performed in accordance with the performance requirements as specified in TS 36.133 [16].
- 1> submit the *RRCConnectionResumeComplete* message to lower layers for transmission;
 - 1> the procedure ends.

5.3.3.5 Cell re-selection while T300, T302, T303, T305, T306, or T308 is running

The UE shall:

- 1> if cell reselection occurs while T300, T302, T303, T305, T306, or T308 is running:
 - 2> if timer T302, T303, T305, T306, and/or T308 is running:
 - 3> stop timer T302, T303, T305, T306, and T308, whichever ones were running;

- 3> perform the actions as specified in 5.3.3.7;
- 2> if timer T300 is running:
 - 3> stop timer T300;
 - 3> if UE has sent *RRCConnectionResumeRequest* message and has not received *RRCConnectionResume* message:
 - 4> reset MAC and re-establish RLC for all RBs that are established;
 - 4> suspend SRB1;
 - 3> else:
 - 4> reset MAC, release the MAC configuration and re-establish RLC for all RBs that are established;
- 3> inform upper layers about the failure to establish the RRC connection or failure to resume the RRC connection with suspend indication;

5.3.3.6 T300 expiry

The UE shall:

- 1> if timer T300 expires:
 - 2> if UE has sent *RRCConnectionResumeRequest* message and has not received *RRCConnectionResume* message:
 - 3> reset MAC and re-establish RLC for all RBs that are established;
 - 3> suspend SRB1;
 - 2> else:
 - 3> reset MAC, release the MAC configuration and re-establish RLC for all RBs that are established;
- 2> if the UE is a NB-IoT UE:
 - 3> if *connEstFailOffset* is included in *SystemInformationBlockType2-NB*:
 - 4> use *connEstFailOffset* for the parameter $Q_{\text{offset_temp}}$ for the concerned cell when performing cell selection and reselection according to TS 36.304 [4];
 - 3> else:
 - 4> use value of infinity for the parameter $Q_{\text{offset_temp}}$ for the concerned cell when performing cell selection and reselection according to TS 36.304 [4];

NOTE 0: For NB-IoT, the number of times that the UE detects T300 expiry on the same cell before applying *connEstFailOffset* and the amount of time that the UE applies *connEstFailOffset* before removing the offset from evaluation of the cell is up to UE implementation.

- 2> else if the UE supports RRC Connection Establishment failure temporary Q_{offset} and T300 has expired a consecutive *connEstFailCount* times on the same cell for which *txFailParams* is included in *SystemInformationBlockType2*:
 - 3> for a period as indicated by *connEstFailOffsetValidity*:
 - 4> use *connEstFailOffset* for the parameter $Q_{\text{offset_temp}}$ for the concerned cell when performing cell selection and reselection according to TS 36.304 [4] and TS 25.304 [40];

NOTE 1: When performing cell selection, if no suitable or acceptable cell can be found, it is up to UE implementation whether to stop using *connEstFailOffset* for the parameter $Q_{\text{offset_temp}}$ during *connEstFailOffsetValidity* for the concerned cell.

- 2> except for NB-IoT, store the following connection establishment failure information in the *VarConnEstFailReport* by setting its fields as follows:
 - 3> clear the information included in *VarConnEstFailReport*, if any;
 - 3> set the *plmn-Identity* to the PLMN selected by upper layers (see TS 23.122 [11], TS 24.301 [35]) from the PLMN(s) included in the *plmn-IdentityList* in *SystemInformationBlockType1*;
 - 3> set the *failedCellId* to the global cell identity of the cell where connection establishment failure is detected;
 - 3> set the *measResultFailedCell* to include the RSRP and RSRQ, if available, of the cell where connection establishment failure is detected and based on measurements collected up to the moment the UE detected the failure;
 - 3> if available, set the *measResultNeighCells*, in order of decreasing ranking-criterion as used for cell reselection, to include neighbouring cell measurements for at most the following number of neighbouring cells: 6 intra-frequency and 3 inter-frequency neighbours per frequency as well as 3 inter-RAT neighbours, per frequency/ set of frequencies (GERAN) per RAT and according to the following:
 - 4> for each neighbour cell included, include the optional fields that are available;
- NOTE 2: The UE includes the latest results of the available measurements as used for cell reselection evaluation, which are performed in accordance with the performance requirements as specified in TS 36.133 [16].
- 3> if detailed location information is available, set the content of the *locationInfo* as follows:
 - 4> include the *locationCoordinates*;
 - 4> include the *horizontalVelocity*, if available;
 - 3> set the *numberOfPreamblesSent* to indicate the number of preambles sent by MAC for the failed random access procedure;
 - 3> set *contentionDetected* to indicate whether contention resolution was not successful as specified in TS 36.321 [6] for at least one of the transmitted preambles for the failed random access procedure;
 - 3> set *maxTxPowerReached* to indicate whether or not the maximum power level was used for the last transmitted preamble, see TS 36.321 [6];
- 2> inform upper layers about the failure to establish the RRC connection or failure to resume the RRC connection with suspend indication, upon which the procedure ends;

The UE may discard the connection establishment failure information, i.e. release the UE variable *VarConnEstFailReport*, 48 hours after the failure is detected, upon power off or upon detach.

5.3.3.7 T302, T303, T305, T306, or T308 expiry or stop

The UE shall:

- 1> if timer T302 expires or is stopped:
 - 2> inform upper layers about barring alleviation for mobile terminating access;
- 2> if timer T303 is not running:
 - 3> inform upper layers about barring alleviation for mobile originating calls;
- 2> if timer T305 is not running:
 - 3> inform upper layers about barring alleviation for mobile originating signalling;
- 2> if timer T306 is not running:
 - 3> inform upper layers about barring alleviation for mobile originating CS fallback;
- 2> if timer T308 is not running:

- 3> inform upper layers about barring alleviation for ACDC;
- 1> if timer T303 expires or is stopped:
 - 2> if timer T302 is not running:
 - 3> inform upper layers about barring alleviation for mobile originating calls;
- 1> if timer T305 expires or is stopped:
 - 2> if timer T302 is not running:
 - 3> inform upper layers about barring alleviation for mobile originating signalling;
- 1> if timer T306 expires or is stopped:
 - 2> if timer T302 is not running:
 - 3> inform upper layers about barring alleviation for mobile originating CS fallback;
- 1> if timer T308 expires or is stopped:
 - 2> if timer T302 is not running:
 - 3> inform upper layers about barring alleviation for ACDC;

5.3.3.8 Reception of the *RRConnectionReject* by the UE

The UE shall:

- 1> stop timer T300;
- 1> reset MAC;
- 1> except for NB-IoT, start timer T302, with the timer value set to the *waitTime*;
- 1> if the UE is a NB-IoT UE; or
- 1> if the *extendedWaitTime* is present and the UE supports delay tolerant access:
 - 2> forward the *extendedWaitTime* to upper layers;
- 1> if *deprioritisationReq* is included and the UE supports RRC Connection Reject with deprioritisation:
 - 2> start or restart timer T325 with the timer value set to the *deprioritisationTimer* signalled;
 - 2> store the *deprioritisationReq* until T325 expiry;

NOTE: The UE stores the deprioritisation request irrespective of any cell reselection absolute priority assignments (by dedicated or common signalling) and regardless of RRC connections in E-UTRAN or other RATs unless specified otherwise.

- 1> if the *RRConnectionReject* is received in response to an *RRConnectionResumeRequest*:
 - 2> if the *rrc-SuspendIndication* is not present:
 - 3> release all radio resources, including release of the RLC entity, the MAC configuration and the associated PDCP entity for all established or suspended RBs;
 - 3> discard the stored UE AS context and *resumeIdentity*;
 - 3> inform upper layers about the failure to resume the RRC connection without suspend indication and that access barring for mobile originating calls, mobile originating signalling, mobile terminating access and except for NB-IoT for mobile originating CS fallback is applicable, upon which the procedure ends;
 - 2> else:
 - 3> suspend SRB1;

- 3> inform upper layers about the failure to resume the RRC connection with suspend indication and that access barring for mobile originating calls, mobile originating signalling, mobile terminating access and except for NB-IoT for mobile originating CS fallback is applicable, upon which the procedure ends;

1> else:

- 2> release the MAC configuration;
- 2> inform upper layers about the failure to establish the RRC connection and that access barring for mobile originating calls, mobile originating signalling, mobile terminating access and except for NB-IoT, for mobile originating CS fallback is applicable, upon which the procedure ends;

5.3.3.9 Abortion of RRC connection establishment

If upper layers abort the RRC connection establishment procedure while the UE has not yet entered RRC_CONNECTED, the UE shall:

- 1> stop timer T300, if running;
- 1> reset MAC, release the MAC configuration and re-establish RLC for all RBs that are established;

5.3.3.10 Handling of SSAC related parameters

Upon request from the upper layers, the UE shall:

- 1> if *SystemInformationBlockType2* includes *ac-BarringPerPLMN-List* and the *ac-BarringPerPLMN-List* contains an *AC-BarringPerPLMN* entry with the *plmn-IdentityIndex* corresponding to the PLMN selected by upper layers (see TS 23.122 [11], TS 24.301 [35]):
 - 2> select the *AC-BarringPerPLMN* entry with the *plmn-IdentityIndex* corresponding to the PLMN selected by upper layers;
 - 2> in the remainder of this procedure, use the selected *AC-BarringPerPLMN* entry (i.e. presence or absence of access barring parameters in this entry) irrespective of the common access barring parameters included in *SystemInformationBlockType2*;

1> else:

- 2> in the remainder of this procedure use the common access barring parameters (i.e. presence or absence of these parameters) included in *SystemInformationBlockType2*;

1> set the local variables *BarringFactorForMMTEL-Voice* and *BarringTimeForMMTEL-Voice* as follows:

2> if *ssac-BarringForMMTEL-Voice* is present:

- 3> if the UE has one or more Access Classes, as stored on the USIM, with a value in the range 11..15, which is valid for the UE to use according to TS 22.011 [10] and TS 23.122 [11], and

NOTE: ACs 12, 13, 14 are only valid for use in the home country and ACs 11, 15 are only valid for use in the HPLMN/ EHPLMN.

- 3> if, for at least one of these Access Classes, the corresponding bit in the *ac-BarringForSpecialAC* contained in *ssac-BarringForMMTEL-Voice* is set to zero:

4> set *BarringFactorForMMTEL-Voice* to one and *BarringTimeForMMTEL-Voice* to zero;

3> else:

4> set *BarringFactorForMMTEL-Voice* and *BarringTimeForMMTEL-Voice* to the value of *ac-BarringFactor* and *ac-BarringTime* included in *ssac-BarringForMMTEL-Voice*, respectively;

2> else set *BarringFactorForMMTEL-Voice* to one and *BarringTimeForMMTEL-Voice* to zero;

1> set the local variables *BarringFactorForMMTEL-Video* and *BarringTimeForMMTEL-Video* as follows:

2> if *ssac-BarringForMMTEL-Video* is present:

- 3> if the UE has one or more Access Classes, as stored on the USIM, with a value in the range 11..15, which is valid for the UE to use according to TS 22.011 [10] and TS 23.122 [11], and
- 3> if, for at least one of these Access Classes, the corresponding bit in the *ac-BarringForSpecialAC* contained in *ssac-BarringForMMTEL-Video* is set to zero:
 - 4> set *BarringFactorForMMTEL-Video* to one and *BarringTimeForMMTEL-Video* to zero;
- 3> else:
 - 4> set *BarringFactorForMMTEL-Video* and *BarringTimeForMMTEL-Video* to the value of *ac-BarringFactor* and *ac-BarringTime* included in *ssac-BarringForMMTEL-Video*, respectively;
- 2> else set *BarringFactorForMMTEL-Video* to one and *BarringTimeForMMTEL-Video* to zero;
- 1> forward the variables *BarringFactorForMMTEL-Voice*, *BarringTimeForMMTEL-Voice*, *BarringFactorForMMTEL-Video* and *BarringTimeForMMTEL-Video* to the upper layers;

5.3.3.11 Access barring check

- 1> if timer T302 or "Tbarring" is running:
 - 2> consider access to the cell as barred;
 - 1> else if *SystemInformationBlockType2* includes "AC barring parameter":
 - 2> if the UE has one or more Access Classes, as stored on the USIM, with a value in the range 11..15, which is valid for the UE to use according to TS 22.011 [10] and TS 23.122 [11], and
- NOTE: ACs 12, 13, 14 are only valid for use in the home country and ACs 11, 15 are only valid for use in the HPLMN/ EHPLMN.
- 2> for at least one of these valid Access Classes the corresponding bit in the *ac-BarringForSpecialAC* contained in "AC barring parameter" is set to *zero*:
 - 3> consider access to the cell as not barred;
 - 2> else:
 - 3> draw a random number '*rand*' uniformly distributed in the range: $0 \leq rand < 1$;
 - 3> if '*rand*' is lower than the value indicated by *ac-BarringFactor* included in "AC barring parameter":
 - 4> consider access to the cell as not barred;
 - 3> else:
 - 4> consider access to the cell as barred;
 - 1> else:
 - 2> consider access to the cell as not barred;
 - 1> if access to the cell is barred and both timers T302 and "Tbarring" are not running:
 - 2> draw a random number '*rand*' that is uniformly distributed in the range $0 \leq rand < 1$;
 - 2> start timer "Tbarring" with the timer value calculated as follows, using the *ac-BarringTime* included in "AC barring parameter":
 - "Tbarring" = $(0.7 + 0.6 * rand) * ac-BarringTime$;

5.3.3.12 EAB check

The UE shall:

- 1> if *SystemInformationBlockType14* is present and includes the *eab-Param*:
 - 2> if the *eab-Common* is included in the *eab-Param*:
 - 3> if the UE belongs to the category of UEs as indicated in the *eab-Category* contained in *eab-Common*; and
 - 3> if for the Access Class of the UE, as stored on the USIM and with a value in the range 0..9, the corresponding bit in the *eab-BarringBitmap* contained in *eab-Common* is set to *one*:
 - 4> consider access to the cell as barred;
 - 3> else:
 - 4> consider access to the cell as not barred due to EAB;
 - 2> else (the *eab-PerPLMN-List* is included in the *eab-Param*):
 - 3> select the entry in the *eab-PerPLMN-List* corresponding to the PLMN selected by upper layers (see TS 23.122 [11], TS 24.301 [35]);
 - 3> if the *eab-Config* for that PLMN is included:
 - 4> if the UE belongs to the category of UEs as indicated in the *eab-Category* contained in *eab-Config*; and
 - 4> if for the Access Class of the UE, as stored on the USIM and with a value in the range 0..9, the corresponding bit in the *eab-BarringBitmap* contained in *eab-Config* is set to *one*:
 - 5> consider access to the cell as barred;
 - 4> else:
 - 5> consider access to the cell as not barred due to EAB;
 - 3> else:
 - 4> consider access to the cell as not barred due to EAB;
 - 1> else:
 - 2> consider access to the cell as not barred due to EAB;

5.3.3.13 Access barring check for ACDC

The UE shall:

- 1> if timer T302 is running:
 - 2> consider access to the cell as barred;
- 1> else if *SystemInformationBlockType2* includes "ACDC barring parameter":
 - 2> draw a random number '*rand*' uniformly distributed in the range: $0 \leq rand < 1$;
 - 2> if '*rand*' is lower than the value indicated by *ac-BarringFactor* included in "ACDC barring parameter":
 - 3> consider access to the cell as not barred;
 - 2> else:
 - 3> consider access to the cell as barred;
- 1> else:
 - 2> consider access to the cell as not barred;
- 1> if access to the cell is barred and timer T302 is not running:

- 2> draw a random number '*rand*' that is uniformly distributed in the range $0 \leq rand < 1$;
- 2> start timer "Tbarring" with the timer value calculated as follows, using the *ac-BarringTime* included in "ACDC barring parameter":

"Tbarring" = $(0.7 + 0.6 * rand) * ac-BarringTime$.

5.3.3.14 Access Barring check for NB-IoT

The UE shall:

- 1> if *ab-Enabled* included in *MasterInformationBlock-NB* is set to *TRUE* and *SystemInformationBlockType14-NB* is broadcast:
- 2> if the *ab-Common* is included in *ab-Param*:
- 3> if the UE belongs to the category of UEs as indicated in the *ab-Category* contained in *ab-Common*; and
- 3> if for the Access Class of the UE, as stored on the USIM and with a value in the range 0..9, the corresponding bit in the *ab-BarringBitmap* contained in *ab-Common* is set to *one*:
- 4> if the *establishmentCause* received from higher layers is set to *mo-ExceptionData* and *ab-BarringForExceptionData* is set to *FALSE* in the *ab-Common*:
- 5> consider access to the cell as not barred;
- 4> else:
- 5> if the UE has one or more Access Classes, as stored on the USIM, with a value in the range 11..15, which is valid for the UE to use according to TS 22.011 [10] and TS 23.122 [11] and for at least one of these valid Access Classes for the UE, the corresponding bit in the *ab-BarringForSpecialAC* contained in *ab-Common* is set to *zero*:

NOTE 1: ACs 12, 13, 14 are only valid for use in the home country and ACs 11, 15 are only valid for use in the HPLMN/ EHPLMN.

- 6> consider access to the cell as not barred;
- 5> else:
- 6> consider access to the cell as barred;
- 3> else;
- 4> consider access to the cell as not barred;
- 2> else (the *ab-PerPLMN-List* is included in the *ab-Param*):
- 3> select the *ab-PerPLMN* entry in *ab-PerPLMN-List* corresponding to the PLMN selected by upper layers (see TS 23.122 [11], TS 24.301 [35]);
- 3> if the *ab-Config* for that PLMN is included:
- 4> if the UE belongs to the category of UEs as indicated in the *ab-Category* contained in *ab-Config*; and
- 4> if for the Access Class of the UE, as stored on the USIM and with a value in the range 0..9, the corresponding bit in the *ab-BarringBitmap* contained in *ab-Config* is set to *one*:
- 5> if the *establishmentCause* received from higher layers is set to *mo-ExceptionData* and *ab-BarringForExceptionData* is set to *FALSE* in the *ab-Config*:
- 6> consider access to the cell as not barred;
- 5> else:
- 6> if the UE has one or more Access Classes, as stored on the USIM, with a value in the range 11..15, which is valid for the UE to use according to TS 22.011 [10] and TS 23.122 [11] and

for at least one of these valid Access Classes for the UE, the corresponding bit in the *ab-BarringForSpecialAC* contained in *ab-Config* is set to *zero*:

NOTE 2: ACs 12, 13, 14 are only valid for use in the home country and ACs 11, 15 are only valid for use in the HPLMN/ EHPLMN.

- 7> consider access to the cell as not barred;
- 6> else:
 - 7> consider access to the cell as barred;
- 4> else:
 - 5> consider access to the cell as not barred;
- 3> else:
 - 4> consider access to the cell as not barred;
- 1> else:
 - 2> consider access to the cell as not barred;

5.3.3.15 Failure to deliver NAS information in RRCConnectionSetupComplete message

The UE shall:

- 1> if the UE is a NB-IoT UE and radio link failure occurs before the successful delivery of *RRCConnectionSetupComplete* message has been confirmed by lower layers:
- 2> inform upper layers about the possible failure to deliver the NAS information contained in the *RRCConnectionSetupComplete* message;

5.3.4 Initial security activation

5.3.4.1 General

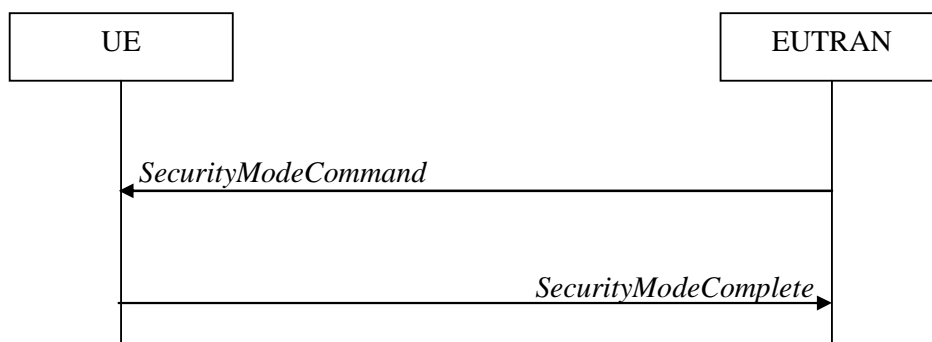

Figure 5.3.4.1-1: Security mode command, successful

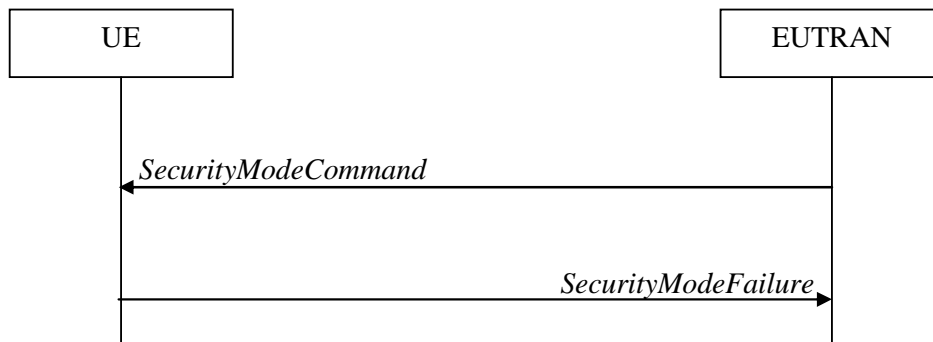

Figure 5.3.4.1-2: Security mode command, failure

The purpose of this procedure is to activate AS security upon RRC connection establishment.

5.3.4.2 Initiation

E-UTRAN initiates the security mode command procedure to a UE in RRC_CONNECTED. Moreover, E-UTRAN applies the procedure as follows:

- when only SRB1, or for NB-IoT SRB1 and SRB1bis, is established, i.e. prior to establishment of SRB2 and/ or DRBs.

5.3.4.3 Reception of the *SecurityModeCommand* by the UE

The UE shall:

- 1> derive the K_{eNB} key, as specified in TS 33.401 [32];
- 1> derive the K_{RRcInt} key associated with the *integrityProtAlgorithm* indicated in the *SecurityModeCommand* message, as specified in TS 33.401 [32];
- 1> request lower layers to verify the integrity protection of the *SecurityModeCommand* message, using the algorithm indicated by the *integrityProtAlgorithm* as included in the *SecurityModeCommand* message and the K_{RRcInt} key;
- 1> if the *SecurityModeCommand* message passes the integrity protection check:
 - 2> derive the K_{RRcEnc} key and the K_{UPenc} key associated with the *cipheringAlgorithm* indicated in the *SecurityModeCommand* message, as specified in TS 33.401 [32];
 - 2> if connected as an RN:
 - 3> derive the K_{UPint} key associated with the *integrityProtAlgorithm* indicated in the *SecurityModeCommand* message, as specified in TS 33.401 [32];
 - 2> configure lower layers to apply integrity protection using the indicated algorithm and the K_{RRcInt} key immediately, i.e. integrity protection shall be applied to all subsequent messages received and sent by the UE, including the *SecurityModeComplete* message;
 - 2> configure lower layers to apply ciphering using the indicated algorithm, the K_{RRcEnc} key and the K_{UPenc} key after completing the procedure, i.e. ciphering shall be applied to all subsequent messages received and sent by the UE, except for the *SecurityModeComplete* message which is sent unciphered;
 - 2> if connected as an RN:
 - 3> configure lower layers to apply integrity protection using the indicated algorithm and the K_{UPint} key, for DRBs that are subsequently configured to apply integrity protection, if any;
 - 2> consider AS security to be activated;
 - 2> upon RRC connection establishment, if UE does not need UL gaps during continuous uplink transmission:

- 3> configure lower layers to stop using UL gaps during continuous uplink transmission in FDD for *SecurityModeComplete* message and subsequent uplink transmission in RRC_CONNECTED except for UL transmissions as specified in TS36.211 [21];
 - 2> submit the *SecurityModeComplete* message to lower layers for transmission, upon which the procedure ends;
- 1> else:
- 2> continue using the configuration used prior to the reception of the *SecurityModeCommand* message, i.e. neither apply integrity protection nor ciphering.
 - 2> submit the *SecurityModeFailure* message to lower layers for transmission, upon which the procedure ends;

5.3.5 RRC connection reconfiguration

5.3.5.1 General

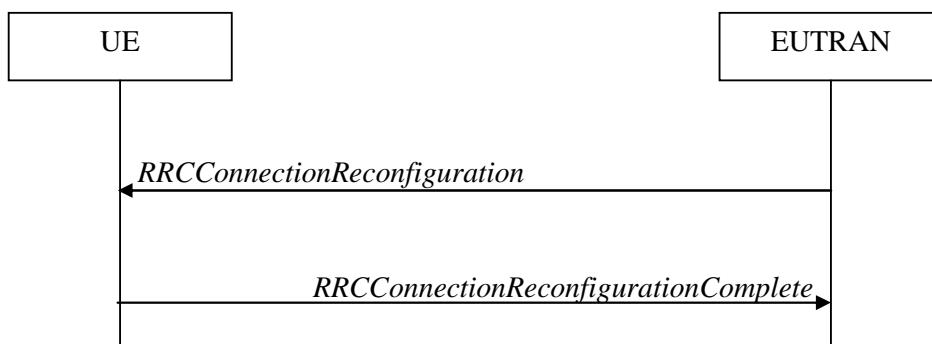

Figure 5.3.5.1-1: RRC connection reconfiguration, successful

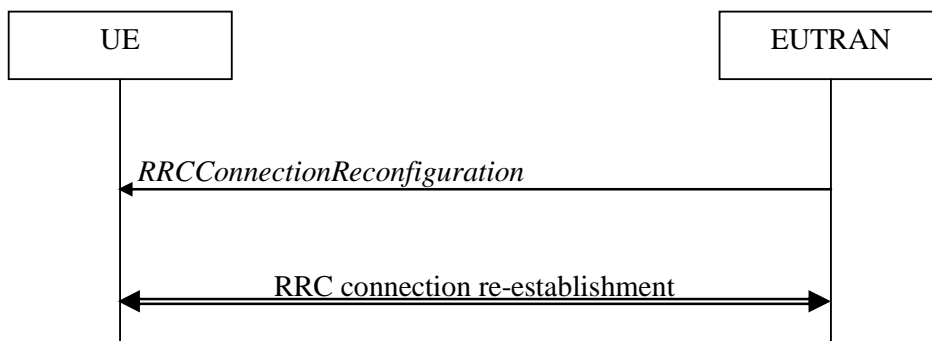

Figure 5.3.5.1-2: RRC connection reconfiguration, failure

The purpose of this procedure is to modify an RRC connection, e.g. to establish/ modify/ release RBs, to perform handover, to setup/ modify/ release measurements, to add/ modify/ release SCells. As part of the procedure, NAS dedicated information may be transferred from E-UTRAN to the UE.

5.3.5.2 Initiation

E-UTRAN may initiate the RRC connection reconfiguration procedure to a UE in RRC_CONNECTED. E-UTRAN applies the procedure as follows:

- the *mobilityControlInfo* is included only when AS-security has been activated, and SRB2 with at least one DRB are setup and not suspended;
- the establishment of RBs (other than SRB1, that is established during RRC connection establishment) is included only when AS security has been activated;
- the addition of SCells is performed only when AS security has been activated;

5.3.5.3 Reception of an *RRCCConnectionReconfiguration* not including the *mobilityControlInfo* by the UE

If the *RRCCConnectionReconfiguration* message does not include the *mobilityControlInfo* and the UE is able to comply with the configuration included in this message, the UE shall:

- 1> if this is the first *RRCCConnectionReconfiguration* message after successful completion of the RRC connection re-establishment procedure:
 - 2> re-establish PDCP for SRB2 and for all DRBs that are established, if any;
 - 2> re-establish RLC for SRB2 and for all DRBs that are established, if any;
 - 2> if the *RRCCConnectionReconfiguration* message includes the *fullConfig*:
 - 3> perform the radio configuration procedure as specified in 5.3.5.8;
 - 2> if the *RRCCConnectionReconfiguration* message includes the *radioResourceConfigDedicated*:
 - 3> perform the radio resource configuration procedure as specified in 5.3.10;
 - 2> resume SRB2 and all DRBs that are suspended, if any;

NOTE 1: The handling of the radio bearers after the successful completion of the PDCP re-establishment, e.g. the re-transmission of unacknowledged PDCP SDUs (as well as the associated status reporting), the handling of the SN and the HFN, is specified in TS 36.323 [8].

NOTE 2: The UE may discard SRB2 messages and data that it receives prior to completing the reconfiguration used to resume these bearers.

1> else:

- 2> if the *RRCCConnectionReconfiguration* message includes the *radioResourceConfigDedicated*:
 - 3> perform the radio resource configuration procedure as specified in 5.3.10;

NOTE 3: If the *RRCCConnectionReconfiguration* message includes the establishment of radio bearers other than SRB1, the UE may start using these radio bearers immediately, i.e. there is no need to wait for an outstanding acknowledgment of the *SecurityModeComplete* message.

- 1> if the received *RRCCConnectionReconfiguration* includes the *sCellToReleaseList*:
 - 2> perform SCell release as specified in 5.3.10.3a;
- 1> if the received *RRCCConnectionReconfiguration* includes the *sCellToAddModList*:
 - 2> perform SCell addition or modification as specified in 5.3.10.3b;
- 1> if the received *RRCCConnectionReconfiguration* includes the *scg-Configuration*; or
- 1> if the current UE configuration includes one or more split DRBs and the received *RRCCConnectionReconfiguration* includes *radioResourceConfigDedicated* including *drb-ToAddModList*:
 - 2> perform SCG reconfiguration as specified in 5.3.10.10;
- 1> if the received *RRCCConnectionReconfiguration* includes the *systemInformationBlockType1Dedicated*:
 - 2> perform the actions upon reception of the *SystemInformationBlockType1* message as specified in 5.2.2.7;
- 1> if the received *RRCCConnectionReconfiguration* includes the *systemInformationBlockType2Dedicated*:
 - 2> perform the actions upon reception of the *SystemInformationBlockType2* message as specified in 5.2.2.9;
- 1> if the *RRCCConnectionReconfiguration* message includes the *dedicatedInfoNASList*:
 - 2> forward each element of the *dedicatedInfoNASList* to upper layers in the same order as listed;
- 1> if the *RRCCConnectionReconfiguration* message includes the *measConfig*:

- 2> perform the measurement configuration procedure as specified in 5.5.2;
- 1> perform the measurement identity autonomous removal as specified in 5.5.2.2a;
- 1> if the *RRCCConnectionReconfiguration* message includes the *otherConfig*:
 - 2> perform the other configuration procedure as specified in 5.3.10.9;
- 1> if the *RRCCConnectionReconfiguration* message includes the *sl-DiscConfig* or *sl-CommConfig*:
 - 2> perform the sidelink dedicated configuration procedure as specified in 5.3.10.15;
- 1> if the *RRCCConnectionReconfiguration* message includes the *sl-V2X-ConfigDedicated*:
 - 2> perform the V2X sidelink communication dedicated configuration procedure as specified in 5.3.10.15a;
- 1> if the *RRCCConnectionReconfiguration* message includes *wlan-OffloadInfo*:
 - 2> perform the dedicated WLAN offload configuration procedure as specified in 5.6.12.2;
- 1> if the *RRCCConnectionReconfiguration* message includes *rclwi-Configuration*:
 - 2> perform the WLAN traffic steering command procedure as specified in 5.6.16.2;
- 1> if the *RRCCConnectionReconfiguration* message includes *lwa-Configuration*:
 - 2> perform the LWA configuration procedure as specified in 5.6.14.2;
- 1> if the *RRCCConnectionReconfiguration* message includes *lwip-Configuration*:
 - 2> perform the LWIP reconfiguration procedure as specified in 5.6.17.2;
- 1> upon RRC connection establishment, if UE does not need UL gaps during continuous uplink transmission:
 - 2> configure lower layers to stop using UL gaps during continuous uplink transmission in FDD for *RRCCConnectionReconfigurationComplete* message and subsequent uplink transmission in RRC_CONNECTED except for UL transmissions as specified in TS36.211 [21];
- 1> set the content of *RRCCConnectionReconfigurationComplete* message as follows:
 - 2> if the *RRCCConnectionReconfiguration* message includes *perCC-GapIndicationRequest*:
 - 3> include *perCC-GapIndicationList* and *numFreqEffective*;
 - 2> if the frequencies are configured for reduced measurement performance:
 - 3> include *numFreqEffectiveReduced*;
- 1> submit the *RRCCConnectionReconfigurationComplete* message to lower layers for transmission using the new configuration, upon which the procedure ends;

5.3.5.4 Reception of an *RRCCConnectionReconfiguration* including the *mobilityControlInfo* by the UE (handover)

If the *RRCCConnectionReconfiguration* message includes the *mobilityControlInfo* and the UE is able to comply with the configuration included in this message, the UE shall:

- 1> stop timer T310, if running;
- 1> stop timer T312, if running;
- 1> start timer T304 with the timer value set to *t304*, as included in the *mobilityControlInfo*;
- 1> stop timer T370, if running;
- 1> if the *carrierFreq* is included:

2> consider the target PCell to be one on the frequency indicated by the *carrierFreq* with a physical cell identity indicated by the *targetPhysCellId*;

1> else:

2> consider the target PCell to be one on the frequency of the source PCell with a physical cell identity indicated by the *targetPhysCellId*;

1> start synchronising to the DL of the target PCell;

NOTE 1: The UE should perform the handover as soon as possible following the reception of the RRC message triggering the handover, which could be before confirming successful reception (HARQ and ARQ) of this message.

1> if BL UE or UE in CE:

2> if *sameSFN-Indication* is not present in *mobilityControlInfo*:

3> acquire the *MasterInformationBlock* in the target PCell;

1> if *makeBeforeBreak* is configured:

2> perform the remainder of this procedure including and following resetting MAC after the UE has stopped the uplink transmission/downlink reception with the source cell(s);

NOTE 1a: It is up to UE implementation when to stop the uplink transmission/ downlink reception with the source cell(s) to initiate re-tuning for connection to the target cell [16], if *makeBeforeBreak* is configured.

1> reset MCG MAC and SCG MAC, if configured;

1> re-establish PDCP for all RBs that are established;

NOTE 2: The handling of the radio bearers after the successful completion of the PDCP re-establishment, e.g. the re-transmission of unacknowledged PDCP SDUs (as well as the associated status reporting), the handling of the SN and the HFN, is specified in TS 36.323 [8].

NOTE 2b: Void.

1> re-establish MCG RLC and SCG RLC, if configured, for all RBs that are established;

1> configure lower layers to consider the SCell(s) other than the PCell, if configured, to be in deactivated state;

1> apply the value of the *newUE-Identity* as the C-RNTI;

1> if the *RRCCONNECTIONRECONFIGURATION* message includes the *fullConfig*:

2> perform the radio configuration procedure as specified in 5.3.5.8;

1> configure lower layers in accordance with the received *radioResourceConfigCommon*;

1> if the received *RRCCONNECTIONRECONFIGURATION* message includes the *rach-Skip*:

2> configure lower layers to apply the *rach-Skip* for the target MCG, as specified in TS 36.213 [23] and 36.321 [6];

1> configure lower layers in accordance with any additional fields, not covered in the previous, if included in the received *mobilityControlInfo*;

1> if the received *RRCCONNECTIONRECONFIGURATION* includes the *sCellToReleaseList*:

2> perform SCell release as specified in 5.3.10.3a;

1> if the received *RRCCONNECTIONRECONFIGURATION* includes the *scg-Configuration*; or

1> if the current UE configuration includes one or more split DRBs and the received *RRCCONNECTIONRECONFIGURATION* includes *radioResourceConfigDedicated* including *drb-ToAddModList*:

2> perform SCG reconfiguration as specified in 5.3.10.10;

- 1> if the *RRCConnectionReconfiguration* message includes the *radioResourceConfigDedicated*:
 - 2> perform the radio resource configuration procedure as specified in 5.3.10;
 - 1> if the *keyChangeIndicator* received in the *securityConfigHO* is set to *TRUE*:
 - 2> update the K_{eNB} key based on the K_{ASME} key taken into use with the latest successful NAS SMC procedure, as specified in TS 33.401 [32];
 - 1> else:
 - 2> update the K_{eNB} key based on the current K_{eNB} or the NH, using the *nextHopChainingCount* value indicated in the *securityConfigHO*, as specified in TS 33.401 [32];
- NOTE 2b: If the UE needs to update the S- K_{eNB} key as specified in 5.3.10.10, the UE updates the S- K_{eNB} after updating the K_{eNB} key.
- 1> store the *nextHopChainingCount* value;
 - 1> if the *securityAlgorithmConfig* is included in the *securityConfigHO*:
 - 2> derive the K_{RRcint} key associated with the *integrityProtAlgorithm*, as specified in TS 33.401 [32];
 - 2> if connected as an RN:
 - 3> derive the K_{UPint} key associated with the *integrityProtAlgorithm*, as specified in TS 33.401 [32];
 - 2> derive the K_{RRcenc} key and the K_{UPenc} key associated with the *cipheringAlgorithm*, as specified in TS 33.401 [32];
 - 1> else:
 - 2> derive the K_{RRcint} key associated with the current integrity algorithm, as specified in TS 33.401 [32];
 - 2> if connected as an RN:
 - 3> derive the K_{UPint} key associated with the current integrity algorithm, as specified in TS 33.401 [32];
 - 2> derive the K_{RRcenc} key and the K_{UPenc} key associated with the current ciphering algorithm, as specified in TS 33.401 [32];
 - 1> configure lower layers to apply the integrity protection algorithm and the K_{RRcint} key, i.e. the integrity protection configuration shall be applied to all subsequent messages received and sent by the UE, including the message used to indicate the successful completion of the procedure;
 - 1> configure lower layers to apply the ciphering algorithm, the K_{RRcenc} key and the K_{UPenc} key, i.e. the ciphering configuration shall be applied to all subsequent messages received and sent by the UE, including the message used to indicate the successful completion of the procedure;
 - 1> if connected as an RN:
 - 2> configure lower layers to apply the integrity protection algorithm and the K_{UPint} key, for current or subsequently established DRBs that are configured to apply integrity protection, if any;
 - 1> if the received *RRCConnectionReconfiguration* includes the *sCellToAddModList*:
 - 2> perform SCell addition or modification as specified in 5.3.10.3b;
 - 1> if the received *RRCConnectionReconfiguration* includes the *systemInformationBlockType1Dedicated*:
 - 2> perform the actions upon reception of the *SystemInformationBlockType1* message as specified in 5.2.2.7;
 - 1> perform the measurement related actions as specified in 5.5.6.1;
 - 1> if the *RRCConnectionReconfiguration* message includes the *measConfig*:
 - 2> perform the measurement configuration procedure as specified in 5.5.2;

- 1> perform the measurement identity autonomous removal as specified in 5.5.2.2a;
- 1> release *reportProximityConfig* and clear any associated proximity status reporting timer;
- 1> if the *RRCCConnectionReconfiguration* message includes the *otherConfig*:
 - 2> perform the other configuration procedure as specified in 5.3.10.9;
- 1> if the *RRCCConnectionReconfiguration* message includes the *sl-DiscConfig* or *sl-CommConfig*:
 - 2> perform the sidelink dedicated configuration procedure as specified in 5.3.10.15;
- 1> if the *RRCCConnectionReconfiguration* message includes *wlan-OffloadInfo*:
 - 2> perform the dedicated WLAN offload configuration procedure as specified in 5.6.12.2;
- 1> if *handoverWithoutWT-Change* is not configured:
 - 2> release the LWA configuration, if configured, as described in 5.6.14.3;
- 1> release the LWIP configuration, if configured, as described in 5.6.17.3;
- 1> if the *RRCCConnectionReconfiguration* message includes *rclwi-Configuration*:
 - 2> perform the WLAN traffic steering command procedure as specified in 5.6.16.2;
- 1> if the *RRCCConnectionReconfiguration* message includes *lwa-Configuration*:
 - 2> perform the LWA configuration procedure as specified in 5.6.14.2;
- 1> if the *RRCCConnectionReconfiguration* message includes *lwip-Configuration*:
 - 2> perform the LWIP reconfiguration procedure as specified in 5.6.17.2;
- 1> if the *RRCCConnectionReconfiguration* message includes the *sl-V2X-ConfigDedicated* or *mobilityControlInfoV2X*:
 - 2> perform the V2X sidelink communication dedicated configuration procedure as specified in 5.3.10.15a;
- 1> set the content of *RRCCConnectionReconfigurationComplete* message as follows:
 - 2> if the UE has radio link failure or handover failure information available in *VarRLF-Report* and if the RPLMN is included in *plmn-IdentityList* stored in *VarRLF-Report*:
 - 3> include *rlf-InfoAvailable*;
 - 2> if the UE has MBSFN logged measurements available for E-UTRA and if the RPLMN is included in *plmn-IdentityList* stored in *VarLogMeasReport* and if T330 is not running:
 - 3> include *logMeasAvailableMBSFN*;
 - 2> else if the UE has logged measurements available for E-UTRA and if the RPLMN is included in *plmn-IdentityList* stored in *VarLogMeasReport*:
 - 3> include the *logMeasAvailable*;
 - 2> if the UE has connection establishment failure information available in *VarConnEstFailReport* and if the RPLMN is equal to *plmn-Identity* stored in *VarConnEstFailReport*:
 - 3> include *connEstFailInfoAvailable*;
 - 2> if the *RRCCConnectionReconfiguration* message includes *perCC-GapIndicationRequest*:
 - 3> include *perCC-GapIndicationList* and *numFreqEffective*;
 - 2> if the frequencies are configured for reduced measurement performance:
 - 3> include *numFreqEffectiveReduced*;

- 1> submit the *RRCCoexReconfigurationComplete* message to lower layers for transmission;
- 1> if MAC successfully completes the random access procedure; or
- 1> if MAC indicates the successful reception of a PDCCH transmission addressed to C-RNTI and if *rach-Skip* is configured:
 - 2> stop timer T304;
 - 2> release *rach-Skip*;
 - 2> apply the parts of the CQI reporting configuration, the scheduling request configuration and the sounding RS configuration that do not require the UE to know the SFN of the target PCell, if any;
 - 2> apply the parts of the measurement and the radio resource configuration that require the UE to know the SFN of the target PCell (e.g. measurement gaps, periodic CQI reporting, scheduling request configuration, sounding RS configuration), if any, upon acquiring the SFN of the target PCell;

NOTE 3: Whenever the UE shall setup or reconfigure a configuration in accordance with a field that is received it applies the new configuration, except for the cases addressed by the above statements.

- 2> if the UE is configured to provide IDC indications:
 - 3> if the UE has transmitted an *InDeviceCoexIndication* message during the last 1 second preceding reception of the *RRCCoexReconfiguration* message including *mobilityControlInfo*:
 - 4> initiate transmission of the *InDeviceCoexIndication* message in accordance with 5.6.9.3;
 - 2> if the UE is configured to provide power preference indications, overheating assistance information, SPS assistance information, delay budget report or maximum bandwidth preference indications:
 - 3> if the UE has transmitted a *UEAssistanceInformation* message during the last 1 second preceding reception of the *RRCCoexReconfiguration* message including *mobilityControlInfo*:
 - 4> initiate transmission of the *UEAssistanceInformation* message in accordance with 5.6.10.3;
- 2> if *SystemInformationBlockType15* is broadcast by the PCell:
 - 3> if the UE has transmitted a *MBMSInterestIndication* message during the last 1 second preceding reception of the *RRCCoexReconfiguration* message including *mobilityControlInfo*:
 - 4> ensure having a valid version of *SystemInformationBlockType15* for the PCell;
 - 4> determine the set of MBMS frequencies of interest in accordance with 5.8.5.3;
 - 4> determine the set of MBMS services of interest in accordance with 5.8.5.3a;
 - 4> initiate transmission of the *MBMSInterestIndication* message in accordance with 5.8.5.4;
- 2> if *SystemInformationBlockType18* is broadcast by the target PCell; and the UE transmitted a *SidelinkUEInformation* message indicating a change of sidelink communication related parameters relevant in target PCell (i.e. change of *commRxInterestedFreq* or *commTxResourceReq*, *commTxResourceReqUC* if *SystemInformationBlockType18* includes *commTxResourceUC-ReqAllowed* or *commTxResourceInfoReqRelay* if PCell broadcasts *SystemInformationBlockType19* including *discConfigRelay*) during the last 1 second preceding reception of the *RRCCoexReconfiguration* message including *mobilityControlInfo*; or
- 2> if *SystemInformationBlockType19* is broadcast by the target PCell; and the UE transmitted a *SidelinkUEInformation* message indicating a change of sidelink discovery related parameters relevant in target PCell (i.e. change of *discRxInterest* or *discTxResourceReq*, *discTxResourceReqPS* if *SystemInformationBlockType19* includes *discConfigPS* or *discRxGapReq* or *discTxGapReq* if the UE is configured with *gapRequestsAllowedDedicated* set to *true* or if the UE is not configured with *gapRequestsAllowedDedicated* and *SystemInformationBlockType19* includes *gapRequestsAllowedCommon*) during the last 1 second preceding reception of the *RRCCoexReconfiguration* message including *mobilityControlInfo*; or

2> if *SystemInformationBlockType21* is broadcast by the target PCell; and the UE transmitted a *SidelinkUEInformation* message indicating a change of V2X sidelink communication related parameters relevant in target PCell (i.e. change of *v2x-CommRxInterestedFreqList* or *v2x-CommTxResourceReq*) during the last 1 second preceding reception of the *RRCConnectionReconfiguration* message including *mobilityControlInfo*:

3> initiate transmission of the *SidelinkUEInformation* message in accordance with 5.10.2.3;

2> the procedure ends;

NOTE 4: The UE is not required to determine the SFN of the target PCell by acquiring system information from that cell before performing RACH access in the target PCell, except for BL UEs or UEs in CE when *sameSFN-Indication* is not present in *mobilityControlInfo*.

5.3.5.5 Reconfiguration failure

The UE shall:

1> if the UE is unable to comply with (part of) the configuration included in the *RRCConnectionReconfiguration* message:

2> continue using the configuration used prior to the reception of *RRCConnectionReconfiguration* message;

2> if security has not been activated:

3> perform the actions upon leaving RRC_CONNECTED as specified in 5.3.12, with release cause other;

2> else:

3> initiate the connection re-establishment procedure as specified in 5.3.7, upon which the connection reconfiguration procedure ends;

NOTE 1: The UE may apply above failure handling also in case the *RRCConnectionReconfiguration* message causes a protocol error for which the generic error handling as defined in 5.7 specifies that the UE shall ignore the message.

NOTE 2: If the UE is unable to comply with part of the configuration, it does not apply any part of the configuration, i.e. there is no partial success/ failure.

5.3.5.6 T304 expiry (handover failure)

The UE shall:

1> if T304 expires (handover failure):

NOTE 1: Following T304 expiry any dedicated preamble, if provided within the *rach-ConfigDedicated*, is not available for use by the UE anymore.

2> revert back to the configuration used in the source PCell, excluding the configuration configured by the *physicalConfigDedicated*, the *mac-MainConfig* and the *sps-Config*;

NOTE 1a: In the context above, "the configuration" includes state variables and parameters of each radio bearer. PDCP entities associated with RLC UM and SRB bearers are reset after the successful RRC connection re-establishment procedure according to Clause 5.2 in TS 36.323 [8].

2> store the following handover failure information in *VarRLF-Report* by setting its fields as follows:

3> clear the information included in *VarRLF-Report*, if any;

3> set the *plmn-IdentityList* to include the list of EPLMNs stored by the UE (i.e. includes the RPLMN);

3> set the *measResultLastServCell* to include the RSRP and RSRQ, if available, of the source PCell based on measurements collected up to the moment the UE detected handover failure and in accordance with the following;

- 4> if the UE includes *rsrqResult*, include the *lastServCellRSRQ-Type*;
- 3> set the *measResultNeighCells* to include the best measured cells, other than the source PCell, ordered such that the best cell is listed first, and based on measurements collected up to the moment the UE detected handover failure, and set its fields as follows;
 - 4> if the UE was configured to perform measurements for one or more EUTRA frequencies, include the *measResultListEUTRA*;
 - 4> if the UE includes *rsrqResult*, include the *rsrq-Type*;
 - 4> if the UE was configured to perform measurement reporting for one or more neighbouring UTRA frequencies, include the *measResultListUTRA*;
 - 4> if the UE was configured to perform measurement reporting for one or more neighbouring GERAN frequencies, include the *measResultListGERAN*;
 - 4> if the UE was configured to perform measurement reporting for one or more neighbouring CDMA2000 frequencies, include the *measResultsCDMA2000*;
 - 4> for each neighbour cell included, include the optional fields that are available;

NOTE 2: The measured quantities are filtered by the L3 filter as configured in the mobility measurement configuration. The measurements are based on the time domain measurement resource restriction, if configured. Blacklisted cells are not required to be reported.

- 3> if detailed location information is available, set the content of the *locationInfo* as follows:
 - 4> include the *locationCoordinates*;
 - 4> include the *horizontalVelocity*, if available;
- 3> set the *failedPCellId* to the global cell identity, if available, and otherwise to the physical cell identity and carrier frequency of the target PCell of the failed handover;
- 3> include *previousPCellId* and set it to the global cell identity of the PCell where the last *RRCConnectionReconfiguration* message including *mobilityControlInfo* was received;
- 3> set the *timeConnFailure* to the elapsed time since reception of the last *RRCConnectionReconfiguration* message including the *mobilityControlInfo*;
- 3> set the *connectionFailureType* to 'hof';
- 3> set the *c-RNTI* to the C-RNTI used in the source PCell;
- 2> initiate the connection re-establishment procedure as specified in 5.3.7, upon which the RRC connection reconfiguration procedure ends;

The UE may discard the handover failure information, i.e. release the UE variable *VarRLF-Report*, 48 hours after the failure is detected, upon power off or upon detach.

NOTE 3: E-UTRAN may retrieve the handover failure information using the UE information procedure with *rlf-ReportReq* set to *true*, as specified in 5.6.5.3.

5.3.5.7 Void

5.3.5.7a T307 expiry (SCG change failure)

The UE shall:

- 1> if T307 expires:

NOTE 1: Following T307 expiry any dedicated preamble, if provided within the *rach-ConfigDedicatedSCG*, is not available for use by the UE anymore.

- 2> initiate the SCG failure information procedure as specified in 5.6.13 to report SCG change failure;

5.3.5.8 Radio Configuration involving full configuration option

The UE shall:

- 1> release/ clear all current dedicated radio configurations except the MCG C-RNTI, the MCG security configuration and the PDCP, RLC, logical channel configurations for the RBs and the logged measurement configuration;

NOTE 1: Radio configuration is not just the resource configuration but includes other configurations like *MeasConfig* and *OtherConfig*.

- 1> if the *RRCConnectionReconfiguration* message includes the *mobilityControlInfo*:

- 2> release/ clear all current common radio configurations;
- 2> use the default values specified in 9.2.5 for timer T310, T311 and constant N310, N311;

- 1> else:

- 2> use values for timers T301, T310, T311 and constants N310, N311, as included in *ue-TimersAndConstants* received in *SystemInformationBlockType2* (or *SystemInformationBlockType2-NB* in NB-IoT);

- 1> apply the default physical channel configuration as specified in 9.2.4;

- 1> apply the default semi-persistent scheduling configuration as specified in 9.2.3;

- 1> apply the default MAC main configuration as specified in 9.2.2;

- 1> if the UE is a NB-IoT UE; or

- 1> for each *srb-Identity* value included in the *srb-ToAddModList* (SRB reconfiguration):

- 2> apply the specified configuration defined in 9.1.2 for the corresponding SRB;
- 2> apply the corresponding default RLC configuration for the SRB specified in 9.2.1.1 for SRB1 or in 9.2.1.2 for SRB2;
- 2> apply the corresponding default logical channel configuration for the SRB as specified in 9.2.1.1 for SRB1 or in 9.2.1.2 for SRB2;

NOTE 2: This is to get the SRBs (SRB1 and SRB2 for handover and SRB2 for reconfiguration after reestablishment) to a known state from which the reconfiguration message can do further configuration.

- 1> for each *eps-BearerIdentity* value included in the *drb-ToAddModList* that is part of the current UE configuration:

- 2> release the PDCP entity;
- 2> release the RLC entity or entities;
- 2> release the DTCH logical channel;
- 2> release the *drb-identity*;

NOTE 3: This will retain the *eps-bearerIdentity* but remove the DRBs including *drb-identity* of these bearers from the current UE configuration and trigger the setup of the DRBs within the AS in Clause 5.3.10.3 using the new configuration. The *eps-bearerIdentity* acts as the anchor for associating the released and re-setup DRB. In the AS the DRB re-setup is equivalent with a new DRB setup (including new PDCP and logical channel configurations).

- 1> for each *eps-BearerIdentity* value that is part of the current UE configuration but not part of the *drb-ToAddModList*:

- 2> perform DRB release as specified in 5.3.10.2;

5.3.6 Counter check

5.3.6.1 General

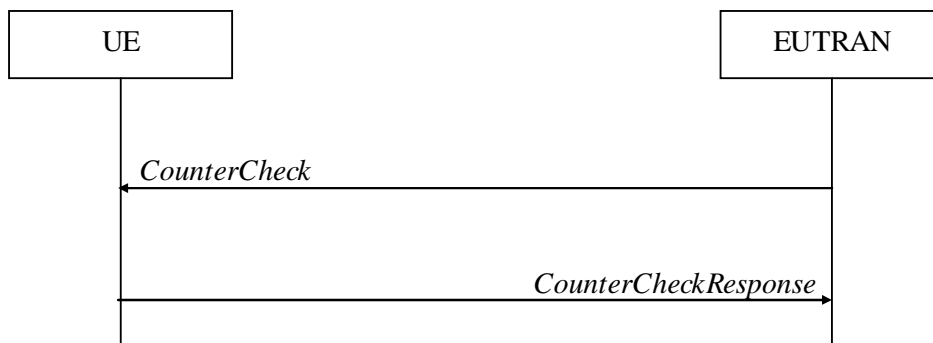

Figure 5.3.6.1-1: Counter check procedure

The counter check procedure is used by E-UTRAN to request the UE to verify the amount of data sent/ received on each DRB. More specifically, the UE is requested to check if, for each DRB, the most significant bits of the COUNT match with the values indicated by E-UTRAN.

NOTE: The procedure enables E-UTRAN to detect packet insertion by an intruder (a 'man in the middle').

5.3.6.2 Initiation

E-UTRAN initiates the procedure by sending a *CounterCheck* message.

NOTE: E-UTRAN may initiate the procedure when any of the COUNT values reaches a specific value.

5.3.6.3 Reception of the *CounterCheck* message by the UE

Upon receiving the *CounterCheck* message, the UE shall:

- 1> for each DRB that is established:
 - 2> if no COUNT exists for a given direction (uplink or downlink) because it is a uni-directional bearer configured only for the other direction:
 - 3> assume the COUNT value to be 0 for the unused direction;
 - 2> if the *drb-Identity* is not included in the *drb-CountMSB-InfoList*:
 - 3> include the DRB in the *drb-CountInfoList* in the *CounterCheckResponse* message by including the *drb-Identity*, the *count-Uplink* and the *count-Downlink* set to the value of the corresponding COUNT;
 - 2> else if, for at least one direction, the most significant bits of the COUNT are different from the value indicated in the *drb-CountMSB-InfoList*:
 - 3> include the DRB in the *drb-CountInfoList* in the *CounterCheckResponse* message by including the *drb-Identity*, the *count-Uplink* and the *count-Downlink* set to the value of the corresponding COUNT;
- 1> for each DRB that is included in the *drb-CountMSB-InfoList* in the *CounterCheck* message that is not established:
 - 2> include the DRB in the *drb-CountInfoList* in the *CounterCheckResponse* message by including the *drb-Identity*, the *count-Uplink* and the *count-Downlink* with the most significant bits set identical to the corresponding values in the *drb-CountMSB-InfoList* and the least significant bits set to zero;
- 1> submit the *CounterCheckResponse* message to lower layers for transmission upon which the procedure ends;

5.3.7 RRC connection re-establishment

5.3.7.1 General

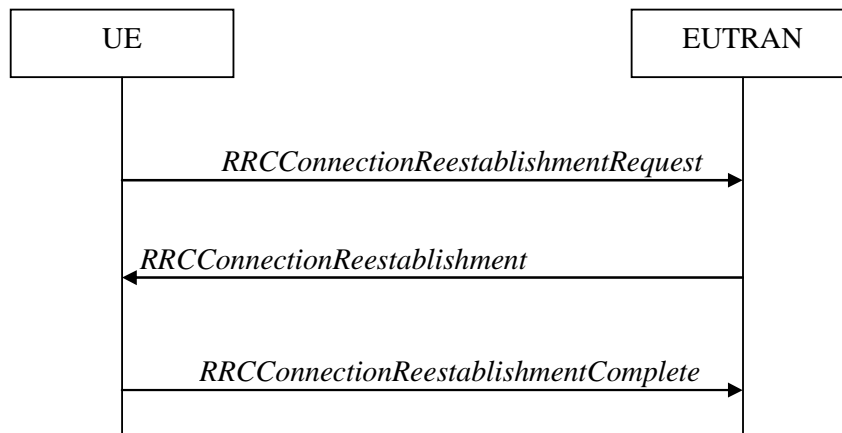

Figure 5.3.7.1-1: RRC connection re-establishment, successful

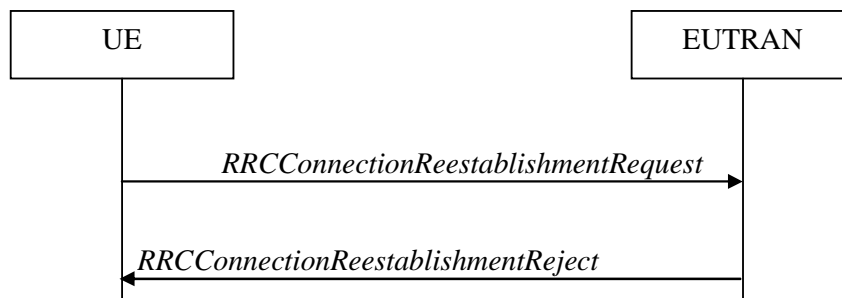

Figure 5.3.7.1-2: RRC connection re-establishment, failure

The purpose of this procedure is to re-establish the RRC connection, which involves the resumption of SRB1 (SRB1bis for a NB-IoT UE for which AS security has not been activated) operation, the re-activation of security (except for a NB-IoT UE for which AS security has not been activated) and the configuration of only the PCell.

Except for a NB-IoT UE for which AS security has not been activated, a UE in RRC_CONNECTED, for which security has been activated, may initiate the procedure in order to continue the RRC connection. The connection re-establishment succeeds only if the concerned cell is prepared i.e. has a valid UE context. In case E-UTRAN accepts the re-establishment, SRB1 operation resumes while the operation of other radio bearers remains suspended. If AS security has not been activated, the UE does not initiate the procedure but instead moves to RRC_IDLE directly.

When AS security has not been activated, a NB-IoT UE supporting RRC connection re-establishment for the Control Plane CIoT EPS optimisation in RRC_CONNECTED may initiate the procedure in order to continue the RRC connection.

E-UTRAN applies the procedure as follows:

- When AS security has been activated:
 - to reconfigure SRB1 and to resume data transfer only for this RB;
 - to re-activate AS security without changing algorithms.
- For a NB-IoT UE supporting RRC connection re-establishment for the Control Plane CIoT EPS optimisation, when AS security has not been activated:
 - to re-establish SRB1bis and to continue data transfer for this RB.

5.3.7.2 Initiation

The UE shall only initiate the procedure either when AS security has been activated or for a NB-IoT UE supporting RRC connection re-establishment for the Control Plane CIoT EPS optimisation. The UE initiates the procedure when one of the following conditions is met:

- 1> upon detecting radio link failure, in accordance with 5.3.11; or
- 1> upon handover failure, in accordance with 5.3.5.6; or
- 1> upon mobility from E-UTRA failure, in accordance with 5.4.3.5; or
- 1> upon integrity check failure indication from lower layers; or
- 1> upon an RRC connection reconfiguration failure, in accordance with 5.3.5.5;

Upon initiation of the procedure, the UE shall:

- 1> stop timer T310, if running;
- 1> stop timer T312, if running;
- 1> stop timer T313, if running;
- 1> stop timer T307, if running;
- 1> start timer T311;
- 1> stop timer T370, if running;
- 1> suspend all RBs except SRB0;
- 1> reset MAC;
- 1> release the MCG SCell(s), if configured, in accordance with 5.3.10.3a;
- 1> apply the default physical channel configuration as specified in 9.2.4;
- 1> except for NB-IoT, for the MCG, apply the default semi-persistent scheduling configuration as specified in 9.2.3;
- 1> for the MCG, apply the default MAC main configuration as specified in 9.2.2;
- 1> release *powerPrefIndicationConfig*, if configured and stop timer T340, if running;
- 1> release *reportProximityConfig*, if configured and clear any associated proximity status reporting timer;
- 1> release *obtainLocationConfig*, if configured;
- 1> release *idc-Config*, if configured;
- 1> release *sps-AssistanceInfoReport*, if configured;
- 1> release *measSubframePatternPCell*, if configured;
- 1> release the entire SCG configuration, if configured, except for the DRB configuration (as configured by *drb-ToAddModListSCG*);
- 1> release *naics-Info* for the PCell, if configured;
- 1> if connected as an RN and configured with an RN subframe configuration:
 - 2> release the RN subframe configuration;
- 1> release the LWA configuration, if configured, as described in 5.6.14.3;
- 1> release the LWIP configuration, if configured, as described in 5.6.17.3;
- 1> release *delayBudgetReportingConfig*, if configured and stop timer T342, if running;

- 1> perform cell selection in accordance with the cell selection process as specified in TS 36.304 [4];
- 1> release *bw-PreferenceIndicationTimer*, if configured and stop timer T341, if running;
- 1> release *overheatingAssistanceConfig*, if configured and stop timer T345, if running;

5.3.7.3 Actions following cell selection while T311 is running

Upon selecting a suitable E-UTRA cell, the UE shall:

- 1> stop timer T311;
- 1> start timer T301;
- 1> apply the *timeAlignmentTimerCommon* included in *SystemInformationBlockType2*;
- 1> if the UE is a NB-IoT UE supporting RRC connection re-establishment for the Control Plane CIoT EPS optimisation and AS security has not been activated; and
- 1> if *cp-reestablishment* is not included in *SystemInformationBlockType2-NB*:
 - 2> perform the actions upon leaving RRC_CONNECTED as specified in 5.3.12, with release cause 'RRC connection failure';
- 1> else:
 - 2> initiate transmission of the *RRCConnectionReestablishmentRequest* message in accordance with 5.3.7.4;

NOTE: This procedure applies also if the UE returns to the source PCell.

Upon selecting an inter-RAT cell, the UE shall:

- 1> if the selected cell is a UTRA cell, and if the UE supports Radio Link Failure Report for Inter-RAT MRO, include *selectedUTRA-CellId* in the *VarRLF-Report* and set it to the physical cell identity and carrier frequency of the selected UTRA cell;
- 1> perform the actions upon leaving RRC_CONNECTED as specified in 5.3.12, with release cause 'RRC connection failure';

5.3.7.4 Actions related to transmission of *RRCConnectionReestablishmentRequest* message

Except for NB-IoT, if the procedure was initiated due to radio link failure or handover failure, the UE shall:

- 1> set the *reestablishmentCellId* in the *VarRLF-Report* to the global cell identity of the selected cell;

The UE shall set the contents of *RRCConnectionReestablishmentRequest* message as follows:

- 1> except for a NB-IoT UE for which AS security has not been activated, set the *ue-Identity* as follows:
 - 2> set the *c-RNTI* to the C-RNTI used in the source PCell (handover and mobility from E-UTRA failure) or used in the PCell in which the trigger for the re-establishment occurred (other cases);
 - 2> set the *physCellId* to the physical cell identity of the source PCell (handover and mobility from E-UTRA failure) or of the PCell in which the trigger for the re-establishment occurred (other cases);
 - 2> set the *shortMAC-I* to the 16 least significant bits of the MAC-I calculated:
 - 3> over the ASN.1 encoded as per clause 8 (i.e., a multiple of 8 bits) *VarShortMAC-Input* (or *VarShortMAC-Input-NB* in NB-IoT);
 - 3> with the K_{RRCint} key and integrity protection algorithm that was used in the source PCell (handover and mobility from E-UTRA failure) or of the PCell in which the trigger for the re-establishment occurred (other cases); and
 - 3> with all input bits for COUNT, BEARER and DIRECTION set to binary ones;

- 1> for a NB-IoT UE for which AS security has not been activated, set the *ue-Identity* as follows:
 - 2> request upper layers for calculated ul-NAS-MAC and ul-NAS-Count using the *cellIdentity* indicated in *SystemInformationBlockType1-NB* of the current cell;
 - 2> set the *s-TMSI* to the S-TMSI provided by upper layers;
 - 2> set the *ul-NAS-MAC* to the ul-NAS-MAC value provided by upper layers;
 - 2> set the *ul-NAS-Count* to the ul-NAS-Count value provided by upper layers;
 - 1> set the *reestablishmentCause* as follows:
 - 2> if the re-establishment procedure was initiated due to reconfiguration failure as specified in 5.3.5.5 (the UE is unable to comply with the reconfiguration):
 - 3> set the *reestablishmentCause* to the value *reconfigurationFailure*;
 - 2> else if the re-establishment procedure was initiated due to handover failure as specified in 5.3.5.6 (intra-LTE handover failure) or 5.4.3.5 (inter-RAT mobility from EUTRA failure):
 - 3> set the *reestablishmentCause* to the value *handoverFailure*;
 - 2> else:
 - 3> set the *reestablishmentCause* to the value *otherFailure*;
 - 1> if the UE is a NB-IoT UE:
 - 2> if the UE supports DL channel quality reporting and *cqi-Reporting* is present in *SystemInformationBlockType2-NB*:
 - 3> set the *cqi-NPDCCH* to include the latest results of the downlink channel quality measurements of the serving cell as specified in TS 36.133 [16];
- NOTE: The downlink channel quality measurements may use measurement period T1 or T2, as defined in TS 36.133 [16]. In case period T2 is used the RRC-MAC interactions are left to UE implementation.
- 2> if the UE supports MAC PDU containing the UE contention resolution identity MAC control element without RRC response message, set *earlyContentionResolution* to TRUE.

The UE shall submit the *RRCCConnectionReestablishmentRequest* message to lower layers for transmission.

5.3.7.5 Reception of the *RRCCConnectionReestablishment* by the UE

NOTE 1: Prior to this, lower layer signalling is used to allocate a C-RNTI. For further details see TS 36.321 [6];

The UE shall:

- 1> stop timer T301;
- 1> consider the current cell to be the PCell;
- 1> except for a NB-IoT UE for which AS security has not been activated:
 - 2> re-establish PDCP for SRB1;
 - 2> re-establish RLC for SRB1;
 - 2> perform the radio resource configuration procedure in accordance with the received *radioResourceConfigDedicated* and as specified in 5.3.10;
 - 2> resume SRB1;

NOTE 2: E-UTRAN should not transmit any message on SRB1 prior to receiving the *RRCCConnectionReestablishmentComplete* message.

- 2> update the K_{eNB} key based on the K_{ASME} key to which the current K_{eNB} is associated, using the *nextHopChainingCount* value indicated in the *RRCConnectionReestablishment* message, as specified in TS 33.401 [32];
- 2> store the *nextHopChainingCount* value;
- 2> derive the K_{RRcint} key associated with the previously configured integrity algorithm, as specified in TS 33.401 [32];
- 2> derive the K_{RRcenc} key and the K_{UPenc} key associated with the previously configured ciphering algorithm, as specified in TS 33.401 [32];
- 2> if connected as an RN:
 - 3> derive the K_{UPint} key associated with the previously configured integrity algorithm, as specified in TS 33.401 [32];
- 2> configure lower layers to activate integrity protection using the previously configured algorithm and the K_{RRcint} key immediately, i.e., integrity protection shall be applied to all subsequent messages received and sent by the UE, including the message used to indicate the successful completion of the procedure;
- 2> if connected as an RN:
 - 3> configure lower layers to apply integrity protection using the previously configured algorithm and the K_{UPint} key, for subsequently resumed or subsequently established DRBs that are configured to apply integrity protection, if any;
- 2> configure lower layers to apply ciphering using the previously configured algorithm, the K_{RRcenc} key and the K_{UPenc} key immediately, i.e., ciphering shall be applied to all subsequent messages received and sent by the UE, including the message used to indicate the successful completion of the procedure;
- 2> if the UE is not a NB-IoT UE:
 - 3> set the content of *RRCConnectionReestablishmentComplete* message as follows:
 - 4> if the UE has radio link failure or handover failure information available in *VarRLF-Report* and if the RPLMN is included in *plmn-IdentityList* stored in *VarRLF-Report*:
 - 5> include the *rlf-InfoAvailable*;
 - 4> if the UE has MBSFN logged measurements available for E-UTRA and if the RPLMN is included in *plmn-IdentityList* stored in *VarLogMeasReport* and if T330 is not running:
 - 5> include *logMeasAvailableMBSFN*;
 - 4> else if the UE has logged measurements available for E-UTRA and if the RPLMN is included in *plmn-IdentityList* stored in *VarLogMeasReport*:
 - 5> include the *logMeasAvailable*;
 - 4> if the UE has connection establishment failure information available in *VarConnEstFailReport* and if the RPLMN is equal to *plmn-Identity* stored in *VarConnEstFailReport*:
 - 5> include the *connEstFailInfoAvailable*;
 - 3> perform the measurement related actions as specified in 5.5.6.1;
 - 3> perform the measurement identity autonomous removal as specified in 5.5.2.2a;
- 2> else:
 - 3> if the UE supports serving cell idle mode measurements reporting and *servingCellMeasInfo* is present in *SystemInformationBlockType2-NB*:
 - 4> set the *measResultServCell* to include the measurements of the serving cell;

NOTE 2a: The UE includes the latest results of the serving cell measurements as used for cell selection/ reselection evaluation, which are performed in accordance with the performance requirements as specified in TS 36.133 [16].

- 2> submit the *RRCConnectionReestablishmentComplete* message to lower layers for transmission;
- 2> if *SystemInformationBlockType15* is broadcast by the PCell:
 - 3> if the UE has transmitted an *MBMSInterestIndication* message during the last 1 second preceding detection of radio link failure:
 - 4> ensure having a valid version of *SystemInformationBlockType15* for the PCell;
 - 4> determine the set of MBMS frequencies of interest in accordance with 5.8.5.3;
 - 4> determine the set of MBMS services of interest in accordance with 5.8.5.3a;
 - 4> initiate transmission of the *MBMSInterestIndication* message in accordance with 5.8.5.4;
 - 2> if *SystemInformationBlockType18* is broadcast by the PCell; and the UE transmitted a *SidelinkUEInformation* message indicating a change of sidelink communication related parameters relevant in PCell (i.e. change of *commRxInterestedFreq* or *commTxResourceReq*, *commTxResourceReqUC* if *SystemInformationBlockType18* includes *commTxResourceUC-ReqAllowed* or *commTxResourceInfoReqRelay* if PCell broadcasts *SystemInformationBlockType19* including *discConfigRelay*) during the last 1 second preceding detection of radio link failure; or
 - 2> if *SystemInformationBlockType19* is broadcast by the PCell; and the UE transmitted a *SidelinkUEInformation* message indicating a change of sidelink discovery related parameters relevant in PCell (i.e. change of *discRxInterest* or *discTxResourceReq*, *discTxResourceReqPS* if *SystemInformationBlockType19* includes *discConfigPS* or *discRxGapReq* or *discTxGapReq* if the UE is configured with *gapRequestsAllowedDedicated* set to *true* or if the UE is not configured with *gapRequestsAllowedDedicated* and *SystemInformationBlockType19* includes *gapRequestsAllowedCommon*) during the last 1 second preceding detection of radio link failure; or
 - 2> if *SystemInformationBlockType21* including *sl-V2X-ConfigCommon* is broadcast by the PCell; and the UE transmitted a *SidelinkUEInformation* message indicating a change of V2X sidelink communication related parameters relevant in PCell (i.e. change of *v2x-CommRxInterestedFreqList* or *v2x-CommTxResourceReq*) during the last 1 second preceding detection of radio link failure:
 - 3> initiate transmission of the *SidelinkUEInformation* message in accordance with 5.10.2.3;
- 1> for a NB-IoT UE for which AS security has not been activated:
 - 2> validate *dl-NAS-MAC*, as specified in TS 33.401 [32];
 - 2> if *dl-NAS-MAC* check fails:
 - 3> perform the actions upon leaving *RRC_CONNECTED* as specified in 5.3.12, with release cause 'RRC connection failure', upon which the procedure ends;
 - 2> except for a UE that only supports the Control Plane CIoT EPS optimisation:
 - 3> re-establish PDCP for SRB1;
 - 3> re-establish RLC for SRB1;
 - 2> re-establish RLC for SRB1bis;
 - 2> perform the radio resource configuration procedure in accordance with the received *radioResourceConfigDedicated* and as specified in 5.3.10;
 - 2> except for a UE that only supports the Control Plane CIoT EPS optimisation:
 - 3> resume SRB1;
 - 2> resume SRB1bis;

NOTE 3: E-UTRAN should not transmit any message on SRB1bis prior to receiving the *RRCConnectionReestablishmentComplete* message.

2> if the UE supports serving cell idle mode measurements reporting and *servingCellMeasInfo* is present in *SystemInformationBlockType2-NB*:

3> set the *measResultServCell* to include the measurements of the serving cell;

NOTE 4: The UE includes the latest results of the serving cell measurements as used for cell selection/ reselection evaluation, which are performed in accordance with the performance requirements as specified in TS 36.133 [16].

2> submit the *RRCConnectionReestablishmentComplete* message to lower layers for transmission;

1> the procedure ends;

5.3.7.6 T311 expiry

Upon T311 expiry, the UE shall:

1> perform the actions upon leaving RRC_CONNECTED as specified in 5.3.12, with release cause 'RRC connection failure';

5.3.7.7 T301 expiry or selected cell no longer suitable

The UE shall:

1> if timer T301 expires; or

1> if the selected cell becomes no longer suitable according to the cell selection criteria as specified in TS 36.304 [4]:

2> perform the actions upon leaving RRC_CONNECTED as specified in 5.3.12, with release cause 'RRC connection failure';

5.3.7.8 Reception of *RRCConnectionReestablishmentReject* by the UE

Upon receiving the *RRCConnectionReestablishmentReject* message, the UE shall:

1> perform the actions upon leaving RRC_CONNECTED as specified in 5.3.12, with release cause 'RRC connection failure';

5.3.8 RRC connection release

5.3.8.1 General

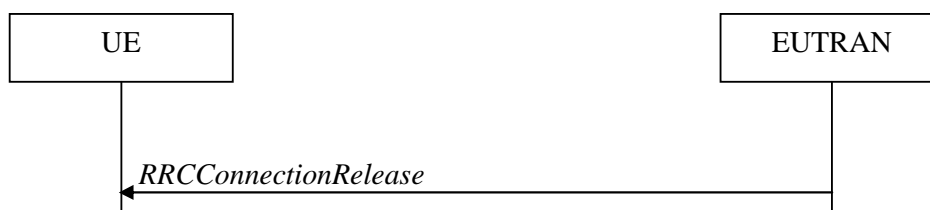

Figure 5.3.8.1-1: RRC connection release, successful

The purpose of this procedure is:

- to release the RRC connection, which includes the release of the established radio bearers as well as all radio resources; or
- to suspend the RRC connection, which includes the suspension of the established radio bearers.

5.3.8.2 Initiation

E-UTRAN initiates the RRC connection release procedure to a UE in RRC_CONNECTED.

5.3.8.3 Reception of the *RRConnectionRelease* by the UE

The UE shall:

- 1> except for NB-IoT, BL UEs or UEs in CE, delay the following actions defined in this clause 60 ms from the moment the *RRConnectionRelease* message was received or optionally when lower layers indicate that the receipt of the *RRConnectionRelease* message has been successfully acknowledged, whichever is earlier;
- 1> for BL UEs or UEs in CE, delay the following actions defined in this clause 1.25 seconds from the moment the *RRConnectionRelease* message was received or optionally when lower layers indicate that the receipt of the *RRConnectionRelease* message has been successfully acknowledged, whichever is earlier;
- 1> for NB-IoT, delay the following actions defined in this clause 10 seconds from the moment the *RRConnectionRelease* message was received or optionally when lower layers indicate that the receipt of the *RRConnectionRelease* message has been successfully acknowledged, whichever is earlier.

NOTE: For NB-IoT, when STATUS reporting, as defined in TS 36.322 [7], has not been triggered and the UE has sent positive HARQ feedback (ACK), as defined in TS 36.321 [6], the lower layers can be considered to have indicated that the receipt of the *RRConnectionRelease* message has been successfully acknowledged.

- 1> if the *RRConnectionRelease* message includes *redirectedCarrierInfo* indicating redirection to *geran*; or
- 1> if the *RRConnectionRelease* message includes *idleModeMobilityControlInfo* including *freqPriorityListGERAN*:
 - 2> if AS security has not been activated, and
 - 2> if upper layers indicate that redirect to GERAN without AS security is not allowed:
 - 3> ignore the content of the *RRConnectionRelease*;
 - 3> perform the actions upon leaving RRC_CONNECTED as specified in 5.3.12, with release cause 'other', upon which the procedure ends;
- 1> if the *RRConnectionRelease* message includes the *idleModeMobilityControlInfo*:
 - 2> store the cell reselection priority information provided by the *idleModeMobilityControlInfo*;
 - 2> if the *t320* is included:
 - 3> start timer T320, with the timer value set according to the value of *t320*;
- 1> else:
 - 2> apply the cell reselection priority information broadcast in the system information;
- 1> for NB-IoT, if the *RRConnectionRelease* message includes the *redirectedCarrierInfo*:
 - 2> if the *redirectedCarrierOffsetDedicated* is included in the *redirectedCarrierInfo*:
 - 3> store the dedicated offset for the frequency in *redirectedCarrierInfo*;
 - 3> start timer T322, with the timer value set according to the value of *T322* in *redirectedCarrierInfo*;
- 1> if the *releaseCause* received in the *RRConnectionRelease* message indicates *loadBalancingTAURequired*:
 - 2> perform the actions upon leaving RRC_CONNECTED as specified in 5.3.12, with release cause 'load balancing TAU required';
- 1> else if the *releaseCause* received in the *RRConnectionRelease* message indicates *cs-FallbackHighPriority*:
 - 2> perform the actions upon leaving RRC_CONNECTED as specified in 5.3.12, with release cause 'CS Fallback High Priority';

- 1> else:
 - 2> if the *extendedWaitTime* is present; and
 - 2> if the UE supports delay tolerant access or the UE is a NB-IoT UE:
 - 3> forward the *extendedWaitTime* to upper layers;
 - 2> if the *extendedWaitTime-CPdata* is present and the NB-IoT UE only supports the Control Plane CIoT EPS optimisation:
 - 3> forward the *extendedWaitTime-CPdata* to upper layers;
 - 2> if the *releaseCause* received in the *RRCConnectionRelease* message indicates *rrc-Suspend*:
 - 3> perform the actions upon leaving RRC_CONNECTED as specified in 5.3.12, with release cause 'RRC suspension';
- 2> else:
 - 3> perform the actions upon leaving RRC_CONNECTED as specified in 5.3.12, with release cause 'other';

5.3.8.4 T320 expiry

The UE shall:

- 1> if T320 expires:
 - 2> if stored, discard the cell reselection priority information provided by the *idleModeMobilityControlInfo* or inherited from another RAT;
 - 2> apply the cell reselection priority information broadcast in the system information;

5.3.8.5 T322 expiry or stop

The UE shall:

- 1> if T322 expires or is stopped:
 - 2> discard the *redirectedCarrierOffsetDedicated* provided in *RRCConnectionRelease* message;

5.3.8.6 UE actions upon receiving the expiry of *DataInactivityTimer*

Upon receiving the expiry of *DataInactivityTimer* from lower layers, the UE shall:

- 1> perform the actions upon leaving RRC_CONNECTED as specified in 5.3.12, with release cause 'RRC connection failure';

5.3.9 RRC connection release requested by upper layers

5.3.9.1 General

The purpose of this procedure is to release the RRC connection. Access to the current PCell may be barred as a result of this procedure.

NOTE: Upper layers invoke the procedure, e.g. upon determining that the network has failed an authentication check, see TS 24.301 [35].

5.3.9.2 Initiation

The UE initiates the procedure when upper layers request the release of the RRC connection. The UE shall not initiate the procedure for power saving purposes.

The UE shall:

- 1> if the upper layers indicate barring of the PCell:
 - 2> treat the PCell used prior to entering RRC_IDLE as barred according to TS 36.304 [4];
- 1> perform the actions upon leaving RRC_CONNECTED as specified in 5.3.12, with release cause 'other';

5.3.10 Radio resource configuration

5.3.10.0 General

The UE shall:

- 1> if the received *radioResourceConfigDedicated* includes the *srb-ToAddModList*:
 - 2> perform the SRB addition or reconfiguration as specified in 5.3.10.1;
- 1> if the received *radioResourceConfigDedicated* includes the *drb-ToReleaseList*:
 - 2> perform DRB release as specified in 5.3.10.2;
- 1> if the received *radioResourceConfigDedicated* includes the *drb-ToAddModList*:
 - 2> perform DRB addition or reconfiguration as specified in 5.3.10.3;
- 1> if the received *radioResourceConfigDedicated* includes the *mac-MainConfig*:
 - 2> perform MAC main reconfiguration as specified in 5.3.10.4;
- 1> if the received *radioResourceConfigDedicated* includes *sps-Config*:
 - 2> perform SPS reconfiguration according to 5.3.10.5;
- 1> if the received *radioResourceConfigDedicated* includes the *physicalConfigDedicated*:
 - 2> reconfigure the physical channel configuration as specified in 5.3.10.6.
- 1> if the received *radioResourceConfigDedicated* includes the *rlf-TimersAndConstants*:
 - 2> reconfigure the values of timers and constants as specified in 5.3.10.7;
- 1> if the received *radioResourceConfigDedicated* includes the *measSubframePatternPCell*:
 - 2> reconfigure the time domain measurement resource restriction for the serving cell as specified in 5.3.10.8;
- 1> if the received *radioResourceConfigDedicated* includes the *naics-Info*:
 - 2> perform NAICS neighbour cell information reconfiguration for the PCell as specified in 5.3.10.13;
- 1> if the received *RadioResourceConfigDedicatedPSCell* includes the *naics-Info*:
 - 2> perform NAICS neighbour cell information reconfiguration for the PSCell as specified in 5.3.10.13;
- 1> if the received *RadioResourceConfigDedicatedSCell-r10* includes the *naics-Info*:
 - 2> perform NAICS neighbour cell information reconfiguration for the SCell as specified in 5.3.10.13;

5.3.10.1 SRB addition/ modification

The UE shall:

- 1> if the UE is a NB-IoT UE and SRB1 is not established; or
- 1> for each *srb-Identity* value included in the *srb-ToAddModList* that is not part of the current UE configuration (SRB establishment):

- 2> if the UE is not a NB-IoT UE that only supports the Control Plane CIoT EPS optimisation:
 - 3> apply the specified configuration defined in 9.1.2 for the corresponding SRB;
 - 3> establish a PDCP entity and configure it with the current (MCG) security configuration, if applicable;
 - 3> establish an (MCG) RLC entity in accordance with the received *rlc-Config*;
 - 3> establish a (MCG) DCCH logical channel in accordance with the received *logicalChannelConfig* and with the logical channel identity set in accordance with 9.1.2;
- 2> if the UE is a NB-IoT UE:
 - 3> apply the specified configuration defined in 9.1.2 for SRB1bis;
 - 3> establish an (MCG) RLC entity in accordance with the received *rlc-Config*;
 - 3> establish a (MCG) DCCH logical channel in accordance with the received *logicalChannelConfig* and with the logical channel identity set in accordance with 9.1.2.1a;
- 1> if the UE is a NB-IoT UE and SRB1 is established; or
- 1> for each *srb-Identity* value included in the *srb-ToAddModList* that is part of the current UE configuration (SRB reconfiguration):
 - 2> reconfigure the RLC entity in accordance with the received *rlc-Config*;
 - 2> reconfigure the DCCH logical channel in accordance with the received *logicalChannelConfig*;

5.3.10.2 DRB release

The UE shall:

- 1> for each *drb-Identity* value included in the *drb-ToReleaseList* that is part of the current UE configuration (DRB release); or
- 1> for each *drb-identity* value that is to be released as the result of full configuration option according to 5.3.5.8:
 - 2> release the PDCP entity;
 - 2> release the RLC entity or entities;
 - 2> release the DTCH logical channel;
- 1> if the procedure was triggered due to handover:
 - 2> indicate the release of the DRB(s) and the *eps-BearerIdentity* of the released DRB(s) to upper layers after successful handover;
- 1> else:
 - 2> indicate the release of the DRB(s) and the *eps-BearerIdentity* of the released DRB(s) to upper layers immediately.

NOTE: The UE does not consider the message as erroneous if the *drb-ToReleaseList* includes any *drb-Identity* value that is not part of the current UE configuration.

5.3.10.3 DRB addition/ modification

The UE shall:

- 1> for each *drb-Identity* value included in the *drb-ToAddModList* that is not part of the current UE configuration (DRB establishment including the case when full configuration option is used):
 - 2> if the concerned entry of *drb-ToAddModList* includes the *drb-TypeLWA* set to *TRUE* (i.e. add LWA DRB):

- 3> perform the LWA specific DRB addition or reconfiguration as specified in 5.3.10.3a2;
- 2> if the concerned entry of *drb-ToAddModList* includes the *drb-TypeLWIP* (i.e. add LWIP DRB):
 - 3> perform LWIP specific DRB addition or reconfiguration as specified in 5.3.10.3a3;
- 2> else if *drb-ToAddModListSCG* is not received or does not include the *drb-Identity* value (i.e. add MCG DRB):
 - 3> establish a PDCP entity and configure it with the current MCG security configuration and in accordance with the received *pdcp-Config*;
 - 3> establish an MCG RLC entity or entities in accordance with the received *rlc-Config*;
 - 3> establish an MCG DTCH logical channel in accordance with the received *logicalChannelIdentity* and the received *logicalChannelConfig*;
- 2> if the *RRCCONNECTIONRECONFIGURATION* message includes the *fullConfig* IE:
 - 3> associate the established DRB with corresponding included *eps-BearerIdentity*;
- 2> else:
 - 3> indicate the establishment of the DRB(s) and the *eps-BearerIdentity* of the established DRB(s) to upper layers;
- 1> for each *drb-Identity* value included in the *drb-ToAddModList* that is part of the current UE configuration (DRB reconfiguration):
 - 2> if the DRB indicated by *drb-Identity* is an LWA DRB (i.e. LWA to LTE only or reconfigure LWA DRB):
 - 3> perform the LWA specific DRB reconfiguration as specified in 5.3.10.3a2;
 - 2> else if the concerned entry of *drb-ToAddModList* includes the *drb-TypeLWA* set to *TRUE* (i.e. LTE only to LWA DRB):
 - 3> perform the LWA specific DRB reconfiguration as specified in 5.3.10.3a2;
 - 2> if the concerned entry of *drb-ToAddModList* includes the *drb-TypeLWIP* (i.e. add or reconfigure LWIP DRB):
 - 3> perform LWIP specific DRB addition or reconfiguration as specified in 5.3.10.3a3;
 - 2> if *drb-ToAddModListSCG* is not received or does not include the *drb-Identity* value:
 - 3> if the DRB indicated by *drb-Identity* is an MCG DRB (reconfigure MCG):
 - 4> if the *pdcp-Config* is included:
 - 5> reconfigure the PDCP entity in accordance with the received *pdcp-Config*;
 - 4> if the *rlc-Config* is included:
 - 5> reconfigure the RLC entity or entities in accordance with the received *rlc-Config*;
 - 4> if the *logicalChannelConfig* is included:
 - 5> reconfigure the DTCH logical channel in accordance with the received *logicalChannelConfig*;

NOTE: Removal and addition of the same *drb-Identity* in a single *radioResourceConfigDedicated* is not supported. In case *drb-Identity* is removed and added due to handover or re-establishment with the full configuration option, the eNB can use the same value of *drb-Identity*.

5.3.10.3a1 DC specific DRB addition or reconfiguration

For the *drb-Identity* value for which this procedure is initiated, the UE shall:

- 1> if *drb-ToAddModListSCG* is received and includes the *drb-Identity* value; and *drb-Identity* value is not part of the current UE configuration (i.e. DC specific DRB establishment):
 - 2> if *drb-ToAddModList* is received and includes the *drb-Identity* value (i.e. add split DRB):
 - 3> establish a PDCP entity and configure it with the current MCG security configuration and in accordance with the *pdcp-Config* included in *drb-ToAddModList*;
 - 3> establish an MCG RLC entity and an MCG DTCH logical channel in accordance with the *rlc-Config*, *logicalChannelIdentity* and *logicalChannelConfig* included in *drb-ToAddModList*;
 - 3> establish an SCG RLC entity and an SCG DTCH logical channel in accordance with the *rlc-ConfigSCG*, *logicalChannelIdentitySCG* and *logicalChannelConfigSCG* included in *drb-ToAddModListSCG*;
 - 2> else (i.e. add SCG DRB):
 - 3> establish a PDCP entity and configure it with the current SCG security configuration and in accordance with the *pdcp-Config* included in *drb-ToAddModListSCG*;
 - 3> establish an SCG RLC entity or entities and an SCG DTCH logical channel in accordance with the *rlc-ConfigSCG*, *logicalChannelIdentitySCG* and *logicalChannelConfigSCG* included in *drb-ToAddModListSCG*;
 - 2> indicate the establishment of the DRB(s) and the *eps-BearerIdentity* of the established DRB(s) to upper layers;
- 1> else (i.e. DC specific DRB modification; *drb-ToAddModList* and/ or *drb-ToAddModListSCG* received):
 - 2> if the DRB indicated by *drb-Identity* is a split DRB:
 - 3> if *drb-ToAddModList* is received and includes the *drb-Identity* value, while for this entry *drb-TypeChange* is included and set to *toMCG* (i.e. split to MCG):
 - 4> release the SCG RLC entity and the SCG DTCH logical channel;
 - 4> reconfigure the PDCP entity in accordance with the *pdcp-Config*, if included in *drb-ToAddModList*;
 - 4> reconfigure the MCG RLC entity and/ or the MCG DTCH logical channel in accordance with the *rlc-Config* and *logicalChannelConfig*, if included in *drb-ToAddModList*;
 - 3> else (i.e. reconfigure split):
 - 4> reconfigure the PDCP entity in accordance with the *pdcp-Config*, if included in *drb-ToAddModList*;
 - 4> reconfigure the MCG RLC entity and/ or the MCG DTCH logical channel in accordance with the *rlc-Config* and *logicalChannelConfig*, if included in *drb-ToAddModList*;
 - 4> reconfigure the SCG RLC entity and/ or the SCG DTCH logical channel in accordance with the *rlc-ConfigSCG* and *logicalChannelConfigSCG*, if included in *drb-ToAddModListSCG*;
 - 2> if the DRB indicated by *drb-Identity* is an SCG DRB:
 - 3> if *drb-ToAddModList* is received and includes the *drb-Identity* value, while for this entry *drb-TypeChange* is included and set to *toMCG* (i.e. SCG to MCG):
 - 4> reconfigure the PDCP entity with the current MCG security configuration and in accordance with the *pdcp-Config*, if included in *drb-ToAddModList*;
 - 4> reconfigure the SCG RLC entity or entities and the SCG DTCH logical channel to be an MCG RLC entity or entities and an MCG DTCH logical channel;
 - 4> reconfigure the MCG RLC entity or entities and/ or the MCG DTCH logical channel in accordance with the *rlc-Config*, *logicalChannelIdentity* and *logicalChannelConfig*, if included in *drb-ToAddModList*;
 - 3> else (i.e. *drb-ToAddModListSCG* is received and includes the *drb-Identity* value i.e. reconfigure SCG):

- 4> reconfigure the PDCP entity in accordance with the *pdcp-Config*, if included in *drb-ToAddModListSCG*;
 - 4> reconfigure the SCG RLC entity or entities and/ or the SCG DTCH logical channel in accordance with the *rlc-ConfigSCG* and *logicalChannelConfigSCG*, if included in *drb-ToAddModListSCG*;
- 2> if the DRB indicated by *drb-Identity* is an MCG DRB:
- 3> if *drb-ToAddModListSCG* is received and includes the *drb-Identity* value, while for this entry *drb-Type* is included and set to *split* (i.e. MCG to split):
 - 4> reconfigure the PDCP entity in accordance with the *pdcp-Config*, if included in *drb-ToAddModList*;
 - 4> reconfigure the MCG RLC entity and/ or the MCG DTCH logical channel in accordance with the *rlc-Config* and *logicalChannelConfig*, if included in *drb-ToAddModList*;
 - 4> establish an SCG RLC entity and an SCG DTCH logical channel in accordance with the *rlc-ConfigSCG*, *logicalChannelIdentitySCG* and *logicalChannelConfigSCG*, included in *drb-ToAddModListSCG*;
 - 3> else (i.e. *drb-Type* is included and set to *scg* i.e. MCG to SCG):
 - 4> reconfigure the PDCP entity with the current SCG security configuration and in accordance with the *pdcp-Config*, if included in *drb-ToAddModListSCG*;
 - 4> reconfigure the MCG RLC entity or entities and the MCG DTCH logical channel to be an SCG RLC entity or entities and an SCG DTCH logical channel;
 - 4> reconfigure the SCG RLC entity or entities and/ or the SCG DTCH logical channel in accordance with the *rlc-ConfigSCG*, *logicalChannelIdentitySCG* and *logicalChannelConfigSCG*, if included in *drb-ToAddModListSCG*;

5.3.10.3a2 LWA specific DRB addition or reconfiguration

For the *drb-Identity* value for which this procedure is initiated, the UE shall:

- 1> if the *drb-Identity* value is not part of the current UE configuration (i.e. add LWA DRB):
 - 2> establish a PDCP entity and configure it with the current security configuration and in accordance with the *pdcp-Config* included in *drb-ToAddModList*;
 - 2> establish an RLC entity and an DTCH logical channel in accordance with the *rlc-Config*, *logicalChannelIdentity* and *logicalChannelConfig* included in *drb-ToAddModList*;
 - 2> enable data handling for this DRB at the LWAAP entity;
 - 2> if *lwa-WLAN-AC* is configured:
 - 3> apply the received *lwa-WLAN-AC* when performing transmissions of packets for this DRB over WLAN;
 - 2> indicate the establishment of the DRB and the *eps-BearerIdentity* of the established DRB to upper layers;
- 1> else if the DRB indicated by *drb-Identity* is not an LWA DRB (i.e. LTE only to LWA DRB):
 - 2> reconfigure the PDCP entity in accordance with the *pdcp-Config*, if included in *drb-ToAddModList*;
 - 2> reconfigure the RLC entity and/ or the DTCH logical channel in accordance with the *rlc-Config* and *logicalChannelConfig*, if included in *drb-ToAddModList*;
 - 2> enable data handling for this DRB at the LWAAP entity;
 - 2> if *lwa-WLAN-AC* is configured:
 - 3> apply the received *lwa-WLAN-AC* when performing transmissions of packets for this DRB over WLAN;
- 1> else if the concerned entry of *drb-ToAddModList* includes the *drb-TypeLWA* set to *FALSE* (i.e. LWA to LTE only DRB):

- 2> reconfigure the PDCP entity in accordance with the *pdcp-Config*, if included in *drb-ToAddModList*;
- 2> reconfigure the RLC entity and/ or the DTCH logical channel in accordance with the *rlc-Config* and *logicalChannelConfig*, if included in *drb-ToAddModList*;
- 2> perform PDCP data recovery as specified in TS 36.323 [8] if bearer is configured with RLC AM;
- 2> disable data handling for this DRB at the LWAAP entity;
- 1> else (i.e. reconfigure LWA DRB):
 - 2> reconfigure the PDCP entity in accordance with the *pdcp-Config*, if included in *drb-ToAddModList*;
 - 2> reconfigure the RLC entity and/ or the DTCH logical channel in accordance with the *rlc-Config* and *logicalChannelConfig*, if included in *drb-ToAddModList*;
 - 2> if *lwa-WLAN-AC* is configured:
 - 3> apply the received *lwa-WLAN-AC* when performing transmissions of packets for this DRB over WLAN;

5.3.10.3a3 LWIP specific DRB addition or reconfiguration

For the *drb-Identity* value for which this procedure is initiated, the UE shall:

- 1> if the *drb-TypeLWIP* is set to *lwip*:
 - 2> indicate to higher layers to use LWIP resources in both UL and DL for the DRB associated with the *drb-Identity*;
 - 2> if *lwip-DL-Aggregation* is set to TRUE:
 - 3> indicate to higher layers to apply decoding of LWIPEP header with GRE sequence number for both LTE and WLAN DL reception for the DRB associated with the *drb-Identity*;
 - 2> if *lwip-DL-Aggregation* is set to FALSE:
 - 3> indicate to higher layers to stop decoding of LWIPEP header with GRE sequence number for both LTE and WLAN DL reception for the DRB associated with the *drb-Identity*;
 - 2> if *lwip-UL-Aggregation* is set to TRUE:
 - 3> indicate to higher layers to insert LWIPEP header with GRE sequence number for both LTE and WLAN UL transmissions for the DRB associated with the *drb-Identity*;
 - 2> if *lwip-UL-Aggregation* is set to FALSE:
 - 3> indicate to higher layers to stop inserting LWIPEP header with GRE sequence number for both LTE and WLAN UL transmissions for the DRB associated with the *drb-Identity*;
- 1> if the *drb-TypeLWIP* is set to *lwip-DL-only*:
 - 2> indicate to higher layers to use LWIP resources in the DL only for the DRB associated with the *drb-Identity*;
 - 2> if *lwip-DL-Aggregation* is set to TRUE:
 - 3> indicate to higher layers to apply decoding of LWIPEP header with GRE sequence number for both LTE and WLAN DL reception for the DRB associated with the *drb-Identity*;
- 1> if the *drb-TypeLWIP* is set to *lwip-UL-only*:
 - 2> indicate to higher layers to use LWIP resources in the UL only for the DRB associated with the *drb-Identity*;
 - 2> if *lwip-UL-Aggregation* is set to TRUE:
 - 3> indicate to higher layers to insert LWIPEP header with GRE sequence number for both LTE and WLAN UL transmissions for the DRB associated with the *drb-Identity*;

- 1> if the *drb-TypeLWIP* is set to *eutran*:
- 2> indicate to higher layers to stop using LWIP resources for the DRB associated with the *drb-Identity*;

5.3.10.3a SCell release

The UE shall:

- 1> if the release is triggered by reception of the *sCellToReleaseList* or the *sCellToReleaseListSCG*:
 - 2> for each *sCellIndex* value included either in the *sCellToReleaseList* or in the *sCellToReleaseListSCG*:
 - 3> if the current UE configuration includes an SCell with value *sCellIndex*:
 - 4> release the SCell;
 - 1> if the release is triggered by RRC connection re-establishment:
 - 2> release all SCells that are part of the current UE configuration;

5.3.10.3b SCell addition/ modification

The UE shall:

- 1> for each *sCellIndex* value included either in the *sCellToAddModList* or in the *sCellToAddModListSCG* that is not part of the current UE configuration (SCell addition):
 - 2> add the SCell, corresponding to the *cellIdentification*, in accordance with the *radioResourceConfigCommonSCell* and *radioResourceConfigDedicatedSCell*, both included either in the *sCellToAddModList* or in the *sCellToAddModListSCG*;
 - 2> configure lower layers to consider the SCell to be in deactivated state;
 - 2> for each *measId* included in the *measIdList* within *VarMeasConfig*:
 - 3> if SCells are not applicable for the associated measurement; and
 - 3> if the concerned SCell is included in *cellsTriggeredList* defined within the *VarMeasReportList* for this *measId*:
 - 4> remove the concerned SCell from *cellsTriggeredList* defined within the *VarMeasReportList* for this *measId*;
 - 1> for each *sCellIndex* value included either in the *sCellToAddModList* or in the *sCellToAddModListSCG* that is part of the current UE configuration (SCell modification):
 - 2> modify the SCell configuration in accordance with the *radioResourceConfigDedicatedSCell*, included either in the *sCellToAddModList* or in the *sCellToAddModListSCG*;

5.3.10.3c PSCell addition or modification

The UE shall:

- 1> if the PSCell is not part of the current UE configuration (i.e. PSCell addition):
 - 2> add the PSCell, corresponding to the *cellIdentification*, in accordance with the received *radioResourceConfigCommonPSCell* and *radioResourceConfigDedicatedPSCell*;
 - 2> configure lower layers to consider the PSCell to be in activated state;
- 1> if the PSCell is part of the current UE configuration (i.e. PSCell modification):
 - 2> modify the PSCell configuration in accordance with the received *radioResourceConfigDedicatedPSCell*;

5.3.10.4 MAC main reconfiguration

Except for NB-IoT, the UE shall:

- 1> if the procedure is triggered to perform SCG MAC main reconfiguration:
 - 2> if SCG MAC is not part of the current UE configuration (i.e. SCG establishment):
 - 3> create an SCG MAC entity;
 - 2> reconfigure the SCG MAC main configuration as specified in the following i.e. assuming it concerns the SCG MAC whenever MAC main configuration is referenced and that it is based on the received *mac-MainConfigSCG* instead of *mac-MainConfig*:
- 1> reconfigure the MAC main configuration in accordance with the received *mac-MainConfig* other than *stag-ToReleaseList* and *stag-ToAddModList*;
- 1> if the received *mac-MainConfig* includes the *stag-ToReleaseList*:
 - 2> for each *STAG-Id* value included in the *stag-ToReleaseList* that is part of the current UE configuration:
 - 3> release the STAG indicated by *STAG-Id*;
- 1> if the received *mac-MainConfig* includes the *stag-ToAddModList*:
 - 2> for each *stag-Id* value included in *stag-ToAddModList* that is not part of the current UE configuration (STAG addition):
 - 3> add the STAG, corresponding to the *stag-Id*, in accordance with the received *timeAlignmentTimerSTAG*;
 - 2> for each *stag-Id* value included in *stag-ToAddModList* that is part of the current UE configuration (STAG modification):
 - 3> reconfigure the STAG, corresponding to the *stag-Id*, in accordance with the received *timeAlignmentTimerSTAG*;

For NB-IoT, the UE shall:

- 1> reconfigure the MAC main configuration in accordance with the received *mac-MainConfig*;

5.3.10.5 Semi-persistent scheduling reconfiguration

The UE shall:

- 1> reconfigure the semi-persistent scheduling in accordance with the received *sps-Config*;

5.3.10.6 Physical channel reconfiguration

Except for NB-IoT, the UE shall:

- 1> if the *antennaInfo-r10* is included in the received *physicalConfigDedicated* and the previous version of this field that was received by the UE was *antennaInfo* (without suffix i.e. the version defined in REL-8):
 - 2> apply the default antenna configuration as specified in 9.2.4;
- 1> if the *cqi-ReportConfig-r10* is included in the received *physicalConfigDedicated* and the previous version of this field that was received by the UE was *cqi-ReportConfig* (without suffix i.e. the version defined in REL-8):
 - 2> apply the default CQI reporting configuration as specified in 9.2.4;

NOTE: Application of the default configuration involves release of all extensions introduced in REL-9 and later.

- 1> reconfigure the physical channel configuration in accordance with the received *physicalConfigDedicated*;
- 1> if the *antennaInfo* is included and set to *explicitValue*:

- 2> if the configured *transmissionMode* is *tm1*, *tm2*, *tm5*, *tm6* or *tm7*; or
- 2> if the configured *transmissionMode* is *tm8* and *pmi-RI-Report* is not present; or
- 2> if the configured *transmissionMode* is *tm9* and *pmi-RI-Report* is not present; or
- 2> if the configured *transmissionMode* is *tm9* and *pmi-RI-Report* is present and *antennaPortsCount* within *csi-RS* is set to *an1*:
 - 3> release *ri-ConfigIndex* in *cqi-ReportPeriodic*, if previously configured;
- 1> else if the *antennaInfo* is included and set to *defaultValue*:
 - 2> release *ri-ConfigIndex* in *cqi-ReportPeriodic*, if previously configured;
- 1> if the *pusch-EnhancementsConfig* is included in the received *physicalConfigDedicated*, for the associated serving cell:
 - 2> if PUSCH enhancement mode is previously released or not configured and *pusch-EnhancementsConfig* is set to *setup*, or
 - 2> if PUSCH enhancement mode is previously configured and *pusch-EnhancementConfig* is set to *release*:
 - 3> instruct the associated MAC entity to perform partial reset;
- 1> if the procedure was not triggered due to handover and *ce-Mode* is included in the received *physicalConfigDedicated*, for the associated serving cell:
 - 2> if *ce-Mode* is not currently configured and *ce-Mode* is set to *setup*, or
 - 2> if *ce-Mode* is currently configured and *ce-Mode* is set to *release*:
 - 3> instruct the associated MAC entity to perform partial reset;

For NB-IoT, the UE shall:

- 1> if the *carrierConfigDedicated* is not included in the received *physicalConfigDedicated*:
 - 2> if the UE is configured with a carrier configuration previously received in *carrierConfigDedicated*:
 - 3> use the carrier configuration received in *carrierConfigDedicated*;
 - 2> else:
 - 3> use the carrier configuration received in system information for the uplink and downlink carrier used during the random access procedure;
- 1> else:
 - 2> use the carrier configuration received in *carrierConfigDedicated*;
 - 2> start to use the new carrier immediately after the last transport block carrying the RRC message has been acknowledged by the MAC layer, and any subsequent RRC response message sent for the current RRC procedure is therefore sent on the new carrier;
- 1> reconfigure the physical channel configuration in accordance with the received *physicalConfigDedicated*.

5.3.10.7 Radio Link Failure Timers and Constants reconfiguration

The UE shall:

- 1> if the received *rlf-TimersAndConstants* is set to release:
 - 2> use values for timers T301, T310, T311 and constants N310, N311, as included in *ue-TimersAndConstants* received in *SystemInformationBlockType2* (or *SystemInformationBlockType2-NB* in NB-IoT);
- 1> else:

- 2> reconfigure the value of timers and constants in accordance with received *rlf-TimersAndConstants*;
- 1> if the received *rlf-TimersAndConstantsSCG* is set to release:
 - 2> stop timer T313, if running, and
 - 2> release the value of timer *t313* as well as constants *n313* and *n314*;
- 1> else:
 - 2> reconfigure the value of timers and constants in accordance with received *rlf-TimersAndConstantsSCG*;

5.3.10.8 Time domain measurement resource restriction for serving cell

The UE shall:

- 1> if the received *measSubframePatternPCell* is set to *release*:
 - 2> release the time domain measurement resource restriction for the PCell, if previously configured
- 1> else:
 - 2> apply the time domain measurement resource restriction for the PCell in accordance with the received *measSubframePatternPCell*;

5.3.10.9 Other configuration

The UE shall:

- 1> if the received *otherConfig* includes the *reportProximityConfig*:
 - 2> if *proximityIndicationEUTRA* is set to *enabled*:
 - 3> consider itself to be configured to provide proximity indications for E-UTRA frequencies in accordance with 5.3.14;
 - 2> else:
 - 3> consider itself not to be configured to provide proximity indications for E-UTRA frequencies;
 - 2> if *proximityIndicationUTRA* is set to *enabled*:
 - 3> consider itself to be configured to provide proximity indications for UTRA frequencies in accordance with 5.3.14;
 - 2> else:
 - 3> consider itself not to be configured to provide proximity indications for UTRA frequencies;
- 1> if the received *otherConfig* includes the *obtainLocation*:
 - 2> attempt to have detailed location information available for any subsequent measurement report;

NOTE: The UE is requested to attempt to have valid detailed location information available whenever sending a measurement report for which it is configured to include available detailed location information. The UE may not succeed e.g. because the user manually disabled the GPS hardware, due to no/poor satellite coverage. Further details, e.g. regarding when to activate GNSS, are up to UE implementation.

- 1> if the received *otherConfig* includes the *idc-Config*:
 - 2> if *idc-Indication* is included (i.e. set to *setup*):
 - 3> consider itself to be configured to provide IDC indications in accordance with 5.6.9;
 - 3> if *idc-Indication-UL-CA* is included (i.e. set to *setup*):

- 4> consider itself to be configured to indicate UL CA related information in IDC indications in accordance with 5.6.9;
- 3> if *idc-HardwareSharingIndication* is included (i.e. set to *setup*):
 - 4> consider itself to be configured to indicate IDC hardware sharing problem indications in IDC indications in accordance with 5.6.9;
- 2> else:
 - 3> consider itself not to be configured to provide IDC indications;
- 2> if *autonomousDenialParameters* is included:
 - 3> consider itself to be allowed to deny any transmission in a particular UL subframe if during the number of subframes indicated by *autonomousDenialValidity*, preceeding and including this particular subframe, it autonomously denied fewer UL subframes than indicated by *autonomousDenialSubframes*;
- 2> else:
 - 3> consider itself not to be allowed to deny any UL transmission;
- 1> if the received *otherConfig* includes the *powerPrefIndicationConfig*:
 - 2> if *powerPrefIndicationConfig* is set to *setup*:
 - 3> consider itself to be configured to provide power preference indications in accordance with 5.6.10;
 - 2> else:
 - 3> consider itself not to be configured to provide power preference indications;
- 1> if the received *otherConfig* includes the *sps-AssistanceInfoReport*:
 - 2> if *sps-AssistanceInfoReport* is set to TRUE:
 - 3> consider itself to be configured to provide SPS assistance information in accordance with 5.6.10;
 - 2> else:
 - 3> consider itself not to be configured to provide SPS assistance information;
- 1> if the received *otherConfig* includes the *bw-PreferenceIndicationTimer*:
 - 2> consider itself to be configured to provide maximum PDSCH/PUSCH bandwidth preference indication in accordance with 5.6.10;
- 1> else:
 - 2> consider itself not to be configured to provide maximum PDSCH/PUSCH bandwidth indication preference;
- 1> if the received *otherConfig* includes the *delayBudgetReportingConfig*:
 - 2> if *delayBudgetReportingConfig* is set to *setup*:
 - 3> consider itself to be configured to send delay budget reports in accordance with 5.6.18;
 - 2> else:
 - 3> consider itself not to be configured to send delay budget reports and stop timer T342, if running;
- 1> if the received *otherConfig* includes the *overheatingAssistanceConfig*:
 - 2> if *overheatingAssistanceConfig* is set to *setup*:
 - 3> consider itself to be configured to provide overheating assistance information in accordance with 5.6.10;
 - 2> else:

- 3> consider itself not to be configured to provide overheating assistance information and stop timer T345, if running;
- 1> for BL UEs or UEs in CE, if the received *otherConfig* includes the *rlm-ReportConfig*:
 - 2> if *rlm-ReportConfig* is set to *setup*:
 - 3> consider itself to be configured to detect "early-out-of-sync" and "early-in-sync" RLM events as specified in 5.3.11;
 - 3> if *rlmReportRep-MPDCCH* is set to *setup*:
 - 4> consider itself to be configured to report *rlmReportRep-MPDCCH* in accordance with 5.6.10;
 - 2> else:
 - 3> consider itself not to be configured to detect "early-out-of-sync" and "early-in-sync" RLM events and stop timer T343, timer T344, timer T314 and timer T315 if running;

5.3.10.10 SCG reconfiguration

The UE shall:

- 1> if *makeBeforeBreakSCG* is configured:
 - 2> stop timer T313, if running;
 - 2> start timer T307 with the timer value set to *t307*, as included in the *mobilityControlInfoSCG*;
 - 2> start synchronising to the DL of the target PSCell, if needed;
 - 2> perform the remainder of this procedure including and following resetting MAC after the UE has stopped the uplink transmission/downlink reception with the source SCG cell(s);

NOTE 0a: It is up to UE implementation when to stop the uplink transmission/ downlink reception with the source SCG cell(s) to initiate re-tuning for the connection to the target cell [16], if *makeBeforeBreakSCG* is configured.

- 1> if the received *scg-Configuration* is set to *release* or includes the *mobilityControlInfoSCG* (i.e. SCG release/change):
 - 2> if *mobilityControlInfo* is not received (i.e. SCG release/ change without HO):
 - 3> reset SCG MAC, if configured;
 - 3> for each *drb-Identity* value that is part of the current UE configuration:
 - 4> if the DRB indicated by *drb-Identity* is an SCG DRB:
 - 5> re-establish the PDCP entity and the SCG RLC entity or entities;
 - 4> if the DRB indicated by *drb-Identity* is a split DRB:
 - 5> perform PDCP data recovery and re-establish the SCG RLC entity;
 - 4> if the DRB indicated by *drb-Identity* is an MCG DRB; and
 - 4> *drb-ToAddModListSCG* is received and includes the *drb-Identity* value, while for this entry *drb-Type* is included and set to *scg* (i.e. MCG to SCG):
 - 5> re-establish the PDCP entity and the MCG RLC entity or entities;
 - 3> configure lower layers to consider the SCG SCell(s), except for the PSCell, to be in deactivated state;
 - 1> if the received *scg-Configuration* is set to *release*:

- 2> release the entire SCG configuration, except for the DRB configuration (i.e. as configured by *drb-ToAddModListSCG*);
 - 2> if the current UE configuration includes one or more split or SCG DRBs and the received *RRConnectionReconfiguration* message includes *radioResourceConfigDedicated* including *drb-ToAddModList*:
 - 3> reconfigure the SCG or split DRB by *drb-ToAddModList* as specified in 5.3.10.12;
 - 2> stop timer T313, if running;
 - 2> stop timer T307, if running;
 - 1> else:
 - 2> if the received *scg-ConfigPartMCG* includes the *scg-Counter*:
 - 3> update the S- K_{eNB} key based on the K_{eNB} key and using the received *scg-Counter* value, as specified in TS 33.401 [32];
 - 3> derive the K_{UPenc} key associated with the *cipheringAlgorithmSCG* included in *mobilityControlInfoSCG* within the received *scg-ConfigPartSCG*, as specified in TS 33.401 [32];
 - 3> configure lower layers to apply the ciphering algorithm and the K_{UPenc} key;
 - 2> if the received *scg-ConfigPartSCG* includes the *radioResourceConfigDedicatedSCG*:
 - 3> reconfigure the dedicated radio resource configuration for the SCG as specified in 5.3.10.11;
 - 2> if the current UE configuration includes one or more split or SCG DRBs and the received *RRConnectionReconfiguration* message includes *radioResourceConfigDedicated* including *drb-ToAddModList*:
 - 3> reconfigure the SCG or split DRB by *drb-ToAddModList* as specified in 5.3.10.12;
 - 2> if the received *scg-ConfigPartSCG* includes the *sCellToReleaseListSCG*:
 - 3> perform SCell release for the SCG as specified in 5.3.10.3a;
 - 2> if the received *scg-ConfigPartSCG* includes the *pSCellToAddMod*:
 - 3> perform PSCell addition or modification as specified in 5.3.10.3c;
- NOTE 0: This procedure is also used to release the PSCell e.g. PSCell change, SI change for the PSCell.
- 2> if the received *scg-ConfigPartSCG* includes the *sCellToAddModListSCG*:
 - 3> perform SCell addition or modification as specified in 5.3.10.3b;
 - 2> configure lower layers in accordance with *mobilityControlInfoSCG*, if received;
 - 2> if *rach-SkipSCG* is configured:
 - 3> configure lower layers to apply the *rach-SkipSCG* for the target SCG, as specified in TS 36.213 [23] and TS 36.321 [6];
 - 2> if the received *scg-ConfigPartSCG* includes the *mobilityControlInfoSCG* (i.e. SCG change):
 - 3> resume all SCG DRBs and resume SCG transmission for split DRBs, if suspended;
 - 3> stop timer T313, if running;
 - 3> start timer T307 with the timer value set to *t307*, as included in the *mobilityControlInfoSCG*, if *makeBeforeBreakSCG* is not configured;
 - 3> start synchronising to the DL of the target PSCell;

- 3> initiate the random access procedure on the PSCell, as specified in TS 36.321 [6], if *rach-SkipSCG* is not configured:

NOTE 1: The UE is not required to determine the SFN of the target PSCell by acquiring system information from that cell before performing RACH access in the target PSCell.

- 3> the procedure ends, except that the following actions are performed when MAC successfully completes the random access procedure on the PSCell or when MAC indicates the successful reception of a PDCCH transmission addressed to C-RNTI and if *rach-skipSCG* is configured:
 - 4> stop timer T307;
 - 4> release *rach-SkipSCG*;
 - 4> apply the parts of the CQI reporting configuration, the scheduling request configuration and the sounding RS configuration that do not require the UE to know the SFN of the target PSCell, if any;
 - 4> apply the parts of the measurement and the radio resource configuration that require the UE to know the SFN of the target PSCell (e.g. periodic CQI reporting, scheduling request configuration, sounding RS configuration), if any, upon acquiring the SFN of the target PSCell;

NOTE 2: Whenever the UE shall setup or reconfigure a configuration in accordance with a field that is received it applies the new configuration, except for the cases addressed by the above statements.

5.3.10.11 SCG dedicated resource configuration

The UE shall:

- 1> if the received *radioResourceConfigDedicatedSCG* includes the *drb-ToAddModListSCG*:
 - 2> for each *drb-Identity* value included in the *drb-ToAddModListSCG* perform the DC specific DRB addition or reconfiguration as specified in 5.3.10.3a1
- 1> if the received *radioResourceConfigDedicatedSCG* includes the *mac-MainConfigSCG*:
 - 2> perform the SCG MAC main reconfiguration as specified in 5.3.10.4;
- 1> if the received *radioResourceConfigDedicatedSCG* includes the *rlf-TimersAndConstantsSCG*:
 - 2> reconfigure the values of timers and constants as specified in 5.3.10.7;

5.3.10.12 Reconfiguration SCG or split DRB by *drb-ToAddModList*

The UE shall:

- 1> for each split or SCG DRBs that is part of the current configuration:
 - 2> if the corresponding *drb-Identity* value is included in the received *drb-ToAddModList*; and
 - 2> if the corresponding *drb-Identity* value is not included in the received *drb-ToAddModListSCG* (i.e. reconfigure split, split to MCG or SCG to MCG):
 - 3> perform the DC specific DRB addition or reconfiguration as specified in 5.3.10.3a1;

5.3.10.13 Neighbour cell information reconfiguration

The UE shall:

- 1> if the received *naics-Info* is set to *release*:
 - 2> instruct lower layer to release all the NAICS neighbour cell information for the concerned cell, if previously configured;
- 1> if the received *naics-Info* includes the *neighCellsToReleaseList-r12*:

- 2> for each *physCellId-r12* value included in the *neighCellsToReleaseList-r12* that is part of the current NAICS neighbour cell information of the concerned cell:
 - 3> instruct lower layer to release the NAICS neighbour cell information for the concerned cell;
- 1> if the received *naics-Info* includes the *NeighCellsToAddModList-r12*:
 - 2> for each *physCellId-r12* value included in the *neighCellsToAddModList-r12* that is not part of the current NAICS neighbour cell information of the concerned cell:
 - 3> instruct lower layer to add the NAICS neighbour cell information for the concerned cell;
 - 2> for each *physCellId-r12* value included in the *neighCellsToAddModList-r12* that is part of the current NAICS neighbour cell information of the concerned cell:
 - 3> instruct lower layer to modify the NAICS neighbour cell information in accordance with the received *NeighCellsInfo* for the concerned cell;

5.3.10.14 Void

5.3.10.15 Sidelink dedicated configuration

The UE shall:

- 1> if the *RRConnectionReconfiguration* message includes the *sl-CommConfig*:
 - 2> if *commTxResources* is included and set to *setup*:
 - 3> from the next SC period use the resources indicated by *commTxResources* for sidelink communication transmission, as specified in 5.10.4;
 - 2> else if *commTxResources* is included and set to *release*:
 - 3> from the next SC period, release the resources allocated for sidelink communication transmission previously configured by *commTxResources*;
- 1> if the *RRConnectionReconfiguration* message includes the *sl-DiscConfig*:
 - 2> if *discTxResources* is included and set to *setup*:
 - 3> from the next discovery period, as defined by *discPeriod*, use the resources indicated by *discTxResources* for sidelink discovery announcement, as specified in 5.10.6;
 - 2> else if *discTxResources* is included and set to *release*:
 - 3> from the next discovery period, as defined by *discPeriod*, release the resources allocated for sidelink discovery announcement previously configured by *discTxResources*;
 - 2> if *discTxResourcesPS* is included and set to *setup*:
 - 3> from the next discovery period, as defined by *discPeriod*, use the resources indicated by *discTxResourcesPS* for sidelink discovery announcement, as specified in 5.10.6;
 - 2> else if *discTxResourcesPS* is included and set to *release*:
 - 3> from the next discovery period, as defined by *discPeriod*, release the resources allocated for sidelink discovery announcement previously configured by *discTxResourcesPS*;
 - 2> if *discTxInterFreqInfo* is included and set to *setup*:
 - 3> from the next discovery period, as defined by *discPeriod*, use the resources indicated by *discTxInterFreqInfo* for sidelink discovery announcement, as specified in 5.10.6;
 - 2> else if *discTxInterFreqInfo* is included and set to *release*:

- 3> from the next discovery period, as defined by *discPeriod*, release the resources allocated for sidelink discovery announcement previously configured by *discTxInterFreqInfo*;
- 2> if *discRxGapConfig* is included and set to *setup*:
 - 3> from the next gap period, as defined by *gapPeriod*, use the gaps indicated by *discRxGapConfig* for sidelink discovery monitoring, as specified in 5.10.5;
- 2> else if *discRxGapConfig* is included and set to *release*:
 - 3> from the next gap period, as defined by *gapPeriod*, release the gaps configured for sidelink discovery monitoring previously configured by *discRxGapConfig*;
- 2> if *discTxGapConfig* is included and set to *setup*:
 - 3> from the next gap period, as defined by *gapPeriod*, use the gaps indicated by *discTxGapConfig* for sidelink discovery announcement, as specified in 5.10.6;
- 2> else if *discTxGapConfig* is included and set to *release*:
 - 3> from the next gap period, as defined by *gapPeriod*, release the gaps configured for sidelink discovery announcement previously configured by *discTxGapConfig*;
- 2> if *discSysInfoToReportConfig* is included and set to *setup*:
 - 3> start timer T370 with the timer value set to 60s;
- 2> else if *discSysInfoToReportConfig* is included and set to *release*:
 - 3> stop timer T370 and release *discSysInfoToReportConfig*;

5.3.10.15a V2X sidelink Communication dedicated configuration

The UE shall:

- 1> if the *RRCConnectionReconfiguration* message includes the *sl-V2X-ConfigDedicated*:
 - 2> if *commTxResources* is included and set to *setup*:
 - 3> use the resources indicated by *commTxResources* for V2X sidelink communication transmission, as specified in 5.10.13;
 - 3> perform CBR measurement on the transmission resource pool indicated in *commTxResources* for V2X sidelink communication transmission, as specified in 5.5.3;
 - 2> else if *commTxResources* is included and set to *release*:
 - 3> release the resources allocated for V2X sidelink communication transmission previously configured by *commTxResources*;
 - 2> if *v2x-InterFreqInfoList* is included:
 - 3> use the synchronization configuration and resource configuration parameters for V2X sidelink communication on frequencies included in *v2x-InterFreqInfoList*, as specified in 5.10.13;
 - 3> perform CBR measurement on the transmission resource pool indicated in *v2x-InterFreqInfoList* for V2X sidelink communication transmission, as specified in 5.5.3;
- 1> if the *RRCConnectionReconfiguration* message includes the *mobilityControlInfoV2X*:
 - 2> if *v2x-CommRxPool* is included:
 - 3> use the resources indicated by *v2x-CommRxPool* for V2X sidelink communication reception, as specified in 5.10.12;
 - 2> if *v2x-CommTxPoolExceptional* is included:

- 3> use the resources indicated by *v2x-CommTxPoolExceptional* for V2X sidelink communication transmission, as specified in 5.10.13;
- 3> perform CBR measurement on the transmission resource pool indicated by *v2x-CommTxPoolExceptional* for V2X sidelink communication transmission, as specified in 5.5.3;

5.3.10.16 T370 expiry

The UE shall:

- 1> if T370 expires:
 - 2> release *discSysInfoToReportConfig*;

5.3.11 Radio link failure related actions

5.3.11.1 Detection of physical layer problems in RRC_CONNECTED

The UE shall:

- 1> upon receiving N310 consecutive "out-of-sync" indications for the PCell from lower layers while neither T300, T301, T304 nor T311 is running:
 - 2> start timer T310;
- 1> upon receiving N313 consecutive "out-of-sync" indications for the PSCell from lower layers while T307 is not running:
 - 2> start T313;

NOTE: Physical layer monitoring and related autonomous actions do not apply to SCells except for the PSCell.

5.3.11.1a Early detection of physical layer problems in RRC_CONNECTED

The UE shall:

- 1> upon receiving N310 consecutive "early-out-of-sync" indications for the PCell from lower layers:
 - 2> start timer T314 with the timer value set to the value of T310;

5.3.11.1b Detection of physical layer improvements in RRC_CONNECTED

The UE shall:

- 1> upon receiving N311 consecutive "early-in-sync" indications for the PCell from lower layers:
 - 2> start timer T315 with the timer value set to the value of T310;

5.3.11.2 Recovery of physical layer problems

Upon receiving N311 consecutive "in-sync" indications for the PCell from lower layers while T310 is running, the UE shall:

- 1> stop timer T310;
- 1> stop timer T312, if running;

NOTE 1: In this case, the UE maintains the RRC connection without explicit signalling, i.e. the UE maintains the entire radio resource configuration.

NOTE 2: Periods in time where neither "in-sync" nor "out-of-sync" is reported by layer 1 do not affect the evaluation of the number of consecutive "in-sync" or "out-of-sync" indications.

Upon receiving N314 consecutive "in-sync" indications for the PCell from lower layers while T313 is running, the UE shall:

- 1> stop timer T313;

5.3.11.2a Recovery of early detection of physical layer problems

Upon receiving N311 consecutive "in-sync" indications for the PCell from lower layers while T314 is running, the UE shall:

- 1> stop timer T314;

5.3.11.2b Cancellation of physical layer improvements in RRC_CONNECTED

Upon receiving N311 consecutive "in-sync" indications for the PCell from lower layers while T315 is running, the UE shall:

- 1> stop timer T315;

5.3.11.3 Detection of radio link failure

The UE shall:

- 1> upon T310 expiry; or
- 1> upon T312 expiry; or
- 1> upon random access problem indication from MCG MAC while neither T300, T301, T304 nor T311 is running; or
- 1> upon indication from MCG RLC that the maximum number of retransmissions has been reached for an SRB or for an MCG or split DRB:
 - 2> consider radio link failure to be detected for the MCG i.e. RLF;
 - 2> except for NB-IoT, store the following radio link failure information in the *VarRLF-Report* by setting its fields as follows:
 - 3> clear the information included in *VarRLF-Report*, if any;
 - 3> set the *plmn-IdentityList* to include the list of EPLMNs stored by the UE (i.e. includes the RPLMN);
 - 3> set the *measResultLastServCell* to include the RSRP and RSRQ, if available, of the PCell based on measurements collected up to the moment the UE detected radio link failure;
 - 3> set the *measResultNeighCells* to include the best measured cells, other than the PCell, ordered such that the best cell is listed first, and based on measurements collected up to the moment the UE detected radio link failure, and set its fields as follows:
 - 4> if the UE was configured to perform measurements for one or more EUTRA frequencies, include the *measResultListEUTRA*;
 - 4> if the UE was configured to perform measurement reporting for one or more neighbouring UTRA frequencies, include the *measResultListUTRA*;
 - 4> if the UE was configured to perform measurement reporting for one or more neighbouring GERAN frequencies, include the *measResultListGERAN*;
 - 4> if the UE was configured to perform measurement reporting for one or more neighbouring CDMA2000 frequencies, include the *measResultsCDMA2000*;
 - 4> for each neighbour cell included, include the optional fields that are available;

NOTE 1: The measured quantities are filtered by the L3 filter as configured in the mobility measurement configuration. The measurements are based on the time domain measurement resource restriction, if configured. Blacklisted cells are not required to be reported.

- 3> if detailed location information is available, set the content of the *locationInfo* as follows:
 - 4> include the *locationCoordinates*;
 - 4> include the *horizontalVelocity*, if available;
- 3> set the *failedPCellId* to the global cell identity, if available, and otherwise to the physical cell identity and carrier frequency of the PCell where radio link failure is detected;
- 3> set the *tac-FailedPCell* to the tracking area code, if available, of the PCell where radio link failure is detected;
- 3> if an *RRCConnectionReconfiguration* message including the *mobilityControlInfo* was received before the connection failure:
 - 4> if the last *RRCConnectionReconfiguration* message including the *mobilityControlInfo* concerned an intra E-UTRA handover:
 - 5> include the *previousPCellId* and set it to the global cell identity of the PCell where the last *RRCConnectionReconfiguration* message including *mobilityControlInfo* was received;
 - 5> set the *timeConnFailure* to the elapsed time since reception of the last *RRCConnectionReconfiguration* message including the *mobilityControlInfo*;
 - 4> if the last *RRCConnectionReconfiguration* message including the *mobilityControlInfo* concerned a handover to E-UTRA from UTRA and if the UE supports Radio Link Failure Report for Inter-RAT MRO:
 - 5> include the *previousUTRA-CellId* and set it to the physical cell identity, the carrier frequency and the global cell identity, if available, of the UTRA Cell in which the last *RRCConnectionReconfiguration* message including *mobilityControlInfo* was received;
 - 5> set the *timeConnFailure* to the elapsed time since reception of the last *RRCConnectionReconfiguration* message including the *mobilityControlInfo*;
- 3> if the UE supports QCI1 indication in Radio Link Failure Report and has a DRB for which QCI is 1:
 - 4> include the *drb-EstablishedWithQCI-1*;
- 3> set the *connectionFailureType* to *rlf*;
- 3> set the *c-RNTI* to the C-RNTI used in the PCell;
- 3> set the *rlf-Cause* to the trigger for detecting radio link failure;
- 2> if AS security has not been activated:
 - 3> if the UE is a NB-IoT UE:
 - 4> if the UE supports RRC connection re-establishment for the Control Plane CIoT EPS optimisation:
 - 5> initiate the RRC connection re-establishment procedure as specified in 5.3.7;
 - 4> else:
 - 5> perform the actions upon leaving RRC_CONNECTED as specified in 5.3.12, with release cause 'RRC connection failure';
 - 3> else:
 - 4> perform the actions upon leaving RRC_CONNECTED as specified in 5.3.12, with release cause 'other';

- 2> else:
- 3> initiate the connection re-establishment procedure as specified in 5.3.7;

The UE shall:

- 1> upon T313 expiry; or
- 1> upon random access problem indication from SCG MAC; or
- 1> upon indication from SCG RLC that the maximum number of retransmissions has been reached for an SCG or split DRB:
 - 2> consider radio link failure to be detected for the SCG i.e. SCG-RLF;
 - 2> initiate the SCG failure information procedure as specified in 5.6.13 to report SCG radio link failure;

The UE may discard the radio link failure information, i.e. release the UE variable *VarRLF-Report*, 48 hours after the radio link failure is detected, upon power off or upon detach.

5.3.11.3a Detection of early-out-of-sync event

The UE shall:

- 1> upon T314 expiry;
- 2> consider "early-out-of-sync" event to be detected and initiate transmission of the *UEAssistanceInformation* message in accordance with 5.6.10;

5.3.11.3b Detection of early-in-sync event

The UE shall:

- 1> upon T315 expiry;
- 2> consider "early-in-sync" event to be detected and initiate transmission of the *UEAssistanceInformation* message in accordance with 5.6.10;

5.3.12 UE actions upon leaving RRC_CONNECTED

Upon leaving RRC_CONNECTED, the UE shall:

- 1> reset MAC;
- 1> stop all timers that are running except T320, T322, T325, T330;
- 1> if leaving RRC_CONNECTED was triggered by suspension of the RRC:
 - 2> re-establish RLC entities for all SRBs and DRBs;
 - 2> store the UE AS Context including the current RRC configuration, the current security context, the PDCP state including ROHC state, C-RNTI used in the source PCell, the *cellIdentity* and the physical cell identity of the source PCell;
 - 2> store the following information provided by E-UTRAN:
 - 3> the *resumeIdentity*;
 - 2> suspend all SRB(s) and DRB(s), except SRB0;
 - 2> indicate the suspension of the RRC connection to upper layers;
 - 2> configure lower layers to suspend integrity protection and ciphering;

NOTE 1: Ciphering is not applied for the subsequent *RRCConnectionResume* message used to resume the connection. An integrity check is performed by lower layers, but merely upon request from RRC.

1> else:

2> release all radio resources, including release of the RLC entity, the MAC configuration and the associated PDCP entity for all established RBs;

2> indicate the release of the RRC connection to upper layers together with the release cause;

1> if leaving RRC_CONNECTED was triggered neither by reception of the *MobilityFromEUTRACommand* message nor by selecting an inter-RAT cell while T311 was running:

2> if timer T350 is configured:

3> start timer T350;

3> apply *rclwi-Configuration* if configured, otherwise apply the *wlan-Id-List* corresponding to the RPLMN included in *SystemInformationBlockType17*;

2> else:

3> release the *wlan-OffloadConfigDedicated*, if received;

3> if the *wlan-OffloadConfigCommon* corresponding to the RPLMN is broadcast by the cell:

4> apply the *wlan-OffloadConfigCommon* corresponding to the RPLMN included in *SystemInformationBlockType17*;

4> apply *steerToWLAN* if configured, otherwise apply the *wlan-Id-List* corresponding to the RPLMN included in *SystemInformationBlockType17*;

2> enter RRC_IDLE and perform procedures as specified in TS 36.304 [4, 5.2.7];

1> else:

2> release the *wlan-OffloadConfigDedicated*, if received;

NOTE 2: BL UEs or UEs in CE verifies validity of SI when released to RRC_IDLE.

1> release the LWA configuration, if configured, as described in 5.6.14.3;

1> release the LWIP configuration, if configured, as described in 5.6.17.3;

5.3.13 UE actions upon PUCCH/ SRS release request

Upon receiving a PUCCH release request from lower layers, for an indicated serving cell the UE shall:

1> apply the default physical channel configuration for *cqi-ReportConfig* for the indicated serving cell as specified in 9.2.4 and release *cqi-ReportConfigSCell*, for each SCell that sends HARQ feedback on the indicated serving cell, if any;

1> apply the default physical channel configuration for *schedulingRequestConfig* as specified in 9.2.4, for the concerned CG;

Upon receiving an SRS release request from lower layers, for an indicated serving cell the UE shall:

1> apply the default physical channel configuration for *soundingRS-UL-ConfigDedicated*, as specified in 9.2.4;

NOTE: Upon PUCCH/ SRS release request, the UE does not modify the *soundingRS-UL-ConfigDedicatedAperiodic* i.e. it does not apply the default for this field (release).

5.3.14 Proximity indication

5.3.14.1 General

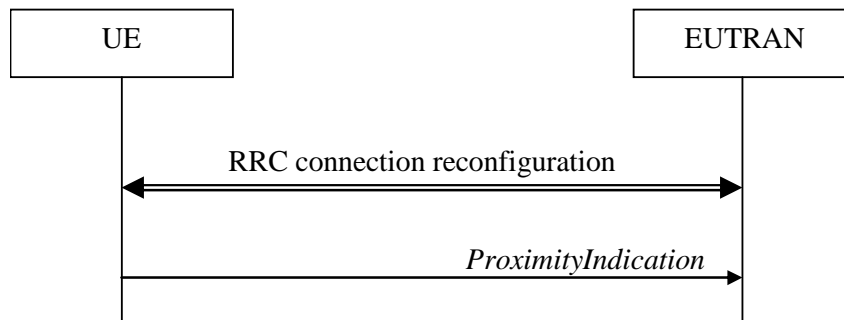

Figure 5.3.14.1-1: Proximity indication

The purpose of this procedure is to indicate that the UE is entering or leaving the proximity of one or more CSG member cells. The detection of proximity is based on an autonomous search function as defined in TS 36.304 [4].

5.3.14.2 Initiation

A UE in RRC_CONNECTED shall:

- 1> if the UE enters the proximity of one or more CSG member cell(s) on an E-UTRA frequency while proximity indication is enabled for such E-UTRA cells; or
- 1> if the UE enters the proximity of one or more CSG member cell(s) on an UTRA frequency while proximity indication is enabled for such UTRA cells; or
- 1> if the UE leaves the proximity of all CSG member cell(s) on an E-UTRA frequency while proximity indication is enabled for such E-UTRA cells; or
- 1> if the UE leaves the proximity of all CSG member cell(s) on an UTRA frequency while proximity indication is enabled for such UTRA cells:
 - 2> if the UE has previously not transmitted a *ProximityIndication* for the RAT and frequency during the current RRC connection, or if more than 5 s has elapsed since the UE has last transmitted a *ProximityIndication* (either entering or leaving) for the RAT and frequency:
 - 3> initiate transmission of the *ProximityIndication* message in accordance with 5.3.14.3;

NOTE: In the conditions above, "if the UE enters the proximity of one or more CSG member cell(s)" includes the case of already being in the proximity of such cell(s) at the time proximity indication for the corresponding RAT is enabled.

5.3.14.3 Actions related to transmission of *ProximityIndication* message

The UE shall set the contents of *ProximityIndication* message as follows:

- 1> if the UE applies the procedure to report entering the proximity of CSG member cell(s):
 - 2> set *type* to *entering*;
- 1> else if the UE applies the procedure to report leaving the proximity of CSG member cell(s):
 - 2> set *type* to *leaving*;
- 1> if the proximity indication was triggered for one or more CSG member cell(s) on an E-UTRA frequency:
 - 2> set the *carrierFreq* to *eutra* with the value set to the E-ARFCN value of the E-UTRA cell(s) for which proximity indication was triggered;

1> else if the proximity indication was triggered for one or more CSG member cell(s) on a UTRA frequency:

2> set the *carrierFreq* to *utra* with the value set to the ARFCN value of the UTRA cell(s) for which proximity indication was triggered;

The UE shall submit the *ProximityIndication* message to lower layers for transmission.

5.3.15 Void

5.4 Inter-RAT mobility

5.4.1 Introduction

The general principles of connected mode mobility are described in 5.3.1.3. The general principles of the security handling upon connected mode mobility are described in 5.3.1.2.

For the (network controlled) inter RAT mobility from E-UTRA for a UE in RRC_CONNECTED, a single procedure is defined that supports both handover, cell change order with optional network assistance (NACC) and enhanced CS fallback to CDMA2000 1xRTT. In case of mobility to CDMA2000, the eNB decides when to move to the other RAT while the target RAT determines to which cell the UE shall move.

5.4.2 Handover to E-UTRA

5.4.2.1 General

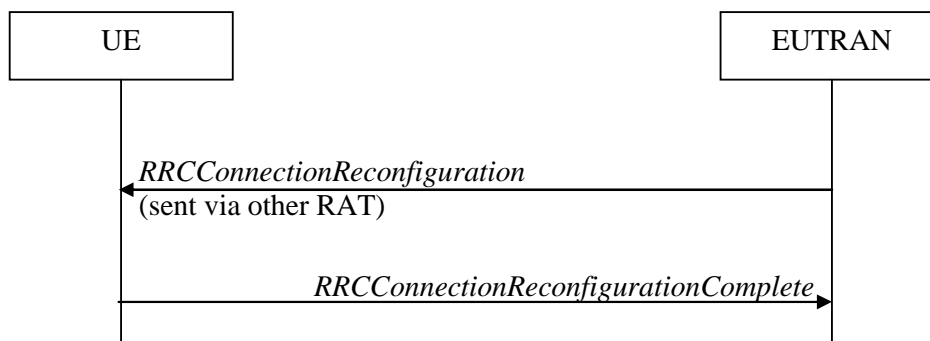

Figure 5.4.2.1-1: Handover to E-UTRA, successful

The purpose of this procedure is to, under the control of the network, transfer a connection between the UE and another Radio Access Network (e.g. GERAN or UTRAN) to E-UTRAN.

The handover to E-UTRA procedure applies when SRBs, possibly in combination with DRBs, are established in another RAT. Handover from UTRAN to E-UTRAN applies only after integrity has been activated in UTRAN.

5.4.2.2 Initiation

The RAN using another RAT initiates the handover to E-UTRA procedure, in accordance with the specifications applicable for the other RAT, by sending the *RRCConnectionReconfiguration* message via the radio access technology from which the inter-RAT handover is performed.

E-UTRAN applies the procedure as follows:

- to activate ciphering, possibly using NULL algorithm, if not yet activated in the other RAT;
- to establish SRB1, SRB2 and one or more DRBs, i.e. at least the DRB associated with the default EPS bearer is established;

5.4.2.3 Reception of the *RRConnectionReconfiguration* by the UE

If the UE is able to comply with the configuration included in the *RRConnectionReconfiguration* message, the UE shall:

- 1> apply the default physical channel configuration as specified in 9.2.4;
- 1> apply the default semi-persistent scheduling configuration as specified in 9.2.3;
- 1> apply the default MAC main configuration as specified in 9.2.2;
- 1> start timer T304 with the timer value set to *t304*, as included in the *mobilityControlInfo*;
- 1> consider the target PCell to be one on the frequency indicated by the *carrierFreq* with a physical cell identity indicated by the *targetPhysCellId*;
- 1> start synchronising to the DL of the target PCell;
- 1> set the C-RNTI to the value of the *newUE-Identity*;
- 1> for the target PCell, apply the downlink bandwidth indicated by the *dl-Bandwidth*;
- 1> for the target PCell, apply the uplink bandwidth indicated by (the absence or presence of) the *ul-Bandwidth*;
- 1> configure lower layers in accordance with the received *radioResourceConfigCommon*;
- 1> configure lower layers in accordance with any additional fields, not covered in the previous, if included in the received *mobilityControlInfo*;
- 1> perform the radio resource configuration procedure as specified in 5.3.10;
- 1> forward the *nas-SecurityParamToEUTRA* to the upper layers;
- 1> derive the K_{eNB} key, as specified in TS 33.401 [32];
- 1> derive the K_{RRcInt} key associated with the *integrityProtAlgorithm*, as specified in TS 33.401 [32];
- 1> derive the K_{RRcEnc} key and the K_{UPenc} key associated with the *cipheringAlgorithm*, as specified in TS 33.401 [32];
- 1> configure lower layers to apply the indicated integrity protection algorithm and the K_{RRcInt} key immediately, i.e. the indicated integrity protection configuration shall be applied to all subsequent messages received and sent by the UE, including the message used to indicate the successful completion of the procedure;
- 1> configure lower layers to apply the indicated ciphering algorithm, the K_{RRcEnc} key and the K_{UPenc} key immediately, i.e. the indicated ciphering configuration shall be applied to all subsequent messages received and sent by the UE, including the message used to indicate the successful completion of the procedure;
- 1> if the received *RRConnectionReconfiguration* includes the *sCellToAddModList*:
 - 2> perform SCell addition as specified in 5.3.10.3b;
- 1> if the *RRConnectionReconfiguration* message includes the *measConfig*:
 - 2> perform the measurement configuration procedure as specified in 5.5.2;
- 1> perform the measurement identity autonomous removal as specified in 5.5.2.2a;
- 1> if the *RRConnectionReconfiguration* message includes the *otherConfig*:
 - 2> perform the other configuration procedure as specified in 5.3.10.9;
- 1> if the *RRConnectionReconfiguration* message includes *wlan-OffloadInfo*:
 - 2> perform the dedicated WLAN offload configuration procedure as specified in 5.6.12.2;
- 1> if the *RRConnectionReconfiguration* message includes *rclwi-Configuration*:
 - 2> perform the WLAN traffic steering command procedure as specified in 5.6.16.2;

- 1> if the *RRCCONNECTIONRECONFIGURATION* message includes *lwa-Configuration*:
 - 2> perform the LWA configuration procedure as specified in 5.6.14.2;
 - 1> if the *RRCCONNECTIONRECONFIGURATION* message includes *lwip-Configuration*:
 - 2> perform the LWIP reconfiguration procedure as specified in 5.6.17.2;
 - 1> set the content of *RRCCONNECTIONRECONFIGURATIONCOMPLETE* message as follows:
 - 2> if the UE has radio link failure or handover failure information available in *VarRLF-Report* and if the RPLMN is included in *plmn-IdentityList* stored in *VarRLF-Report*:
 - 3> include *rlf-InfoAvailable*;
 - 2> if the UE has MBSFN logged measurements available for E-UTRA and if the RPLMN is included in *plmn-IdentityList* stored in *VarLogMeasReport* and if T330 is not running:
 - 3> include *logMeasAvailableMBSFN*;
 - 2> else if the UE has logged measurements available for E-UTRA and if the RPLMN is included in *plmn-IdentityList* stored in *VarLogMeasReport*:
 - 3> include the *logMeasAvailable*;
 - 2> if the UE has connection establishment failure information available in *VarConnEstFailReport* and if the RPLMN is equal to *plmn-Identity* stored in *VarConnEstFailReport*:
 - 3> include *connEstFailInfoAvailable*;
 - 1> submit the *RRCCONNECTIONRECONFIGURATIONCOMPLETE* message to lower layers for transmission using the new configuration;
 - 1> if the *RRCCONNECTIONRECONFIGURATION* message does not include *rlf-TimersAndConstants* set to *setup*:
 - 2> use the default values specified in 9.2.5 for timer T310, T311 and constant N310, N311;
 - 1> if MAC successfully completes the random access procedure:
 - 2> stop timer T304;
 - 2> apply the parts of the CQI reporting configuration, the scheduling request configuration and the sounding RS configuration that do not require the UE to know the SFN of the target PCell, if any;
 - 2> apply the parts of the measurement and the radio resource configuration that require the UE to know the SFN of the target PCell (e.g. measurement gaps, periodic CQI reporting, scheduling request configuration, sounding RS configuration), if any, upon acquiring the SFN of the target PCell;
- NOTE 1: Whenever the UE shall setup or reconfigure a configuration in accordance with a field that is received it applies the new configuration, except for the cases addressed by the above statements.
- 2> enter E-UTRA RRC_CONNECTED, upon which the procedure ends;
- NOTE 2: The UE is not required to determine the SFN of the target PCell by acquiring system information from that cell before performing RACH access in the target PCell.

5.4.2.4 Reconfiguration failure

The UE shall:

- 1> if the UE is unable to comply with (part of) the configuration included in the *RRCCONNECTIONRECONFIGURATION* message:
 - 2> perform the actions defined for this failure case as defined in the specifications applicable for the other RAT;

NOTE 1: The UE may apply above failure handling also in case the *RRCConnectionReconfiguration* message causes a protocol error for which the generic error handling as defined in 5.7 specifies that the UE shall ignore the message.

NOTE 2: If the UE is unable to comply with part of the configuration, it does not apply any part of the configuration, i.e. there is no partial success/ failure.

5.4.2.5 T304 expiry (handover to E-UTRA failure)

The UE shall:

- 1> upon T304 expiry (handover to E-UTRA failure):
- 2> reset MAC;
- 2> perform the actions defined for this failure case as defined in the specifications applicable for the other RAT;

5.4.3 Mobility from E-UTRA

5.4.3.1 General

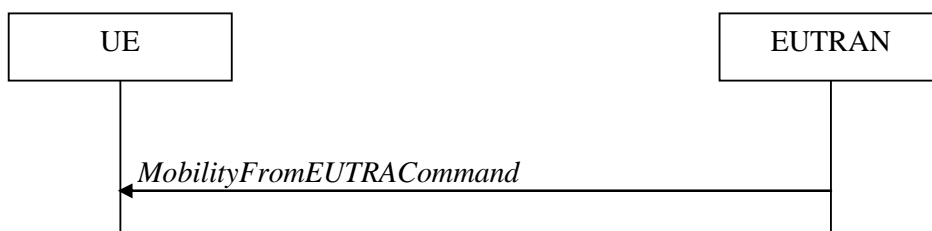

Figure 5.4.3.1-1: Mobility from E-UTRA, successful

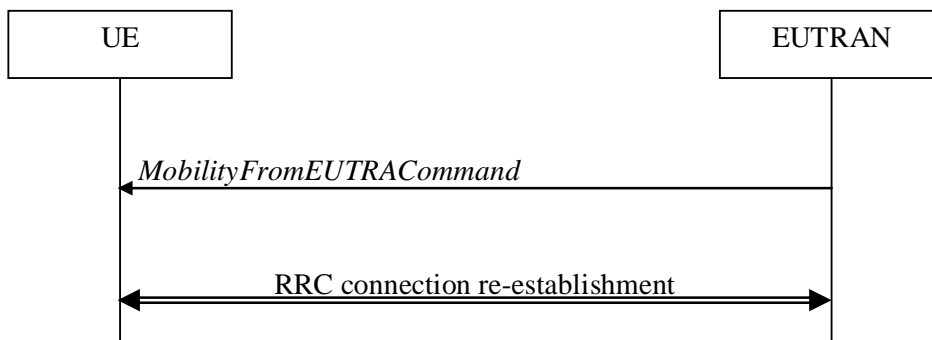

Figure 5.4.3.1-2: Mobility from E-UTRA, failure

The purpose of this procedure is to move a UE in RRC_CONNECTED to a cell using another Radio Access Technology (RAT), e.g. GERAN, UTRA or CDMA2000 systems. The mobility from E-UTRA procedure covers the following type of mobility:

- handover, i.e. the *MobilityFromEUTRACCommand* message includes radio resources that have been allocated for the UE in the target cell;
- cell change order, i.e. the *MobilityFromEUTRACCommand* message may include information facilitating access of and/ or connection establishment in the target cell, e.g. system information. Cell change order is applicable only to GERAN; and
- enhanced CS fallback to CDMA2000 1xRTT, i.e. the *MobilityFromEUTRACCommand* message includes radio resources that have been allocated for the UE in the target cell. The enhanced CS fallback to CDMA2000 1xRTT may be combined with concurrent handover or redirection to CDMA2000 HRPD.

NOTE: For the case of dual receiver/transmitter enhanced CS fallback to CDMA2000 1xRTT, the *DLInformationTransfer* message is used instead of the *MobilityFromEUTRACommand* message (see TS 36.300 [9]).

5.4.3.2 Initiation

E-UTRAN initiates the mobility from E-UTRA procedure to a UE in RRC_CONNECTED, possibly in response to a *MeasurementReport* message or in response to reception of CS fallback indication for the UE from MME, by sending a *MobilityFromEUTRACommand* message. E-UTRAN applies the procedure as follows:

- the procedure is initiated only when AS-security has been activated, and SRB2 with at least one DRB are setup and not suspended;

5.4.3.3 Reception of the *MobilityFromEUTRACommand* by the UE

The UE shall be able to receive a *MobilityFromEUTRACommand* message and perform a cell change order to GERAN, even if no prior UE measurements have been performed on the target cell.

The UE shall:

- 1> stop timer T310, if running;
- 1> stop timer T312, if running;
- 1> if the *MobilityFromEUTRACommand* message includes the *purpose* set to *handover*:
 - 2> if the *targetRAT-Type* is set to *utra* or *geran*:
 - 3> consider inter-RAT mobility as initiated towards the RAT indicated by the *targetRAT-Type* included in the *MobilityFromEUTRACommand* message;
 - 3> forward the *nas-SecurityParamFromEUTRA* to the upper layers;
 - 3> access the target cell indicated in the inter-RAT message in accordance with the specifications of the target RAT;
 - 3> if the *targetRAT-Type* is set to *geran*:
 - 4> use the contents of *systemInformation*, if provided for PS Handover, as the system information to begin access on the target GERAN cell;

NOTE 1: If there are DRBs for which no radio bearers are established in the target RAT as indicated in the *targetRAT-MessageContainer* in the message, the E-UTRA RRC part of the UE does not indicate the release of the concerned DRBs to the upper layers. Upper layers may derive which bearers are not established from information received from the AS of the target RAT.

NOTE 2: In case of SR-VCC, the DRB to be replaced is specified in [61].

- 2> else if the *targetRAT-Type* is set to *cdma2000-1XRTT* or *cdma2000-HRPD*:
 - 3> forward the *targetRAT-Type* and the *targetRAT-MessageContainer* to the CDMA2000 upper layers for the UE to access the cell(s) indicated in the inter-RAT message in accordance with the specifications of the CDMA2000 target-RAT;
- 1> else if the *MobilityFromEUTRACommand* message includes the *purpose* set to *cellChangeOrder*:
 - 2> start timer T304 with the timer value set to *t304*, as included in the *MobilityFromEUTRACommand* message;
 - 2> if the *targetRAT-Type* is set to *geran*:
 - 3> if *networkControlOrder* is included in the *MobilityFromEUTRACommand* message:
 - 4> apply the value as specified in TS 44.060 [36];
 - 3> else:

- 4> acquire *networkControlOrder* and apply the value as specified in TS 44.060 [36];
- 3> use the contents of *systemInformation*, if provided, as the system information to begin access on the target GERAN cell;
- 2> establish the connection to the target cell indicated in the *CellChangeOrder*;

NOTE 3: The criteria for success or failure of the cell change order to GERAN are specified in TS 44.060[36].

1> if the *MobilityFromEUTRACommand* message includes the *purpose* set to *e-CSFB*:

- 2> if *messageContCDMA2000-1XRTT* is present:
 - 3> forward the *messageContCDMA2000-1XRTT* to the CDMA2000 upper layers for the UE to access the cell(s) indicated in the inter-RAT message in accordance with the specification of the target RAT;
- 2> if *mobilityCDMA2000-HRPD* is present and is set to *handover*:
 - 3> forward the *messageContCDMA2000-HRPD* to the CDMA2000 upper layers for the UE to access the cell(s) indicated in the inter-RAT message in accordance with the specification of the target RAT;
- 2> if *mobilityCDMA2000-HRPD* is present and is set to *redirection*:
 - 3> forward the *redirectCarrierCDMA2000-HRPD* to the CDMA2000 upper layers;

NOTE 4: When the CDMA2000 upper layers in the UE receive both the *messageContCDMA2000-1XRTT* and *messageContCDMA2000-HRPD* the UE performs concurrent access to both CDMA2000 1xRTT and CDMA2000 HRPD RAT.

NOTE 5: The UE should perform the handover, the cell change order or enhanced 1xRTT CS fallback as soon as possible following the reception of the RRC message *MobilityFromEUTRACommand*, which could be before confirming successful reception (HARQ and ARQ) of this message.

5.4.3.4 Successful completion of the mobility from E-UTRA

Upon successfully completing the handover, the cell change order or enhanced 1xRTT CS fallback, the UE shall:

- 1> perform the actions upon leaving RRC_CONNECTED as specified in 5.3.12, with release cause 'other';

NOTE: If the UE performs enhanced 1xRTT CS fallback along with concurrent mobility to CDMA2000 HRPD and the connection to either CDMA2000 1xRTT or CDMA2000 HRPD succeeds, then the mobility from E-UTRA is considered successful.

5.4.3.5 Mobility from E-UTRA failure

The UE shall:

- 1> if T304 expires (mobility from E-UTRA failure); or
- 1> if the UE does not succeed in establishing the connection to the target radio access technology; or
- 1> if the UE is unable to comply with (part of) the configuration included in the *MobilityFromEUTRACommand* message; or
- 1> if there is a protocol error in the inter RAT information included in the *MobilityFromEUTRACommand* message, causing the UE to fail the procedure according to the specifications applicable for the target RAT:
 - 2> stop T304, if running;
 - 2> if the *cs-FallbackIndicator* in the *MobilityFromEUTRACommand* message was set to *TRUE* or *e-CSFB* was present:
 - 3> indicate to upper layers that the CS fallback procedure has failed;
 - 2> revert back to the configuration used in the source PCell, excluding the configuration configured by the *physicalConfigDedicated*, *mac-MainConfig* and *sps-Config*;

2> initiate the connection re-establishment procedure as specified in 5.3.7;

NOTE: For enhanced CS fallback to CDMA2000 1xRTT, the above UE behavior applies only when the UE is attempting the enhanced 1xRTT CS fallback and connection to the target radio access technology fails or if the UE is attempting enhanced 1xRTT CS fallback along with concurrent mobility to CDMA2000 HRPD and connection to both the target radio access technologies fails.

5.4.4 Handover from E-UTRA preparation request (CDMA2000)

5.4.4.1 General

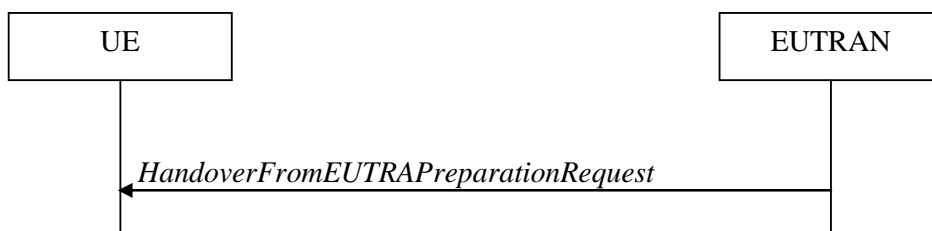

Figure 5.4.4.1-1: Handover from E-UTRA preparation request

The purpose of this procedure is to trigger the UE to prepare for handover or enhanced 1xRTT CS fallback to CDMA2000 by requesting a connection with this network. The UE may use this procedure to concurrently prepare for handover to CDMA2000 HRPD along with preparation for enhanced CS fallback to CDMA2000 1xRTT. This procedure applies to CDMA2000 capable UEs only.

This procedure is also used to trigger the UE which supports dual Rx/Tx enhanced 1xCsFB to redirect its second radio to CDMA2000 1xRTT.

The handover from E-UTRA preparation request procedure applies when signalling radio bearers are established.

5.4.4.2 Initiation

E-UTRAN initiates the handover from E-UTRA preparation request procedure to a UE in RRC_CONNECTED, possibly in response to a *MeasurementReport* message or CS fallback indication for the UE, by sending a *HandoverFromEUTRAPreparationRequest* message. E-UTRAN initiates the procedure only when AS security has been activated.

5.4.4.3 Reception of the *HandoverFromEUTRAPreparationRequest* by the UE

Upon reception of the *HandoverFromEUTRAPreparationRequest* message, the UE shall:

- 1> if *dualRxTxRedirectIndicator* is present in the received message:
 - 2> forward *dualRxTxRedirectIndicator* to the CDMA2000 upper layers;
 - 2> forward *redirectCarrierCDMA2000-1XRTT* to the CDMA2000 upper layers, if included;
- 1> else:
 - 2> indicate the request to prepare handover or enhanced 1xRTT CS fallback and forward the *cdma2000-Type* to the CDMA2000 upper layers;
 - 2> if *cdma2000-Type* is set to *type1XRTT*:
 - 3> forward the *rand* and the *mobilityParameters* to the CDMA2000 upper layers;
 - 2> if *concurrPrepCDMA2000-HRPD* is present in the received message:
 - 3> forward *concurrPrepCDMA2000-HRPD* to the CDMA2000 upper layers;
 - 2> else:

3> forward *concurrPrepCDMA2000-HRPD*, with its value set to *FALSE*, to the CDMA2000 upper layers;

5.4.5 UL handover preparation transfer (CDMA2000)

5.4.5.1 General



Figure 5.4.5.1-1: UL handover preparation transfer

The purpose of this procedure is to tunnel the handover related CDMA2000 dedicated information or enhanced 1xRTT CS fallback related CDMA2000 dedicated information from UE to E-UTRAN when requested by the higher layers. The procedure is triggered by the higher layers on receipt of *HandoverFromEUTRAPreparationRequest* message. If preparing for enhanced CS fallback to CDMA2000 1xRTT and handover to CDMA2000 HRPD, the UE sends two consecutive *ULHandoverPreparationTransfer* messages to E-UTRAN, one per addressed CDMA2000 RAT Type. This procedure applies to CDMA2000 capable UEs only.

5.4.5.2 Initiation

A UE in RRC_CONNECTED initiates the UL handover preparation transfer procedure whenever there is a need to transfer handover or enhanced 1xRTT CS fallback related non-3GPP dedicated information. The UE initiates the UL handover preparation transfer procedure by sending the *ULHandoverPreparationTransfer* message.

5.4.5.3 Actions related to transmission of the *ULHandoverPreparationTransfer* message

The UE shall set the contents of the *ULHandoverPreparationTransfer* message as follows:

- 1> include the *cdma2000-Type* and the *dedicatedInfo*;
- 1> if the *cdma2000-Type* is set to *type1XRTT*:
 - 2> include the *meid* and set it to the value received from the CDMA2000 upper layers;
- 1> submit the *ULHandoverPreparationTransfer* message to lower layers for transmission, upon which the procedure ends;

5.4.5.4 Failure to deliver the *ULHandoverPreparationTransfer* message

The UE shall:

- 1> if the UE is unable to guarantee successful delivery of *ULHandoverPreparationTransfer* messages:
 - 2> inform upper layers about the possible failure to deliver the information contained in the concerned *ULHandoverPreparationTransfer* message;

5.4.6 Inter-RAT cell change order to E-UTRAN

5.4.6.1 General

The purpose of the inter-RAT cell change order to E-UTRAN procedure is to transfer, under the control of the source radio access technology, a connection between the UE and another radio access technology (e.g. GSM/ GPRS) to E-UTRAN.

5.4.6.2 Initiation

The procedure is initiated when a radio access technology other than E-UTRAN, e.g. GSM/GPRS, using procedures specific for that RAT, orders the UE to change to an E-UTRAN cell. In response, upper layers request the establishment of an RRC connection as specified in clause 5.3.3.

NOTE: Within the message used to order the UE to change to an E-UTRAN cell, the source RAT should specify the identity of the target E-UTRAN cell as specified in the specifications for that RAT.

The UE shall:

- 1> upon receiving an *RRCConnectionSetup* message;
- 2> consider the inter-RAT cell change order procedure to have completed successfully;

5.4.6.3 UE fails to complete an inter-RAT cell change order

If the inter-RAT cell change order fails the UE shall return to the other radio access technology and proceed as specified in the appropriate specifications for that RAT.

The UE shall:

- 1> upon failure to establish the RRC connection as specified in clause 5.3.3;
- 2> consider the inter-RAT cell change order procedure to have failed;

NOTE: The cell change was network ordered. Therefore, failure to change to the target PCell should not cause the UE to move to UE-controlled cell selection.

5.5 Measurements

5.5.1 Introduction

The UE reports measurement information in accordance with the measurement configuration as provided by E-UTRAN. E-UTRAN provides the measurement configuration applicable for a UE in RRC_CONNECTED by means of dedicated signalling, i.e. using the *RRCConnectionReconfiguration* or *RRCConnectionResume* message.

The UE can be requested to perform the following types of measurements:

- Intra-frequency measurements: measurements at the downlink carrier frequency(ies) of the serving cell(s).
- Inter-frequency measurements: measurements at frequencies that differ from any of the downlink carrier frequency(ies) of the serving cell(s).
- Inter-RAT measurements of UTRA frequencies.
- Inter-RAT measurements of GERAN frequencies.
- Inter-RAT measurements of CDMA2000 HRPD or CDMA2000 1xRTT or WLAN frequencies.
- CBR measurements.

The measurement configuration includes the following parameters:

1. **Measurement objects:** The objects on which the UE shall perform the measurements.
 - For intra-frequency and inter-frequency measurements a measurement object is a single E-UTRA carrier frequency. Associated with this carrier frequency, E-UTRAN can configure a list of cell specific offsets, a list of 'blacklisted' cells and a list of 'whitelisted' cells. Blacklisted cells are not considered in event evaluation or measurement reporting.
 - For inter-RAT UTRA measurements a measurement object is a set of cells on a single UTRA carrier frequency.

- For inter-RAT GERAN measurements a measurement object is a set of GERAN carrier frequencies.
- For inter-RAT CDMA2000 measurements a measurement object is a set of cells on a single (HRPD or 1xRTT) carrier frequency.
- For inter-RAT WLAN measurements a measurement object is a set of WLAN identifiers and optionally a set of WLAN frequencies.
- For CBR measurements a measurement object is a set of transmission resource pools for V2X sidelink communication.

NOTE 1: Some measurements using the above mentioned measurement objects, only concern a single cell, e.g. measurements used to report neighbouring cell system information, PCell UE Rx-Tx time difference, or a pair of cells, e.g. SSTD measurements between the PCell and the PSCell.

2. **Reporting configurations:** A list of reporting configurations where each reporting configuration consists of the following:
 - Reporting criterion: The criterion that triggers the UE to send a measurement report. This can either be periodical or a single event description.
 - Reporting format: The quantities that the UE includes in the measurement report and associated information (e.g. number of cells to report).
3. **Measurement identities:** A list of measurement identities where each measurement identity links one measurement object with one reporting configuration. By configuring multiple measurement identities it is possible to link more than one measurement object to the same reporting configuration, as well as to link more than one reporting configuration to the same measurement object. The measurement identity is used as a reference number in the measurement report.
4. **Quantity configurations:** One quantity configuration is configured per RAT type. The quantity configuration defines the measurement quantities and associated filtering used for all event evaluation and related reporting of that measurement type. One filter can be configured per measurement quantity.
5. **Measurement gaps:** Periods that the UE may use to perform measurements, i.e. no (UL, DL) transmissions are scheduled.

E-UTRAN only configures a single measurement object for a given frequency (except for WLAN and except for CBR measurements), i.e. it is not possible to configure two or more measurement objects for the same frequency with different associated parameters, e.g. different offsets and/ or blacklists. E-UTRAN may configure multiple instances of the same event e.g. by configuring two reporting configurations with different thresholds.

The UE maintains a single measurement object list, a single reporting configuration list, and a single measurement identities list. The measurement object list includes measurement objects, that are specified per RAT type, possibly including intra-frequency object(s) (i.e. the object(s) corresponding to the serving frequency(ies)), inter-frequency object(s) and inter-RAT objects. Similarly, the reporting configuration list includes E-UTRA and inter-RAT reporting configurations. Any measurement object can be linked to any reporting configuration of the same RAT type. Some reporting configurations may not be linked to a measurement object. Likewise, some measurement objects may not be linked to a reporting configuration.

The measurement procedures distinguish the following types of cells:

1. The serving cell(s) - these are the PCell and one or more SCells, if configured for a UE supporting CA.
2. Listed cells - these are cells listed within the measurement object(s) or, for inter-RAT WLAN, the WLANs matching the WLAN identifiers configured in the measurement object or the WLAN the UE is connected to.
3. Detected cells - these are cells that are not listed within the measurement object(s) but are detected by the UE on the carrier frequency(ies) indicated by the measurement object(s) or, for inter-RAT WLAN, the WLANs not included in the *measObjectWLAN* but meeting the triggering requirements.

For E-UTRA, the UE measures and reports on the serving cell(s), listed cells, detected cells, transmission resource pools for V2X sidelink communication, and, for RSSI and channel occupancy measurements, the UE measures and reports on any reception on the indicated frequency. For inter-RAT UTRA, the UE measures and reports on listed cells and optionally on cells that are within a range for which reporting is allowed by E-UTRAN. For inter-RAT GERAN,

the UE measures and reports on detected cells. For inter-RAT CDMA2000, the UE measures and reports on listed cells. For inter-RAT WLAN, the UE measures and reports on listed cells.

NOTE 2: For inter-RAT UTRA and CDMA2000, the UE measures and reports also on detected cells for the purpose of SON.

NOTE 3: This specification is based on the assumption that typically CSG cells of home deployment type are not indicated within the neighbour list. Furthermore, the assumption is that for non-home deployments, the physical cell identity is unique within the area of a large macro cell (i.e. as for UTRAN).

Whenever the procedural specification, other than contained in clause 5.5.2, refers to a field it concerns a field included in the *VarMeasConfig* unless explicitly stated otherwise i.e. only the measurement configuration procedure covers the direct UE action related to the received *measConfig*.

5.5.2 Measurement configuration

5.5.2.1 General

E-UTRAN applies the procedure as follows:

- to ensure that, whenever the UE has a *measConfig*, it includes a *measObject* for each serving frequency;
- to configure at most one measurement identity using a reporting configuration with the *purpose* set to *reportCGI*;
- for serving frequencies, set the EARFCN within the corresponding *measObject* according to the band as used for reception/ transmission;
- to configure at most one measurement identity using a reporting configuration with *ul-DelayConfig*;

The UE shall:

- 1> if the received *measConfig* includes the *measObjectToRemoveList*:
 - 2> perform the measurement object removal procedure as specified in 5.5.2.4;
- 1> if the received *measConfig* includes the *measObjectToAddModList*:
 - 2> perform the measurement object addition/ modification procedure as specified in 5.5.2.5;
- 1> if the received *measConfig* includes the *reportConfigToRemoveList*:
 - 2> perform the reporting configuration removal procedure as specified in 5.5.2.6;
- 1> if the received *measConfig* includes the *reportConfigToAddModList*:
 - 2> perform the reporting configuration addition/ modification procedure as specified in 5.5.2.7;
- 1> if the received *measConfig* includes the *quantityConfig*:
 - 2> perform the quantity configuration procedure as specified in 5.5.2.8;
- 1> if the received *measConfig* includes the *measIdToRemoveList*:
 - 2> perform the measurement identity removal procedure as specified in 5.5.2.2;
- 1> if the received *measConfig* includes the *measIdToAddModList*:
 - 2> perform the measurement identity addition/ modification procedure as specified in 5.5.2.3;
- 1> if the received *measConfig* includes the *measGapConfig* or *measGapConfigPerCC-List*:
 - 2> perform the measurement gap configuration procedure as specified in 5.5.2.9;
- 1> if the received *measConfig* includes the *measGapSharingConfig*:

- 2> perform the measurement gap sharing configuration procedure as specified in 5.5.2.12;
- 1> if the received *measConfig* includes the *s-Measure*:
 - 2> set the parameter *s-Measure* within *VarMeasConfig* to the lowest value of the RSRP ranges indicated by the received value of *s-Measure*;
- 1> if the received *measConfig* includes the *preRegistrationInfoHRPD*:
 - 2> forward the *preRegistrationInfoHRPD* to CDMA2000 upper layers;
- 1> if the received *measConfig* includes the *speedStatePars*:
 - 2> set the parameter *speedStatePars* within *VarMeasConfig* to the received value of *speedStatePars*;
- 1> if the received *measConfig* includes the *allowInterruptions*:
 - 2> set the parameter *allowInterruptions* within *VarMeasConfig* to the received value of *allowInterruptions*;

5.5.2.2 Measurement identity removal

The UE shall:

- 1> for each *measId* included in the received *measIdToRemoveList* that is part of the current UE configuration in *VarMeasConfig*:
 - 2> remove the entry with the matching *measId* from the *measIdList* within the *VarMeasConfig*;
 - 2> remove the measurement reporting entry for this *measId* from the *VarMeasReportList*, if included;
 - 2> stop the periodical reporting timer or timer T321, whichever one is running, and reset the associated information (e.g. *timeToTrigger*) for this *measId*;

NOTE: The UE does not consider the message as erroneous if the *measIdToRemoveList* includes any *measId* value that is not part of the current UE configuration.

5.5.2.2a Measurement identity autonomous removal

The UE shall:

- 1> for each *measId* included in the *measIdList* within *VarMeasConfig*:
 - 2> if the associated *reportConfig* concerns an event involving a serving cell while the concerned serving cell is not configured; or
 - 2> if the associated *reportConfig* concerns an event involving a WLAN mobility set while the concerned WLAN mobility set is not configured; or
 - 2> if the associated *reportConfig* concerns an event involving a transmission resource pool for V2X sidelink communication while the concerned resource pool is not configured:
 - 3> remove the *measId* from the *measIdList* within the *VarMeasConfig*;
 - 3> remove the measurement reporting entry for this *measId* from the *VarMeasReportList*, if included;
 - 3> stop the periodical reporting timer if running, and reset the associated information (e.g. *timeToTrigger*) for this *measId*;

NOTE 1: The above UE autonomous removal of *measId*'s applies only for measurement events A1, A2, A6, and also applies for events A3 and A5 if configured for PSCell and W2 and W3 and V1 and V2, if configured.

NOTE 2: When performed during re-establishment, the UE is only configured with a primary frequency (i.e. the SCell(s) and WLAN mobility set are released, if configured).

5.5.2.3 Measurement identity addition/ modification

E-UTRAN applies the procedure as follows:

- configure a *measId* only if the corresponding measurement object, the corresponding reporting configuration and the corresponding quantity configuration, are configured;

The UE shall:

- 1> for each *measId* included in the received *measIdToAddModList*:
 - 2> if an entry with the matching *measId* exists in the *measIdList* within the *VarMeasConfig*:
 - 3> replace the entry with the value received for this *measId*;
 - 2> else:
 - 3> add a new entry for this *measId* within the *VarMeasConfig*;
 - 2> remove the measurement reporting entry for this *measId* from the *VarMeasReportList*, if included;
 - 2> stop the periodical reporting timer or timer T321, whichever one is running, and reset the associated information (e.g. *timeToTrigger*) for this *measId*;
 - 2> if the *triggerType* is set to *periodical* and the *purpose* is set to *reportCGI* in the *reportConfig* associated with this *measId*:
 - 3> if the *measObject* associated with this *measId* concerns E-UTRA:
 - 4> if the *si-RequestForHO* is included in the *reportConfig* associated with this *measId*:
 - 5> if the UE is a category 0 UE according to TS 36.306 [5]:
 - 6> start timer T321 with the timer value set to 190 ms for this *measId*;
 - 5> else:
 - 6> start timer T321 with the timer value set to 150 ms for this *measId*;
 - 4> else:
 - 5> start timer T321 with the timer value set to 1 second for this *measId*;
 - 3> else if the *measObject* associated with this *measId* concerns UTRA:
 - 4> if the *si-RequestForHO* is included in the *reportConfig* associated with this *measId*:
 - 5> for UTRA FDD, start timer T321 with the timer value set to 2 seconds for this *measId*;
 - 5> for UTRA TDD, start timer T321 with the timer value set to [1 second] for this *measId*;
 - 4> else:
 - 5> start timer T321 with the timer value set to 8 seconds for this *measId*;
 - 3> else:
 - 4> start timer T321 with the timer value set to 8 seconds for this *measId*;

5.5.2.4 Measurement object removal

The UE shall:

- 1> for each *measObjectId* included in the received *measObjectToRemoveList* that is part of the current UE configuration in *VarMeasConfig*:
 - 2> remove the entry with the matching *measObjectId* from the *measObjectList* within the *VarMeasConfig*;

- 2> remove all *measId* associated with this *measObjectId* from the *measIdList* within the *VarMeasConfig*, if any;
- 2> if a *measId* is removed from the *measIdList*:
 - 3> remove the measurement reporting entry for this *measId* from the *VarMeasReportList*, if included;
 - 3> stop the periodical reporting timer or timer T321, whichever one is running, and reset the associated information (e.g. *timeToTrigger*) for this *measId*;

NOTE: The UE does not consider the message as erroneous if the *measObjectToRemoveList* includes any *measObjectId* value that is not part of the current UE configuration.

5.5.2.5 Measurement object addition/ modification

The UE shall:

- 1> for each *measObjectId* included in the received *measObjectToAddModList*:
 - 2> if an entry with the matching *measObjectId* exists in the *measObjectList* within the *VarMeasConfig*, for this entry:
 - 3> reconfigure the entry with the value received for this *measObject*, except for the fields *cellsToAddModList*, *blackCellsToAddModList*, *whiteCellsToAddModList*, *altTTT-CellsToAddModList*, *cellsToRemoveList*, *blackCellsToRemoveList*, *whiteCellsToRemoveList*, *altTTT-CellsToRemoveList*, *measSubframePatternConfigNeigh*, *measDS-Config*, *wlan-ToAddModList*, *wlan-ToRemoveList*, *tx-ResourcePoolToRemoveList* and *tx-ResourcePoolToAddList*;
 - 3> if the received *measObject* includes the *cellsToRemoveList*:
 - 4> for each *cellIndex* included in the *cellsToRemoveList*:
 - 5> remove the entry with the matching *cellIndex* from the *cellsToAddModList*;
 - 3> if the received *measObject* includes the *cellsToAddModList*:
 - 4> for each *cellIndex* value included in the *cellsToAddModList*:
 - 5> if an entry with the matching *cellIndex* exists in the *cellsToAddModList*:
 - 6> replace the entry with the value received for this *cellIndex*;
 - 5> else:
 - 6> add a new entry for the received *cellIndex* to the *cellsToAddModList*;
 - 3> if the received *measObject* includes the *blackCellsToRemoveList*:
 - 4> for each *cellIndex* included in the *blackCellsToRemoveList*:
 - 5> remove the entry with the matching *cellIndex* from the *blackCellsToAddModList*;

NOTE 1: For each *cellIndex* included in the *blackCellsToRemoveList* that concerns overlapping ranges of cells, a cell is removed from the black list of cells only if all cell indexes containing it are removed.

- 3> if the received *measObject* includes the *blackCellsToAddModList*:
 - 4> for each *cellIndex* included in the *blackCellsToAddModList*:
 - 5> if an entry with the matching *cellIndex* is included in the *blackCellsToAddModList*:
 - 6> replace the entry with the value received for this *cellIndex*;
 - 5> else:
 - 6> add a new entry for the received *cellIndex* to the *blackCellsToAddModList*;
 - 3> if the received *measObject* includes the *whiteCellsToRemoveList*:

4> for each *cellIndex* included in the *whiteCellsToRemoveList*:

5> remove the entry with the matching *cellIndex* from the *whiteCellsToAddModList*;

NOTE 2: For each *cellIndex* included in the *whiteCellsToRemoveList* that concerns overlapping ranges of cells, a cell is removed from the white list of cells only if all cell indexes containing it are removed.

3> if the received *measObject* includes the *whiteCellsToAddModList*:

4> for each *cellIndex* included in the *whiteCellsToAddModList*:

5> if an entry with the matching *cellIndex* is included in the *whiteCellsToAddModList*:

6> replace the entry with the value received for this *cellIndex*;

5> else:

6> add a new entry for the received *cellIndex* to the *whiteCellsToAddModList*;

3> if the received *measObject* includes the *altTTT-CellsToRemoveList*:

4> for each *cellIndex* included in the *altTTT-CellsToRemoveList*:

5> remove the entry with the matching *cellIndex* from the *altTTT-CellsToAddModList*;

NOTE 3: For each *cellIndex* included in the *altTTT-CellsToRemoveList* that concerns overlapping ranges of cells, a cell is removed from the list of cells only if all cell indexes containing it are removed.

3> if the received *measObject* includes the *altTTT-CellsToAddModList*:

4> for each *cellIndex* value included in the *altTTT-CellsToAddModList*:

5> if an entry with the matching *cellIndex* exists in the *altTTT-CellsToAddModList*:

6> replace the entry with the value received for this *cellIndex*;

5> else:

6> add a new entry for the received *cellIndex* to the *altTTT-CellsToAddModList*;

3> if the received *measObject* includes *measSubframePatternConfigNeigh*:

4> set *measSubframePatternConfigNeigh* within the *VarMeasConfig* to the value of the received field

3> if the received *measObject* includes *measDS-Config*:

4> if *measDS-Config* is set to *setup*:

5> if the received *measDS-Config* includes the *measCSI-RS-ToRemoveList*:

6> for each *measCSI-RS-Id* included in the *measCSI-RS-ToRemoveList*:

7> remove the entry with the matching *measCSI-RS-Id* from the *measCSI-RS-ToAddModList*;

5> if the received *measDS-Config* includes the *measCSI-RS-ToAddModList*, for each *measCSI-RS-Id* value included in the *measCSI-RS-ToAddModList*:

6> if an entry with the matching *measCSI-RS-Id* exists in the *measCSI-RS-ToAddModList*:

7> replace the entry with the value received for this *measCSI-RS-Id*;

6> else:

7> add a new entry for the received *measCSI-RS-Id* to the *measCSI-RS-ToAddModList*;

5> set other fields of the *measDS-Config* within the *VarMeasConfig* to the value of the received fields;

- 5> perform the discovery signals measurement timing configuration procedure as specified in 5.5.2.10;
- 4> else:
 - 5> release the discovery signals measurement configuration;
- 3> for each *measId* associated with this *measObjectId* in the *measIdList* within the *VarMeasConfig*, if any:
 - 4> remove the measurement reporting entry for this *measId* from the *VarMeasReportList*, if included;
 - 4> stop the periodical reporting timer or timer T321, whichever one is running, and reset the associated information (e.g. *timeToTrigger*) for this *measId*;
- 3> if the received *measObject* includes the *wlan-ToRemoveList*:
 - 4> for each *WLAN-Identifiers* included in the *wlan-ToRemoveList*:
 - 5> remove the entry with the matching *WLAN-Identifiers* from the *wlan-ToAddModList*;

NOTE 3a: Matching of *WLAN-Identifiers* requires that all WLAN identifier fields should be same.

- 3> if the received *measObject* includes the *wlan-ToAddModList*:
 - 4> for each *WLAN-Identifiers* included in the *wlan-ToAddModList*:
 - 5> add a new entry for the received *WLAN-Identifiers* to the *wlan-ToAddModList*;
- 3> if the received *measObject* includes the *tx-ResourcePoolToRemoveList*:
 - 4> for each transmission resource pool indicated in *tx-ResourcePoolToRemoveList*:
 - 5> remove the entry with the matching identity of the transmission resource pool from the *tx-ResourcePoolToAddList*;
- 3> if the received *measObject* includes the *tx-ResourcePoolToAddList*:
 - 4> for each transmission resource pool indicated in *tx-ResourcePoolToAddList*:
 - 5> add a new entry for the received identity of the transmission resource pool to the *tx-ResourcePoolToAddList*;
- 2> else:
 - 3> add a new entry for the received *measObject* to the *measObjectList* within *VarMeasConfig*;

NOTE 4: UE does not need to retain *cellForWhichToReportCGI* in the *measObject* after reporting *cgi-Info*.

5.5.2.6 Reporting configuration removal

The UE shall:

- 1> for each *reportConfigId* included in the received *reportConfigToRemoveList* that is part of the current UE configuration in *VarMeasConfig*:
 - 2> remove the entry with the matching *reportConfigId* from the *reportConfigList* within the *VarMeasConfig*;
 - 2> remove all *measId* associated with the *reportConfigId* from the *measIdList* within the *VarMeasConfig*, if any;
- 2> if a *measId* is removed from the *measIdList*:
 - 3> remove the measurement reporting entry for this *measId* from the *VarMeasReportList*, if included;
 - 3> stop the periodical reporting timer or timer T321, whichever one is running, and reset the associated information (e.g. *timeToTrigger*) for this *measId*;

NOTE: The UE does not consider the message as erroneous if the *reportConfigToRemoveList* includes any *reportConfigId* value that is not part of the current UE configuration.

5.5.2.7 Reporting configuration addition/ modification

The UE shall:

- 1> for each *reportConfigId* included in the received *reportConfigToAddModList*:
 - 2> if an entry with the matching *reportConfigId* exists in the *reportConfigList* within the *VarMeasConfig*, for this entry:
 - 3> reconfigure the entry with the value received for this *reportConfig*;
 - 3> for each *measId* associated with this *reportConfigId* included in the *measIdList* within the *VarMeasConfig*, if any:
 - 4> remove the measurement reporting entry for this *measId* from in *VarMeasReportList*, if included;
 - 4> stop the periodical reporting timer or timer T321, whichever one is running, and reset the associated information (e.g. *timeToTrigger*) for this *measId*;
 - 2> else:
 - 3> add a new entry for the received *reportConfig* to the *reportConfigList* within the *VarMeasConfig*;

5.5.2.8 Quantity configuration

The UE shall:

- 1> for each RAT for which the received *quantityConfig* includes parameter(s):
 - 2> set the corresponding parameter(s) in *quantityConfig* within *VarMeasConfig* to the value of the received *quantityConfig* parameter(s);
- 1> for each *measId* included in the *measIdList* within *VarMeasConfig*:
 - 2> remove the measurement reporting entry for this *measId* from the *VarMeasReportList*, if included;
 - 2> stop the periodical reporting timer or timer T321, whichever one is running, and reset the associated information (e.g. *timeToTrigger*) for this *measId*;

5.5.2.9 Measurement gap configuration

The UE shall:

- 1> if *measGapConfig* is set to *setup*:
 - 2> if a measurement gap configuration *measGapConfig* or *measGapConfigPerCC-List* is already setup, release the measurement gap configuration;
 - 2> if the *gapOffset* in *measGapConfig* indicates a non-uniform gap pattern:
 - 3> setup the measurement gap configuration indicated by the *measGapConfig* in accordance with the received *gapOffset*, i.e., the first subframe of the first gap of each non-uniform gap pattern occurs at an SFN and subframe meeting the following condition (SFN and subframe of MCG cells):

$$\text{SFN mod } T = \text{FLOOR}(\text{gapOffset}/10);$$

$$\text{subframe} = \text{gapOffset mod } 10;$$
 with $T = \text{LMGRP}/10$ as defined in TS 36.133 [16];
- 2> else:

- 3> setup the measurement gap configuration indicated by the *measGapConfig* in accordance with the received *gapOffset*, i.e., the first subframe of each gap occurs at an SFN and subframe meeting the following condition (SFN and subframe of MCG cells):

$$\text{SFN mod } T = \text{FLOOR}(\text{gapOffset}/10);$$

$$\text{subframe} = \text{gapOffset mod } 10;$$

with $T = \text{MGRP}/10$ as defined in TS 36.133 [16];

NOTE 1: The UE applies a single gap, which timing is relative to the MCG cells, even when configured with DC.

- 1> else if *measGapConfig* is set to *release*:

- 2> release the measurement gap configuration *measGapConfig*;

- 1> if *measGapConfigPerCC-List* is set to *setup*:

- 2> if a measurement gap configuration *measGapConfig* is already setup, release *measGapConfig*;

- 2> if *measGapConfigToRemoveList* is included:

- 3> for each *ServCellIndex* included in the *measGapConfigToRemoveList*:

- 4> release *measGapConfigCC* for the serving cell indicated by *servCellId*;

- 2> if *measGapConfigToAddModList* is included:

- 3> for each *ServCellIndex* included in the *measGapConfigToAddModList*:

- 4> store *measGapConfigCC* for the serving cell indicated by *servCellId*;

- 2> for each serving cell with stored *measGapConfigCC* indicating a non-uniform gap pattern, setup the measurement gap configuration indicated by the *measGapConfigCC* in accordance with the received *gapOffset*, i.e., the first subframe of the first gap of each non-uniform gap pattern occurs at an SFN and subframe meeting the following condition (SFN and subframe of MCG cells):

$$\text{SFN mod } T = \text{FLOOR}(\text{gapOffset}/10);$$

$$\text{subframe} = \text{gapOffset mod } 10;$$

with $T = \text{LMGRP}/10$ as defined in TS 36.133 [16];

- 2> for each serving cell with stored *measGapConfigCC* not indicating a non-uniform gap pattern, setup the measurement gap configuration indicated by the *measGapConfigCC* in accordance with the received *gapOffset*, i.e., the first subframe of each gap occurs at an SFN and subframe meeting the following condition (SFN and subframe of MCG cells):

$$\text{SFN mod } T = \text{FLOOR}(\text{gapOffset}/10);$$

$$\text{subframe} = \text{gapOffset mod } 10;$$

with $T = \text{MGRP}/10$ as defined in TS 36.133 [16];

NOTE 2: The UE applies gap timing relative to the MCG cells, even when configured with DC.

- 1> else (*measGapConfigPerCC-List* is set to *release*):

- 2> release the measurement gap configuration *measGapConfigPerCC-List*;

NOTE 3: When a SCell is released, the UE is not required to apply a per CC measurement gap configuration associated to the SCell.

5.5.2.10 Discovery signals measurement timing configuration

The UE shall setup the discovery signals measurement timing configuration (DMTC) in accordance with the received *dmtc-PeriodOffset*, i.e., the first subframe of each DMTC occasion occurs at an SFN and subframe of the PCell meeting the following condition:

$$\text{SFN mod } T = \text{FLOOR}(\textit{dmtc-Offset}/10);$$

$$\text{subframe} = \textit{dmtc-Offset} \bmod 10;$$

with $T = \textit{dmtc-Periodicity}/10$;

On the concerned frequency, the UE shall not consider discovery signals transmission in subframes outside the DMTC occasion for measurements including RRM measurements.

5.5.2.11 RSSI measurement timing configuration

The UE shall setup the RSSI measurement timing configuraton (RMTC) in accordance with the received *rmtc-Period*, *rmtc-SubframeOffset* if configured otherwise determined by the UE randomly, i.e. the first symbol of each RMTC occasion occurs at first symbol of an SFN and subframe of the PCell meeting the following condition:

$$\text{SFN mod } T = \text{FLOOR}(\textit{rmtc-SubframeOffset}/10);$$

$$\text{subframe} = \textit{rmtc-SubframeOffset} \bmod 10;$$

with $T = \textit{rmtc-Period}/10$;

On the concerned frequency, the UE shall not consider RSSI measurements outside the configured RMTC occasion which lasts for *measDuration* for RSSI and channel occupancy measurements.

5.5.2.12 Measurement gap sharing configuration

The UE shall:

- 1> if *measGapSharingConfig* is set to *setup*:
 - 2> if a measurement gap sharing configuration is already setup, release the measurement gap sharing configuration;
 - 2> setup the measurement gap sharing configuration indicated by the *measGapSharingConfig* in accordance with the received *measGapSharingScheme* as defined in TS 36.133 [16];
- 1> else:
 - 2> release the measurement gap sharing configuration;

5.5.3 Performing measurements

5.5.3.1 General

For all measurements, except for UE Rx–Tx time difference measurements, RSSI, UL PDCP Packet Delay per QCI measurement, channel occupancy measurements, CBR measurement, and except for WLAN measurements of Band, Carrier Info, Available Admission Capacity, Backhaul Bandwidth, Channel Utilization, and Station Count, the UE applies the layer 3 filtering as specified in 5.5.3.2, before using the measured results for evaluation of reporting criteria or for measurement reporting.

The UE shall:

- 1> whenever the UE has a *measConfig*, perform RSRP and RSRQ measurements for each serving cell as follows:
 - 2> for the PCell, apply the time domain measurement resource restriction in accordance with *measSubframePatternPCell*, if configured;
 - 2> if the UE supports CRS based discovery signals measurement:

- 3> for each SCell in deactivated state, apply the discovery signals measurement timing configuration in accordance with *measDS-Config*, if configured within the *measObject* corresponding to the frequency of the SCell;
- 1> if the UE has a *measConfig* with *rs-sinr-Config* configured, perform RS-SINR (as indicated in the associated *reportConfig*) measurements as follows:
 - 2> perform the corresponding measurements on the frequency indicated in the associated *measObject* using available idle periods or using autonomous gaps as necessary;
- 1> for each *measId* included in the *measIdList* within *VarMeasConfig*:
 - 2> if the *purpose* for the associated *reportConfig* is set to *reportCGI*:
 - 3> if *si-RequestForHO* is configured for the associated *reportConfig*:
 - 4> perform the corresponding measurements on the frequency and RAT indicated in the associated *measObject* using autonomous gaps as necessary;
 - 3> else:
 - 4> perform the corresponding measurements on the frequency and RAT indicated in the associated *measObject* using available idle periods or using autonomous gaps as necessary;

NOTE 1: If autonomous gaps are used to perform measurements, the UE is allowed to temporarily abort communication with all serving cell(s), i.e. create autonomous gaps to perform the corresponding measurements within the limits specified in TS 36.133 [16]. Otherwise, the UE only supports the measurements with the purpose set to *reportCGI* only if E-UTRAN has provided sufficient idle periods.

- 3> try to acquire the global cell identity of the cell indicated by the *cellForWhichToReportCGI* in the associated *measObject* by acquiring the relevant system information from the concerned cell;
- 3> if an entry in the *cellAccessRelatedInfoList* includes the selected PLMN, acquire the relevant system information from the concerned cell;
- 3> if the cell indicated by the *cellForWhichToReportCGI* included in the associated *measObject* is an E-UTRAN cell:
 - 4> try to acquire the CSG identity, if the CSG identity is broadcast in the concerned cell;
 - 4> try to acquire the *trackingAreaCode* in the concerned cell;
 - 4> try to acquire the list of additional PLMN Identities, as included in the *plmn-IdentityList*, if multiple PLMN identities are broadcast in the concerned cell;
 - 4> if *cellAccessRelatedInfoList* is included, use *trackingAreaCode* and *plmn-IdentityList* from the entry of *cellAccessRelatedInfoList* containing the selected PLMN;
 - 4> if the *includeMultiBandInfo* is configured:
 - 5> try to acquire the *freqBandIndicator* in the *SystemInformationBlockType1* of the concerned cell;
 - 5> try to acquire the list of additional frequency band indicators, as included in the *multiBandInfoList*, if multiple frequency band indicators are included in the *SystemInformationBlockType1* of the concerned cell;
 - 5> try to acquire the *freqBandIndicatorPriority*, if the *freqBandIndicatorPriority* is included in the *SystemInformationBlockType1* of the concerned cell;

NOTE 2: The 'primary' PLMN is part of the global cell identity.

- 3> if the cell indicated by the *cellForWhichToReportCGI* included in the associated *measObject* is a UTRAN cell:
 - 4> try to acquire the LAC, the RAC and the list of additional PLMN Identities, if multiple PLMN identities are broadcast in the concerned cell;

- 4> try to acquire the CSG identity, if the CSG identity is broadcast in the concerned cell;
- 3> if the cell indicated by the *cellForWhichToReportCGI* included in the associated *measObject* is a GERAN cell:
 - 4> try to acquire the RAC in the concerned cell;
- 3> if the cell indicated by the *cellForWhichToReportCGI* included in the associated *measObject* is a CDMA2000 cell and the *cdma2000-Type* included in the *measObject* is *typeHRPD*:
 - 4> try to acquire the Sector ID in the concerned cell;
- 3> if the cell indicated by the *cellForWhichToReportCGI* included in the associated *measObject* is a CDMA2000 cell and the *cdma2000-Type* included in the *measObject* is *typeIXRTT*:
 - 4> try to acquire the BASE ID, SID and NID in the concerned cell;
- 2> if the *ul-DelayConfig* is configured for the associated *reportConfig*:
 - 3> ignore the *measObject*;
 - 3> configure the PDCP layer to perform UL PDCP Packet Delay per QCI measurement;
- 2> else:
 - 3> if a measurement gap configuration is setup; or
 - 3> if the UE does not require measurement gaps to perform the concerned measurements:
 - 4> if *s-Measure* is not configured; or
 - 4> if *s-Measure* is configured and the PCell RSRP, after layer 3 filtering, is lower than this value; or
 - 4> if *measDS-Config* is configured in the associated *measObject*:
 - 5> if the UE supports CSI-RS based discovery signals measurement; and
 - 5> if the *eventId* in the associated *reportConfig* is set to *eventC1* or *eventC2*, or if *reportStrongestCSI-RSs* is included in the associated *reportConfig*:
 - 6> perform the corresponding measurements of CSI-RS resources on the frequency indicated in the concerned *measObject*, applying the discovery signals measurement timing configuration in accordance with *measDS-Config* in the concerned *measObject*;
 - 6> if *reportCRS-Meas* is included in the associated *reportConfig*, perform the corresponding measurements of neighbouring cells on the frequencies indicated in the concerned *measObject* as follows:
 - 7> for neighbouring cells on the primary frequency, apply the time domain measurement resource restriction in accordance with *measSubframePatternConfigNeigh*, if configured in the concerned *measObject*;
 - 7> apply the discovery signals measurement timing configuration in accordance with *measDS-Config* in the concerned *measObject*;
 - 5> else:
 - 6> perform the corresponding measurements of neighbouring cells on the frequencies and RATs indicated in the concerned *measObject* as follows:
 - 7> for neighbouring cells on the primary frequency, apply the time domain measurement resource restriction in accordance with *measSubframePatternConfigNeigh*, if configured in the concerned *measObject*;
 - 7> if the UE supports CRS based discovery signals measurement, apply the discovery signals measurement timing configuration in accordance with *measDS-Config*, if configured in the concerned *measObject*;

- 4> if the *ue-RxTxTimeDiffPeriodical* is configured in the associated *reportConfig*:
 - 5> perform the UE Rx–Tx time difference measurements on the PCell;
- 4> if the *reportSSTD-Meas* is set to *true* in the associated *reportConfig*:
 - 5> perform SSTD measurements between the PCell and the PSCell;
- 4> if the *measRSSI-ReportConfig* is configured in the associated *reportConfig*:
 - 5> perform the RSSI and channel occupancy measurements on the frequency indicated in the associated *measObject*;
- 2> perform the evaluation of reporting criteria as specified in 5.5.4;

The UE capable of CBR measurement when configured to transmit non-P2X related V2X sidelink communication shall:

- 1> if in coverage on the frequency used for V2X sidelink communication transmission as defined in TS 36.304 [4, 11.4]; or
- 1> if the concerned frequency is included in *v2x-InterFreqInfoList* in *RRCConnectionReconfiguration* or in *v2x-InterFreqInfoList* within *SystemInformationBlockType21*:
 - 2> if the UE is in RRC_IDLE:
 - 3> if the concerned frequency is the camped frequency:
 - 4> perform CBR measurement on the pools in *v2x-CommTxPoolNormalCommon* and *v2x-CommTxPoolExceptional* if included in *SystemInformationBlockType21*;
 - 3> else if *v2x-CommTxPoolNormal* or *v2x-CommTxPoolExceptional* is included in *v2x-InterFreqInfoList* for the concerned frequency within *SystemInformationBlockType21*:
 - 4> perform CBR measurement on pools in *v2x-CommTxPoolNormal* and *v2x-CommTxPoolExceptional* in *v2x-InterFreqInfoList* for the concerned frequency in *SystemInformationBlockType21*;
 - 3> else if the concerned frequency broadcasts *SystemInformationBlockType21*:
 - 4> perform CBR measurement on pools in *v2x-CommTxPoolNormalCommon* and *v2x-CommTxPoolExceptional* if included in *SystemInformationBlockType21* broadcast on the concerned frequency;
 - 2> if the UE is in RRC_CONNECTED:
 - 3> if *tx-ResourcePoolToAddList* is included in *VarMeasConfig*:
 - 4> perform CBR measurements on each resource pool indicated in *tx-ResourcePoolToAddList*;
 - 3> if the concerned frequency is the PCell's frequency:
 - 4> perform CBR measurement on the pools in *v2x-CommTxPoolNormalDedicated* or *v2x-SchedulingPool* if included in *RRCConnectionReconfiguration*, *v2x-CommTxPoolExceptional* if included in *SystemInformationBlockType21* for the concerned frequency and *v2x-CommTxPoolExceptional* if included in *mobilityControlInfoV2X*;
 - 3> else if *v2x-CommTxPoolNormal*, *v2x-SchedulingPool* or *v2x-CommTxPoolExceptional* is included in *v2x-InterFreqInfoList* for the concerned frequency within *RRCConnectionReconfiguration*:
 - 4> perform CBR measurement on pools in *v2x-CommTxPoolNormal*, *v2x-SchedulingPool*, and *v2x-CommTxPoolExceptional* if included in *v2x-InterFreqInfoList* for the concerned frequency in *RRCConnectionReconfiguration*;
 - 3> else if the concerned frequency broadcasts *SystemInformationBlockType21*:
 - 4> perform CBR measurement on pools in *v2x-CommTxPoolNormalCommon* and *v2x-CommTxPoolExceptional* if included in *SystemInformationBlockType21* for the concerned frequency;

1> else:

- 2> perform CBR measurement on pools in *v2x-CommTxPoolList* in *SL-V2X-Preconfiguration* for the concerned frequency;

NOTE 3: The *s-Measure* defines when the UE is required to perform measurements. The UE is however allowed to perform measurements also when the PCell RSRP exceeds *s-Measure*, e.g., to measure cells broadcasting a CSG identity following use of the autonomous search function as defined in TS 36.304 [4].

NOTE 4: The UE may not perform the WLAN measurements it is configured with e.g. due to connection to another WLAN based on user preferences as specified in TS 23.402 [75] or due to turning off WLAN.

5.5.3.2 Layer 3 filtering

The UE shall:

- 1> for each measurement quantity that the UE performs measurements according to 5.5.3.1:

NOTE 1: This does not include quantities configured solely for UE Rx-Tx time difference, SSTD measurements and RSSI, channel occupancy measurements, WLAN measurements of Band, Carrier Info, Available Admission Capacity, Backhaul Bandwidth, Channel Utilization, and Station Count, CBR measurement, and UL PDCP Packet Delay per QCI measurement i.e. for those types of measurements the UE ignores the *triggerQuantity* and *reportQuantity*.

- 2> filter the measured result, before using for evaluation of reporting criteria or for measurement reporting, by the following formula:

$$F_n = (1 - a) \cdot F_{n-1} + a \cdot M_n$$

where

M_n is the latest received measurement result from the physical layer;

F_n is the updated filtered measurement result, that is used for evaluation of reporting criteria or for measurement reporting;

F_{n-1} is the old filtered measurement result, where F_0 is set to M_1 when the first measurement result from the physical layer is received; and

$a = 1/2^{(k/4)}$, where k is the *filterCoefficient* for the corresponding measurement quantity received by the *quantityConfig*;

- 2> adapt the filter such that the time characteristics of the filter are preserved at different input rates, observing that the *filterCoefficient* k assumes a sample rate equal to 200 ms;

NOTE 2: If k is set to 0, no layer 3 filtering is applicable.

NOTE 3: The filtering is performed in the same domain as used for evaluation of reporting criteria or for measurement reporting, i.e., logarithmic filtering for logarithmic measurements.

NOTE 4: The filter input rate is implementation dependent, to fulfil the performance requirements set in [16]. For further details about the physical layer measurements, see TS 36.133 [16].

5.5.4 Measurement report triggering

5.5.4.1 General

If security has been activated successfully, the UE shall:

- 1> for each *measId* included in the *measIdList* within *VarMeasConfig*:
- 2> if the corresponding *reportConfig* includes a purpose set to *reportStrongestCellsForSON*:
- 3> consider any neighbouring cell detected on the associated frequency to be applicable;

- 2> else if the corresponding *reportConfig* includes a purpose set to *reportCGI*:
 - 3> consider any neighbouring cell detected on the associated frequency/ set of frequencies (GERAN) which has a physical cell identity matching the value of the *cellForWhichToReportCGI* included in the corresponding *measObject* within the *VarMeasConfig* to be applicable;
- 2> else:
 - 3> if the corresponding *measObject* concerns E-UTRA:
 - 4> if the *ue-RxTxTimeDiffPeriodical* is configured in the corresponding *reportConfig*:
 - 5> consider only the PCell to be applicable;
 - 4> else if the *reportSSTD-Meas* is set to *true* in the corresponding *reportConfig*:
 - 5> consider the PCell to be applicable;
 - 4> else if the *eventA1* or *eventA2* is configured in the corresponding *reportConfig*:
 - 5> consider only the serving cell to be applicable;
 - 4> else if *eventC1* or *eventC2* is configured in the corresponding *reportConfig*; or if *reportStrongestCSI-RSs* is included in the corresponding *reportConfig*:
 - 5> consider a CSI-RS resource on the associated frequency to be applicable when the concerned CSI-RS resource is included in the *measCSI-RS-ToAddModList* defined within the *VarMeasConfig* for this *measId*;
 - 4> else if *measRSSI-ReportConfig* is configured in the corresponding *reportConfig*:
 - 5> consider the resource indicated by the *rmtc-Config* on the associated frequency to be applicable;
 - 4> else:
 - 5> if *useWhiteCellList* is set to *TRUE*:
 - 6> consider any neighbouring cell detected on the associated frequency to be applicable when the concerned cell is included in the *whiteCellsToAddModList* defined within the *VarMeasConfig* for this *measId*;
 - 5> else:
 - 6> consider any neighbouring cell detected on the associated frequency to be applicable when the concerned cell is not included in the *blackCellsToAddModList* defined within the *VarMeasConfig* for this *measId*;
 - 5> for events involving a serving cell on one frequency and neighbours on another frequency, consider the serving cell on the other frequency as a neighbouring cell;
 - 4> if the corresponding *reportConfig* includes *alternativeTimeToTrigger* and if the UE supports *alternativeTimeToTrigger*:
 - 5> use the value of *alternativeTimeToTrigger* as the time to trigger instead of the value of *timeToTrigger* in the corresponding *reportConfig* for cells included in the *altTTT-CellsToAddModList* of the corresponding *measObject*;
 - 3> else if the corresponding *measObject* concerns UTRA or CDMA2000:
 - 4> consider a neighbouring cell on the associated frequency to be applicable when the concerned cell is included in the *cellsToAddModList* defined within the *VarMeasConfig* for this *measId* (i.e. the cell is included in the white-list);

NOTE 0: The UE may also consider a neighbouring cell on the associated UTRA frequency to be applicable when the concerned cell is included in the *csg-allowedReportingCells* within the *VarMeasConfig* for this *measId*, if configured in the corresponding *measObjectUTRA* (i.e. the cell is included in the range of physical cell identities for which reporting is allowed).

- 3> else if the corresponding *measObject* concerns GERAN:
 - 4> consider a neighbouring cell on the associated set of frequencies to be applicable when the concerned cell matches the *ncc-Permitted* defined within the *VarMeasConfig* for this *measId*;
- 3> else if the corresponding *measObject* concerns WLAN:
 - 4> consider a WLAN on the associated set of frequencies, as indicated by *carrierFreq* or on all WLAN frequencies when *carrierFreq* is not present, to be applicable if the WLAN matches all WLAN identifiers of at least one entry within *wlan-Id-List* for this *measId*;
- 2> if *tx-ResourcePoolToAddList* is configured in the *measObject*, and if the corresponding *reportConfig* includes a purpose set to *sidelink* or includes *eventV1* or *eventV2*:
 - 3> consider the transmission resource pools indicated by the *tx-ResourcePoolToAddList* defined within the *VarMeasConfig* for this *measId* to be applicable;
- 2> if the corresponding *reportConfig* includes a purpose set to *reportLocation*:
 - 3> consider only the PCell to be applicable;
- 2> if the *triggerType* is set to *event* and if the entry condition applicable for this event, i.e. the event corresponding with the *eventId* of the corresponding *reportConfig* within *VarMeasConfig*, is fulfilled for one or more applicable cells for all measurements after layer 3 filtering taken during *timeToTrigger* defined for this event within the *VarMeasConfig*, while the *VarMeasReportList* does not include a measurement reporting entry for this *measId* (a first cell triggers the event):
 - 3> include a measurement reporting entry within the *VarMeasReportList* for this *measId*;
 - 3> set the *numberOfReportsSent* defined within the *VarMeasReportList* for this *measId* to 0;
 - 3> include the concerned cell(s) in the *cellsTriggeredList* defined within the *VarMeasReportList* for this *measId*;
 - 3> if the UE supports T312 and if *useT312* is included for this event and if T310 is running:
 - 4> if T312 is not running:
 - 5> start timer T312 with the value configured in the corresponding *measObject*;
 - 3> initiate the measurement reporting procedure, as specified in 5.5.5;
- 2> if the *triggerType* is set to *event* and if the entry condition applicable for this event, i.e. the event corresponding with the *eventId* of the corresponding *reportConfig* within *VarMeasConfig*, is fulfilled for one or more applicable cells not included in the *cellsTriggeredList* for all measurements after layer 3 filtering taken during *timeToTrigger* defined for this event within the *VarMeasConfig* (a subsequent cell triggers the event):
 - 3> set the *numberOfReportsSent* defined within the *VarMeasReportList* for this *measId* to 0;
 - 3> include the concerned cell(s) in the *cellsTriggeredList* defined within the *VarMeasReportList* for this *measId*;
 - 3> if the UE supports T312 and if *useT312* is included for this event and if T310 is running:
 - 4> if T312 is not running:
 - 5> start timer T312 with the value configured in the corresponding *measObject*;
 - 3> initiate the measurement reporting procedure, as specified in 5.5.5;
- 2> if the *triggerType* is set to *event* and if the leaving condition applicable for this event is fulfilled for one or more of the cells included in the *cellsTriggeredList* defined within the *VarMeasReportList* for this *measId* for all measurements after layer 3 filtering taken during *timeToTrigger* defined within the *VarMeasConfig* for this event:

- 3> remove the concerned cell(s) in the *cellsTriggeredList* defined within the *VarMeasReportList* for this *measId*;
- 3> if the UE supports T312 and if *useT312* is included for this event and if T310 is running:
 - 4> if T312 is not running:
 - 5> start timer T312 with the value configured in the corresponding *measObject*;
- 3> if *reportOnLeave* is set to *TRUE* for the corresponding reporting configuration or if *a6-ReportOnLeave* is set to *TRUE* for the corresponding reporting configuration:
 - 4> initiate the measurement reporting procedure, as specified in 5.5.5;
- 3> if the *cellsTriggeredList* defined within the *VarMeasReportList* for this *measId* is empty:
 - 4> remove the measurement reporting entry within the *VarMeasReportList* for this *measId*;
 - 4> stop the periodical reporting timer for this *measId*, if running;
- 2> if the *triggerType* is set to *event* and if the entry condition applicable for this event, i.e. the event corresponding with the *eventId* of the corresponding *reportConfig* within *VarMeasConfig*, is fulfilled for one or more applicable CSI-RS resources for all measurements after layer 3 filtering taken during *timeToTrigger* defined for this event within the *VarMeasConfig*, while the *VarMeasReportList* does not include an measurement reporting entry for this *measId* (i.e. a first CSI-RS resource triggers the event):
 - 3> include a measurement reporting entry within the *VarMeasReportList* for this *measId*;
 - 3> set the *numberOfReportsSent* defined within the *VarMeasReportList* for this *measId* to 0;
 - 3> include the concerned CSI-RS resource(s) in the *csi-RS-TriggeredList* defined within the *VarMeasReportList* for this *measId*;
 - 3> initiate the measurement reporting procedure, as specified in 5.5.5;
- 2> if the *triggerType* is set to *event* and if the entry condition applicable for this event, i.e. the event corresponding with the *eventId* of the corresponding *reportConfig* within *VarMeasConfig*, is fulfilled for one or more applicable CSI-RS resources not included in the *csi-RS-TriggeredList* for all measurements after layer 3 filtering taken during *timeToTrigger* defined for this event within the *VarMeasConfig* (i.e. a subsequent CSI-RS resource triggers the event):
 - 3> set the *numberOfReportsSent* defined within the *VarMeasReportList* for this *measId* to 0;
 - 3> include the concerned CSI-RS resource(s) in the *csi-RS-TriggeredList* defined within the *VarMeasReportList* for this *measId*;
 - 3> initiate the measurement reporting procedure, as specified in 5.5.5;
- 2> if the *triggerType* is set to *event* and if the leaving condition applicable for this event is fulfilled for one or more of the CSI-RS resources included in the *csi-RS-TriggeredList* defined within the *VarMeasReportList* for this *measId* for all measurements after layer 3 filtering taken during *timeToTrigger* defined within the *VarMeasConfig* for this event:
 - 3> remove the concerned CSI-RS resource(s) in the *csi-RS-TriggeredList* defined within the *VarMeasReportList* for this *measId*;
 - 3> if *c1-ReportOnLeave* is set to *TRUE* for the corresponding reporting configuration or if *c2-ReportOnLeave* is set to *TRUE* for the corresponding reporting configuration:
 - 4> initiate the measurement reporting procedure, as specified in 5.5.5;
 - 3> if the *csi-RS-TriggeredList* defined within the *VarMeasReportList* for this *measId* is empty:
 - 4> remove the measurement reporting entry within the *VarMeasReportList* for this *measId*;
 - 4> stop the periodical reporting timer for this *measId*, if running;

- 2> if the *triggerType* is set to *event* and if the entry condition applicable for this event, i.e. the event corresponding with the *eventId* of the corresponding *reportConfig* within *VarMeasConfig*, is fulfilled for one or more applicable transmission resource pools for all measurements taken during *timeToTrigger* defined for this event within the *VarMeasConfig*, while the *VarMeasReportList* does not include an measurement reporting entry for this *measId* (a first transmission resource pool triggers the event):
 - 3> include a measurement reporting entry within the *VarMeasReportList* for this *measId*;
 - 3> set the *numberOfReportsSent* defined within the *VarMeasReportList* for this *measId* to 0;
 - 3> include the concerned transmission resource pool(s) in the *poolsTriggeredList* defined within the *VarMeasReportList* for this *measId*;
 - 3> initiate the measurement reporting procedure, as specified in 5.5.5;
- 2> if the *triggerType* is set to *event* and if the entry condition applicable for this event, i.e. the event corresponding with the *eventId* of the corresponding *reportConfig* within *VarMeasConfig*, is fulfilled for one or more applicable transmission resource pools not included in the *poolsTriggeredList* for all measurements taken during *timeToTrigger* defined for this event within the *VarMeasConfig* (a subsequent transmission resource pool triggers the event):
 - 3> set the *numberOfReportsSent* defined within the *VarMeasReportList* for this *measId* to 0;
 - 3> include the concerned transmission resource pool(s) in the *poolsTriggeredList* defined within the *VarMeasReportList* for this *measId*;
 - 3> initiate the measurement reporting procedure, as specified in 5.5.5;
- 2> if the *triggerType* is set to *event* and if the leaving condition applicable for this event is fulfilled for one or more applicable transmission resource pools included in the *poolsTriggeredList* defined within the *VarMeasReportList* for this *measId* for all measurements taken during *timeToTrigger* defined within the *VarMeasConfig* for this event:
 - 3> remove the concerned transmission resource pool(s) from the *poolsTriggeredList* defined within the *VarMeasReportList* for this *measId*;
 - 3> if the *poolsTriggeredList* defined within the *VarMeasReportList* for this *measId* is empty:
 - 4> remove the measurement reporting entry within the *VarMeasReportList* for this *measId*;
 - 4> stop the periodical reporting timer for this *measId*, if running;
- 2> if *measRSSI-ReportConfig* is included and if a (first) measurement result is available:
 - 3> include a measurement reporting entry within the *VarMeasReportList* for this *measId*;
 - 3> set the *numberOfReportsSent* defined within the *VarMeasReportList* for this *measId* to 0;
 - 3> initiate the measurement reporting procedure as specified in 5.5.5 immediately when RSSI sample values are reported by the physical layer after the first L1 measurement duration;
- 2> else if the *purpose* is included and set to *reportStrongestCells*, *reportStrongestCellsForSON*, *reportLocation* or *sidelink* and if a (first) measurement result is available:
 - 3> include a measurement reporting entry within the *VarMeasReportList* for this *measId*;
 - 3> set the *numberOfReportsSent* defined within the *VarMeasReportList* for this *measId* to 0;
 - 3> if the *purpose* is set to *reportStrongestCells* and *reportStrongestCSI-RSs* is not included:
 - 4> if the *triggerType* is set to *periodical* and the corresponding *reportConfig* includes the *ul-DelayConfig*:
 - 5> initiate the measurement reporting procedure, as specified in 5.5.5, immediately after a first measurement result is provided by lower layers;
 - 4> else if the corresponding measurement object concerns WLAN:

- 5> initiate the measurement reporting procedure, as specified in 5.5.5, immediately after the quantity to be reported becomes available for the PCell and for the applicable WLAN(s);
- 4> else if the *reportAmount* exceeds 1:
 - 5> initiate the measurement reporting procedure, as specified in 5.5.5, immediately after the quantity to be reported becomes available for the PCell;
- 4> else (i.e. the *reportAmount* is equal to 1):
 - 5> initiate the measurement reporting procedure, as specified in 5.5.5, immediately after the quantity to be reported becomes available for the PCell and for the strongest cell among the applicable cells, or becomes available for the pair of PCell and the PSCell in case of SSTD measurements;
- 3> if the *purpose* is set to *reportLocation* or *sidelink*:
 - 4> if the *purpose* is set to *reportLocation*:
 - 5> initiate the measurement reporting procedure, as specified in 5.5.5, immediately after both the quantity to be reported for the PCell and the location information become available;
 - 4> else if the *purpose* is set to *sidelink*:
 - 5> initiate the measurement reporting procedure as specified in 5.5.5 immediately after both the quantity to be reported for the PCell and the CBR measurement result become available;
- 3> else if the *purpose* is not set to *reportStrongestCells* or *reportStrongestCSI-RSs* is included:
 - 4> initiate the measurement reporting procedure, as specified in 5.5.5, when it has determined the strongest cells on the associated frequency;
- 2> upon expiry of the periodical reporting timer for this *measId*:
 - 3> initiate the measurement reporting procedure, as specified in 5.5.5;
- 2> if the *purpose* is included and set to *reportCGI* and if the UE acquired the information needed to set all fields of *cgi-Info* for the requested cell:
 - 3> include a measurement reporting entry within the *VarMeasReportList* for this *measId*;
 - 3> set the *numberOfReportsSent* defined within the *VarMeasReportList* for this *measId* to 0;
 - 3> stop timer T321;
 - 3> initiate the measurement reporting procedure, as specified in 5.5.5;
- 2> upon expiry of the T321 for this *measId*:
 - 3> include a measurement reporting entry within the *VarMeasReportList* for this *measId*;
 - 3> set the *numberOfReportsSent* defined within the *VarMeasReportList* for this *measId* to 0;
 - 3> initiate the measurement reporting procedure, as specified in 5.5.5;

NOTE 2: The UE does not stop the periodical reporting with *triggerType* set to *event* or to *periodical* while the corresponding measurement is not performed due to the PCell RSRP being equal to or better than *s-Measure* or due to the measurement gap not being setup.

NOTE 3: If the UE is configured with DRX, the UE may delay the measurement reporting for event triggered and periodical triggered measurements until the Active Time, which is defined in TS 36.321 [6].

5.5.4.2 Event A1 (Serving becomes better than threshold)

The UE shall:

- 1> consider the entering condition for this event to be satisfied when condition A1-1, as specified below, is fulfilled;

- 1> consider the leaving condition for this event to be satisfied when condition A1-2, as specified below, is fulfilled;
- 1> for this measurement, consider the primary or secondary cell that is configured on the frequency indicated in the associated *measObjectEUTRA* to be the serving cell;

Inequality A1-1 (Entering condition)

$$M_s - H_{ys} > Thresh$$

Inequality A1-2 (Leaving condition)

$$M_s + H_{ys} < Thresh$$

The variables in the formula are defined as follows:

M_s is the measurement result of the serving cell, not taking into account any offsets.

H_{ys} is the hysteresis parameter for this event (i.e. *hysteresis* as defined within *reportConfigEUTRA* for this event).

Thresh is the threshold parameter for this event (i.e. *a1-Threshold* as defined within *reportConfigEUTRA* for this event).

M_s is expressed in dBm in case of RSRP, or in dB in case of RSRQ and RS-SINR.

H_{ys} is expressed in dB.

Thresh is expressed in the same unit as ***M_s***.

5.5.4.3 Event A2 (Serving becomes worse than threshold)

The UE shall:

- 1> consider the entering condition for this event to be satisfied when condition A2-1, as specified below, is fulfilled;
- 1> consider the leaving condition for this event to be satisfied when condition A2-2, as specified below, is fulfilled;
- 1> for this measurement, consider the primary or secondary cell that is configured on the frequency indicated in the associated *measObjectEUTRA* to be the serving cell;

Inequality A2-1 (Entering condition)

$$M_s + H_{ys} < Thresh$$

Inequality A2-2 (Leaving condition)

$$M_s - H_{ys} > Thresh$$

The variables in the formula are defined as follows:

M_s is the measurement result of the serving cell, not taking into account any offsets.

H_{ys} is the hysteresis parameter for this event (i.e. *hysteresis* as defined within *reportConfigEUTRA* for this event).

Thresh is the threshold parameter for this event (i.e. *a2-Threshold* as defined within *reportConfigEUTRA* for this event).

M_s is expressed in dBm in case of RSRP, or in dB in case of RSRQ and RS-SINR.

H_{ys} is expressed in dB.

Thresh is expressed in the same unit as ***M_s***.

5.5.4.4 Event A3 (Neighbour becomes offset better than PCell/ PSCell)

The UE shall:

- 1> consider the entering condition for this event to be satisfied when condition A3-1, as specified below, is fulfilled;

- 1> consider the leaving condition for this event to be satisfied when condition A3-2, as specified below, is fulfilled;
- 1> if *usePSCell* of the corresponding *reportConfig* is set to *true*:
- 2> use the PSCell for *Mp*, *Ofp* and *Ocp*;
- 1> else:
- 2> use the PCell for *Mp*, *Ofp* and *Ocp*;

NOTE The cell(s) that triggers the event is on the frequency indicated in the associated *measObject* which may be different from the frequency used by the PCell/ PSCell.

Inequality A3-1 (Entering condition)

$$Mn + Ofn + Ocn - Hys > Mp + Ofp + Ocp + Off$$

Inequality A3-2 (Leaving condition)

$$Mn + Ofn + Ocn + Hys < Mp + Ofp + Ocp + Off$$

The variables in the formula are defined as follows:

Mn is the measurement result of the neighbouring cell, not taking into account any offsets.

Ofn is the frequency specific offset of the frequency of the neighbour cell (i.e. *offsetFreq* as defined within *measObjectEUTRA* corresponding to the frequency of the neighbour cell).

Ocn is the cell specific offset of the neighbour cell (i.e. *cellIndividualOffset* as defined within *measObjectEUTRA* corresponding to the frequency of the neighbour cell), and set to zero if not configured for the neighbour cell.

Mp is the measurement result of the PCell/ PSCell, not taking into account any offsets.

Ofp is the frequency specific offset of the frequency of the PCell/ PSCell (i.e. *offsetFreq* as defined within *measObjectEUTRA* corresponding to the frequency of the PCell/ PSCell).

Ocp is the cell specific offset of the PCell/ PSCell (i.e. *cellIndividualOffset* as defined within *measObjectEUTRA* corresponding to the frequency of the PCell/ PSCell), and is set to zero if not configured for the PCell/ PSCell.

Hys is the hysteresis parameter for this event (i.e. *hysteresis* as defined within *reportConfigEUTRA* for this event).

Off is the offset parameter for this event (i.e. *a3-Offset* as defined within *reportConfigEUTRA* for this event).

Mn*, *Mp are expressed in dBm in case of RSRP, or in dB in case of RSRQ and RS-SINR.

Ofn*, *Ocn*, *Ofp*, *Ocp*, *Hys*, *Off are expressed in dB.

5.5.4.5 Event A4 (Neighbour becomes better than threshold)

The UE shall:

- 1> consider the entering condition for this event to be satisfied when condition A4-1, as specified below, is fulfilled;
- 1> consider the leaving condition for this event to be satisfied when condition A4-2, as specified below, is fulfilled;

Inequality A4-1 (Entering condition)

$$Mn + Ofn + Ocn - Hys > Thresh$$

Inequality A4-2 (Leaving condition)

$$Mn + Ofn + Ocn + Hys < Thresh$$

The variables in the formula are defined as follows:

Mn is the measurement result of the neighbouring cell, not taking into account any offsets.

Ofn is the frequency specific offset of the frequency of the neighbour cell (i.e. *offsetFreq* as defined within *measObjectEUTRA* corresponding to the frequency of the neighbour cell).

Ocn is the cell specific offset of the neighbour cell (i.e. *cellIndividualOffset* as defined within *measObjectEUTRA* corresponding to the frequency of the neighbour cell), and set to zero if not configured for the neighbour cell.

Hys is the hysteresis parameter for this event (i.e. *hysteresis* as defined within *reportConfigEUTRA* for this event).

Thresh is the threshold parameter for this event (i.e. *a4-Threshold* as defined within *reportConfigEUTRA* for this event).

Mn is expressed in dBm in case of RSRP, or in dB in case of RSRQ and RS-SINR.

Ofn, Ocn, Hys are expressed in dB.

Thresh is expressed in the same unit as **Mn**.

5.5.4.6 Event A5 (PCell/ PSCell becomes worse than threshold1 and neighbour becomes better than threshold2)

The UE shall:

- 1> consider the entering condition for this event to be satisfied when both condition A5-1 and condition A5-2, as specified below, are fulfilled;
- 1> consider the leaving condition for this event to be satisfied when condition A5-3 or condition A5-4, i.e. at least one of the two, as specified below, is fulfilled;
- 1> if *usePSCell* of the corresponding *reportConfig* is set to *true*:
 - 2> use the PSCell for *Mp*;
- 1> else:
 - 2> use the PCell for *Mp*;

NOTE: The cell(s) that triggers the event is on the frequency indicated in the associated *measObject* which may be different from the frequency used by the PCell/ PSCell.

Inequality A5-1 (Entering condition 1)

$$Mp + Hys < Thresh1$$

Inequality A5-2 (Entering condition 2)

$$Mn + Ofn + Ocn - Hys > Thresh2$$

Inequality A5-3 (Leaving condition 1)

$$Mp - Hys > Thresh1$$

Inequality A5-4 (Leaving condition 2)

$$Mn + Ofn + Ocn + Hys < Thresh2$$

The variables in the formula are defined as follows:

Mp is the measurement result of the PCell/ PSCell, not taking into account any offsets.

Mn is the measurement result of the neighbouring cell, not taking into account any offsets.

Ofn is the frequency specific offset of the frequency of the neighbour cell (i.e. *offsetFreq* as defined within *measObjectEUTRA* corresponding to the frequency of the neighbour cell).

Ocn is the cell specific offset of the neighbour cell (i.e. *cellIndividualOffset* as defined within *measObjectEUTRA* corresponding to the frequency of the neighbour cell), and set to zero if not configured for the neighbour cell.

Hys is the hysteresis parameter for this event (i.e. *hysteresis* as defined within *reportConfigEUTRA* for this event).

Thresh1 is the threshold parameter for this event (i.e. *a5-Threshold1* as defined within *reportConfigEUTRA* for this event).

Thresh2 is the threshold parameter for this event (i.e. *a5-Threshold2* as defined within *reportConfigEUTRA* for this event).

Mn, Mp are expressed in dBm in case of RSRP, or in dB in case of RSRQ and RS-SINR.

Ofn, Ocn, Hys are expressed in dB.

Thresh1 is expressed in the same unit as **Mp**.

Thresh2 is expressed in the same unit as **Mn**.

5.5.4.6a Event A6 (Neighbour becomes offset better than SCell)

The UE shall:

1> consider the entering condition for this event to be satisfied when condition A6-1, as specified below, is fulfilled;

1> consider the leaving condition for this event to be satisfied when condition A6-2, as specified below, is fulfilled;

1> for this measurement, consider the (secondary) cell that is configured on the frequency indicated in the associated *measObjectEUTRA* to be the serving cell;

NOTE: The neighbour(s) is on the same frequency as the SCell i.e. both are on the frequency indicated in the associated *measObject*.

Inequality A6-1 (Entering condition)

$$Mn + Ocn - Hys > Ms + Ocs + Off$$

Inequality A6-2 (Leaving condition)

$$Mn + Ocn + Hys < Ms + Ocs + Off$$

The variables in the formula are defined as follows:

Mn is the measurement result of the neighbouring cell, not taking into account any offsets.

Ocn is the cell specific offset of the neighbour cell (i.e. *cellIndividualOffset* as defined within *measObjectEUTRA* corresponding to the frequency of the neighbour cell), and set to zero if not configured for the neighbour cell.

Ms is the measurement result of the serving cell, not taking into account any offsets.

Ocs is the cell specific offset of the serving cell (i.e. *cellIndividualOffset* as defined within *measObjectEUTRA* corresponding to the serving frequency), and is set to zero if not configured for the serving cell.

Hys is the hysteresis parameter for this event (i.e. *hysteresis* as defined within *reportConfigEUTRA* for this event).

Off is the offset parameter for this event (i.e. *a6-Offset* as defined within *reportConfigEUTRA* for this event).

Mn, Ms are expressed in dBm in case of RSRP, or in dB in case of RSRQ and RS-SINR.

Ocn, Ocs, Hys, Off are expressed in dB.

5.5.4.7 Event B1 (Inter RAT neighbour becomes better than threshold)

The UE shall:

1> for UTRA and CDMA2000, only trigger the event for cells included in the corresponding measurement object;

1> consider the entering condition for this event to be satisfied when condition B1-1, as specified below, is fulfilled;

1> consider the leaving condition for this event to be satisfied when condition B1-2, as specified below, is fulfilled;

Inequality B1-1 (Entering condition)

$$Mn + Ofn - Hys > Thresh$$

Inequality B1-2 (Leaving condition)

$$Mn + Ofn + Hys < Thresh$$

The variables in the formula are defined as follows:

Mn is the measurement result of the inter-RAT neighbour cell, not taking into account any offsets. For CDMA 2000 measurement result, *pilotStrength* is divided by -2.

Ofn is the frequency specific offset of the frequency of the inter-RAT neighbour cell (i.e. *offsetFreq* as defined within the *measObject* corresponding to the frequency of the neighbour inter-RAT cell).

Hys is the hysteresis parameter for this event (i.e. *hysteresis* as defined within *reportConfigInterRAT* for this event).

Thresh is the threshold parameter for this event (i.e. *b1-Threshold* as defined within *reportConfigInterRAT* for this event). For CDMA2000, *b1-Threshold* is divided by -2.

Mn is expressed in dBm or in dB, depending on the measurement quantity of the inter-RAT neighbour cell.

Ofn, Hys are expressed in dB.

Thresh is expressed in the same unit as **Mn**.

5.5.4.8 Event B2 (PCell becomes worse than threshold1 and inter RAT neighbour becomes better than threshold2)

The UE shall:

- 1> for UTRA and CDMA2000, only trigger the event for cells included in the corresponding measurement object;
- 1> consider the entering condition for this event to be satisfied when both condition B2-1 and condition B2-2, as specified below, are fulfilled;
- 1> consider the leaving condition for this event to be satisfied when condition B2-3 or condition B2-4, i.e. at least one of the two, as specified below, is fulfilled;

Inequality B2-1 (Entering condition 1)

$$Mp + Hys < Thresh1$$

Inequality B2-2 (Entering condition 2)

$$Mn + Ofn - Hys > Thresh2$$

Inequality B2-3 (Leaving condition 1)

$$Mp - Hys > Thresh1$$

Inequality B2-4 (Leaving condition 2)

$$Mn + Ofn + Hys < Thresh2$$

The variables in the formula are defined as follows:

Mp is the measurement result of the PCell, not taking into account any offsets.

Mn is the measurement result of the inter-RAT neighbour cell, not taking into account any offsets. For CDMA2000 measurement result, *pilotStrength* is divided by -2.

Ofn is the frequency specific offset of the frequency of the inter-RAT neighbour cell (i.e. *offsetFreq* as defined within the *measObject* corresponding to the frequency of the inter-RAT neighbour cell).

Hys is the hysteresis parameter for this event (i.e. *hysteresis* as defined within *reportConfigInterRAT* for this event).

Thresh1 is the threshold parameter for this event (i.e. *b2-Threshold1* as defined within *reportConfigInterRAT* for this event).

Thresh2 is the threshold parameter for this event (i.e. *b2-Threshold2* as defined within *reportConfigInterRAT* for this event). For CDMA2000, *b2-Threshold2* is divided by -2.

Mp is expressed in dBm in case of RSRP, or in dB in case of RSRQ.

Mn is expressed in dBm or dB, depending on the measurement quantity of the inter-RAT neighbour cell.

Ofn, Hys are expressed in dB.

Thresh1 is expressed in the same unit as **Mp**.

Thresh2 is expressed in the same unit as **Mn**.

5.5.4.9 Event C1 (CSI-RS resource becomes better than threshold)

The UE shall:

1> consider the entering condition for this event to be satisfied when condition C1-1, as specified below, is fulfilled;

1> consider the leaving condition for this event to be satisfied when condition C1-2, as specified below, is fulfilled;

Inequality C1-1 (Entering condition)

$$Mcr + Ocr - Hys > Thresh$$

Inequality C1-2 (Leaving condition)

$$Mcr + Ocr + Hys < Thresh$$

The variables in the formula are defined as follows:

Mcr is the measurement result of the CSI-RS resource, not taking into account any offsets.

Ocr is the CSI-RS specific offset (i.e. *csi-RS-IndividualOffset* as defined within *measObjectEUTRA* corresponding to the frequency of the CSI-RS resource), and set to zero if not configured for the CSI-RS resource.

Hys is the hysteresis parameter for this event (i.e. *hysteresis* as defined within *reportConfigEUTRA* for this event).

Thresh is the threshold parameter for this event (i.e. *c1-Threshold* as defined within *reportConfigEUTRA* for this event).

Mcr, Thresh are expressed in dBm.

Ocr, Hys are expressed in dB.

5.5.4.10 Event C2 (CSI-RS resource becomes offset better than reference CSI-RS resource)

The UE shall:

1> consider the entering condition for this event to be satisfied when condition C2-1, as specified below, is fulfilled;

1> consider the leaving condition for this event to be satisfied when condition C2-2, as specified below, is fulfilled;

NOTE: The CSI-RS resource(s) that triggers the event is on the same frequency as the reference CSI-RS resource, i.e. both are on the frequency indicated in the associated *measObject*.

Inequality C2-1 (Entering condition)

$$Mcr + Ocr - Hys > Mref + Oref + Off$$

Inequality C2-2 (Leaving condition)

$$Mcr + Ocr + Hys < Mref + Oref + Off$$

The variables in the formula are defined as follows:

Mcr is the measurement result of the CSI-RS resource, not taking into account any offsets.

Ocr is the CSI-RS specific offset of the CSI-RS resource (i.e. *csi-RS-IndividualOffset* as defined within *measObjectEUTRA* corresponding to the frequency of the CSI-RS resource), and set to zero if not configured for the CSI-RS resource.

Mref is the measurement result of the reference CSI-RS resource (i.e. *c2-RefCSI-RS* as defined within *reportConfigEUTRA* for this event), not taking into account any offsets.

Oref is the CSI-RS specific offset of the reference CSI-RS resource (i.e. *csi-RS-IndividualOffset* as defined within *measObjectEUTRA* corresponding to the frequency of the reference CSI-RS resource), and is set to zero if not configured for the reference CSI-RS resource.

Hys is the hysteresis parameter for this event (i.e. *hysteresis* as defined within *reportConfigEUTRA* for this event).

Off is the offset parameter for this event (i.e. *c2-Offset* as defined within *reportConfigEUTRA* for this event).

Mcr, **Mref** are expressed in dBm.

Ocr, **Oref**, **Hys**, **Off** are expressed in dB.

5.5.4.11 Event W1 (WLAN becomes better than a threshold)

The UE shall:

1> consider the entering condition for this event to be satisfied when *wlan-MobilitySet* within *VarWLAN-MobilityConfig* does not contain any entries and condition W1-1, as specified below, is fulfilled;

1> consider the leaving condition for this event to be satisfied when condition W1-2, as specified below, is fulfilled;

Inequality W1-1 (Entering condition)

$$Mn - Hys > Thresh$$

Inequality W1-2 (Leaving condition)

$$Mn + Hys < Thresh$$

The variables in the formula are defined as follows:

Mn is the measurement result of WLAN(s) configured in the measurement object, not taking into account any offsets.

Hys is the hysteresis parameter for this event.

Thresh is the threshold parameter for this event (i.e. *w1-Threshold* as defined within *reportConfigInterRAT* for this event).

Mn is expressed in dBm.

Hys is expressed in dB.

Thresh is expressed in the same unit as **Mn**.

5.5.4.12 Event W2 (All WLAN inside WLAN mobility set becomes worse than threshold1 and a WLAN outside WLAN mobility set becomes better than threshold2)

The UE shall:

1> consider the entering condition for this event to be satisfied when both conditions W2-1 and W2-2 as specified below are fulfilled;

1> consider the leaving condition for this event to be satisfied when condition W2-3 or condition W2-4, i.e. at least one of the two, as specified below is fulfilled;

Inequality W2-1 (Entering condition 1)

$$Ms + Hys < Thresh1$$

Inequality W2-2 (Entering condition 2)

$$Mn - Hys > Thresh2$$

Inequality W2-3 (Leaving condition 1)

$$Ms - Hys > Thresh1$$

Inequality W2-4 (Leaving condition 2)

$$Mn + Hys < Thresh2$$

The variables in the formula are defined as follows:

Ms is the measurement result of WLAN(s) which matches all WLAN identifiers of at least one entry within *wlan-MobilitySet* in *VarWLAN-MobilityConfig*, not taking into account any offsets.

Mn is the measurement result of WLAN(s) configured in the measurement object which does not match all WLAN identifiers of any entry within *wlan-MobilitySet* in *VarWLAN-MobilityConfig*, not taking into account any offsets.

Hys is the hysteresis parameter for this event.

Thresh1 is the threshold parameter for this event (i.e. *w2-Threshold1* as defined within *reportConfigInterRAT* for this event).

Thresh2 is the threshold parameter for this event (i.e. *w2-Threshold2* as defined within *reportConfigInterRAT* for this event).

Mn, Ms are expressed in dBm.

Hys is expressed in dB.

Thresh1 is expressed in the same unit as **Ms**.

Thresh2 is expressed in the same unit as **Mn**.

5.5.4.13 Event W3 (All WLAN inside WLAN mobility set becomes worse than a threshold)

The UE shall:

1> consider the entering condition for this event to be satisfied when condition W3-1, as specified below, is fulfilled;

1> consider the leaving condition for this event to be satisfied when condition W3-2, as specified below, is fulfilled;

Inequality W3-1 (Entering condition)

$$Ms + Hys < Thresh$$

Inequality W3-2 (Leaving condition)

$$Ms - Hys > Thresh$$

The variables in the formula are defined as follows:

Ms is the measurement result of WLAN(s) which matches all WLAN identifiers of at least one entry within *wlan-MobilitySet* in *VarWLAN-MobilityConfig*, not taking into account any offsets.

Hys is the hysteresis parameter for this event.

Thresh is the threshold parameter for this event (i.e. *w3-Threshold* as defined within *reportConfigInterRAT* for this event).

Ms is expressed in dBm.

Hys is expressed in dB.

Thresh is expressed in the same unit as ***Ms***.

5.5.4.14 Event V1 (The channel busy ratio is above a threshold)

The UE shall:

- 1> consider the entering condition for this event to be satisfied when condition V1-1, as specified below, is fulfilled;
- 1> consider the leaving condition for this event to be satisfied when condition V1-2, as specified below, is fulfilled;

Inequality V1-1 (Entering condition)

$$Ms - Hys > Thresh$$

Inequality V1-2 (Leaving condition)

$Ms + Hys < Thresh$ The variables in the formula are defined as follows:

Ms is the measurement result of channel busy ratio of the transmission resource pool, not taking into account any offsets.

Hys is the hysteresis parameter for this event (i.e. *hysteresis* as defined within *reportConfigEUTRA* for this event).

Thresh is the threshold parameter for this event (i.e. *v1-Threshold* as defined within *ReportConfigEUTRA*).

Ms is expressed in decimal from 0 to 1 in steps of 0.01.

Hys is expressed in the same unit as ***Ms***.

Thresh is expressed in the same unit as ***Ms***.

5.5.4.15 Event V2 (The channel busy ratio is below a threshold)

The UE shall:

- 1> consider the entering condition for this event to be satisfied when condition V2-1, as specified below, is fulfilled;
- 1> consider the leaving condition for this event to be satisfied when condition V2-2, as specified below, is fulfilled;

Inequality V2-1 (Entering condition)

$$Ms + Hys < Thresh$$

Inequality V2-2 (Leaving condition)

$$Ms - Hys > Thresh$$

The variables in the formula are defined as follows:

Ms is the measurement result of channel busy ratio of the transmission resource pool, not taking into account any offsets.

Hys is the hysteresis parameter for this event (i.e. *hysteresis* as defined within *reportConfigEUTRA* for this event).

Thresh is the threshold parameter for this event (i.e. *v2-Threshold* as defined within *ReportConfigEUTRA*).

Ms is expressed in decimal from 0 to 1 in steps of 0.01.

Hys is expressed is in the same unit as *Ms*.

Thresh is expressed in the same unit as *Ms*.

5.5.5 Measurement reporting

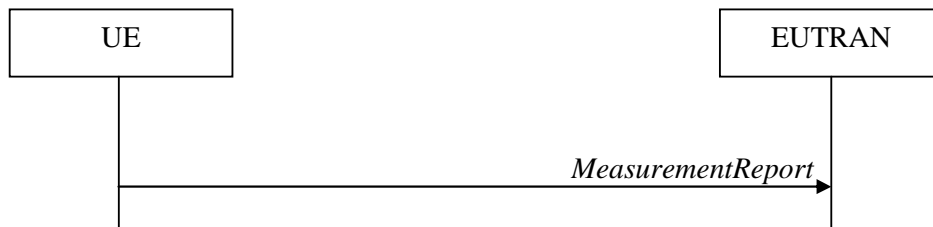

Figure 5.5.5-1: Measurement reporting

The purpose of this procedure is to transfer measurement results from the UE to E-UTRAN. The UE shall initiate this procedure only after successful security activation.

For the *measId* for which the measurement reporting procedure was triggered, the UE shall set the *measResults* within the *MeasurementReport* message as follows:

- 1> set the *measId* to the measurement identity that triggered the measurement reporting;
- 1> set the *measResultPCell* to include the quantities of the PCell;
- 1> set the *measResultServFreqList* to include for each SCell that is configured, if any, within *measResultSCell* the quantities of the concerned SCell, if available according to performance requirements in [16], except if *purpose* for the *reportConfig* associated with the *measId* that triggered the measurement reporting is set to *reportLocation*;
- 1> if the *reportConfig* associated with the *measId* that triggered the measurement reporting includes *reportAddNeighMeas*:
 - 2> for each serving frequency for which *measObjectId* is referenced in the *measIdList*, other than the frequency corresponding with the *measId* that triggered the measurement reporting:
 - 3> set the *measResultServFreqList* to include within *measResultBestNeighCell* the *physCellId* and the quantities of the best non-serving cell, based on RSRP, on the concerned serving frequency;
- 1> if there is at least one applicable neighbouring cell to report:
 - 2> set the *measResultNeighCells* to include the best neighbouring cells up to *maxReportCells* in accordance with the following:
 - 3> if the *triggerType* is set to *event*:
 - 4> include the cells included in the *cellsTriggeredList* as defined within the *VarMeasReportList* for this *measId*;
 - 3> else:
 - 4> include the applicable cells for which the new measurement results became available since the last periodical reporting or since the measurement was initiated or reset;

NOTE 1: The reliability of the report (i.e. the certainty it contains the strongest cells on the concerned frequency) depends on the measurement configuration i.e. the *reportInterval*. The related performance requirements are specified in TS 36.133 [16].

- 3> for each cell that is included in the *measResultNeighCells*, include the *physCellId*;

- 3> if the *triggerType* is set to *event*; or the *purpose* is set to *reportStrongestCells* or to *reportStrongestCellsForSON*:
 - 4> for each included cell, include the layer 3 filtered measured results in accordance with the *reportConfig* for this *measId*, ordered as follows:
 - 5> if the *measObject* associated with this *measId* concerns E-UTRA:
 - 6> set the *measResult* to include the quantity(ies) indicated in the *reportQuantity* within the concerned *reportConfig* in order of decreasing *triggerQuantity*, i.e. the best cell is included first;
 - 5> if the *measObject* associated with this *measId* concerns UTRA FDD and if *ReportConfigInterRAT* includes the *reportQuantityUTRA-FDD*:
 - 6> set the *measResult* to include the quantities indicated by the *reportQuantityUTRA-FDD* in order of decreasing *measQuantityUTRA-FDD* within the *quantityConfig*, i.e. the best cell is included first;
 - 5> if the *measObject* associated with this *measId* concerns UTRA FDD and if *ReportConfigInterRAT* does not include the *reportQuantityUTRA-FDD*; or
 - 5> if the *measObject* associated with this *measId* concerns UTRA TDD, GERAN or CDMA2000:
 - 6> set the *measResult* to the quantity as configured for the concerned RAT within the *quantityConfig* in order of either decreasing quantity for UTRA and GERAN or increasing quantity for CDMA2000 *pilotStrength*, i.e. the best cell is included first;
 - 3> else if the *purpose* is set to *reportCGI*:
 - 4> if the mandatory present fields of the *cgi-Info* for the cell indicated by the *cellForWhichToReportCGI* in the associated *measObject* have been obtained:
 - 5> if the *includeMultiBandInfo* is configured:
 - 6> include the *freqBandIndicator*;
 - 6> if the cell broadcasts the *multiBandInfoList*, include the *multiBandInfoList*;
 - 6> if the cell broadcasts the *freqBandIndicatorPriority*, include the *freqBandIndicatorPriority*;
 - 5> if the cell broadcasts a CSG identity:
 - 6> include the *csg-Identity*;
 - 6> include the *csg-MemberStatus* and set it to *member* if the cell is a CSG member cell;
 - 5> if the *si-RequestForHO* is configured within the *reportConfig* associated with this *measId*:
 - 6> include the *cgi-Info* containing all the fields other than the *plmn-IdentityList* that have been successfully acquired;
 - 6> include, within the *cgi-Info*, the field *plmn-IdentityList* in accordance with the following:
 - 7> if the cell is a CSG member cell, determine the subset of the PLMN identities, starting from the second entry of PLMN identities in the broadcast information, that meet the following conditions:
 - a) equal to the RPLMN or an EPLMN; and
 - b) the CSG whitelist of the UE includes an entry comprising of the concerned PLMN identity and the CSG identity broadcast by the cell;
 - 7> if the subset of PLMN identities determined according to the previous includes at least one PLMN identity, include the *plmn-IdentityList* and set it to include this subset of the PLMN identities;

- 7> if the cell is a CSG member cell, include the *primaryPLMN-Suitable* if the primary PLMN meets conditions a) and b) specified above;
 - 7> if the cell does not broadcast *csg-Identity* and the UE is capable of reporting the *plmn-IdentityList* from cells not broadcasting *csg-Identity*:
 - 8> include in the *plmn-IdentityList* the list of identities starting from the second entry of PLMN identities in the broadcast information;
 - 5> else:
 - 6> include the *cgi-Info* containing all the fields that have been successfully acquired and in accordance with the following:
 - 7> include in the *plmn-IdentityList* the list of identities starting from the second entry of PLMN Identities in the broadcast information;
 - 1> for the cells included according to the previous (i.e. covering the PCell, the SCells, the best non-serving cells on serving frequencies as well as neighbouring EUTRA cells) include results according to the extended RSRQ if corresponding results are available according to the associated performance requirements defined in 36.133 [16];
 - 1> if there is at least one applicable CSI-RS resource to report:
 - 2> set the *measResultCSI-RS-List* to include the best CSI-RS resources up to *maxReportCells* in accordance with the following:
 - 3> if the *triggerType* is set to *event*:
 - 4> include the CSI-RS resources included in the *csi-RS-TriggeredList* as defined within the *VarMeasReportList* for this *measId*;
 - 3> else:
 - 4> include the applicable CSI-RS resources for which the new measurement results became available since the last periodical reporting or since the measurement was initiated or reset;
- NOTE 2: The reliability of the report (i.e. the certainty it contains the strongest CSI-RS resources on the concerned frequency) depends on the measurement configuration i.e. the *reportInterval*. The related performance requirements are specified in TS 36.133 [16].
- 3> for each CSI-RS resource that is included in the *measResultCSI-RS-List*:
 - 4> include the *measCSI-RS-Id*;
 - 4> include the layer 3 filtered measured results in accordance with the *reportConfig* for this *measId*, ordered as follow:
 - 5> set the *csi-RSRP-Result* to include the quantity indicated in the *reportQuantity* within the concerned *reportConfig* in order of decreasing *triggerQuantityCSI-RS*, i.e. the best CSI-RS resource is included first;
 - 4> if *reportCRS-Meas* is included within the associated *reportConfig*, and the cell indicated by *physCellId* of this CSI-RS resource is not a serving cell:
 - 5> set the *measResultNeighCells* to include the cell indicated by *physCellId* of this CSI-RS resource, and include the *physCellId*;
 - 5> set the *rsrpResult* to include the RSRP of the concerned cell, if available according to performance requirements in [16];
 - 5> set the *rsrqResult* to include the RSRQ of the concerned cell, if available according to performance requirements in [16];
 - 1> if the *ue-RxTxTimeDiffPeriodical* is configured within the corresponding *reportConfig* for this *measId*;
 - 2> set the *ue-RxTxTimeDiffResult* to the measurement result provided by lower layers;

- 2> set the *currentSFN*;
- 1> if the *measRSSI-ReportConfig* is configured within the corresponding *reportConfig* for this *measId*:
 - 2> set the *rsi-Result* to the average of sample value(s) provided by lower layers in the *reportInterval*;
 - 2> set the *channelOccupancy* to the rounded percentage of sample values which are beyond to the *channelOccupancyThreshold* within all the sample values in the *reportInterval*;
- 1> if uplink PDCP delay results are available:
 - 2> set the *ul-PDCP-DelayResultList* to include the uplink PDCP delay results available;
- 1> if the *includeLocationInfo* is configured in the corresponding *reportConfig* for this *measId* or if *purpose* for the *reportConfig* associated with the *measId* that triggered the measurement reporting is set to *reportLocation*; and detailed location information that has not been reported is available, set the content of the *locationInfo* as follows:
 - 2> include the *locationCoordinates*;
 - 2> if available, include the *gnss-TOD-msec*, except if *purpose* for the *reportConfig* associated with the *measId* that triggered the measurement reporting is set to *reportLocation*;
- 1> if the *reportSSTD-Meas* is set to *true* within the corresponding *reportConfig* for this *measId*:
 - 2> set the *measResultSSTD* to the measurement results provided by lower layers;
- 1> if there is at least one applicable transmission resource pool to report:
 - 2> set the *measResultListCBR* to include the CBR measurement results in accordance with the following:
 - 3> if the *triggerType* is set to *event*:
 - 4> include the transmission resource pools included in the *poolsTriggeredList* as defined within the *VarMeasReportList* for this *measId*;
 - 3> else:
 - 4> include the applicable transmission resource pools for which the new measurement results became available since the last periodical reporting or since the measurement was initiated or reset;
 - 3> for each transmission resource pool to be reported:
 - 4> set the *poolIdentity* to the *poolReportId* of this transmission resource pool;
 - 4> if *adjacencyPSSCH-PSSCH* is set to *TRUE* for this transmission resource pool:
 - 5> set the *cbr-PSSCH* to the CBR measurement result on PSSCH and PSCCH of this transmission resource pool provided by lower layers;
 - 4> else:
 - 5> set the *cbr-PSSCH* to the CBR measurement result on PSSCH of this transmission resource pool provided by lower layers if available;
 - 5> set the *cbr-PSCCH* to the CBR measurement result on PSCCH of this transmission resource pool provided by lower layers if available;
- 1> increment the *numberOfReportsSent* as defined within the *VarMeasReportList* for this *measId* by 1;
- 1> stop the periodical reporting timer, if running;
- 1> if the *numberOfReportsSent* as defined within the *VarMeasReportList* for this *measId* is less than the *reportAmount* as defined within the corresponding *reportConfig* for this *measId*:
 - 2> start the periodical reporting timer with the value of *reportInterval* as defined within the corresponding *reportConfig* for this *measId*;

1> else:

2> if the *triggerType* is set to *periodical*:

3> remove the entry within the *VarMeasReportList* for this *measId*;

3> remove this *measId* from the *measIdList* within *VarMeasConfig*;

1> if the measured results are for CDMA2000 HRPD:

2> set the *preRegistrationStatusHRPD* to the UE's CDMA2000 upper layer's HRPD *preRegistrationStatus*;

1> if the measured results are for CDMA2000 1xRTT:

2> set the *preRegistrationStatusHRPD* to *FALSE*;

1> if the measured results are for WLAN:

2> set the *measResultListWLAN* to include the quantities within the *quantityConfigWLAN* for up to *maxReportCells* WLAN(s), determined according to the following:

3> include WLAN the UE is connected to, if any;

3> if *reportAnyWLAN* is set to *TRUE*:

4> consider WLAN with any WLAN identifiers to be applicable for measurement reporting;

3> else:

4> consider only WLANs which do not match all WLAN identifiers of any entry within *wlan-MobilitySet* in *VarWLAN-MobilityConfig* to be applicable for measurement reporting;

3> include applicable WLAN in order of decreasing WLAN RSSI, i.e. the best WLAN is included first;

2> for each included WLAN:

3> set *wlan-Identifiers* to include all WLAN identifiers that can be acquired for the WLAN measured;

3> set *connectedWLAN* to *TRUE* if the UE is connected to the WLAN measured;

3> if *reportQuantityWLAN* exists within the *ReportConfigInterRAT* within the *VarMeasConfig* for this *measId*:

4> if *bandRequestWLAN* is set to *TRUE*:

5> set *bandWLAN* to include WLAN band of the WLAN measured;

4> if *carrierInfoRequestWLAN* is set to *TRUE*:

5> set *carrierInfoWLAN* to include WLAN carrier information of the WLAN measured if it can be acquired;

4> if *availableAdmissionCapacityRequestWLAN* is set to *TRUE*:

5> set the *measResult* to include *availableAdmissionCapacityWLAN* if it can be acquired;

4> if *backhaulDL-BandwidthRequestWLAN* is set to *TRUE*:

5> set the *measResult* to include *backhaulDL-BandwidthWLAN* if it can be acquired;

4> if *backhaulUL-BandwidthRequestWLAN* is set to *TRUE*:

5> set the *measResult* to include *backhaulUL-BandwidthWLAN* if it can be acquired;

4> if *channelUtilizationRequestWLAN* is set to *TRUE*:

5> set the *measResult* to include *channelUtilizationWLAN* if it can be acquired;

4> if *stationCountRequestWLAN* is set to *TRUE*:

5> set the *measResult* to include *stationCountWLAN* if it can be acquired;

1> submit the *MeasurementReport* message to lower layers for transmission, upon which the procedure ends;

5.5.6 Measurement related actions

5.5.6.1 Actions upon handover and re-establishment

E-UTRAN applies the handover procedure as follows:

- when performing the handover procedure, as specified in 5.3.5.4, ensure that a *measObjectId* corresponding to each handover target serving frequency is configured as a result of the procedures described in this clause and in 5.3.5.4;
- when changing the band while the physical frequency remains unchanged, E-UTRAN releases the *measObject* corresponding to the source frequency and adds a *measObject* corresponding to the target frequency (i.e. it does not reconfigure the *measObject*);

E-UTRAN applies the re-establishment procedure as follows:

- when performing the connection re-establishment procedure, as specified in 5.3.7, ensure that a *measObjectId* corresponding each target serving frequency is configured as a result of the procedure described in this clause and the subsequent connection reconfiguration procedure immediately following the re-establishment procedure;
- in the first reconfiguration following the re-establishment when changing the band while the physical frequency remains unchanged, E-UTRAN releases the *measObject* corresponding to the source frequency and adds a *measObject* corresponding to the target frequency (i.e. it does not reconfigure the *measObject*);

The UE shall:

- 1> for each *measId* included in the *measIdList* within *VarMeasConfig*:
 - 2> if the *triggerType* is set to *periodical*:
 - 3> remove this *measId* from the *measIdList* within *VarMeasConfig*;
- 1> if the procedure was triggered due to a handover or successful re-establishment and the procedure involves a change of primary frequency, update the *measId* values in the *measIdList* within *VarMeasConfig* as follows:
 - 2> if a *measObjectId* value corresponding to the target primary frequency exists in the *measObjectList* within *VarMeasConfig*:
 - 3> for each *measId* value in the *measIdList*:
 - 4> if the *measId* value is linked to the *measObjectId* value corresponding to the source primary frequency:
 - 5> link this *measId* value to the *measObjectId* value corresponding to the target primary frequency;
 - 4> else if the *measId* value is linked to the *measObjectId* value corresponding to the target primary frequency:
 - 5> link this *measId* value to the *measObjectId* value corresponding to the source primary frequency;
 - 2> else:
 - 3> remove all *measId* values that are linked to the *measObjectId* value corresponding to the source primary frequency;
- 1> remove all measurement reporting entries within *VarMeasReportList*;
- 1> stop the periodical reporting timer or timer T321, whichever one is running, as well as associated information (e.g. *timeToTrigger*) for all *measId*;
- 1> release the measurement gaps, if activated;

NOTE: If the UE requires measurement gaps to perform inter-frequency or inter-RAT measurements, the UE resumes the inter-frequency and inter-RAT measurements after the E-UTRAN has setup the measurement gaps.

5.5.6.2 Speed dependant scaling of measurement related parameters

The UE shall adjust the value of the following parameter configured by the E-UTRAN depending on the UE speed: *timeToTrigger*. The UE shall apply 3 different levels, which are selected as follows:

The UE shall:

- 1> perform mobility state detection using the mobility state detection as specified in TS 36.304 [4] with the following modifications:
 - 2> counting handovers instead of cell reselections;
 - 2> applying the parameter applicable for RRC_CONNECTED as included in *speedStatePars* within *VarMeasConfig*;
- 1> if high mobility state is detected:
 - 2> use the *timeToTrigger* value multiplied by *sf-High* within *VarMeasConfig*;
- 1> else if medium mobility state is detected:
 - 2> use the *timeToTrigger* value multiplied by *sf-Medium* within *VarMeasConfig*;
- 1> else:
 - 2> no scaling is applied;

5.5.7 Inter-frequency RSTD measurement indication

5.5.7.1 General

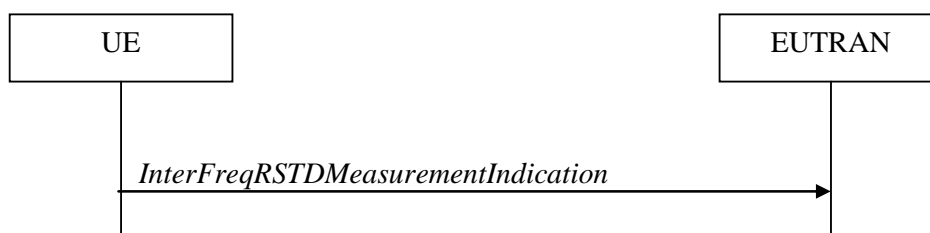

Figure 5.5.7.1-1: Inter-frequency RSTD measurement indication

The purpose of this procedure is to indicate to the network that the UE is going to start/stop OTDOA inter-frequency RSTD measurements which require measurement gaps as specified in [16, 8.1.2.6]. The procedure is also used to indicate to the network that the UE is going to start/stop OTDOA intra-frequency RSTD measurements which require measurement gaps.

NOTE: It is a network decision to configure the measurement gap.

5.5.7.2 Initiation

The UE shall:

- 1> if and only if upper layers indicate to start performing inter-frequency RSTD measurements and the UE requires measurement gaps for these measurements while measurement gaps are either not configured or not sufficient:
 - 2> initiate the procedure to indicate start;

NOTE 1: The UE verifies the measurement gap situation only upon receiving the indication from upper layers. If at this point in time sufficient gaps are available, the UE does not initiate the procedure. Unless it receives a new indication from upper layers, the UE is only allowed to further repeat the procedure in the same PCell once per frequency if the provided measurement gaps are insufficient.

1> if and only if upper layers indicate to stop performing inter-frequency RSTD measurements:

2> initiate the procedure to indicate stop;

NOTE 2: The UE may initiate the procedure to indicate stop even if it did not previously initiate the procedure to indicate start.

5.5.7.3 Actions related to transmission of *InterFreqRSTDMeasurementIndication* message

The UE shall set the contents of *InterFreqRSTDMeasurementIndication* message as follows:

1> if the procedure is initiated to indicate start or stop of inter-frequency RSTD measurements:

2> set the *rstd-InterFreqIndication* as follows:

3> if the procedure is initiated to indicate start of inter-frequency RSTD measurements:

4> set the *rstd-InterFreqInfoList* according to the information received from upper layers;

3> else if the procedure is initiated to indicate stop of inter-frequency RSTD measurements:

4> set the *rstd-InterFreqIndication* to the value *stop*;

1> else:

2> set the *rstd-InterFreqIndication* as follows:

3> if the procedure is initiated to indicate start of intra-frequency RSTD measurements:

4> set the *carrierFreq* in the *rstd-InterFreqInfoList* to the carrier frequency of the serving cell;

3> else if the procedure is initiated to indicate stop of intra-frequency RSTD measurements:

4> set the *rstd-InterFreqIndication* to the value *stop*;

1> submit the *InterFreqRSTDMeasurementIndication* message to lower layers for transmission, upon which the procedure ends;

5.6 Other

5.6.0 General

For NB-IoT, only a subset of the procedures described in this clause apply.

Table 5.6.0-1 specifies the procedures that are applicable to NB-IoT. All other procedures are not applicable to NB-IoT; this is not further stated in the corresponding procedures.

Table 5.6.0-1: "Other" Procedures applicable to a NB-IoT UE

Clause	Procedures
5.6.1	DL information transfer
5.6.2	UL information transfer
5.6.3	UE Capability transfer

5.6.1 DL information transfer

5.6.1.1 General

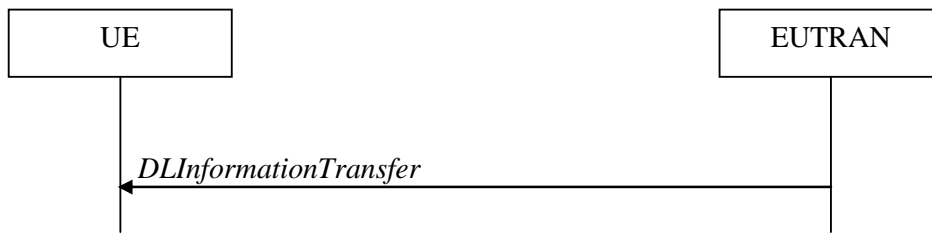

Figure 5.6.1.1-1: DL information transfer

The purpose of this procedure is to transfer NAS or (tunnelled) non-3GPP dedicated information from E-UTRAN to a UE in RRC_CONNECTED.

5.6.1.2 Initiation

E-UTRAN initiates the DL information transfer procedure whenever there is a need to transfer NAS or non-3GPP dedicated information. E-UTRAN initiates the DL information transfer procedure by sending the *DLInformationTransfer* message.

5.6.1.3 Reception of the *DLInformationTransfer* by the UE

Upon receiving *DLInformationTransfer* message, the UE shall:

- 1> if the UE is a NB-IoT UE; or
- 1> if the *dedicatedInfoType* is set to *dedicatedInfoNAS*:
 - 2> forward the *dedicatedInfoNAS* to the NAS upper layers.
- 1> if the *dedicatedInfoType* is set to *dedicatedInfoCDMA2000-1XRTT* or to *dedicatedInfoCDMA2000-HRPD*:
 - 2> forward the *dedicatedInfoCDMA2000* to the CDMA2000 upper layers;

5.6.2 UL information transfer

5.6.2.1 General



Figure 5.6.2.1-1: UL information transfer

The purpose of this procedure is to transfer NAS or (tunnelled) non-3GPP dedicated information from the UE to E-UTRAN.

5.6.2.2 Initiation

A UE in RRC_CONNECTED initiates the UL information transfer procedure whenever there is a need to transfer NAS or non-3GPP dedicated information, except at RRC connection establishment or resume in which case the NAS information is piggybacked to the *RRCConnectionSetupComplete* or *RRCConnectionResumeComplete* message

correspondingly. The UE initiates the UL information transfer procedure by sending the *ULInformationTransfer* message. When CDMA2000 information has to be transferred, the UE shall initiate the procedure only if SRB2 is established.

5.6.2.3 Actions related to transmission of *ULInformationTransfer* message

The UE shall set the contents of the *ULInformationTransfer* message as follows:

- 1> if there is a need to transfer NAS information:
 - 2> if the UE is a NB-IoT UE:
 - 3> set the *dedicatedInfoNAS* to include the information received from upper layers;
 - 2> else, set the *dedicatedInfoType* to include the *dedicatedInfoNAS*;
- 1> if there is a need to transfer CDMA2000 1XRTT information:
 - 2> set the *dedicatedInfoType* to include the *dedicatedInfoCDMA2000-1XRTT*;
- 1> if there is a need to transfer CDMA2000 HRPD information:
 - 2> set the *dedicatedInfoType* to include the *dedicatedInfoCDMA2000-HRPD*;
- 1> upon RRC connection establishment, if UE supports the Control Plane CIoT EPS optimisation and UE does not need UL gaps during continuous uplink transmission:
 - 2> configure lower layers to stop using UL gaps during continuous uplink transmission in FDD for *ULInformationTransfer* message and subsequent uplink transmission in RRC_CONNECTED except for UL transmissions as specified in TS36.211 [21];
- 1> submit the *ULInformationTransfer* message to lower layers for transmission, upon which the procedure ends;

5.6.2.4 Failure to deliver *ULInformationTransfer* message

The UE shall:

- 1> if the UE is a NB-IoT UE, AS security is not started and radio link failure occurs before the successful delivery of *ULInformationTransfer* messages has been confirmed by lower layers; or
- 1> if mobility (i.e. handover, RRC connection re-establishment) occurs before the successful delivery of *ULInformationTransfer* messages has been confirmed by lower layers:
 - 2> inform upper layers about the possible failure to deliver the information contained in the concerned *ULInformationTransfer* messages;

5.6.3 UE capability transfer

5.6.3.1 General

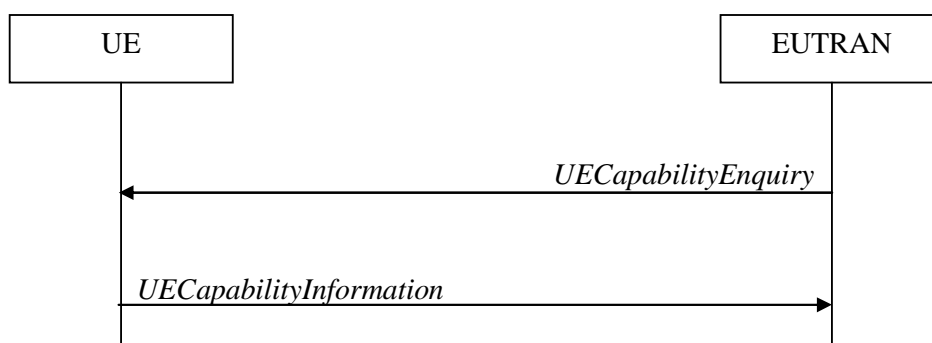

Figure 5.6.3.1-1: UE capability transfer

The purpose of this procedure is to transfer UE radio access capability information from the UE to E-UTRAN.

If the UE has changed its E-UTRAN radio access capabilities, the UE shall request higher layers to initiate the necessary NAS procedures (see TS 23.401 [41]) that would result in the update of UE radio access capabilities using a new RRC connection.

NOTE: Change of the UE's GERAN UE radio capabilities in RRC_IDLE is supported by use of Tracking Area Update.

5.6.3.2 Initiation

E-UTRAN initiates the procedure to a UE in RRC_CONNECTED when it needs (additional) UE radio access capability information.

5.6.3.3 Reception of the *UECapabilityEnquiry* by the UE

The UE shall:

- 1> for NB-IoT, set the contents of *UECapabilityInformation* message as follows:
 - 2> include the UE Radio Access Capability Parameters within the *ue-Capability-Container*;
 - 2> include *ue-RadioPagingInfo*;
 - 2> submit the *UECapabilityInformation* message to lower layers for transmission, upon which the procedure ends;
- 1> else, set the contents of *UECapabilityInformation* message as follows:
 - 2> if the *ue-CapabilityRequest* includes *eutra*:
 - 3> include the *UE-EUTRA-Capability* within a *ue-CapabilityRAT-Container* and with the *rat-Type* set to *eutra*;
 - 3> if the UE supports FDD and TDD:
 - 4> set all fields of *UECapabilityInformation*, except field *fdd-Add-UE-EUTRA-Capabilities* and *tdd-Add-UE-EUTRA-Capabilities* (including their sub-fields), to include the values applicable for both FDD and TDD (i.e. functionality supported by both modes);
 - 4> if (some of) the UE capability fields have a different value for FDD and TDD:
 - 5> if for FDD, the UE supports additional functionality compared to what is indicated by the previous fields of *UECapabilityInformation*:
 - 6> include field *fdd-Add-UE-EUTRA-Capabilities* and set it to include fields reflecting the additional functionality applicable for FDD;
 - 5> if for TDD, the UE supports additional functionality compared to what is indicated by the previous fields of *UECapabilityInformation*:
 - 6> include field *tdd-Add-UE-EUTRA-Capabilities* and set it to include fields reflecting the additional functionality applicable for TDD;

NOTE 1: The UE includes fields of *XDD-Add-UE-EUTRA-Capabilities* in accordance with the following:

- The field is included only if one or more of its sub-fields (or bits in the feature group indicators string) has a value that is different compared to the value signalled elsewhere within *UE-EUTRA-Capability*; (this value signalled elsewhere is also referred to as the *Common value*, that is supported for both XDD modes)
- For the fields that are included in *XDD-Add-UE-EUTRA-Capabilities*, the UE sets:
 - the sub-fields (or bits in the feature group indicators string) that are not allowed to be different to the same value as the *Common value*;

- the sub-fields (or bits in the feature group indicators string) that are allowed to be different to a value indicating at least the same functionality as indicated by the *Common value*;
- 3> else (UE supports single xDD mode):
- 4> set all fields of *UECapabilityInformation*, except field *fdd-Add-UE-EUTRA-Capabilities* and *tdd-Add-UE-EUTRA-Capabilities* (including their sub-fields), to include the values applicable for the xDD mode supported by the UE;
- 3> compile a list of band combinations, candidate for inclusion in the *UECapabilityInformation* message, comprising of band combinations supported by the UE according to the following priority order (i.e. listed in order of decreasing priority):
- 4> include all non-CA bands, regardless of whether UE supports carrier aggregation, only:
 - if the UE includes *ue-Category-v1020* (i.e. indicating category 6 to 8); or
 - if for at least one of the non-CA bands, the UE supports more MIMO layers with TM9 and TM10 than implied by the UE category; or
 - if the UE supports TM10 with one or more CSI processes;
 - 4> if the *UECapabilityEnquiry* message includes *requestedFrequencyBands* and UE supports *requestedFrequencyBands*:
 - 5> include all 2DL+1UL CA band combinations, only consisting of bands included in *requestedFrequencyBands*;
 - 5> include all other CA band combinations, only consisting of bands included in *requestedFrequencyBands*, and prioritized in the order of *requestedFrequencyBands*, (i.e. first include remaining band combinations containing the first-listed band, then include remaining band combinations containing the second-listed band, and so on);
 - 4> else (no requested frequency bands):
 - 5> include all 2DL+1UL CA band combinations;
 - 5> include all other CA band combinations;
 - 4> if UE supports *maximumCCsRetrieval* and if the *UECapabilityEnquiry* message includes the *requestedMaxCCsDL* and the *requestedMaxCCsUL* (i.e. both UL and DL maximums are given):
 - 5> remove from the list of candidates the band combinations for which the number of CCs in DL exceeds the value indicated in the *requestedMaxCCsDL* or for which the number of CCs in UL exceeds the value indicated in the *requestedMaxCCsUL*;
 - 5> indicate in *requestedCCsUL* the same value as received in *requestedMaxCCsUL*;
 - 5> indicate in *requestedCCsDL* the same value as received in *requestedMaxCCsDL*;
 - 4> else if UE supports *maximumCCsRetrieval* and if the *UECapabilityEnquiry* message includes the *requestedMaxCCsDL* (i.e. only DL maximum limit is given):
 - 5> remove from the list of candidates the band combinations for which the number of CCs in DL exceeds the value indicated in the *requestedMaxCCsDL*;
 - 5> indicate value in *requestedCCsDL* the same value as received in *requestedMaxCCsDL*;
 - 4> else if UE supports *maximumCCsRetrieval* and if the *UECapabilityEnquiry* message includes the *requestedMaxCCsUL* (i.e. only UL maximum limit is given):
 - 5> remove from the list of candidates the band combinations for which the number of CCs in UL exceeds the value indicated in the *requestedMaxCCsUL*;
 - 5> indicate in *requestedCCsUL* the same value as received in *requestedMaxCCsUL*;

- 4> if the UE supports *reducedIntNonContComb* and the *UECapabilityEnquiry* message includes *requestReducedIntNonContComb*:
 - 5> set *reducedIntNonContCombRequested* to true;
 - 5> remove from the list of candidates the intra-band non-contiguous CA band combinations which support is implied by another intra-band non-contiguous CA band combination included in the list of candidates as specified in TS 36.306 [5, 4.3.5.21]:
- 4> if the UE supports *requestReducedFormat* and UE supports *skipFallbackCombinations* and *UECapabilityEnquiry* message includes *requestSkipFallbackComb*:
 - 5> set *skipFallbackCombRequested* to true;
 - 5> for each band combination included in the list of candidates (including 2DL+1UL CA band combinations), starting with the ones with the lowest number of DL and UL carriers, that concerns a fallback band combination of another band combination included in the list of candidates as specified in TS 36.306 [5]:
 - 6> remove the band combination from the list of candidates;
 - 6> include *differentFallbackSupported* in the band combination included in the list of candidates whose fallback concerns the removed band combination, if its capabilities differ from the removed band combination;
- 4> if the UE supports *requestReducedFormat* and *diffFallbackCombReport*, and *UECapabilityEnquiry* message includes *requestDiffFallbackCombList*:
 - 5> if the UE does not support *skipFallbackCombinations* or *UECapabilityEnquiry* message does not include *requestSkipFallbackComb*:
 - 6> remove all band combination from the list of candidates;
 - 5> for each CA band combination indicated in *requestDiffFallbackCombList*:
 - 6> include the CA band combination, if not already in the list of candidates;
 - 6> include the fallback combinations for which the supported UE capabilities are different from the capability of the CA band combination;
 - 5> include CA band combinations indicated in *requestDiffFallbackCombList* into *requestedDiffFallbackCombList*;
- 3> if the *UECapabilityEnquiry* message includes *requestReducedFormat* and UE supports *requestReducedFormat*:
 - 4> include in *supportedBandCombinationReduced* as many as possible of the band combinations included in the list of candidates, including the non-CA combinations, determined according to the rules and priority order defined above;
- 3> else
 - 4> if the *UECapabilityEnquiry* message includes *requestedFrequencyBands* and UE supports *requestedFrequencyBands*:
 - 5> include in *supportedBandCombination* as many as possible of the band combinations included in the list of candidates, including the non-CA combinations and up to 5DL+5UL CA band combinations, determined according to the rules and priority order defined above;
 - 5> include in *supportedBandCombinationAdd* as many as possible of the remaining band combinations included in the list of candidates, (i.e. the candidates not included in *supportedBandCombination*), up to 5DL+5UL CA band combinations, determined according to the rules and priority order defined above;
 - 4> else

- 5> include in *supportedBandCombination* as many as possible of the band combinations included in the list of candidates, including the non-CA combinations and up to 5DL+5UL CA band combinations, determined according to the rules defined above;
- 5> if it is not possible to include in *supportedBandCombination* all the band combinations to be included according to the above, selection of the subset of band combinations to be included is left up to UE implementation;
- 3> indicate in *requestedBands* the same bands and in the same order as included in *requestedFrequencyBands*, if received;
- 3> if the UE is a category 0, M1 or M2 UE, or supports any UE capability information in *ue-RadioPagingInfo*, according to TS 36.306 [5]:
 - 4> include *ue-RadioPagingInfo* and set the fields according to TS 36.306 [5];
- 2> if the *ue-CapabilityRequest* includes *geran-cs* and if the UE supports GERAN CS domain:
 - 3> include the UE radio access capabilities for GERAN CS within a *ue-CapabilityRAT-Container* and with the *rat-Type* set to *geran-cs*;
- 2> if the *ue-CapabilityRequest* includes *geran-ps* and if the UE supports GERAN PS domain:
 - 3> include the UE radio access capabilities for GERAN PS within a *ue-CapabilityRAT-Container* and with the *rat-Type* set to *geran-ps*;
- 2> if the *ue-CapabilityRequest* includes *utra* and if the UE supports UTRA:
 - 3> include the UE radio access capabilities for UTRA within a *ue-CapabilityRAT-Container* and with the *rat-Type* set to *utra*;
- 2> if the *ue-CapabilityRequest* includes *cdma2000-1XRTT* and if the UE supports CDMA2000 1xRTT:
 - 3> include the UE radio access capabilities for CDMA2000 within a *ue-CapabilityRAT-Container* and with the *rat-Type* set to *cdma2000-1XRTT*;
- 1> submit the *UECapabilityInformation* message to lower layers for transmission, upon which the procedure ends;

5.6.4 CSFB to 1x Parameter transfer

5.6.4.1 General

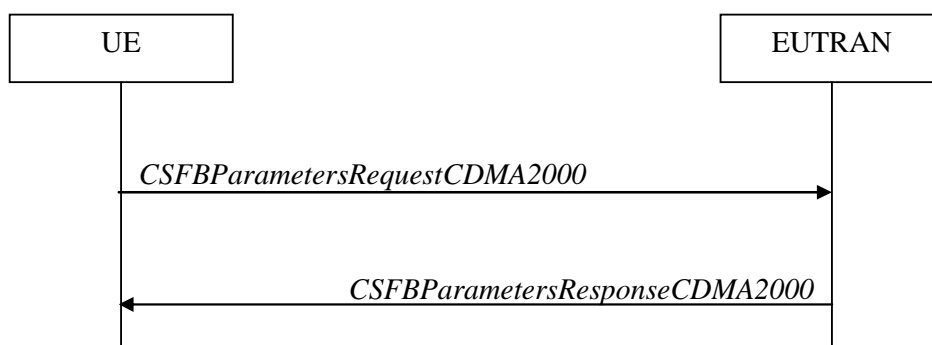

Figure 5.6.4.1-1: CSFB to 1x Parameter transfer

The purpose of this procedure is to transfer the CDMA2000 1xRTT parameters required to register the UE in the CDMA2000 1xRTT network for CSFB support.

5.6.4.2 Initiation

A UE in RRC_CONNECTED initiates the CSFB to 1x parameter transfer procedure upon request from the CDMA2000 upper layers. The UE initiates the CSFB to 1x parameter transfer procedure by sending the *CSFBParametersRequestCDMA2000* message.

5.6.4.3 Actions related to transmission of *CSFBParametersRequestCDMA2000* message

The UE shall:

- 1> submit the *CSFBParametersRequestCDMA2000* message to lower layers for transmission using the current configuration;

5.6.4.4 Reception of the *CSFBParametersResponseCDMA2000* message

Upon reception of the *CSFBParametersResponseCDMA2000* message, the UE shall:

- 1> forward the *rand* and the *mobilityParameters* to the CDMA2000 1xRTT upper layers;

5.6.5 UE Information

5.6.5.1 General

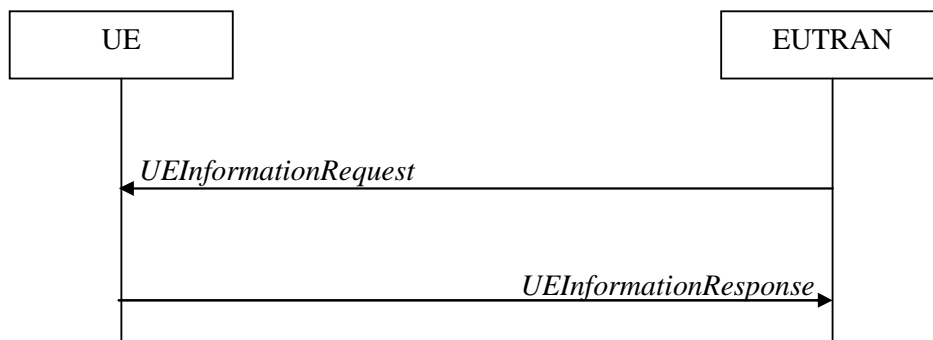

Figure 5.6.5.1-1: UE information procedure

The UE information procedure is used by E-UTRAN to request the UE to report information.

5.6.5.2 Initiation

E-UTRAN initiates the procedure by sending the *UEInformationRequest* message. E-UTRAN should initiate this procedure only after successful security activation.

5.6.5.3 Reception of the *UEInformationRequest* message

Upon receiving the *UEInformationRequest* message, the UE shall, only after successful security activation:

- 1> if *rach-ReportReq* is set to *true*, set the contents of the *rach-Report* in the *UEInformationResponse* message as follows:
 - 2> set the *numberOfPreamblesSent* to indicate the number of preambles sent by MAC for the last successfully completed random access procedure;
 - 2> if contention resolution was not successful as specified in TS 36.321 [6] for at least one of the transmitted preambles for the last successfully completed random access procedure:
 - 3> set the *contentionDetected* to *true*;
 - 2> else:
 - 3> set the *contentionDetected* to *false*;

- 1> if *rlf-ReportReq* is set to *true* and the UE has radio link failure information or handover failure information available in *VarRLF-Report* and if the RPLMN is included in *plmn-IdentityList* stored in *VarRLF-Report*:
 - 2> set *timeSinceFailure* in *VarRLF-Report* to the time that elapsed since the last radio link or handover failure in E-UTRA;
 - 2> set the *rlf-Report* in the *UEInformationResponse* message to the value of *rlf-Report* in *VarRLF-Report*;
 - 2> discard the *rlf-Report* from *VarRLF-Report* upon successful delivery of the *UEInformationResponse* message confirmed by lower layers;
- 1> if *connEstFailReportReq* is set to *true* and the UE has connection establishment failure information in *VarConnEstFailReport* and if the RPLMN is equal to *plmn-Identity* stored in *VarConnEstFailReport*:
 - 2> set *timeSinceFailure* in *VarConnEstFailReport* to the time that elapsed since the last connection establishment failure in E-UTRA;
 - 2> set the *connEstFailReport* in the *UEInformationResponse* message to the value of *connEstFailReport* in *VarConnEstFailReport*;
 - 2> discard the *connEstFailReport* from *VarConnEstFailReport* upon successful delivery of the *UEInformationResponse* message confirmed by lower layers;
- 1> if the *logMeasReportReq* is present and if the RPLMN is included in *plmn-IdentityList* stored in *VarLogMeasReport*:
 - 2> if *VarLogMeasReport* includes one or more logged measurement entries, set the contents of the *logMeasReport* in the *UEInformationResponse* message as follows:
 - 3> include the *absoluteTimeStamp* and set it to the value of *absoluteTimeInfo* in the *VarLogMeasReport*;
 - 3> include the *traceReference* and set it to the value of *traceReference* in the *VarLogMeasReport*;
 - 3> include the *traceRecordingSessionRef* and set it to the value of *traceRecordingSessionRef* in the *VarLogMeasReport*;
 - 3> include the *tce-Id* and set it to the value of *tce-Id* in the *VarLogMeasReport*;
 - 3> include the *logMeasInfoList* and set it to include one or more entries from *VarLogMeasReport* starting from the entries logged first;
 - 3> if the *VarLogMeasReport* includes one or more additional logged measurement entries that are not included in the *logMeasInfoList* within the *UEInformationResponse* message:
 - 4> include the *logMeasAvailable*;
- 1> if *mobilityHistoryReportReq* is set to *true*:
 - 2> include the *mobilityHistoryReport* and set it to include entries from *VarMobilityHistoryReport*;
 - 2> include in the *mobilityHistoryReport* an entry for the current cell, possibly after removing the oldest entry if required, and set its fields as follows:
 - 3> set *visitedCellId* to the global cell identity of the current cell;
 - 3> set field *timeSpent* to the time spent in the current cell;
- 1> if the *logMeasReport* is included in the *UEInformationResponse*:
 - 2> submit the *UEInformationResponse* message to lower layers for transmission via SRB2;
 - 2> discard the logged measurement entries included in the *logMeasInfoList* from *VarLogMeasReport* upon successful delivery of the *UEInformationResponse* message confirmed by lower layers;
- 1> else:
 - 2> submit the *UEInformationResponse* message to lower layers for transmission via SRB1;

5.6.6 Logged Measurement Configuration

5.6.6.1 General

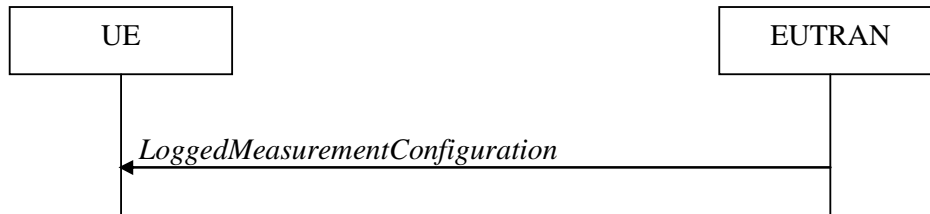

Figure 5.6.6.1-1: Logged measurement configuration

The purpose of this procedure is to configure the UE to perform logging of measurement results while in RRC_IDLE and to perform logging of measurement results for MBSFN in both RRC_IDLE and RRC_CONNECTED. The procedure applies to logged measurements capable UEs that are in RRC_CONNECTED.

NOTE: E-UTRAN may retrieve stored logged measurement information by means of the UE information procedure.

5.6.6.2 Initiation

E-UTRAN initiates the logged measurement configuration procedure to UE in RRC_CONNECTED by sending the *LoggedMeasurementConfiguration* message.

5.6.6.3 Reception of the *LoggedMeasurementConfiguration* by the UE

Upon receiving the *LoggedMeasurementConfiguration* message the UE shall:

- 1> discard the logged measurement configuration as well as the logged measurement information as specified in 5.6.7;
- 1> store the received *loggingDuration*, *loggingInterval* and *areaConfiguration*, if included, in *VarLogMeasConfig*;
- 1> if the *LoggedMeasurementConfiguration* message includes *plmn-IdentityList*:
 - 2> set *plmn-IdentityList* in *VarLogMeasReport* to include the RPLMN as well as the PLMNs included in *plmn-IdentityList*;
- 1> else:
 - 2> set *plmn-IdentityList* in *VarLogMeasReport* to include the RPLMN;
- 1> store the received *absoluteTimeInfo*, *traceReference*, *traceRecordingSessionRef* and *tce-Id* in *VarLogMeasReport*;
- 1> store the received *targetMBSFN-AreaList*, if included, in *VarLogMeasConfig*;
- 1> start timer T330 with the timer value set to the *loggingDuration*;

5.6.6.4 T330 expiry

Upon expiry of T330 the UE shall:

- 1> release *VarLogMeasConfig*;

The UE is allowed to discard stored logged measurements, i.e. to release *VarLogMeasReport*, 48 hours after T330 expiry.

5.6.7 Release of Logged Measurement Configuration

5.6.7.1 General

The purpose of this procedure is to release the logged measurement configuration as well as the logged measurement information.

5.6.7.2 Initiation

The UE shall initiate the procedure upon receiving a logged measurement configuration in another RAT. The UE shall also initiate the procedure upon power off or detach.

The UE shall:

- 1> stop timer T330, if running;
- 1> if stored, discard the logged measurement configuration as well as the logged measurement information, i.e. release the UE variables *VarLogMeasConfig* and *VarLogMeasReport*;

5.6.8 Measurements logging

5.6.8.1 General

This procedure specifies the logging of available measurements by a UE in RRC_IDLE that has a logged measurement configuration and the logging of available measurements by a UE in both RRC_IDLE and RRC_CONNECTED if *targetMBSFN-AreaList* is included in *VarLogMeasConfig*.

5.6.8.2 Initiation

While T330 is running, the UE shall:

- 1> if measurement logging is suspended:
 - 2> if during the last logging interval the IDC problems detected by the UE is resolved, resume measurement logging;
- 1> if not suspended, perform the logging in accordance with the following:
 - 2> if *targetMBSFN-AreaList* is included in *VarLogMeasConfig*:
 - 3> if the UE is camping normally on an E-UTRA cell or is connected to E-UTRA; and
 - 3> if the RPLMN is included in *plmn-IdentityList* stored in *VarLogMeasReport*; and
 - 3> if the PCell (in RRC_CONNECTED) or cell where the UE is camping (in RRC_IDLE) is part of the area indicated by *areaConfiguration* if configured in *VarLogMeasConfig*;
 - 4> for MBSFN areas, indicated in *targetMBSFN-AreaList*, from which the UE is receiving MBMS service:
 - 5> perform MBSFN measurements in accordance with the performance requirements as specified in TS 36.133 [16];

NOTE 1: When configured to perform MBSFN measurement logging by *targetMBSFN-AreaList*, the UE is not required to receive additional MBSFN subframes, i.e. logging is based on the subframes corresponding to the MBMS services the UE is receiving.

- 5> perform logging at regular time intervals as defined by the *loggingInterval* in *VarLogMeasConfig*, but only for those intervals for which MBSFN measurement results are available as specified in TS 36.133 [16];
- 2> *else* if the UE is camping normally on an E-UTRA cell and if the RPLMN is included in *plmn-IdentityList* stored in *VarLogMeasReport* and, if the cell is part of the area indicated by *areaConfiguration* if configured in *VarLogMeasConfig*:
- 3> perform the logging at regular time intervals, as defined by the *loggingInterval* in *VarLogMeasConfig*;
- 2> when adding a logged measurement entry in *VarLogMeasReport*, include the fields in accordance with the following:
 - 3> if the UE detected IDC problems during the last logging interval;
 - 4> if *measResultServCell* in *VarLogMeasReport* is not empty;
 - 5> include *InDeviceCoexDetected*;
 - 5> suspend measurement logging from the next logging interval;
 - 4> *else*;
 - 5> suspend measurement logging;

NOTE 1A: The UE may detect the start of IDC problems as early as Phase 1 as described in 23.4 of TS 36.300 [9].

- 3> set the *relativeTimeStamp* to indicate the elapsed time since the moment at which the logged measurement configuration was received;
- 3> if detailed location information became available during the last logging interval, set the content of the *locationInfo* as follows:
 - 4> include the *locationCoordinates*;
- 3> if *targetMBSFN-AreaList* is included in *VarLogMeasConfig*:
 - 4> for each MBSFN area, for which the mandatory measurements result fields became available during the last logging interval:
 - 5> set the *rsrpResultMBSFN*, *rsrqResultMBSFN* to include measurement results that became available during the last logging interval;
 - 5> include the fields *signallingBLER-Result* or *dataBLER-MCH-ResultList* if the concerned BLER results are available,
 - 5> set the *mbsfn-AreaId* and *carrierFrequency* to indicate the MBSFN area in which the UE is receiving MBSFN transmission;
 - 4> if in RRC_CONNECTED:
 - 5> set the *servCellIdentity* to indicate global cell identity of the PCell;
 - 5> set the *measResultServCell* to include the layer 3 filtered measured results of the PCell;
 - 5> if available, set the *measResultNeighCells* to include the layer 3 filtered measured results of SCell(s) and neighbouring cell(s) measurements that became available during the last logging interval, in order of decreasing RSRP, for at most the following number of cells: 6 intra-frequency and 3 inter-frequency cells per frequency and according to the following:
 - 6> for each cell included, include the optional fields that are available;
 - 5> if available, optionally set the *measResultNeighCells* to include the layer 3 filtered measured results of neighbouring cell(s) measurements that became available during the last logging interval, in order of decreasing RSCP(UTRA)/RSSI(GERAN)/PilotStrength(cdma2000), for at most the following number of cells: 3 inter-RAT cells per frequency (UTRA, cdma2000)/set of frequencies (GERAN), and according to the following:

- 6> for each cell included, include the optional fields that are available;
- 4> if in RRC_IDLE:
 - 5> set the *servCellIdentity* to indicate global cell identity of the serving cell;
 - 5> set the *measResultServCell* to include the quantities of the serving cell;
 - 5> if available, set the *measResultNeighCells*, in order of decreasing ranking-criterion as used for cell re-selection, to include neighbouring cell measurements that became available during the last logging interval for at most the following number of neighbouring cells: 6 intra-frequency and 3 inter-frequency neighbours per frequency and according to the following:
 - 6> for each neighbour cell included, include the optional fields that are available;
 - 5> if available, optionally set the *measResultNeighCells*, in order of decreasing ranking-criterion as used for cell re-selection, to include neighbouring cell measurements that became available during the last logging interval, for at most the following number of cells: 3 inter-RAT cells per frequency (UTRA, cdma2000)/set of frequencies (GERAN), and according to the following:
 - 6> for each cell included, include the optional fields that are available;
 - 4> for the cells included according to the previous (i.e. covering previous and current serving cells as well as neighbouring EUTRA cells) include results according to the extended RSRQ if corresponding results are available according to the associated performance requirements defined in TS 36.133 [16];
 - 4> for the cells included according to the previous (i.e. covering previous and current serving cells as well as neighbouring EUTRA cells) include RSRQ type if the result was based on measurements using a wider band or using all OFDM symbols;

NOTE 2: The UE includes the latest results in accordance with the performance requirements as specified in TS 36.133 [16]. E.g. RSRP and RSRQ results are available only if the UE has a sufficient number of results/ receives a sufficient number of subframes during the logging interval.

3> else:

- 4> set the *servCellIdentity* to indicate global cell identity of the cell the UE is camping on;
- 4> set the *measResultServCell* to include the quantities of the cell the UE is camping on;
- 4> if available, set the *measResultNeighCells*, in order of decreasing ranking-criterion as used for cell re-selection, to include neighbouring cell measurements that became available during the last logging interval for at most the following number of neighbouring cells: 6 intra-frequency and 3 inter-frequency neighbours per frequency as well as 3 inter-RAT neighbours, per frequency/ set of frequencies (GERAN) per RAT and according to the following:
 - 5> for each neighbour cell included, include the optional fields that are available;
- 4> for the cells included according to the previous (i.e. covering previous and current serving cells as well as neighbouring EUTRA cells) include results according to the extended RSRQ if corresponding results are available according to the associated performance requirements defined in TS 36.133 [16];
- 4> for the cells included according to the previous (i.e. covering previous and current serving cells as well as neighbouring EUTRA cells) include RSRQ type if the result was based on measurements using a wider band or using all OFDM symbols;

NOTE 3: The UE includes the latest results of the available measurements as used for cell reselection evaluation in RRC_IDLE or as used for evaluation of reporting criteria or for measurement reporting according to 5.5.3 in RRC_CONNECTED, which are performed in accordance with the performance requirements as specified in TS 36.133 [16].

- 2> when the memory reserved for the logged measurement information becomes full, stop timer T330 and perform the same actions as performed upon expiry of T330, as specified in 5.6.6.4;

5.6.9 In-device coexistence indication

5.6.9.1 General

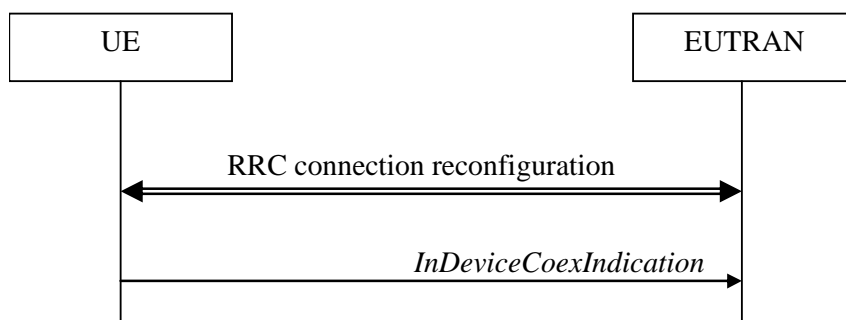

Figure 5.6.9.1-1: In-device coexistence indication

The purpose of this procedure is to inform E-UTRAN about (a change of) the In-Device Coexistence (IDC) problems experienced by the UE in RRC_CONNECTED, as described in TS 36.300 [9], and to provide the E-UTRAN with information in order to resolve them.

5.6.9.2 Initiation

A UE capable of providing IDC indications may initiate the procedure when it is configured to provide IDC indications and upon change of IDC problem information.

Upon initiating the procedure, the UE shall:

- 1> if configured to provide IDC indications:
 - 2> if the UE did not transmit an *InDeviceCoexIndication* message since it was configured to provide IDC indications:
 - 3> if on one or more frequencies for which a *measObjectEUTRA* is configured, the UE is experiencing IDC problems that it cannot solve by itself; or
 - 3> if configured to provide IDC indications for UL CA; and if on one or more supported UL CA combination comprising of carrier frequencies for which a measurement object is configured, the UE is experiencing IDC problems that it cannot solve by itself:
 - 4> initiate transmission of the *InDeviceCoexIndication* message in accordance with 5.6.9.3;
 - 2> else:
 - 3> if the set of frequencies, for which a *measObjectEUTRA* is configured and on which the UE is experiencing IDC problems that it cannot solve by itself, is different from the set indicated in the last transmitted *InDeviceCoexIndication* message; or
 - 3> if for one or more of the frequencies in the previously reported set of frequencies, the *interferenceDirection* is different from the value indicated in the last transmitted *InDeviceCoexIndication* message; or
 - 3> if the TDM assistance information is different from the assistance information included in the last transmitted *InDeviceCoexIndication* message; or
 - 3> if configured to provide IDC indications for UL CA; and if the *victimSystemType* is different from the value indicated in the last transmitted *InDeviceCoexIndication* message; or
 - 3> if configured to provide IDC indications for UL CA; and if the set of supported UL CA combinations on which the UE is experiencing IDC problems that it cannot solve by itself and that the UE includes in *affectedCarrierFreqCombList* according to 5.6.9.3, is different from the set indicated in the last transmitted *InDeviceCoexIndication* message;

4> initiate transmission of the *InDeviceCoexIndication* message in accordance with 5.6.9.3;

NOTE 1: The term "IDC problems" refers to interference issues applicable across several subframes/slots where not necessarily all the subframes/slots are affected.

NOTE 2: For the frequencies on which a serving cell or serving cells is configured that is activated, IDC problems consist of interference issues that the UE cannot solve by itself, during either active data exchange or upcoming data activity which is expected in up to a few hundred milliseconds.
For frequencies on which a SCell or SCells is configured that is deactivated, reporting IDC problems indicates an anticipation that the activation of the SCell or SCells would result in interference issues that the UE would not be able to solve by itself.
For a non-serving frequency, reporting IDC problems indicates an anticipation that if the non-serving frequency or frequencies became a serving frequency or serving frequencies then this would result in interference issues that the UE would not be able to solve by itself.

5.6.9.3 Actions related to transmission of *InDeviceCoexIndication* message

The UE shall set the contents of the *InDeviceCoexIndication* message as follows:

- 1> if there is at least one E-UTRA carrier frequency, for which a measurement object is configured, that is affected by IDC problems:
 - 2> include the field *affectedCarrierFreqList* with an entry for each affected E-UTRA carrier frequency for which a measurement object is configured;
 - 2> for each E-UTRA carrier frequency included in the field *affectedCarrierFreqList*, include *interferenceDirection* and set it accordingly;
 - 2> include Time Domain Multiplexing (TDM) based assistance information, unless *idc-HardwareSharingIndication* is configured and the UE has no Time Domain Multiplexing based assistance information that could be used to resolve the IDC problems:
 - 3> if the UE has DRX related assistance information that could be used to resolve the IDC problems:
 - 4> include *drx-CycleLength*, *drx-Offset* and *drx-ActiveTime*;
 - 3> else (the UE has desired subframe reservation patterns related assistance information that could be used to resolve the IDC problems):
 - 4> include *idc-SubframePatternList*;
 - 3> use the MCG as timing reference if TDM based assistance information regarding the SCG is included;
 - 1> if the UE is configured to provide UL CA information and there is a supported UL CA combination comprising of carrier frequencies for which a measurement object is configured, that is affected by IDC problems:
 - 2> include *victimSystemType* in *ul-CA-AssistanceInfo*;
 - 2> if the UE sets *victimSystemType* to *wlan* or *Bluetooth*:
 - 3> include *affectedCarrierFreqCombList* in *ul-CA-AssistanceInfo* with an entry for each supported UL CA combination comprising of carrier frequencies for which a measurement object is configured, that is affected by IDC problems;
 - 2> else:
 - 3> optionally include *affectedCarrierFreqCombList* in *ul-CA-AssistanceInfo* with an entry for each supported UL CA combination comprising of carrier frequencies for which a measurement object is configured, that is affected by IDC problems;
 - 1> if *idc-HardwareSharingIndication* is configured, and there is at least one E-UTRA carrier frequency, for which a measurement object is configured, the UE is experiencing hardware sharing problems that it cannot solve by itself:
 - 2> include the *hardwareSharingProblem* and set it accordingly;

NOTE 1: When sending an *InDeviceCoexIndication* message to inform E-UTRAN the IDC problems, the UE includes all assistance information (rather than providing e.g. the changed part(s) of the assistance information).

NOTE 2: Upon not anymore experiencing a particular IDC problem that the UE previously reported, the UE provides an IDC indication with the modified contents of the *InDeviceCoexIndication* message (e.g. by an empty message).

The UE shall submit the *InDeviceCoexIndication* message to lower layers for transmission.

5.6.10 UE Assistance Information

5.6.10.1 General

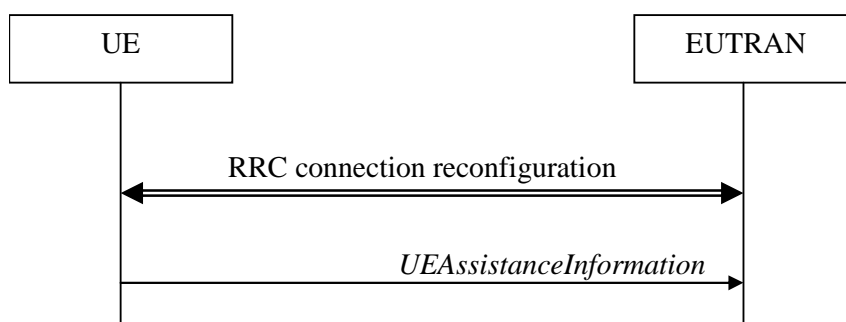

Figure 5.6.10.1-1: UE Assistance Information

The purpose of this procedure is to inform E-UTRAN of the UE's power saving preference and SPS assistance information, maximum PDSCH/PUSCH bandwidth configuration preference, overheating assistance information, or the UE's delay budget report carrying desired increment/decrement in the Uu air interface delay or connected mode DRX cycle length and for BL UEs or UEs in CE of the RLM event ("early-out-of-sync" or "early-in-sync") and RLM information. Upon configuring the UE to provide power preference indications E-UTRAN may consider that the UE does not prefer a configuration primarily optimised for power saving until the UE explicitly indicates otherwise.

5.6.10.2 Initiation

A UE capable of providing power preference indications in RRC_CONNECTED may initiate the procedure in several cases including upon being configured to provide power preference indications and upon change of power preference. A UE capable of providing SPS assistance information in RRC_CONNECTED may initiate the procedure in several cases including upon being configured to provide SPS assistance information and upon change of SPS assistance information.

A UE capable of providing delay budget report in RRC_CONNECTED may initiate the procedure in several cases, including upon being configured to provide delay budget report and upon change of delay budget preference.

A UE capable of CE mode and providing maximum PDSCH/PUSCH bandwidth preference in RRC_CONNECTED may initiate the procedure upon being configured to provide maximum PDSCH/PUSCH bandwidth preference and/or upon change of maximum PDSCH/PUSCH bandwidth preference.

A UE capable of providing overheating assistance information in RRC_CONNECTED may initiate the procedure if it was configured to do so, upon detecting internal overheating, or upon detecting that it is no longer experiencing an overheating condition.

Upon initiating the procedure, the UE shall:

- 1> if configured to provide power preference indications:
 - 2> if the UE did not transmit a *UEAssistanceInformation* message with *powerPrefIndication* since it was configured to provide power preference indications; or
 - 2> if the current power preference is different from the one indicated in the last transmission of the *UEAssistanceInformation* message and timer T340 is not running;

- 3> initiate transmission of the *UEAssistanceInformation* message in accordance with 5.6.10.3;
- 1> if configured to provide maximum PDSCH/PUSCH bandwidth preference:
 - 2> if the UE did not transmit a *UEAssistanceInformation* message with *bw-Preference* since it was configured to provide maximum PDSCH/PUSCH bandwidth preference; or
 - 2> if the current maximum PDSCH/PUSCH bandwidth preference is different from the one indicated in the last transmission of the *UEAssistanceInformation* message and timer T341 is not running;
 - 3> initiate transmission of the *UEAssistanceInformation* message in accordance with 5.6.10.3;
- 1> if configured to provide SPS assistance information:
 - 2> if the UE did not transmit a *UEAssistanceInformation* message with *sps-AssistanceInformation* since it was configured to provide SPS assistance information; or
 - 2> if the current SPS assistance information is different from the one indicated in the last transmission of the *UEAssistanceInformation* message:
 - 3> initiate transmission of the *UEAssistanceInformation* message in accordance with 5.6.10.3;
- 1> if configured to report RLM events:
 - 2> if "early-out-of-sync" event has been detected and T343 is not running; or
 - 2> if "early-in-sync" event has been detected and T344 is not running;
 - 3> initiate transmission of the *UEAssistanceInformation* message in accordance with 5.6.10.3;
- 1> if configured to provide delay budget report:
 - 2> if the UE did not transmit a *UEAssistanceInformation* message with *delayBudgetReport* since it was configured to provide delay budget report; or
 - 2> if the current delay budget is different from the one indicated in the last transmission of the *UEAssistanceInformation* message and timer T342 is not running;
 - 3> initiate transmission of the *UEAssistanceInformation* message in accordance with 5.6.10.3;
- 1> if configured to provide overheating assistance information:
 - 2> if the overheating condition has been detected and T345 is not running; or
 - 2> if the current overheating assistance information is different from the one indicated in the last transmission of the *UEAssistanceInformation* message and timer T345 is not running;
 - 3> initiate transmission of the *UEAssistanceInformation* message in accordance with 5.6.10.3;

5.6.10.3 Actions related to transmission of *UEAssistanceInformation* message

The UE shall set the contents of the *UEAssistanceInformation* message for power preference indications:

- 1> if configured to provide power preference indication and if the UE prefers a configuration primarily optimised for power saving:
 - 2> set *powerPrefIndication* to *lowPowerConsumption*;
- 1> else if configured to provide power preference indication:
 - 2> start or restart timer T340 with the timer value set to the *powerPrefIndicationTimer*;
 - 2> set *powerPrefIndication* to *normal*;

The UE shall set the contents of the *UEAssistanceInformation* message for SPS assistance information:

- 1> if configured to provide SPS assistance information:

- 2> if there is any traffic for V2X sidelink communication which needs to report SPS assistance information:
 - 3> include *trafficPatternInfoListSL* in the *UEAssistanceInformation* message;
- 2> if there is any traffic for uplink communication which needs to report SPS assistance information:
 - 3> include *trafficPatternInfoListUL* in the *UEAssistanceInformation* message;

The UE shall set the contents of the *UEAssistanceInformation* message for bandwidth preference indications:

- 1> start timer T341 with the timer value set to the *bw-PreferenceIndicationTimer*;
- 1> set *bw-Preference* to its preferred configuration;

The UE shall set the contents of the *UEAssistanceInformation* message for delay budget report:

- 1> if configured to provide delay budget report:
 - 2> if the UE prefers an adjustment in the connected mode DRX cycle length:
 - 3> set *delayBudgetReport* to *type1* according to a desired value;
 - 2> else if the UE prefers coverage enhancement configuration change:
 - 3> set *delayBudgetReport* to *type2* according to a desired value;
 - 2> start or restart timer T342 with the timer value set to the *delayBudgetReportingProhibitTimer*;

The UE shall set the contents of the *UEAssistanceInformation* message for the RLM report:

- 1> if T314 has expired:
 - 2> set *rlm-event* to *earlyOutOfSync*;
 - 2> start timer T343 with the timer value set to the *rlmReportTimer*;
- 1> if T315 has expired:
 - 2> set *rlm-event* to *earlyInSync*;
 - 2> start timer T344 with the timer value set to the *rlmReportTimer*;
 - 2> if configured to report *rlmReportRep-MPDCCH*:
 - 3> set *excessRep-MPDCCH* to the value indicated by lower layers;

The UE shall set the contents of the *UEAssistanceInformation* message for overheating assistance indication:

- 1> if the UE experiences internal overheating:
 - 2> if the UE prefers to temporarily reduce its DL category and UL category:
 - 3> include *reducedUE-Category* in the *OverheatingAssistance* IE;
 - 3> set *reducedUE-CategoryDL* to the number to which the UE prefers to temporarily reduce its DL category;
 - 3> set *reducedUE-CategoryUL* to the number to which the UE prefers to temporarily reduce its UL category;
 - 2> if the UE prefers to temporarily reduce the number of maximum secondary component carriers:
 - 3> include *reducedMaxCCs* in the *OverheatingAssistance* IE;
 - 3> set *reducedCCsDL* to the number of maximum SCells the UE prefers to be temporarily configured in downlink;
 - 3> set *reducedCCsUL* to the number of maximum SCells the UE prefers to be temporarily configured in uplink;
 - 2> start timer T345 with the timer value set to the *overheatingIndicationProhibitTimer*;

- 1> else (if the UE no longer experiences an overheating condition):
 - 2> do not include *reducedUE-Category* and *reducedMaxCCs* in OverheatingAssistance IE;
 - 2> start timer T345 with the timer value set to the *overheatingIndicationProhibitTimer*;

The UE shall submit the *UEAssistanceInformation* message to lower layers for transmission.

NOTE 1: It is up to UE implementation when and how to trigger SPS assistance information.

NOTE 2: It is up to UE implementation to set the content of *trafficPatternInfoListSL* and *trafficPatternInfoListUL*.

NOTE 3: Traffic patterns for different Destination Layer 2 IDs are provided in different entries in *trafficPatternInfoListSL*.

5.6.11 Mobility history information

5.6.11.1 General

This procedure specifies how the mobility history information is stored by the UE, covering RRC_CONNECTED and RRC_IDLE.

5.6.11.2 Initiation

If the UE supports storage of mobility history information, the UE shall:

- 1> Upon change of cell, consisting of PCell in RRC_CONNECTED or serving cell in RRC_IDLE, to another E-UTRA or inter-RAT cell or when entering out of service:
 - 2> include an entry in variable *VarMobilityHistoryReport* possibly after removing the oldest entry, if necessary, according to following:
 - 3> if the global cell identity of the previous PCell/ serving cell is available:
 - 4> include the global cell identity of that cell in the field *visitedCellId* of the entry;
 - 3> else:
 - 4> include the physical cell identity and carrier frequency of that cell in the field *visitedCellId* of the entry;
 - 3> set the field *timeSpent* of the entry as the time spent in the previous PCell/ serving cell;
 - 1> upon entering E-UTRA (in RRC_CONNECTED or RRC_IDLE) while previously out of service and/ or using another RAT:
 - 2> include an entry in variable *VarMobilityHistoryReport* possibly after removing the oldest entry, if necessary, according to following:
 - 3> set the field *timeSpent* of the entry as the time spent outside E-UTRA;

5.6.12 RAN-assisted WLAN interworking

5.6.12.1 General

The purpose of this procedure is to facilitate access network selection and traffic steering between E-UTRAN and WLAN.

If required by upper layers (see TS 24.312 [66]), the UE shall provide an up-to-date set of the applicable parameters provided by *wlan-OffloadConfigCommon* or *wlan-OffloadConfigDedicated* to upper layers, and inform upper layers when no parameters are configured. The parameter set from either *wlan-OffloadConfigCommon* or *wlan-OffloadConfigDedicated* is selected as specified in clauses 5.2.2.24, 5.3.12, 5.6.12.2 and 5.6.12.4.

5.6.12.2 Dedicated WLAN offload configuration

The UE shall:

- 1> if the received *wlan-OffloadInfo* is set to *release*:
 - 2> release *wlan-OffloadConfigDedicated* and *t350*;
 - 2> if the *wlan-OffloadConfigCommon* corresponding to the RPLMN is broadcast by the cell:
 - 3> apply the *wlan-OffloadConfigCommon* corresponding to the RPLMN included in *SystemInformationBlockType17*;
- 1> else:
 - 2> apply the received *wlan-OffloadConfigDedicated*;

5.6.12.3 WLAN offload RAN evaluation

The UE shall:

- 1> if the UE is configured with either *wlan-OffloadConfigCommon* or *wlan-OffloadConfigDedicated*; and
- 1> if the UE is in RRC_IDLE or none of *rclwi-Configuration*, *lwa-Configuration* and *lwip-Configuration* is configured:
 - 2> provide measurement results required for the evaluation of the network selection and traffic steering rules as defined in TS 24.312 [66] to upper layers;
 - 2> evaluate the network selection and traffic steering rules as defined in TS 36.304 [4] using WLAN identifiers as indicated in other clauses (either provided in *steerToWLAN* included in *rclwi-Configuration* or in *wlan-Id-List* included in *SystemInformationBlockType17*);

5.6.12.4 T350 expiry or stop

The UE shall:

- 1> if T350 expires or is stopped:
 - 2> release the *wlan-OffloadConfigDedicated* and *t350*;
 - 2> release *rclwi-Configuration* if configured;
 - 2> if the *wlan-OffloadConfigCommon* corresponding to the RPLMN is broadcast by the cell:
 - 3> apply the *wlan-OffloadConfigCommon* and the *wlan-Id-List* corresponding to the RPLMN included in *SystemInformationBlockType17*;

5.6.12.5 Cell selection/ re-selection while T350 is running

The UE shall:

- 1> if, while T350 is running, the UE selects/ reselects a cell which is not the PCell when the *wlan-OffloadDedicated* was configured:
 - 2> stop timer T350;
 - 2> perform the actions as specified in 5.6.12.4;

5.6.13 SCG failure information

5.6.13.1 General

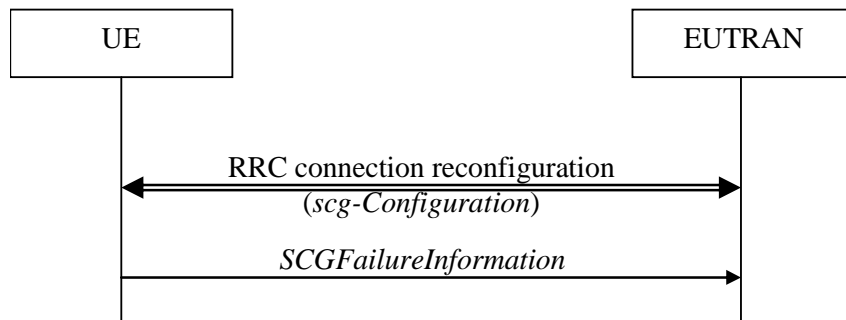

Figure 5.6.13.1-1: SCG failure information

The purpose of this procedure is to inform E-UTRAN about an SCG failure the UE has experienced i.e. SCG radio link failure, SCG change failure.

5.6.13.2 Initiation

A UE initiates the procedure to report SCG failures when SCG transmission is not suspended and when one of the following conditions is met:

- 1> upon detecting radio link failure for the SCG, in accordance with 5.3.11; or
- 1> upon SCG change failure, in accordance with 5.3.5.7a; or
- 1> upon stopping uplink transmission towards the PSCell due to exceeding the maximum uplink transmission timing difference when *powerControlMode* is configured to 1, in accordance with clause 7.17.2 of TS 36.133 [29].

Upon initiating the procedure, the UE shall:

- 1> suspend all SCG DRBs and suspend SCG transmission for split DRBs;
- 1> reset SCG-MAC;
- 1> stop T307;
- 1> initiate transmission of the *SCGFailureInformation* message in accordance with 5.6.13.3;

5.6.13.3 Actions related to transmission of *SCGFailureInformation* message

The UE shall set the contents of the *SCGFailureInformation* message as follows:

- 1> if the UE initiates transmission of the *SCGFailureInformation* message to provide SCG radio link failure information:
 - 2> include *failureType* and set it to the trigger for detecting SCG radio link failure;
- 1> else if the UE initiates transmission of the *SCGFailureInformation* message to provide SCG change failure information:
 - 2> include *failureType* and set it to *scg-ChangeFailure*;
- 1> else if the UE initiates transmission of the *SCGFailureInformation* message due to exceeding maximum uplink transmission timing difference:
 - 2> include *failureType* and set it to *maxUL-TimingDiff*;

- 1> set the *measResultServFreqList* to include for each SCG cell that is configured, if any, within *measResultSCell* the quantities of the concerned SCell, if available according to performance requirements in [16];
- 1> for each SCG serving frequency included in *measResultServFreqList*, include within *measResultBestNeighCell* the *physCellId* and the quantities of the best non-serving cell, based on RSRP, on the concerned serving frequency;
- 1> set the *measResultNeighCells* to include the best measured cells on non-serving E-UTRA frequencies, ordered such that the best cell is listed first, and based on measurements collected up to the moment the UE detected the failure, and set its fields as follows:
 - 2> if the UE was configured to perform measurements for one or more non-serving EUTRA frequencies and measurement results are available, include the *measResultListEUTRA*;
 - 2> for each neighbour cell included, include the optional fields that are available;

NOTE 2: The measured quantities are filtered by the L3 filter as configured in the mobility measurement configuration. The measurements are based on the time domain measurement resource restriction, if configured. Blacklisted cells are not required to be reported.

The UE shall submit the *SCGFailureInformation* message to lower layers for transmission.

5.6.14 LTE-WLAN Aggregation

5.6.14.1 Introduction

E-UTRAN can configure the UE to connect to a WLAN and configure bearers for LWA (referred to as LWA DRBs). The UE uses the WLAN parameters received from E-UTRAN in performing WLAN measurements. The UE also performs WLAN connection management as described in 5.6.15 while LWA is configured.

5.6.14.2 Reception of LWA configuration

Upon reception of LWA configuration, the UE shall:

- 1> if the received *lwa-Configuration* is set to *release*:
 - 2> release the LWA configuration as described in 5.6.14.3;
- 1> else:
 - 2> if the received *lwa-Config* includes *lwa-WT-Counter*:
 - 3> determine the S-K_{WT} key based on the K_{eNB} key and received *lwa-WT-Counter* value, as specified in TS 33.401 [32];
 - 3> forward the S-K_{WT} key to upper layers to be used as a PMK or PSK for WLAN authentication;
 - 2> if the received *lwa-Config* includes *lwa-MobilityConfig*:
 - 3> if the received *lwa-MobilityConfig* includes *wlan-ToReleaseList*:
 - 4> for each *WLAN-Identifiers* included in *wlan-ToReleaseList*:
 - 5> remove the *WLAN-Identifiers* if already part of the current *wlan-MobilitySet* in *VarWLAN-MobilityConfig*;
 - 3> if the received *lwa-MobilityConfig* includes *wlan-ToAddList*:
 - 4> for each *WLAN-Identifiers* included in *wlan-ToAddList*:
 - 5> add the *WLAN-Identifiers* to the current *wlan-MobilitySet* in *VarWLAN-MobilityConfig*;
 - 3> if the received *lwa-MobilityConfig* includes *associationTimer*:
 - 4> start or restart timer T351 with the timer value set to the *associationTimer*;

- 3> if the received *lwa-MobilityConfig* includes *successReportRequested*:
 - 4> set *successReportRequested* in *VarWLAN-MobilityConfig* to the value of *successReportRequested*;
- 3> if the received *lwa-MobilityConfig* includes *wlan-SuspendConfig*:
 - 4> set the field(s) in *wlan-SuspendConfig* within *VarWLAN-MobilityConfig* to the value(s) of field(s) included in *wlan-SuspendConfig*;
- 2> start WLAN Status Monitoring as described in 5.6.15.4;

5.6.14.3 Release of LWA configuration

To release the LWA configuration, the UE shall:

- 1> for each LWA DRB that is part of the current UE configuration:
 - 2> disable data handling for this DRB at the LWAAP entity;
 - 2> perform PDCP data recovery as specified in TS 36.323 [8];
- 1> delete any existing values in *VarWLAN-MobilityConfig* and *VarWLAN-Status*;
- 1> stop timer T351, if running;
- 1> stop WLAN status monitoring and WLAN connection attempts for LWA;
- 1> indicate the release of LWA configuration, if configured, to upper layers;

5.6.15 WLAN connection management

5.6.15.1 Introduction

WLAN connection management procedures in this clause are triggered as specified in other clauses where the UE is using a WLAN connection for LWA, RCLWI or LWIP.

The UE stores the current WLAN mobility set, which is a set of one or more WLAN identifier(s) (e.g. BSSID, SSID, HESSID) in *wlan-MobilitySet* in *VarWLAN-MobilityConfig*. This WLAN mobility set can be configured and updated by the eNB. A WLAN is considered to be inside the WLAN mobility set if its identifiers match all WLAN identifiers of at least one entry in *wlan-MobilitySet* and outside the WLAN mobility set otherwise. When the UE receives a new or updated WLAN mobility set, it initiates connection to a WLAN inside the WLAN mobility set, if not already connected to such a WLAN, and starts WLAN status monitoring as described in 5.6.15.4. The UE can perform WLAN mobility within the WLAN mobility set (connect or reconnect to a WLAN inside the WLAN mobility set) without any signalling to E-UTRAN.

The UE reports the WLAN connection status information to E-UTRAN as described in 5.6.15.2. The information in this report is based on the monitoring of WLAN connection as described in 5.6.15.4.

5.6.15.2 WLAN connection status reporting

5.6.15.2.1 General



Figure 5.6.15.2.1-1: WLAN connection status reporting

The purpose of this procedure is to inform E-UTRAN about the status of WLAN connection for LWA, RCLWI, or LWIP.

5.6.15.2.2 Initiation

The UE in RRC_CONNECTED initiates the WLAN status reporting procedure when:

- 1> it connects successfully to a WLAN inside WLAN mobility set while T351 is running after a WLAN mobility set change; or
- 1> after a *lwa-WT-Counter* update or after a *lwip-Counter* update (if success report is requested by the eNB); or
- 1> its connection or connection attempts to all WLAN(s) inside WLAN mobility set fails in accordance with WLAN Status Monitoring described in 5.6.15.4; or
- 1> T351 expires; or
- 1> its WLAN connection to all WLAN(s) inside WLAN mobility set becomes temporarily unavailable; or
- 1> its WLAN connection to a WLAN inside the WLAN mobility set is successfully established after its previous WLAN Connection Status Report indicating WLAN temporary suspension;

Upon initiating the procedure, the UE shall:

- 1> initiate transmission of the *WLANConnectionStatusReport* message in accordance with 5.6.15.2.3;

5.6.15.2.3 Actions related to transmission of *WLANConnectionStatusReport* message

The UE shall set the contents of the *WLANConnectionStatusReport* message as follows:

- 1> set *wlan-status* to *status* in *VarWLAN-Status*;
- 1> submit the *WLANConnectionStatusReport* message to lower layers for transmission, upon which the procedure ends;

5.6.15.3 T351 Expiry (WLAN connection attempt timeout)

Upon T351 expiry, the UE shall:

- 1> set the *status* in *VarWLAN-Status* to *failureTimeout*;
- 1> perform WLAN connection status reporting procedure in 5.6.15.2;
- 1> stop WLAN status monitoring and WLAN connection attempts;

5.6.15.4 WLAN status monitoring

To perform WLAN status monitoring, the UE shall:

- 1> if UE is not configured with *rclwi-Configuration* and WLAN connection to a WLAN inside the WLAN mobility set is successfully established or maintained after a WLAN mobility set configuration update, after a *lwa-WT-Counter* update or after a *lwip-Counter* update:
 - 2> set the *status* in *VarWLAN-Status* to *successfulAssociation*;
 - 2> stop timer T351, if running;
 - 2> if *successReportRequested* in *VarWLAN-MobilityConfig* is set to *TRUE*:
 - 3> perform WLAN Connection Status Reporting procedure in 5.6.15.2;
- 1> if WLAN connection or connection attempts to all WLAN(s) inside WLAN mobility set fails:
 - 2> if the failure is due to WLAN radio link issues:

- 3> set the *status* in *VarWLAN-Status* to *failureWlanRadioLink*;
 - 2> else if the failure is due to UE internal problems related to WLAN:
 - 3> set the *status* in *VarWLAN-Status* to *failureWlanUnavailable*;
- NOTE 1: The UE internal problems related to WLAN include connection to another WLAN based on user preferences or turning off WLAN connection or connection rejection from WLAN or other WLAN problems.
- 3> remove all WLAN related measurement reporting entries within *VarMeasReportList*;
 - 2> stop timer T351, if running;
 - 2> perform WLAN Connection Status Reporting procedure in 5.6.15.2;
 - 2> if the UE is configured with *rclwi-Configuration*:
 - 3> release *rclwi-Configuration* and inform upper layers of a move-traffic-from-WLAN indication (see TS 24.302 [74]);
 - 2> stop WLAN Status Monitoring and WLAN connection attempts;
 - 1> if *wlan-SuspendResumeAllowed* in *wlan-SuspendConfig* within *VarWLAN-MobilityConfig* is set to *TRUE*:
 - 2> if WLAN connection to all WLAN(s) inside WLAN mobility set becomes temporarily unavailable:
 - 3> set the *status* in *VarWLAN-Status* to *suspended*;
 - 3> if *wlan-SuspendTriggersStatusReport* in *wlan-SuspendConfig* within *VarWLAN-MobilityConfig* is set to *TRUE*:
 - 4> trigger PDCP Status Report as specified in [8];
 - 3> perform WLAN Connection Status Reporting procedure in 5.6.15.2;
 - 2> if the *status* in *VarWLAN-Status* in the last WLAN Connection Status Report by this UE was *suspended* and WLAN connection to a WLAN inside the WLAN mobility set is successfully established:
 - 3> set the *status* in *VarWLAN-Status* to *resumed*;
 - 3> perform WLAN Connection Status Reporting procedure in 5.6.15.2;

5.6.16 RAN controlled LTE-WLAN interworking

5.6.16.1 General

The purpose of this procedure is to perform RAN-controlled LTE-WLAN interworking (RCLWI) i.e. control access network selection and traffic steering between E-UTRAN and WLAN.

5.6.16.2 WLAN traffic steering command

The UE shall:

- 1> if the received *rclwi-Configuration* is set to *setup*:
- 2> if the *command* is set to *steerToWLAN*:
 - 3> inform the upper layers of a move-traffic-to-WLAN indication along with the WLAN identifier lists in *steerToWLAN* (see TS 24.302 [74]);
 - 3> store *steerToWLAN* in *wlan-MobilitySet* in *VarWLAN-MobilityConfig*;
 - 3> perform the WLAN status monitoring procedure as specified in 5.6.15.4 using *steerToWLAN* as the WLAN mobility set;

- 2> else:
 - 3> inform the upper layers of a move-traffic-from-WLAN indication (see TS 24.302 [74]);
 - 3> clear *wlan-MobilitySet* in *VarWLAN-MobilityConfig*;
 - 3> stop performing the WLAN status monitoring procedure as specified in 5.6.15.4;
 - 3> delete any existing values in *VarWLAN-Status*;
- 1> else (the *rclwi-Configuration* is released):
 - 2> clear *wlan-MobilitySet* in *VarWLAN-MobilityConfig*;
 - 2> stop performing the WLAN status monitoring procedure as specified in 5.6.15.4;
 - 2> delete any existing values in *VarWLAN-Status*;
 - 2> inform the upper layers of release of the *rclwi-Configuration*.

5.6.17 LTE-WLAN aggregation with IPsec tunnel

5.6.17.1 General

The WLAN resources that are used over the LWIP tunnel as described in TS 36.300 [9] established as part of LWIP procedures are referred to as 'LWIP resources'. The purpose of this clause is to specify procedures to indicate to higher layers to initiate the establishment/ release of the LWIP tunnel over WLAN and to indicate which DRB(s) shall use the LWIP resources.

5.6.17.2 LWIP reconfiguration

The UE shall:

- 1> if the received *lwip-Configuration* is set to *release*:
 - 2> release the LWIP configuration, if configured, as described in 5.6.17.3;
- 1> else:
 - 2> if *lwip-MobilityConfig* is included:
 - 3> if the received *lwip-MobilityConfig* includes *wlan-ToReleaseList*:
 - 4> for each *WLAN-Identifiers* included in *wlan-ToReleaseList*:
 - 5> remove the *WLAN-Identifiers* if already part of the current *wlan-MobilitySet* in *VarWLAN-MobilityConfig*;
 - 3> if the received *lwip-MobilityConfig* includes *wlan-ToAddList*:
 - 4> for each *WLAN-Identifiers* included in *wlan-ToAddList*:
 - 5> add the *WLAN-Identifiers* to the current *wlan-MobilitySet* in *VarWLAN-MobilityConfig*;
 - 3> if the received *lwip-MobilityConfig* includes *associationTimer*:
 - 4> start timer T351 with the timer value set according to the value of *associationTimer*;
 - 3> if the received *lwip-MobilityConfig* includes *successReportRequested*:
 - 4> set *successReportRequested* in *VarWLAN-MobilityConfig* to the value of *successReportRequested*;
 - 2> if *tunnelConfigLWIP* is included:
 - 3> indicate to higher layers to configure the LWIP tunnel according to the received *tunnelConfigLWIP* [32];

3> if *lwip-Counter* is included:

4> determine the LWIP-PSK based on the K_{eNB} key and received *lwip-Counter* value, as specified in TS 33.401 [32];

4> forward the LWIP-PSK to upper layers for LWIP tunnel establishment;

2> start WLAN Status Monitoring as described in 5.6.15.4;

5.6.17.3 LWIP release

The UE shall:

1> delete any existing values in *VarWLAN-MobilityConfig* and *VarWLAN-Status*;

1> stop timer T351, if running;

1> release the *lwip-Configuration*;

1> indicate to higher layers to stop all DRBs from using the LWIP resources;

1> indicate to higher layers to release the LWIP tunnel [32];

1> stop WLAN status monitoring and WLAN connection attempts for LWIP;

5.6.18 Void

5.7 Generic error handling

5.7.1 General

The generic error handling defined in the subsequent clauses applies unless explicitly specified otherwise e.g. within the procedure specific error handling.

The UE shall consider a value as not comprehended when it is set:

- to an extended value that is not defined in the version of the transfer syntax supported by the UE.
- to a spare or reserved value unless the specification defines specific behaviour that the UE shall apply upon receiving the concerned spare/ reserved value.

The UE shall consider a field as not comprehended when it is defined:

- as spare or reserved unless the specification defines specific behaviour that the UE shall apply upon receiving the concerned spare/ reserved field.

5.7.2 ASN.1 violation or encoding error

The UE shall:

1> when receiving an RRC message on the BCCH, BR-BCCH, PCCH, CCCH, MCCH, SC-MCCH or SBCCH for which the abstract syntax is invalid [13]:

2> ignore the message;

NOTE: This clause applies in case one or more fields is set to a value, other than a spare, reserved or extended value, not defined in this version of the transfer syntax. E.g. in the case the UE receives value 12 for a field defined as INTEGER (1..11). In cases like this, it may not be possible to reliably detect which field is in the error hence the error handling is at the message level.

5.7.3 Field set to a not comprehended value

The UE shall, when receiving an RRC message on any logical channel:

- 1> if the message includes a field that has a value that the UE does not comprehend:
 - 2> if a default value is defined for this field:
 - 3> treat the message while using the default value defined for this field;
 - 2> else if the concerned field is optional:
 - 3> treat the message as if the field were absent and in accordance with the need code for absence of the concerned field;
 - 2> else:
 - 3> treat the message as if the field were absent and in accordance with clause 5.7.4;

5.7.4 Mandatory field missing

The UE shall:

- 1> if the message includes a field that is mandatory to include in the message (e.g. because conditions for mandatory presence are fulfilled) and that field is absent or treated as absent:
 - 2> if the RRC message was received on DCCH or CCCH:
 - 3> ignore the message;
 - 2> else:
 - 3> if the field concerns a (sub-field of) an entry of a list (i.e. a SEQUENCE OF):
 - 4> treat the list as if the entry including the missing or not comprehended field was not present;
 - 3> else if the field concerns a sub-field of another field, referred to as the 'parent' field i.e. the field that is one nesting level up compared to the erroneous field:
 - 4> consider the 'parent' field to be set to a not comprehended value;
 - 4> apply the generic error handling to the subsequent 'parent' field(s), until reaching the top nesting level i.e. the message level;
 - 3> else (field at message level):
 - 4> ignore the message;

NOTE 1: The error handling defined in these clauses implies that the UE ignores a message with the message type or version set to a not comprehended value.

NOTE 2: The nested error handling for messages received on logical channels other than DCCH and CCCH applies for errors in extensions also, even for errors that can be regarded as invalid E-UTRAN operation e.g. E-UTRAN not observing conditional presence.

The following ASN.1 further clarifies the levels applicable in case of nested error handling for errors in extension fields.

```
-- /example/ ASN1START
-- Example with extension addition group
ItemInfoList ::=                               SEQUENCE (SIZE (1..max)) OF ItemInfo
ItemInfo ::=                                   SEQUENCE {
  itemIdentity                               INTEGER (1..max),
  field1                                     Field1,
  field2                                     Field2                                     OPTIONAL,
  -- Need ON
```

```

...
[[ field3-r9          Field3-r9          OPTIONAL,          -- Cond Cond1
   field4-r9          Field4-r9          OPTIONAL          -- Need ON
]]
}

-- Example with traditional non-critical extension (empty sequence)

BroadcastInfoBlock1 ::= SEQUENCE {
  itemIdentity          INTEGER (1..max),
  field1                Field1,
  field2                Field2          OPTIONAL,          -- Need ON
  nonCriticalExtension BroadcastInfoBlock1-v940-IEs OPTIONAL
}

BroadcastInfoBlock1-v940-IEs ::= SEQUENCE {
  field3-r9          Field3-r9          OPTIONAL,          -- Cond Cond1
  field4-r9          Field4-r9          OPTIONAL,          -- Need ON
  nonCriticalExtension SEQUENCE {}      OPTIONAL          -- Need OP
}

-- ASN1STOP

```

The UE shall, apply the following principles regarding the levels applicable in case of nested error handling:

- an extension addition group is not regarded as a level on its own. E.g. in the ASN.1 extract in the previous, a error regarding the conditionality of *field3* would result in the entire itemInfo entry to be ignored (rather than just the extension addition group containing *field3* and *field4*)
- a traditional *nonCriticalExtension* is not regarded as a level on its own. E.g. in the ASN.1 extract in the previous, a error regarding the conditionality of *field3* would result in the entire *BroadcastInfoBlock1* to be ignored (rather than just the non critical extension containing *field3* and *field4*).

5.7.5 Not comprehended field

The UE shall, when receiving an RRC message on any logical channel:

- 1> if the message includes a field that the UE does not comprehend:
- 2> treat the rest of the message as if the field was absent;

NOTE: This clause does not apply to the case of an extension to the value range of a field. Such cases are addressed instead by the requirements in clause 5.7.3.

5.8 MBMS

5.8.1 Introduction

5.8.1.1 General

In general the control information relevant only for UEs supporting MBMS is separated as much as possible from unicast control information. Most of the MBMS control information is provided on a logical channel specific for MBMS common control information: the MCCH. E-UTRA employs one MCCH logical channel per MBSFN area. In case the network configures multiple MBSFN areas, the UE acquires the MBMS control information from the MCCHs that are configured to identify if services it is interested to receive are ongoing. The action applicable when the UE is unable to simultaneously receive MBMS and unicast services is up to UE implementation. In this release of the specification, an MBMS capable UE is only required to support reception of a single MBMS service at a time, and reception of more than one MBMS service (also possibly on more than one MBSFN area) in parallel is left for UE implementation. The MCCH carries the *MBSFNAreaConfiguration* message, which indicates the MBMS sessions that are ongoing as well as the (corresponding) radio resource configuration. The MCCH may also carry the *MBMSCountingRequest* message, when E-UTRAN wishes to count the number of UEs in RRC_CONNECTED that are receiving or interested to receive one or more specific MBMS services.

A limited amount of MBMS control information is provided on the BCCH. This primarily concerns the information needed to acquire the MCCH(s). This information is carried by means of a single MBMS specific *SystemInformationBlock: SystemInformationBlockType13*. An MBSFN area is identified solely by the *mbsfn-AreaId* in *SystemInformationBlockType13*. At mobility, the UE considers that the MBSFN area is continuous when the source cell and the target cell broadcast the same value in the *mbsfn-AreaId*.

5.8.1.2 Scheduling

The MCCH information is transmitted periodically, using a configurable repetition period. Scheduling information is not provided for MCCH i.e. both the time domain scheduling as well as the lower layer configuration are semi-statically configured, as defined within *SystemInformationBlockType13*.

For MBMS user data, which is carried by the MTCH logical channel, E-UTRAN periodically provides MCH scheduling information (MSI) at lower layers (MAC). This MCH information only concerns the time domain scheduling i.e. the frequency domain scheduling and the lower layer configuration are semi-statically configured. The periodicity of the MSI is configurable and defined by the MCH scheduling period.

5.8.1.3 MCCH information validity and notification of changes

Change of MCCH information only occurs at specific radio frames, i.e. the concept of a modification period is used. Within a modification period, the same MCCH information may be transmitted a number of times, as defined by its scheduling (which is based on a repetition period). The modification period boundaries are defined by SFN values for which $SFN \bmod m = 0$, where m is the number of radio frames comprising the modification period. The modification period is configured by means of *SystemInformationBlockType13*.

When the network changes (some of) the MCCH information, it notifies the UEs about the change during a first modification period. In the next modification period, the network transmits the updated MCCH information. These general principles are illustrated in figure 5.8.1.3-1, in which different colours indicate different MCCH information. Upon receiving a change notification, a UE interested to receive MBMS services acquires the new MCCH information immediately from the start of the next modification period. The UE applies the previously acquired MCCH information until the UE acquires the new MCCH information.

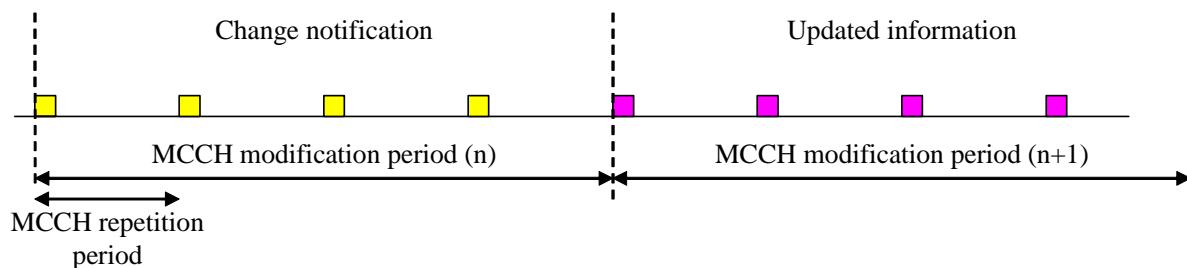

Figure 5.8.1.3-1: Change of MCCH Information

Indication of an MBMS specific RNTI, the M-RNTI (see TS 36.321 [6]), on PDCCH is used to inform UEs in RRC_IDLE and UEs in RRC_CONNECTED about an MCCH information change. When receiving an MCCH information change notification, the UE knows that the MCCH information will change at the next modification period boundary. The notification on PDCCH indicates which of the MCCHs will change, which is done by means of an 8-bit bitmap. Within this bitmap, the bit at the position indicated by the field *notificationIndicator* is used to indicate changes for that MBSFN area: if the bit is set to "1", the corresponding MCCH will change. No further details are provided e.g. regarding which MCCH information will change. The MCCH information change notification is used to inform the UE about a change of MCCH information upon session start or about the start of MBMS counting.

The MCCH information change notifications on PDCCH are transmitted periodically and are carried on MBSFN subframes only except on MBMS-dedicated cell or FeMBMS/Unicast-mixed cell where the MCCH information change is provided on non-MBSFN subframes. These MCCH information change notification occasions are common for all MCCHs that are configured, and configurable by parameters included in *SystemInformationBlockType13*: a repetition coefficient, a radio frame offset and a subframe index. These common notification occasions are based on the MCCH with the shortest modification period.

NOTE 1: E-UTRAN may modify the MBMS configuration information provided on MCCH at the same time as updating the MBMS configuration information carried on BCCH i.e. at a coinciding BCCH and MCCH modification period. Upon detecting that a new MCCH is configured on BCCH, a UE interested to receive one or more MBMS services should acquire the MCCH, unless it knows that the services it is interested in are not provided by the corresponding MBSFN area.

A UE that is receiving an MBMS service via MRB shall acquire the MCCH information from the start of each modification period. A UE interested to receive MBMS from a carrier on which *dl-Bandwidth* included in *MasterInformationBlock* is set to *n6* shall acquire the MCCH information at least once every MCCH modification period. A UE that is not receiving an MBMS service via MRB, as well as UEs that are receiving an MBMS service via MRB but potentially interested to receive other services not started yet in another MBSFN area from a carrier on which *dl-Bandwidth* included in *MasterInformationBlock* is other than *n6*, shall verify that the stored MCCH information remains valid by attempting to find the MCCH information change notification at least *notificationRepetitionCoeff* times during the modification period of the applicable MCCH(s), if no MCCH information change notification is received.

NOTE 2: In case the UE is aware which MCCH(s) E-UTRAN uses for the service(s) it is interested to receive, the UE may only need to monitor change notifications for a subset of the MCCHs that are configured, referred to as the 'applicable MCCH(s)' in the above.

5.8.2 MCCH information acquisition

5.8.2.1 General

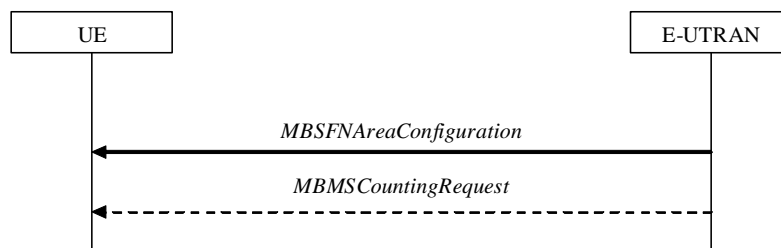

Figure 5.8.2.1-1: MCCH information acquisition

The UE applies the MCCH information acquisition procedure to acquire the MBMS control information that is broadcasted by the E-UTRAN. The procedure applies to MBMS capable UEs that are in RRC_IDLE or in RRC_CONNECTED.

5.8.2.2 Initiation

A UE interested to receive MBMS services shall apply the MCCH information acquisition procedure upon entering the corresponding MBSFN area (e.g. upon power on, following UE mobility) and upon receiving a notification that the MCCH information has changed. A UE that is receiving an MBMS service shall apply the MCCH information acquisition procedure to acquire the MCCH, that corresponds with the service that is being received, at the start of each modification period.

Unless explicitly stated otherwise in the procedural specification, the MCCH information acquisition procedure overwrites any stored MCCH information, i.e. delta configuration is not applicable for MCCH information and the UE discontinues using a field if it is absent in MCCH information unless explicitly specified otherwise.

5.8.2.3 MCCH information acquisition by the UE

An MBMS capable UE shall:

- 1> if the procedure is triggered by an MCCH information change notification:
 - 2> start acquiring the *MBSFNAreaConfiguration* message and the *MBMSCountingRequest* message if present, from the beginning of the modification period following the one in which the change notification was received;

NOTE 1: The UE continues using the previously received MCCH information until the new MCCH information has been acquired.

1> if the UE enters an MBSFN area:

2> acquire the *MBSFNAreaConfiguration* message and the *MBMSCountingRequest* message if present, at the next repetition period;

1> if the UE is receiving an MBMS service:

2> start acquiring the *MBSFNAreaConfiguration* message and the *MBMSCountingRequest* message if present, that both concern the MBSFN area of the service that is being received, from the beginning of each modification period;

5.8.2.4 Actions upon reception of the *MBSFNAreaConfiguration* message

No UE requirements related to the contents of this *MBSFNAreaConfiguration* apply other than those specified elsewhere e.g. within procedures using the concerned system information, the corresponding field descriptions.

5.8.2.5 Actions upon reception of the *MBMSCountingRequest* message

Upon receiving *MBMSCountingRequest* message, the UE shall perform the MBMS Counting procedure as specified in 5.8.4.

5.8.3 MBMS PTM radio bearer configuration

5.8.3.1 General

The MBMS PTM radio bearer configuration procedure is used by the UE to configure RLC, MAC and the physical layer upon starting and/or stopping to receive an MRB. The procedure applies to UEs interested to receive one or more MBMS services.

NOTE: In case the UE is unable to receive an MBMS service due to capability limitations, upper layers may take appropriate action e.g. terminate a lower priority unicast service.

5.8.3.2 Initiation

The UE applies the MRB establishment procedure to start receiving a session of a service it has an interest in. The procedure may be initiated e.g. upon start of the MBMS session, upon (re-)entry of the corresponding MBSFN service area, upon becoming interested in the MBMS service, upon removal of UE capability limitations inhibiting reception of the concerned service.

The UE applies the MRB release procedure to stop receiving a session. The procedure may be initiated e.g. upon stop of the MBMS session, upon leaving the corresponding MBSFN service area, upon losing interest in the MBMS service, when capability limitations start inhibiting reception of the concerned service.

5.8.3.3 MRB establishment

Upon MRB establishment, the UE shall:

1> establish an RLC entity in accordance with the configuration specified in 9.1.1.4;

1> configure an MTCH logical channel in accordance with the received *logicalChannelIdentity*, applicable for the MRB, as included in the *MBSFNAreaConfiguration* message;

1> configure the physical layer in accordance with the *pmch-Config*, applicable for the MRB, as included in the *MBSFNAreaConfiguration* message;

1> inform upper layers about the establishment of the MRB by indicating the corresponding *tmgi* and *sessionId*;

5.8.3.4 MRB release

Upon MRB release, the UE shall:

- 1> release the RLC entity as well as the related MAC and physical layer configuration;
- 1> inform upper layers about the release of the MRB by indicating the corresponding *tmgi* and *sessionId*;

5.8.4 MBMS Counting Procedure

5.8.4.1 General

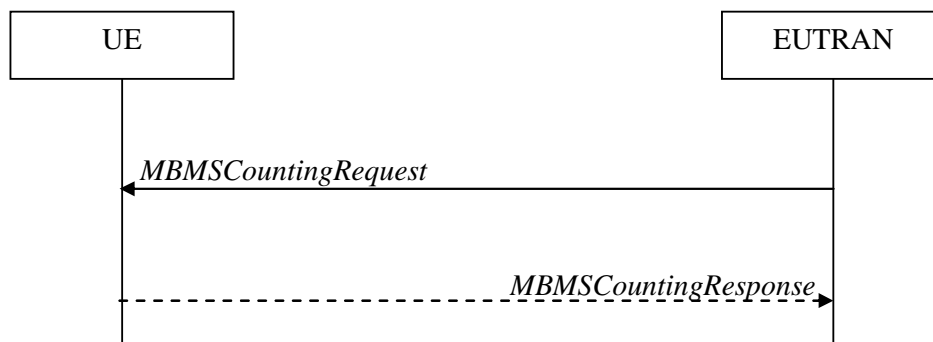

Figure 5.8.4.1-1: MBMS Counting procedure

The MBMS Counting procedure is used by the E-UTRAN to count the number of RRC_CONNECTED mode UEs which are receiving via an MRB or interested to receive via an MRB the specified MBMS services.

The UE determines interest in an MBMS service, that is identified by the TMGI, by interaction with upper layers.

5.8.4.2 Initiation

E-UTRAN initiates the procedure by sending an *MBMSCountingRequest* message.

5.8.4.3 Reception of the *MBMSCountingRequest* message by the UE

Upon receiving the *MBMSCountingRequest* message, the UE in RRC_CONNECTED mode shall:

- 1> if the *SystemInformationBlockType1*, that provided the scheduling information for the *systemInformationBlockType13* that included the configuration of the MCCH via which the *MBMSCountingRequest* message was received, contained the identity of the Registered PLMN; and
- 1> if the UE is receiving via an MRB or interested to receive via an MRB at least one of the services in the received *countingRequestList*:
 - 2> if more than one entry is included in the *mbsfn-AreaInfoList* received in the *SystemInformationBlockType13* that included the configuration of the MCCH via which the *MBMSCountingRequest* message was received:
 - 3> include the *mbsfn-AreaIndex* in the *MBMSCountingResponse* message and set it to the index of the entry in the *mbsfn-AreaInfoList* within the received *SystemInformationBlockType13* that corresponds with the MBSFN area used to transfer the received *MBMSCountingRequest* message;
 - 2> for each MBMS service included in the received *countingRequestList*:
 - 3> if the UE is receiving via an MRB or interested to receive via an MRB this MBMS service:
 - 4> include an entry in the *countingResponseList* within the *MBMSCountingResponse* message with *countingResponseService* set it to the index of the entry in the *countingRequestList* within the received

MBMSCountingRequest that corresponds with the MBMS service the UE is receiving or interested to receive;

- 2> submit the *MBMSCountingResponse* message to lower layers for transmission upon which the procedure ends;

NOTE 1: UEs that are receiving an MBMS User Service [56] by means of a Unicast Bearer Service [57] (i.e. via a DRB), but are interested to receive the concerned MBMS User Service [56] via an MBMS Bearer Service (i.e. via an MRB), respond to the counting request.

NOTE 2: If ciphering is used at upper layers, the UE does not respond to the counting request if it can not decipher the MBMS service for which counting is performed (see TS 22.146 [62, 5.3]).

NOTE 3: The UE treats the *MBMSCountingRequest* messages received in each modification period independently. In the unlikely case E-UTRAN would repeat an *MBMSCountingRequest* (i.e. including the same services) in a subsequent modification period, the UE responds again. The UE provides at most one *MBMSCountingResponse* message to multiple transmission attempts of an *MBMSCountingRequest* messages in a given modification period.

5.8.5 MBMS interest indication

5.8.5.1 General

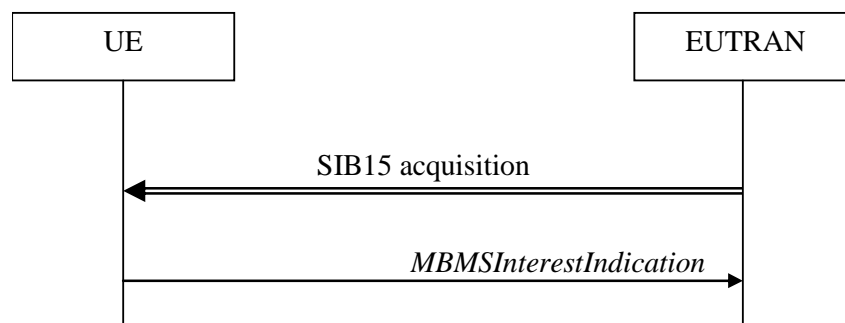

Figure 5.8.5.1-1: MBMS interest indication

The purpose of this procedure is to inform E-UTRAN that the UE is receiving or is interested to receive MBMS service(s) via an MRB or SC-MRB, and if so, to inform E-UTRAN about the priority of MBMS versus unicast reception.

5.8.5.2 Initiation

An MBMS or SC-PTM capable UE in RRC_CONNECTED may initiate the procedure in several cases including upon successful connection establishment, upon entering or leaving the service area, upon session start or stop, upon change of interest, upon change of priority between MBMS reception and unicast reception or upon change to a PCell broadcasting *SystemInformationBlockType15*.

Upon initiating the procedure, the UE shall:

- 1> if *SystemInformationBlockType15* is broadcast by the PCell:
 - 2> ensure having a valid version of *SystemInformationBlockType15* for the PCell;
- 2> if the UE did not transmit an *MBMSInterestIndication* message since last entering RRC_CONNECTED state; or
- 2> if since the last time the UE transmitted an *MBMSInterestIndication* message, the UE connected to a PCell not broadcasting *SystemInformationBlockType15*:
- 3> if the set of MBMS frequencies of interest, determined in accordance with 5.8.5.3, is not empty:
 - 4> initiate transmission of the *MBMSInterestIndication* message in accordance with 5.8.5.4;

2> else:

- 3> if the set of MBMS frequencies of interest, determined in accordance with 5.8.5.3, has changed since the last transmission of the *MBMSInterestIndication* message; or
- 3> if the prioritisation of reception of all indicated MBMS frequencies compared to reception of any of the established unicast bearers has changed since the last transmission of the *MBMSInterestIndication* message:
- 4> initiate transmission of the *MBMSInterestIndication* message in accordance with 5.8.5.4;

NOTE: The UE may send an *MBMSInterestIndication* even when it is able to receive the MBMS services it is interested in i.e. to avoid that the network allocates a configuration inhibiting MBMS reception.

3> else if *SystemInformationBlockType20* is broadcast by the PCell:

- 4> if since the last time the UE transmitted an *MBMSInterestIndication* message, the UE connected to a PCell not broadcasting *SystemInformationBlockType20*; or
- 4> if the set of MBMS services of interest determined in accordance with 5.8.5.3a is different from *mbms-Services* included in the last transmission of the *MBMSInterestIndication* message;
- 5> initiate the transmission of the *MBMSInterestIndication* message in accordance with 5.8.5.4.

5.8.5.3 Determine MBMS frequencies of interest

The UE shall:

1> consider a frequency to be part of the MBMS frequencies of interest if the following conditions are met:

- 2> at least one MBMS session the UE is receiving or interested to receive via an MRB or SC-MRB is ongoing or about to start; and

NOTE 1: The UE may determine whether the session is ongoing from the start and stop time indicated in the User Service Description (USD), see TS 36.300 [9] or TS 26.346 [57].

- 2> for at least one of these MBMS sessions *SystemInformationBlockType15* acquired from the PCell includes for the concerned frequency one or more MBMS SAIs as indicated in the USD for this session; and

NOTE 2: The UE considers a frequency to be part of the MBMS frequencies of interest even though E-UTRAN may (temporarily) not employ an MRB or SC-MRB for the concerned session. I.e. the UE does not verify if the session is indicated on (SC-)MCCH

NOTE 3: The UE considers the frequencies of interest independently of any synchronization state, e.g. [9, Annex J.1]

- 2> the UE is capable of simultaneously receiving MRBs and/or is capable of simultaneously receiving SC-MRBs on the set of MBMS frequencies of interest, regardless of whether a serving cell is configured on each of these frequencies or not; and

- 2> the *supportedBandCombination* the UE included in *UE-EUTRA-Capability* contains at least one band combination including the set of MBMS frequencies of interest;

NOTE 4: Indicating a frequency implies that the UE supports *SystemInformationBlockType13* or *SystemInformationBlockType20* acquisition for the concerned frequency i.e. the indication should be independent of whether a serving cell is configured on that frequency.

NOTE 5: When evaluating which frequencies it can receive simultaneously, the UE does not take into account the serving frequencies that are currently configured i.e. it only considers MBMS frequencies it is interested to receive.

NOTE 6: The set of MBMS frequencies of interest includes at most one frequency for a given physical frequency. The UE only considers a physical frequency to be part of the MBMS frequencies of interest if it supports at least one of the bands indicated for this physical frequency in *SystemInformationBlockType1* (for serving frequency) or *SystemInformationBlockType15* (for neighbouring frequencies). In this case, E-UTRAN may assume the UE supports MBMS reception on any of the bands supported by the UE (i.e. according to *supportedBandCombination*).

5.8.5.3a Determine MBMS services of interest

The UE shall:

- 1> consider a MBMS service to be part of the MBMS services of interest if the following conditions are met:
 - 2> the UE is SC-PTM capable; and
 - 2> the UE is receiving or interested to receive this service via an SC-MRB; and
 - 2> one session of this service is ongoing or about to start; and
 - 2> one or more MBMS SAIs in the USD for this service is included in *SystemInformationBlockType15* acquired from the PCell for a frequency belonging to the set of MBMS frequencies of interest, determined according to 5.8.5.3.

5.8.5.4 Actions related to transmission of *MBMSInterestIndication* message

The UE shall set the contents of the *MBMSInterestIndication* message as follows:

- 1> if the set of MBMS frequencies of interest, determined in accordance with 5.8.5.3, is not empty:
 - 2> include *mbms-FreqList* and set it to include the MBMS frequencies of interest sorted by decreasing order of interest, using the EARFCN corresponding with *freqBandIndicator* included in *SystemInformationBlockType1* (for serving frequency), if applicable, and the EARFCN(s) as included in *SystemInformationBlockType15* (for neighbouring frequencies);

NOTE 1: The EARFCN included in *mbms-FreqList* is merely used to indicate a physical frequency the UE is interested to receive i.e. the UE may not support the band corresponding to the included EARFCN (but it does support at least one of the bands indicated in system information for the concerned physical frequency).

- 2> include *mbms-Priority* if the UE prioritises reception of all indicated MBMS frequencies above reception of any of the unicast bearers;
- 2> if *SystemInformationBlockType20* is broadcast by the PCell:
 - 3> include *mbms-Services* and set it to indicate the set of MBMS services of interest determined in accordance with 5.8.5.3a;

NOTE 2: If the UE prioritises MBMS reception and unicast data cannot be supported because of congestion on the MBMS carrier(s), E-UTRAN may initiate release of unicast bearers. It is up to E-UTRAN implementation whether all bearers or only GBR bearers are released. E-UTRAN does not initiate re-establishment of the released unicast bearers upon alleviation of the congestion.

The UE shall submit the *MBMSInterestIndication* message to lower layers for transmission.

5.8a SC-PTM

5.8a.1 Introduction

5.8a.1.1 General

SC-PTM control information is provided on a specific logical channel: the SC-MCCH. The SC-MCCH carries the *SCPTMConfiguration* message which indicates the MBMS sessions that are ongoing as well as the (corresponding)

information on when each session may be scheduled, i.e. scheduling period, scheduling window and start offset. The *SCPTMConfiguration* message also provides information about the neighbour cells transmitting the MBMS sessions which are ongoing on the current cell. In this release of the specification, an SC-PTM capable UE is only required to support reception of a single MBMS service at a time, and reception of more than one MBMS service in parallel is left for UE implementation.

A limited amount of SC-PTM control information is provided on the BCCH or BR-BCCH. This primarily concerns the information needed to acquire the SC-MCCH.

NOTE: For BL UEs and UEs in CE, SC-MCCH transmission uses a 1.4 MHz channel bandwidth and a maximum TBS of 936 bits, see TS 36.213 [23]. For NB-IoT UEs, the maximum TBS for SC-MCCH transmission is 680 bits, see TS 36.213 [23].

5.8a.1.2 SC-MCCH scheduling

The SC-MCCH information (i.e. information transmitted in messages sent over SC-MCCH) is transmitted periodically, using a configurable repetition period. SC-MCCH transmissions (and the associated radio resources and MCS) are indicated on PDCCH.

5.8a.1.3 SC-MCCH information validity and notification of changes

Change of SC-MCCH information only occurs at specific radio frames, i.e. the concept of a modification period is used. Within a modification period, the same SC-MCCH information may be transmitted a number of times, as defined by its scheduling (which is based on a repetition period). The modification period boundaries are defined by SFN values for which $\text{SFN} \bmod m = 0$, where m is the number of radio frames comprising the modification period. The modification period is configured by means of *SystemInformationBlockType20* (*SystemInformationBlockType20-NB* in NB-IoT). If H-SFN is provided in *SystemInformationBlockType1-BR*, modification period boundaries for BL UEs or UEs in CE are defined by SFN values for which $(\text{H-SFN} * 1024 + \text{SFN}) \bmod m = 0$. The modification period boundaries for NB-IoT UEs are defined by SFN values for which $(\text{H-SFN} * 1024 + \text{SFN}) \bmod m = 0$.

When the network changes (some of) the SC-MCCH information, it notifies the UEs, other than BL UEs, UEs in CE or NB-IoT UEs, about the change in the first subframe which can be used for SC-MCCH transmission in a repetition period. LSB bit in 8-bit bitmap when set to '1' indicates the change in SC-MCCH. Upon receiving a change notification, a UE interested to receive MBMS services transmitted using SC-PTM acquires the new SC-MCCH information starting from the same subframe. The UE applies the previously acquired SC-MCCH information until the UE acquires the new SC-MCCH information.

When the network changes (some of) the SC-MCCH information for start of new MBMS service(s) transmitted using SC-PTM, it notifies BL UEs, UEs in CE or NB-IoT UEs about the change in every PDCCH which schedules the first SC-MCCH in a repetition period in the current modification period. The notification is transmitted with 1 bit. The bit, when set to '1', indicates the start of new MBMS service(s), see TS 36.212 [22, 5.3.3.1.14 & 6.4.3.3]. Upon receiving a change notification, a BL UE, UE in CE or NB-IoT UE interested to receive MBMS services transmitted using SC-PTM acquires the new SC-MCCH information scheduled by the PDCCH. The BL UE, UE in CE or NB-IoT UE applies the previously acquired SC-MCCH information until the BL UE, UE in CE or NB-IoT UE acquires the new SC-MCCH information.

When the network changes SC-MTCH specific information e.g. start of new MBMS service(s) transmitted using SC-PTM or change of ongoing MBMS service(s) transmitted using SC-PTM, it notifies the BL UEs, UEs in CE or NB-IoT UEs in the PDCCH which schedules the SC-MTCH in the current modification period. The notification is transmitted with a 2 bit bitmap. The LSB in the 2-bit bitmap, when set to '1', indicates the change of the on-going MBMS service and the MSB in the 2-bit bitmap, when set to '1', indicates the start of new MBMS service(s), see TS 36.212 [22, 5.3.3.1.12 & 5.3.3.1.13 & 6.4.3.2]. In the case the network changes an on-going SC-MTCH transmission in the next modification period, it notifies the BL UEs, UEs in CE or NB-IoT UEs in the PDCCH which schedules this SC-MTCH in the current modification period. In the case the network starts new MBMS service(s) transmitted using SC-PTM, the network notifies the UEs which have on-going SC-MTCH in the PDCCH scheduling each of the SC-MTCH. Upon receiving such notification, a BL UE, UE in CE or NB-IoT UE acquires the new SC-MCCH information at the start of the next modification period. The BL UE, UE in CE or NB-IoT UE applies the previously acquired SC-MCCH information until the BL UE, UE in CE or NB-IoT UE acquires the new SC-MCCH information.

5.8a.1.4 Procedures

The SC-PTM capable UE receiving or interested to receive MBMS service(s) via SC-MRB applies SC-PTM procedures described in 5.8a and, except for NB-IoT UE, the MBMS interest indication procedure as specified in 5.8.5.

5.8a.2 SC-MCCH information acquisition

5.8a.2.1 General

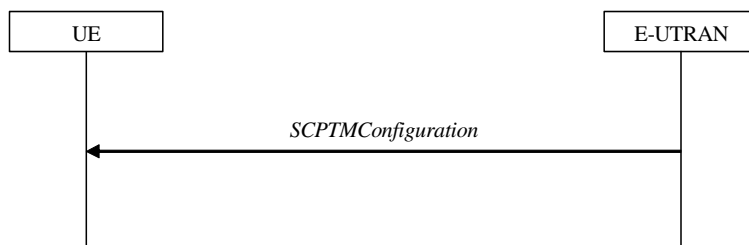

Figure 5.8a.2.1-1: SC-MCCH information acquisition

The UE applies the SC-MCCH information acquisition procedure to acquire the SC-PTM control information that is broadcast by the E-UTRAN. The procedure applies to SC-PTM capable UEs that are in RRC_IDLE. This procedure also applies to SC-PTM capable UEs that are in RRC_CONNECTED except for BL UEs, UEs in CE or NB-IoT UEs.

5.8a.2.2 Initiation

A UE interested to receive MBMS services via SC-MRB shall apply the SC-MCCH information acquisition procedure upon entering the cell broadcasting *SystemInformationBlockType20* (*SystemInformationBlockType20-NB* in NB-IoT) (e.g. upon power on, following UE mobility) and upon receiving a notification that the SC-MCCH information has changed. A UE, except for BL UE, UE in CE or NB-IoT UE, that is receiving an MBMS service via SC-MRB shall apply the SC-MCCH information acquisition procedure to acquire the SC-MCCH information that corresponds with the service that is being received, at the start of each modification period. The BL UE, UE in CE or NB-IoT UE that is receiving an MBMS service via SC-MRB shall apply the SC-MCCH information acquisition procedure upon receiving a notification that the SC-MCCH information that corresponds with the service that is being received is about to be changed. The BL UE, UE in CE or NB-IoT UE that is receiving an MBMS service via SC-MRB may apply the SC-MCCH information acquisition procedure upon receiving a notification that the SC-MCCH information is about to be changed due to start of a new service.

Unless explicitly stated otherwise in the procedural specification, the SC-MCCH information acquisition procedure overwrites any stored SC-MCCH information, i.e. delta configuration is not applicable for SC-MCCH information and the UE discontinues using a field if it is absent in SC-MCCH information unless explicitly specified otherwise.

5.8a.2.3 SC-MCCH information acquisition by the UE

A SC-PTM capable UE shall:

- 1> if the procedure is triggered by an SC-MCCH information change notification and the UE has no ongoing MBMS service:
 - 2> except for a BL UE, UE in CE or NB-IoT UE, start acquiring the *SCPTMConfiguration* message from the subframe in which the change notification was received;
 - 2> for a BL UE, UE in CE or NB-IoT UE, acquire the *SCPTMConfiguration* message scheduled by the PDCCH in which the change notification was received;

NOTE 1: The UE continues using the previously received SC-MCCH information until the new SC-MCCH information has been acquired.

- 1> if the UE enters a cell broadcasting *SystemInformationBlockType20* (*SystemInformationBlockType20-NB* in NB-IoT):

- 2> acquire the *SCPTMConfiguration* message at the next repetition period;
- 1> if the UE is receiving an MBMS service via an SC-MRB:
 - 2> except for BL UE, UE in CE or NB-IoT UE, start acquiring the *SCPTMConfiguration* message from the beginning of each modification period;
 - 2> a BL UE, UE in CE or NB-IoT UE shall start acquiring the *SCPTMConfiguration* message at the start of the next modification period upon receiving a notification that the SC-MCCH information that corresponds with the service that is being received is about to be changed;
 - 2> a BL UE, UE in CE or NB-IoT UE may start acquiring the *SCPTMConfiguration* message at the start of the next modification period upon receiving a notification that the SC-MCCH information is about to be changed due to start of a new service;

5.8a.2.4 Actions upon reception of the *SCPTMConfiguration* message

No UE requirements related to the contents of this *SCPTMConfiguration* apply other than those specified elsewhere e.g. within procedures using the concerned system information, the corresponding field descriptions.

5.8a.3 SC-PTM radio bearer configuration

5.8a.3.1 General

The SC-PTM radio bearer configuration procedure is used by the UE to configure RLC, MAC and the physical layer upon starting and/or stopping to receive an SC-MRB transmitted on SC-MTCH. The procedure applies to SC-PTM capable UEs that are in RRC_IDLE and to SC-PTM capable UEs that are not BL UEs, UEs in CE or NB-IoT UEs in RRC_CONNECTED, and are interested to receive one or more MBMS services via SC-MRB.

NOTE: In case the UE is unable to receive an MBMS service via an SC-MRB due to capability limitations, upper layers may take appropriate action e.g. terminate a lower priority unicast service.

5.8a.3.2 Initiation

The UE applies the SC-MRB establishment procedure to start receiving a session of a MBMS service it has an interest in. The procedure may be initiated e.g. upon start of the MBMS session, upon entering a cell providing via SC-MRB a MBMS service in which the UE has interest, upon becoming interested in the MBMS service, upon removal of UE capability limitations inhibiting reception of the concerned service.

The UE applies the SC-MRB release procedure to stop receiving a session. The procedure may be initiated e.g. upon stop of the MBMS session, upon leaving the cell where a SC-MRB is established, upon losing interest in the MBMS service, when capability limitations start inhibiting reception of the concerned service.

5.8a.3.3 SC-MRB establishment

Upon SC-MRB establishment, the UE shall:

- 1> establish an RLC entity in accordance with the configuration specified in 9.1.1.7;
- 1> configure a SC-MTCH logical channel applicable for the SC-MRB and instruct MAC to receive DL-SCH on the cell where the *SCPTMConfiguration* message was received for the MBMS service for which the SC-MRB is established and using *g-RNTI* and *sc-mtch-SchedulingInfo* (if included) in this message for this MBMS service;
- 1> configure the physical layer in accordance with the *sc-mtch-InfoList*, applicable for the SC-MRB, as included in the *SCPTMConfiguration* message;
- 1> inform upper layers about the establishment of the SC-MRB by indicating the corresponding *tmgi* and *sessionId*;

5.8a.3.4 SC-MRB release

Upon SC-MRB release, the UE shall:

- 1> release the RLC entity as well as the related MAC and physical layer configuration;
- 1> inform upper layers about the release of the SC-MRB by indicating the corresponding *tmgi* and *sessionId*;

5.9 RN procedures

5.9.1 RN reconfiguration

5.9.1.1 General

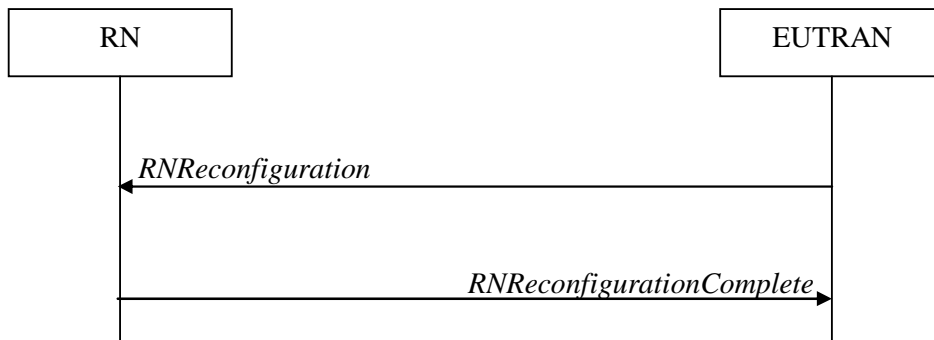

Figure 5.9.1.1-1: RN reconfiguration

The purpose of this procedure is to configure/reconfigure the RN subframe configuration and/or to update the system information relevant for the RN in RRC_CONNECTED.

5.9.1.2 Initiation

E-UTRAN may initiate the RN reconfiguration procedure to an RN in RRC_CONNECTED when AS security has been activated.

5.9.1.3 Reception of the *RNReconfiguration* by the RN

The RN shall:

- 1> if the *rn-SystemInfo* is included:
 - 2> if the *systemInformationBlockType1* is included:
 - 3> act upon the received *SystemInformationBlockType1* as specified in 5.2.2.7;
 - 2> if the *SystemInformationBlockType2* is included:
 - 3> act upon the received *SystemInformationBlockType2* as specified in 5.2.2.9;
- 1> if the *rn-SubframeConfig* is included:
 - 2> reconfigure lower layers in accordance with the received *subframeConfigPatternFDD* or *subframeConfigPatternTDD*;
 - 2> if the *rpdcch-Config* is included:
 - 3> reconfigure lower layers in accordance with the received *rpdcch-Config*;
- 1> submit the *RNReconfigurationComplete* message to lower layers for transmission, upon which the procedure ends;

5.10 Sidelink

5.10.1 Introduction

The sidelink communication and associated synchronisation resource configuration applies for the frequency at which it was received/ acquired. Moreover, for a UE configured with one or more SCells, the sidelink communication and associated synchronisation resource configuration provided by dedicated signalling applies for the PCell/ the primary frequency. The sidelink discovery and associated synchronisation resource configuration applies for the frequency at which it was received/ acquired or the indicated frequency in the configuration. For a UE configured with one or more SCells, the sidelink discovery and associated synchronisation resource configuration provided by dedicated signalling applies for the the PCell/ the primary frequency / any other indicated frequency.

NOTE 1: Upper layers configure the UE to receive or transmit sidelink communication on a specific frequency, to monitor or transmit non-PS related sidelink discovery announcements on one or more frequencies or to monitor or transmit PS related sidelink discovery announcements on a specific frequency, but only if the UE is authorised to perform these particular ProSe related sidelink activities.

NOTE 2: It is up to UE implementation which actions to take (e.g. termination of unicast services, detach) when it is unable to perform the desired sidelink activities, e.g. due to UE capability limitations.

Sidelink communication consists of one-to-many and one-to-one sidelink communication. One-to-many sidelink communication consists of relay related and non-relay related one-to-many sidelink communication. One-to-one sidelink communication consists of relay related and non-relay related one-to-one sidelink communication. In relay related one-to-one sidelink communication the communicating parties consist of one sidelink relay UE and one sidelink remote UE.

Sidelink discovery consists of public safety related (PS related) and non-PS related sidelink discovery. PS related sidelink discovery consists of relay related and non-relay related PS related sidelink discovery. Upper layers indicate to RRC whether a particular sidelink announcement is PS related or non-PS related.

Upper layers indicate to RRC whether a particular sidelink procedure is V2X related or not.

The specification covers the use of UE to network sidelink relays by specifying the additional requirements that apply for a sidelink relay UE and a sidelink remote UE. I.e. for such UEs the regular sidelink UE requirements equally apply unless explicitly stated otherwise.

5.10.1a Conditions for sidelink communication operation

When it is specified that the UE shall perform sidelink communication operation only if the conditions defined in this clause are met, the UE shall perform sidelink communication operation only if:

- 1> if the UE's serving cell is suitable (RRC_IDLE or RRC_CONNECTED); and if either the selected cell on the frequency used for sidelink communication operation belongs to the registered or equivalent PLMN as specified in TS 24.334 [69] or the UE is out of coverage on the frequency used for sidelink communication operation as defined in TS 36.304 [4, 11.4]; or
- 1> if the UE is camped on a serving cell (RRC_IDLE) on which it fulfils the conditions to support sidelink communication in limited service state as specified in TS 23.303 [68, 4.5.6]; and if either the serving cell is on the frequency used for sidelink communication operation or the UE is out of coverage on the frequency used for sidelink communication operation as defined in TS 36.304 [4, 11.4]; or
- 1> if the UE has no serving cell (RRC_IDLE);

5.10.1b Conditions for PS related sidelink discovery operation

When it is specified that the UE shall perform PS related sidelink discovery operation only if the conditions defined in this clause are met, the UE shall perform PS related sidelink discovery operation only if:

- 1> if the UE's serving cell is suitable (RRC_IDLE or RRC_CONNECTED); and if either the selected cell on the frequency used for PS related sidelink discovery operation belongs to the registered or other PLMN as specified in TS 24.334 [69] or the UE is out of coverage on the frequency used for PS related sidelink discovery operation as defined in TS 36.304 [4, 11.4]; or

- 1> if the UE is camped on a serving cell (RRC_IDLE) on which it fulfils the conditions to support sidelink discovery in limited service state as specified in TS 23.303 [68, 4.5.6]; and if either the serving cell is on the frequency used for PS related sidelink discovery operation or the UE is out of coverage on the frequency used for PS related sidelink discovery operation as defined in TS 36.304 [4, 11.4]; or
- 1> if the UE has no serving cell (RRC_IDLE);

5.10.1c Conditions for non-PS related sidelink discovery operation

When it is specified that the UE shall perform non-PS related sidelink discovery operation only if the conditions defined in this clause are met, the UE shall perform non-PS related sidelink discovery operation only if:

- 1> if the UE's serving cell (RRC_IDLE) or PCell (RRC_CONNECTED) is suitable; and if the selected cell on the frequency used for non-PS related sidelink discovery operation belongs to the registered or other PLMN as specified in TS 24.334 [69].

5.10.1d Conditions for V2X sidelink communication operation

When it is specified that the UE shall perform V2X sidelink communication operation only if the conditions defined in this clause are met, the UE shall perform V2X sidelink communication operation only if:

- 1> if the UE's serving cell is suitable (RRC_IDLE or RRC_CONNECTED); and if either the selected cell on the frequency used for V2X sidelink communication operation belongs to the registered or equivalent PLMN as specified in TS 24.334 [69] or the UE is out of coverage on the frequency used for V2X sidelink communication operation as defined in TS 36.304 [4, 11.4]; or
- 1> if the UE's serving cell (for RRC_IDLE or RRC_CONNECTED) fulfils the conditions to support V2X sidelink communication in limited service state as specified in TS 23.285 [78, 4.4.8]; and if either the serving cell is on the frequency used for V2X sidelink communication operation or the UE is out of coverage on the frequency used for V2X sidelink communication operation as defined in TS 36.304 [4, 11.4]; or
- 1> if the UE has no serving cell (RRC_IDLE);

5.10.2 Sidelink UE information

5.10.2.1 General

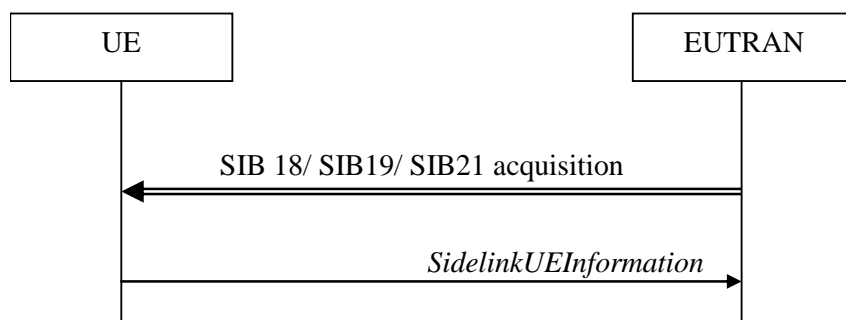

Figure 5.10.2-1: Sidelink UE information

The purpose of this procedure is to inform E-UTRAN that the UE is interested or no longer interested to receive sidelink communication or discovery, to receive V2X sidelink communication, as well as to request assignment or release of transmission resources for sidelink communication or discovery announcements or V2X sidelink communication or sidelink discovery gaps, to report parameters related to sidelink discovery from system information of inter-frequency/PLMN cells and to report the synchronization reference used by the UE for V2X sidelink communication.

5.10.2.2 Initiation

A UE capable of sidelink communication or V2X sidelink communication or sidelink discovery that is in RRC_CONNECTED may initiate the procedure to indicate it is (interested in) receiving sidelink communication or V2X sidelink communication or sidelink discovery in several cases including upon successful connection establishment, upon change of interest, upon change to a PCell broadcasting *SystemInformationBlockType18* or *SystemInformationBlockType19* or *SystemInformationBlockType21* including *sl-V2X-ConfigCommon*. A UE capable of sidelink communication or V2X sidelink communication or sidelink discovery may initiate the procedure to request assignment of dedicated resources for the concerned sidelink communication transmission or discovery announcements or V2X sidelink communication transmission or to request sidelink discovery gaps for sidelink discovery transmission or sidelink discovery reception and a UE capable of inter-frequency/PLMN sidelink discovery parameter reporting may initiate the procedure to report parameters related to sidelink discovery from system information of inter-frequency/PLMN cells.

NOTE 1: A UE in RRC_IDLE that is configured to transmit sidelink communication / V2X sidelink communication / sidelink discovery announcements, while *SystemInformationBlockType18*/*SystemInformationBlockType19*/*SystemInformationBlockType21* including *sl-V2X-ConfigCommon* does not include the resources for transmission (in normal conditions), initiates connection establishment in accordance with 5.3.3.1a.

Upon initiating the procedure, the UE shall:

- 1> if *SystemInformationBlockType18* is broadcast by the PCell:
 - 2> ensure having a valid version of *SystemInformationBlockType18* for the PCell;
 - 2> if configured by upper layers to receive sidelink communication:
 - 3> if the UE did not transmit a *SidelinkUEInformation* message since last entering RRC_CONNECTED state; or
 - 3> if since the last time the UE transmitted a *SidelinkUEInformation* message the UE connected to a PCell not broadcasting *SystemInformationBlockType18*; or

NOTE 2: After handover/ re-establishment from a source PCell not broadcasting *SystemInformationBlockType18* the UE repeats the same interest information that it provided previously as such a source PCell may not forward the interest information.

- 3> if the last transmission of the *SidelinkUEInformation* message did not include *commRxInterestedFreq*; or if the frequency configured by upper layers to receive sidelink communication on has changed since the last transmission of the *SidelinkUEInformation* message:
 - 4> initiate transmission of the *SidelinkUEInformation* message to indicate the sidelink communication reception frequency of interest in accordance with 5.10.2.3;
- 2> else:
 - 3> if the last transmission of the *SidelinkUEInformation* message included *commRxInterestedFreq*:
 - 4> initiate transmission of the *SidelinkUEInformation* message to indicate it is no longer interested in sidelink communication reception in accordance with 5.10.2.3;
 - 2> if configured by upper layers to transmit non-relay related one-to-many sidelink communication:
 - 3> if the UE did not transmit a *SidelinkUEInformation* message since last entering RRC_CONNECTED state; or
 - 3> if since the last time the UE transmitted a *SidelinkUEInformation* message the UE connected to a PCell not broadcasting *SystemInformationBlockType18*; or
 - 3> if the last transmission of the *SidelinkUEInformation* message did not include *commTxResourceReq*; or if the information carried by the *commTxResourceReq* has changed since the last transmission of the *SidelinkUEInformation* message:
 - 4> initiate transmission of the *SidelinkUEInformation* message to indicate the non-relay related one-to-many sidelink communication transmission resources required by the UE in accordance with 5.10.2.3;

- 2> else:
 - 3> if the last transmission of the *SidelinkUEInformation* message included *commTxResourceReq*:
 - 4> initiate transmission of the *SidelinkUEInformation* message to indicate it no longer requires non-relay related one-to-many sidelink communication transmission resources in accordance with 5.10.2.3;
 - 2> if configured by upper layer to transmit relay related one-to-many sidelink communication:
 - 3> if the UE did not transmit a *SidelinkUEInformation* message since entering RRC_CONNECTED state; or
 - 3> if since the last time the UE transmitted a *SidelinkUEInformation* message the UE connected to a PCell not broadcasting *SystemInformationBlockType18*, connected to a PCell not broadcasting *SystemInformationBlockType19* or broadcasting *SystemInformationBlockType19* not including *discConfigRelay*; or
 - 3> if the last transmission of *SidelinkUEInformation* message did not include *commTxResourceReqRelay*; or if the information carried by the *commTxResourceReqRelay* has changed since the last transmission of the *SidelinkUEInformation* message:
 - 4> if the UE is acting as sidelink relay UE:
 - 5> initiate transmission of the *SidelinkUEInformation* message to indicate the relay related one-to-many sidelink communication transmission resources required by the UE in accordance with 5.10.2.3;
- 2> else:
 - 3> if the last transmission of the *SidelinkUEInformation* message included *commTxResourceReqRelay*:
 - 4> initiate transmission of the *SidelinkUEInformation* message to indicate it no longer requires relay related one-to-many sidelink communication transmission resources in accordance with 5.10.2.3;
 - 2> if configured by upper layers to transmit non-relay related one-to-one sidelink communication:
 - 3> if the UE did not transmit a *SidelinkUEInformation* message since last entering RRC_CONNECTED state; or
 - 3> if since the last time the UE transmitted a *SidelinkUEInformation* message the UE connected to a PCell not broadcasting *SystemInformationBlockType18* or connected to a PCell broadcasting *SystemInformationBlockType18* not including *commTxResourceUC-ReqAllowed*; or
 - 3> if the last transmission of the *SidelinkUEInformation* message did not include *commTxResourceReqUC*; or if the information carried by the *commTxResourceReqUC* has changed since the last transmission of the *SidelinkUEInformation* message:
 - 4> if *commTxResourceUC-ReqAllowed* is included in *SystemInformationBlockType18*:
 - 5> initiate transmission of the *SidelinkUEInformation* message to indicate the non-relay related one-to-one sidelink communication transmission resources required by the UE in accordance with 5.10.2.3;
- 2> else:
 - 3> if the last transmission of the *SidelinkUEInformation* message included *commTxResourceReqUC*:
 - 4> initiate transmission of the *SidelinkUEInformation* message to indicate it no longer requires non-relay related one-to-one sidelink communication transmission resources in accordance with 5.10.2.3;
 - 2> if configured by upper layers to transmit relay related one-to-one sidelink communication:
 - 3> if the UE did not transmit a *SidelinkUEInformation* message since last entering RRC_CONNECTED state; or
 - 3> if since the last time the UE transmitted a *SidelinkUEInformation* message the UE connected to a PCell not broadcasting *SystemInformationBlockType18*, connected to a PCell not broadcasting

- SystemInformationBlockType19* or broadcasting *SystemInformationBlockType19* not including *discConfigRelay*; or
- 3> if the last transmission of the *SidelinkUEInformation* message did not include *commTxResourceReqRelayUC*; or if the information carried by the *commTxResourceReqRelayUC* has changed since the last transmission of the *SidelinkUEInformation* message:
 - 4> if the UE is acting as sidelink relay UE; or
 - 4> if the UE has a selected sidelink relay UE; and if *SystemInformationBlockType19* is broadcast by the PCell and includes *discConfigRelay*; and if the sidelink remote UE threshold conditions as specified in 5.10.11.5 are met;
 - 5> initiate transmission of the *SidelinkUEInformation* message to indicate the relay related one-to-one sidelink communication transmission resources required by the UE in accordance with 5.10.2.3;
 - 2> else:
 - 3> if the last transmission of the *SidelinkUEInformation* message included *commTxResourceReqRelayUC*:
 - 4> initiate transmission of the *SidelinkUEInformation* message to indicate it no longer requires relay related one-to-one sidelink communication transmission resources in accordance with 5.10.2.3;
- 1> if *SystemInformationBlockType19* is broadcast by the PCell:
- 2> ensure having a valid version of *SystemInformationBlockType19* for the PCell;
 - 2> if configured by upper layers to receive sidelink discovery announcements on a serving frequency or on one or more frequencies included in *discInterFreqList*, if included in *SystemInformationBlockType19* of the PCell:
 - 3> if the UE did not transmit a *SidelinkUEInformation* message since last entering RRC_CONNECTED state; or
 - 3> if since the last time the UE transmitted a *SidelinkUEInformation* message the UE connected to a PCell not broadcasting *SystemInformationBlockType19*; or
 - 3> if the last transmission of the *SidelinkUEInformation* message did not include *discRxInterest*:
 - 4> initiate transmission of the *SidelinkUEInformation* message to indicate it is interested in sidelink discovery reception in accordance with 5.10.2.3;
 - 2> else:
 - 3> if the last transmission of the *SidelinkUEInformation* message included *discRxInterest*:
 - 4> initiate transmission of the *SidelinkUEInformation* message to indicate it is no longer interested in sidelink discovery reception in accordance with 5.10.2.3;
 - 2> if the UE is configured by upper layers to transmit non-PS related sidelink discovery announcements on the primary frequency or on one or more frequencies included in *discInterFreqList*, if included in *SystemInformationBlockType19* of the PCell, with *discTxResourcesInterFreq* included within *discResourcesNonPS* and not set to *noTxOnCarrier*:
 - 3> if the UE did not transmit a *SidelinkUEInformation* message since last entering RRC_CONNECTED state; or
 - 3> if since the last time the UE transmitted a *SidelinkUEInformation* message the UE connected to a PCell not broadcasting *SystemInformationBlockType19* or connected to a PCell broadcasting *SystemInformationBlockType19* not including *discTxResourcesInterFreq* within *discResourcesNonPS* or *discTxResourcesInterFreq* did not include all frequencies for which the UE will request resources; or
 - 3> if the last transmission of the *SidelinkUEInformation* message did not include *discTxResourceReq*; or if the non-PS related sidelink discovery announcement resources required by the UE have changed (i.e. resulting in a change of *discTxResourceReq*) since the last transmission of the *SidelinkUEInformation* message:

- 4> initiate transmission of the *SidelinkUEInformation* message to indicate the non-PS related sidelink discovery announcement resources required by the UE in accordance with 5.10.2.3;
- 2> else:
 - 3> if the last transmission of the *SidelinkUEInformation* message included *discTxResourceReq*:
 - 4> initiate transmission of the *SidelinkUEInformation* message to indicate it no longer requires non-PS related sidelink discovery announcement resources in accordance with 5.10.2.3;
 - 2> if configured by upper layers to transmit PS related sidelink discovery announcements on the primary frequency or, in case of non-relay PS related sidelink discovery announcements, on a frequency included in *discInterFreqList*, if included in *SystemInformationBlockType19*, with *discTxResourcesInterFreq* included within *discResourcesPS* and not set to *noTxOnCarrier*:
 - 3> if the UE did not transmit a *SidelinkUEInformation* message since last entering RRC_CONNECTED state; or
 - 3> if since the last time the UE transmitted a *SidelinkUEInformation* message the UE connected to a PCell not broadcasting *SystemInformationBlockType19*, connected to a PCell broadcasting *SystemInformationBlockType19* not including *discConfigPS*, or in case of non-relay PS related transmission: (connected to a PCell broadcasting *SystemInformationBlockType19* not including *discTxResourcesInterFreq* within *discResourcesPS* or for which *discTxResourcesInterFreq* did not include all frequencies for which the UE will request resources), or in case of relay related PS sidelink discovery announcements: (connected to a PCell broadcasting *SystemInformationBlockType19* not including *discConfigRelay*) sidelink; or
 - 3> if the last transmission of the *SidelinkUEInformation* message did not include *discTxResourceReqPS*; or if the PS related sidelink discovery announcement resources required by the UE have changed (i.e. resulting in a change of *discTxResourceReqPS*) since the last transmission of the *SidelinkUEInformation* message:
 - 4> if configured by upper layers to transmit non-relay PS related sidelink discovery announcements; or
 - 4> if the UE is acting as sidelink relay UE; and if *SystemInformationBlockType19* includes *discConfigRelay*; and if the sidelink relay UE threshold conditions as specified in 5.10.10.4 are met; or
 - 4> if the UE is selecting a sidelink relay UE / has a selected sidelink relay UE; and if *SystemInformationBlockType19* includes *discConfigRelay*; and if the sidelink remote UE threshold conditions as specified in 5.10.11.5 are met:
 - 5> initiate transmission of the *SidelinkUEInformation* message to indicate the PS related sidelink discovery announcement resources required by the UE in accordance with 5.10.2.3;
 - 2> else:
 - 3> if the last transmission of the *SidelinkUEInformation* message included *discTxResourceReqPS*:
 - 4> initiate transmission of the *SidelinkUEInformation* message to indicate it no longer requires PS related sidelink discovery announcement resources in accordance with 5.10.2.3;
 - 2> if configured by upper layers to monitor or transmit sidelink discovery announcements; and if the UE requires sidelink discovery gaps, to perform such actions:
 - 3> if the UE did not transmit a *SidelinkUEInformation* message since last entering RRC_CONNECTED state; or
 - 3> if since the last time the UE transmitted a *SidelinkUEInformation* message the UE connected to a PCell not broadcasting *SystemInformationBlockType19* or connected to a PCell broadcasting *SystemInformationBlockType19* not including *gapRequestsAllowedCommon* while at the same time the UE was not configured with *gapRequestsAllowedDedicated*; or
 - 3> if the last transmission of the *SidelinkUEInformation* message did not include the gaps required to monitor or transmit the sidelink discovery announcements (i.e. UE requiring gaps to monitor discovery announcements while *discRxGapReq* was not included or UE requiring gaps to transmit discovery announcements while *discTxGapReq* was not included); or if the sidelink discovery gaps required by the

UE have changed (i.e. resulting in a change of *discRxGapReq* or *discTxGapReq*) since the last transmission of the *SidelinkUEInformation* message:

4> if the UE is configured with *gapRequestsAllowedDedicated* set to *true*; or

4> if the UE is not configured with *gapRequestsAllowedDedicated* and *gapRequestsAllowedCommon* is included in *SystemInformationBlockType19*:

5> initiate transmission of the *SidelinkUEInformation* message to indicate the sidelink discovery gaps required by the UE in accordance with 5.10.2.3;

2> else:

3> if the last transmission of the *SidelinkUEInformation* message included *discTxGapReq* or *discRxGapReq*:

4> initiate transmission of the *SidelinkUEInformation* message to indicate it no longer requires sidelink discovery gaps in accordance with 5.10.2.3;

2> if the UE acquired the relevant parameters from the system information of one or more cells on a carrier included in the *discSysInfoToReportConfig* and T370 is running:

3> if the UE has configured lower layers to transmit or monitor the sidelink discovery announcements on those cells:

4> initiate transmission of the *SidelinkUEInformation* message to report the acquired system information parameters and stop T370;

1> if *SystemInformationBlockType21* including *sl-V2X-ConfigCommon* is broadcast by the PCell:

2> ensure having a valid version of *SystemInformationBlockType21* for the PCell;

2> if configured by upper layers to receive V2X sidelink communication on a primary frequency or on one or more frequencies included in *v2x-InterFreqInfoList*, if included in *SystemInformationBlockType21* of the PCell:

3> if the UE did not transmit a *SidelinkUEInformation* message since last entering RRC_CONNECTED state; or

3> if since the last time the UE transmitted a *SidelinkUEInformation* message the UE connected to a PCell not broadcasting *SystemInformationBlockType21* including *sl-V2X-ConfigCommon*; or

3> if the last transmission of the *SidelinkUEInformation* message did not include *v2x-CommRxInterestedFreqList*; or if the frequency(ies) configured by upper layers to receive V2X sidelink communication on has changed since the last transmission of the *SidelinkUEInformation* message:

4> initiate transmission of the *SidelinkUEInformation* message to indicate the V2X sidelink communication reception frequency(ies) of interest in accordance with 5.10.2.3;

2> else:

3> if the last transmission of the *SidelinkUEInformation* message included *v2x-CommRxInterestedFreqList*:

4> initiate transmission of the *SidelinkUEInformation* message to indicate it is no longer interested in V2X sidelink communication reception in accordance with 5.10.2.3;

2> if configured by upper layers to transmit V2X sidelink communication on a primary frequency or on one or more frequencies included in *v2x-InterFreqInfoList*, if included in *SystemInformationBlockType21* of the PCell:

3> if the UE did not transmit a *SidelinkUEInformation* message since last entering RRC_CONNECTED state; or

3> if since the last time the UE transmitted a *SidelinkUEInformation* message the UE connected to a PCell not broadcasting *SystemInformationBlockType21* including *sl-V2X-ConfigCommon*; or

- 3> if the last transmission of the *SidelinkUEInformation* message did not include *v2x-CommTxResourceReq*; or if the information carried by the *v2x-CommTxResourceReq* has changed since the last transmission of the *SidelinkUEInformation* message:
 - 4> initiate transmission of the *SidelinkUEInformation* message to indicate the V2X sidelink communication transmission resources required by the UE in accordance with 5.10.2.3;
- 2> else:
 - 3> if the last transmission of the *SidelinkUEInformation* message included *v2x-CommTxResourceReq*:
 - 4> initiate transmission of the *SidelinkUEInformation* message to indicate it no longer requires V2X sidelink communication transmission resources in accordance with 5.10.2.3;

5.10.2.3 Actions related to transmission of *SidelinkUEInformation* message

The UE shall set the contents of the *SidelinkUEInformation* message as follows:

- 1> if the UE initiates the procedure to indicate it is (no more) interested to receive sidelink communication or discovery or receive V2X sidelink communication or to request (configuration/ release) of sidelink communication or V2X sidelink communication or sidelink discovery transmission resources (i.e. UE includes all concerned information, irrespective of what triggered the procedure):
 - 2> if *SystemInformationBlockType18* is broadcast by the PCell:
 - 3> if configured by upper layers to receive sidelink communication:
 - 4> include *commRxInterestedFreq* and set it to the sidelink communication frequency;
 - 3> if configured by upper layers to transmit non-relay related one-to-many sidelink communication:
 - 4> include *commTxResourceReq* and set its fields as follows:
 - 5> set *carrierFreq* to indicate the sidelink communication frequency i.e. the same value as indicated in *commRxInterestedFreq* if included;
 - 5> set *destinationInfoList* to include the non-relay related one-to-many sidelink communication transmission destination(s) for which it requests E-UTRAN to assign dedicated resources;
 - 3> if configured by upper layers to transmit non-relay related one-to-one sidelink communication; and
 - 3> if *commTxResourceUC-ReqAllowed* is included in *SystemInformationBlockType18*:
 - 4> include *commTxResourceReqUC* and set its fields as follows:
 - 5> set *carrierFreq* to indicate the one-to-one sidelink communication frequency i.e. the same value as indicated in *commRxInterestedFreq* if included;
 - 5> set *destinationInfoList* to include the non-relay related one-to-one sidelink communication transmission destination(s) for which it requests E-UTRAN to assign dedicated resources;
 - 3> if configured by upper layers to transmit relay related one-to-one sidelink communication; and
 - 3> if *SystemInformationBlockType19* is broadcast by the PCell including *discConfigRelay*; and
 - 3> if the UE is acting as sidelink relay UE; or if the UE has a selected sidelink relay UE; and if the sidelink remote UE threshold conditions as specified in 5.10.11.5 are met:
 - 4> include *commTxResourceReqRelayUC* and set its fields as follows:
 - 5> set *destinationInfoList* to include the one-to-one sidelink communication transmission destination(s) for which it requests E-UTRAN to assign dedicated resources;
 - 4> include *ue-Type* and set it to *relayUE* if the UE is acting as sidelink relay UE and to *remoteUE* otherwise;
 - 3> if configured by upper layers to transmit relay related one-to-many sidelink communication; and

- 3> if *SystemInformationBlockType19* is broadcast by the PCell including *discConfigRelay*; and
- 3> if the UE is acting as sidelink relay UE:
 - 4> include *commTxResourceReqRelay* and set its fields as follows:
 - 5> set *destinationInfoList* to include the one-to-many sidelink communication transmission destination(s) for which it requests E-UTRAN to assign dedicated resources;
 - 4> include *ue-Type* and set it to *relayUE*;
- 2> if *SystemInformationBlockType19* is broadcast by the PCell:
 - 3> if configured by upper layers to receive sidelink discovery announcements on a serving frequency or one or more frequencies included in *discInterFreqList*, if included in *SystemInformationBlockType19*:
 - 4> include *discRxInterest*;
 - 3> if the UE is configured by upper layers to transmit non-PS related sidelink discovery announcements:
 - 4> for each frequency on which the UE is configured to transmit non-PS related sidelink discovery announcements that concerns the primary frequency or that is included in *discInterFreqList* with *discTxResourcesInterFreq* included within *discResourcesNonPS* and not set to *noTxOnCarrier*:
 - 5> for the first frequency, include *discTxResourceReq* and set it to indicate the number of discovery messages for sidelink discovery announcement(s) for which it requests E-UTRAN to assign dedicated resources as well as the concerned frequency, if different from the primary;
 - 5> for any additional frequency, include *discTxResourceReqAddFreq* and set it to indicate the number of discovery messages for sidelink discovery announcement(s) for which it requests E-UTRAN to assign dedicated resources as well as the concerned frequency;
 - 3> if configured by upper layers to transmit PS related sidelink discovery announcements; and
 - 3> if the frequency on which the UE is configured to transmit PS related sidelink discovery announcements either concerns the primary frequency or, in case of non-relay PS related sidelink discovery announcements, is included in *discInterFreqList* with *discTxResources InterFreq* included within *discResourcesPS* and not set to *noTxOnCarrier*:
 - 4> if configured by upper layers to transmit non-relay PS related sidelink discovery announcements and *SystemInformationBlockType19* includes *discConfigPS*; or
 - 4> if the UE is acting as sidelink relay UE; and if *SystemInformationBlockType19* includes *discConfigRelay*; and if the sidelink relay UE threshold conditions as specified in 5.10.10.4 are met; or
 - 4> if the UE is selecting a sidelink relay UE / has a selected sidelink relay UE; and if *SystemInformationBlockType19* includes *discConfigRelay*; and if the sidelink remote UE threshold conditions as specified in 5.10.11.5 are met:
 - 5> include *discTxResourceReqPS* and set it to indicate the number of discovery messages for PS related sidelink discovery announcement(s) for which it requests E-UTRAN to assign dedicated resources as well as the concerned frequency, if different from the primary;
- 2> if *SystemInformationBlockType21* is broadcast by the PCell and *SystemInformationBlockType21* includes *sl-V2X-ConfigCommon*:
 - 3> if configured by upper layers to receive V2X sidelink communication:
 - 4> include *v2x-CommRxInterestedFreqList* and set it to the frequency(ies) for V2X sidelink communication reception;
 - 3> if configured by upper layers to transmit V2X sidelink communication:
 - 4> if configured by upper layers to transmit P2X related V2X sidelink communication:
 - 5> include *p2x-CommTxType* set to *true*;

- 4> include *v2x-CommTxResourceReq* and set its fields as follows for each frequency on which the UE is configured for V2X sidelink communication transmission:
 - 5> set *carrierFreqCommTx* to indicate the frequency for V2X sidelink communication transmission;
 - 5> set *v2x-TypeTxSync* to the current synchronization reference type used on the associated *carrierFreqCommTx* for V2X sidelink communication transmission;
 - 5> set *v2x-DestinationInfoList* to include the V2X sidelink communication transmission destination(s) for which it requests E-UTRAN to assign dedicated resources;
- 1> else if the UE initiates the procedure to request sidelink discovery transmission and/ or reception gaps:
 - 2> if the UE is configured with *gapRequestsAllowedDedicated* set to *true*; or
 - 2> if the UE is not configured with *gapRequestsAllowedDedicated* and *gapRequestsAllowedCommon* is included in *SystemInformationBlockType19*:
 - 3> if the UE requires sidelink discovery gaps to monitor the sidelink discovery announcements the UE is configured to monitor by upper layers:
 - 4> include *discRxGapReq* and set it to indicate, for each frequency that either concerns the primary frequency or is included in *discInterFreqList* on which the UE is configured to monitor sidelink discovery announcements and for which it requires sidelink discovery gaps to do so, the gap pattern(s) as well as the concerned frequency, if different from the primary;
 - 3> if the UE requires sidelink discovery gaps to transmit the sidelink discovery announcements the UE is configured to transmit by upper layers:
 - 4> include *discTxGapReq* and set it to indicate, for each frequency that either concerns the primary or is included in *discInterFreqList* on which the UE is configured to transmit sidelink discovery announcements and for which it requires sidelink discovery gaps to do so, the gap pattern(s) as well as the concerned frequency, if different from the primary;
- 1> else if the UE initiates the procedure to report the system information parameters related to sidelink discovery of carriers other than the primary:
 - 2> include *discSysInfoReportFreqList* and set it to report the system information parameter acquired from the cells on those carriers;

The UE shall submit the *SidelinkUEInformation* message to lower layers for transmission.

5.10.3 Sidelink communication monitoring

A UE capable of sidelink communication that is configured by upper layers to receive sidelink communication shall:

- 1> if the conditions for sidelink communication operation as defined in 5.10.1a are met:
 - 2> if in coverage on the frequency used for sidelink communication, as defined in TS 36.304 [4, 11.4]:
 - 3> if the cell chosen for sidelink communication reception broadcasts *SystemInformationBlockType18* including *commRxPool*:
 - 4> configure lower layers to monitor sidelink control information and the corresponding data using the pool of resources indicated by *commRxPool*;

NOTE 1: If *commRxPool* includes one or more entries including *rxParametersNCell*, the UE may only monitor such entries if the associated PSS/SSS or SLSSIDs is detected. When monitoring such pool(s), the UE applies the timing of the concerned PSS/SSS or SLSS.

- 2> else (i.e. out of coverage on the sidelink carrier):
 - 3> configure lower layers to monitor sidelink control information and the corresponding data using the pool of resources that were preconfigured (i.e. *preconfigComm* in *SL-Preconfiguration* defined in 9.3);

NOTE 2: The UE may monitor in accordance with the timing of the selected SyncRef UE, or if the UE does not have a selected SyncRef UE, based on the UE's own timing.

5.10.4 Sidelink communication transmission

A UE capable of sidelink communication that is configured by upper layers to transmit non-relay related sidelink communication and has related data to be transmitted or a UE capable of relay related sidelink communication that is configured by upper layers to transmit relay related sidelink communications and satisfies the conditions for relay related sidelink communication specified in this clause shall:

- 1> if the conditions for sidelink communication operation as defined in 5.10.1a are met:
 - 2> if in coverage on the frequency used for sidelink communication, as defined in TS 36.304 [4, 11.4]:
 - 3> if the UE is in RRC_CONNECTED and uses the PCell for sidelink communication:
 - 4> if the UE is configured, by the current PCell/ the PCell in which physical layer problems or radio link failure was detected, with *commTxResources* set to *scheduled*:
 - 5> if T310 or T311 is running; and if the PCell at which the UE detected physical layer problems or radio link failure broadcasts *SystemInformationBlockType18* including *commTxPoolExceptional*; or
 - 5> if T301 is running and the cell on which the UE initiated connection re-establishment broadcasts *SystemInformationBlockType18* including *commTxPoolExceptional*:
 - 6> configure lower layers to transmit the sidelink control information and the corresponding data using the pool of resources indicated by the first entry in *commTxPoolExceptional*;
 - 5> else:
 - 6> configure lower layers to request E-UTRAN to assign transmission resources for sidelink communication;
 - 4> else if the UE is configured with *commTxPoolNormalDedicated* or *commTxPoolNormalDedicatedExt*:
 - 5> if *priorityList* is included for the entries of *commTxPoolNormalDedicated* or *commTxPoolNormalDedicatedExt*:
 - 6> configure lower layers to transmit the sidelink control information and the corresponding data using the one or more pools of resources indicated by *commTxPoolNormalDedicated* or *commTxPoolNormalDedicatedExt* i.e. indicate all entries of this field to lower layers;
 - 5> else:
 - 6> configure lower layers to transmit the sidelink control information and the corresponding data using the pool of resources indicated by the first entry in *commTxPoolNormalDedicated*;
 - 3> else (i.e. sidelink communication in RRC_IDLE or on cell other than PCell in RRC_CONNECTED):
 - 4> if the cell chosen for sidelink communication transmission broadcasts *SystemInformationBlockType18*:
 - 5> if *SystemInformationBlockType18* includes *commTxPoolNormalCommon*:
 - 6> if *priorityList* is included for the entries of *commTxPoolNormalCommon* or *commTxPoolNormalCommonExt*:
 - 7> configure lower layers to transmit the sidelink control information and the corresponding data using the one or more pools of resources indicated by *commTxPoolNormalCommon* and/or *commTxPoolNormalCommonExt* i.e. indicate all entries of these fields to lower layers;
 - 6> else:
 - 7> configure lower layers to transmit the sidelink control information and the corresponding data using the pool of resources indicated by the first entry in *commTxPoolNormalCommon*;

- 5> else if *SystemInformationBlockType18* includes *commTxPoolExceptional*:
 - 6> from the moment the UE initiates connection establishment until receiving an *RRCConnectionReconfiguration* including *sl-CommConfig* or until receiving an *RRCConnectionRelease* or an *RRCConnectionReject*;
 - 7> configure lower layers to transmit the sidelink control information and the corresponding data using the pool of resources indicated by the first entry in *commTxPoolExceptional*;
- 2> else (i.e. out of coverage on sidelink carrier):
 - 3> if *priorityList* is included for the entries of *preconfigComm* in *SL-Preconfiguration* defined in 9.3:
 - 4> configure lower layers to transmit the sidelink control information and the corresponding data using the one or more pools of resources indicated *preconfigComm* i.e. indicate all entries of this field to lower layers and in accordance with the timing of the selected SyncRef UE, or if the UE does not have a selected SyncRef UE, based on the UEs own timing;
 - 3> else:
 - 4> configure lower layers to transmit the sidelink control information and the corresponding data using the pool of resources that were preconfigured i.e. indicated by the first entry in *preconfigComm* in *SL-Preconfiguration* defined in 9.3 and in accordance with the timing of the selected SyncRef UE, or if the UE does not have a selected SyncRef UE, based on the UEs own timing;

The conditions for relay related sidelink communication are as follows:

- 1> if the transmission concerns sidelink relay communication; and the UE is capable of sidelink relay or sidelink remote operation:
 - 2> if the UE is in RRC_IDLE; and if the UE has a selected sidelink relay UE: configure lower layers to transmit the sidelink control information and the corresponding data using the resources, as specified previously in this clause, only if the following condition is met:
 - 3> if the sidelink remote UE threshold conditions as specified in 5.10.11.5 are met; and if the UE configured lower layers with a pool of resources included in *SystemInformationBlockType18* (i.e. *commTxPoolNormalCommon*, *commTxPoolNormalCommonExt* or *commTxPoolExceptional*); and *commTxAllowRelayCommon* is included in *SystemInformationBlockType18*;
 - 2> if the UE is in RRC_CONNECTED: configure lower layers to transmit the sidelink control information and the corresponding data using the resources, as specified previously in this clause, only if the following condition is met:
 - 3> if the UE configured lower layers with resources provided by dedicated signalling (i.e. *commTxResources*); and the UE is configured with *commTxAllowRelayDedicated* set to *true*;

5.10.5 Sidelink discovery monitoring

A UE capable of non-PS related sidelink discovery that is configured by upper layers to monitor non-PS related sidelink discovery announcements shall:

- 1> for each frequency the UE is configured to monitor non-PS related sidelink discovery announcements on, prioritising the frequencies included in *discInterFreqList*, if included in *SystemInformationBlockType19*:
 - 2> if the PCell or the cell the UE is camping on indicates the pool of resources to monitor sidelink discovery announcements on by *discRxResourcesInterFreq* in *discResourcesNonPS* within *discInterFreqList* in *SystemInformationBlockType19*:
 - 3> configure lower layers to monitor sidelink discovery announcements using the pool of resources indicated by *discRxResourcesInterFreq* in *discResourcesNonPS* within *SystemInformationBlockType19*;
 - 2> else if the cell used for sidelink discovery monitoring broadcasts *SystemInformationBlockType19*:

- 3> configure lower layers to monitor sidelink discovery announcements using the pool of resources indicated by *discRxPool* in *SystemInformationBlockType19*;
- 2> if the UE is configured with *discRxGapConfig* and requires sidelink discovery gaps to monitor sidelink discovery announcements on the concerned frequency;
 - 3> configure lower layers to monitor the concerned frequency using the sidelink discovery gaps indicated by *discRxGapConfig*;
- 2> else:
 - 3> configure lower layers to monitor the concerned frequency without affecting normal operation;

A UE capable of PS related sidelink discovery that is configured by upper layers to monitor PS related sidelink discovery announcements shall:

- 1> if out of coverage on the frequency, as defined in TS 36.304 [4, 11.4]:
 - 2> configure lower layers to monitor sidelink discovery announcements using the pool of resources that were preconfigured (i.e. indicated by *discRxPoolList* within *preconfigDisc* in *SL-Preconfiguration* defined in 9.3);
- 1> else if configured by upper layers to monitor non-relay PS related discovery announcements; and if the PCell or the cell the UE is camping on indicates a pool of resources to monitor sidelink discovery announcements on by *discRxResourcesInterFreq* in *discResourcesPS* within *discInterFreqList* in *SystemInformationBlockType19*:
 - 2> configure lower layers to monitor sidelink discovery announcements using the pool of resources indicated by *discRxResourcesInterFreq* in *discResourcesPS* in *SystemInformationBlockType19*;
- 1> else if configured by upper layers to monitor PS related sidelink discovery announcements; and if the cell used for sidelink discovery monitoring broadcasts *SystemInformationBlockType19*:
 - 2> configure lower layers to monitor sidelink discovery announcements using the pool of resources indicated by *discRxPoolPS* in *SystemInformationBlockType19*;
- 1> if the UE is configured with *discRxGapConfig* and requires sidelink discovery gaps to monitor sidelink discovery announcements on the concerned frequency;
 - 2> configure lower layers to monitor the concerned frequency using the sidelink discovery gaps indicated by *discRxGapConfig*;
- 1> else:
 - 2> configure lower layers to monitor the concerned frequency without affecting normal operation;

NOTE 1: The requirement not to affect normal UE operation also applies for the acquisition of sidelink discovery related system and synchronisation information from inter-frequency cells.

NOTE 2: The UE is not required to monitor all pools simultaneously.

NOTE 3: It is up to UE implementation to decide whether a cell is sufficiently good to be used to monitor sidelink discovery announcements.

NOTE 4: If *discRxPool*, *discRxPoolPS* or *discRxResourcesInterFreq* includes one or more entries including *rxParameters*, the UE may only monitor such entries if the associated SLSSIDs are detected. When monitoring such pool(s) the UE applies the timing of the corresponding SLSS.

5.10.6 Sidelink discovery announcement

A UE capable of non-PS related sidelink discovery that is configured by upper layers to transmit non-PS related sidelink discovery announcements shall, for each frequency the UE is configured to transmit such announcements on:

NOTE: In case the configured resources are insufficient it is up to UE implementation to decide which sidelink discovery announcements to transmit.

- 1> if the frequency used to transmit sidelink discovery announcements concerns the serving frequency (RRC_IDLE) or primary frequency (RRC_CONNECTED):

- 2> if the UE's serving cell (RRC_IDLE) or PCell (RRC_CONNECTED) is suitable as defined in TS 36.304 [4]:
 - 3> if the UE is in RRC_CONNECTED (i.e. PCell is used for sidelink discovery announcement):
 - 4> if the UE is configured with *discTxResources* set to *scheduled*:
 - 5> configure lower layers to transmit the sidelink discovery announcement using the assigned resources indicated by *scheduled* in *discTxResources*;
 - 4> else if the UE is configured with *discTxPoolDedicated* (i.e. *discTxResources* set to *ue-Selected*):
 - 5> select an entry of the list of resource pool entries in *discTxPoolDedicated* and configure lower layers to use it to transmit the sidelink discovery announcements as specified in 5.10.6a;
 - 3> else if T300 is not running (i.e. UE in RRC_IDLE, announcing via serving cell):
 - 4> if *SystemInformationBlockType19* of the serving cell includes *discTxPoolCommon*:
 - 5> select an entry of the list of resource pool entries in *discTxPoolCommon* and configure lower layers to use it to transmit the sidelink discovery announcements as specified in 5.10.6a;
- 1> else if, for the frequency used to transmit sidelink discovery announcements on, the UE is configured with dedicated resources (i.e. with *discTxResources-r12*, if *discTxCarrierFreq* is included in *discTxInterFreqInfo*, or with *discTxResources* within *discTxInfoInterFreqListAdd* in *discTxInterFreqInfo*); and the conditions for non-PS related sidelink discovery operation as defined in 5.10.1c are met:
 - 2> if the UE is configured with *discTxResources* set to *scheduled*:
 - 3> configure lower layers to transmit the sidelink discovery announcement using the assigned resources indicated by *scheduled* in *discTxResources*;
 - 2> else if the UE is configured with *discTxResources* set to *ue-Selected*:
 - 3> select an entry of the list of resource pool entries in *ue-Selected* and configure lower layers to use it to transmit the sidelink discovery announcements as specified in 5.10.6a;
- 1> else if the frequency used to transmit sidelink discovery announcements on is included in *discInterFreqList* within *SystemInformationBlockType19* of the serving cell/ PCell, and *discTxResourcesInterFreq* within *discResourcesNonPS* in the corresponding entry of *discInterFreqList* is set to *discTxPoolCommon* (i.e. serving cell/ PCell broadcasts pool of resources) and the conditions for non-PS related sidelink discovery operation as defined in 5.10.1c are met; or
 - 1> else if *discTxPoolCommon* is included in *SystemInformationBlockType19* acquired from cell selected on the sidelink discovery announcement frequency; and the conditions for non-PS related sidelink discovery operation as defined in 5.10.1c are met:
 - 2> select an entry of the list of resource pool entries in *discTxPoolCommon* and configure lower layers to use it to transmit the sidelink discovery announcements as specified in 5.10.6a;
- 1> if the UE is configured with *discTxGapConfig* and requires sidelink discovery gaps to transmit sidelink discovery announcements on the concerned frequency;
 - 2> configure lower layers to transmit on the concerned frequency using the sidelink discovery gaps indicated by *discTxGapConfig*,
- 1> else:
 - 2> configure lower layers to transmit on the concerned frequency without affecting normal operation;

A UE capable of PS related sidelink discovery that is configured by upper layers to transmit PS related sidelink discovery announcements shall:

- 1> if out of coverage on the frequency used to transmit PS related sidelink discovery announcements as defined in TS 36.304 [4, 11.4] and the conditions for PS -related sidelink discovery operation as defined in 5.10.1b are met:
 - 2> if configured by upper layers to transmit non-relay PS related sidelink discovery announcements; or

- 2> if the UE is selecting a sidelink relay UE/ has a selected sidelink relay UE:
 - 3> configure lower layers to transmit sidelink discovery announcements using the pool of resources that were preconfigured and in accordance with the following;
 - 4> randomly select, using a uniform distribution, an entry of *preconfigDisc* in *SL-Preconfiguration* defined in 9.3;
 - 4> using the timing of the selected SyncRef UE, or if the UE does not have a selected SyncRef UE, based on the UEs own timing;
- 1> else if the frequency used to transmit sidelink discovery announcements concerns the serving frequency (RRC_IDLE) or primary frequency (RRC_CONNECTED) and the conditions for PS related sidelink discovery operation as defined in 5.10.1b are met:
 - 2> if configured by upper layers to transmit non-relay PS related sidelink discovery announcements; or
 - 2> if the UE is acting as sidelink relay UE; and if the UE is in RRC_IDLE; and if the sidelink relay UE threshold conditions as specified in 5.10.10.4 are met; or
 - 2> if the UE is acting as sidelink relay UE; and if the UE is in RRC_CONNECTED; or
 - 2> if the UE is selecting a sidelink relay UE / has a selected sidelink relay UE; and if the sidelink remote UE threshold conditions as specified in 5.10.11.5 are met:
 - 3> if the UE is configured with *discTxPoolPS-Dedicated*; or
 - 3> if the UE is in RRC_IDLE; and if *discTxPoolPS-Common* is included in *SystemInformationBlockType19*:
 - 4> select an entry of the list of resource pool entries and configure lower layers to use it to transmit the sidelink discovery announcements as specified in 5.10.6a;
 - 3> else if the UE is configured with *discTxResourcesPS* set to *scheduled*:
 - 4> configure lower layers to transmit the sidelink discovery announcement using the assigned resources indicated by *scheduled* in *discTxResourcesPS*;
- 1> else if, for the frequency used to transmit sidelink discovery announcements on, the UE is configured with dedicated resources (i.e. with *discTxResourcesPS* in *discTxInterFreqInfo* within *sl-DiscConfig*); and the conditions for PS related sidelink discovery operation as defined in 5.10.1b are met:
 - 2> if configured by upper layers to transmit non-relay PS related sidelink discovery announcements:
 - 3> if the UE is configured with *discTxResourcesPS* set to *scheduled*:
 - 4> configure lower layers to transmit the sidelink discovery announcement using the assigned resources indicated by *scheduled* in *discTxResourcesPS*;
 - 3> else if the UE is configured with *discTxResourcesPS* set to *ue-Selected*:
 - 4> select an entry of the list of resource pool entries in *ue-Selected* and configure lower layers to use it to transmit the sidelink discovery announcements as specified in 5.10.6a;
 - 1> else if the frequency used to transmit sidelink discovery announcements on is included in *discInterFreqList* within *SystemInformationBlockType19* of the serving cell/ PCell, while *discTxResourcesInterFreq* within *discResourcesPS* in the corresponding entry of *discInterFreqList* is set to *discTxPoolCommon* (i.e. serving cell/ PCell broadcasts pool of resources) and the conditions for PS related sidelink discovery operation as defined in 5.10.1b are met:
 - 2> if configured by upper layers to transmit non-relay PS related sidelink discovery announcements:
 - 3> select an entry of the list of resource pool entries in *discTxPoolCommon* and configure lower layers to use it to transmit the sidelink discovery announcements as specified in 5.10.6a;
 - 1> else if *discTxPoolPS-Common* is included in *SystemInformationBlockType19* acquired from cell selected on the sidelink discovery announcement frequency; and the conditions for PS related sidelink discovery operation as defined in 5.10.1b are met:

- 2> if configured by upper layers to transmit non-relay PS related sidelink discovery announcements:
 - 3> select an entry of the list of resource pool entries in *discTxPoolPS-Common* and configure lower layers to use it to transmit the sidelink discovery announcements as specified in 5.10.6a;
- 1> if the UE is configured with *discTxGapConfig* and requires gaps to transmit sidelink discovery announcements on the concerned frequency;
 - 2> configure lower layers to transmit on the concerned frequency using the gaps indicated by *discTxGapConfig*,
- 1> else:
 - 2> configure lower layers to transmit on the concerned frequency without affecting normal operation;

5.10.6a Sidelink discovery announcement pool selection

A UE that is configured with a list of resource pool entries for sidelink discovery announcement transmission (i.e. by *SL-DiscTxPoolList*) shall:

- 1> if *poolSelection* is set to *rsrpBased*:
 - 2> select a pool from the list of pools the UE is configured with for which the RSRP measurement of the reference cell selected as defined in 5.10.6b, after applying the layer 3 filter defined by *quantityConfig* as specified in 5.5.3.2, is in-between *threshLow* and *threshHigh*;
- 1> else:
 - 2> randomly select, using a uniform distribution, a pool from the list of pools the UE is configured with;
- 1> configure lower layers to transmit the sidelink discovery announcement using the selected pool of resources;

NOTE 1: When performing resource pool selection based on RSRP, the UE uses the latest results of the available measurements used for cell reselection evaluation in RRC_IDLE/ for measurement report triggering evaluation in RRC_CONNECTED, which are performed in accordance with the performance requirements specified in TS 36.133 [16].

5.10.6b Sidelink discovery announcement reference carrier selection

A UE capable of sidelink discovery that is configured by upper layers to transmit sidelink discovery announcements shall:

- 1> for each frequency the UE is transmitting sidelink discovery announcements on, select a cell to be used as reference for synchronisation and DL measurements in accordance with the following:
 - 2> if the frequency concerns the primary frequency:
 - 3> use the PCell as reference;
 - 2> else if the frequency concerns a secondary frequency:
 - 3> use the concerned SCell as reference;
 - 2> else if the UE is configured with *discTxRefCarrierDedicated* for the frequency:
 - 3> use the cell indicated by this field as reference;
 - 2> else if the UE is configured with *refCarrierCommon* for the frequency:
 - 3> use the serving cell (RRC_IDLE)/ PCell (RRC_CONNECTED) as reference;
 - 2> else:
 - 3> use the DL frequency paired with the one used to transmit sidelink discovery announcements on as reference;

5.10.7 Sidelink synchronisation information transmission

5.10.7.1 General

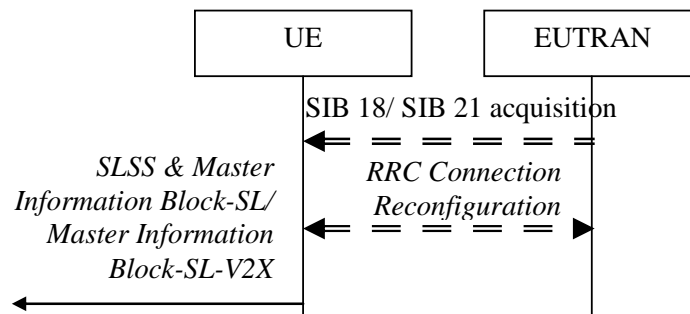

Figure 5.10.7.1-1: Synchronisation information transmission for sidelink communication or V2X sidelink communication, in (partial) coverage

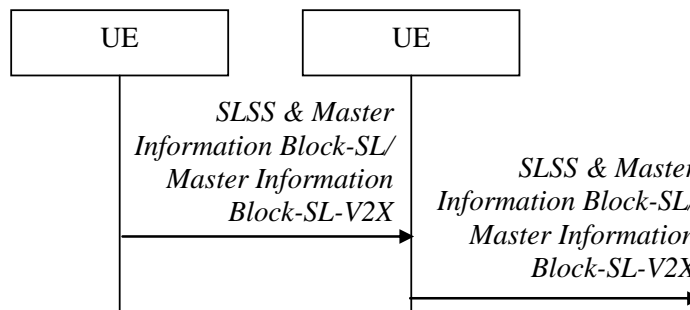

Figure 5.10.7.1-2: Synchronisation information transmission for sidelink communication or V2X sidelink communication / sidelink discovery, out of coverage

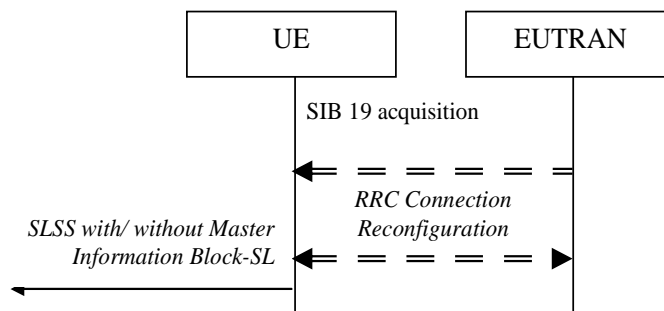

Figure 5.10.7.1-3: Synchronisation information transmission for sidelink discovery, in (partial) coverage

The purpose of this procedure is to provide synchronisation information to a UE. For sidelink discovery, the synchronisation information concerns a Sidelink Synchronisation Signal (SLSS) and, in case of PS related discovery, also timing information and some additional configuration parameters (i.e. the *MasterInformationBlock-SL* message), while for sidelink communication or V2X sidelink communication it concerns an SLSS and the *MasterInformationBlock-SL* or *MasterInformationBlock-SL-V2X* message. A UE transmits synchronisation information either when E-UTRAN configures it to do so by dedicated signalling (i.e. network based), or when not configured by dedicated signalling (i.e. UE based) and E-UTRAN broadcasts (in coverage) or pre-configures a threshold (out of coverage).

The synchronisation information transmitted by the UE may be derived from information/ signals received from E-UTRAN (in coverage) or received from a UE acting as synchronisation reference for the transmitting UE or received from GNSS. In the remainder, the UE acting as synchronisation reference is referred to as SyncRef UE.

5.10.7.2 Initiation

A UE capable of SLSS transmission shall, when transmitting sidelink discovery announcements in accordance with 5.10.6 and when the following conditions are met:

- 1> if in coverage on the frequency used for sidelink discovery, as defined in TS 36.304 [4, 11.4]:
 - 2> if in RRC_CONNECTED; and if *networkControlledSyncTx* is configured and set to *on*; or
 - 2> if *networkControlledSyncTx* is not configured; and *syncTxThreshIC* is included in *SystemInformationBlockType19*; and the RSRP measurement of the reference cell, selected as defined in 5.10.6b, is below the value of *syncTxThreshIC*;
 - 3> if the sidelink discovery announcements are not PS related; or if *syncTxPeriodic* is not included:
 - 4> transmit SLSS on the frequency used for sidelink discovery in accordance with 5.10.7.3 and TS 36.211 [21];
 - 3> else:
 - 4> transmit SLSS on the frequency used for sidelink discovery in accordance with 5.10.7.3 and TS 36.211 [21];
 - 4> transmit the *MasterInformationBlock-SL* message on the frequency used for sidelink discovery, in the same subframe as SLSS, and in accordance with 5.10.7.4;
- 1> else (i.e. out of coverage, PS):
 - 2> if *syncTxThreshOoC* is included in the preconfigured sidelink parameters (i.e. *SL-Preconfiguration* defined in 9.3); and the UE has not selected SyncRef UE or the S-RSRP measurement result of the selected SyncRef UE is below the value of *syncTxThreshOoC*;
 - 3> transmit SLSS on the frequency used for sidelink discovery in accordance with 5.10.7.3 and TS 36.211 [21];
 - 3> transmit the *MasterInformationBlock-SL* message on the frequency used for sidelink discovery, in the same subframe as SLSS, and in accordance with 5.10.7.4;

A UE capable of sidelink communication that is configured by upper layers to transmit sidelink communication shall, irrespective of whether or not it has data to transmit:

- 1> if the conditions for sidelink communication operation as defined in 5.10.1a are met:
 - 2> if in RRC_CONNECTED; and if *networkControlledSyncTx* is configured and set to *on*:
 - 3> transmit SLSS in accordance with 5.10.7.3 and TS 36.211 [21];
 - 3> transmit the *MasterInformationBlock-SL* message, in the same subframe as SLSS, and in accordance with 5.10.7.4;

A UE shall, when transmitting sidelink communication in accordance with 5.10.4 and when the following conditions are met:

- 1> if in coverage on the frequency used for sidelink communication, as defined in TS 36.304 [4, 11.4]:
 - 2> if the UE is in RRC_CONNECTED; and *networkControlledSyncTx* is not configured; and *syncTxThreshIC* is included in *SystemInformationBlockType18*; and the RSRP measurement of the cell chosen for sidelink communication transmission is below the value of *syncTxThreshIC*; or
 - 2> if the UE is in RRC_IDLE; and *syncTxThreshIC* is included in *SystemInformationBlockType18*; and the RSRP measurement of the cell chosen for sidelink communication transmission is below the value of *syncTxThreshIC*;
 - 3> transmit SLSS in accordance with 5.10.7.3 and TS 36.211 [21];
 - 3> transmit the *MasterInformationBlock-SL* message, in the same subframe as SLSS, and in accordance with 5.10.7.4;

1> else (i.e. out of coverage):

- 2> if *syncTxThreshOoC* is included in the preconfigured sidelink parameters (i.e. *SL-Preconfiguration* defined in 9.3); and the UE has no selected SyncRef UE or the S-RSRP measurement result of the selected SyncRef UE is below the value of *syncTxThreshOoC*:
 - 3> transmit SLSS in accordance with 5.10.7.3 and TS 36.211 [21];
 - 3> transmit the *MasterInformationBlock-SL* message, in the same subframe as SLSS, and in accordance with 5.10.7.4;

A UE capable of V2X sidelink communication and SLSS/PSBCH transmission shall, when transmitting non-P2X related V2X sidelink communication in accordance with 5.10.13, and if the conditions for V2X sidelink communication operation as defined in 5.10.1d are met and when the following conditions are met:

- 1> if in coverage on the frequency used for V2X sidelink communication, as defined in TS 36.304 [4, 11.4]; and has selected GNSS or the cell as synchronization reference as defined in 5.10.13.3; or
- 1> if out of coverage on the frequency used for V2X sidelink communication, as defined in TS 36.304 [4, 11.4], and the frequency used to transmit V2X sidelink communication is included in *v2x-InterFreqInfoList* in *RRCConnectionReconfiguration* or in *v2x-InterFreqInfoList* within *SystemInformationBlockType21* of the serving cell/ PCell; and has selected GNSS or the cell as synchronization reference as defined in 5.10.13.3:
 - 2> if in RRC_CONNECTED; and if *networkControlledSyncTx* is configured and set to *on*; or
 - 2> if *networkControlledSyncTx* is not configured; and for the concerned frequency *syncTxThreshIC* is configured; and the RSRP measurement of the reference cell, selected as defined in 5.10.13.3, for V2X sidelink communication transmission is below the value of *syncTxThreshIC*:
 - 3> transmit SLSS on the frequency used for V2X sidelink communication in accordance with 5.10.7.3 and TS 36.211 [21];
 - 3> transmit the *MasterInformationBlock-SL-V2X* message on the frequency used for V2X sidelink communication, in the same subframe as SLSS, and in accordance with 5.10.7.4;

1> else:

- 2> for the frequency used for V2X sidelink communication, if *syncOffsetIndicators* is included in *SL-V2X-Preconfiguration*:
 - 3> if *syncTxThreshOoC* is included in *SL-V2X-Preconfiguration*; and the UE is not directly synchronized to GNSS, and the UE has no selected SyncRef UE or the S-RSRP measurement result of the selected SyncRef UE is below the value of *syncTxThreshOoC*; or
 - 3> if the UE selects GNSS as the synchronization reference source:
 - 4> transmit SLSS in accordance with 5.10.7.3 and TS 36.211 [21];
 - 4> transmit the *MasterInformationBlock-SL-V2X* message, in the same subframe as SLSS, and in accordance with 5.10.7.4;

5.10.7.3 Transmission of SLSS

The UE shall select the SLSSID and the subframe in which to transmit SLSS as follows:

- 1> if triggered by sidelink discovery announcement and in coverage on the frequency used for sidelink discovery, as defined in TS 36.304 [4, 11.4]:
 - 2> select the SLSSID included in the entry of *discSyncConfig* included in the received *SystemInformationBlockType19*, that includes *txParameters*;
 - 2> use *syncOffsetIndicator* corresponding to the selected SLSSID;
 - 2> for each pool used for the transmission of discovery announcements (each corresponding to the selected SLSSID):

- 3> if a subframe indicated by *syncOffsetIndicator* corresponds to the first subframe of the discovery transmission pool;
 - 4> if *discTxGapConfig* is configured and includes the concerned subframe; or the subframe is not used for regular uplink transmission:
 - 5> select the concerned subframe;
 - 3> else
 - 4> if *discTxGapConfig* is configured and includes the concerned subframe; or the subframe is not used for regular uplink transmission:
 - 5> select the subframe indicated by *syncOffsetIndicator* that precedes and which, in time domain, is nearest to the first subframe of the discovery transmission pool;
 - 3> if the sidelink discovery announcements concern PS; and if *syncTxPeriodic* is included:
 - 4> additionally select each subframe that periodically occurs 40 subframes after the selected subframe;
- 1> if triggered by sidelink communication and in coverage on the frequency used for sidelink communication, as defined in TS 36.304 [4, 11.4]:
 - 2> select the SLSSID included in the entry of *commSyncConfig* that is included in the received *SystemInformationBlockType18* and includes *txParameters*;
 - 2> use *syncOffsetIndicator* corresponding to the selected SLSSID;
 - 2> if in RRC_CONNECTED; and if *networkControlledSyncTx* is configured and set to *on*:
 - 3> select the subframe(s) indicated by *syncOffsetIndicator*;
 - 2> else (when transmitting communication):
 - 3> select the subframe(s) indicated by *syncOffsetIndicator* within the SC period in which the UE intends to transmit sidelink control information or data;
- 1> if triggered by V2X sidelink communication and in coverage on the frequency used for V2X sidelink communication, as defined in TS 36.304 [4, 11.4]; or
- 1> if triggered by V2X sidelink communication, and out of coverage on the frequency used for V2X sidelink communication, and the concerned frequency is included in *v2x-InterFreqInfoList* in *RRCConnectionReconfiguration* or in *v2x-InterFreqInfoList* within *SystemInformationBlockType21* of the serving cell/ PCell;
 - 2> if the UE has selected GNSS as synchronization reference in accordance with 5.10.8.2:
 - 3> select SLSSID 0;
 - 3> use *syncOffsetIndicator* included in the entry of *v2x-SyncConfig* corresponding to the concerned frequency in *v2x-InterFreqInfoList* or within *SystemInformationBlockType21*, that includes *txParameters* and *gnss-Sync*;
 - 3> select the subframe(s) indicated by *syncOffsetIndicator*;
 - 2> if the UE has selected a cell as synchronization reference in accordance with 5.10.8.2:
 - 3> select the SLSSID included in the entry of *v2x-SyncConfig* configured for the concerned frequency in *v2x-InterFreqInfoList* or within *SystemInformationBlockType21*, that includes *txParameters* and does not include *gnss-Sync*;
 - 3> use *syncOffsetIndicator* corresponding to the selected SLSSID;
 - 3> select the subframe(s) indicated by *syncOffsetIndicator*;
- 1> else if triggered by V2X sidelink communication and the UE has GNSS as the synchronization reference:

- 2> select SLSSID 0;
- 2> if *syncOffsetIndicator3* is configured for the frequency used for V2X sidelink communication in *SL-V2X-Preconfiguration*:
 - 3> select the subframe(s) indicated by *syncOffsetIndicator3*;
- 2> else:
 - 3> select the subframe(s) indicated by *syncOffsetIndicator1*;
- 1> else:
 - 2> select the synchronisation reference UE (i.e. SyncRef UE) as defined in 5.10.8;
 - 2> if the UE has a selected SyncRef UE and *inCoverage* in the *MasterInformationBlock-SL* or *MasterInformationBlock-SL-V2X* message received from this UE is set to *TRUE*; or
 - 2> if the UE has a selected SyncRef UE and *inCoverage* in the *MasterInformationBlock-SL* or *MasterInformationBlock-SL-V2X* message received from this UE is set to *FALSE* while the SLSS from this UE is part of the set defined for out of coverage, see TS 36.211 [21]:
 - 3> select the same SLSSID as the SLSSID of the selected SyncRef UE;
 - 3> select the subframe in which to transmit the SLSS according to the *syncOffsetIndicator1* or *syncOffsetIndicator2* included in the preconfigured sidelink parameters (i.e. *preconfigSync* in *SL-Preconfiguration* or *v2x-CommPreconfigSync* in *SL-V2X-Preconfiguration* defined in 9.3) corresponding to the concerned frequency, such that the subframe timing is different from the SLSS of the selected SyncRef UE;
 - 2> else if the UE has a selected SyncRef UE and the SLSS from this UE was transmitted on the subframe indicated by *syncOffsetIndicator3* that is included in the *syncOffsetIndicators* in *SL-V2X-Preconfiguration*, and is corresponding to the frequency used for V2X sidelink communication:
 - 3> select SLSSID 169;
 - 3> select the subframe(s) indicated by *syncOffsetIndicator2*;
 - 2> else if the UE has a selected SyncRef UE:
 - 3> select the SLSSID from the set defined for out of coverage having an index that is 168 more than the index of the SLSSID of the selected SyncRef UE, see TS 36.211 [21];
 - 3> select the subframe in which to transmit the SLSS according to *syncOffsetIndicator1* or *syncOffsetIndicator2* included in the preconfigured sidelink parameters (i.e. *preconfigSync* in *SL-Preconfiguration* or *v2x-CommPreconfigSync* in *SL-V2X-Preconfiguration* defined in 9.3), such that the subframe timing is different from the SLSS of the selected SyncRef UE;
 - 2> else (i.e. no SyncRef UE selected):
 - 3> if triggered by V2X sidelink communication, randomly select, using a uniform distribution, an SLSSID from the set of sequences defined for out of coverage except SLSSID 168 and 169, see TS 36.211 [21];
 - 3> else, randomly select, using a uniform distribution, an SLSSID from the set of sequences defined for out of coverage, see TS 36.211 [21];
 - 3> select the subframe in which to transmit the SLSS according to the *syncOffsetIndicator1* or *syncOffsetIndicator2* (arbitrary selection between these) included in the preconfigured sidelink parameters (i.e. *preconfigSync* in *SL-Preconfiguration* or *v2x-CommPreconfigSync* in *SL-V2X-Preconfiguration* defined in 9.3);

5.10.7.4 Transmission of *MasterInformationBlock-SL* or *MasterInformationBlock-SL-V2X* message

The UE shall set the contents of the *MasterInformationBlock-SL* or *MasterInformationBlock-SL-V2X* message as follows:

- 1> if in coverage on the frequency used for the sidelink operation that triggered this procedure as defined in TS 36.304 [4, 11.4]:
 - 2> set *inCoverage* to *TRUE*;
 - 2> set *sl-Bandwidth* to the value of *ul-Bandwidth* as included in the received *SystemInformationBlockType2* of the cell chosen for the concerned sidelink operation;
 - 2> if *tdd-Config* is included in the received *SystemInformationBlockType1*:
 - 3> set *subframeAssignmentSL* to the value representing the same meaning as of *subframeAssignment* that is included in *tdd-Config* in the received *SystemInformationBlockType1*;
 - 2> else:
 - 3> set *subframeAssignmentSL* to *none*;
 - 2> if triggered by sidelink communication; and if *syncInfoReserved* is included in an entry of *commSyncConfig* from the received *SystemInformationBlockType18*:
 - 3> set *reserved* to the value of *syncInfoReserved* in the received *SystemInformationBlockType18*;
 - 2> if triggered by sidelink discovery; and if *syncInfoReserved* is included in an entry of *discSyncConfig* from the received *SystemInformationBlockType19*:
 - 3> set *reserved* to the value of *syncInfoReserved* in the received *SystemInformationBlockType19*;
 - 2> if triggered by V2X sidelink communication; and if *syncInfoReserved* is included in an entry of *v2x-SyncConfig* from the received *SystemInformationBlockType21*:
 - 3> set *reserved* to the value of *syncInfoReserved* in the received *SystemInformationBlockType21*;
 - 2> else:
 - 3> set all bits in *reserved* to 0;
- 1> else if out of coverage on the frequency used for V2X sidelink communication as defined in TS 36.304 [4, 11.4]; and the concerned frequency is included in *v2x-InterFreqInfoList* in *RRConnectionReconfiguration* or in *v2x-InterFreqInfoList* within *SystemInformationBlockType21* of the serving cell/ PCell:
 - 2> set *inCoverage* to *TRUE*;
 - 2> set *sl-Bandwidth* to the value of the corresponding field included in *v2x-InterFreqInfoList*;
 - 2> set *subframeAssignmentSL* and *reserved* to the value of the corresponding field included in the preconfigured sidelink parameters (i.e. *v2x-CommPreconfigGeneral* in *SL-V2X-Preconfiguration* defined in 9.3);
- 1> else if out of coverage on the frequency used for V2X sidelink communication as defined in TS 36.304 [4, 11.4]; and the UE selects GNSS timing as the synchronization reference source and *syncOffsetIndicator3* is not included in *SL-V2X-Preconfiguration*:
 - 2> set *inCoverage* to *TRUE*;
 - 2> set *sl-Bandwidth*, *subframeAssignmentSL* and *reserved* to the value of the corresponding field included in the preconfigured sidelink parameters (i.e. *v2x-CommPreconfigGeneral* in *SL-V2X-Preconfiguration* defined in 9.3);
- 1> else if the UE has a selected SyncRef UE (as defined in 5.10.8):
 - 2> set *inCoverage* to *FALSE*;

2> set *sl-Bandwidth*, *subframeAssignmentSL* and *reserved* to the value of the corresponding field included in the received *MasterInformationBlock-SL* or *MasterInformationBlock-SL-V2X*;

1> else:

2> set *inCoverage* to *FALSE*;

2> set *sl-Bandwidth*, *subframeAssignmentSL* and *reserved* to the value of the corresponding field included in the preconfigured sidelink parameters (i.e. *preconfigGeneral* in *SL-Preconfiguration* or *v2x-CommPreconfigGeneral* in *SL-V2X-Preconfiguration* defined in 9.3);

1> set *directFrameNumber* and *directSubframeNumber* according to the subframe used to transmit the SLSS, as specified in 5.10.7.3;

1> submit the *MasterInformationBlock-SL* or *MasterInformationBlock-SL-V2X* message to lower layers for transmission upon which the procedure ends;

5.10.7.5 Void

5.10.8 Sidelink synchronisation reference

5.10.8.1 General

The purpose of this procedure is to select a synchronisation reference and used a.o. when transmitting sidelink communication, V2X sidelink communication, sidelink discovery or synchronisation information.

5.10.8.2 Selection and reselection of synchronisation reference

The UE shall:

- 1> if triggered by V2X sidelink communication, and in coverage on the frequency for V2X sidelink communication; or
- 1> if triggered by V2X sidelink communication, and out of coverage on the frequency for V2X sidelink communication, and the frequency used to transmit V2X sidelink communication is included in *v2x-InterFreqInfoList* in *RRCConnectionReconfiguration* or in *v2x-InterFreqInfoList* within *SystemInformationBlockType21* of the serving cell/ PCell:
 - 2> if *typeTxSync* is configured for the concerned frequency and set to *enb*:
 - 3> select a cell as the synchronization reference source as defined in 5.10.13.3;
 - 2> else if *typeTxSync* for the concerned frequency is not configured or is set to *gnss*, and GNSS is reliable in accordance with TS 36.101 [42] and TS 36.133 [16]:
 - 3> select GNSS as the synchronization reference source;
 - 2> else (i.e., there is no GNSS which is reliable in accordance with TS 36.101 [42] and TS 36.133 [16]):
 - 3> search SLSSID=0 on the concerned frequency to detect candidate SLSS, in accordance with TS 36.133 [16];
 - 3> when evaluating the detected SLSS, apply layer 3 filtering as specified in 5.5.3.2 using the preconfigured *filterCoefficient* as defined in 9.3, before using the S-RSRP measurement results;
 - 3> if the S-RSRP of the SyncRef UE identified by the detected SLSS exceeds the minimum requirement defined in TS 36.133 [16]:
 - 4> select the SyncRef UE;
 - 3> else (i.e., no SLSSID=0 detected):
 - 4> select a cell as the synchronization reference source as defined in 5.10.13.3;

- 1> else, if triggered by V2X sidelink communication, and out of coverage on the frequency for V2X sidelink communication, and for the frequency used for V2X sidelink communication, if *syncPriority* in *SL-V2X-Preconfiguration* is set to *gnss* and GNSS is reliable in accordance with TS 36.101 [42] and TS 36.133 [16]:
 - 2> select GNSS as the synchronization reference source;
- 1> else, for the frequency used for sidelink communication, V2X sidelink communication or sidelink discovery, if out of coverage on that frequency as defined in TS 36.304 [4, 11.4]:
 - 2> perform a full search (i.e. covering all subframes and all possible SLSSIDs) to detect candidate SLSS, in accordance with TS 36.133 [16]
 - 2> when evaluating the one or more detected SLSSIDs, apply layer 3 filtering as specified in 5.5.3.2 using the preconfigured *filterCoefficient* as defined in 9.3, before using the S-RSRP measurement results;
 - 2> if the UE has selected a SyncRef UE:
 - 3> if the S-RSRP of the strongest candidate SyncRef UE exceeds the minimum requirement TS 36.133 [16] by *syncRefMinHyst* and the strongest candidate SyncRef UE belongs to the same priority group as the current SyncRef UE and the S-RSRP of the strongest candidate SyncRef UE exceeds the S-RSRP of the current SyncRef UE by *syncRefDiffHyst*; or
 - 3> if the S-RSRP of the candidate SyncRef UE exceeds the minimum requirement TS 36.133 [16] by *syncRefMinHyst* and the candidate SyncRef UE belongs to a higher priority group than the current SyncRef UE; or
 - 3> if GNSS becomes reliable in accordance with TS 36.101 [42] and TS 36.133 [16], and GNSS belongs to a higher priority group than the current SyncRef UE; or
 - 3> if the S-RSRP of the current SyncRef UE is less than the minimum requirement defined in TS 36.133 [16]:
 - 4> consider no SyncRef UE to be selected;
 - 2> if the UE has selected GNSS as the synchronization reference for V2X sidelink communication:
 - 3> if the S-RSRP of the candidate SyncRef UE exceeds the minimum requirement defined in TS 36.133 [16] by *syncRefMinHyst* and the candidate SyncRef UE belongs to a higher priority group than GNSS; or
 - 3> if GNSS becomes not reliable in accordance with TS 36.101 [42] and TS 36.133 [16]:
 - 4> consider GNSS not to be selected;
 - 2> if the UE has not selected a SyncRef UE and has not selected GNSS as synchronization reference source:
 - 3> if not concerning V2X sidelink communication, and if the UE detects one or more SLSSIDs for which the S-RSRP exceeds the minimum requirement defined in TS 36.133 [16] by *syncRefMinHyst* and for which the UE received the corresponding *MasterInformationBlock-SL* message (candidate SyncRef UEs), select a SyncRef UE according to the following priority group order:
 - 4> UEs of which *inCoverage*, included in the *MasterInformationBlock-SL* message received from this UE, is set to *TRUE*, starting with the UE with the highest S-RSRP result (priority group 1);
 - 4> UEs of which SLSSID is part of the set defined for in coverage, starting with the UE with the highest S-RSRP result (priority group 2);
 - 4> Other UEs, starting with the UE with the highest S-RSRP result (priority group 3);
 - 3> for V2X sidelink communication, if the UE detects one or more SLSSIDs for which the S-RSRP exceeds the minimum requirement defined in TS 36.133 [16] by *syncRefMinHyst* and for which the UE received the corresponding *MasterInformationBlock-SL-V2X* message (candidate SyncRef UEs), or if the UE detects GNSS that is reliable in accordance with TS 36.101 [42] and TS 36.133 [16], select a synchronization reference according to the following priority group order:
 - 4> if *syncPriority* corresponding to the concerned frequency in *SL-V2X-Preconfiguration* is set to *enb*:

- 5> UEs of which SLSSID is part of the set defined for in coverage, and *inCoverage*, included in the *MasterInformationBlock-SL-V2X* message received from this UE, is set to *TRUE*, starting with the UE with the highest S-RSRP result (priority group 1);
- 5> UE of which SLSSID is part of the set defined for in coverage, and *inCoverage*, included in the *MasterInformationBlock-SL-V2X* message received from this UE, is set to *FALSE*, starting with the UE with the highest S-RSRP result (priority group 2);
- 5> GNSS that is reliable in accordance with TS 36.101 [42] and TS 36.133 [16] (priority group 3);
- 5> UEs of which SLSSID is 0, and *inCoverage*, included in the *MasterInformationBlock-SL-V2X* message received from this UE, is set to *TRUE*, or of which SLSSID is 0 and SLSS is transmitted on subframes indicated by *syncOffsetIndicator3*, starting with the UE with the highest S-RSRP result (priority group 4);
- 5> UEs of which SLSSID is 0 and is not transmitted on subframes indicated by *syncOffsetIndicator3*, and *inCoverage*, included in the *MasterInformationBlock-SL-V2X* message received from this UE, is set to *FALSE*, starting with the UE with the highest S-RSRP result (priority group 5);
- 5> UEs of which SLSSID is 169, and *inCoverage*, included in the *MasterInformationBlock-SL-V2X* message received from this UE, is set to *FALSE*, starting with the UE with the highest S-RSRP result (priority group 5);
- 5> Other UEs, starting with the UE with the highest S-RSRP result (priority group 6);
- 4> if *syncPriority* corresponding to the concerned frequency in *SL-V2X-Preconfiguration* is set to *gnss*:
 - 5> GNSS that is reliable in accordance with TS 36.101 [42] and TS 36.133 [16] (priority group 1);
 - 5> UEs of which SLSSID is part of the set defined for in coverage, and *inCoverage*, included in the *MasterInformationBlock-SL-V2X* message received from this UE, is set to *TRUE*, starting with the UE with the highest S-RSRP result (priority group 2);
 - 5> UEs of which SLSSID is 0, and *inCoverage*, included in the *MasterInformationBlock-SL-V2X* message received from this UE, is set to *TRUE*, or of which SLSSID is 0 and SLSS is transmitted on subframes indicated by *syncOffsetIndicator3*, starting with the UE with the highest S-RSRP result (priority group 2);
 - 5> UE of which SLSSID is part of the set defined for in coverage, and *inCoverage*, included in the *MasterInformationBlock-SL-V2X* message received from this UE, is set to *FALSE*, starting with the UE with the highest S-RSRP result (priority group 3);
 - 5> UEs of which SLSSID is 0 and is not transmitted on subframes indicated by *syncOffsetIndicator3*, and *inCoverage*, included in the *MasterInformationBlock-SL-V2X* message received from this UE, is set to *FALSE*, starting with the UE with the highest S-RSRP result (priority group 3);
 - 5> UEs of which SLSSID is 169, and *inCoverage*, included in the *MasterInformationBlock-SL-V2X* message received from this UE, is set to *FALSE*, starting with the UE with the highest S-RSRP result (priority group 3);
 - 5> Other UEs, starting with the UE with the highest S-RSRP result (priority group 4);

5.10.9 Sidelink common control information

5.10.9.1 General

The sidelink common control information is carried by a single message, the *MasterInformationBlock-SL* (MIB-SL) message for sidelink discovery and sidelink communication or the *MasterInformationBlock-SL-V2X* (MIB-SL-V2X) message for V2X sidelink communication. The MIB-SL or MIB-SL-V2X includes timing information as well as some configuration parameters and is transmitted via SL-BCH.

The MIB-SL for sidelink discovery and sidelink communication uses a fixed schedule with a periodicity of 40 ms without repetitions. In particular, the MIB-SL is scheduled in subframes indicated by *syncOffsetIndicator-r12* i.e. for which $(10 \cdot \text{DFN} + \text{subframe number}) \bmod 40 = \text{syncOffsetIndicator-r12}$.

The MIB-SL-V2X for V2X sidelink communication uses a fixed schedule with a periodicity of 160 ms without repetitions. In particular, the MIB-SL-V2X is scheduled in subframes indicated by *SL-OffsetIndicatorSync* i.e. for which $(10 \cdot \text{DFN} + \text{subframe number}) \bmod 160 = \text{SL-OffsetIndicatorSync}$.

The sidelink common control information may change at any transmission i.e. neither a modification period nor a change notification mechanism is used.

A UE configured to receive or transmit sidelink communication or PS related sidelink discovery shall:

- 1> if the UE has a selected SyncRef UE, as specified in 5.10.8.2:
 - 2> ensure having a valid version of the *MasterInformationBlock-SL* message of that SyncRefUE;

A UE configured to receive or transmit V2X sidelink communication shall:

- 1> if the UE has a selected SyncRef UE, as specified in 5.10.8.2:
 - 2> ensure having a valid version of the *MasterInformationBlock-SL-V2X* message of that SyncRefUE;

5.10.9.2 Actions related to reception of *MasterInformationBlock-SL/* *MasterInformationBlock-SL-V2X* message

Upon receiving *MasterInformationBlock-SL* or *MasterInformationBlock-SL-V2X*, the UE shall:

- 1> apply the values of *sl-Bandwidth*, *subframeAssignmentSL*, *directFrameNumber* and *directSubframeNumber* included in the received *MasterInformationBlock-SL* or *MasterInformationBlock-SL-V2X* message;

5.10.10 Sidelink relay UE operation

5.10.10.1 General

This procedure is used by a UE supporting sidelink relay UE operation and involves evaluation of the AS-layer conditions that need to be met in order for upper layers to configure a sidelink relay UE to receive/ transmit relay related PS sidelink discovery/ relay related sidelink communication. The AS-layer conditions merely comprise of being configured with radio resources that can be used for transmission.

A UE that fulfils the criteria specified in 5.10.10.2 and 5.10.10.3 and that is configured by higher layers accordingly is acting as a sidelink relay UE.

5.10.10.2 AS-conditions for relay related sidelink communication transmission by sidelink relay UE

A UE capable of sidelink relay UE operation shall inform upper layers that it is configured with radio resources that can be used for relay related sidelink communication transmission if the following conditions are met:

- 1> if in RRC_CONNECTED; and if the UE is configured with *commTxResources*; and the UE is configured with *commTxAllowRelayDedicated* set to *true*;

5.10.10.3 AS-conditions for relay PS related sidelink discovery transmission by sidelink relay UE

A UE capable of sidelink relay UE operation shall inform upper layers that it is configured with radio resources that can be used for relay PS related sidelink discovery transmission if the following conditions are met:

- 1> if in RRC_IDLE; and if the UE's serving cell is suitable as defined in TS 36.304 [4]; and if *SystemInformationBlockType19* includes *discConfigPS* including *discTxPoolPS-Common* and *discConfigRelay*; and if the sidelink relay UE threshold conditions as specified in 5.10.10.4 are met;
- 1> else if in RRC_CONNECTED; and if *discTxResourcesPS* is configured;

5.10.10.4 Sidelink relay UE threshold conditions

A UE capable of sidelink relay UE operation shall:

- 1> if the threshold conditions specified in this clause were not met:
 - 2> if neither *threshHigh* nor *threshLow* is included in *relayUE-Config* within *SystemInformationBlockType19*:
 - 3> consider the threshold conditions to be met (entry);
 - 2> else if *threshHigh* is not included in *relayUE-Config* within *SystemInformationBlockType19*; or the RSRP measurement of the PCell, or the cell on which the UE camps, is below *threshHigh* by *hystMax* (also included within *relayUE-Config*); and
 - 2> if *threshLow* is not included in *relayUE-Config* within *SystemInformationBlockType19*; or the RSRP measurement of the PCell, or the cell on which the UE camps, is above *threshLow* by *hystMin* (also included within *relayUE-Config*):
 - 3> consider the threshold conditions to be met (entry);
- 1> else:
 - 2> if *threshHigh* is included in *relayUE-Config* within *SystemInformationBlockType19*; and the RSRP measurement of the PCell, or the cell on which the UE camps, is above *threshHigh* (also included within *relayUE-Config*); or
 - 2> if *threshLow* is included in *relayUE-Config* within *SystemInformationBlockType19*; and the RSRP measurement of the PCell, or the cell on which the UE camps, is below *threshLow* (also included within *relayUE-Config*);
 - 3> consider the threshold conditions not to be met (leave);

5.10.11 Sidelink remote UE operation

5.10.11.1 General

This procedure is used by a UE supporting sidelink remote UE operation and involves evaluation of the AS-layer conditions that need to be met in order for upper layers to configure a sidelink remote UE to receive/ transmit relay related sidelink PS discovery/ relay related sidelink communication. The AS-layer conditions merely comprise of being configured with radio resources that can be used for transmission, as well as whether or not having a selected sidelink relay UE.

5.10.11.2 AS-conditions for relay related sidelink communication transmission by sidelink remote UE

A UE capable of sidelink remote UE operation shall inform upper layers whether it is configured with radio resources that can be used for relay related sidelink communication transmission if the following conditions are met:

- 1> if the UE is out of coverage; and is preconfigured with *SL-Preconfiguration* including *discTxPoolList* and *preconfigRelay*;
- 1> else if in RRC_IDLE; and if the UE's serving cell is suitable as defined in TS 36.304 [4]; and if *SystemInformationBlockType18* includes *commTxPoolNormalCommon* and *commTxAllowRelayCommon*; and if *SystemInformationBlockType19* includes *discConfigRelay*; and if the sidelink remote UE threshold conditions as specified in 5.10.11.5 are met;
- 1> else if in RRC_CONNECTED; and if the UE is configured with *commTxResources*; and the UE is configured with *commTxAllowRelayDedicated* set to *true*;

5.10.11.3 AS-conditions for relay PS related sidelink discovery transmission by sidelink remote UE

A UE capable of sidelink remote UE operation shall inform upper layers whether it is configured with radio resources that can be used for relay PS related sidelink discovery transmission if the following conditions are met:

- 1> if the UE is out of coverage; and is preconfigured with *SL-Preconfiguration* including *discTxPoolList* and *preconfigRelay*;
- 1> else if in RRC_IDLE; and if the UE's serving cell is suitable as defined in TS 36.304 [4]; and if *SystemInformationBlockType19* includes *discConfigPS* including *discTxPoolPS-Common* and *discConfigRelay*; and if the sidelink remote UE threshold conditions as specified in 5.10.11.5 are met;
- 1> else if in RRC_CONNECTED; and if *discTxResourcesPS* is configured;

5.10.11.4 Selection and reselection of sidelink relay UE

A UE capable of sidelink remote UE operation that is configured by upper layers to search for a sidelink relay UE shall:

- 1> if out of coverage on the frequency used for sidelink communication, as defined in TS 36.304 [4, 11.4]; or
- 1> if the serving frequency is used for sidelink communication and the RSRP measurement of the cell on which the UE camps (RRC_IDLE)/ the PCell (RRC_CONNECTED) is below *threshHigh* within *remoteUE-Config* :
 - 2> search for candidate sidelink relay UEs, in accordance with TS 36.133 [16]
 - 2> when evaluating the one or more detected sidelink relay UEs, apply layer 3 filtering as specified in 5.5.3.2 across measurements that concern the same ProSe Relay UE ID and using the *filterCoefficient* in *SystemInformationBlockType19* (in coverage) or the preconfigured *filterCoefficient* as defined in 9.3(out of coverage), before using the SD-RSRP measurement results;

NOTE 1: The details of the interaction with upper layers are up to UE implementation.

- 2> if the UE does not have a selected sidelink relay UE:
 - 3> select a candidate sidelink relay UE which SD-RSRP exceeds *q-RxLevMin* included in either *reselectionInfoIC* (in coverage) or *reselectionInfoOoC* (out of coverage) by *minHyst*;
 - 2> else if SD-RSRP of the currently selected sidelink relay UE is below *q-RxLevMin* included in either *reselectionInfoIC* (in coverage) or *reselectionInfoOoC* (out of coverage); or if upper layers indicate not to use the currently selected sidelink relay: (i.e. sidelink relay UE reselection):
 - 3> select a candidate sidelink relay UE which SD-RSRP exceeds *q-RxLevMin* included in either *reselectionInfoIC* (in coverage) or *reselectionInfoOoC* (out of coverage) by *minHyst*;
 - 2> else if the UE did not detect any candidate sidelink relay UE which SD-RSRP exceeds *q-RxLevMin* included in either *reselectionInfoIC* (in coverage) or *reselectionInfoOoC* (out of coverage) by *minHyst*:
 - 3> consider no sidelink relay UE to be selected;

NOTE 2: The UE may perform sidelink relay UE reselection in a manner resulting in selection of the sidelink relay UE, amongst all candidate sidelink relay UEs meeting higher layer criteria, that has the best radio link quality. Further details, including interaction with upper layers, are up to UE implementation.

5.10.11.5 Sidelink remote UE threshold conditions

A UE capable of sidelink remote UE operation shall:

- 1> if the threshold conditions specified in this clause were not met:
 - 2> if *threshHigh* is not included in *remoteUE-Config* within *SystemInformationBlockType19*; or
 - 2> if *threshHigh* is included in *remoteUE-Config* within *SystemInformationBlockType19*; and the RSRP measurement of the PCell, or the cell on which the UE camps, is below *threshHigh* by *hystMax* (also included within *remoteUE-Config*):

- 3> consider the threshold conditions to be met (entry);
- 1> else:
 - 2> if *threshHigh* is included in *remoteUE-Config* within *SystemInformationBlockType19*; and the RSRP measurement of the PCell, or the cell on which the UE camps, is above *threshHigh* (also included within *remoteUE-Config*):
 - 3> consider the threshold conditions not to be met (leave);

5.10.12 V2X sidelink communication monitoring

A UE capable of V2X sidelink communication that is configured by upper layers to receive V2X sidelink communication shall:

- 1> if the conditions for sidelink operation as defined in 5.10.1d are met:
 - 2> if in coverage on the frequency used for V2X sidelink communication, as defined in TS 36.304 [4, 11.4]:
 - 3> if the frequency used to receive V2X sidelink communication is included in *v2x-InterFreqInfoList* within *RRCConnectionReconfiguration* or in *v2x-InterFreqInfoList* within *SystemInformationBlockType21* of the serving cell/Pcell, and *v2x-CommRxPool* is included in *SL-V2X-InterFreqUE-Config* within *v2x-UE-ConfigList* in the entry of *v2x-InterFreqInfoList* for the concerned frequency:
 - 4> configure lower layers to monitor sidelink control information and the corresponding data using the pool of resources indicated in *v2x-CommRxPool*;
 - 3> else:
 - 4> if the cell chosen for V2X sidelink communication reception broadcasts *SystemInformationBlockType21* including *v2x-CommRxPool* in *sl-V2X-ConfigCommon* or,
 - 4> if the UE is configured with *v2x-CommRxPool* included in *mobilityControlInfoV2X* in *RRCConnectionReconfiguration*:
 - 5> configure lower layers to monitor sidelink control information and the corresponding data using the pool of resources indicated in *v2x-CommRxPool*;
 - 2> else (i.e. out of coverage on the frequency used for V2X sidelink communication, as defined in TS 36.304 [4, 11.4]):
 - 3> if the frequency used to receive V2X sidelink communication is included in *v2x-InterFreqInfoList* within *RRCConnectionReconfiguration* or in *v2x-InterFreqInfoList* within *SystemInformationBlockType21* of the serving cell/Pcell, and *v2x-CommRxPool* is included in *SL-V2X-InterFreqUE-Config* within *v2x-UE-ConfigList* in the entry of *v2x-InterFreqInfoList* for the concerned frequency:
 - 4> configure lower layers to monitor sidelink control information and the corresponding data using the pool of resources indicated in *v2x-CommRxPool*;
 - 3> else:
 - 4> configure lower layers to monitor sidelink control information and the corresponding data using the pool of resources that were preconfigured (i.e. *v2x-CommRxPoolList* in *SL-V2X-Preconfiguration* defined in 9.3);

5.10.13 V2X sidelink communication transmission

5.10.13.1 Transmission of V2X sidelink communication

A UE capable of V2X sidelink communication that is configured by upper layers to transmit V2X sidelink communication and has related data to be transmitted shall:

- 1> if the conditions for sidelink operation as defined in 5.10.1d are met:

- 2> if in coverage on the frequency used for V2X sidelink communication as defined in TS 36.304 [4, 11.4]; or
- 2> if the frequency used to transmit V2X sidelink communication is included in *v2x-InterFreqInfoList* in *RRCConnectionReconfiguration* or in *v2x-InterFreqInfoList* within *SystemInformationBlockType21*:
- 3> if the UE is in RRC_CONNECTED and uses the PCell or the frequency included in *v2x-InterFreqInfoList* in *RRCConnectionReconfiguration* for V2X sidelink communication:
 - 4> if the UE is configured, by the current PCell with *commTxResources* set to *scheduled*:
 - 5> if T310 or T311 is running; and if the PCell at which the UE detected physical layer problems or radio link failure broadcasts *SystemInformationBlockType21* including *v2x-CommTxPoolExceptional* in *sl-V2X-ConfigCommon*, or *v2x-CommTxPoolExceptional* is included in *v2x-InterFreqInfoList* for the concerned frequency in *SystemInformationBlockType21* or *RRCConnectionReconfiguration*; or
 - 5> if T301 is running and the cell on which the UE initiated connection re-establishment broadcasts *SystemInformationBlockType21* including *v2x-CommTxPoolExceptional* in *sl-V2X-ConfigCommon*, or *v2x-CommTxPoolExceptional* is included in *v2x-InterFreqInfoList* for the concerned frequency in *SystemInformationBlockType21*; or
 - 5> if T304 is running and the UE is configured with *v2x-CommTxPoolExceptional* included in *mobilityControlInfoV2X* in *RRCConnectionReconfiguration* or in *v2x-InterFreqInfoList* for the concerned frequency in *RRCConnectionReconfiguration*:
 - 6> configure lower layers to transmit the sidelink control information and the corresponding data based on random selection using the pool of resources indicated by *v2x-CommTxPoolExceptional* as defined in TS 36.321 [6];
 - 5> else:
 - 6> configure lower layers to request E-UTRAN to assign transmission resources for V2X sidelink communication;
- 4> else if the UE is configured with *v2x-CommTxPoolNormalDedicated* or *v2x-CommTxPoolNormal* or *p2x-CommTxPoolNormal* in the entry of *v2x-InterFreqInfoList* for the concerned frequency in *sl-V2X-ConfigDedicated* in *RRCConnectionReconfiguration*:
 - 5> if the UE is configured to transmit non-P2X related V2X sidelink communication and a result of sensing on the resources configured in *v2x-CommTxPoolNormalDedicated* or *v2x-CommTxPoolNormal* in the entry of *v2x-InterFreqInfoList* for the concerned frequency in *RRCConnectionReconfiguration* is not available in accordance with TS 36.213 [23]; or
 - 5> if the UE is configured to transmit P2X related V2X sidelink communication and selects to use partial sensing according to 5.10.13.1a, and a result of partial sensing on the resources configured in *v2x-CommTxPoolNormalDedicated* or *p2x-CommTxPoolNormal* in the entry of *v2x-InterFreqInfoList* for the concerned frequency in *RRCConnectionReconfiguration* is not available in accordance with TS 36.213 [23]:
 - 6> if *v2x-CommTxPoolExceptional* is included in *mobilityControlInfoV2X* in *RRCConnectionReconfiguration* (i.e., handover case); or
 - 6> if *v2x-CommTxPoolExceptional* is included in the entry of *v2x-InterFreqInfoList* for the concerned frequency in *RRCConnectionReconfiguration*; or
 - 6> if the PCell broadcasts *SystemInformationBlockType21* including *v2x-CommTxPoolExceptional* in *sl-V2X-ConfigCommon* or *v2x-CommTxPoolExceptional* in *v2x-InterFreqInfoList* for the concerned frequency:
 - 7> configure lower layers to transmit the sidelink control information and the corresponding data based on random selection using the pool of resources indicated by *v2x-CommTxPoolExceptional* as defined in TS 36.321 [6];
 - 5> else if the UE is configured to transmit P2X related V2X sidelink communication:
 - 6> select a resource pool according to 5.10.13.2;

- 6> perform P2X related V2X sidelink communication according to 5.10.13.1a;
- 5> else if the UE is configured to transmit non-P2X related V2X sidelink communication:
 - 6> configure lower layers to transmit the sidelink control information and the corresponding data based on sensing (as defined in TS 36.321 [6] and TS 36.213 [23]) using one of the resource pools indicated by *v2x-commTxPoolNormalDedicated* or *v2x-CommTxPoolNormal* in the entry of *v2x-InterFreqInfoList* for the concerned frequency, which is selected according to 5.10.13.2;
- 3> else:
 - 4> if the cell chosen for V2X sidelink communication transmission broadcasts *SystemInformationBlockType21*:
 - 5> if the UE is configured to transmit non-P2X related V2X sidelink communication, and if *SystemInformationBlockType21* includes *v2x-CommTxPoolNormalCommon* or *v2x-CommTxPoolNormal* in *v2x-InterFreqInfoList* for the concerned frequency in *sl-V2X-ConfigCommon* and a result of sensing on the resources configured in *v2x-CommTxPoolNormalCommon* or *v2x-CommTxPoolNormal* in *v2x-InterFreqInfoList* for the concerned frequency is available in accordance with TS 36.213 [23]:
 - 6> configure lower layers to transmit the sidelink control information and the corresponding data based on sensing (as defined in TS 36.321 [6] and TS 36.213 [23]) using one of the resource pools indicated by *v2x-CommTxPoolNormalCommon* or *v2x-CommTxPoolNormal* in *v2x-InterFreqInfoList* for the concerned frequency, which is selected according to 5.10.13.2;
 - 5> else if the UE is configured to transmit P2X related V2X sidelink communication, and if *SystemInformationBlockType21* includes *p2x-CommTxPoolNormalCommon* or *p2x-CommTxPoolNormal* in *v2x-InterFreqInfoList* for the concerned frequency in *sl-V2X-ConfigCommon*, and if the UE selects to use random selection according to 5.10.13.1a, or selects to use partial sensing according to 5.10.13.1a and a result of partial sensing on the resources configured in *p2x-CommTxPoolNormalCommon* or *p2x-CommTxPoolNormal* in *v2x-InterFreqInfoList* for the concerned frequency is available in accordance with TS 36.213 [23]:
 - 6> select a resource pool from *p2x-CommTxPoolNormalCommon* or *p2x-CommTxPoolNormal* in *v2x-InterFreqInfoList* for the concerned frequency according to 5.10.13.2, but ignoring *zoneConfig* in *SystemInformationBlockType21*;
 - 6> perform P2X related V2X sidelink communication according to 5.10.13.1a;
 - 5> else if *SystemInformationBlockType21* includes *v2x-CommTxPoolExceptional* in *sl-V2X-ConfigCommon* or *v2x-CommTxPoolExceptional* in *v2x-InterFreqInfoList* for the concerned frequency:
 - 6> from the moment the UE initiates connection establishment until receiving an *RRCCONNECTIONRECONFIGURATION* including *sl-V2X-ConfigDedicated*, or until receiving an *RRCCONNECTIONRELEASE* or an *RRCCONNECTIONREJECT*; or
 - 6> if the UE is in RRC_IDLE and a result of sensing on the resources configured in *v2x-CommTxPoolNormalCommon* or *v2x-CommTxPoolNormal* in *v2x-InterFreqInfoList* for the concerned frequency in *SystemInformationBlockType21* is not available in accordance with TS 36.213 [23]; or
 - 6> if the UE is in RRC_IDLE and UE selects to use partial sensing according to 5.10.13.1a and a result of partial sensing on the resources configured in *p2x-CommTxPoolNormalCommon* or *p2x-CommTxPoolNormal* in *v2x-InterFreqInfoList* for the concerned frequency in *SystemInformationBlockType21* is not available in accordance with TS 36.213 [23]:
 - 7> configure lower layers to transmit the sidelink control information and the corresponding data based on random selection (as defined in TS 36.321 [6]) using the pool of resources indicated in *v2x-CommTxPoolExceptional*;
- 2> else:

- 3> configure lower layers to transmit the sidelink control information and the corresponding data based on sensing (as defined in TS 36.321 [6] and TS 36.213 [23]) using one of the resource pools indicated by *v2x-CommTxPoolList* in *SL-V2X-Preconfiguration* in case of non-P2X related V2X sidelink communication, which is selected according to 5.10.13.2, or using one of the resource pools indicated by *p2x-CommTxPoolList* in *SL-V2X-Preconfiguration* in case of P2X related V2X sidelink communication, which is selected according to 5.10.13.2, and in accordance with the timing of the selected reference as defined in 5.10.8;

The UE capable of non-P2X related V2X sidelink communication that is configured by upper layers to transmit V2X sidelink communication shall perform sensing on all pools of resources which may be used for transmission of the sidelink control information and the corresponding data. The pools of resources are indicated by *SL-V2X-Preconfiguration*, *v2x-CommTxPoolNormalCommon*, *v2x-CommTxPoolNormalDedicated* in *sl-V2X-ConfigDedicated*, or *v2x-CommTxPoolNormal* in *v2x-InterFreqInfoList* for the concerned frequency, as configured above.

NOTE 1: If there are multiple frequencies for which normal or exceptional pools are configured, it is up to UE implementation which frequency is selected for V2X sidelink communication transmission.

5.10.13.1a Transmission of P2X related V2X sidelink communication

A UE configured to transmit P2X related V2X sidelink communication shall:

- 1> if *partialSensing* is included and *randomSelection* is not included in *resourceSelectionConfigP2X* of the pool selected; or
- 1> if both *partialSensing* and *randomSelection* are included in *resourceSelectionConfigP2X* of the pool selected, and the UE selects to use partial sensing:
 - 2> configure lower layers to transmit the sidelink control information and the corresponding data based on partial sensing (as defined in TS 36.321 [6] and TS 36.213 [23]) using the selected resource pool, if the UE supports partial sensing;
- 1> if *partialSensing* is not included and *randomSelection* is included in *resourceSelectionConfigP2X* of the pool selected.
 - 2> configure lower layers to transmit the sidelink control information and the corresponding data based on random selection (as defined in TS 36.321 [6] and TS 36.213 [23]) using the selected resource pool;
- 1> if both *partialSensing* and *randomSelection* is included in *resourceSelectionConfigP2X* of the pool selected, and the UE selects to use random selection:
 - 2> configure lower layers to transmit the sidelink control information and the corresponding data based on random selection using the selected resource pool and indicates to lower layers that transmissions of multiple MAC PDUs are allowed (as defined in TS 36.321 [6] and TS 36.213 [23]).

NOTE: If both *partialSensing* and *randomSelection* is included in *resourceSelectionConfigP2X* of the pool selected, the selection between partial sensing and random selection is left to UE implementation.

5.10.13.2 V2X sidelink communication transmission pool selection

For a frequency used for V2X sidelink communication, if *zoneConfig* is not ignored as specified in 5.10.13.1, the UE configured by upper layers for V2X sidelink communication shall only use the pool which corresponds to geographical coordinates of the UE, if *zoneConfig* is included in *SystemInformationBlockType21* of the serving cell (RRC_IDLE)/PCell (RRC_CONNECTED) or in *RRCConnectionReconfiguration* for the concerned frequency, and the UE is configured to use resource pools provided by RRC signalling for the concerned frequency; or if *zoneConfig* is included in *SL-V2X-Preconfiguration* for the concerned frequency, and the UE is configured to use resource pools in *SL-V2X-Preconfiguration* for the frequency, according to 5.10.13.1. The UE shall only use the pool which is associated with the synchronization reference source selected in accordance with 5.10.8.2.

- 1> if the UE is configured to transmit on *p2x-CommTxPoolNormalCommon* or on *p2x-CommTxPoolNormal* in *v2x-InterFreqInfoList* in *SystemInformationBlockType21* according to 5.10.13.1; or
- 1> if the UE is configured to transmit on *p2x-CommTxPoolList-r14* in *SL-V2X-Preconfiguration* according to 5.10.13.1; or

- 1> if *zoneConfig* is not included in *SystemInformationBlockType21* and the UE is configured to transmit on *v2x-CommTxPoolNormalCommon* or *v2x-CommTxPoolNormalDedicated*; or
- 1> if *zoneConfig* is included in *SystemInformationBlockType21* and the UE is configured to transmit on *v2x-CommTxPoolNormalDedicated* for P2X related V2X sidelink communication and *zoneID* is not included in *v2x-CommTxPoolNormalDedicated*; or
- 1> if *zoneConfig* is not included in the entry of *v2x-InterFreqInfoList* for the concerned frequency and the UE is configured to transmit on *v2x-CommTxPoolNormal* in *v2x-InterFreqInfoList* or *p2x-CommTxPoolNormal* in *v2x-InterFreqInfoList* in *RRCConnectionReconfiguration*; or
- 1> if *zoneConfig* is included in the entry of *v2x-InterFreqInfoList* for the concerned frequency and the UE is configured to transmit on *p2x-CommTxPoolNormal* in *v2x-InterFreqInfoList* in *RRCConnectionReconfiguration* and *zoneID* is not included in *p2x-CommTxPoolNormal*; or
- 1> if *zoneConfig* is not included in *SL-V2X-Preconfiguration* for the concerned frequency and the UE is configured to transmit on *v2x-CommTxPoolList* in *SL-V2X-Preconfiguration* for the concerned frequency:
 - 2> select a pool associated with the synchronization reference source selected in accordance with 5.10.8.2;

NOTE 0: If multiple pools are associated with the selected synchronization reference source, it is up to UE implementation which resource pool is selected for V2X sidelink communication transmission.

- 1> if *zoneConfig* is included in *SystemInformationBlockType21* and the UE is configured to transmit on *v2x-CommTxPoolNormalCommon* or *v2x-CommTxPoolNormalDedicated* for non-P2X related V2X sidelink communication; or
- 1> if *zoneConfig* is included in *SystemInformationBlockType21* and the UE is configured to transmit on *v2x-CommTxPoolNormalDedicated* for P2X related V2X sidelink communication and *zoneID* is included in *v2x-CommTxPoolNormalDedicated*; or
- 1> if *zoneConfig* is included in the entry of *v2x-InterFreqInfoList* for the concerned frequency, and if the UE is configured to transmit on *v2x-CommTxPoolNormal* in *v2x-InterFreqInfoList* or is configured to transmit on *p2x-CommTxPoolNormal* in *v2x-InterFreqInfoList* in *RRCConnectionReconfiguration* and *zoneID* is included in *p2x-CommTxPoolNormal*; or
- 1> if *zoneConfig* is included in *SL-V2X-Preconfiguration* for the concerned frequency and the UE is configured to transmit on *v2x-CommTxPoolList* in *SL-V2X-Preconfiguration* for the concerned frequency:
 - 2> select the pool configured with *zoneID* equal to the zone identity determined below and associated with the synchronization reference source selected in accordance with 5.10.8.2;

The UE shall determine an identity of the zone (i.e. *Zone_id*) in which it is located using the following formulae, if *zoneConfig* is included in *SystemInformationBlockType21* or in *SL-V2X-Preconfiguration*:

$$x_1 = \text{Floor}(x / L) \text{ Mod } N_x;$$

$$y_1 = \text{Floor}(y / W) \text{ Mod } N_y;$$

$$\text{Zone_id} = y_1 * N_x + x_1.$$

The parameters in the formulae are defined as follows:

L is the value of *zoneLength* included in *zoneConfig* in *SystemInformationBlockType21* or in *SL-V2X-Preconfiguration*;

W is the value of *zoneWidth* included in *zoneConfig* in *SystemInformationBlockType21* or in *SL-V2X-Preconfiguration*;

N_x is the value of *zoneIdLongiMod* included in *zoneConfig* in *SystemInformationBlockType21* or in *SL-V2X-Preconfiguration*;

N_y is the value of *zoneIdLatiMod* included in *zoneConfig* in *SystemInformationBlockType21* or in *SL-V2X-Preconfiguration*;

x is the geodesic distance in longitude between UE's current location and geographical coordinates (0, 0) according to WGS84 model [80] and it is expressed in meters;

y is the geodesic distance in latitude between UE's current location and geographical coordinates (0, 0) according to WGS84 model [80] and it is expressed in meters.

The UE shall select a pool of resources which includes a *zoneID* equals to the *Zone_id* calculated according to above mentioned formulae and indicated by *v2x-CommTxPoolNormalDedicated*, *v2x-CommTxPoolNormalCommon*, *v2x-CommTxPoolNormal* in *v2x-InterFreqInfoList* or *p2x-CommTxPoolNormal* in *v2x-InterFreqInfoList* in *RRCConnectionReconfiguration*, or *v2x-CommTxPoolList* according to 5.10.13.1.

NOTE 1: The UE uses its latest geographical coordinates to perform resource pool selection.

NOTE 2: If geographical coordinates are not available and zone specific TX resource pools are configured for the concerned frequency, it is up to UE implementation which resource pool is selected for V2X sidelink communication transmission.

5.10.13.3 V2X sidelink communication transmission reference cell selection

A UE capable of V2X sidelink communication that is configured by upper layers to transmit V2X sidelink communication shall:

- 1> for each frequency used to transmit V2X sidelink communication, select a cell to be used as reference for synchronisation and DL measurements in accordance with the following:
 - 2> if the frequency concerns the primary frequency:
 - 3> use the PCell (RRC_CONNECTED) or the serving cell (RRC_IDLE) as reference;
 - 2> else if the frequency concerns a secondary frequency:
 - 3> use the concerned SCell as reference;
 - 2> else if the UE is in coverage of the concerned frequency:
 - 3> use the DL frequency paired with the one used to transmit V2X sidelink communication as reference;
 - 2> else (i.e., out of coverage on the concerned frequency):
 - 3> use the PCell (RRC_CONNECTED) or the serving cell (RRC_IDLE) as reference, if needed;

5.10.14 DFN derivation from GNSS

When the UE selects GNSS as the synchronization reference source, the DFN used for V2X sidelink communication is derived from the current UTC time, by the following formulae:

$$DFN = \text{Floor}(0.1 * (T_{current} - T_{ref} - \text{offsetDFN})) \bmod 1024$$

$$\text{SubframeNumber} = \text{Floor}(T_{current} - T_{ref} - \text{offsetDFN}) \bmod 10$$

Where:

$T_{current}$ is the current UTC time that obtained from GNSS. This value is expressed in milliseconds;

T_{ref} is the reference UTC time 00:00:00 on Gregorian calendar date 1 January, 1900 (midnight between Thursday, December 31, 1899 and Friday, January 1, 1900). This value is expressed in milliseconds;

offsetDFN is the value *offsetDFN* if configured, otherwise it is zero. This value is expressed in milliseconds.

NOTE: In case of leap second change event, how V2X UE obtains the scheduled time of leap second change to adjust $T_{current}$ correspondingly is left to UE implementation. How V2X UE handles the sudden discontinuity of DFN is left to UE implementation.

6 Protocol data units, formats and parameters (tabular & ASN.1)

6.1 General

The contents of each RRC message is specified in clause 6.2 using ASN.1 to specify the message syntax and using tables when needed to provide further detailed information about the fields specified in the message syntax. The syntax of the information elements that are defined as stand-alone abstract types is further specified in a similar manner in clause 6.3.

The need for fields to be present in a message or an abstract type, i.e., the ASN.1 fields that are specified as OPTIONAL in the abstract notation (ASN.1), is specified by means of comment text tags attached to the OPTIONAL statement in the abstract syntax. All comment text tags are available for use in the downlink direction only. The meaning of each tag is specified in table 6.1-1.

Table 6.1-1: Meaning of abbreviations used to specify the need for fields to be present

Abbreviation	Meaning
Cond <i>conditionTag</i> (Used in downlink only)	<i>Conditionally present</i> A field for which the need is specified by means of conditions. For each <i>conditionTag</i> , the need is specified in a tabular form following the ASN.1 segment. In case, according to the conditions, a field is not present, the UE takes no action and where applicable shall continue to use the existing value (and/ or the associated functionality) unless explicitly stated otherwise (e.g. in the conditional presence table or in the description of the field itself).
Need OP (Used in downlink only)	<i>Optionally present</i> A field that is optional to signal. For downlink messages, the UE is not required to take any special action on absence of the field beyond what is specified in the procedural text or the field description table following the ASN.1 segment. The UE behaviour on absence should be captured either in the procedural text or in the field description.
Need ON (Used in downlink only)	<i>Optionally present, No action</i> A field that is optional to signal. If the message is received by the UE, and in case the field is absent, the UE takes no action and where applicable shall continue to use the existing value (and/ or the associated functionality).
Need OR (Used in downlink only)	<i>Optionally present, Release</i> A field that is optional to signal. If the message is received by the UE, and in case the field is absent, the UE shall discontinue/ stop using/ delete any existing value (and/ or the associated functionality).

Any field with Need ON in system information shall be interpreted as Need OR.

Need codes may not be specified for a parent extension field/ extension group, used in downlink, which includes one or more child extension fields. Upon absence of such a parent extension field/ extension group, the UE shall:

- For each individual child extension field, including extensions that are mandatory to include in the optional group, act in accordance with the need code that is defined for the extension;
- Apply this behaviour not only for child extension fields included directly within the optional parent extension field/ extension group, but also for extension fields defined at further nesting levels as long as for none of the fields in-between the concerned extension field and the parent extension field a need code is specified;

NOTE 1: The above applies for groups of non critical extensions using double brackets (referred to as extension groups), as well as non-critical extensions at the end of a message or at the end of a structure contained in a BIT STRING or OCTET STRING (referred to as parent extension fields).

Need codes, conditions and ASN.1 defaults specified for a particular (child) field only apply in case the (parent) field including the particular field is present. This rule does not apply for optional parent extension fields/ extension groups without need codes,

NOTE 2: The previous rule implies that E-UTRAN has to include such a parent extension field to release a child field that is either:

- Optional with need OR, or
- Conditional while the UE releases the child field when absent.

The handling of need codes as specified in the previous is illustrated by means of an example, as shown in the following ASN.1.

```
-- /example/ ASN1START
RRCMessage-r8-IEs ::= SEQUENCE {
    field1          InformationElement1,
    field2          InformationElement2          OPTIONAL, -- Need ON
    nonCriticalExtension RRCMessage-v8a0-IEs
}
RRCMessage-v8a0-IEs ::= SEQUENCE {
    field3          InformationElement3          OPTIONAL, -- Need ON
    nonCriticalExtension RRCMessage-v940-IEs
}
RRCMessage-v940-IEs ::= SEQUENCE {
    field4          InformationElement4          OPTIONAL, -- Need OR
    nonCriticalExtension SEQUENCE {}
}
InformationElement1 ::= SEQUENCE {
    field11         InformationElement11         OPTIONAL, -- Need ON
    field12         InformationElement12         OPTIONAL, -- Need OR
    ...,
    [[ field13         InformationElement13         OPTIONAL, -- Need OR
    field14         InformationElement14         OPTIONAL, -- Need ON
    ]]
}
InformationElement2 ::= SEQUENCE {
    field21         InformationElement11         OPTIONAL, -- Need OR
    ...
}
-- ASN1STOP
```

The handling of need codes as specified in the previous implies that:

- if *field2* in *RRCMessage-r8-IEs* is absent, the UE does not modify *field21*;
- if *field2* in *RRCMessage-r8-IEs* is present but does not include *field21*, the UE releases *field21*;
- if the extension group containing *field13* is absent, the UE releases *field13* and does not modify *field14*;
- if *nonCriticalExtension* defined by IE *RRCMessage-v8a0-IEs* is absent, the UE does not modify *field3* and releases *field4*;

In the ASN.1 of this specification, the first bit of a bit string refers to the leftmost bit, unless stated otherwise.

6.2 RRC messages

NOTE: The messages included in this clause reflect the current status of the discussions. Additional messages may be included at a later stage.

6.2.1 General message structure

– *EUTRA-RRC-Definitions*

This ASN.1 segment is the start of the E-UTRA RRC PDU definitions.

```
-- ASN1START
EUTRA-RRC-Definitions DEFINITIONS AUTOMATIC TAGS ::=
BEGIN
-- ASN1STOP
```

– *BCCH-BCH-Message*

The *BCCH-BCH-Message* class is the set of RRC messages that may be sent from the E-UTRAN to the UE via BCH on the BCCH logical channel.

```
-- ASN1START
BCCH-BCH-Message ::= SEQUENCE {
    message          BCCH-BCH-MessageType
}
BCCH-BCH-MessageType ::=
    MasterInformationBlock
-- ASN1STOP
```

– *BCCH-BCH-Message-MBMS*

The *BCCH-BCH-Message-MBMS* class is the set of RRC messages that may be sent from the E-UTRAN to the UE via BCH on the BCCH logical channel in an MBMS-dedicated cell.

```
-- ASN1START
BCCH-BCH-Message-MBMS ::= SEQUENCE {
    message          BCCH-BCH-MessageType-MBMS-r14
}
BCCH-BCH-MessageType-MBMS-r14 ::=
    MasterInformationBlock-MBMS-r14
-- ASN1STOP
```

– *BCCH-DL-SCH-Message*

The *BCCH-DL-SCH-Message* class is the set of RRC messages that may be sent from the E-UTRAN to the UE via DL-SCH on the BCCH logical channel.

```
-- ASN1START
BCCH-DL-SCH-Message ::= SEQUENCE {
    message          BCCH-DL-SCH-MessageType
}
BCCH-DL-SCH-MessageType ::= CHOICE {
    c1              CHOICE {
        systemInformation          SystemInformation,
        systemInformationBlockType1 SystemInformationBlockType1
    },
    messageClassExtension SEQUENCE {}
}
-- ASN1STOP
```

– *BCCH-DL-SCH-Message-BR*

The *BCCH-DL-SCH-Message-BR* class is the set of RRC messages that may be sent from the E-UTRAN to the UE via DL-SCH on the BR-BCCH logical channel.

```
-- ASN1START
BCCH-DL-SCH-Message-BR ::= SEQUENCE {
  message          BCCH-DL-SCH-MessageType-BR-r13
}
BCCH-DL-SCH-MessageType-BR-r13 ::= CHOICE {
  c1              CHOICE {
    systemInformation-BR-r13          SystemInformation-BR-r13,
    systemInformationBlockType1-BR-r13 SystemInformationBlockType1-BR-r13
  },
  messageClassExtension SEQUENCE {}
}
-- ASN1STOP
```

– *BCCH-DL-SCH-Message-MBMS*

The *BCCH-DL-SCH-Message-MBMS* class is the set of RRC messages that may be sent from the E-UTRAN to the UE via DL-SCH on the BCCH logical channel in an MBMS-dedicated cell.

```
-- ASN1START
BCCH-DL-SCH-Message-MBMS ::= SEQUENCE {
  message          BCCH-DL-SCH-MessageType-MBMS-r14
}
BCCH-DL-SCH-MessageType-MBMS-r14 ::= CHOICE {
  c1              CHOICE {
    systemInformation-MBMS-r14          SystemInformation-MBMS-r14,
    systemInformationBlockType1-MBMS-r14 SystemInformationBlockType1-MBMS-r14
  },
  messageClassExtension SEQUENCE {}
}
-- ASN1STOP
```

– *MCCH-Message*

The *MCCH-Message* class is the set of RRC messages that may be sent from the E-UTRAN to the UE on the MCCH logical channel.

```
-- ASN1START
MCCH-Message ::= SEQUENCE {
  message          MCCH-MessageType
}
MCCH-MessageType ::= CHOICE {
  c1              CHOICE {
    mbsfnAreaConfiguration-r9          MBSFNAreaConfiguration-r9
  },
  later          CHOICE {
    c2              CHOICE {
    mbsCountingRequest-r10          MBMSCountingRequest-r10
    },
    messageClassExtension SEQUENCE {}
  }
}
-- ASN1STOP
```

– *PCCH-Message*

The *PCCH-Message* class is the set of RRC messages that may be sent from the E-UTRAN to the UE on the PCCH logical channel.

```
-- ASN1START
PCCH-Message ::= SEQUENCE {
    message          PCCH-MessageType
}
PCCH-MessageType ::= CHOICE {
    c1               CHOICE {
        paging                               Paging
    },
    messageClassExtension SEQUENCE {}
}
-- ASN1STOP
```

– *DL-CCCH-Message*

The *DL-CCCH-Message* class is the set of RRC messages that may be sent from the E-UTRAN to the UE on the downlink CCCH logical channel.

```
-- ASN1START
DL-CCCH-Message ::= SEQUENCE {
    message          DL-CCCH-MessageType
}
DL-CCCH-MessageType ::= CHOICE {
    c1               CHOICE {
        rrcConnectionReestablishment          RRCConnectionReestablishment,
        rrcConnectionReestablishmentReject    RRCConnectionReestablishmentReject,
        rrcConnectionReject                   RRCConnectionReject,
        rrcConnectionSetup                    RRCConnectionSetup
    },
    messageClassExtension SEQUENCE {}
}
-- ASN1STOP
```

– *DL-DCCH-Message*

The *DL-DCCH-Message* class is the set of RRC messages that may be sent from the E-UTRAN to the UE or from the E-UTRAN to the RN on the downlink DCCH logical channel.

```
-- ASN1START
DL-DCCH-Message ::= SEQUENCE {
    message          DL-DCCH-MessageType
}
DL-DCCH-MessageType ::= CHOICE {
    c1               CHOICE {
        csfbParametersResponseCDMA2000          CSFBParametersResponseCDMA2000,
        dlInformationTransfer                    DLInformationTransfer,
        handoverFromEUTRAPreparationRequest      HandoverFromEUTRAPreparationRequest,
        mobilityFromEUTRACCommand               MobilityFromEUTRACCommand,
        rrcConnectionReconfiguration            RRCConnectionReconfiguration,
        rrcConnectionRelease                    RRCConnectionRelease,
        securityModeCommand                     SecurityModeCommand,
        ueCapabilityEnquiry                     UECapabilityEnquiry,
        counterCheck                             CounterCheck,
        ueInformationRequest-r9                  UEInformationRequest-r9,
        loggedMeasurementConfiguration-r10       LoggedMeasurementConfiguration-r10,
        rnReconfiguration-r10                    RNReconfiguration-r10,
        rrcConnectionResume-r13                 RRCConnectionResume-r13,
        spare3 NULL, spare2 NULL, spare1 NULL
    },
}
-- ASN1STOP
```

```

    messageClassExtension SEQUENCE {}
  }
-- ASN1STOP

```

– *UL-CCCH-Message*

The *UL-CCCH-Message* class is the set of RRC messages that may be sent from the UE to the E-UTRAN on the uplink CCCH logical channel.

```

-- ASN1START
UL-CCCH-Message ::= SEQUENCE {
    message          UL-CCCH-MessageType
}
UL-CCCH-MessageType ::= CHOICE {
    c1              CHOICE {
        rrcConnectionReestablishmentRequest  RRCConnectionReestablishmentRequest,
        rrcConnectionRequest                RRCConnectionRequest
    },
    messageClassExtension CHOICE {
        c2              CHOICE {
            rrcConnectionResumeRequest-r13      RRCConnectionResumeRequest-r13
        },
        messageClassExtensionFuture-r13 SEQUENCE {}
    }
}
-- ASN1STOP

```

– *UL-DCCH-Message*

The *UL-DCCH-Message* class is the set of RRC messages that may be sent from the UE to the E-UTRAN or from the RN to the E-UTRAN on the uplink DCCH logical channel.

```

-- ASN1START
UL-DCCH-Message ::= SEQUENCE {
    message          UL-DCCH-MessageType
}
UL-DCCH-MessageType ::= CHOICE {
    c1              CHOICE {
        csfbParametersRequestCDMA2000          CSFBParametersRequestCDMA2000,
        measurementReport                      MeasurementReport,
        rrcConnectionReconfigurationComplete   RRCConnectionReconfigurationComplete,
        rrcConnectionReestablishmentComplete  RRCConnectionReestablishmentComplete,
        rrcConnectionSetupComplete           RRCConnectionSetupComplete,
        securityModeComplete                  SecurityModeComplete,
        securityModeFailure                    SecurityModeFailure,
        ueCapabilityInformation                UECapabilityInformation,
        ulHandoverPreparationTransfer          ULHandoverPreparationTransfer,
        ulInformationTransfer                  ULInformationTransfer,
        counterCheckResponse                   CounterCheckResponse,
        ueInformationResponse-r9               UEInformationResponse-r9,
        proximityIndication-r9                 ProximityIndication-r9,
        rnReconfigurationComplete-r10         RNReconfigurationComplete-r10,
        mbmsCountingResponse-r10             MBMSCountingResponse-r10,
        interFreqRSTDMeasurementIndication-r10 InterFreqRSTDMeasurementIndication-r10
    },
    messageClassExtension CHOICE {
        c2              CHOICE {
            ueAssistanceInformation-r11         UEAssistanceInformation-r11,
            inDeviceCoexIndication-r11         InDeviceCoexIndication-r11,
            mbmsInterestIndication-r11         MBMSInterestIndication-r11,
            scgFailureInformation-r12          SCGFailureInformation-r12,
            sidelinkUEInformation-r12         SidelinkUEInformation-r12,
            wlanConnectionStatusReport-r13    WLANConnectionStatusReport-r13,
            rrcConnectionResumeComplete-r13   RRCConnectionResumeComplete-r13,
            spare9 NULL, spare8 NULL, spare7 NULL,
            spare6 NULL, spare5 NULL, spare4 NULL,

```

```

        spare3 NULL, spare2 NULL, spare1 NULL
    },
    messageClassExtensionFuture-r11 SEQUENCE {}
}
-- ASN1STOP

```

– SC-MCCH-Message

The *SC-MCCH-Message* class is the set of RRC messages that may be sent from the E-UTRAN to the UE on the SC-MCCH logical channel.

```

-- ASN1START
SC-MCCH-Message-r13 ::= SEQUENCE {
    message SC-MCCH-MessageType-r13
}

SC-MCCH-MessageType-r13 ::= CHOICE {
    c1 CHOICE {
        scptmConfiguration-r13 SCPTMConfiguration-r13
    },
    messageClassExtension CHOICE {
        c2 CHOICE {
            scptmConfiguration-BR-r14 SCPTMConfiguration-BR-r14,
            spare NULL
        },
        messageClassExtensionFuture-r14 SEQUENCE {}
    }
}
-- ASN1STOP

```

6.2.2 Message definitions

– CounterCheck

The *CounterCheck* message is used by the E-UTRAN to indicate the current COUNT MSB values associated to each DRB and to request the UE to compare these to its COUNT MSB values and to report the comparison results to E-UTRAN.

Signalling radio bearer: SRB1

RLC-SAP: AM

Logical channel: DCCH

Direction: E-UTRAN to UE

CounterCheck message

```

-- ASN1START
CounterCheck ::= SEQUENCE {
    rrc-TransactionIdentifier RRC-TransactionIdentifier,
    criticalExtensions CHOICE {
        c1 CHOICE {
            counterCheck-r8 CounterCheck-r8-IEs,
            spare3 NULL, spare2 NULL, spare1 NULL
        },
        criticalExtensionsFuture SEQUENCE {}
    }
}

CounterCheck-r8-IEs ::= SEQUENCE {
    drb-CountMSB-InfoList DRB-CountMSB-InfoList,
    nonCriticalExtension CounterCheck-v8a0-IEs OPTIONAL
}

```

```

}
CounterCheck-v8a0-IEs ::= SEQUENCE {
    lateNonCriticalExtension    OCTET STRING                OPTIONAL,
    nonCriticalExtension        SEQUENCE {}                OPTIONAL
}
DRB-CountMSB-InfoList ::= SEQUENCE (SIZE (1..maxDRB)) OF DRB-CountMSB-Info
DRB-CountMSB-Info ::= SEQUENCE {
    drb-Identity                DRB-Identity,
    countMSB-Uplink             INTEGER(0..33554431),
    countMSB-Downlink           INTEGER(0..33554431)
}
-- ASN1STOP

```

CounterCheck field descriptions
count-MSB-Downlink Indicates the value of 25 MSBs from downlink COUNT associated to this DRB.
count-MSB-Uplink Indicates the value of 25 MSBs from uplink COUNT associated to this DRB.
drb-CountMSB-InfoList Indicates the MSBs of the COUNT values of the DRBs.

– CounterCheckResponse

The *CounterCheckResponse* message is used by the UE to respond to a *CounterCheck* message.

Signalling radio bearer: SRB1

RLC-SAP: AM

Logical channel: DCCH

Direction: UE to E-UTRAN

CounterCheckResponse message

```

-- ASN1START
CounterCheckResponse ::= SEQUENCE {
    rrc-TransactionIdentifier    RRC-TransactionIdentifier,
    criticalExtensions           CHOICE {
        counterCheckResponse-r8    CounterCheckResponse-r8-IEs,
        criticalExtensionsFuture    SEQUENCE {}
    }
}
CounterCheckResponse-r8-IEs ::= SEQUENCE {
    drb-CountInfoList           DRB-CountInfoList,
    nonCriticalExtension        CounterCheckResponse-v8a0-IEs    OPTIONAL
}
CounterCheckResponse-v8a0-IEs ::= SEQUENCE {
    lateNonCriticalExtension    OCTET STRING                OPTIONAL,
    nonCriticalExtension        SEQUENCE {}                OPTIONAL
}
DRB-CountInfoList ::= SEQUENCE (SIZE (0..maxDRB)) OF DRB-CountInfo
DRB-CountInfo ::= SEQUENCE {
    drb-Identity                DRB-Identity,
    count-Uplink                INTEGER(0..4294967295),
    count-Downlink              INTEGER(0..4294967295)
}
-- ASN1STOP

```

CounterCheckResponse field descriptions
count-Downlink Indicates the value of downlink COUNT associated to this DRB.
count-Uplink Indicates the value of uplink COUNT associated to this DRB.
drb-CountInfoList Indicates the COUNT values of the DRBs.

– CSFBParametersRequestCDMA2000

The *CSFBParametersRequestCDMA2000* message is used by the UE to obtain the CDMA2000 1xRTT Parameters from the network. The UE needs these parameters to generate the CDMA2000 1xRTT Registration message used to register with the CDMA2000 1xRTT Network which is required to support CSFB to CDMA2000 1xRTT.

Signalling radio bearer: SRB1

RLC-SAP: AM

Logical channel: DCCH

Direction: UE to E-UTRAN

CSFBParametersRequestCDMA2000 message

```
-- ASN1START
CSFBParametersRequestCDMA2000 ::= SEQUENCE {
    criticalExtensions          CHOICE {
        csfbParametersRequestCDMA2000-r8    CSFBParametersRequestCDMA2000-r8-IEs,
        criticalExtensionsFuture            SEQUENCE {}
    }
}

CSFBParametersRequestCDMA2000-r8-IEs ::= SEQUENCE {
    nonCriticalExtension        CSFBParametersRequestCDMA2000-v8a0-IEs  OPTIONAL
}

CSFBParametersRequestCDMA2000-v8a0-IEs ::= SEQUENCE {
    lateNonCriticalExtension    OCTET STRING                            OPTIONAL,
    nonCriticalExtension        SEQUENCE {}                            OPTIONAL
}
-- ASN1STOP
```

– CSFBParametersResponseCDMA2000

The *CSFBParametersResponseCDMA2000* message is used to provide the CDMA2000 1xRTT Parameters to the UE so the UE can register with the CDMA2000 1xRTT Network to support CSFB to CDMA2000 1xRTT.

Signalling radio bearer: SRB1

RLC-SAP: AM

Logical channel: DCCH

Direction: E-UTRAN to UE

```
CSFBParametersResponseCDMA2000 message
-- ASN1START
CSFBParametersResponseCDMA2000 ::= SEQUENCE {
    rrc-TransactionIdentifier    RRC-TransactionIdentifier,
    criticalExtensions          CHOICE {
        csfbParametersResponseCDMA2000-r8    CSFBParametersResponseCDMA2000-r8-IEs,
        criticalExtensionsFuture            SEQUENCE {}
    }
}
-- ASN1STOP
```

```

CSFBParametersResponseCDMA2000-r8-IEs ::= SEQUENCE {
    rand                                RAND-CDMA2000,
    mobilityParameters                 MobilityParametersCDMA2000,
    nonCriticalExtension                 CSFBParametersResponseCDMA2000-v8a0-IEs OPTIONAL
}

CSFBParametersResponseCDMA2000-v8a0-IEs ::= SEQUENCE {
    lateNonCriticalExtension            OCTET STRING                                OPTIONAL,
    nonCriticalExtension                 SEQUENCE {}                                OPTIONAL
}

-- ASN1STOP

```

– *DLInformationTransfer*

The *DLInformationTransfer* message is used for the downlink transfer of NAS or non-3GPP dedicated information.

Signalling radio bearer: SRB2 or SRB1 (only if SRB2 not established yet. If SRB2 is suspended, E-UTRAN does not send this message until SRB2 is resumed.)

RLC-SAP: AM

Logical channel: DCCH

Direction: E-UTRAN to UE

DLInformationTransfer message

```

-- ASN1START

DLInformationTransfer ::= SEQUENCE {
    rrc-TransactionIdentifier           RRC-TransactionIdentifier,
    criticalExtensions                  CHOICE {
        cl                               CHOICE {
            dlInformationTransfer-r8      DLInformationTransfer-r8-IEs,
            spare3 NULL, spare2 NULL, spare1 NULL
        },
        criticalExtensionsFuture          SEQUENCE {}
    }
}

DLInformationTransfer-r8-IEs ::= SEQUENCE {
    dedicatedInfoType                  CHOICE {
        dedicatedInfoNAS                 DedicatedInfoNAS,
        dedicatedInfoCDMA2000-1xRTT      DedicatedInfoCDMA2000,
        dedicatedInfoCDMA2000-HRPD       DedicatedInfoCDMA2000
    },
    nonCriticalExtension                 DLInformationTransfer-v8a0-IEs    OPTIONAL
}

DLInformationTransfer-v8a0-IEs ::= SEQUENCE {
    lateNonCriticalExtension            OCTET STRING                                OPTIONAL,
    nonCriticalExtension                 SEQUENCE {}                                OPTIONAL
}

-- ASN1STOP

```

– *HandoverFromEUTRAPreparationRequest (CDMA2000)*

The *HandoverFromEUTRAPreparationRequest* message is used to trigger the handover preparation procedure with a CDMA2000 RAT. This message is also used to trigger a tunneled preparation procedure with a CDMA2000 1xRTT RAT to obtain traffic channel resources for the enhanced CS fallback to CDMA2000 1xRTT, which may also involve a concurrent preparation for handover to CDMA2000 HRPD. Also, this message is used to trigger the dual Rx/Tx redirection procedure with a CDMA2000 1xRTT RAT.

Signalling radio bearer: SRB1

RLC-SAP: AM

Logical channel: DCCH

Direction: E-UTRAN to UE

HandoverFromEUTRAPreparationRequest message

```
-- ASN1START
HandoverFromEUTRAPreparationRequest ::= SEQUENCE {
  rrc-TransactionIdentifier      RRC-TransactionIdentifier,
  criticalExtensions             CHOICE {
    cl                           CHOICE {
      handoverFromEUTRAPreparationRequest-r8
      HandoverFromEUTRAPreparationRequest-r8-IEs,
      spare3 NULL, spare2 NULL, spare1 NULL
    },
    criticalExtensionsFuture      SEQUENCE {}
  }
}

HandoverFromEUTRAPreparationRequest-r8-IEs ::= SEQUENCE {
  cdma2000-Type                 CDMA2000-Type,
  rand                          RAND-CDMA2000          OPTIONAL, -- Cond cdma2000-Type
  mobilityParameters            MobilityParametersCDMA2000 OPTIONAL, -- Cond cdma2000-Type
  nonCriticalExtension          HandoverFromEUTRAPreparationRequest-v890-IEs OPTIONAL
}

HandoverFromEUTRAPreparationRequest-v890-IEs ::= SEQUENCE {
  lateNonCriticalExtension      OCTET STRING          OPTIONAL,
  nonCriticalExtension          HandoverFromEUTRAPreparationRequest-v920-IEs OPTIONAL
}

HandoverFromEUTRAPreparationRequest-v920-IEs ::= SEQUENCE {
  concurrPrepCDMA2000-HRPD-r9   BOOLEAN          OPTIONAL, -- Cond cdma2000-Type
  nonCriticalExtension          HandoverFromEUTRAPreparationRequest-v1020-IEs OPTIONAL
}

HandoverFromEUTRAPreparationRequest-v1020-IEs ::= SEQUENCE {
  dualRxTxRedirectIndicator-r10  ENUMERATED {true}  OPTIONAL, -- Cond cdma2000-1XRTT
  redirectCarrierCDMA2000-1XRTT-r10 CarrierFreqCDMA2000 OPTIONAL, -- Cond dualRxTxRedirect
  nonCriticalExtension          SEQUENCE {}              OPTIONAL
}
-- ASN1STOP
```

HandoverFromEUTRAPreparationRequest field descriptions

concurrPrepCDMA2000-HRPD

Value TRUE indicates that upper layers should initiate concurrent preparation for handover to CDMA2000 HRPD in addition to preparation for enhanced CS fallback to CDMA2000 1xRTT.

dualRxTxRedirectIndicator

Value TRUE indicates that the second radio of the dual Rx/Tx UE is being redirected to CDMA2000 1xRTT [51].

redirectCarrierCDMA2000-1XRTT

Used to indicate the CDMA2000 1xRTT carrier frequency where the UE is being redirected to.

Conditional presence	Explanation
<i>cdma2000-1XRTT</i>	The field is optionally present, need ON, if the <i>cdma2000-Type = type1XRTT</i> ; otherwise it is not present.
<i>cdma2000-Type</i>	The field is mandatory present if the <i>cdma2000-Type = type1XRTT</i> ; otherwise it is not present.
<i>dualRxTxRedirect</i>	The field is optionally present, need ON, if <i>dualRxTxRedirectIndicator</i> is present; otherwise it is not present.

– *InDeviceCoexIndication*

The *InDeviceCoexIndication* message is used to inform E-UTRAN about IDC problems which can not be solved by the UE itself, as well as to provide information that may assist E-UTRAN when resolving these problems.

Signalling radio bearer: SRB1

RLC-SAP: AM

Logical channel: DCCH

Direction: UE to E-UTRAN

InDeviceCoexIndication message

```
-- ASN1START

InDeviceCoexIndication-r11 ::= SEQUENCE {
    criticalExtensions          CHOICE {
        c1                     CHOICE {
            inDeviceCoexIndication-r11 InDeviceCoexIndication-r11-IEs,
            spare3 NULL, spare2 NULL, spare1 NULL
        },
        criticalExtensionsFuture SEQUENCE {}
    }
}

InDeviceCoexIndication-r11-IEs ::= SEQUENCE {
    affectedCarrierFreqList-r11 AffectedCarrierFreqList-r11          OPTIONAL,
    tdm-AssistanceInfo-r11      TDM-AssistanceInfo-r11          OPTIONAL,
    lateNonCriticalExtension     OCTET STRING                    OPTIONAL,
    nonCriticalExtension         InDeviceCoexIndication-v11d0-IEs    OPTIONAL
}

InDeviceCoexIndication-v11d0-IEs ::= SEQUENCE {
    ul-CA-AssistanceInfo-r11    SEQUENCE {
        affectedCarrierFreqCombList-r11 AffectedCarrierFreqCombList-r11          OPTIONAL,
        victimSystemType-r11           VictimSystemType-r11                    OPTIONAL,
    }
    nonCriticalExtension         InDeviceCoexIndication-v1310-IEs    OPTIONAL
}

InDeviceCoexIndication-v1310-IEs ::= SEQUENCE {
    affectedCarrierFreqList-v1310 AffectedCarrierFreqList-v1310          OPTIONAL,
    affectedCarrierFreqCombList-r13 AffectedCarrierFreqCombList-r13          OPTIONAL,
    nonCriticalExtension         InDeviceCoexIndication-v1360-IEs    OPTIONAL
}

InDeviceCoexIndication-v1360-IEs ::= SEQUENCE {
    hardwareSharingProblem-r13   ENUMERATED {true}                OPTIONAL,
    nonCriticalExtension         SEQUENCE {}                    OPTIONAL
}

AffectedCarrierFreqList-r11 ::= SEQUENCE (SIZE (1..maxFreqIDC-r11)) OF AffectedCarrierFreq-r11
AffectedCarrierFreqList-v1310 ::= SEQUENCE (SIZE (1..maxFreqIDC-r11)) OF AffectedCarrierFreq-v1310

AffectedCarrierFreq-r11 ::= SEQUENCE {
    carrierFreq-r11              MeasObjectId,
    interferenceDirection-r11    ENUMERATED {eutra, other, both, spare}
}

AffectedCarrierFreq-v1310 ::= SEQUENCE {
    carrierFreq-v1310            MeasObjectId-v1310                OPTIONAL
}

AffectedCarrierFreqCombList-r11 ::= SEQUENCE (SIZE (1..maxCombIDC-r11)) OF AffectedCarrierFreqComb-r11
AffectedCarrierFreqCombList-r13 ::= SEQUENCE (SIZE (1..maxCombIDC-r11)) OF AffectedCarrierFreqComb-r13

AffectedCarrierFreqComb-r11 ::= SEQUENCE (SIZE (2..maxServCell-r10)) OF MeasObjectId
AffectedCarrierFreqComb-r13 ::= SEQUENCE (SIZE (2..maxServCell-r13)) OF MeasObjectId

```

```

TDM-AssistanceInfo-r11 ::= CHOICE {
  drx-AssistanceInfo-r11      SEQUENCE {
    drx-CycleLength-r11      ENUMERATED {sf40, sf64, sf80, sf128, sf160,
                                         sf256, spare2, spare1},
    drx-Offset-r11           INTEGER (0..255) OPTIONAL,
    drx-ActiveTime-r11       ENUMERATED {sf20, sf30, sf40, sf60, sf80,
                                         sf100, spare2, spare1}
  },
  idc-SubframePatternList-r11 IDC-SubframePatternList-r11,
  ...
}

IDC-SubframePatternList-r11 ::= SEQUENCE (SIZE (1..maxSubframePatternIDC-r11)) OF IDC-
SubframePattern-r11

IDC-SubframePattern-r11 ::= CHOICE {
  subframePatternFDD-r11      BIT STRING (SIZE (4)),
  subframePatternTDD-r11     CHOICE {
    subframeConfig0-r11      BIT STRING (SIZE (70)),
    subframeConfig1-5-r11    BIT STRING (SIZE (10)),
    subframeConfig6-r11      BIT STRING (SIZE (60))
  },
  ...
}

VictimSystemType-r11 ::= SEQUENCE {
  gps-r11                     ENUMERATED {true} OPTIONAL,
  glonass-r11                 ENUMERATED {true} OPTIONAL,
  bds-r11                     ENUMERATED {true} OPTIONAL,
  galileo-r11                 ENUMERATED {true} OPTIONAL,
  wlan-r11                    ENUMERATED {true} OPTIONAL,
  bluetooth-r11              ENUMERATED {true} OPTIONAL
}

-- ASN1STOP

```

<i>InDeviceCoexIndication</i> field descriptions
<p>AffectedCarrierFreq If <i>carrierFreq-v1310</i> is included, <i>carrierFreq-r11</i> is ignored by eNB.</p>
<p>affectedCarrierFreqCombList Indicates a list of E-UTRA carrier frequencies that are affected by IDC problems due to Inter-Modulation Distortion and harmonics from E-UTRA when configured with UL CA. <i>affectedCarrierFreqCombList-r13</i> is used when more than 5 serving cells are configured or affected combinations contain <i>MeasObjectId</i> larger than 32. If <i>affectedCarrierFreqCombList-r13</i> is included, <i>affectedCarrierFreqCombList-r11</i> shall not be included.</p>
<p>affectedCarrierFreqList List of E-UTRA carrier frequencies affected by IDC problems. If E-UTRAN includes <i>affectedCarrierFreqList-v1310</i> it includes the same number of entries, and listed in the same order, as in <i>affectedCarrierFreqList-r11</i>.</p>
<p>drx-ActiveTime Indicates the desired active time that the E-UTRAN is recommended to configure. Value in number of subframes. Value <i>sf20</i> corresponds to 20 subframes, <i>sf30</i> corresponds to 30 subframes and so on.</p>
<p>drx-CycleLength Indicates the desired DRX cycle length that the E-UTRAN is recommended to configure. Value in number of subframes. Value <i>sf40</i> corresponds to 40 subframes, <i>sf64</i> corresponds to 64 subframes and so on.</p>
<p>drx-Offset Indicates the desired DRX starting offset that the E-UTRAN is recommended to configure. The UE shall set the value of <i>drx-Offset</i> smaller than the value of <i>drx-CycleLength</i>. The starting frame and subframe satisfy the relation: $[(SFN * 10) + \text{subframe number}] \bmod (drx-CycleLength) = drx-Offset$.</p>
<p>hardwareSharingProblem Indicates whether the UE has hardware sharing problems that the UE cannot solve by itself. The field is present (i.e. value <i>true</i>), if the UE has such hardware sharing problems. Otherwise the field is absent.</p>
<p>idc-SubframePatternList A list of one or more subframe patterns indicating which HARQ process E-UTRAN is requested to abstain from using. Value 0 indicates that E-UTRAN is requested to abstain from using the subframe. For FDD, the radio frame in which the pattern starts (i.e. the radio frame in which the first/leftmost bit of the <i>subframePatternFDD</i> corresponds to subframe #0) occurs when $SFN \bmod 2 = 0$. For TDD, the first/leftmost bit corresponds to the subframe #0 of the radio frame satisfying $SFN \bmod x = 0$, where <i>x</i> is the size of the bit string divided by 10. The UE shall indicate a subframe pattern that follows HARQ time line, as specified in TS 36.213 [23], i.e. if a subframe is set to 1 in the subframe pattern, also the corresponding subframes carrying the potential UL grant [23, 8.0], the UL HARQ retransmission [23, 8.0] and the DL/UL HARQ feedback [23, 7.3, 8.3 and 9.1.2] shall be set to 1.</p>
<p>interferenceDirection Indicates the direction of IDC interference. Value <i>eutra</i> indicates that only E-UTRA is victim of IDC interference, value <i>other</i> indicates that only another radio is victim of IDC interference and value <i>both</i> indicates that both E-UTRA and another radio are victims of IDC interference. The other radio refers to either the ISM radio or GNSS (see TR 36.816 [63]).</p>
<p>victimSystemType Indicate the list of victim system types to which IDC interference is caused from E-UTRA when configured with UL CA. Value <i>gps</i>, <i>glonass</i>, <i>bds</i> and <i>galileo</i> indicates the type of GNSS. Value <i>wlan</i> indicates WLAN and value <i>bluetooth</i> indicates Bluetooth.</p>

– *InterFreqRSTDMeasurementIndication*

The *InterFreqRSTDMeasurementIndication* message is used to indicate that the UE is going to either start or stop OTDOA inter-frequency RSTD measurement which requires measurement gaps as specified in TS 36.133 [16, 8.1.2.6]. The *InterFreqRSTDMeasurementIndication* message is also used to indicate to the network that the UE is going to start/stop OTDOA intra-frequency RSTD measurements which require measurement gaps.

Signalling radio bearer: SRB1

RLC-SAP: AM

Logical channel: DCCH

Direction: UE to E-UTRAN

InterFreqRSTDMeasurementIndication message

```
-- ASN1START
InterFreqRSTDMeasurementIndication-r10 ::= SEQUENCE {
    criticalExtensions CHOICE {
        c1 CHOICE {
            interFreqRSTDMeasurementIndication-r10 InterFreqRSTDMeasurementIndication-r10-IEs,
            spare3 NULL, spare2 NULL, spare1 NULL
        }
    }
}
```

```

    },
    criticalExtensionsFuture          SEQUENCE {}
  }
}

InterFreqRSTDMeasurementIndication-r10-IEs ::= SEQUENCE {
  rstd-InterFreqIndication-r10      CHOICE {
    start                             SEQUENCE {
      rstd-InterFreqInfoList-r10     RSTD-InterFreqInfoList-r10
    },
    stop                              NULL
  },
  lateNonCriticalExtension           OCTET STRING OPTIONAL,
  nonCriticalExtension               SEQUENCE {}      OPTIONAL
}

RSTD-InterFreqInfoList-r10 ::= SEQUENCE (SIZE(1..maxRSTD-Freq-r10)) OF RSTD-InterFreqInfo-r10

RSTD-InterFreqInfo-r10 ::= SEQUENCE {
  carrierFreq-r10                   ARFCN-ValueEUTRA,
  measPRS-Offset-r10                INTEGER (0..39),
  . . .
  [[ carrierFreq-v1090               ARFCN-ValueEUTRA-v9e0      OPTIONAL
  ]]
}

-- ASN1STOP

```

InterFreqRSTDMeasurementIndication field descriptions
<p>carrierFreq The EARFCN value of the carrier received from upper layers for which the UE needs to perform the inter-frequency RSTD measurements. If the UE includes <i>carrierFreq-v1090</i>, it shall set <i>carrierFreq-r10</i> to <i>maxEARFCN</i>. In case the UE starts intra-frequency RSTD measurements the <i>carrierFreq</i> indicates the carrier frequency of the serving cell.</p>
<p>measPRS-Offset Indicates the requested gap offset for performing inter-frequency or intra-frequency RSTD measurements. It is the smallest subframe offset from the beginning of subframe 0 of SFN=0 of the serving cell of the requested gap for measuring PRS positioning occasions in the carrier frequency <i>carrierFreq</i> for which the UE needs to perform the inter-frequency or intra-frequency RSTD measurements. The PRS positioning occasion information is received from upper layers. The value of <i>measPRS-Offset</i> is obtained by mapping the starting subframe of the PRS positioning occasion in the measured cell onto the corresponding subframe in the serving cell and is calculated as the serving cell's number of subframes from SFN=0 mod 40. The UE shall take into account any additional time required by the UE to start PRS measurements on the other carrier when it does this mapping for determining the <i>measPRS-Offset</i>. NOTE: Figure 6.2.2-1 illustrates the <i>measPRS-Offset</i> field.</p>
<p>rstd-InterFreqIndication Indicates the inter-frequency or intra-frequency RSTD measurement action, i.e. the UE is going to start or stop inter-frequency or intra-frequency RSTD measurement.</p>

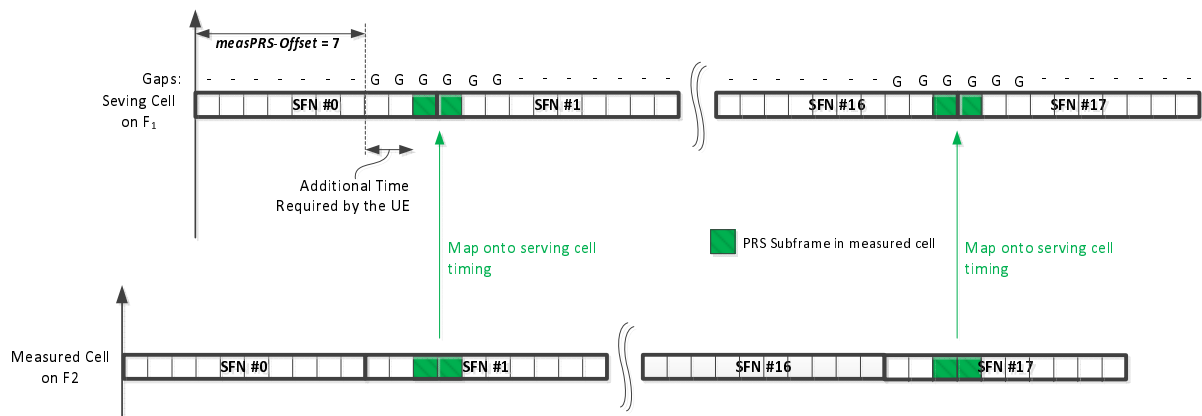

Figure 6.2.2-1 (informative): Exemplary calculation of *measPRS-Offset* field.

– *LoggedMeasurementConfiguration*

The *LoggedMeasurementConfiguration* message is used by E-UTRAN to configure the UE to perform logging of measurement results while in RRC_IDLE or to perform logging of measurement results for MBSFN while in both RRC_IDLE and RRC_CONNECTED. It is used to transfer the logged measurement configuration for network performance optimisation, see TS 37.320 [60].

Signalling radio bearer: SRB1

RLC-SAP: AM

Logical channel: DCCH

Direction: E-UTRAN to UE

LoggedMeasurementConfiguration message

```
-- ASN1START

LoggedMeasurementConfiguration-r10 ::= SEQUENCE {
    criticalExtensions          CHOICE {
        c1                     CHOICE {
            loggedMeasurementConfiguration-r10    LoggedMeasurementConfiguration-r10-IEs,
            spare3 NULL, spare2 NULL, spare1 NULL
        },
        criticalExtensionsFuture          SEQUENCE {}
    }
}

LoggedMeasurementConfiguration-r10-IEs ::= SEQUENCE {
    traceReference-r10          TraceReference-r10,
    traceRecordingSessionRef-r10    OCTET STRING (SIZE (2)),
    tce-Id-r10                  OCTET STRING (SIZE (1)),
    absoluteTimeInfo-r10        AbsoluteTimeInfo-r10,
    areaConfiguration-r10        AreaConfiguration-r10          OPTIONAL, -- Need OR
    loggingDuration-r10          LoggingDuration-r10,
    loggingInterval-r10          LoggingInterval-r10,
    nonCriticalExtension          LoggedMeasurementConfiguration-v1080-IEs    OPTIONAL
}

LoggedMeasurementConfiguration-v1080-IEs ::= SEQUENCE {
    lateNonCriticalExtension-r10    OCTET STRING          OPTIONAL,
    nonCriticalExtension             LoggedMeasurementConfiguration-v1130-IEs    OPTIONAL
}

LoggedMeasurementConfiguration-v1130-IEs ::= SEQUENCE {
    plmn-IdentityList-r11          PLMN-IdentityList3-r11    OPTIONAL, -- Need OR
    areaConfiguration-v1130        AreaConfiguration-v1130    OPTIONAL, -- Need OR
    nonCriticalExtension             LoggedMeasurementConfiguration-v1250-IEs    OPTIONAL
}

LoggedMeasurementConfiguration-v1250-IEs ::= SEQUENCE {
    targetMBSFN-AreaList-r12        TargetMBSFN-AreaList-r12    OPTIONAL, -- Need OP
    nonCriticalExtension             SEQUENCE {}          OPTIONAL
}

TargetMBSFN-AreaList-r12 ::=
    SEQUENCE (SIZE (0..maxMBSFN-Area)) OF TargetMBSFN-Area-r12

TargetMBSFN-Area-r12 ::=
    SEQUENCE {
        mbsfn-AreaId-r12            MBSFN-AreaId-r12          OPTIONAL, -- Need OR
        carrierFreq-r12             ARFCN-ValueEUTRA-r9,
        ...
    }

-- ASN1STOP
```

LoggedMeasurementConfiguration field descriptions
absoluteTimeInfo Indicates the absolute time in the current cell.
areaConfiguration Used to restrict the area in which the UE performs measurement logging to cells broadcasting either one of the included cell identities or one of the included tracking area codes/ identities.
plmn-IdentityList Indicates a set of PLMNs defining when the UE performs measurement logging as well as the associated status indication and information retrieval i.e. the UE performs these actions when the RPLMN is part of this set of PLMNs.
targetMBSFN-AreaList Used to indicate logging of MBSFN measurements and further restrict the area and frequencies for which the UE performs measurement logging for MBSFN. If both MBSFN area id and carrier frequency are present, a specific MBSFN area is indicated. If only carrier frequency is present, all MBSFN areas on that carrier frequency are indicated. If there is no entry in the list, any MBSFN area is indicated.
tce-Id Parameter Trace Collection Entity Id: See TS 32.422 [58].
traceRecordingSessionRef Parameter Trace Recording Session Reference: See TS 32.422 [58]

– **MasterInformationBlock**

The *MasterInformationBlock* includes the system information transmitted on BCH.

Signalling radio bearer: N/A

RLC-SAP: TM

Logical channel: BCCH

Direction: E-UTRAN to UE

MasterInformationBlock

```

-- ASN1START
MasterInformationBlock ::= SEQUENCE {
    dl-Bandwidth          ENUMERATED {
                          n6, n15, n25, n50, n75, n100},
    phich-Config         PHICH-Config,
    systemFrameNumber    BIT STRING (SIZE (8)),
    schedulingInfoSIB1-BR-r13 INTEGER (0..31),
    spare                BIT STRING (SIZE (5))
}
-- ASN1STOP

```

MasterInformationBlock field descriptions
dl-Bandwidth Parameter: transmission bandwidth configuration, N_{RB} in downlink, see TS 36.101 [42, table 5.6-1]. n6 corresponds to 6 resource blocks, n15 to 15 resource blocks and so on.
phich-Config Specifies the PHICH configuration. If the UE is a BL UE or UE in CE, it shall ignore this field.
schedulingInfoSIB1-BR Indicates the index to the tables that define <i>SystemInformationBlockType1-BR</i> scheduling information. The tables are specified in TS 36.213 [23, Table 7.1.6-1 and Table 7.1.7.2.7-1]. Value 0 means that <i>SystemInformationBlockType1-BR</i> is not scheduled.
systemFrameNumber Defines the 8 most significant bits of the SFN. As indicated in TS 36.211 [21, 6.6.1], the 2 least significant bits of the SFN are acquired implicitly in the P-BCH decoding, i.e. timing of 40ms P-BCH TTI indicates 2 least significant bits (within 40ms P-BCH TTI, the first radio frame: 00, the second radio frame: 01, the third radio frame: 10, the last radio frame: 11). One value applies for all serving cells of a Cell Group (i.e. MCG or SCG). The associated functionality is common (i.e. not performed independently for each cell).

– *MasterInformationBlock-MBMS*

The *MasterInformationBlock-MBMS* includes the system information transmitted on BCH.

Signalling radio bearer: N/A

RLC-SAP: TM

Logical channel: BCCH

Direction: E-UTRAN to UE

MasterInformationBlock-MBMS

```
-- ASN1START
MasterInformationBlock-MBMS-r14 ::= SEQUENCE {
    dl-Bandwidth-MBMS-r14          ENUMERATED {
                                   n6, n15, n25, n50, n75, n100},
    systemFrameNumber-r14        BIT STRING (SIZE (6)),
    additionalNonMBSFNSubframes-r14 INTEGER (0..3),
    spare                          BIT STRING (SIZE (13))
}
-- ASN1STOP
```

MasterInformationBlock-MBMS field descriptions

additionalNonMBSFNSubframes

Configures additional non-MBSFN subframes where *SystemInformationBlockType1-MBMS* and *SystemInformation-MBMS* may be transmitted. Value 0, 1, 2, 3 mean zero, one, two, three additional non-MBSFN subframes are configured after each subframe which has PBCH.

dl-Bandwidth-MBMS

Parameter: transmission bandwidth configuration, N_{RB} in downlink, see TS 36.101 [42, table 5.6-1]. n6 corresponds to 6 resource blocks, n15 to 15 resource blocks and so on.

systemFrameNumber

Defines the 6 most significant bits of the SFN of the MBMS-dedicated cell. As indicated in TS 36.211 [21, 6.6.1], the 4 least significant bits of the SFN are acquired implicitly in the P-BCH decoding, i.e. timing of 160ms P-BCH TTI indicates 4 least significant bits (within 40ms P-BCH TTI, the first radio frame: 00, the fourth radio frame: 01, the eighth radio frame: 10, the last radio frame: 11).

– *MBMSCountingRequest*

The *MBMSCountingRequest* message is used by E-UTRAN to count the UEs that are receiving or interested to receive specific MBMS services.

Signalling radio bearer: N/A

RLC-SAP: UM

Logical channel: MCCH

Direction: E-UTRAN to UE

MBMSCountingRequest message

```
-- ASN1START
MBMSCountingRequest-r10 ::= SEQUENCE {
    countingRequestList-r10      CountingRequestList-r10,
    lateNonCriticalExtension     OCTET STRING                OPTIONAL,
    nonCriticalExtension         SEQUENCE {                          OPTIONAL
}

CountingRequestList-r10 ::= SEQUENCE (SIZE (1..maxServiceCount)) OF CountingRequestInfo-r10

CountingRequestInfo-r10 ::= SEQUENCE {
    tmgi-r10                     TMGI-r9,
    ...
}
```

```
}
-- ASN1STOP
```

– MBMSCountingResponse

The *MBMSCountingResponse* message is used by the UE to respond to an *MBMSCountingRequest* message.

Signalling radio bearer: SRB1

RLC-SAP: AM

Logical channel: DCCH

Direction: UE to E-UTRAN

MBMSCountingResponse message

```
-- ASN1START
MBMSCountingResponse-r10 ::= SEQUENCE {
  criticalExtensions          CHOICE {
    c1                        CHOICE {
      countingResponse-r10   MBMSCountingResponse-r10-IEs,
      spare3 NULL, spare2 NULL, spare1 NULL
    },
    criticalExtensionsFuture SEQUENCE {}
  }
}

MBMSCountingResponse-r10-IEs ::= SEQUENCE {
  mbsfn-AreaIndex-r10      INTEGER (0..maxMBSFN-Area-1) OPTIONAL,
  countingResponseList-r10 CountingResponseList-r10 OPTIONAL,
  lateNonCriticalExtension OCTET STRING OPTIONAL,
  nonCriticalExtension     SEQUENCE {} OPTIONAL
}

CountingResponseList-r10 ::= SEQUENCE (SIZE (1..maxServiceCount)) OF CountingResponseInfo-r10

CountingResponseInfo-r10 ::= SEQUENCE {
  countingResponseService-r10 INTEGER (0..maxServiceCount-1),
  ...
}
-- ASN1STOP
```

MBMSCountingResponse field descriptions

countingResponseList

List of MBMS services which the UE is receiving or interested to receive. Value 0 for field *countingResponseService* corresponds to the first entry in *countingRequestList* within *MBMSCountingRequest*, value 1 corresponds to the second entry in this list and so on.

mbsfn-AreaIndex

Index of the entry in field *mbsfn-AreaInfoList* within *SystemInformationBlockType13*. Value 0 corresponds to the first entry in *mbsfn-AreaInfoList* within *SystemInformationBlockType13*, value 1 corresponds to the second entry in this list and so on.

– *MBMSInterestIndication*

The *MBMSInterestIndication* message is used to inform E-UTRAN that the UE is receiving/ interested to receive or no longer receiving/ interested to receive MBMS via an MRB or SC-MRB.

Signalling radio bearer: SRB1

RLC-SAP: AM

Logical channel: DCCH

Direction: UE to E-UTRAN

MBMSInterestIndication message

```
-- ASN1START
MBMSInterestIndication-r11 ::= SEQUENCE {
    criticalExtensions          CHOICE {
        c1                     CHOICE {
            interestIndication-r11 MBMSInterestIndication-r11-IEs,
            spare3 NULL, spare2 NULL, spare1 NULL
        },
        criticalExtensionsFuture SEQUENCE {}
    }
}

MBMSInterestIndication-r11-IEs ::= SEQUENCE {
    mbms-FreqList-r11          CarrierFreqListMBMS-r11          OPTIONAL,
    mbms-Priority-r11          ENUMERATED {true}                OPTIONAL,
    lateNonCriticalExtension   OCTET STRING                  OPTIONAL,
    nonCriticalExtension       MBMSInterestIndication-v1310-IEs OPTIONAL
}

MBMSInterestIndication-v1310-IEs ::= SEQUENCE {
    mbms-Services-r13          MBMS-ServiceList-r13            OPTIONAL,
    nonCriticalExtension       SEQUENCE {}                      OPTIONAL
}
-- ASN1STOP
```

MBMSInterestIndication field descriptions

mbms-FreqList

List of MBMS frequencies on which the UE is receiving or interested to receive MBMS via an MRB or SC-MRB.

mbms-Priority

Indicates whether the UE prioritises MBMS reception above unicast reception. The field is present (i.e. value *true*), if the UE prioritises reception of all listed MBMS frequencies above reception of any of the unicast bearers. Otherwise the field is absent.

– *MBSFNAreaConfiguration*

The *MBSFNAreaConfiguration* message contains the MBMS control information applicable for an MBSFN area. For each MBSFN area included in *SystemInformationBlockType13* E-UTRAN configures an MCCH (i.e. the MCCH identifies the MBSFN area) and signals the *MBSFNAreaConfiguration* message.

Signalling radio bearer: N/A

RLC-SAP: UM

Logical channel: MCCH

Direction: E-UTRAN to UE

MBSFNAreaConfiguration message

```
-- ASN1START
MBSFNAreaConfiguration-r9 ::= SEQUENCE {
```

```

commonSF-Alloc-r9          CommonSF-AllocPatternList-r9,
commonSF-AllocPeriod-r9   ENUMERATED {
                           rf4, rf8, rf16, rf32, rf64, rf128, rf256},
pmch-InfoList-r9          PMCH-InfoList-r9,
nonCriticalExtension       MBSFNAreaConfiguration-v930-IEs OPTIONAL
}

MBSFNAreaConfiguration-v930-IEs ::= SEQUENCE {
  lateNonCriticalExtension  OCTET STRING          OPTIONAL,
  nonCriticalExtension      MBSFNAreaConfiguration-v1250-IEs OPTIONAL
}

MBSFNAreaConfiguration-v1250-IEs ::= SEQUENCE {
  pmch-InfoListExt-r12     PMCH-InfoListExt-r12  OPTIONAL,  -- Need OR
  nonCriticalExtension      MBSFNAreaConfiguration-v1430-IEs OPTIONAL
}

MBSFNAreaConfiguration-v1430-IEs ::= SEQUENCE {
  commonSF-Alloc-r14       CommonSF-AllocPatternList-r14,
  nonCriticalExtension      SEQUENCE {}           OPTIONAL
}

CommonSF-AllocPatternList-r9 ::= SEQUENCE (SIZE (1..maxMBSFN-Allocations)) OF MBSFN-
SubframeConfig

CommonSF-AllocPatternList-r14 ::= SEQUENCE (SIZE (1..maxMBSFN-Allocations)) OF MBSFN-
SubframeConfig-v1430

-- ASN1STOP

```

MBSFNAreaConfiguration field descriptions

commonSF-Alloc

Indicates the subframes allocated to the MBSFN area. E-UTRAN always sets this field to cover at least the subframes configured by *SystemInformationBlockType13* for this MCCH, regardless of whether any MBMS sessions are ongoing.

commonSF-AllocPeriod

Indicates the period during which resources corresponding with field *commonSF-Alloc* are divided between the (P)MCH that are configured for this MBSFN area. The subframe allocation patterns, as defined by *commonSF-Alloc*, repeat continuously during this period. Value rf4 corresponds to 4 radio frames, rf8 corresponds to 8 radio frames and so on. The *commonSF-AllocPeriod* starts in the radio frames for which: $\text{SFN mod } \text{commonSF-AllocPeriod} = 0$.

pmch-InfoList

EUTRAN may include *pmch-InfoListExt* even if *pmch-InfoList* does not include *maxPMCH-PerMBSFN* entries. EUTRAN configures at most *maxPMCH-PerMBSFN* entries i.e. across *pmch-InfoList* and *pmch-InfoListExt*.

– *MeasurementReport*

The *MeasurementReport* message is used for the indication of measurement results.

Signalling radio bearer: SRB1

RLC-SAP: AM

Logical channel: DCCH

Direction: UE to E-UTRAN

MeasurementReport message

```

-- ASN1START
MeasurementReport ::=
  criticalExtensions
  c1
  measurementReport-r8          MeasurementReport-r8-IEs,
  spare7 NULL,
  spare6 NULL, spare5 NULL, spare4 NULL,
  spare3 NULL, spare2 NULL, spare1 NULL
  },
  criticalExtensionsFuture      SEQUENCE {}
}

```

```

MeasurementReport-r8-IEs ::= SEQUENCE {
    measResults           MeasResults,
    nonCriticalExtension  MeasurementReport-v8a0-IEs OPTIONAL
}

MeasurementReport-v8a0-IEs ::= SEQUENCE {
    lateNonCriticalExtension OCTET STRING OPTIONAL,
    nonCriticalExtension     SEQUENCE {}    OPTIONAL
}

-- ASN1STOP

```

– *MobilityFromEUTRACommand*

The *MobilityFromEUTRACommand* message is used to command handover or a cell change from E-UTRA to another RAT (3GPP or non-3GPP), or enhanced CS fallback to CDMA2000 1xRTT.

Signalling radio bearer: SRB1

RLC-SAP: AM

Logical channel: DCCH

Direction: E-UTRAN to UE

MobilityFromEUTRACommand message

```

-- ASN1START

MobilityFromEUTRACommand ::= SEQUENCE {
    rrc-TransactionIdentifier RRC-TransactionIdentifier,
    criticalExtensions        CHOICE {
        c1
            mobilityFromEUTRACommand-r8 MobilityFromEUTRACommand-r8-IEs,
            mobilityFromEUTRACommand-r9 MobilityFromEUTRACommand-r9-IEs,
            spare2 NULL, spare1 NULL
        },
    criticalExtensionsFuture SEQUENCE {}
}

MobilityFromEUTRACommand-r8-IEs ::= SEQUENCE {
    cs-FallbackIndicator BOOLEAN,
    purpose               CHOICE {
        handover           Handover,
        cellChangeOrder    CellChangeOrder
    },
    nonCriticalExtension  MobilityFromEUTRACommand-v8a0-IEs OPTIONAL
}

MobilityFromEUTRACommand-v8a0-IEs ::= SEQUENCE {
    lateNonCriticalExtension OCTET STRING OPTIONAL,
    nonCriticalExtension     MobilityFromEUTRACommand-v8d0-IEs OPTIONAL
}

MobilityFromEUTRACommand-v8d0-IEs ::= SEQUENCE {
    bandIndicator          BandIndicatorGERAN OPTIONAL, -- Cond GERAN
    nonCriticalExtension   SEQUENCE {}      OPTIONAL
}

MobilityFromEUTRACommand-r9-IEs ::= SEQUENCE {
    cs-FallbackIndicator BOOLEAN,
    purpose               CHOICE {
        handover           Handover,
        cellChangeOrder    CellChangeOrder,
        e-CSFB-r9         E-CSFB-r9,
        ...
    },
    nonCriticalExtension  MobilityFromEUTRACommand-v930-IEs OPTIONAL
}

MobilityFromEUTRACommand-v930-IEs ::= SEQUENCE {
    lateNonCriticalExtension OCTET STRING OPTIONAL,
    nonCriticalExtension     MobilityFromEUTRACommand-v960-IEs OPTIONAL
}

```

```

}
MobilityFromEUTRACommand-v960-IEs ::= SEQUENCE {
    bandIndicator          BandIndicatorGERAN          OPTIONAL,    -- Cond GERAN
    nonCriticalExtension   SEQUENCE {}                OPTIONAL
}

Handover ::=
    SEQUENCE {
        targetRAT-Type     ENUMERATED {
            ultra, geran, cdma2000-1XRTT, cdma2000-HRPD,
            spare4, spare3, spare2, spare1, ...},
        targetRAT-MessageContainer OCTET STRING,
        nas-SecurityParamFromEUTRA OCTET STRING (SIZE (1)) OPTIONAL,    -- Cond UTRAGERAN
        systemInformation     SI-OrPSI-GERAN          OPTIONAL    -- Cond PSHO
    }

CellChangeOrder ::=
    SEQUENCE {
        t304                ENUMERATED {
            ms100, ms200, ms500, ms1000,
            ms2000, ms4000, ms8000, ms10000-v1310},
        targetRAT-Type     CHOICE {
            geran           SEQUENCE {
                physCellId   PhysCellIdGERAN,
                carrierFreq   CarrierFreqGERAN,
                networkControlOrder BIT STRING (SIZE (2))    OPTIONAL,    -- Need OP
                systemInformation SI-OrPSI-GERAN              OPTIONAL    -- Need OP
            },
            ...
        }
    }

SI-OrPSI-GERAN ::=
    CHOICE {
        si      SystemInfoListGERAN,
        psi     SystemInfoListGERAN
    }

E-CSFB-r9 ::=
    SEQUENCE {
        messageContCDMA2000-1XRTT-r9    OCTET STRING          OPTIONAL,    -- Need ON
        mobilityCDMA2000-HRPD-r9        ENUMERATED {
            handover, redirection
        }
        messageContCDMA2000-HRPD-r9     OCTET STRING          OPTIONAL,    -- Cond concHO
        redirectCarrierCDMA2000-HRPD-r9 CarrierFreqCDMA2000    OPTIONAL    -- Cond concRedir
    }

-- ASN1STOP

```

MobilityFromEUTRACommand field descriptions	
bandIndicator	Indicates how to interpret the ARFCN of the BCCH carrier.
carrierFreq	contains the carrier frequency of the target GERAN cell.
cs-FallbackIndicator	Value <i>true</i> indicates that the CS fallback procedure to UTRAN or GERAN is triggered.
messageContCDMA2000-1XRTT	This field contains a message specified in CDMA2000 1xRTT standard that either tells the UE to move to specific 1xRTT target cell(s) or indicates a failure to allocate resources for the enhanced CS fallback to CDMA2000 1xRTT.
messageContCDMA2000-HRPD	This field contains a message specified in CDMA2000 HRPD standard that either tells the UE to move to specific HRPD target cell(s) or indicates a failure to allocate resources for the handover to CDMA2000 HRPD.
mobilityCDMA2000-HRPD	This field indicates whether or not mobility to CDMA2000 HRPD is to be performed by the UE and it also indicates the type of mobility to CDMA2000 HRPD that is to be performed; If this field is not present the UE shall perform only the enhanced CS fallback to CDMA2000 1xRTT.
nas-SecurityParamFromEUTRA	Used to deliver the key synchronisation and Key freshness for the E-UTRAN to UTRAN handovers as specified in TS 33.401. The content of the parameter is defined in TS24.301.
networkControlOrder	Parameter NETWORK_CONTROL_ORDER in TS 44.060 [36].
purpose	Indicates which type of mobility procedure the UE is requested to perform. EUTRAN always applies value <i>e-CSFB</i> in case of enhanced CS fallback to CDMA2000 (e.g. also when that procedure results in handover to CDMA2000 1XRTT only, in handover to CDMA2000 HRPD only or in redirection to CDMA2000 HRPD only),
redirectCarrierCDMA2000-HRPD	The <i>redirectCarrierCDMA2000-HRPD</i> indicates a CDMA2000 carrier frequency and is used to redirect the UE to a HRPD carrier frequency.
SystemInfoListGERAN	If <i>purpose = CellChangeOrder</i> and if the field is not present, the UE has to acquire SI/PSI from the GERAN cell.
t304	Timer T304 as described in clause 7.3. Value <i>ms100</i> corresponds with 100 ms, <i>ms200</i> corresponds with 200 ms and so on. EUTRAN includes extended value <i>ms10000-v1310</i> only when UE supports CE.
targetRAT-Type	Indicates the target RAT type.
targetRAT-MessageContainer	The field contains a message specified in another standard, as indicated by the <i>targetRAT-Type</i> , and carries information about the target cell identifier(s) and radio parameters relevant for the target radio access technology. NOTE 1. A complete message is included, as specified in the other standard.

Conditional presence	Explanation
<i>concHO</i>	The field is mandatory present if the <i>mobilityCDMA2000-HRPD</i> is set to " <i>handover</i> "; otherwise the field is optional present, need ON.
<i>concRedir</i>	The field is mandatory present if the <i>mobilityCDMA2000-HRPD</i> is set to " <i>redirection</i> "; otherwise the field is not present.
<i>GERAN</i>	The field should be present if the <i>purpose</i> is set to " <i>handover</i> " and the <i>targetRAT-Type</i> is set to " <i>geran</i> "; otherwise the field is not present
<i>PSHO</i>	The field is mandatory present in case of PS handover toward GERAN; otherwise the field is optionally present, but not used by the UE
<i>UTRAGERAN</i>	The field is mandatory present if the <i>targetRAT-Type</i> is set to " <i>utra</i> " or " <i>geran</i> "; otherwise the field is not present

NOTE 1: The correspondence between the value of the *targetRAT-Type*, the standard to apply and the message contained within the *targetRAT-MessageContainer* is shown in the table below:

targetRAT-Type	Standard to apply	targetRAT-MessageContainer
cdma2000-1XRTT	C.S0001 or later, C.S0007 or later, C.S0008 or later	
cdma2000-HRPD	C.S0024 or later	
geran	GSM TS 04.18, version 8.5.0 or later, or TS 44.018 (clause 9.1.15)	HANDOVER COMMAND
	TS 44.060, version 6.13.0 or later (clause 11.2.43)	PS HANDOVER COMMAND
	TS 44.060, version 7.6.0 or later (clause 11.2.46)	DTM HANDOVER COMMAND
utra	TS 25.331 (clause 10.2.16a)	HANDOVER TO UTRAN COMMAND

– Paging

The *Paging* message is used for the notification of one or more UEs.

Signalling radio bearer: N/A

RLC-SAP: TM

Logical channel: PCCH

Direction: E-UTRAN to UE

Paging message

```

-- ASN1START
Paging ::= SEQUENCE {
    pagingRecordList          PagingRecordList          OPTIONAL, -- Need ON
    systemInfoModification    ENUMERATED {true}         OPTIONAL, -- Need ON
    etws-Indication           ENUMERATED {true}         OPTIONAL, -- Need ON
    nonCriticalExtension       Paging-v890-IEs           OPTIONAL
}

Paging-v890-IEs ::= SEQUENCE {
    lateNonCriticalExtension   OCTET STRING          OPTIONAL,
    nonCriticalExtension       Paging-v920-IEs       OPTIONAL
}

Paging-v920-IEs ::= SEQUENCE {
    cmas-Indication-r9        ENUMERATED {true}     OPTIONAL, -- Need ON
    nonCriticalExtension       Paging-v1130-IEs     OPTIONAL
}

Paging-v1130-IEs ::= SEQUENCE {
    eab-ParamModification-r11  ENUMERATED {true}     OPTIONAL, -- Need ON
    nonCriticalExtension       Paging-v1310-IEs     OPTIONAL
}

Paging-v1310-IEs ::= SEQUENCE {
    redistributionIndication-r13  ENUMERATED {true}     OPTIONAL, --Need ON
    systemInfoModification-eDRX-r13  ENUMERATED {true}     OPTIONAL, -- Need ON
    nonCriticalExtension          SEQUENCE {}              OPTIONAL
}

PagingRecordList ::= SEQUENCE (SIZE (1..maxPageRec)) OF PagingRecord

PagingRecord ::= SEQUENCE {
    ue-Identity                PagingUE-Identity,
    cn-Domain                  ENUMERATED {ps, cs},
    ...
}

PagingUE-Identity ::= CHOICE {
    s-TMSI                     S-TMSI,
    imsi                       IMSI,
    ...
}

IMSI ::= SEQUENCE (SIZE (6..21)) OF IMSI-Digit

```

```

IMSI-Digit ::= INTEGER (0..9)
-- ASN1STOP

```

<i>Paging field descriptions</i>
cmas-Indication If present: indication of a CMAS notification.
cn-Domain Indicates the origin of paging.
eab-ParamModification If present: indication of an EAB parameters (SIB14) modification.
etws-Indication If present: indication of an ETWS primary notification and/ or ETWS secondary notification.
imsi The International Mobile Subscriber Identity, a globally unique permanent subscriber identity, see TS 23.003 [27]. The first element contains the first IMSI digit, the second element contains the second IMSI digit and so on.
redistributionIndication If present: indication to trigger E-UTRAN inter-frequency redistribution procedure as specified in TS 36.304 [4, 5.2.4.10]
systemInfoModification If present: indication of a BCCH modification other than SIB10, SIB11, SIB12 and SIB14. This indication does not apply to UEs using eDRX cycle longer than the BCCH modification period.
systemInfoModification-eDRX If present: indication of a BCCH modification other than SIB10, SIB11, SIB12 and SIB14. This indication applies only to UEs using eDRX cycle longer than the BCCH modification period.
ue-Identity Provides the NAS identity of the UE that is being paged.

– *ProximityIndication*

The *ProximityIndication* message is used to indicate that the UE is entering or leaving the proximity of one or more CSG member cell(s).

Signalling radio bearer: SRB1

RLC-SAP: AM

Logical channel: DCCH

Direction: UE to E-UTRAN

ProximityIndication message

```

-- ASN1START
ProximityIndication-r9 ::= SEQUENCE {
    criticalExtensions          CHOICE {
        c1                     CHOICE {
            proximityIndication-r9          ProximityIndication-r9-IEs,
            spare3 NULL, spare2 NULL, spare1 NULL
        },
        criticalExtensionsFuture          SEQUENCE {}
    }
}

ProximityIndication-r9-IEs ::= SEQUENCE {
    type-r9                    ENUMERATED {entering, leaving},
    carrierFreq-r9             CHOICE {
        eutra-r9                ARFCN-ValueEUTRA,
        utra-r9                 ARFCN-ValueUTRA,
        ...,
        eutra2-v9e0             ARFCN-ValueEUTRA-v9e0
    },
    nonCriticalExtension          ProximityIndication-v930-IEs
    OPTIONAL
}

ProximityIndication-v930-IEs ::= SEQUENCE {

```

```

    lateNonCriticalExtension      OCTET STRING      OPTIONAL,
    nonCriticalExtension          SEQUENCE {}          OPTIONAL
}
-- ASN1STOP

```

ProximityIndication field descriptions

carrierFreq

Indicates the RAT and frequency of the CSG member cell(s), for which the proximity indication is sent. For E-UTRA and UTRA frequencies, the UE shall set the ARFCN according to a band it previously considered suitable for accessing (one of) the CSG member cell(s), for which the proximity indication is sent.

type

Used to indicate whether the UE is entering or leaving the proximity of CSG member cell(s).

– **RNReconfiguration**

The *RNReconfiguration* is a command to modify the RN subframe configuration and/or to convey changed system information.

Signalling radio bearer: SRB1

RLC-SAP: AM

Logical channel: DCCH

Direction: E-UTRAN to RN

RNReconfiguration message

```

-- ASN1START
RNReconfiguration-r10 ::=      SEQUENCE {
    rrc-TransactionIdentifier    RRC-TransactionIdentifier,
    criticalExtensions           CHOICE {
        c1                       CHOICE {
            rnReconfiguration-r10 RNReconfiguration-r10-IEs,
            spare3 NULL, spare2 NULL, spare1 NULL
        },
        criticalExtensionsFuture SEQUENCE {}
    }
}

RNReconfiguration-r10-IEs ::= SEQUENCE {
    rn-SystemInfo-r10           RN-SystemInfo-r10           OPTIONAL, -- Need ON
    rn-SubframeConfig-r10       RN-SubframeConfig-r10       OPTIONAL, -- Need ON
    lateNonCriticalExtension     OCTET STRING                OPTIONAL,
    nonCriticalExtension         SEQUENCE {}                  OPTIONAL
}

RN-SystemInfo-r10 ::=         SEQUENCE {
    systemInformationBlockType1-r10 OCTET STRING (CONTAINING SystemInformationBlockType1)
    OPTIONAL, -- Need ON
    systemInformationBlockType2-r10 SystemInformationBlockType2   OPTIONAL, -- Need ON
    ...
}
-- ASN1STOP

```

– **RNReconfigurationComplete**

The *RNReconfigurationComplete* message is used to confirm the successful completion of an RN reconfiguration.

Signalling radio bearer: SRB1

RLC-SAP: AM

Logical channel: DCCH

Direction: RN to E-UTRAN

RNReconfigurationComplete message

```
-- ASN1START
RNReconfigurationComplete-r10 ::= SEQUENCE {
  rrc-TransactionIdentifier      RRC-TransactionIdentifier,
  criticalExtensions             CHOICE {
    c1                           CHOICE {
      rnReconfigurationComplete-r10  RNReconfigurationComplete-r10-IEs,
      spare3 NULL, spare2 NULL, spare1 NULL
    },
    criticalExtensionsFuture        SEQUENCE {}
  }
}

RNReconfigurationComplete-r10-IEs ::= SEQUENCE {
  lateNonCriticalExtension      OCTET STRING          OPTIONAL,
  nonCriticalExtension          SEQUENCE {}           OPTIONAL
}
-- ASN1STOP
```

RRCConnectionReconfiguration

The *RRCConnectionReconfiguration* message is the command to modify an RRC connection. It may convey information for measurement configuration, mobility control, radio resource configuration (including RBs, MAC main configuration and physical channel configuration) including any associated dedicated NAS information and security configuration.

Signalling radio bearer: SRB1

RLC-SAP: AM

Logical channel: DCCH

Direction: E-UTRAN to UE

RRCConnectionReconfiguration message

```
-- ASN1START
RRCConnectionReconfiguration ::= SEQUENCE {
  rrc-TransactionIdentifier      RRC-TransactionIdentifier,
  criticalExtensions             CHOICE {
    c1                           CHOICE {
      rrcConnectionReconfiguration-r8  RRCConnectionReconfiguration-r8-IEs,
      spare7 NULL,
      spare6 NULL, spare5 NULL, spare4 NULL,
      spare3 NULL, spare2 NULL, spare1 NULL
    },
    criticalExtensionsFuture        SEQUENCE {}
  }
}

RRCConnectionReconfiguration-r8-IEs ::= SEQUENCE {
  measConfig                    MeasConfig          OPTIONAL, -- Need ON
  mobilityControlInfo           MobilityControlInfo  OPTIONAL, -- Cond HO
  dedicatedInfoNASList          SEQUENCE (SIZE(1..maxDRB)) OF
    DedicatedInfoNAS            OPTIONAL, -- Cond nonHO
  radioResourceConfigDedicated  RadioResourceConfigDedicated  OPTIONAL, -- Cond HO-toEUTRA
  securityConfigHO              SecurityConfigHO    OPTIONAL, -- Cond HO
  nonCriticalExtension          RRCConnectionReconfiguration-v890-IEs  OPTIONAL
}
-- ASN1STOP
```

```

RRCConnectionReconfiguration-v890-IEs ::= SEQUENCE {
  lateNonCriticalExtension      OCTET STRING (CONTAINING RRCConnectionReconfiguration-v8m0-
IEs)      OPTIONAL,
  nonCriticalExtension          RRCConnectionReconfiguration-v920-IEs      OPTIONAL
}

-- Late non-critical extensions:
RRCConnectionReconfiguration-v8m0-IEs ::= SEQUENCE {
  -- Following field is only for pre REL-10 late non-critical extensions
  lateNonCriticalExtension      OCTET STRING      OPTIONAL,
  nonCriticalExtension          RRCConnectionReconfiguration-v10i0-IEs      OPTIONAL
}

RRCConnectionReconfiguration-v10i0-IEs ::= SEQUENCE {
  antennaInfoDedicatedPCell-v10i0 AntennaInfoDedicated-v10i0      OPTIONAL, -- Need ON
  nonCriticalExtension          RRCConnectionReconfiguration-v10i0-IEs      OPTIONAL
}

RRCConnectionReconfiguration-v10l0-IEs ::= SEQUENCE {
  mobilityControlInfo-v10l0      MobilityControlInfo-v10l0      OPTIONAL,
  sCellToAddModList-v10l0      SCellToAddModList-v10l0      OPTIONAL, -- Need ON
  -- Following field is only for late non-critical extensions from REL-10 to REL-11
  lateNonCriticalExtension      OCTET STRING      OPTIONAL,
  nonCriticalExtension          RRCConnectionReconfiguration-v12f0-IEs      OPTIONAL
}

RRCConnectionReconfiguration-v12f0-IEs ::= SEQUENCE {
  scg-Configuration-v12f0      SCG-Configuration-v12f0      OPTIONAL, -- Cond nonFullConfig
  -- Following field is only for late non-critical extensions from REL-12
  lateNonCriticalExtension      OCTET STRING      OPTIONAL,
  nonCriticalExtension          RRCConnectionReconfiguration-v1370-IEs      OPTIONAL
}

RRCConnectionReconfiguration-v1370-IEs ::= SEQUENCE {
  radioResourceConfigDedicated-v1370 RadioResourceConfigDedicated-v1370      OPTIONAL, -- Need ON
  sCellToAddModListExt-v1370      SCellToAddModListExt-v1370      OPTIONAL, -- Need ON
  nonCriticalExtension          RRCConnectionReconfiguration-v13c0-IEs      OPTIONAL
}

RRCConnectionReconfiguration-v13c0-IEs ::= SEQUENCE {
  radioResourceConfigDedicated-v13c0 RadioResourceConfigDedicated-v13c0      OPTIONAL, -- Need ON
  sCellToAddModList-v13c0      SCellToAddModList-v13c0      OPTIONAL, -- Need ON
  sCellToAddModListExt-v13c0      SCellToAddModListExt-v13c0      OPTIONAL, -- Need ON
  scg-Configuration-v13c0      SCG-Configuration-v13c0      OPTIONAL, -- Need ON
  -- Following field is only for late non-critical extensions from REL-13 onwards
  nonCriticalExtension          SEQUENCE {}      OPTIONAL
}

-- Regular non-critical extensions:
RRCConnectionReconfiguration-v920-IEs ::= SEQUENCE {
  otherConfig-r9      OtherConfig-r9      OPTIONAL, -- Need ON
  fullConfig-r9      ENUMERATED {true}      OPTIONAL, -- Cond HO-Reestab
  nonCriticalExtension      RRCConnectionReconfiguration-v1020-IEs      OPTIONAL
}

RRCConnectionReconfiguration-v1020-IEs ::= SEQUENCE {
  sCellToReleaseList-r10      SCellToReleaseList-r10      OPTIONAL, -- Need ON
  sCellToAddModList-r10      SCellToAddModList-r10      OPTIONAL, -- Need ON
  nonCriticalExtension          RRCConnectionReconfiguration-v1130-IEs      OPTIONAL
}

RRCConnectionReconfiguration-v1130-IEs ::= SEQUENCE {
  systemInformationBlockType1Dedicated-r11 OCTET STRING (CONTAINING
SystemInformationBlockType1)
  OPTIONAL, -- Need ON
  nonCriticalExtension          RRCConnectionReconfiguration-v1250-IEs      OPTIONAL
}

RRCConnectionReconfiguration-v1250-IEs ::= SEQUENCE {
  wlan-OffloadInfo-r12      CHOICE {
    release      NULL,
    setup      SEQUENCE {
      wlan-OffloadConfigDedicated-r12 WLAN-OffloadConfig-r12,
      t350-r12      ENUMERATED {min5, min10, min20, min30, min60,
min120, min180, spare1}      OPTIONAL -- Need OR
    }
  }
  OPTIONAL, -- Need ON
}

```

```

    scg-Configuration-r12          SCG-Configuration-r12          OPTIONAL,  -- Cond
nonFullConfig
    sl-SyncTxControl-r12          SL-SyncTxControl-r12          OPTIONAL,  -- Need ON
    sl-DiscConfig-r12            SL-DiscConfig-r12           OPTIONAL,  -- Need ON
    sl-CommConfig-r12           SL-CommConfig-r12          OPTIONAL,  -- Need ON
    nonCriticalExtension          RRCCONNECTIONRECONFIGURATION-v1310-IES OPTIONAL
}

RRCCONNECTIONRECONFIGURATION-v1310-IES ::= SEQUENCE {
    sCellToReleaseListExt-r13     SCellToReleaseListExt-r13   OPTIONAL,  -- Need ON
    sCellToAddModListExt-r13     SCellToAddModListExt-r13   OPTIONAL,  -- Need ON
    lwa-Configuration-r13        LWA-Configuration-r13      OPTIONAL,  -- Need ON
    lwip-Configuration-r13       LWIP-Configuration-r13     OPTIONAL,  -- Need ON
    rclwi-Configuration-r13      RCLWI-Configuration-r13    OPTIONAL,  -- Need ON
    nonCriticalExtension          RRCCONNECTIONRECONFIGURATION-v1430-IES
OPTIONAL
}

RRCCONNECTIONRECONFIGURATION-v1430-IES ::= SEQUENCE {
    sl-V2X-ConfigDedicated-r14    SL-V2X-ConfigDedicated-r14  OPTIONAL,  -- Need ON
    sCellToAddModListExt-v1430    SCellToAddModListExt-v1430  OPTIONAL,  -- Need ON
    perCC-GapIndicationRequest-r14 ENUMERATED{true}              OPTIONAL,  -- Need ON
    systemInformationBlockType2Dedicated-r14 OCTET STRING (CONTAINING
SystemInformationBlockType2)
    nonCriticalExtension          SEQUENCE { }                      OPTIONAL
}

SL-SyncTxControl-r12 ::=          SEQUENCE {
    networkControlledSyncTx-r12   ENUMERATED {on, off}        OPTIONAL  -- Need OP
}

PSCellToAddMod-r12 ::=           SEQUENCE {
    sCellIndex-r12                SCellIndex-r10,
    cellIdentification-r12        SEQUENCE {
        physCellId-r12           PhysCellId,
        dl-CarrierFreq-r12       ARFCN-ValueEUTRA-r9
    }
    radioResourceConfigCommonPSCell-r12 RadioResourceConfigCommonPSCell-r12 OPTIONAL,  -- Cond SCellAdd
SCellAdd
    radioResourceConfigDedicatedPSCell-r12 RadioResourceConfigDedicatedPSCell-r12 OPTIONAL,  --
Cond SCellAdd2
    ...
    [[ antennaInfoDedicatedPSCell-v1280      AntennaInfoDedicated-v10i0  OPTIONAL  -- Need ON
]],
    [[ sCellIndex-r13                        SCellIndex-r13  OPTIONAL  -- Need ON
]],
    [[ radioResourceConfigDedicatedPSCell-v1370 RadioResourceConfigDedicatedPSCell-v1370
OPTIONAL  -- Need ON
]],
    [[ radioResourceConfigDedicatedPSCell-v13c0 RadioResourceConfigDedicatedPSCell-v13c0
OPTIONAL  -- Need ON
]]
}

PSCellToAddMod-v12f0 ::=         SEQUENCE {
    radioResourceConfigCommonPSCell-r12     RadioResourceConfigCommonPSCell-v12f0  OPTIONAL
}

PSCellToAddMod-v1440 ::=         SEQUENCE {
    radioResourceConfigCommonPSCell-r14     RadioResourceConfigCommonPSCell-v1440  OPTIONAL
}

PowerCoordinationInfo-r12 ::= SEQUENCE {
    p-MeNB-r12          INTEGER (1..16),
    p-SeNB-r12          INTEGER (1..16),
    powerControlMode-r12 INTEGER (1..2)
}

SCellToAddModList-r10 ::=        SEQUENCE (SIZE (1..maxSCell-r10)) OF SCellToAddMod-r10
SCellToAddModList-v10i0 ::=      SEQUENCE (SIZE (1..maxSCell-r10)) OF SCellToAddMod-v10i0
SCellToAddModList-v13c0 ::=      SEQUENCE (SIZE (1..maxSCell-r10)) OF SCellToAddMod-v13c0
SCellToAddModListExt-r13 ::=     SEQUENCE (SIZE (1..maxSCell-r13)) OF SCellToAddModExt-r13
SCellToAddModListExt-v1370 ::=   SEQUENCE (SIZE (1..maxSCell-r13)) OF SCellToAddModExt-v1370

```

```

SCellToAddModListExt-v13c0 ::= SEQUENCE (SIZE (1..maxSCell-r13)) OF SCellToAddMod-v13c0
SCellToAddModListExt-v1430 ::= SEQUENCE (SIZE (1..maxSCell-r13)) OF SCellToAddModExt-v1430
SCellToAddMod-r10 ::=
    SEQUENCE {
        sCellIndex-r10                SCellIndex-r10,
        cellIdentification-r10        SEQUENCE {
            physCellId-r10            PhysCellId,
            dl-CarrierFreq-r10        ARFCN-ValueEUTRA
        }
        radioResourceConfigCommonSCell-r10  RadioResourceConfigCommonSCell-r10  OPTIONAL, -- Cond SCellAdd
    }
SCellAdd
    radioResourceConfigDedicatedSCell-r10  RadioResourceConfigDedicatedSCell-r10  OPTIONAL, --
Cond SCellAdd2
    ...
    [[ dl-CarrierFreq-v1090            ARFCN-ValueEUTRA-v9e0  OPTIONAL  -- Cond EARFCN-max
    ]],
    [[ antennaInfoDedicatedSCell-v10i0  AntennaInfoDedicated-v10i0  OPTIONAL  -- Need ON
    ]],
    [[ srs-SwitchFromServCellIndex-r14  INTEGER (0.. 31)  OPTIONAL  -- Need ON
    ]]
}

SCellToAddMod-v1010 ::=
    SEQUENCE {
        radioResourceConfigCommonSCell-v1010  RadioResourceConfigCommonSCell-v1010  OPTIONAL
    }

SCellToAddMod-v13c0 ::=
    SEQUENCE {
        radioResourceConfigDedicatedSCell-v13c0  RadioResourceConfigDedicatedSCell-v13c0  OPTIONAL
    }

SCellToAddModExt-r13 ::=
    SEQUENCE {
        sCellIndex-r13                SCellIndex-r13,
        cellIdentification-r13        SEQUENCE {
            physCellId-r13            PhysCellId,
            dl-CarrierFreq-r13        ARFCN-ValueEUTRA-r9
        }
        radioResourceConfigCommonSCell-r13  RadioResourceConfigCommonSCell-r10  OPTIONAL, -- Cond SCellAdd
    }
SCellAdd
    radioResourceConfigDedicatedSCell-r13  RadioResourceConfigDedicatedSCell-r10  OPTIONAL, --
Cond SCellAdd2
    antennaInfoDedicatedSCell-r13        AntennaInfoDedicated-v10i0  OPTIONAL  -- Need ON
}

SCellToAddModExt-v1370 ::=
    SEQUENCE {
        radioResourceConfigCommonSCell-v1370  RadioResourceConfigCommonSCell-v1010  OPTIONAL
    }

SCellToAddModExt-v1430 ::=
    SEQUENCE {
        srs-SwitchFromServCellIndex-r14  INTEGER (0.. 31)  OPTIONAL, -- Need ON
        ...
    }

SCellToReleaseList-r10 ::=
    SEQUENCE (SIZE (1..maxSCell-r10)) OF SCellIndex-r10
SCellToReleaseListExt-r13 ::=
    SEQUENCE (SIZE (1..maxSCell-r13)) OF SCellIndex-r13
SCG-Configuration-r12 ::=
    CHOICE {
        release
        setup
            scg-ConfigPartMCG-r12
            scg-Counter-r12                INTEGER (0.. 65535)  OPTIONAL, -- Need ON
            powerCoordinationInfo-r12      PowerCoordinationInfo-r12  OPTIONAL, -- Need ON
            ...
        }
        scg-ConfigPartSCG-r12                SCG-ConfigPartSCG-r12  OPTIONAL, -- Need ON
    }
}

SCG-Configuration-v12f0 ::=
    CHOICE {
        release
        setup
            scg-ConfigPartSCG-v12f0        SCG-ConfigPartSCG-v12f0  OPTIONAL  -- Need ON
    }
}

SCG-Configuration-v13c0 ::=
    CHOICE {
        release
        NULL,
    }
}

```

```

    setup
      scg-ConfigPartSCG-v13c0
    }
  }
}

SCG-ConfigPartSCG-r12 ::=
  SEQUENCE {
    radioResourceConfigDedicatedSCG-r12 RadioResourceConfigDedicatedSCG-r12 OPTIONAL, -- Need ON
    sCellToReleaseListSCG-r12           SCellToReleaseList-r10           OPTIONAL, -- Need ON
    pSCellToAddMod-r12                  PSCellToAddMod-r12              OPTIONAL, -- Need ON
    sCellToAddModListSCG-r12            SCellToAddModList-r10          OPTIONAL, -- Need ON
    mobilityControlInfoSCG-r12          MobilityControlInfoSCG-r12     OPTIONAL, -- Need ON
    ...
    [[
      sCellToReleaseListSCG-Ext-r13      SCellToReleaseListExt-r13      OPTIONAL, -- Need ON
      sCellToAddModListSCG-Ext-r13      SCellToAddModListExt-r13      OPTIONAL, -- Need ON
    ]],
    [[
      sCellToAddModListSCG-Ext-v1370    SCellToAddModListExt-v1370    OPTIONAL, -- Need ON
    ]],
    [[
      pSCellToAddMod-v1440              PSCellToAddMod-v1440          OPTIONAL, -- Need ON
    ]]
  }

SCG-ConfigPartSCG-v12f0 ::=
  SEQUENCE {
    pSCellToAddMod-v12f0                PSCellToAddMod-v12f0          OPTIONAL, -- Need ON
    sCellToAddModListSCG-v12f0          SCellToAddModList-v1010       OPTIONAL, -- Need ON
  }

SCG-ConfigPartSCG-v13c0 ::=
  SEQUENCE {
    sCellToAddModListSCG-v13c0          SCellToAddModList-v13c0       OPTIONAL, -- Need ON
    sCellToAddModListSCG-Ext-v13c0     SCellToAddModListExt-v13c0    OPTIONAL, -- Need ON
  }

SecurityConfigHO ::=
  SEQUENCE {
    handoverType
      CHOICE {
        intraLTE
          SEQUENCE {
            securityAlgorithmConfig SecurityAlgorithmConfig OPTIONAL, -- Cond
          }
        interRAT
          SEQUENCE {
            securityAlgorithmConfig SecurityAlgorithmConfig,
            nas-SecurityParamToEUTRA OCTET STRING (SIZE(6))
          }
      }
    ...
  }
}

-- ASN1STOP

```

<i>RRCConnectionReconfiguration</i> field descriptions
<p><i>dedicatedInfoNASList</i> This field is used to transfer UE specific NAS layer information between the network and the UE. The RRC layer is transparent for each PDU in the list.</p>
<p><i>fullConfig</i> Indicates the full configuration option is applicable for the RRC Connection Reconfiguration message.</p>
<p><i>keyChangeIndicator</i> true is used only in an intra-cell handover when a K_{eNB} key is derived from a K_{ASME} key taken into use through the latest successful NAS SMC procedure, as described in TS 33.401 [32] for K_{eNB} re-keying. false is used in an intra-LTE handover when the new K_{eNB} key is obtained from the current K_{eNB} key or from the NH as described in TS 33.401 [32].</p>
<p><i>lwa-Configuration</i> This field is used to provide parameters for LWA configuration. E-UTRAN does not simultaneously configure LWA with DC, LWIP or RCLWI for a UE.</p>
<p><i>lwip-Configuration</i> This field is used to provide parameters for LWIP configuration. E-UTRAN does not simultaneously configure LWIP with DC, LWA or RCLWI for a UE.</p>
<p><i>nas-securityParamToEUTRA</i> This field is used to transfer UE specific NAS layer information between the network and the UE. The RRC layer is transparent for this field, although it affects activation of AS- security after inter-RAT handover to E-UTRA. The content is defined in TS 24.301.</p>
<p><i>networkControlledSyncTx</i> This field indicates whether the UE shall transmit synchronisation information (i.e. become synchronisation source). Value <i>On</i> indicates the UE to transmit synchronisation information while value <i>Off</i> indicates the UE to not transmit such information.</p>
<p><i>nextHopChainingCount</i> Parameter NCC: See TS 33.401 [32]</p>
<p><i>perCC-GapIndicationRequest</i> Indicates that UE shall include <i>perCC-GapIndicationList</i> and <i>numFreqEffective</i> in the <i>RRCConnectionReconfigurationComplete</i> message. <i>numFreqEffectiveReduced</i> may also be included if frequencies are configured for reduced measurement performance.</p>
<p><i>p-MeNB</i> Indicates the guaranteed power for the MeNB, as specified in TS 36.213 [23]. The value N corresponds to N-1 in TS 36.213 [23].</p>
<p><i>powerControlMode</i> Indicates the power control mode used in DC. Value 1 corresponds to DC power control mode 1 and value 2 indicates DC power control mode 2, as specified in TS 36.213 [23].</p>
<p><i>p-SeNB</i> Indicates the guaranteed power for the SeNB as specified in TS 36.213 [23, Table 5.1.4.2-1]. The value N corresponds to N-1 in TS 36.213 [23].</p>
<p><i>rclwi-Configuration</i> WLAN traffic steering command as specified in 5.6.16.2. E-UTRAN does not simultaneously configure RCLWI with DC, LWA or LWIP for a UE.</p>
<p><i>sCellIndex</i> The <i>sCellIndex</i> is unique within the scope of the UE. In case of DC, an SCG cell can not use the same value as used for an MCG cell. For <i>pSCellToAddMod</i>, if <i>sCellIndex-r13</i> is present the UE shall ignore <i>sCellIndex-r12</i>.</p>
<p><i>sCellToAddModList</i>, <i>sCellToAddModListExt</i> Indicates the SCell to be added or modified. E-UTRAN uses field <i>sCellToAddModList-r10</i> to add or modify SCells (with <i>sCellIndex-r10</i>) for a UE that does not support carrier aggregation with more than 5 component carriers. If E-UTRAN includes <i>sCellToAddModListExt-v1430</i> it includes the same number of entries, and listed in the same order, as in <i>sCellToAddModListExt-r13</i>. If E-UTRAN includes <i>sCellToAddModList-v1010</i> it includes the same number of entries, and listed in the same order, as in <i>sCellToAddModList-r10</i>. If E-UTRAN includes <i>sCellToAddModListExt-v1370</i> it includes the same number of entries, and listed in the same order, as in <i>sCellToAddModListExt-r13</i>. If E-UTRAN includes <i>sCellToAddModListExt-v13c0</i> it includes the same number of entries, and listed in the same order, as in <i>sCellToAddModListExt-r13</i>.</p>
<p><i>sCellToAddModListSCG</i>, <i>sCellToAddModListSCG-Ext</i> Indicates the SCG cell to be added or modified. The field is used for SCG cells other than the PSCell (which is added/modified by field <i>pSCellToAddMod</i>). E-UTRAN uses field <i>sCellToAddModListSCG-r12</i> to add or modify SCells (with <i>sCellIndex-r10</i>) for a UE that does not support carrier aggregation with more than 5 component carriers. If E-UTRAN includes <i>sCellToAddModListSCG-v1010</i> it includes the same number of entries, and listed in the same order, as in <i>sCellToAddModListSCG-r12</i>. If E-UTRAN includes <i>sCellToAddModListSCG-Ext-v1370</i> it includes the same number of entries, and listed in the same order, as in <i>sCellToAddModListSCG-Ext-r13</i>. If E-UTRAN includes <i>sCellToAddModListSCG-Ext-v13c0</i> it includes the same number of entries, and listed in the same order, as in <i>sCellToAddModListSCG-Ext-r13</i>.</p>
<p><i>sCellToReleaseList</i>, <i>sCellToReleaseListExt</i> Indicates the SCell to be released. E-UTRAN uses field <i>sCellToReleaseList-r10</i> to release SCells for a UE that does not support carrier aggregation with more than 5 component carriers.</p>

RRCConnectionReconfiguration field descriptions	
sCellToReleaseListSCG, sCellToReleaseListSCG-Ext	Indicates the SCG cell to be released. The field is also used to release the PSCell e.g. upon change of PSCell, upon system information change for the PSCell. E-UTRAN uses field <i>sCellToReleaseListSCG-r12</i> to release SCells for a UE that does not support carrier aggregation with more than 5 component carriers.
scg-Counter	A counter used upon initial configuration of SCG security as well as upon refresh of S-K _{eNB} . E-UTRAN includes the field upon SCG change when one or more SCG DRBs are configured. Otherwise E-UTRAN does not include the field.
sl-V2X-ConfigDedicated	Indicates sidelink configuration for non-P2X related V2X sidelink communication as well as P2X related V2X sidelink communication.
srs-SwitchFromServCellIndex	Indicates the serving cell whose UL transmission may be interrupted during SRS transmission on a PUSCH-less cell. During SRS transmission on a PUSCH-less cell, the UE may temporarily suspend the UL transmission on a serving cell with PUSCH in the same CG to allow the PUSCH-less cell to transmit SRS. The PUSCH-less cell is always a TDD cell but the serving cell with PUSCH may be either a FDD or TDD cell.
systemInformationBlockType1Dedicated	This field is used to transfer <i>SystemInformationBlockType1</i> or <i>SystemInformationBlockType1-BR</i> to the UE.
systemInformationBlockType2Dedicated	This field is used to transfer BR version of <i>SystemInformationBlockType2</i> to BL UEs or UEs in CE or <i>SystemInformationBlockType2</i> to non-BL UEs.
t350	Timer T350 as described in clause 7.3. Value <i>minN</i> corresponds to N minutes.

Conditional presence	Explanation
<i>EARFCN-max</i>	The field is mandatory present if <i>dl-CarrierFreq-r10</i> is included and set to <i>maxEARFCN</i> . Otherwise the field is not present.
<i>fullConfig</i>	This field is mandatory present for handover within E-UTRA when the <i>fullConfig</i> is included; otherwise it is optionally present, Need OP.
<i>HO</i>	The field is mandatory present in case of handover within E-UTRA or to E-UTRA; otherwise the field is not present.
<i>HO-Reestab</i>	This field is optionally present, need ON, in case of handover within E-UTRA or upon the first reconfiguration after RRC connection re-establishment; otherwise the field is not present.
<i>HO-toEUTRA</i>	The field is mandatory present in case of handover to E-UTRA or for reconfigurations when <i>fullConfig</i> is included; otherwise the field is optionally present, need ON.
<i>nonFullConfig</i>	The field is not present when the <i>fullConfig</i> is included or in case of handover to E-UTRA; otherwise it is optional present, need ON.
<i>nonHO</i>	The field is not present in case of handover within E-UTRA or to E-UTRA; otherwise it is optional present, need ON.
<i>SCellAdd</i>	The field is mandatory present upon SCell addition; otherwise it is not present.
<i>SCellAdd2</i>	The field is mandatory present upon SCell addition; otherwise it is optionally present, need ON.

RRCConnectionReconfigurationComplete

The *RRCConnectionReconfigurationComplete* message is used to confirm the successful completion of an RRC connection reconfiguration.

Signalling radio bearer: SRB1

RLC-SAP: AM

Logical channel: DCCH

Direction: UE to E-UTRAN

RRCConnectionReconfigurationComplete message

```
-- ASN1START
RRCConnectionReconfigurationComplete ::= SEQUENCE {
    rrc-TransactionIdentifier      RRC-TransactionIdentifier,
    criticalExtensions             CHOICE {
        rrcConnectionReconfigurationComplete-r8
    }
}
```

```

        criticalExtensionsFuture      RRCConnectionReconfigurationComplete-r8-IEs,
    }                                SEQUENCE {}
}

RRCConnectionReconfigurationComplete-r8-IEs ::= SEQUENCE {
    nonCriticalExtension              RRCConnectionReconfigurationComplete-v8a0-IEs  OPTIONAL
}

RRCConnectionReconfigurationComplete-v8a0-IEs ::= SEQUENCE {
    lateNonCriticalExtension          OCTET STRING                                OPTIONAL,
    nonCriticalExtension              RRCConnectionReconfigurationComplete-v1020-IEs  OPTIONAL
}

RRCConnectionReconfigurationComplete-v1020-IEs ::= SEQUENCE {
    rlf-InfoAvailable-r10            ENUMERATED {true}                            OPTIONAL,
    logMeasAvailable-r10             ENUMERATED {true}                            OPTIONAL,
    nonCriticalExtension              RRCConnectionReconfigurationComplete-v1130-IEs  OPTIONAL
}

RRCConnectionReconfigurationComplete-v1130-IEs ::= SEQUENCE {
    connEstFailInfoAvailable-r11     ENUMERATED {true}                            OPTIONAL,
    nonCriticalExtension              RRCConnectionReconfigurationComplete-v1250-IEs  OPTIONAL
}

RRCConnectionReconfigurationComplete-v1250-IEs ::= SEQUENCE {
    logMeasAvailableMBSFN-r12        ENUMERATED {true}                            OPTIONAL,
    nonCriticalExtension              RRCConnectionReconfigurationComplete-v1430-IEs
    OPTIONAL
}

RRCConnectionReconfigurationComplete-v1430-IEs ::= SEQUENCE {
    perCC-GapIndicationList-r14      PerCC-GapIndicationList-r14                OPTIONAL,
    numFreqEffective-r14              INTEGER (1..12)                            OPTIONAL,
    numFreqEffectiveReduced-r14       INTEGER (1..12)                            OPTIONAL,
    nonCriticalExtension              SEQUENCE {}                                OPTIONAL
}

-- ASN1STOP

```

***RRCConnectionReconfigurationComplete* field descriptions**

numFreqEffective

This field is used to indicate the number of effective frequencies that a UE measures in series according to TS 36.133 [16]. Simultaneous measurement in parallel on multiple frequencies can be equivalent to a single effective frequency. The frequencies configured for reduced measurement performance should not be included.

numFreqEffectiveReduced

This field is used to indicate the number of effective frequencies that a UE measures in series according to TS 36.133 [16] for frequencies configured for reduced measurement performance. Simultaneous measurement in parallel on multiple frequencies can be equivalent to a single effective frequency.

perCC-GapIndicationList

This field is used to indicate per CC measurement gap preference by the UE.

– ***RRCConnectionReestablishment***

The *RRCConnectionReestablishment* message is used to re-establish SRB1.

Signalling radio bearer: SRB0

RLC-SAP: TM

Logical channel: CCCH

Direction: E-UTRAN to UE

***RRCConnectionReestablishment* message**

```

-- ASN1START

RRCConnectionReestablishment ::= SEQUENCE {
    rrc-TransactionIdentifier        RRC-TransactionIdentifier,
    criticalExtensions                CHOICE {

```

```

        c1
            rrcConnectionReestablishment-r8      CHOICE {
                spare7 NULL,
                spare6 NULL, spare5 NULL, spare4  NULL,
                spare3 NULL, spare2 NULL, spare1  NULL
            },
            criticalExtensionsFuture              SEQUENCE {}
        }
    }

RRConnectionReestablishment-r8-IEs ::= SEQUENCE {
    radioResourceConfigDedicated      RadioResourceConfigDedicated,
    nextHopChainingCount               NextHopChainingCount,
    nonCriticalExtension                RRConnectionReestablishment-v8a0-IEs  OPTIONAL
}

RRConnectionReestablishment-v8a0-IEs ::= SEQUENCE {
    lateNonCriticalExtension            OCTET STRING                               OPTIONAL,
    nonCriticalExtension                SEQUENCE {}                               OPTIONAL
}

-- ASN1STOP

```

– *RRConnectionReestablishmentComplete*

The *RRConnectionReestablishmentComplete* message is used to confirm the successful completion of an RRC connection re-establishment.

Signalling radio bearer: SRB1

RLC-SAP: AM

Logical channel: DCCH

Direction: UE to E-UTRAN

RRConnectionReestablishmentComplete message

```

-- ASN1START

RRConnectionReestablishmentComplete ::= SEQUENCE {
    rrc-TransactionIdentifier           RRC-TransactionIdentifier,
    criticalExtensions                   CHOICE {
        rrcConnectionReestablishmentComplete-r8
        criticalExtensionsFuture         SEQUENCE {}
    }
}

RRConnectionReestablishmentComplete-r8-IEs ::= SEQUENCE {
    nonCriticalExtension                 RRConnectionReestablishmentComplete-v920-IEs  OPTIONAL
}

RRConnectionReestablishmentComplete-v920-IEs ::= SEQUENCE {
    rlf-InfoAvailable-r9                ENUMERATED {true}                               OPTIONAL,
    nonCriticalExtension                 RRConnectionReestablishmentComplete-v8a0-IEs  OPTIONAL
}

RRConnectionReestablishmentComplete-v8a0-IEs ::= SEQUENCE {
    lateNonCriticalExtension             OCTET STRING                               OPTIONAL,
    nonCriticalExtension                 RRConnectionReestablishmentComplete-v1020-IEs  OPTIONAL
}

RRConnectionReestablishmentComplete-v1020-IEs ::= SEQUENCE {
    logMeasAvailable-r10                ENUMERATED {true}                               OPTIONAL,
    nonCriticalExtension                 RRConnectionReestablishmentComplete-v1130-IEs  OPTIONAL
}

RRConnectionReestablishmentComplete-v1130-IEs ::= SEQUENCE {
    connEstFailInfoAvailable-r11        ENUMERATED {true}                               OPTIONAL,
    nonCriticalExtension                 RRConnectionReestablishmentComplete-v1250-IEs  OPTIONAL
}

RRConnectionReestablishmentComplete-v1250-IEs ::= SEQUENCE {

```

```

logMeasAvailableMBSFN-r12      ENUMERATED {true}      OPTIONAL,
nonCriticalExtension            SEQUENCE {}          OPTIONAL
}
-- ASN1STOP

```

***RRCCConnectionReestablishmentComplete* field descriptions**

rif-InfoAvailable

This field is used to indicate the availability of radio link failure or handover failure related measurements

– ***RRCCConnectionReestablishmentReject***

The *RRCCConnectionReestablishmentReject* message is used to indicate the rejection of an RRC connection re-establishment request.

Signalling radio bearer: SRB0

RLC-SAP: TM

Logical channel: CCCH

Direction: E-UTRAN to UE

***RRCCConnectionReestablishmentReject* message**

```

-- ASN1START
RRCCConnectionReestablishmentReject ::= SEQUENCE {
    criticalExtensions      CHOICE {
        rrcConnectionReestablishmentReject-r8
        criticalExtensionsFuture      RRCCConnectionReestablishmentReject-r8-IEs,
        SEQUENCE {}
    }
}
RRCCConnectionReestablishmentReject-r8-IEs ::= SEQUENCE {
    nonCriticalExtension      RRCCConnectionReestablishmentReject-v8a0-IEs OPTIONAL
}
RRCCConnectionReestablishmentReject-v8a0-IEs ::= SEQUENCE {
    lateNonCriticalExtension  OCTET STRING      OPTIONAL,
    nonCriticalExtension      SEQUENCE {}          OPTIONAL
}
-- ASN1STOP

```

– ***RRCCConnectionReestablishmentRequest***

The *RRCCConnectionReestablishmentRequest* message is used to request the reestablishment of an RRC connection.

Signalling radio bearer: SRB0

RLC-SAP: TM

Logical channel: CCCH

Direction: UE to E-UTRAN

***RRCCConnectionReestablishmentRequest* message**

```

-- ASN1START
RRCCConnectionReestablishmentRequest ::= SEQUENCE {
    criticalExtensions      CHOICE {
        rrcConnectionReestablishmentRequest-r8
        criticalExtensionsFuture      RRCCConnectionReestablishmentRequest-r8-IEs,
        SEQUENCE {}
    }
}

```

```

}
RRCConnectionReestablishmentRequest-r8-IEs ::= SEQUENCE {
    ue-Identity                ReestabUE-Identity,
    reestablishmentCause       ReestablishmentCause,
    spare                       BIT STRING (SIZE (2))
}

ReestabUE-Identity ::= SEQUENCE {
    c-RNTI                     C-RNTI,
    physCellId                 PhysCellId,
    shortMAC-I                 ShortMAC-I
}

ReestablishmentCause ::= ENUMERATED {
    reconfigurationFailure, handoverFailure,
    otherFailure, spare1}

-- ASN1STOP

```

***RRCConnectionReestablishmentRequest* field descriptions**

physCellId

The Physical Cell Identity of the PCell the UE was connected to prior to the failure.

reestablishmentCause

Indicates the failure cause that triggered the re-establishment procedure. eNB is not expected to reject a *RRCConnectionReestablishmentRequest* due to unknown cause value being used by the UE.

ue-Identity

UE identity included to retrieve UE context and to facilitate contention resolution by lower layers.

RRCConnectionReject

The *RRCConnectionReject* message is used to reject the RRC connection establishment.

Signalling radio bearer: SRB0

RLC-SAP: TM

Logical channel: CCCH

Direction: E-UTRAN to UE

***RRCConnectionReject* message**

```

-- ASN1START
RRCConnectionReject ::= SEQUENCE {
    criticalExtensions          CHOICE {
        c1                      CHOICE {
            rrcConnectionReject-r8          RRCConnectionReject-r8-IEs,
            spare3 NULL, spare2 NULL, spare1 NULL
        },
        criticalExtensionsFuture          SEQUENCE {}
    }
}

RRCConnectionReject-r8-IEs ::= SEQUENCE {
    waitTime                    INTEGER (1..16),
    nonCriticalExtension         RRCConnectionReject-v8a0-IEs          OPTIONAL
}

RRCConnectionReject-v8a0-IEs ::= SEQUENCE {
    lateNonCriticalExtension     OCTET STRING                          OPTIONAL,
    nonCriticalExtension         RRCConnectionReject-v1020-IEs        OPTIONAL
}

RRCConnectionReject-v1020-IEs ::= SEQUENCE {
    extendedWaitTime-r10        INTEGER (1..1800)                      OPTIONAL,  -- Need ON
    nonCriticalExtension         RRCConnectionReject-v1130-IEs        OPTIONAL
}

RRCConnectionReject-v1130-IEs ::= SEQUENCE {

```

```

deprioritisationReq-r11          SEQUENCE {
  deprioritisationType-r11      ENUMERATED {frequency, e-utra},
  deprioritisationTimer-r11    ENUMERATED {min5, min10, min15, min30}
}
nonCriticalExtension            RRCConnectionReject-v1320-IEs
OPTIONAL
}

RRCConnectionReject-v1320-IEs ::= SEQUENCE {
  rrc-SuspendIndication-r13    ENUMERATED {true}
  nonCriticalExtension          SEQUENCE {}
}

-- ASN1STOP

```

RRCConnectionReject field descriptions

deprioritisationReq	Indicates whether the current frequency or RAT is to be de-prioritised. The UE shall be able to store a de-prioritisation request for up to 8 frequencies (applicable when receiving another frequency specific de-prioritisation request before T325 expiry).
deprioritisationTimer	Indicates the period for which either the current carrier frequency or E-UTRA is de-prioritised. Value <i>minN</i> corresponds to N minutes.
extendedWaitTime	Value in seconds for the wait time for Delay Tolerant access requests.
rrc-SuspendIndication	If present, this field indicates that the UE should remain suspended and not release its stored context.
waitTime	Wait time value in seconds.

– RRCConnectionRelease

The *RRCConnectionRelease* message is used to command the release of an RRC connection.

Signalling radio bearer: SRB1

RLC-SAP: AM

Logical channel: DCCH

Direction: E-UTRAN to UE

RRCConnectionRelease message

```

-- ASN1START

RRCConnectionRelease ::= SEQUENCE {
  rrc-TransactionIdentifier    RRC-TransactionIdentifier,
  criticalExtensions           CHOICE {
    c1
      rrcConnectionRelease-r8  RRCConnectionRelease-r8-IEs,
      spare3 NULL, spare2 NULL, spare1 NULL
    },
  criticalExtensionsFuture     SEQUENCE {}
}

RRCConnectionRelease-r8-IEs ::= SEQUENCE {
  releaseCause                ReleaseCause,
  redirectedCarrierInfo        RedirectedCarrierInfo
  OPTIONAL, -- Need ON
  idleModeMobilityControlInfo IdleModeMobilityControlInfo
  OPTIONAL, -- Need OP
  nonCriticalExtension         RRCConnectionRelease-v890-IEs
  OPTIONAL
}

RRCConnectionRelease-v890-IEs ::= SEQUENCE {
  lateNonCriticalExtension     OCTET STRING (CONTAINING RRCConnectionRelease-v9e0-IEs)
  OPTIONAL,
  nonCriticalExtension         RRCConnectionRelease-v920-IEs
  OPTIONAL
}

```

```

-- Late non critical extensions
RRCConnectionRelease-v9e0-IEs ::= SEQUENCE {
    redirectedCarrierInfo-v9e0      RedirectedCarrierInfo-v9e0      OPTIONAL,  -- Cond
NoRedirect-r8
    idleModeMobilityControlInfo-v9e0  IdleModeMobilityControlInfo-v9e0  OPTIONAL,  -- Cond
IdleInfoEUTRA
    nonCriticalExtension              SEQUENCE {}                  OPTIONAL
}

-- Regular non critical extensions
RRCConnectionRelease-v920-IEs ::= SEQUENCE {
    cellInfoList-r9                  CHOICE {
        geran-r9                      CellInfoListGERAN-r9,
        utra-FDD-r9                   CellInfoListUTRA-FDD-r9,
        utra-TDD-r9                   CellInfoListUTRA-TDD-r9,
        . . . ,
        utra-TDD-r10                  CellInfoListUTRA-TDD-r10
    }
    nonCriticalExtension              RRCConnectionRelease-v1020-IEs  OPTIONAL,  -- Cond Redirection
}

RRCConnectionRelease-v1020-IEs ::= SEQUENCE {
    extendedWaitTime-r10              INTEGER (1..1800)            OPTIONAL,  -- Need ON
    nonCriticalExtension              RRCConnectionRelease-v1320-IEs  OPTIONAL
}

RRCConnectionRelease-v1320-IEs ::= SEQUENCE {
    resumeIdentity-r13                ResumeIdentity-r13          OPTIONAL,  -- Need OR
    nonCriticalExtension              SEQUENCE {}                OPTIONAL
}

ReleaseCause ::=
    ENUMERATED {loadBalancingTAUrequired,
                other, cs-FallbackHighPriority-v1020, rrc-Suspend-v1320}

RedirectedCarrierInfo ::=
    CHOICE {
        eutra                          ARFCN-ValueEUTRA,
        geran                          CarrierFreqsGERAN,
        utra-FDD                       ARFCN-ValueUTRA,
        utra-TDD                       ARFCN-ValueUTRA,
        cdma2000-HRPD                  CarrierFreqCDMA2000,
        cdma2000-1xRTT                CarrierFreqCDMA2000,
        . . . ,
        utra-TDD-r10                  CarrierFreqListUTRA-TDD-r10
    }

RedirectedCarrierInfo-v9e0 ::=
    SEQUENCE {
        eutra-v9e0                    ARFCN-ValueEUTRA-v9e0
    }

CarrierFreqListUTRA-TDD-r10 ::=
    SEQUENCE (SIZE (1..maxFreqUTRA-TDD-r10)) OF ARFCN-ValueUTRA

IdleModeMobilityControlInfo ::=
    SEQUENCE {
        freqPriorityListEUTRA          FreqPriorityListEUTRA      OPTIONAL,  -- Need ON
        freqPriorityListGERAN          FreqPriorityListGERAN      OPTIONAL,  -- Need ON
        freqPriorityListUTRA-FDD       FreqPriorityListUTRA-FDD   OPTIONAL,  -- Need ON
        freqPriorityListUTRA-TDD       FreqPriorityListUTRA-TDD   OPTIONAL,  -- Need ON
        bandClassPriorityListHRPD      BandClassPriorityListHRPD  OPTIONAL,  -- Need ON
        bandClassPriorityList1XRTT     BandClassPriorityList1XRTT  OPTIONAL,  -- Need ON
        t320                           ENUMERATED {
            min5, min10, min20, min30, min60, min120, min180,
            spare1}
            OPTIONAL,  -- Need OR
        . . . ,
        [[ freqPriorityListExtEUTRA-r12  FreqPriorityListExtEUTRA-r12  OPTIONAL  --
Need ON
        ]],
        [[ freqPriorityListEUTRA-v1310   FreqPriorityListEUTRA-v1310   OPTIONAL,  --
Need ON
        ]],
        [[ freqPriorityListExtEUTRA-v1310 FreqPriorityListExtEUTRA-v1310  OPTIONAL  --
Need ON
        ]],
    }

IdleModeMobilityControlInfo-v9e0 ::=
    SEQUENCE {
        freqPriorityListEUTRA-v9e0     SEQUENCE (SIZE (1..maxFreq)) OF FreqPriorityEUTRA-v9e0
    }

FreqPriorityListEUTRA ::=
    SEQUENCE (SIZE (1..maxFreq)) OF FreqPriorityEUTRA

```



```

FreqPriorityListExtEUTRA-r12 ::= SEQUENCE (SIZE (1..maxFreq)) OF FreqPriorityEUTRA-r12
FreqPriorityListEUTRA-v1310 ::= SEQUENCE (SIZE (1..maxFreq)) OF FreqPriorityEUTRA-v1310
FreqPriorityListExtEUTRA-v1310 ::= SEQUENCE (SIZE (1..maxFreq)) OF FreqPriorityEUTRA-v1310
FreqPriorityEUTRA ::= SEQUENCE {
    carrierFreq
    cellReselectionPriority
}
FreqPriorityEUTRA-v9e0 ::= SEQUENCE {
    carrierFreq-v9e0 OPTIONAL -- Cond EARFCN-max
}
FreqPriorityEUTRA-r12 ::= SEQUENCE {
    carrierFreq-r12
    cellReselectionPriority-r12
}
FreqPriorityEUTRA-v1310 ::= SEQUENCE {
    cellReselectionSubPriority-r13 OPTIONAL --
Need ON
}
FreqsPriorityListGERAN ::= SEQUENCE (SIZE (1..maxGNFG)) OF FreqsPriorityGERAN
FreqsPriorityGERAN ::= SEQUENCE {
    carrierFreqs
    cellReselectionPriority
}
FreqPriorityListUTRA-FDD ::= SEQUENCE (SIZE (1..maxUTRA-FDD-Carrier)) OF FreqPriorityUTRA-FDD
FreqPriorityUTRA-FDD ::= SEQUENCE {
    carrierFreq
    cellReselectionPriority
}
FreqPriorityListUTRA-TDD ::= SEQUENCE (SIZE (1..maxUTRA-TDD-Carrier)) OF FreqPriorityUTRA-TDD
FreqPriorityUTRA-TDD ::= SEQUENCE {
    carrierFreq
    cellReselectionPriority
}
BandClassPriorityListHRPD ::= SEQUENCE (SIZE (1..maxCDMA-BandClass)) OF BandClassPriorityHRPD
BandClassPriorityHRPD ::= SEQUENCE {
    bandClass
    cellReselectionPriority
}
BandClassPriorityList1XRTT ::= SEQUENCE (SIZE (1..maxCDMA-BandClass)) OF BandClassPriority1XRTT
BandClassPriority1XRTT ::= SEQUENCE {
    bandClass
    cellReselectionPriority
}
CellInfoListGERAN-r9 ::= SEQUENCE (SIZE (1..maxCellInfoGERAN-r9)) OF CellInfoGERAN-r9
CellInfoGERAN-r9 ::= SEQUENCE {
    physCellId-r9
    carrierFreq-r9
    systemInformation-r9
}
CellInfoListUTRA-FDD-r9 ::= SEQUENCE (SIZE (1..maxCellInfoUTRA-r9)) OF CellInfoUTRA-FDD-r9
CellInfoUTRA-FDD-r9 ::= SEQUENCE {
    physCellId-r9
    ultra-BCCH-Container-r9
}
CellInfoListUTRA-TDD-r9 ::= SEQUENCE (SIZE (1..maxCellInfoUTRA-r9)) OF CellInfoUTRA-TDD-r9
CellInfoUTRA-TDD-r9 ::= SEQUENCE {

```

```

    physCellId-r9                PhysCellIdUTRA-TDD,
    ultra-BCCH-Container-r9      OCTET STRING
}
CellInfoListUTRA-TDD-r10 ::= SEQUENCE (SIZE (1..maxCellInfoUTRA-r9)) OF CellInfoUTRA-TDD-r10
CellInfoUTRA-TDD-r10 ::= SEQUENCE {
    physCellId-r10                PhysCellIdUTRA-TDD,
    carrierFreq-r10              ARFCN-ValueUTRA,
    ultra-BCCH-Container-r10     OCTET STRING
}
-- ASN1STOP

```

RRCConnectionRelease field descriptions

carrierFreq or bandClass

The carrier frequency (UTRA and E-UTRA) and band class (HRPD and 1xRTT) for which the associated cellReselectionPriority is applied.

carrierFreqs

The list of GERAN carrier frequencies organised into one group of GERAN carrier frequencies.

cellInfoList

Used to provide system information of one or more cells on the redirected inter-RAT carrier frequency. The system information can be used if, upon redirection, the UE selects an inter-RAT cell indicated by the *physCellId* and *carrierFreq* (GERAN and UTRA TDD) or by the *physCellId* (other RATs). The choice shall match the *redirectedCarrierInfo*. In particular, E-UTRAN only applies value *utra-TDD-r10* in case *redirectedCarrierInfo* is set to *utra-TDD-r10*.

extendedWaitTime

Value in seconds for the wait time for Delay Tolerant access requests.

freqPriorityListX

Provides a cell reselection priority for each frequency, by means of separate lists for each RAT (including E-UTRA). The UE shall be able to store at least 3 occurrences of *FreqsPriorityGERAN*. If E-UTRAN includes *freqPriorityListEUTRA-v9e0* and/or *freqPriorityListEUTRA-v1310* it includes the same number of entries, and listed in the same order, as in *freqPriorityListEUTRA* (i.e. without suffix). Field *freqPriorityListExt* includes additional neighbouring inter-frequencies, i.e. extending the size of the inter-frequency carrier list using the general principles specified in 5.1.2. EUTRAN only includes *freqPriorityListExtEUTRA* if *freqPriorityListEUTRA* (i.e. without suffix) includes *maxFreq* entries. If E-UTRAN includes *freqPriorityListExtEUTRA-v1310* it includes the same number of entries, and listed in the same order, as in *freqPriorityListExtEUTRA-r12*.

idleModeMobilityControlInfo

Provides dedicated cell reselection priorities. Used for cell reselection as specified in TS 36.304 [4]. For E-UTRA and UTRA frequencies, a UE that supports multi-band cells for the concerned RAT considers the dedicated priorities to be common for all overlapping bands (i.e. regardless of the ARFCN that is used).

redirectedCarrierInfo

The *redirectedCarrierInfo* indicates a carrier frequency (downlink for FDD) and is used to redirect the UE to an E-UTRA or an inter-RAT carrier frequency, by means of the cell selection upon leaving RRC_CONNECTED as specified in TS 36.304 [4].

releaseCause

The *releaseCause* is used to indicate the reason for releasing the RRC Connection. The cause value *cs-FallbackHighPriority* is only applicable when *redirectedCarrierInfo* is present with the value set to *utra-FDD*, *utra-TDD* or *utra-TDD-r10*.

E-UTRAN should not set the *releaseCause* to *loadBalancingTAURequired* or to *cs-FallbackHighPriority* if the *extendedWaitTime* is present.

systemInformation

Container for system information of the GERAN cell i.e. one or more System Information (SI) messages as defined in TS 44.018 [45, table 9.1.1].

t320

Timer T320 as described in clause 7.3. Value minN corresponds to N minutes.

utra-BCCH-Container

Contains System Information Container message as defined in TS 25.331 [19].

Conditional presence	Explanation
<i>EARFCN-max</i>	The field is mandatory present if the corresponding <i>carrierFreq</i> (i.e. without suffix) is set to <i>maxEARFCN</i> . Otherwise the field is not present.
<i>IdleInfoEUTRA</i>	The field is optionally present, need OP, if the <i>IdleModeMobilityControlInfo</i> (i.e. without suffix) is included and includes <i>freqPriorityListEUTRA</i> ; otherwise the field is not present.
<i>NoRedirect-r8</i>	The field is optionally present, need OP, if the <i>redirectedCarrierInfo</i> (i.e. without suffix) is not included; otherwise the field is not present.
<i>Redirection</i>	The field is optionally present, need ON, if the <i>redirectedCarrierInfo</i> is included and set to <i>geran</i> , <i>utra-FDD</i> , <i>utra-TDD</i> or <i>utra-TDD-r10</i> ; otherwise the field is not present.

– *RRCCConnectionRequest*

The *RRCCConnectionRequest* message is used to request the establishment of an RRC connection.

Signalling radio bearer: SRB0

RLC-SAP: TM

Logical channel: CCCH

Direction: UE to E-UTRAN

RRCCConnectionRequest message

```
-- ASN1START
RRCCConnectionRequest ::=
    SEQUENCE {
        criticalExtensions      CHOICE {
            rrcConnectionRequest-r8      RRCCConnectionRequest-r8-IEs,
            criticalExtensionsFuture      SEQUENCE {}
        }
    }

RRCCConnectionRequest-r8-IEs ::=
    SEQUENCE {
        ue-Identity             InitialUE-Identity,
        establishmentCause      EstablishmentCause,
        spare                   BIT STRING (SIZE (1))
    }

InitialUE-Identity ::=
    CHOICE {
        s-TMSI                  S-TMSI,
        randomValue             BIT STRING (SIZE (40))
    }

EstablishmentCause ::=
    ENUMERATED {
        emergency, highPriorityAccess, mt-Access, mo-Signalling,
        mo-Data, delayTolerantAccess-v1020, mo-VoiceCall-v1280,
        spare1}
-- ASN1STOP
```

RRCCConnectionRequest field descriptions

establishmentCause

Provides the establishment cause for the RRC connection request as provided by the upper layers. W.r.t. the cause value names: *highPriorityAccess* concerns AC11..AC15, 'mt' stands for 'Mobile Terminating' and 'mo' for 'Mobile Originating'. eNB is not expected to reject a *RRCCConnectionRequest* due to unknown cause value being used by the UE.

randomValue

Integer value in the range 0 to $2^{40} - 1$.

ue-Identity

UE identity included to facilitate contention resolution by lower layers.

– *RRCCConnectionResume*

The *RRCCConnectionResume* message is used to resume the suspended RRC connection.

Signalling radio bearer: SRB1

RLC-SAP: AM

Logical channel: DCCH

Direction: E-UTRAN to UE

***RRCConnectionResume* message**

```
-- ASN1START
RRCConnectionResume-r13 ::= SEQUENCE {
    rrc-TransactionIdentifier      RRC-TransactionIdentifier,
    criticalExtensions              CHOICE {
        c1                         CHOICE {
            rrcConnectionResume-r13  RRCConnectionResume-r13-IEs,
            spare3                     NULL,
            spare2                     NULL,
            spare1                     NULL
        },
        criticalExtensionsFuture      SEQUENCE {}
    }
}

RRCConnectionResume-r13-IEs ::= SEQUENCE {
    radioResourceConfigDedicated-r13  RadioResourceConfigDedicated    OPTIONAL,    -- Need ON
    nextHopChainingCount-r13          NextHopChainingCount,
    measConfig-r13                    MeasConfig                        OPTIONAL,    -- Need ON
    antennaInfoDedicatedPCell-r13     AntennaInfoDedicated-v10i0        OPTIONAL,    -- Need ON
    drb-ContinueROHC-r13              ENUMERATED {true}                 OPTIONAL,    -- Need OP
    lateNonCriticalExtension           OCTET STRING                       OPTIONAL,
    rrcConnectionResume-v1430-IEs     RRCConnectionResume-v1430-IEs    OPTIONAL
}

RRCConnectionResume-v1430-IEs ::= SEQUENCE {
    otherConfig-r14                   OtherConfig-r9                     OPTIONAL,    -- Need ON
    nonCriticalExtension               SEQUENCE {}                       OPTIONAL
}
-- ASN1STOP
```

***RRCConnectionResume* field descriptions**

drb-ContinueROHC

This field indicates whether to continue or reset the header compression protocol context for the DRBs configured with the header compression protocol. Presence of the field indicates that the header compression protocol context continues while absence indicates that the header compression protocol context is reset.

– ***RRCConnectionResumeComplete***

The *RRCConnectionResumeComplete* message is used to confirm the successful completion of an RRC connection resumption

Signalling radio bearer: SRB1

RLC-SAP: AM

Logical channel: DCCH

Direction: UE to E-UTRAN

***RRCConnectionResumeComplete* message**

```
-- ASN1START
RRCConnectionResumeComplete-r13 ::= SEQUENCE {
    rrc-TransactionIdentifier      RRC-TransactionIdentifier,
    criticalExtensions              CHOICE {
        rrcConnectionResumeComplete-r13  RRCConnectionResumeComplete-r13-IEs,
        criticalExtensionsFuture          SEQUENCE {}
    }
}
```

```

}
}
RRCConnectionResumeComplete-r13-IEs ::= SEQUENCE {
    selectedPLMN-Identity-r13      INTEGER (1..maxPLMN-r11)          OPTIONAL,
    dedicatedInfoNAS-r13          DedicatedInfoNAS                OPTIONAL,
    rlf-InfoAvailable-r13         ENUMERATED {true}              OPTIONAL,
    logMeasAvailable-r13          ENUMERATED {true}              OPTIONAL,
    connEstFailInfoAvailable-r13  ENUMERATED {true}              OPTIONAL,
    mobilityState-r13             ENUMERATED {normal, medium, high, spare} OPTIONAL,
    mobilityHistoryAvail-r13      ENUMERATED {true}              OPTIONAL,
    logMeasAvailableMBSFN-r13     ENUMERATED {true}              OPTIONAL,
    lateNonCriticalExtension      OCTET STRING                    OPTIONAL,
    nonCriticalExtension           SEQUENCE {}                     OPTIONAL
}
-- ASN1STOP

```

RRCConnectionResumeComplete field descriptions

selectedPLMN-Identity

Index of the PLMN selected by the UE from the *plmn-IdentityList* fields included in SIB1. 1 if the 1st PLMN is selected from the 1st *plmn-IdentityList* included in SIB1, 2 if the 2nd PLMN is selected from the same *plmn-IdentityList*, or when no more PLMN are present within the same *plmn-IdentityList*, then the PLMN listed 1st in the subsequent *plmn-IdentityList* within the same SIB1 and so on.

– **RRCConnectionResumeRequest**

The *RRCConnectionResumeRequest* message is used to request the resumption of a suspended RRC connection.

Signalling radio bearer: SRB0

RLC-SAP: TM

Logical channel: CCCH

Direction: UE to E-UTRAN

RRCConnectionResumeRequest message

```

-- ASN1START
RRCConnectionResumeRequest-r13 ::= SEQUENCE {
    criticalExtensions             CHOICE {
        rrcConnectionResumeRequest-r13  RRCConnectionResumeRequest-r13-IEs,
        criticalExtensionsFuture         SEQUENCE {}
    }
}
RRCConnectionResumeRequest-r13-IEs ::= SEQUENCE {
    resumeIdentity-r13           CHOICE {
        resumeID-r13              ResumeIdentity-r13,
        truncatedResumeID-r13     BIT STRING (SIZE (24))
    },
    shortResumeMAC-I-r13        BIT STRING (SIZE (16)),
    resumeCause-r13             ResumeCause,
    spare                       BIT STRING (SIZE (1))
}
ResumeCause ::= ENUMERATED {
    emergency, highPriorityAccess, mt-Access, mo-Signalling,
    mo-Data, delayTolerantAccess-v1020, mo-VoiceCall-v1280,
    spare1}
-- ASN1STOP

```

<i>RRCConnectionResumeRequest</i> field descriptions	
<i>resumeCause</i>	Provides the resume cause for the RRC connection resume request as provided by the upper layers.
<i>resumIdentity</i>	UE identity to facilitate UE context retrieval at eNB
<i>shortResumeMAC-I</i>	Authentication token to facilitate UE authentication at eNB

– ***RRCConnectionSetup***

The *RRCConnectionSetup* message is used to establish SRB1.

Signalling radio bearer: SRB0

RLC-SAP: TM

Logical channel: CCCH

Direction: E-UTRAN to UE

RRCConnectionSetup message

```
-- ASN1START
RRCConnectionSetup ::=
    SEQUENCE {
        rrc-TransactionIdentifier      RRC-TransactionIdentifier,
        criticalExtensions             CHOICE {
            c1                         CHOICE {
                rrcConnectionSetup-r8      RRCConnectionSetup-r8-IEs,
                spare7 NULL,
                spare6 NULL, spare5 NULL, spare4 NULL,
                spare3 NULL, spare2 NULL, spare1 NULL
            },
            criticalExtensionsFuture       SEQUENCE {}
        }
    }

RRCConnectionSetup-r8-IEs ::=
    SEQUENCE {
        radioResourceConfigDedicated    RadioResourceConfigDedicated,
        nonCriticalExtension             RRCConnectionSetup-v8a0-IEs      OPTIONAL
    }

RRCConnectionSetup-v8a0-IEs ::= SEQUENCE {
        lateNonCriticalExtension         OCTET STRING                OPTIONAL,
        nonCriticalExtension             SEQUENCE {}                  OPTIONAL
    }
-- ASN1STOP
```

– ***RRCConnectionSetupComplete***

The *RRCConnectionSetupComplete* message is used to confirm the successful completion of an RRC connection establishment.

Signalling radio bearer: SRB1

RLC-SAP: AM

Logical channel: DCCH

Direction: UE to E-UTRAN

RRCConnectionSetupComplete message

```
-- ASN1START
RRCConnectionSetupComplete ::=
    SEQUENCE {
        rrc-TransactionIdentifier      RRC-TransactionIdentifier,
```

```

criticalExtensions          CHOICE {
  c1                        CHOICE {
    rrcConnectionSetupComplete-r8      RRCConnectionSetupComplete-r8-IEs,
    spare3 NULL, spare2 NULL, spare1 NULL
  },
  criticalExtensionsFuture          SEQUENCE {}
}

RRCConnectionSetupComplete-r8-IEs ::= SEQUENCE {
  selectedPLMN-Identity          INTEGER (1..maxPLMN-r11),
  registeredMME                  RegisteredMME                      OPTIONAL,
  dedicatedInfoNAS              DedicatedInfoNAS,
  nonCriticalExtension          RRCConnectionSetupComplete-v8a0-IEs OPTIONAL
}

RRCConnectionSetupComplete-v8a0-IEs ::= SEQUENCE {
  lateNonCriticalExtension      OCTET STRING                      OPTIONAL,
  nonCriticalExtension          RRCConnectionSetupComplete-v1020-IEs OPTIONAL
}

RRCConnectionSetupComplete-v1020-IEs ::= SEQUENCE {
  gummei-Type-r10              ENUMERATED {native, mapped}          OPTIONAL,
  rlf-InfoAvailable-r10        ENUMERATED {true}                  OPTIONAL,
  logMeasAvailable-r10        ENUMERATED {true}                  OPTIONAL,
  rn-SubframeConfigReq-r10    ENUMERATED {required, notRequired} OPTIONAL,
  nonCriticalExtension          RRCConnectionSetupComplete-v1130-IEs OPTIONAL
}

RRCConnectionSetupComplete-v1130-IEs ::= SEQUENCE {
  connEstFailInfoAvailable-r11  ENUMERATED {true}          OPTIONAL,
  nonCriticalExtension          RRCConnectionSetupComplete-v1250-IEs OPTIONAL
}

RRCConnectionSetupComplete-v1250-IEs ::= SEQUENCE {
  mobilityState-r12            ENUMERATED {normal, medium, high, spare} OPTIONAL,
  mobilityHistoryAvail-r12     ENUMERATED {true}                  OPTIONAL,
  logMeasAvailableMBSFN-r12   ENUMERATED {true}                  OPTIONAL,
  nonCriticalExtension          RRCConnectionSetupComplete-v1320-IEs
  OPTIONAL
}

RRCConnectionSetupComplete-v1320-IEs ::= SEQUENCE {
  ce-ModeB-r13                ENUMERATED {supported}              OPTIONAL,
  s-TMSI-r13                   S-TMSI                            OPTIONAL,
  attachWithoutPDN-Connectivity-r13  ENUMERATED {true}          OPTIONAL,
  up-CIoT-EPS-Optimisation-r13  ENUMERATED {true}          OPTIONAL,
  cp-CIoT-EPS-Optimisation-r13  ENUMERATED {true}          OPTIONAL,
  nonCriticalExtension          RRCConnectionSetupComplete-v1330-IEs OPTIONAL
}

RRCConnectionSetupComplete-v1330-IEs ::= SEQUENCE {
  ue-CE-NeedULGaps-r13        ENUMERATED {true}                  OPTIONAL,
  nonCriticalExtension          RRCConnectionSetupComplete-v1430-IEs OPTIONAL
}

RRCConnectionSetupComplete-v1430-IEs ::= SEQUENCE {
  dcn-ID-r14                   INTEGER (0..65535)                  OPTIONAL,
  nonCriticalExtension          SEQUENCE {}                          OPTIONAL
}

RegisteredMME ::=
  plmn-Identity                PLMN-Identity                      OPTIONAL,
  mmegi                        BIT STRING (SIZE (16)),
  mmec                          MMEC
}

-- ASN1STOP

```

<i>RRCConnectionSetupComplete</i> field descriptions
<p><i>attachWithoutPDN-Connectivity</i> This field is used to indicate that the UE performs an Attach without PDN connectivity procedure, as indicated by the upper layers and specified in TS 24.301 [35].</p>
<p><i>cp-CIoT-EPS-Optimisation</i> This field is included when the UE supports the Control plane CiOT EPS Optimisation, as indicated by the upper layers, see TS 24.301 [35].</p>
<p><i>ce-ModeB</i> Indicates whether the UE supports operation in CE mode B, as specified in TS 36.306 [5].</p>
<p><i>dcn-ID</i> The Dedicated Core Network Identity, see TS 23.401 [41].</p>
<p><i>gummei-Type</i> This field is used to indicate whether the GUMMEI included is native (assigned by EPC) or mapped (from 2G/3G identifiers).</p>
<p><i>mmegi</i> Provides the Group Identity of the registered MME within the PLMN, as provided by upper layers, see TS 23.003 [27].</p>
<p><i>mobilityState</i> This field indicates the UE mobility state (as defined in TS 36.304 [4, 5.2.4.3]) just prior to UE going into RRC_CONNECTED state. The UE indicates the value of <i>medium</i> and <i>high</i> when being in Medium-mobility and High-mobility states respectively. Otherwise the UE indicates the value <i>normal</i>.</p>
<p><i>registeredMME</i> This field is used to transfer the GUMMEI of the MME where the UE is registered, as provided by upper layers.</p>
<p><i>rn-SubframeConfigReq</i> If present, this field indicates that the connection establishment is for an RN and whether a subframe configuration is requested or not.</p>
<p><i>selectedPLMN-Identity</i> Index of the PLMN selected by the UE from the <i>plmn-IdentityList</i> fields included in SIB1. 1 if the 1st PLMN is selected from the 1st <i>plmn-IdentityList</i> included in SIB1, 2 if the 2nd PLMN is selected from the same <i>plmn-IdentityList</i>, or when no more PLMN are present within the same <i>plmn-IdentityList</i>, then the PLMN listed 1st in the subsequent <i>plmn-IdentityList</i> within the same SIB1 and so on.</p>
<p><i>up-CIoT-EPS-Optimisation</i> This field is included when the UE supports the User plane CiOT EPS Optimisation, as indicated by the upper layers, see TS 24.301 [35].</p>
<p><i>ue-CE-NeedULGaps</i> Indicates whether the UE needs uplink gaps during continuous uplink transmission in FDD as specified in TS 36.211 [21] and TS 36.306 [5].</p>

– SCGFailureInformation

The *SCGFailureInformation* message is used to provide information regarding failures detected by the UE.

Signalling radio bearer: SRB1

RLC-SAP: AM

Logical channel: DCCH

Direction: UE to E-UTRAN

***SCGFailureInformation* message**

```
-- ASN1START
SCGFailureInformation-r12 ::= SEQUENCE {
    criticalExtensions          CHOICE {
        c1                      CHOICE {
            scgFailureInformation-r12          SCGFailureInformation-r12-IEs,
            spare3 NULL, spare2 NULL, spare1 NULL
        },
        criticalExtensionsFuture SEQUENCE {}
    }
}

SCGFailureInformation-r12-IEs ::= SEQUENCE {
    failureReportSCG-r12      FailureReportSCG-r12          OPTIONAL,
    nonCriticalExtension      SCGFailureInformation-v1310-IEs OPTIONAL
}
-- ASN1END
```



```

SCGFailureInformation-v1310-IEs ::= SEQUENCE {
    lateNonCriticalExtension      OCTET STRING (CONTAINING SCGFailureInformation-v12d0-IEs)
                                OPTIONAL,
    nonCriticalExtension          SEQUENCE {}                                OPTIONAL
}

-- Late non-critical extensions:
SCGFailureInformation-v12d0-IEs ::= SEQUENCE {
    failureReportSCG-v12d0      FailureReportSCG-v12d0                    OPTIONAL,
    nonCriticalExtension        SEQUENCE {}                                OPTIONAL
}

-- Regular non-critical extensions:
FailureReportSCG-r12 ::= SEQUENCE {
    failureType-r12              ENUMERATED {t313-Expiry, randomAccessProblem,
                                             rlc-MaxNumRetx, scg-ChangeFailure },
    measResultServFreqList-r12  MeasResultServFreqList-r10              OPTIONAL,
    measResultNeighCells-r12    MeasResultList2EUTRA-r9                OPTIONAL,
    ...,
    [[ failureType-v1290        ENUMERATED {maxUL-TimingDiff-v1290} OPTIONAL
    ]],
    [[ measResultServFreqListExt-r13 MeasResultServFreqListExt-r13    OPTIONAL
    ]]
}

FailureReportSCG-v12d0 ::= SEQUENCE {
    measResultNeighCells-v12d0  MeasResultList2EUTRA-v9e0          OPTIONAL
}

-- ASN1STOP

```

– SCPTMConfiguration

The *SCPTMConfiguration* message contains the control information applicable for MBMS services transmitted via SC-MRB.

Signalling radio bearer: N/A

RLC-SAP: UM

Logical channel: SC-MCCH

Direction: E-UTRAN to UE

SCPTMConfiguration message

```

-- ASN1START
SCPTMConfiguration-r13 ::= SEQUENCE {
    sc-mtch-InfoList-r13        SC-MTCH-InfoList-r13,
    scptm-NeighbourCellList-r13 SCPTM-NeighbourCellList-r13          OPTIONAL,  -- Need OP
    lateNonCriticalExtension    OCTET STRING                        OPTIONAL,
    nonCriticalExtension        SCPTMConfiguration-v1340          OPTIONAL
}

SCPTMConfiguration-v1340 ::= SEQUENCE {
    p-b-r13                    INTEGER (0..3)                      OPTIONAL,  -- Need ON
    nonCriticalExtension        SEQUENCE {}                          OPTIONAL
}

-- ASN1STOP

```

SCPTMConfiguration field descriptions
<p>sc-mtch-InfoList Provides the configuration of each SC-MTCH in the current cell.</p>
<p>scptm-NeighbourCellList List of neighbour cells providing MBMS services via SC-MRB. When absent, the UE shall assume that MBMS services listed in the <i>SCPTMConfiguration</i> message are not provided via SC-MRB in any neighbour cell.</p>
<p>p-b Parameter: P_B for the PDSCH scrambled by G-RNTI, see TS 36.213 [23, Table 5.2-1].</p>

– SCPTMConfiguration-BR

The *SCPTMConfiguration-BR* message contains the control information applicable for MBMS services transmitted via SC-MRB for BL UEs or UEs in CE.

Signalling radio bearer: N/A

RLC-SAP: UM

Logical channel: SC-MCCH

Direction: E-UTRAN to UE

SCPTMConfiguration-BR message

```
-- ASN1START
SCPTMConfiguration-BR-r14 ::= SEQUENCE {
    sc-mtch-InfoList-r14          SC-MTCH-InfoList-BR-r14,
    scptm-NeighbourCellList-r14  SCPTM-NeighbourCellList-r13  OPTIONAL, -- Need OP
    p-b-r14                      INTEGER (0..3)                   OPTIONAL, -- Need OR
    lateNonCriticalExtension      OCTET STRING                       OPTIONAL,
    nonCriticalExtension          SEQUENCE {}                       OPTIONAL
}
-- ASN1STOP
```

SCPTMConfiguration-BR field descriptions
<p>p-b Parameter: P_B for the PDSCH scrambled by G-RNTI, see TS 36.213 [23, Table 5.2-1].</p>
<p>sc-mtch-InfoList Provides the configuration of each SC-MTCH in the current cell for BL UEs or UEs in CE.</p>
<p>scptm-NeighbourCellList List of neighbour cells providing MBMS services via SC-MRB. When absent, the BL UE or UE in CE shall assume that MBMS services listed in the <i>SCPTMConfiguration-BR</i> message are not provided via SC-MRB in any neighbour cell.</p>

– SecurityModeCommand

The *SecurityModeCommand* message is used to command the activation of AS security.

Signalling radio bearer: SRB1

RLC-SAP: AM

Logical channel: DCCH

Direction: E-UTRAN to UE

SecurityModeCommand message

```
-- ASN1START
SecurityModeCommand ::= SEQUENCE {
    rrc-TransactionIdentifier  RRC-TransactionIdentifier,
    criticalExtensions         CHOICE {

```

```

        c1
            securityModeCommand-r8
            spare3 NULL, spare2 NULL, spare1 NULL
        },
        criticalExtensionsFuture
    }
}

SecurityModeCommand-r8-IEs ::= SEQUENCE {
    securityConfigSMC
    nonCriticalExtension
}

SecurityModeCommand-v8a0-IEs ::= SEQUENCE {
    lateNonCriticalExtension
    nonCriticalExtension
}

SecurityConfigSMC ::= SEQUENCE {
    securityAlgorithmConfig
    ...
}

-- ASN1STOP

```

– *SecurityModeComplete*

The *SecurityModeComplete* message is used to confirm the successful completion of a security mode command.

Signalling radio bearer: SRB1

RLC-SAP: AM

Logical channel: DCCH

Direction: UE to E-UTRAN

SecurityModeComplete message

```

-- ASN1START

SecurityModeComplete ::= SEQUENCE {
    rrc-TransactionIdentifier
    criticalExtensions
    securityModeComplete-r8
    criticalExtensionsFuture
}

SecurityModeComplete-r8-IEs ::= SEQUENCE {
    nonCriticalExtension
    OPTIONAL
}

SecurityModeComplete-v8a0-IEs ::= SEQUENCE {
    lateNonCriticalExtension
    nonCriticalExtension
}

-- ASN1STOP

```

– *SecurityModeFailure*

The *SecurityModeFailure* message is used to indicate an unsuccessful completion of a security mode command.

Signalling radio bearer: SRB1

RLC-SAP: AM

Logical channel: DCCH

Direction: UE to E-UTRAN

SecurityModeFailure message

```
-- ASN1START
SecurityModeFailure ::= SEQUENCE {
    rrc-TransactionIdentifier RRC-TransactionIdentifier,
    criticalExtensions CHOICE {
        securityModeFailure-r8 SecurityModeFailure-r8-IEs,
        criticalExtensionsFuture SEQUENCE {}
    }
}

SecurityModeFailure-r8-IEs ::= SEQUENCE {
    nonCriticalExtension SecurityModeFailure-v8a0-IEs
    OPTIONAL
}

SecurityModeFailure-v8a0-IEs ::= SEQUENCE {
    lateNonCriticalExtension OCTET STRING OPTIONAL,
    nonCriticalExtension SEQUENCE {} OPTIONAL
}
-- ASN1STOP
```

SidelinkUEInformation

The *SidelinkUEInformation* message is used for the indication of sidelink information to the eNB.

Signalling radio bearer: SRB1

RLC-SAP: AM

Logical channel: DCCH

Direction: UE to E-UTRAN

SidelinkUEInformation message

```
-- ASN1START
SidelinkUEInformation-r12 ::= SEQUENCE {
    criticalExtensions CHOICE {
        c1 CHOICE {
            sidelinkUEInformation-r12 SidelinkUEInformation-r12-IEs,
            spare3 NULL, spare2 NULL, spare1 NULL
        },
        criticalExtensionsFuture SEQUENCE {}
    }
}

SidelinkUEInformation-r12-IEs ::= SEQUENCE {
    commRxInterestedFreq-r12 ARFCN-ValueEUTRA-r9 OPTIONAL,
    commTxResourceReq-r12 SL-CommTxResourceReq-r12 OPTIONAL,
    discRxInterest-r12 ENUMERATED {true} OPTIONAL,
    discTxResourceReq-r12 INTEGER (1..63) OPTIONAL,
    lateNonCriticalExtension OCTET STRING OPTIONAL,
    nonCriticalExtension SidelinkUEInformation-v1310-IEs OPTIONAL
}

SidelinkUEInformation-v1310-IEs ::= SEQUENCE {
    commTxResourceReqUC-r13 SL-CommTxResourceReq-r12 OPTIONAL,
    commTxResourceInfoReqRelay-r13 SEQUENCE {
        commTxResourceReqRelay-r13 SL-CommTxResourceReq-r12 OPTIONAL,
        commTxResourceReqRelayUC-r13 SL-CommTxResourceReq-r12 OPTIONAL,
    }
}
```

```

    ue-Type-r13          ENUMERATED {relayUE, remoteUE}
  }
  discTxResourceReq-v1310 SEQUENCE {
    carrierFreqDiscTx-r13 INTEGER (1..maxFreq) OPTIONAL,
    discTxResourceReqAddFreq-r13 SL-DiscTxResourceReqPerFreqList-r13 OPTIONAL
  }
  discTxResourceReqPS-r13 SL-DiscTxResourceReq-r13 OPTIONAL,
  discRxGapReq-r13       SL-GapRequest-r13 OPTIONAL,
  discTxGapReq-r13       SL-GapRequest-r13 OPTIONAL,
  discSysInfoReportFreqList-r13 SL-DiscSysInfoReportFreqList-r13 OPTIONAL,
  nonCriticalExtension    SidelinkUEInformation-v1430-IEs OPTIONAL
}

SidelinkUEInformation-v1430-IEs ::= SEQUENCE {
  v2x-CommRxInterestedFreqList-r14 SL-V2X-CommFreqList-r14 OPTIONAL,
  p2x-CommTxType-r14                ENUMERATED {true} OPTIONAL,
  v2x-CommTxResourceReq-r14         SL-V2X-CommTxFreqList-r14 OPTIONAL,
  nonCriticalExtension              SEQUENCE {} OPTIONAL
}

SL-CommTxResourceReq-r12 ::= SEQUENCE {
  carrierFreq-r12 ARFCN-ValueEUTRA-r9 OPTIONAL,
  destinationInfoList-r12 SL-DestinationInfoList-r12
}

SL-DiscTxResourceReqPerFreqList-r13 ::= SEQUENCE (SIZE (1..maxFreq)) OF SL-DiscTxResourceReq-r13

SL-DiscTxResourceReq-r13 ::= SEQUENCE {
  carrierFreqDiscTx-r13 INTEGER (1..maxFreq) OPTIONAL,
  discTxResourceReq-r13 INTEGER (1..63)
}

SL-DestinationInfoList-r12 ::= SEQUENCE (SIZE (1..maxSL-Dest-r12)) OF SL-DestinationIdentity-r12

SL-DestinationIdentity-r12 ::= BIT STRING (SIZE (24))

SL-DiscSysInfoReportFreqList-r13 ::= SEQUENCE (SIZE (1..maxSL-DiscSysInfoReportFreq-r13)) OF SL-DiscSysInfoReport-r13

SL-V2X-CommFreqList-r14 ::= SEQUENCE (SIZE (1..maxFreqV2X-r14)) OF INTEGER (0..maxFreqV2X-1-r14)

SL-V2X-CommTxFreqList-r14 ::= SEQUENCE (SIZE (1..maxFreqV2X-r14)) OF SL-V2X-CommTxResourceReq-r14

SL-V2X-CommTxResourceReq-r14 ::= SEQUENCE {
  carrierFreqCommTx-r14 INTEGER (0..maxFreqV2X-1-r14) OPTIONAL,
  v2x-TypeTxSync-r14    SL-TypeTxSync-r14 OPTIONAL,
  v2x-DestinationInfoList-r14 SL-DestinationInfoList-r12 OPTIONAL
}

-- ASN1STOP

```

SidelinkUEInformation field descriptions
<p>carrierFreqCommTx Indicates the index of the frequency on which the UE is interested to transmit V2X sidelink communication. The value 1 corresponds to the frequency of first entry in <i>v2x-InterFreqInfoList</i> broadcast in SIB21, the value 2 corresponds to the frequency of second entry in <i>v2x-InterFreqInfoList</i> broadcast in SIB21 and so on. The value 0 corresponds the PCell's frequency.</p>
<p>carrierFreqDiscTx Indicates the frequency by the index of the entry in field <i>discInterFreqList</i> within <i>SystemInformationBlockType19</i>. Value 1 corresponds to the first entry in <i>discInterFreqList</i> within <i>SystemInformationBlockType19</i>, value 2 corresponds to the second entry in this list and so on.</p>
<p>commRxInterestedFreq Indicates the frequency on which the UE is interested to receive sidelink communication.</p>
<p>commTxResourceReq Indicates the frequency on which the UE is interested to transmit non-relay related sidelink communication as well as the one-to-many sidelink communication transmission destination(s) for which the UE requests E-UTRAN to assign dedicated resources. NOTE 1.</p>
<p>commTxResourceReqRelay Indicates the relay related one-to-many sidelink communication transmission destination(s) for which the sidelink relay UE requests E-UTRAN to assign dedicated resources.</p>
<p>commTxResourceReqRelayUC Indicates the relay related one-to-one sidelink communication transmission destination(s) for which the sidelink relay UE or sidelink remote UE requests E-UTRAN to assign dedicated resources i.e. either contains the unicast destination identity of the sidelink relay UE or of the sidelink remote UE.</p>
<p>commTxResourceReqUC Indicates the frequency on which the UE is interested to transmit non-relay related one-to-one sidelink communication as well as the sidelink communication transmission destination(s) for which the UE requests E-UTRAN to assign dedicated resources. NOTE 1.</p>
<p>destinationInfoList Indicates the destination(s) for relay or non-relay related one-to-one or one-to-many sidelink communication. For one-to-one sidelink communication the destination is identified by the ProSe UE ID for unicast communication, while for one-to-many the destination it is identified by the ProSe Layer-2 Group ID as specified in TS 23.303 [68].</p>
<p>discRxInterest Indicates that the UE is interested to monitor sidelink discovery announcements.</p>
<p>discSysInfoReportFreqList Indicates, for one or more frequencies, a list of sidelink discovery related parameters acquired from system Information of cells on configured inter-frequency carriers.</p>
<p>discTxResourceReq Indicates the number of separate discovery message(s) the UE wants to transmit every discovery period. This field concerns the resources the UE requires every discovery period for transmitting sidelink discovery announcement(s).</p>
<p>discTxResourceReqAddFreq Indicates, for any frequencies in addition to the one covered by <i>discTxResourceReq</i>, the number of separate discovery message(s) the UE wants to transmit every discovery period. This field concerns the resources the UE requires every discovery period for transmitting sidelink discovery announcement(s).</p>
<p>discTxResourceReqPS Indicates the number of separate PS related discovery message(s) the UE wants to transmit every discovery period. This field concerns the resources the UE requires every discovery period for transmitting PS related sidelink discovery announcement(s).</p>
<p>p2x-CommTxType Indicates that the requested transmission resource pool is for P2X related V2X sidelink communication.</p>
<p>v2x-CommRxInterestedFreqList Indicates the index(es) of the frequency(ies) on which the UE is interested to receive V2X sidelink communication. The value 1 corresponds to the frequency of first entry in <i>v2x-InterFreqInfoList</i> broadcast in SIB21, the value 2 corresponds to the frequency of second entry in <i>v2x-InterFreqInfoList</i> broadcast in SIB21 and so on. The value 0 corresponds the PCell's frequency.</p>
<p>v2x-DestinationInfoList Indicates the destination(s) for V2X sidelink communication.</p>
<p>v2x-TypeTxSync Indicates the synchronization reference used by the UE.</p>

NOTE 1: When configuring *commTxResourceReq*, *commTxResourceReqUC*, *commTxResourceReqRelay* and *commTxResourceReqRelayUC*, E-UTRAN configures at most *maxSL-Dest-r12* destinations in total (i.e. as included in the four fields together).

– SystemInformation

The *SystemInformation* message is used to convey one or more System Information Blocks. All the SIBs included are transmitted with the same periodicity. *SystemInformation-BR* and *SystemInformation-MBMS* use the same structure as *SystemInformation*.

Signalling radio bearer: N/A

RLC-SAP: TM

Logical channels: BCCH and BR-BCCH

Direction: E-UTRAN to UE

SystemInformation message

```
-- ASN1START
SystemInformation-BR-r13 ::= SystemInformation
SystemInformation-MBMS-r14 ::= SystemInformation

SystemInformation ::=
    criticalExtensions
    systemInformation-r8
    criticalExtensionsFuture
}
SystemInformation-r8-IEs ::=
    sib-TypeAndInfo
    sib2
    sib3
    sib4
    sib5
    sib6
    sib7
    sib8
    sib9
    sib10
    sib11
    . . .
    sib12-v920
    sib13-v920
    sib14-v1130
    sib15-v1130
    sib16-v1130
    sib17-v1250
    sib18-v1250
    sib19-v1250
    sib20-v1310
    sib21-v1430
    },
    nonCriticalExtension
}
SystemInformation-v8a0-IEs ::= SEQUENCE {
    lateNonCriticalExtension OCTET STRING OPTIONAL,
    nonCriticalExtension SEQUENCE {} OPTIONAL
}
-- ASN1STOP
```

– SystemInformationBlockType1

SystemInformationBlockType1 contains information relevant when evaluating if a UE is allowed to access a cell and defines the scheduling of other system information. *SystemInformationBlockType1-BR* uses the same structure as *SystemInformationBlockType1*.

Signalling radio bearer: N/A

RLC-SAP: TM

Logical channels: BCCH and BR-BCCH

Direction: E-UTRAN to UE

SystemInformationBlockType1 message

```

-- ASN1START
SystemInformationBlockType1-BR-r13 ::= SystemInformationBlockType1

SystemInformationBlockType1 ::= SEQUENCE {
    cellAccessRelatedInfo          SEQUENCE {
        plmn-IdentityList          PLMN-IdentityList,
        trackingAreaCode           TrackingAreaCode,
        cellIdentity               CellIdentity,
        cellBarred                 ENUMERATED {barred, notBarred},
        intraFreqReselection       ENUMERATED {allowed, notAllowed},
        csg-Indication             BOOLEAN,
        csg-Identity               CSG-Identity          OPTIONAL -- Need OR
    },
    cellSelectionInfo              SEQUENCE {
        q-RxLevMin                 Q-RxLevMin,
        q-RxLevMinOffset           INTEGER (1..8)          OPTIONAL -- Need OP
    },
    p-Max                          P-Max                OPTIONAL, -- Need OP
    freqBandIndicator              FreqBandIndicator,
    schedulingInfoList             SchedulingInfoList,
    tdd-Config                     TDD-Config          OPTIONAL, -- Cond TDD
    si-WindowLength               ENUMERATED {
        ms1, ms2, ms5, ms10, ms15, ms20,
        ms40},
    systemInfoValueTag             INTEGER (0..31),
    nonCriticalExtension            SystemInformationBlockType1-v890-IEs OPTIONAL
}

SystemInformationBlockType1-v890-IEs ::= SEQUENCE {
    lateNonCriticalExtension       OCTET STRING (CONTAINING SystemInformationBlockType1-v8h0-
    IEs)                            OPTIONAL,
    nonCriticalExtension            SystemInformationBlockType1-v920-IEs OPTIONAL
}

-- Late non critical extensions
SystemInformationBlockType1-v8h0-IEs ::= SEQUENCE {
    multiBandInfoList             MultiBandInfoList          OPTIONAL, -- Need OR
    nonCriticalExtension            SystemInformationBlockType1-v9e0-IEs OPTIONAL
}

SystemInformationBlockType1-v9e0-IEs ::= SEQUENCE {
    freqBandIndicator-v9e0         FreqBandIndicator-v9e0     OPTIONAL, -- Cond FBI-max
    multiBandInfoList-v9e0         MultiBandInfoList-v9e0     OPTIONAL, -- Cond mFBI-max
    nonCriticalExtension            SystemInformationBlockType1-v10j0-IEs OPTIONAL
}

SystemInformationBlockType1-v10j0-IEs ::= SEQUENCE {
    freqBandInfo-r10               NS-PmaxList-r10           OPTIONAL, -- Need OR
    multiBandInfoList-v10j0        MultiBandInfoList-v10j0   OPTIONAL, -- Need OR
    nonCriticalExtension            SystemInformationBlockType1-v10l0-IEs
    OPTIONAL
}

SystemInformationBlockType1-v10l0-IEs ::= SEQUENCE {
    freqBandInfo-v10l0             NS-PmaxList-v10l0         OPTIONAL, -- Need OR
    multiBandInfoList-v10l0        MultiBandInfoList-v10l0   OPTIONAL, -- Need OR
    nonCriticalExtension            SEQUENCE {}                OPTIONAL
}

-- Regular non critical extensions
SystemInformationBlockType1-v920-IEs ::= SEQUENCE {
    ims-EmergencySupport-r9        ENUMERATED {true}         OPTIONAL, -- Need OR
    cellSelectionInfo-v920         CellSelectionInfo-v920    OPTIONAL, -- Cond RSRQ
    nonCriticalExtension            SystemInformationBlockType1-v1130-IEs
    OPTIONAL
}

```



```

SystemInformationBlockType1-v1130-IEs ::= SEQUENCE {
    tdd-Config-v1130                TDD-Config-v1130                OPTIONAL,    -- Cond TDD-OR
    cellSelectionInfo-v1130         CellSelectionInfo-v1130     OPTIONAL,    -- Cond WB-RSRQ
    nonCriticalExtension
}

SystemInformationBlockType1-v1250-IEs ::= SEQUENCE {
    cellAccessRelatedInfo-v1250     SEQUENCE {
        category0Allowed-r12        ENUMERATED {true}          OPTIONAL    -- Need OP
    },
    cellSelectionInfo-v1250         CellSelectionInfo-v1250     OPTIONAL,    -- Cond RSRQ2
    freqBandIndicatorPriority-r12    ENUMERATED {true}          OPTIONAL,    -- Cond mFBI
    nonCriticalExtension            SystemInformationBlockType1-v1310-IEs OPTIONAL
}

SystemInformationBlockType1-v1310-IEs ::= SEQUENCE {
    hyperSFN-r13                    BIT STRING (SIZE (10))     OPTIONAL,    -- Need OR
    eDRX-Allowed-r13                ENUMERATED {true}          OPTIONAL,    -- Need OR
    cellSelectionInfoCE-r13         CellSelectionInfoCE-r13    OPTIONAL,    -- Need OP
    bandwidthReducedAccessRelatedInfo-r13 SEQUENCE {
        si-WindowLength-BR-r13      ENUMERATED {
            ms20, ms40, ms60, ms80, ms120,
            ms160, ms200, spare},
        si-RepetitionPattern-r13     ENUMERATED {everyRF, every2ndRF, every4thRF,
            every8thRF},
        schedulingInfoList-BR-r13    SchedulingInfoList-BR-r13 OPTIONAL,    -- Cond SI-
BR
        fdd-DownlinkOrTddSubframeBitmapBR-r13 CHOICE {
            subframePattern10-r13    BIT STRING (SIZE (10)),
            subframePattern40-r13    BIT STRING (SIZE (40))
        }
        fdd-UplinkSubframeBitmapBR-r13 BIT STRING (SIZE (10))     OPTIONAL,    -- Need OP
        startSymbolBR-r13             INTEGER (1..4),
        si-HoppingConfigCommon-r13    ENUMERATED {on,off},
        si-ValidityTime-r13           ENUMERATED {true}          OPTIONAL,    -- Need OP
        systemInfoValueTagList-r13    SystemInfoValueTagList-r13 OPTIONAL
        OPTIONAL,    -- Cond BW-reduced
    }
    nonCriticalExtension            SystemInformationBlockType1-v1320-IEs OPTIONAL
}

SystemInformationBlockType1-v1320-IEs ::= SEQUENCE {
    freqHoppingParametersDL-r13     SEQUENCE {
        mpdcch-pdsch-HoppingNB-r13   ENUMERATED {nb2, nb4}      OPTIONAL,    -- Need OR
        interval-DLHoppingConfigCommonModeA-r13 CHOICE {
            interval-FDD-r13          ENUMERATED {int1, int2, int4, int8},
            interval-TDD-r13          ENUMERATED {int1, int5, int10, int20}
        }
        OPTIONAL,    -- Need OR
        interval-DLHoppingConfigCommonModeB-r13 CHOICE {
            interval-FDD-r13          ENUMERATED {int2, int4, int8, int16},
            interval-TDD-r13          ENUMERATED {int5, int10, int20, int40}
        }
        OPTIONAL,    -- Need OR
        mpdcch-pdsch-HoppingOffset-r13 INTEGER (1..maxAvailNarrowBands-r13) OPTIONAL --
Need OR
    }
    nonCriticalExtension            OPTIONAL,    -- Cond Hopping
    SystemInformationBlockType1-v1350-IEs
    OPTIONAL
}

SystemInformationBlockType1-v1350-IEs ::= SEQUENCE {
    cellSelectionInfoCE1-r13        CellSelectionInfoCE1-r13   OPTIONAL,    -- Need OP
    nonCriticalExtension            SystemInformationBlockType1-v1360-IEs
    OPTIONAL
}

SystemInformationBlockType1-v1360-IEs ::= SEQUENCE {
    cellSelectionInfoCE1-v1360      CellSelectionInfoCE1-v1360 OPTIONAL,    -- Cond
QrxlevminCE1
    nonCriticalExtension            SystemInformationBlockType1-v1430-IEs    OPTIONAL
}

SystemInformationBlockType1-v1430-IEs ::= SEQUENCE {
    eCallOverIMS-Support-r14        ENUMERATED {true}          OPTIONAL,    -- Need OR
    tdd-Config-v1430                TDD-Config-v1430          OPTIONAL,    -- Cond TDD-OR
    cellAccessRelatedInfoList-r14   SEQUENCE (SIZE (1..maxPLMN-1-r14)) OF
CellAccessRelatedInfo-r14    OPTIONAL,    -- Need OR
    nonCriticalExtension            SystemInformationBlockType1-v1450-IEs
    OPTIONAL
}

```

```

SystemInformationBlockType1-v1450-IEs ::= SEQUENCE {
    tdd-Config-v1450                TDD-Config-v1450                OPTIONAL,  -- Cond TDD-OR
    nonCriticalExtension             SEQUENCE {}                OPTIONAL
}

PLMN-IdentityList ::= SEQUENCE (SIZE (1..maxPLMN-r11)) OF PLMN-IdentityInfo

PLMN-IdentityInfo ::= SEQUENCE {
    plmn-Identity                    PLMN-Identity,
    cellReservedForOperatorUse       ENUMERATED {reserved, notReserved}
}

SchedulingInfoList ::= SEQUENCE (SIZE (1..maxSI-Message)) OF SchedulingInfo

SchedulingInfo ::= SEQUENCE {
    si-Periodicity                    ENUMERATED {
        rf8, rf16, rf32, rf64, rf128, rf256, rf512},
    sib-MappingInfo                  SIB-MappingInfo
}

SchedulingInfoList-BR-r13 ::= SEQUENCE (SIZE (1..maxSI-Message)) OF SchedulingInfo-BR-r13

SchedulingInfo-BR-r13 ::= SEQUENCE {
    si-Narrowband-r13                INTEGER (1..maxAvailNarrowBands-r13),
    si-TBS-r13                       ENUMERATED {b152, b208, b256, b328, b408, b504, b600, b712,
        b808, b936}
}

SIB-MappingInfo ::= SEQUENCE (SIZE (0..maxSIB-1)) OF SIB-Type

SIB-Type ::= ENUMERATED {
    sibType3, sibType4, sibType5, sibType6,
    sibType7, sibType8, sibType9, sibType10,
    sibType11, sibType12-v920, sibType13-v920,
    sibType14-v1130, sibType15-v1130,
    sibType16-v1130, sibType17-v1250, sibType18-v1250,
    ..., sibType19-v1250, sibType20-v1310, sibType21-v1430}

SystemInfoValueTagList-r13 ::= SEQUENCE (SIZE (1..maxSI-Message)) OF SystemInfoValueTagSI-r13

SystemInfoValueTagSI-r13 ::= INTEGER (0..3)

CellSelectionInfo-v920 ::= SEQUENCE {
    q-QualMin-r9                     Q-QualMin-r9,
    q-QualMinOffset-r9               INTEGER (1..8)                OPTIONAL  -- Need OP
}

CellSelectionInfo-v1130 ::= SEQUENCE {
    q-QualMinWB-r11                  Q-QualMin-r9
}

CellSelectionInfo-v1250 ::= SEQUENCE {
    q-QualMinRSRQ-OnAllSymbols-r12   Q-QualMin-r9
}

CellAccessRelatedInfo-r14 ::= SEQUENCE {
    plmn-IdentityList-r14            PLMN-IdentityList,
    trackingAreaCode-r14              TrackingAreaCode,
    cellIdentity-r14                 CellIdentity
}

-- ASN1STOP

```

SystemInformationBlockType1 field descriptions
<p>bandwithReducedAccessRelatedInfo Access related information for BL UEs and UEs in CE. NOTE 3.</p>
<p>category0Allowed The presence of this field indicates category 0 UEs are allowed to access the cell.</p>
<p>cellAccessRelatedInfoList This field contains a list allowing signalling of access related information per PLMN. One PLMN can be included in only one entry of this list. NOTE 4.</p>
<p>cellBarred barred means the cell is barred, as defined in TS 36.304 [4].</p>
<p>cellIdentity Indicates the cell identity. NOTE 2.</p>
<p>cellReservedForOperatorUse As defined in TS 36.304 [4].</p>
<p>cellSelectionInfoCE Cell selection information for BL UEs and UEs in CE. If absent, coverage enhancement S criteria is not applicable. NOTE 3.</p>
<p>cellSelectionInfoCE1 Cell selection information for BL UEs and UEs in CE supporting CE Mode B. E-UTRAN includes this IE only if <i>cellSelectionInfoCE</i> is present in <i>SystemInformationBlockType1-BR</i>. NOTE 3.</p>
<p>csg-Identity Identity of the Closed Subscriber Group the cell belongs to.</p>
<p>csg-Indication If set to TRUE the UE is only allowed to access the cell if it is a CSG member cell, if selected during manual CSG selection or to obtain limited service, see TS 36.304 [4].</p>
<p>eCallOverIMS-Support Indicates whether the cell supports eCall over IMS services for UEs as defined in TS 23.401 [41]. If absent, eCall over IMS is not supported by the network in the cell. NOTE 2.</p>
<p>eDRX-Allowed The presence of this field indicates if idle mode extended DRX is allowed in the cell. The UE shall stop using extended DRX in idle mode if <i>eDRX-Allowed</i> is not present.</p>
<p>fdd-DownlinkOrTddSubframeBitmapBR The set of valid subframes for FDD downlink or TDD transmissions, see TS 36.213 [23]. If this field is present, <i>SystemInformationBlockType1-BR-r13</i> is transmitted in <i>RRCCConnectionReconfiguration</i>, and if <i>RRCCConnectionReconfiguration</i> does not include <i>systemInformationBlockType2Dedicated</i>, UE may assume the valid subframes in <i>fdd-DownlinkOrTddSubframeBitmapBR</i> are not indicated as MBSFN subframes. If this field is not present, the set of valid subframes is the set of non-MBSFN subframes as indicated by <i>mbsfn-SubframeConfigList</i>. If neither this field nor <i>mbsfn-SubframeConfigList</i> is present, all subframes are considered as valid subframes for FDD downlink transmission, all DL subframes according to the uplink-downlink configuration (see TS 36.211 [21]) are considered as valid subframes for TDD DL transmission, and all UL subframes according to the uplink-downlink configuration (see TS 36.211 [21]) are considered as valid subframes for TDD UL transmission. The first/leftmost bit corresponds to the subframe #0 of the radio frame satisfying $SFN \bmod x = 0$, where x is the size of the bit string divided by 10. Value 0 in the bitmap indicates that the corresponding subframe is invalid for transmission. Value 1 in the bitmap indicates that the corresponding subframe is valid for transmission.</p>
<p>fdd-UplinkSubframeBitmapBR The set of valid subframes for FDD uplink transmissions for BL UEs, see TS 36.213 [23]. If the field is not present, then UE considers all uplink subframes as valid subframes for FDD uplink transmissions. The first/leftmost bit corresponds to the subframe #0 of the radio frame satisfying $SFN \bmod x = 0$, where x is the size of the bit string divided by 10. Value 0 in the bitmap indicates that the corresponding subframe is invalid for transmission. Value 1 in the bitmap indicates that the corresponding subframe is valid for transmission.</p>
<p>freqBandIndicatorPriority If the field is present and supported by the UE, the UE shall prioritize the frequency bands in the <i>multiBandInfoList</i> field in decreasing priority order. Only if the UE does not support any of the frequency band in <i>multiBandInfoList</i>, the UE shall use the value in <i>freqBandIndicator</i> field. Otherwise, the UE applies frequency band according to the rules defined in <i>multiBandInfoList</i>. NOTE 2.</p>
<p>freqBandInfo A list of <i>additionalPmax</i> and <i>additionalSpectrumEmission</i> values, as defined in TS 36.101 [42, table 6.2.4-1] for UEs neither in CE nor BL UEs and TS 36.101 [42, table 6.2.4E-1] for UEs in CE or BL UEs, for the frequency band in <i>freqBandIndicator</i>. If E-UTRAN includes <i>freqBandInfo-v1010</i> it includes the same number of entries, and listed in the same order, as in <i>freqBandInfo-r10</i>.</p>
<p>freqHoppingParametersDL Downlink frequency hopping parameters for BR versions of SI messages, MPDCCH/PDSCH of paging, MPDCCH/PDSCH of RAR/Msg4 and unicast MPDCCH/PDSCH. If not present, the UE is not configured downlink frequency hopping.</p>
<p>hyperSFN Indicates hyper SFN which increments by one when the SFN wraps around.</p>

SystemInformationBlockType1 field descriptions
<p>ims-EmergencySupport Indicates whether the cell supports IMS emergency bearer services for UEs in limited service mode. If absent, IMS emergency call is not supported by the network in the cell for UEs in limited service mode. NOTE 2.</p>
<p>intraFreqReselection Used to control cell reselection to intra-frequency cells when the highest ranked cell is barred, or treated as barred by the UE, as specified in TS 36.304 [4]. NOTE 2.</p>
<p>multiBandInfoList A list of additional frequency band indicators, as defined in TS 36.101 [42, table 5.5-1] that the cell belongs to. If the UE supports the frequency band in the <i>freqBandIndicator</i> field it shall apply that frequency band. Otherwise, the UE shall apply the first listed band which it supports in the <i>multiBandInfoList</i> field. If E-UTRAN includes <i>multiBandInfoList-v9e0</i> it includes the same number of entries, and listed in the same order, as in <i>multiBandInfoList</i> (i.e. without suffix). See Annex D for more descriptions. The UE shall ignore the rule defined in this field description if <i>freqBandIndicatorPriority</i> is present and supported by the UE.</p>
<p>multiBandInfoList-v10j0 A list of <i>additionalPmax</i> and <i>additionalSpectrumEmission</i> values, as defined in TS 36.101 [42, table 6.2.4-1] for UEs neither in CE nor BL UEs and TS 36.101 [42, table 6.2.4E-1] for UEs in CE or BL UEs, for the frequency bands in <i>multiBandInfoList</i> (i.e. without suffix) and <i>multiBandInfoList-v9e0</i>. If E-UTRAN includes <i>multiBandInfoList-v10j0</i>, it includes the same number of entries, and listed in the same order, as in <i>multiBandInfoList</i> (i.e. without suffix). If E-UTRAN includes <i>multiBandInfoList-v10l0</i> it includes the same number of entries, and listed in the same order, as in <i>multiBandInfoList-v10j0</i>.</p>
<p>plmn-IdentityList List of PLMN identities. The first listed <i>PLMN-Identity</i> is the primary PLMN. NOTE 2.</p>
<p>p-Max Value applicable for the cell. If absent the UE applies the maximum power according to its capability as specified in TS 36.101 [42, 6.2.2]. NOTE 2.</p>
<p>q-QualMin Parameter "Q_{qualmin}" in TS 36.304 [4]. If <i>cellSelectionInfo-v920</i> is not present, the UE applies the (default) value of negative infinity for Q_{qualmin}. NOTE 1.</p>
<p>q-QualMinRSRQ-OnAllSymbols If this field is present and supported by the UE, the UE shall, when performing RSRQ measurements, perform RSRQ measurement on all OFDM symbols in accordance with TS 36.214 [48]. NOTE 1.</p>
<p>q-QualMinOffset Parameter "Q_{qualminoffset}" in TS 36.304 [4]. Actual value Q_{qualminoffset} = field value [dB]. If <i>cellSelectionInfo-v920</i> is not present or the field is not present, the UE applies the (default) value of 0 dB for Q_{qualminoffset}. Affects the minimum required quality level in the cell.</p>
<p>q-QualMinWB If this field is present and supported by the UE, the UE shall, when performing RSRQ measurements, use a wider bandwidth in accordance with TS 36.133 [16]. NOTE 1.</p>
<p>q-RxLevMinOffset Parameter Q_{rxlevminoffset} in TS 36.304 [4]. Actual value Q_{rxlevminoffset} = field value * 2 [dB]. If absent, the UE applies the (default) value of 0 dB for Q_{rxlevminoffset}. Affects the minimum required Rx level in the cell.</p>
<p>sib-MappingInfo List of the SIBs mapped to this <i>SystemInformation</i> message. There is no mapping information of SIB2; it is always present in the first <i>SystemInformation</i> message listed in the <i>schedulingInfoList</i> list.</p>
<p>si-HoppingConfigCommon Frequency hopping activation/deactivation for BR versions of SI messages and MPDCCH/PDSCH of paging.</p>
<p>si-Narrowband This field indicates the index of a narrowband used to broadcast the SI message towards BL UEs and UEs in CE, see TS 36.211 [21, 6.4.1] and TS 36.213 [23, 7.1.6]. Field values (1..<i>maxAvailNarrowBands-r13</i>) correspond to narrowband indices (0..<i>maxAvailNarrowBands-r13-1</i>) as specified in TS 36.211 [21].</p>
<p>si-RepetitionPattern Indicates the radio frames within the SI window used for SI message transmission. Value <i>everyRF</i> corresponds to every radio frame, value <i>every2ndRF</i> corresponds to every 2 radio frames, and so on. The first transmission of the SI message is transmitted from the first radio frame of the SI window.</p>
<p>si-Periodicity Periodicity of the SI-message in radio frames, such that <i>rf8</i> denotes 8 radio frames, <i>rf16</i> denotes 16 radio frames, and so on.</p>
<p>si-TBS This field indicates the transport block size information used to broadcast the SI message towards BL UEs and UEs in CE, see TS 36.213 [23, Table 7.1.7.2.1-1] for a 6 PRB bandwidth and a QPSK modulation.</p>
<p>schedulingInfoList-BR Indicates additional scheduling information of SI messages for BL UEs and UEs in CE. It includes the same number of entries, and listed in the same order, as in <i>schedulingInfoList</i> (without suffix).</p>
<p>si-ValidityTime Indicates system information validity timer. If set to TRUE, the timer is set to 3h, otherwise the timer is set to 24h.</p>

SystemInformationBlockType1 field descriptions
<p>si-WindowLength, si-WindowLength-BR Common SI scheduling window for all SIs. Unit in milliseconds, where ms1 denotes 1 millisecond, ms2 denotes 2 milliseconds and so on. In case <i>si-WindowLength-BR-r13</i> is present and the UE is a BL UE or a UE in CE, the UE shall use <i>si-WindowLength-BR-r13</i> and ignore the original field <i>si-WindowLength</i> (without suffix). UEs other than BL UEs or UEs in CE shall ignore the extension field <i>si-WindowLength-BR-r13</i>.</p>
<p>startSymbolBR For BL UEs and UEs in CE, indicates the OFDM starting symbol for any MPDCCH, PDSCH scheduled on the same cell except the PDSCH carrying <i>SystemInformationBlockType1-BR</i>, see TS 36.213 [23]. Values 1, 2, and 3 are applicable for <i>dl-Bandwidth</i> greater than 10 resource blocks. Values 2, 3, and 4 are applicable otherwise.</p>
<p>systemInfoValueTagList Indicates SI message specific value tags for BL UEs and UEs in CE. It includes the same number of entries, and listed in the same order, as in <i>schedulingInfoList</i> (without suffix).</p>
<p>systemInfoValueTagSI SI message specific value tag as specified in clause 5.2.1.3. Common for all SIBs within the SI message other than MIB, SIB1, SIB10, SIB11, SIB12 and SIB14.</p>
<p>systemInfoValueTag Common for all SIBs other than MIB, MIB-MBMS, SIB1, SIB1-MBMS, SIB10, SIB11, SIB12 and SIB14. Change of MIB, MIB-MBMS, SIB1 and SIB1-MBMS is detected by acquisition of the corresponding message.</p>
<p>tdd-Config Specifies the TDD specific physical channel configurations. NOTE 2.</p>
<p>trackingAreaCode A <i>trackingAreaCode</i> that is common for all the PLMNs listed. NOTE2. NOTE 5.</p>

NOTE 1: The value the UE applies for parameter " Q_{qualmin} " in TS 36.304 [4] depends on the $q\text{-QualMin}$ fields signalled by E-UTRAN and supported by the UE. In case multiple candidate options are available, the UE shall select the highest priority candidate option according to the priority order indicated by the following table (top row is highest priority).

q-QualMinRSRQ-OnAllSymbols	q-QualMinWB	Value of parameter "Q_{qualmin}" in TS 36.304 [4]
Included	Included	$q\text{-QualMinRSRQ-OnAllSymbols} - (q\text{-QualMin} - q\text{-QualMinWB})$
Included	Not included	$q\text{-QualMinRSRQ-OnAllSymbols}$
Not included	Included	$q\text{-QualMinWB}$
Not included	Not included	$q\text{-QualMin}$

NOTE 2: E-UTRAN sets this field to the same value for all instances of SIB1 message that are broadcasted within the same cell.

NOTE 3: E-UTRAN configures this field only in the BR version of SIB1 message.

NOTE 4: E-UTRAN configures at most 6 PLMNs in total (i.e. across all the PLMN lists in SIB1).

NOTE 5: E-UTRAN configures only one value for this parameter per PLMN.

Conditional presence	Explanation
<i>BW-reduced</i>	The field is optional present, Need OR, if <i>schedulingInfoSIB1-BR</i> in MIB is set to a value greater than 0. Otherwise the field is not present.
<i>FBI-max</i>	The field is mandatory present if <i>freqBandIndicator</i> (i.e. without suffix) is set to <i>maxFBI</i> . Otherwise the field is not present.
<i>mFBI</i>	The field is optional present, Need OR, if <i>multiBandInfoList</i> is present. Otherwise the field is not present.
<i>mFBI-max</i>	The field is mandatory present if one or more entries in <i>multiBandInfoList</i> (i.e. without suffix, introduced in -v8h0) is set to <i>maxFBI</i> . Otherwise the field is not present.
<i>RSRQ</i>	The field is mandatory present if SIB3 is being broadcast and <i>threshServingLowQ</i> is present in SIB3; otherwise optionally present, Need OP.
<i>RSRQ2</i>	The field is mandatory present if <i>q-QualMinRSRQ-OnAllSymbols</i> is present in SIB3; otherwise it is not present and the UE shall delete any existing value for this field.
<i>Hopping</i>	The field is mandatory present if <i>si-HoppingConfigCommon</i> field is broadcasted and set to <i>on</i> . Otherwise the field is optionally present, need OP.
<i>QrxlevminCE1</i>	The field is optionally present, Need OR, if <i>q-RxLevMinCE1-r13</i> is set below -140 dBm. Otherwise the field is not present.
<i>TDD</i>	This field is mandatory present for TDD; it is not present for FDD and the UE shall delete any existing value for this field.
<i>TDD-OR</i>	The field is optional present for TDD, need OR; it is not present for FDD.
<i>WB-RSRQ</i>	The field is optionally present, need OP if the measurement bandwidth indicated by <i>allowedMeasBandwidth</i> in <i>systemInformationBlockType3</i> is 50 resource blocks or larger; otherwise it is not present.
<i>SI-BR</i>	The field is mandatory present if <i>schedulingInfoSIB1-BR</i> is included in MIB with a value greater than 0. Otherwise the field is not present.

– *SystemInformationBlockType1-MBMS*

SystemInformationBlockType1-MBMS contains information relevant for receiving service from MBMS-dedicated cell and defines the scheduling of other system information.

Signalling radio bearer: N/A

RLC-SAP: TM

Logical channels: BCCH

Direction: E-UTRAN to UE

SystemInformationBlockType1-MBMS message

```
-- ASN1START
SystemInformationBlockType1-MBMS-r14 ::= SEQUENCE {
    cellAccessRelatedInfo-r14 SEQUENCE {
        plmn-IdentityList-r14 PLMN-IdentityList-MBMS-r14,
        trackingAreaCode-r14 TrackingAreaCode,
        cellIdentity-r14 CellIdentity
    },
    freqBandIndicator-r14 FreqBandIndicator-r11,
    multiBandInfoList-r14 MultiBandInfoList-r11 OPTIONAL, -- Need OR
    schedulingInfoList-MBMS-r14 SchedulingInfoList-MBMS-r14,
    si-WindowLength-r14 ENUMERATED {
        ms1, ms2, ms5, ms10, ms15, ms20, ms40, ms80},
    systemInfoValueTag-r14 INTEGER (0..31),
    nonMBSFN-SubframeConfig-r14 NonMBSFN-SubframeConfig-r14 OPTIONAL, --Need OR
    pdsch-ConfigCommon-r14 PDSCH-ConfigCommon,
    systemInformationBlockType13-r14 SystemInformationBlockType13-r9 OPTIONAL, --Need OR
    cellAccessRelatedInfoList-r14 SEQUENCE (SIZE (1..maxPLMN-1-r14)) OF
        CellAccessRelatedInfo-r14 OPTIONAL, -- Need OR
    nonCriticalExtension SEQUENCE {} OPTIONAL
}

PLMN-IdentityList-MBMS-r14 ::= SEQUENCE (SIZE (1..maxPLMN-r11)) OF PLMN-Identity

SchedulingInfoList-MBMS-r14 ::= SEQUENCE (SIZE (1..maxSI-Message)) OF SchedulingInfo-MBMS-r14

SchedulingInfo-MBMS-r14 ::= SEQUENCE {
    si-Periodicity-r14 ENUMERATED {
```

```

        sib-MappingInfo-r14          rf16, rf32, rf64, rf128, rf256, rf512},
    }                               SIB-MappingInfo-MBMS-r14

SIB-MappingInfo-MBMS-r14 ::= SEQUENCE (SIZE (0..maxSIB-1)) OF SIB-Type-MBMS-r14

SIB-Type-MBMS-r14 ::=
    ENUMERATED {
        sibType10, sibType11, sibType12-v920, sibType13-v920,
        sibType15-v1130, sibType16-v1130, ...}

NonMBSFN-SubframeConfig-r14 ::=
    SEQUENCE {
        radioFrameAllocationPeriod-r14  ENUMERATED {rf4, rf8, rf16, rf32, rf64, rf128, rf512},
        radioFrameAllocationOffset-r14  INTEGER (0..7),
        subframeAllocation-r14          BIT STRING (SIZE(9))
    }

-- ASN1STOP

```

SystemInformationBlockType1-MBMS field descriptions
<p>cellAccessRelatedInfoList This field contains a list allowing signalling of access related information per PLMN. One PLMN can be included in only one entry of this list. NOTE 2.</p>
<p>cellIdentity Indicates the cell identity. NOTE 1.</p>
<p>freqBandIndicator A list of as defined in TS 36.101 [42, table 6.2.4-1] for the frequency band in <i>freqBandIndicator</i>.</p>
<p>multiBandInfoList A list of additional frequency band indicators, as defined in TS 36.101 [42, table 5.5-1] that the cell belongs to. If the UE supports the frequency band in the <i>freqBandIndicator</i> field it shall apply that frequency band. Otherwise, the UE shall apply the first listed band which it supports in the <i>multiBandInfoList</i> field.</p>
<p>nonMBSFN-SubframeConfig Defines the non-MBSFN subframes within the radio frame allocation period defined by the <i>radioFrameAllocationPeriod</i> and the <i>radioFrameAllocationOffset</i>.</p>
<p>plmn-IdentityList List of PLMN identities. The first listed <i>PLMN-Identity</i> is the primary PLMN. NOTE 1.</p>
<p>radioFrameAllocationPeriod, radioFrameAllocationOffset Radio-frames that contain non-MBSFN subframes occur when equation $SFN \bmod radioFrameAllocationPeriod = radioFrameAllocationOffset$ is satisfied. Value rf4 for <i>radioFrameAllocationPeriod</i> denotes 4 radio frames, rf8 denotes 8 radio frames, and so on.</p>
<p>schedulingInfoList-MBMS Indicates additional scheduling information of SI messages on MBMS-dedicated cell.</p>
<p>sib-MappingInfo List of the SIBs mapped to this <i>SystemInformation</i> message.</p>
<p>si-Periodicity Periodicity of the SI-message in radio frames, such that rf16 denotes 16 radio frames, rf32 denotes 32 radio frames, and so on.</p>
<p>si-WindowLength Common SI scheduling window for all SIs. Unit in milliseconds, where ms1 denotes 1 millisecond, ms2 denotes 2 milliseconds and so on.</p>
<p>subframeAllocation Defines the subframes that are allocated for non-MBSFN within the radio frame allocation period defined by the <i>radioFrameAllocationPeriod</i> and the <i>radioFrameAllocationOffset</i>. "0" denotes that the corresponding subframe is a MBSFN subframe. "1" denotes that the corresponding subframe is a non-MBSFN subframe. If E-UTRAN configures a value other than "0" for <i>additionalNonMBSFNSubframes</i> within <i>MasterInformationBlock-MBMS</i>, <i>subframeAllocation</i> configuration should also indicate subframes pointed out by <i>additionalNonMBSFNSubframes</i> as non-MBSFN subframes.</p>
<p>systemInformationBlockType13 E-UTRAN does not configure this field if <i>schedulingInfoList-MBMS</i> indicates that <i>SystemInformationBlockType13</i> is present.</p>
<p>systemInfoValueTag Common for all SIBs other than MIB, SIB1, SIB10, SIB11, SIB12 and SIB14. Change of MIB and SIB1 is detected by acquisition of the corresponding message.</p>
<p>trackingAreaCode A <i>trackingAreaCode</i> that is common for all the PLMNs listed. NOTE 1.</p>

NOTE 1: E-UTRAN sets this field to the same value for all instances of SIB1-MBMS message that are broadcasted within the same cell.

UEAssistanceInformation

The *UEAssistanceInformation* message is used for the indication of UE assistance information to the eNB.

Signalling radio bearer: SRB1

RLC-SAP: AM

Logical channel: DCCH

Direction: UE to E-UTRAN

UEAssistanceInformation message

```

-- ASN1START
UEAssistanceInformation-r11 ::= SEQUENCE {
    criticalExtensions          CHOICE {
        c1                     CHOICE {
            ueAssistanceInformation-r11 UEAssistanceInformation-r11-IEs,
            spare3 NULL, spare2 NULL, spare1 NULL
        },
        criticalExtensionsFuture SEQUENCE {}
    }
}

UEAssistanceInformation-r11-IEs ::= SEQUENCE {
    powerPrefIndication-r11    ENUMERATED {normal, lowPowerConsumption} OPTIONAL,
    lateNonCriticalExtension    OCTET STRING OPTIONAL,
    nonCriticalExtension        UEAssistanceInformation-v1430-IEs OPTIONAL
}

UEAssistanceInformation-v1430-IEs ::= SEQUENCE {
    bw-Preference-r14          BW-Preference-r14 OPTIONAL,
    sps-AssistanceInformation-r14 SEQUENCE {
        trafficPatternInfoListSL-r14 TrafficPatternInfoList-r14 OPTIONAL,
        trafficPatternInfoListUL-r14 TrafficPatternInfoList-r14 OPTIONAL
    } OPTIONAL,
    rlm-Report-r14            SEQUENCE {
        rlm-Event-r14          ENUMERATED {earlyOutOfSync, earlyInSync},
        excessRep-MPDCCH-r14   ENUMERATED {excessRep1, excessRep2} OPTIONAL
    } OPTIONAL,
    delayBudgetReport-r14     DelayBudgetReport-r14 OPTIONAL,
    nonCriticalExtension        UEAssistanceInformation-v1450-IEs OPTIONAL
}

UEAssistanceInformation-v1450-IEs ::= SEQUENCE {
    overheatingAssistance-r14 OverheatingAssistance-r14 OPTIONAL,
    nonCriticalExtension        SEQUENCE {} OPTIONAL
}

BW-Preference-r14 ::= SEQUENCE {
    dl-Preference-r14          ENUMERATED {mhz1dot4, mhz5, mhz20} OPTIONAL,
    ul-Preference-r14          ENUMERATED {mhz1dot4, mhz5} OPTIONAL
}

TrafficPatternInfoList-r14 ::= SEQUENCE (SIZE (1..maxTrafficPattern-r14)) OF TrafficPatternInfo-r14

TrafficPatternInfo-r14 ::= SEQUENCE {
    trafficPeriodicity-r14     ENUMERATED {
        sf20, sf50, sf100, sf200, sf300, sf400, sf500,
        sf600, sf700, sf800, sf900, sf1000},
    timingOffset-r14          INTEGER (0..10239),
    priorityInfoSL-r14        SL-Priority-r13 OPTIONAL,
    logicalChannelIdentityUL-r14 INTEGER (3..10) OPTIONAL,
    messageSize-r14          BIT STRING (SIZE (6))
}

DelayBudgetReport-r14 ::= CHOICE {
    type1                     ENUMERATED {
        msMinus1280, msMinus640, msMinus320, msMinus160,
        msMinus80, msMinus60, msMinus40, msMinus20, ms0, ms20,
        ms40, ms60, ms80, ms160, ms320, ms640, ms1280},
    type2                     ENUMERATED {

```



```
msMinus192, msMinus168, msMinus144, msMinus120,
msMinus96, msMinus72, msMinus48, msMinus24, ms0, ms24,
ms48, ms72, ms96, ms120, ms144, ms168, ms192}
}
OverheatingAssistance-r14 ::= SEQUENCE {
    reducedUE-Category          SEQUENCE {
        reducedUE-CategoryDL    INTEGER (0..19),
        reducedUE-CategoryUL    INTEGER (0..21)
    }
    OPTIONAL,
    reducedMaxCCs               SEQUENCE {
        reducedCCsDL            INTEGER (0..31),
        reducedCCsUL            INTEGER (0..31)
    }
    OPTIONAL
}
-- ASN1STOP
```

UEAssistanceInformation field descriptions
<p>delayBudgetReport Indicates the UE-preferred adjustment to connected mode DRX or coverage enhancement configuration.</p>
<p>dl-Preference Indicates UE's preference on configuration of maximum PDSCH bandwidth. The value mhz1dot4 corresponds to CE mode usage in 1.4MHz bandwidth, mhz5 corresponds to CE mode usage in 5MHz bandwidth, and mhz20 corresponds to CE mode usage in 20MHz bandwidth or normal coverage.</p>
<p>excessRep-MPDCCH Indicates the excess number of repetitions on MPDCCH. Value excessRep1 and excessRep2 indicate the excess number of repetitions defined in TS 36.133 [16].</p>
<p>logicalChannelIdentityUL Indicates the logical channel identity associated with the reported traffic pattern in the uplink logical channel.</p>
<p>messageSize Indicates the maximum TB size based on the observed traffic pattern. The value refers to the index of TS 36.321 [6, table 6.1.3.1-1].</p>
<p>powerPrefIndication Value <i>lowPowerConsumption</i> indicates the UE prefers a configuration that is primarily optimised for power saving. Otherwise the value is set to <i>normal</i>.</p>
<p>priorityInfoSL Indicates the traffic priority (i.e., PPPP) associated with the reported traffic pattern for V2X sidelink communication.</p>
<p>reducedCCsDL Indicates the UE's preference on reduced configuration corresponding to the maximum number of downlink SCells indicated by the field, to address overheating.</p>
<p>reducedCCsUL Indicates the UE's preference on reduced configuration corresponding to the maximum number of uplink SCells indicated by the field, to address overheating.</p>
<p>reducedUE-CategoryDL, reducedUE-CategoryUL Indicates that UE prefers a configuration corresponding to the reduced UE category, to address overheating. The reduced UE DL category and reduced UE UL category should be indicated according to supported combinations for UE UL and DL Categories, see TS 36.306 [5, Table 4.1A-6].</p>
<p>rlm-Event This field provides the RLM event ("early-out-of-sync" or "early-in-sync").</p>
<p>rlm-Report This field provides the RLM report for BL UEs and UEs in CE.</p>
<p>sps-AssistanceInformation Indicates the UE assistance information to assist E-UTRAN to configure SPS.</p>
<p>timingOffset This field indicates the estimated timing for a packet arrival in a SL/UL logical channel. Specifically, the value indicates the timing offset with respect to subframe#0 of SFN#0 in milliseconds.</p>
<p>trafficPatternInfoListSL This field provides the traffic characteristics of sidelink logical channel(s) that are setup for V2X sidelink communication.</p>
<p>trafficPatternInfoListUL This field provides the traffic characteristics of uplink logical channel(s).</p>
<p>trafficPeriodicity This field indicates the estimated data arrival periodicity in a SL/UL logical channel. Value sf20 corresponds to 20 ms, sf50 corresponds to 50 ms and so on.</p>
<p>type1 Indicates the preferred amount of increment/decrement to the connected mode DRX cycle length with respect to the current configuration. Value in number of milliseconds. Value ms40 corresponds to 40 milliseconds, msMinus40 corresponds to -40 milliseconds and so on.</p>
<p>type2 Indicates the preferred amount of increment/decrement to the coverage enhancement configuration with respect to the current configuration so that the Uu air interface delay changes by the indicated amount. Value in number of milliseconds. Value ms24 corresponds to 24 milliseconds, msMinus24 corresponds to -24 milliseconds and so on.</p>
<p>ul-Preference Indicates UE's preference on configuration of maximum PUSCH bandwidth. The value mhz1dot4 corresponds to CE mode usage in 1.4MHz bandwidth, and mhz5 corresponds to CE mode usage in 5MHz bandwidth.</p>

– **UECapabilityEnquiry**

The *UECapabilityEnquiry* message is used to request the transfer of UE radio access capabilities for E-UTRA as well as for other RATs.

Signalling radio bearer: SRB1

RLC-SAP: AM

Logical channel: DCCH

Direction: E-UTRAN to UE

UECapabilityEnquiry message

```

-- ASN1START
UECapabilityEnquiry ::= SEQUENCE {
    rrc-TransactionIdentifier RRC-TransactionIdentifier,
    criticalExtensions CHOICE {
        c1 CHOICE {
            ueCapabilityEnquiry-r8 UECapabilityEnquiry-r8-IEs,
            spare3 NULL, spare2 NULL, spare1 NULL
        },
        criticalExtensionsFuture SEQUENCE {}
    }
}

UECapabilityEnquiry-r8-IEs ::= SEQUENCE {
    ue-CapabilityRequest UE-CapabilityRequest,
    nonCriticalExtension UECapabilityEnquiry-v8a0-IEs OPTIONAL
}

UECapabilityEnquiry-v8a0-IEs ::= SEQUENCE {
    lateNonCriticalExtension OCTET STRING OPTIONAL,
    nonCriticalExtension UECapabilityEnquiry-v1180-IEs OPTIONAL
}

UECapabilityEnquiry-v1180-IEs ::= SEQUENCE {
    requestedFrequencyBands-r11 SEQUENCE (SIZE (1..16)) OF FreqBandIndicator-r11 OPTIONAL,
    nonCriticalExtension UECapabilityEnquiry-v1310-IEs OPTIONAL
}

UECapabilityEnquiry-v1310-IEs ::= SEQUENCE {
    requestReducedFormat-r13 ENUMERATED {true} OPTIONAL, -- Need ON
    requestSkipFallbackComb-r13 ENUMERATED {true} OPTIONAL, -- Need ON
    requestedMaxCCsDL-r13 INTEGER (2..32) OPTIONAL, -- Need ON
    requestedMaxCCsUL-r13 INTEGER (2..32) OPTIONAL, -- Need ON
    requestReducedIntNonContComb-r13 ENUMERATED {true} OPTIONAL, -- Need ON
    nonCriticalExtension UECapabilityEnquiry-v1430-IEs OPTIONAL
}

UECapabilityEnquiry-v1430-IEs ::= SEQUENCE {
    requestDiffFallbackCombList-r14 BandCombinationList-r14 OPTIONAL, -- Need ON
    nonCriticalExtension SEQUENCE {} OPTIONAL
}

UE-CapabilityRequest ::= SEQUENCE (SIZE (1..maxRAT-Capabilities)) OF RAT-Type
-- ASN1STOP

```

UECapabilityEnquiry field descriptions
<p>requestDiffFallbackCombList List of CA band combinations for which the UE is requested to provide different capabilities for their fallback band combinations in conjunction with the capabilities supported for the CA band combinations in this list. The UE shall exclude fallback band combinations for which their supported UE capabilities are the same as the CA band combination indicated in this list.</p>
<p>requestReducedFormat Indicates that the UE if supported is requested to provide supported CA band combinations in the <i>supportedBandCombinationReduced-r13</i> instead of the <i>supportedBandCombination-r10</i>. The E-UTRAN includes this field if <i>requestSkipFallbackComb</i> or <i>requestDiffFallbackCombList</i> is included in the message.</p>
<p>requestSkipFallbackComb Indicates that the UE shall explicitly exclude fallback CA band combinations in capability signalling.</p>
<p>ue-CapabilityRequest List of the RATs for which the UE is requested to transfer the UE radio access capabilities i.e. E-UTRA, UTRA, GERAN-CS, GERAN-PS, CDMA2000.</p>
<p>requestedFrequencyBands List of frequency bands for which the UE is requested to provide supported CA band combinations and non CA bands.</p>
<p>requestedMaxCCsDL, requestedMaxCCsUL Indicates the maximum number of CCs for which the UE is requested to provide supported CA band combinations and non-CA bands.</p>
<p>requestReducedIntNonContComb Indicates that the UE shall explicitly exclude supported intra-band non-contiguous CA band combinations other than included in capability signalling as specified in TS 36.306 [5, 4.3.5.21].</p>

– UECapabilityInformation

The *UECapabilityInformation* message is used to transfer of UE radio access capabilities requested by the E-UTRAN.

Signalling radio bearer: SRB1

RLC-SAP: AM

Logical channel: DCCH

Direction: UE to E-UTRAN

UECapabilityInformation message

```

-- ASN1START
UECapabilityInformation ::= SEQUENCE {
    rrc-TransactionIdentifier RRC-TransactionIdentifier,
    criticalExtensions CHOICE {
        c1 CHOICE {
            ueCapabilityInformation-r8 UECapabilityInformation-r8-IEs,
            spare7 NULL,
            spare6 NULL, spare5 NULL, spare4 NULL,
            spare3 NULL, spare2 NULL, spare1 NULL
        },
        criticalExtensionsFuture SEQUENCE {}
    }
}

UECapabilityInformation-r8-IEs ::= SEQUENCE {
    ue-CapabilityRAT-ContainerList UE-CapabilityRAT-ContainerList,
    nonCriticalExtension UECapabilityInformation-v8a0-IEs OPTIONAL
}

UECapabilityInformation-v8a0-IEs ::= SEQUENCE {
    lateNonCriticalExtension OCTET STRING OPTIONAL,
    nonCriticalExtension UECapabilityInformation-v1250-IEs OPTIONAL
}

UECapabilityInformation-v1250-IEs ::= SEQUENCE {
    ue-RadioPagingInfo-r12 UE-RadioPagingInfo-r12 OPTIONAL,
    nonCriticalExtension SEQUENCE {} OPTIONAL
}
-- ASN1STOP

```

UECapabilityInformation field descriptions**ue-RadioPagingInfo**

This field contains UE capability information used for paging.

UEInformationRequest

The *UEInformationRequest* is the command used by E-UTRAN to retrieve information from the UE.

Signalling radio bearer: SRB1

RLC-SAP: AM

Logical channel: DCCH

Direction: E-UTRAN to UE

UEInformationRequest message

```
-- ASN1START
UEInformationRequest-r9 ::= SEQUENCE {
  rrc-TransactionIdentifier RRC-TransactionIdentifier,
  criticalExtensions CHOICE {
    c1 CHOICE {
      ueInformationRequest-r9 UEInformationRequest-r9-IEs,
      spare3 NULL, spare2 NULL, spare1 NULL
    },
    criticalExtensionsFuture SEQUENCE {}
  }
}

UEInformationRequest-r9-IEs ::= SEQUENCE {
  rach-ReportReq-r9 BOOLEAN,
  rlf-ReportReq-r9 BOOLEAN,
  nonCriticalExtension UEInformationRequest-v930-IEs OPTIONAL
}

UEInformationRequest-v930-IEs ::= SEQUENCE {
  lateNonCriticalExtension OCTET STRING OPTIONAL,
  nonCriticalExtension UEInformationRequest-v1020-IEs OPTIONAL
}

UEInformationRequest-v1020-IEs ::= SEQUENCE {
  logMeasReportReq-r10 ENUMERATED {true} OPTIONAL, -- Need ON
  nonCriticalExtension UEInformationRequest-v1130-IEs OPTIONAL
}

UEInformationRequest-v1130-IEs ::= SEQUENCE {
  connEstFailReportReq-r11 ENUMERATED {true} OPTIONAL, -- Need ON
  nonCriticalExtension UEInformationRequest-v1250-IEs OPTIONAL
}

UEInformationRequest-v1250-IEs ::= SEQUENCE {
  mobilityHistoryReportReq-r12 ENUMERATED {true} OPTIONAL, -- Need ON
  nonCriticalExtension SEQUENCE {} OPTIONAL
}
-- ASN1STOP
```

UEInformationRequest field descriptions**rach-ReportReq**

This field is used to indicate whether the UE shall report information about the random access procedure.

UEInformationResponse

The *UEInformationResponse* message is used by the UE to transfer the information requested by the E-UTRAN.

Signalling radio bearer: SRB1 or SRB2 (when logged measurement information is included)

RLC-SAP: AM

Logical channel: DCCH

Direction: UE to E-UTRAN

UEInformationResponse message

```

-- ASN1START
UEInformationResponse-r9 ::= SEQUENCE {
    rrc-TransactionIdentifier RRC-TransactionIdentifier,
    criticalExtensions CHOICE {
        cl CHOICE {
            ueInformationResponse-r9 UEInformationResponse-r9-IEs,
            spare3 NULL, spare2 NULL, spare1 NULL
        },
        criticalExtensionsFuture SEQUENCE {}
    }
}

UEInformationResponse-r9-IEs ::= SEQUENCE {
    rach-Report-r9 SEQUENCE {
        numberOfPreamblesSent-r9 NumberOfPreamblesSent-r11,
        contentionDetected-r9 BOOLEAN
    },
    rlf-Report-r9 RLF-Report-r9 OPTIONAL,
    nonCriticalExtension UEInformationResponse-v930-IEs OPTIONAL
}

-- Late non critical extensions
UEInformationResponse-v9e0-IEs ::= SEQUENCE {
    rlf-Report-v9e0 RLF-Report-v9e0 OPTIONAL,
    nonCriticalExtension SEQUENCE {} OPTIONAL
}

-- Regular non critical extensions
UEInformationResponse-v930-IEs ::= SEQUENCE {
    lateNonCriticalExtension OCTET STRING (CONTAINING UEInformationResponse-v9e0-IEs) OPTIONAL,
    nonCriticalExtension UEInformationResponse-v1020-IEs OPTIONAL
}

UEInformationResponse-v1020-IEs ::= SEQUENCE {
    logMeasReport-r10 LogMeasReport-r10 OPTIONAL,
    nonCriticalExtension UEInformationResponse-v1130-IEs OPTIONAL
}

UEInformationResponse-v1130-IEs ::= SEQUENCE {
    connEstFailReport-r11 ConnEstFailReport-r11 OPTIONAL,
    nonCriticalExtension UEInformationResponse-v1250-IEs OPTIONAL
}

UEInformationResponse-v1250-IEs ::= SEQUENCE {
    mobilityHistoryReport-r12 MobilityHistoryReport-r12 OPTIONAL,
    nonCriticalExtension SEQUENCE {} OPTIONAL
}

RLF-Report-r9 ::= SEQUENCE {
    measResultLastServCell-r9 SEQUENCE {
        rsrpResult-r9 RSRP-Range,
        rsrqResult-r9 RSRQ-Range OPTIONAL
    },
    measResultNeighCells-r9 SEQUENCE {
        measResultListEUTRA-r9 MeasResultList2EUTRA-r9 OPTIONAL,
        measResultListUTRA-r9 MeasResultList2UTRA-r9 OPTIONAL,
        measResultListGERAN-r9 MeasResultListGERAN OPTIONAL,
        measResultsCDMA2000-r9 MeasResultList2CDMA2000-r9 OPTIONAL
    } OPTIONAL,
    ...
    [[ locationInfo-r10 LocationInfo-r10 OPTIONAL,
        failedPCellId-r10 CHOICE {
            cellGlobalId-r10 CellGlobalIdEUTRA,
            pci-arfcn-r10 SEQUENCE {
                physCellId-r10 PhysCellId,
                carrierFreq-r10 ARFCN-ValueEUTRA
            }
        }
    ] ]
}

```

```

    }
    reestablishmentCellId-r10      CellGlobalIdEUTRA      OPTIONAL,
    timeConnFailure-r10           INTEGER (0..1023)      OPTIONAL,
    connectionFailureType-r10     ENUMERATED {rlf, hof}  OPTIONAL,
    previousPCellId-r10          CellGlobalIdEUTRA      OPTIONAL
  ]],
  [[ failedPCellId-v1090         SEQUENCE {
      carrierFreq-v1090          ARFCN-ValueEUTRA-v9e0
    }
  ]],
  [[ basicFields-r11             SEQUENCE {
      c-RNTI-r11                 C-RNTI,
      rlf-Cause-r11              ENUMERATED {
          t310-Expiry, randomAccessProblem,
          rlc-MaxNumRetx, t312-Expiry-r12},
      timeSinceFailure-r11      TimeSinceFailure-r11
    }
  ]],
  previousUTRA-CellId-r11        SEQUENCE {
    carrierFreq-r11             ARFCN-ValueUTRA,
    physCellId-r11             CHOICE {
      fdd-r11                   PhysCellIdUTRA-FDD,
      tdd-r11                   PhysCellIdUTRA-TDD
    },
    cellGlobalId-r11           CellGlobalIdUTRA      OPTIONAL,
  }
  selectedUTRA-CellId-r11        SEQUENCE {
    carrierFreq-r11             ARFCN-ValueUTRA,
    physCellId-r11             CHOICE {
      fdd-r11                   PhysCellIdUTRA-FDD,
      tdd-r11                   PhysCellIdUTRA-TDD
    }
  }
  ]],
  [[ failedPCellId-v1250         SEQUENCE {
      tac-FailedPCell-r12       TrackingAreaCode
    }
  ]],
  measResultLastServCell-v1250   RSRQ-Range-v1250      OPTIONAL,
  lastServCellRSRQ-Type-r12      RSRQ-Type-r12        OPTIONAL,
  measResultListEUTRA-v1250     MeasResultList2EUTRA-v1250  OPTIONAL
  ]],
  [[ drb-EstablishedWithQCI-1-r13  ENUMERATED {qci1}    OPTIONAL
  ]],
  [[ measResultLastServCell-v1360   RSRP-Range-v1360    OPTIONAL
  ]]
}

RLF-Report-v9e0 ::= SEQUENCE {
  measResultListEUTRA-v9e0 MeasResultList2EUTRA-v9e0
}

MeasResultList2EUTRA-r9 ::= SEQUENCE (SIZE (1..maxFreq)) OF MeasResult2EUTRA-r9

MeasResultList2EUTRA-v9e0 ::= SEQUENCE (SIZE (1..maxFreq)) OF MeasResult2EUTRA-v9e0

MeasResultList2EUTRA-v1250 ::= SEQUENCE (SIZE (1..maxFreq)) OF MeasResult2EUTRA-v1250

MeasResult2EUTRA-r9 ::= SEQUENCE {
  carrierFreq-r9 ARFCN-ValueEUTRA,
  measResultList-r9 MeasResultListEUTRA
}

MeasResult2EUTRA-v9e0 ::= SEQUENCE {
  carrierFreq-v9e0 ARFCN-ValueEUTRA-v9e0 OPTIONAL
}

MeasResult2EUTRA-v1250 ::= SEQUENCE {
  rsrq-Type-r12 RSRQ-Type-r12 OPTIONAL
}

MeasResultList2UTRA-r9 ::= SEQUENCE (SIZE (1..maxFreq)) OF MeasResult2UTRA-r9

MeasResult2UTRA-r9 ::= SEQUENCE {
  carrierFreq-r9 ARFCN-ValueUTRA,
  measResultList-r9 MeasResultListUTRA
}

MeasResultList2CDMA2000-r9 ::= SEQUENCE (SIZE (1..maxFreq)) OF MeasResult2CDMA2000-r9

```

```

MeasResult2CDMA2000-r9 ::= SEQUENCE {
    carrierFreq-r9          CarrierFreqCDMA2000,
    measResultList-r9      MeasResultsCDMA2000
}

LogMeasReport-r10 ::= SEQUENCE {
    absoluteTimeStamp-r10  AbsoluteTimeInfo-r10,
    traceReference-r10     TraceReference-r10,
    traceRecordingSessionRef-r10 OCTET STRING (SIZE (2)),
    tce-Id-r10             OCTET STRING (SIZE (1)),
    logMeasInfoList-r10   LogMeasInfoList-r10,
    logMeasAvailable-r10  ENUMERATED {true} OPTIONAL,
    ...
}

LogMeasInfoList-r10 ::= SEQUENCE (SIZE (1..maxLogMeasReport-r10)) OF LogMeasInfo-r10

LogMeasInfo-r10 ::= SEQUENCE {
    locationInfo-r10      LocationInfo-r10 OPTIONAL,
    relativeTimeStamp-r10 INTEGER (0..7200),
    servCellIdentity-r10 CellGlobalIdEUTRA,
    measResultServCell-r10 SEQUENCE {
        rsrpResult-r10    RSRP-Range,
        rsrqResult-r10    RSRQ-Range
    },
    measResultNeighCells-r10 SEQUENCE {
        measResultListEUTRA-r10 MeasResultList2EUTRA-r9 OPTIONAL,
        measResultListUTRA-r10  MeasResultList2UTRA-r9 OPTIONAL,
        measResultListGERAN-r10 MeasResultList2GERAN-r10 OPTIONAL,
        measResultListCDMA2000-r10 MeasResultList2CDMA2000-r9 OPTIONAL
    } OPTIONAL,
    ...,
    [[ measResultListEUTRA-v1090 MeasResultList2EUTRA-v9e0 OPTIONAL
    ]],
    [[ measResultListMBSFN-r12 MeasResultListMBSFN-r12 OPTIONAL,
        measResultServCell-v1250 RSRQ-Range-v1250 OPTIONAL,
        servCellRSRQ-Type-r12 RSRQ-Type-r12 OPTIONAL,
        measResultListEUTRA-v1250 MeasResultList2EUTRA-v1250 OPTIONAL
    ]],
    [[ inDeviceCoexDetected-r13 ENUMERATED {true} OPTIONAL
    ]],
    [[ measResultServCell-v1360 RSRP-Range-v1360 OPTIONAL
    ]]
}

MeasResultListMBSFN-r12 ::= SEQUENCE (SIZE (1..maxMBSFN-Area)) OF MeasResultMBSFN-r12

MeasResultMBSFN-r12 ::= SEQUENCE {
    mbsfn-Area-r12 SEQUENCE {
        mbsfn-AreaId-r12 MBSFN-AreaId-r12,
        carrierFreq-r12 ARFCN-ValueEUTRA-r9
    },
    rsrpResultMBSFN-r12 RSRP-Range,
    rsrqResultMBSFN-r12 MBSFN-RSRQ-Range-r12,
    signallingBLER-Result-r12 BLER-Result-r12 OPTIONAL,
    dataBLER-MCH-ResultList-r12 DataBLER-MCH-ResultList-r12 OPTIONAL,
    ...
}

DataBLER-MCH-ResultList-r12 ::= SEQUENCE (SIZE (1..maxPMCH-PerMBSFN)) OF DataBLER-MCH-Result-r12

DataBLER-MCH-Result-r12 ::= SEQUENCE {
    mch-Index-r12 INTEGER (1..maxPMCH-PerMBSFN),
    dataBLER-Result-r12 BLER-Result-r12
}

BLER-Result-r12 ::= SEQUENCE {
    bler-r12 BLER-Range-r12,
    blocksReceived-r12 SEQUENCE {
        n-r12 BIT STRING (SIZE (3)),
        m-r12 BIT STRING (SIZE (8))
    }
}

BLER-Range-r12 ::= INTEGER(0..31)

MeasResultList2GERAN-r10 ::= SEQUENCE (SIZE (1..maxCellListGERAN)) OF MeasResultListGERAN

```



```

ConnEstFailReport-r11 ::=
  failedCellId-r11
  locationInfo-r11
  measResultFailedCell-r11
    rsrpResult-r11
    rsrqResult-r11
  },
  measResultNeighCells-r11
    measResultListEUTRA-r11
    measResultListUTRA-r11
    measResultListGERAN-r11
    measResultsCDMA2000-r11
  } OPTIONAL,
  numberOfPreamblesSent-r11
  contentionDetected-r11
  maxTxPowerReached-r11
  timeSinceFailure-r11
  measResultListEUTRA-v1130
  . . .
  [[ measResultFailedCell-v1250
    failedCellRSRQ-Type-r12
    measResultListEUTRA-v1250
  ]],
  [[ measResultFailedCell-v1360
  ]],
}

NumberOfPreamblesSent-r11 ::=
  INTEGER (1..200)

TimeSinceFailure-r11 ::=
  INTEGER (0..172800)

MobilityHistoryReport-r12 ::=
  VisitedCellInfoList-r12

-- ASN1STOP

```

UEInformationResponse field descriptions
<p>absoluteTimeStamp Indicates the absolute time when the logged measurement configuration logging is provided, as indicated by E-UTRAN within <i>absoluteTimeInfo</i>.</p>
<p>bler Indicates the measured BLER value. The coding of BLER value is defined in TS 36.133 [16].</p>
<p>blocksReceived Indicates total number of MCH blocks, which were received by the UE and used for the corresponding BLER calculation, within the measurement period as defined in TS 36.133 [16].</p>
<p>carrierFreq In case the UE includes <i>carrierFreq-v9e0</i> and/ or <i>carrierFreq-v1090</i>, the UE shall set the corresponding entry of <i>carrierFreq-r9</i> and/ or <i>carrierFreq-r10</i> respectively to <i>maxEARFCN</i>. For E-UTRA and UTRA frequencies, the UE sets the ARFCN according to the band used when obtaining the concerned measurement results.</p>
<p>connectionFailureType This field is used to indicate whether the connection failure is due to radio link failure or handover failure.</p>
<p>contentionDetected This field is used to indicate that contention was detected for at least one of the transmitted preambles, see TS 36.321 [6].</p>
<p>c-RNTI This field indicates the C-RNTI used in the PCell upon detecting radio link failure or the C-RNTI used in the source PCell upon handover failure.</p>
<p>dataBLER-MCH-ResultList Includes a BLER result per MCH on subframes using <i>dataMCS</i>, with the applicable MCH(s) listed in the same order as in <i>pmch-InfoList</i> within <i>MBSFNAreaConfiguration</i>.</p>
<p>drb-EstablishedWithQCI-1 This field is used to indicate the radio link failure occurred while a bearer with QCI value equal to 1 was configured, see TS 24.301 [35].</p>
<p>failedCellId This field is used to indicate the cell in which connection establishment failed.</p>
<p>failedPCellId This field is used to indicate the PCell in which RLF is detected or the target PCell of the failed handover. The UE sets the EARFCN according to the band used for transmission/ reception when the failure occurred.</p>
<p>inDeviceCoexDetected Indicates that measurement logging is suspended due to IDC problem detection.</p>
<p>maxTxPowerReached This field is used to indicate whether or not the maximum power level was used for the last transmitted preamble, see TS 36.321 [6].</p>
<p>mch-Index Indicates the MCH by referring to the entry as listed in <i>pmch-InfoList</i> within <i>MBSFNAreaConfiguration</i>.</p>
<p>measResultFailedCell This field refers to the last measurement results taken in the cell, where connection establishment failure happened. For UE supporting CE Mode B, when CE mode B is not restricted by upper layers, <i>measResultFailedCell-v1360</i> is reported if the measured RSRP is less than -140 dBm.</p>
<p>measResultLastServCell This field refers to the last measurement results taken in the PCell, where radio link failure or handover failure happened. For BL UEs or UEs in CE, when operating in CE Mode B, <i>measResultLastServCell-v1360</i> is reported if the measured RSRP is less than -140 dBm.</p>
<p>measResultListEUTRA If <i>measResultListEUTRA-v9e0</i>, <i>measResultListEUTRA-v1090</i> or <i>measResultListEUTRA-v1130</i> is included, the UE shall include the same number of entries, and listed in the same order, as in <i>measResultListEUTRA-r9</i>, <i>measResultListEUTRA-r10</i> and/ or <i>measResultListEUTRA-r11</i> respectively.</p>
<p>measResultListEUTRA-v1250 If included in <i>RLF-Report-r9</i> the UE shall include the same number of entries, and listed in the same order, as in <i>measResultListEUTRA-r9</i>; If included in <i>LogMeasInfo-r10</i> the UE shall include the same number of entries, and listed in the same order, as in <i>measResultListEUTRA-r10</i>; If included in <i>ConnEstFailReport-r11</i> the UE shall include the same number of entries, and listed in the same order, as in <i>measResultListEUTRA-r11</i>;</p>
<p>measResultServCell This field refers to the log measurement results taken in the Serving cell. For UE supporting CE Mode B, when CE mode B is not restricted by upper layers, <i>measResultServCell-v1360</i> is reported if the measured RSRP is less than -140 dBm.</p>
<p>mobilityHistoryReport This field is used to indicate the time of stay in 16 most recently visited E-UTRA cells or of stay out of E-UTRA.</p>
<p>numberOfPreamblesSent This field is used to indicate the number of RACH preambles that were transmitted. Corresponds to parameter <i>PREAMBLE_TRANSMISSION_COUNTER</i> in TS 36.321 [6].</p>

UEInformationResponse field descriptions
<p>previousPCellId This field is used to indicate the source PCell of the last handover (source PCell when the last <i>RRC-Connection-Reconfiguration</i> message including <i>mobilityControlInfo</i> was received).</p>
<p>previousUTRA-CellId This field is used to indicate the source UTRA cell of the last successful handover to E-UTRAN, when RLF occurred at the target PCell. The UE sets the ARFCN according to the band used for transmission/ reception on the concerned cell.</p>
<p>reestablishmentCellId This field is used to indicate the cell in which the re-establishment attempt was made after connection failure.</p>
<p>relativeTimeStamp Indicates the time of logging measurement results, measured relative to the <i>absoluteTimeStamp</i>. Value in seconds.</p>
<p>rlf-Cause This field is used to indicate the cause of the last radio link failure that was detected. In case of handover failure information reporting (i.e., the <i>connectionFailureType</i> is set to <i>'hof'</i>), the UE is allowed to set this field to any value.</p>
<p>selectedUTRA-CellId This field is used to indicate the UTRA cell that the UE selects after RLF is detected, while T311 is running. The UE sets the ARFCN according to the band selected for transmission/ reception on the concerned cell.</p>
<p>signallingBLER-Result Includes a BLER result of MBSFN subframes using <i>signallingMCS</i>.</p>
<p>tac-FailedPCell This field is used to indicate the Tracking Area Code of the PCell in which RLF is detected.</p>
<p>tce-Id Parameter Trace Collection Entity Id: See TS 32.422 [58].</p>
<p>timeConnFailure This field is used to indicate the time elapsed since the last HO initialization until connection failure. Actual value = field value * 100ms. The maximum value 1023 means 102.3s or longer.</p>
<p>timeSinceFailure This field is used to indicate the time that elapsed since the connection (establishment) failure. Value in seconds. The maximum value 172800 means 172800s or longer.</p>
<p>traceRecordingSessionRef Parameter Trace Recording Session Reference: See TS 32.422 [58].</p>

– *ULHandoverPreparationTransfer (CDMA2000)*

The *ULHandoverPreparationTransfer* message is used for the uplink transfer of handover related CDMA2000 information when requested by the higher layers.

Signalling radio bearer: SRB1

RLC-SAP: AM

Logical channel: DCCH

Direction: UE to E-UTRAN

ULHandoverPreparationTransfer message

```
-- ASN1START
ULHandoverPreparationTransfer ::= SEQUENCE {
    criticalExtensions          CHOICE {
        c1                      CHOICE {
            ulHandoverPreparationTransfer-r8          ULHandoverPreparationTransfer-r8-IEs,
            spare3 NULL, spare2 NULL, spare1 NULL
        },
        criticalExtensionsFuture          SEQUENCE {}
    }
}

ULHandoverPreparationTransfer-r8-IEs ::= SEQUENCE {
    cdma2000-Type          CDMA2000-Type,
    meid                   BIT STRING (SIZE (56)) OPTIONAL,
    dedicatedInfo          DedicatedInfoCDMA2000,
    nonCriticalExtension    ULHandoverPreparationTransfer-v8a0-IEs OPTIONAL
}

ULHandoverPreparationTransfer-v8a0-IEs ::= SEQUENCE {
```

```

    lateNonCriticalExtension      OCTET STRING          OPTIONAL,
    nonCriticalExtension          SEQUENCE {}              OPTIONAL
}
-- ASN1STOP

```

***ULHandoverPreparationTransfer* field descriptions**

meid

The 56 bit mobile identification number provided by the CDMA2000 Upper layers.

– ***ULInformationTransfer***

The *ULInformationTransfer* message is used for the uplink transfer of NAS or non-3GPP dedicated information.

Signalling radio bearer: SRB2 or SRB1 (only if SRB2 not established yet). If SRB2 is suspended, the UE does not send this message until SRB2 is resumed

RLC-SAP: AM

Logical channel: DCCH

Direction: UE to E-UTRAN

***ULInformationTransfer* message**

```

-- ASN1START
ULInformationTransfer ::= SEQUENCE {
    criticalExtensions          CHOICE {
        c1                     CHOICE {
            ulInformationTransfer-r8          ULInformationTransfer-r8-IEs,
            spare3 NULL, spare2 NULL, spare1 NULL
        },
        criticalExtensionsFuture          SEQUENCE {}
    }
}

ULInformationTransfer-r8-IEs ::= SEQUENCE {
    dedicatedInfoType          CHOICE {
        dedicatedInfoNAS          DedicatedInfoNAS,
        dedicatedInfoCDMA2000-1XRTT          DedicatedInfoCDMA2000,
        dedicatedInfoCDMA2000-HRPD          DedicatedInfoCDMA2000
    },
    nonCriticalExtension          ULInformationTransfer-v8a0-IEs
    OPTIONAL
}

ULInformationTransfer-v8a0-IEs ::= SEQUENCE {
    lateNonCriticalExtension      OCTET STRING          OPTIONAL,
    nonCriticalExtension          SEQUENCE {}              OPTIONAL
}
-- ASN1STOP

```

– ***WLANConnectionStatusReport***

The *WLANConnectionStatusReport* message is used to inform the successful connection to WLAN or failure of the WLAN connection or connection attempt(s).

Signalling radio bearer: SRB1

RLC-SAP: AM

Logical channel: DCCH

Direction: UE to E-UTRAN

WLANConnectionStatusReport message

```
-- ASN1START
WLANConnectionStatusReport-r13 ::= SEQUENCE {
    criticalExtensions          CHOICE {
        c1                     CHOICE {
            wlanConnectionStatusReport-r13 WLANConnectionStatusReport-r13-IEs,
            spare3 NULL, spare2 NULL, spare1 NULL
        },
        criticalExtensionsFuture SEQUENCE {}
    }
}

WLANConnectionStatusReport-r13-IEs ::= SEQUENCE {
    wlan-Status-r13           WLAN-Status-r13,
    lateNonCriticalExtension  OCTET STRING OPTIONAL,
    nonCriticalExtension      WLANConnectionStatusReport-v1430-IEs OPTIONAL
}

WLANConnectionStatusReport-v1430-IEs ::= SEQUENCE {
    wlan-Status-v1430        WLAN-Status-v1430,
    nonCriticalExtension      SEQUENCE {} OPTIONAL
}
-- ASN1STOP
```

WLANConnectionStatusReport field descriptions

wlan-Status

Indicates the connection status to WLAN and the cause of failures. If the *wlan-Status-v1430* is included, E-UTRAN ignores the *wlan-Status-r13*.

6.3 RRC information elements

6.3.1 System information blocks

– *SystemInformationBlockType2*

The IE *SystemInformationBlockType2* contains radio resource configuration information that is common for all UEs.

NOTE: UE timers and constants related to functionality for which parameters are provided in another SIB are included in the corresponding SIB.

SystemInformationBlockType2 information element

```
-- ASN1START
SystemInformationBlockType2 ::= SEQUENCE {
    ac-BarringInfo          SEQUENCE {
        ac-BarringForEmergency    BOOLEAN,
        ac-BarringForMO-Signalling AC-BarringConfig OPTIONAL, -- Need OP
        ac-BarringForMO-Data      AC-BarringConfig OPTIONAL, -- Need OP
    }
    radioResourceConfigCommon RadioResourceConfigCommonSIB,
    ue-TimersAndConstants     UE-TimersAndConstants,
    freqInfo                  SEQUENCE {
        ul-CarrierFreq            ARFCN-ValueEUTRA OPTIONAL, -- Need OP
        ul-Bandwidth              ENUMERATED {n6, n15, n25, n50, n75, n100}
                                   OPTIONAL, -- Need OP
    }
}
-- ASN1STOP
```

```

        additionalSpectrumEmission          AdditionalSpectrumEmission
    },
    mbsfn-SubframeConfigList                MBSFN-SubframeConfigList          OPTIONAL,  -- Need OR
    timeAlignmentTimerCommon                TimeAlignmentTimer,
    . . . ,
    lateNonCriticalExtension                OCTET STRING (CONTAINING SystemInformationBlockType2-v8h0-IEs)
        OPTIONAL,
    [[ ssac-BarringForMMTEL-Voice-r9        AC-BarringConfig                  OPTIONAL,  -- Need OP
      ssac-BarringForMMTEL-Video-r9        AC-BarringConfig                  OPTIONAL   -- Need OP
    ]],
    [[ ac-BarringForCSFB-r10                AC-BarringConfig                  OPTIONAL   -- Need OP
    ]],
    [[ ac-BarringSkipForMMTELVoice-r12      ENUMERATED {true}                 OPTIONAL,  -- Need OP
      ac-BarringSkipForMMTELVideo-r12     ENUMERATED {true}                 OPTIONAL,  -- Need OP
      ac-BarringSkipForSMS-r12            ENUMERATED {true}                 OPTIONAL,  -- Need OP
      ac-BarringPerPLMN-List-r12          AC-BarringPerPLMN-List-r12       OPTIONAL   -- Need OP
    ]],
    [[ voiceServiceCauseIndication-r12     ENUMERATED {true}                 OPTIONAL   -- Need OP
    ]],
    [[ acdc-BarringForCommon-r13            ACDC-BarringForCommon-r13         OPTIONAL,  -- Need OP
      acdc-BarringPerPLMN-List-r13        ACDC-BarringPerPLMN-List-r13     OPTIONAL   -- Need OP
    ]],
    [[
      udt-RestrictingForCommon-r13         UDT-Restricting-r13               OPTIONAL,  -- Need OR
      udt-RestrictingPerPLMN-List-r13     UDT-RestrictingPerPLMN-List-r13  OPTIONAL,  -- Need OR
      cIoT-EPS-OptimisationInfo-r13       CIOT-EPS-OptimisationInfo-r13    OPTIONAL,  -- Need OP
      useFullResumeID-r13                 ENUMERATED {true}                 OPTIONAL   -- Need OP
    ]],
    [[ unicastFreqHoppingInd-r13           ENUMERATED {true}                 OPTIONAL   -- Need OP
    ]],
    [[ mbsfn-SubframeConfigList-v1430      MBSFN-SubframeConfigList-v1430   OPTIONAL,  -- Need OP
      videoServiceCauseIndication-r14     ENUMERATED {true}                 OPTIONAL   -- Need OP
    ]]
}

SystemInformationBlockType2-v8h0-IEs ::= SEQUENCE {
    multiBandInfoList                SEQUENCE (SIZE (1..maxMultiBands)) OF AdditionalSpectrumEmission
    OPTIONAL,  -- Need OR
    nonCriticalExtension                SystemInformationBlockType2-v9e0-IEs    OPTIONAL
}

SystemInformationBlockType2-v9e0-IEs ::= SEQUENCE {
    ul-CarrierFreq-v9e0                ARFCN-ValueEUTRA-v9e0                OPTIONAL,  -- Cond ul-FreqMax
    nonCriticalExtension                SystemInformationBlockType2-v9i0-IEs
    OPTIONAL
}

SystemInformationBlockType2-v9i0-IEs ::= SEQUENCE {
-- Following field is for any non-critical extensions from REL-9
    nonCriticalExtension                OCTET STRING (CONTAINING SystemInformationBlockType2-v10m0-IEs)
        OPTIONAL,
    dummy                SEQUENCE {}                OPTIONAL
}

SystemInformationBlockType2-v10m0-IEs ::= SEQUENCE {
    freqInfo-v1010                SEQUENCE {
        additionalSpectrumEmission-v1010                AdditionalSpectrumEmission-v1010
        }
        OPTIONAL,
    multiBandInfoList-v1010                SEQUENCE (SIZE (1..maxMultiBands)) OF
        AdditionalSpectrumEmission-v1010                OPTIONAL,
    nonCriticalExtension                SystemInformationBlockType2-v10x0-IEs                OPTIONAL
}

SystemInformationBlockType2-v10x0-IEs ::= SEQUENCE {
-- Following field is for non-critical extensions up-to REL-12
    lateNonCriticalExtension                OCTET STRING                OPTIONAL,
    nonCriticalExtension                SystemInformationBlockType2-v13c0-IEs                OPTIONAL
}

SystemInformationBlockType2-v13c0-IEs ::= SEQUENCE {
    uplinkPowerControlCommon-v13c0                UplinkPowerControlCommon-v1310                OPTIONAL,  -- Need OR
-- Following field is for non-critical extensions from REL-13
    nonCriticalExtension                SEQUENCE {}                OPTIONAL
}

AC-BarringConfig ::= SEQUENCE {
    ac-BarringFactor                ENUMERATED {

```

```

        p00, p05, p10, p15, p20, p25, p30, p40,
        p50, p60, p70, p75, p80, p85, p90, p95},
    ac-BarringTime      ENUMERATED {s4, s8, s16, s32, s64, s128, s256, s512},
    ac-BarringForSpecialAC BIT STRING (SIZE(5))
}

MBSFN-SubframeConfigList ::= SEQUENCE (SIZE (1..maxMBSFN-Allocations)) OF MBSFN-SubframeConfig

MBSFN-SubframeConfigList-v1430 ::= SEQUENCE (SIZE (1..maxMBSFN-Allocations)) OF MBSFN-SubframeConfig-v1430

AC-BarringPerPLMN-List-r12 ::= SEQUENCE (SIZE (1.. maxPLMN-r11)) OF AC-BarringPerPLMN-r12

AC-BarringPerPLMN-r12 ::= SEQUENCE {
    plmn-IdentityIndex-r12      INTEGER (1..maxPLMN-r11),
    ac-BarringInfo-r12         SEQUENCE {
        ac-BarringForEmergency-r12    BOOLEAN,
        ac-BarringForMO-Signalling-r12 AC-BarringConfig    OPTIONAL, -- Need OP
        ac-BarringForMO-Data-r12      AC-BarringConfig    OPTIONAL -- Need OP
    }
    ac-BarringSkipForMMTELVoice-r12  ENUMERATED {true}    OPTIONAL, -- Need OP
    ac-BarringSkipForMMTELVideo-r12  ENUMERATED {true}    OPTIONAL, -- Need OP
    ac-BarringSkipForSMS-r12         ENUMERATED {true}    OPTIONAL, -- Need OP
    ac-BarringForCSFB-r12           AC-BarringConfig    OPTIONAL, -- Need OP
    ssac-BarringForMMTEL-Voice-r12   AC-BarringConfig    OPTIONAL, -- Need OP
    ssac-BarringForMMTEL-Video-r12   AC-BarringConfig    OPTIONAL -- Need OP
}

ACDC-BarringForCommon-r13 ::= SEQUENCE {
    acdc-HPLMNOnly-r13          BOOLEAN,
    barringPerACDC-CategoryList-r13 BarringPerACDC-CategoryList-r13
}

ACDC-BarringPerPLMN-List-r13 ::= SEQUENCE (SIZE (1.. maxPLMN-r11)) OF ACDC-BarringPerPLMN-r13

ACDC-BarringPerPLMN-r13 ::= SEQUENCE {
    plmn-IdentityIndex-r13      INTEGER (1..maxPLMN-r11),
    acdc-OnlyForHPLMN-r13       BOOLEAN,
    barringPerACDC-CategoryList-r13 BarringPerACDC-CategoryList-r13
}

BarringPerACDC-CategoryList-r13 ::= SEQUENCE (SIZE (1..maxACDC-Cat-r13)) OF BarringPerACDC-Category-r13

BarringPerACDC-Category-r13 ::= SEQUENCE {
    acdc-Category-r13           INTEGER (1..maxACDC-Cat-r13),
    acdc-BarringConfig-r13      SEQUENCE {
        ac-BarringFactor-r13      ENUMERATED {
            p00, p05, p10, p15, p20, p25, p30, p40,
            p50, p60, p70, p75, p80, p85, p90, p95},
        ac-BarringTime-r13        ENUMERATED {s4, s8, s16, s32, s64, s128, s256, s512}
    }
    OPTIONAL -- Need OP
}

UDT-Restricting-r13 ::= SEQUENCE {
    udt-Restricting-r13         ENUMERATED {true}    OPTIONAL, --Need OR
    udt-RestrictingTime-r13     ENUMERATED {s4, s8, s16, s32, s64, s128, s256, s512}
    OPTIONAL --Need OR
}

UDT-RestrictingPerPLMN-List-r13 ::= SEQUENCE (SIZE (1..maxPLMN-r11)) OF UDT-RestrictingPerPLMN-r13

UDT-RestrictingPerPLMN-r13 ::= SEQUENCE {
    plmn-IdentityIndex-r13      INTEGER (1..maxPLMN-r11),
    udt-Restricting-r13         UDT-Restricting-r13    OPTIONAL --Need OR
}

CIOT-EPS-OptimisationInfo-r13 ::= SEQUENCE (SIZE (1.. maxPLMN-r11)) OF CIOT-OptimisationPLMN-r13

CIOT-OptimisationPLMN-r13 ::= SEQUENCE {
    up-CIoT-EPS-Optimisation-r13  ENUMERATED {true}    OPTIONAL, -- Need OP
    cp-CIoT-EPS-Optimisation-r13  ENUMERATED {true}    OPTIONAL, -- Need OP
    attachWithoutPDN-Connectivity-r13  ENUMERATED {true}    OPTIONAL -- Need OP
}

-- ASN1STOP

```

SystemInformationBlockType2 field descriptions
<p>ac-BarringFactor If the random number drawn by the UE is lower than this value, access is allowed. Otherwise the access is barred. The values are interpreted in the range [0,1): p00 = 0, p05 = 0.05, p10 = 0.10, ..., p95 = 0.95. Values other than p00 can only be set if all bits of the corresponding <i>ac-BarringForSpecialAC</i> are set to 0.</p>
<p>ac-BarringForCSFB Access class barring for mobile originating CS fallback.</p>
<p>ac-BarringForEmergency Access class barring for AC 10.</p>
<p>ac-BarringForMO-Data Access class barring for mobile originating calls.</p>
<p>ac-BarringForMO-Signalling Access class barring for mobile originating signalling.</p>
<p>ac-BarringForSpecialAC Access class barring for AC 11-15. The first/ leftmost bit is for AC 11, the second bit is for AC 12, and so on.</p>
<p>ac-BarringTime Mean access barring time value in seconds.</p>
<p>acdc-BarringConfig Barring configuration for an ACDC category. If the field is absent, access to the cell is considered as not barred for the ACDC category in accordance with clause 5.3.3.13.</p>
<p>acdc-Category Indicates the ACDC category as defined in TS 24.105 [72].</p>
<p>acdc-OnlyForHPLMN Indicates whether ACDC is applicable for UEs not in their HPLMN for the corresponding PLMN. <i>TRUE</i> indicates that ACDC is applicable only for UEs in their HPLMN for the corresponding PLMN. <i>FALSE</i> indicates that ACDC is applicable for both UEs in their HPLMN and UEs not in their HPLMN for the corresponding PLMN.</p>
<p>additionalSpectrumEmission The UE requirements related to IE <i>AdditionalSpectrumEmission</i> are defined in TS 36.101 [42, table 6.2.4-1] for UEs neither in CE nor BL UEs and TS 36.101 [42, table 6.2.4E-1] for UEs in CE or BL UEs. NOTE 1.</p>
<p>attachWithoutPDN-Connectivity If present, the field indicates that attach without PDN connectivity as specified in TS 24.301 [35] is supported for this PLMN.</p>
<p>barringPerACDC-CategoryList A list of barring information per ACDC category according to the order defined in TS 22.011 [10]. The first entry in the list corresponds to the highest ACDC category of which applications are the least restricted in access attempts at a cell, the second entry in the list corresponds to the ACDC category of which applications are restricted more than applications of the highest ACDC category in access attempts at a cell, and so on. The last entry in the list corresponds to the lowest ACDC category of which applications are the most restricted in access attempts at a cell.</p>
<p>clot-EPS-OptimisationInfo A list of Clot EPS related parameters. Value 1 indicates parameters for the PLMN listed 1st in the 1st <i>plmn-IdentityList</i> included in SIB1. Value 2 indicates parameters for the the PLMN listed 2nd in the same <i>plmn-IdentityList</i>, or when no more PLMN are present within the same <i>plmn-IdentityList</i>, then the value indicates paramters for PLMN listed 1st in the subsequent <i>plmn-IdentityList</i> within the same SIB1 and so on. NOTE 1.</p>
<p>cp-Clot-EPS-Optimisation This field indicates if the UE is allowed to establish the connection with Control plane Clot EPS Optimisation, see TS 24.301 [35].</p>
<p>dummy This field is not used in the specification. If received it shall be ignored by the UE.</p>
<p>mbsfn-SubframeConfigList Defines the subframes that are reserved for MBSFN in downlink. NOTE 1. If the cell is a FeMBMS/Unicast mixed cell, EUTRAN includes <i>mbsfn-SubframeConfigList-v1430</i>. If a FeMBMS/Unicast mixed cell does not use sub-frames #4 or #9 as MBSFN sub-frames, <i>mbsfn-SubframeConfigList-v1430</i> is still included and indicates all sub-frames as non-MBSFN sub-frames.</p>
<p>multiBandInfoList A list of <i>AdditionalSpectrumEmission</i> i.e. one for each additional frequency band included in <i>multiBandInfoList</i> in <i>SystemInformationBlockType1</i>, listed in the same order. If E-UTRAN includes <i>multiBandInfoList-v1010</i> it includes the same number of entries, and listed in the same order, as in <i>multiBandInfoList</i>.</p>
<p>plmn-IdentityIndex Index of the PLMN across the <i>plmn-IdentityList</i> fields included in SIB1. Value 1 indicates the PLMN listed 1st in the 1st <i>plmn-IdentityList</i> included in SIB1. Value 2 indicates the PLMN listed 2nd in the same <i>plmn-IdentityList</i>, or when no more PLMN are present within the same <i>plmn-IdentityList</i>, then the PLMN listed 1st in the subsequent <i>plmn-IdentityList</i> within the same SIB1 and so on. NOTE 1.</p>
<p>ssac-BarringForMMTEL-Video Service specific access class barring for MMTEL video originating calls.</p>
<p>ssac-BarringForMMTEL-Voice Service specific access class barring for MMTEL voice originating calls.</p>

SystemInformationBlockType2 field descriptions
<p>udt-Restricting Value TRUE indicates that the UE should indicate to the higher layers to restrict unattended data traffic TS 22.101 [77] irrespective of the UE being in RRC_IDLE or RRC_CONNECTED. The UE shall not indicate to the higher layers if the UE has one or more Access Classes, as stored on the USIM, with a value in the range 11..15, which is valid for the UE to use according to TS 22.011 [10] and TS 23.122 [11].</p>
<p>udt-RestrictingTime If present and when the <i>udt-Restricting</i> changes from TRUE, the UE runs a timer for a period equal to $\text{rand} * \text{udt-RestrictingTime}$, where <i>rand</i> is a random number drawn that is uniformly distributed in the range $0 \leq \text{rand} < 1$ value in seconds. The timer stops if <i>udt-Restricting</i> changes to FALSE. Upon timer expiry, the UE indicates to the higher layers that the restriction is alleviated.</p>
<p>unicastFreqHoppingInd This field indicates if the UE is allowed to indicate support of frequency hopping for unicast MPDCCH/PDSCH/PUSCH as described in TS 36.321 [6]. This field is included only in the BR version of SI message carrying <i>SystemInformationBlockType2</i>.</p>
<p>ul-Bandwidth Parameter: transmission bandwidth configuration, N_{RB}, in uplink, see TS 36.101 [42, table 5.6-1]. Value n_6 corresponds to 6 resource blocks, n_{15} to 15 resource blocks and so on. If for FDD this parameter is absent, the uplink bandwidth is equal to the downlink bandwidth. For TDD this parameter is absent and it is equal to the downlink bandwidth. NOTE 1.</p>
<p>ul-CarrierFreq For FDD: If absent, the (default) value determined from the default TX-RX frequency separation defined in TS 36.101 [42, table 5.7.3-1] applies. For TDD: This parameter is absent and it is equal to the downlink frequency. NOTE 1.</p>
<p>up-CIoT-EPS-Optimisation This field indicates if the UE is allowed to resume the connection with User plane CiOT EPS Optimisation, see TS 24.301 [35].</p>
<p>useFullResumeID This field indicates if the UE indicates full resume ID of 40 bits in <i>RRCConnectionResumeRequest</i>.</p>
<p>videoServiceCauseIndication Indicates whether the UE is requested to use the establishment cause <i>mo-VoiceCall</i> for mobile originating MMTEL video calls.</p>
<p>voiceServiceCauseIndication Indicates whether UE is requested to use the establishment cause <i>mo-VoiceCall</i> for mobile originating MMTEL voice calls.</p>

Conditional presence	Explanation
<i>ul-FreqMax</i>	The field is mandatory present if <i>ul-CarrierFreq</i> (i.e. without suffix) is present and set to <i>maxEARFCN</i> . Otherwise the field is not present.

NOTE 1: E-UTRAN sets this field to the same value for all instances of SI message that are broadcasted within the same cell.

– SystemInformationBlockType3

The IE *SystemInformationBlockType3* contains cell re-selection information common for intra-frequency, inter-frequency and/ or inter-RAT cell re-selection (i.e. applicable for more than one type of cell re-selection but not necessarily all) as well as intra-frequency cell re-selection information other than neighbouring cell related.

SystemInformationBlockType3 information element

```
-- ASN1START
SystemInformationBlockType3 ::= SEQUENCE {
    cellReselectionInfoCommon SEQUENCE {
        q-Hyst ENUMERATED {
            dB0, dB1, dB2, dB3, dB4, dB5, dB6, dB8, dB10,
            dB12, dB14, dB16, dB18, dB20, dB22, dB24},
        speedStateReselectionPars SEQUENCE {
            mobilityStateParameters MobilityStateParameters,
            q-HystSF SEQUENCE {
                sf-Medium ENUMERATED {
                    dB-6, dB-4, dB-2, dB0},
                sf-High ENUMERATED {
```

```

    }
    },
    cellReselectionServingFreqInfo SEQUENCE {
        s-NonIntraSearch ReselectionThreshold OPTIONAL, -- Need OP
        threshServingLow ReselectionThreshold,
        cellReselectionPriority CellReselectionPriority
    },
    intraFreqCellReselectionInfo SEQUENCE {
        q-RxLevMin Q-RxLevMin,
        p-Max P-Max OPTIONAL, -- Need OP
        s-IntraSearch ReselectionThreshold OPTIONAL, -- Need OP
        allowedMeasBandwidth AllowedMeasBandwidth OPTIONAL, -- Need OP
        presenceAntennaPort1 PresenceAntennaPort1,
        neighCellConfig NeighCellConfig,
        t-ReselectionEUTRA T-Reselection,
        t-ReselectionEUTRA-SF SpeedStateScaleFactors OPTIONAL -- Need OP
    },
    ...,
    lateNonCriticalExtension OCTET STRING (CONTAINING SystemInformationBlockType3-
v10j0-IEs) OPTIONAL,
    [[ s-IntraSearch-v920 SEQUENCE {
        s-IntraSearchP-r9 ReselectionThreshold,
        s-IntraSearchQ-r9 ReselectionThresholdQ-r9 OPTIONAL, -- Need OP
    }
    s-NonIntraSearch-v920 SEQUENCE {
        s-NonIntraSearchP-r9 ReselectionThreshold,
        s-NonIntraSearchQ-r9 ReselectionThresholdQ-r9 OPTIONAL, -- Need OP
    }
    q-QualMin-r9 Q-QualMin-r9 OPTIONAL, -- Need OP
    threshServingLowQ-r9 ReselectionThresholdQ-r9 OPTIONAL -- Need OP
    ]],
    [[ q-QualMinWB-r11 Q-QualMin-r9 OPTIONAL -- Cond WB-RSRQ
    ]],
    [[ q-QualMinRSRQ-OnAllSymbols-r12 Q-QualMin-r9 OPTIONAL --
Cond RSRQ
    ]],
    [[ cellReselectionServingFreqInfo-v1310 CellReselectionServingFreqInfo-v1310 OPTIONAL, --
Need OP
    redistributionServingInfo-r13 RedistributionServingInfo-r13 OPTIONAL, --Need OR
    cellSelectionInfoCE-r13 CellSelectionInfoCE-r13 OPTIONAL, -- Need
OP
    t-ReselectionEUTRA-CE-r13 T-ReselectionEUTRA-CE-r13 OPTIONAL -- Need
OP
    ]],
    [[ cellSelectionInfoCE1-r13 CellSelectionInfoCE1-r13 OPTIONAL -- Need OP
    ]],
    [[ cellSelectionInfoCE1-v1360 CellSelectionInfoCE1-v1360 OPTIONAL -- Cond
QrxlevminCE1
    ]],
    [[ cellReselectionInfoCommon-v1460 CellReselectionInfoCommon-v1460 OPTIONAL -- Need OR
    ]]
}

RedistributionServingInfo-r13 ::= SEQUENCE {
    redistributionFactorServing-r13 INTEGER(0..10),
    redistributionFactorCell-r13 ENUMERATED{true} OPTIONAL, --Need OP
    t360-r13 ENUMERATED {min4, min8, min16, min32,infinity,
        spare3,spare2,spare1},
    redistrOnPagingOnly-r13 ENUMERATED {true} OPTIONAL --Need OP
}

CellReselectionServingFreqInfo-v1310 ::= SEQUENCE {
    cellReselectionSubPriority-r13 CellReselectionSubPriority-r13
}

-- Late non critical extensions
SystemInformationBlockType3-v10j0-IEs ::= SEQUENCE {
    freqBandInfo-r10 NS-PmaxList-r10 OPTIONAL, -- Need OR
    multiBandInfoList-v10j0 MultiBandInfoList-v10j0 OPTIONAL, -- Need OR
    nonCriticalExtension SystemInformationBlockType3-v1010-IEs
OPTIONAL
}

SystemInformationBlockType3-v1010-IEs ::= SEQUENCE {
    freqBandInfo-v1010 NS-PmaxList-v1010 OPTIONAL, -- Need OR
    multiBandInfoList-v1010 MultiBandInfoList-v1010 OPTIONAL, -- Need OR

```

```
    nonCriticalExtension          SEQUENCE {}                OPTIONAL
  }
CellReselectionInfoCommon-v1460 ::= SEQUENCE {
  s-SearchDeltaP-r14            ENUMERATED {dB6, dB9, dB12, dB15}
}
-- ASN1STOP
```

SystemInformationBlockType3 field descriptions
<p>allowedMeasBandwidth If absent, the value corresponding to the downlink bandwidth indicated by the <i>dl-Bandwidth</i> included in <i>MasterInformationBlock</i> applies.</p>
<p>cellSelectionInfoCE Parameters included in coverage enhancement S criteria for BL UEs and UEs in CE, applicable for intra-frequency neighbour cells. If absent, coverage enhancement S criteria is not applicable.</p>
<p>cellSelectionInfoCE1 Parameters included in coverage enhancement S criteria for BL UEs and UEs in CE supporting CE Mode B, applicable for intra-frequency neighbour cells. E-UTRAN includes this IE only if <i>cellSelectionInfoCE</i> in SIB3 is present.</p>
<p>cellReselectionInfoCommon Cell re-selection information common for cells.</p>
<p>cellReselectionServingFreqInfo Information common for Cell re-selection to inter-frequency and inter-RAT cells.</p>
<p>freqBandInfo A list of <i>additionalPmax</i> and <i>additionalSpectrumEmission</i> values, as defined in TS 36.101 [42, table 6.2.4-1] for UEs neither in CE nor BL UEs and TS 36.101 [42, table 6.2.4E-1] for UEs in CE or BL UEs, applicable for the intra-frequency neighbouring E-UTRA cells if the UE selects the frequency band from <i>freqBandIndicator</i> in <i>SystemInformationBlockType1</i>. If E-UTRAN includes <i>freqBandInfo-v1010</i> it includes the same number of entries, and listed in the same order, as in <i>freqBandInfo-r10</i>.</p>
<p>intraFreqcellReselectionInfo Cell re-selection information common for intra-frequency cells.</p>
<p>multiBandInfoList-v10j0 A list of <i>additionalPmax</i> and <i>additionalSpectrumEmission</i> values, as defined in TS 36.101 [42, table 6.2.4-1] for UEs neither in CE nor BL UEs and TS 36.101 [42, table 6.2.4E-1] for UEs in CE or BL UEs, applicable for the intra-frequency neighbouring E-UTRA cells if the UE selects the frequency bands in <i>multiBandInfoList</i> (i.e. without suffix) or <i>multiBandInfoList-v9e0</i>. If E-UTRAN includes <i>multiBandInfoList-v10j0</i>, it includes the same number of entries, and listed in the same order, as in <i>multiBandInfoList</i> (i.e. without suffix). If E-UTRAN includes <i>multiBandInfoList-v1010</i> it includes the same number of entries, and listed in the same order, as in <i>multiBandInfoList-v10j0</i>.</p>
<p>p-Max Value applicable for the intra-frequency neighbouring E-UTRA cells. If absent the UE applies the maximum power according to its capability as specified in TS 36.101 [42, 6.2.2].</p>
<p>redistrOnPagingOnly If this field is present and the UE is redistribution capable, the UE shall only wait for the paging message to trigger E-UTRAN inter-frequency redistribution procedure as specified in 5.2.4.10 of TS 36.304 [4].</p>
<p>q-Hyst Parameter Q_{hyst} in TS 36.304 [4], Value in dB. Value dB1 corresponds to 1 dB, dB2 corresponds to 2 dB and so on.</p>
<p>q-HystSF Parameter "Speed dependent ScalingFactor for Q_{hyst}" in TS 36.304 [4]. The sf-Medium and sf-High concern the additional hysteresis to be applied, in Medium and High Mobility state respectively, to Q_{hyst} as defined in TS 36.304 [4]. In dB. Value dB-6 corresponds to -6dB, dB-4 corresponds to -4dB and so on.</p>
<p>q-QualMin Parameter "$Q_{qualmin}$" in TS 36.304 [4], applicable for intra-frequency neighbour cells. If the field is not present, the UE applies the (default) value of negative infinity for $Q_{qualmin}$. NOTE 1.</p>
<p>q-QualMinRSRQ-OnAllSymbols If this field is present and supported by the UE, the UE shall, when performing RSRQ measurements, perform RSRQ measurement on all OFDM symbols in accordance with TS 36.214 [48]. NOTE 1.</p>
<p>q-QualMinWB If this field is present and supported by the UE, the UE shall, when performing RSRQ measurements, use a wider bandwidth in accordance with TS 36.133 [16]. NOTE 1.</p>
<p>q-RxLevMin Parameter "$Q_{rxlevmin}$" in TS 36.304 [4], applicable for intra-frequency neighbour cells.</p>
<p>redistributionFactorCell If <i>redistributionFactorCell</i> is present, <i>redistributionFactorServing</i> is only applicable for the serving cell otherwise it is applicable for serving frequency</p>
<p>redistributionFactorServing Parameter <i>redistributionFactorServing</i> in TS 36.304 [4].</p>
<p>s-IntraSearch Parameter "$S_{intraSearchP}$" in TS 36.304 [4]. If the field <i>s-IntraSearchP</i> is present, the UE applies the value of <i>s-IntraSearchP</i> instead. Otherwise if neither <i>s-IntraSearch</i> nor <i>s-IntraSearchP</i> is present, the UE applies the (default) value of infinity for $S_{intraSearchP}$.</p>
<p>s-IntraSearchP Parameter "$S_{intraSearchP}$" in TS 36.304 [4]. See descriptions under <i>s-IntraSearch</i>.</p>
<p>s-IntraSearchQ Parameter "$S_{intraSearchQ}$" in TS 36.304 [4]. If the field is not present, the UE applies the (default) value of 0 dB for $S_{intraSearchQ}$.</p>

SystemInformationBlockType3 field descriptions
s-NonIntraSearch Parameter "S _{nonIntraSearchP} " in TS 36.304 [4]. If the field <i>s-NonIntraSearchP</i> is present, the UE applies the value of <i>s-NonIntraSearchP</i> instead. Otherwise if neither <i>s-NonIntraSearch</i> nor <i>s-NonIntraSearchP</i> is present, the UE applies the (default) value of infinity for S _{nonIntraSearchP} .
s-NonIntraSearchP Parameter "S _{nonIntraSearchP} " in TS 36.304 [4]. See descriptions under <i>s-NonIntraSearch</i> .
s-NonIntraSearchQ Parameter "S _{nonIntraSearchQ} " in TS 36.304 [4]. If the field is not present, the UE applies the (default) value of 0 dB for S _{nonIntraSearchQ} .
s-SearchDeltaP Parameter "S _{SearchDeltaP} " in TS 36.304 [4]. This parameter is only applicable for UEs supporting relaxed monitoring as specified in TS 36.306 [5]. Value dB6 corresponds to 6 dB, dB9 corresponds to 9 dB and so on.
speedStateReselectionPars Speed dependent reselection parameters, see TS 36.304 [4]. If this field is absent, i.e., <i>mobilityStateParameters</i> is also not present, UE behaviour is specified in TS 36.304 [4].
t360 Parameter "T360" in TS 36.304 [4]. Value <i>min4</i> corresponds to 4 minutes, value <i>min8</i> corresponds to 8 minutes, and so on.
threshServingLow Parameter "Thresh _{Serving, LowP} " in TS 36.304 [4].
threshServingLowQ Parameter "Thresh _{Serving, LowQ} " in TS 36.304 [4].
t-ReselectionEUTRA Parameter "T _{reselectionEUTRA} " in TS 36.304 [4].
t-ReselectionEUTRA-SF Parameter "Speed dependent ScalingFactor for T _{reselectionEUTRA} " in TS 36.304 [4]. If the field is not present, the UE behaviour is specified in TS 36.304 [4].

NOTE 1: The value the UE applies for parameter "Q_{qualmin}" in TS 36.304 [4] depends on the *q-QualMin* fields signalled by E-UTRAN and supported by the UE. In case multiple candidate options are available, the UE shall select the highest priority candidate option according to the priority order indicated by the following table (top row is highest priority).

q-QualMinRSRQ-OnAllSymbols	q-QualMinWB	Value of parameter "Q _{qualmin} " in TS 36.304 [4]
Included	Included	$q\text{-QualMinRSRQ-OnAllSymbols} - (q\text{-QualMin} - q\text{-QualMinWB})$
Included	Not included	$q\text{-QualMinRSRQ-OnAllSymbols}$
Not included	Included	$q\text{-QualMinWB}$
Not included	Not included	$q\text{-QualMin}$

Conditional presence	Explanation
<i>QrxlevminCE1</i>	The field is optionally present, Need OR, if <i>q-RxLevMinCE1-r13</i> is set below -140 dBm. Otherwise the field is not present.
<i>RSRQ</i>	The field is optionally present, Need OR, if <i>threshServingLowQ</i> is present in SIB3; otherwise it is not present.
<i>WB-RSRQ</i>	The field is optionally present, need OP if the measurement bandwidth indicated by <i>allowedMeasBandwidth</i> is 50 resource blocks or larger; otherwise it is not present.

– SystemInformationBlockType4

The IE *SystemInformationBlockType4* contains neighbouring cell related information relevant only for intra-frequency cell re-selection. The IE includes cells with specific re-selection parameters as well as blacklisted cells.

SystemInformationBlockType4 information element

```
-- ASN1START
SystemInformationBlockType4 ::= SEQUENCE {
    intraFreqNeighCellList      IntraFreqNeighCellList      OPTIONAL, -- Need OR
    intraFreqBlackCellList     IntraFreqBlackCellList     OPTIONAL, -- Need OR
    csg-PhysCellIdRange       PhysCellIdRange            OPTIONAL, -- Cond CSG
    . . .
    lateNonCriticalExtension    OCTET STRING                OPTIONAL
}
```

```

}
IntraFreqNeighCellList ::= SEQUENCE (SIZE (1..maxCellIntra)) OF IntraFreqNeighCellInfo
IntraFreqNeighCellInfo ::= SEQUENCE {
    physCellId PhysCellId,
    q-OffsetCell Q-OffsetRange,
    ...
}
IntraFreqBlackCellList ::= SEQUENCE (SIZE (1..maxCellBlack)) OF PhysCellIdRange
-- ASN1STOP

```

SystemInformationBlockType4 field descriptions

csg-PhysCellIdRange

Set of physical cell identities reserved for CSG cells on the frequency on which this field was received. The received *csg-PhysCellIdRange* applies if less than 24 hours has elapsed since it was received and the UE is camped on a cell of the same primary PLMN where this field was received. The 3 hour validity restriction (clause 5.2.1.3) does not apply to this field. The UE shall not apply any stored *csg-PhysCellIdRange* when it is in *any cell selection* state defined in TS 36.304 [4].

intraFreqBlackCellList

List of blacklisted intra-frequency neighbouring cells.

intraFreqNeighbCellList

List of intra-frequency neighbouring cells with specific cell re-selection parameters.

q-OffsetCell

Parameter "Qoffset_{s,n}" in TS 36.304 [4].

Conditional presence	Explanation
CSG	This field is optional, need OP, for non-CSG cells, and mandatory for CSG cells.

SystemInformationBlockType5

The IE *SystemInformationBlockType5* contains information relevant only for inter-frequency cell re-selection i.e. information about other E-UTRA frequencies and inter-frequency neighbouring cells relevant for cell re-selection. The IE includes cell re-selection parameters common for a frequency as well as cell specific re-selection parameters.

SystemInformationBlockType5 information element

```

-- ASN1START
SystemInformationBlockType5 ::= SEQUENCE {
    interFreqCarrierFreqList InterFreqCarrierFreqList,
    ...,
    lateNonCriticalExtension OCTET STRING (CONTAINING SystemInformationBlockType5-
v8h0-IEs) OPTIONAL,
    [[ interFreqCarrierFreqList-v1250 InterFreqCarrierFreqList-v1250 OPTIONAL, -- Need OR
interFreqCarrierFreqListExt-r12 InterFreqCarrierFreqListExt-r12 OPTIONAL -- Need OR
]],
OR
    [[ interFreqCarrierFreqListExt-v1280 InterFreqCarrierFreqListExt-v1280 OPTIONAL -- Need
OR
]],
OR
    [[ interFreqCarrierFreqList-v1310 InterFreqCarrierFreqList-v1310 OPTIONAL, -- Need
OR
interFreqCarrierFreqListExt-v1310 InterFreqCarrierFreqListExt-v1310 OPTIONAL -- Need
OR
]],
    [[ interFreqCarrierFreqList-v1350 InterFreqCarrierFreqList-v1350 OPTIONAL, -- Need OR
interFreqCarrierFreqListExt-v1350 InterFreqCarrierFreqListExt-v1350 OPTIONAL -- Need OR
]],
OR
    [[ interFreqCarrierFreqListExt-v1360 InterFreqCarrierFreqListExt-v1360 OPTIONAL -- Need
OR
]],
    [[ scptm-FreqOffset-r14 INTEGER (1..8) OPTIONAL -- Need OP
]]
}
-- Late non critical extensions
SystemInformationBlockType5-v8h0-IEs ::= SEQUENCE {

```

```

interFreqCarrierFreqList-v8h0 SEQUENCE (SIZE (1..maxFreq)) OF InterFreqCarrierFreqInfo-v8h0
    OPTIONAL, -- Need OP
nonCriticalExtension          SystemInformationBlockType5-v9e0-IEs
OPTIONAL
}

SystemInformationBlockType5-v9e0-IEs ::= SEQUENCE {
    interFreqCarrierFreqList-v9e0 SEQUENCE (SIZE (1..maxFreq)) OF InterFreqCarrierFreqInfo-v9e0
        OPTIONAL, -- Need OR
    nonCriticalExtension          SystemInformationBlockType5-v10j0-IEs    OPTIONAL
}

SystemInformationBlockType5-v10j0-IEs ::= SEQUENCE {
    interFreqCarrierFreqList-v10j0 SEQUENCE (SIZE (1..maxFreq)) OF InterFreqCarrierFreqInfo-v10j0
        OPTIONAL, -- Need OR
    nonCriticalExtension          SystemInformationBlockType5-v10l0-IEs
    OPTIONAL
}

SystemInformationBlockType5-v10l0-IEs ::= SEQUENCE {
    interFreqCarrierFreqList-v10l0 SEQUENCE (SIZE (1..maxFreq)) OF InterFreqCarrierFreqInfo-v10l0
        OPTIONAL, -- Need OR
    nonCriticalExtension          SystemInformationBlockType5-v13a0-IEs    OPTIONAL
}

SystemInformationBlockType5-v13a0-IEs ::= SEQUENCE {
    -- Late non critical extensions from REL-10 upto REL-12
    lateNonCriticalExtension      OCTET STRING                        OPTIONAL, -- Need OR
    interFreqCarrierFreqList-v13a0 InterFreqCarrierFreqList-v13a0  OPTIONAL, -- Need OR
    -- Late non critical extensions from REL-13
    nonCriticalExtension          SEQUENCE {}                        OPTIONAL
}

InterFreqCarrierFreqList ::= SEQUENCE (SIZE (1..maxFreq)) OF InterFreqCarrierFreqInfo

InterFreqCarrierFreqList-v1250 ::= SEQUENCE (SIZE (1.. maxFreq)) OF InterFreqCarrierFreqInfo-v1250

InterFreqCarrierFreqList-v1310 ::= SEQUENCE (SIZE (1.. maxFreq)) OF InterFreqCarrierFreqInfo-v1310

InterFreqCarrierFreqList-v1350 ::= SEQUENCE (SIZE (1.. maxFreq)) OF InterFreqCarrierFreqInfo-v1350

InterFreqCarrierFreqList-v13a0 ::= SEQUENCE (SIZE (1.. maxFreq)) OF InterFreqCarrierFreqInfo-v1360

InterFreqCarrierFreqListExt-r12 ::= SEQUENCE (SIZE (1.. maxFreq)) OF InterFreqCarrierFreqInfo-r12

InterFreqCarrierFreqListExt-v1280 ::= SEQUENCE (SIZE (1.. maxFreq)) OF InterFreqCarrierFreqInfo-
v10j0

InterFreqCarrierFreqListExt-v1310 ::= SEQUENCE (SIZE (1.. maxFreq)) OF InterFreqCarrierFreqInfo-
v1310

InterFreqCarrierFreqListExt-v1350 ::= SEQUENCE (SIZE (1.. maxFreq)) OF InterFreqCarrierFreqInfo-
v1350

InterFreqCarrierFreqListExt-v1360 ::= SEQUENCE (SIZE (1..maxFreq)) OF InterFreqCarrierFreqInfo-
v1360

InterFreqCarrierFreqInfo ::= SEQUENCE {
    dl-CarrierFreq                ARFCN-ValueEUTRA,
    q-RxLevMin                    Q-RxLevMin,
    p-Max                          P-Max                            OPTIONAL, -- Need OP
    t-ReselectionEUTRA            T-Reselection,
    t-ReselectionEUTRA-SF        SpeedStateScaleFactors        OPTIONAL, -- Need OP
    threshX-High                  ReselectionThreshold,
    threshX-Low                   ReselectionThreshold,
    allowedMeasBandwidth          AllowedMeasBandwidth,
    presenceAntennaPort1         PresenceAntennaPort1,
    cellReselectionPriority        CellReselectionPriority        OPTIONAL, -- Need OP
    neighCellConfig              NeighCellConfig,
    q-OffsetFreq                  Q-OffsetRange                DEFAULT dB0,
    interFreqNeighCellList        InterFreqNeighCellList        OPTIONAL, -- Need OR
    interFreqBlackCellList        InterFreqBlackCellList        OPTIONAL, -- Need OR
    ...,
    [[ q-QualMin-r9                Q-QualMin-r9                OPTIONAL, -- Need OP
    threshX-Q-r9                  SEQUENCE {
        threshX-HighQ-r9          ReselectionThresholdQ-r9,
        threshX-LowQ-r9           ReselectionThresholdQ-r9
    }
    ] ]
    OPTIONAL -- Cond RSRQ
}

```

```

    ]],
    [[ q-QualMinWB-r11          Q-QualMin-r9          OPTIONAL    -- Cond WB-RSRQ
    ]]
}

InterFreqCarrierFreqInfo-v8h0 ::= SEQUENCE {
    multiBandInfoList          MultiBandInfoList          OPTIONAL    -- Need OR
}

InterFreqCarrierFreqInfo-v9e0 ::= SEQUENCE {
    dl-CarrierFreq-v9e0        ARFCN-ValueEUTRA-v9e0     OPTIONAL,   -- Cond dl-FreqMax
    multiBandInfoList-v9e0     MultiBandInfoList-v9e0    OPTIONAL    -- Need OR
}

InterFreqCarrierFreqInfo-v10j0 ::= SEQUENCE {
    freqBandInfo-r10           NS-PmaxList-r10           OPTIONAL,   -- Need OR
    multiBandInfoList-v10j0    MultiBandInfoList-v10j0   OPTIONAL    -- Need OR
}

InterFreqCarrierFreqInfo-v10l0 ::= SEQUENCE {
    freqBandInfo-v10l0         NS-PmaxList-v10l0         OPTIONAL,   -- Need OR
    multiBandInfoList-v10l0    MultiBandInfoList-v10l0   OPTIONAL    -- Need OR
}

InterFreqCarrierFreqInfo-v1250 ::= SEQUENCE {
    reducedMeasPerformance-r12 ENUMERATED {true}         OPTIONAL,   -- Need OP
    q-QualMinRSRQ-OnAllSymbols-r12 Q-QualMin-r9              OPTIONAL    -- Cond RSRQ2
}

InterFreqCarrierFreqInfo-r12 ::= SEQUENCE {
    dl-CarrierFreq-r12         ARFCN-ValueEUTRA-r9,
    q-RxLevMin-r12             Q-RxLevMin,
    p-Max-r12                  P-Max                      OPTIONAL,   -- Need OP
    t-ReselectionEUTRA-r12     T-Reselection,
    t-ReselectionEUTRA-SF-r12  SpeedStateScaleFactors    OPTIONAL,   -- Need OP
    threshX-High-r12           ReselectionThreshold,
    threshX-Low-r12            ReselectionThreshold,
    allowedMeasBandwidth-r12   AllowedMeasBandwidth,
    presenceAntennaPort1-r12   PresenceAntennaPort1,
    cellReselectionPriority-r12 CellReselectionPriority     OPTIONAL,   -- Need OP
    neighCellConfig-r12        NeighCellConfig,
    q-OffsetFreq-r12           Q-OffsetRange              DEFAULT dB0,
    interFreqNeighCellList-r12 InterFreqNeighCellList     OPTIONAL,   -- Need OR
    interFreqBlackCellList-r12 InterFreqBlackCellList     OPTIONAL,   -- Need OR
    q-QualMin-r12              Q-QualMin-r9                OPTIONAL,   -- Need OP
    threshX-Q-r12              SEQUENCE {
        threshX-HighQ-r12      ReselectionThresholdQ-r9,
        threshX-LowQ-r12       ReselectionThresholdQ-r9
    }
    q-QualMinWB-r12            Q-QualMin-r9                OPTIONAL,   -- Cond RSRQ
    multiBandInfoList-r12      MultiBandInfoList-r11      OPTIONAL,   -- Need OR
    reducedMeasPerformance-r12 ENUMERATED {true}         OPTIONAL,   -- Need OP
    q-QualMinRSRQ-OnAllSymbols-r12 Q-QualMin-r9              OPTIONAL,   -- Cond RSRQ2
    ...
}

InterFreqCarrierFreqInfo-v1310 ::= SEQUENCE {
    cellReselectionSubPriority-r13 CellReselectionSubPriority-r13 OPTIONAL,   -- Need
OP
    redistributionInterFreqInfo-r13 RedistributionInterFreqInfo-r13 OPTIONAL, --Need OP
    cellSelectionInfoCE-r13      CellSelectionInfoCE-r13      OPTIONAL,   -- Need OP
    t-ReselectionEUTRA-CE-r13    T-ReselectionEUTRA-CE-r13    OPTIONAL,   -- Need OP
}

InterFreqCarrierFreqInfo-v1350 ::= SEQUENCE {
    cellSelectionInfoCE1-r13      CellSelectionInfoCE1-r13      OPTIONAL    -- Need OP
}

InterFreqCarrierFreqInfo-v1360 ::= SEQUENCE {
    cellSelectionInfoCE1-v1360    CellSelectionInfoCE1-v1360    OPTIONAL    -- Cond QrxlevminCE1
}

InterFreqNeighCellList ::= SEQUENCE (SIZE (1..maxCellInter)) OF InterFreqNeighCellInfo

InterFreqNeighCellInfo ::= SEQUENCE {
    physCellId                   PhysCellId,
    q-OffsetCell                  Q-OffsetRange
}

```



```
InterFreqBlackCellList ::=          SEQUENCE (SIZE (1..maxCellBlack)) OF PhysCellIdRange

RedistributionInterFreqInfo-r13 ::=  SEQUENCE {
  redistributionFactorFreq-r13      RedistributionFactor-r13    OPTIONAL,  --Need OP
  redistributionNeighCellList-r13   RedistributionNeighCellList-r13  OPTIONAL  --Need
OP
}

RedistributionNeighCellList-r13 ::= SEQUENCE (SIZE (1..maxCellInter)) OF RedistributionNeighCell-r13

RedistributionNeighCell-r13 ::=      SEQUENCE {
  physCellId-r13                    PhysCellId,
  redistributionFactorCell-r13       RedistributionFactor-r13
}

RedistributionFactor-r13 ::=         INTEGER(1..10)

-- ASN1STOP
```

SystemInformationBlockType5 field descriptions
<p>cellSelectionInfoCE Parameters included in coverage enhancement S criteria for BL UEs and UEs in CE, applicable for inter-frequency neighbour cells. If absent, coverage enhancement S criteria is not applicable.</p>
<p>cellSelectionInfoCE1 Parameters included in coverage enhancement S criteria for BL UEs and UEs in CE supporting CE Mode B. E-UTRAN includes this IE only in an entry of <i>InterFreqCarrierFreqList-v1350</i> or <i>InterFreqCarrierFreqListExt-v1350</i> if <i>cellSelectionInfoCE</i> is present in the corresponding entry of <i>InterFreqCarrierFreqList-v1310</i> or <i>InterFreqCarrierFreqListExt-v1310</i> is present.</p>
<p>freqBandInfo A list of <i>additionalPmax</i> and <i>additionalSpectrumEmission</i> values, as defined in TS 36.101 [42, table 6.2.4-1] for UEs neither in CE nor BL UEs and TS 36.101 [42, table 6.2.4E-1] for UEs in CE or BL UEs, for the frequency band represented by <i>dl-CarrierFreq</i> for which cell reselection parameters are common. If E-UTRAN includes <i>freqBandInfo-v1010</i> it includes the same number of entries, and listed in the same order, as in <i>freqBandInfo-r10</i>.</p>
<p>interFreqBlackCellList List of blacklisted inter-frequency neighbouring cells.</p>
<p>interFreqCarrierFreqList List of neighbouring inter-frequencies. E-UTRAN does not configure more than one entry for the same physical frequency regardless of the E-ARFCN used to indicate this. If E-UTRAN includes <i>interFreqCarrierFreqList-v8h0</i>, <i>interFreqCarrierFreqList-v9e0</i>, <i>InterFreqCarrierFreqList-v1250</i>, <i>InterFreqCarrierFreqList-v1310</i>, <i>InterFreqCarrierFreqList-v1350</i> and/or <i>InterFreqCarrierFreqList-v13a0</i>, it includes the same number of entries, and listed in the same order, as in <i>interFreqCarrierFreqList</i> (i.e. without suffix). See Annex D for more descriptions.</p>
<p>interFreqCarrierFreqListExt List of additional neighbouring inter-frequencies, i.e. extending the size of the inter-frequency carrier list using the general principles specified in 5.1.2. E-UTRAN does not configure more than one entry for the same physical frequency regardless of the E-ARFCN used to indicate this. EUTRAN may include <i>interFreqCarrierFreqListExt</i> even if <i>interFreqCarrierFreqList</i> (i.e. without suffix) does not include <i>maxFreq</i> entries. If E-UTRAN includes <i>InterFreqCarrierFreqListExt-v1310</i>, <i>InterFreqCarrierFreqListExt-v1350</i> and/or <i>InterFreqCarrierFreqListExt-v1360</i>, it includes the same number of entries, and listed in the same order, as in <i>interFreqCarrierFreqListExt-r12</i>.</p>
<p>interFreqNeighCellList List of inter-frequency neighbouring cells with specific cell re-selection parameters.</p>
<p>multiBandInfoList Indicates the list of frequency bands in addition to the band represented by <i>dl-CarrierFreq</i> for which cell reselection parameters are common. E-UTRAN indicates at most <i>maxMultiBands</i> frequency bands (i.e. the total number of entries across both <i>multiBandInfoList</i> and <i>multiBandInfoList-v9e0</i> is below this limit).</p>
<p>multiBandInfoList-v10j0 A list of <i>additionalPmax</i> and <i>additionalSpectrumEmission</i> values, as defined in TS 36.101 [42, table 6.2.4-1] for UEs neither in CE nor BL UEs and TS 36.101 [42, table 6.2.4E-1, for UEs in CE or BL UEs, for the frequency bands in <i>multiBandInfoList</i> (i.e. without suffix) and <i>multiBandInfoList-v9e0</i>. If E-UTRAN includes <i>multiBandInfoList-v10j0</i>, it includes the same number of entries, and listed in the same order, as in <i>multiBandInfoList</i> (i.e. without suffix). If E-UTRAN includes <i>multiBandInfoList-v1010</i> it includes the same number of entries, and listed in the same order, as in <i>multiBandInfoList-v10j0</i>.</p>
<p>p-Max Value applicable for the neighbouring E-UTRA cells on this carrier frequency. If absent the UE applies the maximum power according to its capability as specified in TS 36.101 [42], clause 6.2.2.</p>
<p>q-OffsetCell Parameter "Qoffset_{s,n}" in TS 36.304 [4].</p>
<p>q-OffsetFreq Parameter "Qoffset_{frequency}" in TS 36.304 [4].</p>
<p>q-QualMin Parameter "Q_{qualmin}" in TS 36.304 [4]. If the field is not present, the UE applies the (default) value of negative infinity for Q_{qualmin}. NOTE 1.</p>
<p>q-QualMinRSRQ-OnAllSymbols If this field is present and supported by the UE, the UE shall, when performing RSRQ measurements, perform RSRQ measurement on all OFDM symbols in accordance with TS 36.214 [48]. NOTE 1.</p>
<p>q-QualMinWB If this field is present and supported by the UE, the UE shall, when performing RSRQ measurements, use a wider bandwidth in accordance with TS 36.133 [16]. NOTE 1.</p>
<p>redistributionFactorFreq Parameter <i>redistributionFactorFreq</i> in TS 36.304 [4].</p>
<p>redistributionFactorCell Parameter <i>redistributionFactorCell</i> in TS 36.304 [4].</p>
<p>reducedMeasPerformance Value <i>TRUE</i> indicates that the neighbouring inter-frequency is configured for reduced measurement performance, see TS 36.133 [16]. If the field is not included, the neighbouring inter-frequency is configured for normal measurement performance, see TS 36.133 [16].</p>

SystemInformationBlockType5 field descriptions
scptm-FreqOffset Parameter $Q_{\text{offsetSCPTM}}$ in TS 36.304 [4]. Actual value $Q_{\text{offsetSCPTM}} = \text{field value} * 2$ [dB]. If the field is not present, the UE uses infinite dBs for the SC-PTM frequency offset with cell ranking as specified in TS 36.304 [4].
threshX-High Parameter "Thresh _{X, HighP} " in TS 36.304 [4].
threshX-HighQ Parameter "Thresh _{X, HighQ} " in TS 36.304 [4].
threshX-Low Parameter "Thresh _{X, LowP} " in TS 36.304 [4].
threshX-LowQ Parameter "Thresh _{X, LowQ} " in TS 36.304 [4].
t-ReselectionEUTRA Parameter "Treselction _{EUTRA} " in TS 36.304 [4].
t-ReselectionEUTRA-SF Parameter "Speed dependent ScalingFactor for Treselction _{EUTRA} " in TS 36.304 [4]. If the field is not present, the UE behaviour is specified in TS 36.304 [4].

NOTE 1: The value the UE applies for parameter " Q_{qualmin} " in TS 36.304 [4] depends on the q -QualMin fields signalled by E-UTRAN and supported by the UE. In case multiple candidate options are available, the UE shall select the highest priority candidate option according to the priority order indicated by the following table (top row is highest priority).

q-QualMinRSRQ-OnAllSymbols	q-QualMinWB	Value of parameter " Q_{qualmin} " in TS 36.304 [4]
Included	Included	$q\text{-QualMinRSRQ-OnAllSymbols} - (q\text{-QualMin} - q\text{-QualMinWB})$
Included	Not included	$q\text{-QualMinRSRQ-OnAllSymbols}$
Not included	Included	$q\text{-QualMinWB}$
Not included	Not included	$q\text{-QualMin}$

Conditional presence	Explanation
<i>dl-FreqMax</i>	The field is mandatory present if, for the corresponding entry in <i>InterFreqCarrierFreqList</i> (i.e. without suffix), <i>dl-CarrierFreq</i> (i.e. without suffix) is set to <i>maxEARFCN</i> . Otherwise the field is not present.
<i>QrxlevminCE1</i>	The field is optionally present, Need OR, if <i>q-RxLevMinCE1-r13</i> is set below -140 dBm. Otherwise the field is not present.
<i>RSRQ</i>	The field is mandatory present if <i>threshServingLowQ</i> is present in <i>systemInformationBlockType3</i> ; otherwise it is not present.
<i>RSRQ2</i>	The field is mandatory present for all EUTRA carriers listed in SIB5 if <i>q-QualMinRSRQ-OnAllSymbols</i> is present in SIB3; otherwise it is not present and the UE shall delete any existing value for this field.
<i>WB-RSRQ</i>	The field is optionally present, need OP if the measurement bandwidth indicated by <i>allowedMeasBandwidth</i> is 50 resource blocks or larger; otherwise it is not present.

SystemInformationBlockType6

The IE *SystemInformationBlockType6* contains information relevant only for inter-RAT cell re-selection i.e. information about UTRA frequencies and UTRA neighbouring cells relevant for cell re-selection. The IE includes cell re-selection parameters common for a frequency.

SystemInformationBlockType6 information element

```
-- ASN1START
SystemInformationBlockType6 ::= SEQUENCE {
    carrierFreqListUTRA-FDD      CarrierFreqListUTRA-FDD      OPTIONAL,      -- Need OR
    carrierFreqListUTRA-TDD      CarrierFreqListUTRA-TDD      OPTIONAL,      -- Need OR
    t-ReselectionUTRA            T-Reselection,
    t-ReselectionUTRA-SF         SpeedStateScaleFactors      OPTIONAL,      -- Need OP
    . . .
    lateNonCriticalExtension      OCTET STRING      (CONTAINING SystemInformationBlockType6-
v8h0-IEs)                       OPTIONAL,
    [[ carrierFreqListUTRA-FDD-v1250 SEQUENCE (SIZE (1..maxUTRA-FDD-Carrier)) OF
                                     CarrierFreqInfoUTRA-v1250      OPTIONAL,      -- Cond UTRA-FDD
    carrierFreqListUTRA-TDD-v1250 SEQUENCE (SIZE (1..maxUTRA-TDD-Carrier)) OF
```

```

        carrierFreqListUTRA-FDD-Ext-r12 CarrierFreqInfoUTRA-v1250 OPTIONAL, -- Cond UTRA-TDD
        carrierFreqListUTRA-TDD-Ext-r12 CarrierFreqListUTRA-FDD-Ext-r12 OPTIONAL, -- Cond UTRA-FDD
        carrierFreqListUTRA-TDD-Ext-r12 CarrierFreqListUTRA-TDD-Ext-r12 OPTIONAL -- Cond
UTRA-TDD
    ]]
}

SystemInformationBlockType6-v8h0-IEs ::= SEQUENCE {
    carrierFreqListUTRA-FDD-v8h0 SEQUENCE (SIZE (1..maxUTRA-FDD-Carrier)) OF CarrierFreqInfoUTRA-
FDD-v8h0 OPTIONAL, -- Cond UTRA-FDD
    nonCriticalExtension SEQUENCE {} OPTIONAL
}

CarrierFreqInfoUTRA-v1250 ::= SEQUENCE {
    reducedMeasPerformance-r12 ENUMERATED {true} OPTIONAL -- Need OP
}

CarrierFreqListUTRA-FDD ::= SEQUENCE (SIZE (1..maxUTRA-FDD-Carrier)) OF CarrierFreqUTRA-FDD

CarrierFreqUTRA-FDD ::= SEQUENCE {
    carrierFreq ARFCN-ValueUTRA,
    cellReselectionPriority CellReselectionPriority OPTIONAL, -- Need OP
    threshX-High ReselectionThreshold,
    threshX-Low ReselectionThreshold,
    q-RxLevMin INTEGER (-60..-13),
    p-MaxUTRA INTEGER (-50..33),
    q-QualMin INTEGER (-24..0),
    ...,
    [[ threshX-Q-r9 SEQUENCE {
        threshX-HighQ-r9 ReselectionThresholdQ-r9,
        threshX-LowQ-r9 ReselectionThresholdQ-r9
    } OPTIONAL -- Cond RSRQ
    ]]
}

CarrierFreqInfoUTRA-FDD-v8h0 ::= SEQUENCE {
    multiBandInfoList SEQUENCE (SIZE (1..maxMultiBands)) OF FreqBandIndicator-
UTRA-FDD OPTIONAL -- Need OR
}

CarrierFreqListUTRA-FDD-Ext-r12 ::= SEQUENCE (SIZE (1..maxUTRA-FDD-Carrier)) OF
CarrierFreqUTRA-FDD-Ext-r12

CarrierFreqUTRA-FDD-Ext-r12 ::= SEQUENCE {
    carrierFreq-r12 ARFCN-ValueUTRA,
    cellReselectionPriority-r12 CellReselectionPriority OPTIONAL, -- Need OP
    threshX-High-r12 ReselectionThreshold,
    threshX-Low-r12 ReselectionThreshold,
    q-RxLevMin-r12 INTEGER (-60..-13),
    p-MaxUTRA-r12 INTEGER (-50..33),
    q-QualMin-r12 INTEGER (-24..0),
    threshX-Q-r12 SEQUENCE {
        threshX-HighQ-r12 ReselectionThresholdQ-r9,
        threshX-LowQ-r12 ReselectionThresholdQ-r9
    } OPTIONAL, -- Cond RSRQ
    multiBandInfoList-r12 SEQUENCE (SIZE (1..maxMultiBands)) OF FreqBandIndicator-
UTRA-FDD OPTIONAL, -- Need OR
    reducedMeasPerformance-r12 ENUMERATED {true} OPTIONAL, -- Need OP
    ...
}

CarrierFreqListUTRA-TDD ::= SEQUENCE (SIZE (1..maxUTRA-TDD-Carrier)) OF CarrierFreqUTRA-TDD

CarrierFreqUTRA-TDD ::= SEQUENCE {
    carrierFreq ARFCN-ValueUTRA,
    cellReselectionPriority CellReselectionPriority OPTIONAL, -- Need OP
    threshX-High ReselectionThreshold,
    threshX-Low ReselectionThreshold,
    q-RxLevMin INTEGER (-60..-13),
    p-MaxUTRA INTEGER (-50..33),
    ...
}

CarrierFreqListUTRA-TDD-Ext-r12 ::= SEQUENCE (SIZE (1..maxUTRA-TDD-Carrier)) OF
CarrierFreqUTRA-TDD-r12

CarrierFreqUTRA-TDD-r12 ::= SEQUENCE {
    carrierFreq-r12 ARFCN-ValueUTRA,

```

```

cellReselectionPriority-r12      CellReselectionPriority      OPTIONAL,      -- Need OP
threshX-High-r12                ReselectionThreshold,
threshX-Low-r12                 ReselectionThreshold,
q-RxLevMin-r12                  INTEGER (-60..-13),
p-MaxUTRA-r12                   INTEGER (-50..33),
reducedMeasPerformance-r12     ENUMERATED {true}          OPTIONAL,      -- Need OP
...
}

FreqBandIndicator-UTRA-FDD ::=          INTEGER (1..86)

-- ASN1STOP

```

SystemInformationBlockType6 field descriptions

carrierFreqListUTRA-FDD	List of carrier frequencies of UTRA FDD. E-UTRAN does not configure more than one entry for the same physical frequency regardless of the ARFCN used to indicate this. If E-UTRAN includes <i>carrierFreqListUTRA-FDD-v8h0</i> and/or <i>carrierFreqListUTRA-FDD-v1250</i> , it includes the same number of entries, and listed in the same order, as in <i>carrierFreqListUTRA-FDD</i> (i.e. without suffix). See Annex D for more descriptions.
carrierFreqListUTRA-FDD-Ext	List of additional carrier frequencies of UTRA FDD. E-UTRAN does not configure more than one entry for the same physical frequency regardless of the ARFCN used to indicate this. EUTRAN may include <i>carrierFreqListUTRA-FDD-Ext</i> even if <i>carrierFreqListUTRA-FDD</i> (i.e without suffix) does not include <i>maxUTRA-FDD-Carrier</i> entries.
carrierFreqListUTRA-TDD	List of carrier frequencies of UTRA TDD. E-UTRAN does not configure more than one entry for the same physical frequency regardless of the ARFCN used to indicate this. If E-UTRAN includes <i>carrierFreqListUTRA-TDD-v1250</i> , it includes the same number of entries, and listed in the same order, as in <i>carrierFreqListUTRA-TDD</i> (i.e. without suffix).
carrierFreqListUTRA-TDD-Ext	List of additional carrier frequencies of UTRA TDD. E-UTRAN does not configure more than one entry for the same physical frequency regardless of the ARFCN used to indicate this. EUTRAN may include <i>carrierFreqListUTRA-TDD-Ext</i> even if <i>carrierFreqListUTRA-TDD</i> (i.e without suffix) does not include <i>maxUTRA-TDD-Carrier</i> entries.
multiBandInfoList	Indicates the list of frequency bands in addition to the band represented by <i>carrierFreq</i> in the <i>CarrierFreqUTRA-FDD</i> for which UTRA cell reselection parameters are common.
p-MaxUTRA	The maximum allowed transmission power on the (uplink) carrier frequency, see TS 25.304 [40]. In dBm
q-QualMin	Parameter "Q _{qualmin} " in TS 25.304 [40]. Actual value = field value [dB].
q-RxLevMin	Parameter "Q _{rxlevmin} " in TS 25.304 [40]. Actual value = field value * 2+1 [dBm].
reducedMeasPerformance	Value <i>TRUE</i> indicates that the UTRA carrier frequency is configured for reduced measurement performance, see TS 36.133 [16]. If the field is not included, the UTRA carrier frequency is configured for normal measurement performance, see TS 36.133 [16].
t-ReselectionUTRA	Parameter "T _{reselectionUTRAN} " in TS 36.304 [4].
t-ReselectionUTRA-SF	Parameter "Speed dependent ScalingFactor for T _{reselectionUTRA} " in TS 36.304 [4]. If the field is not present, the UE behaviour is specified in TS 36.304 [4].
threshX-High	Parameter "Thresh _{X, HighP} " in TS 36.304 [4].
threshX-HighQ	Parameter "Thresh _{X, HighQ} " in TS 36.304 [4].
threshX-Low	Parameter "Thresh _{X, LowP} " in TS 36.304 [4].
threshX-LowQ	Parameter "Thresh _{X, LowQ} " in TS 36.304 [4].

Conditional presence	Explanation
<i>RSRQ</i>	The field is mandatory present if the <i>threshServingLowQ</i> is present in <i>systemInformationBlockType3</i> ; otherwise it is not present.
<i>UTRA-FDD</i>	The field is optionally present, need OR, if the <i>carrierFreqListUTRA-FDD</i> is present. Otherwise it is not present.
<i>UTRA-TDD</i>	The field is optionally present, need OR, if the <i>carrierFreqListUTRA-TDD</i> is present. Otherwise it is not present.

– SystemInformationBlockType7

The IE *SystemInformationBlockType7* contains information relevant only for inter-RAT cell re-selection i.e. information about GERAN frequencies relevant for cell re-selection. The IE includes cell re-selection parameters for each frequency.

SystemInformationBlockType7 information element

```
-- ASN1START
SystemInformationBlockType7 ::= SEQUENCE {
    t-ReselectionGERAN          T-Reselection,
    t-ReselectionGERAN-SF      SpeedStateScaleFactors          OPTIONAL, -- Need OR
    carrierFreqsInfoList       CarrierFreqsInfoListGERAN        OPTIONAL, -- Need OR
    ...,
    lateNonCriticalExtension    OCTET STRING                      OPTIONAL
}
CarrierFreqsInfoListGERAN ::= SEQUENCE (SIZE (1..maxGNFG)) OF CarrierFreqsInfoGERAN
CarrierFreqsInfoGERAN ::= SEQUENCE {
    carrierFreqs                CarrierFreqsGERAN,
    commonInfo                  SEQUENCE {
        cellReselectionPriority  CellReselectionPriority          OPTIONAL, -- Need OP
        ncc-Permitted           BIT STRING (SIZE (8)),
        q-RxLevMin              INTEGER (0..45),
        p-MaxGERAN              INTEGER (0..39)                  OPTIONAL, -- Need OP
        threshX-High            ReselectionThreshold,
        threshX-Low             ReselectionThreshold
    },
    ...
}
-- ASN1STOP
```

SystemInformationBlockType7 field descriptions

carrierFreqs	The list of GERAN carrier frequencies organised into one group of GERAN carrier frequencies.
carrierFreqsInfoList	Provides a list of neighbouring GERAN carrier frequencies, which may be monitored for neighbouring GERAN cells. The GERAN carrier frequencies are organised in groups and the cell reselection parameters are provided per group of GERAN carrier frequencies.
commonInfo	Defines the set of cell reselection parameters for the group of GERAN carrier frequencies.
ncc-Permitted	Field encoded as a bit map, where bit N is set to "0" if a BCCH carrier with NCC = N-1 is not permitted for monitoring and set to "1" if the BCCH carrier with NCC = N-1 is permitted for monitoring; N = 1 to 8; bit 1 of the bitmap is the leading bit of the bit string.
p-MaxGERAN	Maximum allowed transmission power for GERAN on an uplink carrier frequency, see TS 45.008 [28]. Value in dBm. Applicable for the neighbouring GERAN cells on this carrier frequency. If <i>pmaxGERAN</i> is absent, the maximum power according to the UE capability is used.
q-RxLevMin	Parameter "Q _{rxlevmin} " in TS 36.304 [4], minimum required RX level in the GSM cell. The actual value of Q _{rxlevmin} in dBm = (field value * 2) – 115.
threshX-High	Parameter "Thresh _{X, HighP} " in TS 36.304 [4].
threshX-Low	Parameter "Thresh _{X, LowP} " in TS 36.304 [4].
t-ReselectionGERAN	Parameter "Tresselection _{GERAN} " in TS 36.304 [4].
t-ReselectionGERAN-SF	Parameter "Speed dependent ScalingFactor for Tresselection _{GERAN} " in TS 36.304 [4]. If the field is not present, the UE behaviour is specified in TS 36.304 [4].

SystemInformationBlockType8

The IE *SystemInformationBlockType8* contains information relevant only for inter-RAT cell re-selection i.e. information about CDMA2000 frequencies and CDMA2000 neighbouring cells relevant for cell re-selection. The IE includes cell re-selection parameters common for a frequency as well as cell specific re-selection parameters.

SystemInformationBlockType8 information element

```
-- ASN1START
SystemInformationBlockType8 ::= SEQUENCE {
    systemTimeInfo          SystemTimeInfoCDMA2000          OPTIONAL, -- Need OR
    searchWindowSize        INTEGER (0..15)                OPTIONAL, -- Need OR
    parametersHRPD          SEQUENCE {
        preRegistrationInfoHRPD      PreRegistrationInfoHRPD,
        cellReselectionParametersHRPD CellReselectionParametersCDMA2000 OPTIONAL -- Need OR
    }
    parameters1XRTT        SEQUENCE {
        csfb-RegistrationParam1XRTT   CSFB-RegistrationParam1XRTT   OPTIONAL, -- Need OP
        longCodeState1XRTT           BIT STRING (SIZE (42))        OPTIONAL, -- Need OR
        cellReselectionParameters1XRTT CellReselectionParametersCDMA2000 OPTIONAL -- Need OR
    }
    . . .
    lateNonCriticalExtension OCTET STRING                  OPTIONAL,
    [[ csfb-SupportForDualRxUEs-r9   BOOLEAN                      OPTIONAL, -- Need OR
    cellReselectionParametersHRPD-v920 CellReselectionParametersCDMA2000-v920 OPTIONAL, --
Cond NCL-HRPD
    cellReselectionParameters1XRTT-v920 CellReselectionParametersCDMA2000-v920 OPTIONAL, --
Cond NCL-1XRTT
    csfb-RegistrationParam1XRTT-v920   CSFB-RegistrationParam1XRTT-v920   OPTIONAL, --
Cond REG-1XRTT
    ac-BarringConfig1XRTT-r9           AC-BarringConfig1XRTT-r9       OPTIONAL -- Cond REG-
1XRTT
    ]],
    [[ csfb-DualRxTxSupport-r10       ENUMERATED {true}           OPTIONAL -- Cond REG-
1XRTT
    ]],
    [[ sib8-PerPLMN-List-r11          SIB8-PerPLMN-List-r11       OPTIONAL -- Need OR
    ]]
}

CellReselectionParametersCDMA2000 ::= SEQUENCE {
    bandClassList          BandClassListCDMA2000,
    neighCellList          NeighCellListCDMA2000,
    t-ReselectionCDMA2000  T-Reselection,
    t-ReselectionCDMA2000-SF SpeedStateScaleFactors          OPTIONAL -- Need OP
}

CellReselectionParametersCDMA2000-r11 ::= SEQUENCE {
    bandClassList          BandClassListCDMA2000,
    neighCellList-r11     SEQUENCE (SIZE (1..16)) OF NeighCellCDMA2000-r11,
    t-ReselectionCDMA2000  T-Reselection,
    t-ReselectionCDMA2000-SF SpeedStateScaleFactors          OPTIONAL -- Need OP
}

CellReselectionParametersCDMA2000-v920 ::= SEQUENCE {
    neighCellList-v920     NeighCellListCDMA2000-v920
}

NeighCellListCDMA2000 ::= SEQUENCE (SIZE (1..16)) OF NeighCellCDMA2000

NeighCellCDMA2000 ::= SEQUENCE {
    bandClass              BandclassCDMA2000,
    neighCellsPerFreqList NeighCellsPerBandclassListCDMA2000
}

NeighCellCDMA2000-r11 ::= SEQUENCE {
    bandClass              BandclassCDMA2000,
    neighFreqInfoList-r11 SEQUENCE (SIZE (1..16)) OF NeighCellsPerBandclassCDMA2000-
r11
}

NeighCellsPerBandclassListCDMA2000 ::= SEQUENCE (SIZE (1..16)) OF NeighCellsPerBandclassCDMA2000

NeighCellsPerBandclassCDMA2000 ::= SEQUENCE {
    arfcn                  ARFCN-ValueCDMA2000,
```

```

    physCellIdList                PhysCellIdListCDMA2000
}

NeighCellsPerBandclassCDMA2000-r11 ::= SEQUENCE {
    arfcn                          ARFCN-ValueCDMA2000,
    physCellIdList-r11            SEQUENCE (SIZE (1..40)) OF PhysCellIdCDMA2000
}

NeighCellListCDMA2000-v920 ::= SEQUENCE (SIZE (1..16)) OF NeighCellCDMA2000-v920

NeighCellCDMA2000-v920 ::= SEQUENCE {
    neighCellsPerFreqList-v920    NeighCellsPerBandclassListCDMA2000-v920
}

NeighCellsPerBandclassListCDMA2000-v920 ::= SEQUENCE (SIZE (1..16)) OF
NeighCellsPerBandclassCDMA2000-v920

NeighCellsPerBandclassCDMA2000-v920 ::= SEQUENCE {
    physCellIdList-v920           PhysCellIdListCDMA2000-v920
}

PhysCellIdListCDMA2000 ::= SEQUENCE (SIZE (1..16)) OF PhysCellIdCDMA2000

PhysCellIdListCDMA2000-v920 ::= SEQUENCE (SIZE (0..24)) OF PhysCellIdCDMA2000

BandclassListCDMA2000 ::= SEQUENCE (SIZE (1..maxCDMA-BandClass)) OF BandClassInfoCDMA2000

BandClassInfoCDMA2000 ::= SEQUENCE {
    bandClass                      BandclassCDMA2000,
    cellReselectionPriority        CellReselectionPriority                OPTIONAL, -- Need OP
    threshX-High                  INTEGER (0..63),
    threshX-Low                   INTEGER (0..63),
    ...
}

AC-BarringConfig1XRTT-r9 ::= SEQUENCE {
    ac-Barring0to9-r9             INTEGER (0..63),
    ac-Barring10-r9              INTEGER (0..7),
    ac-Barring11-r9              INTEGER (0..7),
    ac-Barring12-r9              INTEGER (0..7),
    ac-Barring13-r9              INTEGER (0..7),
    ac-Barring14-r9              INTEGER (0..7),
    ac-Barring15-r9              INTEGER (0..7),
    ac-BarringMsg-r9             INTEGER (0..7),
    ac-BarringReg-r9             INTEGER (0..7),
    ac-BarringEmg-r9             INTEGER (0..7)
}

SIB8-PerPLMN-List-r11 ::= SEQUENCE (SIZE (1..maxPLMN-r11)) OF SIB8-PerPLMN-r11

SIB8-PerPLMN-r11 ::= SEQUENCE {
    plmn-Identity-r11            INTEGER (1..maxPLMN-r11),
    parametersCDMA2000-r11      CHOICE {
        explicitValue            ParametersCDMA2000-r11,
        defaultValue             NULL
    }
}

ParametersCDMA2000-r11 ::= SEQUENCE {
    systemTimeInfo-r11          CHOICE {
        explicitValue            SystemTimeInfoCDMA2000,
        defaultValue             NULL
    }
    searchWindowSize-r11        INTEGER (0..15),
    parametersHRPD-r11          SEQUENCE {
        preRegistrationInfoHRPD-r11 PreRegistrationInfoHRPD,
        cellReselectionParametersHRPD-r11 CellReselectionParametersCDMA2000-r11 OPTIONAL -- Need
OR
    }
    parameters1XRTT-r11        SEQUENCE {
        csfb-RegistrationParam1XRTT-r11 CSFB-RegistrationParam1XRTT                OPTIONAL, -- Need OP
        csfb-RegistrationParam1XRTT-Ext-r11 CSFB-RegistrationParam1XRTT-v920        OPTIONAL, -- Cond
REG-1XRTT-PerPLMN
        longCodeState1XRTT-r11        BIT STRING (SIZE (42)) OPTIONAL, -- Cond PerPLMN-LC
        cellReselectionParameters1XRTT-r11 CellReselectionParametersCDMA2000-r11 OPTIONAL, --
Need OR
        ac-BarringConfig1XRTT-r11        AC-BarringConfig1XRTT-r9                OPTIONAL, -- Cond
REG-1XRTT-PerPLMN

```



```

        csfb-SupportForDualRxUEs-r11          BOOLEAN          OPTIONAL, -- Need OR
        csfb-DualRxTxSupport-r11             ENUMERATED {true}    OPTIONAL -- Cond REG-1XRTT-
PerPLMN
    }          OPTIONAL, -- Need OR
    ...
}
-- ASN1STOP

```

SystemInformationBlockType8 field descriptions

ac-BarringConfig1XRTT

Contains the access class barring parameters the UE uses to calculate the access class barring factor, see C.S0097 [53].

ac-Barring0to9

Parameter used for calculating the access class barring factor for access overload classes 0 through 9. It is the parameter "PSIST" in C.S0004 [34] for access overload classes 0 through 9.

ac-BarringEmg

Parameter used for calculating the access class barring factor for emergency calls and emergency message transmissions for access overload classes 0 through 9. It is the parameter "PSIST_EMG" in C.S0004 [34].

ac-BarringMsg

Parameter used for modifying the access class barring factor for message transmissions. It is the parameter "MSG_PSIST" in C.S0004 [34].

ac-BarringN

Parameter used for calculating the access class barring factor for access overload class N (N = 10 to 15). It is the parameter "PSIST" in C.S0004 [34] for access overload class N.

ac-BarringReg

Parameter used for modifying the access class barring factor for autonomous registrations. It is the parameter "REG_PSIST" in C.S0004 [34].

bandClass

Identifies the Frequency Band in which the Carrier can be found. Details can be found in C.S0057 [24, Table 1.5].

bandClassList

List of CDMA2000 frequency bands.

cellReselectionParameters1XRTT

Cell reselection parameters applicable only to CDMA2000 1xRTT system.

cellReselectionParameters1XRTT-Ext

Cell reselection parameters applicable for cell reselection to CDMA2000 1XRTT system.

cellReselectionParameters1XRTT-v920

Cell reselection parameters applicable for cell reselection to CDMA2000 1XRTT system. The field is not present if *cellReselectionParameters1XRTT* is not present; otherwise it is optionally present.

cellReselectionParametersHRPD

Cell reselection parameters applicable for cell reselection to CDMA2000 HRPD system

cellReselectionParametersHRPD-Ext

Cell reselection parameters applicable for cell reselection to CDMA2000 HRPD system.

cellReselectionParametersHRPD-v920

Cell reselection parameters applicable for cell reselection to CDMA2000 HRPD system. The field is not present if *cellReselectionParametersHRPD* is not present; otherwise it is optionally present.

csfb-DualRxTxSupport

Value TRUE indicates that the network supports dual Rx/Tx enhanced 1xCSFB, which enables UEs capable of dual Rx/Tx enhanced 1xCSFB to switch off their 1xRTT receiver/transmitter while camped in E-UTRAN [51].

csfb-RegistrationParam1XRTT

Contains the parameters the UE will use to determine if it should perform a CDMA2000 1xRTT Registration/Re-Registration. This field is included if either CSFB or enhanced CS fallback to CDMA2000 1xRTT is supported.

csfb-SupportForDualRxUEs

Value TRUE indicates that the network supports dual Rx CSFB [51].

longCodeState1XRTT

The state of long code generation registers in CDMA2000 1XRTT system as defined in C.S0002 [12, Clause 1.3] at $\lceil t/10 \rceil \times 10 + 320$ ms, where t equals to the *cdma-SystemTime*. This field is required for reporting CGI for 1xRTT, SRVCC handover and enhanced CS fallback to CDMA2000 1xRTT operation. Otherwise this IE is not needed. This field is excluded when estimating changes in system information, i.e. changes of *longCodeState1XRTT* should neither result in system information change notifications nor in a modification of *systemInfoValue Tag* in SIB1.

SystemInformationBlockType8 field descriptions
<p>neighCellList List of CDMA2000 neighbouring cells. The total number of neighbouring cells in neighCellList for each RAT (1XRTT or HRPD) is limited to 32.</p>
<p>neighCellList-v920 Extended List of CDMA2000 neighbouring cells. The combined total number of CDMA2000 neighbouring cells in both <i>neighCellList</i> and <i>neighCellList-v920</i> is limited to 32 for HRPD and 40 for 1xRTT.</p>
<p>neighCellsPerFreqList List of carrier frequencies and neighbour cell ids in each frequency within a CDMA2000 Band, see C.S0002 [12] or C.S0024 [26].</p>
<p>neighCellsPerFreqList-v920 Extended list of neighbour cell ids, in the same CDMA2000 Frequency Band as the corresponding instance in "NeighCellListCDMA2000".</p>
<p>parameters1XRTT Parameters applicable for interworking with CDMA2000 1XRTT system.</p>
<p>parametersCDMA2000 Provides the corresponding SIB8 parameters for the CDMA2000 network associated with the PLMN indicated in <i>plmn-Identity</i>. A choice is used to indicate whether for this PLMN the parameters are signalled explicitly or set to the (default) values common for all PLMNs i.e. the values not included in <i>sib8-PerPLMN-List</i>.</p>
<p>parametersHRPD Parameters applicable only for interworking with CDMA2000 HRPD systems.</p>
<p>physCellIdList Identifies the list of CDMA2000 cell ids, see C.S0002 [12] or C.S0024 [26].</p>
<p>physCellIdList-v920 Extended list of CDMA2000 cell ids, in the same CDMA2000 ARFCN as the corresponding instance in "NeighCellsPerBandclassCDMA2000".</p>
<p>plmn-Identity Indicates the PLMN associated with this CDMA2000 network. Value 1 indicates the PLMN listed 1st in the 1st <i>plmn-IdentityList</i> included in SIB1, value 2 indicates the PLMN listed 2nd in the same <i>plmn-IdentityList</i>, or when no more PLMN are present within the same <i>plmn-identityList</i>, then the PLMN listed 1st in the subsequent <i>plmn-IdentityList</i> within the same SIB1 and so on. A PLMN which identity is not indicated in the <i>sib8-PerPLMN-List</i>, does not support inter-working with CDMA2000.</p>
<p>preRegistrationInfoHRPD The CDMA2000 HRPD Pre-Registration Information tells the UE if it should pre-register with the CDMA2000 HRPD network and identifies the Pre-registration zone to the UE.</p>
<p>searchWindowSize The search window size is a CDMA2000 parameter to be used to assist in searching for the neighbouring pilots. For values see C.S0005 [25, Table 2.6.6.2.1-1] and C.S0024 [26, Table 8.7.6.2-4]. This field is required for a UE with <i>rx-ConfigHRPD= single</i> and/ or <i>rx-Config1XRTT= single</i> to perform handover, cell re-selection, UE measurement based redirection and enhanced 1xRTT CS fallback from E-UTRAN to CDMA2000 according to this specification and TS 36.304 [4].</p>
<p>sib8-PerPLMN-List This field provides the values for the interworking CDMA2000 networks corresponding, if any, to the UE's RPLMN.</p>
<p>systemTimeInfo Information on CDMA2000 system time. This field is required for a UE with <i>rx-ConfigHRPD= single</i> and/ or <i>rx-Config1XRTT= single</i> to perform handover, cell re-selection, UE measurement based redirection and enhanced 1xRTT CS fallback from E-UTRAN to CDMA2000 according to this specification and TS 36.304 [4]. This field is excluded when estimating changes in system information, i.e. changes of <i>systemTimeInfo</i> should neither result in system information change notifications nor in a modification of <i>systemInfoValueTag</i> in SIB1. For the field included in <i>ParametersCDMA2000</i>, a choice is used to indicate whether for this PLMN the parameters are signalled explicitly or set to the (default) value common for all PLMNs i.e. the value not included in <i>sib8-PerPLMN-List</i>.</p>
<p>threshX-High Parameter "Thresh_{X, HighP}" in TS 36.304 [4]. This specifies the high threshold used in reselection towards this CDMA2000 band class expressed as an unsigned binary number equal to FLOOR $(-2 \times 10 \times \log_{10} E_c/I_0)$ in units of 0.5 dB, as defined in C.S0005 [25].</p>
<p>threshX-Low Parameter "Thresh_{X, LowP}" in TS 36.304 [4]. This specifies the low threshold used in reselection towards this CDMA2000 band class expressed as an unsigned binary number equal to FLOOR $(-2 \times 10 \times \log_{10} E_c/I_0)$ in units of 0.5 dB, as defined in C.S0005 [25].</p>
<p>t-ReselectionCDMA2000 Parameter "Treselction_{CDMA_HRPD}" or "Treselction_{CDMA_1xRTT}" in TS 36.304 [4].</p>

SystemInformationBlockType8 field descriptions	
t-ReselectionCDMA2000-SF	
Parameter "Speed dependent ScalingFactor for Treselection _{CDMA-HRPD} " or Treselection _{CDMA-1XRTT} " in TS 36.304 [4]. If the field is not present, the UE behaviour is specified in TS 36.304 [4].	

Conditional presence	Explanation
<i>NCL-1XRTT</i>	The field is optional present, need OR, if <i>cellReselectionParameters1xRTT</i> is present; otherwise it is not present.
<i>NCL-HRPD</i>	The field is optional present, need OR, if <i>cellReselectionParametersHRPD</i> is present; otherwise it is not present.
<i>PerPLMN-LC</i>	The field is optional present, need OR, when <i>systemTimeInfo</i> is included in <i>SIB8PerPLMN</i> for this CDMA2000 network; otherwise it is not present.
<i>REG-1XRTT</i>	The field is optional present, need OR, if <i>csfb-RegistrationParam1XRTT</i> is present; otherwise it is not present.
<i>REG-1XRTT-PerPLMN</i>	The field is optional present, need OR, if <i>csfb-RegistrationParam1XRTT</i> is included in <i>SIB8PerPLMN</i> for this CDMA2000 network; otherwise it is not present.

– SystemInformationBlockType9

The IE *SystemInformationBlockType9* contains a home eNB name (HNB Name).

SystemInformationBlockType9 information element

```
-- ASN1START
SystemInformationBlockType9 ::= SEQUENCE {
    hnb-Name                OCTET STRING (SIZE(1..48))    OPTIONAL,    -- Need OR
    . . . ,
    lateNonCriticalExtension OCTET STRING                OPTIONAL
}
-- ASN1STOP
```

SystemInformationBlockType9 field descriptions	
hnb-Name	
Carries the name of the home eNB, coded in UTF-8 with variable number of bytes per character, see TS 22.011 [10].	

– SystemInformationBlockType10

The IE *SystemInformationBlockType10* contains an ETWS primary notification.

SystemInformationBlockType10 information element

```
-- ASN1START
SystemInformationBlockType10 ::= SEQUENCE {
    messageIdentifier        BIT STRING (SIZE (16)),
    serialNumber             BIT STRING (SIZE (16)),
    warningType              OCTET STRING (SIZE (2)),
    dummy                   OCTET STRING (SIZE (50))    OPTIONAL,    -- Need OP
    . . . ,
    lateNonCriticalExtension OCTET STRING                OPTIONAL
}
-- ASN1STOP
```

SystemInformationBlockType10 field descriptions
<p>messageIdentifier</p> <p>Identifies the source and type of ETWS notification. The leading bit (which is equivalent to the leading bit of the equivalent IE defined in TS 36.413 [39, 9.2.1.44]) contains bit 7 of the first octet of the equivalent IE, defined in and encoded according to TS 23.041 [37, 9.4.3.2.1], while the trailing bit contains bit 0 of the second octet of the same equivalent IE.</p>
<p>serialNumber</p> <p>Identifies variations of an ETWS notification. The leading bit (which is equivalent to the leading bit of the equivalent IE defined in TS 36.413 [39, 9.2.1.45]) contains bit 7 of the first octet of the equivalent IE, defined in and encoded according to TS 23.041 [37, 9.4.3.2.2], while the trailing bit contains bit 0 of the second octet of the same equivalent IE.</p>
<p>dummy</p> <p>This field is not used in the specification. If received it shall be ignored by the UE.</p>
<p>warningType</p> <p>Identifies the warning type of the ETWS primary notification and provides information on emergency user alert and UE popup. The first octet (which is equivalent to the first octet of the equivalent IE defined in TS 36.413 [39, 9.2.1.50]) contains the first octet of the equivalent IE defined in and encoded according to TS 23.041 [37, 9.3.24], and so on.</p>

– SystemInformationBlockType11

The IE *SystemInformationBlockType11* contains an ETWS secondary notification.

SystemInformationBlockType11 information element

```

-- ASN1START
SystemInformationBlockType11 ::= SEQUENCE {
    messageIdentifier          BIT STRING (SIZE (16)),
    serialNumber              BIT STRING (SIZE (16)),
    warningMessageSegmentType ENUMERATED {notLastSegment, lastSegment},
    warningMessageSegmentNumber INTEGER (0..63),
    warningMessageSegment     OCTET STRING,
    dataCodingScheme          OCTET STRING (SIZE (1))    OPTIONAL,  -- Cond Segment1
    . . .
    lateNonCriticalExtension  OCTET STRING              OPTIONAL
}
-- ASN1STOP

```

SystemInformationBlockType11 field descriptions
<p>dataCodingScheme</p> <p>Identifies the alphabet/coding and the language applied variations of an ETWS notification. The octet (which is equivalent to the octet of the equivalent IE defined in TS 36.413 [39, 9.2.1.52]) contains the octet of the equivalent IE defined in TS 23.041 [37, 9.4.3.2.3] and encoded according to TS 23.038 [38].</p>
<p>messageIdentifier</p> <p>Identifies the source and type of ETWS notification. The leading bit (which is equivalent to the leading bit of the equivalent IE defined in TS 36.413 [39, 9.2.1.44]) contains bit 7 of the first octet of the equivalent IE, defined in and encoded according to TS 23.041 [37, 9.4.3.2.1], while the trailing bit contains bit 0 of second octet of the same equivalent IE.</p>
<p>serialNumber</p> <p>Identifies variations of an ETWS notification. The leading bit (which is equivalent to the leading bit of the equivalent IE defined in TS 36.413 [39, 9.2.1.45]) contains bit 7 of the first octet of the equivalent IE, defined in and encoded according to TS 23.041 [37, 9.4.3.2.2], while the trailing bit contains bit 0 of second octet of the same equivalent IE.</p>
<p>warningMessageSegment</p> <p>Carries a segment of the <i>Warning Message Contents</i> IE defined in TS 36.413 [39, 9.2.1.53]. The first octet of the <i>Warning Message Contents</i> IE is equivalent to the first octet of the <i>CB data</i> IE defined in and encoded according to TS 23.041 [37, 9.4.2.2.5] and so on.</p>
<p>warningMessageSegmentNumber</p> <p>Segment number of the ETWS warning message segment contained in the SIB. A segment number of zero corresponds to the first segment, one corresponds to the second segment, and so on.</p>
<p>warningMessageSegmentType</p> <p>Indicates whether the included ETWS warning message segment is the last segment or not.</p>

Conditional presence	Explanation
<i>Segment1</i>	The field is mandatory present in the first segment of SIB11, otherwise it is not present.

– SystemInformationBlockType12

The IE *SystemInformationBlockType12* contains a CMAS notification.

SystemInformationBlockType12 information element

```
-- ASN1START
SystemInformationBlockType12-r9 ::= SEQUENCE {
  messageIdentifier-r9          BIT STRING (SIZE (16)),
  serialNumber-r9              BIT STRING (SIZE (16)),
  warningMessageSegmentType-r9 ENUMERATED {notLastSegment, lastSegment},
  warningMessageSegmentNumber-r9 INTEGER (0..63),
  dataCodingScheme-r9          OCTET STRING,
  lateNonCriticalExtension      OCTET STRING (SIZE (1))    OPTIONAL, -- Cond Segment1
  ...
}
-- ASN1STOP
```

SystemInformationBlockType12 field descriptions

<i>dataCodingScheme</i>	Identifies the alphabet/coding and the language applied variations of a CMAS notification. The octet (which is equivalent to the octet of the equivalent IE defined in TS 36.413 [39, 9.2.1.52]) contains the octet of the equivalent IE defined in TS 23.041 [37, 9.4.3.2.3] and encoded according to TS 23.038 [38].
<i>messageIdentifier</i>	Identifies the source and type of CMAS notification. The leading bit (which is equivalent to the leading bit of the equivalent IE defined in TS 36.413 [39, 9.2.1.44]) contains bit 7 of the first octet of the equivalent IE, defined in and encoded according to TS 23.041 [37, 9.4.3.2.1], while the trailing bit contains bit 0 of second octet of the same equivalent IE.
<i>serialNumber</i>	Identifies variations of a CMAS notification. The leading bit (which is equivalent to the leading bit of the equivalent IE defined in TS 36.413 [39, 9.2.1.45]) contains bit 7 of the first octet of the equivalent IE, defined in and encoded according to TS 23.041 [37, 9.4.3.2.2], while the trailing bit contains bit 0 of second octet of the same equivalent IE.
<i>warningMessageSegment</i>	Carries a segment of the <i>Warning Message Contents</i> IE defined in TS 36.413 [39]. The first octet of the <i>Warning Message Contents</i> IE is equivalent to the first octet of the <i>CB data</i> IE defined in and encoded according to TS 23.041 [37, 9.4.2.2.5] and so on.
<i>warningMessageSegmentNumber</i>	Segment number of the CMAS warning message segment contained in the SIB. A segment number of zero corresponds to the first segment, one corresponds to the second segment, and so on.
<i>warningMessageSegmentType</i>	Indicates whether the included CMAS warning message segment is the last segment or not.

Conditional presence	Explanation
<i>Segment1</i>	The field is mandatory present in the first segment of SIB12, otherwise it is not present.

– SystemInformationBlockType13

The IE *SystemInformationBlockType13* contains the information required to acquire the MBMS control information associated with one or more MBSFN areas.

SystemInformationBlockType13 information element

```
-- ASN1START
SystemInformationBlockType13-r9 ::= SEQUENCE {
  mbsfn-AreaInfoList-r9      MBSFN-AreaInfoList-r9,
  notificationConfig-r9      MBMS-NotificationConfig-r9,
  lateNonCriticalExtension    OCTET STRING                OPTIONAL,
  ...
}
```

```

notificationConfig-v1430          MBMS-NotificationConfig-v1430          OPTIONAL
]]
}
-- ASN1STOP

```

SystemInformationBlockType13 field descriptions

notificationConfig

Indicates the MBMS notification related configuration parameters. The UE shall ignore this field when *dl-Bandwidth* included in *MasterInformationBlock* is set to *n6*.

– SystemInformationBlockType14

The IE *SystemInformationBlockType14* contains the EAB parameters.

SystemInformationBlockType14 information element

```

-- ASN1START
SystemInformationBlockType14-r11 ::= SEQUENCE {
    eab-Param-r11          CHOICE {
        eab-Common-r11    EAB-Config-r11,
        eab-PerPLMN-List-r11 SEQUENCE (SIZE (1..maxPLMN-r11)) OF EAB-ConfigPLMN-
r11
    }
    lateNonCriticalExtension OCTET STRING OPTIONAL, -- Need OR
    ...                      OPTIONAL,
}
EAB-ConfigPLMN-r11 ::= SEQUENCE {
    eab-Config-r11        EAB-Config-r11        OPTIONAL -- Need OR
}
EAB-Config-r11 ::= SEQUENCE {
    eab-Category-r11      ENUMERATED {a, b, c},
    eab-BarringBitmap-r11 BIT STRING (SIZE (10))
}
-- ASN1STOP

```

SystemInformationBlockType14 field descriptions

eab-BarringBitmap

Extended access class barring for AC 0-9. The first/ leftmost bit is for AC 0, the second bit is for AC 1, and so on.

eab-Category

Indicates the category of UEs for which EAB applies. Value *a* corresponds to all UEs, value *b* corresponds to the UEs that are neither in their HPLMN nor in a PLMN that is equivalent to it, and value *c* corresponds to the UEs that are neither in the PLMN listed as most preferred PLMN of the country where the UEs are roaming in the operator-defined PLMN selector list on the USIM, nor in their HPLMN nor in a PLMN that is equivalent to their HPLMN, see TS 22.011 [10].

eab-Common

The EAB parameters applicable for all PLMN(s).

eab-PerPLMN-List

The EAB parameters per PLMN, listed in the same order as the PLMN(s) listed across the *plmn-IdentityList* fields in *SystemInformationBlockType1*.

– SystemInformationBlockType15

The IE *SystemInformationBlockType15* contains the MBMS Service Area Identities (SAI) of the current and/ or neighbouring carrier frequencies.

SystemInformationBlockType15 information element

```

-- ASN1START
SystemInformationBlockType15-r11 ::= SEQUENCE {
    mbms-SAI-IntraFreq-r11          MBMS-SAI-List-r11          OPTIONAL, -- Need OR
    mbms-SAI-InterFreqList-r11     MBMS-SAI-InterFreqList-r11 OPTIONAL, -- Need OR
}

```

```

    lateNonCriticalExtension          OCTET STRING          OPTIONAL,
    ...,
    [[ mbms-SAI-InterFreqList-v1140  MBMS-SAI-InterFreqList-v1140  OPTIONAL  -- Cond
InterFreq
    ]],
    [[ mbms-IntraFreqCarrierType-r14  MBMS-CarrierType-r14          OPTIONAL,  -- Need OR
      mbms-InterFreqCarrierTypeList-r14
                                          MBMS-InterFreqCarrierTypeList-r14  OPTIONAL  -- Need
OR
    ]]
}

MBMS-SAI-List-r11 ::=                SEQUENCE (SIZE (1..maxSAI-MBMS-r11)) OF MBMS-SAI-r11
MBMS-SAI-r11 ::=                      INTEGER (0..65535)
MBMS-SAI-InterFreqList-r11 ::=       SEQUENCE (SIZE (1..maxFreq)) OF MBMS-SAI-InterFreq-r11
MBMS-SAI-InterFreqList-v1140 ::=    SEQUENCE (SIZE (1..maxFreq)) OF MBMS-SAI-InterFreq-v1140
MBMS-SAI-InterFreq-r11 ::=           SEQUENCE {
    dl-CarrierFreq-r11                ARFCN-ValueEUTRA-r9,
    mbms-SAI-List-r11                  MBMS-SAI-List-r11
}

MBMS-SAI-InterFreq-v1140 ::=         SEQUENCE {
    MultiBandInfoList-r11              MultiBandInfoList-r11          OPTIONAL  -- Need OR
}

MBMS-InterFreqCarrierTypeList-r14 ::= SEQUENCE (SIZE (1..maxFreq)) OF MBMS-CarrierType-r14
MBMS-CarrierType-r14 ::=             SEQUENCE {
    carrierType-r14                    ENUMERATED {mbms, fembmsMixed, fembmsDedicated},
    frameOffset-r14                    INTEGER (0..3)                  OPTIONAL  -- Need OR
}

-- ASN1STOP

```

SystemInformationBlockType15 field descriptions

carrierType	Indicates whether the carrier is pre-Rel-14 MBMS carrier (<i>mbms</i>) or FeMBMS/Unicast mixed carrier (<i>fembmsMixed</i>) or MBMS-dedicated carrier (<i>fembmsDedicated</i>).
frameOffset	For MBMS-dedicated carrier, the <i>frameOffset</i> gives the radio frame which contains PBCH by SFN mod 4 = <i>frameOffset</i> .
mbms-InterFreqCarrierTypeList	Indicates whether this is an FeMBMS carrier. The field is included only if <i>mbms-SAI-InterFreqList-r11</i> is included. The number of entries is the same in both fields and carrier type relates to the frequency indicated in <i>mbms-SAI-InterFreqList-r11</i> in the corresponding entry index.
mbms-IntraFreqCarrierType	Contains indication whether the carrier is pre-Rel-14 MBMS carrier, FeMBMS/Unicast mixed carrier or MBMS-dedicated carrier.
mbms-SAI-InterFreqList	Contains a list of neighboring frequencies including additional bands, if any, that provide MBMS services and the corresponding MBMS SAIs.
mbms-SAI-IntraFreq	Contains the list of MBMS SAIs for the current frequency. A duplicate MBMS SAI indicates that this and all following SAIs are not offered by this cell but only by neighbour cells on the current frequency. For MBMS service continuity, the UE shall use all MBMS SAIs listed in <i>mbms-SAI-IntraFreq</i> to derive the MBMS frequencies of interest.
mbms-SAI-List	Contains a list of MBMS SAIs for a specific frequency.
multiBandInfoList	A list of additional frequency bands applicable for the cells participating in the MBSFN transmission.

Conditional presence	Explanation
<i>InterFreq</i>	The field is optionally present, need OR, if the <i>mbms-SAI-InterFreqList-r11</i> is present. Otherwise it is not present.

– SystemInformationBlockType16

The IE *SystemInformationBlockType16* contains information related to GPS time and Coordinated Universal Time (UTC). The UE may use the parameters provided in this system information block to obtain the UTC, the GPS and the local time.

NOTE: The UE may use the time information for numerous purposes, possibly involving upper layers e.g. to assist GPS initialisation, to synchronise the UE clock (a.o. to determine MBMS session start/ stop).

SystemInformationBlockType16 information element

```
-- ASN1START
SystemInformationBlockType16-r11 ::= SEQUENCE {
    timeInfo-r11 SEQUENCE {
        timeInfoUTC-r11 INTEGER (0..549755813887),
        dayLightSavingTime-r11 BIT STRING (SIZE (2)) OPTIONAL, -- Need OR
        leapSeconds-r11 INTEGER (-127..128) OPTIONAL, -- Need OR
        localTimeOffset-r11 INTEGER (-63..64) OPTIONAL, -- Need OR
    }
    lateNonCriticalExtension OCTET STRING OPTIONAL,
    ...
}
-- ASN1STOP
```

SystemInformationBlockType16 field descriptions

dayLightSavingTime

It indicates if and how daylight saving time (DST) is applied to obtain the local time. The semantics is the same as the semantics of the *Daylight Saving Time* IE in TS 24.301 [35] and TS 24.008 [49]. The first/leftmost bit of the bit string contains the b2 of octet 3, i.e. the value part of the *Daylight Saving Time* IE, and the second bit of the bit string contains b1 of octet 3.

leapSeconds

Number of leap seconds offset between GPS Time and UTC. UTC and GPS time are related i.e. GPS time - *leapSeconds* = UTC time.

localTimeOffset

Offset between UTC and local time in units of 15 minutes. Actual value = field value * 15 minutes. Local time of the day is calculated as UTC time + *localTimeOffset*.

timeInfoUTC

Coordinated Universal Time corresponding to the SFN boundary at or immediately after the ending boundary of the SI-window in which *SystemInformationBlockType16* is transmitted. The field counts the number of UTC seconds in 10 ms units since 00:00:00 on Gregorian calendar date 1 January, 1900 (midnight between Sunday, December 31, 1899 and Monday, January 1, 1900). NOTE 1.

This field is excluded when estimating changes in system information, i.e. changes of *timeInfoUTC* should neither result in system information change notifications nor in a modification of *systemInfoValueTag* in SIB1.

NOTE 1: The UE may use this field together with the *leapSeconds* field to obtain GPS time as follows: GPS Time (in seconds) = *timeInfoUTC* (in seconds) - 2,524,953,600 (seconds) + *leapSeconds*, where 2,524,953,600 is the number of seconds between 00:00:00 on Gregorian calendar date 1 January, 1900 and 00:00:00 on Gregorian calendar date 6 January, 1980 (start of GPS time).

– SystemInformationBlockType17

The IE *SystemInformationBlockType17* contains information relevant for traffic steering between E-UTRAN and WLAN.

SystemInformationBlockType17 information element

```
-- ASN1START
SystemInformationBlockType17-r12 ::= SEQUENCE {
    wlan-OffloadInfoPerPLMN-List-r12 SEQUENCE (SIZE (1..maxPLMN-r11)) OF
    wlan-OffloadInfoPerPLMN-r12 OPTIONAL, -- Need OR
    lateNonCriticalExtension OCTET STRING OPTIONAL,
    ...
}
-- ASN1STOP
```



```

WLAN-OffloadInfoPerPLMN-r12 ::= SEQUENCE {
    wlan-OffloadConfigCommon-r12 WLAN-OffloadConfig-r12 OPTIONAL, -- Need OR
    wlan-Id-List-r12 WLAN-Id-List-r12 OPTIONAL, -- Need OR
    ...
}

WLAN-Id-List-r12 ::= SEQUENCE (SIZE (1..maxWLAN-Id-r12)) OF WLAN-Identifiers-r12

WLAN-Identifiers-r12 ::= SEQUENCE {
    ssid-r12 OCTET STRING (SIZE (1..32)) OPTIONAL, -- Need OR
    bssid-r12 OCTET STRING (SIZE (6)) OPTIONAL, -- Need OR
    hessid-r12 OCTET STRING (SIZE (6)) OPTIONAL, -- Need OR
    ...
}

-- ASN1STOP

```

SystemInformationBlockType17 field descriptions

bssid

Basic Service Set Identifier (BSSID) defined in IEEE 802.11-2012 [67].

hessid

Homogenous Extended Service Set Identifier (HESSID) defined in IEEE 802.11-2012 [67].

ssid

Service Set Identifier (SSID) defined in IEEE 802.11-2012 [67].

wlan-OffloadInfoPerPLMN-List

The WLAN offload configuration per PLMN includes the same number of entries, listed in the same order as the PLMN(s) listed across the *plmn-IdentityList* fields in *SystemInformationBlockType1*.

SystemInformationBlockType18

The IE *SystemInformationBlockType18* indicates E-UTRAN supports the sidelink UE information procedure and may contain sidelink communication related resource configuration information.

SystemInformationBlockType18 information element

```

-- ASN1START

SystemInformationBlockType18-r12 ::= SEQUENCE {
    commConfig-r12 SEQUENCE {
        commRxPool-r12 SL-CommRxPoolList-r12,
        commTxPoolNormalCommon-r12 SL-CommTxPoolList-r12 OPTIONAL, -- Need OR
        commTxPoolExceptional-r12 SL-CommTxPoolList-r12 OPTIONAL, -- Need OR
        commSyncConfig-r12 SL-SyncConfigList-r12 OPTIONAL, -- Need OR
    }
    lateNonCriticalExtension OCTET STRING OPTIONAL, -- Need OR
    ...
    [[ commTxPoolNormalCommonExt-r13 SL-CommTxPoolListExt-r13 OPTIONAL, -- Need OR
      commTxResourceUC-ReqAllowed-r13 ENUMERATED {true} OPTIONAL, -- Need OR
      commTxAllowRelayCommon-r13 ENUMERATED {true} OPTIONAL, -- Need OR
    ]]
}

-- ASN1STOP

```

SystemInformationBlockType18 field descriptions
<p>commRxPool Indicates the resources by which the UE is allowed to receive sidelink communication while in RRC_IDLE and while in RRC_CONNECTED.</p>
<p>commSyncConfig Indicates the configuration by which the UE is allowed to receive and transmit synchronisation information. E-UTRAN configures <i>commSyncConfig</i> including <i>txParameters</i> when configuring UEs by dedicated signalling to transmit synchronisation information.</p>
<p>commTxAllowRelayCommon Indicates whether the UE is allowed to transmit relay related sidelink communication data using the transmission pools included in <i>SystemInformationBlockType18</i> i.e. either via <i>commTxPoolNormalCommon</i>, <i>commTxPoolNormalCommonExt</i> or via <i>commTxPoolExceptional</i>.</p>
<p>commTxPoolExceptional Indicates the resources by which the UE is allowed to transmit sidelink communication in exceptional conditions, as specified in 5.10.4.</p>
<p>commTxPoolNormalCommon Indicates the resources by which the UE is allowed to transmit sidelink communication while in RRC_IDLE or when in RRC_CONNECTED while transmitting sidelink via a frequency other than the primary.</p>
<p>commTxPoolNormalCommonExt Indicates transmission resource pool(s) in addition to the pool(s) indicated by field <i>commTxPoolNormalCommon</i>, by which the UE is allowed to transmit sidelink communication while in RRC_IDLE or when in RRC_CONNECTED while transmitting sidelink via a frequency other than the primary. E-UTRAN configures <i>commTxPoolNormalCommonExt</i> only when it configures <i>commTxPoolNormalCommon</i>.</p>
<p>commTxResourceUC-ReqAllowed Indicates whether the UE is allowed to request transmission pools for non-relay related one-to-one sidelink communication.</p>

– SystemInformationBlockType19

The IE *SystemInformationBlockType19* indicates E-UTRAN supports the sidelink UE information procedure and may contain sidelink discovery related resource configuration information.

SystemInformationBlockType19 information element

```

-- ASN1START
SystemInformationBlockType19-r12 ::= SEQUENCE {
    discConfig-r12          SEQUENCE {
        discRxPool-r12      SL-DiscRxPoolList-r12,
        discTxPoolCommon-r12 SL-DiscTxPoolList-r12          OPTIONAL, -- Need OR
        discTxPowerInfo-r12 SL-DiscTxPowerInfoList-r12     OPTIONAL, -- Cond Tx
        discSyncConfig-r12  SL-SyncConfigList-r12           OPTIONAL, -- Need OR
    }
    discInterFreqList-r12  SL-CarrierFreqInfoList-r12      OPTIONAL, -- Need OR
    lateNonCriticalExtension OCTET STRING                  OPTIONAL,
    ...
    [[ discConfig-v1310    SEQUENCE {
        discInterFreqList-v1310 SL-CarrierFreqInfoList-v1310 OPTIONAL, -- Need OR
        gapRequestsAllowedCommon ENUMERATED {true}          OPTIONAL, -- Need OR
    }
    discConfigRelay-r13    SEQUENCE {
        relayUE-Config-r13     SL-DiscConfigRelayUE-r13,
        remoteUE-Config-r13    SL-DiscConfigRemoteUE-r13
    }
    discConfigPS-13        SEQUENCE {
        discRxPoolPS-r13       SL-DiscRxPoolList-r12,
        discTxPoolPS-Common-r13 SL-DiscTxPoolList-r12          OPTIONAL, -- Need OR
    }
    ] ]
}

SL-CarrierFreqInfoList-r12 ::= SEQUENCE (SIZE (1..maxFreq)) OF SL-CarrierFreqInfo-r12

SL-CarrierFreqInfoList-v1310 ::= SEQUENCE (SIZE (1..maxFreq)) OF SL-CarrierFreqInfo-v1310

SL-CarrierFreqInfo-r12 ::= SEQUENCE {
    carrierFreq-r12          ARFCN-ValueEUTRA-r9,
    plmn-IdentityList-r12    PLMN-IdentityList4-r12          OPTIONAL, -- Need OP
}

SL-DiscConfigRelayUE-r13 ::= SEQUENCE {

```

```

    threshHigh-r13          RSRP-RangeSL4-r13          OPTIONAL,  -- Need OR
    threshLow-r13           RSRP-RangeSL4-r13          OPTIONAL,  -- Need OR
    hystMax-r13             ENUMERATED {dB0, dB3, dB6, dB9, dB12, dB12, dB12}  OPTIONAL,  -- Cond
ThreshHigh
    hystMin-r13             ENUMERATED {dB0, dB3, dB6, dB9, dB12}  OPTIONAL    -- Cond ThreshLow
}

SL-DiscConfigRemoteUE-r13 ::= SEQUENCE {
    threshHigh-r13          RSRP-RangeSL4-r13          OPTIONAL,  -- Need OR
    hystMax-r13             ENUMERATED {dB0, dB3, dB6, dB9, dB12}  OPTIONAL,  -- Cond ThreshHigh
    reselectionInfoIC-r13   ReselectionInfoRelay-r13
}

ReselectionInfoRelay-r13 ::= SEQUENCE {
    q-RxLevMin-r13          Q-RxLevMin,
    -- Note that the mapping of individual values may be different for PC5, but the granularity/
    -- number of values is same as for Uu
    filterCoefficient-r13   FilterCoefficient,
    minHyst-r13             ENUMERATED {dB0, dB3,
                                     dB6, dB9, dB12, dB12, dB12}  OPTIONAL    -- Need OR
}

SL-CarrierFreqInfo-v1310 ::= SEQUENCE {
    discResourcesNonPS-r13   SL-ResourcesInterFreq-r13    OPTIONAL,  -- Need OR
    discResourcesPS-r13      SL-ResourcesInterFreq-r13    OPTIONAL,  -- Need OR
    discConfigOther-r13      SL-DiscConfigOtherInterFreq-r13  OPTIONAL,  -- Need OR
    ...
}

PLMN-IdentityList4-r12 ::= SEQUENCE (SIZE (1..maxPLMN-r11)) OF PLMN-IdentityInfo2-r12

PLMN-IdentityInfo2-r12 ::= CHOICE {
    plmn-Index-r12           INTEGER (1..maxPLMN-r11),
    plmnIdentity-r12         PLMN-Identity
}

SL-DiscTxResourcesInterFreq-r13 ::= CHOICE {
    acquireSI-FromCarrier-r13  NULL,
    discTxPoolCommon-r13       SL-DiscTxPoolList-r12,
    requestDedicated-r13       NULL,
    noTxOnCarrier-r13          NULL
}

SL-DiscConfigOtherInterFreq-r13 ::= SEQUENCE {
    txPowerInfo-r13           SL-DiscTxPowerInfoList-r12    OPTIONAL,  -- Cond Tx
    refCarrierCommon-r13       ENUMERATED {pCell}             OPTIONAL,  -- Need OR
    discSyncConfig-r13         SL-SyncConfigListNFreq-r13    OPTIONAL,  -- Need OR
    discCellSelectionInfo-r13   CellSelectionInfoNFreq-r13    OPTIONAL,  -- Need OR
}

SL-ResourcesInterFreq-r13 ::= SEQUENCE {
    discRxResourcesInterFreq-r13  SL-DiscRxPoolList-r12    OPTIONAL,  -- Need OR
    discTxResourcesInterFreq-r13  SL-DiscTxResourcesInterFreq-r13  OPTIONAL,  -- Need OR
}

-- ASN1STOP

```

SystemInformationBlockType19 field descriptions	
discCellSelectionInfo	Parameters that may be used by the UE to select/ reselect a cell on the concerned non serving frequency. If absent, the UE acquires the information from the target cell on the concerned frequency. See TS 36.304 [4, 11.4].
discInterFreqList	Indicates the neighbouring frequencies on which sidelink discovery announcement is supported. May also provide further information i.e. reception resource pool and/ or transmission resource pool, or an indication how resources could be obtained.
discRxPool	Indicates the resources by which the UE is allowed to receive non-PS related sidelink discovery announcements while in RRC_IDLE and while in RRC_CONNECTED.
discRxPoolPS	Indicates the resources by which the UE is allowed to receive PS related sidelink discovery announcements while in RRC_IDLE and while in RRC_CONNECTED.
discRxResourcesInterFreq	Indicates the resource pool configuration for receiving discovery announcements on a carrier frequency.
discSyncConfig	Indicates the configuration by which the UE is allowed to receive and transmit synchronisation information. E-UTRAN configures <i>discSyncConfig</i> including <i>txParameters</i> when configuring UEs by dedicated signalling to transmit synchronisation information.
discTxPoolCommon	Indicates the resources by which the UE is allowed to transmit non-PS related sidelink discovery announcements while in RRC_IDLE.
discTxPoolPS-Common	Indicates the resources by which the UE is allowed to transmit PS related sidelink discovery announcements while in RRC_IDLE.
discTxResourcesInterFreq	For the concerned frequency, either provides the UE with a pool of sidelink discovery announcement transmission resources the UE is allowed to use while in RRC_IDLE, or indicates whether such transmission is allowed, and if so how the UE may obtain the required resources. Value <i>noTxOnCarrier</i> indicates that the UE is not allowed to transmit sidelink discovery announcements on the concerned frequency. Value <i>acquireSI-FromCarrier</i> indicates that the required resources are to be obtained by autonomously acquiring SIB19 and other relevant SIBs from the concerned frequency. Value <i>requestDedicated</i> indicates, that for the concerned carrier, the required sidelink discovery resources are to be obtained by means of a dedicated resource request using the <i>SidelinkUEInformation</i> message.
plmn-IdentityList	List of PLMN identities for the neighbouring frequency indicated by <i>carrierFreq</i> . Absence of the field indicates the same PLMN identities as listed across the <i>plmn-IdentityList</i> fields (without suffix) in <i>SystemInformationBlockType1</i> .
plmn-Index	Index of the corresponding entry across the <i>plmn-IdentityList</i> fields (without suffix) within <i>SystemInformationBlockType1</i> .
refCarrierCommon	Indicates if the PCell (RRC_CONNECTED)/ serving cell (RRC_IDLE) is to be used as reference for DL measurements and synchronization, instead of the DL frequency paired with the one used to transmit sidelink discovery announcements on, see TS 36.213 [23, 14.3.1].
reselectionInfoC	Includes the parameters used by the UE when selecting/ reselecting a sidelink relay UE.
SL-CarrierFreqInfoList-v1310	If included, the UE shall include the same number of entries, and listed in the same order, as in <i>SL-CarrierFreqInfoList-r12</i> .
threshHigh, threshLow (relayUE)	Indicates when a sidelink remote UE or sidelink relay UE that is in network coverage may use the broadcast PS related sidelink discovery Tx resource pool, if broadcast, or request Tx resources by dedicated signalling otherwise. For remote UEs, this parameter is used similarly for relay related sidelink communication.

Conditional presence	Explanation
<i>ThreshHigh</i>	The field is mandatory present if <i>threshHigh</i> is included in the corresponding IE. Otherwise the field is not present and UE shall delete any existing value for this field.
<i>ThreshLow</i>	The field is mandatory present if <i>threshLow</i> is included. Otherwise the field is not present UE shall delete any existing value for this field.
<i>Tx</i>	The field is mandatory present if <i>discTxPoolCommon</i> is included. Otherwise the field is optional present, need OR.

SystemInformationBlockType20

The IE *SystemInformationBlockType20* contains the information required to acquire the control information associated transmission of MBMS using SC-PTM.

SystemInformationBlockType20 information element

```

-- ASN1START
SystemInformationBlockType20-r13 ::= SEQUENCE {
    sc-mcch-RepetitionPeriod-r13      ENUMERATED {rf2, rf4, rf8, rf16, rf32, rf64, rf128, rf256},
    sc-mcch-Offset-r13                INTEGER (0..10),
    sc-mcch-FirstSubframe-r13        INTEGER (0..9),
    sc-mcch-duration-r13              INTEGER (2..9) OPTIONAL,
    sc-mcch-ModificationPeriod-r13    ENUMERATED {rf2, rf4, rf8, rf16, rf32, rf64, rf128, rf256,
        rf512, rf1024, r2048, rf4096, rf8192, rf16384, rf32768,
        rf65536},
    lateNonCriticalExtension           OCTET STRING                               OPTIONAL,
    ...
    [[ br-BCCH-Config-r14              SEQUENCE {
        dummy          ENUMERATED {rf1},
        dummy2         ENUMERATED {rf1},
        mpdcch-Narrowband-SC-MCCH-r14    INTEGER (1..maxAvailNarrowBands-r13),
        mpdcch-NumRepetition-SC-MCCH-r14  ENUMERATED {r1, r2, r4, r8, r16,
            r32, r64, r128, r256},
        mpdcch-StartSF-SC-MCCH-r14       CHOICE {
            fdd-r14          ENUMERATED {v1, v1dot5, v2, v2dot5, v4,
                v5, v8, v10},
            tdd-r14          ENUMERATED {v1, v2, v4, v5, v8, v10, v20}
        },
        mpdcch-PDSCH-HoppingConfig-SC-MCCH-r14  ENUMERATED {off, ce-ModeA, ce-ModeB},
        sc-mcch-CarrierFreq-r14            ARFCN-ValueEUTRA-r9,
        sc-mcch-Offset-BR-r14              INTEGER (0..10),
        sc-mcch-RepetitionPeriod-BR-r14     ENUMERATED {rf32, rf128, rf512, rf1024,
            rf2048, rf4096, rf8192, rf16384},
        sc-mcch-ModificationPeriod-BR-r14    ENUMERATED { rf32, rf128, rf256, rf512, rf1024,
            rf2048, rf4096, rf8192, rf16384, rf32768,
            rf65536, rf131072, rf262144, rf524288,
            rf1048576}
    }
    sc-mcch-SchedulingInfo-r14           SC-MCCH-SchedulingInfo-r14           OPTIONAL, -- Need OR
    pdsch-maxNumRepetitionCEmodeA-SC-MTCH-r14
        ENUMERATED { r16, r32 }         OPTIONAL, -- Need OR
    pdsch-maxNumRepetitionCEmodeB-SC-MTCH-r14
        ENUMERATED {
            r192, r256, r384, r512, r768, r1024,
            r1536, r2048}               OPTIONAL -- Need OR
    ]],
    [[ sc-mcch-RepetitionPeriod-v1470     ENUMERATED {rf1}                     OPTIONAL, -- Need OR
        sc-mcch-ModificationPeriod-v1470  ENUMERATED {rf1}                     OPTIONAL -- Need OR
    ]]
}

SC-MCCH-SchedulingInfo-r14 ::= SEQUENCE {
    onDurationTimerSCPTM-r14             ENUMERATED {psf10, psf20, psf100, psf300,
        psf500, psf1000, psf1200, psf1600},
    drx-InactivityTimerSCPTM-r14         ENUMERATED {psf0, psf1, psf2, psf4, psf8, psf16,
        psf32, psf64, psf128, psf256, psf512,
        psf1024, psf2048, psf4096, psf8192, psf16384},
    schedulingPeriodStartOffsetSCPTM-r14 CHOICE {
        sf10          INTEGER(0..9),
        sf20          INTEGER(0..19),
        sf32          INTEGER(0..31),
        sf40          INTEGER(0..39),
        sf64          INTEGER(0..63),
        sf80          INTEGER(0..79),
        sf128         INTEGER(0..127),
        sf160         INTEGER(0..159),
        sf256         INTEGER(0..255),
        sf320         INTEGER(0..319),
        sf512         INTEGER(0..511),
        sf640         INTEGER(0..639),
        sf1024        INTEGER(0..1023),
        sf2048        INTEGER(0..2047),
        sf4096        INTEGER(0..4095),
        sf8192        INTEGER(0..8191)
    },
}

```

```
} ...  
-- ASN1STOP
```

SystemInformationBlockType20 field descriptions
br-BCCH-Config-r14 The field is present if <i>SystemInformationBlockType20</i> is sent on BR-BCCH. Otherwise the field is absent.
drx-InactivityTimerSCPTM Timer for listening to SC-MCCH scheduling in TS 36.321 [6]. Value in number of MPDCCH sub-frames. Value psf0 corresponds to 0 MPDCCH sub-frame, psf1 corresponds to 1 MPDCCH sub-frame and so on.
dummy This field is not used in the specification. If received it shall be ignored by the UE.
mpdcch-Narrowband-SC-MCCH Narrowband for MPDCCH for SC-MCCH, see TS 36.213 [23].
mpdcch-NumRepetitions-SC-MCCH The maximum number of MPDCCH repetitions the UE needs to monitor for SC-MCCH, see TS 36.213 [23].
mpdcch-StartSF-SC-MCCH Configuration of the starting subframes of the MPDCCH search space for SC-MCCH, see TS 36.213 [23].
mpdcch-PDSCH-HoppingConfig-SC-MCCH Frequency hopping configuration for MPDCCH/PDSCH for SC-MCCH, see TS 36.213 [23].
onDurationTimerSCPTM Indicates the duration in subframes during which SC-MCCH may be scheduled in MPDCCH sub-frames, see TS 36.321 [6].
pdsch-maxNumRepetitionCEmodeA-SC-MTCH Maximum value to indicate the set of PDSCH repetition numbers for SC-MTCH to UEs in CE mode A, see TS 36.213 [23].
pdsch-maxNumRepetitionCEmodeB-SC-MTCH Maximum value to indicate the set of PDSCH repetition numbers for SC-MTCH CE to UEs in mode B, see TS 36.213 [23].
schedulingPeriodStartOffsetSCPTM <i>SCPTM-SchedulingCycle</i> and <i>SCPTM-SchedulingOffset</i> in TS 36.321 [6]. The value of <i>SCPTM-SchedulingCycle</i> is in number of sub-frames. Value sf10 corresponds to 10 sub-frames, sf20 corresponds to 20 sub-frames and so on. The value of <i>SCPTM-SchedulingOffset</i> is in number of sub-frames.
sc-mcch-CarrierFreq Downlink carrier used for all multicast SC-MCCH transmissions.
sc-mcch-duration Indicates, starting from the subframe indicated by <i>sc-mcch-FirstSubframe</i> , the duration in subframes during which SC-MCCH may be scheduled in PDCCH sub-frames, see TS 36.321 [6]. Absence of this IE means that SC-MCCH is only scheduled in the subframe indicated by <i>sc-mcch-FirstSubframe</i> .
sc-mcch-ModificationPeriod Defines periodically appearing boundaries, i.e. radio frames for which $\text{SFN mod } sc\text{-}mcch\text{-}ModificationPeriod = 0$. The contents of different transmissions of SC-MCCH information can only be different if there is at least one such boundary in-between them. Value rf2 corresponds to 2 radio frames, value rf4 corresponds to 4 radio frames and so on. In case <i>sc-mcch-ModificationPeriod-v1470</i> is configured, the UE shall ignore the configuration of <i>sc-mcch-ModificationPeriod-r13</i> .
sc-mcch-ModificationPeriod-BR Defines periodically appearing boundaries for BL UE or UE in CE, i.e. radio frames for which $(\text{H-SFN} \cdot 1024 + \text{SFN}) \text{ mod } sc\text{-}mcch\text{-}ModificationPeriod\text{-}BR = 0$ if hyperSFN is present in <i>SystemInformationBlockType1-BR</i> or radio frames for which $\text{SFN mod } sc\text{-}mcch\text{-}ModificationPeriod\text{-}BR = 0$ otherwise. The contents of different transmissions of SC-MCCH information can only be different if there is at least one such boundary in-between them. Value rf32 corresponds to 32 radio frames, value rf128 corresponds to 128 radio frames and so on.
sc-mcch-FirstSubframe Indicates the first subframe in which SC-MCCH is scheduled
sc-mcch-Offset Indicates, together with the <i>sc-mcch-RepetitionPeriod</i> , the radio frames in which SC-MCCH is scheduled i.e. SC-MCCH is scheduled in radio frames for which: $\text{SFN mod } sc\text{-}mcch\text{-}RepetitionPeriod = sc\text{-}mcch\text{-}Offset$.
sc-mcch-Offset-BR Indicates, together with the <i>sc-mcch-RepetitionPeriod-BR</i> , the boundary of the SC-MCCH repetition period for BL UE or UE in CE: $(\text{H-SFN} \cdot 1024 + \text{SFN}) \text{ mod } sc\text{-}mcch\text{-}RepetitionPeriod\text{-}BR = sc\text{-}mcch\text{-}Offset\text{-}BR$ if hyperSFN is present in <i>SystemInformationBlockType1-BR</i> or radio frames for which $(\text{SFN mod } sc\text{-}mcch\text{-}RepetitionPeriod\text{-}BR) = sc\text{-}mcch\text{-}Offset\text{-}BR$ otherwise.
sc-mcch-RepetitionPeriod Defines the interval between transmissions of SC-MCCH information, in radio frames. Value rf2 corresponds to 2 radio frames, rf4 corresponds to 4 radio frames and so on. In case <i>sc-mcch-RepetitionPeriod-v1470</i> is configured, the UE shall ignore the configuration of <i>sc-mcch-RepetitionPeriod-r13</i> .
sc-mcch-RepetitionPeriod-BR Defines the interval between transmissions of SC-MCCH information for BL UE or UE in CE, in radio frames. Value rf32 corresponds to 32 radio frames, rf128 corresponds to 128 radio frames and so on.
sc-mcch-SchedulingInfo DRX information for the SC-MCCH. If this field is absent, DRX is not used for SC-MCCH reception.

– *SystemInformationBlockType21*

The IE *SystemInformationBlockType21* contains V2X sidelink communication configuration.

***SystemInformationBlockType21* information element**

```
-- ASN1START
SystemInformationBlockType21-r14 ::= SEQUENCE {
  sl-V2X-ConfigCommon-r14          SL-V2X-ConfigCommon-r14          OPTIONAL,  -- Need OR
  lateNonCriticalExtension         OCTET STRING                    OPTIONAL,
  ...
}

SL-V2X-ConfigCommon-r14 ::= SEQUENCE {
  v2x-CommRxPool-r14              SL-CommRxPoolListV2X-r14          OPTIONAL,  -- Need OR
  v2x-CommTxPoolNormalCommon-r14  SL-CommTxPoolListV2X-r14          OPTIONAL,  -- Need OR
  p2x-CommTxPoolNormalCommon-r14  SL-CommTxPoolListV2X-r14          OPTIONAL,  -- Need OR
  v2x-CommTxPoolExceptional-r14   SL-CommResourcePoolV2X-r14        OPTIONAL,  -- Need OR
  v2x-SyncConfig-r14              SL-SyncConfigListV2X-r14          OPTIONAL,  -- Need OR
  v2x-InterFreqInfoList-r14       SL-InterFreqInfoListV2X-r14       OPTIONAL,  -- Need OR
  v2x-ResourceSelectionConfig-r14  SL-CommTxPoolSensingConfig-r14    OPTIONAL,  -- Need OR
  zoneConfig-r14                  SL-ZoneConfig-r14                 OPTIONAL,  -- Need OR
  typeTxSync-r14                  SL-TypeTxSync-r14                 OPTIONAL,  -- Need OR
  thresSL-TxPrioritization-r14     SL-Priority-r13                   OPTIONAL,  -- Need OR
  anchorCarrierFreqList-r14        SL-AnchorCarrierFreqList-V2X-r14  OPTIONAL,  -- Need OR
  offsetDFN-r14                   INTEGER (0..1000)                  OPTIONAL,  -- Need OR
  cbr-CommonTxConfigList-r14       SL-CBR-CommonTxConfigList-r14     OPTIONAL,  -- Need OR
}

-- ASN1STOP
```

SystemInformationBlockType21 field descriptions	
anchorCarrierFreqList	Indicates carrier frequencies which may include inter-carrier resource configuration for V2X sidelink communication.
cbr-CommonTxConfigList	Indicates the common list of CBR ranges and the list of PSSCH transmissions parameter configurations available to configure congestion control to the UE for V2X sidelink communication.
offsetDFN	Indicates the timing offset for the UE to determine DFN timing when GNSS is used for timing reference for the PCell. Value 0 corresponds to 0 milliseconds, value 1 corresponds to 0.001 milliseconds, value 2 corresponds to 0.002 milliseconds, and so on.
p2x-CommTxPoolNormalCommon	Indicates the resources by which the UE is allowed to transmit P2X related V2X sidelink communication. <i>zoneID</i> is not configured in the pools in this field.
thresSL-TxPrioritization	Indicates the threshold used to determine whether SL V2X transmission is prioritized over uplink transmission if they overlap in time (see TS 36.321 [6]). This value shall overwrite <i>thresSL-TxPrioritization</i> configured in <i>SL-V2X-Preconfiguration</i> if any.
typeTxSync	Indicates the prioritized synchronization type (i.e. eNB or GNSS) for performing V2X sidelink communication on the carrier frequency on which this field is broadcast.
v2x-CommRxPool	Indicates the resources by which the UE is allowed to receive V2X sidelink communication while in RRC_IDLE and RRC_CONNECTED.
v2x-CommTxPoolExceptional	Indicates the resources by which the UE is allowed to transmit V2X sidelink communication in exceptional conditions, as specified in 5.10.13.
v2x-CommTxPoolNormalCommon	Indicates the resources by which the UE is allowed to transmit non-P2X related V2X sidelink communication when in RRC_IDLE or when in RRC_CONNECTED while transmitting V2X sidelink communication via a frequency other than the primary. E-UTRAN configures one resource pool per zone.
v2x-InterFreqInfoList	Indicates synchronization and resource allocation configurations of neighboring frequencies for V2X sidelink communication.
v2x-ResourceSelectionConfig	Indicates V2X sidelink communication configurations used for UE autonomous resource selection.
v2x-SyncConfig	Indicates the configuration by which the UE is allowed to receive and transmit synchronisation information for V2X sidelink communication. E-UTRAN configures <i>v2x-SyncConfig</i> including <i>txParameters</i> when configuring UEs to transmit synchronisation information.
zoneConfig	Indicates zone configurations used for V2X sidelink communication in 5.10.13.2.

6.3.2 Radio resource control information elements

– *AntennaInfo*

The IE *AntennaInfoCommon* and the *AntennaInfoDedicated* are used to specify the common and the UE specific antenna configuration respectively.

AntennaInfo information elements

```
-- ASN1START
AntennaInfoCommon ::=
    SEQUENCE {
        antennaPortsCount
        ENUMERATED {an1, an2, an4, spare1}
    }
AntennaInfoDedicated ::=
    SEQUENCE {
        transmissionMode
        ENUMERATED {
            tm1, tm2, tm3, tm4, tm5, tm6,
            tm7, tm8-v920},
        codebookSubsetRestriction
        CHOICE {
            n2TxAntenna-tm3
            BIT STRING (SIZE (2)),
            n4TxAntenna-tm3
            BIT STRING (SIZE (4)),
            n2TxAntenna-tm4
            BIT STRING (SIZE (6)),
            n4TxAntenna-tm4
            BIT STRING (SIZE (64)),
            n2TxAntenna-tm5
            BIT STRING (SIZE (4)),
        }
    }
-- ASN1END
```

```

        n4TxAntenna-tm5          BIT STRING (SIZE (16)),
        n2TxAntenna-tm6          BIT STRING (SIZE (4)),
        n4TxAntenna-tm6          BIT STRING (SIZE (16))
    } OPTIONAL, -- Cond TM
    ue-TransmitAntennaSelection CHOICE{
        release          NULL,
        setup            ENUMERATED {closedLoop, openLoop}
    }
}

AntennaInfoDedicated-v920 ::= SEQUENCE {
    codebookSubsetRestriction-v920 CHOICE {
        n2TxAntenna-tm8-r9          BIT STRING (SIZE (6)),
        n4TxAntenna-tm8-r9          BIT STRING (SIZE (32))
    } OPTIONAL -- Cond TM8
}

AntennaInfoDedicated-r10 ::= SEQUENCE {
    transmissionMode-r10          ENUMERATED {
        tm1, tm2, tm3, tm4, tm5, tm6, tm7, tm8-v920,
        tm9-v1020, tm10-v1130, spare6, spare5, spare4,
        spare3, spare2, spare1},
    codebookSubsetRestriction-r10 BIT STRING OPTIONAL, -- Cond TMX
    ue-TransmitAntennaSelection CHOICE{
        release          NULL,
        setup            ENUMERATED {closedLoop, openLoop}
    }
}

AntennaInfoDedicated-v10i0 ::= SEQUENCE {
    maxLayersMIMO-r10          ENUMERATED {twoLayers, fourLayers, eightLayers} OPTIONAL --
Need OR
}

AntennaInfoDedicated-v1250 ::= SEQUENCE {
    alternativeCodebookEnabledFor4TX-r12 BOOLEAN
}

AntennaInfoDedicated-v1430 ::= SEQUENCE {
    ce-UE-TxAntennaSelection-config-r14 ENUMERATED {on} OPTIONAL -- Need OR
}

-- ASN1STOP

```

AntennaInfo field descriptions
<p>alternativeCodebookEnabledFor4TX Indicates whether code book in TS 36.213 [23] Table 7.2.4-0A to Table 7.2.4-0D is being used for deriving CSI feedback and reporting. E-UTRAN only configures the field if the UE is configured with a) <i>tm8</i> with 4 CRS ports, <i>tm9</i> or <i>tm10</i> with 4 CSI-RS ports and b) PMI/RI reporting.</p>
<p>antennaPortsCount Parameter represents the number of cell specific antenna ports where an1 corresponds to 1, an2 to 2 antenna ports etc. see TS 36.211 [21, 6.2.1].</p>
<p>ce-ue-TxAntennaSelection-config Configuration of UL closed-loop transmit antenna selection for non-BL UE in CE Mode A, see TS 36.212 [22].</p>
<p>codebookSubsetRestriction Parameter: <i>codebookSubsetRestriction</i>, see TS 36.213 [23, 7.2] and TS 36.211 [21, 6.3.4.2.3]. The number of bits in the <i>codebookSubsetRestriction</i> for applicable transmission modes is defined in TS 36.213 [23, Table 7.2-1b]. If the UE is configured with <i>transmissionMode</i> <i>tm8</i>, E-UTRAN configures the field <i>codebookSubsetRestriction</i> if PMI/RI reporting is configured. If the UE is configured with <i>transmissionMode</i> <i>tm9</i>, E-UTRAN configures the field <i>codebookSubsetRestriction</i> if PMI/RI reporting is configured and if the number of CSI-RS ports is greater than 1. E-UTRAN does not configure the field <i>codebookSubsetRestriction</i> in other cases where the UE is configured with <i>transmissionMode</i> <i>tm8</i> or <i>tm9</i>. Furthermore, E-UTRAN does not configure the field <i>codebookSubsetRestriction</i> if the UE is configured with <i>eMIMO-Type</i> unless it is set to <i>beamformed</i>, <i>alternativeCodebookEnabledBeamformed</i> is set to <i>FALSE</i> and <i>csi-RS-ConfigNZPIdListExt</i> is not configured.</p>
<p>maxLayersMIMO Indicates the maximum number of layers for spatial multiplexing used to determine the rank indication bit width and Kc determination of the soft buffer size for the corresponding serving cell according to TS 36.212 [22]. EUTRAN configures this field only when <i>transmissionMode</i> is set to <i>tm3</i>, <i>tm4</i>, <i>tm9</i> or <i>tm10</i> for the corresponding serving cell. When configuring the field for a serving cell which <i>transmissionMode</i> is set to <i>tm3</i> or <i>tm4</i>, EUTRAN only configures value <i>fourLayers</i>: For a serving cell which <i>transmissionMode</i> is set to <i>tm9</i> or <i>tm10</i>, EUTRAN only configures the field only if <i>intraBandContiguousCC-InfoList</i> is indicated for the band and the band combination of the corresponding serving cell or the UE supports <i>maxLayersMIMO-Indication</i>.</p>
<p>transmissionMode Points to one of Transmission modes defined in TS 36.213 [23, 7.1] where <i>tm1</i> refers to transmission mode 1, <i>tm2</i> to transmission mode 2 etc.</p>
<p>ue-TransmitAntennaSelection For value <i>setup</i>, the field indicates whether UE transmit antenna selection control is closed-loop or open-loop as described in TS 36.213 [23, 8.7].</p>

Conditional presence	Explanation
<i>TM</i>	The field is mandatory present if the <i>transmissionMode</i> is set to <i>tm3</i> , <i>tm4</i> , <i>tm5</i> or <i>tm6</i> . Otherwise the field is not present and the UE shall delete any existing value for this field.
<i>TM8</i>	The field is optional present, need OR, if <i>AntennaInfoDedicated</i> is included and <i>transmissionMode</i> is set to <i>tm8</i> . If <i>AntennaInfoDedicated</i> is included and <i>transmissionMode</i> is set to a value other than <i>tm8</i> , the field is not present and the UE shall delete any existing value for this field. Otherwise the field is not present.
<i>TMX</i>	The field is mandatory present if the <i>transmissionMode-r10</i> is set to <i>tm3</i> , <i>tm4</i> , <i>tm5</i> or <i>tm6</i> . The field is optionally present, need OR, if the <i>transmissionMode-r10</i> is set to <i>tm8</i> or <i>tm9</i> . Otherwise the field is not present and the UE shall delete any existing value for this field.

— AntennaInfoUL

The IE *AntennaInfoUL* is used to specify the UL antenna configuration.

AntennaInfoUL information elements

```

-- ASN1START
AntennaInfoUL-r10 ::= SEQUENCE {
    transmissionModeUL-r10      ENUMERATED {tm1, tm2, spare6, spare5,
                                             spare4, spare3, spare2, spare1} OPTIONAL, --
Need OR
    fourAntennaPortActivated-r10  ENUMERATED {setup}          OPTIONAL          -- Need OR
}
-- ASN1STOP

```

AntennaInfoUL field descriptions
<p>fourAntennaPortActivated Parameter indicates if four antenna ports are used. See TS 36.213 [23, 8.2]. E-UTRAN optionally configures <i>fourAntennaPortActivated</i> only if <i>transmissionModeUL</i> is set to <i>tm2</i>.</p>
<p>transmissionModeUL Points to one of UL Transmission modes defined in TS 36.213 [23, 8.0] where <i>tm1</i> refers to transmission mode 1, <i>tm2</i> to transmission mode 2 etc.</p>

– CQI-ReportAperiodic

The IE *CQI-ReportAperiodic* is used to specify the aperiodic CQI reporting configuration.

CQI-ReportAperiodic information elements

```

-- ASN1START
CQI-ReportAperiodic-r10 ::= CHOICE {
  release      NULL,
  setup       SEQUENCE {
    cqi-ReportModeAperiodic-r10  CQI-ReportModeAperiodic,
    aperiodicCSI-Trigger-r10     SEQUENCE {
      trigger1-r10                BIT STRING (SIZE (8)),
      trigger2-r10                BIT STRING (SIZE (8))
    }
  }
}
OPTIONAL -- Need OR

CQI-ReportAperiodic-v1250 ::= CHOICE {
  release      NULL,
  setup       SEQUENCE {
    aperiodicCSI-Trigger-v1250   SEQUENCE {
      trigger-SubframeSetIndicator-r12  ENUMERATED {s1, s2},
      trigger1-SubframeSetIndicator-r12  BIT STRING (SIZE (8)),
      trigger2-SubframeSetIndicator-r12  BIT STRING (SIZE (8))
    }
  }
}

CQI-ReportAperiodic-v1310 ::= CHOICE {
  release      NULL,
  setup       SEQUENCE {
    aperiodicCSI-Trigger-v1310   SEQUENCE {
      trigger1-r13                BIT STRING (SIZE (32)),
      trigger2-r13                BIT STRING (SIZE (32)),
      trigger3-r13                BIT STRING (SIZE (32)),
      trigger4-r13                BIT STRING (SIZE (32)),
      trigger5-r13                BIT STRING (SIZE (32)),
      trigger6-r13                BIT STRING (SIZE (32))
    }
    aperiodicCSI-Trigger2-r13    CHOICE {
      release      NULL,
      setup       SEQUENCE {
        trigger1-SubframeSetIndicator-r13  BIT STRING (SIZE (32)),
        trigger2-SubframeSetIndicator-r13  BIT STRING (SIZE (32)),
        trigger3-SubframeSetIndicator-r13  BIT STRING (SIZE (32)),
        trigger4-SubframeSetIndicator-r13  BIT STRING (SIZE (32)),
        trigger5-SubframeSetIndicator-r13  BIT STRING (SIZE (32)),
        trigger6-SubframeSetIndicator-r13  BIT STRING (SIZE (32))
      }
    }
  }
}
OPTIONAL, -- Need ON

CQI-ReportAperiodicProc-r11 ::= SEQUENCE {
  cqi-ReportModeAperiodic-r11  CQI-ReportModeAperiodic,
  trigger01-r11                 BOOLEAN,
  trigger10-r11                 BOOLEAN,
  trigger11-r11                 BOOLEAN
}

CQI-ReportAperiodicProc-v1310 ::= SEQUENCE {
  trigger001-r13                BOOLEAN,
  trigger010-r13                BOOLEAN,
  trigger011-r13                BOOLEAN,
}

```

```

trigger100-r13          BOOLEAN,
trigger101-r13          BOOLEAN,
trigger110-r13          BOOLEAN,
trigger111-r13          BOOLEAN
}

CQI-ReportAperiodicHybrid-r14 ::= SEQUENCE {
  triggers-r14           CHOICE {
    oneBit-r14           SEQUENCE {
      trigger1-Indicator-r14 BIT STRING (SIZE (8))
    },
    twoBit-r14           SEQUENCE {
      trigger01-Indicator-r14 BIT STRING (SIZE (8)),
      trigger10-Indicator-r14 BIT STRING (SIZE (8)),
      trigger11-Indicator-r14 BIT STRING (SIZE (8))
    },
    threeBit-r14        SEQUENCE {
      trigger001-Indicator-r14 BIT STRING (SIZE (32)),
      trigger010-Indicator-r14 BIT STRING (SIZE (32)),
      trigger011-Indicator-r14 BIT STRING (SIZE (32)),
      trigger100-Indicator-r14 BIT STRING (SIZE (32)),
      trigger101-Indicator-r14 BIT STRING (SIZE (32)),
      trigger110-Indicator-r14 BIT STRING (SIZE (32)),
      trigger111-Indicator-r14 BIT STRING (SIZE (32))
    }
  }
}
OPTIONAL -- Need OR

CQI-ReportModeAperiodic ::= ENUMERATED {
  rm12, rm20, rm22, rm30, rm31,
  rm32-v1250, rm10-v1310, rm11-v1310
}

-- ASN1STOP

```

CQI-ReportAperiodic field descriptions
<p>aperiodicCSI-Trigger Indicates for which serving cell(s) the aperiodic CSI report is triggered when one or more SCells are configured. <i>trigger1-r10</i> corresponds to the CSI request field 10 while <i>trigger1-r13</i> corresponds to the CSI request field 010, <i>trigger2-r10</i> corresponds to the CSI request field 11 while <i>trigger2-r13</i> corresponds to the CSI request field 011, <i>trigger3-r13</i> corresponds to the CSI request field 100, see TS 36.213 [23], table 7.2.1-1A and table 7.2.1-1D, and so on. The leftmost bit, bit 0 in the bit string corresponds to the cell with <i>ServCellIndex</i>=0 and bit 1 in the bit string corresponds to the cell with <i>ServCellIndex</i>=1 etc. Each bit has either value 0 (means no aperiodic CSI report is triggered) or value 1 (means the aperiodic CSI report is triggered). At most 5 bits can be set to value 1 in the bit string in <i>aperiodicCSI-Trigger-r10</i> and in <i>aperiodicCSI-Trigger-v1250</i> and at most 32 bits can be set to value 1 in the bit string in <i>aperiodicCSI-Trigger-v1310</i>. E-UTRAN configures value 1 only for cells configured with <i>transmissionMode</i> set in range <i>tm1</i> to <i>tm9</i>. One value applies for all serving cells configured with <i>transmissionMode</i> set in range <i>tm1</i> to <i>tm9</i> and belonging to the same PUCCH group (the associated functionality is common i.e. not performed independently for each cell).</p>
<p>trigger01-IndicatorN, trigger10-IndicatorN, trigger11-IndicatorN Indicates for which eMIMO-Type the aperiodic CSI report is triggered (the corresponding CSI process, CSI subframe set)-pair(s) and/or a serving cell) as applicable, See TS 36.213 [23, table 7.2.1-1D, 7.2.1-1E].</p>
<p>trigger001-IndicatorN.. trigger111-IndicatorN Indicates for which eMIMO-Type the aperiodic CSI report is triggered (the corresponding CSI process, CSI subframe set)-pair(s) and/or a serving cell) as applicable, See TS 36.213 [23, table 7.2.1-1A, 7.2.1-1B, and 7.2.1-1C].</p>
<p>trigger01 Indicates whether or not reporting for this CSI-process or reporting for this CSI-process corresponding to a CSI subframe set is triggered by CSI request field set to 01, for a CSI request applicable for the serving cell on the same frequency as the CSI process, see TS 36.213 [23, table 7.2.1-1D and 7.2.1-1E].</p>
<p>trigger10, trigger11 Indicates whether or not reporting for this CSI-process or reporting for this CSI-process corresponding to a CSI subframe set is triggered by CSI request field set to 10 or 11, see TS 36.213 [23, table 7.2.1-1B]. EUTRAN configures at most 5 CSI processes, across all serving frequencies within each CG, to be triggered by a CSI request field set to value 10. The same restriction applies for value 11. In case E-UTRAN simultaneously triggers CSI requests for more than 5 CSI processes some limitations apply, see TS 36.213 [23].</p>
<p>trigger001 Indicates whether or not reporting for this CSI-process or reporting for this CSI-process corresponding to a CSI subframe set is triggered by CSI request field set to 001, for a CSI request applicable for the serving cell on the same frequency as the CSI process, see TS 36.213 [23, table 7.2.1-1D and 7.2.1-1E].</p>
<p>trigger010, trigger011, trigger100, trigger101, Trigger110, Trigger111 Indicates whether or not reporting for this CSI-process or reporting for this CSI-process corresponding to a CSI subframe set is triggered by CSI request field set to 010, 011, 100, 101, 110 or 111, see TS 36.213 [23, table 7.2.1-1D and 7.2.1-1E].</p>
<p>trigger-SubframeSetIndicator For a serving cell configured with <i>csi-MeasSubframeSets-r12</i>, indicates for which CSI subframe set the aperiodic CSI report is triggered for the serving cell if the aperiodic CSI is triggered by the CSI request field 01 or 001, see TS 36.213 [23, table 7.2.1-1C or table 7.2.1-1E]. Value s1 corresponds to CSI subframe set 1 and value s2 corresponds to CSI subframe set 2.</p>
<p>trigger1-SubframeSetIndicator If signalled in the <i>aperiodicCSI-Trigger-v1250</i>, indicates for which CSI subframe set the aperiodic CSI report is triggered when aperiodic CSI is triggered by the CSI request field 10, see TS 36.213 [23, table 7.2.1-1C] or by the CSI request field 010, see TS 36.213 [23, table 7.2.1-1E]. The leftmost bit, bit 0 in the bit string corresponds to the cell with <i>ServCellIndex</i>=0 and bit 1 in the bit string corresponds to the cell with <i>ServCellIndex</i>=1 etc. Each bit has either value 0 (means that aperiodic CSI report is triggered for CSI subframe set 1) or value 1 (means that aperiodic CSI report is triggered for CSI subframe set 2).</p>
<p>trigger2-SubframeSetIndicator If signalled in the <i>aperiodicCSI-Trigger-v1250</i>, indicates for which CSI subframe set the aperiodic CSI report is triggered when aperiodic CSI is triggered by the CSI request field 11, see TS 36.213 [23, table 7.2.1-1C] or by the CSI request field 011, see TS 36.213 [23, table 7.2.1-1E]. The leftmost bit, bit 0 in the bit string corresponds to the cell with <i>ServCellIndex</i>=0 and bit 1 in the bit string corresponds to the cell with <i>ServCellIndex</i>=1 etc. Each bit has either value 0 (means that aperiodic CSI report is triggered for CSI subframe set 1) or value 1 (means that aperiodic CSI report is triggered for CSI subframe set 2).</p>
<p>trigger3-SubframeSetIndicator Indicates for which CSI subframe set the aperiodic CSI report is triggered when aperiodic CSI is triggered by the CSI request field 100, see TS 36.213 [23, table 7.2.1-1E]. The leftmost bit, bit 0 in the bit string corresponds to the cell with <i>ServCellIndex</i>=0 and bit 1 in the bit string corresponds to the cell with <i>ServCellIndex</i> =1 etc. Each bit has either value 0 (means that aperiodic CSI report is triggered for CSI subframe set 1) or value 1 (means that aperiodic CSI report is triggered for CSI subframe set 2).</p>

CQI-ReportAperiodic field descriptions
<p>trigger4-SubframeSetIndicator Indicates for which CSI subframe set the aperiodic CSI report is triggered when aperiodic CSI is triggered by the CSI request field 101, see TS 36.213 [23, table 7.2.1-1E]. The leftmost bit, bit 0 in the bit string corresponds to the cell with <i>ServCellIndex</i>=0 and bit 1 in the bit string corresponds to the cell with <i>ServCellIndex</i>=1 etc. Each bit has either value 0 (means that aperiodic CSI report is triggered for CSI subframe set 1) or value 1 (means that aperiodic CSI report is triggered for CSI subframe set 2).</p>
<p>trigger5-SubframeSetIndicator Indicates for which CSI subframe set the aperiodic CSI report is triggered when aperiodic CSI is triggered by the CSI request field 110, see TS 36.213 [23, table 7.2.1-1E]. The leftmost bit, bit 0 in the bit string corresponds to the cell with <i>ServCellIndex</i>=0 and bit 1 in the bit string corresponds to the cell with <i>ServCellIndex</i>=1 etc. Each bit has either value 0 (means that aperiodic CSI report is triggered for CSI subframe set 1) or value 1 (means that aperiodic CSI report is triggered for CSI subframe set 2).</p>
<p>trigger6-SubframeSetIndicator Indicates for which CSI subframe set the aperiodic CSI report is triggered when aperiodic CSI is triggered by the CSI request field 111, see TS 36.213 [23, table 7.2.1-1E]. The leftmost bit, bit 0 in the bit string corresponds to the cell with <i>ServCellIndex</i>=0 and bit 1 in the bit string corresponds to the cell with <i>ServCellIndex</i>=1 etc. Each bit has either value 0 (means that aperiodic CSI report is triggered for CSI subframe set 1) or value 1 (means that aperiodic CSI report is triggered for CSI subframe set 2).</p>

– CQI-ReportBoth

The IE *CQI-ReportBoth* is used to specify the CQI reporting configuration common to both periodic and aperiodic configurations.

CQI-ReportBoth information elements

```

-- ASN1START

CQI-ReportBoth-r11 ::=          SEQUENCE {
    csi-IM-ConfigToReleaseList-r11    CSI-IM-ConfigToReleaseList-r11    OPTIONAL,    -- Need ON
    csi-IM-ConfigToAddModList-r11     CSI-IM-ConfigToAddModList-r11     OPTIONAL,    -- Need ON
    csi-ProcessToReleaseList-r11      CSI-ProcessToReleaseList-r11      OPTIONAL,    -- Need ON
    csi-ProcessToAddModList-r11       CSI-ProcessToAddModList-r11       OPTIONAL,    -- Need ON
}

CQI-ReportBoth-v1250 ::=       SEQUENCE {
    csi-IM-ConfigToReleaseListExt-r12  CSI-IM-ConfigId-v1250             OPTIONAL,    -- Need ON
    csi-IM-ConfigToAddModListExt-r12  CSI-IM-ConfigExt-r12              OPTIONAL,    -- Need ON
}

CQI-ReportBoth-v1310 ::=       SEQUENCE {
    csi-IM-ConfigToReleaseListExt-r13  CSI-IM-ConfigToReleaseListExt-r13  OPTIONAL,    -- Need ON
    csi-IM-ConfigToAddModListExt-r13  CSI-IM-ConfigToAddModListExt-r13  OPTIONAL,    -- Need ON
}

CSI-IM-ConfigToAddModList-r11 ::= SEQUENCE (SIZE (1..maxCSI-IM-r11)) OF CSI-IM-Config-r11
CSI-IM-ConfigToAddModListExt-r13 ::= SEQUENCE (SIZE (1..maxCSI-IM-v1310)) OF CSI-IM-ConfigExt-r12
CSI-IM-ConfigToReleaseList-r11 ::= SEQUENCE (SIZE (1..maxCSI-IM-r11)) OF CSI-IM-ConfigId-r11
CSI-IM-ConfigToReleaseListExt-r13 ::= SEQUENCE (SIZE (1..maxCSI-IM-v1310)) OF CSI-IM-ConfigId-
v1310
CSI-ProcessToAddModList-r11 ::= SEQUENCE (SIZE (1..maxCSI-Proc-r11)) OF CSI-Process-r11
CSI-ProcessToReleaseList-r11 ::= SEQUENCE (SIZE (1..maxCSI-Proc-r11)) OF CSI-ProcessId-r11

CQI-ReportBothProc-r11 ::=      SEQUENCE {
    ri-Ref-CSI-ProcessId-r11          CSI-ProcessId-r11                  OPTIONAL,    -- Need OR
    pmi-RI-Report-r11                 ENUMERATED {setup}                 OPTIONAL,    -- Need OR
}

-- ASN1STOP

```

CQI-ReportBoth field descriptions
<p>csi-IM-ConfigToAddModList For a serving frequency E-UTRAN configures one or more <i>CSI-IM-Config</i> only when transmission mode 10 is configured for the serving cell on this carrier frequency.</p>
<p>csi-ProcessToAddModList For a serving frequency E-UTRAN configures one or more <i>CSI-Process</i> only when transmission mode 10 is configured for the serving cell on this carrier frequency.</p>
<p>cqi-ReportModeAperiodic Parameter: <i>reporting mode</i>. Value <i>rm12</i> corresponds to Mode 1-2, <i>rm20</i> corresponds to Mode 2-0, <i>rm22</i> corresponds to Mode 2-2 etc. PUSCH reporting modes are described in TS 36.213 [23, 7.2.1]. The UE shall ignore <i>cqi-ReportModeAperiodic-r10</i> when transmission mode 10 is configured for the serving cell on this carrier frequency. The UE shall ignore <i>cqi-ReportModeAperiodic-r10</i> configured for the PCell/ PSCell when the transmission bandwidth of the PCell/PSCell in downlink is 6 resource blocks.</p>
<p>pmi-RI-Report See TS 36.213 [23, 7.2]. The presence of this field means PMI/RI reporting is configured; otherwise the PMI/RI reporting is not configured. EUTRAN configures this field only when <i>transmissionMode</i> is set to <i>tm8</i>, <i>tm9</i> or <i>tm10</i>. The UE shall ignore <i>pmi-RI-Report-r9/ pmi-RI-Report-r10</i> when transmission mode 10 is configured for the serving cell on this carrier frequency.</p>
<p>ri-Ref-CSI-ProcessId CSI process whose RI value the UE inherits when reporting RI, in the same subframe, for CSI reporting. E-UTRAN ensures that the CSI process that inherits the RI value is configured in accordance with the conditions specified in TS 36.213 [23, 7.2.1, 7.2.2].</p>

CQI-ReportConfig

The IE *CQI-ReportConfig* is used to specify the CQI reporting configuration.

CQI-ReportConfig information elements

```

-- ASN1START
CQI-ReportConfig ::=
    SEQUENCE {
        cqi-ReportModeAperiodic    CQI-ReportModeAperiodic OPTIONAL,      -- Need OR
        nomPDSCH-RS-EPRE-Offset    INTEGER (-1..6),
        cqi-ReportPeriodic         CQI-ReportPeriodic   OPTIONAL      -- Need ON
    }

CQI-ReportConfig-v920 ::=
    SEQUENCE {
        cqi-Mask-r9                 ENUMERATED {setup}          OPTIONAL,      -- Cond cqi-Setup
        pmi-RI-Report-r9           ENUMERATED {setup}          OPTIONAL      -- Cond PMIRI
    }

CQI-ReportConfig-r10 ::=
    SEQUENCE {
        cqi-ReportAperiodic-r10    CQI-ReportAperiodic-r10    OPTIONAL,      -- Need ON
        nomPDSCH-RS-EPRE-Offset    INTEGER (-1..6),
        cqi-ReportPeriodic-r10     CQI-ReportPeriodic-r10     OPTIONAL,      -- Need ON
        pmi-RI-Report-r9           ENUMERATED {setup}          OPTIONAL,      -- Cond
    }
PMIRIPCell
    csi-SubframePatternConfig-r10 CHOICE {
        release                     NULL,
        setup                       SEQUENCE {
            csi-MeasSubframeSet1-r10 MeasSubframePattern-r10,
            csi-MeasSubframeSet2-r10 MeasSubframePattern-r10
        }
    }
    }
    }
    OPTIONAL      -- Need ON

CQI-ReportConfig-v1130 ::=
    SEQUENCE {
        cqi-ReportPeriodic-v1130    CQI-ReportPeriodic-v1130,
        cqi-ReportBoth-r11         CQI-ReportBoth-r11
    }

CQI-ReportConfig-v1250 ::=
    SEQUENCE {
        csi-SubframePatternConfig-r12 CHOICE {
            release                     NULL,
            setup                       SEQUENCE {
                csi-MeasSubframeSets-r12 BIT STRING (SIZE (10))
            }
        }
        }
        }
        OPTIONAL,      -- Need ON
        cqi-ReportBoth-v1250         CQI-ReportBoth-v1250     OPTIONAL,      -- Need ON
        cqi-ReportAperiodic-v1250    CQI-ReportAperiodic-v1250 OPTIONAL,      -- Need ON
        altCQI-Table-r12             ENUMERATED {

```



```

    allSubframes, csi-SubframeSet1,
    csi-SubframeSet2, spare1} OPTIONAL -- Need OP
}
CQI-ReportConfig-v1310 ::= SEQUENCE {
    cqi-ReportBoth-v1310 CQI-ReportBoth-v1310 OPTIONAL, -- Need ON
    cqi-ReportAperiodic-v1310 CQI-ReportAperiodic-v1310 OPTIONAL, -- Need ON
    cqi-ReportPeriodic-v1310 CQI-ReportPeriodic-v1310 OPTIONAL -- Need ON
}
CQI-ReportConfig-v1320 ::= SEQUENCE {
    cqi-ReportPeriodic-v1320 CQI-ReportPeriodic-v1320 OPTIONAL -- Need ON
}
CQI-ReportConfig-v1430 ::= SEQUENCE {
    cqi-ReportAperiodicHybrid-r14 CQI-ReportAperiodicHybrid-r14 OPTIONAL -- Need ON
}
CQI-ReportConfigSCell-r10 ::= SEQUENCE {
    cqi-ReportModeAperiodic-r10 CQI-ReportModeAperiodic OPTIONAL, -- Need OR
    nomPDSCH-RS-EPRE-Offset-r10 INTEGER (-1..6),
    cqi-ReportPeriodicSCell-r10 CQI-ReportPeriodic-r10 OPTIONAL, -- Need ON
    pmi-RI-Report-r10 ENUMERATED {setup} OPTIONAL -- Cond
}
PMIRISCell
}
-- ASN1STOP

```

CQI-ReportConfig field descriptions

altCQI-Table

Indicates the applicability of the alternative CQI table (i.e. Table 7.2.3-2 in TS 36.213 [23]) for both aperiodic and periodic CSI reporting for the concerned serving cell. Value *allSubframes* means the alternative CQI table applies to all the subframes and CSI processes, if configured, and value *csi-SubframeSet1* means the alternative CQI table applies to CSI subframe set1, and value *csi-SubframeSet2* means the alternative CQI table applies to CSI subframe set2. EUTRAN sets the value to *csi-SubframeSet1* or *csi-SubframeSet2* only if *transmissionMode* is set in range *tm1* to *tm9* and *csi-SubframePatternConfig-r10* is configured for the concerned serving cell and different CQI tables apply to the two CSI subframe sets; otherwise EUTRAN sets the value to *allSubframes*. If this field is not present, the UE shall use Table 7.2.3-1 in TS 36.213 [23] for all subframes and CSI processes, if configured.

cqi-Mask

Limits CQI/PMI/PTI/RI reports to the on-duration period of the DRX cycle, see TS 36.321 [6]. One value applies for all CSI processes and all serving cells (the associated functionality is common i.e. not performed independently for each cell).

cqi-ReportAperiodic

E-UTRAN does not configure *CQI-ReportAperiodic* when transmission mode 10 is configured for all serving cells. E-UTRAN configures *cqi-ReportAperiodic-v1250* only if *cqi-ReportAperiodic-r10* and *csi-MeasSubframeSets-r12* are configured. E-UTRAN configures *cqi-ReportAperiodic-v1310* only if *cqi-ReportAperiodic-r10* is configured.

cqi-ReportModeAperiodic

Parameter: *reporting mode*. Value *rm12* corresponds to Mode 1-2, *rm20* corresponds to Mode 2-0, *rm22* corresponds to Mode 2-2 etc. PUSCH reporting modes are described in TS 36.213 [23, 7.2.1]. The UE shall ignore *cqi-ReportModeAperiodic-r10* when transmission mode 10 is configured for the serving cell on this carrier frequency. The UE shall ignore *cqi-ReportModeAperiodic-r10* configured for the PCell/ PSCell when the transmission bandwidth of the PCell/PSCell in downlink is 6 resource blocks.

csi-MeasSubframeSets

Indicates the two CSI subframe sets. Value 0 means the subframe belongs to CSI subframe set 1 and value 1 means the subframe belongs to CSI subframe set 2. CSI subframe set 1 refers to $C_{CSI,0}$ in TS 36.213 [23, 7.2] and CSI subframe set 2 refers to $C_{CSI,1}$ in TS 36.213 [23, 7.2]. EUTRAN does not configure *csi-MeasSubframeSet1-r10* and *csi-MeasSubframeSet2-r10* if either *csi-MeasSubframeSets-r12* for PCell or *eimta-MainConfigPCell-r12* is configured.

csi-MeasSubframeSet1, csi-MeasSubframeSet2

Indicates the CSI measurement subframe sets. *csi-MeasSubframeSet1* refers to $C_{CSI,0}$ in TS 36.213 [23, 7.2] and *csi-MeasSubframeSet2* refers to $C_{CSI,1}$ in TS 36.213 [23, 7.2]. E-UTRAN only configures the two CSI measurement subframe sets for the PCell.

nomPDSCH-RS-EPRE-Offset

Parameter: Δ_{offset} see TS 36.213 [23, 7.2.3]. Actual value = field value * 2 [dB].

pmi-RI-Report

See TS 36.213 [23, 7.2]. The presence of this field means PMI/RI reporting is configured; otherwise the PMI/RI reporting is not configured. EUTRAN configures this field only when *transmissionMode* is set to *tm8*, *tm9* or *tm10*. The UE shall ignore *pmi-RI-Report-r9* *pmi-RI-Report-r10* when transmission mode 10 is configured for the serving cell on this carrier frequency.

Conditional presence	Explanation
<i>cqi-Setup</i>	This field is not present for an Scell except for the PSCell, while it is conditionally present for the PCell and the PSCell according to the following. The field is optional present, need OR, if the <i>cqi-ReportPeriodic</i> in the <i>cqi-ReportConfig</i> is set to <i>setup</i> . If the field <i>cqi-ReportPeriodic</i> is present and set to <i>release</i> , the field is not present and the UE shall delete any existing value for this field. Otherwise the field is not present.
<i>PMIRI</i>	The field is optional present, need OR, if <i>cqi-ReportPeriodic</i> is included and set to <i>setup</i> , or <i>cqi-ReportModeAperiodic</i> is included. If the field <i>cqi-ReportPeriodic</i> is present and set to <i>release</i> and <i>cqi-ReportModeAperiodic</i> is absent, the field is not present and the UE shall delete any existing value for this field. Otherwise the field is not present.
<i>PMIRIPCell</i>	The field is optional present, need OR, if <i>cqi-ReportPeriodic</i> is included in the <i>CQI-ReportConfig-r10</i> and set to <i>setup</i> , or <i>cqi-ReportAperiodic</i> is included in the <i>CQI-ReportConfig-r10</i> and set to <i>setup</i> . If the field <i>cqi-ReportPeriodic</i> is present in the <i>CQI-ReportConfig-r10</i> and set to <i>release</i> and <i>cqi-ReportAperiodic</i> is included in the <i>CQI-ReportConfig-r10</i> and set to <i>release</i> , the field is not present and the UE shall delete any existing value for this field. Otherwise the field is not present.
<i>PMIRISCell</i>	The field is optional present, need OR, if <i>cqi-ReportPeriodicSCell</i> is included and set to <i>setup</i> , or <i>cqi-ReportModeAperiodic-r10</i> is included in the <i>CQI-ReportConfigSCell</i> . If the field <i>cqi-ReportPeriodicSCell</i> is present and set to <i>release</i> and <i>cqi-ReportModeAperiodic-r10</i> is absent in the <i>CQI-ReportConfigSCell</i> , the field is not present and the UE shall delete any existing value for this field. Otherwise the field is not present.

– CQI-ReportPeriodic

The IE *CQI-ReportPeriodic* is used to specify the periodic CQI reporting configuration elements.

CQI-ReportPeriodic information elements

```
-- ASN1START
CQI-ReportPeriodic ::= CHOICE {
  release          NULL,
  setup           SEQUENCE {
    cqi-PUCCH-ResourceIndex    INTEGER (0..1185),
    cqi-pmi-ConfigIndex        INTEGER (0..1023),
    cqi-FormatIndicatorPeriodic CHOICE {
      widebandCQI              NULL,
      subbandCQI               SEQUENCE {
        k                       INTEGER (1..4)
      }
    },
    ri-ConfigIndex             INTEGER (0..1023)  OPTIONAL,      -- Need OR
    simultaneousAckNackAndCQI  BOOLEAN
  }
}

CQI-ReportPeriodic-r10 ::= CHOICE {
  release          NULL,
  setup           SEQUENCE {
    cqi-PUCCH-ResourceIndex-r10    INTEGER (0..1184),
    cqi-PUCCH-ResourceIndexP1-r10  INTEGER (0..1184)  OPTIONAL,      -- Need OR
    cqi-pmi-ConfigIndex            INTEGER (0..1023),
    cqi-FormatIndicatorPeriodic-r10 CHOICE {
      widebandCQI-r10              SEQUENCE {
        csi-ReportMode-r10         ENUMERATED {submode1, submode2}  OPTIONAL  -- Need OR
      },
      subbandCQI-r10               SEQUENCE {
        k                           INTEGER (1..4),
        periodicityFactor-r10      ENUMERATED {n2, n4}
      }
    },
    ri-ConfigIndex                 INTEGER (0..1023)  OPTIONAL,      -- Need OR
    simultaneousAckNackAndCQI      BOOLEAN,
    cqi-Mask-r9                    ENUMERATED {setup}  OPTIONAL,      -- Need OR
    csi-ConfigIndex-r10            CHOICE {
      release                       NULL,
      setup                          SEQUENCE {
        cqi-pmi-ConfigIndex2-r10    INTEGER (0..1023),
        ri-ConfigIndex2-r10        INTEGER (0..1023)  OPTIONAL  -- Need OR
      }
    }
  }  OPTIONAL  -- Need ON
}
-- ASN1END
```

```

}

CQI-ReportPeriodic-v1130 ::= SEQUENCE {
    simultaneousAckNackAndCQI-Format3-r11    ENUMERATED {setup}    OPTIONAL,    -- Need OR
    cqi-ReportPeriodicProcExtToReleaseList-r11 CQI-ReportPeriodicProcExtToReleaseList-r11
    OPTIONAL,    -- Need ON
    cqi-ReportPeriodicProcExtToAddModList-r11 CQI-ReportPeriodicProcExtToAddModList-r11    OPTIONAL
    -- Need ON
}

CQI-ReportPeriodic-v1310 ::= SEQUENCE {
    cri-ReportConfig-r13    CRI-ReportConfig-r13    OPTIONAL,    -- Need OR
    simultaneousAckNackAndCQI-Format4-Format5-r13    ENUMERATED {setup}    OPTIONAL-- Need OR
}

CQI-ReportPeriodic-v1320 ::= SEQUENCE {
    periodicityFactorWB-r13    ENUMERATED {n2, n4}    OPTIONAL    -- Need OR
}

CQI-ReportPeriodicProcExtToAddModList-r11 ::= SEQUENCE (SIZE (1..maxCQI-ProcExt-r11)) OF CQI-
ReportPeriodicProcExt-r11

CQI-ReportPeriodicProcExtToReleaseList-r11 ::= SEQUENCE (SIZE (1..maxCQI-ProcExt-r11)) OF CQI-
ReportPeriodicProcExtId-r11

CQI-ReportPeriodicProcExt-r11 ::= SEQUENCE {
    cqi-ReportPeriodicProcExtId-r11 CQI-ReportPeriodicProcExtId-r11,
    cqi-pmi-ConfigIndex-r11    INTEGER (0..1023),
    cqi-FormatIndicatorPeriodic-r11 CHOICE {
        widebandCQI-r11    SEQUENCE {
            csi-ReportMode-r11    ENUMERATED {submode1, submode2}    OPTIONAL    -- Need OR
        },
        subbandCQI-r11    SEQUENCE {
            k    INTEGER (1..4),
            periodicityFactor-r11    ENUMERATED {n2, n4}
        }
    },
    ri-ConfigIndex-r11    INTEGER (0..1023)    OPTIONAL,    -- Need OR
    csi-ConfigIndex-r11    CHOICE {
        release    NULL,
        setup    SEQUENCE {
            cqi-pmi-ConfigIndex2-r11    INTEGER (0..1023),
            ri-ConfigIndex2-r11    INTEGER (0..1023)    OPTIONAL    -- Need OR
        }
    }
    OPTIONAL,    -- Need ON
    ...,
    [[ cri-ReportConfig-r13    CRI-ReportConfig-r13    OPTIONAL    -- Need ON
    ]],
    [[ periodicityFactorWB-r13    ENUMERATED {n2, n4}    OPTIONAL    -- Need ON
    ]]
}

CRI-ReportConfig-r13 ::= CHOICE {
    release    NULL,
    setup    SEQUENCE {
        cri-ConfigIndex-r13    CRI-ConfigIndex-r13,
        cri-ConfigIndex2-r13    CRI-ConfigIndex-r13    OPTIONAL    -- Need OR
    }
}

CRI-ConfigIndex-r13 ::= INTEGER (0..1023)

-- ASN1STOP

```

CQI-ReportPeriodic field descriptions
<p>cqi-FormatIndicatorPeriodic Parameter: <i>PUCCH CQI Feedback Type</i>, see TS 36.213 [23, table 7.2.2-1]. Depending on transmissionMode, reporting mode is implicitly given from the table.</p>
<p>cqi-Mask Limits CQI/PMI/PTI/RI reports to the on-duration period of the DRX cycle, see TS 36.321 [6]. One value applies for all CSI processes and all serving cells (the associated functionality is common i.e. not performed independently for each cell).</p>
<p>cqi-pmi-ConfigIndex Parameter: <i>CQI/PMI Periodicity and Offset Configuration Index $I_{CQI/PMI}$</i>, see TS 36.213 [23, tables 7.2.2-1A and 7.2.2-1C]. If subframe patterns for CSI (CQI/PMI/PTI/RI) reporting are configured (i.e. <i>csi-SubframePatternConfig</i> is configured), the parameter applies to the subframe pattern corresponding to <i>csi-MeasSubframeSet1</i> or corresponding to the CSI subframe set 1 indicated by <i>csi-MeasSubframeSets-r12</i>.</p>
<p>cqi-pmi-ConfigIndex2 Parameter: <i>CQI/PMI Periodicity and Offset Configuration Index $I_{CQI/PMI}$</i>, see TS 36.213 [23, tables 7.2.2-1A and 7.2.2-1C]. The parameter applies to the subframe pattern corresponding to <i>csi-MeasSubframeSet2</i> or corresponding to the CSI subframe set 2 indicated by <i>csi-MeasSubframeSets-r12</i>.</p>
<p>cqi-PUCCH-ResourceIndex, cqi-PUCCH-ResourceIndexP1 Parameter $n_{PUCCH}^{(2,p)}$ for antenna port P0 and for antenna port P1 respectively, see TS 36.213 [23, 7.2]. E-UTRAN does not apply value 1185. One value applies for all CSI processes.</p>
<p>cqi-ReportAperiodic E-UTRAN does not configure <i>CQI-ReportAperiodic</i> when transmission mode 10 is configured for all serving cells. E-UTRAN configures <i>cqi-ReportAperiodic-v1250</i> only if <i>cqi-ReportAperiodic-r10</i> and <i>csi-MeasSubframeSets-r12</i> are configured. E-UTRAN configures <i>cqi-ReportAperiodic-v1310</i> only if <i>cqi-ReportAperiodic-r10</i> is configured.</p>
<p>cqi-ReportModeAperiodic Parameter: <i>reporting mode</i>. Value rm12 corresponds to Mode 1-2, rm20 corresponds to Mode 2-0, rm22 corresponds to Mode 2-2 etc. PUSCH reporting modes are described in TS 36.213 [23, 7.2.1]. The UE shall ignore <i>cqi-ReportModeAperiodic-r10</i> when transmission mode 10 is configured for the serving cell on this carrier frequency. The UE shall ignore <i>cqi-ReportModeAperiodic-r10</i> configured for the PCell/ PSCell when the transmission bandwidth of the PCell/PSCell in downlink is 6 resource blocks.</p>
<p>CQI-ReportPeriodicProcExt A set of periodic CQI related parameters for which E-UTRAN may configure different values for each CSI process. For a serving frequency E-UTRAN configures one or more <i>CQI-ReportPeriodicProcExt</i> only when transmission mode 10 is configured for the serving cell on this carrier frequency.</p>
<p>cri-ConfigIndex Parameter: <i>cri-ConfigIndex I_{CRI}</i> see TS 36.213 [23]. The parameter applies to the subframe pattern corresponding to <i>csi-MeasSubframeSet1</i>. EUTRAN configures the field if subframe patterns for CSI (CQI/PMI/PTI/RI/CRI) reporting are configured (i.e. <i>csi-SubframePatternConfig</i> is configured).</p>
<p>cri-ConfigIndex2 Parameter: <i>cri-ConfigIndex I_{CRI}</i> see TS 36.213 [23]. The parameter applies to the subframe pattern corresponding to <i>csi-MeasSubframeSet2</i> or corresponding to the CSI subframe set 2 indicated by <i>csi-MeasSubframeSets</i>. E-UTRAN configures <i>cri-ConfigIndex2</i> only if <i>cri-ConfigIndex</i> is configured.</p>
<p>cri-ReportConfig E-UTRAN configures the field only if the UE is configured with <i>eMIMO-Type</i> set to "beamformed" and if multiple references to RS configuration using non-zero power transmission are configured (i.e. if <i>csi-RS-ConfigNZPIdListExt</i> is configured).</p>
<p>csi-ConfigIndex E-UTRAN configures <i>csi-ConfigIndex</i> only for PCell and only if <i>csi-SubframePatternConfig</i> is configured. The UE shall release <i>csi-ConfigIndex</i> if <i>csi-SubframePatternConfig</i> is released.</p>
<p>csi-ProcessToAddModList For a serving frequency E-UTRAN configures one or more <i>CSI-Process</i> only when transmission mode 10 is configured for the serving cell on this carrier frequency.</p>
<p>csi-ReportMode Parameter: <i>PUCCH_format1-1_CSI_reporting_mode</i>, see TS 36.213 [23, 7.2.2].</p>
<p>K Parameter: K, see TS 36.213 [23, 7.2.2].</p>
<p>nomPDSCH-RS-EPRE-Offset Parameter: Δ_{offset} see TS 36.213 [23, 7.2.3]. Actual value = field value * 2 [dB].</p>
<p>periodicityFactor, periodicityFactorWB Parameter: H', see TS 36.213 [23, 7.2.2]. EUTRAN configures field <i>periodicityFactorWB</i> only when the UE is configured with <i>eMIMO-Type</i> set to <i>nonPrecoded</i> and with <i>cqi-FormatIndicatorPeriodic</i> set to <i>widebandCQI</i>.</p>
<p>ri-ConfigIndex Parameter: <i>RI Config Index I_{RI}</i>, see TS 36.213 [23, 7.2.2-1B]. If subframe patterns for CSI (CQI/PMI/PTI/RI/CRI) reporting are configured (i.e. <i>csi-SubframePatternConfig</i> is configured), the parameter applies to the subframe pattern corresponding to <i>csi-MeasSubframeSet1</i>.</p>

CQI-ReportPeriodic field descriptions
<p><i>ri-ConfigIndex2</i> Parameter: <i>RI Config Index I_{RI}</i>, see TS 36.213 [23, 7.2.2-1B]. The parameter applies to the subframe pattern corresponding to <i>csi-MeasSubframeSet2</i> or corresponding to the CSI subframe set 2 indicated by <i>csi-MeasSubframeSets-r12</i>. E-UTRAN configures <i>ri-ConfigIndex2</i> only if <i>ri-ConfigIndex</i> is configured.</p>
<p><i>simultaneousAckNackAndCQI</i> Parameter: <i>Simultaneous-AN-and-CQI</i>, see TS 36.213 [23, 10.1]. TRUE indicates that simultaneous transmission of ACK/NACK and CQI is allowed. One value applies for all CSI processes. For SCells except for the PSCell and PUCCH SCell this field is not applicable and the UE shall ignore the value.</p>
<p><i>simultaneousAckNackAndCQI-Format3</i> Indicates that the UE shall perform simultaneous transmission of HARQ A/N and periodic CQI report multiplexing on PUCCH format 3, see TS 36.213 [23, 7.2, 10.1.1]. E-UTRAN configures this information only when <i>pucch-Format</i> is set to <i>format3</i>. One value applies for all CSI processes. For SCells except for the PSCell and PUCCH SCell this field is not applicable and the UE shall ignore the value.</p>
<p><i>simultaneousAckNackAndCQI-Format4-Format5</i> Indicates that the UE shall perform simultaneous transmission of HARQ A/N and periodic CSI report multiplexing on PUCCH format 4 and format 5, see TS 36.213 [23, 10.1.1]. E-UTRAN configures this information only when <i>pucch-Format</i> is set to <i>format4</i> or <i>format5</i>. One value applies for all CSI processes. For SCells except for the PSCell and PUCCH SCell this field is not applicable and the UE shall ignore the value.</p>

– *CQI-ReportPeriodicProcExtId*

The IE *CQI-ReportPeriodicProcExtId* is used to identify a periodic CQI reporting configuration that E-UTRAN may configure in addition to the configuration specified by the IE *CQI-ReportPeriodic-r10*. These additional configurations are specified by the IE *CQI-ReportPeriodicProcExt-r11*. The identity is unique within the scope of a carrier frequency.

***CQI-ReportPeriodicProcExtId* information elements**

```
-- ASN1START
CQI-ReportPeriodicProcExtId-r11 ::=                INTEGER (1..maxCQI-ProcExt-r11)
-- ASN1STOP
```

– *CrossCarrierSchedulingConfig*

The IE *CrossCarrierSchedulingConfig* is used to specify the configuration when the cross carrier scheduling is used in a cell.

***CrossCarrierSchedulingConfig* information elements**

```
-- ASN1START
CrossCarrierSchedulingConfig-r10 ::=              SEQUENCE {
  schedulingCellInfo-r10                        CHOICE {
    own-r10                                     SEQUENCE {                               -- No cross carrier
      cif-Presence-r10                          BOOLEAN
    },
    other-r10                                   SEQUENCE {                               -- Cross carrier
      schedulingCellId-r10                       ServCellIndex-r10,
      pdsch-Start-r10                           INTEGER (1..4)
    }
  }
}

CrossCarrierSchedulingConfig-r13 ::=              SEQUENCE {
  schedulingCellInfo-r13                        CHOICE {
    own-r13                                     SEQUENCE {                               -- No cross carrier
      cif-Presence-r13                          BOOLEAN
    },
    other-r13                                   SEQUENCE {                               -- Cross carrier scheduling
      schedulingCellId-r13                       ServCellIndex-r13,
      pdsch-Start-r13                           INTEGER (1..4),
      cif-InSchedulingCell-r13                  INTEGER (1..7)
    }
  }
}
```

```

}
}
CrossCarrierSchedulingConfigLAA-UL-r14 ::= SEQUENCE {
    schedulingCellId-r14          ServCellIndex-r13,
    cif-InSchedulingCell-r14     INTEGER (1..7)
}
-- ASN1STOP

```

CrossCarrierSchedulingConfig field descriptions

cif-Presence

The field is used to indicate whether carrier indicator field is present (value TRUE) or not (value FALSE) in PDCCH/EPDCCH DCI formats, see TS 36.212 [22, 5.3.3.1].

cif-InSchedulingCell

The field indicates the CIF value used in the scheduling cell to indicate this cell, see TS 36.212 [22, 5.3.3.1]. In case of carrier indicator field is present, the CIF value is 0.

pdsch-Start

The starting OFDM symbol of PDSCH for the concerned SCell, see TS 36.213 [23, 7.1.6.4]. Values 1, 2, 3 are applicable when *dl-Bandwidth* for the concerned SCell is greater than 10 resource blocks, values 2, 3, 4 are applicable when *dl-Bandwidth* for the concerned SCell is less than or equal to 10 resource blocks, see TS 36.211 [21, Table 6.7-1].

schedulingCellId

Indicates which cell signals the downlink allocations and uplink grants, if applicable, for the concerned SCell. In case the UE is configured with DC, the scheduling cell is part of the same cell group (i.e. MCG or SCG) as the scheduled cell. In case the UE is configured with *crossCarrierSchedulingConfigLAA-UL*, *schedulingCellId* indicated in *crossCarrierSchedulingConfigLAA-UL* only indicates which cell signals the uplink grants.

– CSI-IM-Config

The IE *CSI-IM-Config* is the CSI Interference Measurement (IM) configuration that E-UTRAN may configure on a serving frequency, see TS 36.213 [23, 7.2.6].

CSI-IM-Config information elements

```

-- ASN1START
CSI-IM-Config-r11 ::= SEQUENCE {
    csi-IM-ConfigId-r11          CSI-IM-ConfigId-r11,
    resourceConfig-r11          INTEGER (0..31),
    subframeConfig-r11          INTEGER (0..154),
    ...
    [[ interferenceMeasRestriction-r13  BOOLEAN  OPTIONAL  -- Need ON
    ]]
}

CSI-IM-ConfigExt-r12 ::= SEQUENCE {
    csi-IM-ConfigId-v1250        CSI-IM-ConfigId-v1250,
    resourceConfig-r12          INTEGER (0..31),
    subframeConfig-r12          INTEGER (0..154),
    ...
    [[ interferenceMeasRestriction-r13  BOOLEAN  OPTIONAL,  -- Need ON
    csi-IM-ConfigId-v1310          CSI-IM-ConfigId-v1310  OPTIONAL  -- Need ON
    ]]
}
-- ASN1STOP

```

CSI-IM-Config field descriptions

resourceConfig

Parameter: CSI reference signal configuration, see TS 36.213 [23, 7.2.6] and TS 36.211 [21, table 6.10.5.2-1 and 6.10.5.2-2] for 4 REs.

subframeConfig

Parameter: $I_{\text{CSI-RS}}$, see TS 36.213 [23, 7.2.6] and TS 36.211 [21, table 6.10.5.3-1].

– *CSI-IM-ConfigId*

The IE *CSI-IM-ConfigId* is used to identify a CSI-IM configuration that is configured by the IE *CSI-IM-Config*. The identity is unique within the scope of a carrier frequency.

CSI-IM-ConfigId information elements

```
-- ASN1START
CSI-IM-ConfigId-r11 ::=          INTEGER (1..maxCSI-IM-r11)
CSI-IM-ConfigId-r12 ::=          INTEGER (1..maxCSI-IM-r12)
CSI-IM-ConfigId-v1250 ::=       INTEGER (maxCSI-IM-r12)
CSI-IM-ConfigId-v1310 ::=       INTEGER (minCSI-IM-r13..maxCSI-IM-r13)
CSI-IM-ConfigId-r13 ::=          INTEGER (1..maxCSI-IM-r13)
-- ASN1STOP
```

– *CSI-Process*

The IE *CSI-Process* is the CSI process configuration that E-UTRAN may configure on a serving frequency.

CSI-Process information elements

```
-- ASN1START
CSI-Process-r11 ::=      SEQUENCE {
  csi-ProcessId-r11      CSI-ProcessId-r11,
  csi-RS-ConfigNZPId-r11 CSI-RS-ConfigNZPId-r11,
  csi-IM-ConfigId-r11    CSI-IM-ConfigId-r11,
  p-C-AndCBSRList-r11    P-C-AndCBSR-Pair-r13a,
  cqi-ReportBothProc-r11 CQI-ReportBothProc-r11          OPTIONAL,      -- Need OR
  cqi-ReportPeriodicProcId-r11 INTEGER (0..maxCQI-ProcExt-r11) OPTIONAL,      -- Need OR
  cqi-ReportAperiodicProc-r11 CQI-ReportAperiodicProc-r11 OPTIONAL,      -- Need OR
  ...,
  [[ alternativeCodebookEnabledFor4TXProc-r12 ENUMERATED {true} OPTIONAL,      -- Need ON
    csi-IM-ConfigIdList-r12 CHOICE {
      release NULL,
      setup SEQUENCE (SIZE (1..2)) OF CSI-IM-ConfigId-r12
    } OPTIONAL,      -- Need ON
    cqi-ReportAperiodicProc2-r12 CHOICE {
      release NULL,
      setup CQI-ReportAperiodicProc-r11
    } OPTIONAL      -- Need ON
  ]],
  [[ cqi-ReportAperiodicProc-v1310 CHOICE {
      release NULL,
      setup CQI-ReportAperiodicProc-v1310
    } OPTIONAL,      -- Need ON
    cqi-ReportAperiodicProc2-v1310 CHOICE {
      release NULL,
      setup CQI-ReportAperiodicProc-v1310
    } OPTIONAL,      -- Need ON
    eMIMO-Type-r13 CSI-RS-ConfigEMIMO-r13 OPTIONAL      -- Need ON
  ]],
  [[ dummy CSI-RS-ConfigEMIMO-v1430 OPTIONAL,      -- Need ON
    eMIMO-Hybrid-r14 CSI-RS-ConfigEMIMO-Hybrid-r14 OPTIONAL,      -- Need ON
    advancedCodebookEnabled-r14 BOOLEAN OPTIONAL      -- Need ON
  ]],
  [[ eMIMO-Type-v1480 CSI-RS-ConfigEMIMO-v1480 OPTIONAL      -- Need ON
  ]]
}
-- ASN1STOP
```

CSI-Process field descriptions
<p>advancedCodebookEnabled Value TRUE indicates that the UE should use the advanced code book defined in TS 36.213 [23]. EUTRAN does not configure the field when the UE is configured with <i>eMIMO-Type</i> is set to <i>beamformed</i>, when the UE is configured with <i>eMIMO-Hybrid</i> or when the UE is configured with <i>semiOpenLoop</i>.</p>
<p>alternativeCodebookEnabledFor4TXProc Indicates whether code book in TS 36.213 [23] Table 7.2.4-0A to Table 7.2.4-0D is being used for deriving CSI feedback and reporting for a CSI process. EUTRAN may configure the field only if the number of CSI-RS ports for non-zero power transmission CSI-RS configuration is 4.</p>
<p>cqi-ReportAperiodicProc If <i>csi-MeasSubframeSets-r12</i> is configured for the same frequency as the CSI process, <i>cqi-ReportAperiodicProc</i> applies for CSI subframe set 1. If <i>csi-MeasSubframeSet1-r10</i> or <i>csi-MeasSubframeSet2-r10</i> are configured for the same frequency as the CSI process, <i>cqi-ReportAperiodicProc</i> applies for CSI subframe set 1 or CSI subframe set 2. Otherwise, <i>cqi-ReportAperiodicProc</i> applies for all subframes. E-UTRAN configures <i>cqi-ReportAperiodicProc-v1310</i> only if <i>cqi-ReportAperiodicProc-r11</i> is configured</p>
<p>cqi-ReportAperiodicProc2 <i>cqi-ReportAperiodicProc2</i> is configured only if <i>csi-MeasSubframeSets-r12</i> is configured for the same frequency as the CSI process. <i>cqi-ReportAperiodicProc2</i> is for CSI subframe set 2. E-UTRAN shall set <i>cqi-ReportModeAperiodic-r11</i> in <i>cqi-ReportAperiodicProc2</i> the same as in <i>cqi-ReportAperiodicProc</i>. E-UTRAN configures <i>cqi-ReportAperiodicProc2-v1310</i> only if <i>cqi-ReportAperiodicProc2-r12</i> is configured.</p>
<p>cqi-ReportBothProc Includes CQI configuration parameters applicable for both aperiodic and periodic CSI reporting, for which CSI process specific values may be configured. E-UTRAN configures the field if and only if <i>cqi-ReportPeriodicProcId</i> is included and/ or if <i>cqi-ReportAperiodicProc</i> is included.</p>
<p>cqi-ReportPeriodicProcId Refers to a periodic CQI reporting configuration that is configured for the same frequency as the CSI process. Value 0 refers to the set of parameters defined by the REL-10 CQI reporting configuration fields, while the other values refer to the additional configurations E-UTRAN assigns by <i>CQI-ReportPeriodicProcExt-r11</i> (and as covered by <i>CQI-ReportPeriodicProcExtId</i>).</p>
<p>csi-IM-ConfigId Refers to a CSI-IM configuration that is configured for the same frequency as the CSI process. If <i>csi-IM-ConfigId-v1250</i> or <i>csi-IM-ConfigId-v1310</i> is configured, the UE only considers this extension (i.e., UE ignores <i>csi-IM-ConfigId-r11</i> and <i>csi-IM-ConfigId-r12</i>).</p>
<p>csi-IM-ConfigIdList Refers to one or two CSI-IM configurations that are configured for the same frequency as the CSI process. <i>csi-IM-ConfigIdList</i> can include 2 entries only if <i>csi-MeasSubframeSets-r12</i> is configured for the same frequency as the CSI process.</p>
<p>csi-RS-ConfigNZPId Refers to a CSI RS configuration using non-zero power transmission that is configured for the same frequency as the CSI process.</p>
<p>dummy This field is not used in the specification. If received it shall be ignored by the UE.</p>
<p>eMIMO-Type Parameter: <i>eMIMO-Type</i>, see TS 36.213 [23], TS 36.211 [21]. If <i>eMIMO-Type</i> is set to <i>nonPrecoded</i>, the codebooks used for deriving CSI feedback are in TS 36.213 [23, Table 7.2.4-10 to Table 7.2.4-17]. Choice values <i>nonPrecoded</i> and <i>beamformed</i> correspond to 'CLASS A' and 'CLASS B' respectively, see TS 36.212 [22] and TS 36.213 [23].</p>
<p>p-C-AndCBSRList The UE shall ignore <i>p-C-AndCBSRList-r11</i> if configured with <i>eMIMO-Type</i> unless it is set to <i>beamformed</i>, <i>alternativeCodebookEnabledBeamformed</i> (in <i>CSI-RS-ConfigBeamformed</i>) is set to <i>FALSE</i> and <i>csi-RS-ConfigNZPIdListExt</i> is not configured,</p>

– CSI-ProcessId

The IE *CSI-ProcessId* is used to identify a CSI process that is configured by the IE *CSI-Process*. The identity is unique within the scope of a carrier frequency.

CSI-ProcessId information elements

```
-- ASN1START
CSI-ProcessId-r11 ::=          INTEGER (1..maxCSI-Proc-r11)
-- ASN1STOP
```

– CSI-RS-Config

The IE *CSI-RS-Config* is used to specify the CSI (Channel-State Information) reference signal configuration.

CSI-RS-Config information elements

```

-- ASN1START
CSI-RS-Config-r10 ::= SEQUENCE {
  csi-RS-r10 CHOICE {
    release NULL,
    setup SEQUENCE {
      antennaPortsCount-r10 ENUMERATED {an1, an2, an4, an8},
      resourceConfig-r10 INTEGER (0..31),
      subframeConfig-r10 INTEGER (0..154),
      p-C-r10 INTEGER (-8..15)
    }
  }
  zeroTxPowerCSI-RS-r10 ZeroTxPowerCSI-RS-Conf-r12 OPTIONAL, -- Need ON
}

CSI-RS-Config-v1250 ::= SEQUENCE {
  zeroTxPowerCSI-RS2-r12 ZeroTxPowerCSI-RS-Conf-r12 OPTIONAL, -- Need ON
  ds-ZeroTxPowerCSI-RS-r12 CHOICE {
    release NULL,
    setup SEQUENCE {
      zeroTxPowerCSI-RS-List-r12 SEQUENCE (SIZE (1..maxDS-ZTP-CSI-RS-r12)) OF
ZeroTxPowerCSI-RS-r12
    }
  }
}
ON
}

CSI-RS-Config-v1310 ::= SEQUENCE {
  eMIMO-Type-r13 CSI-RS-ConfigEMIMO-r13 OPTIONAL -- Need ON
}

CSI-RS-Config-v1430 ::= SEQUENCE {
  dummy CSI-RS-ConfigEMIMO-v1430 OPTIONAL, -- Need ON
  eMIMO-Hybrid-r14 CSI-RS-ConfigEMIMO-Hybrid-r14 OPTIONAL, -- Need ON
  advancedCodebookEnabled-r14 BOOLEAN OPTIONAL, -- Need ON
}

CSI-RS-Config-v1480 ::= SEQUENCE {
  eMIMO-Type-v1480 CSI-RS-ConfigEMIMO-v1480 OPTIONAL -- Need ON
}

ZeroTxPowerCSI-RS-Conf-r12 ::= CHOICE {
  release NULL,
  setup ZeroTxPowerCSI-RS-r12
}

ZeroTxPowerCSI-RS-r12 ::= SEQUENCE {
  zeroTxPowerResourceConfigList-r12 BIT STRING (SIZE (16)),
  zeroTxPowerSubframeConfig-r12 INTEGER (0..154)
}
-- ASN1STOP

```

CSI-RS-Config field descriptions
<p>advancedCodebookEnabled Value TRUE indicates that the UE should use the advanced code book defined in TS 36.213 [23]. EUTRAN does not configure the field when the UE is configured with <i>eMIMO-Type</i> is set to <i>beamformed</i>, when the UE is configured with <i>eMIMO-Hybrid</i> or when the UE is configured with <i>semiOpenLoop</i>.</p>
<p>antennaPortsCount Parameter represents the number of antenna ports used for transmission of CSI reference signals where value an1 corresponds to 1 antenna port, an2 to 2 antenna ports and so on, see TS 36.211 [21, 6.10.5].</p>
<p>ds-ZeroTxPowerCSI-RS Parameter for additional <i>zeroTxPowerCSI-RS</i> for a serving cell, concerning the CSI-RS included in discovery signals.</p>
<p>dummy This field is not used in the specification. If received it shall be ignored by the UE.</p>
<p>eMIMO-Type Parameter: <i>eMIMO-Type</i>, see TS 36.213 [23], TS 36.211 [21]. If <i>eMIMO-Type</i> is set to <i>nonPrecoded</i>, the codebooks used for deriving CSI feedback are in TS 36.213 [23, Table 7.2.4-10 to Table 7.2.4-17]. Choice values <i>nonPrecoded</i> and <i>beamformed</i> correspond to 'CLASS A' and 'CLASS B' respectively, see TS 36.212 [22] and TS 36.213 [23].</p>
<p>p-C Parameter: P_c, see TS 36.213 [23, 7.2.5]. The UE shall ignore <i>p-C-r10</i> if configured with <i>eMIMO-Type</i> unless it is set to <i>beamformed</i>, <i>alternativeCodebookEnabledBeamformed</i> (in <i>CSI-RS-ConfigBeamformed</i>) is set to <i>FALSE</i> and <i>csi-RS-ConfigNZPIdListExt</i> is not configured.</p>
<p>resourceConfig Parameter: CSI reference signal configuration, see TS 36.211 [21, table 6.10.5.2-1 and 6.10.5.2-2].</p>
<p>subframeConfig Parameter: $I_{\text{CSI-RS}}$, see TS 36.211 [21, table 6.10.5.3-1].</p>
<p>zeroTxPowerCSI-RS2 Parameter for additional <i>zeroTxPowerCSI-RS</i> for a serving cell. E-UTRAN configures the field only if <i>csi-MeasSubframeSets-r12</i> and <i>TM 1 – 9</i> are configured for the serving cell.</p>
<p>zeroTxPowerResourceConfigList Parameter: <i>ZeroPowerCSI-RS</i>, see TS 36.213 [23, 7.2.7].</p>
<p>zeroTxPowerSubframeConfig Parameter: $I_{\text{CSI-RS}}$, see TS 36.211 [21, table 6.10.5.3-1].</p>

– CSI-RS-ConfigBeamformed

The IE *CSI-RS-ConfigBeamformed* is used to specify the beamforming configuration of EBF/ FD-MIMO.

CSI-RS-ConfigBeamformed information elements

```

-- ASN1START
CSI-RS-ConfigBeamformed-r13 ::= SEQUENCE {
    csi-RS-ConfigNZPIdListExt-r13 SEQUENCE (SIZE (1..7)) OF CSI-RS-ConfigNZPId-r13
    OPTIONAL, -- Need OR
    csi-IM-ConfigIdList-r13 SEQUENCE (SIZE (1..8)) OF CSI-IM-ConfigId-r13
    OPTIONAL, -- Need OR
    p-C-AndCBSR-PerResourceConfigList-r13 SEQUENCE (SIZE (1..8)) OF P-C-AndCBSR-Pair-r13
    OPTIONAL, -- Need OR
    ace-For4Tx-PerResourceConfigList-r13 SEQUENCE (SIZE (1..7)) OF BOOLEAN OPTIONAL, -- Need
OR
    alternativeCodebookEnabledBeamformed-r13 ENUMERATED {true} OPTIONAL, -- Need OR
    channelMeasRestriction-r13 ENUMERATED {on} OPTIONAL -- Need OR
}
CSI-RS-ConfigBeamformed-r14 ::= SEQUENCE {
    csi-RS-ConfigNZPIdListExt-r14 SEQUENCE (SIZE (1..7)) OF CSI-RS-ConfigNZPId-r13
    OPTIONAL, -- Need OR
    csi-IM-ConfigIdList-r14 SEQUENCE (SIZE (1..8)) OF CSI-IM-ConfigId-r13
    OPTIONAL, -- Need OR
    p-C-AndCBSR-PerResourceConfigList-r14 SEQUENCE (SIZE (1..8)) OF P-C-AndCBSR-Pair-r13
    OPTIONAL, -- Need OR
    ace-For4Tx-PerResourceConfigList-r14 SEQUENCE (SIZE (1..7)) OF BOOLEAN OPTIONAL, -- Need
OR
    alternativeCodebookEnabledBeamformed-r14 ENUMERATED {true} OPTIONAL, -- Need OR
    channelMeasRestriction-r14 ENUMERATED {on} OPTIONAL, -- Need OR
    csi-RS-ConfigNZP-ApList-r14 SEQUENCE (SIZE (1..8)) OF CSI-RS-ConfigNZP-r11
    OPTIONAL, -- Need OR
    nzp-ResourceConfigOriginal-v1430 CSI-RS-Config-NZP-v1430 OPTIONAL, -- Need OR

```

```

csi-RS-NZP-Activation-r14          CSI-RS-ConfigNZP-Activation-r14 OPTIONAL    -- Need
OR
}
CSI-RS-ConfigBeamformed-v1430 ::= SEQUENCE {
  csi-RS-ConfigNZP-ApList-r14      SEQUENCE (SIZE (1..8)) OF CSI-RS-ConfigNZP-r11
                                     OPTIONAL,    -- Need OR
  nzp-ResourceConfigOriginal-v1430 CSI-RS-Config-NZP-v1430    OPTIONAL,    -- Need OR
  csi-RS-NZP-Activation-r14        CSI-RS-ConfigNZP-Activation-r14 OPTIONAL    -- Need
OR
}
CSI-RS-Config-NZP-v1430 ::= SEQUENCE {
  transmissionComb-r14             NZP-TransmissionComb-r14    OPTIONAL,    -- Need OR
  frequencyDensity-r14            NZP-FrequencyDensity-r14    OPTIONAL,    -- Need OR
}
CSI-RS-ConfigNZP-Activation-r14 ::= SEQUENCE {
  csi-RS-NZP-mode-r14             ENUMERATED {semiPersistent, aperiodic},
  activatedResources-r14           INTEGER (0..4)
}
-- ASN1STOP

```

CSI-RS-ConfigBeamformed field descriptions
<p>ace-For4Tx-PerResourceConfigList The field indicates the <i>alternativeCodeBookEnabledFor4TX-r12</i> per CSI-RS resource. E-UTRAN configures the field only if <i>csi-RS-ConfigNZPIdListExt</i> is configured.</p>
<p>activatedResources The number of activated CSI-RS resources, which concerns a subset of the aperiodic CSI-RS resources (for both semi-persistent and aperiodic mode). E-UTRAN configures at most the minimum between <i>nMaxResource</i> as configured by <i>MIMO-UE-ParametersPerTM-r1430</i> and the number of resources as configured by <i>csi-RS-ConfigNZP-ApList-r14</i>.</p>
<p>alternativeCodebookEnabledBeamformed The field indicates whether code book in TS 36.213 [23, Table 7.2.4-18 to Table 7.2.4-20] is being used for deriving CSI feedback and reporting for a CSI process. E-UTRAN configures the field only for a process referring to a single RS configuration using non-zero power transmission (i.e a process for which <i>csi-RS-ConfigNZPIdListExt</i> is not configured). Field <i>alternativeCodebookEnabledBeamformed</i> corresponds to parameter <i>alternativeCodebookEnabledCLASSB_K1</i> in TS 36.212 [22] and TS 36.213 [23].</p>
<p>csi-IM-ConfigIdList E-UTRAN configures the field <i>csi-IM-ConfigIdList</i> only if the IE is included in CSI-Process is configured (i.e. when TM10 is configured for the serving cell).</p>
<p>CSI-RS-ConfigBeamformed If <i>csi-RS-ConfigNZPIdListExt-r13</i> is configured, E-UTRAN configures the same total number of entries for NZP, <i>csi-IM-ConfigIdList-r13</i> and <i>p-C-AndCBSR-PerResourceConfigList-r13</i>.</p>
<p>csi-RS-ConfigNZP-ApList The field is used to configure NZP configurations for aperiodic or semi-persistent CSI RS reporting for which MAC controls activation. EUTRAN configures this field only when the UE is configured to use 2, 4 or and 8 ports CSI-RS, in which case EUTRAN configures the number of entries to be the same as the number of NZP resource configurations. For all these entries the UE shall ignore field <i>subframeConfig</i>. EUTRAN always configures this field together with <i>csi-RS-NZP-Activation</i>. Furthermore, for a given process, E-UTRAN does not simultaneously configure the periodic NZP configuration(s) and NZP CSI RS configurations for aperiodic or semi-persistent reporting.</p>
<p>csi-RS-ConfigNZP-EMIMO The field is used to configure NZP configurations additional to the one defined by the original NZP configuration as included in <i>CSI-RS-Config/CSI-Process</i> when using 12 and 16 ports CSI-RS.</p>
<p>csi-RS-ConfigNZPIdListExt (in CSI-RS-ConfigBeamformed) Indicates the NZP configuration(s) in addition to the original NZP configuration, as defined by <i>csi-RS-Config-r10</i> (TM9) or <i>csi-RS-ConfigNZPId-r11</i> (TM10). I.e. extends the size of the NZP configuration list (originally a single entry i.e. list of size 1) using the general principles specified in 5.1.2.</p>
<p>p-C-AndCBSR-PerResourceConfigList E-UTRAN does not configure the field <i>p-C-AndCBSR-PerResourceConfigList</i> if the UE is configured with <i>eMIMO-Type</i> set to <i>beamformed</i>, <i>alternativeCodebookEnabledBeamformed</i> is set to <i>FALSE</i> and <i>csi-RS-ConfigNZPIdListExt</i> is not configured.</p>

CSI-RS-ConfigEMIMO

The IE *CSI-RS-ConfigEMIMO* is used to specify the CSI (Channel-State Information) reference signal configuration for EBF/ FD-MIMO.

CSI-RS-ConfigEMIMO information elements

```

-- ASN1START
CSI-RS-ConfigEMIMO-r13 ::= CHOICE {
  release          NULL,
  setup           CHOICE {
    nonPrecoded-r13  CSI-RS-ConfigNonPrecoded-r13,
    beamformed-r13  CSI-RS-ConfigBeamformed-r13
  }
}

CSI-RS-ConfigEMIMO-v1430 ::= CHOICE {
  release          NULL,
  setup           CHOICE {
    nonPrecoded-v1430 CSI-RS-ConfigNonPrecoded-v1430,
    beamformed-v1430  CSI-RS-ConfigBeamformed-v1430
  }
}

CSI-RS-ConfigEMIMO-v1480 ::= CHOICE {
  release          NULL,
  setup           CHOICE {
    nonPrecoded-v1480 CSI-RS-ConfigNonPrecoded-v1480,
    beamformed-v1480  CSI-RS-ConfigBeamformed-v1430
  }
}

CSI-RS-ConfigEMIMO2-r14 ::= CHOICE {
  release          NULL,
  setup           CSI-RS-ConfigBeamformed-r14
}

CSI-RS-ConfigEMIMO-Hybrid-r14 ::= CHOICE {
  release          NULL,
  setup           SEQUENCE {
    periodicityOffsetIndex-r14  INTEGER (0..1023)          OPTIONAL,  -- Need OR
    eMIMO-Type2-r14             CSI-RS-ConfigEMIMO2-r14  OPTIONAL  -- Need ON
  }
}

-- ASN1STOP

```

CSI-RS-ConfigEMIMO field descriptions***periodicityOffsetIndex***

This parameter is associated with the first EMIMO configuration of the hybrid eMIMO configuration.

CSI-RS-ConfigNonPrecoded

The IE *CSI-RS-ConfigNonPrecoded* is used to specify the non-precoded EBF/ FD-MIMO configuration.

```

-- ASN1START
CSI-RS-ConfigNonPrecoded-r13 ::= SEQUENCE {
  p-C-AndCBSRList-r13          P-C-AndCBSR-Pair-r13          OPTIONAL,  -- Need OR
  codebookConfigN1-r13        ENUMERATED {n1, n2, n3, n4, n8},
  codebookConfigN2-r13        ENUMERATED {n1, n2, n3, n4, n8},
  codebookOverSamplingRateConfig-O1-r13  ENUMERATED {n4, n8}          OPTIONAL,  -- Need OR
  codebookOverSamplingRateConfig-O2-r13  ENUMERATED {n4, n8}          OPTIONAL,  -- Need OR
  codebookConfig-r13          INTEGER (1..4),
  csi-IM-ConfigIdList-r13     SEQUENCE (SIZE (1..2)) OF CSI-IM-ConfigId-r13
  OPTIONAL,  -- Need OR
  csi-RS-ConfigNZIP-EMIMO-r13  CSI-RS-ConfigNZIP-EMIMO-r13  OPTIONAL  -- Need ON
}

CSI-RS-ConfigNonPrecoded-v1430 ::= SEQUENCE {
  csi-RS-ConfigNZIP-EMIMO-v1430  CSI-RS-ConfigNZIP-EMIMO-v1430  OPTIONAL,  -- Need ON
  codebookConfigN1-v1430        ENUMERATED {n5, n6, n7, n10, n12, n14, n16},
  codebookConfigN2-v1430        ENUMERATED {n5, n6, n7},
  nzip-ResourceConfigTM9-Original-v1430  CSI-RS-Config-NZIP-v1430
}

```

```

}
CSI-RS-ConfigNonPrecoded-v1480 ::= SEQUENCE {
  csi-RS-ConfigNZP-EMIMO-v1480      CSI-RS-ConfigNZP-EMIMO-v1430  OPTIONAL,  -- Need ON
  codebookConfigN1-v1480            ENUMERATED {n5, n6, n7, n10, n12, n14, n16}
  OPTIONAL,  -- Need OR
  codebookConfigN2-v1480            ENUMERATED {n5, n6, n7}          OPTIONAL,  -- Need OR
  nzp-ResourceConfigTM9-Original-v1480  CSI-RS-Config-NZP-v1430
}
-- ASN1STOP

```

CSI-RS-ConfigNonPrecoded field descriptions

codebookConfig

Indicates a sub-set of the codebook entry, see TS 36.213 [23].

codebookConfigNx

Indicates the number of antenna ports per polarization in dimension x as used for transmission of CSI reference signals. Value n1 corresponds to 1, value n2 corresponds to 2 and so on, see TS 36.213 [23]. E-UTRAN configures the field in accordance with the restrictions as specified in TS 36.213 [23]. If *codebookConfigNx* in CSI-RS-ConfigNonPrecoded-v1480 is configured, the UE shall ignore the field *codebookConfigNx* in CSI-RS-ConfigNonPrecoded-r13.

codebookOverSamplingRateConfig-Ox

Indicates the spatial over-sampling rate in dimension x as used for transmission of CSI reference signals. Value n4 corresponds to 4 and value n8 corresponds to 8, see TS 36.213 [23].

csi-IM-Configd(List)

E-UTRAN configures the field *csi-IM-ConfigdList* only if the IE is included in CSI-Process is configured (i.e. when TM10 is configured for the serving cell).

csi-RS-ConfigNZP-EMIMO

The field is used to configure NZP configurations additional to the one defined by the original NZP configuration as included in *CSI-RS-Config/CSI-Process* when using more than 8 ports CSI-RS as defined in TS 36.211 [21], table 6.10.5-1.

CSI-RS-ConfigNZP

The IE *CSI-RS-ConfigNZP* is the CSI-RS resource configuration using non-zero power transmission that E-UTRAN may configure on a serving frequency.

CSI-RS-ConfigNZP information elements

```

-- ASN1START
CSI-RS-ConfigNZP-r11 ::= SEQUENCE {
  csi-RS-ConfigNZPId-r11      CSI-RS-ConfigNZPId-r11,
  antennaPortsCount-r11      ENUMERATED {an1, an2, an4, an8},
  resourceConfig-r11         INTEGER (0..31),
  subframeConfig-r11         INTEGER (0..154),
  scramblingIdentity-r11      INTEGER (0..503),
  qcl-CRS-Info-r11           SEQUENCE {
    qcl-ScramblingIdentity-r11  INTEGER (0..503),
    crs-PortsCount-r11          ENUMERATED {n1, n2, n4, spare1},
    mbsfn-SubframeConfigList-r11 CHOICE {
      release                     NULL,
      setup                       SEQUENCE {
        subframeConfigList      MBSFN-SubframeConfigList
      }
    }
  }
  OPTIONAL  -- Need ON
}
OPTIONAL,  -- Need OR
...
[[ csi-RS-ConfigNZPId-v1310      CSI-RS-ConfigNZPId-v1310      OPTIONAL  -- Need ON
]],
[[ transmissionComb-r14          NZP-TransmissionComb-r14      OPTIONAL,  -- Need OR
  frequencyDensity-r14          NZP-FrequencyDensity-r14     OPTIONAL,  -- Need OR
]],
[[ mbsfn-SubframeConfigList-v1430 CHOICE {
  release                     NULL,
  setup                       SEQUENCE {
    subframeConfigList-v1430   MBSFN-SubframeConfigList-v1430
  }
}
OPTIONAL  -- Need OP
]]

```

```

}
CSI-RS-ConfigNWP-EMIMO-r13 ::= CHOICE {
  release          NULL,
  setup           SEQUENCE {
    nzp-resourceConfigList-r13 SEQUENCE (SIZE (1..2)) OF NZP-ResourceConfig-r13,
    cdmType-r13             ENUMERATED {cdm2, cdm4} OPTIONAL -- Need OR
  }
}

CSI-RS-ConfigNWP-EMIMO-v1430 ::= SEQUENCE {
  -- All extensions are for Non-Precoded so could be grouped by setup/ release choice
  nzp-resourceConfigListExt-r14 SEQUENCE (SIZE (0..4)) OF NZP-ResourceConfig-r13,
  cdmType-v1430             ENUMERATED {cdm8 }             OPTIONAL -- Need OR
}

NZP-ResourceConfig-r13 ::= SEQUENCE {
  resourceConfig-r13          ResourceConfig-r13,
  ...,
  [[ transmissionComb-r14     NZP-TransmissionComb-r14     OPTIONAL, -- Need OR
   frequencyDensity-r14     NZP-FrequencyDensity-r14     OPTIONAL -- Need OR
  ]]
}

ResourceConfig-r13 ::=
  INTEGER (0..31)

NZP-TransmissionComb-r14 ::=
  INTEGER (0..2)
NZP-FrequencyDensity-r14 ::=
  ENUMERATED {d1, d2, d3}

-- ASN1STOP

```

CSI-RS-ConfigNWP field descriptions

antennaPortsCount	Parameter represents the number of antenna ports used for transmission of CSI reference signals where an1 corresponds to 1, an2 to 2 antenna ports etc. see TS 36.211 [21, 6.10.5].
cdmType	Parameter: <i>CDMType</i> , see TS 36.211 [21, 6.10.5.2].
csi-RS-ConfigNZPId	Refers to a CSI RS configuration using non-zero power transmission that is configured for the same frequency as the CSI process. UE shall ignore <i>CSI-RS-ConfigNZPId-r11</i> if <i>CSI-RS-ConfigNZPId-v1310</i> is signalled.
frequencyDensity	Indicates the frequency-domain density reduction. E-UTRAN configures the values in accordance with the restrictions specified in TS 36.213 [23].
mbsfn-SubframeConfigList	Indicates the MBSFN configuration for the CSI-RS resources. If <i>qcl-CRS-Info-r11</i> is absent, the field is released.
nzp-resourceConfigList	Indicate a list of non-zero power transmission CSI-RS resources using parameter <i>resourceConfig</i> .
qcl-CRS-Info	Indicates CRS antenna ports that is quasi co-located with the CSI-RS antenna ports, see TS 36.213 [23, 7.2.5]. EUTRAN configures this field if and only if the UE is configured with <i>qcl-Operation</i> set to <i>typeB</i> .
resourceConfig	Parameter: CSI reference signal configuration, see TS 36.211 [21, table 6.10.5.2-1 and 6.10.5.2-2].
subframeConfig	Parameter: $I_{\text{CSI-RS}}$, see TS 36.211 [21, table 6.10.5.3-1].
scramblingIdentity	Parameter: Pseudo-random sequence generator parameter, n_{ID} , see TS 36.213 [23, 7.2.5].
transmissionComb	Indicates the transmission combining offset. E-UTRAN configures the values in accordance with the restrictions specified in TS 36.213 [23].

CSI-RS-ConfigNZPId

The IE *CSI-RS-ConfigNZPId* is used to identify a CSI-RS resource configuration using non-zero transmission power, as configured by the IE *CSI-RS-ConfigNWP*. The identity is unique within the scope of a carrier frequency.

CSI-RS-ConfigNZPId information elements

```
-- ASN1START
```

```

CSI-RS-ConfigNZPId-r11 ::=                INTEGER (1..maxCSI-RS-NZP-r11)
CSI-RS-ConfigNZPId-v1310 ::=             INTEGER (minCSI-RS-NZP-r13..maxCSI-RS-NZP-r13)
CSI-RS-ConfigNZPId-r13 ::=                INTEGER (1..maxCSI-RS-NZP-r13)

-- ASN1STOP

```

– *CSI-RS-ConfigZP*

The IE *CSI-RS-ConfigZP* is the CSI-RS resource configuration, for which UE assumes zero transmission power, that E-UTRAN may configure on a serving frequency.

CSI-RS-ConfigZP information elements

```

-- ASN1START

CSI-RS-ConfigZP-r11 ::= SEQUENCE {
  csi-RS-ConfigZPId-r11    CSI-RS-ConfigZPId-r11,
  resourceConfigList-r11  BIT STRING (SIZE (16)),
  subframeConfig-r11      INTEGER (0..154),
  ...
}

CSI-RS-ConfigZP-ApList-r14 ::= CHOICE {
  release    NULL,
  setup      SEQUENCE (SIZE (1.. maxCSI-RS-ZP-r11)) OF CSI-RS-ConfigZP-r11
}

-- ASN1STOP

```

CSI-RS-ConfigZP field descriptions

CSI-RS-ConfigZP-ApList

Indicates the aperiodic zero power CSI-RS present in a given subframe. See 36.213 [23, Table 7.1.9-2]. First entry in the list corresponds to aperiodic trigger 00, second entry in the list corresponds to aperiodic trigger 01 and so on.

resourceConfigList

Parameter: *ZeroPowerCSI-RS*, see TS 36.213 [23, 7.2.7].

subframeConfig

Parameter: $I_{\text{CSI-RS}}$, see TS 36.211 [21, table 6.10.5.3-1].

– *CSI-RS-ConfigZPId*

The IE *CSI-RS-ConfigZPId* is used to identify a CSI-RS resource configuration for which UE assumes zero transmission power, as configured by the IE *CSI-RS-ConfigZP*. The identity is unique within the scope of a carrier frequency.

CSI-RS-ConfigZPId information elements

```

-- ASN1START

CSI-RS-ConfigZPId-r11 ::=                INTEGER (1..maxCSI-RS-ZP-r11)

-- ASN1STOP

```

– *DataInactivityTimer*

The IE *DataInactivityTimer* is used to control Data inactivity operation. Corresponds to the timer for data inactivity monitoring in TS 36.321 [6]. Value s1 corresponds to 1 second, s2 corresponds to 2 seconds and so on.

DataInactivityTimer information element

```

-- ASN1START

DataInactivityTimer-r14 ::=              ENUMERATED {
  s1, s2, s3, s5, s7, s10, s15, s20, s40, s50, s60,

```

```
s80, s100, s120, s150, s180}
```

```
-- ASN1STOP
```

– *DMRS-Config*

The IE *DMRS-Config* is the DMRS configuration that E-UTRAN may configure on a serving frequency.

DMRS-Config information elements

```
-- ASN1START
DMRS-Config-r11 ::= CHOICE {
  release          NULL,
  setup           SEQUENCE {
    scramblingIdentity-r11    INTEGER (0..503),
    scramblingIdentity2-r11   INTEGER (0..503)
  }
}
DMRS-Config-v1310 ::= SEQUENCE {
  dmrs-tableAlt-r13          ENUMERATED {true}          OPTIONAL -- Need OR
}
-- ASN1STOP
```

DMRS-Config field descriptions

scramblingIdentity, scramblingIdentity2

Parameter: $n_{ID}^{DMRS,j}$, see TS 36.211 [21, 6.10.3.1].

dmrs-tableAlt

The field indicates whether to use an alternative table for DMRS upon PDSCH transmission, see TS 36.213 [23].

– *DRB-Identity*

The IE *DRB-Identity* is used to identify a DRB used by a UE.

DRB-Identity information elements

```
-- ASN1START
DRB-Identity ::= INTEGER (1..32)
-- ASN1STOP
```

– *EPDCCH-Config*

The IE *EPDCCH-Config* specifies the subframes and resource blocks for EPDCCH monitoring that E-UTRAN may configure for a serving cell.

EPDCCH-Config information element

```
-- ASN1START
EPDCCH-Config-r11 ::= SEQUENCE{
  config-r11      CHOICE {
    release          NULL,
    setup           SEQUENCE {
      subframePatternConfig-r11 CHOICE {
        release      NULL,
        setup        SEQUENCE {
          subframePattern-r11    MeasSubframePattern-r10
        }
      }
    }
  }
  startSymbol-r11          INTEGER (1..4)          OPTIONAL, -- Need ON
  setConfigToReleaseList-r11 EPDCCH-SetConfigToReleaseList-r11 OPTIONAL, -- Need ON
  setConfigToAddModList-r11  EPDCCH-SetConfigToAddModList-r11  OPTIONAL -- Need ON
}
```



```

    }
  }
}

EPDCCH-SetConfigToAddModList-r11 ::= SEQUENCE (SIZE(1..maxEPDCCH-Set-r11)) OF EPDCCH-SetConfig-
r11

EPDCCH-SetConfigToReleaseList-r11 ::= SEQUENCE (SIZE(1..maxEPDCCH-Set-r11)) OF EPDCCH-SetConfigId-
r11

EPDCCH-SetConfig-r11 ::= SEQUENCE {
  setConfigId-r11 EPDCCH-SetConfigId-r11,
  transmissionType-r11 ENUMERATED {localised, distributed},
  resourceBlockAssignment-r11 SEQUENCE {
    numberPRB-Pairs-r11 ENUMERATED {n2, n4, n8},
    resourceBlockAssignment-r11 BIT STRING (SIZE(4..38))
  },
  dmrs-ScramblingSequenceInt-r11 INTEGER (0..503),
  pucch-ResourceStartOffset-r11 INTEGER (0..2047),
  re-MappingQCL-ConfigId-r11 PDSCH-RE-MappingQCL-ConfigId-r11 OPTIONAL, -- Need OR
  ...
  [[ csi-RS-ConfigZPID2-r12 CHOICE {
    release NULL,
    setup CSI-RS-ConfigZPID-r11
  } OPTIONAL -- Need ON
]],
  [[ numberPRB-Pairs-v1310 CHOICE {
    release NULL,
    setup ENUMERATED {n6}
  } OPTIONAL, -- Need ON
  mpdcch-config-r13 CHOICE {
    release NULL,
    setup SEQUENCE {
      csi-NumRepetitionCE-r13 ENUMERATED {sf1, sf2, sf4, sf8, sf16, sf32},
      mpdcch-pdsch-HoppingConfig-r13 ENUMERATED {on,off},
      mpdcch-StartSF-U ESS-r13 CHOICE {
        fdd-r13 ENUMERATED {v1, v1dot5, v2, v2dot5, v4,
          v5, v8, v10},
        tdd-r13 ENUMERATED {v1, v2, v4, v5, v8, v10,
          v20, spare1}
      },
      mpdcch-NumRepetition-r13 ENUMERATED {r1, r2, r4, r8, r16,
        r32, r64, r128, r256},
      mpdcch-Narrowband-r13 INTEGER (1.. maxAvailNarrowBands-r13)
    }
  } OPTIONAL -- Need ON
]]
}

EPDCCH-SetConfigId-r11 ::= INTEGER (0..1)

-- ASN1STOP

```

EPDCCH-Config field descriptions
<p>csi-NumRepetitionCE Number of subframes for CSI reference resource, see TS 36.213 [23]. Value sf1 corresponds to 1 subframe, sf2 corresponds to 2 subframes and so on.</p>
<p>csi-RS-ConfigZPId2 Indicates the rate matching parameters in addition to those indicated by <i>re-MappingQCL-ConfigId</i>. E-UTRAN configures this field only when tm10 is configured.</p>
<p>dmrs-ScramblingSequenceInt The DMRS scrambling sequence initialization parameter $n_{ID,i}^{EPDCCH}$ or $n_{ID,i}^{MPDCCH}$ defined in TS 36.211 [21, 6.10.3A.1].</p>
<p>EPDCCH-SetConfig Provides EPDCCH configuration set. See TS 36.213 [23, 9.1.4]. E-UTRAN configures at least one <i>EPDCCH-SetConfig</i> when <i>EPDCCH-Config</i> is configured. For BL UEs or UEs in CE, EUTRAN does not configure more than one EPDCCH-SetConfig.</p>
<p>mpdcch-Narrowband Parameter: n_{NB}, see TS 36.211 [21, 6.8B.5]. Field values (1..<i>maxAvailNarrowBands-r13</i>) correspond to narrowband indices (0..<i>maxAvailNarrowBands-r13-1</i>) as specified in TS 36.211 [21].</p>
<p>mpdcch-NumRepetition Maximum numbers of repetitions for UE-SS for MPDCCH, see TS 36.211 [21].</p>
<p>mpdcch-pdsch-HoppingConfig Frequency hopping activation/deactivation for unicast MPDCCH/PDSCH, see TS 36.211 [21]. E-UTRAN does not configure the value <i>on</i> if <i>freqHoppingParametersDL</i> is not present in <i>SystemInformationBlockType1</i>.</p>
<p>mpdcch-StartSF-U ESS Starting subframe configuration for an MPDCCH UE-specific search space, see TS 36.211 [21]. Value v1 corresponds to 1, value v1dot5 corresponds to 1.5, and so on.</p>
<p>numberPRB-Pairs Indicates the number of physical resource-block pairs used for the EPDCCH set. Value n2 corresponds to 2 physical resource-block pairs; n4 corresponds to 4 physical resource-block pairs and so on. Value n8 is not supported if <i>dl-Bandwidth</i> is set to 6 resource blocks. EUTRAN configures value up to n6 only for BL UEs or UEs in CE. Value n6 is only applicable to BL UEs or UEs in CE .</p>
<p>pucch-ResourceStartOffset PUCCH format 1a, 1b and 3 resource starting offset for the EPDCCH set. See TS 36.213 [23, 10.1].</p>
<p>re-MappingQCL-ConfigId Indicates the starting OFDM symbol, the related rate matching parameters and quasi co-location assumption for EPDCCH when the UE is configured with tm10. This field provides the identity of a configured <i>PDSCH-RE-MappingQCL-Config</i>. E-UTRAN configures this field only when tm10 is configured.</p>
<p>resourceBlockAssignment Indicates the index to a specific combination of physical resource-block pair for EPDCCH set. See TS 36.213 [23, 9.1.4.4]. The size of <i>resourceBlockAssignment</i> is specified in TS 36.213 [23, 9.1.4.4] and based on <i>numberPRB-Pairs</i> and the signalled value of <i>dl-Bandwidth</i>. If <i>numberPRB-Pairs-v1310</i> field is present, the total number of physical resource-block pairs is 6 and it is composed of one subset of 2 physical resource-block pairs and another subset of 4 physical resource-block pairs, and the <i>resourceBlockAssignment</i> field defines the subset of 2 physical resource-block pairs.</p>
<p>setConfigId Indicates the identity of the EPDCCH configuration set.</p>
<p>startSymbol Indicates the OFDM starting symbol for any EPDCCH and PDSCH scheduled by EPDCCH on the same cell, see TS 36.213 [23, 9.1.4.1]. If not present, the UE shall release the configuration and shall derive the starting OFDM symbol of EPDCCH and PDSCH scheduled by EPDCCH from PCFICH. Values 1, 2, and 3 are applicable for <i>dl-Bandwidth</i> greater than 10 resource blocks. Values 2, 3, and 4 are applicable otherwise. E-UTRAN does not configure the field for UEs configured with tm10.</p>
<p>subframePatternConfig Configures the subframes which the UE shall monitor the UE-specific search space on EPDCCH, except for pre-defined rules in TS 36.213 [23, 9.1.4]. If the field is not configured when EPDCCH is configured, the UE shall monitor the UE-specific search space on EPDCCH in all subframes except for pre-defined rules in TS 36.213 [23, 9.1.4].</p>
<p>transmissionType Indicates whether distributed or localized EPDCCH transmission mode is used as defined in TS 36.211 [21, 6.8A.1].</p>

– *EIMTA-MainConfig*

The IE *EIMTA-MainConfig* is used to specify the eIMTA-RNTI used for eIMTA and the subframes used for monitoring PDCCH with eIMTA-RNTI. The IE *EIMTA-MainConfigServCell* is used to specify the eIMTA related parameters applicable for the concerned serving cell.

EIMTA-MainConfig information element

```

-- ASN1START
EIMTA-MainConfig-r12 ::= CHOICE {
  release      NULL,
  setup        SEQUENCE {
    eimta-RNTI-r12      C-RNTI,
    eimta-CommandPeriodicity-r12  ENUMERATED {sf10, sf20, sf40, sf80},
    eimta-CommandSubframeSet-r12  BIT STRING (SIZE(10))
  }
}

EIMTA-MainConfigServCell-r12 ::= CHOICE {
  release      NULL,
  setup        SEQUENCE {
    eimta-UL-DL-ConfigIndex-r12      INTEGER (1..5),
    eimta-HARQ-ReferenceConfig-r12    ENUMERATED {sa2, sa4, sa5},
    mbsfn-SubframeConfigList-v1250    CHOICE {
      release      NULL,
      setup        SEQUENCE {
        subframeConfigList-r12      MBSFN-SubframeConfigList
      }
    }
  }
}
-- ASN1STOP

```

EIMTA-MainConfig field descriptions***eimta-CommandPeriodicity***

Configures the periodicity to monitor PDCCH with eIMTA-RNTI, see TS 36.213 [23, 13.1]. Value sf10 corresponds to 10 subframes, sf20 corresponds to 20 subframes and so on.

eimta-CommandSubframeSet

Configures the subframe(s) to monitor PDCCH with eIMTA-RNTI within the periodicity configured by *eimta-CommandPeriodicity*. The 10 bits correspond to all subframes in the last radio frame within each periodicity. The left most bit is for subframe 0 and so on. Each bit can be of value 0 or 1. The value of 1 means that the corresponding subframe is configured for monitoring PDCCH with eIMTA-RNTI, and the value of 0 means otherwise. In case of TDD as PCell, only the downlink and the special subframes indicated by the UL/ DL configuration in SIB1 can be configured for monitoring PDCCH with eIMTA-RNTI. In case of FDD as PCell, any of the ten subframes can be configured for monitoring PDCCH with eIMTA-RNTI.

eimta-HARQ-ReferenceConfig

Indicates UL/ DL configuration used as the DL HARQ reference configuration for this serving cell. Value sa2 corresponds to Configuration2, sa4 to Configuration4 etc, as specified in TS 36.211 [21, table 4.2-2]. E-UTRAN configures the same value for all serving cells residing on same frequency band.

eimta-UL-DL-ConfigIndex

Index of *l*, see TS 36.212 [22, 5.3.3.1.4]. E-UTRAN configures the same value for all serving cells residing on same frequency band.

mbsfn-SubframeConfigList

Configure the MBSFN subframes for the UE on this serving cell. An uplink subframe indicated by the DL/UL subframe configuration in SIB1 can be configured as MBSFN subframe.

LogicalChannelConfig

The IE *LogicalChannelConfig* is used to configure the logical channel parameters.

***LogicalChannelConfig* information element**

```

-- ASN1START
LogicalChannelConfig ::= SEQUENCE {
  ul-SpecificParameters SEQUENCE {
    priority      INTEGER (1..16),
    prioritisedBitRate  ENUMERATED {
      kBps0, kBps8, kBps16, kBps32, kBps64, kBps128,
      kBps256, infinity, kBps512-v1020, kBps1024-v1020,
      kBps2048-v1020, spare5, spare4, spare3, spare2,
      spare1},
    bucketSizeDuration  ENUMERATED {
      ms50, ms100, ms150, ms300, ms500, ms1000, spare2,

```

```

        spare1},
    } logicalChannelGroup          INTEGER (0..3)          OPTIONAL          -- Need OR
      OPTIONAL,                  -- Cond UL
    ...,
    [[ logicalChannelSR-Mask-r9    ENUMERATED {setup}    OPTIONAL          -- Cond SRmask
    ]],
    [[ logicalChannelSR-Prohibit-r12  BOOLEAN                OPTIONAL          -- Need ON
    ]],
    [[ laa-UL-Allowed-r14           BOOLEAN                OPTIONAL,        -- Need ON
    bitRateQueryProhibitTimer-r14    ENUMERATED {
        s0, s0dot4, s0dot8, s1dot6, s3, s6, s12,
        s30}
    ]],
    ]],
}
-- ASN1STOP

```

LogicalChannelConfig field descriptions

bitRateQueryProhibitTimer

The timer is used for bit rate recommendation query in TS 36.321 [6], clause 5.18, in seconds. Value s0 means 0s, s0dot4 means 0.4s and so on.

bucketSizeDuration

Bucket Size Duration for logical channel prioritization in TS 36.321 [6]. Value in milliseconds. Value ms50 corresponds to 50 ms, ms100 corresponds to 100 ms and so on.

laa-UL-Allowed

Indicates whether the data of a logical channel is allowed to be transmitted via UL of LAA SCells. Value *TRUE* indicates that the logical channel is allowed to be sent via UL of LAA SCells. Value *FALSE* indicates that the logical channel is not allowed to be sent via UL of LAA SCells.

logicalChannelGroup

Mapping of logical channel to logical channel group for BSR reporting in TS 36.321 [6].

logicalChannelSR-Mask

Controlling SR triggering on a logical channel basis when an uplink grant is configured. See TS 36.321 [6].

logicalChannelSR-Prohibit

Value *TRUE* indicates that the *logicalChannelSR-ProhibitTimer* is enabled for the logical channel. E-UTRAN only (optionally) configures the field (i.e. indicates value *TRUE*) if *logicalChannelSR-ProhibitTimer* is configured. See TS 36.321 [6].

prioritisedBitRate

Prioritized Bit Rate for logical channel prioritization in TS 36.321 [6]. Value in kilobytes/second. Value kbps0 corresponds to 0 kB/second, kbps8 corresponds to 8 kB/second, kbps16 corresponds to 16 kB/second and so on. Infinity is the only applicable value for SRB1 and SRB2

priority

Logical channel priority in TS 36.321 [6]. Value is an integer.

Conditional presence	Explanation
SRmask	The field is optionally present if <i>ul-SpecificParameters</i> is present, need OR; otherwise it is not present.
UL	The field is mandatory present for UL logical channels; otherwise it is not present.

LWA-Configuration

The IE *LWA-Configuration* is used to setup/modify/release LTE-WLAN Aggregation.

```

-- ASN1START
LWA-Configuration-r13 ::= CHOICE {
    release          NULL,
    setup           SEQUENCE {
        lwa-Config-r13
    }
}

LWA-Config-r13 ::= SEQUENCE {
    lwa-MobilityConfig-r13    WLAN-MobilityConfig-r13    OPTIONAL,  -- Need ON
    lwa-WT-Counter-r13       INTEGER (0..65535)           OPTIONAL,  -- Need ON
    ...,
    [[ wt-MAC-Address-r14    OCTET STRING (SIZE (6)) OPTIONAL  -- Need ON
    ]],
}

```

```
-- ASN1STOP
```

LWA-Configuration field descriptions
<i>lwa-MobilityConfig</i> Indicates the parameters used for WLAN mobility.
<i>lwa-WT-Counter</i> Indicates the parameter used by UE for WLAN authentication.
<i>wt-MAC-Address</i> Indicates the WT MAC address of the WT handling the LWA operation for the UE. The UE uses this MAC address in uplink transmissions to enable routing of LWA uplink data from the AP to the WT. E-UTRAN configures the field only if <i>ul-LWA-Config-r14</i> is configured for at least one LWA bearer.

– *LWIP-Configuration*

The IE *LWIP-Configuration* is used to add, modify or release DRBs that are using LWIP Tunnel.

```
-- ASN1START
LWIP-Configuration-r13 ::= CHOICE {
  release          NULL,
  setup           SEQUENCE {
    lwip-Config-r13
  }
}

LWIP-Config-r13 ::= SEQUENCE {
  lwip-MobilityConfig-r13  WLAN-MobilityConfig-r13  OPTIONAL,  -- Need ON
  tunnelConfigLWIP-r13    TunnelConfigLWIP-r13    OPTIONAL,  -- Need ON
  ...
}
-- ASN1STOP
```

LWIP-Configuration field descriptions
<i>lwip-MobilityConfig</i> Indicates the WLAN mobility set for LWIP.
<i>tunnelConfigLWIP</i> Indicates the parameters used for establishing the LWIP tunnel.

– *MAC-MainConfig*

The IE *MAC-MainConfig* is used to specify the MAC main configuration for signalling and data radio bearers. All MAC main configuration parameters can be configured independently per Cell Group (i.e. MCG or SCG), unless explicitly specified otherwise.

MAC-MainConfig information element

```
-- ASN1START
MAC-MainConfig ::= SEQUENCE {
  ul-SCH-Config          SEQUENCE {
    maxHARQ-Tx          ENUMERATED {
      n1, n2, n3, n4, n5, n6, n7, n8,
      n10, n12, n16, n20, n24, n28,
      spare2, spare1}  OPTIONAL,  -- Need ON
    periodicBSR-Timer  PeriodicBSR-Timer-r12  OPTIONAL,  -- Need ON
    retxBSR-Timer      RetxBSR-Timer-r12,
    ttiBundling        BOOLEAN
  }
  drx-Config            DRX-Config          OPTIONAL,  -- Need ON
  timeAlignmentTimerDedicated  TimeAlignmentTimer,
  phr-Config           CHOICE {
    release            NULL,
    setup             SEQUENCE {
      periodicPHR-Timer  ENUMERATED {sf10, sf20, sf50, sf100, sf200,
        sf500, sf1000, infinity},
    }
  }
}
-- ASN1STOP
```

```

        prohibitPHR-Timer                ENUMERATED {sf0, sf10, sf20, sf50, sf100,
                                           sf200, sf500, sf1000},
        dl-PathlossChange                 ENUMERATED {dB1, dB3, dB6, infinity}
    }
}
OPTIONAL, -- Need ON
...
[[ sr-ProhibitTimer-r9                   INTEGER (0..7)                OPTIONAL -- Need ON
]],
[[ mac-MainConfig-v1020                  SEQUENCE {
    sCellDeactivationTimer-r10           ENUMERATED {
        rf2, rf4, rf8, rf16, rf32, rf64, rf128,
        spare}                  OPTIONAL, -- Need OP
    extendedBSR-Sizes-r10              ENUMERATED {setup}           OPTIONAL, -- Need OR
    extendedPHR-r10                    ENUMERATED {setup}           OPTIONAL -- Need OR
}
]],
[[ stag-ToReleaseList-r11                STAG-ToReleaseList-r11      OPTIONAL, -- Need ON
    stag-ToAddModList-r11               STAG-ToAddModList-r11      OPTIONAL, -- Need ON
    drx-Config-v1130                    DRX-Config-v1130           OPTIONAL -- Need ON
]],
[[ e-HARQ-Pattern-r12                   BOOLEAN                      OPTIONAL, -- Need ON
    dualConnectivityPHR                  CHOICE {
        release                        NULL,
        setup                          SEQUENCE {
            phr-ModeOtherCG-r12        ENUMERATED {real, virtual}
        }
    }
    logicalChannelSR-Config-r12          CHOICE {
        release                        NULL,
        setup                          SEQUENCE {
            logicalChannelSR-ProhibitTimer-r12  ENUMERATED {sf20, sf40, sf64, sf128, sf512,
sf1024, sf2560, spare1}
        }
    }
]],
[[ drx-Config-v1310                     DRX-Config-v1310           OPTIONAL, -- Need ON
    extendedPHR2-r13                     BOOLEAN                      OPTIONAL, -- Need ON
    eDRX-Config-CycleStartOffset-r13     CHOICE {
        release                        NULL,
        setup                          CHOICE {
            sf5120                     INTEGER(0..1),
            sf10240                    INTEGER(0..3)
        }
    }
]],
[[ drx-Config-r13                       CHOICE {
        release                        NULL,
        setup                          DRX-Config-r13
    }
]],
[[ skipUplinkTx-r14                     CHOICE {
        release                        NULL,
        setup                          SEQUENCE {
            skipUplinkTxSPS-r14         ENUMERATED {true}          OPTIONAL, -- Need OR
            skipUplinkTxDynamic-r14    ENUMERATED {true}          OPTIONAL -- Need OR
        }
    }
    dataInactivityTimerConfig-r14        CHOICE {
        release                        NULL,
        setup                          SEQUENCE {
            dataInactivityTimer-r14    DataInactivityTimer-r14
        }
    }
]],
[[ rai-Activation-r14                   ENUMERATED {true}           OPTIONAL -- Need OR
]]
}

MAC-MainConfigSCell-r11 ::= SEQUENCE {
    stag-Id-r11                      STAG-Id-r11                OPTIONAL, -- Need OP
    ...
}

DRX-Config ::= CHOICE {
    release                        NULL,
    setup                          SEQUENCE {
        onDurationTimer            ENUMERATED {

```

```

        psf1, psf2, psf3, psf4, psf5, psf6,
        psf8, psf10, psf20, psf30, psf40,
        psf50, psf60, psf80, psf100,
        psf200},
drx-InactivityTimer          ENUMERATED {
        psf1, psf2, psf3, psf4, psf5, psf6,
        psf8, psf10, psf20, psf30, psf40,
        psf50, psf60, psf80, psf100,
        psf200, psf300, psf500, psf750,
        psf1280, psf1920, psf2560, psf0-v1020,
        spare9, spare8, spare7, spare6,
        spare5, spare4, spare3, spare2,
        spare1},
drx-RetransmissionTimer     ENUMERATED {
        psf1, psf2, psf4, psf6, psf8, psf16,
        psf24, psf33},
longDRX-CycleStartOffset   CHOICE {
    sf10                     INTEGER(0..9),
    sf20                     INTEGER(0..19),
    sf32                     INTEGER(0..31),
    sf40                     INTEGER(0..39),
    sf64                     INTEGER(0..63),
    sf80                     INTEGER(0..79),
    sf128                   INTEGER(0..127),
    sf160                   INTEGER(0..159),
    sf256                   INTEGER(0..255),
    sf320                   INTEGER(0..319),
    sf512                   INTEGER(0..511),
    sf640                   INTEGER(0..639),
    sf1024                  INTEGER(0..1023),
    sf1280                  INTEGER(0..1279),
    sf2048                  INTEGER(0..2047),
    sf2560                  INTEGER(0..2559)
},
shortDRX                    SEQUENCE {
    shortDRX-Cycle          ENUMERATED {
        sf2, sf5, sf8, sf10, sf16, sf20,
        sf32, sf40, sf64, sf80, sf128, sf160,
        sf256, sf320, sf512, sf640},
    drxShortCycleTimer     INTEGER (1..16)
}
}
-- Need OR
}

DRX-Config-v1130 ::=
    drx-RetransmissionTimer-v1130        SEQUENCE {
    longDRX-CycleStartOffset-v1130      ENUMERATED {psf0-v1130} OPTIONAL, --Need OR
    sf60-v1130                          CHOICE {
        sf60-v1130                   INTEGER(0..59),
        sf70-v1130                   INTEGER(0..69)
    }
    shortDRX-Cycle-v1130                ENUMERATED {sf4-v1130} OPTIONAL --Need OR
}

DRX-Config-v1310 ::=
    longDRX-CycleStartOffset-v1310      SEQUENCE {
    sf60-v1310                          SEQUENCE {
        sf60-v1310                   INTEGER(0..59)
    }
}
OPTIONAL --Need OR

DRX-Config-r13 ::=
    onDurationTimer-v1310                SEQUENCE {
    drx-RetransmissionTimer-v1310       ENUMERATED {psf300, psf400, psf500, psf600,
        psf800, psf1000, psf1200, psf1600}
        OPTIONAL, --Need OR
    drx-ULRetransmissionTimer-r13      ENUMERATED {psf40, psf64, psf80, psf96, psf112,
        psf128, psf160, psf320}
        OPTIONAL, --Need OR
}

PeriodicBSR-Timer-r12 ::=
    ENUMERATED {
        sf5, sf10, sf16, sf20, sf32, sf40, sf64, sf80,
        sf128, sf160, sf320, sf640, sf1280, sf2560,
        infinity, spare1}

RetxBSR-Timer-r12 ::=
    ENUMERATED {
        sf320, sf640, sf1280, sf2560, sf5120,

```

```
sf10240, spare2, spare1}
STAG-ToReleaseList-r11 ::= SEQUENCE (SIZE (1..maxSTAG-r11)) OF STAG-Id-r11
STAG-ToAddModList-r11 ::= SEQUENCE (SIZE (1..maxSTAG-r11)) OF STAG-ToAddMod-r11
STAG-ToAddMod-r11 ::= SEQUENCE {
    stag-Id-r11          STAG-Id-r11,
    timeAlignmentTimerSTAG-r11  TimeAlignmentTimer,
    ...
}
STAG-Id-r11 ::= INTEGER (1..maxSTAG-r11)
-- ASN1STOP
```

MAC-MainConfig field descriptions
<p>dl-PathlossChange DL Pathloss Change and the change of the required power backoff due to power management (as allowed by P-MPRc [42]) for PHR reporting in TS 36.321 [6]. Value in dB. Value dB1 corresponds to 1 dB, dB3 corresponds to 3 dB and so on. The same value applies for each serving cell (although the associated functionality is performed independently for each cell).</p>
<p>drx-Config Used to configure DRX as specified in TS 36.321 [6]. E-UTRAN configures the values in <i>DRX-Config-v1130</i> only if the UE indicates support for IDC indication. E-UTRAN configures <i>drx-Config-v1130</i>, <i>drx-Config-v1310</i> and <i>drx-Config-r13</i> only if <i>drx-Config</i> (without suffix) is configured. E-UTRAN configures <i>drx-Config-r13</i> only if UE supports CE or if the UE is configured with uplink of an LAA SCell.</p>
<p>drx-InactivityTimer Timer for DRX in TS 36.321 [6]. Value in number of PDCCH sub-frames. Value psf0 corresponds to 0 PDCCH sub-frame and behaviour as specified in 7.3.2 applies, value psf1 corresponds to 1 PDCCH sub-frame, psf2 corresponds to 2 PDCCH sub-frames and so on.</p>
<p>drx-RetransmissionTimer Timer for DRX in TS 36.321 [6]. Value in number of PDCCH sub-frames. Value psf0 corresponds to 0 PDCCH sub-frame and behaviour as specified in 7.3.2 applies, value psf1 corresponds to 1 PDCCH sub-frame, psf2 corresponds to 2 PDCCH sub-frames and so on. In case <i>drx-RetransmissionTimer-v1130</i> or <i>drx-RetransmissionTimer-v1310</i> is signalled, the UE shall ignore <i>drx-RetransmissionTimer</i> (i.e. without suffix).</p>
<p>drx-ULRetransmissionTimer Timer for DRX in TS 36.321 [6]. Value in number of PDCCH sub-frames. Value psf0 corresponds to 0 PDCCH sub-frame and behaviour as specified in 7.3.2 applies, value psf1 corresponds to 1 PDCCH sub-frame, psf2 corresponds to 2 PDCCH sub-frames and so on.</p>
<p>drxShortCycleTimer Timer for DRX in TS 36.321 [6]. Value in multiples of shortDRX-Cycle. A value of 1 corresponds to shortDRX-Cycle, a value of 2 corresponds to 2 * shortDRX-Cycle and so on.</p>
<p>dualConnectivityPHR Indicates if power headroom shall be reported using Dual Connectivity Power Headroom Report MAC Control Element defined in TS 36.321 [6] (value <i>setup</i>). If PHR functionality and dual connectivity are configured, E-UTRAN always configures the value <i>setup</i> for this field and configures <i>phr-Config</i> and <i>dualConnectivityPHR</i> for both CGs.</p>
<p>e-HARQ-Pattern TRUE indicates that enhanced HARQ pattern for TTI bundling is enabled for FDD. E-UTRAN enables this field only when <i>ttiBundling</i> is set to <i>TRUE</i>.</p>
<p>eDRX-Config-CycleStartOffset Indicates <i>longDRX-Cycle</i> and <i>drxStartOffset</i> in TS 36.321 [6]. The value of <i>longDRX-Cycle</i> is in number of sub-frames. The value of <i>drxStartOffset</i>, in number of subframes, is indicated by the value of <i>eDRX-Config-CycleStartOffset</i> multiplied by 2560 plus the offset value configured in <i>longDRX-CycleStartOffset</i>. E-UTRAN only configures value <i>setup</i> when the value in <i>longDRX-CycleStartOffset</i> is sf2560.</p>
<p>extendedBSR-Sizes If value <i>setup</i> is configured, the BSR index indicates extended BSR size levels as defined in TS 36.321 [6, Table 6.1.3.1-2].</p>
<p>extendedPHR Indicates if power headroom shall be reported using the Extended Power Headroom Report MAC control element defined in TS 36.321 [6] (value <i>setup</i>). E-UTRAN always configures the value <i>setup</i> if more than one and up to eight Serving Cell(s) with uplink is configured and none of the serving cells with uplink configured has a <i>servingCellIndex</i> higher than seven and if PUCCH on SCell is not configured and if dual connectivity is not configured. E-UTRAN configures <i>extendedPHR</i> only if <i>phr-Config</i> is configured. The UE shall release <i>extendedPHR</i> if <i>phr-Config</i> is released.</p>
<p>extendedPHR2 Indicates if power headroom shall be reported using the Extended Power Headeroom Report MAC Control Element defined in TS 36.321 [6] (value <i>setup</i>). E-UTRAN always configures the value <i>setup</i> if any of the serving cells with uplink configured has a <i>servingCellIndex</i> higher than seven in case dual connectivity is not configured or if PUCCH SCell (with any number of serving cells with uplink configured) is configured. E-UTRAN configures <i>extendedPHR2</i> only if <i>phr-Config</i> is configured. The UE shall release <i>extendedPHR2</i> if <i>phr-Config</i> is released.</p>
<p>logicalChannelSR-ProhibitTimer Timer used to delay the transmission of an SR for logical channels enabled by <i>logicalChannelSR-Prohibit</i>. Value sf20 corresponds to 20 subframes, sf40 corresponds to 40 subframes, and so on. See TS 36.321 [6].</p>
<p>longDRX-CycleStartOffset <i>longDRX-Cycle</i> and <i>drxStartOffset</i> in TS 36.321 [6] unless <i>eDRX-Config-CycleStartOffset</i> is configured. The value of <i>longDRX-Cycle</i> is in number of sub-frames. Value sf10 corresponds to 10 sub-frames, sf20 corresponds to 20 sub-frames and so on. If <i>shortDRX-Cycle</i> is configured, the value of <i>longDRX-Cycle</i> shall be a multiple of the <i>shortDRX-Cycle</i> value. The value of <i>drxStartOffset</i> value is in number of sub-frames. In case <i>longDRX-CycleStartOffset-v1130</i> is signalled, the UE shall ignore <i>longDRX-CycleStartOffset</i> (i.e. without suffix). In case <i>longDRX-CycleStartOffset-v1310</i> is signalled, the UE shall ignore <i>longDRX-CycleStartOffset</i> (i.e. without suffix).</p>
<p>maxHARQ-Tx Maximum number of transmissions for UL HARQ in TS 36.321 [6].</p>

MAC-MainConfig field descriptions
<p>onDurationTimer Timer for DRX in TS 36.321 [6]. Value in number of PDCCH sub-frames. Value psf1 corresponds to 1 PDCCH sub-frame, psf2 corresponds to 2 PDCCH sub-frames and so on. In case <i>onDurationTimer-v1310</i> is signalled, the UE shall ignore <i>onDurationTimer</i> (i.e. without suffix).</p>
<p>periodicBSR-Timer Timer for BSR reporting in TS 36.321 [6]. Value in number of sub-frames. Value sf10 corresponds to 10 sub-frames, sf20 corresponds to 20 sub-frames and so on.</p>
<p>periodicPHR-Timer Timer for PHR reporting in TS 36.321 [6]. Value in number of sub-frames. Value sf10 corresponds to 10 subframes, sf20 corresponds to 20 subframes and so on.</p>
<p>phr-ModeOtherCG Indicates the mode (i.e. <i>real</i> or <i>virtual</i>) used for the PHR of the activated cells that are part of the other Cell Group (i.e. MCG or SCG), when DC is configured.</p>
<p>prohibitPHR-Timer Timer for PHR reporting in TS 36.321 [6]. Value in number of sub-frames. Value sf0 corresponds to 0 subframes and behaviour as specified in 7.3.2 applies, sf100 corresponds to 100 subframes and so on.</p>
<p>rai-Activation Activation of release assistance indication (RAI) in TS 36.321 [6] for BL UEs.</p>
<p>retxBSR-Timer Timer for BSR reporting in TS 36.321 [6]. Value in number of sub-frames. Value sf640 corresponds to 640 sub-frames, sf1280 corresponds to 1280 sub-frames and so on.</p>
<p>sCellDeactivationTimer SCell deactivation timer in TS 36.321 [6]. Value in number of radio frames. Value rf4 corresponds to 4 radio frames, value rf8 corresponds to 8 radio frames and so on. E-UTRAN only configures the field if the UE is configured with one or more SCells other than the PSCell and PUCCH SCell. If the field is absent, the UE shall delete any existing value for this field and assume the value to be set to <i>infinity</i>. The same value applies for each SCell of a Cell Group (i.e. MCG or SCG) (although the associated functionality is performed independently for each SCell). Field <i>sCellDeactivationTimer</i> does not apply for the PUCCH SCell.</p>
<p>shortDRX-Cycle Short DRX cycle in TS 36.321 [6]. Value in number of sub-frames. Value sf2 corresponds to 2 sub-frames, sf5 corresponds to 5 subframes and so on. In case <i>shortDRX-Cycle-v1130</i> is signalled, the UE shall ignore <i>shortDRX-Cycle</i> (i.e. without suffix). Short DRX cycle is not configured for UEs in CE.</p>
<p>skipUplinkTxDynamic If configured, the UE skips UL transmissions for an uplink grant other than a configured uplink grant if no data is available for transmission in the UE buffer as described in TS 36.321 [6].</p>
<p>skipUplinkTxSPS If configured, the UE skips UL transmissions for a configured uplink grant if no data is available for transmission in the UE buffer as described in TS 36.321 [6]. E-UTRAN always configures <i>skipUplinkTxSPS</i> when <i>semiPersistSchedIntervalUL</i> is shorter than sf10.</p>
<p>sr-ProhibitTimer Timer for SR transmission on PUCCH in TS 36.321 [6]. Value in number of SR period(s) of shortest SR period of any serving cell with PUCCH. Value 0 means that behaviour as specified in 7.3.2 applies. Value 1 corresponds to one SR period, Value 2 corresponds to 2*SR periods and so on. SR period is defined in TS 36.213 [23, table 10.1.5-1].</p>
<p>stag-Id Indicates the TAG of an SCell, see TS 36.321 [6]. Uniquely identifies the TAG within the scope of a Cell Group (i.e. MCG or SCG). If the field is not configured for an SCell (e.g. absent in <i>MAC-MainConfigSCell</i>), the SCell is part of the PTAG.</p>
<p>stag-ToAddModList, stag-ToReleaseList Used to configure one or more STAGs. E-UTRAN ensures that a STAG contains at least one SCell with configured uplink. If, due to SCell release a reconfiguration would result in an 'empty' TAG, E-UTRAN includes release of the concerned TAG.</p>
<p>timeAlignmentTimerSTAG Indicates the value of the time alignment timer for an STAG, see TS 36.321 [6].</p>
<p>ttiBundling TRUE indicates that TTI bundling TS 36.321 [6] is enabled while FALSE indicates that TTI bundling is disabled. TTI bundling can be enabled for FDD and for TDD for configurations 0, 1 and 6 and additionally for configurations 2 and 3 when <i>symPUSCH-UpPTS-r14</i> is configured. The functionality is performed independently per Cell Group (i.e. MCG or SCG), but E-UTRAN does not configure TTI bundling for the SCG. For a TDD PCell, E-UTRAN does not simultaneously enable TTI bundling and semi-persistent scheduling in this release of specification. Furthermore, for a Cell Group, E-UTRAN does not simultaneously configure TTI bundling and SCells with configured uplink, and E-UTRAN does not simultaneously configure TTI bundling and eIMTA.</p>

P-C-AndCBSR

The IE *P-C-AndCBSR* is used to specify the power control and codebook subset restriction configuration.

P-C-AndCBSR information elements

```

-- ASN1START
P-C-AndCBSR-r11 ::= SEQUENCE {
    p-C-r11                INTEGER (-8..15),
    codebookSubsetRestriction-r11  BIT STRING
}

P-C-AndCBSR-r13 ::= SEQUENCE {
    p-C-r13                INTEGER (-8..15),
    cbsr-Selection-r13     CHOICE {
        nonPrecoded-r13    SEQUENCE {
            codebookSubsetRestriction1-r13  BIT STRING,
            codebookSubsetRestriction2-r13  BIT STRING
        },
        beamformedK1a-r13  SEQUENCE {
            codebookSubsetRestriction3-r13  BIT STRING
        },
        beamformedKN-r13  SEQUENCE {
            codebookSubsetRestriction-r13   BIT STRING
        }
    },
    ...
}

P-C-AndCBSR-Pair-r13a ::= SEQUENCE (SIZE (1..2)) OF P-C-AndCBSR-r11
P-C-AndCBSR-Pair-r13  ::= SEQUENCE (SIZE (1..2)) OF P-C-AndCBSR-r13
-- ASN1STOP

```

P-C-AndCBSR field descriptions

cbsr-Selection

Indicates which codebook subset restriction parameter(s) are to be used. E-UTRAN applies values *nonPrecoded* when *eMIMO-Type* is set to *nonPrecoded*. E-UTRAN applies value *beamformedK1a* when *eMIMO-Type* is set to *beamformed*, *alternativeCodebookEnabledBeamformed* is set to *TRUE* and *csi-RS-ConfigNZPIdListExt* is not configured. E-UTRAN applies value *beamformedKN* when *csi-RS-ConfigNZPIdListExt* is configured. E-UTRAN applies value *beamformedKN* when *eMIMO-Type* is set to *beamformed*, *csi-RS-ConfigNZPIdListExt* is not configured and *alternativeCodebookEnabledBeamformed* is set to *FALSE*.

codebookSubsetRestriction

Parameter: *codebookSubsetRestriction*, see TS 36.213 [23] and TS 36.211 [21]. The number of bits in the *codebookSubsetRestriction* for applicable transmission modes is defined in TS 36.213 [23].

codebookSubsetRestriction1

Parameter: *codebookSubsetRestriction1*, see TS 36.213 [23, Table 7.2-1d]. The number of bits in the *codebookSubsetRestriction1* for applicable transmission modes is defined in TS 36.213 [23].

codebookSubsetRestriction2

Parameter: *codebookSubsetRestriction2*, see TS 36.213 [23, Table 7.2-1e]. The number of bits in the *codebookSubsetRestriction2* for applicable transmission modes is defined in TS 36.213 [23].

codebookSubsetRestriction3

Parameter: *codebookSubsetRestriction3*, see TS 36.213 [23, Table 7.2-1f]. The UE shall ignore *codebookSubsetRestriction-r11* or *codebookSubsetRestriction-r10* if *codebookSubsetRestriction3-r13* is configured. The number of bits in the *codebookSubsetRestriction3* for applicable transmission modes is defined in TS 36.213 [23].

p-C

Parameter: P_c , see TS 36.213 [23, 7.2.5].

P-C-AndCBSR-Pair

E-UTRAN includes a single entry if the UE is configured with TM9. If the UE is configured with TM10 and E-UTRAN includes 2 entries, this indicates that the subframe patterns configured for CSI (CQI/PMI/PTI/RI/CRI) reporting (i.e. as defined by field *csi-MeasSubframeSet1* and *csi-MeasSubframeSet2*, or as defined by *csi-MeasSubframeSets-r12*) are to be used for this CSI process, while including a single entry indicates that the subframe patterns are not to be used for this CSI process. For a UE configured with TM10, E-UTRAN does not include 2 entries with *csi-MeasSubframeSet1* and *csi-MeasSubframeSet2* for CSI processes concerning a secondary frequency. Furthermore, E-UTRAN includes 2 entries when configuring both *cqi-pmi-ConfigIndex* and *cqi-pmi-ConfigIndex2*.

PDCCH-ConfigSCell

The IE *PDCCH-ConfigSCell* specifies PDCCH monitoring parameters that E-UTRAN may configure for a serving cell.

PDCCH-ConfigSCell information element

```

-- ASN1START
PDCCH-ConfigSCell-r13 ::= SEQUENCE {
    skipMonitoringDCI-format0-1A-r13  ENUMERATED {true}          OPTIONAL  -- Need OR
}

PDCCH-ConfigLAA-r14 ::= SEQUENCE {
    maxNumberOfSchedSubframes-Format0B-r14  ENUMERATED {sf2, sf3, sf4}  OPTIONAL,  -- Need OR
    maxNumberOfSchedSubframes-Format4B-r14  ENUMERATED {sf2, sf3, sf4}  OPTIONAL,  -- Need OR
    skipMonitoringDCI-Format0A-r14          ENUMERATED {true}          OPTIONAL,  -- Need OR
    skipMonitoringDCI-Format4A-r14          ENUMERATED {true}          OPTIONAL,  -- Need OR
    pdcch-CandidateReductions-Format0A-r14  PDCCH-CandidateReductions-r13  OPTIONAL,  -- Need ON
    pdcch-CandidateReductions-Format4A-r14  PDCCH-CandidateReductionsLAA-UL-r14  OPTIONAL,  -- Need ON
    pdcch-CandidateReductions-Format0B-r14  PDCCH-CandidateReductionsLAA-UL-r14  OPTIONAL,  -- Need ON
    pdcch-CandidateReductions-Format4B-r14  PDCCH-CandidateReductionsLAA-UL-r14  OPTIONAL  -- Need ON
}

PDCCH-CandidateReductionValue-r13 ::= ENUMERATED {n0, n33, n66, n100}

PDCCH-CandidateReductionValue-r14 ::= ENUMERATED {n0, n50, n100, n150}

PDCCH-CandidateReductions-r13 ::= CHOICE {
    release  NULL,
    setup   SEQUENCE {
        pdcch-candidateReductionAL1-r13  PDCCH-CandidateReductionValue-r13,
        pdcch-candidateReductionAL2-r13  PDCCH-CandidateReductionValue-r13,
        pdcch-candidateReductionAL3-r13  PDCCH-CandidateReductionValue-r13,
        pdcch-candidateReductionAL4-r13  PDCCH-CandidateReductionValue-r13,
        pdcch-candidateReductionAL5-r13  PDCCH-CandidateReductionValue-r13
    }
}

PDCCH-CandidateReductionsLAA-UL-r14 ::= CHOICE {
    release  NULL,
    setup   SEQUENCE {
        pdcch-candidateReductionAL1-r14  PDCCH-CandidateReductionValue-r13,
        pdcch-candidateReductionAL2-r14  PDCCH-CandidateReductionValue-r13,
        pdcch-candidateReductionAL3-r14  PDCCH-CandidateReductionValue-r14,
        pdcch-candidateReductionAL4-r14  PDCCH-CandidateReductionValue-r14,
        pdcch-candidateReductionAL5-r14  PDCCH-CandidateReductionValue-r14
    }
}
-- ASN1STOP

```

PDCCH-ConfigSCell field descriptions	
maxNumberOfSchedSubframes-Format0B	Indicates maximum number of schedulable subframes for DCI format 0B as specified in TS 36.213 [23]. Value sf2 corresponds to 2 subframes, value sf3 corresponds to 3 subframes and so on.
maxNumberOfSchedSubframes-Format4B	Indicates maximum number of schedulable subframes for DCI format 4B as specified in TS 36.213 [23]. Value sf2 corresponds to 2 subframes, value sf3 corresponds to 3 subframes and so on.
skipMonitoringDCI-format0-1A	Indicates whether the UE is configured to omit monitoring DCI format 0/1A, see TS 36.213 [23, 9.1.1].
skipMonitoringDCI-Format0A	Indicates whether the UE is configured to omit monitoring DCI format 0A as specified in TS 36.213 [23].
skipMonitoringDCI-Format4A	Indicates whether the UE is configured to omit monitoring DCI format 4A as specified in TS 36.213 [23].
pdccch-candidateReductionALx	Indicates reduced (E)PDCCH monitoring requirements on UE specific search space of the x-th aggregation level, see TS 36.213 [23, 9.1.1]. Value n0 corresponds to 0%, value n33 corresponds to 33% and so on.
pdccch-CandidateReductions-Formatx	Indicates number of blind detections on UE specific search space for each aggregation layer as specified in TS 36.213 [23]. The field can only be present when the UE is configured with uplink of an LAA SCell. If <i>pdccch-CandidateReductions-Formatx</i> is not configured, <i>pdccch-CandidateReductions-r13</i> applies to the corresponding DCIs (if configured).

– PDCP-Config

The IE *PDCP-Config* is used to set the configurable PDCP parameters for data radio bearers.

PDCP-Config information element

```
-- ASN1START
PDCP-Config ::=
    discardTimer                SEQUENCE {
        ENUMERATED {
            ms50, ms100, ms150, ms300, ms500,
            ms750, ms1500, infinity
        }
        OPTIONAL,                -- Cond Setup
    }
    rlc-AM                      SEQUENCE {
        statusReportRequired    BOOLEAN
    }
        OPTIONAL,                -- Cond Rlc-AM
    rlc-UM                      SEQUENCE {
        pdcp-SN-Size            ENUMERATED {len7bits, len12bits}
    }
        OPTIONAL,                -- Cond Rlc-UM
    headerCompression          CHOICE {
        notUsed                NULL,
        rohc                   SEQUENCE {
            maxCID              INTEGER (1..16383)                DEFAULT 15,
            profiles            SEQUENCE {
                profile0x0001    BOOLEAN,
                profile0x0002    BOOLEAN,
                profile0x0003    BOOLEAN,
                profile0x0004    BOOLEAN,
                profile0x0006    BOOLEAN,
                profile0x0101    BOOLEAN,
                profile0x0102    BOOLEAN,
                profile0x0103    BOOLEAN,
                profile0x0104    BOOLEAN
            }
        }
    },
    ...
},
...,
[[ rn-IntegrityProtection-r10    ENUMERATED {enabled}    OPTIONAL    -- Cond RN
]],
[[ pdcp-SN-Size-v1130           ENUMERATED {len15bits}    OPTIONAL    -- Cond Rlc-AM2
]],
[[ ul-DataSplitDRB-ViaSCG-r12    BOOLEAN                OPTIONAL,    -- Need ON
   t-Reordering-r12             ENUMERATED {
       ms0, ms20, ms40, ms60, ms80, ms100, ms120, ms140,
       ms160, ms180, ms200, ms220, ms240, ms260, ms280, ms300,
       ms500, ms750, spare14, spare13, spare12, spare11, spare10,
       spare9, spare8, spare7, spare6, spare5, spare4, spare3,
       spare2, spare1}
   }
   OPTIONAL    -- Cond SetupS
]],
```

```

[[ ul-DataSplitThreshold-r13 CHOICE {
    release NULL,
    setup ENUMERATED {
        b0, b100, b200, b400, b800, b1600, b3200, b6400, b12800,
        b25600, b51200, b102400, b204800, b409600, b819200,
        spare1}
    }
    pdcpc-SN-Size-v1310 ENUMERATED {len18bits} OPTIONAL, -- Cond Rlc-AM3
    statusFeedback-r13 CHOICE {
        release NULL,
        setup SEQUENCE {
            statusPDU-TypeForPolling-r13 ENUMERATED {type1, type2} OPTIONAL, --
Need ON
            statusPDU-Periodicity-Type1-r13 ENUMERATED {
                ms5, ms10, ms20, ms30, ms40, ms50, ms60, ms70, ms80, ms90,
                ms100, ms150, ms200, ms300, ms500, ms1000, ms2000, ms5000,
                ms10000, ms20000, ms50000} OPTIONAL, -- Need ON
            statusPDU-Periodicity-Type2-r13 ENUMERATED {
                ms5, ms10, ms20, ms30, ms40, ms50, ms60, ms70, ms80, ms90,
                ms100, ms150, ms200, ms300, ms500, ms1000, ms2000, ms5000,
                ms10000, ms20000, ms50000} OPTIONAL, -- Need ON
            statusPDU-Periodicity-Offset-r13 ENUMERATED {
                ms1, ms2, ms5, ms10, ms25, ms50, ms100, ms250, ms500,
                ms2500, ms5000, ms25000} OPTIONAL -- Need ON
        }
    }
    }
]],
[[ ul-LWA-Config-r14 CHOICE {
    release NULL,
    setup SEQUENCE {
        ul-LWA-DRB-ViaWLAN-r14 BOOLEAN,
        ul-LWA-DataSplitThreshold-r14 ENUMERATED {
            b0, b100, b200, b400, b800, b1600, b3200, b6400,
            b12800, b25600, b51200, b102400, b204800, b409600,
            b819200 } OPTIONAL -- Need ON
        }
    }
    uplinkOnlyHeaderCompression-r14 CHOICE {
        notUsed-r14 NULL,
        rohc-r14 SEQUENCE {
            maxCID-r14 INTEGER (1..16383) DEFAULT 15,
            profiles-r14 SEQUENCE {
                profile0x0006-r14 BOOLEAN
            },
            ...
        }
    }
    }
]],
-- ASN1STOP

```

PDCP-Config field descriptions
<p>discardTimer Indicates the discard timer value specified in TS 36.323 [8]. Value in milliseconds. Value ms50 means 50 ms, ms100 means 100 ms and so on.</p>
<p>headerCompression E-UTRAN does not reconfigure header compression for an MCG DRB except for upon handover and upon the first reconfiguration after RRC connection re-establishment. E-UTRAN does not reconfigure header compression for a SCG DRB except for upon SCG change involving PDCP re-establishment. For split and LWA DRBs E-UTRAN configures only <i>notUsed</i>. If <i>headerCompression</i> is configured, the UE shall apply the configured ROHC profile(s) in both uplink and downlink.</p>
<p>maxCID Indicates the value of the MAX_CID parameter as specified in TS 36.323 [8]. The total value of MAX_CIDs across all bearers for the UE should be less than or equal to the value of <i>maxNumberROHC-ContextSessions</i> parameter as indicated by the UE.</p>
<p>pdcp-SN-Size Indicates the PDCP Sequence Number length in bits. For RLC UM: value <i>len7bits</i> means that the 7-bit PDCP SN format is used and <i>len12bits</i> means that the 12-bit PDCP SN format is used. For RLC AM: value <i>len15bits</i> means that the 15-bit PDCP SN format is used, value <i>len18bits</i> means that the 18-bit PDCP SN format is used, otherwise if the field is not included upon setup of the PDCP entity 12-bit PDCP SN format is used, as specified in TS 36.323 [8].</p>
<p>profiles The profiles used by both compressor and decompressor in both UE and E-UTRAN. The field indicates which of the ROHC profiles specified in TS 36.323 [8] are supported, i.e. value <i>true</i> indicates that the profile is supported. Profile 0x0000 shall always be supported when the use of ROHC is configured. If support of two ROHC profile identifiers with the same 8 LSB's is signalled, only the profile corresponding to the highest value shall be applied. E-UTRAN does not configure ROHC while <i>t-Reordering</i> is configured (i.e. for split DRBs, for LWA bearers or upon reconfiguration from split or LWA to MCG DRB).</p>
<p>statusFeedback Indicates whether the UE shall send PDCP Status Report periodically or by E-UTRAN polling as specified in TS 36.323 [8]. E-UTRAN configures this field only for LWA DRB.</p>
<p>statusPDU-TypeForPolling Indicates the PDCP Control PDU option when it is triggered by E-UTRAN polling. Value <i>type1</i> indicates using the legacy PDCP Control PDU for PDCP status reporting and value <i>type2</i> indicates using the LWA specific PDCP Control PDU for LWA status reporting as specified in TS 36.323 [8].</p>
<p>statusPDU-Periodicity-Type1 Indicates the value of the PDCP Status reporting periodicity for <i>type1</i> Status PDU, as specified in TS 36.323 [8]. Value in milliseconds. Value ms5 means 5 ms, ms10 means 10 ms and so on.</p>
<p>statusPDU-Periodicity-Type2 Indicates the value of the PDCP Status reporting periodicity for <i>type2</i> Status PDU, as specified in TS 36.323 [8]. Value in milliseconds. Value ms5 means 5 ms, ms10 means 10 ms and so on.</p>
<p>statusPDU-Periodicity-Offset Indicates the value of the offset for <i>type2</i> Status PDU periodicity, as specified in TS 36.323 [8]. Value in milliseconds. Value ms1 means 1 ms, ms2 means 2 ms and so on.</p>
<p>t-Reordering Indicates the value of the reordering timer, as specified in TS 36.323 [8]. Value in milliseconds. Value ms0 means 0 ms and behaviour as specified in 7.3.2 applies, ms20 means 20 ms and so on.</p>
<p>rn-IntegrityProtection Indicates that integrity protection or verification shall be applied for all subsequent packets received and sent by the RN on the DRB.</p>
<p>statusReportRequired Indicates whether or not the UE shall send a PDCP Status Report upon re-establishment of the PDCP entity and upon PDCP data recovery as specified in TS 36.323 [8].</p>
<p>ul-DataSplitDRB-ViaSCG Indicates whether the UE shall send PDCP PDUs via SCG as specified in TS 36.323 [8]. E-UTRAN only configures the field (i.e. indicates value <i>TRUE</i>) for split DRBs.</p>
<p>ul-DataSplitThreshold Indicates the threshold value for uplink data split operation specified in TS 36.323 [8]. Value b100 means 100 Bytes, b200 means 200 Bytes and so on. E-UTRAN only configures this field for split DRBs.</p>
<p>ul-LWA-DRB-ViaWLAN Indicates whether the UE shall send PDCP PDUs via the LWAAP entity as specified in TS 36.323 [8]. E-UTRAN only configures this field (i.e. indicates value <i>TRUE</i>) for LWA DRBs.</p>
<p>ul-LWA-DataSplitThreshold Indicates the threshold value for uplink data split operation as specified in TS 36.323 [8]. Value b0 means 0 Bytes, b100 means 100 Bytes and so on. E-UTRAN only configures this field for LWA DRBs.</p>

PDCP-Config field descriptions	
<i>uplinkOnlyHeaderCompression</i>	
Indicates the ROHC configuration that the UE shall apply uplink-only ROHC operations, see TS 36.323 [8]. E-UTRAN only configures this field when <i>headerCompression</i> is not configured.	
E-UTRAN does not reconfigure header compression for an MCG DRB except for upon handover and upon the first reconfiguration after RRC connection re-establishment. E-UTRAN does not reconfigure header compression for a SCG DRB except for upon SCG change involving PDCP re-establishment. For split and LWA DRBs E-UTRAN configures only <i>notUsed</i> .	

Conditional presence	Explanation
<i>Rlc-AM</i>	The field is mandatory present upon setup of a PDCP entity for a radio bearer configured with RLC AM. The field is optional, need ON, in case of reconfiguration of a PDCP entity at handover, at the first reconfiguration after RRC re-establishment or at SCG change involving PDCP re-establishment or PDCP data recovery for a radio bearer configured with RLC AM. Otherwise the field is not present.
<i>Rlc-AM2</i>	The field is optionally present, need OP, upon setup of a PDCP entity for a radio bearer configured with RLC AM. Otherwise the field is not present.
<i>Rlc-AM3</i>	The field is optionally present, need OP, upon setup of a PDCP entity for a radio bearer configured with RLC AM, if <i>pdcp-SN-Size-v1130</i> is absent. Otherwise the field is not present.
<i>Rlc-UM</i>	The field is mandatory present upon setup of a PDCP entity for a radio bearer configured with RLC UM. It is optionally present, Need ON, upon handover within E-UTRA, upon the first reconfiguration after re-establishment and upon SCG change involving PDCP re-establishment. Otherwise the field is not present.
<i>RN</i>	The field is optionally present when signalled to the RN, need OR. Otherwise the field is not present.
<i>Setup</i>	The field is mandatory present in case of radio bearer setup. Otherwise the field is optionally present, need ON.
<i>SetupS</i>	The field is mandatory present in case of setup of or reconfiguration to a split DRB or LWA DRB. The field is optionally present upon reconfiguration of a split DRB or LWA DRB or upon DRB type change from split to MCG DRB or from LWA to LTE only, need ON. Otherwise the field is not present.

PDSCH-Config

The IE *PDSCH-ConfigCommon* and the IE *PDSCH-ConfigDedicated* are used to specify the common and the UE specific PDSCH configuration respectively.

PDSCH-Config information element

```
-- ASN1START
PDSCH-ConfigCommon ::= SEQUENCE {
    referenceSignalPower      INTEGER (-60..50),
    p-b                       INTEGER (0..3)
}

PDSCH-ConfigCommon-v1310 ::= SEQUENCE {
    pdsch-maxNumRepetitionCEmodeA-r13  ENUMERATED {
        r16, r32 }                                OPTIONAL, -- Need OR
    pdsch-maxNumRepetitionCEmodeB-r13  ENUMERATED {
        r192, r256, r384, r512, r768, r1024,
        r1536, r2048 }                            OPTIONAL -- Need OR
}

PDSCH-ConfigDedicated ::= SEQUENCE {
    p-a                       ENUMERATED {
        dB-6, dB-4dot77, dB-3, dB-1dot77,
        dB0, dB1, dB2, dB3 }
}

PDSCH-ConfigDedicated-v1130 ::= SEQUENCE {
    dmrs-ConfigPDSCH-r11      DMRS-Config-r11            OPTIONAL, -- Need ON
    qcl-Operation              ENUMERATED {typeA, typeB}    OPTIONAL, -- Need OR
    re-MappingQCLConfigToReleaseList-r11 RE-MappingQCLConfigToReleaseList-r11 OPTIONAL, --
Need ON
-- ASN1END
```



```

re-MappingQCLConfigToAddModList-r11      RE-MappingQCLConfigToAddModList-r11      OPTIONAL      --
Need ON
}
PDSCH-ConfigDedicated-v1280 ::=          SEQUENCE {
  tbsIndexAlt-r12                        ENUMERATED {a26, a33}                      OPTIONAL      -- Need OR
}
PDSCH-ConfigDedicated-v1310 ::=          SEQUENCE {
  dmrs-ConfigPDSCH-v1310                 DMRS-Config-v1310                          OPTIONAL      -- Need ON
}
PDSCH-ConfigDedicated-v1430 ::=          SEQUENCE {
  ce-PDSCH-MaxBandwidth-r14              ENUMERATED {bw5, bw20}                     OPTIONAL,    -- Need OP
  ce-PDSCH-TenProcesses-r14              ENUMERATED {on}                            OPTIONAL,    -- Need OR
  ce-HARQ-AckBundling-r14                ENUMERATED {on}                            OPTIONAL,    -- Need OR
  ce-SchedulingEnhancement-r14           ENUMERATED {range1, range2}                OPTIONAL,    -- Need OR
  tbsIndexAlt2-r14                        ENUMERATED {b33}                          OPTIONAL,    -- Need OR
}
PDSCH-ConfigDedicatedSCell-v1430 ::=     SEQUENCE {
  tbsIndexAlt2-r14                        ENUMERATED {b33}                          OPTIONAL,    -- Need OR
}
RE-MappingQCLConfigToAddModList-r11 ::=   SEQUENCE (SIZE (1..maxRE-MapQCL-r11)) OF PDSCH-RE-
MappingQCL-Config-r11
RE-MappingQCLConfigToReleaseList-r11 ::=  SEQUENCE (SIZE (1..maxRE-MapQCL-r11)) OF PDSCH-RE-
MappingQCL-ConfigId-r11
PDSCH-RE-MappingQCL-Config-r11 ::=       SEQUENCE {
  pdsch-RE-MappingQCL-ConfigId-r11      PDSCH-RE-MappingQCL-ConfigId-r11,
  optionalSetOfFields-r11                SEQUENCE {
    crs-PortsCount-r11                   ENUMERATED {n1, n2, n4, spare1},
    crs-FreqShift-r11                    INTEGER (0..5),
    mbsfn-SubframeConfigList-r11        CHOICE {
      release                             NULL,
      setup                               SEQUENCE {
        subframeConfigList               MBSFN-SubframeConfigList
      }
    }
  }
  pdsch-Start-r11                        ENUMERATED {reserved, n1, n2, n3, n4, assigned}
}
csi-RS-ConfigZPID-r11                    CSI-RS-ConfigZPID-r11,
qcl-CSIRSR-ConfigNZPID-r11              CSI-RS-ConfigNZPID-r11                      OPTIONAL,    -- Need OR
...
[[ mbsfn-SubframeConfigList-v1430 CHOICE {
  release                                NULL,
  setup                                  SEQUENCE {
    subframeConfigList-v1430            MBSFN-SubframeConfigList-v1430
  }
}
]]
]]
}
-- ASN1STOP

```

PDSCH-Config field descriptions
<p>ce-HARQ-AckBundling Activation of PDSCH HARQ-ACK bundling in half duplex FDD in CE mode A, see TS 36.212 [22] and TS 36.213 [23].</p>
<p>ce-PDSCH-MaxBandwidth Maximum PDSCH channel bandwidth in CE mode A and B, see TS 36.212 [22] and TS 36.213 [23]. Value bw5 corresponds to 5 MHz, and value bw20 corresponds to 20 MHz. If this field is absent, the UE shall release any existing value and set the maximum PDSCH channel bandwidth in CE mode A and B to 1.4 MHz. Parameter: transmission bandwidth configuration, see TS 36.101 [42, table 5.6-1]. The max bandwidth can be configured to 5MHz for BL UEs and 5MHz or 20MHz for UEs in CE.</p>
<p>ce-PDSCH-TenProcesses Configuration of 10 (instead of 8) DL HARQ processes in FDD in CE mode A, see TS 36.212 [22] and TS 36.213 [23].</p>
<p>ce-SchedulingEnhancement Activation of dynamic HARQ-ACK delay for HD-FDD for PDSCH in CE mode A controlled by the DCI, see TS 36.212 [22] and TS 36.213 [23]. Value range1 corresponds to the first range of HARQ-ACK delays, and value range2 corresponds to second range of HARQ-ACK delays.</p>
<p>mbsfn-SubframeConfigList Indicates the MBSFN configuration for the CSI-RS resources. If <i>optionalSetOfFields</i> is absent, the field is released.</p>
<p>optionalSetOfFields If absent, the UE releases the configuration provided previously, if any, and applies the values from the serving cell configured on the same frequency.</p>
<p>p-a Parameter: P_A, see TS 36.213 [23, 5.2]. Value dB-6 corresponds to -6 dB, dB-4dot77 corresponds to -4.77 dB etc.</p>
<p>p-b Parameter: P_B, see TS 36.213 [23, Table 5.2-1].</p>
<p>pdsch-maxNumRepetitionCEmodeA Maximum value to indicate the set of PDSCH repetition numbers for CE mode A, see TS 36.211 [21] and TS 36.213 [23].</p>
<p>pdsch-maxNumRepetitionCEmodeB Maximum value to indicate the set of PDSCH repetition numbers for CE mode B, see TS 36.211 [21] and TS 36.213 [23].</p>
<p>pdsch-Start The starting OFDM symbol of PDSCH for the concerned serving cell, see TS 36.213 [23, 7.1.6.4]. Values 1, 2, 3 are applicable when <i>dl-Bandwidth</i> for the concerned serving cell is greater than 10 resource blocks, values 2, 3, 4 are applicable when <i>dl-Bandwidth</i> for the concerned serving cell is less than or equal to 10 resource blocks, see TS 36.211 [21, Table 6.7-1]. Value <i>n1</i> corresponds to 1, value <i>n2</i> corresponds to 2 and so on.</p>
<p>qcl-CSI-RS-ConfigNZPId Indicates the CSI-RS resource that is quasi co-located with the PDSCH antenna ports, see TS 36.213 [23, 7.1.9]. E-UTRAN configures this field if and only if the UE is configured with <i>qcl-Operation</i> set to <i>typeB</i>.</p>
<p>qcl-Operation Indicates the quasi co-location behaviour to be used by the UE, type A and type B, as described in TS 36.213 [23, 7.1.10].</p>
<p>referenceSignalPower Parameter: <i>Reference-signal power</i>, which provides the downlink reference-signal EPRE, see TS 36.213 [23, 5.2]. The actual value in dBm.</p>
<p>re-MappingQCLConfigToAddModList, re-MappingQCLConfigToReleaseList For a serving frequency E-UTRAN configures at least one <i>PDSCH-RE-MappingQCL-Config</i> when transmission mode 10 is configured for the serving cell on this carrier frequency. Otherwise it does not configure this field.</p>
<p>tbsIndexAlt Indicates the applicability of the alternative TBS index for the I_{TBS} 26 and 33 (see TS 36.213 [23, Table 7.1.7.2.1-1]) to all subframes scheduled by DCI format 2C or 2D. Value a26 refers to the alternative TBS index I_{TBS} 26A, and value a33 refers to the alternative TBS index I_{TBS} 33A. If this field is not configured, the UE shall use I_{TBS} 26 specified in Table 7.1.7.2.1-1 in TS 36.213 [23] for all subframes instead. If neither this field nor <i>tbsIndexAlt2</i> configures an alternative TBS index for I_{TBS} 33, the UE shall use I_{TBS} 33 specified in Table 7.1.7.2.1-1 in TS 36.213 [23] for all subframes instead.</p>
<p>tbsIndexAlt2 Indicates the applicability of the alternative TBS index for the I_{TBS} 33 (see TS 36.213 [23, Table 7.1.7.2.1-1]) to all subframes. Value b33 refers to the alternative TBS index I_{TBS} 33B. If neither this field nor <i>tbsIndexAlt</i> configures an alternative TBS index for I_{TBS} 33, the UE shall use I_{TBS} 33 specified in Table 7.1.7.2.1-1 in TS 36.213 [23] for all subframes instead.</p>

– PDSCH-RE-MappingQCL-ConfigId

The IE *PDSCH-RE-MappingQCL-ConfigId* is used to identify a set of PDSCH parameters related to resource element mapping and quasi co-location, as configured by the IE *PDSCH-RE-MappingQCL-Config*. The identity is unique within the scope of a carrier frequency.

PDSCH-RE-MappingQCL-ConfigId information elements

```
-- ASN1START
PDSCH-RE-MappingQCL-ConfigId-r11 ::=          INTEGER (1..maxRE-MapQCL-r11)
-- ASN1STOP
```

– **PerCC-GapIndicationList**

The IE *PerCC-GapIndicationList* is used to specify the UE measurement gap preference.

PerCC-GapIndication information elements

```
-- ASN1START
PerCC-GapIndicationList-r14 ::= SEQUENCE (SIZE (1..maxServCell-r13)) OF PerCC-GapIndication-r14
PerCC-GapIndication-r14 ::=          SEQUENCE {
    servCellId-r14                      ServCellIndex-r13,
    gapIndication-r14                   ENUMERATED {gap, ncsg, nogap-noNcsg}
}
-- ASN1STOP
```

PerCC-GapIndication field descriptions**servCellId**

This field identifies the serving cell for which the measurement gap preference is provided.

gapIndication

This field is used to indicate the measurement gap preference per component carrier (serving cell) by the UE both in non-CA and CA configurations. Value *gap* indicates that a measurement gap is needed for the associated *servCellId*, value *nogap-noNcsg* indicates that neither a measurement gap nor a ncsg is needed for the associated *servCellId*, value *ncsg* indicates that ncsg is needed for the associated *servCellId*. The UE shall indicate the per CC measurement gap preference consistently for the same non-CA or CA configuration and measurement configuration during the same RRC connection.

– **PHICH-Config**

The IE *PHICH-Config* is used to specify the PHICH configuration.

PHICH-Config information element

```
-- ASN1START
PHICH-Config ::=          SEQUENCE {
    phich-Duration          ENUMERATED {normal, extended},
    phich-Resource          ENUMERATED {oneSixth, half, one, two}
}
-- ASN1STOP
```

PHICH-Config field descriptions**phich-Duration**

Parameter: *PHICH-Duration*, see TS 36.211 [21, Table 6.9.3-1].

phich-Resource

Parameter: *Ng*, see TS 36.211 [21, 6.9]. Value *oneSixth* corresponds to 1/6, *half* corresponds to 1/2 and so on.

– **PhysicalConfigDedicated**

The IE *PhysicalConfigDedicated* is used to specify the UE specific physical channel configuration.

PhysicalConfigDedicated information element

```
-- ASN1START
```

```

PhysicalConfigDedicated ::= SEQUENCE {
  pdsch-ConfigDedicated      PDSCH-ConfigDedicated      OPTIONAL,    -- Need ON
  pucch-ConfigDedicated      PUCCH-ConfigDedicated      OPTIONAL,    -- Need ON
  pusch-ConfigDedicated      PUSCH-ConfigDedicated      OPTIONAL,    -- Need ON
  uplinkPowerControlDedicated UplinkPowerControlDedicated OPTIONAL,    -- Need ON
  tpc-PDCCH-ConfigPUCCH      TPC-PDCCH-Config          OPTIONAL,    -- Need ON
  tpc-PDCCH-ConfigPUSCH      TPC-PDCCH-Config          OPTIONAL,    -- Need ON
  cqi-ReportConfig           CQI-ReportConfig          OPTIONAL,    -- Cond CQI-
r8
  soundingRS-UL-ConfigDedicated SoundingRS-UL-ConfigDedicated OPTIONAL,    -- Need ON
  antennaInfo                 CHOICE {
    explicitValue              AntennaInfoDedicated,
    defaultValue              NULL
  }
  schedulingRequestConfig      SchedulingRequestConfig    OPTIONAL,    -- Cond AI-r8
  ...,
r8
  [[ cqi-ReportConfig-v920      CQI-ReportConfig-v920      OPTIONAL,    -- Cond CQI-
r8
  antennaInfo-v920            AntennaInfoDedicated-v920  OPTIONAL,    -- Cond AI-
r8
  ]],
  [[ antennaInfo-r10           CHOICE {
    explicitValue-r10          AntennaInfoDedicated-r10,
    defaultValue              NULL
  }
  antennaInfoUL-r10           AntennaInfoUL-r10          OPTIONAL,    -- Cond AI-r10
  cif-Presence-r10           BOOLEAN                      OPTIONAL,    -- Need ON
  cqi-ReportConfig-r10       CQI-ReportConfig-r10       OPTIONAL,    -- Cond CQI-r10
  csi-RS-Config-r10          CSI-RS-Config-r10          OPTIONAL,    -- Need ON
  pucch-ConfigDedicated-v1020 PUCCH-ConfigDedicated-v1020 OPTIONAL,    -- Need ON
  pusch-ConfigDedicated-v1020 PUSCH-ConfigDedicated-v1020 OPTIONAL,    -- Need ON
  schedulingRequestConfig-v1020 SchedulingRequestConfig-v1020 OPTIONAL,    -- Need ON
  soundingRS-UL-ConfigDedicated-v1020 SoundingRS-UL-ConfigDedicated-v1020 OPTIONAL,    -- Need ON
  soundingRS-UL-ConfigDedicatedAperiodic-r10 SoundingRS-UL-ConfigDedicatedAperiodic-r10 OPTIONAL,    -- Need ON
  uplinkPowerControlDedicated-v1020 UplinkPowerControlDedicated-v1020 OPTIONAL,    -- Need ON
  ]],
  [[ additionalSpectrumEmissionCA-r10 CHOICE {
    release                    NULL,
    setup                      SEQUENCE {
      additionalSpectrumEmissionPCell-r10 AdditionalSpectrumEmission
    }
  }
  ]],
  [[ -- DL configuration as well as configuration applicable for DL and UL
  csi-RS-ConfigNZPTToReleaseList-r11 CSI-RS-ConfigNZPTToReleaseList-r11 OPTIONAL,    -- Need ON
  csi-RS-ConfigNZPTToAddModList-r11 CSI-RS-ConfigNZPTToAddModList-r11 OPTIONAL,    -- Need ON
  csi-RS-ConfigZPTToReleaseList-r11 CSI-RS-ConfigZPTToReleaseList-r11 OPTIONAL,    -- Need ON
  csi-RS-ConfigZPTToAddModList-r11 CSI-RS-ConfigZPTToAddModList-r11 OPTIONAL,    -- Need ON
  epdccb-Config-r11           EPDCCB-Config-r11          OPTIONAL,    -- Need ON
  pdsch-ConfigDedicated-v1130 PDSCH-ConfigDedicated-v1130 OPTIONAL,    -- Need ON
  -- UL configuration
  cqi-ReportConfig-v1130      CQI-ReportConfig-v1130      OPTIONAL,    -- Need ON
  pucch-ConfigDedicated-v1130 PUCCH-ConfigDedicated-v1130 OPTIONAL,    -- Need ON
  pusch-ConfigDedicated-v1130 PUSCH-ConfigDedicated-v1130 OPTIONAL,    -- Need ON
  uplinkPowerControlDedicated-v1130 UplinkPowerControlDedicated-v1130 OPTIONAL,    -- Need ON
  ]],
  [[ antennaInfo-v1250         AntennaInfoDedicated-v1250  OPTIONAL,    -- Cond AI-r10
  eimta-MainConfig-r12        EIMTA-MainConfig-r12        OPTIONAL,    -- Need ON
  eimta-MainConfigPCell-r12    EIMTA-MainConfigServCell-r12 OPTIONAL,    -- Need ON
  pucch-ConfigDedicated-v1250 PUCCH-ConfigDedicated-v1250 OPTIONAL,    -- Need ON
  cqi-ReportConfigPCell-v1250 CQI-ReportConfig-v1250      OPTIONAL,    -- Need ON
  uplinkPowerControlDedicated-v1250 UplinkPowerControlDedicated-v1250 OPTIONAL,    -- Need ON
  pusch-ConfigDedicated-v1250 PUSCH-ConfigDedicated-v1250 OPTIONAL,    -- Need ON
  csi-RS-Config-v1250         CSI-RS-Config-v1250         OPTIONAL,    -- Need ON
  ]],
  [[ pdsch-ConfigDedicated-v1280 PDSCH-ConfigDedicated-v1280 OPTIONAL,    -- Need ON
  ]],
  [[ pdsch-ConfigDedicated-v1310 PDSCH-ConfigDedicated-v1310 OPTIONAL,    -- Need ON
  pucch-ConfigDedicated-r13    PUCCH-ConfigDedicated-r13    OPTIONAL,    -- Need ON
  ]],

```

```

pusch-ConfigDedicated-r13          PUSCH-ConfigDedicated-r13  OPTIONAL,      -- Need ON
pdcch-CandidateReductions-r13
    PDCCH-CandidateReductions-r13  OPTIONAL,      -- Need ON
cqi-ReportConfig-v1310             CQI-ReportConfig-v1310     OPTIONAL,      -- Need ON
soundingRS-UL-ConfigDedicated-v1310
    SoundingRS-UL-ConfigDedicated-v1310  OPTIONAL,      -- Need ON
soundingRS-UL-ConfigDedicatedUpPTsExt-r13
    SoundingRS-UL-ConfigDedicatedUpPTsExt-r13  OPTIONAL,      -- Need ON
soundingRS-UL-ConfigDedicatedAperiodic-v1310
    SoundingRS-UL-ConfigDedicatedAperiodic-v1310  OPTIONAL,      -- Need ON
soundingRS-UL-ConfigDedicatedAperiodicUpPTsExt-r13
    SoundingRS-UL-ConfigDedicatedAperiodicUpPTsExt-r13  OPTIONAL,      -- Need ON
csi-RS-Config-v1310                CSI-RS-Config-v1310        OPTIONAL,      -- Need ON
ce-Mode-r13                         CHOICE {
    release                          NULL,
    setup                            ENUMERATED {ce-ModeA,ce-ModeB}
}
    OPTIONAL,      -- Need ON
csi-RS-ConfigNZPTToAddModListExt-r13  CSI-RS-ConfigNZPTToAddModListExt-r13  OPTIONAL,      -- Need
ON
csi-RS-ConfigNZPTToReleaseListExt-r13  CSI-RS-ConfigNZPTToReleaseListExt-r13  OPTIONAL      --
Need ON
}],
[[ cqi-ReportConfig-v1320             CQI-ReportConfig-v1320     OPTIONAL,      -- Need ON
]],
[[ typeA-SRS-TPC-PDCCH-Group-r14     CHOICE {
    release                          NULL,
    setup                            SEQUENCE (SIZE (1..32)) OF SRS-TPC-PDCCH-Config-r14
}
    OPTIONAL,      -- Need ON
must-Config-r14                     CHOICE {
    release                          NULL,
    setup                            SEQUENCE {
        k-max-r14                    ENUMERATED {11, 13},
        p-a-must-r14                 ENUMERATED {
            dB-6, dB-4dot77, dB-3, dB-1dot77,
            dB0, dB1, dB2, dB3}
        }
    }
    OPTIONAL,      -- Need ON
pusch-EnhancementsConfig-r14        PUSCH-EnhancementsConfig-r14  OPTIONAL,      -- Need
ON
ce-pdsch-pusch-EnhancementConfig-r14  ENUMERATED {on}            OPTIONAL,      -- Need OR
antennaInfo-v1430                   AntennaInfoDedicated-v1430  OPTIONAL,      -- Need ON
pucch-ConfigDedicated-v1430         PUCCH-ConfigDedicated-v1430  OPTIONAL,      -- Need ON
pdsch-ConfigDedicated-v1430         PDSCH-ConfigDedicated-v1430  OPTIONAL,      -- Need ON
pusch-ConfigDedicated-v1430         PUSCH-ConfigDedicated-v1430  OPTIONAL,      -- Need ON
soundingRS-UL-PeriodicConfigDedicatedList-r14
    SoundingRS-UL-PeriodicConfigDedicatedList-r14  SEQUENCE (SIZE (1..2)) OF
SoundingRS-UL-ConfigDedicated        OPTIONAL,      -- Cond PeriodicSRSPCell
soundingRS-UL-PeriodicConfigDedicatedUpPTsExtList-r14
    SoundingRS-UL-PeriodicConfigDedicatedUpPTsExtList-r14  SEQUENCE (SIZE (1..4)) OF
SoundingRS-UL-ConfigDedicatedUpPTsExt-r13  OPTIONAL,      -- Cond PeriodicSRSExt
soundingRS-UL-AperiodicConfigDedicatedList-r14
    SoundingRS-UL-AperiodicConfigDedicatedList-r14  SEQUENCE (SIZE (1..2)) OF
SoundingRS-UL-ConfigDedicatedAperiodic-r10  OPTIONAL,      -- Cond AperiodicSRS
soundingRS-UL-ConfigDedicatedApUpPTsExtList-r14
    SoundingRS-UL-ConfigDedicatedApUpPTsExtList-r14  SEQUENCE (SIZE (1..4)) OF SoundingRS-UL-
ConfigDedicatedAperiodicUpPTsExt-r13  OPTIONAL,      -- Cond AperiodicSRSExt
csi-RS-Config-v1430                  CSI-RS-Config-v1430        OPTIONAL,      -- Need ON
csi-RS-ConfigZP-ApList-r14           CSI-RS-ConfigZP-ApList-r14  OPTIONAL,      -- Need ON
cqi-ReportConfig-v1430               CQI-ReportConfig-v1430     OPTIONAL,      -- Need ON
semiOpenLoop-r14                     BOOLEAN                     OPTIONAL,      -- Need ON
]],
[[ csi-RS-Config-v1480                CSI-RS-Config-v1480        OPTIONAL,      -- Need ON
]]
}

PhysicalConfigDedicated-v1370 ::= SEQUENCE {
    pucch-ConfigDedicated-v1370       PUCCH-ConfigDedicated-v1370  OPTIONAL,      -- Cond
PUCCH-Format4or5
}

PhysicalConfigDedicated-v13c0 ::= SEQUENCE {
    pucch-ConfigDedicated-v13c0       PUCCH-ConfigDedicated-v13c0
}

PhysicalConfigDedicatedSCell-r10 ::= SEQUENCE {
    -- DL configuration as well as configuration applicable for DL and UL
    nonUL-Configuration-r10           SEQUENCE {
        antennaInfo-r10               AntennaInfoDedicated-r10    OPTIONAL,      -- Need ON
        crossCarrierSchedulingConfig-r10
            CrossCarrierSchedulingConfig-r10  OPTIONAL,      -- Need ON
        csi-RS-Config-r10              CSI-RS-Config-r10          OPTIONAL,      -- Need ON
    }
}

```

```

    pdsch-ConfigDedicated-r10                PDSCH-ConfigDedicated    OPTIONAL,    -- Need ON
  }
  -- UL configuration
ul-Configuration-r10                        SEQUENCE {
  antennaInfoUL-r10                        AntennaInfoUL-r10        OPTIONAL,    -- Need ON
  pusch-ConfigDedicatedSCell-r10          PUSCH-ConfigDedicatedSCell-r10    OPTIONAL,    -- Cond PUSCH-SCell1
  uplinkPowerControlDedicatedSCell-r10    UplinkPowerControlDedicatedSCell-r10    OPTIONAL,    -- Need ON
  cqi-ReportConfigSCell-r10              CQI-ReportConfigSCell-r10    OPTIONAL,    -- Need ON
  soundingRS-UL-ConfigDedicated-r10       SoundingRS-UL-ConfigDedicated    OPTIONAL,    -- Need ON
  soundingRS-UL-ConfigDedicated-v1020     SoundingRS-UL-ConfigDedicated-v1020    OPTIONAL,    -- Need ON
  soundingRS-UL-ConfigDedicatedAperiodic-r10    SoundingRS-UL-ConfigDedicatedAperiodic-r10    OPTIONAL,    -- Need ON
}
...
[[ -- DL configuration as well as configuration applicable for DL and UL
  csi-RS-ConfigNZPTToReleaseList-r11      CSI-RS-ConfigNZPTToReleaseList-r11    OPTIONAL,    -- Need ON
  csi-RS-ConfigNZPTToAddModList-r11      CSI-RS-ConfigNZPTToAddModList-r11    OPTIONAL,    -- Need ON
  csi-RS-ConfigZPTToReleaseList-r11      CSI-RS-ConfigZPTToReleaseList-r11    OPTIONAL,    -- Need ON
  csi-RS-ConfigZPTToAddModList-r11      CSI-RS-ConfigZPTToAddModList-r11    OPTIONAL,    -- Need ON
  epdcch-Config-r11                      EPDCCH-Config-r11          OPTIONAL,    -- Need ON
  pdsch-ConfigDedicated-v1130            PDSCH-ConfigDedicated-v1130    OPTIONAL,    -- Need ON
-- UL configuration
  cqi-ReportConfig-v1130                  CQI-ReportConfig-v1130      OPTIONAL,    -- Need ON
  pusch-ConfigDedicated-v1130            PUSCH-ConfigDedicated-v1130    OPTIONAL,    -- Cond PUSCH-SCell1
  uplinkPowerControlDedicatedSCell-v1130    UplinkPowerControlDedicated-v1130    OPTIONAL,    -- Need ON
]],
[[ antennaInfo-v1250                      AntennaInfoDedicated-v1250    OPTIONAL,    -- Need ON
  eimta-MainConfigSCell-r12              EIMTA-MainConfigServCell-r12    OPTIONAL,    -- Need ON
  cqi-ReportConfigSCell-v1250            CQI-ReportConfig-v1250      OPTIONAL,    -- Need ON
  uplinkPowerControlDedicatedSCell-v1250    UplinkPowerControlDedicated-v1250    OPTIONAL,    -- Need ON
  csi-RS-Config-v1250                    CSI-RS-Config-v1250          OPTIONAL,    -- Need ON
]],
[[ pdsch-ConfigDedicated-v1280            PDSCH-ConfigDedicated-v1280    OPTIONAL,    -- Need ON
]],
[[ pucch-Cell-r13                          ENUMERATED {true}            OPTIONAL,    -- Cond PUCCH-SCell1
  pucch-SCell                             CHOICE {
    release                                NULL,
    setup                                  SEQUENCE {
      pucch-ConfigDedicated-r13          PUCCH-ConfigDedicated-r13    OPTIONAL,    -- Need ON
      schedulingRequestConfig-r13        SchedulingRequestConfigSCell-r13    OPTIONAL,    -- Need ON
      tpc-PDCCH-ConfigPUCCH-SCell-r13    TPC-PDCCH-ConfigSCell-r13    OPTIONAL,    -- Need ON
      pusch-ConfigDedicated-r13          PUSCH-ConfigDedicated-r13    OPTIONAL,    -- Cond PUSCH-SCell
      uplinkPowerControlDedicated-r13    UplinkPowerControlDedicatedSCell-v1310    OPTIONAL,    -- Need ON
    }
  }
  crossCarrierSchedulingConfig-r13        CrossCarrierSchedulingConfig-r13    OPTIONAL,    -- Cond Cross-Carrier-Config
  pdcch-ConfigSCell-r13                  PDCCH-ConfigSCell-r13        OPTIONAL,    -- Need ON
  cqi-ReportConfig-v1310                  CQI-ReportConfig-v1310      OPTIONAL,    -- Need ON
  pdsch-ConfigDedicated-v1310            PDSCH-ConfigDedicated-v1310    OPTIONAL,    -- Need ON
  soundingRS-UL-ConfigDedicated-v1310     SoundingRS-UL-ConfigDedicated-v1310    OPTIONAL,    -- Need ON
  soundingRS-UL-ConfigDedicatedUpPPTsExt-r13    SoundingRS-UL-ConfigDedicatedUpPPTsExt-r13    OPTIONAL,    -- Need ON
  soundingRS-UL-ConfigDedicatedAperiodic-v1310    SoundingRS-UL-ConfigDedicatedAperiodic-v1310    OPTIONAL,    -- Need ON
  soundingRS-UL-ConfigDedicatedAperiodicUpPPTsExt-r13    SoundingRS-UL-ConfigDedicatedAperiodicUpPPTsExt-r13    OPTIONAL,    -- Need ON
  csi-RS-Config-v1310                    CSI-RS-Config-v1310          OPTIONAL,    -- Need ON
  laa-SCellConfiguration-r13              LAA-SCellConfiguration-r13    OPTIONAL,    -- Need ON

```

```

ON      csi-RS-ConfigNZPTToAddModListExt-r13 CSI-RS-ConfigNZPTToAddModListExt-r13 OPTIONAL, -- Need
Need ON csi-RS-ConfigNZPToreleaseListExt-r13 CSI-RS-ConfigNZPToreleaseListExt-r13 OPTIONAL --
]] ,
[[ cqi-ReportConfig-v1320 CQI-ReportConfig-v1320 OPTIONAL -- Need ON
]] ,
[[ laa-SCellConfiguration-v1430 LAA-SCellConfiguration-v1430
OPTIONAL, -- Need ON
typeB-SRS-TPC-PDCCH-Config-r14 SRS-TPC-PDCCH-Config-r14 OPTIONAL, -- Need ON

uplinkPUSCH-LessPowerControlDedicated-v1430 UplinkPUSCH-LessPowerControlDedicated-v1430
OPTIONAL, -- Need ON
soundingRS-UL-PeriodicConfigDedicatedList-r14 SEQUENCE (SIZE (1..2)) OF
SoundingRS-UL-ConfigDedicated OPTIONAL, -- Cond PeriodicSRS
soundingRS-UL-PeriodicConfigDedicatedUpPTsExtList-r14 SEQUENCE (SIZE
(1..4)) OF SoundingRS-UL-ConfigDedicatedUpPTsExt-r13 OPTIONAL, -- Cond
PeriodicSRSExt
soundingRS-UL-AperiodicConfigDedicatedList-r14 SEQUENCE (SIZE (1..2)) OF
SoundingRS-AperiodicSet-r14 OPTIONAL, -- Cond AperiodicSRS
soundingRS-UL-ConfigDedicatedApUpPTsExtList-r14 SEQUENCE (SIZE (1..4)) OF
SoundingRS-AperiodicSetUpPTsExt-r14 OPTIONAL, -- Cond AperiodicSRSExt
must-Config-r14 CHOICE {
  release NULL,
  setup SEQUENCE {
    k-max-r14 ENUMERATED {11, 13},
    p-a-must-r14 ENUMERATED {
      dB-6, dB-4dot77, dB-3, dB-1dot77,
      dB0, dB1, dB2, dB3} OPTIONAL, -- Need ON
  }
}
pusch-ConfigDedicated-v1430 PUSCH-ConfigDedicatedSCell-v1430 OPTIONAL, -- Need
ON
csi-RS-Config-v1430 CSI-RS-Config-v1430 OPTIONAL, -- Need ON
csi-RS-ConfigZP-ApList-r14 CSI-RS-ConfigZP-ApList-r14 OPTIONAL, -- Need
ON
cqi-ReportConfig-v1430 CQI-ReportConfig-v1430 OPTIONAL, -- Need ON
semiOpenLoop-r14 BOOLEAN OPTIONAL, -- Need ON
pdsch-ConfigDedicatedSCell-v1430 PDSCH-ConfigDedicatedSCell-v1430 OPTIONAL
-- Need ON
]] ,
[[ csi-RS-Config-v1480 CSI-RS-Config-v1480 OPTIONAL -- Need ON
]]
}

PhysicalConfigDedicatedSCell-v1370 ::= SEQUENCE {
  pucch-SCell-v1370 CHOICE {
    release NULL,
    setup SEQUENCE {
      pucch-ConfigDedicated-v1370 PUCCH-ConfigDedicated-v1370 OPTIONAL -- Cond
PUCCH-Format4or5
    }
  }
}

PhysicalConfigDedicatedSCell-v13c0 ::= SEQUENCE {
  pucch-SCell-v13c0 CHOICE {
    release NULL,
    setup SEQUENCE {
      pucch-ConfigDedicated-v13c0 PUCCH-ConfigDedicated-v13c0
    }
  }
}

LAA-SCellConfiguration-r13 ::= SEQUENCE {
  subframeStartPosition-r13 ENUMERATED {s0, s07},
  laa-SCellSubframeConfig-r13 BIT STRING (SIZE(8))
}

LAA-SCellConfiguration-v1430 ::= SEQUENCE {
  crossCarrierSchedulingConfig-UL-r14 CHOICE {
    release NULL,
    setup SEQUENCE {
      crossCarrierSchedulingConfigLAA-UL-r14 CrossCarrierSchedulingConfigLAA-UL-r14
    }
  }
  OPTIONAL, -- Cond Cross-Carrier-ConfigUL
  lbt-Config-r14 LBT-Config-r14 OPTIONAL, -- Need ON
  pdcch-ConfigLAA-r14 PDCCH-ConfigLAA-r14 OPTIONAL, -- Need ON

```

```

absenceOfAnyOtherTechnology-r14      ENUMERATED {true}      OPTIONAL,      -- Need OR
soundingRS-UL-ConfigDedicatedAperiodic-v1430
      SoundingRS-UL-ConfigDedicatedAperiodic-v1430      OPTIONAL      -- Need ON
}

LBT-Config-r14 ::= CHOICE{
  maxEnergyDetectionThreshold-r14      INTEGER(-85..-52),
  energyDetectionThresholdOffset-r14    INTEGER(-13..20)
}

CSI-RS-ConfigNZPToAddModList-r11 ::= SEQUENCE (SIZE (1..maxCSI-RS-NZP-r11)) OF CSI-RS-ConfigNZP-
r11

CSI-RS-ConfigNZPToAddModListExt-r13 ::= SEQUENCE (SIZE (1..maxCSI-RS-NZP-v1310)) OF CSI-RS-
ConfigNZP-r11

CSI-RS-ConfigNZPToReleaseList-r11 ::= SEQUENCE (SIZE (1..maxCSI-RS-NZP-r11)) OF CSI-RS-
ConfigNZPId-r11

CSI-RS-ConfigNZPToReleaseListExt-r13 ::= SEQUENCE (SIZE (1..maxCSI-RS-NZP-v1310)) OF CSI-RS-
ConfigNZPId-v1310

CSI-RS-ConfigZPToAddModList-r11 ::= SEQUENCE (SIZE (1..maxCSI-RS-ZP-r11)) OF CSI-RS-ConfigZP-r11

CSI-RS-ConfigZPToReleaseList-r11 ::= SEQUENCE (SIZE (1..maxCSI-RS-ZP-r11)) OF CSI-RS-ConfigZPId-
r11

SoundingRS-AperiodicSet-r14 ::= SEQUENCE{
  srs-CC-SetIndexList-r14
      SEQUENCE (SIZE (1..4)) OF SRS-CC-SetIndex-r14
  soundingRS-UL-ConfigDedicatedAperiodic-r14
      SoundingRS-UL-ConfigDedicatedAperiodic-r10
      OPTIONAL,      -- Cond SRS-Trigger-TypeA
}

SoundingRS-AperiodicSetUpPTsExt-r14 ::= SEQUENCE{
  srs-CC-SetIndexList-r14
      SEQUENCE (SIZE (1..4)) OF SRS-CC-SetIndex-r14
  soundingRS-UL-ConfigDedicatedAperiodicUpPTsExt-r14
      SoundingRS-UL-ConfigDedicatedAperiodicUpPTsExt-r13
      OPTIONAL,      -- Cond SRS-Trigger-TypeA
}

-- ASN1STOP

```

PhysicalConfigDedicated field descriptions
<p>absenceOfAnyOtherTechnology Presence of this field indicates absence on a long term basis (e.g. by level of regulation) of any other technology sharing the carrier; absence of this field indicates the potential presence of any other technology sharing the carrier, as specified in TS 36.213 [23].</p>
<p>additionalSpectrumEmissionPCell E-UTRAN does not configure this field in this release of the specification.</p>
<p>antennaInfo A choice is used to indicate whether the <i>antennaInfo</i> is signalled explicitly or set to the default antenna configuration as specified in clause 9.2.4.</p>
<p>ce-Mode Indicates the CE mode as specified in TS 36.213 [23].</p>
<p>ce-pdsch-pusch-Enhancement-Config Activation of new numbers of repetitions for PUSCH and modulation restrictions for PDSCH/PUSCH in CE mode A, see TS 36.212 [22] and TS 36.213 [23].</p>
<p>csi-RS-Config For a serving frequency E-UTRAN does not configure <i>csi-RS-Config</i> (includes <i>zeroTxPowerCSI-RS</i>) when transmission mode 10 is configured for the serving cell on this carrier frequency.</p>
<p>csi-RS-ConfigNZPToAddModList For a serving frequency E-UTRAN configures one or more <i>CSI-RS-ConfigNZP</i> only when transmission mode 9 or 10 is configured for the serving cell on this carrier frequency. For a serving frequency, EUTRAN configures a maximum number of <i>CSI-RS-ConfigNZP</i> in accordance with transmission mode (including CSI processes), eMIMO (including class) and associated UE capabilities (e.g. k-Max, n-MaxList).</p>
<p>csi-RS-ConfigZP-ApList The aperiodic ZP CSI-RS for PDSCH rate matching. The field <i>subframeConfig</i> is applicable to semi-persistent CSI RS reporting. In other cases, the UE shall ignore field <i>subframeConfig</i>.</p>
<p>csi-RS-ConfigZPToAddModList For a serving frequency E-UTRAN configures one or more <i>CSI-RS-ConfigZP</i> only when transmission mode 10 is configured for the serving cell on this carrier frequency.</p>
<p>eimta-MainConfigPCell, eimta-MainConfigSCell If E-UTRAN configures <i>eimta-MainConfigPCell</i> or <i>eimta-MainConfigSCell</i> for one serving cell in a frequency band, E-UTRAN configures <i>eimta-MainConfigPCell</i> or <i>eimta-MainConfigSCell</i> for all serving cells residing on the frequency band. E-UTRAN configures <i>eimta-MainConfigPCell</i> or <i>eimta-MainConfigSCell</i> only if <i>eimta-MainConfig</i> is configured.</p>
<p>energyDetectionThresholdOffset Indicates the offset to the default maximum energy detection threshold value. Unit in dB. Value -13 corresponds to -13dB, value -12 corresponds to -12dB, and so on (i.e. in steps of 1dB) as specified in TS 36.213 [23].</p>
<p>epdcch-Config Indicates the <i>EPDCCH-Config</i> for the cell. E-UTRAN does not configure <i>EPDCCH-Config</i> for an SCell that is configured with value <i>other</i> for <i>schedulingCellInfo</i> in <i>CrossCarrierSchedulingConfig</i>.</p>
<p>k-max Indicates the maximum number of interfering spatial layers signaled in the assistance information for MUST. Value I1 corresponds to 1 layer, Value I3 corresponds to 3 layers.</p>
<p>laa-SCellSubframeConfig A bit-map indicating LAA SCell subframe configuration, "1" denotes that the corresponding subframe is allocated as MBSFN subframe. The bitmap is interpreted as follows: Starting from the first/leftmost bit in the bitmap, the allocation applies to subframes #1, #2, #3, #4, #6, #7, #8, and #9.</p>
<p>maxEnergyDetectionThreshold Indicates the absolute maximum energy detection threshold value. Unit in dBm. Value -85 corresponds to -85 dBm, value -84 corresponds to -84 dBm, and so on (i.e. in steps of 1dBm) as specified in TS 36.213 [23]. If the field is not configured, the UE shall use a default maximum energy detection threshold value as specified in TS 36.213 [23].</p>
<p>p-a-must Parameter: P_A, see TS 36.213 [23, 5.2]. Value dB-6 corresponds to -6 dB, dB-4dot77 corresponds to -4.77 dB etc.</p>
<p>pdsch-ConfigDedicated-v1130 For a serving frequency E-UTRAN configures <i>pdsch-ConfigDedicated-v1130</i> only when transmission mode 10 is configured for the serving cell on this carrier frequency.</p>
<p>pdsch-ConfigDedicated-v1280 For a serving frequency E-UTRAN configures <i>pdsch-ConfigDedicated-v1280</i> only when transmission mode 9 or 10 is configured for the serving cell on this carrier frequency.</p>
<p>pucch-Cell If present, PUCCH feedback of this SCell is sent on the PUCCH SCell. If absent, PUCCH feedback of this SCell is sent on PCell or PSCell, or if the cell concerns the PUCCH SCell, on the concerned cell. If this field is not modified upon change of PUCCH SCell, the UE shall always send the PUCCH feedback of the concerned SCell using the configured PUCCH SCell.</p>
<p>pucch-ConfigDedicated E-UTRAN configures <i>pucch-ConfigDedicated-r13</i> only if <i>pucch-ConfigDedicated</i> (i.e., without suffix) is not configured. UE shall ignore <i>pucch-ConfigDedicated-v1020</i> when <i>pucch-ConfigDedicated-r13</i> is configured.</p>

PhysicalConfigDedicated field descriptions
<p>pucch-SCell If present, the concerned SCell is the PUCCH SCell. E-UTRAN only configures this field upon SCell addition i.e. this field is only released when the SCell is released. The field is not applicable for an LAA SCell in this release.</p>
<p>pusch-ConfigDedicated-r13 E-UTRAN configures <i>pusch-ConfigDedicated-r13</i> only if <i>pusch-ConfigDedicated</i> is not configured.</p>
<p>pusch-ConfigDedicated-v1250 E-UTRAN configures <i>pusch-ConfigDedicated-v1250</i> only if <i>tpc-SubframeSet</i> is configured.</p>
<p>pusch-EnhancementsConfig Indicates that the UE shall transmit in the PUSCH enhancement mode if <i>pusch-EnhancementsConfig</i> is set to <i>setup</i>, see TS 36.211 [21] and TS 36.213 [23].</p>
<p>semiOpenLoop Value TRUE indicates that semi-open-loop transmission is used for deriving CSI reporting and corresponding PDSCH transmission (DMRS).</p>
<p>soundingRS-UL-PeriodicConfigDedicatedList Indicates periodic soundingRS configuration except for the extension sounding symbols of the UpPTs subframe. E-UTRAN configures this field in <i>PhysicalConfigDedicated</i> only for the UE indicating support of <i>ce-SRS-Enhancement-r14</i> or <i>ce-SRS-EnhancementWithoutComb4-r14</i>. E-UTRAN configures this field in <i>PhysicalConfigDedicatedSCell-r10</i> only for the UE indicating support of <i>srs-UpPTS-6sym-r14</i>.</p>
<p>soundingRS-UL-PeriodicConfigDedicatedUpPTsExtList Indicates periodic soundingRS configuration in extension sounding symbols of the UpPTs subframe. E-UTRAN configures this field in <i>PhysicalConfigDedicated</i> only for the UE indicating support of <i>ce-SRS-Enhancement-r14</i> or <i>ce-SRS-EnhancementWithoutComb4-r14</i>. E-UTRAN configures this field in <i>PhysicalConfigDedicatedSCell-r10</i> only for the UE indicating support of <i>srs-UpPTS-6sym-r14</i>.</p>
<p>soundingRS-UL-AperiodicConfigDedicatedList Indicates aperiodic soundingRS configuration except for the extension sounding symbols of the UpPTs subframe. E-UTRAN configures this field in <i>PhysicalConfigDedicated</i> only for the UE indicating support of <i>ce-SRS-Enhancement-r14</i> or <i>ce-SRS-EnhancementWithoutComb4-r14</i>. E-UTRAN configures this field in <i>PhysicalConfigDedicatedSCell-r10</i> only for the UE indicating support of <i>srs-UpPTS-6sym-r14</i>.</p>
<p>soundingRS-UL-DedicatedApUpPTsExtList Indicates aperiodic soundingRS configuration in extension sounding symbols of the UpPTs subframe. E-UTRAN configures this field in <i>PhysicalConfigDedicated</i> only for the UE indicating support of <i>ce-SRS-Enhancement-r14</i> or <i>ce-SRS-EnhancementWithoutComb4-r14</i>. E-UTRAN configures this field in <i>PhysicalConfigDedicatedSCell-r10</i> only for the UE indicating support of <i>srs-UpPTS-6sym-r14</i>.</p>
<p>srs-CC-SetIndexList Indicates the <i>srs-CC-SetIndex</i> list which the <i>soundingRS-UL-ConfigDedicatedAperiodic</i> and <i>soundingRS-UL-ConfigDedicatedAperiodicUpPTsExt</i> belongs to.</p>
<p>subframeStartPosition Indicates possible starting positions of transmission in the first subframe of the DL transmission burst, see TS 36.211 [21]. Value <i>s0</i> means the starting position is subframe boundary, <i>s07</i> means the starting position is either subframe boundary or slot boundary.</p>
<p>tpc-PDCCH-ConfigPUCCH PDCCH configuration for power control of PUCCH using format 3/3A, see TS 36.212 [22].</p>
<p>tpc-PDCCH-ConfigPUSCH PDCCH configuration for power control of PUSCH using format 3/3A, see TS 36.212 [22].</p>
<p>typeA-SRS-TPC-PDCCH-Group Indicates Type A trigger configuration for SRS transmission on a PUSCH-less SCell. E-UTRAN configures the UE with either <i>typeA-SRS-TPC-PDCCH-Group</i> or <i>typeB-SRS-TPC-PDCCH-Group</i>, if any.</p>
<p>uplinkPowerControlDedicated E-UTRAN configures <i>uplinkPowerControlDedicated-v1130</i> only if <i>uplinkPowerControlDedicated</i> (without suffix) is configured.</p>
<p>uplinkPowerControlDedicatedSCell E-UTRAN configures <i>uplinkPowerControlDedicatedSCell-v1130</i> only if <i>uplinkPowerControlDedicatedSCell-r10</i> is configured for this serving cell.</p>

Conditional presence	Explanation
<i>AI-r8</i>	The field is optionally present, need ON, if <i>antennaInfoDedicated-r10</i> is absent. Otherwise the field is not present
<i>AI-r10</i>	The field is optionally present, need ON, if <i>antennaInfoDedicated</i> is absent. Otherwise the field is not present
<i>AperiodicSRS</i>	If <i>soundingRS-UL-ConfigDedicatedAperiodic-r10</i> is absent, the field is optional, Need ON. Otherwise the field is not present and the UE shall delete any existing value for this field.
<i>AperiodicSRSExt</i>	If <i>soundingRS-UL-ConfigDedicatedAperiodicUpPTsExt-r13</i> is absent, the field is optional, Need ON. Otherwise the field is not present and the UE shall delete any existing value for this field.
<i>CommonUL</i>	The field is mandatory present if <i>ul-Configuration of RadioResourceConfigCommonSCell-r10</i> is present; otherwise it is optional, need ON.
<i>CQI-r8</i>	The field is optionally present, need ON, if <i>cqi-ReportConfig-r10</i> is absent. Otherwise the field is not present
<i>CQI-r10</i>	The field is optionally present, need ON, if <i>cqi-ReportConfig</i> is absent. Otherwise the field is not present
<i>Cross-Carrier-Config</i>	The field is optionally present, need ON, if <i>crossCarrierSchedulingConfig-r10</i> is absent. Otherwise the field is not present
<i>Cross-Carrier-ConfigUL</i>	The field is optionally present, need ON, if <i>crossCarrierSchedulingConfig-r10</i> and <i>crossCarrierSchedulingConfig-r13</i> are absent or <i>schedulingCellInfo</i> is set to 'own'. Otherwise the field is not present.
<i>PeriodicSRS</i>	If <i>soundingRS-UL-ConfigDedicated-r10</i> is absent, the field is optional, Need ON. Otherwise the field is not present and the UE shall delete any existing value for this field.
<i>PeriodicSRSPCell</i>	If <i>soundingRS-UL-ConfigDedicated</i> is absent, the field is optional, Need ON. Otherwise the field is not present and the UE shall delete any existing value for this field.
<i>PeriodicSRSExt</i>	If <i>soundingRS-UL-ConfigDedicatedUpPTsExt-r13</i> is absent, the field is optional, Need ON. Otherwise the field is not present and the UE shall delete any existing value for this field.
<i>PUCCH-Format4or5</i>	The field is mandatory present with <i>pucch-Format-v1370</i> set to <i>setup</i> if <i>pucch-ConfigDedicated-r13</i> is configured and <i>pucch-ConfigDedicated-r13</i> indicates PUCCH format 4 or PUCCH format 5; otherwise it is not present and the UE shall delete any existing value for this field.
<i>PUCCH-SCell1</i>	The field is optionally present, need OR, for SCell not configured with <i>pucch-configDedicated-r13</i> . Otherwise it is not present.
<i>PUSCH-SCell</i>	The field is optionally present, need ON, if <i>pusch-ConfigDedicatedSCell-r10</i> and <i>pusch-ConfigDedicated-v1130</i> are absent. Otherwise the field is not present
<i>PUSCH-SCell1</i>	The field is optionally present, need ON, for SCell not configured with <i>pucch-configDedicated-r13</i> . Otherwise it is not present.
<i>SCellAdd</i>	The field is mandatory present if <i>cellIdentification</i> is present; otherwise it is optional, need ON.
<i>SRS-Trigger-TypeA</i>	The field is mandatory present if <i>typeA-SRS-TPC-PDCCH-Group-r14</i> is present. Otherwise the field is not present and the UE shall delete any existing value for this field.

NOTE 1: During handover, the UE performs a MAC reset, which involves reverting to the default CQI/ SRS/ SR configuration in accordance with clause 5.3.13 and TS 36.321 [6, 5.9 & 5.2]. Hence, for these parts of the dedicated radio resource configuration, the default configuration (rather than the configuration used in the source PCell) is used as the basis for the delta signalling that is included in the message used to perform handover.

NOTE 2: Since delta signalling is not supported for the common SCell configuration, E-UTRAN can only add or release the uplink of an SCell by releasing and adding the concerned SCell.

P-Max

The IE *P-Max* is used to limit the UE's uplink transmission power on a carrier frequency and is used to calculate the parameter *Pcompensation* defined in TS 36.304 [4]. Corresponds to parameter P_{EMAX} or $P_{EMAX,c}$ in TS 36.101 [42]. The UE transmit power on one serving cell shall not exceed the configured maximum UE output power of the serving cell determined by this value as specified in TS 36.101 [42, 6.2.5 or 6.2.5A] or, when transmitting sidelink discovery announcements within the coverage of the concerned cell, as specified in TS 36.101 [42, 6.2.5D].

***P-Max* information element**

```
-- ASN1START
```

```
P-Max ::= INTEGER (-30..33)
```

```
-- ASN1STOP
```

– PRACH-Config

The IE *PRACH-ConfigSIB* and IE *PRACH-Config* are used to specify the PRACH configuration in the system information and in the mobility control information, respectively.

PRACH-Config information elements

```
-- ASN1START
PRACH-ConfigSIB ::= SEQUENCE {
    rootSequenceIndex      INTEGER (0..837),
    prach-ConfigInfo      PRACH-ConfigInfo
}

PRACH-ConfigSIB-v1310 ::= SEQUENCE {
    rsrp-ThresholdsPrachInfoList-r13  RSRP-ThresholdsPrachInfoList-r13,
    mpdcch-startSF-CSS-RA-r13        CHOICE {
        fdd-r13      ENUMERATED {v1, v1dot5, v2, v2dot5, v4, v5, v8,
                                v10},
        tdd-r13      ENUMERATED {v1, v2, v4, v5, v8, v10, v20, spare}
    } OPTIONAL, -- Cond MP
    prach-HoppingOffset-r13          INTEGER (0..94) OPTIONAL, -- Need OR
    prach-ParametersListCE-r13      PRACH-ParametersListCE-r13
}

PRACH-Config ::= SEQUENCE {
    rootSequenceIndex      INTEGER (0..837),
    prach-ConfigInfo      PRACH-ConfigInfo OPTIONAL -- Need ON
}

PRACH-Config-v1310 ::= SEQUENCE {
    rsrp-ThresholdsPrachInfoList-r13  RSRP-ThresholdsPrachInfoList-r13 OPTIONAL, --
Cond MP
    mpdcch-startSF-CSS-RA-r13        CHOICE {
        fdd-r13      ENUMERATED {v1, v1dot5, v2, v2dot5, v4, v5, v8,
                                v10},
        tdd-r13      ENUMERATED {v1, v2, v4, v5, v8, v10, v20, spare}
    } OPTIONAL, -- Cond MP
    prach-HoppingOffset-r13          INTEGER (0..94) OPTIONAL, -- Need OR
    prach-ParametersListCE-r13      PRACH-ParametersListCE-r13 OPTIONAL, -- Cond MP
    initial-CE-level-r13            INTEGER (0..3) OPTIONAL -- Need OR
}

PRACH-Config-v1430 ::= SEQUENCE {
    rootSequenceIndexHighSpeed-r14    INTEGER (0..837),
    zeroCorrelationZoneConfigHighSpeed-r14  INTEGER (0..12),
    prach-ConfigIndexHighSpeed-r14      INTEGER (0..63),
    prach-FreqOffsetHighSpeed-r14       INTEGER (0..94)
}

PRACH-ConfigSCell-r10 ::= SEQUENCE {
    prach-ConfigIndex-r10              INTEGER (0..63)
}

PRACH-ConfigInfo ::= SEQUENCE {
    prach-ConfigIndex      INTEGER (0..63),
    highSpeedFlag          BOOLEAN,
    zeroCorrelationZoneConfig  INTEGER (0..15),
    prach-FreqOffset       INTEGER (0..94)
}

PRACH-ParametersListCE-r13 ::= SEQUENCE (SIZE(1..maxCE-Level-r13)) OF PRACH-ParametersCE-r13

PRACH-ParametersCE-r13 ::= SEQUENCE {
    prach-ConfigIndex-r13      INTEGER (0..63),
    prach-FreqOffset-r13      INTEGER (0..94),
    prach-StartingSubframe-r13  ENUMERATED {sf2, sf4, sf8, sf16, sf32, sf64, sf128,
                                             sf256} OPTIONAL, -- Need OP
    maxNumPreambleAttemptCE-r13  ENUMERATED {n3, n4, n5, n6, n7, n8, n10} OPTIONAL, -- Need OP
    numRepetitionPerPreambleAttempt-r13  ENUMERATED {n1, n2, n4, n8, n16, n32, n64, n128},
    mpdcch-NarrowbandsToMonitor-r13      SEQUENCE (SIZE(1..2)) OF
```

```

    INTEGER (1..maxAvailNarrowBands-r13),
mpdcch-NumRepetition-RA-r13      ENUMERATED {r1, r2, r4, r8, r16,
prach-HoppingConfig-r13        r32, r64, r128, r256},
}                                ENUMERATED {on,off}
RSRP-ThresholdsPrachInfoList-r13 ::= SEQUENCE (SIZE(1..3)) OF RSRP-Range
-- ASN1STOP
```

PRACH-Config field descriptions
<p>initial-CE-level Indicates initial PRACH CE level at random access, see TS 36.321 [6]. If not configured, UE selects PRACH CE level based on measured RSRP level, see TS 36.321 [6].</p>
<p>highSpeedFlag Parameter: High-speed-flag, see TS 36.211 [21, 5.7.2]. TRUE corresponds to Restricted set and FALSE to Unrestricted set.</p>
<p>maxNumPreambleAttemptCE Maximum number of preamble transmission attempts per CE level. See TS 36.321 [6]. If the field is absent, the UE shall use the default value n3.</p>
<p>mpdcch-NarrowbandsToMonitor Narrowbands to monitor for MPDCCH for RAR, see TS 36.213 [23, 6.2]. Field values (1..<i>maxAvailNarrowBands-r13</i>) correspond to narrowband indices (0..<i>maxAvailNarrowBands-r13-1</i>) as specified in TS 36.211 [21].</p>
<p>mpdcch-NumRepetition-RA Maximum number of repetitions for MPDCCH common search space (CSS) for RAR, Msg3 and Msg4, see TS 36.211 [21].</p>
<p>mpdcch-startSF-CSS-RA Starting subframe configuration for MPDCCH common search space (CSS), including RAR, Msg3 retransmission, PDSCH with contention resolution and PDSCH with CCCH MAC SDU, see TS 36.211 [21] and TS 36.213 [23]. Value v1 corresponds to 1, value v1dot5 corresponds to 1.5, and so on.</p>
<p>numRepetitionPerPreambleAttempt Number of PRACH repetitions per attempt for each CE level, See TS 36.211 [21].</p>
<p>prach-ConfigIndex Parameter: <i>prach-ConfigurationIndex</i>, see TS 36.211 [21, 5.7.1].</p>
<p>prach-ConfigIndexHighSpeed Parameter: <i>prach-ConfigurationIndexHighSpeed</i>, see TS 36.211 [21, 5.7.1]. If this field is present, the UE shall ignore <i>prach-ConfigIndex</i>.</p>
<p>prach-FreqOffset Parameter: <i>prach-FrequencyOffset</i>, see TS 36.211 [21, 5.7.1]. For TDD the value range is dependent on the value of <i>prach-ConfigIndex</i>.</p>
<p>prach-FreqOffsetHighSpeed Parameter: <i>prach-FrequencyOffsetHighSpeed</i>, see TS 36.211 [21, 5.7.1]. For TDD the value range is dependent on the value of <i>prach-ConfigIndexHighSpeed</i>. If this field is present, the UE shall ignore <i>prach-FreqOffset</i>.</p>
<p>prach-HoppingConfig Coverage level specific frequency hopping configuration for PRACH.</p>
<p>prach-HoppingOffset Parameter: PRACH frequency hopping offset, expressed as a number of resource blocks, see TS 36.211 [21, 5.7.1]</p>
<p>prach-ParametersListCE Configures PRACH parameters for each CE level. The first entry in the list is the PRACH parameters of CE level 0, the second entry in the list is the PRACH parameters of CE level 1, and so on.</p>
<p>prach-StartingSubframe PRACH starting subframe periodicity, expressed in number of subframes available for preamble transmission (PRACH opportunities), see TS 36.211 [21]. Value sf2 corresponds to 2 subframes, sf4 corresponds to 4 subframes and so on. EUTRAN configures the PRACH starting subframe periodicity larger than or equal to the number of PRACH repetitions per attempt for each CE level (<i>numRepetitionPerPreambleAttempt</i>). If the field is absent, the value is determined implicitly in TS 36.211 [21, 5.7.1].</p>
<p>rootSequenceIndex Parameter: <i>RACH_ROOT_SEQUENCE</i>, see TS 36.211 [21, 5.7.1].</p>
<p>rootSequenceIndexHighSpeed The field indicates starting logical root sequence index used to derive the 64 random access preambles based on restricted set type B in high speed scenario, see TS 36.211 [21, 5.7.2]. If this field is present, the UE shall generate random access preambles based on restricted set type B and ignore <i>rootSequenceIndex</i>.</p>
<p>rsrp-ThresholdsPrachInfoList The criterion for BL UEs and UEs in CE to select PRACH resource set. Up to 3 RSRP threshold values are signalled to determine the CE level for PRACH, see TS 36.213 [23]. The first element corresponds to RSRP threshold 1, the second element corresponds to RSRP threshold 2 and so on, see TS 36.321 [6]. The UE shall ignore this field if only one CE level, i.e. CE level 0, is configured in <i>prach-ParametersListCE</i>. The number of RSRP thresholds present in <i>rsrp-ThresholdsPrachInfoList</i> is equal to the number of CE levels configured in <i>prach-ParametersListCE</i> minus one.</p>
<p>zeroCorrelationZoneConfig Parameter: Ncs configuration, see TS 36.211 [21, 5.7.2: table 5.7.2-2] for preamble format 0..3 and TS 36.211 [21, 5.7.2: table 5.7.2-3] for preamble format 4.</p>
<p>zeroCorrelationZoneConfigHighSpeed The field indicates Ncs configuration for the restricted set type B in high speed scenario, see TS 36.211 [21, 5.7.2]. If this field is present, the UE shall generate random access preambles based on restricted set type B and ignore <i>zeroCorrelationZoneConfig</i>.</p>

Conditional presence	Explanation
<i>MP</i>	The field is mandatory present.

– *PresenceAntennaPort1*

The IE *PresenceAntennaPort1* is used to indicate whether all the neighbouring cells use Antenna Port 1. When set to *TRUE*, the UE may assume that at least two cell-specific antenna ports are used in all neighbouring cells.

***PresenceAntennaPort1* information element**

```
-- ASN1START
PresenceAntennaPort1 ::=          BOOLEAN
-- ASN1STOP
```

– *PUCCH-Config*

The IE *PUCCH-ConfigCommon* and IE *PUCCH-ConfigDedicated* are used to specify the common and the UE specific PUCCH configuration respectively.

***PUCCH-Config* information elements**

```
-- ASN1START
PUCCH-ConfigCommon ::=          SEQUENCE {
  deltaPUCCH-Shift                ENUMERATED {ds1, ds2, ds3},
  nRB-CQI                          INTEGER (0..98),
  nCS-AN                           INTEGER (0..7),
  n1PUCCH-AN                       INTEGER (0..2047)
}

PUCCH-ConfigCommon-v1310 ::=    SEQUENCE {
  n1PUCCH-AN-InfoList-r13          N1PUCCH-AN-InfoList-r13    OPTIONAL, -- Need OR
  pucch-NumRepetitionCE-Msg4-Level0-r13  ENUMERATED {n1, n2, n4, n8}    OPTIONAL, -- Need OR
  pucch-NumRepetitionCE-Msg4-Level1-r13  ENUMERATED {n1, n2, n4, n8}    OPTIONAL, -- Need OR
  pucch-NumRepetitionCE-Msg4-Level2-r13  ENUMERATED {n4, n8, n16, n32}   OPTIONAL, -- Need OR
  pucch-NumRepetitionCE-Msg4-Level3-r13  ENUMERATED {n4, n8, n16, n32}   OPTIONAL, -- Need OR
}

PUCCH-ConfigCommon-v1430 ::=    SEQUENCE {
  pucch-NumRepetitionCE-Msg4-Level3-r14  ENUMERATED {n64, n128}        OPTIONAL, -- Need OR
}

PUCCH-ConfigDedicated ::=       SEQUENCE {
  ackNackRepetition                CHOICE {
    release                          NULL,
    setup                            SEQUENCE {
      repetitionFactor              ENUMERATED {n2, n4, n6, spare1},
      n1PUCCH-AN-Rep                INTEGER (0..2047)
    }
  },
  tdd-AckNackFeedbackMode          ENUMERATED {bundling, multiplexing} OPTIONAL, -- Cond TDD
}

PUCCH-ConfigDedicated-v1020 ::= SEQUENCE {
  pucch-Format-r10                 CHOICE {
    format3-r10                     PUCCH-Format3-Conf-r13,
    channelSelection-r10             SEQUENCE {
      n1PUCCH-AN-CS-r10             CHOICE {
        release                      NULL,
        setup                        SEQUENCE {
          n1PUCCH-AN-CS-List-r10     SEQUENCE (SIZE (1..2)) OF N1PUCCH-AN-CS-r10
        }
      }
    }
  }
  OPTIONAL, -- Need ON
}
  twoAntennaPortActivatedPUCCH-Format1alb-r10  ENUMERATED {true}    OPTIONAL, -- Need OR
  simultaneousPUCCH-PUSCH-r10                 ENUMERATED {true}    OPTIONAL, -- Need OR
-- ASN1STOP
```

```

    n1PUCCH-AN-RepP1-r10                                INTEGER (0..2047)          OPTIONAL    -- Need OR
  }
PUCCH-ConfigDedicated-v1130 ::= SEQUENCE {
  n1PUCCH-AN-CS-v1130 CHOICE {
    release NULL,
    setup SEQUENCE {
      n1PUCCH-AN-CS-ListP1-r11 SEQUENCE (SIZE (2..4)) OF INTEGER (0..2047)
    }
  }
  nPUCCH-Param-r11 CHOICE {
    release NULL,
    setup SEQUENCE {
      nPUCCH-Identity-r11 INTEGER (0..503),
      n1PUCCH-AN-r11 INTEGER (0..2047)
    }
  }
} OPTIONAL -- Need ON

PUCCH-ConfigDedicated-v1250 ::= SEQUENCE {
  nkaPUCCH-Param-r12 CHOICE {
    release NULL,
    setup SEQUENCE {
      nkaPUCCH-AN-r12 INTEGER (0..2047)
    }
  }
}

PUCCH-ConfigDedicated-r13 ::= SEQUENCE {
--Release 8
  ackNackRepetition-r13 CHOICE {
    release NULL,
    setup SEQUENCE {
      repetitionFactor-r13 ENUMERATED {n2, n4, n6, spare1},
      n1PUCCH-AN-Rep-r13 INTEGER (0..2047)
    }
  },
  tdd-AckNackFeedbackMode-r13 ENUMERATED {bundling, multiplexing} OPTIONAL, -- Cond TDD
--Release 10
  pucch-Format-r13 CHOICE {
    format3-r13 SEQUENCE {
      n3PUCCH-AN-List-r13 SEQUENCE (SIZE (1..4)) OF INTEGER (0..549) OPTIONAL, -- Need ON
      twoAntennaPortActivatedPUCCH-Format3-r13 CHOICE {
        release NULL,
        setup SEQUENCE {
          n3PUCCH-AN-ListP1-r13 SEQUENCE (SIZE (1..4)) OF INTEGER (0..549)
        }
      }
    } OPTIONAL -- Need ON
  },
  channelSelection-r13 SEQUENCE {
    n1PUCCH-AN-CS-r13 CHOICE {
      release NULL,
      setup SEQUENCE {
        n1PUCCH-AN-CS-List-r13 SEQUENCE (SIZE (1..2)) OF N1PUCCH-AN-CS-r10,
        dummy SEQUENCE (SIZE (2..4)) OF INTEGER (0..2047)
      }
    }
  } OPTIONAL -- Need ON
},
  format4-r13 SEQUENCE {
    format4-resourceConfiguration-r13 SEQUENCE (SIZE (4)) OF Format4-resource-r13,
    format4-MultiCSI-resourceConfiguration-r13 SEQUENCE (SIZE (1..2)) OF Format4-resource-
r13 OPTIONAL -- Need OR
  },
  format5-r13 SEQUENCE {
    format5-resourceConfiguration-r13 SEQUENCE (SIZE (4)) OF Format5-resource-r13,
    format5-MultiCSI-resourceConfiguration-r13 Format5-resource-r13 OPTIONAL -- Need OR
  }
} OPTIONAL -- Need OR
  twoAntennaPortActivatedPUCCH-Format1alb-r13 ENUMERATED {true} OPTIONAL, -- Need OR
  simultaneousPUCCH-PUSCH-r13 ENUMERATED {true} OPTIONAL, -- Need OR
  n1PUCCH-AN-RepP1-r13 INTEGER (0..2047) OPTIONAL, -- Need OR
--Release 11
  nPUCCH-Param-r13 CHOICE {
    release NULL,
    setup SEQUENCE {
      nPUCCH-Identity-r13 INTEGER (0..503),
      n1PUCCH-AN-r13 INTEGER (0..2047)
    }
  }
}

```



```
}
--Release 12
nkaPUCCH-Param-r13 CHOICE {
  release NULL,
  setup SEQUENCE {
    nkaPUCCH-AN-r13 INTEGER (0..2047)
  }
}
OPTIONAL, -- Need ON

--Release 13
spatialBundlingPUCCH-r13 BOOLEAN,
spatialBundlingPUSCH-r13 BOOLEAN,
harq-TimingTDD-r13 BOOLEAN,
codebooksizeDetermination-r13 ENUMERATED {dai,cc} OPTIONAL, -- Need OR
maximumPayloadCoderate-r13 INTEGER (0..7) OPTIONAL, -- Need OR
pucch-NumRepetitionCE-r13 CHOICE {
  release NULL,
  setup CHOICE {
    modeA SEQUENCE {
      pucch-NumRepetitionCE-format1-r13 ENUMERATED {r1, r2, r4, r8},
      pucch-NumRepetitionCE-format2-r13 ENUMERATED {r1, r2, r4, r8}
    },
    modeB SEQUENCE {
      pucch-NumRepetitionCE-format1-r13 ENUMERATED {r4, r8, r16, r32},
      pucch-NumRepetitionCE-format2-r13 ENUMERATED {r4, r8, r16, r32}
    }
  }
}
OPTIONAL --Need ON

PUCCH-ConfigDedicated-v1370 ::= SEQUENCE {
  pucch-Format-v1370 CHOICE {
    release NULL,
    setup PUCCH-Format3-Conf-r13
  }
}

PUCCH-ConfigDedicated-v13c0 ::= SEQUENCE {
  channelSelection-v13c0 SEQUENCE {
    n1PUCCH-AN-CS-v13c0 CHOICE {
      release NULL,
      setup SEQUENCE {
        n1PUCCH-AN-CS-ListP1-v13c0 SEQUENCE (SIZE (2..4)) OF INTEGER (0..2047)
      }
    }
  }
}

PUCCH-Format3-Conf-r13 ::= SEQUENCE {
  n3PUCCH-AN-List-r13 SEQUENCE (SIZE (1..4)) OF INTEGER (0..549) OPTIONAL, -- Need ON
  twoAntennaPortActivatedPUCCH-Format3-r13 CHOICE {
    release NULL,
    setup SEQUENCE {
      n3PUCCH-AN-ListP1-r13 SEQUENCE (SIZE (1..4)) OF INTEGER (0..549)
    }
  }
}
OPTIONAL -- Need ON

PUCCH-ConfigDedicated-v1430 ::= SEQUENCE {
  pucch-NumRepetitionCE-format1-r14 ENUMERATED {r64,r128} OPTIONAL -- Need OR
}

Format4-resource-r13 ::= SEQUENCE {
  startingPRB-format4-r13 INTEGER (0..109),
  numberOfPRB-format4-r13 INTEGER (0..7)
}

Format5-resource-r13 ::= SEQUENCE {
  startingPRB-format5-r13 INTEGER (0..109),
  cdm-index-format5-r13 INTEGER (0..1)
}

N1PUCCH-AN-CS-r10 ::= SEQUENCE (SIZE (1..4)) OF INTEGER (0..2047)

N1PUCCH-AN-InfoList-r13 ::= SEQUENCE (SIZE(1..maxCE-Level-r13)) OF INTEGER (0..2047)

-- ASN1STOP
```

PUCCH-Config field descriptions
<p>ackNackRepetition Parameter indicates whether ACK/NACK repetition is configured, see TS 36.213 [23, 10.1].</p>
<p>cdm-index-format5 Parameter n_{oc} see TS 36.211 [21, 5.4.2c] for determining PUCCH resource(s) of PUCCH format 5.</p>
<p>codebooksizeDetermination Parameter indicates whether HARQ codebook size is determined with downlink assignment indicator based solution or number of configured CCs, see TS 36.212 [22, 5.2.2.6, 5.2.3.1 and 5.3.3.1.2] and TS 36.213 [23, 10.1.2.2.3, 10.1.3.2.3, 10.1.3.2.3.1, 10.1.3.2.3.2 and 10.1.3.2.4].</p>
<p>deltaPUCCH-Shift Parameter: Δ_{shift}^{PUCCH}, see TS 36.211 [21, 5.4.1], where ds1 corresponds to value 1, ds2 corresponds to value 2 etc.</p>
<p>dummy This field is not used in the specification. If received it shall be ignored by the UE.</p>
<p>harq-TimingTDD Parameter indicates for a TDD SCell when aggregated with a TDD PCell of different UL/DL configurations whether deriving the HARQ timing for such a cell is done in the same way as the DL HARQ timing of an FDD SCell with a TDD PCell, see TS 36.213 [23, 10.2].</p>
<p>maximumPayloadCoderate Maximum payload or code rate for multi P-CSI on each PUCCH resource, see TS 36.213 [23,10.1.1].</p>
<p>n1PUCCH-AN Parameter: $N_{PUCCH}^{(1)}$, see TS 36.213 [23, 10.1]. $n1PUCCH-AN-r11$ indicates UE-specific PUCCH AN resource offset, see TS 36.213 [23, 10.1].</p>
<p>n1PUCCH-AN-CS-List Parameter: $n_{PUCCH,j}^{(1)}$ for antenna port p_0 for PUCCH format 1b with channel selection, see TS 36.213 [23, 10.1.2.2.1, 10.1.3.2.1].</p>
<p>n1PUCCH-AN-CS-ListP1 Parameter: $n_{PUCCH,j}^{(1,\tilde{p}_1)}$ for antenna port p_1 for PUCCH format 1b with channel selection, see TS 36.213 [23, 10.1]. E-UTRAN configures this field only when <i>pucch-Format</i> is set to <i>channelSelection</i>.</p>
<p>n1PUCCH-AN-Rep, n1PUCCH-AN-RepP1 Parameter: $n_{PUCCH,ANRep}^{(1,p)}$ for antenna port P0 and for antenna port P1 respectively, see TS 36.213 [23, 10.1].</p>
<p>n3PUCCH-AN-List, n3PUCCH-AN-ListP1 Parameter: $n_{PUCCH}^{(3,p)}$ for antenna port P0 and for antenna port P1 respectively, see TS 36.213 [23, 10.1].</p>
<p>nCS-An Parameter: $N_{cs}^{(1)}$ see TS 36.211 [21, 5.4].</p>
<p>nkaPUCCH-AN Parameter: $N_{PUCCH}^{K_A}$, see TS 36.213 [23, 10.1.3]. $nkaPUCCH-AN-r12$ indicates PUCCH format 1a/1b starting offset for the subframe set K^A, see TS 36.213 [23, 10.1.3]. E-UTRAN configures <i>nkaPUCCH-AN</i> only if <i>eimta-MainConfig</i> is configured.</p>
<p>nPUCCH-Identity Parameter: n_{ID}^{PUCCH}, see TS 36.211 [21, 5.5.1.5].</p>
<p>nRB-CQI Parameter: $N_{RB}^{(2)}$, see TS 36.211 [21, 5.4].</p>
<p>numberOfPRB-format4 Parameter $n_{PUCCH}^{(4)}$ see TS 36.213 [23, Table 10.1.1-2] for determining PUCCH resource(s) of PUCCH format 4.</p>
<p>n1PUCCH-AN-InfoList Starting offsets of the PUCCH resource(s) indicated by SIB1-BR. The first entry in the list is the starting offset of the PUCCH resource(s) of CE level 0, the second entry in the list is the starting offset of the PUCCH resource(s) of CE level 1, and so on. If E-UTRAN includes <i>n1PUCCH-AN-InfoList</i>, it includes the same number of entries as in <i>prach-ParametersListCE</i>. See TS 36.213 [23].</p>
<p>pucch-Format Parameter indicates one of the PUCCH formats for transmission of HARQ-ACK, see TS 36.213 [23, 10.1]. For TDD, if the UE is configured with PCell only, the <i>channelSelection</i> indicates the transmission of HARQ-ACK multiplexing as defined in Tables 10.1.3-5, 10.1.3-6, and 10.1.3-7 in TS 36.213 [23] for PUCCH, and in 7.3 in TS 36.213 [23] for PUSCH. E-UTRAN only configures <i>pucch-Format-v1370</i> when <i>pucch-Format-r13</i> is configured and set to <i>format4</i> or <i>format5</i>.</p>

PUCCH-Config field descriptions	
<i>pucch-NumRepetitionCE</i>	Number of PUCCH repetitions for PUCCH format 1/1a and for PUCCH format 2/2a/2b for CE modes A and B, see TS 36.211 [21] and TS 36.213 [23]. The UE shall ignore <i>pucch-NumRepetitionCE-format2-r13</i> , if received, for CE mode B in this release of specification. For UE in CE mode B supporting extended PUCCH repetition, if <i>pucch-NumRepetitionCE-format1-r14</i> is included then the UE shall ignore <i>pucch-NumRepetitionCE-format1-r13</i> .
<i>pucch-NumRepetitionCE-Msg4-Level0, pucch-NumRepetitionCE-Msg4-Level1, pucch-NumRepetitionCE-Msg4-Level2, pucch-NumRepetitionCE-Msg4-Level3</i>	Number of repetitions for PUCCH carrying HARQ response to PDSCH containing Msg4 for PRACH CE levels 0, 1, 2 and 3, see TS 36.211 [21] and TS 36.213 [23]. Value n1 corresponds to 1 repetition, value n2 corresponds to 2 repetitions, and so on. For BL UEs or non-BL UEs in enhanced coverage supporting extended PUCCH repetition, if <i>pucch-NumRepetitionCE-Msg4-Level3-r14</i> is included then the UE shall ignore <i>pucch-NumRepetitionCE-Msg4-Level3-r13</i> .
<i>repetitionFactor</i>	Parameter N_{ANRep} see TS 36.213 [23, 10.1] where n2 corresponds to repetition factor 2, n4 to 4.
<i>simultaneousPUCCH-PUSCH</i>	Parameter indicates whether simultaneous PUCCH and PUSCH transmissions is configured, see TS 36.213 [23, 10.1 and 5.1.1]. E-UTRAN configures this field for the PCell, only when the <i>nonContiguousUL-RA-WithinCC-Info</i> is set to <i>supported</i> in the band on which PCell is configured. Likewise, E-UTRAN configures this field for the PSCell, only when the <i>nonContiguousUL-RA-WithinCC-Info</i> is set to <i>supported</i> in the band on which PSCell is configured. Likewise, E-UTRAN configures this field for the PUCCH SCell, only when the <i>nonContiguousUL-RA-WithinCC-Info</i> is set to <i>supported</i> in the band on which PUCCH SCell is configured.
<i>spatialBundlingPUCCH</i>	Parameter indicates whether spatial bundling is enabled or not for PUCCH, see TS 36.212 [22, 5.2.3.1].
<i>spatialBundlingPUSCH</i>	Parameter indicates whether spatial bundling is enabled or not for PUSCH, see see TS 36.212 [22, 5.2.2.6].
<i>startingPRB-format4</i>	Parameter $n_{\text{PUCCH}}^{(4)}$ see TS 36.211 [21, 5.4.3] for determining PUCCH resource(s) of PUCCH format 4.
<i>startingPRB-format5</i>	Parameter $n_{\text{PUCCH}}^{(5)}$ see TS 36.211 [21, 5.4.3] for determining PUCCH resource(s) of PUCCH format 5.
<i>tdd-AckNackFeedbackMode</i>	Parameter indicates one of the TDD ACK/NACK feedback modes used, see TS 36.213 [23, 7.3 and 10.1.3]. The value bundling corresponds to use of ACK/NACK bundling whereas, the value multiplexing corresponds to ACK/NACK multiplexing as defined in Tables 10.1.3-2, 10.1.3-3, and 10.1.3-4 in TS 36.213 [23]. The same value applies to both ACK/NACK feedback modes on PUCCH as well as on PUSCH.
<i>twoAntennaPortActivatedPUCCH-Format1a1b</i>	Indicates whether two antenna ports are configured for PUCCH format 1a/1b for HARQ-ACK, see TS 36.213 [23, 10.1]. The field also applies for PUCCH format 1a/1b transmission when <i>format3</i> is configured, see TS 36.213 [23, 10.1.2.2.2, 10.1.3.2.2].
<i>twoAntennaPortActivatedPUCCH-Format3</i>	Indicates whether two antenna ports are configured for PUCCH format 3 for HARQ-ACK, see TS 36.213 [23, 10.1].

Conditional presence	Explanation
<i>TDD</i>	The field is mandatory present for TDD if the <i>pucch-Format</i> is not present. If the <i>pucch-Format</i> is present, the field is not present and the UE shall delete any existing value for this field. It is not present for FDD and the UE shall delete any existing value for this field.

PUSCH-Config

The IE *PUSCH-ConfigCommon* is used to specify the common PUSCH configuration and the reference signal configuration for PUSCH and PUCCH. The IE *PUSCH-ConfigDedicated* is used to specify the UE specific PUSCH configuration.

PUSCH-Config information element

```
-- ASN1START
PUSCH-ConfigCommon ::=
    pusch-ConfigBasic
        n-SB
        hoppingMode
        pusch-HoppingOffset
        enable64QAM
    SEQUENCE {
        SEQUENCE {
            INTEGER (1..4),
            ENUMERATED {interSubFrame, intraAndInterSubFrame},
            INTEGER (0..98),
            BOOLEAN
```

```

    },
    ul-ReferenceSignalsPUSCH          UL-ReferenceSignalsPUSCH
  }
PUSCH-ConfigCommon-v1270 ::=      SEQUENCE {
  enable64QAM-v1270                  ENUMERATED {true}
}
PUSCH-ConfigCommon-v1310 ::=      SEQUENCE {
  pusch-maxNumRepetitionCModeA-r13  ENUMERATED {
    r8, r16, r32 }                    OPTIONAL, -- Need OR
  pusch-maxNumRepetitionCModeB-r13  ENUMERATED {
    r192, r256, r384, r512, r768, r1024,
    r1536, r2048}                    OPTIONAL, -- Need OR
  pusch-HoppingOffset-v1310         INTEGER (1..maxAvailNarrowBands-r13)  OPTIONAL -- Need OR
}
PUSCH-ConfigDedicated ::=         SEQUENCE {
  betaOffset-ACK-Index              INTEGER (0..15),
  betaOffset-RI-Index               INTEGER (0..15),
  betaOffset-CQI-Index              INTEGER (0..15)
}
PUSCH-ConfigDedicated-v1020 ::=   SEQUENCE {
  betaOffsetMC-r10                  SEQUENCE {
    betaOffset-ACK-Index-MC-r10      INTEGER (0..15),
    betaOffset-RI-Index-MC-r10      INTEGER (0..15),
    betaOffset-CQI-Index-MC-r10     INTEGER (0..15)
  }
  groupHoppingDisabled-r10          ENUMERATED {true}                    OPTIONAL, -- Need OR
  dmrs-WithOCC-Activated-r10       ENUMERATED {true}                    OPTIONAL -- Need OR
}
PUSCH-ConfigDedicated-v1130 ::=   SEQUENCE {
  pusch-DMRS-r11                   CHOICE {
    release                          NULL,
    setup                            SEQUENCE {
      nPUSCH-Identity-r11            INTEGER (0..509),
      nDMRS-CSH-Identity-r11        INTEGER (0..509)
    }
  }
}
PUSCH-ConfigDedicated-v1250 ::=   SEQUENCE {
  uciOnPUSCH                       CHOICE {
    release                          NULL,
    setup                            SEQUENCE {
      betaOffset-ACK-Index-SubframeSet2-r12  INTEGER (0..15),
      betaOffset-RI-Index-SubframeSet2-r12   INTEGER (0..15),
      betaOffset-CQI-Index-SubframeSet2-r12  INTEGER (0..15),
      betaOffsetMC-r12                    SEQUENCE {
        betaOffset-ACK-Index-MC-SubframeSet2-r12  INTEGER (0..15),
        betaOffset-RI-Index-MC-SubframeSet2-r12  INTEGER (0..15),
        betaOffset-CQI-Index-MC-SubframeSet2-r12  INTEGER (0..15)
      }
    }
  }
  }
}
PUSCH-ConfigDedicated-r13 ::=     SEQUENCE {
  betaOffset-ACK-Index-r13          INTEGER (0..15),
  betaOffset2-ACK-Index-r13         INTEGER (0..15)                    OPTIONAL, -- Need OR
  betaOffset-RI-Index-r13           INTEGER (0..15),
  betaOffset-CQI-Index-r13          INTEGER (0..15),
  betaOffsetMC-r13                  SEQUENCE {
    betaOffset-ACK-Index-MC-r13        INTEGER (0..15),
    betaOffset2-ACK-Index-MC-r13       INTEGER (0..15)                    OPTIONAL, -- Need OR
    betaOffset-RI-Index-MC-r13         INTEGER (0..15),
    betaOffset-CQI-Index-MC-r13        INTEGER (0..15)
  }
  }
  }
  groupHoppingDisabled-r13          ENUMERATED {true}                    OPTIONAL, -- Need OR
  dmrs-WithOCC-Activated-r13       ENUMERATED {true}                    OPTIONAL, -- Need OR
  pusch-DMRS-r11                   CHOICE {
    release                          NULL,
    setup                            SEQUENCE {
      nPUSCH-Identity-r13            INTEGER (0..509),
      nDMRS-CSH-Identity-r13        INTEGER (0..509)
    }
  }
}

```

```

}
uciOnPUSCH                                CHOICE {
  release                                  NULL,
  setup                                   SEQUENCE {
    betaOffset-ACK-Index-SubframeSet2-r13  INTEGER (0..15),
    betaOffset2-ACK-Index-SubframeSet2-r13  INTEGER (0..15) OPTIONAL, -- Need OR
    betaOffset-RI-Index-SubframeSet2-r13    INTEGER (0..15),
    betaOffset-CQI-Index-SubframeSet2-r13   INTEGER (0..15),
    betaOffsetMC-r12                        SEQUENCE {
      betaOffset-ACK-Index-MC-SubframeSet2-r13  INTEGER (0..15),
      betaOffset2-ACK-Index-MC-SubframeSet2-r13  INTEGER (0..15) OPTIONAL, -- Need OR
      betaOffset-RI-Index-MC-SubframeSet2-r13   INTEGER (0..15),
      betaOffset-CQI-Index-MC-SubframeSet2-r13  INTEGER (0..15)
    }
  }
}
pusch-HoppingConfig-r13                    ENUMERATED {on}
}
}
PUSCH-ConfigDedicated-v1430 ::=          SEQUENCE {
  ce-PUSCH-NB-MaxTBS-r14                  ENUMERATED {on}
  ce-PUSCH-MaxBandwidth-r14              ENUMERATED {bw5}
  tdd-PUSCH-UpPTS-r14                    TDD-PUSCH-UpPTS-r14
  ul-DMRS-IFDMA-r14                      BOOLEAN,
  enable256QAM-r14                        Enable256QAM-r14
}
PUSCH-ConfigDedicatedSCell-r10 ::=      SEQUENCE {
  groupHoppingDisabled-r10                ENUMERATED {true}
  dmrs-WithOCC-Activated-r10              ENUMERATED {true}
}
PUSCH-ConfigDedicatedSCell-v1430 ::=    SEQUENCE {
  enable256QAM-r14                        Enable256QAM-r14
}
TDD-PUSCH-UpPTS-r14 ::=                  CHOICE {
  release                                  NULL,
  setup                                   SEQUENCE {
    symPUSCH-UpPTS-r14                    ENUMERATED {sym1, sym2, sym3, sym4, sym5, sym6}
    dmrs-LessUpPTS-Config-r14              ENUMERATED {true}
  }
}
Enable256QAM-r14 ::=                     CHOICE {
  release                                  NULL,
  setup                                   CHOICE {
    tpc-SubframeSet-Configured-r14        SEQUENCE {
      subframeSet1-DCI-Format0-r14        BOOLEAN,
      subframeSet1-DCI-Format4-r14        BOOLEAN,
      subframeSet2-DCI-Format0-r14        BOOLEAN,
      subframeSet2-DCI-Format4-r14        BOOLEAN
    },
    tpc-SubframeSet-NotConfigured-r14     SEQUENCE {
      dci-Format0-r14                      BOOLEAN,
      dci-Format4-r14                      BOOLEAN
    }
  }
}
PUSCH-EnhancementsConfig-r14 ::=        CHOICE {
  release                                  NULL,
  setup                                   SEQUENCE {
    pusch-HoppingOffsetPUSCH-Enh-r14      INTEGER (1..100)
    interval-ULHoppingPUSCH-Enh-r14      CHOICE {
      interval-FDD-PUSCH-Enh-r14          ENUMERATED {int1, int2, int4, int8},
      interval-TDD-PUSCH-Enh-r14         ENUMERATED {int1, int5, int10, int20}
    }
  }
}
UL-ReferenceSignalsPUSCH ::=             SEQUENCE {
  groupHoppingEnabled                      BOOLEAN,
  groupAssignmentPUSCH                     INTEGER (0..29),
  sequenceHoppingEnabled                   BOOLEAN,
  cyclicShift                              INTEGER (0..7)
}

```

-- ASN1STOP

PUSCH-Config field descriptions
<p><i>betaOffset-ACK-Index, betaOffset2-ACK-Index, betaOffset-ACK-Index-MC, betaOffset2-ACK-Index-MC</i></p> <p>Parameter: $I_{offset}^{HARQ-ACK}$, $I_{offset,X}^{HARQ-ACK}$, $I_{offset,MC}^{HARQ-ACK}$ and $I_{offset,MC,X}^{HARQ-ACK}$, for single- and multiple-codeword respectively, see TS 36.213 [23, Table 8.6.3-1]. <i>betaOffset-ACK-Index</i> and <i>betaOffset2-ACK-Index</i> are used for single-codeword and <i>betaOffset-ACK-Index-MC</i> and <i>betaOffset2-ACK-Index-MC</i> are used for multiple-codeword. If <i>betaOffset2-ACK-Index</i> is configured; <i>betaOffset-ACK-Index</i> is used when up to 22 HARQ-ACK bits are transmitted otherwise <i>betaOffset2-ACK-Index</i> is used. If <i>betaOffset-ACK2-Index-MC</i> is configured; <i>betaOffset-ACK-Index-MC</i> is used when up to 22 HARQ-ACK bits are transmitted otherwise <i>betaOffset2-ACK-Index-MC</i> is used. One value applies for all serving cells with an uplink in a cell group (MCG or SCG or the group of cells configured to send PUCCH on the same cell in case PUCCH SCell is configured) and not configured with uplink power control subframe sets. The same value also applies for subframe set 1 of all serving cells with an uplink in that cell group and configured with uplink power control subframe sets (the associated functionality is common i.e. not performed independently for each cell).</p>
<p><i>betaOffset-ACK-Index-SubframeSet2, betaOffset2-ACK-Index-SubframeSet2, betaOffset-ACK-Index-MC-SubframeSet2, betaOffset2-ACK-Index-MC-SubframeSet2</i></p> <p>Parameter: $I_{offset,set2}^{HARQ-ACK}$, $I_{offset,set2,X}^{HARQ-ACK}$, $I_{offset,MC,set2}^{HARQ-ACK}$ and $I_{offset,MC,set2,X}^{HARQ-ACK}$ respectively, see TS 36.213 [23, Table 8.6.3-1]. <i>betaOffset-ACK-Index-SubframeSet2</i> and <i>betaOffset2-ACK-Index-SubframeSet2</i> are used for single-codeword, <i>betaOffset-ACK-Index-MC-SubframeSet2</i>, <i>betaOffset2-ACK-Index-MC-SubframeSet2</i> are used for multiple-codeword. If <i>betaOffset2-ACK-Index-SubframeSet2</i> is configured; <i>betaOffset-ACK-Index-SubframeSet2</i> is used when up to 22 HARQ-ACK bits are transmitted otherwise <i>betaOffset2-ACK-Index-SubframeSet2</i> is used. If <i>betaOffset2-ACK-Index-MC-SubframeSet2</i> is configured; <i>betaOffset-ACK-Index-MC-SubframeSet2</i> is used when up to 22 HARQ-ACK bits are transmitted otherwise <i>betaOffset2-ACK-Index-MC-SubframeSet2</i> is used. One value applies for subframe set 2 of all serving cells with an uplink in a cell group (MCG or SCG or the group of cells configured to send PUCCH on the same cell in case PUCCH SCell is configured) and configured with uplink power control subframe sets (the associated functionality is common i.e. not performed independently for each cell configured with uplink power control subframe sets).</p>
<p><i>betaOffset-CQI-Index, betaOffset-CQI-Index-MC</i></p> <p>Parameter: I_{offset}^{CQI}, for single- and multiple-codeword respectively, see TS 36.213 [23, Table 8.6.3-3]. One value applies for all serving cells with an uplink in a cell group (MCG or SCG or the group of cells configured to send PUCCH on the same cell in case PUCCH SCell is configured) and not configured with uplink power control subframe sets. The same value also applies for subframe set 1 of all serving cells with an uplink in that cell group and configured with uplink power control subframe sets (the associated functionality is common i.e. not performed independently for each cell).</p>
<p><i>betaOffset-CQI-Index-SubframeSet2, betaOffset-CQI-Index-MC-SubframeSet2</i></p> <p>Parameter: I_{offset}^{CQI}, for single- and multiple-codeword respectively, see TS 36.213 [23, Table 8.6.3-3]. One value applies for subframe set 2 of all serving cells with an uplink in a cell group (MCG or SCG or the group of cells configured to send PUCCH on the same cell in case PUCCH SCell is configured) and configured with uplink power control subframe sets (the associated functionality is common i.e. not performed independently for each cell configured with uplink power control subframe sets).</p>
<p><i>betaOffset-RI-Index, betaOffset-RI-Index-MC</i></p> <p>Parameter: I_{offset}^{RI}, for single- and multiple-codeword respectively, see TS 36.213 [23, Table 8.6.3-2]. One value applies for all serving cells with an uplink in a cell group (MCG or SCG or the group of cells configured to send PUCCH on the same cell in case PUCCH SCell is configured) and not configured with uplink power control subframe sets. The same value also applies for subframe set 1 of all serving cells with an uplink in that cell group and configured with uplink power control subframe sets (the associated functionality is common i.e. not performed independently for each cell).</p>
<p><i>betaOffset-RI-Index-SubframeSet2, betaOffset-RI-Index-MC-SubframeSet2</i></p> <p>Parameter: I_{offset}^{RI}, for single- and multiple-codeword respectively, see TS 36.213 [23, Table 8.6.3-2]. One value applies for subframe set 2 of all serving cells with an uplink in a cell group (MCG or SCG or the group of cells configured to send PUCCH on the same cell in case PUCCH SCell is configured) and configured with uplink power control subframe sets (the associated functionality is common i.e. not performed independently for each cell configured with uplink power control subframe sets).</p>
<p><i>ce-PUSCH-MaxBandwidth</i></p> <p>Maximum PUSCH channel bandwidth in CE mode A, see TS 36.212 [22] and TS 36.213 [23]. Value bw5 corresponds to 5 MHz. If this field is not configured, the maximum PUSCH channel bandwidth in CE mode A set to 1.4 MHz. The maximum PUSCH channel bandwidth in CE mode B is 1.4 MHz regardless of the setting of this parameter.</p> <p>Parameter: transmission bandwidth configuration, see TS 36.101 [42, table 5.6-1].</p>
<p><i>ce-PUSCH-NB-MaxTBS</i></p> <p>Activation of 2984 bits maximum PUSCH TBS in 1.4 MHz in CE mode A, see TS 36.212 [22] and TS 36.213 [23].</p>
<p><i>cyclicShift</i></p> <p>Parameters: <i>cyclicShift</i>, see TS 36.211 [21, Table 5.5.2.1.1-2].</p>
<p><i>dmrs-LessUpPTS-Config</i></p> <p>Indicates the UE not to transmit DMRS for PUSCH in UpPTS, see TS36.211 [21, 5.5.2.1.2].</p>

PUSCH-Config field descriptions
<p>dmrs-WithOCC-Activated Parameter: <i>Activate-DMRS-with OCC</i>, see TS 36.211 [21, 5.5.2.1].</p>
<p>enable256QAM See TS 36.213 [23, 8.6.1]. If <i>enable256QAM</i> is included and if uplink power control subframe sets are configured by <i>tpc-SubframeSet</i>, the field indicates (if set to TRUE) per uplink power control subframe set and DCI format 0/0A/0B and 4/4A/4B that 256QAM is allowed for UE UL categories 16 to 20 indicated in <i>ue-CategoryUL-v1430</i>, while FALSE indicates that 256 QAM is not allowed. If <i>enable256QAM</i> is included and if uplink power control subframe sets are not configured by <i>tpc-SubframeSet</i>, the field indicates (if set to TRUE) per DCI format 0/0A/0B and 4/4A/4B that 256QAM is allowed for UE UL categories 16 to 20 indicated in <i>ue-CategoryUL-v1430</i>, while FALSE indicates that 256 QAM is not allowed.</p>
<p>enable64QAM See TS 36.213 [23, 8.6.1]. If <i>enable64QAM</i> (without suffix) is set to TRUE, it indicates that 64QAM is allowed for UE categories 5 and 8 indicated in <i>ue-Category</i> and UL categories indicated in <i>ue-CategoryUL</i> which support UL 64QAM and can fallback to category 5 or 8, see TS 36.306 [5, Table 4.1A-2 and Table 4.1A-6], while FALSE indicates that 64QAM is not allowed. If <i>enable64QAM-v1270</i> is set to TRUE, it indicates that 64QAM is allowed for UL categories indicated in <i>ue-CategoryUL</i> which support UL 64QAM but cannot fallback category 5 or 8, see TS 36.306 [5, Table 4.1A-2 and Table 4.1A-6]. E-UTRAN configures <i>enable64QAM-v1270</i> only when <i>enable64QAM</i> (without suffix) is set to TRUE.</p>
<p>interval-ULHoppingPUSCH-Enh Number of consecutive absolute subframes over which PUSCH stays at the same PRBs before hopping to other PRBs. For <i>interval-FDD-PUSCH-Enh</i>, int1 corresponds to 1 subframe, int2 corresponds to 2 subframes, and so on. For <i>interval-TDD-PUSCH-Enh</i>, int1 corresponds to 1 subframe, int5 corresponds to 5 subframes, and so on. See TS 36.211 [21, 5.3.4].</p>
<p>groupAssignmentPUSCH Parameter: ΔSS See TS 36.211 [21, 5.5.1.3].</p>
<p>groupHoppingDisabled Parameter: <i>Disable-sequence-group-hopping</i>, see TS 36.211 [21, 5.5.1.3].</p>
<p>groupHoppingEnabled Parameter: <i>Group-hopping-enabled</i>, see TS 36.211 [21, 5.5.1.3].</p>
<p>hoppingMode Parameter: <i>Hopping-mode</i>, see TS 36.211 [21, 5.3.4].</p>
<p>nDMRS-CSH-Identity Parameter: $N_{ID}^{csh_DMRS}$, see TS 36.211 [21, 5.5.2.1.1].</p>
<p>nPUSCH-Identity Parameter: n_{ID}^{PUSCH}, see TS 36.211 [21, 5.5.1.5].</p>
<p>n-SB Parameter: N_{sb} see TS 36.211 [21, 5.3.4].</p>
<p>pusch-HoppingConfig For BL UEs and UEs in CE, frequency hopping activation/deactivation for unicast PUSCH, see TS 36.211 [21]</p>
<p>pusch-hoppingOffset Except for BL UEs and UEs in CE, parameter: N_{RB}^{HO}, see TS 36.211 [21, 5.3.4]. For BL UEs and UEs in CE, the <i>pusch-hoppingOffset-v1310</i> indicates the parameter $f_{NB,hop}^{PUSCH}$, see TS 36.211 [21, 5.3.4]. In case <i>pusch-hoppingOffset-v1310</i> is signalled, the BL UEs and UEs in CE shall ignore <i>pusch-hoppingOffset</i> (i.e. without suffix).</p>
<p>pusch-HoppingOffsetPUSCH-Enh Indicates the frequency domain hopping offset between PRBs for PUSCH in frequency hopping, see TS 36.211 [21, 5.3.4]. Value 1 corresponds to 1 PRB, value 2 corresponds to 2 PRBs, and so on.</p>
<p>pusch-maxNumRepetitionCEmodeA Maximum value to indicate the set of PUSCH repetition numbers for CE mode A, see TS 36.211 [21] and TS 36.213 [23]. E-UTRAN does not configure value r8. If the field is not configured, the UE shall apply the default value as defined in TS 36.213 [23, 8.0].</p>
<p>pusch-maxNumRepetitionCEmodeB Maximum value to indicate the set of PUSCH repetition numbers for CE mode B, see TS 36.211 [21] and TS 36.213 [23].</p>
<p>sequenceHoppingEnabled Parameter: <i>Sequence-hopping-enabled</i>, see TS 36.211 [21, 5.5.1.4].</p>
<p>symPUSCH-UpPTS Indicates the number of data symbols that configured for PUSCH transmission in UpPTS. Values <i>sym2</i>, <i>sym3</i>, <i>sym4</i>, <i>sym5</i> and <i>sym6</i> can be used for normal cyclic prefix, if <i>dmrsLess-UpPTS</i> is set to <i>true</i>, otherwise, values <i>sym2</i>, <i>sym3</i>, <i>sym4</i>, <i>sym5</i> can be used for normal cyclic prefix and values <i>sym1</i>, <i>sym2</i>, <i>sym3</i> and <i>sym4</i> can be used for extended cyclic prefix, see TS 36.213 [23], clause 8.6.2 and TS 36.211 [21], clause 5.3.4.</p>
<p>ul-DMRS-IFDMA Value <i>TRUE</i> indicates that the UE is configured with enhanced UL DMRS.</p>
<p>ul-ReferenceSignalsPUSCH Used to specify parameters needed for the transmission on PUSCH (or PUCCH).</p>

RACH-ConfigCommon

The IE *RACH-ConfigCommon* is used to specify the generic random access parameters.

RACH-ConfigCommon information element

```

-- ASN1START
RACH-ConfigCommon ::= SEQUENCE {
  preambleInfo SEQUENCE {
    numberOfRA-Preambles ENUMERATED {
      n4, n8, n12, n16, n20, n24, n28,
      n32, n36, n40, n44, n48, n52, n56,
      n60, n64},
    preambleGroupAConfig SEQUENCE {
      sizeOfRA-PreamblesGroupA ENUMERATED {
        n4, n8, n12, n16, n20, n24, n28,
        n32, n36, n40, n44, n48, n52, n56,
        n60},
      messageSizeGroupA ENUMERATED {b56, b144, b208, b256},
      messagePowerOffsetGroupB ENUMERATED {
        minusinfinity, dB0, dB5, dB8, dB10, dB12,
        dB15, dB18},
      ...
    } OPTIONAL -- Need OP
  },
  powerRampingParameters PowerRampingParameters,
  ra-SupervisionInfo SEQUENCE {
    preambleTransMax PreambleTransMax,
    ra-ResponseWindowSize ENUMERATED {
      sf2, sf3, sf4, sf5, sf6, sf7,
      sf8, sf10},
    mac-ContentionResolutionTimer ENUMERATED {
      sf8, sf16, sf24, sf32, sf40, sf48,
      sf56, sf64}
  },
  maxHARQ-Msg3Tx INTEGER (1..8),
  ...
  [[ preambleTransMax-CE-r13 PreambleTransMax OPTIONAL, -- Need OR
    rach-CE-LevelInfoList-r13 RACH-CE-LevelInfoList-r13 OPTIONAL -- Need OR
  ]]
}

RACH-ConfigCommon-v1250 ::= SEQUENCE {
  txFailParams-r12 SEQUENCE {
    connEstFailCount-r12 ENUMERATED {n1, n2, n3, n4},
    connEstFailOffsetValidity-r12 ENUMERATED {s30, s60, s120, s240,
      s300, s420, s600, s900},
    connEstFailOffset-r12 INTEGER (0..15) OPTIONAL -- Need OP
  }
}

RACH-ConfigCommonSCell-r11 ::= SEQUENCE {
  powerRampingParameters-r11 PowerRampingParameters,
  ra-SupervisionInfo-r11 SEQUENCE {
    preambleTransMax-r11 PreambleTransMax
  },
  ...
}

RACH-CE-LevelInfoList-r13 ::= SEQUENCE (SIZE (1..maxCE-Level-r13)) OF RACH-CE-LevelInfo-r13

RACH-CE-LevelInfo-r13 ::= SEQUENCE {
  preambleMappingInfo-r13 SEQUENCE {
    firstPreamble-r13 INTEGER(0..63),
    lastPreamble-r13 INTEGER(0..63)
  },
  ra-ResponseWindowSize-r13 ENUMERATED {sf20, sf50, sf80, sf120, sf180,
    sf240, sf320, sf400},
  mac-ContentionResolutionTimer-r13 ENUMERATED {sf80, sf100, sf120,
    sf160, sf200, sf240, sf480, sf960},
  rar-HoppingConfig-r13 ENUMERATED {on,off},
  ...
}

```

```

}
PowerRampingParameters ::= SEQUENCE {
    powerRampingStep          ENUMERATED {dB0, dB2,dB4, dB6},
    preambleInitialReceivedTargetPower  ENUMERATED {
        dBm-120, dBm-118, dBm-116, dBm-114, dBm-112,
        dBm-110, dBm-108, dBm-106, dBm-104, dBm-102,
        dBm-100, dBm-98, dBm-96, dBm-94,
        dBm-92, dBm-90}
}
PreambleTransMax ::= ENUMERATED {
    n3, n4, n5, n6, n7, n8, n10, n20, n50,
    n100, n200}
-- ASN1STOP

```

RACH-ConfigCommon field descriptions
<p><i>connEstFailCount</i> Number of times that the UE detects T300 expiry on the same cell before applying <i>connEstFailOffset</i>.</p>
<p><i>connEstFailOffset</i> Parameter "Qoffset_{temp}" in TS 36.304 [4]. If the field is not present the value of infinity shall be used for "Qoffset_{temp}".</p>
<p><i>connEstFailOffsetValidity</i> Amount of time that the UE applies <i>connEstFailOffset</i> before removing the offset from evaluation of the cell. Value s30 corresponds to 30 seconds, s60 corresponds to 60 seconds, and so on.</p>
<p><i>mac-ContentionResolutionTimer</i> Timer for contention resolution in TS 36.321 [6]. Value in subframes. Value sf8 corresponds to 8 subframes, sf16 corresponds to 16 subframes and so on.</p>
<p><i>maxHARQ-Msg3Tx</i> Maximum number of Msg3 HARQ transmissions in TS 36.321 [6], used for contention based random access. Value is an integer.</p>
<p><i>messagePowerOffsetGroupB</i> Threshold for preamble selection in TS 36.321 [6]. Value in dB. Value minusinfinity corresponds to -infinity. Value dB0 corresponds to 0 dB, dB5 corresponds to 5 dB and so on.</p>
<p><i>messageSizeGroupA</i> Threshold for preamble selection in TS 36.321 [6]. Value in bits. Value b56 corresponds to 56 bits, b144 corresponds to 144 bits and so on.</p>
<p><i>numberOfRA-Preambles</i> Number of non-dedicated random access preambles in TS 36.321 [6]. Value is an integer. Value n4 corresponds to 4, n8 corresponds to 8 and so on.</p>
<p><i>powerRampingStep</i> Power ramping factor in TS 36.321 [6]. Value in dB. Value dB0 corresponds to 0 dB, dB2 corresponds to 2 dB and so on.</p>
<p><i>preambleInitialReceivedTargetPower</i> Initial preamble power in TS 36.321 [6]. Value in dBm. Value dBm-120 corresponds to -120 dBm, dBm-118 corresponds to -118 dBm and so on.</p>
<p><i>preambleMappingInfo</i> Provides the mapping of preambles to groups for each CE level, as specified in TS 36.321 [6]. When random access preambles group B is used, <i>firstPreamble-r13</i> is set to 0 and <i>lastPreamble-r13</i> is set to <i>numberOfRA-Preambles-1</i>.</p>
<p><i>preamblesGroupAConfig</i> Provides the configuration for preamble grouping in TS 36.321 [6]. If the field is not signalled, the size of the random access preambles group A [6] is equal to <i>numberOfRA-Preambles</i>.</p>
<p><i>preambleTransMax, preambleTransMax-CE</i> Maximum number of preamble transmission in TS 36.321 [6]. Value is an integer. Value n3 corresponds to 3, n4 corresponds to 4 and so on.</p>
<p><i>rach-CE-LevelInfoList</i> Provides RACH information each coverage level. The first entry in the list contains RACH information of CE level 0, the second entry in the list contains RACH information of CE level 1, and so on. If E-UTRAN includes <i>rach-CE-LevelInfoList</i>, it includes the same number of entries as in <i>prach-ParametersListCE</i>.</p>
<p><i>ra-ResponseWindowSize</i> Duration of the RA response window in TS 36.321 [6]. Value in subframes. Value sf2 corresponds to 2 subframes, sf3 corresponds to 3 subframes and so on. The same value applies for each serving cell (although the associated functionality is performed independently for each cell).</p>
<p><i>rar-HoppingConfig</i> Frequency hopping activation/deactivation for RAR/Msg3/Msg4 for a CE level, see TS 36.211 [21].</p>
<p><i>sizeOfRA-PreamblesGroupA</i> Size of the random access preambles group A in TS 36.321 [6]. Value is an integer. Value n4 corresponds to 4, n8 corresponds to 8 and so on.</p>

– *RACH-ConfigDedicated*

The IE *RACH-ConfigDedicated* is used to specify the dedicated random access parameters.

***RACH-ConfigDedicated* information element**

```
-- ASN1START
RACH-ConfigDedicated ::= SEQUENCE {
    ra-PreambleIndex      INTEGER (0..63),
    ra-PRACH-MaskIndex    INTEGER (0..15)
}
-- ASN1STOP
```

RACH-ConfigDedicated field descriptions

ra-PRACH-MaskIndex

Explicitly signalled PRACH Mask Index for RA Resource selection in TS 36.321 [6].

ra-PreambleIndex

Explicitly signalled Random Access Preamble for RA Resource selection in TS 36.321 [6].

– *RadioResourceConfigCommon*

The IE *RadioResourceConfigCommonSIB* and IE *RadioResourceConfigCommon* are used to specify common radio resource configurations in the system information and in the mobility control information, respectively, e.g., the random access parameters and the static physical layer parameters.

***RadioResourceConfigCommon* information element**

```
-- ASN1START
RadioResourceConfigCommonSIB ::= SEQUENCE {
    rach-ConfigCommon      RACH-ConfigCommon,
    bccch-Config           BCCH-Config,
    pcch-Config            PCCH-Config,
    prach-Config           PRACH-ConfigSIB,
    pdsch-ConfigCommon     PDSCH-ConfigCommon,
    pusch-ConfigCommon     PUSCH-ConfigCommon,
    pucch-ConfigCommon     PUCCH-ConfigCommon,
    soundingRS-UL-ConfigCommon SoundingRS-UL-ConfigCommon,
    uplinkPowerControlCommon UplinkPowerControlCommon,
    ul-CyclicPrefixLength  UL-CyclicPrefixLength,
    ...,
    [[ uplinkPowerControlCommon-v1020 UplinkPowerControlCommon-v1020 OPTIONAL -- Need OR
    ]],
    [[ rach-ConfigCommon-v1250 RACH-ConfigCommon-v1250 OPTIONAL -- Need OR
    ]],
    [[ pusch-ConfigCommon-v1270 PUSCH-ConfigCommon-v1270 OPTIONAL -- Need OR
    ]],
    [[ bccch-Config-v1310 BCCH-Config-v1310 OPTIONAL, -- Need OR
    pcch-Config-v1310 PCCH-Config-v1310 OPTIONAL, -- Need OR
    freqHoppingParameters-r13 FreqHoppingParameters-r13 OPTIONAL, -- Need OR
    pdsch-ConfigCommon-v1310 PDSCH-ConfigCommon-v1310 OPTIONAL, -- Need OR
    pusch-ConfigCommon-v1310 PUSCH-ConfigCommon-v1310 OPTIONAL, -- Need OR
    prach-ConfigCommon-v1310 PRACH-ConfigSIB-v1310 OPTIONAL, -- Need OR
    pucch-ConfigCommon-v1310 PUCCH-ConfigCommon-v1310 OPTIONAL -- Need OR
    ]],
    [[ highSpeedConfig-r14 HighSpeedConfig-r14 OPTIONAL, -- Need OR
    prach-Config-v1430 PRACH-Config-v1430 OPTIONAL, -- Need OR
    pucch-ConfigCommon-v1430 PUCCH-ConfigCommon-v1430 OPTIONAL -- Need OR
    ]],
}

RadioResourceConfigCommon ::= SEQUENCE {
    rach-ConfigCommon      RACH-ConfigCommon OPTIONAL, -- Need ON
    prach-Config           PRACH-Config,
    pdsch-ConfigCommon     PDSCH-ConfigCommon OPTIONAL, -- Need ON
    pusch-ConfigCommon     PUSCH-ConfigCommon,
    phich-Config           PHICH-Config OPTIONAL, -- Need ON
    pucch-ConfigCommon     PUCCH-ConfigCommon OPTIONAL, -- Need ON
    soundingRS-UL-ConfigCommon SoundingRS-UL-ConfigCommon OPTIONAL, -- Need ON
}
```

```

uplinkPowerControlCommon      UplinkPowerControlCommon      OPTIONAL,  -- Need ON
antennaInfoCommon             AntennaInfoCommon              OPTIONAL,  -- Need ON
p-Max                          P-Max                           OPTIONAL,  -- Need OP
tdd-Config                     TDD-Config                      OPTIONAL,  -- Cond TDD
ul-CyclicPrefixLength         UL-CyclicPrefixLength,
...
[[ uplinkPowerControlCommon-v1020 UplinkPowerControlCommon-v1020      OPTIONAL  -- Need ON
]],
[[ tdd-Config-v1130                TDD-Config-v1130                OPTIONAL  -- Cond TDD3
]],
[[ pusch-ConfigCommon-v1270        PUSCH-ConfigCommon-v1270        OPTIONAL  -- Need OR
]],
[[
prach-Config-v1310              PRACH-Config-v1310              OPTIONAL,  -- Need ON
freqHoppingParameters-r13       FreqHoppingParameters-r13       OPTIONAL,  -- Need ON
pdsch-ConfigCommon-v1310        PDSCH-ConfigCommon-v1310        OPTIONAL,  -- Need ON
pucch-ConfigCommon-v1310        PUCCH-ConfigCommon-v1310        OPTIONAL,  -- Need ON
pusch-ConfigCommon-v1310        PUSCH-ConfigCommon-v1310        OPTIONAL,  -- Need ON
uplinkPowerControlCommon-v1310  UplinkPowerControlCommon-v1310  OPTIONAL  -- Need ON
]],
[[ highSpeedConfig-r14            HighSpeedConfig-r14            OPTIONAL,  -- Need OR
prach-Config-v1430              PRACH-Config-v1430            OPTIONAL,  -- Need OR
pucch-ConfigCommon-v1430        PUCCH-ConfigCommon-v1430        OPTIONAL,  -- Need OR
tdd-Config-v1430                TDD-Config-v1430              OPTIONAL,  -- Cond TDD3
]],
[[
tdd-Config-v1450                TDD-Config-v1450              OPTIONAL  -- Cond TDD3
]]
}

RadioResourceConfigCommonPSCell-r12 ::= SEQUENCE {
    basicFields-r12                RadioResourceConfigCommonSCell-r10,
    pucch-ConfigCommon-r12         PUCCH-ConfigCommon,
    rach-ConfigCommon-r12         RACH-ConfigCommon,
    uplinkPowerControlCommonPSCell-r12 UplinkPowerControlCommonPSCell-r12,
    ...
    [[ uplinkPowerControlCommonPSCell-v1310
                                           UplinkPowerControlCommon-v1310      OPTIONAL  -- Need ON
    ]]
}

RadioResourceConfigCommonPSCell-v12f0 ::= SEQUENCE {
    basicFields-v12f0              RadioResourceConfigCommonSCell-v1010
}

RadioResourceConfigCommonPSCell-v1440 ::= SEQUENCE {
    basicFields-v1440              RadioResourceConfigCommonSCell-v1440
}

RadioResourceConfigCommonSCell-r10 ::= SEQUENCE {
    -- DL configuration as well as configuration applicable for DL and UL
    nonUL-Configuration-r10        SEQUENCE {
        -- 1: Cell characteristics
        dl-Bandwidth-r10            ENUMERATED {n6, n15, n25, n50, n75, n100},
        -- 2: Physical configuration, general
        antennaInfoCommon-r10       AntennaInfoCommon,
        mbsfn-SubframeConfigList-r10 MBSFN-SubframeConfigList      OPTIONAL,  -- Need OR
        -- 3: Physical configuration, control
        phich-Config-r10            PHICH-Config,
        -- 4: Physical configuration, physical channels
        pdsch-ConfigCommon-r10      PDSCH-ConfigCommon,
        tdd-Config-r10              TDD-Config                      OPTIONAL  -- Cond
    }
}

TDDSCell
},
-- UL configuration
ul-Configuration-r10              SEQUENCE {
    ul-FreqInfo-r10                SEQUENCE {
        ul-CarrierFreq-r10          ARFCN-ValueEUTRA              OPTIONAL,  -- Need OP
        ul-Bandwidth-r10            ENUMERATED {n6, n15,
                                                    n25, n50, n75, n100}          OPTIONAL,  -- Need OP
        additionalSpectrumEmissionSCell-r10 AdditionalSpectrumEmission
    },
    p-Max-r10                      P-Max                          OPTIONAL,  -- Need OP
    uplinkPowerControlCommonSCell-r10 UplinkPowerControlCommonSCell-r10,
    -- A special version of IE UplinkPowerControlCommon may be introduced
    -- 3: Physical configuration, control
    soundingRS-UL-ConfigCommon-r10 SoundingRS-UL-ConfigCommon,
    ul-CyclicPrefixLength-r10      UL-CyclicPrefixLength,

```

```

-- 4: Physical configuration, physical channels
prach-ConfigSCell-r10 PRACH-ConfigSCell-r10 OPTIONAL, -- Cond TDD-
OR-NoR11
pusch-ConfigCommon-r10 PUSCH-ConfigCommon OPTIONAL, -- Need OR
}
...
[[ ul-CarrierFreq-v1090 ARFCN-ValueEUTRA-v9e0 OPTIONAL -- Need OP
]],
[[ rach-ConfigCommonSCell-r11 RACH-ConfigCommonSCell-r11 OPTIONAL, -- Cond
ULSCell
prach-ConfigSCell-r11 PRACH-Config OPTIONAL, -- Cond UL
tdd-Config-v1130 TDD-Config-v1130 OPTIONAL, -- Cond TDD2
uplinkPowerControlCommonSCell-v1130 UplinkPowerControlCommonSCell-v1130 OPTIONAL -- Cond UL
]],
[[ pusch-ConfigCommon-v1270 PUSCH-ConfigCommon-v1270 OPTIONAL -- Need OR
]],
[[ pucch-ConfigCommon-r13 PUCCH-ConfigCommon OPTIONAL, -- Cond UL
uplinkPowerControlCommonSCell-v1310 UplinkPowerControlCommonSCell-v1310 OPTIONAL -- Cond UL
]],
[[ highSpeedConfigSCell-r14 HighSpeedConfigSCell-r14 OPTIONAL, -- Need OR
prach-Config-v1430 PRACH-Config-v1430 OPTIONAL, -- Cond UL
ul-Configuration-r14 SEQUENCE {
ul-FreqInfo-r14 SEQUENCE {
ul-CarrierFreq-r14 ARFCN-ValueEUTRA-r9 OPTIONAL, -- Need OP
ul-Bandwidth-r14 ENUMERATED {n6, n15,
n25, n50, n75, n100} OPTIONAL, -- Need OP
additionalSpectrumEmissionSCell-r14 AdditionalSpectrumEmission
},
p-Max-r14 P-Max OPTIONAL, -- Need OP
soundingRS-UL-ConfigCommon-r14 SoundingRS-UL-ConfigCommon,
ul-CyclicPrefixLength-r14 UL-CyclicPrefixLength,
prach-ConfigSCell-r14 PRACH-ConfigSCell-r10 OPTIONAL, -- Cond TDD-
OR-NoR11
uplinkPowerControlCommonPUSCH-LessCell-v1430 UplinkPowerControlCommonPUSCH-LessCell-v1430 OPTIONAL -- Need OR
}
harq-ReferenceConfig-r14 ENUMERATED {sa2,sa4,sa5} OPTIONAL, -- Cond ULSRS
OR
soundingRS-FlexibleTiming-r14 ENUMERATED {true} OPTIONAL -- Need OR
]],
[[ mbsfn-SubframeConfigList-v1430 MBSFN-SubframeConfigList-v1430 OPTIONAL-- Need ON
]]
}

RadioResourceConfigCommonSCell-v1010 ::= SEQUENCE {
-- UL configuration
ul-Configuration-v1010 SEQUENCE {
additionalSpectrumEmissionSCell-v1010 AdditionalSpectrumEmission-v1010
}
}

RadioResourceConfigCommonSCell-v1440 ::= SEQUENCE {
ul-Configuration-v1440 SEQUENCE {
ul-FreqInfo-v1440 SEQUENCE {
additionalSpectrumEmissionSCell-v1440 AdditionalSpectrumEmission-v1010
}
}
}

BCCH-Config ::= SEQUENCE {
modificationPeriodCoeff ENUMERATED {n2, n4, n8, n16}
}

BCCH-Config-v1310 ::= SEQUENCE {
modificationPeriodCoeff-v1310 ENUMERATED {n64}
}

FreqHoppingParameters-r13 ::= SEQUENCE {
dummy ENUMERATED {nb2, nb4} OPTIONAL,
dummy2 CHOICE {
interval-FDD-r13 ENUMERATED {int1, int2, int4, int8},
interval-TDD-r13 ENUMERATED {int1, int5, int10, int20}
}
dummy3 CHOICE {
interval-FDD-r13 ENUMERATED {int2, int4, int8, int16},
interval-TDD-r13 ENUMERATED {int5, int10, int20, int40}
}
}

```

```

    }
    interval-ULHoppingConfigCommonModeA-r13 CHOICE {
        interval-FDD-r13          ENUMERATED {int1, int2, int4, int8},
        interval-TDD-r13         ENUMERATED {int1, int5, int10, int20}
    }
    interval-ULHoppingConfigCommonModeB-r13 CHOICE {
        interval-FDD-r13          ENUMERATED {int2, int4, int8, int16},
        interval-TDD-r13         ENUMERATED {int5, int10, int20, int40}
    }
    dummy4          INTEGER (1..maxAvailNarrowBands-r13)          OPTIONAL
}

PCCCH-Config ::=
    defaultPagingCycle          SEQUENCE {
        ENUMERATED {
            rf32, rf64, rf128, rf256},
        nB          ENUMERATED {
            fourT, twoT, oneT, halfT, quarterT, oneEighthT,
            oneSixteenthT, oneThirtySecondT}
    }

PCCCH-Config-v1310 ::=
    paging-narrowBands-r13      INTEGER (1..maxAvailNarrowBands-r13),
    mpdcch-NumRepetition-Paging-r13  ENUMERATED {r1, r2, r4, r8, r16, r32, r64, r128, r256},
    nB-v1310          ENUMERATED {one64thT, one128thT, one256thT}
    OPTIONAL          -- Need OR

UL-CyclicPrefixLength ::=
    ENUMERATED {len1, len2}

HighSpeedConfig-r14 ::=
    highSpeedEnhancedMeasFlag-r14  ENUMERATED {true}          OPTIONAL, -- Need OR
    highSpeedEnhancedDemodulationFlag-r14  ENUMERATED {true}  OPTIONAL, -- Need OR
}

HighSpeedConfigSCell-r14 ::=
    highSpeedEnhancedDemodulationFlag-r14  ENUMERATED {true}          OPTIONAL, -- Need OR
}

-- ASN1STOP

```

RadioResourceConfigCommon field descriptions
<p>additionalSpectrumEmissionSCell The UE requirements related to <i>additionalSpectrumEmissionSCell</i> are defined in TS 36.101 [42]. E-UTRAN configures the same value in <i>additionalSpectrumEmissionSCell</i> for all SCell(s) of the same band with UL configured. The <i>additionalSpectrumEmissionSCell</i> is applicable for all serving cells (including PCell) of the same band with UL configured.</p>
<p>defaultPagingCycle Default paging cycle, used to derive 'T' in TS 36.304 [4]. Value rf32 corresponds to 32 radio frames, rf64 corresponds to 64 radio frames and so on.</p>
<p>dummy This field is not used in the specification. If received it shall be ignored by the UE.</p>
<p>harq-ReferenceConfig Indicates UL/ DL configuration used as the DL HARQ reference configuration for this serving cell. Value sa2 corresponds to Configuration2, sa4 to Configuration4 etc, as specified in TS 36.211 [21, table 4.2-2]. E-UTRAN configures the same value for all serving cells residing on same frequency band.</p>
<p>highSpeedEnhancedMeasFlag If the field is present, the UE shall apply the high speed measurement enhancements as specified in TS 36.133 [16].</p>
<p>highSpeedEnhancedDemodulationFlag If the field is present, the UE shall apply the advanced receiver in SFN scenario as specified in TS 36.101 [6].</p>
<p>interval-DLHoppingConfigCommonModeX Number of consecutive absolute subframes over which MPDCCH or PDSCH for CE mode X stays at the same narrowband before hopping to another narrowband. For interval-FDD, int1 corresponds to 1 subframe, int2 corresponds to 2 subframes, and so on. For interval-TDD, int1 corresponds to 1 subframe, int5 corresponds to 5 subframes, and so on.</p>
<p>interval-ULHoppingConfigCommonModeX Number of consecutive absolute subframes over which PUCCH or PUSCH for CE mode X stays at the same narrowband before hopping to another narrowband. For interval-FDD, int1 corresponds to 1 subframe, int2 corresponds to 2 subframes, and so on. For interval-TDD, int1 corresponds to 1 subframe, int5 corresponds to 5 subframes, and so on.</p>
<p>modificationPeriodCoeff Actual modification period, expressed in number of radio frames = $modificationPeriodCoeff * defaultPagingCycle$. n2 corresponds to value 2, n4 corresponds to value 4, n8 corresponds to value 8, n16 corresponds to value 16, and n64 corresponds to value 64.</p>
<p>mpdcch-NumRepetition-Paging Maximum number of repetitions for MPDCCH common search space (CSS) for paging, see TS 36.211 [21].</p>
<p>mpdcch-pdsch-HoppingOffset Parameter: $f_{NB, hop}^{DL}$, see TS 36.211 [21, 6.4.1].</p>
<p>mpdcch-pdsch-HoppingNB The number of narrowbands for MPDCCH/PDSCH frequency hopping. Value nb2 corresponds to 2 narrowbands and value nb4 corresponds to 4 narrowbands.</p>
<p>nB Parameter: nB is used as one of parameters to derive the Paging Frame and Paging Occasion according to TS 36.304 [4]. Value in multiples of 'T' as defined in TS 36.304 [4]. A value of fourT corresponds to 4 * T, a value of twoT corresponds to 2 * T and so on. In case <i>nB-v1310</i> is signalled, the UE shall ignore <i>nB</i> (i.e. without suffix). EUTRAN configures <i>nB-v1310</i> only in the BR version of SI message.</p>
<p>paging-narrowBands Number of narrowbands used for paging, see TS 36.304 [4], TS 36.212 [22] and TS 36.213 [23].</p>
<p>p-Max Pmax to be used in the target cell. If absent, for the band used in the target cell, the UE applies the maximum power according to its capability as specified in 36.101 [42, 6.2.2]. In case the UE is configured with uplink intra-band contiguous CA and the UE indicates <i>ue-CA-PowerClass-N</i> in that band combination, then the <i>p-Max</i> in <i>RadioResourceConfigCommonSCell</i> for that SCell, if present, also applies for that band combination whenever that SCell is activated.</p>
<p>prach-ConfigSCell Indicates a PRACH configuration for an SCell. The field is not applicable for an LAA SCell in this release.</p>
<p>rach-ConfigCommonSCell Indicates a RACH configuration for an SCell. The field is not applicable for an LAA SCell in this release.</p>
<p>soundingRS-FlexibleTiming Indicates the SRS flexible timing (if configured) for aperiodic SRS triggered by DL grant. If the SRS transmission is collided with ACK/NACK, postpone once to the next configured SRS transmission opportunity.</p>
<p>ul-Bandwidth Parameter: transmission bandwidth configuration, N_{RB}, in uplink, see TS 36.101 [42, table 5.6-1]. Value n6 corresponds to 6 resource blocks, n15 to 15 resource blocks and so on. If for FDD this parameter is absent, the uplink bandwidth is equal to the downlink bandwidth. For TDD this parameter is absent and it is equal to the downlink bandwidth.</p>

RadioResourceConfigCommon field descriptions
<p>additionalSpectrumEmissionSCell The UE requirements related to <i>additionalSpectrumEmissionSCell</i> are defined in TS 36.101 [42]. E-UTRAN configures the same value in <i>additionalSpectrumEmissionSCell</i> for all SCell(s) of the same band with UL configured. The <i>additionalSpectrumEmissionSCell</i> is applicable for all serving cells (including PCell) of the same band with UL configured.</p>
<p>ul-CarrierFreq For FDD: If absent, the (default) value determined from the default TX-RX frequency separation defined in TS 36.101 [42, table 5.7.3-1] applies. For TDD: This parameter is absent and it is equal to the downlink frequency.</p>
<p>ul-CyclicPrefixLength Parameter: Uplink cyclic prefix length see TS 36.211 [21, 5.2.1] where len1 corresponds to normal cyclic prefix and len2 corresponds to extended cyclic prefix.</p>

Conditional presence	Explanation
<i>MP-A</i>	The field is mandatory present for CE mode A. Otherwise the field is optional, Need OR.
<i>MP-B</i>	The field is mandatory present for CE mode B. Otherwise the field is optional, Need OR.
<i>TDD</i>	The field is optional for TDD, Need ON; it is not present for FDD and the UE shall delete any existing value for this field.
<i>TDD2</i>	If <i>tdd-Config-r10</i> is present, the field is optional, Need OR. Otherwise the field is not present and the UE shall delete any existing value for this field.
<i>TDD3</i>	If <i>tdd-Config</i> is present, the field is optional, Need OR. Otherwise the field is not present and the UE shall delete any existing value for this field.
<i>TDD-OR-NoR11</i>	If <i>prach-ConfigSCell-r11</i> is absent, the field is optional for TDD, Need OR. Otherwise the field is not present and the UE shall delete any existing value for this field.
<i>TDDSCell</i>	This field is mandatory present for TDD; it is not present for FDD and LAA SCell, and the UE shall delete any existing value for this field.
<i>UL</i>	If the SCell is part of the STAG or concerns the PSCell or PUCCH SCell and if <i>ul-Configuration</i> is included, the field is optional, Need OR. Otherwise the field is not present and the UE shall delete any existing value for this field.
<i>ULSCell</i>	For the PSCell (IE is included in <i>RadioResourceConfigCommonPSCell</i>) the field is absent. Otherwise, if the SCell is part of the STAG and if <i>ul-Configuration</i> is included, the field is optional, Need OR. Otherwise the field is not present and the UE shall delete any existing value for this field.
<i>ULSRS</i>	If <i>ul-Configuration-r10</i> is absent, the field is optional, Need OR. Otherwise the field is not present and the UE shall delete any existing value for this field.

RadioResourceConfigDedicated

The IE *RadioResourceConfigDedicated* is used to setup/modify/release RBs, to modify the MAC main configuration, to modify the SPS configuration and to modify dedicated physical configuration.

RadioResourceConfigDedicated information element

```

-- ASN1START
RadioResourceConfigDedicated ::=
    SEQUENCE {
        srb-ToAddModList          SRB-ToAddModList          OPTIONAL,    -- Cond HO-Conn
        drb-ToAddModList          DRB-ToAddModList          OPTIONAL,    -- Cond HO-
    toEUTRA
        drb-ToReleaseList         DRB-ToReleaseList         OPTIONAL,    -- Need ON
        mac-MainConfig            CHOICE {
            explicitValue         MAC-MainConfig,
            defaultValue          NULL
        } OPTIONAL,    -- Cond HO-
    toEUTRA2
        sps-Config                SPS-Config                OPTIONAL,    -- Need ON
        physicalConfigDedicated   PhysicalConfigDedicated OPTIONAL,    -- Need ON
        . . .
        [[ rlf-TimersAndConstants-r9   RLF-TimersAndConstants-r9   OPTIONAL    -- Need ON
        ]],
        [[ measSubframePatternPCell-r10 MeasSubframePatternPCell-r10 OPTIONAL    -- Need ON
        ]],
        [[ neighCellsCRS-Info-r11      NeighCellsCRS-Info-r11      OPTIONAL    -- Need ON
        ]],
        [[ naics-Info-r12              NAICS-AssistanceInfo-r12      OPTIONAL    -- Need ON
        ]],
    }

```

```

[[ neighCellsCRS-Info-r13          NeighCellsCRS-Info-r13          OPTIONAL,  -- Cond
CRSIM
   rlf-TimersAndConstants-r13      RLF-TimersAndConstants-r13      OPTIONAL  -- Need ON
]],
[[ sps-Config-v1430                SPS-Config-v1430                OPTIONAL  -- Cond SPS
]]
}

RadioResourceConfigDedicated-v1370 ::= SEQUENCE {
   physicalConfigDedicated-v1370    PhysicalConfigDedicated-v1370    OPTIONAL  -- Need ON
}

RadioResourceConfigDedicated-v13c0 ::= SEQUENCE {
   physicalConfigDedicated-v13c0     PhysicalConfigDedicated-v13c0
}

RadioResourceConfigDedicatedPSCell-r12 ::= SEQUENCE {
   -- UE specific configuration extensions applicable for an PSCell
   physicalConfigDedicatedPSCell-r12 PhysicalConfigDedicated          OPTIONAL,  -- Need ON
   sps-Config-r12                    SPS-Config                      OPTIONAL,  -- Need ON
   naics-Info-r12                    NAICS-AssistanceInfo-r12        OPTIONAL,  -- Need ON
   ...,
   [[ neighCellsCRS-InfoPSCell-r13    NeighCellsCRS-Info-r13          OPTIONAL  -- Need ON
   ]],
   [[ sps-Config-v1430                SPS-Config-v1430                OPTIONAL  -- Cond SPS2
   ]]
}

RadioResourceConfigDedicatedPSCell-v1370 ::= SEQUENCE {
   physicalConfigDedicatedPSCell-v1370 PhysicalConfigDedicated-v1370    OPTIONAL  -- Need ON
}

RadioResourceConfigDedicatedPSCell-v13c0 ::= SEQUENCE {
   physicalConfigDedicatedPSCell-v13c0 PhysicalConfigDedicated-v13c0
}

RadioResourceConfigDedicatedSCG-r12 ::= SEQUENCE {
   drb-ToAddModListSCG-r12          DRB-ToAddModListSCG-r12          OPTIONAL,  -- Need ON
   mac-MainConfigSCG-r12            MAC-MainConfig                   OPTIONAL,  -- Need ON
   rlf-TimersAndConstantsSCG-r12    RLF-TimersAndConstantsSCG-r12    OPTIONAL,  -- Need ON
   ...
}

RadioResourceConfigDedicatedSCell-r10 ::= SEQUENCE {
   -- UE specific configuration extensions applicable for an SCell
   physicalConfigDedicatedSCell-r10 PhysicalConfigDedicatedSCell-r10  OPTIONAL,  -- Need
ON
   ...,
   [[ mac-MainConfigSCell-r11         MAC-MainConfigSCell-r11         OPTIONAL  -- Cond SCellAdd
   ]],
   [[ naics-Info-r12                  NAICS-AssistanceInfo-r12        OPTIONAL  -- Need ON
   ]],
   [[ neighCellsCRS-InfoSCell-r13     NeighCellsCRS-Info-r13          OPTIONAL  -- Need ON
   ]],
   [[ physicalConfigDedicatedSCell-v1370 PhysicalConfigDedicatedSCell-v1370 OPTIONAL  -- Need
ON
   ]]
}

RadioResourceConfigDedicatedSCell-v13c0 ::= SEQUENCE {
   physicalConfigDedicatedSCell-v13c0 PhysicalConfigDedicatedSCell-v13c0
}

SRB-ToAddModList ::= SEQUENCE (SIZE (1..2)) OF SRB-ToAddMod

SRB-ToAddMod ::= SEQUENCE {
   srb-Identity                      INTEGER (1..2),
   rlc-Config                         CHOICE {
      explicitValue                   RLC-Config,
      defaultValue                    NULL
   } OPTIONAL,  -- Cond Setup
   logicalChannelConfig              CHOICE {
      explicitValue                   LogicalChannelConfig,
      defaultValue                    NULL
   } OPTIONAL,  -- Cond Setup
   ...
}

```

```

DRB-ToAddModList ::= SEQUENCE (SIZE (1..maxDRB)) OF DRB-ToAddMod
DRB-ToAddModListSCG-r12 ::= SEQUENCE (SIZE (1..maxDRB)) OF DRB-ToAddModSCG-r12
DRB-ToAddMod ::= SEQUENCE {
    eps-BearerIdentity      INTEGER (0..15)          OPTIONAL,      -- Cond DRB-Setup
    drb-Identity            DRB-Identity,
    pdcp-Config            PDCP-Config          OPTIONAL,      -- Cond PDCP
    rlc-Config             RLC-Config          OPTIONAL,      -- Cond SetupM
    logicalChannelIdentity  INTEGER (3..10)     OPTIONAL,      -- Cond DRB-SetupM
    logicalChannelConfig    LogicalChannelConfig OPTIONAL,      -- Cond SetupM
    ...,
    [[ drb-TypeChange-r12   ENUMERATED {toMCG}   OPTIONAL,      -- Need OP
      rlc-Config-v1250     RLC-Config-v1250     OPTIONAL      -- Need ON
    ]],
    [[ rlc-Config-v1310     RLC-Config-v1310     OPTIONAL,      -- Need ON
      drb-TypeLWA-r13      BOOLEAN              OPTIONAL,      -- Need ON
      drb-TypeLWIP-r13     ENUMERATED {lwip, lwip-DL-only,
                                       lwip-UL-only, eutran}    OPTIONAL      -- Need ON
    ]],
    [[ rlc-Config-v1430     RLC-Config-v1430     OPTIONAL,      -- Need ON
      lwip-UL-Aggregation-r14 BOOLEAN          OPTIONAL,      -- Cond LWIP
      lwip-DL-Aggregation-r14 BOOLEAN          OPTIONAL,      -- Cond LWIP
      lwa-WLAN-AC-r14      ENUMERATED {ac-bk, ac-be, ac-vi, ac-vo} OPTIONAL      -- Cond UL-LWA
    ]],
    ]],
}

DRB-ToAddModSCG-r12 ::= SEQUENCE {
    drb-Identity-r12        DRB-Identity,
    drb-Type-r12           CHOICE {
        split-r12          NULL,
        scg-r12            SEQUENCE {
            eps-BearerIdentity-r12 INTEGER (0..15) OPTIONAL,      -- Cond DRB-Setup
            pdcp-Config-r12      PDCP-Config  OPTIONAL      -- Cond PDCP-S
        }
    },
    rlc-ConfigSCG-r12      RLC-Config          OPTIONAL,      -- Cond SetupS2
    rlc-Config-v1250       RLC-Config-v1250     OPTIONAL,      -- Cond SetupS
    logicalChannelIdentitySCG-r12 INTEGER (3..10)     OPTIONAL,      -- Cond DRB-SetupS
    logicalChannelConfigSCG-r12 LogicalChannelConfig OPTIONAL,      -- Cond SetupS
    ...,
    [[ rlc-Config-v1430     RLC-Config-v1430     OPTIONAL      -- Need ON
    ]],
}

DRB-ToReleaseList ::= SEQUENCE (SIZE (1..maxDRB)) OF DRB-Identity

MeasSubframePatternPCell-r10 ::= CHOICE {
    release                NULL,
    setup                  MeasSubframePattern-r10
}

NeighCellsCRS-Info-r11 ::= CHOICE {
    release                NULL,
    setup                  CRS-AssistanceInfoList-r11
}

CRS-AssistanceInfoList-r11 ::= SEQUENCE (SIZE (1..maxCellReport)) OF CRS-AssistanceInfo-r11

CRS-AssistanceInfo-r11 ::= SEQUENCE {
    physCellId-r11        PhysCellId,
    antennaPortsCount-r11 ENUMERATED {an1, an2, an4, spare1},
    mbsfn-SubframeConfigList-r11 MBSFN-SubframeConfigList,
    ...,
    [[ mbsfn-SubframeConfigList-v1430 MBSFN-SubframeConfigList-v1430 OPTIONAL      -- Need ON
    ]],
}

NeighCellsCRS-Info-r13 ::= CHOICE {
    release                NULL,
    setup                  CRS-AssistanceInfoList-r13
}

CRS-AssistanceInfoList-r13 ::= SEQUENCE (SIZE (1..maxCellReport)) OF CRS-AssistanceInfo-r13

CRS-AssistanceInfo-r13 ::= SEQUENCE {
    physCellId-r13        PhysCellId,
    antennaPortsCount-r13 ENUMERATED {an1, an2, an4, spare1},
}

```

```

    mbsfn-SubframeConfigList-r13      MBSFN-SubframeConfigList      OPTIONAL,  -- Need ON
    ...,
    [[ mbsfn-SubframeConfigList-v1430  MBSFN-SubframeConfigList-v1430  OPTIONAL  -- Need ON
    ]]
}

NAICS-AssistanceInfo-r12 ::=      CHOICE {
  release                          NULL,
  setup                            SEQUENCE {
    neighCellsToReleaseList-r12    NeighCellsToReleaseList-r12    OPTIONAL,  -- Need ON
    neighCellsToAddModList-r12     NeighCellsToAddModList-r12     OPTIONAL,  -- Need ON
    servCellp-a-r12                P-a                             OPTIONAL,  -- Need ON
  }
}

NeighCellsToReleaseList-r12 ::=    SEQUENCE (SIZE (1..maxNeighCell-r12)) OF PhysCellId

NeighCellsToAddModList-r12 ::=    SEQUENCE (SIZE (1..maxNeighCell-r12)) OF NeighCellsInfo-r12

NeighCellsInfo-r12 ::=            SEQUENCE {
  physCellId-r12                  PhysCellId,
  p-b-r12                          INTEGER (0..3),
  crs-PortsCount-r12              ENUMERATED {n1, n2, n4, spare},
  mbsfn-SubframeConfig-r12        MBSFN-SubframeConfigList        OPTIONAL,  -- Need ON
  p-aList-r12                      SEQUENCE (SIZE (1..maxP-a-PerNeighCell-r12)) OF P-a,
  transmissionModeList-r12        BIT STRING (SIZE(8)),
  resAllocGranularity-r12         INTEGER (1..4),
  ...
}

P-a ::= ENUMERATED {      dB-6, dB-4dot77, dB-3, dB-1dot77,
                        dB0, dB1, dB2, dB3}

-- ASN1STOP

```

RadioResourceConfigDedicated field descriptions
<p>crs-PortsCount Parameter represents the number of antenna ports for cell-specific reference signal used by the signaled neighboring cell where n1 corresponds to 1 antenna port, n2 to 2 antenna ports etc. see TS 36.211 [21, 6.10.1].</p>
<p>drb-Identity In case of DC, the DRB identity is unique within the scope of the UE i.e. an SCG DRB can not use the same value as used for an MCG or split DRB. For a split DRB the same identity is used for the MCG- and SCG parts of the configuration.</p>
<p>drb-ToAddModListSCG When an SCG is configured, E-UTRAN configures at least one SCG or split DRB.</p>
<p>drb-Type This field indicates whether the DRB is split or SCG DRB. E-UTRAN does not configure split and SCG DRBs simultaneously for the UE.</p>
<p>drb-TypeChange Indicates that a split/SCG DRB is reconfigured to an MCG DRB (i.e. E-UTRAN only signals the field in case the DRB type changes).</p>
<p>drb-TypeLWA Indicates whether a DRB is (re)configured as an LWA DRB or an LWA DRB is reconfigured not to use WLAN resources. NOTE 1</p>
<p>drb-TypeLWIP Indicates whether a DRB is (re)configured to use LWIP Tunnel in UL and DL (value <i>lwip</i>), DL only (value <i>lwip-DL-only</i>), UL only (value <i>lwip-UL-only</i>) or not to use LWIP Tunnel (value <i>eutran</i>).</p>
<p>logicalChannelConfig For SRBs a choice is used to indicate whether the logical channel configuration is signalled explicitly or set to the default logical channel configuration for SRB1 as specified in 9.2.1.1 or for SRB2 as specified in 9.2.1.2.</p>
<p>logicalChannelIdentity The logical channel identity for both UL and DL.</p>
<p>lwa-WLAN-AC For LWA bearers, indicates the corresponding WLAN access category for uplink. AC-BK (value <i>ac-bk</i>) corresponds to Background access category, AC-BE (value <i>ac-be</i>) corresponds to Best Effort access category, AC-VI (value <i>ac-vi</i>) corresponds to Video access category and AC-VO (value <i>ac-vo</i>) corresponds to Voice access category as defined by IEEE 802.11-2012 [67]. If <i>lwa-WLAN-AC</i> is not configured, it is left up to UE to decide which IEEE 802.11 AC value to use when performing transmissions of packets for this DRB over WLAN in the uplink.</p>
<p>lwip-DL-Aggregation, lwip-UL-Aggregation Indicates whether LWIP is configured to utilize LWIP aggregation in DL or UL.</p>
<p>mac-MainConfig Although the ASN.1 includes a choice that is used to indicate whether the mac-MainConfig is signalled explicitly or set to the default MAC main configuration as specified in 9.2.2, EUTRAN does not apply "defaultValue".</p>
<p>mbsfn-SubframeConfig Defines the MBSFN subframe configuration used by the signaled neighboring cell. If absent, UE assumes no MBSFN configuration for the neighboring cell.</p>
<p>measSubframePatternPCell Time domain measurement resource restriction pattern for the PCell measurements (RSRP, RSRQ and the radio link monitoring).</p>
<p>neighCellsCRS-Info, neighCellsCRS-InfoSCell, neighCellsCRS-InfoPSCell This field contains assistance information used by the UE to mitigate interference from CRS while performing RRM/RLM/CSI measurement or data demodulation or DL control channel demodulation. When the received CRS assistance information is for a cell with CRS non-colliding with that of the CRS of the cell to measure, the UE may use the CRS assistance information to mitigate CRS interference. When the received CRS assistance information is for a cell with CRS colliding with that of the CRS of the cell to measure, the UE may use the CRS assistance information to mitigate CRS interference RRM/RLM (as specified in TS 36.133 [16]) and for CSI (as specified in TS 36.101 [42]) on the subframes indicated by <i>measSubframePatternPCell</i>, <i>measSubframePatternConfigNeigh</i>, <i>csi-MeasSubframeSet1</i> if configured, and the CSI subframe set 1 if <i>csi-MeasSubframeSets-r12</i> is configured. The UE may use CRS assistance information to mitigate CRS interference from the cells in the <i>CRS-AssistanceInfoList</i> for the demodulation purpose or DL control channel demodulation as specified in TS 36.101 [42]. EUTRAN does not configure <i>neighCellsCRS-Info-r11</i> or <i>neighCellsCRS-Info-r13</i> if <i>eimta-MainConfigPCell-r12</i> is configured.</p>
<p>neighCellsToAddModList This field contains assistance information used by the UE to cancel and suppress interference of a neighbouring cell. If this field is present for a neighbouring cell, the UE assumes that the transmission parameters listed in the sub-fields are used by the neighbouring cell. If this field is present for a neighbouring cell, the UE assumes the neighbour cell is subframe and SFN synchronized to the serving cell, has the same system bandwidth, UL/DL and special subframe configuration, and cyclic prefix length as the serving cell.</p>
<p>p-aList Indicates the restricted subset of power offset for QPSK, 16QAM, and 64QAM PDSCH transmissions for the neighbouring cell by using the parameter P_A, see TS 36.213 [23, 5.2]. Value dB-6 corresponds to -6 dB, dB-4dot77 corresponds to -4.77 dB etc.</p>

RadioResourceConfigDedicated field descriptions
<p>p-b Parameter: P_B, indicates the cell-specific ratio used by the signaled neighboring cell, see TS 36.213 [23, Table 5.2-1].</p>
<p>physicalConfigDedicated The default dedicated physical configuration is specified in 9.2.4.</p>
<p>resAllocGranularity Indicates the resource allocation and precoding granularity in PRB pair level of the signaled neighboring cell, see TS 36.213 [23, 7.1.6].</p>
<p>rlc-Config For SRBs a choice is used to indicate whether the RLC configuration is signalled explicitly or set to the values defined in the default RLC configuration for SRB1 in 9.2.1.1 or for SRB2 in 9.2.1.2. RLC AM is the only applicable RLC mode for SRB1 and SRB2. E-UTRAN does not reconfigure the RLC mode of DRBs except when a full configuration option is used, and may reconfigure the RLC SN field size and the AM RLC LI field size only upon handover within E-UTRA or upon the first reconfiguration after RRC connection re-establishment or upon SCG Change for SCG and split DRBs.</p>
<p>servCellp-a Indicates the power offset for QPSK C-RNTI based PDSCH transmissions used by the serving cell, see TS 36.213 [23, 5.2]. Value dB-6 corresponds to -6 dB, dB-4dot77 corresponds to -4.77 dB etc.</p>
<p>sps-Config The default SPS configuration is specified in 9.2.3. Except for handover or releasing SPS for MCG, E-UTRAN does not reconfigure <i>sps-Config</i> for MCG when there is a configured downlink assignment or a configured uplink grant for MCG (see TS 36.321 [6]). Except for SCG change or releasing SPS for SCG, E-UTRAN does not reconfigure <i>sps-Config</i> for SCG when there is a configured downlink assignment or a configured uplink grant for SCG (see TS 36.321 [6]).</p>
<p>srb-Identity Value 1 is applicable for SRB1 only. Value 2 is applicable for SRB2 only.</p>
<p>transmissionModeList Indicates a subset of transmission mode 1, 2, 3, 4, 6, 8, 9, 10, for the signaled neighboring cell for which <i>NeighCellsInfo</i> applies. When TM10 is signaled, other signaled transmission parameters in <i>NeighCellsInfo</i> are not applicable to up to 8 layer transmission scheme of TM10. E-UTRAN may indicate TM9 when TM10 with QCL type A and DMRS scrambling with $n_{ID}^{(i)} = N_{ID}^{cell}$ in TS 36.211 [21, 6.10.3.1] is used in the signalled neighbour cell and TM9 or TM10 with QCL type A and DMRS scrambling with $n_{ID}^{(i)} = N_{ID}^{cell}$ in TS 36.211 [21, 6.10.3.1] is used in the serving cell. UE behaviour with NAICS when TM10 is used is only defined when QCL type A and DMRS scrambling with $n_{ID}^{(i)} = N_{ID}^{cell}$ in TS 36.211 [21, 6.10.3.1] is used for the serving cell and all signalled neighbour cells. The first/ leftmost bit is for transmission mode 1, the second bit is for transmission mode 2, and so on.</p>

NOTE 1: It is up to eNB to ensure that the field indicating LWA bearer type is set to FALSE when LWA bearer is no longer used (e.g. during handover or re-establishment where LWA configuration is released).

Conditional presence	Explanation
<i>UL-LWA</i>	The field is optionally present, need ON if <i>ul-LWA-Config-r14</i> is present. Otherwise the field is not present.
<i>CRSIM</i>	The field is optionally present, need ON, if <i>neighCellsCRS-Info-r11</i> is not present; otherwise it is not present.
<i>DRB-Setup</i>	The field is mandatory present if the corresponding DRB is being set up; otherwise it is not present.
<i>DRB-SetupM</i>	The field is mandatory present upon setup of MCG or split DRB; The field is optionally present, Need ON, upon change from SCG to MCG DRB; otherwise it is not present.
<i>DRB-SetupS</i>	The field is mandatory present upon setup of SCG or split DRB, or upon change from MCG to split DRB; The field is optionally present, Need ON, upon change from MCG to SCG DRB; otherwise it is not present.
<i>HO-Conn</i>	The field is mandatory present in case of handover to E-UTRA or when the <i>fullConfig</i> is included in the <i>RRConnectionReconfiguration</i> message or in case of RRC connection establishment (excluding <i>RRConnectionResume</i>); otherwise the field is optionally present, need ON. Upon connection establishment/ re-establishment only SRB1 is applicable (excluding <i>RRConnectionResume</i>).
<i>HO-toEUTRA</i>	The field is mandatory present in case of handover to E-UTRA or when the <i>fullConfig</i> is included in the <i>RRConnectionReconfiguration</i> message; In case of RRC connection establishment (excluding <i>RRConnectionResume</i>); and RRC connection re-establishment the field is not present; otherwise the field is optionally present, need ON.
<i>HO-toEUTRA2</i>	The field is mandatory present in case of handover to E-UTRA or when the <i>fullConfig</i> is included in the <i>RRConnectionReconfiguration</i> message; otherwise the field is optionally present, need ON.
<i>LWIP</i>	The field is optionally present, Need ON, if <i>drbTypeLWIP-r13</i> is not set to eutran; otherwise it is not present and the UE shall delete any existing value for this field.
<i>PDCP</i>	The field is mandatory present if the corresponding DRB is being setup; the field is optionally present, need ON, upon reconfiguration of the corresponding split DRB or LWA DRB, upon the corresponding DRB type change from split to MCG bearer, upon the corresponding DRB type change from MCG to split bearer or LWA bearer, upon the corresponding DRB type change from LWA to LTE only bearer, upon handover within E-UTRA and upon the first reconfiguration after re-establishment but in all these cases only when <i>fullConfig</i> is not included in the <i>RRConnectionReconfiguration</i> message; otherwise it is not present.
<i>PDCP-S</i>	The field is mandatory present if the corresponding DRB is being setup; the field is optionally present, need ON, upon SCG change; otherwise it is not present.
<i>RLC-Setup</i>	This field is optionally present if the corresponding DRB is being setup, need ON; otherwise it is not present.
<i>SCellAdd</i>	The field is optionally present, need ON, upon SCell addition; otherwise it is not present.
<i>Setup</i>	The field is mandatory present if the corresponding SRB/DRB is being setup; otherwise the field is optionally present, need ON.
<i>SetupM</i>	The field is mandatory present upon setup of an MCG or split DRB; otherwise the field is optionally present, need ON.
<i>SetupS</i>	The field is mandatory present upon setup of an SCG or split DRB, as well as upon change from MCG to split DRB; otherwise the field is optionally present, need ON.
<i>SetupS2</i>	The field is mandatory present upon setup of an SCG or split DRB, as well as upon change from MCG to split or SCG DRB. For an SCG DRB the field is optionally present, need ON. Otherwise the field is not present.
<i>SPS</i>	The field is optionally present, need ON, if <i>sps-Config</i> (without suffix) is not configured; otherwise it is not present.
<i>SPS2</i>	The field is optionally present, need ON, if <i>sps-Config-r12</i> is not configured; otherwise it is not present.

– *RCLWI-Configuration*

The IE *RCLWI-Configuration* is used to add, modify or release the RCLWI configuration.

```

-- ASN1START
RCLWI-Configuration-r13 ::= CHOICE {
    release
        NULL,
    setup
        SEQUENCE {
            rclwi-Config-r13
            RCLWI-Config-r13
        }
}
RCLWI-Config-r13 ::= SEQUENCE {

```

```

command CHOICE {
  steerToWLAN-r13 SEQUENCE {
    mobilityConfig-r13 WLAN-Id-List-r12
  },
  steerToLTE-r13 NULL
},
...
}
-- ASN1STOP

```

– RLC-Config

The IE *RLC-Config* is used to specify the RLC configuration of SRBs and DRBs.

RLC-Config information element

```

-- ASN1START
RLC-Config ::= CHOICE {
  am SEQUENCE {
    ul-AM-RLC UL-AM-RLC,
    dl-AM-RLC DL-AM-RLC
  },
  um-Bi-Directional SEQUENCE {
    ul-UM-RLC UL-UM-RLC,
    dl-UM-RLC DL-UM-RLC
  },
  um-Uni-Directional-UL SEQUENCE {
    ul-UM-RLC UL-UM-RLC
  },
  um-Uni-Directional-DL SEQUENCE {
    dl-UM-RLC DL-UM-RLC
  },
  ...
}

RLC-Config-v1250 ::= SEQUENCE {
  ul-extended-RLC-LI-Field-r12 BOOLEAN,
  dl-extended-RLC-LI-Field-r12 BOOLEAN
}

RLC-Config-v1310 ::= SEQUENCE {
  ul-extended-RLC-AM-SN-r13 BOOLEAN,
  dl-extended-RLC-AM-SN-r13 BOOLEAN,
  pollPDU-v1310 OPTIONAL -- Need OR
}

RLC-Config-v1430 ::= CHOICE {
  release NULL,
  setup SEQUENCE {
    pollByte-r14
  }
}

UL-AM-RLC ::= SEQUENCE {
  t-PollRetransmit T-PollRetransmit,
  pollPDU PollPDU,
  pollByte PollByte,
  maxRetxThreshold ENUMERATED {
    t1, t2, t3, t4, t6, t8, t16, t32
  }
}

DL-AM-RLC ::= SEQUENCE {
  t-Reordering T-Reordering,
  t-StatusProhibit T-StatusProhibit
}

UL-UM-RLC ::= SEQUENCE {
  sn-FieldLength SN-FieldLength
}

DL-UM-RLC ::= SEQUENCE {
  sn-FieldLength SN-FieldLength,
  t-Reordering T-Reordering
}

```



```

}
SN-FieldLength ::=          ENUMERATED {size5, size10}
T-PollRetransmit ::=        ENUMERATED {
    ms5, ms10, ms15, ms20, ms25, ms30, ms35,
    ms40, ms45, ms50, ms55, ms60, ms65, ms70,
    ms75, ms80, ms85, ms90, ms95, ms100, ms105,
    ms110, ms115, ms120, ms125, ms130, ms135,
    ms140, ms145, ms150, ms155, ms160, ms165,
    ms170, ms175, ms180, ms185, ms190, ms195,
    ms200, ms205, ms210, ms215, ms220, ms225,
    ms230, ms235, ms240, ms245, ms250, ms300,
    ms350, ms400, ms450, ms500, ms800-v1310,
    ms1000-v1310, ms2000-v1310, ms4000-v1310,
    spare5, spare4, spare3, spare2, spare1}
PollPDU ::=                 ENUMERATED {
    p4, p8, p16, p32, p64, p128, p256, pInfinity}
PollPDU-v1310 ::=          ENUMERATED {
    p512, p1024, p2048, p4096, p6144, p8192, p12288, p16384}
PollByte ::=                ENUMERATED {
    kB25, kB50, kB75, kB100, kB125, kB250, kB375,
    kB500, kB750, kB1000, kB1250, kB1500, kB2000,
    kB3000, kBInfinity, spare1}
PollByte-r14 ::=           ENUMERATED {
    kB1, kB2, kB5, kB8, kB10, kB15, kB3500,
    kB4000, kB4500, kB5000, kB5500, kB6000, kB6500,
    kB7000, kB7500, kB8000, kB9000, kB10000, kB11000, kB12000,
    kB13000, kB14000, kB15000, kB16000, kB17000, kB18000,
    kB19000, kB20000, kB25000, kB30000, kB35000, kB40000}
T-Reordering ::=           ENUMERATED {
    ms0, ms5, ms10, ms15, ms20, ms25, ms30, ms35,
    ms40, ms45, ms50, ms55, ms60, ms65, ms70,
    ms75, ms80, ms85, ms90, ms95, ms100, ms110,
    ms120, ms130, ms140, ms150, ms160, ms170,
    ms180, ms190, ms200, ms1600-v1310}
T-StatusProhibit ::=       ENUMERATED {
    ms0, ms5, ms10, ms15, ms20, ms25, ms30, ms35,
    ms40, ms45, ms50, ms55, ms60, ms65, ms70,
    ms75, ms80, ms85, ms90, ms95, ms100, ms105,
    ms110, ms115, ms120, ms125, ms130, ms135,
    ms140, ms145, ms150, ms155, ms160, ms165,
    ms170, ms175, ms180, ms185, ms190, ms195,
    ms200, ms205, ms210, ms215, ms220, ms225,
    ms230, ms235, ms240, ms245, ms250, ms300,
    ms350, ms400, ms450, ms500, ms800-v1310,
    ms1000-v1310, ms1200-v1310, ms1600-v1310, ms2000-v1310,
    ms2400-v1310, spare2,
    spare1}
-- ASN1STOP

```

RLC-Config field descriptions
<p>dl-extended-RLC-LI-Field, ul-extended-RLC-LI-Field Indicates the RLC LI field size. Value <i>TRUE</i> means that 15 bit LI length shall be used, otherwise 11 bit LI length shall be used; see TS 36.322 [7]. E-UTRAN enables this field only when <i>RLC-Config</i> (without suffix) is set to <i>am</i>.</p>
<p>maxRetxThreshold Parameter for RLC AM in TS 36.322 [7]. Value t1 corresponds to 1 retransmission, t2 to 2 retransmissions and so on.</p>
<p>pollByte Parameter for RLC AM in TS 36.322 [7]. Value kB25 corresponds to 25 kBytes, kB50 to 50 kBytes and so on. kBInfinity corresponds to an infinite amount of kBytes. In case <i>pollByte-r14</i> is signalled, the UE shall ignore pollByte (i.e. without suffix).</p>
<p>pollPDU Parameter for RLC AM in TS 36.322 [7]. Value p4 corresponds to 4 PDUs, p8 to 8 PDUs and so on. pInfinity corresponds to an infinite number of PDUs. In case <i>pollPDU-r13</i> is signalled, the UE shall ignore <i>pollPDU</i> (i.e. without suffix). E-UTRAN enables <i>pollPDU-v1310</i> field only when <i>RLC-Config</i> (without suffix) is set to <i>am</i>.</p>
<p>sn-FieldLength Indicates the UM RLC SN field size, see TS 36.322 [7], in bits. Value size5 means 5 bits, size10 means 10 bits.</p>
<p>t-PollRetransmit Timer for RLC AM in TS 36.322 [7], in milliseconds. Value ms5 means 5ms, ms10 means 10ms and so on. EUTRAN configures values msX-v1310 (with suffix) only if UE supports CE.</p>
<p>t-Reordering Timer for reordering in TS 36.322 [7], in milliseconds. Value ms0 means 0ms and behaviour as specified in 7.3.2 applies, ms5 means 5ms and so on.</p>
<p>t-StatusProhibit Timer for status reporting in TS 36.322 [7], in milliseconds. Value ms0 means 0ms and behaviour as specified in 7.3.2 applies, ms5 means 5ms and so on. EUTRAN configures values msX-v1310 (with suffix) only if UE supports operation in CE.</p>
<p>ul-extended-RLC-AM-SN, dl-extended-RLC-AM-SN Indicates whether or not the UE shall use the extended SN and SO length for AM bearer. Value <i>TRUE</i> means that 16 bit SN length and 16 bit SO length shall be used, otherwise 10 bit SN length and 15 bit SO length shall be used; see TS 36.322 [7].</p>

– RLF-TimersAndConstants

The IE *RLF-TimersAndConstants* contains UE specific timers and constants applicable for UEs in RRC_CONNECTED.

RLF-TimersAndConstants information element

```

-- ASN1START
RLF-TimersAndConstants-r9 ::=
    CHOICE {
        release
        setup
            t301-r9
            t310-r9
            n310-r9
            t311-r9
            n311-r9
            ...
    }
}

RLF-TimersAndConstants-r13 ::=
    CHOICE {
        release
        setup
            t301-v1310
            ...
            [[ t310-v1330
            ]]
    }
}

```

```

RLF-TimersAndConstantsSCG-r12 ::=
  CHOICE {
    release
    setup
      t313-r12
      n313-r12
      n314-r12
      ...
  }
-- ASN1STOP

```

RLF-TimersAndConstants field descriptions

n3xy

Constants are described in clause 7.4. n1 corresponds with 1, n2 corresponds with 2 and so on.

t3xy

Timers are described in clause 7.3. Value ms0 corresponds with 0 ms, ms50 corresponds with 50 ms and so on.

E-UTRAN configures *RLF-TimersAndConstants-r13* only if UE supports *ce-ModeB*. UE shall use the extended values *t3xy-v1310* and *t3xy-v1330*, if present, and ignore the values signaled by *t3xy-r9*.

RN-SubframeConfig

The IE *RN-SubframeConfig* is used to specify the subframe configuration for an RN.

RN-SubframeConfig information element

```

-- ASN1START
RN-SubframeConfig-r10 ::=
  SEQUENCE {
    subframeConfigPattern-r10
      CHOICE {
        subframeConfigPatternFDD-r10 BIT STRING (SIZE(8)),
        subframeConfigPatternTDD-r10 INTEGER (0..31)
      }
      OPTIONAL, -- Need ON
    rpdccch-Config-r10
      SEQUENCE {
        resourceAllocationType-r10
          ENUMERATED {type0, type1, type2Localized, type2Distributed,
            spare4, spare3, spare2, spare1},
        resourceBlockAssignment-r10
          CHOICE {
            type01-r10
              CHOICE {
                nrb6-r10 BIT STRING (SIZE(6)),
                nrb15-r10 BIT STRING (SIZE(8)),
                nrb25-r10 BIT STRING (SIZE(13)),
                nrb50-r10 BIT STRING (SIZE(17)),
                nrb75-r10 BIT STRING (SIZE(19)),
                nrb100-r10 BIT STRING (SIZE(25))
              },
            type2-r10
              CHOICE {
                nrb6-r10 BIT STRING (SIZE(5)),
                nrb15-r10 BIT STRING (SIZE(7)),
                nrb25-r10 BIT STRING (SIZE(9)),
                nrb50-r10 BIT STRING (SIZE(11)),
                nrb75-r10 BIT STRING (SIZE(12)),
                nrb100-r10 BIT STRING (SIZE(13))
              },
            ...
          },
        demodulationRS-r10
          CHOICE {
            interleaving-r10
              ENUMERATED {crs},
            noInterleaving-r10
              ENUMERATED {crs, dmrs}
          },
        pdsch-Start-r10
          INTEGER (1..3),
        pucch-Config-r10
          CHOICE {
            tdd
              CHOICE {
                channelSelectionMultiplexingBundling
                  SEQUENCE {
                    n1PUCCH-AN-List-r10
                      SEQUENCE (SIZE (1..4)) OF INTEGER (0..2047)
                  },
                fallbackForFormat3
                  SEQUENCE {
                    n1PUCCH-AN-P0-r10
                      INTEGER (0..2047),
                    n1PUCCH-AN-P1-r10
                      INTEGER (0..2047)
                  }
              }
            OPTIONAL -- Need OR
          }
      }
  }
-- ASN1STOP

```

```

    },
    fdd
        n1PUCCH-AN-P0-r10      INTEGER (0..2047),
        n1PUCCH-AN-P1-r10      INTEGER (0..2047)          OPTIONAL    -- Need OR
    }
    },
    ...
}
...
OPTIONAL,    -- Need ON
}
-- ASN1STOP

```

RN-SubframeConfig field descriptions

demodulationRS

Indicates which reference signals are used for R-PDCCH demodulation according to TS 36.216 [55, 7.4.1]. Value interleaving corresponds to cross-interleaving and value noInterleaving corresponds to no cross-interleaving according to TS 36.216 [55, 7.4.2 and 7.4.3].

n1PUCCH-AN-List

Parameter: $n_{\text{PUCCH},l}^{(1)}$, see TS 36.216, [55, 7.5.1]. This parameter is only applicable for TDD. Configures PUCCH HARQ-ACK resources if the RN is configured to use HARQ-ACK channel selection, HARQ-ACK multiplexing or HARQ-ACK bundling.

n1PUCCH-AN-P0, n1PUCCH-AN-P1

Parameter: $n_{\text{PUCCH}}^{(1,p)}$, for antenna port P0 and for antenna port P1 respectively, see TS 36.216, [55, 7.5.1] for FDD and [55, 7.5.2] for TDD.

pdsch-Start

Parameter: *DL-StartSymbol*, see TS 36.216 [55, Table 5.4-1].

resourceAllocationType

Represents the resource allocation used: type 0, type 1 or type 2 according to TS 36.213 [23, 7.1.6]. Value type0 corresponds to type 0, value type1 corresponds to type 1, value type2Localized corresponds to type 2 with localized virtual resource blocks and type2Distributed corresponds to type 2 with distributed virtual resource blocks.

resourceBlockAssignment

Indicates the resource block assignment bits according to TS 36.213 [23, 7.1.6]. Value type01 corresponds to type 0 and type 1, and the value type2 corresponds to type 2. Value nrb6 corresponds to a downlink system bandwidth of 6 resource blocks, value nrb15 corresponds to a downlink system bandwidth of 15 resource blocks, and so on.

subframeConfigPatternFDD

Parameter: *SubframeConfigurationFDD*, see TS 36.216 [55, Table 5.2-1]. Defines the DL subframe configuration for eNB-to-RN transmission, i.e. those subframes in which the eNB may indicate downlink assignments for the RN. The radio frame in which the pattern starts (i.e. the radio frame in which the first bit of the *subframeConfigPatternFDD* corresponds to subframe #0) occurs when $\text{SFN mod } 4 = 0$.

subframeConfigPatternTDD

Parameter: *SubframeConfigurationTDD*, see TS 36.216 [55, Table 5.2-2]. Defines the DL and UL subframe configuration for eNB-RN transmission.

SchedulingRequestConfig

The IE *SchedulingRequestConfig* is used to specify the Scheduling Request related parameters

SchedulingRequestConfig information element

```

-- ASN1START
SchedulingRequestConfig ::= CHOICE {
    release      NULL,
    setup        SEQUENCE {
        sr-PUCCH-ResourceIndex      INTEGER (0..2047),
        sr-ConfigIndex              INTEGER (0..157),
        dsr-TransMax                 ENUMERATED {
            n4, n8, n16, n32, n64, spare3, spare2, spare1}
        }
    }
}

SchedulingRequestConfig-v1020 ::= SEQUENCE {
    sr-PUCCH-ResourceIndexP1-r10    INTEGER (0..2047)          OPTIONAL    -- Need OR
}

```

```

SchedulingRequestConfigSCell-r13 ::= CHOICE {
  release      NULL,
  setup       SEQUENCE {
    sr-PUCCH-ResourceIndex-r13      INTEGER (0..2047),
    sr-PUCCH-ResourceIndexP1-r13    INTEGER (0..2047)          OPTIONAL,      -- Need OR
    sr-ConfigIndex-r13              INTEGER (0..157),
    dsr-TransMax-r13                ENUMERATED {
                                   n4, n8, n16, n32, n64, spare3, spare2, spare1}
  }
}
-- ASN1STOP

```

SchedulingRequestConfig field descriptions

dsr-TransMax

Parameter for SR transmission in TS 36.321 [6, 5.4.4]. The value n4 corresponds to 4 transmissions, n8 corresponds to 8 transmissions and so on. EUTRAN configures the same value for all serving cells for which this field is configured.

sr-ConfigIndex

Parameter I_{SR} . See TS 36.213 [23,10.1]. The values 156 and 157 are not applicable for Release 8.

sr-PUCCH-ResourceIndex, sr-PUCCH-ResourceIndexP1

Parameter: $n_{PUCCH,SRI}^{(1,p)}$ for antenna port P0 and for antenna port P1 respectively, see TS 36.213 [23, 10.1]. E-UTRAN configures *sr-PUCCH-ResourceIndexP1* only if *sr-PUCCHResourceIndex* is configured.

– SoundingRS-UL-Config

The IE *SoundingRS-UL-Config* is used to specify the uplink Sounding RS configuration for periodic and aperiodic sounding.

SoundingRS-UL-Config information element

```

-- ASN1START
SoundingRS-UL-ConfigCommon ::= CHOICE {
  release      NULL,
  setup       SEQUENCE {
    srs-BandwidthConfig      ENUMERATED {bw0, bw1, bw2, bw3, bw4, bw5, bw6, bw7},
    srs-SubframeConfig       ENUMERATED {
                                   sc0, sc1, sc2, sc3, sc4, sc5, sc6, sc7,
                                   sc8, sc9, sc10, sc11, sc12, sc13, sc14, sc15},
    ackNackSRS-SimultaneousTransmission BOOLEAN,
    srs-MaxUpPts             ENUMERATED {true}          OPTIONAL      -- Cond TDD
  }
}

SoundingRS-UL-ConfigDedicated ::= CHOICE{
  release      NULL,
  setup       SEQUENCE {
    srs-Bandwidth            ENUMERATED {bw0, bw1, bw2, bw3},
    srs-HoppingBandwidth     ENUMERATED {hbw0, hbw1, hbw2, hbw3},
    freqDomainPosition       INTEGER (0..23),
    duration                 BOOLEAN,
    srs-ConfigIndex          INTEGER (0..1023),
    transmissionComb         INTEGER (0..1),
    cyclicShift              ENUMERATED {cs0, cs1, cs2, cs3, cs4, cs5, cs6, cs7}
  }
}

SoundingRS-UL-ConfigDedicated-v1020 ::= SEQUENCE {
  srs-AntennaPort-r10       SRS-AntennaPort
}

SoundingRS-UL-ConfigDedicated-v1310 ::= CHOICE{
  release      NULL,
  setup       SEQUENCE {
    transmissionComb-v1310   INTEGER (2..3)          OPTIONAL,      -- Need OR
    cyclicShift-v1310        ENUMERATED {cs8, cs9, cs10, cs11} OPTIONAL,      -- Need
OR
    transmissionCombNum-r13   ENUMERATED {n2, n4}     OPTIONAL      -- Need OR

```

```

}
}
SoundingRS-UL-ConfigDedicatedUpPTsExt-r13 ::= CHOICE{
  release      NULL,
  setup       SEQUENCE {
    srs-UpPtsAdd-r13      ENUMERATED {sym2, sym4},
    srs-Bandwidth-r13     ENUMERATED {bw0, bw1, bw2, bw3},
    srs-HoppingBandwidth-r13  ENUMERATED {hbw0, hbw1, hbw2, hbw3},
    freqDomainPosition-r13 INTEGER (0..23),
    duration-r13         BOOLEAN,
    srs-ConfigIndex-r13  INTEGER (0..1023),
    transmissionComb-r13 INTEGER (0..3),
    cyclicShift-r13     ENUMERATED {cs0, cs1, cs2, cs3, cs4, cs5, cs6, cs7,
                                   cs8, cs9, cs10, cs11},
    srs-AntennaPort-r13  SRS-AntennaPort,
    transmissionCombNum-r13  ENUMERATED {n2, n4}
  }
}

SoundingRS-UL-ConfigDedicatedAperiodic-r10 ::= CHOICE{
  release      NULL,
  setup       SEQUENCE {
    srs-ConfigIndexAp-r10  INTEGER (0..31),
    srs-ConfigApDCI-Format4-r10  SEQUENCE (SIZE (1..3)) OF SRS-ConfigAp-r10  OPTIONAL,--
Need ON
    srs-ActivateAp-r10     CHOICE {
      release      NULL,
      setup       SEQUENCE {
        srs-ConfigApDCI-Format0-r10  SRS-ConfigAp-r10,
        srs-ConfigApDCI-Format1a2b2c-r10  SRS-ConfigAp-r10,
        ...
      }
    }
  }
}
OPTIONAL -- Need ON

SoundingRS-UL-ConfigDedicatedAperiodic-v1310 ::= CHOICE{
  release      NULL,
  setup       SEQUENCE {
    srs-ConfigApDCI-Format4-v1310  SEQUENCE (SIZE (1..3)) OF SRS-ConfigAp-v1310
OPTIONAL,--Need ON
    srs-ActivateAp-v1310           CHOICE {
      release      NULL,
      setup       SEQUENCE {
        srs-ConfigApDCI-Format0-v1310  SRS-ConfigAp-v1310  OPTIONAL, -- Need ON
        srs-ConfigApDCI-Format1a2b2c-v1310  SRS-ConfigAp-v1310  OPTIONAL -- Need ON
      }
    }
  }
}
OPTIONAL -- Need ON

SoundingRS-UL-ConfigDedicatedAperiodicUpPTsExt-r13 ::= CHOICE{
  release      NULL,
  setup       SEQUENCE {
    srs-UpPtsAdd-r13      ENUMERATED {sym2, sym4},
    srs-ConfigIndexAp-r13  INTEGER (0..31),
    srs-ConfigApDCI-Format4-r13  SEQUENCE (SIZE (1..3)) OF SRS-ConfigAp-r13  OPTIONAL,--
Need ON
    srs-ActivateAp-r13     CHOICE {
      release      NULL,
      setup       SEQUENCE {
        srs-ConfigApDCI-Format0-r13  SRS-ConfigAp-r13,
        srs-ConfigApDCI-Format1a2b2c-r13  SRS-ConfigAp-r13
      }
    }
  }
}
OPTIONAL -- Need ON

SoundingRS-UL-ConfigDedicatedAperiodic-v1430 ::= CHOICE{
  release      NULL,
  setup       SEQUENCE {
    srs-SubframeIndication-r14  INTEGER (1..4)  OPTIONAL -- Need ON
  }
}

SRS-ConfigAp-r10 ::= SEQUENCE {
  srs-AntennaPortAp-r10  SRS-AntennaPort,

```

```
    srs-BandwidthAp-r10          ENUMERATED {bw0, bw1, bw2, bw3},
    freqDomainPositionAp-r10     INTEGER (0..23),
    transmissionCombAp-r10       INTEGER (0..1),
    cyclicShiftAp-r10            ENUMERATED {cs0, cs1, cs2, cs3, cs4, cs5, cs6, cs7}
}

SRS-ConfigAp-v1310 ::= SEQUENCE {
    transmissionCombAp-v1310     INTEGER (2..3)                OPTIONAL, -- Need OR
    cyclicShiftAp-v1310          ENUMERATED {cs8, cs9, cs10, cs11}    OPTIONAL, -- Need OR
    transmissionCombNum-r13      ENUMERATED {n2, n4}                  OPTIONAL  -- Need OR
}

SRS-ConfigAp-r13 ::= SEQUENCE {
    srs-AntennaPortAp-r13       SRS-AntennaPort,
    srs-BandwidthAp-r13         ENUMERATED {bw0, bw1, bw2, bw3},
    freqDomainPositionAp-r13     INTEGER (0..23),
    transmissionCombAp-r13       INTEGER (0..3),
    cyclicShiftAp-r13           ENUMERATED {cs0, cs1, cs2, cs3, cs4, cs5, cs6, cs7,
                                           cs8, cs9, cs10, cs11},
    transmissionCombNum-r13      ENUMERATED {n2, n4}
}

SRS-AntennaPort ::=
    ENUMERATED {an1, an2, an4, spare1}

-- ASN1STOP
```

SoundingRS-UL-Config field descriptions	
ackNackSRS-SimultaneousTransmission Parameter: <i>Simultaneous-AN-and-SRS</i> , see TS 36.213 [23, 8.2]. For SCells without PUCCH configured, this field is not applicable and the UE shall ignore the value.	
cyclicShift, cyclicShiftAp Parameter: n_{SRS} for periodic and aperiodic sounding reference signal transmission respectively except for an LAA SCell. See TS 36.211 [21, 5.5.3.1], where cs_0 corresponds to 0 etc.	
duration Parameter: Duration for periodic sounding reference signal transmission except for an LAA SCell. See TS 36.213 [21, 8.2]. FALSE corresponds to "single" and value TRUE to "indefinite".	
freqDomainPosition, freqDomainPositionAp Parameter: n_{RRC} for periodic and aperiodic sounding reference signal transmission respectively, see TS 36.211 [21, 5.5.3.2].	
srs-AntennaPort, srs-AntennaPortAp Indicates the number of antenna ports used for periodic and aperiodic sounding reference signal transmission respectively, see TS 36.211 [21, 5.5.3]. UE shall release <i>srs-AntennaPort</i> if <i>SoundingRS-UL-ConfigDedicated</i> is released.	
srs-Bandwidth, srs-BandwidthAp Parameter: B_{SRS} for periodic and aperiodic sounding reference signal transmission respectively, see TS 36.211 [21, tables 5.5.3.2-1, 5.5.3.2-2, 5.5.3.2-3 and 5.5.3.2-4]. For LAA SCell only bw_0 is applied.	
srs-BandwidthConfig Parameter: SRS Bandwidth Configuration. See TS 36.211, [21, table 5.5.3.2-1, 5.5.3.2-2, 5.5.3.2-3 and 5.5.3.2-4]. Actual configuration depends on UL bandwidth. bw_0 corresponds to value 0, bw_1 to value 1 and so on.	
srs-ConfigApDCI-Format0 / srs-ConfigApDCI-Format1a2b2c / srs-ConfigApDCI-Format4 Parameters indicate the resource configurations for aperiodic sounding reference signal transmissions triggered by DCI formats 0, 1A, 2B, 2C, 4. See TS 36.213 [23, 8.2].	
srs-ConfigIndex, srs-ConfigIndexAp Parameter: l_{SRS} for periodic and aperiodic sounding reference signal transmission respectively except for an LAA SCell. See TS 36.213 [23, table 8.2-1 and table 8.2-2] for periodic and TS 36.213 [23, table 8.2-4 and table 8.2-5] for aperiodic SRS transmission.	
srs-HoppingBandwidth Parameter: SRS hopping bandwidth $b_{\text{hop}} \in \{0,1,2,3\}$ for periodic sounding reference signal transmission except for an LAA SCell, see TS 36.211 [21, 5.5.3.2] where hbw_0 corresponds to value 0, hbw_1 to value 1 and so on.	
srs-MaxUpPts Parameter: $srsMaxUpPts$, see TS 36.211 [21, 5.5.3.2]. If this field is present, reconfiguration of $m_{\text{SRS},0}^{\text{max}}$ applies for UpPts, otherwise reconfiguration does not apply.	
srs-SubframeConfig Parameter: SRS SubframeConfiguration except for an LAA SCell. See TS 36.211, [21, table 5.5.3.3-1] applies for FDD whereas TS 36.211 [21, table 5.5.3.3-2] applies for TDD. sc_0 corresponds to value 0, sc_1 corresponds to value 1 and so on.	
srs-SubframeIndication Parameter: SRS subframe indication in SRS parameter set configuration for aperiodic sounding reference signal transmission on an LAA SCell configured with uplink, see TS 36.213 [23].	
srs-UpPtsAdd The field only applies for TDD and frame structure type 3, see TS 36.211 [21]. If E-UTRAN configures both <i>soundingRS-UL-ConfigDedicatedUpPTsExt</i> and <i>soundingRS-UL-ConfigDedicatedAperiodicUpPTsExt</i> <i>srs-UpPtsAdd</i> in both fields is set to the same value. If E-UTRAN configures <i>soundingRS-UL-PeriodicConfigDedicatedUpPTsExtList-r14</i> with a number of <i>soundingRS-UL-ConfigDedicatedUpPTsExt</i> and/or <i>soundingRS-UL-AperiodicConfigDedicatedList-r14</i> with a number of <i>soundingRS-UL-ConfigDedicatedAperiodicUpPTsExt</i> , <i>srs-UpPtsAdd</i> in all fields are set to the same value.	
transmissionComb, transmissionCombAp Parameter: $\bar{k}_{\text{TC}} \in \{0..3\}$ for periodic and aperiodic sounding reference signal transmission respectively, see TS 36.211 [21, 5.5.3.2].	

Conditional presence	Explanation
<i>TDD</i>	This field is optional present for TDD, need OR; it is not present for FDD and the UE shall delete any existing value for this field.

– SPS-Config

The IE *SPS-Config* is used to specify the semi-persistent scheduling configuration.

SPS-Config information element

```

-- ASN1START
SPS-Config ::= SEQUENCE {
    semiPersistSchedC-RNTI          C-RNTI          OPTIONAL,      -- Need OR
    sps-ConfigDL                    SPS-ConfigDL       OPTIONAL,      -- Need ON
    sps-ConfigUL                    SPS-ConfigUL       OPTIONAL,      -- Need ON
}

SPS-Config-v1430 ::= SEQUENCE {
    ul-SPS-V-RNTI-r14              C-RNTI          OPTIONAL,      -- Need OR
    sl-SPS-V-RNTI-r14              C-RNTI          OPTIONAL,      -- Need OR
    sps-ConfigUL-ToAddModList-r14  SPS-ConfigUL-ToAddModList-r14 OPTIONAL,      -- Need ON
    sps-ConfigUL-ToReleaseList-r14 SPS-ConfigUL-ToReleaseList-r14 OPTIONAL,      -- Need ON
    sps-ConfigSL-ToAddModList-r14  SPS-ConfigSL-ToAddModList-r14 OPTIONAL,      -- Need ON
    sps-ConfigSL-ToReleaseList-r14 SPS-ConfigSL-ToReleaseList-r14 OPTIONAL,      -- Need ON
}

SPS-ConfigUL-ToAddModList-r14 ::= SEQUENCE (SIZE (1..maxConfigSPS-r14)) OF SPS-ConfigUL

SPS-ConfigUL-ToReleaseList-r14 ::= SEQUENCE (SIZE (1..maxConfigSPS-r14)) OF SPS-ConfigIndex-r14

SPS-ConfigSL-ToAddModList-r14 ::= SEQUENCE (SIZE (1..maxConfigSPS-r14)) OF SPS-ConfigSL-r14

SPS-ConfigSL-ToReleaseList-r14 ::= SEQUENCE (SIZE (1..maxConfigSPS-r14)) OF SPS-ConfigIndex-r14

SPS-ConfigDL ::= CHOICE{
    release          NULL,
    setup           SEQUENCE {
        semiPersistSchedIntervalDL    ENUMERATED {
            sf10, sf20, sf32, sf40, sf64, sf80,
            sf128, sf160, sf320, sf640, spare6,
            spare5, spare4, spare3, spare2,
            spare1},
        numberOfConfSPS-Processes      INTEGER (1..8),
        n1PUCCH-AN-PersistentList     N1PUCCH-AN-PersistentList,
        ...,
        [[ twoAntennaPortActivated-r10 CHOICE {
            release          NULL,
            setup           SEQUENCE {
                n1PUCCH-AN-PersistentListPl-r10 N1PUCCH-AN-PersistentList
            }
        }
        ]],
    }
}
OPTIONAL      -- Need ON

}

SPS-ConfigUL ::= CHOICE {
    release          NULL,
    setup           SEQUENCE {
        semiPersistSchedIntervalUL    ENUMERATED {
            sf10, sf20, sf32, sf40, sf64, sf80,
            sf128, sf160, sf320, sf640, sf1-v1430,
            sf2-v1430, sf3-v1430, sf4-v1430, sf5-v1430,
            spare1},
        implicitReleaseAfter          ENUMERATED {e2, e3, e4, e8},
        p0-Persistent                 SEQUENCE {
            p0-NominalPUSCH-Persistent INTEGER (-126..24),
            p0-UE-PUSCH-Persistent    INTEGER (-8..7)
        }
        OPTIONAL,
        twoIntervalsConfig            ENUMERATED {true}
        OPTIONAL,
        ...,
        [[ p0-PersistentSubframeSet2-r12 CHOICE {
            release          NULL,
            setup           SEQUENCE {
                p0-NominalPUSCH-PersistentSubframeSet2-r12 INTEGER (-126..24),
                p0-UE-PUSCH-PersistentSubframeSet2-r12    INTEGER (-8..7)
            }
        }
        ]],
    }
}
OPTIONAL      -- Need ON

[[,
[[ numberOfConfULSPS-Processes-r13    INTEGER (1..8)    OPTIONAL      -- Need OR
]],
[[ fixedRV-NonAdaptive-r14           ENUMERATED {true}    OPTIONAL,      -- Need OR
sps-ConfigIndex-r14                 SPS-ConfigIndex-r14  OPTIONAL,      -- Need OR
semiPersistSchedIntervalUL-v1430    ENUMERATED {
    sf50, sf100, sf200, sf300, sf400, sf500,
    sf600, sf700, sf800, sf900, sf1000, spare5,
}
]]
}

```

```

                                                                    spare4, spare3, spare2, spare1} OPTIONAL    -- Need OR
    ]]
  }
}
SPS-ConfigSL-r14 ::= SEQUENCE {
  sps-ConfigIndex-r14          SPS-ConfigIndex-r14,
  semiPersistSchedIntervalSL-r14  ENUMERATED {
    sf20, sf50, sf100, sf200, sf300, sf400,
    sf500, sf600, sf700, sf800, sf900, sf1000,
    spare4, spare3, spare2, spare1}
}
SPS-ConfigIndex-r14 ::= INTEGER (1..maxConfigSPS-r14)
N1PUCCH-AN-PersistentList ::= SEQUENCE (SIZE (1..4)) OF INTEGER (0..2047)
-- ASN1STOP
```

SPS-Config field descriptions
<p>fixedRV-NonAdaptive If this field is present and <i>skipUplinkTxSPS</i> is configured, non-adaptive retransmissions on configured uplink grant uses redundancy version 0, otherwise the redundancy version for each retransmission is updated based on the sequence of redundancy versions as described in TS 36.321 [6].</p>
<p>implicitReleaseAfter Number of empty transmissions before implicit release, see TS 36.321 [6, 5.10.2]. Value e2 corresponds to 2 transmissions, e3 corresponds to 3 transmissions and so on. If <i>skipUplinkTxSPS</i> is configured, the UE shall ignore this field.</p>
<p>n1PUCCH-AN-PersistentList, n1PUCCH-AN-PersistentListP1 List of parameter: $n_{\text{PUCCH}}^{(1,p)}$ for antenna port P0 and for antenna port P1 respectively, see TS 36.213 [23, 10.1]. Field <i>n1-PUCCH-AN-PersistentListP1</i> is applicable only if the <i>twoAntennaPortActivatedPUCCH-Format1a1b</i> in <i>PUCCH-ConfigDedicated-v1020</i> is set to <i>true</i>. Otherwise the field is not configured.</p>
<p>numberOfConfSPS-Processes The number of configured HARQ processes for downlink Semi-Persistent Scheduling, see TS 36.321 [6].</p>
<p>numberOfConfUISPS-Processes The number of configured HARQ processes for uplink Semi-Persistent Scheduling, see TS 36.321 [6]. E-UTRAN always configures this field for asynchronous UL HARQ. Otherwise it does not configure this field.</p>
<p>p0-NominalPUSCH-Persistent Parameter: $P_{\text{O_NOMINAL_PUSCH}}(0)$. See TS 36.213 [23, 5.1.1.1], unit dBm step 1. This field is applicable for persistent scheduling, only. If choice setup is used and <i>p0-Persistent</i> is absent, apply the value of <i>p0-NominalPUSCH</i> for <i>p0-NominalPUSCH-Persistent</i>. If uplink power control subframe sets are configured by <i>tpc-SubframeSet</i>, this field applies for uplink power control subframe set 1.</p>
<p>p0-NominalPUSCH-PersistentSubframeSet2 Parameter: $P_{\text{O_NOMINAL_PUSCH}}(0)$. See TS 36.213 [23, 5.1.1.1], unit dBm step 1. This field is applicable for persistent scheduling, only. If <i>p0-PersistentSubframeSet2-r12</i> is not configured, apply the value of <i>p0-NominalPUSCH-SubframeSet2-r12</i> for <i>p0-NominalPUSCH-PersistentSubframeSet2</i>. E-UTRAN configures this field only if uplink power control subframe sets are configured by <i>tpc-SubframeSet</i>, in which case this field applies for uplink power control subframe set 2.</p>
<p>p0-UE-PUSCH-Persistent Parameter: $P_{\text{O_UE_PUSCH}}(0)$. See TS 36.213 [23, 5.1.1.1], unit dB. This field is applicable for persistent scheduling, only. If choice setup is used and <i>p0-Persistent</i> is absent, apply the value of <i>p0-UE-PUSCH</i> for <i>p0-UE-PUSCH-Persistent</i>. If uplink power control subframe sets are configured by <i>tpc-SubframeSet</i>, this field applies for uplink power control subframe set 1.</p>
<p>p0-UE-PUSCH-PersistentSubframeSet2 Parameter: $P_{\text{O_UE_PUSCH}}(0)$. See TS 36.213 [23, 5.1.1.1], unit dB. This field is applicable for persistent scheduling, only. If <i>p0-PersistentSubframeSet2-r12</i> is not configured, apply the value of <i>p0-UE-PUSCH-SubframeSet2</i> for <i>p0-UE-PUSCH-PersistentSubframeSet2</i>. E-UTRAN configures this field only if uplink power control subframe sets are configured by <i>tpc-SubframeSet</i>, in which case this field applies for uplink power control subframe set 2.</p>
<p>semiPersistSchedC-RNTI Semi-persistent Scheduling C-RNTI, see TS 36.321 [6].</p>
<p>semiPersistSchedIntervalDL Semi-persistent scheduling interval in downlink, see TS 36.321 [6]. Value in number of sub-frames. Value sf10 corresponds to 10 sub-frames, sf20 corresponds to 20 sub-frames and so on. For TDD, the UE shall round this parameter down to the nearest integer (of 10 sub-frames), e.g. sf10 corresponds to 10 sub-frames, sf32 corresponds to 30 sub-frames, sf128 corresponds to 120 sub-frames.</p>
<p>semiPersistSchedIntervalSL Semi-persistent scheduling interval in sidelink, see TS 36.321 [6]. Value in number of sub-frames. Value sf20 corresponds to 20 sub-frames, sf50 corresponds to 50 sub-frames and so on.</p>
<p>semiPersistSchedIntervalUL Semi-persistent scheduling interval in uplink, see TS 36.321 [6]. Value in number of sub-frames. Value sf10 corresponds to 10 sub-frames, sf20 corresponds to 20 sub-frames and so on. For TDD, when the configured Semi-persistent scheduling interval is greater than or equal to 10 sub-frames, the UE shall round this parameter down to the nearest integer (of 10 sub-frames), e.g. sf10 corresponds to 10 sub-frames, sf32 corresponds to 30 sub-frames, sf128 corresponds to 120 sub-frames. If <i>semiPersistSchedIntervalUL-v1430</i> is configured, the UE only considers this extension (and ignores <i>semiPersistSchedIntervalUL</i> i.e. without suffix).</p>
<p>sl-SPS-V-RNTI SL Semi-Persistent Scheduling V-RNTI for V2X sidelink communication, see TS 36.321 [6].</p>
<p>sps-ConfigIndex Indicates the index of one of multiple SL/UL SPS configurations.</p>
<p>sps-ConfigSL-ToAddModList Indicates the SL SPS configurations to be added or modified, identified by <i>SPS-ConfigIndex</i>.</p>
<p>sps-ConfigSL-ToReleaseList Indicates the SL SPS configurations to be released, identified by <i>SPS-ConfigIndex</i>.</p>

SPS-Config field descriptions	
sps-ConfigUL-ToAddModList	Indicates the UL SPS configurations to be added or modified, identified by <i>SPS-ConfigIndex</i> .
sps-ConfigUL-ToReleaseList	Indicates the UL SPS configurations to be released, identified by <i>SPS-ConfigIndex</i> .
twoIntervalsConfig	Trigger of two-intervals-Semi-Persistent Scheduling in uplink. See TS 36.321 [6, 5.10]. If this field is present and the configured Semi-persistent scheduling interval greater than or equal to 10 sub-frames, two-intervals-SPS is enabled for uplink. Otherwise, two-intervals-SPS is disabled.
ul-SPS-V-RNTI	UL Semi-Persistent Scheduling V-RNTI for UEs capable of multiple uplink SPS configurations and which support V2X communication, see TS 36.321 [6].

Conditional presence	Explanation
<i>TDD</i>	This field is optional present for TDD, need OR; it is not present for FDD and the UE shall delete any existing value for this field.

– *SRS-TPC-PDCCH-Config*

The IE *SRS-TPC-PDCCH-Config* is used to specify the RNTIs and indexes for A-SRS trigger and TPC according to TS 36.212 [22].

***SRS-TPC-PDCCH-Config* information element**

```

-- ASN1START
SRS-TPC-PDCCH-Config-r14 ::= CHOICE {
    release          NULL,
    setup           SEQUENCE {
        srs-TPC-RNTI-r14          BIT STRING (SIZE (16)),
        startingBitOfFormat3B-r14 INTEGER (0..31),
        fieldTypeFormat3B-r14    INTEGER (1..4),
        srs-CC-SetIndexlist-r14  SEQUENCE (SIZE(1..4)) OF SRS-CC-
SetIndex-r14    OPTIONAL    -- Cond SRS-Trigger-TypeA
    }
}

SRS-CC-SetIndex-r14 ::= SEQUENCE {
    cc-SetIndex-r14          INTEGER (0..3),
    cc-IndexInOneCC-Set-r14 INTEGER (0..7)
}
-- ASN1STOP

```

SRS-TPC-PDCCH-Config field descriptions
<p>cc-IndexInOneCC-Set Indicates the CC index in one CC set for Type A associated with the group DCI with SRS request field (optional) and TPC commands for a PUSCH-less SCell</p>
<p>cc-SetIndex Indicates the CC set index for Type A associated with the group DCI with SRS request field (optional) and TPC commands for a PUSCH-less SCell.</p>
<p>fieldTypeFormat3B The type of a field within the group DCI with SRS request fields (optional) and TPC commands for a PUSCH-less SCell, which indicates how many bits in the field are for SRS request (0 or 1/2) and how many bits in the field are for TPC (1 or 2). Note that for Type A, there is a common SRS request field for all SCells in the set, but each SCell has its own TPC command bits. See TS 36.212 [22, 5.3.3.1.7A]. EUTRAN configures this field with the same value for all PUSCH-less SCells.</p>
<p>srs-CC-SetIndexlist Indicates the index of the <i>SRS-TPC-PDCCH-Config</i> for Type A trigger by the group DCI with SRS request field (optional) and TPC commands for a PUSCH-less SCell. Each set may contain at most 8 CCs.</p>
<p>srs-TPC-RNTI RNTI for SRS trigger and power control using DCI format 3B, see TS 36.212 [22, 5.1.3.1].</p>
<p>startingBitOfFormat3B The starting bit position of a block within the group DCI with SRS request fields (optional) and TPC commands for a PUSCH-less SCell.</p>

Conditional presence	Explanation
<i>SRS-Trigger-TypeA</i>	The field is mandatory present if <i>typeA-SRS-TPC-PDCCH-Group-r14</i> is present. Otherwise the field is not present and the UE shall delete any existing value for this field.

– TDD-Config

The IE *TDD-Config* is used to specify the TDD specific physical channel configuration.

TDD-Config information element

```

-- ASN1START
TDD-Config ::=
    subframeAssignment
    specialSubframePatterns
}
SEQUENCE {
    ENUMERATED {
        sa0, sa1, sa2, sa3, sa4, sa5, sa6},
    ENUMERATED {
        ssp0, ssp1, ssp2, ssp3, ssp4, ssp5, ssp6, ssp7,
        ssp8}
}

TDD-Config-v1130 ::=
    specialSubframePatterns-v1130
}
SEQUENCE {
    ENUMERATED {ssp7, ssp9}
}

TDD-Config-v1430 ::=
    specialSubframePatterns-v1430
}
SEQUENCE {
    ENUMERATED {ssp10}
}

TDD-Config-v1450 ::=
    specialSubframePatterns-v1450
}
SEQUENCE {
    ENUMERATED {ssp10-CRS-LessDwPTS}
}

TDD-ConfigSL-r12 ::=
    subframeAssignmentSL-r12
}
SEQUENCE {
    ENUMERATED {
        none, sa0, sa1, sa2, sa3, sa4, sa5, sa6}
}
-- ASN1STOP

```

TDD-Config field descriptions
<p>specialSubframePatterns Indicates Configuration as in TS 36.211 [21, table 4.2-1] where <i>ssp0</i> points to Configuration 0, <i>ssp1</i> to Configuration 1 etc. Value <i>ssp7</i> points to Configuration 7 for extended cyclic prefix, value <i>ssp9</i> points to Configuration 9 for normal cyclic prefix and value <i>ssp10</i> points to Configuration 10 for normal cyclic prefix. Value <i>ssp10-CRS-LessDwPTS</i> corresponds to <i>ssp10</i> without CRS transmission on the 5th symbol of DwPTS. E-UTRAN signals <i>ssp7</i> only when setting <i>specialSubframePatterns</i> (without suffix i.e. the version defined in REL-8) to <i>ssp4</i>. E-UTRAN signals value <i>ssp9</i> only when setting <i>specialSubframePatterns</i> (without suffix) to <i>ssp5</i>. E-UTRAN signals value <i>ssp10</i> or <i>ssp10-CRS-LessDwPTS</i> only when setting <i>specialSubframePatterns</i> (without suffix) to <i>ssp0</i> or <i>ssp5</i>. If <i>specialSubframePatterns-v1130</i>, <i>specialSubframePatterns-v1430</i>, or <i>specialSubframePatterns-v1450</i> is present, the UE shall ignore <i>specialSubframePatterns</i> (without suffix). If <i>specialSubframePatterns-v1430</i> or <i>specialSubframePatterns-v1450</i> is present, the UE shall ignore <i>specialSubframePatterns-v1130</i>. E-UTRAN does not simultaneously configure <i>TDD-Config-v1430</i> and <i>TDD-Config-v1450</i>.</p>
<p>subframeAssignment Indicates DL/UL subframe configuration where <i>sa0</i> points to Configuration 0, <i>sa1</i> to Configuration 1 etc. as specified in TS 36.211 [21, table 4.2-2]. E-UTRAN configures the same value for serving cells residing on same frequency band.</p>
<p>subframeAssignmentSL Indicates UL/ DL subframe configuration where <i>sa0</i> points to Configuration 0, <i>sa1</i> to Configuration 1 etc. as specified in TS 36.211 [21, table 4.2-2]. The value <i>none</i> means that no TDD specific physical channel configuration is applicable (i.e. the carrier on which <i>MasterInformationBlock-SL</i> is transmitted is an FDD UL carrier or the carrier on which <i>MasterInformationBlock-SL-V2X</i> is transmitted is a carrier for V2X sidelink communication).</p>

– TimeAlignmentTimer

The IE *TimeAlignmentTimer* is used to control how long the UE considers the serving cells belonging to the associated TAG to be uplink time aligned. Corresponds to the Timer for time alignment in TS 36.321 [6]. Value in number of sub-frames. Value *sf500* corresponds to 500 sub-frames, *sf750* corresponds to 750 sub-frames and so on.

TimeAlignmentTimer information element

```
-- ASN1START
TimeAlignmentTimer ::=
    ENUMERATED {
        sf500, sf750, sf1280, sf1920, sf2560, sf5120,
        sf10240, infinity}
-- ASN1STOP
```

– TPC-PDCCH-Config

The IE *TPC-PDCCH-Config* is used to specify the RNTIs and indexes for PUCCH and PUSCH power control according to TS 36.212 [22]. The power control function can either be setup or released with the IE.

TPC-PDCCH-Config information element

```
-- ASN1START
TPC-PDCCH-Config ::=
    CHOICE {
        release
            NULL,
        setup
            SEQUENCE {
                tpc-RNTI
                    BIT STRING (SIZE (16)),
                tpc-Index
                    TPC-Index
            }
    }

TPC-PDCCH-ConfigSCell-r13 ::=
    CHOICE {
        release
            NULL,
        setup
            SEQUENCE {
                tpc-Index-PUCCH-SCell-r13
                    TPC-Index
            }
    }

TPC-Index ::=
    CHOICE {
        indexOFFormat3
            INTEGER (1..15),
        indexOFFormat3A
            INTEGER (1..31)
    }
-- ASN1STOP
```

TPC-PDCCH-Config field descriptions
indexOfFormat3 Index of N when DCI format 3 is used. See TS 36.212 [22, 5.3.3.1.6].
IndexOfFormat3A Index of M when DCI format 3A is used. See TS 36.212 [22, 5.3.3.1.7].
tpc-Index Index of N or M, see TS 36.212 [22, 5.3.3.1.6 and 5.3.3.1.7], where N or M is dependent on the used DCI format (i.e. format 3 or 3a).
tpc-Index-PUCCH-SCell Index of N or M, see TS 36.212 [22, 5.3.3.1.6 and 5.3.3.1.7], where N or M is dependent on the used DCI format (i.e. format 3 or 3a).
tpc-RNTI RNTI for power control using DCI format 3/3A, see TS 36.212 [22].

TunnelConfigLWIP

The IE *TunnelConfigLWIP* is used to setup/release LWIP Tunnel.

```

-- ASN1START
TunnelConfigLWIP-r13 ::= SEQUENCE {
    ip-Address-r13          IP-Address-r13,
    ike-Identity-r13       IKE-Identity-r13,
    ...,
    [[ lwip-Counter-r13    INTEGER (0..65535)          OPTIONAL  -- Cond LWIP-Setup
    ]]
}

IKE-Identity-r13 ::= SEQUENCE {
    idI-r13                OCTET STRING
}

IP-Address-r13 ::= CHOICE {
    ipv4-r13                BIT STRING (SIZE (32)),
    ipv6-r13                BIT STRING (SIZE (128))
}
-- ASN1STOP
    
```

TunnelConfigLWIP field descriptions
ip-Address Parameter indicates the LWIP-SeGW IP Address to be used by the UE for initiating LWIP Tunnel establishment [32].
ike-Identity Parameter indicates the IKE Identity elements (IDi) to be used in IKE Authentication Procedures [32].
lwip-Counter Indicates the parameter used by UE for computing the security keys used in LWIP tunnel establishment, as specified in TS 33.401 [32].

Conditional presence	Explanation
<i>LWIP-Setup</i>	The field is mandatory present upon setup of LWIP tunnel. Otherwise the field is optional, Need ON.

UplinkPowerControl

The IE *UplinkPowerControlCommon* and IE *UplinkPowerControlDedicated* are used to specify parameters for uplink power control in the system information and in the dedicated signalling, respectively.

UplinkPowerControl information elements

```

-- ASN1START
UplinkPowerControlCommon ::= SEQUENCE {
    
```

```

    p0-NominalPUSCH          INTEGER (-126..24),
    alpha                    Alpha-r12,
    p0-NominalPUCCH          INTEGER (-127..-96),
    deltaFList-PUCCH        DeltaFList-PUCCH,
    deltaPreambleMsg3       INTEGER (-1..6)
}

UplinkPowerControlCommon-v1020 ::= SEQUENCE {
    deltaF-PUCCH-Format3-r10    ENUMERATED {deltaF-1, deltaF0, deltaF1, deltaF2,
                                             deltaF3, deltaF4, deltaF5, deltaF6},
    deltaF-PUCCH-Format1bCS-r10 ENUMERATED {deltaF1, deltaF2, spare2, spare1}
}

UplinkPowerControlCommon-v1310 ::= SEQUENCE {
    deltaF-PUCCH-Format4-r13    ENUMERATED {deltaF16, deltaF15, deltaF14, deltaF13, deltaF12,
                                             deltaF11, deltaF10, spare1} OPTIONAL, -- Need OR
    deltaF-PUCCH-Format5-13    ENUMERATED {deltaF13, deltaF12, deltaF11, deltaF10, deltaF9,
                                             deltaF8, deltaF7, spare1} OPTIONAL -- Need OR
}

UplinkPowerControlCommonPSCell-r12 ::= SEQUENCE {
-- For uplink power control the additional/ missing fields are signalled (compared to SCell)
    deltaF-PUCCH-Format3-r12    ENUMERATED {deltaF-1, deltaF0, deltaF1, deltaF2,
                                             deltaF3, deltaF4, deltaF5, deltaF6},
    deltaF-PUCCH-Format1bCS-r12 ENUMERATED {deltaF1, deltaF2, spare2, spare1},
    p0-NominalPUCCH-r12        INTEGER (-127..-96),
    deltaFList-PUCCH-r12       DeltaFList-PUCCH
}

UplinkPowerControlCommonSCell-r10 ::= SEQUENCE {
    p0-NominalPUSCH-r10        INTEGER (-126..24),
    alpha-r10                  Alpha-r12
}

UplinkPowerControlCommonSCell-v1130 ::= SEQUENCE {
}

UplinkPowerControlCommonSCell-v1310 ::= SEQUENCE {
-- For uplink power control the additional/ missing fields are signalled (compared to SCell)
    p0-NominalPUCCH            INTEGER (-127..-96),
    deltaFList-PUCCH           DeltaFList-PUCCH,
    deltaF-PUCCH-Format3-r12    ENUMERATED {deltaF-1, deltaF0, deltaF1,
                                             deltaF2, deltaF3, deltaF4, deltaF5,
                                             deltaF6} OPTIONAL, -- Need OR
    deltaF-PUCCH-Format1bCS-r12 ENUMERATED {deltaF1, deltaF2,
                                             spare2, spare1} OPTIONAL, -- Need OR
    deltaF-PUCCH-Format4-r13    ENUMERATED {deltaF16, deltaF15, deltaF14,
                                             deltaF13, deltaF12, deltaF11, deltaF10,
                                             spare1} OPTIONAL, -- Need OR
    deltaF-PUCCH-Format5-13    ENUMERATED {deltaF13, deltaF12, deltaF11,
                                             deltaF10, deltaF9, deltaF8, deltaF7,
                                             spare1} OPTIONAL -- Need OR
}

UplinkPowerControlCommonPUSCH-LessCell-v1430 ::= SEQUENCE {
    p0-Nominal-PeriodicSRS-r14  INTEGER (-126..24) OPTIONAL, -- Need OR
    p0-Nominal-AperiodicSRS-r14 INTEGER (-126..24) OPTIONAL, -- Need OR
    alpha-SRS-r14               Alpha-r12 OPTIONAL -- Need OR
}

UplinkPowerControlDedicated ::= SEQUENCE {
    p0-UE-PUSCH                 INTEGER (-8..7),
    deltaMCS-Enabled            ENUMERATED {en0, en1},
    accumulationEnabled         BOOLEAN,
    p0-UE-PUCCH                 INTEGER (-8..7),
    pSRS-Offset                 INTEGER (0..15),
    filterCoefficient           FilterCoefficient DEFAULT fc4
}

UplinkPowerControlDedicated-v1020 ::= SEQUENCE {
    deltaTxD-OffsetListPUCCH-r10 DeltaTxD-OffsetListPUCCH-r10 OPTIONAL, -- Need OR
    pSRS-OffsetAp-r10            INTEGER (0..15) OPTIONAL -- Need OR
}

UplinkPowerControlDedicated-v1130 ::= SEQUENCE {
    pSRS-Offset-v1130           INTEGER (16..31) OPTIONAL, -- Need OR
    pSRS-OffsetAp-v1130        INTEGER (16..31) OPTIONAL, -- Need OR
}

```



```

    deltaTxD-OffsetListPUCCH-v1130          DeltaTxD-OffsetListPUCCH-v1130  OPTIONAL  -- Need OR
}

UplinkPowerControlDedicated-v1250 ::= SEQUENCE {
    set2PowerControlParameter      CHOICE {
        release                      NULL,
        setup                        SEQUENCE {
            tpc-SubframeSet-r12      BIT STRING (SIZE(10)),
            p0-NominalPUSCH-SubframeSet2-r12  INTEGER (-126..24),
            alpha-SubframeSet2-r12   Alpha-r12,
            p0-UE-PUSCH-SubframeSet2-r12  INTEGER (-8..7)
        }
    }
}

UplinkPUSCH-LessPowerControlDedicated-v1430 ::= SEQUENCE {
    p0-UE-PeriodicSRS-r14          INTEGER (-8..7)          OPTIONAL,  -- Need OR
    p0-UE-AperiodicSRS-r14        INTEGER (-8..7)          OPTIONAL,  -- Need OR
    accumulationEnabled-r14        BOOLEAN
}

UplinkPowerControlDedicatedSCell-r10 ::= SEQUENCE {
    p0-UE-PUSCH-r10                INTEGER (-8..7),
    deltaMCS-Enabled-r10            ENUMERATED {en0, en1},
    accumulationEnabled-r10        BOOLEAN,
    pSRS-Offset-r10                INTEGER (0..15),
    pSRS-OffsetAp-r10              INTEGER (0..15)          OPTIONAL,  -- Need OR
    filterCoefficient-r10          FilterCoefficient        DEFAULT fc4,
    pathlossReferenceLinking-r10    ENUMERATED {pCell, sCell}
}

UplinkPowerControlDedicatedSCell-v1310 ::= SEQUENCE {
--Release 8
    p0-UE-PUCCH                    INTEGER (-8..7),
--Release 10
    deltaTxD-OffsetListPUCCH-r10    DeltaTxD-OffsetListPUCCH-r10    OPTIONAL  -- Need OR
}

Alpha-r12 ::=
    ENUMERATED {a10, a104, a105, a106, a107, a108, a109, a11}

DeltaFList-PUCCH ::=
    SEQUENCE {
        deltaF-PUCCH-Format1        ENUMERATED {deltaF-2, deltaF0, deltaF2},
        deltaF-PUCCH-Format1b       ENUMERATED {deltaF1, deltaF3, deltaF5},
        deltaF-PUCCH-Format2        ENUMERATED {deltaF-2, deltaF0, deltaF1, deltaF2},
        deltaF-PUCCH-Format2a       ENUMERATED {deltaF-2, deltaF0, deltaF2},
        deltaF-PUCCH-Format2b       ENUMERATED {deltaF-2, deltaF0, deltaF2}
    }

DeltaTxD-OffsetListPUCCH-r10 ::= SEQUENCE {
    deltaTxD-OffsetPUCCH-Format1-r10  ENUMERATED {dB0, dB-2},
    deltaTxD-OffsetPUCCH-Format1a1b-r10  ENUMERATED {dB0, dB-2},
    deltaTxD-OffsetPUCCH-Format2a2b-r10  ENUMERATED {dB0, dB-2},
    deltaTxD-OffsetPUCCH-Format3-r10    ENUMERATED {dB0, dB-2},
    ...
}

DeltaTxD-OffsetListPUCCH-v1130 ::= SEQUENCE {
    deltaTxD-OffsetPUCCH-Format1bCS-r11  ENUMERATED {dB0, dB-1}
}

-- ASN1STOP

```

UplinkPowerControl field descriptions
<p>accumulationEnabled Parameter: Accumulation-enabled, see TS 36.213 [23, 5.1.1.1, 5.1.3.1]. TRUE corresponds to "enabled" whereas FALSE corresponds to "disabled".</p>
<p>alpha Parameter: α See TS 36.213 [23, 5.1.1.1] where al0 corresponds to 0, al04 corresponds to value 0.4, al05 to 0.5, al06 to 0.6, al07 to 0.7, al08 to 0.8, al09 to 0.9 and al1 corresponds to 1. This field applies for uplink power control subframe set 1 if uplink power control subframe sets are configured by <i>tpc-SubframeSet</i>.</p>
<p>alpha-SRS Parameter: α_{SRS}. See TS 36.213 [23, 5.1.3.1] where al0 corresponds to 0, al04 corresponds to value 0.4, al05 to 0.5, al06 to 0.6, al07 to 0.7, al08 to 0.8, al09 to 0.9 and al1 corresponds to 1. This field applies for SRS power control on a PUSCH-less SCeLl.</p>
<p>alpha-SubframeSet2 Parameter: α. See TS 36.213 [23, 5.1.1.1] where al0 corresponds to 0, al04 corresponds to value 0.4, al05 to 0.5, al06 to 0.6, al07 to 0.7, al08 to 0.8, al09 to 0.9 and al1 corresponds to 1. This field applies for uplink power control subframe set 2 if uplink power control subframe sets are configured by <i>tpc-SubframeSet</i>.</p>
<p>deltaF-PUCCH-FormatX Parameter: $\Delta_{F_PUCCH}(F)$ for the PUCCH formats 1, 1b, 2, 2a, 2b, 3, 4, 5 and 1b with channel selection. See TS 36.213 [23, 5.1.2] where deltaF-2 corresponds to -2 dB, deltaF0 corresponds to 0 dB and so on.</p>
<p>deltaMCS-Enabled Parameter: K_s See TS 36.213 [23, 5.1.1.1]. en0 corresponds to value 0 corresponding to state "disabled". en1 corresponds to value 1.25 corresponding to "enabled".</p>
<p>deltaPreambleMsg3 Parameter: $\Delta_{PREAMBLE_Msg3}$ see TS 36.213 [23, 5.1.1.1]. Actual value = field value * 2 [dB].</p>
<p>deltaTxD-OffsetPUCCH-FormatX Parameter: $\Delta_{TxD}(F')$ for the PUCCH formats 1, 1a/1b, 1b with channel selection, 2/2a/2b and 3 when two antenna ports are configured for PUCCH transmission. See TS 36.213 [23, 5.1.2.1] where dB0 corresponds to 0 dB, dB-1 corresponds to -1 dB, dB-2 corresponds to -2 dB. EUTRAN configures the field <i>deltaTxD-OffsetPUCCH-Format1bCS-r11</i> for the PCell and/or the PSCell only.</p>
<p>filterCoefficient Specifies the filtering coefficient for RSRP measurements used to calculate path loss, as specified in TS 36.213 [23, 5.1.1.1]. The same filtering mechanism applies as for <i>quantityConfig</i> described in 5.5.3.2.</p>
<p>p0-Nominal-AperiodicSRS Parameter: $P_{O_NOMINAL_SRS,c}(m)$ where $m=1$. See TS 36.213 [23, 5.1.3.1], unit dBm.</p>
<p>p0-Nominal-PeriodicSRS Parameter: $P_{O_NOMINAL_SRS,c}(m)$ where $m=0$. See TS 36.213 [23, 5.1.3.1], unit dBm.</p>
<p>p0-NominalPUCCH Parameter: $P_{O_NOMINAL_PUCCH}$ See TS 36.213 [23, 5.1.2.1], unit dBm.</p>
<p>p0-NominalPUSCH Parameter: $P_{O_NOMINAL_PUSCH}(1)$ See TS 36.213 [23, 5.1.1.1], unit dBm. This field is applicable for non-persistent scheduling only. This field applies for uplink power control subframe set 1 if uplink power control subframe sets are configured by <i>tpc-SubframeSet</i>.</p>
<p>p0-NominalPUSCH-SubframeSet2 Parameter: $P_{O_NOMINAL_PUSCH}(1)$. See TS 36.213 [23, 5.1.1.1], unit dBm. This field is applicable for non-persistent scheduling only. This field applies for uplink power control subframe set 2 if uplink power control subframe sets are configured by <i>tpc-SubframeSet</i>.</p>
<p>p0-UE-AperiodicSRS Parameter: $P_{O_UE_SRS,c}(m)$ where $m=1$. See TS 36.213 [23, 5.1.3.1], unit dB.</p>
<p>p0-UE-PeriodicSRS Parameter: $P_{O_UE_SRS,c}(m)$ where $m=0$. See TS 36.213 [23, 5.1.3.1], unit dB.</p>
<p>p0-UE-PUCCH Parameter: $P_{O_UE_PUCCH}$ See TS 36.213 [23, 5.1.2.1]. Unit dB</p>
<p>p0-UE-PUSCH Parameter: $P_{O_UE_PUSCH}(1)$ See TS 36.213 [23, 5.1.1.1], unit dB. This field is applicable for non-persistent scheduling, only. This field applies for uplink power control subframe set 1 if uplink power control subframe sets are configured by <i>tpc-SubframeSet</i>.</p>

UplinkPowerControl field descriptions
<p>p0-UE-PUSCH-SubframeSet2 Parameter: $P_{O_UE_PUSCH}$ (1) See TS 36.213 [23, 5.1.1.1], unit dB. This field is applicable for non-persistent scheduling, only. This field applies for uplink power control subframe set 2 if uplink power control subframe sets are configured by <i>tpc-SubframeSet</i>.</p>
<p>pathlossReferenceLinking Indicates whether the UE shall apply as pathloss reference either the downlink of the PCell or of the SCell that corresponds with this uplink (i.e. according to the <i>cellIdentification</i> within the field <i>sCellToAddMod</i>). For SCells part of an STAG E-UTRAN sets the value to sCell.</p>
<p>pSRS-Offset, pSRS-OffsetAp Parameter: P_{SRS_OFFSET} for periodic and aperiodic sounding reference signal transmission respectively. See TS 36.213 [23, 5.1.3.1]. For $K_s=1.25$, the actual parameter value is <i>pSRS-Offset</i> value – 3. For $K_s=0$, the actual parameter value is $-10.5 + 1.5 * pSRS-Offset$ value. If <i>pSRS-Offset-v1130</i> is included, the UE ignores <i>pSRS-Offset</i> (i.e., without suffix). Likewise, if <i>pSRS-OffsetAp-v1130</i> is included, the UE ignores <i>pSRS-OffsetAp-r10</i>. For $K_s=0$, E-UTRAN does not set values larger than 26.</p>
<p>tpc-SubframeSet Indicates the uplink subframes (including UpPTS in special subframes) of the uplink power control subframe sets. Value 0 means the subframe belongs to uplink power control subframe set 1, and value 1 means the subframe belongs to uplink power control subframe set 2.</p>

– WLAN-Id-List

The IE *WLAN-Id-List* is used to list WLAN(s) for configuration of WLAN measurements and WLAN mobility set.

```
-- ASN1START
WLAN-Id-List-r13 ::= SEQUENCE (SIZE (1..maxWLAN-Id-r13)) OF WLAN-Identifiers-r12
-- ASN1STOP
```

– WLAN-MobilityConfig

The IE *WLAN-MobilityConfig* is used for configuration of WLAN mobility set and WLAN Status Reporting. E-UTRAN configures at least one WLAN identifier in the *WLAN-MobilityConfig*.

```
-- ASN1START
WLAN-MobilityConfig-r13 ::= SEQUENCE {
    wlan-ToReleaseList-r13          WLAN-Id-List-r13          OPTIONAL,  -- Need ON
    wlan-ToAddList-r13             WLAN-Id-List-r13          OPTIONAL,  -- Need ON
    associationTimer-r13           ENUMERATED {s10, s30,
                                              s60, s120, s240}      OPTIONAL,  -- Need OR
    successReportRequested-r13    ENUMERATED {true}           OPTIONAL,  -- Need OR
    . . .
    [[ wlan-SuspendConfig-r14      WLAN-SuspendConfig-r14  OPTIONAL  -- Need ON
    ]]
}
-- ASN1STOP
```

WLAN-MobilityConfig field descriptions
<p>associationTimer Indicates the maximum time for connection to WLAN before connection failure reporting is initiated. Value s10 means 10 seconds, value s30 means 30 seconds and so on. E-UTRAN includes <i>associationTimer</i> only upon change in WLAN mobility set, <i>lwa-WT-Counter</i> or <i>lwip-Counter</i>.</p>
<p>successReportRequested Indicates whether the UE shall report successful connection to WLAN. Applicable to LWA and LWIP.</p>
<p>wlan-ToAddList Indicates the WLAN identifiers to be added to the WLAN mobility set.</p>
<p>wlan-ToReleaseList Indicates the WLAN identifiers to be removed from the WLAN mobility set.</p>

6.3.3 Security control information elements

– *NextHopChainingCount*

The IE *NextHopChainingCount* is used to update the K_{cNB} key and corresponds to parameter NCC: See TS 33.401 [32, 7.2.8.4].

NextHopChainingCount information element

```
-- ASN1START
NextHopChainingCount ::=                INTEGER (0..7)
-- ASN1STOP
```

– *SecurityAlgorithmConfig*

The IE *SecurityAlgorithmConfig* is used to configure AS integrity protection algorithm (SRBs) and AS ciphering algorithm (SRBs and DRBs). For RNs, the IE *SecurityAlgorithmConfig* is also used to configure AS integrity protection algorithm for DRBs between the RN and the E-UTRAN.

SecurityAlgorithmConfig information element

```
-- ASN1START
SecurityAlgorithmConfig ::=             SEQUENCE {
  cipheringAlgorithm                   CipheringAlgorithm-r12,
  integrityProtAlgorithm                ENUMERATED {
    eia0-v920, eia1, eia2, eia3-v1130, spare4, spare3,
    spare2, spare1, ...}
}
CipheringAlgorithm-r12 ::=             ENUMERATED {
  eea0, eea1, eea2, eea3-v1130, spare4, spare3,
  spare2, spare1, ...}
-- ASN1STOP
```

SecurityAlgorithmConfig field descriptions

cipheringAlgorithm

Indicates the ciphering algorithm to be used for SRBs and DRBs, as specified in TS 33.401 [32, 5.1.3.2].

integrityProtAlgorithm

Indicates the integrity protection algorithm to be used for SRBs, as specified in TS 33.401 [32, 5.1.4.2]. For RNs, also indicates the integrity protection algorithm to be used for integrity protection-enabled DRB(s).

– *ShortMAC-I*

The IE *ShortMAC-I* is used to identify and verify the UE at RRC connection re-establishment. The 16 least significant bits of the MAC-I calculated using the security configuration of the source PCell, as specified in 5.3.7.4.

ShortMAC-I information element

```
-- ASN1START
ShortMAC-I ::=                          BIT STRING (SIZE (16))
-- ASN1STOP
```

6.3.4 Mobility control information elements

– *AdditionalSpectrumEmission*

If an extension is signalled using the extended value range (as defined by IE *AdditionalSpectrumEmission-v1010*), the corresponding original field, using the value range as defined by IE *AdditionalSpectrumEmission* i.e. without suffix) shall be set to value 32, if signalled. UE supporting an LTE band assigned NS values larger than 32 as defined in TS 36.101 [42, 6.2.4], needs to support extension signaling (as defined by IE *AdditionalSpectrumEmission-v1010*).

***AdditionalSpectrumEmission* information element**

```
-- ASN1START
AdditionalSpectrumEmission ::=      INTEGER (1..32)
AdditionalSpectrumEmission-v1010 ::=  INTEGER (33..288)
-- ASN1STOP
```

– *ARFCN-ValueCDMA2000*

The IE *ARFCN-ValueCDMA2000* used to indicate the CDMA2000 carrier frequency within a CDMA2000 band, see C.S0002 [12].

***ARFCN-ValueCDMA2000* information element**

```
-- ASN1START
ARFCN-ValueCDMA2000 ::=      INTEGER (0..2047)
-- ASN1STOP
```

– *ARFCN-ValueEUTRA*

The IE *ARFCN-ValueEUTRA* is used to indicate the ARFCN applicable for a downlink, uplink or bi-directional (TDD) E-UTRA carrier frequency, as defined in TS 36.101 [42]. If an extension is signalled using the extended value range (as defined by IE *ARFCN-ValueEUTRA-v9e0*), the UE shall only consider this extension (and hence ignore the corresponding original field, using the value range as defined by IE *ARFCN-ValueEUTRA* i.e. without suffix, if signalled). In dedicated signalling, E-UTRAN only provides an EARFCN corresponding to an E-UTRA band supported by the UE.

***ARFCN-ValueEUTRA* information element**

```
-- ASN1START
ARFCN-ValueEUTRA ::=      INTEGER (0..maxEARFCN)
ARFCN-ValueEUTRA-v9e0 ::=  INTEGER (maxEARFCN-Plus1..maxEARFCN2)
ARFCN-ValueEUTRA-r9 ::=    INTEGER (0..maxEARFCN2)
-- ASN1STOP
```

NOTE: For fields using the original value range, as defined by IE *ARFCN-ValueEUTRA* i.e. without suffix, value *maxEARFCN* indicates that the E-UTRA carrier frequency is indicated by means of an extension. In such a case, UEs not supporting the extension consider the field to be set to a not supported value.

– ***ARFCN-ValueGERAN***

The IE *ARFCN-ValueGERAN* is used to specify the ARFCN value applicable for a GERAN BCCH carrier frequency, see TS 45.005 [20].

***ARFCN-ValueGERAN* information element**

```
-- ASN1START
ARFCN-ValueGERAN ::=          INTEGER (0..1023)
-- ASN1STOP
```

– ***ARFCN-ValueUTRA***

The IE *ARFCN-ValueUTRA* is used to indicate the ARFCN applicable for a downlink (Nd, FDD) or bi-directional (Nt, TDD) UTRA carrier frequency, as defined in TS 25.331 [19].

***ARFCN-ValueUTRA* information element**

```
-- ASN1START
ARFCN-ValueUTRA ::=          INTEGER (0..16383)
-- ASN1STOP
```

– ***BandclassCDMA2000***

The IE *BandclassCDMA2000* is used to define the CDMA2000 band in which the CDMA2000 carrier frequency can be found, as defined in C.S0057 [24, table 1.5-1].

***BandclassCDMA2000* information element**

```
-- ASN1START
BandclassCDMA2000 ::=          ENUMERATED {
                                bc0, bc1, bc2, bc3, bc4, bc5, bc6, bc7, bc8,
                                bc9, bc10, bc11, bc12, bc13, bc14, bc15, bc16,
                                bc17, bc18-v9a0, bc19-v9a0, bc20-v9a0, bc21-v9a0,
                                spare10, spare9, spare8, spare7, spare6, spare5, spare4,
                                spare3, spare2, spare1, ...}
-- ASN1STOP
```

– ***BandIndicatorGERAN***

The IE *BandIndicatorGERAN* indicates how to interpret an associated GERAN carrier ARFCN, see TS 45.005 [20]. More specifically, the IE indicates the GERAN frequency band in case the ARFCN value can concern either a DCS 1800 or a PCS 1900 carrier frequency. For ARFCN values not associated with one of these bands, the indicator has no meaning.

***BandIndicatorGERAN* information element**

```
-- ASN1START
BandIndicatorGERAN ::=          ENUMERATED {dcs1800, pcs1900}
-- ASN1STOP
```

– ***CarrierFreqCDMA2000***

The IE *CarrierFreqCDMA2000* used to provide the CDMA2000 carrier information.

CarrierFreqCDMA2000 information element

```

-- ASN1START
CarrierFreqCDMA2000 ::=          SEQUENCE {
    bandClass                BandclassCDMA2000,
    arfcn                    ARFCN-ValueCDMA2000
}
-- ASN1STOP

```

CarrierFreqGERAN

The IE *CarrierFreqGERAN* is used to provide an unambiguous carrier frequency description of a GERAN cell.

CarrierFreqGERAN information element

```

-- ASN1START
CarrierFreqGERAN ::=          SEQUENCE {
    arfcn                    ARFCN-ValueGERAN,
    bandIndicator            BandIndicatorGERAN
}
-- ASN1STOP

```

CarrierFreqGERAN field descriptions**arfcn**

GERAN ARFCN of BCCH carrier.

bandIndicator

Indicates how to interpret the ARFCN of the BCCH carrier.

CarrierFreqsGERAN

The IE *CarrierFreqListGERAN* is used to provide one or more GERAN ARFCN values, as defined in TS 45.005 [43], which represents a list of GERAN BCCH carrier frequencies.

CarrierFreqsGERAN information element

```

-- ASN1START
CarrierFreqsGERAN ::=          SEQUENCE {
    startingARFCN            ARFCN-ValueGERAN,
    bandIndicator            BandIndicatorGERAN,
    followingARFCNs          CHOICE {
        explicitListOfARFCNs    ExplicitListOfARFCNs,
        equallySpacedARFCNs     SEQUENCE {
            arfcn-Spacing        INTEGER (1..8),
            numberOfFollowingARFCNs    INTEGER (0..31)
        },
        variableBitMapOfARFCNs  OCTET STRING (SIZE (1..16))
    }
}
ExplicitListOfARFCNs ::=      SEQUENCE (SIZE (0..31)) OF ARFCN-ValueGERAN
-- ASN1STOP

```

CarrierFreqsGERAN field descriptions
arfcn-Spacing Space, d, between a set of equally spaced ARFCN values.
bandIndicator Indicates how to interpret the ARFCN of the BCCH carrier.
explicitListOfARFCNs The remaining ARFCN values in the set are explicitly listed one by one.
followingARFCNs Field containing a representation of the remaining ARFCN values in the set.
numberOfFollowingARFCNs The number, n, of the remaining equally spaced ARFCN values in the set. The complete set of (n+1) ARFCN values is defined as: {s, ((s + d) mod 1024), ((s + 2*d) mod 1024) ... ((s + n*d) mod 1024)}.
startingARFCN The first ARFCN value, s, in the set.
variableBitMapOfARFCNs Bitmap field representing the remaining ARFCN values in the set. The leading bit of the first octet in the bitmap corresponds to the ARFCN = ((s + 1) mod 1024), the next bit to the ARFCN = ((s + 2) mod 1024), and so on. If the bitmap consist of N octets, the trailing bit of octet N corresponds to ARFCN = ((s + 8*N) mod 1024). The complete set of ARFCN values consists of ARFCN = s and the ARFCN values, where the corresponding bit in the bitmap is set to "1".

– **CarrierFreqListMBMS**

The IE *CarrierFreqListMBMS* is used to indicate the E-UTRA ARFCN values of the one or more MBMS frequencies the UE is interested to receive.

CarrierFreqListMBMS information element

```
-- ASN1START
CarrierFreqListMBMS-r11 ::= SEQUENCE (SIZE (1..maxFreqMBMS-r11)) OF ARFCN-ValueEUTRA-r9
-- ASN1STOP
```

– **CDMA2000-Type**

The IE *CDMA2000-Type* is used to describe the type of CDMA2000 network.

CDMA2000-Type information element

```
-- ASN1START
CDMA2000-Type ::= ENUMERATED {type1XRTT, typeHRPD}
-- ASN1STOP
```

– **CellIdentity**

The IE *CellIdentity* is used to unambiguously identify a cell within a PLMN.

CellIdentity information element

```
-- ASN1START
CellIdentity ::= BIT STRING (SIZE (28))
-- ASN1STOP
```

– **CellIndexList**

The IE *CellIndexList* concerns a list of cell indices, which may be used for different purposes.

CellIndexList information element

```

-- ASN1START
CellIndexList ::= SEQUENCE (SIZE (1..maxCellMeas)) OF CellIndex
CellIndex ::= INTEGER (1..maxCellMeas)
-- ASN1STOP

```

– **CellReselectionPriority**

The IE *CellReselectionPriority* concerns the absolute priority of the concerned carrier frequency/ set of frequencies (GERAN)/ bandclass (CDMA2000), as used by the cell reselection procedure. Corresponds with parameter "priority" in TS 36.304 [4]. Value 0 means: lowest priority. The UE behaviour for the case the field is absent, if applicable, is specified in TS 36.304 [4].

CellReselectionPriority information element

```

-- ASN1START
CellReselectionPriority ::= INTEGER (0..7)
-- ASN1STOP

```

– **CellSelectionInfoCE**

The IE *CellSelectionInfoCE* contains cell selection information for CE. The *q-RxLevMinCE* corresponds to parameter $Q_{rxlevmin_CE}$ in TS 36.304 [4]. The *q-QualMinRSRQ-CE* corresponds to parameter $Q_{qualmin_CE}$ in TS 36.304 [4]. If *q-QualMinRSRQ-CE* is not present, the UE applies the (default) value of negative infinity for $Q_{qualmin}$.

CellSelectionInfoCE information element

```

-- ASN1START
CellSelectionInfoCE-r13 ::= SEQUENCE {
  q-RxLevMinCE-r13          Q-RxLevMin,
  q-QualMinRSRQ-CE-r13     Q-QualMin-r9          OPTIONAL  -- Need OR
}
-- ASN1STOP

```

– **CellSelectionInfoCE1**

The IE *CellSelectionInfoCE1* contains cell selection information for BL UEs or UEs in CE supporting CE Mode B. The *q-RxLevMinCE1* corresponds to parameter $Q_{rxlevmin_CE1}$ in TS 36.304 [4]. If *delta-RxLevMinCE1* is not included, actual value $Q_{rxlevmin_CE1} = q-RxLevMinCE1 * 2$ [dBm]. If *delta-RxLevMinCE1* is included, the actual value $Q_{rxlevmin_CE1} = (q-RxLevMinCE1 + delta-RxLevMinCE1) * 2$ [dBm]. The *q-QualMinRSRQ-CE1* corresponds to parameter $Q_{qualmin_CE1}$ in TS 36.304 [4]. If *q-QualMinRSRQ-CE1* is not present, the UE applies the (default) value of negative infinity for $Q_{qualmin}$.

CellSelectionInfoCE1 information element

```

-- ASN1START
CellSelectionInfoCE1-r13 ::= SEQUENCE {
  q-RxLevMinCE1-r13      Q-RxLevMin,
  q-QualMinRSRQ-CE1-r13  Q-QualMin-r9          OPTIONAL  -- Need OR
}
CellSelectionInfoCE1-v1360 ::= SEQUENCE {
  delta-RxLevMinCE1-v1360  INTEGER (-8..-1)
}
-- ASN1STOP

```

– *CellReselectionSubPriority*

The IE *CellReselectionSubPriority* indicates a fractional value to be added to the value of *cellReselectionPriority* to obtain the absolute priority of the concerned carrier frequency for E-UTRA.-Value *oDot2* corresponds to 0.2, *oDot4* corresponds to 0.4 and so on.

***CellReselectionSubPriority* information element**

```
-- ASN1START
CellReselectionSubPriority-r13 ::=          ENUMERATED {oDot2, oDot4, oDot6, oDot8}
-- ASN1STOP
```

– *CSFB-RegistrationParam1XRTT*

The IE *CSFB-RegistrationParam1XRTT* is used to indicate whether or not the UE shall perform a CDMA2000 1xRTT pre-registration if the UE does not have a valid / current pre-registration.

```
-- ASN1START
CSFB-RegistrationParam1XRTT ::=          SEQUENCE {
  sid                BIT STRING (SIZE (15)),
  nid                BIT STRING (SIZE (16)),
  multipleSID        BOOLEAN,
  multipleNID        BOOLEAN,
  homeReg            BOOLEAN,
  foreignSIDReg      BOOLEAN,
  foreignNIDReg      BOOLEAN,
  parameterReg       BOOLEAN,
  powerUpReg         BOOLEAN,
  registrationPeriod BIT STRING (SIZE (7)),
  registrationZone   BIT STRING (SIZE (12)),
  totalZone          BIT STRING (SIZE (3)),
  zoneTimer          BIT STRING (SIZE (3))
}
CSFB-RegistrationParam1XRTT-v920 ::=    SEQUENCE {
  powerDownReg-r9    ENUMERATED {true}
}
-- ASN1STOP
```

CSFB-RegistrationParam1XRTT field descriptions	
foreignNIDReg	The CDMA2000 1xRTT NID roamer registration indicator.
foreignSIDReg	The CDMA2000 1xRTT SID roamer registration indicator.
homeReg	The CDMA2000 1xRTT Home registration indicator.
multipleNID	The CDMA2000 1xRTT Multiple NID storage indicator.
multipleSID	The CDMA2000 1xRTT Multiple SID storage indicator.
nid	Used along with the <i>sid</i> as a pair to control when the UE should Register or Re-Register with the CDMA2000 1xRTT network.
parameterReg	The CDMA2000 1xRTT Parameter-change registration indicator.
powerDownReg	The CDMA2000 1xRTT Power-down registration indicator. If set to TRUE, the UE that has a valid / current CDMA2000 1xRTT pre-registration will perform a CDMA2000 1xRTT power down registration when it is switched off.
powerUpReg	The CDMA2000 1xRTT Power-up registration indicator.
registrationPeriod	The CDMA2000 1xRTT Registration period.
registrationZone	The CDMA2000 1xRTT Registration zone.
sid	Used along with the <i>nid</i> as a pair to control when the UE should Register or Re-Register with the CDMA2000 1xRTT network.
totalZone	The CDMA2000 1xRTT Number of registration zones to be retained.
zoneTimer	The CDMA2000 1xRTT Zone timer length.

– *CellGlobalIdEUTRA*

The IE *CellGlobalIdEUTRA* specifies the Evolved Cell Global Identifier (ECGI), the globally unique identity of a cell in E-UTRA.

CellGlobalIdEUTRA information element

```
-- ASN1START
CellGlobalIdEUTRA ::=
    SEQUENCE {
        plmn-Identity      PLMN-Identity,
        cellIdentity       CellIdentity
    }
-- ASN1STOP
```

CellGlobalIdEUTRA field descriptions

cellIdentity	Identity of the cell within the context of the PLMN.
plmn-Identity	Identifies the PLMN of the cell as given by the first PLMN entry in the <i>plmn-IdentityList</i> in <i>SystemInformationBlockType1</i> .

– *CellGlobalIdUTRA*

The IE *CellGlobalIdUTRA* specifies the global UTRAN Cell Identifier, the globally unique identity of a cell in UTRA.

CellGlobalIdUTRA information element

```
-- ASN1START
```

```

CellGlobalIdUTRA ::=
    plmn-Identity
    cellIdentity
}
SEQUENCE {
    PLMN-Identity,
    BIT STRING (SIZE (28))
}
-- ASN1STOP

```

CellGlobalIdUTRA field descriptions

cellIdentity

UTRA Cell Identifier which is unique within the context of the identified PLMN as defined in TS 25.331 [19].

plmn-Identity

Identifies the PLMN of the cell as given by the common PLMN broadcast in the MIB, as defined in TS 25.331 [19].

– CellGlobalIdGERAN

The IE *CellGlobalIdGERAN* specifies the Cell Global Identification (CGI), the globally unique identity of a cell in GERAN.

CellGlobalIdGERAN information element

```

-- ASN1START
CellGlobalIdGERAN ::=
    plmn-Identity
    locationAreaCode
    cellIdentity
}
SEQUENCE {
    PLMN-Identity,
    BIT STRING (SIZE (16)),
    BIT STRING (SIZE (16))
}
-- ASN1STOP

```

CellGlobalIdGERAN field descriptions

cellIdentity

Cell Identifier which is unique within the context of the GERAN location area as defined in TS 23.003 [27].

locationAreaCode

A fixed length code identifying the location area within a PLMN as defined in TS 23.003 [27].

plmn-Identity

Identifies the PLMN of the cell, as defined in TS 23.003 [27].

– CellGlobalIdCDMA2000

The IE *CellGlobalIdCDMA2000* specifies the Cell Global Identification (CGI), the globally unique identity of a cell in CDMA2000.

CellGlobalIdCDMA2000 information element

```

-- ASN1START
CellGlobalIdCDMA2000 ::=
    cellGlobalId1XRTT
    cellGlobalIdHRPD
}
CHOICE {
    BIT STRING (SIZE (47)),
    BIT STRING (SIZE (128))
}
-- ASN1STOP

```

CellGlobalIdCDMA2000 field descriptions

cellGlobalId1XRTT

Unique identifier for a CDMA2000 1xRTT cell, corresponds to BASEID, SID and NID parameters (in that order) defined in C.S0005 [25].

cellGlobalIdHRPD

Unique identifier for a CDMA2000 HRPD cell, corresponds to SECTOR ID parameter defined in C.S0024 [26, 14.9].

– *CellSelectionInfoNFreq*

The IE *CellSelectionInfoNFreq* includes the parameters used for cell selection on a neighbouring frequency, see TS 36.304 [4].

***CellSelectionInfoNFreq* information element**

```
-- ASN1START
CellSelectionInfoNFreq-r13 ::= SEQUENCE {
  -- Cell selection information as in SIB1
  q-RxLevMin-r13          Q-RxLevMin,
  q-RxLevMinOffset        INTEGER (1..8)          OPTIONAL,  -- Need OP
  -- Cell re-selection information as in SIB3
  q-Hyst-r13              ENUMERATED {
                                dB0, dB1, dB2, dB3, dB4, dB5, dB6, dB8, dB10,
                                dB12, dB14, dB16, dB18, dB20, dB22, dB24},
  q-RxLevMinReselection-r13  Q-RxLevMin,
  t-ReselectionEUTRA-r13    T-Reselection
}
-- ASN1STOP
```

– *CSG-Identity*

The IE *CSG-Identity* is used to identify a Closed Subscriber Group.

***CSG-Identity* information element**

```
-- ASN1START
CSG-Identity ::=
  BIT STRING (SIZE (27))
-- ASN1STOP
```

– *FreqBandIndicator*

The IE *FreqBandIndicator* indicates the E-UTRA operating band as defined in TS 36.101 [42, table 5.5-1]. If an extension is signalled using the extended value range (as defined by IE *FreqBandIndicator-v9e0*), the UE shall only consider this extension (and hence ignore the corresponding original field, using the value range as defined by IE *FreqBandIndicator* i.e. without suffix, if signalled).

***FreqBandIndicator* information element**

```
-- ASN1START
FreqBandIndicator ::=
  INTEGER (1..maxFBI)
FreqBandIndicator-v9e0 ::=
  INTEGER (maxFBI-Plus1..maxFBI2)
FreqBandIndicator-r11 ::=
  INTEGER (1..maxFBI2)
-- ASN1STOP
```

NOTE: For fields using the original value range, as defined by IE *FreqBandIndicator* i.e. without suffix, value *maxFBI* indicates that the frequency band is indicated by means of an extension. In such a case, UEs not supporting the extension consider the field to be set to a not supported value.

– *MobilityControlInfo*

The IE *MobilityControlInfo* includes parameters relevant for network controlled mobility to/within E-UTRA.

MobilityControlInfo information element

```

-- ASN1START
MobilityControlInfo ::= SEQUENCE {
    targetPhysCellId          PhysCellId,
    carrierFreq               CarrierFreqEUTRA          OPTIONAL, -- Cond HO-
toEUTRA2
    carrierBandwidth         CarrierBandwidthEUTRA      OPTIONAL, -- Cond HO-
toEUTRA
    additionalSpectrumEmission AdditionalSpectrumEmission OPTIONAL, -- Cond HO-
toEUTRA
    t304                     ENUMERATED {
                                ms50, ms100, ms150, ms200, ms500, ms1000,
                                ms2000, ms10000-v1310},
    newUE-Identity           C-RNTI,
    radioResourceConfigCommon RadioResourceConfigCommon,
    rach-ConfigDedicated     RACH-ConfigDedicated          OPTIONAL, -- Need OP
    ...,
    [[ carrierFreq-v9e0      CarrierFreqEUTRA-v9e0          OPTIONAL -- Need ON
    ]],
    [[ drb-ContinueROHC-r11  ENUMERATED {true}           OPTIONAL -- Cond HO
    ]],
    [[ mobilityControlInfoV2X-r14 MobilityControlInfoV2X-r14  OPTIONAL, -- Need ON
    handoverWithoutWT-Change-r14 ENUMERATED {keepLWA-Config, sendEndMarker} OPTIONAL, --
Cond HO
    makeBeforeBreak-r14     ENUMERATED {true}           OPTIONAL, -- Need OR
    rach-Skip-r14           RACH-Skip-r14             OPTIONAL, -- Need OR
    sameSFN-Indication-r14  ENUMERATED {true}           OPTIONAL -- Cond HO-
SFNSynced
    ]],
    [[
        mib-RepetitionStatus-r14    BOOLEAN          OPTIONAL, -- Need OR
        schedulingInfoSIB1-BR-r14   INTEGER (0..31)  OPTIONAL -- Cond HO-
SFNSynced
    ]]
}

MobilityControlInfo-v1010 ::= SEQUENCE {
    additionalSpectrumEmission-v1010 AdditionalSpectrumEmission-v1010 OPTIONAL -- Need ON
}

MobilityControlInfoSCG-r12 ::= SEQUENCE {
    t307-r12                     ENUMERATED {
                                ms50, ms100, ms150, ms200, ms500, ms1000,
                                ms2000, spare1},
    ue-IdentitySCG-r12           C-RNTI             OPTIONAL, -- Cond SCGEst,
    rach-ConfigDedicated-r12     RACH-ConfigDedicated OPTIONAL, -- Need OP
    cipheringAlgorithmSCG-r12    CipheringAlgorithm-r12 OPTIONAL, -- Need ON
    ...,
    [[ makeBeforeBreakSCG-r14     ENUMERATED {true}           OPTIONAL, -- Need OR
    rach-SkipSCG-r14            RACH-Skip-r14         OPTIONAL -- Need OR
    ]]
}

MobilityControlInfoV2X-r14 ::= SEQUENCE {
    v2x-CommTxPoolExceptional-r14 SL-CommResourcePoolV2X-r14  OPTIONAL, -- Need OR
    v2x-CommRxPool-r14          SL-CommRxPoolListV2X-r14   OPTIONAL, -- Need OR
    v2x-CommSyncConfig-r14      SL-SyncConfigListV2X-r14   OPTIONAL, -- Need OR
    cbr-MobilityTxConfigList-r14 SL-CBR-CommonTxConfigList-r14 OPTIONAL -- Need OR
}

CarrierBandwidthEUTRA ::= SEQUENCE {
    dl-Bandwidth                ENUMERATED {
                                n6, n15, n25, n50, n75, n100, spare10,
                                spare9, spare8, spare7, spare6, spare5,
                                spare4, spare3, spare2, spare1},
    ul-Bandwidth                ENUMERATED {
                                n6, n15, n25, n50, n75, n100, spare10,
                                spare9, spare8, spare7, spare6, spare5,
                                spare4, spare3, spare2, spare1} OPTIONAL -- Need OP
}

CarrierFreqEUTRA ::= SEQUENCE {
    dl-CarrierFreq              ARFCN-ValueEUTRA,
    ul-CarrierFreq              ARFCN-ValueEUTRA          OPTIONAL -- Cond FDD
}

```

```
CarrierFreqEUTRA-v9e0 ::= SEQUENCE {
  dl-CarrierFreq-v9e0 ARFCN-ValueEUTRA-r9,
  ul-CarrierFreq-v9e0 ARFCN-ValueEUTRA-r9 OPTIONAL -- Cond FDD
}

RACH-Skip-r14 ::= SEQUENCE {
  targetTA-r14 CHOICE {
    ta0-r14 NULL,
    mcg-PTAG-r14 NULL,
    scg-PTAG-r14 NULL,
    mcg-STAG-r14 STAG-Id-r11,
    scg-STAG-r14 STAG-Id-r11
  },
  ul-ConfigInfo-r14 SEQUENCE {
    numberOfConfUL-Processes-r14 INTEGER (1..8),
    ul-SchedInterval-r14 ENUMERATED {sf2, sf5, sf10},
    ul-StartSubframe-r14 INTEGER (0..9),
    ul-Grant-r14 BIT STRING (SIZE (16))
  }
} OPTIONAL -- Need OR

-- ASN1STOP
```

MobilityControlInfo field descriptions
<p>additionalSpectrumEmission For a UE with no SCells configured for UL in the same band as the PCell, the UE shall apply the value for the PCell instead of the corresponding value from <i>SystemInformationBlockType2</i> or <i>SystemInformationBlockType1</i>. For a UE with SCell(s) configured for UL in the same band as the PCell, the UE shall, in case all SCells configured for UL in that band are released after handover completion, apply the value for the PCell instead of the corresponding value from <i>SystemInformationBlockType2</i> or <i>SystemInformationBlockType1</i>. The UE requirements related to IE <i>AdditionalSpectrumEmission</i> are defined in TS 36.101 [42, table 6.2.4-1] for UEs neither in CE nor BL UEs and TS 36.101 [42, table 6.2.4E-1] for UEs in CE or BL UEs.</p>
<p>carrierBandwidth Provides the parameters <i>Downlink bandwidth</i>, and <i>Uplink bandwidth</i>, see TS 36.101 [42].</p>
<p>carrierFreq Provides the EARFCN to be used by the UE in the target cell.</p>
<p>cbr-MobilityTxConfigList Indicates the list of CBR ranges and the list of PSSCH transmission parameter configurations available to configure congestion control to the UE for V2X sidelink communication during handover.</p>
<p>cipheringAlgorithmSCG Indicates the ciphering algorithm to be used for SCG DRBs. E-UTRAN includes the field upon SCG change when one or more SCG DRBs are configured. Otherwise E-UTRAN does not include the field.</p>
<p>dl-Bandwidth Parameter: <i>Downlink bandwidth</i>, see TS 36.101 [42].</p>
<p>drb-ContinueROHC This field indicates whether to continue or reset, for this handover, the header compression protocol context for the RLC UM bearers configured with the header compression protocol. Presence of the field indicates that the header compression protocol context continues while absence indicates that the header compression protocol context is reset. E-UTRAN includes the field only in case of a handover within the same eNB.</p>
<p>handoverWithoutWT-Change Indicates whether UE performs handover where LWA configuration is retained with the same WT If <i>sendEndMarker</i> is configured, the LWA end-marker for PDCP key change indication is used as defined in [8]. If value <i>keepLWA-Config</i> is configured, LWA end marker is not used and UE shall only retain the LWA configuration.</p>
<p>makeBeforeBreak Indicates that the UE shall continue uplink transmission/ downlink reception with the source cell(s) before performing the first transmission through PRACH to the target intra-frequency PCell, or performing initial PUSCH transmission to the target intra-frequency PCell while <i>rach-Skip</i> is configured.</p>
<p>makeBeforeBreakSCG Indicates that the UE shall continue uplink transmission/ downlink reception with the source cell(s) before performing the first transmission through PRACH to the target intra-frequency PSCell, or performing initial PUSCH transmission to the target intra-frequency PSCell while <i>rach-SkipSCG</i> is configured.</p>
<p>mib-RepetitionStatus Indicates whether additional MIB repetition is enabled in the target cell or not. Value TRUE indicates additional MIB repetition is enabled in the target cell. Value FALSE indicates additional MIB repetition is not enabled in the target cell. The absence of this field indicates additional MIB repetition may or may not be enabled in the target cell. See 5.2.1.2 and TS 36.211 [21, 6.4.1]. This field is applicable to BL UE or UE in CE.</p>
<p>mobilityControlInfoV2X Indicates the sidelink configurations of the target cell for V2X sidelink communication during handover.</p>
<p>numberOfConfUL-Processes The number of configured HARQ processes for preallocated uplink grant, see TS 36.321 [6, 5.20]. This field is applicable if a UE is configured with asynchronous HARQ, otherwise it shall be ignored.</p>
<p>rach-ConfigDedicated The dedicated random access parameters. If absent the UE applies contention based random access as specified in TS 36.321 [6].</p>
<p>rach-Skip This field indicates whether random access procedure for the target PCell is skipped.</p>
<p>rach-SkipSCG This field indicates whether random access procedure for the target PSCell is skipped.</p>
<p>sameSFN-Indication This field indicates that the target cell has the same SFN as the source cell and that the BL UE or UE in CE is not required to acquire <i>MasterInformationBlock</i> in the target PCell during handover to obtain the SFN of the target cell, as specified in clause 5.3.5.4.</p>
<p>schedulingInfoSIB1-BR Indicates the index to the tables that define <i>SystemInformationBlockType1-BR</i> scheduling information. The tables are specified in TS 36.213 [23, Table 7.1.6-1 and Table 7.1.7.2.7-1]. Value 0 means <i>SystemInformationBlockType1-BR</i> is not scheduled. If absent when <i>sameSFN-Indication</i> is present, UE assumes that <i>SystemInformationBlockType1-BR</i> scheduling information in target cell may be different from source cell.</p>
<p>t304 Timer T304 as described in clause 7.3. ms50 corresponds with 50 ms, ms100 corresponds with 100 ms and so on. EUTRAN includes extended value <i>ms10000-v1310</i> only when UE supports CE.</p>

MobilityControlInfo field descriptions	
additionalSpectrumEmission	For a UE with no SCells configured for UL in the same band as the PCell, the UE shall apply the value for the PCell instead of the corresponding value from <i>SystemInformationBlockType2</i> or <i>SystemInformationBlockType1</i> . For a UE with SCell(s) configured for UL in the same band as the PCell, the UE shall, in case all SCells configured for UL in that band are released after handover completion, apply the value for the PCell instead of the corresponding value from <i>SystemInformationBlockType2</i> or <i>SystemInformationBlockType1</i> . The UE requirements related to IE <i>AdditionalSpectrumEmission</i> are defined in TS 36.101 [42, table 6.2.4-1] for UEs neither in CE nor BL UEs and TS 36.101 [42, table 6.2.4E-1] for UEs in CE or BL UEs.
t307	Timer T307 as described in clause 7.3. ms50 corresponds with 50 ms, ms100 corresponds with 100 ms and so on.
targetTA	This field refers to the timing adjustment indication, see TS 36.213 [23], indicating the N_{TA} value which the UE shall use for the target PTAG of handover or the target PSTAG of SCG change. <i>ta0</i> corresponds to $N_{TA}=0$. <i>mcg-PTAG</i> corresponds to the latest N_{TA} value of the PTAG associated with MCG. <i>scg-PTAG</i> corresponds to the latest N_{TA} value of the PTAG associated with SCG. <i>mcg-STAG</i> corresponds to the latest N_{TA} value of a MCG STAG indicated by the STAG-Id. <i>scg-STAG</i> corresponds to the latest N_{TA} value of a SCG STAG indicated by the STAG-Id.
ul-Bandwidth	Parameter: <i>Uplink bandwidth</i> , see TS 36.101 [42, table 5.6-1]. For TDD, the parameter is absent and it is equal to downlink bandwidth. If absent for FDD, apply the same value as applies for the downlink bandwidth.
ul-Grant	Indicates the resources of the target PCell/PSCell to be used for the uplink transmission of PUSCH [23, 8.8].
ul-SchedInterval	Indicates the scheduling interval in uplink, see TS 36.321 [6, 5.20]. Value in number of sub-frames. Value sf2 corresponds to 2 subframes, sf5 corresponds to 5 subframes and so on.
ul-StartSubframe	Indicates the subframe in which the UE may initiate the uplink transmission, see TS 36.321 [6, 5.20]. Value 0 corresponds to subframe number 0, 1 corresponds to subframe number 1 and so on. The subframe indicating a valid uplink grant according to the calculation of UL grant configured by <i>ul-StartSubframe</i> and <i>ul-SchedInterval</i> , see TS 36.321 [6, 5.20], is the same across all radio frames.
v2x-CommRxPool	Indicates reception pools for receiving V2X sidelink communication during handover.
v2x-CommSyncConfig	Indicates synchronization configurations for performing V2X sidelink communication during handover.
v2x-CommTxPoolExceptional	Indicates the transmission resources by which the UE is allowed to transmit V2X sidelink communication during handover.

Conditional presence	Explanation
<i>FDD</i>	The field is mandatory with default value (the default duplex distance defined for the concerned band, as specified in TS 36.101 [42]) in case of "FDD"; otherwise the field is not present.
<i>HO</i>	This field is optionally present, need OP, in case of handover within E-UTRA when the <i>fullConfig</i> is not included; otherwise the field is not present.
<i>HO-SFNsynced</i>	This field is optionally present, need OP, in case of source E-UTRA and target E-UTRA cells are SFN synchronised.
<i>HO-toEUTRA</i>	The field is mandatory present in case of inter-RAT handover to E-UTRA; otherwise the field is optionally present, need ON.
<i>HO-toEUTRA2</i>	The field is absent if <i>carrierFreq-v9e0</i> is present. Otherwise it is mandatory present in case of inter-RAT handover to E-UTRA and optionally present, need ON, in all other cases.
<i>SCGEst</i>	This field is mandatory present in case of SCG establishment; otherwise the field is optionally present, need ON.

– *MobilityParametersCDMA2000 (1xRTT)*

The *MobilityParametersCDMA2000* contains the parameters provided to the UE for handover and (enhanced) CSFB to 1xRTT support, as defined in C.S0097 [53].

***MobilityParametersCDMA2000* information element**

```
-- ASN1START
MobilityParametersCDMA2000 ::= OCTET STRING
```

```
-- ASN1STOP
```

– *MobilityStateParameters*

The IE *MobilityStateParameters* contains parameters to determine UE mobility state.

***MobilityStateParameters* information element**

```
-- ASN1START
MobilityStateParameters ::=          SEQUENCE {
  t-Evaluation                      ENUMERATED {
                                      s30, s60, s120, s180, s240, spare3, spare2, spare1},
  t-HystNormal                       ENUMERATED {
                                      s30, s60, s120, s180, s240, spare3, spare2, spare1},
  n-CellChangeMedium                 INTEGER (1..16),
  n-CellChangeHigh                   INTEGER (1..16)
}
-- ASN1STOP
```

***MobilityStateParameters* field descriptions**

<i>n-CellChangeHigh</i>	The number of cell changes to enter high mobility state. Corresponds to N_{CR_H} in TS 36.304 [4].
<i>n-CellChangeMedium</i>	The number of cell changes to enter medium mobility state. Corresponds to N_{CR_M} in TS 36.304 [4].
<i>t-Evaluation</i>	The duration for evaluating criteria to enter mobility states. Corresponds to T_{CRmax} in TS 36.304 [4]. Value in seconds, s30 corresponds to 30 s and so on.
<i>t-HystNormal</i>	The additional duration for evaluating criteria to enter normal mobility state. Corresponds to $T_{CRmaxHyst}$ in TS 36.304 [4]. Value in seconds, s30 corresponds to 30 s and so on.

– *MultiBandInfoList*

***MultiBandInfoList* information element**

```
-- ASN1START
MultiBandInfoList ::= SEQUENCE (SIZE (1..maxMultiBands)) OF FreqBandIndicator
MultiBandInfoList-v9e0 ::= SEQUENCE (SIZE (1..maxMultiBands)) OF MultiBandInfo-v9e0
MultiBandInfoList-v10j0 ::= SEQUENCE (SIZE (1..maxMultiBands)) OF NS-PmaxList-r10
MultiBandInfoList-v10l0 ::= SEQUENCE (SIZE (1..maxMultiBands)) OF NS-PmaxList-v10l0
MultiBandInfoList-r11 ::= SEQUENCE (SIZE (1..maxMultiBands)) OF FreqBandIndicator-r11
MultiBandInfo-v9e0 ::= SEQUENCE {
  freqBandIndicator-v9e0           FreqBandIndicator-v9e0           OPTIONAL    -- Need OP
}
-- ASN1STOP
```

– *NS-PmaxList*

The IE *NS-PmaxList* concerns a list of *additionalPmax* and *additionalSpectrumEmission*, as defined in TS 36.101 [42, table 6.2.4-1] for UEs neither in CE nor BL UEs and TS 36.101 [42, table 6.2.4E-1] for UEs in CE or BL UEs, for a given frequency band. E-UTRAN does not include the same value of *additionalSpectrumEmission* in *SystemInformationBlockType2* within this list.

***NS-PmaxList* information element**

```
-- ASN1START
```

```

NS-PmaxList-r10 ::= SEQUENCE (SIZE (1..maxNS-Pmax-r10)) OF NS-PmaxValue-r10
NS-PmaxList-v1010 ::= SEQUENCE (SIZE (1..maxNS-Pmax-r10)) OF NS-PmaxValue-v1010
NS-PmaxValue-r10 ::= SEQUENCE {
    additionalPmax-r10 P-Max OPTIONAL, -- Need OP
    additionalSpectrumEmission AdditionalSpectrumEmission
}
NS-PmaxValue-v1010 ::= SEQUENCE {
    additionalSpectrumEmission-v1010 AdditionalSpectrumEmission-v1010 OPTIONAL -- Need OP
}
-- ASN1STOP

```

– *PhysCellId*

The IE *PhysCellId* is used to indicate the physical layer identity of the cell, as defined in TS 36.211 [21].

PhysCellId information element

```

-- ASN1START
PhysCellId ::= INTEGER (0..503)
-- ASN1STOP

```

– *PhysCellIdRange*

The IE *PhysCellIdRange* is used to encode either a single or a range of physical cell identities. The range is encoded by using a *start* value and by indicating the number of consecutive physical cell identities (including *start*) in the range. For fields comprising multiple occurrences of *PhysCellIdRange*, E-UTRAN may configure overlapping ranges of physical cell identities.

PhysCellIdRange information element

```

-- ASN1START
PhysCellIdRange ::= SEQUENCE {
    start PhysCellId,
    range ENUMERATED {
        n4, n8, n12, n16, n24, n32, n48, n64, n84,
        n96, n128, n168, n252, n504, spare2,
        spare1} OPTIONAL -- Need OP
}
-- ASN1STOP

```

PhysCellIdRange field descriptions

range

Indicates the number of physical cell identities in the range (including *start*). Value n4 corresponds with 4, n8 corresponds with 8 and so on. The UE shall apply value 1 in case the field is absent, in which case only the physical cell identity value indicated by *start* applies.

start

Indicates the lowest physical cell identity in the range.

– *PhysCellIdRangeUTRA-FDDList*

The IE *PhysCellIdRangeUTRA-FDDList* is used to encode one or more of *PhysCellIdRangeUTRA-FDD*. While the IE *PhysCellIdRangeUTRA-FDD* is used to encode either a single physical layer identity or a range of physical layer identities, i.e. primary scrambling codes. Each range is encoded by using a *start* value and by indicating the number of consecutive physical cell identities (including *start*) in the range.

***PhysCellIdRangeUTRA-FDDList* information element**

```
-- ASN1START
PhysCellIdRangeUTRA-FDDList-r9 ::= SEQUENCE (SIZE (1..maxPhysCellIdRange-r9)) OF
PhysCellIdRangeUTRA-FDD-r9
PhysCellIdRangeUTRA-FDD-r9 ::= SEQUENCE {
    start-r9 PhysCellIdUTRA-FDD,
    range-r9 INTEGER (2..512) OPTIONAL -- Need OP
}
-- ASN1STOP
```

***PhysCellIdRangeUTRA-FDDList* field descriptions**

range

Indicates the number of primary scrambling codes in the range (including *start*). The UE shall apply value 1 in case the field is absent, in which case only the primary scrambling code value indicated by *start* applies.

start

Indicates the lowest primary scrambling code in the range.

– *PhysCellIdCDMA2000*

The IE *PhysCellIdCDMA2000* identifies the PNOffset that represents the "Physical cell identity" in CDMA2000.

***PhysCellIdCDMA2000* information element**

```
-- ASN1START
PhysCellIdCDMA2000 ::= INTEGER (0..maxPNOffset)
-- ASN1STOP
```

– *PhysCellIdGERAN*

The IE *PhysCellIdGERAN* contains the Base Station Identity Code (BSIC).

***PhysCellIdGERAN* information element**

```
-- ASN1START
PhysCellIdGERAN ::= SEQUENCE {
    networkColourCode BIT STRING (SIZE (3)),
    baseStationColourCode BIT STRING (SIZE (3))
}
-- ASN1STOP
```

***PhysCellIdGERAN* field descriptions**

baseStationColourCode

Base Station Colour Code as defined in TS 23.003 [27].

networkColourCode

Network Colour Code as defined in TS 23.003 [27].

– *PhysCellIdUTRA-FDD*

The IE *PhysCellIdUTRA-FDD* is used to indicate the physical layer identity of the cell, i.e. the primary scrambling code, as defined in TS 25.331 [19].

***PhysCellIdUTRA-FDD* information element**

```
-- ASN1START
PhysCellIdUTRA-FDD ::=          INTEGER (0..511)
-- ASN1STOP
```

– *PhysCellIdUTRA-TDD*

The IE *PhysCellIdUTRA-TDD* is used to indicate the physical layer identity of the cell, i.e. the cell parameters ID (TDD), as specified in TS 25.331 [19]. Also corresponds to the Initial Cell Parameter Assignment in TS 25.223 [46].

***PhysCellIdUTRA-TDD* information element**

```
-- ASN1START
PhysCellIdUTRA-TDD ::=          INTEGER (0..127)
-- ASN1STOP
```

– *PLMN-Identity*

The IE *PLMN-Identity* identifies a Public Land Mobile Network. Further information regarding how to set the IE are specified in TS 23.003 [27].

***PLMN-Identity* information element**

```
-- ASN1START
PLMN-Identity ::=              SEQUENCE {
    mcc                        MCC                OPTIONAL,      -- Cond MCC
    mnc                        MNC
}
MCC ::=                        SEQUENCE (SIZE (3)) OF
                                MCC-MNC-Digit
MNC ::=                        SEQUENCE (SIZE (2..3)) OF
                                MCC-MNC-Digit
MCC-MNC-Digit ::=             INTEGER (0..9)
-- ASN1STOP
```

***PLMN-Identity* field descriptions**

mcc

The first element contains the first MCC digit, the second element the second MCC digit and so on. If the field is absent, it takes the same value as the *mcc* of the immediately preceding IE *PLMN-Identity*. See TS 23.003 [27].

mnc

The first element contains the first MNC digit, the second element the second MNC digit and so on. See TS 23.003 [27].

Conditional presence	Explanation
MCC	This IE is mandatory when <i>PLMN-Identity</i> is included in <i>CellGlobalIdEUTRA</i> , in <i>CellGlobalIdUTRA</i> , in <i>CellGlobalIdGERAN</i> or in <i>RegisteredMME</i> . This IE is also mandatory in the first occurrence of the IE <i>PLMN-Identity</i> within the IE <i>PLMN-IdentityList</i> . Otherwise it is optional, need OP.

– PLMN-IdentityList3

Includes a list of PLMN identities.

PLMN-IdentityList3 information element

```
-- ASN1START
PLMN-IdentityList3-r11 ::=          SEQUENCE (SIZE (1..16)) OF PLMN-Identity
-- ASN1STOP
```

– PreRegistrationInfoHRPD

```
-- ASN1START
PreRegistrationInfoHRPD ::=          SEQUENCE {
    preRegistrationAllowed            BOOLEAN,
    preRegistrationZoneId             PreRegistrationZoneIdHRPD    OPTIONAL, -- cond PreRegAllowed
    secondaryPreRegistrationZoneIdList SecondaryPreRegistrationZoneIdListHRPD  OPTIONAL -- Need OR
}
SecondaryPreRegistrationZoneIdListHRPD ::= SEQUENCE (SIZE (1..2)) OF PreRegistrationZoneIdHRPD
PreRegistrationZoneIdHRPD ::=          INTEGER (0..255)
-- ASN1STOP
```

PreRegistrationInfoHRPD field descriptions

preRegistrationAllowed

TRUE indicates that a UE shall perform a CDMA2000 HRPD pre-registration if the UE does not have a valid / current pre-registration. FALSE indicates that the UE is not allowed to perform CDMA2000 HRPD pre-registration in the current cell.

preRegistrationZoneId

ColorCode (see C.S0024 [26], C.S0087 [44]) of the CDMA2000 Reference Cell corresponding to the HRPD sector under the HRPD AN that is configured for this LTE cell. It is used to control when the UE should register or re-register.

secondaryPreRegistrationZoneIdList

List of SecondaryColorCodes (see C.S0024 [26], C.S0087 [44]) of the CDMA2000 Reference Cell corresponding to the HRPD sector under the HRPD AN that is configured for this LTE cell. They are used to control when the UE should re-register.

Conditional presence	Explanation
<i>PreRegAllowed</i>	The field is mandatory in case the <i>preRegistrationAllowed</i> is set to <i>true</i> . Otherwise the field is not present and the UE shall delete any existing value for this field.

– Q-QualMin

The IE *Q-QualMin* is used to indicate for cell selection/ re-selection the required minimum received RSRQ level in the (E-UTRA) cell. Corresponds to parameter Q_{qualmin} in TS 36.304 [4]. Actual value $Q_{\text{qualmin}} = \text{field value [dB]}$.

Q-QualMin information element

```
-- ASN1START
Q-QualMin-r9 ::=          INTEGER (-34..-3)
-- ASN1STOP
```

– Q-RxLevMin

The IE *Q-RxLevMin* is used to indicate for cell selection/ re-selection the required minimum received RSRP level in the (E-UTRA) cell. Corresponds to parameter Q_{rxlevmin} in TS 36.304 [4]. Actual value $Q_{\text{rxlevmin}} = \text{field value} * 2 \text{ [dBm]}$.

Q-RxLevMin information element

```
-- ASN1START
Q-RxLevMin ::=                INTEGER (-70..-22)
-- ASN1STOP
```

Q-OffsetRange

The IE *Q-OffsetRange* is used to indicate a cell, CSI-RS resource or frequency specific offset to be applied when evaluating candidates for cell re-selection or when evaluating triggering conditions for measurement reporting. The value in dB. Value dB-24 corresponds to -24 dB, dB-22 corresponds to -22 dB and so on.

Q-OffsetRange information element

```
-- ASN1START
Q-OffsetRange ::=            ENUMERATED {
                                dB-24, dB-22, dB-20, dB-18, dB-16, dB-14,
                                dB-12, dB-10, dB-8, dB-6, dB-5, dB-4, dB-3,
                                dB-2, dB-1, dB0, dB1, dB2, dB3, dB4, dB5,
                                dB6, dB8, dB10, dB12, dB14, dB16, dB18,
                                dB20, dB22, dB24}
-- ASN1STOP
```

Q-OffsetRangeInterRAT

The IE *Q-OffsetRangeInterRAT* is used to indicate a frequency specific offset to be applied when evaluating triggering conditions for measurement reporting. The value in dB.

Q-OffsetRangeInterRAT information element

```
-- ASN1START
Q-OffsetRangeInterRAT ::=    INTEGER (-15..15)
-- ASN1STOP
```

ReselectionThreshold

The IE *ReselectionThreshold* is used to indicate an Rx level threshold for cell reselection. Actual value of threshold = field value * 2 [dB].

ReselectionThreshold information element

```
-- ASN1START
ReselectionThreshold ::=    INTEGER (0..31)
-- ASN1STOP
```

ReselectionThresholdQ

The IE *ReselectionThresholdQ* is used to indicate a quality level threshold for cell reselection. Actual value of threshold = field value [dB].

ReselectionThresholdQ information element

```
-- ASN1START
ReselectionThresholdQ-r9 ::= INTEGER (0..31)
-- ASN1STOP
```

```
-- ASN1STOP
```

– *SCellIndex*

The IE *SCellIndex* concerns a short identity, used to identify an SCell.

SCellIndex information element

```
-- ASN1START
SCellIndex-r10 ::=                INTEGER (1..7)
SCellIndex-r13 ::=                INTEGER (1..31)
-- ASN1STOP
```

– *ServCellIndex*

The IE *ServCellIndex* concerns a short identity, used to identify a serving cell (i.e. the PCell or an SCell). Value 0 applies for the PCell, while the *SCellIndex* that has previously been assigned applies for SCells.

ServCellIndex information element

```
-- ASN1START
ServCellIndex-r10 ::=             INTEGER (0..7)
ServCellIndex-r13 ::=             INTEGER (0..31)
-- ASN1STOP
```

– *SpeedStateScaleFactors*

The IE *SpeedStateScaleFactors* concerns factors, to be applied when the UE is in medium or high speed state, used for scaling a mobility control related parameter.

SpeedStateScaleFactors information element

```
-- ASN1START
SpeedStateScaleFactors ::=       SEQUENCE {
  sf-Medium                       ENUMERATED {oDot25, oDot5, oDot75, lDot0},
  sf-High                         ENUMERATED {oDot25, oDot5, oDot75, lDot0}
}
-- ASN1STOP
```

SpeedStateScaleFactors field descriptions

sf-High

The concerned mobility control related parameter is multiplied with this factor if the UE is in High Mobility state as defined in TS 36.304 [4]. Value oDot25 corresponds to 0.25, oDot5 corresponds to 0.5, oDot75 corresponds to 0.75 and so on.

sf-Medium

The concerned mobility control related parameter is multiplied with this factor if the UE is in Medium Mobility state as defined in TS 36.304 [4]. Value oDot25 corresponds to 0.25, oDot5 corresponds to 0.5, oDot75 corresponds to 0.75 and so on.

– *SystemInfoListGERAN*

The IE *SystemInfoListGERAN* contains system information of a GERAN cell.

SystemInfoListGERAN information element

```
-- ASN1START
```



```

SystemInfoListGERAN ::=          SEQUENCE (SIZE (1..maxGERAN-SI)) OF
                                OCTET STRING (SIZE (1..23))
-- ASN1STOP

```

SystemInfoListGERAN field descriptions

SystemInfoListGERAN

Each OCTET STRING contains one System Information (SI) message as defined in TS 44.018 [45, table 9.1.1] excluding the L2 Pseudo Length, the RR management Protocol Discriminator and the Skip Indicator or a complete Packet System Information (PSI) message as defined in TS 44.060 [36, table 11.2.1].

SystemTimeInfoCDMA2000

The IE *SystemTimeInfoCDMA2000* informs the UE about the absolute time in the current cell. The UE uses this absolute time knowledge to derive the CDMA2000 Physical cell identity, expressed as PNOffset, of neighbour CDMA2000 cells.

NOTE: The UE needs the CDMA2000 system time with a certain level of accuracy for performing measurements as well as for communicating with the CDMA2000 network (HRPD or 1xRTT).

SystemTimeInfoCDMA2000 information element

```

-- ASN1START
SystemTimeInfoCDMA2000 ::=          SEQUENCE {
    cdma-EUTRA-Synchronisation      BOOLEAN,
    cdma-SystemTime                  CHOICE {
        synchronousSystemTime       BIT STRING (SIZE (39)),
        asynchronousSystemTime      BIT STRING (SIZE (49))
    }
}
-- ASN1STOP

```

SystemTimeInfoCDMA2000 field descriptions

asynchronousSystemTime

The CDMA2000 system time corresponding to the SFN boundary at or after the ending boundary of the SI-Window in which *SystemInformationBlockType8* is transmitted. E-UTRAN includes this field if the E-UTRA frame boundary is not aligned to the start of CDMA2000 system time. This field size is 49 bits and the unit is 8 CDMA chips based on 1.2288 Mcps.

cdma-EUTRA-Synchronisation

TRUE indicates that there is no drift in the timing between E-UTRA and CDMA2000. FALSE indicates that the timing between E-UTRA and CDMA2000 can drift. NOTE 1

synchronousSystemTime

CDMA2000 system time corresponding to the SFN boundary at or after the ending boundary of the SI-window in which *SystemInformationBlockType8* is transmitted. E-UTRAN includes this field if the E-UTRA frame boundary is aligned to the start of CDMA2000 system time. This field size is 39 bits and the unit is 10 ms based on a 1.2288 Mcps chip rate.

NOTE 1: The following table shows the recommended combinations of the *cdma-EUTRA-Synchronisation* field and the choice of *cdma-SystemTime* included by E-UTRAN for FDD and TDD:

FDD/TDD	<i>cdma-EUTRA-Synchronisation</i>	<i>synchronousSystemTime</i>	<i>asynchronousSystemTime</i>
FDD	FALSE	Not Recommended	Recommended
FDD	TRUE	Recommended	Recommended
TDD	FALSE	Not Recommended	Recommended
TDD	TRUE	Recommended	Recommended

– *TrackingAreaCode*

The IE *TrackingAreaCode* is used to identify a tracking area within the scope of a PLMN, see TS 24.301 [35].

***TrackingAreaCode* information element**

```
-- ASN1START
TrackingAreaCode ::=                BIT STRING (SIZE (16))
-- ASN1STOP
```

– *T-Reselection*

The IE *T-Reselection* concerns the cell reselection timer $T_{reselctionRAT}$ for E-UTRA, UTRA, GERAN or CDMA2000. Value in seconds. For value 0, behaviour as specified in 7.3.2 applies.

***T-Reselection* information element**

```
-- ASN1START
T-Reselection ::=                    INTEGER (0..7)
-- ASN1STOP
```

– *T-ReselectionEUTRA-CE*

The IE *T-ReselectionEUTRA-CE* concerns the cell reselection timer $T_{reselctionEUTRA_CE}$ as specified in TS 36.304 [4]. Value in seconds. For value 0, behaviour as specified in 7.3.2 applies.

***T-ReselectionEUTRA-CE* information element**

```
-- ASN1START
T-ReselectionEUTRA-CE-r13 ::=       INTEGER (0..15)
-- ASN1STOP
```

6.3.5 Measurement information elements

– *AllowedMeasBandwidth*

The IE *AllowedMeasBandwidth* is used to indicate the maximum allowed measurement bandwidth on a carrier frequency as defined by the parameter Transmission Bandwidth Configuration " N_{RB} " TS 36.104 [47]. The values mbw6, mbw15, mbw25, mbw50, mbw75, mbw100 indicate 6, 15, 25, 50, 75 and 100 resource blocks respectively.

***AllowedMeasBandwidth* information element**

```
-- ASN1START
AllowedMeasBandwidth ::=            ENUMERATED {mbw6, mbw15, mbw25, mbw50, mbw75, mbw100}
-- ASN1STOP
```

– *CSI-RSRP-Range*

The IE *CSI-RSRP-Range* specifies the value range used in CSI-RSRP measurements and thresholds. Integer value for CSI-RSRP measurements according to mapping table in TS 36.133 [16].

CSI-RSRP-Range information element

```

-- ASN1START
CSI-RSRP-Range-r12 ::=
                                INTEGER(0..97)
-- ASN1STOP

```

– **Hysteresis**

The IE *Hysteresis* is a parameter used within the entry and leave condition of an event triggered reporting condition. The actual value is field value * 0.5 dB, except if included in *reportConfigEUTRA* and associated to *eventV1* or *eventV2*. If included in *reportConfigEUTRA* and associated to *eventV1* or *eventV2*, the actual value is field value divided by 100.

Hysteresis information element

```

-- ASN1START
Hysteresis ::=
                                INTEGER (0..30)
-- ASN1STOP

```

– **LocationInfo**

The IE *LocationInfo* is used to transfer detailed location information available at the UE to correlate measurements and UE position information.

LocationInfo information element

```

-- ASN1START
LocationInfo-r10 ::= SEQUENCE {
    locationCoordinates-r10 CHOICE {
        ellipsoid-Point-r10 OCTET STRING,
        ellipsoidPointWithAltitude-r10 OCTET STRING,
        ...,
        ellipsoidPointWithUncertaintyCircle-r11 OCTET STRING,
        ellipsoidPointWithUncertaintyEllipse-r11 OCTET STRING,
        ellipsoidPointWithAltitudeAndUncertaintyEllipsoid-r11 OCTET STRING,
        ellipsoidArc-r11 OCTET STRING,
        polygon-r11 OCTET STRING
    },
    horizontalVelocity-r10 OCTET STRING OPTIONAL,
    gnss-TOD-msec-r10 OCTET STRING OPTIONAL,
    ...
}
-- ASN1STOP

```

<i>LocationInfo</i> field descriptions
ellipsoidArc Parameter <i>EllipsoidArc</i> defined in TS36.355 [54]. The first/leftmost bit of the first octet contains the most significant bit.
ellipsoid-Point Parameter <i>Ellipsoid-Point</i> defined in TS36.355 [54]. The first/leftmost bit of the first octet contains the most significant bit.
ellipsoidPointWithAltitude Parameter <i>EllipsoidPointWithAltitude</i> defined in TS36.355 [54]. The first/leftmost bit of the first octet contains the most significant bit.
ellipsoidPointWithAltitudeAndUncertaintyEllipsoid Parameter <i>EllipsoidPointWithAltitudeAndUncertaintyEllipsoid</i> defined in TS36.355 [54]. The first/leftmost bit of the first octet contains the most significant bit.
ellipsoidPointWithUncertaintyCircle Parameter <i>Ellipsoid-PointWithUncertaintyCircle</i> defined in TS36.355 [54]. The first/leftmost bit of the first octet contains the most significant bit.
ellipsoidPointWithUncertaintyEllipse Parameter <i>EllipsoidPointWithUncertaintyEllipse</i> defined in TS36.355 [54]. The first/leftmost bit of the first octet contains the most significant bit.
gnss-TOD-msec Parameter <i>Gnss-TOD-msec</i> defined in TS36.355 [54]. The first/leftmost bit of the first octet contains the most significant bit.
horizontalVelocity Parameter <i>HorizontalVelocity</i> defined in TS36.355 [54]. The first/leftmost bit of the first octet contains the most significant bit.
polygon Parameter <i>Polygon</i> defined in TS36.355 [54]. The first/leftmost bit of the first octet contains the most significant bit.

– *MBSFN-RSRQ-Range*

The IE *MBSFN-RSRQ-Range* specifies the value range used in MBSFN RSRQ measurements. Integer value for MBSFN RSRQ measurements according to mapping table in TS 36.133 [16].

***MBSFN-RSRQ-Range* information element**

```
-- ASN1START
MBSFN-RSRQ-Range-r12 ::= INTEGER(0..31)
-- ASN1STOP
```

– *MeasConfig*

The IE *MeasConfig* specifies measurements to be performed by the UE, and covers intra-frequency, inter-frequency and inter-RAT mobility as well as configuration of measurement gaps.

***MeasConfig* information element**

```
-- ASN1START
MeasConfig ::= SEQUENCE {
  -- Measurement objects
  measObjectToRemoveList      MeasObjectToRemoveList      OPTIONAL, -- Need ON
  measObjectToAddModList     MeasObjectToAddModList     OPTIONAL, -- Need ON
  -- Reporting configurations
  reportConfigToRemoveList   ReportConfigToRemoveList   OPTIONAL, -- Need ON
  reportConfigToAddModList   ReportConfigToAddModList   OPTIONAL, -- Need ON
  -- Measurement identities
  measIdToRemoveList        MeasIdToRemoveList        OPTIONAL, -- Need ON
  measIdToAddModList        MeasIdToAddModList        OPTIONAL, -- Need ON
  -- Other parameters
  quantityConfig             QuantityConfig             OPTIONAL, -- Need ON
  measGapConfig              MeasGapConfig              OPTIONAL, -- Need ON
  s-Measure                  RSRP-Range              OPTIONAL, -- Need ON
  preRegistrationInfoHRPD    PreRegistrationInfoHRPD    OPTIONAL, -- Need OP
  speedStatePars             CHOICE {
    release                NULL,
    setup                  SEQUENCE {
      mobilityStateParameters  MobilityStateParameters,

```

```

    timeToTrigger-SF                               SpeedStateScaleFactors
  }
} OPTIONAL, -- Need ON
...
[[ measObjectToAddModList-v9e0                    MeasObjectToAddModList-v9e0    OPTIONAL -- Need ON
]],
[[ allowInterruptions-r11                          BOOLEAN                          OPTIONAL -- Need ON
]],
[[ measScaleFactor-r12                             CHOICE {
    release                                         NULL,
    setup                                           MeasScaleFactor-r12
}
measIdToRemoveListExt-r12                         MeasIdToRemoveListExt-r12     OPTIONAL, -- Need ON
measIdToAddModListExt-r12                         MeasIdToAddModListExt-r12     OPTIONAL, -- Need ON
measRSRQ-OnAllSymbols-r12                         BOOLEAN                          OPTIONAL -- Need ON
]],
[[
[[ measObjectToRemoveListExt-r13                   MeasObjectToRemoveListExt-r13  OPTIONAL, -- Need ON
measObjectToAddModListExt-r13                     MeasObjectToAddModListExt-r13  OPTIONAL, -- Need ON
measIdToAddModList-v1310                           MeasIdToAddModList-v1310      OPTIONAL, -- Need ON
measIdToAddModListExt-v1310                       MeasIdToAddModListExt-v1310   OPTIONAL -- Need ON
]],
[[ measGapConfigPerCC-List-r14                     MeasGapConfigPerCC-List-r14    OPTIONAL, -- Need ON
measGapSharingConfig-r14                           MeasGapSharingConfig-r14       OPTIONAL -- Need ON
]]
]]
}

MeasIdToRemoveList ::= SEQUENCE (SIZE (1..maxMeasId)) OF MeasId
MeasIdToRemoveListExt-r12 ::= SEQUENCE (SIZE (1..maxMeasId)) OF MeasId-v1250
MeasObjectToRemoveList ::= SEQUENCE (SIZE (1..maxObjectId)) OF MeasObjectId
MeasObjectToRemoveListExt-r13 ::= SEQUENCE (SIZE (1..maxObjectId)) OF MeasObjectId-v1310
ReportConfigToRemoveList ::= SEQUENCE (SIZE (1..maxReportConfigId)) OF ReportConfigId
-- ASN1STOP

```

MeasConfig field descriptions
<p>allowInterruptions Value TRUE indicates that the UE is allowed to cause interruptions to serving cells when performing measurements of deactivated SCell carriers for <i>measCycleSCell</i> of less than 640ms, as specified in TS 36.133 [16]. E-UTRAN enables this field only when an SCell is configured.</p>
<p>measGapConfig Used to setup and release measurement gaps. E-UTRAN includes either <i>measGapConfig</i> or <i>measGapConfigPerCC-List</i>, if any.</p>
<p>measGapConfigPerCC-List Used to setup and release serving cell sepecific measurement gaps. E-UTRAN includes either <i>measGapConfig</i> or <i>measGapConfigPerCC-List</i>, if any.</p>
<p>measGapSharingConfig Used to setup and release measurement gap sharing for intra- and inter-frequency measurement for BL UEs.</p>
<p>measIdToAddModList List of measurement identities. Field <i>measIdToAddModListExt</i> includes additional measurement identities i.e. extends the size of the measurement identity list using the general principles specified in 5.1.2. If E-UTRAN includes <i>measIdToAddModList-v1310</i> it includes the same number of entries, and listed in the same order, as in <i>measIdToAddModList</i> (i.e. without suffix). If E-UTRAN includes <i>measIdToAddModListExt-v1310</i>, it includes the same number of entries, and listed in the same order, as in <i>measIdToAddModListExt-r12</i>.</p>
<p>measIdToRemoveList List of measurement identities to remove. Field <i>measIdToRemoveListExt</i> includes additional measurement identities i.e. extends the size of the measurement identity list using the general principles specified in 5.1.2.</p>
<p>measObjectToAddModList If E-UTRAN includes <i>measObjectToAddModList-v9e0</i> it includes the same number of entries, and listed in the same order, as in <i>measObjectToAddModList</i> (i.e. without suffix). Field <i>measObjectToAddModListExt</i> includes additional measurement object identities i.e. extends the size of the measurement object identity list using the general principles specified in 5.1.2.</p>
<p>measObjectToRemoveList List of measurement objects to remove. Field <i>measObjectToRemoveListExt</i> includes additional measurement object identities i.e. extends the size of the measurement object identity list using the general principles specified in 5.1.2.</p>
<p>measRSRQ-OnAllSymbols Value TRUE indicates that the UE shall, when performing RSRQ measurements, perform RSRQ measurement on all OFDM symbols in accordance with TS 36.214 [48]. If <i>widebandRSRQ-Meas</i> is enabled for the frequency in <i>MeasObjectEUTRA</i>, the UE shall, when performing RSRQ measurements, perform RSRQ measurement on all OFDM symbols with wider bandwidth for concerned frequency in accordance with TS 36.214 [48].</p>
<p>measScaleFactor Even if <i>reducedMeasPerformance</i> is not included in any <i>measObjectEUTRA</i> or <i>measObjectUTRA</i>, E-UTRAN may configure this field. The UE behavior is specified in TS 36.133 [16].</p>
<p>preRegistrationInfoHRPD The CDMA2000 HRPD Pre-Registration Information tells the UE if it should pre-register with the CDMA2000 HRPD network and identifies the Pre-registration zone to the UE.</p>
<p>reportConfigToRemoveList List of measurement reporting configurations to remove.</p>
<p>s-Measure PCell quality threshold controlling whether or not the UE is required to perform measurements of intra-frequency, inter-frequency and inter-RAT neighbouring cells. Value "0" indicates to disable <i>s-Measure</i>.</p>
<p>timeToTrigger-SF The <i>timeToTrigger</i> in <i>ReportConfigEUTRA</i> and in <i>ReportConfigInterRAT</i> are multiplied with the scaling factor applicable for the UE's speed state.</p>

– *MeasDS-Config*

The IE *MeasDS-Config* specifies information applicable for discovery signals measurement.

MeasDS-Config information elements

```

-- ASN1START
MeasDS-Config-r12 ::=
    CHOICE {
        release          NULL,
        setup            SEQUENCE {
            dmtc-PeriodOffset-r12
                CHOICE {
                    ms40-r12          INTEGER(0..39),
                    ms80-r12          INTEGER(0..79),
                    ms160-r12         INTEGER(0..159),
                    ...
                }
        }
    },
-- ASN1END

```

```

    ds-OccasionDuration-r12 CHOICE {
        durationFDD-r12 INTEGER(1..maxDS-Duration-r12),
        durationTDD-r12 INTEGER(2..maxDS-Duration-r12)
    },
    measCSI-RS-ToRemoveList-r12 MeasCSI-RS-ToRemoveList-r12 OPTIONAL, -- Need ON
    measCSI-RS-ToAddModList-r12 MeasCSI-RS-ToAddModList-r12 OPTIONAL, -- Need ON
    ...
}
}

MeasCSI-RS-ToRemoveList-r12 ::= SEQUENCE (SIZE (1..maxCSI-RS-Meas-r12)) OF MeasCSI-RS-Id-r12
MeasCSI-RS-ToAddModList-r12 ::= SEQUENCE (SIZE (1..maxCSI-RS-Meas-r12)) OF MeasCSI-RS-Config-r12
MeasCSI-RS-Id-r12 ::= INTEGER (1..maxCSI-RS-Meas-r12)
MeasCSI-RS-Config-r12 ::= SEQUENCE {
    measCSI-RS-Id-r12 MeasCSI-RS-Id-r12,
    physCellId-r12 INTEGER (0..503),
    scramblingIdentity-r12 INTEGER (0..503),
    resourceConfig-r12 INTEGER (0..31),
    subframeOffset-r12 INTEGER (0..4),
    csi-RS-IndividualOffset-r12 Q-OffsetRange,
    ...
}
-- ASN1STOP

```

MeasDS-Config field descriptions

csi-RS-IndividualOffset

CSI-RS individual offset applicable to a specific CSI-RS resource. Value dB-24 corresponds to -24 dB, dB-22 corresponds to -22 dB and so on.

dmTC-PeriodOffset

Indicates the discovery signals measurement timing configuration (DMTC) periodicity (*dmTC-Periodicity*) and offset (*dmTC-Offset*) for this frequency. For DMTC periodicity, value ms40 corresponds to 40ms, ms80 corresponds to 80ms and so on. The value of DMTC offset is in number of subframe(s). The duration of a DMTC occasion is 6ms.

ds-OccasionDuration

Indicates the duration of discovery signal occasion for this frequency. Discovery signal occasion duration is common for all cells transmitting discovery signals on one frequency. If the *carrierFreq* in the measurement object is on an unlicensed band as specified in [42], the UE shall ignore the field *ds-OccasionDuration* for the carrier frequency and apply a value 1 instead.

measCSI-RS-ToAddModList

List of CSI-RS resources to add/ modify in the CSI-RS resource list for discovery signals measurement.

measCSI-RS-ToRemoveList

List of CSI-RS resources to remove from the CSI-RS resource list for discovery signals measurement.

physCellId

Indicates the physical cell identity where UE may assume that the CSI-RS and the PSS/SSS/CRS corresponding to the indicated physical cell identity are quasi co-located with respect to average delay and doppler shift.

resourceConfig

Parameter: CSI reference signal configuration, see TS 36.211 [21, table 6.10.5.2-1 and 6.10.5.2-2]. If the *carrierFreq* in the measurement object is on an unlicensed band as specified in [42], E-UTRAN does not configure the values {0, 4, 5, 9, 10, 11, 18, 19}.

scramblingIdentity

Parameter: Pseudo-random sequence generator parameter, n_{ID} , see TS 36.213 [23, 7.2.5].

subframeOffset

Indicates the subframe offset between SSS of the cell indicated by *physCellId* and the CSI-RS resource in a discovery signal occasion. The field *subframeOffset* is set to values 0 if the *carrierFreq* in the measurement object is on an unlicensed band as specified in [42].

– *MeasGapConfig*

The IE *MeasGapConfig* specifies the measurement gap configuration and controls setup/ release of measurement gaps.

MeasGapConfig information element

```
-- ASN1START
```

```

MeasGapConfig ::=
  CHOICE {
    release      NULL,
    setup       SEQUENCE {
      gapOffset  CHOICE {
        gp0      INTEGER (0..39),
        gp1      INTEGER (0..79),
        ...,
        gp2-r14  INTEGER (0..39),
        gp3-r14  INTEGER (0..79),
        gp-ncsg0-r14  INTEGER (0..39),
        gp-ncsg1-r14  INTEGER (0..79),
        gp-ncsg2-r14  INTEGER (0..39),
        gp-ncsg3-r14  INTEGER (0..79),
        gp-nonUniform1-r14  INTEGER (0..1279),
        gp-nonUniform2-r14  INTEGER (0..2559),
        gp-nonUniform3-r14  INTEGER (0..5119),
        gp-nonUniform4-r14  INTEGER (0..10239)
      }
    }
  }
-- ASN1STOP

```

MeasGapConfig field descriptions

gapOffset

Value *gapOffset* of *gp0* corresponds to gap offset of Gap Pattern Id "0" with MGRP = 40ms, *gapOffset* of *gp1* corresponds to gap offset of Gap Pattern Id "1" with MGRP = 80ms, *gapOffset* of *gp2* corresponds to gap offset of Gap Pattern Id "2" with MGRP = 40ms and MGL = 3ms, *gapOffset* of *gp3* Gap Pattern Id "3" with MGRP = 80ms and MGL = 3ms, *gapOffset* of *gp-ncsg0* corresponds to gap offset of NCSG Pattern Id "0" with VIRP = 40ms and ML = 4ms, *gapOffset* of *gp-ncsg1* corresponds to gap offset of of NCSG Pattern Id "1" with VIRP = 80ms and ML = 4ms, *gapOffset* of *gp-ncsg2* corresponds to gap offset of of NCSG Pattern Id "2" with VIRP = 40ms and ML = 3ms, *gapOffset* of *gp-ncsg3* corresponds to gap offset of of NCSG Pattern Id "3" with VIRP = 80ms and ML = 3ms. *gapOffset* of *gp-nonUniform1* corresponds to gap offset of non uniform gap pattern Id "1" with LMGRP = 1280ms, *gapOffset* of *gp-nonUniform2* corresponds to gap offset of non uniform gap pattern Id "2" with LMGRP = 2560ms, *gapOffset* of *gp-nonUniform3* corresponds to gap offset of non uniform gap pattern Id "3" with LMGRP = 5120ms, *gapOffset* of *gp-nonUniform4* corresponds to gap offset of non uniform gap pattern Id "4" with LMGRP = 10240ms. Also used to specify the measurement gap pattern to be applied, as defined in TS 36.133 [16]. For Gap Patterns (including non-uniform gap patterns, but excluding NCSG patterns), E-UTRAN includes the same *gapOffset* value (gap pattern id and gap offset) for all serving cells that are configured with a Gap Pattern. For NCSG Patterns, E-UTRAN includes *gapOffset* value indicating VIRP and gap offset consistent with the Gap Pattern configuration (MGRP and gap offset).

servCellId

Identifies the serving cell for which measurement gap configuration is provided (setup) or deleted (release).

MeasGapConfigPerCC-List

The IE *MeasGapConfigPerCC-List* specifies the measurement gap configuration and controls setup/ release of measurement gaps.

MeasGapConfigPerCC-List information element

```

-- ASN1START
MeasGapConfigPerCC-List-r14 ::= CHOICE {
  release      NULL,
  setup       SEQUENCE {
    measGapConfigToRemoveList-r14  MeasGapConfigToRemoveList-r14  OPTIONAL,  -- Need ON
    measGapConfigToAddModList-r14  MeasGapConfigToAddModList-r14  OPTIONAL  -- Need ON
  }
}

MeasGapConfigToRemoveList-r14 ::= SEQUENCE (SIZE (1..maxServCell-r13)) OF ServCellIndex-r13

MeasGapConfigToAddModList-r14 ::= SEQUENCE (SIZE (1..maxServCell-r13)) OF MeasGapConfigPerCC-r14

MeasGapConfigPerCC-r14 ::= SEQUENCE {
  servCellId-r14      ServCellIndex-r13,
  measGapConfigCC-r14  MeasGapConfig
}
-- ASN1STOP

```



```
-- ASN1STOP
```

***MeasGapConfigPerCC-List* field descriptions**

measGapConfigToAddModList

List of serving cells and corresponding serving cell specific measurement gap configuration to add /modify.

measGapConfigToRemoveList

List of serving cells for which measurement gap configuration is removed.

– *MeasGapSharingConfig*

The IE *MeasGapSharingConfig* specifies the measurement gap sharing scheme and controls setup/ release of measurement gap sharing.

***MeasGapSharingConfig* information element**

```
-- ASN1START
MeasGapSharingConfig-r14 ::=          CHOICE {
  release                               NULL,
  setup                                 SEQUENCE {
    measGapSharingScheme-r14           ENUMERATED {scheme00, scheme01, scheme10, scheme11}
  }
}
-- ASN1STOP
```

***MeasGapSharingConfig* field descriptions**

measGapSharingScheme

Indicates the measurement gaps sharing scheme for BL UEs in CE mode A and CE mode B, see TS 36.133 [16, Table 8.13.2.1.1.1-2 and Table 8.13.3.1.1.1-3]. Value *scheme00* corresponds to "00", value *scheme01* corresponds to "01", and so on.

– *MeasId*

The IE *MeasId* is used to identify a measurement configuration, i.e., linking of a measurement object and a reporting configuration.

***MeasId* information element**

```
-- ASN1START
MeasId ::=                             INTEGER (1..maxMeasId)
MeasId-v1250 ::=                       INTEGER (maxMeasId-Plus1..maxMeasId-r12)
-- ASN1STOP
```

– *MeasIdToAddModList*

The IE *MeasIdToAddModList* concerns a list of measurement identities to add or modify, with for each entry the *measId*, the associated *measObjectId* and the associated *reportConfigId*. Field *measIdToAddModListExt* includes additional measurement identities i.e. extends the size of the measurement identity list using the general principles specified in 5.1.2.

***MeasIdToAddModList* information element**

```
-- ASN1START
MeasIdToAddModList ::=                 SEQUENCE (SIZE (1..maxMeasId)) OF MeasIdToAddMod
MeasIdToAddModList-v1310 ::=           SEQUENCE (SIZE (1..maxMeasId)) OF MeasIdToAddMod-v1310
-- ASN1STOP
```

```

MeasIdToAddModListExt-r12 ::= SEQUENCE (SIZE (1..maxMeasId)) OF MeasIdToAddModExt-r12
MeasIdToAddModListExt-v1310 ::= SEQUENCE (SIZE (1..maxMeasId)) OF MeasIdToAddMod-v1310
MeasIdToAddMod ::= SEQUENCE {
    measId MeasId,
    measObjectId MeasObjectId,
    reportConfigId ReportConfigId
}
MeasIdToAddModExt-r12 ::= SEQUENCE {
    measId-v1250 MeasId-v1250,
    measObjectId-r12 MeasObjectId,
    reportConfigId-r12 ReportConfigId
}
MeasIdToAddMod-v1310 ::= SEQUENCE {
    measObjectId-v1310 MeasObjectId-v1310 OPTIONAL
}
-- ASN1STOP

```

MeasIdToAddModList field descriptions

measObjectId

If the *measObjectId-v1310* is included, the *measObjectId* or *measObjectId-r12* is ignored by the UE.

MeasObjectCDMA2000

The IE *MeasObjectCDMA2000* specifies information applicable for inter-RAT CDMA2000 neighbouring cells.

MeasObjectCDMA2000 information element

```

-- ASN1START
MeasObjectCDMA2000 ::= SEQUENCE {
    cdma2000-Type CDMA2000-Type,
    carrierFreq CarrierFreqCDMA2000,
    searchWindowSize INTEGER (0..15) OPTIONAL, -- Need ON
    offsetFreq Q-OffsetRangeInterRAT DEFAULT 0,
    cellsToRemoveList CellIndexList OPTIONAL, -- Need ON
    cellsToAddModList CellsToAddModListCDMA2000 OPTIONAL, -- Need ON
    cellForWhichToReportCGI PhysCellIdCDMA2000 OPTIONAL, -- Need ON
    ...
}
CellsToAddModListCDMA2000 ::= SEQUENCE (SIZE (1..maxCellMeas)) OF CellsToAddModCDMA2000
CellsToAddModCDMA2000 ::= SEQUENCE {
    cellIndex INTEGER (1..maxCellMeas),
    physCellId PhysCellIdCDMA2000
}
-- ASN1STOP

```

MeasObjectCDMA2000 field descriptions	
carrierInfo	Identifies CDMA2000 carrier frequency for which this configuration is valid.
cdma2000-Type	The type of CDMA2000 network: CDMA2000 1xRTT or CDMA2000 HRPD.
cellIndex	Entry index in the neighbouring cell list.
cellsToAddModList	List of cells to add/ modify in the neighbouring cell list.
cellsToRemoveList	List of cells to remove from the neighbouring cell list.
physCellId	CDMA2000 Physical cell identity of a cell in neighbouring cell list expressed as PNOffset.
searchWindowSize	Provides the search window size to be used by the UE for the neighbouring pilot, see C.S0005 [25].

– MeasObjectEUTRA

The IE *MeasObjectEUTRA* specifies information applicable for intra-frequency or inter-frequency E-UTRA cells.

MeasObjectEUTRA information element

```
-- ASN1START
MeasObjectEUTRA ::=
    SEQUENCE {
        carrierFreq                ARFCN-ValueEUTRA,
        allowedMeasBandwidth       AllowedMeasBandwidth,
        presenceAntennaPort1       PresenceAntennaPort1,
        neighCellConfig            NeighCellConfig,
        offsetFreq                 Q-OffsetRange                DEFAULT dB0,
        -- Cell list
        cellsToRemoveList          CellIndexList                OPTIONAL,        -- Need ON
        cellsToAddModList          CellsToAddModList            OPTIONAL,        -- Need ON
        -- Black list
        blackCellsToRemoveList     CellIndexList                OPTIONAL,        -- Need ON
        blackCellsToAddModList     BlackCellsToAddModList      OPTIONAL,        -- Need ON
        cellForWhichToReportCGI    PhysCellId                OPTIONAL,        -- Need ON
        . . . ,
        [[measCycleSCell-r10        MeasCycleSCell-r10        OPTIONAL,        -- Need ON
         measSubframePatternConfigNeigh-r10 MeasSubframePatternConfigNeigh-r10 OPTIONAL
         -- Need ON
        ]],
        [[widebandRSRQ-Meas-r11     BOOLEAN OPTIONAL        -- Cond WB-RSRQ
        ]],
        [[
            altTTT-CellsToRemoveList-r12 CellIndexList                OPTIONAL,        -- Need ON
            altTTT-CellsToAddModList-r12 AltTTT-CellsToAddModList-r12 OPTIONAL,        -- Need ON
            t312-r12                 CHOICE {
                release              NULL,
                setup                 ENUMERATED {ms0, ms50, ms100, ms200,
                                                ms300, ms400, ms500, ms1000}
            }
            OPTIONAL,        -- Need ON
            reducedMeasPerformance-r12 BOOLEAN                OPTIONAL,        -- Need ON
            measDS-Config-r12        MeasDS-Config-r12        OPTIONAL        -- Need ON
        ]],
        [[
            whiteCellsToRemoveList-r13 CellIndexList                OPTIONAL,        -- Need ON
            whiteCellsToAddModList-r13 WhiteCellsToAddModList-r13 OPTIONAL,        -- Need ON
            rmtc-Config-r13           RMTc-Config-r13            OPTIONAL,        -- Need ON
            carrierFreq-r13           ARFCN-ValueEUTRA-v9e0    OPTIONAL        -- Need ON
        ]],
        [[
            tx-ResourcePoolToRemoveList-r14 Tx-ResourcePoolMeasList-r14 OPTIONAL,        -- Need ON
            tx-ResourcePoolToAddList-r14  Tx-ResourcePoolMeasList-r14 OPTIONAL,        -- Need ON
            fembms-MixedCarrier-r14      BOOLEAN                OPTIONAL        -- Need ON
        ]],
    ]
}

MeasObjectEUTRA-v9e0 ::=
    SEQUENCE {
        carrierFreq-v9e0            ARFCN-ValueEUTRA-v9e0
    }

CellsToAddModList ::=
    SEQUENCE (SIZE (1..maxCellMeas)) OF CellsToAddMod
```

```

CellsToAddMod ::= SEQUENCE {
    cellIndex                INTEGER (1..maxCellMeas),
    physCellId               PhysCellId,
    cellIndividualOffset     Q-OffsetRange
}

BlackCellsToAddModList ::= SEQUENCE (SIZE (1..maxCellMeas)) OF BlackCellsToAddMod

BlackCellsToAddMod ::= SEQUENCE {
    cellIndex                INTEGER (1..maxCellMeas),
    physCellIdRange         PhysCellIdRange
}

MeasCycleSCell-r10 ::= ENUMERATED {sf160, sf256, sf320, sf512,
                                     sf640, sf1024, sf1280, spare1}

MeasSubframePatternConfigNeigh-r10 ::= CHOICE {
    release                  NULL,
    setup                    SEQUENCE {
        measSubframePatternNeigh-r10 MeasSubframePattern-r10,
        measSubframeCellList-r10     MeasSubframeCellList-r10 OPTIONAL -- Cond
    }
}

MeasSubframeCellList-r10 ::= SEQUENCE (SIZE (1..maxCellMeas)) OF PhysCellIdRange

AltTTT-CellsToAddModList-r12 ::= SEQUENCE (SIZE (1..maxCellMeas)) OF AltTTT-CellsToAddMod-r12

AltTTT-CellsToAddMod-r12 ::= SEQUENCE {
    cellIndex-r12           INTEGER (1..maxCellMeas),
    physCellIdRange-r12    PhysCellIdRange
}

WhiteCellsToAddModList-r13 ::= SEQUENCE (SIZE (1..maxCellMeas)) OF WhiteCellsToAddMod-r13

WhiteCellsToAddMod-r13 ::= SEQUENCE {
    cellIndex-r13           INTEGER (1..maxCellMeas),
    physCellIdRange-r13    PhysCellIdRange
}

RMTC-Config-r13 ::= CHOICE {
    release                  NULL,
    setup                    SEQUENCE {
        rmtc-Period-r13      ENUMERATED {ms40, ms80, ms160, ms320, ms640},
        rmtc-SubframeOffset-r13 INTEGER(0..639) OPTIONAL, -- Need ON
        measDuration-r13    ENUMERATED {sym1, sym14, sym28, sym42, sym70},
        ...
    }
}

Tx-ResourcePoolMeasList-r14 ::= SEQUENCE (SIZE (1..maxSL-PoolToMeasure-r14)) OF SL-V2X-
TxPoolReportIdentity-r14

-- ASN1STOP

```

MeasObjectEUTRA field descriptions
<p>altTTT-CellsToAddModList List of cells to add/ modify in the cell list for which the alternative time to trigger specified by <i>alternativeTimeToTrigger</i> in <i>reportConfigEUTRA</i>, if configured, applies.</p>
<p>altTTT-CellsToRemoveList List of cells to remove from the list of cells for alternative time to trigger.</p>
<p>blackCellsToAddModList List of cells to add/ modify in the black list of cells.</p>
<p>blackCellsToRemoveList List of cells to remove from the black list of cells.</p>
<p>carrierFreq Identifies E-UTRA carrier frequency for which this configuration is valid. E-UTRAN does not configure more than one measurement object for the same physical frequency regardless of the E-ARFCN used to indicate this. CarrierFreq-r13 is included only when the extension list <i>measObjectToAddModListExt-r13</i> is used. If <i>carrierFreq-r13</i> is present, <i>carrierFreq</i> (i.e., without suffix) shall be set to value <i>maxEARFCN</i>.</p>
<p>cellIndex Entry index in the cell list. An entry may concern a range of cells, in which case this value applies to the entire range.</p>
<p>cellIndividualOffset Cell individual offset applicable to a specific cell. Value dB-24 corresponds to -24 dB, dB-22 corresponds to -22 dB and so on.</p>
<p>cellsToAddModList List of cells to add/ modify in the cell list.</p>
<p>cellsToRemoveList List of cells to remove from the cell list.</p>
<p>fembms-MixedCarrier If this field is set to <i>TRUE</i>, the cells on the carrier frequency indicated by the <i>measObject</i> are FeMBMS/Unicast-mixed cells.</p>
<p>measCycleSCell The parameter is used only when an SCell is configured on the frequency indicated by the <i>measObject</i> and is in deactivated state, see TS 36.133 [16, 8.3.3]. E-UTRAN configures the parameter whenever an SCell is configured on the frequency indicated by the <i>measObject</i>, but the field may also be signalled when an SCell is not configured. Value <i>sf160</i> corresponds to 160 sub-frames, <i>sf256</i> corresponds to 256 sub-frames and so on.</p>
<p>measDS-Config Parameters applicable to discovery signals measurement on the carrier frequency indicated by <i>carrierFreq</i>.</p>
<p>measDuration Number of consecutive symbols for which the Physical Layer reports samples of RSSI, see TS 36.214 [48]. Value <i>sym1</i> corresponds to one symbol, <i>sym14</i> corresponds to 14 symbols, and so on.</p>
<p>measSubframeCellList List of cells for which <i>measSubframePatternNeigh</i> is applied.</p>
<p>measSubframePatternNeigh Time domain measurement resource restriction pattern applicable to neighbour cell RSRP and RSRQ measurements on the carrier frequency indicated by <i>carrierFreq</i>. For cells in <i>measSubframeCellList</i> the UE shall assume that the subframes indicated by <i>measSubframePatternNeigh</i> are non-MBSFN subframes, and have the same special subframe configuration as PCell.</p>
<p>offsetFreq Offset value applicable to the carrier frequency. Value dB-24 corresponds to -24 dB, dB-22 corresponds to -22 dB and so on.</p>
<p>physCellId Physical cell identity of a cell in the cell list.</p>
<p>physCellIdRange Physical cell identity or a range of physical cell identities.</p>
<p>reducedMeasPerformance If set to <i>TRUE</i>, the EUTRA carrier frequency is configured for reduced measurement performance, otherwise it is configured for normal measurement performance, see TS 36.133 [16].</p>
<p>rmtc-Config Parameters applicable to RSSI and channel occupancy measurement on the carrier frequency indicated by <i>carrierFreq</i>.</p>
<p>rmtc-Period Indicates the RSSI measurement timing configuration (RMTTC) periodicity for this frequency. Value <i>ms40</i> corresponds to 40 ms periodicity, <i>ms80</i> corresponds to 80 ms periodicity and so on, see TS 36.214 [48].</p>
<p>rmtc-SubframeOffset Indicates the RSSI measurement timing configuration (RMTTC) subframe offset for this frequency. The value of <i>rmtc-SubframeOffset</i> should be smaller than the value of <i>rmtc-Period</i>, see TS 36.214 [48]. For inter-frequency measurements, this field is optional present and if it is not configured, the UE chooses a random value as <i>rmtc-SubframeOffset</i> for <i>measDuration</i> which shall be selected to be between 0 and the configured <i>rmtc-Period</i> with equal probability.</p>

MeasObjectEUTRA field descriptions
t312 The value of timer T312. Value ms0 represents 0 ms, ms50 represents 50 ms and so on.
tx-ResourcePoolToAddList List of transmission resource pool identities to be added to the list of pools configured for CBR measurements and for which <i>poolReportId</i> is included in <i>SL-V2X-ConfigDedicated</i> or <i>SystemInformationBlockType21</i> .
tx-ResourcePoolToRemoveList List of transmission resource pools identities to be removed from the list of pools configured for CBR measurements and for which <i>poolReportId</i> is included in <i>SL-V2X-ConfigDedicated</i> or <i>SystemInformationBlockType21</i> .
widebandRSRQ-Meas If this field is set to TRUE, the UE shall, when performing RSRQ measurements, use a wider bandwidth in accordance with TS 36.133 [16].
whiteCellsToAddModList List of cells to add/modify in the white list of cells.
whiteCellsToRemoveList List of cells to remove from the white list of cells.

Conditional presence	Explanation
<i>always</i>	The field is mandatory present.
<i>WB-RSRQ</i>	The field is optionally present, need ON, if the measurement bandwidth indicated by <i>allowedMeasBandwidth</i> is 50 resource blocks or larger; otherwise it is not present and the UE shall delete any existing value for this field, if configured.

– *MeasObjectGERAN*

The IE *MeasObjectGERAN* specifies information applicable for inter-RAT GERAN neighbouring frequencies.

MeasObjectGERAN information element

```

-- ASN1START
MeasObjectGERAN ::=
    SEQUENCE {
        carrierFreqs          CarrierFreqsGERAN,
        offsetFreq            Q-OffsetRangeInterRAT          DEFAULT 0,
        ncc-Permitted         BIT STRING(SIZE (8))           DEFAULT '11111111'B,
        cellForWhichToReportCGI PhysCellIdGERAN              OPTIONAL, -- Need ON
        ...
    }
-- ASN1STOP

```

MeasObjectGERAN field descriptions
ncc-Permitted Field encoded as a bit map, where bit N is set to "0" if a BCCH carrier with NCC = N-1 is not permitted for monitoring and set to "1" if a BCCH carrier with NCC = N-1 is permitted for monitoring; N = 1 to 8; bit 1 of the bitmap is the leading bit of the bit string.
carrierFreqs If E-UTRAN includes <i>cellForWhichToReportCGI</i> , it includes only one GERAN ARFCN value in <i>carrierFreqs</i> .

– *MeasObjectId*

The IE *MeasObjectId* used to identify a measurement object configuration.

MeasObjectId information element

```

-- ASN1START
MeasObjectId ::=
    INTEGER (1..maxObjectId)
MeasObjectId-v1310 ::=
    INTEGER (maxObjectId-Plus1-r13..maxObjectId-r13)
MeasObjectId-r13 ::=
    INTEGER (1..maxObjectId-r13)
-- ASN1STOP

```

– *MeasObjectToAddModList*

The IE *MeasObjectToAddModList* concerns a list of measurement objects to add or modify

***MeasObjectToAddModList* information element**

```
-- ASN1START
MeasObjectToAddModList ::= SEQUENCE (SIZE (1..maxObjectId)) OF MeasObjectToAddMod
MeasObjectToAddModListExt-r13 ::= SEQUENCE (SIZE (1..maxObjectId)) OF MeasObjectToAddModExt-r13
MeasObjectToAddModList-v9e0 ::= SEQUENCE (SIZE (1..maxObjectId)) OF MeasObjectToAddMod-v9e0
MeasObjectToAddMod ::= SEQUENCE {
    measObjectId          MeasObjectId,
    measObject            CHOICE {
        measObjectEUTRA    MeasObjectEUTRA,
        measObjectUTRA     MeasObjectUTRA,
        measObjectGERAN    MeasObjectGERAN,
        measObjectCDMA2000 MeasObjectCDMA2000,
        . . . ,
        measObjectWLAN-r13 MeasObjectWLAN-r13
    }
}
MeasObjectToAddModExt-r13 ::= SEQUENCE {
    measObjectId-r13      MeasObjectId-v1310,
    measObject-r13       CHOICE {
        measObjectEUTRA-r13 MeasObjectEUTRA,
        measObjectUTRA-r13  MeasObjectUTRA,
        measObjectGERAN-r13 MeasObjectGERAN,
        measObjectCDMA2000-r13 MeasObjectCDMA2000,
        . . . ,
        measObjectWLAN-v1320 MeasObjectWLAN-r13
    }
}
MeasObjectToAddMod-v9e0 ::= SEQUENCE {
    measObjectEUTRA-v9e0 MeasObjectEUTRA-v9e0 OPTIONAL -- Cond eutra
}
-- ASN1STOP
```

Conditional presence	Explanation
<i>eutra</i>	The field is optional present, need OR, if for the corresponding entry in <i>MeasObjectToAddModList</i> or <i>MeasObjectToAddModListExt-r13</i> field <i>measObject</i> is set to <i>measObjectEUTRA</i> and its sub-field <i>carrierFreq</i> is set to <i>maxEARFCN</i> . Otherwise the field is not present and the UE shall delete any existing value for this field.

– *MeasObjectUTRA*

The IE *MeasObjectUTRA* specifies information applicable for inter-RAT UTRA neighbouring cells.

***MeasObjectUTRA* information element**

```
-- ASN1START
MeasObjectUTRA ::= SEQUENCE {
    carrierFreq          ARFCN-ValueUTRA,
    offsetFreq           Q-OffsetRangeInterRAT DEFAULT 0,
    cellsToRemoveList    CellIndexList OPTIONAL, -- Need ON
    cellsToAddModList    CHOICE {
        cellsToAddModListUTRA-FDD CellsToAddModListUTRA-FDD,
        cellsToAddModListUTRA-TDD CellsToAddModListUTRA-TDD
    } OPTIONAL, -- Need ON
    cellForWhichToReportCGI CHOICE {
        utra-FDD PhysCellIdUTRA-FDD,
        utra-TDD PhysCellIdUTRA-TDD
    }
}
```

```

    }
    OPTIONAL, -- Need ON
    ...,
    [[ csg-allowedReportingCells-v930          CSG-AllowedReportingCells-r9    OPTIONAL    --
Need ON
    ]],
    [[ reducedMeasPerformance-r12            BOOLEAN          OPTIONAL    -- Need ON
    ]]
}

CellsToAddModListUTRA-FDD ::= SEQUENCE (SIZE (1..maxCellMeas)) OF CellsToAddModUTRA-FDD

CellsToAddModUTRA-FDD ::= SEQUENCE {
    cellIndex          INTEGER (1..maxCellMeas),
    physCellId         PhysCellIdUTRA-FDD
}

CellsToAddModListUTRA-TDD ::= SEQUENCE (SIZE (1..maxCellMeas)) OF CellsToAddModUTRA-TDD

CellsToAddModUTRA-TDD ::= SEQUENCE {
    cellIndex          INTEGER (1..maxCellMeas),
    physCellId         PhysCellIdUTRA-TDD
}

CSG-AllowedReportingCells-r9 ::= SEQUENCE {
    physCellIdRangeUTRA-FDDList-r9          PhysCellIdRangeUTRA-FDDList-r9    OPTIONAL    -- Need OR
}
-- ASN1STOP

```

MeasObjectUTRA field descriptions

carrierFreq	Identifies UTRA carrier frequency for which this configuration is valid. E-UTRAN does not configure more than one measurement object for the same physical frequency regardless of the ARFCN used to indicate this.
cellIndex	Entry index in the neighbouring cell list.
cellsToAddModListUTRA-FDD	List of UTRA FDD cells to add/ modify in the neighbouring cell list.
cellsToAddModListUTRA-TDD	List of UTRA TDD cells to add/modify in the neighbouring cell list.
cellsToRemoveList	List of cells to remove from the neighbouring cell list.
csg-allowedReportingCells	One or more ranges of physical cell identities for which UTRA-FDD reporting is allowed.
reducedMeasPerformance	If set to <i>TRUE</i> the UTRA carrier frequency is configured for reduced measurement performance, otherwise it is configured for normal measurement performance, see TS 36.133 [16].

MeasObjectWLAN

The IE *MeasObjectWLAN* specifies information applicable for inter-RAT WLAN measurements. E-UTRAN configures at least one WLAN identifier in the *MeasObjectWLAN*.

```

-- ASN1START
MeasObjectWLAN-r13 ::= SEQUENCE {
    carrierFreq-r13          CHOICE {
        bandIndicatorListWLAN-r13    SEQUENCE (SIZE (1..maxWLAN-Bands-r13)) OF WLAN-
BandIndicator-r13,
        carrierInfoListWLAN-r13     SEQUENCE (SIZE (1..maxWLAN-CarrierInfo-r13)) OF WLAN-
CarrierInfo-r13
    }
    OPTIONAL, -- Need ON
    wlan-ToAddModList-r13    WLAN-Id-List-r13          OPTIONAL, -- Need ON
    wlan-ToRemoveList-r13   WLAN-Id-List-r13          OPTIONAL, -- Need ON
    ...
}

WLAN-BandIndicator-r13 ::= ENUMERATED {band2dot4, band5, band60-v1430, spare5, spare4, spare3,
spare2, spare1, ...}
-- ASN1STOP

```

<i>MeasObjectWLAN</i> field descriptions
bandIndicatorListWLAN Includes the list of WLAN bands. Value band2dot4 indicates the 2.4GHz band, value band5 indicates the 5GHz band and value band60 indicates the 60GHz band.
carrierInfoListWLAN Includes the list of WLAN carrier information for the measurement object.
wlan-ToAddModList Includes the list of WLAN identifiers to be added to the measurement configuration.
wlan-ToRemoveList Includes the list of WLAN identifiers to be removed from the measurement configuration.

– *MeasResults*

The IE *MeasResults* covers measured results for intra-frequency, inter-frequency and inter- RAT mobility.

MeasResults information element

```
-- ASN1START
MeasResults ::= SEQUENCE {
    measId MeasId,
    measResultPCell SEQUENCE {
        rsrpResult RSRP-Range,
        rsrqResult RSRQ-Range
    },
    measResultNeighCells CHOICE {
        measResultListEUTRA MeasResultListEUTRA,
        measResultListUTRA MeasResultListUTRA,
        measResultListGERAN MeasResultListGERAN,
        measResultsCDMA2000 MeasResultsCDMA2000,
        ...
    } OPTIONAL,
    ...
    [[ measResultForECID-r9 MeasResultForECID-r9 OPTIONAL
    ]],
    [[ locationInfo-r10 LocationInfo-r10 OPTIONAL,
    measResultServFreqList-r10 MeasResultServFreqList-r10 OPTIONAL
    ]],
    [[ measId-v1250 MeasId-v1250 OPTIONAL,
    measResultPCell-v1250 RSRQ-Range-v1250 OPTIONAL,
    measResultCSI-RS-List-r12 MeasResultCSI-RS-List-r12 OPTIONAL
    ]],
    [[ measResultForRSSI-r13 MeasResultForRSSI-r13 OPTIONAL,
    measResultServFreqListExt-r13 MeasResultServFreqListExt-r13 OPTIONAL,
    measResultSSTD-r13 MeasResultSSTD-r13 OPTIONAL,
    measResultPCell-v1310 SEQUENCE {
        rs-sinr-Result-r13 RS-SINR-Range-r13
    } OPTIONAL,
    ul-PDCP-DelayResultList-r13 UL-PDCP-DelayResultList-r13 OPTIONAL,
    measResultListWLAN-r13 MeasResultListWLAN-r13 OPTIONAL
    ]],
    [[ measResultPCell-v1360 RSRP-Range-v1360 OPTIONAL
    ]],
    [[ measResultListCBR-r14 MeasResultListCBR-r14 OPTIONAL,
    measResultListWLAN-r14 MeasResultListWLAN-r14 OPTIONAL
    ]],
}

MeasResultListEUTRA ::= SEQUENCE (SIZE (1..maxCellReport)) OF MeasResultEUTRA

MeasResultEUTRA ::= SEQUENCE {
    physCellId PhysCellId,
    cgi-Info SEQUENCE {
        cellGlobalId CellGlobalIdEUTRA,
        trackingAreaCode TrackingAreaCode,
        plmn-IdentityList PLMN-IdentityList2 OPTIONAL,
    } OPTIONAL,
    measResult SEQUENCE {
        rsrpResult RSRP-Range OPTIONAL,
        rsrqResult RSRQ-Range OPTIONAL,
        ...
    }
    [[ additionalSI-Info-r9 AdditionalSI-Info-r9 OPTIONAL
    ]],
}
```

```

[[ primaryPLMN-Suitable-r12      ENUMERATED {true}      OPTIONAL,
   measResult-v1250              RSRQ-Range-v1250     OPTIONAL
]],
[[ rs-sinr-Result-r13           RS-SINR-Range-r13    OPTIONAL,
   cgi-Info-v1310               SEQUENCE {
     freqBandIndicator-r13      FreqBandIndicator-r11  OPTIONAL,
     multiBandInfoList-r13     MultiBandInfoList-r11  OPTIONAL,
     freqBandIndicatorPriority-r13  ENUMERATED {true}     OPTIONAL
   }
]],
[[
[[ measResult-v1360             RSRP-Range-v1360     OPTIONAL
]]
]]
}

MeasResultServFreqList-r10 ::= SEQUENCE (SIZE (1..maxServCell-r10)) OF MeasResultServFreq-r10
MeasResultServFreqListExt-r13 ::= SEQUENCE (SIZE (1..maxServCell-r13)) OF MeasResultServFreq-r13

MeasResultServFreq-r10 ::= SEQUENCE {
  servFreqId-r10              ServCellIndex-r10,
  measResultSCell-r10         SEQUENCE {
    rsrpResultSCell-r10       RSRP-Range,
    rsrqResultSCell-r10       RSRQ-Range
  } OPTIONAL,
  measResultBestNeighCell-r10 SEQUENCE {
    physCellId-r10           PhysCellId,
    rsrpResultNCell-r10      RSRP-Range,
    rsrqResultNCell-r10      RSRQ-Range
  } OPTIONAL,
  ...,
  [[ measResultSCell-v1250     RSRQ-Range-v1250     OPTIONAL,
     measResultBestNeighCell-v1250 RSRQ-Range-v1250   OPTIONAL
  ]],
  [[ measResultSCell-v1310     SEQUENCE {
     rs-sinr-Result-r13       RS-SINR-Range-r13
   } OPTIONAL,
     measResultBestNeighCell-v1310 SEQUENCE {
     rs-sinr-Result-r13       RS-SINR-Range-r13
   } OPTIONAL
  ]]
}

MeasResultServFreq-r13 ::= SEQUENCE {
  servFreqId-r13              ServCellIndex-r13,
  measResultSCell-r13         SEQUENCE {
    rsrpResultSCell-r13       RSRP-Range,
    rsrqResultSCell-r13       RSRQ-Range-r13,
    rs-sinr-Result-r13        RS-SINR-Range-r13  OPTIONAL
  } OPTIONAL,
  measResultBestNeighCell-r13 SEQUENCE {
    physCellId-r13           PhysCellId,
    rsrpResultNCell-r13      RSRP-Range,
    rsrqResultNCell-r13      RSRQ-Range-r13,
    rs-sinr-Result-r13        RS-SINR-Range-r13  OPTIONAL
  } OPTIONAL,
  ...,
  [[ measResultBestNeighCell-v1360 SEQUENCE {
     rsrpResultNCell-v1360    RSRP-Range-v1360
   } OPTIONAL
  ]]
}

MeasResultCSI-RS-List-r12 ::= SEQUENCE (SIZE (1..maxCellReport)) OF MeasResultCSI-RS-r12

MeasResultCSI-RS-r12 ::= SEQUENCE {
  measCSI-RS-Id-r12           MeasCSI-RS-Id-r12,
  csi-RSRP-Result-r12         CSI-RSRP-Range-r12,
  ...
}

MeasResultListUTRA ::= SEQUENCE (SIZE (1..maxCellReport)) OF MeasResultUTRA

MeasResultUTRA ::= SEQUENCE {
  physCellId                  CHOICE {
    fdd                        PhysCellIdUTRA-FDD,
    tdd                        PhysCellIdUTRA-TDD
  }
}

```

```

    },
    cgi-Info                               SEQUENCE {
        cellGlobalId                       CellGlobalIdUTRA,
        locationAreaCode                   BIT STRING (SIZE (16))           OPTIONAL,
        routingAreaCode                    BIT STRING (SIZE (8))           OPTIONAL,
        plmn-IdentityList                  PLMN-IdentityList2           OPTIONAL
    }
    measResult                             SEQUENCE {
        ultra-RSCP                          INTEGER (-5..91)              OPTIONAL,
        ultra-EcN0                          INTEGER (0..49)              OPTIONAL,
        ...
        [[ additionalSI-Info-r9              AdditionalSI-Info-r9          OPTIONAL
        ]],
        [[ primaryPLMN-Suitable-r12         ENUMERATED {true}           OPTIONAL
        ]]
    }
}

MeasResultListGERAN ::=                   SEQUENCE (SIZE (1..maxCellReport)) OF MeasResultGERAN

MeasResultGERAN ::= SEQUENCE {
    carrierFreq                             CarrierFreqGERAN,
    physCellId                             PhysCellIdGERAN,
    cgi-Info                               SEQUENCE {
        cellGlobalId                       CellGlobalIdGERAN,
        routingAreaCode                    BIT STRING (SIZE (8))           OPTIONAL
    }
    measResult                             SEQUENCE {
        rssi                               INTEGER (0..63),
        ...
    }
}

MeasResultsCDMA2000 ::=                   SEQUENCE {
    preRegistrationStatusSHRPD              BOOLEAN,
    measResultListCDMA2000                  MeasResultListCDMA2000
}

MeasResultListCDMA2000 ::=                SEQUENCE (SIZE (1..maxCellReport)) OF MeasResultCDMA2000

MeasResultCDMA2000 ::= SEQUENCE {
    physCellId                             PhysCellIdCDMA2000,
    cgi-Info                               CellGlobalIdCDMA2000           OPTIONAL,
    measResult                             SEQUENCE {
        pilotPnPhase                       INTEGER (0..32767)             OPTIONAL,
        pilotStrength                       INTEGER (0..63),
        ...
    }
}

MeasResultListWLAN-r13 ::=                SEQUENCE (SIZE (1..maxCellReport)) OF MeasResultWLAN-r13

MeasResultListWLAN-r14 ::=                SEQUENCE (SIZE (1..maxWLAN-Id-Report-r14)) OF MeasResultWLAN-r13

MeasResultWLAN-r13 ::= SEQUENCE {
    wlan-Identifiers-r13                    WLAN-Identifiers-r12,
    carrierInfoWLAN-r13                     WLAN-CarrierInfo-r13           OPTIONAL,
    bandWLAN-r13                            WLAN-BandIndicator-r13         OPTIONAL,
    rssiWLAN-r13                            WLAN-RSSI-Range-r13,
    availableAdmissionCapacityWLAN-r13      INTEGER (0..31250)             OPTIONAL,
    backhaulDL-BandwidthWLAN-r13            WLAN-backhaulRate-r12         OPTIONAL,
    backhaulUL-BandwidthWLAN-r13            WLAN-backhaulRate-r12         OPTIONAL,
    channelUtilizationWLAN-r13              INTEGER (0..255)               OPTIONAL,
    stationCountWLAN-r13                    INTEGER (0..65535)             OPTIONAL,
    connectedWLAN-r13                       ENUMERATED {true}             OPTIONAL,
    ...
}

MeasResultListCBR-r14 ::=                 SEQUENCE (SIZE (1..maxCBR-Report-r14)) OF MeasResultCBR-r14

MeasResultCBR-r14 ::= SEQUENCE {
    poolIdentity-r14                        SL-V2X-TxPoolReportIdentity-r14,
    cbr-PSSCH-r14                           SL-CBR-r14,
    cbr-PSCCH-r14                           SL-CBR-r14                     OPTIONAL
}

MeasResultForECID-r9 ::=                  SEQUENCE {
    ue-RxTxTimeDiffResult-r9                INTEGER (0..4095),

```

```
    currentSFN-r9                               BIT STRING (SIZE (10))
  }
  PLMN-IdentityList2 ::=                       SEQUENCE (SIZE (1..5)) OF PLMN-Identity
  AdditionalSI-Info-r9 ::=                     SEQUENCE {
    csg-MemberStatus-r9                       ENUMERATED {member}           OPTIONAL,
    csg-Identity-r9                           CSG-Identity                 OPTIONAL
  }
  MeasResultForRSSI-r13 ::=                   SEQUENCE {
    rssi-Result-r13                           RSSI-Range-r13,
    channelOccupancy-r13                      INTEGER (0..100),
    ...
  }
  UL-PDCP-DelayResultList-r13 ::=            SEQUENCE (SIZE (1..maxQCI-r13)) OF UL-PDCP-DelayResult-r13
  UL-PDCP-DelayResult-r13 ::=                SEQUENCE {
    qci-Id-r13                                ENUMERATED {qci1, qci2, qci3, qci4, spare4, spare3, spare2,
    excessDelay-r13                           INTEGER (0..31),
    ...
  }
-- ASN1STOP
```

MeasResults field descriptions
availableAdmissionCapacityWLAN Indicates the available admission capacity of WLAN as defined in IEEE 802.11-2012 [67].
backhaulDL-BandwidthWLAN Indicates the backhaul available downlink bandwidth of WLAN, equal to Downlink Speed times Downlink Load defined in Wi-Fi Alliance Hotspot 2.0 [76].
backhaulUL-BandwidthWLAN Indicates the backhaul available uplink bandwidth of WLAN, equal to Uplink Speed times Uplink Load defined in Wi-Fi Alliance Hotspot 2.0 [76].
bandWLAN Indicates the WLAN band.
carrierInfoWLAN Indicates the WLAN channel information.
cbr-PSSCH Indicates the CBR measurement results on the PSSCH of the pool indicated by <i>poolIdentity</i> . If <i>adjacencyPSCCH-PSSCH</i> is set to <i>TRUE</i> for the pool indicated by <i>poolIdentity</i> , this field indicates the CBR measurement of both the PSSCH and PSCCH resources which are measured together.
cbr-PSCCH Indicates the CBR measurement results on the PSCCH of the pool indicated by <i>poolIdentity</i> . This field is only included if <i>adjacencyPSCCH-PSSCH</i> is set to <i>FALSE</i> for the pool indicated by <i>poolIdentity</i> .
channelOccupancy Indicates the percentage of samples when the RSSI was above the configured <i>channelOccupancyThreshold</i> for the associated <i>reportConfig</i> .
channelUtilizationWLAN Indicates WLAN channel utilization as defined in IEEE 802.11-2012 [67].
connectedWLAN Indicates whether the UE is connected to the WLAN for which the measurement results are applicable.
csg-MemberStatus Indicates whether or not the UE is a member of the CSG of the neighbour cell.
currentSFN Indicates the current system frame number when receiving the UE Rx-Tx time difference measurement results from lower layer.
excessDelay Indicates excess queueing delay ratio in UL, according to excess delay ratio measurement report mapping table, as defined in TS 36.314 [71, Table 4.2.1.1.1-1]
locationAreaCode A fixed length code identifying the location area within a PLMN, as defined in TS 23.003 [27].
measId Identifies the measurement identity for which the reporting is being performed. If the <i>measId-v1250</i> is included, the <i>measId</i> (i.e. without a suffix) is ignored by eNB.
measResult Measured result of an E-UTRA cell; Measured result of a UTRA cell; Measured result of a GERAN cell or frequency; Measured result of a CDMA2000 cell; Measured result of a WLAN; Measured result of UE Rx-Tx time difference; Measured result of UE SFN, radio frame and subframe timing difference; or Measured result of RSSI and channel occupancy.
measResultCSI-RS-List Measured results of the CSI-RS resources in discovery signals measurement.
measResultListCDMA2000 List of measured results for the maximum number of reported best cells for a CDMA2000 measurement identity.
measResultListEUTRA List of measured results for the maximum number of reported best cells for an E-UTRA measurement identity. For UE supporting CE Mode B, when CE mode B is not restricted by upper layers, <i>measResult-v1360</i> is reported if the measured RSRP is less than -140 dBm.
measResultListGERAN List of measured results for the maximum number of reported best cells or frequencies for a GERAN measurement identity.
measResultListUTRA List of measured results for the maximum number of reported best cells for a UTRA measurement identity.
measResultListWLAN List of measured results for the maximum number of reported best WLAN outside the WLAN mobility set and connected WLAN, if any, for a WLAN measurement identity.

MeasResults field descriptions
<p>measResultPCell Measured result of the PCell. For BL UEs or UEs in CE, when operating in CE Mode B, <i>measResultPCell-v1360</i> is reported if the measured RSRP is less than -140 dBm.</p>
<p>measResultsCDMA2000 Contains the CDMA2000 HRPD pre-registration status and the list of CDMA2000 measurements.</p>
<p>MeasResultServFreqList Measured results of the serving frequencies: the measurement result of each SCell, if any, and of the best neighbouring cell on each serving frequency. For UE supporting CE Mode B, when CE mode B is not restricted by upper layers, <i>measResultBestNeighCell-v1360</i> is reported if the measured RSRP is less than -140 dBm.</p>
<p>pilotPnPhase Indicates the arrival time of a CDMA2000 pilot, measured relative to the UE's time reference in units of PN chips, see C.S0005 [25]. This information is used in either SRVCC handover or enhanced 1xRTT CS fallback procedure to CDMA2000 1xRTT.</p>
<p>pilotStrength CDMA2000 Pilot Strength, the ratio of pilot power to total power in the signal bandwidth of a CDMA2000 Forward Channel. See C.S0005 [25] for CDMA2000 1xRTT and C.S0024 [26] for CDMA2000 HRPD.</p>
<p>poolIdentity The identity of the transmission resource pool which is corresponding to the <i>poolReportId</i> configured in a resource pool for V2X sidelink communication.</p>
<p>plmn-IdentityList The list of PLMN Identity read from broadcast information PLMN when the multiple PLMN Identities are broadcast.</p>
<p>preRegistrationStatusHRPD Set to TRUE if the UE is currently pre-registered with CDMA2000 HRPD. Otherwise set to FALSE. This can be ignored by the eNB for CDMA2000 1xRTT.</p>
<p>qci-Id Indicates QCI value for which <i>excessDelay</i> is provided, according to TS 36.314 [71].</p>
<p>routingAreaCode The RAC identity read from broadcast information, as defined in TS 23.003 [27].</p>
<p>rsrpResult Measured RSRP result of an E-UTRA cell. The <i>rsrpResult</i> is only reported if configured by the eNB.</p>
<p>rsrqResult Measured RSRQ result of an E-UTRA cell. The <i>rsrqResult</i> is only reported if configured by the eNB.</p>
<p>rssi GERAN Carrier RSSI. RXLEV is mapped to a value between 0 and 63, TS 45.008 [28]. When mapping the RXLEV value to the RSSI bit string, the first/leftmost bit of the bit string contains the most significant bit.</p>
<p>rssi-Result Measured RSSI result in dBm.</p>
<p>rs-sinr-Result Measured RS-SINR result of an E-UTRA cell. The <i>rs-sinr-Result</i> is only reported if configured by the eNB.</p>
<p>rssiWLAN Measured WLAN RSSI result in dBm.</p>
<p>stationCountWLAN Indicates the total number stations currently associated with this WLAN as defined in IEEE 802.11-2012 [67].</p>
<p>ue-RxTxTimeDiffResult UE Rx-Tx time difference measurement result of the PCell, provided by lower layers. If <i>ue-RxTxTimeDiffPeriodicalTDD-r13</i> is set to <i>TRUE</i>, the measurement mapping is according to EUTRAN TDD UE Rx-Tx time difference report mapping in TS 36.133 [16] and measurement result includes <i>N_{TAoffset}</i>, else the measurement mapping is according to EUTRAN FDD UE Rx-Tx time difference report mapping in TS 36.133 [16].</p>
<p>utra-EcN0 According to CPICH_Ec/No in TS 25.133 [29] for FDD. Fourteen spare values. The field is not present for TDD.</p>
<p>utra-RSCP According to CPICH_RSCP in TS 25.133 [29] for FDD and P-CCPCH_RSCP in TS 25.123 [30] for TDD. Thirty-one spare values.</p>
<p>wlan-Identifiers Indicates the WLAN parameters used for identification of the WLAN for which the measurement results are applicable.</p>

– **MeasResultSSTD**

The IE *MeasResultSSTD* consists of SFN, radio frame and subframe boundary difference between the PCell and the PSCell as specified in TS 36.214 [48] and TS 36.133 [16].

MeasResultSSTD information element

```

-- ASN1START
MeasResultSSTD-r13 ::=
    SEQUENCE {
        sfn-OffsetResult-r13          INTEGER (0..1023),
        frameBoundaryOffsetResult-r13 INTEGER (-5..4),
        subframeBoundaryOffsetResult-r13 INTEGER (0..127)
    }
-- ASN1STOP

```

MeasResultSSTD field descriptions**sfn-OffsetResult**

Indicates the SFN difference between the PCell and the PSCell as an integer value according to TS 36.214 [48].

frameBoundaryOffsetResult

Indicates the frame boundary difference between the PCell and the PSCell as an integer value according to TS 36.214 [48].

subframeBoundaryOffsetResult

Indicates the subframe boundary difference between the PCell and the PSCell as an integer value according to the mapping table in TS 36.133 [16].

MeasScaleFactor

The IE *MeasScaleFactor* specifies the factor for scaling the measurement performance requirements in TS 36.133 [16].

MeasScaleFactor information element

```

-- ASN1START
MeasScaleFactor-r12 ::=
    ENUMERATED {sf-EUTRA-cf1, sf-EUTRA-cf2}
-- ASN1STOP

```

NOTE: If the *reducedMeasPerformance* is not included in any *measObjectEUTRA* or *measObjectUTRA* and the *measScaleFactor* is included in the *measConfig*, E-UTRAN can configure any of the values for the *measScaleFactor* as specified in TS 36.133 [16].

QuantityConfig

The IE *QuantityConfig* specifies the measurement quantities and layer 3 filtering coefficients for E-UTRA and inter-RAT measurements.

QuantityConfig information element

```

-- ASN1START
QuantityConfig ::=
    SEQUENCE {
        quantityConfigEUTRA          QuantityConfigEUTRA          OPTIONAL, -- Need ON
        quantityConfigUTRA           QuantityConfigUTRA           OPTIONAL, -- Need ON
        quantityConfigGERAN          QuantityConfigGERAN          OPTIONAL, -- Need ON
        quantityConfigCDMA2000       QuantityConfigCDMA2000       OPTIONAL, -- Need ON
        . . .
        [[ quantityConfigUTRA-v1020   QuantityConfigUTRA-v1020   OPTIONAL -- Need ON
        ]],
        [[ quantityConfigEUTRA-v1250  QuantityConfigEUTRA-v1250  OPTIONAL -- Need ON
        ]],
        [[ quantityConfigEUTRA-v1310  QuantityConfigEUTRA-v1310  OPTIONAL -- Need ON
        ]],
        [[ quantityConfigWLAN-r13     QuantityConfigWLAN-r13     OPTIONAL -- Need ON
        ]],
    }
QuantityConfigEUTRA ::=
    SEQUENCE {
        filterCoefficientRSRP        FilterCoefficient          DEFAULT fc4,
        filterCoefficientRSRQ        FilterCoefficient          DEFAULT fc4
    }

```

```

}
QuantityConfigEUTRA-v1250 ::= SEQUENCE {
    filterCoefficientCSI-RSRP-r12 FilterCoefficient OPTIONAL -- Need
OR
}
QuantityConfigEUTRA-v1310 ::= SEQUENCE {
    filterCoefficientRS-SINR-r13 FilterCoefficient DEFAULT fc4
}
QuantityConfigUTRA ::= SEQUENCE {
    measQuantityUTRA-FDD ENUMERATED {cpich-RSCP, cpich-EcN0},
    measQuantityUTRA-TDD ENUMERATED {pccpch-RSCP},
    filterCoefficient FilterCoefficient DEFAULT fc4
}
QuantityConfigUTRA-v1020 ::= SEQUENCE {
    filterCoefficient2-FDD-r10 FilterCoefficient DEFAULT fc4
}
QuantityConfigGERAN ::= SEQUENCE {
    measQuantityGERAN ENUMERATED {rssi},
    filterCoefficient FilterCoefficient DEFAULT fc2
}
QuantityConfigCDMA2000 ::= SEQUENCE {
    measQuantityCDMA2000 ENUMERATED {pilotStrength, pilotPnPhaseAndPilotStrength}
}
QuantityConfigWLAN-r13 ::= SEQUENCE {
    measQuantityWLAN-r13 ENUMERATED {rssiWLAN},
    filterCoefficient-r13 FilterCoefficient DEFAULT fc4
}
-- ASN1STOP

```

QuantityConfig field descriptions

filterCoefficient2-FDD	Specifies the filtering coefficient used for the UTRAN FDD measurement quantity, which is not included in <i>measQuantityUTRA-FDD</i> , when <i>reportQuantityUTRA-FDD</i> is present in <i>ReportConfigInterRAT</i> .
filterCoefficientCSI-RSRP	Specifies the filtering coefficient used for CSI-RSRP.
filterCoefficientRSRP	Specifies the filtering coefficient used for RSRP.
filterCoefficientRSRQ	Specifies the filtering coefficient used for RSRQ.
filterCoefficientRS-SINR	Specifies the filtering coefficient used for RS-SINR.
measQuantityCDMA2000	Measurement quantity used for CDMA2000 measurements. <i>pilotPnPhaseAndPilotStrength</i> is only applicable for <i>MeasObjectCDMA2000</i> of <i>cdma2000-Type = type1XRTT</i> .
measQuantityGERAN	Measurement quantity used for GERAN measurements.
measQuantityUTRA	Measurement quantity used for UTRA measurements.
measQuantityWLAN	Measurement quantity used for WLAN measurements.
quantityConfigCDMA2000	Specifies quantity configurations for CDMA2000 measurements.
quantityConfigEUTRA	Specifies filter configurations for E-UTRA measurements.
quantityConfigGERAN	Specifies quantity and filter configurations for GERAN measurements.
quantityConfigUTRA	Specifies quantity and filter configurations for UTRA measurements. Field <i>quantityConfigUTRA-v1020</i> is applicable only when <i>reportQuantityUTRA-FDD</i> is configured.
quantityConfigWLAN	Specifies quantity and filter configurations for WLAN measurements.

– *ReportConfigEUTRA*

The IE *ReportConfigEUTRA* specifies criteria for triggering of an E-UTRA measurement reporting event. The E-UTRA measurement reporting events concerning CRS are labelled AN with N equal to 1, 2 and so on.

- Event A1: Serving becomes better than absolute threshold;
- Event A2: Serving becomes worse than absolute threshold;
- Event A3: Neighbour becomes amount of offset better than PCell/ PSCell;
- Event A4: Neighbour becomes better than absolute threshold;
- Event A5: PCell/ PSCell becomes worse than absolute threshold1 AND Neighbour becomes better than another absolute threshold2;
- Event A6: Neighbour becomes amount of offset better than SCell.

The E-UTRA measurement reporting events concerning CSI-RS are labelled CN with N equal to 1 and 2.

- Event C1: CSI-RS resource becomes better than absolute threshold;
- Event C2: CSI-RS resource becomes amount of offset better than reference CSI-RS resource.

The E-UTRA measurement reporting events concerning CBR are labelled VN with N equal to 1 and 2.

- Event V1: CBR becomes larger than absolute threshold;
- Event V2: CBR becomes smaller than absolute threshold.

***ReportConfigEUTRA* information element**

```
-- ASN1START
ReportConfigEUTRA ::=
  triggerType
  event
  eventId
  eventA1
    a1-Threshold
  },
  eventA2
    a2-Threshold
  },
  eventA3
    a3-Offset
    reportOnLeave
  },
  eventA4
    a4-Threshold
  },
  eventA5
    a5-Threshold1
    a5-Threshold2
  },
  ...,
  eventA6-r10
    a6-Offset-r10
    a6-ReportOnLeave-r10
  },
  eventC1-r12
    c1-Threshold-r12
    c1-ReportOnLeave-r12
  },
  eventC2-r12
    c2-RefCSI-RS-r12
    c2-Offset-r12
    c2-ReportOnLeave-r12
  },
  eventV1-r14
    v1-Threshold-r14
  },
  eventV2-r14
  SEQUENCE {
    CHOICE {
      SEQUENCE {
        CHOICE {
          SEQUENCE {
            ThresholdEUTRA
          }
          SEQUENCE {
            ThresholdEUTRA
          }
          SEQUENCE {
            INTEGER (-30..30),
            BOOLEAN
          }
          SEQUENCE {
            ThresholdEUTRA
          }
          SEQUENCE {
            ThresholdEUTRA,
            ThresholdEUTRA
          }
          SEQUENCE {
            INTEGER (-30..30),
            BOOLEAN
          }
          SEQUENCE {
            ThresholdEUTRA-v1250,
            BOOLEAN
          }
          SEQUENCE {
            MeasCSI-RS-Id-r12,
            INTEGER (-30..30),
            BOOLEAN
          }
          SEQUENCE {
            SL-CBR-r14
          }
        }
      }
    }
  }
```

```

        v2-Threshold-r14                               SL-CBR-r14
    },
    hysteresis                                         Hysteresis,
    timeToTrigger                                     TimeToTrigger
},
periodical                                           SEQUENCE {
    purpose                                           ENUMERATED {
                                                reportStrongestCells, reportCGI}
}
},
triggerQuantity                                     ENUMERATED {rsrp, rsrq},
reportQuantity                                       ENUMERATED {sameAsTriggerQuantity, both},
maxReportCells                                       INTEGER (1..maxCellReport),
reportInterval                                       ReportInterval,
reportAmount                                         ENUMERATED {r1, r2, r4, r8, r16, r32, r64, infinity},
...
[[ si-RequestForHO-r9                                ENUMERATED {setup}           OPTIONAL, -- Cond reportCGI
   ue-RxTxTimeDiffPeriodical-r9                    ENUMERATED {setup}           OPTIONAL, -- Need OR
]],
[[ includeLocationInfo-r10                           ENUMERATED {true}           OPTIONAL, -- Need OR
   reportAddNeighMeas-r10                          ENUMERATED {setup}           OPTIONAL, -- Need OR
]],
[[ alternativeTimeToTrigger-r12                      CHOICE {
    release                                           NULL,
    setup                                             TimeToTrigger
}
   useT312-r12                                       BOOLEAN                       OPTIONAL, -- Need ON
   usePSCell-r12                                       BOOLEAN                       OPTIONAL, -- Need ON
   aN-Threshold1-v1250                               RSRQ-RangeConfig-r12         OPTIONAL, -- Need ON
   a5-Threshold2-v1250                               RSRQ-RangeConfig-r12         OPTIONAL, -- Need ON
   reportStrongestCSI-RSs-r12                       BOOLEAN                       OPTIONAL, -- Need ON
   reportCRS-Meas-r12                               BOOLEAN                       OPTIONAL, -- Need ON
   triggerQuantityCSI-RS-r12                       BOOLEAN                       OPTIONAL, -- Need ON
]],
[[ reportSSTD-Meas-r13                               BOOLEAN                       OPTIONAL, -- Need ON
   rs-sinr-Config-r13                               CHOICE {
    release                                           NULL,
    setup                                             SEQUENCE {
        triggerQuantity-v1310                         ENUMERATED {sinr}           OPTIONAL, -- Need ON
        aN-Threshold1-r13                             RS-SINR-Range-r13          OPTIONAL, -- Need ON
        a5-Threshold2-r13                             RS-SINR-Range-r13          OPTIONAL, -- Need ON
        reportQuantity-v1310                         ENUMERATED {rsrpANDsinr, rsrqANDsinr, all}
    }
}
   useWhiteCellList-r13                             BOOLEAN                       OPTIONAL, -- Need ON
   measRSSI-ReportConfig-r13                       MeasRSSI-ReportConfig-r13   OPTIONAL, -- Need ON
   includeMultiBandInfo-r13                       ENUMERATED {true}           OPTIONAL, -- Cond
reportCGI
    ul-DelayConfig-r13                               UL-DelayConfig-r13          OPTIONAL, -- Need ON
]],
[[ ue-RxTxTimeDiffPeriodicalTDD-r13                BOOLEAN                       OPTIONAL, -- Need ON
]],
[[ purpose-v1430                                     ENUMERATED {reportLocation, sidelink, spare2, spare1}
                                                OPTIONAL, -- Need ON
]],
}

RSRQ-RangeConfig-r12 ::= CHOICE {
    release           NULL,
    setup            RSRQ-Range-v1250
}

ThresholdEUTRA ::= CHOICE{
    threshold-RSRP   RSRP-Range,
    threshold-RSRQ   RSRQ-Range
}

ThresholdEUTRA-v1250 ::= CSI-RSRP-Range-r12

MeasRSSI-ReportConfig-r13 ::= SEQUENCE {
    channelOccupancyThreshold-r13  RSSI-Range-r13           OPTIONAL, -- Need OR
}

-- ASN1STOP

```

ReportConfigEUTRA field descriptions
<p>a3-Offset/ a6-Offset/ c2-Offset Offset value to be used in EUTRA measurement report triggering condition for event a3/ a6/ c2. The actual value is field value * 0.5 dB.</p>
<p>alternativeTimeToTrigger Indicates the time to trigger applicable for cells specified in <i>altTTT-CellsToAddModList</i> of the associated measurement object, if configured</p>
<p>aN-ThresholdM/ cN-ThresholdM Threshold to be used in EUTRA measurement report triggering condition for event number aN/ cN. If multiple thresholds are defined for event number aN/ cN, the thresholds are differentiated by M. E-UTRAN configures <i>aN-Threshold1</i> only for events A1, A2, A4, A5 and <i>a5-Threshold2</i> only for event A5.</p>
<p>c1-ReportOnLeave/ c2-ReportOnLeave Indicates whether or not the UE shall initiate the measurement reporting procedure when the leaving condition is met for a CSI-RS resource in <i>csi-RS-TriggeredList</i>, as specified in 5.5.4.1.</p>
<p>c2-RefCSI-RS Identity of the CSI-RS resource from the <i>measCSI-RS-ToAddModList</i> of the associated <i>measObject</i>, to be used as the reference CSI-RS resource in EUTRA measurement report triggering condition for event c2.</p>
<p>channelOccupancyThreshold RSSI threshold which is used for channel occupancy evaluation.</p>
<p>eventId Choice of E-UTRA event triggered reporting criteria. EUTRAN may set this field to <i>eventC1</i> or <i>eventC2</i> only if <i>measDS-Config</i> is configured in the associated <i>measObject</i> with one or more CSI-RS resources. The <i>eventC1</i> and <i>eventC2</i> are not applicable for the <i>eventId</i> if RS-SINR is configured as <i>triggerQuantity</i> or <i>reportQuantity</i>.</p>
<p>includeMultiBandInfo If this field is present, the UE shall acquire and include multi band information in the measurement report.</p>
<p>maxReportCells Max number of cells, excluding the serving cell, to include in the measurement report concerning CRS, and max number of CSI-RS resources to include in the measurement report concerning CSI-RS.</p>
<p>measRSSI-ReportConfig If this field is present, the UE shall perform measurement reporting for RSSI and channel occupancy and ignore the <i>triggerQuantity</i>, <i>reportQuantity</i> and <i>maxReportCells</i> fields. E-UTRAN only sets this field to <i>true</i> when setting <i>triggerType</i> to <i>periodical</i> and <i>purpose</i> to <i>reportStrongestCells</i>.</p>
<p>reportAmount Number of measurement reports applicable for <i>triggerType event</i> as well as for <i>triggerType periodical</i>. In case <i>purpose</i> is set to <i>reportCGI</i> or <i>reportSSTD-Meas</i> is set to <i>true</i>, only value 1 applies.</p>
<p>reportCRS-Meas Indicates that UE shall include <i>rsrp</i>, <i>rsrq</i> together with <i>csi-rsrp</i> in the measurement report, if possible.</p>
<p>reportOnLeave/ a6-ReportOnLeave Indicates whether or not the UE shall initiate the measurement reporting procedure when the leaving condition is met for a cell in <i>cellsTriggeredList</i>, as specified in 5.5.4.1.</p>
<p>reportQuantity The quantities to be included in the measurement report. The value both means that both the <i>rsrp</i> and <i>rsrq</i> quantities are to be included in the measurement report. The value <i>rsrpANDsinr</i> and <i>rsrqANDsinr</i> mean that both <i>rsrp</i> and <i>rs-sinr</i> quantities, and both <i>rsrq</i> and <i>rs-sinr</i> quantities are to be included respectively in the measurement report. The value <i>all</i> means that <i>rsrp</i>, <i>rsrq</i> and <i>rs-sinr</i> are to be included in the measurement report. In case <i>triggerQuantityCSI-RS</i> is included, only value <i>sameAsTriggerQuantity</i> applies. If <i>reportQuantity-v1310</i> is configured, the UE only considers this extension (and ignores <i>reportQuantity</i> i.e. without suffix).</p>
<p>reportSSTD-Meas If this field is set to <i>true</i>, the UE shall measure SSTD between the PCell and the PSCell as specified in TS 36.214 [48] and ignore the <i>triggerQuantity</i>, <i>reportQuantity</i> and <i>maxReportCells</i> fields. E-UTRAN only sets this field to <i>true</i> when setting <i>triggerType</i> to <i>periodical</i> and <i>purpose</i> to <i>reportStrongestCells</i>.</p>
<p>reportStrongestCSI-RSs Indicates that periodical CSI-RS measurement report is performed. EUTRAN configures value <i>TRUE</i> only if <i>measDS-Config</i> is configured in the associated <i>measObject</i> with one or more CSI-RS resources.</p>
<p>si-RequestForHO The field applies to the <i>reportCGI</i> functionality, and when the field is included, the UE is allowed to use autonomous gaps in acquiring system information from the neighbour cell, applies a different value for T321, and includes different fields in the measurement report.</p>
<p>ThresholdEUTRA For RSRP: RSRP based threshold for event evaluation. The actual value is field value – 140 dBm. For RSRQ: RSRQ based threshold for event evaluation. The actual value is (field value – 40)/2 dB. For RS-SINR: RS-SINR based threshold for event evaluation. The actual value is (field value -46)/2 dB. For CSI-RSRP: CSI-RSRP based threshold for event evaluation. The actual value is field value – 140 dBm. EUTRAN configures the same threshold quantity for all the thresholds of an event.</p>
<p>timeToTrigger Time during which specific criteria for the event needs to be met in order to trigger a measurement report.</p>

ReportConfigEUTRA field descriptions
<p>triggerQuantity The quantity used to evaluate the triggering condition for the event concerning CRS. EUTRAN sets the value according to the quantity of the <i>ThresholdEUTRA</i> for this event. The values <i>rsrp</i>, <i>rsrq</i> and <i>sinr</i> correspond to Reference Signal Received Power (RSRP), Reference Signal Received Quality (RSRQ) and Reference Signal Signal to Noise and Interference Ratio (RS-SINR), see TS 36.214 [48]. If <i>triggerQuantity-v1310</i> is configured, the UE only considers this extension (and ignores <i>triggerQuantity</i> i.e. without suffix).</p>
<p>triggerQuantityCSI-RS The quantity used to evaluate the triggering condition for the event concerning CSI-RS. The value <i>TRUE</i> corresponds to CSI Reference Signal Received Power (CSI-RSRP), see TS 36.214 [48]. E-UTRAN configures value <i>TRUE</i> if and only if the measurement reporting event concerns CSI-RS.</p>
<p>ue-RxTxTimeDiffPeriodical If this field is present, the UE shall perform UE Rx-Tx time difference measurement reporting and ignore the fields <i>triggerQuantity</i>, <i>reportQuantity</i> and <i>maxReportCells</i>. If the field is present, the only applicable values for the corresponding <i>triggerType</i> and <i>purpose</i> are <i>periodical</i> and <i>reportStrongestCells</i> respectively.</p>
<p>ue-RxTxTimeDiffPeriodicalTDD If this field is set to <i>TRUE</i>, the UE shall perform UE Rx-Tx time difference measurement reporting according to EUTRAN TDD UE Rx-Tx time difference report mapping in TS 36.133 [16]. If the field is configured, the <i>ue-RxTxTimeDiffPeriodical</i> shall be configured. The field is applicable for TDD only.</p>
<p>usePSCell If this field is set to <i>TRUE</i> the UE shall use the PSCell instead of the PCell. E-UTRAN configures value <i>TRUE</i> only for events A3 and A5, see 5.5.4.4 and 5.5.4.6.</p>
<p>useT312 If value <i>TRUE</i> is configured, the UE shall use the timer T312 with the value <i>t312</i> as specified in the corresponding <i>measObject</i>. If the corresponding <i>measObject</i> does not include the timer T312 then the timer T312 is considered as not configured. E-UTRAN configures value <i>TRUE</i> only if <i>triggerType</i> is set to <i>event</i>.</p>
<p>useWhiteCellList Indicates whether only the cells included in the white-list of the associated <i>measObject</i> are applicable as specified in 5.5.4.1. E-UTRAN does not configure the field for events A1, A2, C1 and C2.</p>
<p>ul-DelayConfig If the field is present, E-UTRAN configures UL PDCP Packet Delay per QCI measurement and the UE shall ignore the fields <i>triggerQuantity</i> and <i>maxReportCells</i>. The applicable values for the corresponding <i>triggerType</i> and <i>reportInterval</i> are <i>periodical</i> and (one of the) <i>ms1024</i>, <i>ms2048</i>, <i>ms5120</i> or <i>ms10240</i> respectively. The <i>reportInterval</i> indicates the periodicity for performing and reporting of UL PDCP Delay per QCI measurement as specified in TS 36.314 [71].</p>

Conditional presence	Explanation
<i>reportCGI</i>	The field is optional, need OR, in case <i>purpose</i> is included and set to <i>reportCGI</i> ; otherwise the field is not present and the UE shall delete any existing value for this field.

– *ReportConfigId*

The IE *ReportConfigId* is used to identify a measurement reporting configuration.

ReportConfigId information element

```
-- ASN1START
ReportConfigId ::=
    INTEGER (1..maxReportConfigId)
-- ASN1STOP
```

– *ReportConfigInterRAT*

The IE *ReportConfigInterRAT* specifies criteria for triggering of an inter-RAT measurement reporting event. The inter-RAT measurement reporting events for UTRAN, GERAN and CDMA2000 are labelled *BN* with *N* equal to 1, 2 and so on. The inter-RAT measurement reporting events for WLAN are labelled *WN* with *N* equal to 1, 2 and so on.

- Event B1: Neighbour becomes better than absolute threshold;
- Event B2: PCell becomes worse than absolute threshold1 AND Neighbour becomes better than another absolute threshold2.
- Event W1: WLAN becomes better than a threshold;
- Event W2: All WLAN inside WLAN mobility set become worse than a threshold1 and a WLAN outside WLAN mobility set becomes better than a threshold2;
- Event W3: All WLAN inside WLAN mobility set become worse than a threshold.

The b1 and b2 event thresholds for CDMA2000 are the CDMA2000 pilot detection thresholds are expressed as an unsigned binary number equal to $[-2 \times 10 \log_{10} E_c/I_0]$ in units of 0.5dB, see C.S0005 [25] for details.

ReportConfigInterRAT information element

```
-- ASN1START
ReportConfigInterRAT ::=
    triggerType          SEQUENCE {
        event            CHOICE {
            eventId      SEQUENCE {
                eventB1  CHOICE {
                    b1-Threshold          SEQUENCE {
                        b1-ThresholdUTRA   CHOICE {
                            ThresholdUTRA,
                            ThresholdGERAN,
                            ThresholdCDMA2000
                        }
                    },
                    eventB2              SEQUENCE {
                        b2-Threshold1     ThresholdEUTRA,
                        b2-Threshold2     CHOICE {
                            ThresholdUTRA,
                            ThresholdGERAN,
                            ThresholdCDMA2000
                        }
                    },
                    ...,
                    eventW1-r13          SEQUENCE {
                        w1-Threshold-r13  WLAN-RSSI-Range-r13
                    },
                    eventW2-r13          SEQUENCE {
                        w2-Threshold1-r13 WLAN-RSSI-Range-r13,
                        w2-Threshold2-r13 WLAN-RSSI-Range-r13
                    },
                    eventW3-r13          SEQUENCE {
                        w3-Threshold-r13  WLAN-RSSI-Range-r13
                    }
                },
                hysteresis              Hysteresis,
                timeToTrigger            TimeToTrigger
            },
            periodical                  SEQUENCE {
                purpose                  ENUMERATED {
                    reportStrongestCells,
                    reportStrongestCellsForSON,
                    reportCGI
                }
            },
            maxReportCells              INTEGER (1..maxCellReport),
            reportInterval              ReportInterval,
            reportAmount                ENUMERATED {r1, r2, r4, r8, r16, r32, r64, infinity},
            ...,
            [[ si-RequestForHO-r9       ENUMERATED {setup}          OPTIONAL    -- Cond reportCGI
            ]],
            [[ reportQuantityUTRA-FDD-r10  ENUMERATED {both}        OPTIONAL    -- Need OR
            ]],
            [[ includeLocationInfo-r11     BOOLEAN                  OPTIONAL    -- Need ON
            ]],
            [[ b2-Threshold1-v1250        CHOICE {
                release              NULL,
                setup                 RSRQ-Range-v1250
            }
            ]],
            ]],
        ]],
    ]],

```

```

[[ reportQuantityWLAN-r13          ReportQuantityWLAN-r13 OPTIONAL -- Need ON
]],
[[ reportAnyWLAN-r14              BOOLEAN                OPTIONAL -- Need ON
]]
}

ThresholdUTRA ::= CHOICE{
  utra-RSCP          INTEGER (-5..91),
  utra-EcN0          INTEGER (0..49)
}

ThresholdGERAN ::= INTEGER (0..63)

ThresholdCDMA2000 ::= INTEGER (0..63)

ReportQuantityWLAN-r13 ::= SEQUENCE {
  bandRequestWLAN-r13          ENUMERATED {true}  OPTIONAL, -- Need OR
  carrierInfoRequestWLAN-r13  ENUMERATED {true}  OPTIONAL, -- Need OR
  availableAdmissionCapacityRequestWLAN-r13  ENUMERATED {true}  OPTIONAL, -- Need OR
  backhaulDL-BandwidthRequestWLAN-r13        ENUMERATED {true}  OPTIONAL, -- Need OR
  backhaulUL-BandwidthRequestWLAN-r13        ENUMERATED {true}  OPTIONAL, -- Need OR
  channelUtilizationRequestWLAN-r13          ENUMERATED {true}  OPTIONAL, -- Need OR
  stationCountRequestWLAN-r13                ENUMERATED {true}  OPTIONAL, -- Need OR
  ...
}

-- ASN1STOP

```

ReportConfigInterRAT field descriptions	
availableAdmissionCapacityRequestWLAN	The value true indicates that the UE shall include, if available, WLAN Available Admission Capacity in measurement reports.
backhaulDL-BandwidthRequestWLAN	The value true indicates that the UE shall include, if available, WLAN Backhaul Downlink Bandwidth in measurement reports.
backhaulUL-BandwidthRequestWLAN	The value true indicates that the UE shall include, if available, WLAN Backhaul Uplink Bandwidth in measurement reports.
bandRequestWLAN	The value true indicates that the UE shall include WLAN band in measurement reports.
bN-ThresholdM	Threshold to be used in inter RAT measurement report triggering condition for event number bN. If multiple thresholds are defined for event number bN, the thresholds are differentiated by M.
carrierInfoRequestWLAN	The value true indicates that the UE shall include, if available, WLAN Carrier Information in measurement reports.
channelUtilizationRequest-WLAN	The value true indicates that the UE shall include, if available, WLAN Channel Utilization in measurement reports.
eventId	Choice of inter-RAT event triggered reporting criteria.
maxReportCells	Max number of cells, excluding the serving cell, to include in the measurement report. In case <i>purpose</i> is set to <i>reportStrongestCellsForSON</i> only value 1 applies. For inter-RAT WLAN, it is the maximum number of WLANs to include in the measurement report.
Purpose	<i>reportStrongestCellsForSON</i> applies only in case <i>reportConfig</i> is linked to a <i>measObject</i> set to <i>measObjectUTRA</i> or <i>measObjectCDMA2000</i> .
reportAmount	Number of measurement reports applicable for <i>triggerType event</i> as well as for <i>triggerType periodical</i> . In case <i>purpose</i> is set to <i>reportCGI</i> or <i>reportStrongestCellsForSON</i> only value 1 applies.
reportAnyWLAN	Indicates UE to report any WLAN AP meeting the triggering requirements, even if it is not included in the corresponding <i>MeasObjectWLAN</i> .
reportQuantityUTRA-FDD	The quantities to be included in the UTRA measurement report. The value <i>both</i> means that both the cpich RSCP and cpich EcN0 quantities are to be included in the measurement report.
si-RequestForHO	The field applies to the <i>reportCGI</i> functionality, and when the field is included, the UE is allowed to use autonomous gaps in acquiring system information from the neighbour cell, applies a different value for T321, and includes different fields in the measurement report.
stationCountRequestWLAN	The value true indicates that the UE shall include, if available, WLAN Station Count in measurement reports.
b1-ThresholdGERAN, b2-Threshold2GERAN	The actual value is field value – 110 dBm.
b1-ThresholdUTRA, b2-Threshold2UTRA	<i>utra-RSCP</i> corresponds to CPICH_RSCP in TS 25.133 [29] for FDD and P-CCPCH_RSCP in TS 25.123 [30] for TDD. <i>utra-EcN0</i> corresponds to CPICH_Ec/No in TS 25.133 [29] for FDD, and is not applicable for TDD. For <i>utra-RSCP</i> : The actual value is field value – 115 dBm. For <i>utra-EcN0</i> : The actual value is (field value – 49)/2 dB.
timeToTrigger	Time during which specific criteria for the event needs to be met in order to trigger a measurement report.
triggerType	E-UTRAN does not configure the value <i>periodical</i> in case <i>reportConfig</i> is linked to a <i>measObject</i> set to <i>measObjectWLAN</i> .

Conditional presence	Explanation
<i>reportCGI</i>	The field is optional, need OR, in case <i>purpose</i> is included and set to <i>reportCGI</i> ; otherwise the field is not present and the UE shall delete any existing value for this field.

– *ReportConfigToAddModList*

The IE *ReportConfigToAddModList* concerns a list of reporting configurations to add or modify

ReportConfigToAddModList information element

```

-- ASN1START
ReportConfigToAddModList ::=          SEQUENCE (SIZE (1..maxReportConfigId)) OF ReportConfigToAddMod
ReportConfigToAddMod ::=      SEQUENCE {
    reportConfigId                ReportConfigId,
    reportConfig                   CHOICE {
        reportConfigEUTRA          ReportConfigEUTRA,
        reportConfigInterRAT      ReportConfigInterRAT
    }
}
-- ASN1STOP

```

– **ReportInterval**

The *ReportInterval* indicates the interval between periodical reports. The *ReportInterval* is applicable if the UE performs periodical reporting (i.e. when *reportAmount* exceeds 1), for *triggerType event* as well as for *triggerType periodical*. Value ms120 corresponds with 120 ms, ms240 corresponds with 240 ms and so on, while value min1 corresponds with 1 min, min6 corresponds with 6 min and so on.

ReportInterval information element

```

-- ASN1START
ReportInterval ::=                ENUMERATED {
    ms120, ms240, ms480, ms640, ms1024, ms2048, ms5120, ms10240,
    min1, min6, min12, min30, min60, spare3, spare2, spare1}
-- ASN1STOP

```

– **RSRP-Range**

The IE *RSRP-Range* specifies the value range used in RSRP measurements and thresholds. Integer value for RSRP measurements according to mapping table in TS 36.133 [16]. A given field using *RSRP-Range-v1360* shall only be signalled if the corresponding original field (using *RSRP-Range* i.e. without suffix) is set to value 0.

RSRP-Range information element

```

-- ASN1START
RSRP-Range ::=                    INTEGER(0..97)
RSRP-Range-v1360 ::=              INTEGER(-17..-1)
RSRP-RangeSL-r12 ::=              INTEGER(0..13)
RSRP-RangeSL2-r12 ::=            INTEGER(0..7)
RSRP-RangeSL3-r12 ::=            INTEGER(0..11)
RSRP-RangeSL4-r13 ::=            INTEGER(0..49)
-- ASN1STOP

```

RSRP-Range field descriptions
<p>RSRP-Range For UE supporting CE Mode B, when CE mode B is not restricted by upper layers, <i>RSRP-Range-v1360</i> (i.e., with suffix) is reported if the measured RSRP is less than -140 dBm.</p>
<p>RSRP-RangeSL Value 0 corresponds to -infinity, value 1 to -115dBm, value 2 to -110dBm, and so on (i.e. in steps of 5dBm) until value 12, which corresponds to -60dBm, while value 13 corresponds to +infinity.</p>
<p>RSRP-RangeSL2 Value 0 corresponds to -infinity, value 1 to -110dBm, value 2 to -100dBm, and so on (i.e. in steps of 10dBm) until value 6, which corresponds to -60dBm, while value 7 corresponds to +infinity.</p>
<p>RSRP-RangeSL3 Value 0 corresponds to -110dBm, value 1 to -105dBm, value 2 to -100dBm, and so on (i.e. in steps of 5dBm) until value 10, which corresponds to -60dBm, while value 11 corresponds to +infinity.</p>
<p>RSRP-RangeSL4 Indicates the range for SD-RSRP. Value 0 corresponds to -130dBm, value 1 to -128dBm, value 2 to -126dBm, and so on (i.e. in steps of 2dBm) until value 48, which corresponds to -34dBm, while value 49 corresponds to +infinity.</p>

– RSRQ-Range

The IE *RSRQ-Range* specifies the value range used in RSRQ measurements and thresholds. Integer value for RSRQ measurements is according to mapping table in TS 36.133 [16]. A given field using *RSRQ-Range-v1250* shall only be signalled if the corresponding original field (using *RSRQ-Range* i.e. without suffix) is set to value 0 or 34. Only a UE indicating support of *extendedRSRQ-LowerRange-r12* or *rsrq-OnAllSymbols-r12* may report *RSRQ-Range-v1250*, and this may be done without explicit configuration from the E-UTRAN. If received, the UE shall use the value indicated by the *RSRQ-Range-v1250* and ignore the value signalled by *RSRQ-Range* (without the suffix). *RSRQ-Range-r13* covers the original range and extended *RSRQ-Range-v1250*. *RSRQ-Range-r13* may be signalled without the corresponding original field and without any requirements for indicated support of *extendedRSRQ-LowerRange-r12* or *rsrq-OnAllSymbols-r12*.

RSRQ-Range information element

```
-- ASN1START
RSRQ-Range ::= INTEGER(0..34)
RSRQ-Range-v1250 ::= INTEGER(-30..46)
RSRQ-Range-r13 ::= INTEGER(-30..46)
-- ASN1STOP
```

– RSRQ-Type

The IE *RSRQ-Type* specifies the RSRQ value type used in RSRQ measurements, see TS 36.214 [48].

RSRQ-Type information element

```
-- ASN1START
RSRQ-Type-r12 ::= SEQUENCE {
    allSymbols-r12    BOOLEAN,
    wideBand-r12     BOOLEAN
}
-- ASN1STOP
```

RSRQ-Type field descriptions
<p>allSymbols Value TRUE indicates use of all OFDM symbols when performing RSRQ measurements.</p>
<p>wideBand Value TRUE indicates use of a wider bandwidth when performing RSRQ measurements.</p>

– *RS-SINR-Range*

The IE *RS-SINR-Range* specifies the value range used in RS-SINR measurements and thresholds. Integer value for RS-SINR measurements is according to mapping table in TS 36.133 [16].

***RS-SINR-Range* information element**

```
-- ASN1START
RS-SINR-Range-r13 ::=
                                INTEGER(0..127)
-- ASN1STOP
```

– *RSSI-Range-r13*

The IE *RSSI-Range* specifies the value range used in RSSI measurements and thresholds. Integer value for RSSI measurements is according to mapping table in TS 36.133 [16].

***RSSI-Range* information element**

```
-- ASN1START
RSSI-Range-r13 ::=
                                INTEGER(0..76)
-- ASN1STOP
```

– *TimeToTrigger*

The IE *TimeToTrigger* specifies the value range used for time to trigger parameter, which concerns the time during which specific criteria for the event needs to be met in order to trigger a measurement report. Value ms0 corresponds to 0 ms and behaviour as specified in 7.3.2 applies, ms40 corresponds to 40 ms, and so on.

***TimeToTrigger* information element**

```
-- ASN1START
TimeToTrigger ::=
                                ENUMERATED {
                                    ms0, ms40, ms64, ms80, ms100, ms128, ms160, ms256,
                                    ms320, ms480, ms512, ms640, ms1024, ms1280, ms2560,
                                    ms5120}
-- ASN1STOP
```

– *UL-DelayConfig*

The IE *UL-DelayConfig* IE specifies the configuration of the UL PDCP Packet Delay per QCI measurement specified in TS36.314 [71].

***UL-DelayConfig* information element**

```
-- ASN1START
UL-DelayConfig-r13 ::=
    CHOICE {
        release
        setup
            delayThreshold-r13
    }
-- ASN1STOP
```

UL-DelayConfig field descriptions**delayThreshold**

Indicates the delay threshold value used by UE to provide results of UL PDCP Packet Delay per QCI measurement as specified in TS 36.314 [71]. Value in milliseconds. Value ms30 means 30 ms and so on.

WLAN-CarrierInfo

The IE *WLAN-CarrierInfo* is used to identify the WLAN frequency band information, as specified in Annex E in [67].

WLAN-CarrierInfo information element

```
-- ASN1START
WLAN-CarrierInfo-r13 ::= SEQUENCE {
    operatingClass-r13    INTEGER (0..255)           OPTIONAL, -- Need ON
    countryCode-r13      ENUMERATED {unitedStates, europe, japan, global, ...}  OPTIONAL, --
Need ON
    channelNumbers-r13   WLAN-ChannelList-r13      OPTIONAL, -- Need ON
    ...
}
WLAN-ChannelList-r13 ::= SEQUENCE (SIZE (1..maxWLAN-Channels-r13)) OF WLAN-Channel-r13
WLAN-Channel-r13 ::= INTEGER(0..255)
-- ASN1STOP
```

WLAN-CarrierInfo field descriptions**channelNumbers**

Indicates the WLAN channels as defined in IEEE 802.11-2012 [67]. Value 0 is not used.

countryCode

Indicates the country code of WLAN as defined in IEEE 802.11-2012 [67].

operatingClass

Indicates the Operating Class of WLAN as defined in IEEE 802.11-2012 [67].

WLAN-RSSI-Range

The IE *WLAN-RSSI-Range* specifies the value range used in WLAN RSSI measurements and thresholds. Integer value for WLAN RSSI measurements is according to mapping table in TS 36.133 [16]. Value 0 corresponds to -infinity, value 1 to -100dBm, value 2 to -99dBm, and so on (i.e. in steps of 1dBm) until value 140, which corresponds to 39dBm, while value 141 corresponds to +infinity.

WLAN-RSSI-Range information element

```
-- ASN1START
WLAN-RSSI-Range-r13 ::= INTEGER(0..141)
-- ASN1STOP
```

WLAN-Status

The IE *WLAN-Status* indicates the current status of WLAN connection. The values are set as described in Clauses 5.6.15.2 and 5.6.15.4.

WLAN-Status information element

```
-- ASN1START
WLAN-Status-r13 ::= ENUMERATED {successfulAssociation, failureWlanRadioLink,
failureWlanUnavailable, failureTimeout}
-- ASN1STOP
```

```
WLAN-Status-v1430 ::= ENUMERATED {suspended, resumed}
-- ASN1STOP
```

– *WLAN-SuspendConfig*

The IE *WLAN-SuspendConfig* is used for configuration of WLAN suspend/resume functionality.

```
-- ASN1START
WLAN-SuspendConfig-r14 ::= SEQUENCE {
    wlan-SuspendResumeAllowed-r14          BOOLEAN          OPTIONAL,  -- Need ON
    wlan-SuspendTriggersStatusReport-r14   BOOLEAN          OPTIONAL  -- Need ON
}
-- ASN1STOP
```

WLAN-SuspendConfig field descriptions

wlan-SuspendResumeAllowed

Indicates whether the UE is allowed to use suspend-resume mechanism, i.e., to indicate WLAN being temporarily unavailable and WLAN being available again after temporary unavailability.

wlan-SuspendTriggersStatusReport

Indicates whether the UE shall trigger PDCP status report as defined in [8] when WLAN is temporarily unavailable and UE reports this status.

6.3.6 Other information elements

– *AbsoluteTimeInfo*

The IE *AbsoluteTimeInfo* indicates an absolute time in a format YY-MM-DD HH:MM:SS and using BCD encoding. The first/ leftmost bit of the bit string contains the most significant bit of the most significant digit of the year and so on.

AbsoluteTimeInfo information element

```
-- ASN1START
AbsoluteTimeInfo-r10 ::= BIT STRING (SIZE (48))
-- ASN1STOP
```

– *AreaConfiguration*

The *AreaConfiguration* indicates area for which UE is requested to perform measurement logging. If not configured, measurement logging is not restricted to specific cells or tracking areas but applies as long as the RPLMN is contained in *plmn-IdentityList* stored in *VarLogMeasReport*.

AreaConfiguration information element

```
-- ASN1START
AreaConfiguration-r10 ::= CHOICE {
    cellGlobalIdList-r10      CellGlobalIdList-r10,
    trackingAreaCodeList-r10   TrackingAreaCodeList-r10
}
AreaConfiguration-v1130 ::= SEQUENCE {
    trackingAreaCodeList-v1130 TrackingAreaCodeList-v1130
}
CellGlobalIdList-r10 ::= SEQUENCE (SIZE (1..32)) OF CellGlobalIdEUTRA
TrackingAreaCodeList-r10 ::= SEQUENCE (SIZE (1..8)) OF TrackingAreaCode
TrackingAreaCodeList-v1130 ::= SEQUENCE {
```

```

    plmn-Identity-perTAC-List-r11          SEQUENCE (SIZE (1..8)) OF PLMN-Identity
  }
-- ASN1STOP

```

AreaConfiguration field descriptions

plmn-Identity-perTAC-List

Includes the PLMN identity for each of the TA codes included in *trackingAreaCodeList*. The PLMN identity listed first in *plmn-Identity-perTAC-List* corresponds with the TA code listed first in *trackingAreaCodeList* and so on.

– ***BandCombinationList***

The IE *BandCombinationList* contains a list of CA band combinations.

***BandCombinationList* information element**

```

-- ASN1START
BandCombinationList-r14 ::= SEQUENCE (SIZE (1..maxBandComb-r13)) OF BandCombination-r14
BandCombination-r14 ::= SEQUENCE (SIZE (1..maxSimultaneousBands-r10)) OF BandIndication-r14
BandIndication-r14 ::= SEQUENCE {
    bandEUTRA-r14          FreqBandIndicator-r11,
    ca-BandwidthClassDL-r14 CA-BandwidthClass-r10,
    ca-BandwidthClassUL-r14 CA-BandwidthClass-r10          OPTIONAL
}
-- ASN1STOP

```

– ***C-RNTI***

The IE *C-RNTI* identifies a UE having a RRC connection within a cell.

***C-RNTI* information element**

```

-- ASN1START
C-RNTI ::=
    BIT STRING (SIZE (16))
-- ASN1STOP

```

– ***DedicatedInfoCDMA2000***

The *DedicatedInfoCDMA2000* is used to transfer UE specific CDMA2000 information between the network and the UE. The RRC layer is transparent for this information.

***DedicatedInfoCDMA2000* information element**

```

-- ASN1START
DedicatedInfoCDMA2000 ::=
    OCTET STRING
-- ASN1STOP

```

– ***DedicatedInfoNAS***

The IE *DedicatedInfoNAS* is used to transfer UE specific NAS layer information between the network and the UE. The RRC layer is transparent for this information.

***DedicatedInfoNAS* information element**

```

-- ASN1START

```

```
DedicatedInfoNAS ::= OCTET STRING
-- ASN1STOP
```

– *FilterCoefficient*

The IE *FilterCoefficient* specifies the measurement filtering coefficient. Value *fc0* corresponds to $k = 0$, *fc1* corresponds to $k = 1$, and so on.

FilterCoefficient information element

```
-- ASN1START
FilterCoefficient ::= ENUMERATED {
    fc0, fc1, fc2, fc3, fc4, fc5,
    fc6, fc7, fc8, fc9, fc11, fc13,
    fc15, fc17, fc19, spare1, ...}
-- ASN1STOP
```

– *LoggingDuration*

The *LoggingDuration* indicates the duration for which UE is requested to perform measurement logging. Value *min10* corresponds to 10 minutes, value *min20* corresponds to 20 minutes and so on.

LoggingDuration information element

```
-- ASN1START
LoggingDuration-r10 ::= ENUMERATED {
    min10, min20, min40, min60, min90, min120, spare2, spare1}
-- ASN1STOP
```

– *LoggingInterval*

The *LoggingInterval* indicates the periodicity for logging measurement results. Value *ms1280* corresponds to 1.28s, value *ms2560* corresponds to 2.56s and so on.

LoggingInterval information element

```
-- ASN1START
LoggingInterval-r10 ::= ENUMERATED {
    ms1280, ms2560, ms5120, ms10240, ms20480,
    ms30720, ms40960, ms61440}
-- ASN1STOP
```

– *MeasSubframePattern*

The IE *MeasSubframePattern* is used to specify a subframe pattern. The first/leftmost bit corresponds to the subframe #0 of the radio frame satisfying $\text{SFN mod } x = 0$, where SFN is that of PCell and x is the size of the bit string divided by 10. "1" denotes that the corresponding subframe is used.

MeasSubframePattern information element

```
-- ASN1START
MeasSubframePattern-r10 ::= CHOICE {
    subframePatternFDD-r10 BIT STRING (SIZE (40)),
    subframePatternTDD-r10 CHOICE {
        subframeConfig1-5-r10 BIT STRING (SIZE (20)),
```

```

        subframeConfig0-r10          BIT STRING (SIZE (70)),
        subframeConfig6-r10         BIT STRING (SIZE (60)),
        ...
    },
    ...
}
-- ASN1STOP

```

– MMEC

The IE *MMEC* identifies an MME within the scope of an MME Group within a PLMN, see TS 23.003 [27].

MMEC information element

```

-- ASN1START
MMEC ::=                               BIT STRING (SIZE (8))
-- ASN1STOP

```

– NeighCellConfig

The IE *NeighCellConfig* is used to provide the information related to MBSFN and TDD UL/DL configuration of neighbour cells.

NeighCellConfig information element

```

-- ASN1START
NeighCellConfig ::=                   BIT STRING (SIZE (2))
-- ASN1STOP

```

NeighCellConfig field descriptions

neighCellConfig

Provides information related to MBSFN and TDD UL/DL configuration of neighbour cells of this frequency
00: Not all neighbour cells have the same MBSFN subframe allocation as the serving cell on this frequency, if configured, and as the PCell otherwise

10: The MBSFN subframe allocations of all neighbour cells are identical to or subsets of that in the serving cell on this frequency, if configured, and of that in the PCell otherwise

01: No MBSFN subframes are present in all neighbour cells

11: Different UL/DL allocation in neighbouring cells for TDD compared to the serving cell on this frequency, if configured, and compared to the PCell otherwise

For TDD, 00, 10 and 01 are only used for same UL/DL allocation in neighbouring cells compared to the serving cell on this frequency, if configured, and compared to the PCell otherwise.

– OtherConfig

The IE *OtherConfig* contains configuration related to other configuration

OtherConfig information element

```

-- ASN1START
OtherConfig-r9 ::= SEQUENCE {
    reportProximityConfig-r9          ReportProximityConfig-r9          OPTIONAL,  -- Need ON
    ...
    [[
        idc-Config-r11                IDC-Config-r11                OPTIONAL,  -- Need ON
        powerPrefIndicationConfig-r11 PowerPrefIndicationConfig-r11 OPTIONAL,  -- Need ON
        obtainLocationConfig-r11      ObtainLocationConfig-r11      OPTIONAL  -- Need ON
    ]],
}

```

```

[[ bw-PreferenceIndicationTimer-r14      ENUMERATED {s0, s0dot5, s1, s2, s5, s10, s20,
                                           s30, s60, s90, s120, s300, s600, spare3,
                                           spare2, spare1}      OPTIONAL, -- Need OR
sps-AssistanceInfoReport-r14           BOOLEAN                OPTIONAL, -- Need ON
delayBudgetReportingConfig-r14 CHOICE{
  release                               NULL,
  setup                                 SEQUENCE{
    delayBudgetReportingProhibitTimer-r14  ENUMERATED {
                                           s0, s0dot4, s0dot8,
                                           s1dot6, s3, s6, s12, s30}
    }
  }
  }
  } OPTIONAL, -- Need ON
rlm-ReportConfig-r14 CHOICE {
  release                               NULL,
  setup                                 SEQUENCE{
    rlmReportTimer-r14                  ENUMERATED {s0, s0dot5, s1, s2, s5, s10, s20, s30,
    s60, s90, s120, s300, s600, spare3, spare2, spare1},
    rlmReportRep-MPDCCH-r14            ENUMERATED {setup}      OPTIONAL -- Need OR
  }
} OPTIONAL -- Need ON
]],
[[{ overheatingAssistanceConfig-r14 CHOICE{
  release                               NULL,
  setup                                 SEQUENCE{
    overheatingIndicationProhibitTimer-r14  ENUMERATED {s0, s0dot5, s1, s2, s5, s10,
    s20, s30, s60, s90, s120, s300, s600,
    spare3, spare2, spare1}
  }
} OPTIONAL -- Need ON
]]
}

IDC-Config-r11 ::= SEQUENCE {
  idc-Indication-r11      ENUMERATED {setup}      OPTIONAL, -- Need OR
  autonomousDenialParameters-r11 SEQUENCE {
    autonomousDenialSubframes-r11  ENUMERATED {n2, n5, n10, n15,
    n20, n30, spare2, spare1},
    autonomousDenialValidity-r11    ENUMERATED {
    sf200, sf500, sf1000, sf2000,
    spare4, spare3, spare2, spare1}
  }
  } OPTIONAL, -- Need OR
  ...
  [[ idc-Indication-UL-CA-r11      ENUMERATED {setup}      OPTIONAL -- Cond idc-Ind
  ]],
  [[ idc-HardwareSharingIndication-r13  ENUMERATED {setup}      OPTIONAL -- Need OR
  ]]
}

ObtainLocationConfig-r11 ::= SEQUENCE {
  obtainLocation-r11      ENUMERATED {setup}      OPTIONAL -- Need OR
}

PowerPrefIndicationConfig-r11 ::= CHOICE{
  release                NULL,
  setup                  SEQUENCE{
    powerPrefIndicationTimer-r11  ENUMERATED {s0, s0dot5, s1, s2, s5, s10, s20,
    s30, s60, s90, s120, s300, s600, spare3,
    spare2, spare1}
  }
}

ReportProximityConfig-r9 ::= SEQUENCE {
  proximityIndicationEUTRA-r9      ENUMERATED {enabled}      OPTIONAL, -- Need OR
  proximityIndicationUTRA-r9       ENUMERATED {enabled}      OPTIONAL -- Need OR
}

-- ASN1STOP

```

OtherConfig field descriptions	
autonomousDenialSubframes	Indicates the maximum number of the UL subframes for which the UE is allowed to deny any UL transmission. Value n2 corresponds to 2 subframes, n5 to 5 subframes and so on. E-UTRAN does not configure autonomous denial for frequencies on which SCG cells are configured.
autonomousDenialValidity	Indicates the validity period over which the UL autonomous denial subframes shall be counted. Value sf200 corresponds to 200 subframes, sf500 corresponds to 500 subframes and so on.
bw-PreferenceIndicationTimer	Prohibit timer for bandwidth preference indication reporting. Value in seconds. Value s0 means prohibit timer is set to 0 second, value s0dot5 means prohibit timer is set to 0.5 second, value s1 means prohibit timer is set to 1 second and so on.
delayBudgetReportingProhibitTimer	Prohibit timer for delay budget reporting. Value in seconds. Value s0 means prohibit timer is set to 0 second, value s0dot4 means prohibit timer is set to 0.4 second, and so on.
idc-HardwareSharingIndication	The field is used to indicate whether the UE is allowed indicate in <i>InDeviceCoexIndication</i> that the cause of the problems are due to hardware sharing, and whether the UE is allowed to omit the TDM assistance information.
idc-Indication	The field is used to indicate whether the UE is configured to initiate transmission of the <i>InDeviceCoexIndication</i> message to the network.
idc-Indication-UL-CA	The field is used to indicate whether the UE is configured to provide IDC indications for UL CA using the <i>InDeviceCoexIndication</i> message.
obtainLocation	Requests the UE to attempt to have detailed location information available using GNSS. E-UTRAN configures the field only if <i>includeLocationInfo</i> is configured for one or more measurements.
overheatingAssistanceConfig	Configuration for the UE to report assistance information to inform the eNB about UE detected internal overheating.
overheatingIndicationProhibitTimer	Prohibit timer for overheating assistance information reporting. Value in seconds. Value s0 means prohibit timer is set to 0 seconds, value s0dot5 means prohibit timer is set to 0.5 second, value s1 means prohibit timer is set to 1 second and so on.
powerPrefIndicationTimer	Prohibit timer for Power Preference Indication reporting. Value in seconds. Value s0 means prohibit timer is set to 0 second, value s0dot5 means prohibit timer is set to 0.5 second, value s1 means prohibit timer is set to 1 second and so on.
reportProximityConfig	Indicates, for each of the applicable RATs (EUTRA, UTRA), whether or not proximity indication is enabled for CSG member cell(s) of the concerned RAT. Note.
rlmReportTimer	Prohibit timer for RLM event reporting, i.e. "early-out-of-sync" and "early-in-sync" event reporting, as specified in clause 5.6.10. Value in seconds. Value s0 means prohibit timer is set to 0 second, value s0dot5 means prohibit timer is set to 0.5 second, value s1 means prohibit timer is set to 1 second and so on.
rlmReportRep-MPDCCH	The field is used to indicate whether the UE is configured to report excess repetitions on MPDCCH.
sps-AssistanceInfoReport	Value TRUE indicates that the UE is allowed to report SPS-AssistanceInformation.

NOTE: Enabling/ disabling of proximity indication includes enabling/ disabling of the related functionality e.g. autonomous search in connected mode.

Conditional presence	Explanation
<i>idc-Ind</i>	The field is optionally present if <i>idc-Indication</i> is present, need OR. Otherwise the field is not present.

– *RAND-CDMA2000 (1xRTT)*

The *RAND-CDMA2000* concerns a random value, generated by the eNB, to be passed to the CDMA2000 upper layers.

***RAND-CDMA2000* information element**

```
-- ASN1START
RAND-CDMA2000 ::= BIT STRING (SIZE (32))
```

```
-- ASN1STOP
```

– *RAT-Type*

The IE *RAT-Type* is used to indicate the radio access technology (RAT), including E-UTRA, of the requested/transferred UE capabilities.

***RAT-Type* information element**

```
-- ASN1START
RAT-Type ::=
    ENUMERATED {
        eutra, utra, geran-cs, geran-ps, cdma2000-1XRTT,
        spare3, spare2, spare1, ...}
-- ASN1STOP
```

– *ResumeIdentity*

The IE *ResumeIdentity* is used to identify the suspended UE context

***ResumeIdentity* information element**

```
-- ASN1START
ResumeIdentity-r13 ::=
    BIT STRING (SIZE(40))
-- ASN1STOP
```

– *RRC-TransactionIdentifier*

The IE *RRC-TransactionIdentifier* is used, together with the message type, for the identification of an RRC procedure (transaction).

***RRC-TransactionIdentifier* information element**

```
-- ASN1START
RRC-TransactionIdentifier ::=
    INTEGER (0..3)
-- ASN1STOP
```

– *S-TMSI*

The IE *S-TMSI* contains an S-Temporary Mobile Subscriber Identity, a temporary UE identity provided by the EPC which uniquely identifies the UE within the tracking area, see TS 23.003 [27].

***S-TMSI* information element**

```
-- ASN1START
S-TMSI ::=
    SEQUENCE {
        mmec
        m-TMSI
    }
-- ASN1STOP
```

S-TMSI field descriptions***m-TMSI***

The first/leftmost bit of the bit string contains the most significant bit of the M-TMSI.

– ***TraceReference***

The *TraceReference* contains parameter Trace Reference as defined in TS 32.422 [58].

***TraceReference* information element**

```
-- ASN1START
TraceReference-r10 ::= SEQUENCE {
    plmn-identity-r10      PLMN-Identity,
    traceId-r10           OCTET STRING (SIZE (3))
}
-- ASN1STOP
```

– ***UE-CapabilityRAT-ContainerList***

The IE *UE-CapabilityRAT-ContainerList* contains list of containers, one for each RAT for which UE capabilities are transferred, if any.

***UE-CapabilityRAT-ContainerList* information element**

```
-- ASN1START
UE-CapabilityRAT-ContainerList ::= SEQUENCE (SIZE (0..maxRAT-Capabilities)) OF UE-CapabilityRAT-Container
UE-CapabilityRAT-Container ::= SEQUENCE {
    rat-Type              RAT-Type,
    ueCapabilityRAT-Container OCTET STRING
}
-- ASN1STOP
```

UECapabilityRAT-ContainerList* field descriptions**ueCapabilityRAT-Container***

Container for the UE capabilities of the indicated RAT. The encoding is defined in the specification of each RAT:

For E-UTRA: the encoding of UE capabilities is defined in IE *UE-EUTRA-Capability*.

For UTRA: the octet string contains the INTER RAT HANDOVER INFO message defined in TS 25.331 [19].

For GERAN CS: the octet string contains the concatenated string of the Mobile Station Classmark 2 and Mobile Station Classmark 3. The first 5 octets correspond to Mobile Station Classmark 2 and the following octets correspond to Mobile Station Classmark 3. The Mobile Station Classmark 2 is formatted as 'TLV' and is coded in the same way as the *Mobile Station Classmark 2* information element in TS 24.008 [49]. The first octet is the *Mobile station classmark 2 IEI* and its value shall be set to 33H. The second octet is the *Length of mobile station classmark 2* and its value shall be set to 3. The octet 3 contains the first octet of the value part of the *Mobile Station Classmark 2* information element, the octet 4 contains the second octet of the value part of the *Mobile Station Classmark 2* information element and so on. For each of these octets, the first/ leftmost/ most significant bit of the octet contains b8 of the corresponding octet of the Mobile Station Classmark 2. The Mobile Station Classmark 3 is formatted as 'V' and is coded in the same way as the value part in the *Mobile station classmark 3* information element in TS 24.008 [49]. The sixth octet of this octet string contains octet 1 of the value part of *Mobile station classmark 3*, the seventh of octet of this octet string contains octet 2 of the value part of *Mobile station classmark 3* and so on. Note.

For GERAN PS: the encoding of UE capabilities is formatted as 'V' and is coded in the same way as the value part in the *MS Radio Access Capability* information element in TS 24.008 [49].

For CDMA2000-1XRTT: the octet string contains the A21 Mobile Subscription Information and the encoding of this is defined in A.S0008 [33]. The A21 Mobile Subscription Information contains the supported CDMA2000 1xRTT band class and band sub-class information.

NOTE: The value part is specified by means of CSN.1, which encoding results in a bit string, to which final padding may be appended up to the next octet boundary TS 24.008 [49]. The first/ leftmost bit of the CSN.1 bit string is placed in the first/ leftmost/ most significant bit of the first octet. This continues until the last bit of the CSN.1 bit string, which is placed in the last/ rightmost/ least significant bit of the last octet.

– UE-EUTRA-Capability

The IE *UE-EUTRA-Capability* is used to convey the E-UTRA UE Radio Access Capability Parameters, see TS 36.306 [5], and the Feature Group Indicators for mandatory features (defined in Annexes B.1 and C.1) to the network. The IE *UE-EUTRA-Capability* is transferred in E-UTRA or in another RAT.

NOTE 0: For (UE capability specific) guidelines on the use of keyword OPTIONAL, see Annex A.3.5.

UE-EUTRA-Capability information element

```
-- ASN1START
UE-EUTRA-Capability ::=          SEQUENCE {
    accessStratumRelease          AccessStratumRelease,
    ue-Category                   INTEGER (1..5),
    pdcp-Parameters              PDCP-Parameters,
    phyLayerParameters           PhyLayerParameters,
    rf-Parameters                RF-Parameters,
    measParameters               MeasParameters,
    featureGroupIndicators       BIT STRING (SIZE (32))          OPTIONAL,
    interRAT-Parameters          SEQUENCE {
        ultraFDD                 IRAT-ParametersUTRA-FDD          OPTIONAL,
        ultraTDD128              IRAT-ParametersUTRA-TDD128        OPTIONAL,
        ultraTDD384              IRAT-ParametersUTRA-TDD384        OPTIONAL,
        ultraTDD768              IRAT-ParametersUTRA-TDD768        OPTIONAL,
        geran                    IRAT-ParametersGERAN          OPTIONAL,
        cdma2000-HRPD             IRAT-ParametersCDMA2000-HRPD  OPTIONAL,
        cdma2000-1xRTT           IRAT-ParametersCDMA2000-1XRTT  OPTIONAL
    },
    nonCriticalExtension          UE-EUTRA-Capability-v920-IEs    OPTIONAL
}

-- Late non critical extensions
UE-EUTRA-Capability-v9a0-IEs ::= SEQUENCE {
    featureGroupIndRel9Add-r9    BIT STRING (SIZE (32))          OPTIONAL,
    fdd-Add-UE-EUTRA-Capabilities-r9  UE-EUTRA-CapabilityAddXDD-Mode-r9  OPTIONAL,
    tdd-Add-UE-EUTRA-Capabilities-r9  UE-EUTRA-CapabilityAddXDD-Mode-r9  OPTIONAL,
    nonCriticalExtension          UE-EUTRA-Capability-v9c0-IEs    OPTIONAL
}

UE-EUTRA-Capability-v9c0-IEs ::= SEQUENCE {
    interRAT-ParametersUTRA-v9c0    IRAT-ParametersUTRA-v9c0          OPTIONAL,
    nonCriticalExtension            UE-EUTRA-Capability-v9d0-IEs    OPTIONAL
}

UE-EUTRA-Capability-v9d0-IEs ::= SEQUENCE {
    phyLayerParameters-v9d0        PhyLayerParameters-v9d0          OPTIONAL,
    nonCriticalExtension            UE-EUTRA-Capability-v9e0-IEs    OPTIONAL
}

UE-EUTRA-Capability-v9e0-IEs ::= SEQUENCE {
    rf-Parameters-v9e0             RF-Parameters-v9e0              OPTIONAL,
    nonCriticalExtension            UE-EUTRA-Capability-v9h0-IEs    OPTIONAL
}

UE-EUTRA-Capability-v9h0-IEs ::= SEQUENCE {
    interRAT-ParametersUTRA-v9h0    IRAT-ParametersUTRA-v9h0          OPTIONAL,
    -- Following field is only to be used for late REL-9 extensions
    lateNonCriticalExtension        OCTET STRING                      OPTIONAL,
    nonCriticalExtension            UE-EUTRA-Capability-v10c0-IEs    OPTIONAL
}

UE-EUTRA-Capability-v10c0-IEs ::= SEQUENCE {
    otdoa-PositioningCapabilities-r10  OTDOA-PositioningCapabilities-r10  OPTIONAL,
    nonCriticalExtension            UE-EUTRA-Capability-v10f0-IEs    OPTIONAL
}

UE-EUTRA-Capability-v10f0-IEs ::= SEQUENCE {
```

```

rf-Parameters-v10f0          RF-Parameters-v10f0          OPTIONAL,
nonCriticalExtension         UE-EUTRA-Capability-v10i0-IEs  OPTIONAL
}

UE-EUTRA-Capability-v10i0-IEs ::= SEQUENCE {
  rf-Parameters-v10i0          RF-Parameters-v10i0          OPTIONAL,
  -- Following field is only to be used for late REL-10 extensions
  lateNonCriticalExtension     OCTET STRING (CONTAINING UE-EUTRA-Capability-v10j0-IEs)
  OPTIONAL,
  nonCriticalExtension         UE-EUTRA-Capability-v11d0-IEs  OPTIONAL
}

UE-EUTRA-Capability-v10j0-IEs ::= SEQUENCE {
  rf-Parameters-v10j0          RF-Parameters-v10j0          OPTIONAL,
  nonCriticalExtension         SEQUENCE {}              OPTIONAL
}

UE-EUTRA-Capability-v11d0-IEs ::= SEQUENCE {
  rf-Parameters-v11d0          RF-Parameters-v11d0          OPTIONAL,
  otherParameters-v11d0        Other-Parameters-v11d0        OPTIONAL,
  nonCriticalExtension         UE-EUTRA-Capability-v11x0-IEs  OPTIONAL
}

UE-EUTRA-Capability-v11x0-IEs ::= SEQUENCE {
  -- Following field is only to be used for late REL-11 extensions
  lateNonCriticalExtension     OCTET STRING              OPTIONAL,
  nonCriticalExtension         UE-EUTRA-Capability-v12b0-IEs  OPTIONAL
}

UE-EUTRA-Capability-v12b0-IEs ::= SEQUENCE {
  rf-Parameters-v12b0          RF-Parameters-v12b0          OPTIONAL,
  nonCriticalExtension         UE-EUTRA-Capability-v12x0-IEs  OPTIONAL
}

UE-EUTRA-Capability-v12x0-IEs ::= SEQUENCE {
  -- Following field is only to be used for late REL-12 extensions
  lateNonCriticalExtension     OCTET STRING              OPTIONAL,
  nonCriticalExtension         UE-EUTRA-Capability-v1370-IEs  OPTIONAL
}

UE-EUTRA-Capability-v1370-IEs ::= SEQUENCE {
  ce-Parameters-v1370          CE-Parameters-v1370          OPTIONAL,
  fdd-Add-UE-EUTRA-Capabilities-v1370 UE-EUTRA-CapabilityAddXDD-Mode-v1370 OPTIONAL,
  tdd-Add-UE-EUTRA-Capabilities-v1370 UE-EUTRA-CapabilityAddXDD-Mode-v1370 OPTIONAL,
  nonCriticalExtension         UE-EUTRA-Capability-v1380-IEs  OPTIONAL
}

UE-EUTRA-Capability-v1380-IEs ::= SEQUENCE {
  rf-Parameters-v1380          RF-Parameters-v1380          OPTIONAL,
  ce-Parameters-v1380          CE-Parameters-v1380,
  fdd-Add-UE-EUTRA-Capabilities-v1380 UE-EUTRA-CapabilityAddXDD-Mode-v1380,
  tdd-Add-UE-EUTRA-Capabilities-v1380 UE-EUTRA-CapabilityAddXDD-Mode-v1380,
  nonCriticalExtension         UE-EUTRA-Capability-v1390-IEs  OPTIONAL
}

UE-EUTRA-Capability-v1390-IEs ::= SEQUENCE {
  rf-Parameters-v1390          RF-Parameters-v1390          OPTIONAL,
  nonCriticalExtension         UE-EUTRA-Capability-v13x0-IEs  OPTIONAL
}

UE-EUTRA-Capability-v13x0-IEs ::= SEQUENCE {
  lateNonCriticalExtension     OCTET STRING (CONTAINING UE-EUTRA-Capability-v13e0-IEs)
  OPTIONAL,
  nonCriticalExtension         UE-EUTRA-Capability-v1470-IEs  OPTIONAL
}

UE-EUTRA-Capability-v13e0-IEs ::= SEQUENCE {
  phyLayerParameters-v13e0     PhyLayerParameters-v13e0,
  -- Following field is only to be used for late REL-13 extensions
  nonCriticalExtension         SEQUENCE {}              OPTIONAL
}

UE-EUTRA-Capability-v1470-IEs ::= SEQUENCE {
  mbms-Parameters-v1470        MBMS-Parameters-v1470        OPTIONAL,
  phyLayerParameters-v1470     PhyLayerParameters-v1470    OPTIONAL,
  rf-Parameters-v1470          RF-Parameters-v1470          OPTIONAL,
  -- Following field is only to be used for late REL-14 extensions
  nonCriticalExtension         UE-EUTRA-Capability-v14a0-IEs  OPTIONAL
}

```

```

}
UE-EUTRA-Capability-v14a0-IEs ::= SEQUENCE {
    phyLayerParameters-v14a0          PhyLayerParameters-v14a0,
    nonCriticalExtension              UE-EUTRA-Capability-v14b0-IEs    OPTIONAL
}
UE-EUTRA-Capability-v14b0-IEs ::= SEQUENCE {
    rf-Parameters-v14b0              RF-Parameters-v14b0          OPTIONAL,
    nonCriticalExtension              SEQUENCE {}                  OPTIONAL
}
-- Regular non critical extensions
UE-EUTRA-Capability-v920-IEs ::= SEQUENCE {
    phyLayerParameters-v920          PhyLayerParameters-v920,
    interRAT-ParametersGERAN-v920   IRAT-ParametersGERAN-v920,
    interRAT-ParametersUTRA-v920     IRAT-ParametersUTRA-v920    OPTIONAL,
    interRAT-ParametersCDMA2000-v920 IRAT-ParametersCDMA2000-1XRTT-v920 OPTIONAL,
    deviceType-r9                    ENUMERATED {noBenFromBatConsumpOpt} OPTIONAL,
    csg-ProximityIndicationParameters-r9 CSG-ProximityIndicationParameters-r9,
    neighCellSI-AcquisitionParameters-r9 NeighCellSI-AcquisitionParameters-r9,
    son-Parameters-r9                SON-Parameters-r9,
    nonCriticalExtension              UE-EUTRA-Capability-v940-IEs    OPTIONAL
}
UE-EUTRA-Capability-v940-IEs ::= SEQUENCE {
    lateNonCriticalExtension          OCTET STRING (CONTAINING UE-EUTRA-Capability-v9a0-IEs)
    OPTIONAL,
    nonCriticalExtension              UE-EUTRA-Capability-v1020-IEs    OPTIONAL
}
UE-EUTRA-Capability-v1020-IEs ::= SEQUENCE {
    ue-Category-v1020                INTEGER (6..8)              OPTIONAL,
    phyLayerParameters-v1020          PhyLayerParameters-v1020    OPTIONAL,
    rf-Parameters-v1020              RF-Parameters-v1020        OPTIONAL,
    measParameters-v1020             MeasParameters-v1020       OPTIONAL,
    featureGroupIndRel10-r10         BIT STRING (SIZE (32))     OPTIONAL,
    interRAT-ParametersCDMA2000-v1020 IRAT-ParametersCDMA2000-1XRTT-v1020 OPTIONAL,
    ue-BasedNetwPerfMeasParameters-r10 UE-BasedNetwPerfMeasParameters-r10 OPTIONAL,
    interRAT-ParametersUTRA-TDD-v1020 IRAT-ParametersUTRA-TDD-v1020 OPTIONAL,
    nonCriticalExtension              UE-EUTRA-Capability-v1060-IEs    OPTIONAL
}
UE-EUTRA-Capability-v1060-IEs ::= SEQUENCE {
    fdd-Add-UE-EUTRA-Capabilities-v1060 UE-EUTRA-CapabilityAddXDD-Mode-v1060    OPTIONAL,
    tdd-Add-UE-EUTRA-Capabilities-v1060 UE-EUTRA-CapabilityAddXDD-Mode-v1060    OPTIONAL,
    rf-Parameters-v1060                RF-Parameters-v1060        OPTIONAL,
    nonCriticalExtension                 UE-EUTRA-Capability-v1090-IEs    OPTIONAL
}
UE-EUTRA-Capability-v1090-IEs ::= SEQUENCE {
    rf-Parameters-v1090                RF-Parameters-v1090        OPTIONAL,
    nonCriticalExtension                 UE-EUTRA-Capability-v1130-IEs    OPTIONAL
}
UE-EUTRA-Capability-v1130-IEs ::= SEQUENCE {
    pdcp-Parameters-v1130              PDCP-Parameters-v1130,
    phyLayerParameters-v1130           PhyLayerParameters-v1130    OPTIONAL,
    rf-Parameters-v1130                RF-Parameters-v1130,
    measParameters-v1130               MeasParameters-v1130,
    interRAT-ParametersCDMA2000-v1130 IRAT-ParametersCDMA2000-v1130,
    otherParameters-r11                Other-Parameters-r11,
    fdd-Add-UE-EUTRA-Capabilities-v1130 UE-EUTRA-CapabilityAddXDD-Mode-v1130    OPTIONAL,
    tdd-Add-UE-EUTRA-Capabilities-v1130 UE-EUTRA-CapabilityAddXDD-Mode-v1130    OPTIONAL,
    nonCriticalExtension                 UE-EUTRA-Capability-v1170-IEs    OPTIONAL
}
UE-EUTRA-Capability-v1170-IEs ::= SEQUENCE {
    phyLayerParameters-v1170           PhyLayerParameters-v1170    OPTIONAL,
    ue-Category-v1170                  INTEGER (9..10)             OPTIONAL,
    nonCriticalExtension                 UE-EUTRA-Capability-v1180-IEs    OPTIONAL
}
UE-EUTRA-Capability-v1180-IEs ::= SEQUENCE {
    rf-Parameters-v1180                RF-Parameters-v1180        OPTIONAL,
    mbms-Parameters-r11                MBMS-Parameters-r11        OPTIONAL,
    fdd-Add-UE-EUTRA-Capabilities-v1180 UE-EUTRA-CapabilityAddXDD-Mode-v1180    OPTIONAL,
    tdd-Add-UE-EUTRA-Capabilities-v1180 UE-EUTRA-CapabilityAddXDD-Mode-v1180    OPTIONAL,

```

nonCriticalExtension	UE-EUTRA-Capability-v11a0-IEs	OPTIONAL
}		
UE-EUTRA-Capability-v11a0-IEs ::= SEQUENCE {		
ue-Category-v11a0	INTEGER (11..12)	OPTIONAL,
measParameters-v11a0	MeasParameters-v11a0	OPTIONAL,
nonCriticalExtension	UE-EUTRA-Capability-v1250-IEs	OPTIONAL
}		
UE-EUTRA-Capability-v1250-IEs ::= SEQUENCE {		
phyLayerParameters-v1250	PhyLayerParameters-v1250	OPTIONAL,
rf-Parameters-v1250	RF-Parameters-v1250	OPTIONAL,
rlc-Parameters-r12	RLC-Parameters-r12	OPTIONAL,
ue-BasedNetwPerfMeasParameters-v1250	UE-BasedNetwPerfMeasParameters-v1250	OPTIONAL,
ue-CategoryDL-r12	INTEGER (0..14)	OPTIONAL,
ue-CategoryUL-r12	INTEGER (0..13)	OPTIONAL,
wlan-IW-Parameters-r12	WLAN-IW-Parameters-r12	OPTIONAL,
measParameters-v1250	MeasParameters-v1250	OPTIONAL,
dc-Parameters-r12	DC-Parameters-r12	OPTIONAL,
mbms-Parameters-v1250	MBMS-Parameters-v1250	OPTIONAL,
mac-Parameters-r12	MAC-Parameters-r12	OPTIONAL,
fdd-Add-UE-EUTRA-Capabilities-v1250	UE-EUTRA-CapabilityAddXDD-Mode-v1250	OPTIONAL,
tdd-Add-UE-EUTRA-Capabilities-v1250	UE-EUTRA-CapabilityAddXDD-Mode-v1250	OPTIONAL,
sl-Parameters-r12	SL-Parameters-r12	OPTIONAL,
nonCriticalExtension	UE-EUTRA-Capability-v1260-IEs	OPTIONAL
}		
UE-EUTRA-Capability-v1260-IEs ::= SEQUENCE {		
ue-CategoryDL-v1260	INTEGER (15..16)	OPTIONAL,
nonCriticalExtension	UE-EUTRA-Capability-v1270-IEs	OPTIONAL
}		
UE-EUTRA-Capability-v1270-IEs ::= SEQUENCE {		
rf-Parameters-v1270	RF-Parameters-v1270	OPTIONAL,
nonCriticalExtension	UE-EUTRA-Capability-v1280-IEs	OPTIONAL
}		
UE-EUTRA-Capability-v1280-IEs ::= SEQUENCE {		
phyLayerParameters-v1280	PhyLayerParameters-v1280	OPTIONAL,
nonCriticalExtension	UE-EUTRA-Capability-v1310-IEs	OPTIONAL
}		
UE-EUTRA-Capability-v1310-IEs ::= SEQUENCE {		
ue-CategoryDL-v1310	ENUMERATED {n17, m1}	OPTIONAL,
ue-CategoryUL-v1310	ENUMERATED {n14, m1}	OPTIONAL,
pdcp-Parameters-v1310	PDCP-Parameters-v1310,	
rlc-Parameters-v1310	RLC-Parameters-v1310,	
mac-Parameters-v1310	MAC-Parameters-v1310	OPTIONAL,
phyLayerParameters-v1310	PhyLayerParameters-v1310	OPTIONAL,
rf-Parameters-v1310	RF-Parameters-v1310	OPTIONAL,
measParameters-v1310	MeasParameters-v1310	OPTIONAL,
dc-Parameters-v1310	DC-Parameters-v1310	OPTIONAL,
sl-Parameters-v1310	SL-Parameters-v1310	OPTIONAL,
scptm-Parameters-r13	SCPTM-Parameters-r13	OPTIONAL,
ce-Parameters-r13	CE-Parameters-r13	OPTIONAL,
interRAT-ParametersWLAN-r13	IRAT-ParametersWLAN-r13,	
laa-Parameters-r13	LAA-Parameters-r13	OPTIONAL,
lwa-Parameters-r13	LWA-Parameters-r13	OPTIONAL,
wlan-IW-Parameters-v1310	WLAN-IW-Parameters-v1310,	
lwip-Parameters-r13	LWIP-Parameters-r13,	
fdd-Add-UE-EUTRA-Capabilities-v1310	UE-EUTRA-CapabilityAddXDD-Mode-v1310	OPTIONAL,
tdd-Add-UE-EUTRA-Capabilities-v1310	UE-EUTRA-CapabilityAddXDD-Mode-v1310	OPTIONAL,
nonCriticalExtension	UE-EUTRA-Capability-v1320-IEs	OPTIONAL
}		
UE-EUTRA-Capability-v1320-IEs ::= SEQUENCE {		
ce-Parameters-v1320	CE-Parameters-v1320	OPTIONAL,
phyLayerParameters-v1320	PhyLayerParameters-v1320	OPTIONAL,
rf-Parameters-v1320	RF-Parameters-v1320	OPTIONAL,
fdd-Add-UE-EUTRA-Capabilities-v1320	UE-EUTRA-CapabilityAddXDD-Mode-v1320	OPTIONAL,
tdd-Add-UE-EUTRA-Capabilities-v1320	UE-EUTRA-CapabilityAddXDD-Mode-v1320	OPTIONAL,
nonCriticalExtension	UE-EUTRA-Capability-v1330-IEs	OPTIONAL
}		
UE-EUTRA-Capability-v1330-IEs ::= SEQUENCE {		
ue-CategoryDL-v1330	INTEGER (18..19)	OPTIONAL,
phyLayerParameters-v1330	PhyLayerParameters-v1330	OPTIONAL,
ue-CE-NeedULGaps-r13	ENUMERATED {true}	OPTIONAL,

```

    nonCriticalExtension          UE-EUTRA-Capability-v1340-IEs          OPTIONAL
  }
UE-EUTRA-Capability-v1340-IEs ::= SEQUENCE {
  ue-CategoryUL-v1340            INTEGER (15)                      OPTIONAL,
  nonCriticalExtension          UE-EUTRA-Capability-v1350-IEs          OPTIONAL
}
UE-EUTRA-Capability-v1350-IEs ::= SEQUENCE {
  ue-CategoryDL-v1350          ENUMERATED {oneBis}                OPTIONAL,
  ue-CategoryUL-v1350          ENUMERATED {oneBis}                OPTIONAL,
  ce-Parameters-v1350          CE-Parameters-v1350,
  nonCriticalExtension          UE-EUTRA-Capability-v1360-IEs          OPTIONAL
}
UE-EUTRA-Capability-v1360-IEs ::= SEQUENCE {
  other-Parameters-v1360        Other-Parameters-v1360          OPTIONAL,
  nonCriticalExtension          UE-EUTRA-Capability-v1430-IEs          OPTIONAL
}
UE-EUTRA-Capability-v1430-IEs ::= SEQUENCE {
  phyLayerParameters-v1430      PhyLayerParameters-v1430,
  ue-CategoryDL-v1430          ENUMERATED {m2}                OPTIONAL,
  ue-CategoryUL-v1430          ENUMERATED {n16, n17, n18, n19, n20, m2}  OPTIONAL,
  ue-CategoryUL-v1430b         ENUMERATED {n21}                OPTIONAL,
  mac-Parameters-v1430         MAC-Parameters-v1430          OPTIONAL,
  measParameters-v1430         MeasParameters-v1430          OPTIONAL,
  pdcp-Parameters-v1430        PDCP-Parameters-v1430          OPTIONAL,
  rlc-Parameters-v1430         RLC-Parameters-v1430,
  rf-Parameters-v1430          RF-Parameters-v1430          OPTIONAL,
  laa-Parameters-v1430         LAA-Parameters-v1430          OPTIONAL,
  lwa-Parameters-v1430         LWA-Parameters-v1430          OPTIONAL,
  lwip-Parameters-v1430        LWIP-Parameters-v1430          OPTIONAL,
  otherParameters-v1430        Other-Parameters-v1430,
  mmtel-Parameters-r14         MMTTEL-Parameters-r14          OPTIONAL,
  mobilityParameters-r14       MobilityParameters-r14          OPTIONAL,
  ce-Parameters-v1430          CE-Parameters-v1430,
  fdd-Add-UE-EUTRA-Capabilities-v1430 UE-EUTRA-CapabilityAddXDD-Mode-v1430 OPTIONAL,
  tdd-Add-UE-EUTRA-Capabilities-v1430 UE-EUTRA-CapabilityAddXDD-Mode-v1430 OPTIONAL,
  mbms-Parameters-v1430        MBMS-Parameters-v1430          OPTIONAL,
  sl-Parameters-v1430          SL-Parameters-v1430          OPTIONAL,
  ue-BasedNetwPerfMeasParameters-v1430 UE-BasedNetwPerfMeasParameters-v1430 OPTIONAL,
  highSpeedEnhParameters-r14    HighSpeedEnhParameters-r14    OPTIONAL,
  nonCriticalExtension          UE-EUTRA-Capability-v1440-IEs          OPTIONAL
}
UE-EUTRA-Capability-v1440-IEs ::= SEQUENCE {
  lwa-Parameters-v1440          LWA-Parameters-v1440,
  mac-Parameters-v1440          MAC-Parameters-v1440,
  nonCriticalExtension          UE-EUTRA-Capability-v1450-IEs          OPTIONAL
}
UE-EUTRA-Capability-v1450-IEs ::= SEQUENCE {
  phyLayerParameters-v1450      PhyLayerParameters-v1450          OPTIONAL,
  rf-Parameters-v1450           RF-Parameters-v1450            OPTIONAL,
  otherParameters-v1450         OtherParameters-v1450,
  ue-CategoryDL-v1450          INTEGER (20)                    OPTIONAL,
  nonCriticalExtension          UE-EUTRA-Capability-v1460-IEs          OPTIONAL
}
UE-EUTRA-Capability-v1460-IEs ::= SEQUENCE {
  ue-CategoryDL-v1460          INTEGER (21)                    OPTIONAL,
  otherParameters-v1460         Other-Parameters-v1460,
  nonCriticalExtension          SEQUENCE {}                          OPTIONAL
}
UE-EUTRA-CapabilityAddXDD-Mode-r9 ::= SEQUENCE {
  phyLayerParameters-r9         PhyLayerParameters                OPTIONAL,
  featureGroupIndicators-r9     BIT STRING (SIZE (32))          OPTIONAL,
  featureGroupIndRel9Add-r9     BIT STRING (SIZE (32))          OPTIONAL,
  interRAT-ParametersGERAN-r9   IRAT-ParametersGERAN            OPTIONAL,
  interRAT-ParametersUTRA-r9    IRAT-ParametersUTRA-v920        OPTIONAL,
  interRAT-ParametersCDMA2000-r9 IRAT-ParametersCDMA2000-1XRRT-v920 OPTIONAL,
  neighCellSI-AcquisitionParameters-r9 NeighCellSI-AcquisitionParameters-r9 OPTIONAL,
  ...
}
UE-EUTRA-CapabilityAddXDD-Mode-v1060 ::= SEQUENCE {

```



```

phyLayerParameters-v1060          PhyLayerParameters-v1020          OPTIONAL,
featureGroupIndRel10-v1060        BIT STRING (SIZE (32))          OPTIONAL,
interRAT-ParametersCDMA2000-v1060 IRAT-ParametersCDMA2000-1XRTT-v1020 OPTIONAL,
interRAT-ParametersUTRA-TDD-v1060 IRAT-ParametersUTRA-TDD-v1020  OPTIONAL,
...
[[ otdoa-PositioningCapabilities-r10  OTDOA-PositioningCapabilities-r10  OPTIONAL
]]
}

UE-EUTRA-CapabilityAddXDD-Mode-v1130 ::= SEQUENCE {
  phyLayerParameters-v1130          PhyLayerParameters-v1130          OPTIONAL,
  measParameters-v1130              MeasParameters-v1130              OPTIONAL,
  otherParameters-r11               Other-Parameters-r11              OPTIONAL,
  ...
}

UE-EUTRA-CapabilityAddXDD-Mode-v1180 ::= SEQUENCE {
  mbms-Parameters-r11               MBMS-Parameters-r11
}

UE-EUTRA-CapabilityAddXDD-Mode-v1250 ::= SEQUENCE {
  phyLayerParameters-v1250          PhyLayerParameters-v1250          OPTIONAL,
  measParameters-v1250              MeasParameters-v1250              OPTIONAL
}

UE-EUTRA-CapabilityAddXDD-Mode-v1310 ::= SEQUENCE {
  phyLayerParameters-v1310          PhyLayerParameters-v1310          OPTIONAL
}

UE-EUTRA-CapabilityAddXDD-Mode-v1320 ::= SEQUENCE {
  phyLayerParameters-v1320          PhyLayerParameters-v1320          OPTIONAL,
  scptm-Parameters-r13              SCPTM-Parameters-r13              OPTIONAL
}

UE-EUTRA-CapabilityAddXDD-Mode-v1370 ::= SEQUENCE {
  ce-Parameters-v1370               CE-Parameters-v1370              OPTIONAL
}

UE-EUTRA-CapabilityAddXDD-Mode-v1380 ::= SEQUENCE {
  ce-Parameters-v1380               CE-Parameters-v1380
}

UE-EUTRA-CapabilityAddXDD-Mode-v1430 ::= SEQUENCE {
  phyLayerParameters-v1430          PhyLayerParameters-v1430          OPTIONAL,
  mmtel-Parameters-r14              MMTEL-Parameters-r14              OPTIONAL
}

AccessStratumRelease ::=
  ENUMERATED {
    rel8, rel9, rel10, rel11, rel12, rel13,
    rel14, spare1, ...}

MobilityParameters-r14 ::=
  SEQUENCE {
    makeBeforeBreak-r14              ENUMERATED {supported}            OPTIONAL,
    rach-Less-r14                    ENUMERATED {supported}            OPTIONAL
  }

DC-Parameters-r12 ::=
  SEQUENCE {
    drb-TypeSplit-r12                ENUMERATED {supported}            OPTIONAL,
    drb-TypeSCG-r12                  ENUMERATED {supported}            OPTIONAL
  }

DC-Parameters-v1310 ::=
  SEQUENCE {
    pdcp-TransferSplitUL-r13          ENUMERATED {supported}            OPTIONAL,
    ue-SSTD-Meas-r13                  ENUMERATED {supported}            OPTIONAL
  }

MAC-Parameters-r12 ::=
  SEQUENCE {
    logicalChannelSR-ProhibitTimer-r12 ENUMERATED {supported}            OPTIONAL,
    longDRX-Command-r12               ENUMERATED {supported}            OPTIONAL
  }

MAC-Parameters-v1310 ::=
  SEQUENCE {
    extendedMAC-LengthField-r13       ENUMERATED {supported}            OPTIONAL,
    extendedLongDRX-r13                ENUMERATED {supported}            OPTIONAL
  }

MAC-Parameters-v1430 ::=
  SEQUENCE {
    shortSPS-IntervalFDD-r14          ENUMERATED {supported}            OPTIONAL,

```

shortSPS-IntervalTDD-r14	ENUMERATED {supported}	OPTIONAL,
skipUplinkDynamic-r14	ENUMERATED {supported}	OPTIONAL,
skipUplinkSPS-r14	ENUMERATED {supported}	OPTIONAL,
multipleUplinkSPS-r14	ENUMERATED {supported}	OPTIONAL,
dataInactMon-r14	ENUMERATED {supported}	OPTIONAL
}		
MAC-Parameters-v1440 ::=	SEQUENCE {	
rai-Support-r14	ENUMERATED {supported}	OPTIONAL
}		
RLC-Parameters-r12 ::=	SEQUENCE {	
extended-RLC-LI-Field-r12	ENUMERATED {supported}	
}		
RLC-Parameters-v1310 ::=	SEQUENCE {	
extendedRLC-SN-SO-Field-r13	ENUMERATED {supported}	OPTIONAL
}		
RLC-Parameters-v1430 ::=	SEQUENCE {	
extendedPollByte-r14	ENUMERATED {supported}	OPTIONAL
}		
PDCP-Parameters ::=	SEQUENCE {	
supportedROHC-Profiles	SEQUENCE {	
profile0x0001	BOOLEAN,	
profile0x0002	BOOLEAN,	
profile0x0003	BOOLEAN,	
profile0x0004	BOOLEAN,	
profile0x0006	BOOLEAN,	
profile0x0101	BOOLEAN,	
profile0x0102	BOOLEAN,	
profile0x0103	BOOLEAN,	
profile0x0104	BOOLEAN	
},		
maxNumberROHC-ContextSessions	ENUMERATED {	
	cs2, cs4, cs8, cs12, cs16, cs24, cs32,	
	cs48, cs64, cs128, cs256, cs512, cs1024,	
	cs16384, spare2, spare1}	DEFAULT cs16,
...		
}		
PDCP-Parameters-v1130 ::=	SEQUENCE {	
pdcpc-SN-Extension-r11	ENUMERATED {supported}	OPTIONAL,
supportRohcContextContinue-r11	ENUMERATED {supported}	OPTIONAL
}		
PDCP-Parameters-v1310 ::=	SEQUENCE {	
pdcpc-SN-Extension-18bits-r13	ENUMERATED {supported}	OPTIONAL
}		
PDCP-Parameters-v1430 ::=	SEQUENCE {	
supportedUplinkOnlyROHC-Profiles-r14	SEQUENCE {	
profile0x0006-r14	BOOLEAN	
},		
maxNumberROHC-ContextSessions-r14	ENUMERATED {	
	cs2, cs4, cs8, cs12, cs16, cs24, cs32,	
	cs48, cs64, cs128, cs256, cs512, cs1024,	
	cs16384, spare2, spare1}	DEFAULT cs16
}		
PhyLayerParameters ::=	SEQUENCE {	
ue-TxAntennaSelectionSupported	BOOLEAN,	
ue-SpecificRefSigsSupported	BOOLEAN	
}		
PhyLayerParameters-v920 ::=	SEQUENCE {	
enhancedDualLayerFDD-r9	ENUMERATED {supported}	OPTIONAL,
enhancedDualLayerTDD-r9	ENUMERATED {supported}	OPTIONAL
}		
PhyLayerParameters-v9d0 ::=	SEQUENCE {	
tm5-FDD-r9	ENUMERATED {supported}	OPTIONAL,
tm5-TDD-r9	ENUMERATED {supported}	OPTIONAL
}		
PhyLayerParameters-v1020 ::=	SEQUENCE {	
twoAntennaPortsForPUCCH-r10	ENUMERATED {supported}	OPTIONAL,

tm9-With-8Tx-FDD-r10	ENUMERATED {supported}	OPTIONAL,
pmi-Disabling-r10	ENUMERATED {supported}	OPTIONAL,
crossCarrierScheduling-r10	ENUMERATED {supported}	OPTIONAL,
simultaneousPUCCH-PUSCH-r10	ENUMERATED {supported}	OPTIONAL,
multiClusterPUSCH-WithinCC-r10	ENUMERATED {supported}	OPTIONAL,
nonContiguousUL-RA-WithinCC-List-r10	NonContiguousUL-RA-WithinCC-List-r10	OPTIONAL
}		
PhyLayerParameters-v1130 ::=	SEQUENCE {	
crs-InterfHandl-r11	ENUMERATED {supported}	OPTIONAL,
ePDCCH-r11	ENUMERATED {supported}	OPTIONAL,
multiACK-CSI-Reporting-r11	ENUMERATED {supported}	OPTIONAL,
ss-CCH-InterfHandl-r11	ENUMERATED {supported}	OPTIONAL,
tdd-SpecialSubframe-r11	ENUMERATED {supported}	OPTIONAL,
txDiv-PUCCH1b-ChSelect-r11	ENUMERATED {supported}	OPTIONAL,
ul-CoMP-r11	ENUMERATED {supported}	OPTIONAL
}		
PhyLayerParameters-v1170 ::=	SEQUENCE {	
interBandTDD-CA-WithDifferentConfig-r11	BIT STRING (SIZE (2))	OPTIONAL
}		
PhyLayerParameters-v1250 ::=	SEQUENCE {	
e-HARQ-Pattern-FDD-r12	ENUMERATED {supported}	OPTIONAL,
enhanced-4TxCodebook-r12	ENUMERATED {supported}	OPTIONAL,
tdd-FDD-CA-PCellDuplex-r12	BIT STRING (SIZE (2))	OPTIONAL,
phy-TDD-ReConfig-TDD-PCell-r12	ENUMERATED {supported}	OPTIONAL,
phy-TDD-ReConfig-FDD-PCell-r12	ENUMERATED {supported}	OPTIONAL,
pusch-FeedbackMode-r12	ENUMERATED {supported}	OPTIONAL,
pusch-SRS-PowerControl-SubframeSet-r12	ENUMERATED {supported}	OPTIONAL,
csi-SubframeSet-r12	ENUMERATED {supported}	OPTIONAL,
noResourceRestrictionForTTIBundling-r12	ENUMERATED {supported}	OPTIONAL,
discoverySignalsInDeactSCell-r12	ENUMERATED {supported}	OPTIONAL,
naics-Capability-List-r12	NAICS-Capability-List-r12	OPTIONAL
}		
PhyLayerParameters-v1280 ::=	SEQUENCE {	
alternativeTBS-Indices-r12	ENUMERATED {supported}	OPTIONAL
}		
PhyLayerParameters-v1310 ::=	SEQUENCE {	
aperiodicCSI-Reporting-r13	BIT STRING (SIZE (2))	OPTIONAL,
codebook-HARQ-ACK-r13	BIT STRING (SIZE (2))	OPTIONAL,
crossCarrierScheduling-B5C-r13	ENUMERATED {supported}	OPTIONAL,
fdd-HARQ-TimingTDD-r13	ENUMERATED {supported}	OPTIONAL,
maxNumberUpdatedCSI-Proc-r13	INTEGER (5..32)	OPTIONAL,
pucch-Format4-r13	ENUMERATED {supported}	OPTIONAL,
pucch-Format5-r13	ENUMERATED {supported}	OPTIONAL,
pucch-SCell-r13	ENUMERATED {supported}	OPTIONAL,
spatialBundling-HARQ-ACK-r13	ENUMERATED {supported}	OPTIONAL,
supportedBlindDecoding-r13	SEQUENCE {	
maxNumberDecoding-r13	INTEGER (1..32)	OPTIONAL,
pdcch-CandidateReductions-r13	ENUMERATED {supported}	OPTIONAL,
skipMonitoringDCI-Format0-1A-r13	ENUMERATED {supported}	OPTIONAL
}		
uci-PUSCH-Ext-r13	ENUMERATED {supported}	OPTIONAL,
crs-InterfMitigationTM10-r13	ENUMERATED {supported}	OPTIONAL,
pdsch-CollisionHandling-r13	ENUMERATED {supported}	OPTIONAL
}		
PhyLayerParameters-v1320 ::=	SEQUENCE {	
mimo-UE-Parameters-r13	MIMO-UE-Parameters-r13	OPTIONAL
}		
PhyLayerParameters-v1330 ::=	SEQUENCE {	
cch-InterfMitigation-RefRecTypeA-r13	ENUMERATED {supported}	OPTIONAL,
cch-InterfMitigation-RefRecTypeB-r13	ENUMERATED {supported}	OPTIONAL,
cch-InterfMitigation-MaxNumCCs-r13	INTEGER (1.. maxServCell-r13)	OPTIONAL,
crs-InterfMitigationTM1toTM9-r13	INTEGER (1.. maxServCell-r13)	OPTIONAL
}		
PhyLayerParameters-v13e0 ::=	SEQUENCE {	
mimo-UE-Parameters-v13e0	MIMO-UE-Parameters-v13e0	
}		
PhyLayerParameters-v1430 ::=	SEQUENCE {	
ce-PUSCH-NB-MaxTBS-r14	ENUMERATED {supported}	OPTIONAL,
ce-PDSCH-PUSCH-MaxBandwidth-r14	ENUMERATED {bw5, bw20}	OPTIONAL,

ce-HARQ-AckBundling-r14	ENUMERATED {supported}	OPTIONAL,
ce-PDSCH-TenProcesses-r14	ENUMERATED {supported}	OPTIONAL,
ce-RetuningSymbols-r14	ENUMERATED {n0, n1}	OPTIONAL,
ce-PDSCH-PUSCH-Enhancement-r14	ENUMERATED {supported}	OPTIONAL,
ce-SchedulingEnhancement-r14	ENUMERATED {supported}	OPTIONAL,
ce-SRS-Enhancement-r14	ENUMERATED {supported}	OPTIONAL,
ce-PUCCH-Enhancement-r14	ENUMERATED {supported}	OPTIONAL,
ce-ClosedLoopTxAntennaSelection-r14	ENUMERATED {supported}	OPTIONAL,
tdd-SpecialSubframe-r14	ENUMERATED {supported}	OPTIONAL,
tdd-TTI-Bundling-r14	ENUMERATED {supported}	OPTIONAL,
dmrs-LessUpPTS-r14	ENUMERATED {supported}	OPTIONAL,
mimo-UE-Parameters-v1430	MIMO-UE-Parameters-v1430	OPTIONAL,
alternativeTBS-Index-r14	ENUMERATED {supported}	OPTIONAL,
feMBMS-Unicast-Parameters-r14	FeMBMS-Unicast-Parameters-r14	OPTIONAL
}		
PhyLayerParameters-v1450 ::=	SEQUENCE {	
ce-SRS-EnhancementWithoutComb4-r14	ENUMERATED {supported}	OPTIONAL,
crs-LessDwPTS-r14	ENUMERATED {supported}	OPTIONAL
}		
PhyLayerParameters-v1470 ::=	SEQUENCE {	
mimo-UE-Parameters-v1470	MIMO-UE-Parameters-v1470	OPTIONAL,
srs-UpPTS-6sym-r14	ENUMERATED {supported}	OPTIONAL
}		
PhyLayerParameters-v14a0 ::=	SEQUENCE {	
ssp10-TDD-Only-r14	ENUMERATED {supported}	OPTIONAL
}		
MIMO-UE-Parameters-r13 ::=	SEQUENCE {	
parametersTM9-r13	MIMO-UE-ParametersPerTM-r13	OPTIONAL,
parametersTM10-r13	MIMO-UE-ParametersPerTM-r13	OPTIONAL,
srs-EnhancementsTDD-r13	ENUMERATED {supported}	OPTIONAL,
srs-Enhancements-r13	ENUMERATED {supported}	OPTIONAL,
interferenceMeasRestriction-r13	ENUMERATED {supported}	OPTIONAL
}		
MIMO-UE-Parameters-v13e0 ::=	SEQUENCE {	
mimo-WeightedLayersCapabilities-r13	MIMO-WeightedLayersCapabilities-r13	OPTIONAL
}		
MIMO-UE-Parameters-v1430 ::=	SEQUENCE {	
parametersTM9-v1430	MIMO-UE-ParametersPerTM-v1430	OPTIONAL,
parametersTM10-v1430	MIMO-UE-ParametersPerTM-v1430	OPTIONAL
}		
MIMO-UE-Parameters-v1470 ::=	SEQUENCE {	
parametersTM9-v1470	MIMO-UE-ParametersPerTM-v1470,	
parametersTM10-v1470	MIMO-UE-ParametersPerTM-v1470	
}		
MIMO-UE-ParametersPerTM-r13 ::=	SEQUENCE {	
nonPrecoded-r13	MIMO-NonPrecodedCapabilities-r13	OPTIONAL,
beamformed-r13	MIMO-UE-BeamformedCapabilities-r13	OPTIONAL,
channelMeasRestriction-r13	ENUMERATED {supported}	OPTIONAL,
dmrs-Enhancements-r13	ENUMERATED {supported}	OPTIONAL,
csi-RS-EnhancementsTDD-r13	ENUMERATED {supported}	OPTIONAL
}		
MIMO-UE-ParametersPerTM-v1430 ::=	SEQUENCE {	
nzp-CSI-RS-AperiodicInfo-r14	SEQUENCE {	
nMaxProc-r14	INTEGER(5..32),	
nMaxResource-r14	ENUMERATED {ffs1, ffs2, ffs3, ffs4}	OPTIONAL,
}		
nzp-CSI-RS-PeriodicInfo-r14	SEQUENCE {	
nMaxResource-r14	ENUMERATED {ffs1, ffs2, ffs3, ffs4}	OPTIONAL,
}		
zp-CSI-RS-AperiodicInfo-r14	ENUMERATED {supported}	OPTIONAL,
ul-dmrs-Enhancements-r14	ENUMERATED {supported}	OPTIONAL,
densityReductionNP-r14	ENUMERATED {supported}	OPTIONAL,
densityReductionBF-r14	ENUMERATED {supported}	OPTIONAL,
hybridCSI-r14	ENUMERATED {supported}	OPTIONAL,
semiOL-r14	ENUMERATED {supported}	OPTIONAL,
csi-ReportingNP-r14	ENUMERATED {supported}	OPTIONAL,
csi-ReportingAdvanced-r14	ENUMERATED {supported}	OPTIONAL
}		

```

MIMO-UE-ParametersPerTM-v1470 ::= SEQUENCE {
  csi-ReportingAdvancedMaxPorts-r14      ENUMERATED {n8, n12, n16, n20, n24, n28}      OPTIONAL
}

MIMO-CA-ParametersPerBoBC-r13 ::= SEQUENCE {
  parametersTM9-r13                      MIMO-CA-ParametersPerBoBCPerTM-r13      OPTIONAL,
  parametersTM10-r13                     MIMO-CA-ParametersPerBoBCPerTM-r13      OPTIONAL
}

MIMO-CA-ParametersPerBoBC-v1430 ::= SEQUENCE {
  parametersTM9-v1430                     MIMO-CA-ParametersPerBoBCPerTM-v1430    OPTIONAL,
  parametersTM10-v1430                     MIMO-CA-ParametersPerBoBCPerTM-v1430    OPTIONAL
}

MIMO-CA-ParametersPerBoBC-v1470 ::= SEQUENCE {
  parametersTM9-v1470                     MIMO-CA-ParametersPerBoBCPerTM-v1470    ,
  parametersTM10-v1470                     MIMO-CA-ParametersPerBoBCPerTM-v1470
}

MIMO-CA-ParametersPerBoBCPerTM-r13 ::= SEQUENCE {
  nonPrecoded-r13                        MIMO-NonPrecodedCapabilities-r13        OPTIONAL,
  beamformed-r13                         MIMO-BeamformedCapabilityList-r13       OPTIONAL,
  dmrs-Enhancements-r13                  ENUMERATED {different}                  OPTIONAL
}

MIMO-CA-ParametersPerBoBCPerTM-v1430 ::= SEQUENCE {
  csi-ReportingNP-r14                     ENUMERATED {different}                   OPTIONAL,
  csi-ReportingAdvanced-r14               ENUMERATED {different}                   OPTIONAL
}

MIMO-CA-ParametersPerBoBCPerTM-v1470 ::= SEQUENCE {
  csi-ReportingAdvancedMaxPorts-r14       ENUMERATED {n8, n12, n16, n20, n24, n28}  OPTIONAL
}

MIMO-NonPrecodedCapabilities-r13 ::= SEQUENCE {
  config1-r13                             ENUMERATED {supported}                   OPTIONAL,
  config2-r13                             ENUMERATED {supported}                   OPTIONAL,
  config3-r13                             ENUMERATED {supported}                   OPTIONAL,
  config4-r13                             ENUMERATED {supported}                   OPTIONAL
}

MIMO-UE-BeamformedCapabilities-r13 ::= SEQUENCE {
  altCodebook-r13                         ENUMERATED {supported}                   OPTIONAL,
  mimo-BeamformedCapabilities-r13         MIMO-BeamformedCapabilityList-r13
}

MIMO-BeamformedCapabilityList-r13 ::= SEQUENCE (SIZE (1..maxCSI-Proc-r11)) OF MIMO-
BeamformedCapabilities-r13

MIMO-BeamformedCapabilities-r13 ::= SEQUENCE {
  k-Max-r13                               INTEGER (1..8),
  n-MaxList-r13                           BIT STRING (SIZE (1..7))                OPTIONAL
}

MIMO-WeightedLayersCapabilities-r13 ::= SEQUENCE {
  relWeightTwoLayers-r13                  ENUMERATED {v1, v1dot25, v1dot5, v1dot75, v2, v2dot5, v3, v4},
  relWeightFourLayers-r13                 ENUMERATED {v1, v1dot25, v1dot5, v1dot75, v2, v2dot5, v3, v4}
  OPTIONAL,
  relWeightEightLayers-r13                ENUMERATED {v1, v1dot25, v1dot5, v1dot75, v2, v2dot5, v3,
v4}
  OPTIONAL,
  totalWeightedLayers-r13                 INTEGER (2..128)
}

NonContiguousUL-RA-WithinCC-List-r10 ::= SEQUENCE (SIZE (1..maxBands)) OF NonContiguousUL-RA-
WithinCC-r10

NonContiguousUL-RA-WithinCC-r10 ::= SEQUENCE {
  nonContiguousUL-RA-WithinCC-Info-r10    ENUMERATED {supported}                   OPTIONAL
}

RF-Parameters ::= SEQUENCE {
  supportedBandListEUTRA                  SupportedBandListEUTRA
}

RF-Parameters-v9e0 ::= SEQUENCE {
  supportedBandListEUTRA-v9e0             SupportedBandListEUTRA-v9e0              OPTIONAL
}

```

```

RF-Parameters-v1020 ::= SEQUENCE {
    supportedBandCombination-r10 SupportedBandCombination-r10
}

RF-Parameters-v1060 ::= SEQUENCE {
    supportedBandCombinationExt-r10 SupportedBandCombinationExt-r10
}

RF-Parameters-v1090 ::= SEQUENCE {
    supportedBandCombination-v1090 SupportedBandCombination-v1090 OPTIONAL
}

RF-Parameters-v10f0 ::= SEQUENCE {
    modifiedMPR-Behavior-r10 BIT STRING (SIZE (32)) OPTIONAL
}

RF-Parameters-v10i0 ::= SEQUENCE {
    supportedBandCombination-v10i0 SupportedBandCombination-v10i0 OPTIONAL
}

RF-Parameters-v10j0 ::= SEQUENCE {
    multiNS-Pmax-r10 ENUMERATED {supported} OPTIONAL
}

RF-Parameters-v1130 ::= SEQUENCE {
    supportedBandCombination-v1130 SupportedBandCombination-v1130 OPTIONAL
}

RF-Parameters-v1180 ::= SEQUENCE {
    freqBandRetrieval-r11 ENUMERATED {supported} OPTIONAL,
    requestedBands-r11 SEQUENCE (SIZE (1.. maxBands)) OF FreqBandIndicator-r11
    OPTIONAL,
    supportedBandCombinationAdd-r11 SupportedBandCombinationAdd-r11 OPTIONAL
}

RF-Parameters-v11d0 ::= SEQUENCE {
    supportedBandCombinationAdd-v11d0 SupportedBandCombinationAdd-v11d0 OPTIONAL
}

RF-Parameters-v1250 ::= SEQUENCE {
    supportedBandListEUTRA-v1250 SupportedBandListEUTRA-v1250 OPTIONAL,
    supportedBandCombination-v1250 SupportedBandCombination-v1250 OPTIONAL,
    supportedBandCombinationAdd-v1250 SupportedBandCombinationAdd-v1250 OPTIONAL,
    freqBandPriorityAdjustment-r12 ENUMERATED {supported} OPTIONAL
}

RF-Parameters-v1270 ::= SEQUENCE {
    supportedBandCombination-v1270 SupportedBandCombination-v1270 OPTIONAL,
    supportedBandCombinationAdd-v1270 SupportedBandCombinationAdd-v1270 OPTIONAL
}

RF-Parameters-v1310 ::= SEQUENCE {
    eNB-RequestedParameters-r13 SEQUENCE {
        reducedIntNonContCombRequested-r13 ENUMERATED {true} OPTIONAL,
        requestedCCsDL-r13 INTEGER (2..32) OPTIONAL,
        requestedCCsUL-r13 INTEGER (2..32) OPTIONAL,
        skipFallbackCombRequested-r13 ENUMERATED {true} OPTIONAL
    }
    maximumCCsRetrieval-r13 ENUMERATED {supported} OPTIONAL,
    skipFallbackCombinations-r13 ENUMERATED {supported} OPTIONAL,
    reducedIntNonContComb-r13 ENUMERATED {supported} OPTIONAL,
    supportedBandListEUTRA-v1310 SupportedBandListEUTRA-v1310 OPTIONAL,
    supportedBandCombinationReduced-r13 SupportedBandCombinationReduced-r13 OPTIONAL
}

RF-Parameters-v1320 ::= SEQUENCE {
    supportedBandListEUTRA-v1320 SupportedBandListEUTRA-v1320 OPTIONAL,
    supportedBandCombination-v1320 SupportedBandCombination-v1320 OPTIONAL,
    supportedBandCombinationAdd-v1320 SupportedBandCombinationAdd-v1320 OPTIONAL,
    supportedBandCombinationReduced-v1320 SupportedBandCombinationReduced-v1320 OPTIONAL
}

RF-Parameters-v1380 ::= SEQUENCE {
    supportedBandCombination-v1380 SupportedBandCombination-v1380 OPTIONAL,
    supportedBandCombinationAdd-v1380 SupportedBandCombinationAdd-v1380 OPTIONAL,
    supportedBandCombinationReduced-v1380 SupportedBandCombinationReduced-v1380 OPTIONAL
}

```

```

RF-Parameters-v1390 ::= SEQUENCE {
    supportedBandCombination-v1390 SupportedBandCombination-v1390 OPTIONAL,
    supportedBandCombinationAdd-v1390 SupportedBandCombinationAdd-v1390 OPTIONAL,
    supportedBandCombinationReduced-v1390 SupportedBandCombinationReduced-v1390 OPTIONAL
}

RF-Parameters-v12b0 ::= SEQUENCE {
    maxLayersMIMO-Indication-r12 ENUMERATED {supported} OPTIONAL
}

RF-Parameters-v1430 ::= SEQUENCE {
    supportedBandCombination-v1430 SupportedBandCombination-v1430 OPTIONAL,
    supportedBandCombinationAdd-v1430 SupportedBandCombinationAdd-v1430 OPTIONAL,
    supportedBandCombinationReduced-v1430 SupportedBandCombinationReduced-v1430 OPTIONAL,
    eNB-RequestedParameters-v1430 SEQUENCE {
        requestedDiffFallbackCombList-r14 BandCombinationList-r14
    } OPTIONAL,
    diffFallbackCombReport-r14 ENUMERATED {supported} OPTIONAL
}

RF-Parameters-v1450 ::= SEQUENCE {
    supportedBandCombination-v1450 SupportedBandCombination-v1450 OPTIONAL,
    supportedBandCombinationAdd-v1450 SupportedBandCombinationAdd-v1450 OPTIONAL,
    supportedBandCombinationReduced-v1450 SupportedBandCombinationReduced-v1450 OPTIONAL
}

RF-Parameters-v1470 ::= SEQUENCE {
    supportedBandCombination-v1470 SupportedBandCombination-v1470 OPTIONAL,
    supportedBandCombinationAdd-v1470 SupportedBandCombinationAdd-v1470 OPTIONAL,
    supportedBandCombinationReduced-v1470 SupportedBandCombinationReduced-v1470 OPTIONAL
}

RF-Parameters-v14b0 ::= SEQUENCE {
    supportedBandCombination-v14b0 SupportedBandCombination-v14b0 OPTIONAL,
    supportedBandCombinationAdd-v14b0 SupportedBandCombinationAdd-v14b0 OPTIONAL,
    supportedBandCombinationReduced-v14b0 SupportedBandCombinationReduced-v14b0 OPTIONAL
}

SupportedBandCombination-r10 ::= SEQUENCE (SIZE (1..maxBandComb-r10)) OF BandCombinationParameters-
r10

SupportedBandCombinationExt-r10 ::= SEQUENCE (SIZE (1..maxBandComb-r10)) OF
BandCombinationParametersExt-r10

SupportedBandCombination-v1090 ::= SEQUENCE (SIZE (1..maxBandComb-r10)) OF
BandCombinationParameters-v1090

SupportedBandCombination-v10i0 ::= SEQUENCE (SIZE (1..maxBandComb-r10)) OF
BandCombinationParameters-v10i0

SupportedBandCombination-v1130 ::= SEQUENCE (SIZE (1..maxBandComb-r10)) OF
BandCombinationParameters-v1130

SupportedBandCombination-v1250 ::= SEQUENCE (SIZE (1..maxBandComb-r10)) OF
BandCombinationParameters-v1250

SupportedBandCombination-v1270 ::= SEQUENCE (SIZE (1..maxBandComb-r10)) OF
BandCombinationParameters-v1270

SupportedBandCombination-v1320 ::= SEQUENCE (SIZE (1..maxBandComb-r10)) OF
BandCombinationParameters-v1320

SupportedBandCombination-v1380 ::= SEQUENCE (SIZE (1..maxBandComb-r10)) OF
BandCombinationParameters-v1380

SupportedBandCombination-v1390 ::= SEQUENCE (SIZE (1..maxBandComb-r10)) OF
BandCombinationParameters-v1390

SupportedBandCombination-v1430 ::= SEQUENCE (SIZE (1..maxBandComb-r10)) OF
BandCombinationParameters-v1430

SupportedBandCombination-v1450 ::= SEQUENCE (SIZE (1..maxBandComb-r10)) OF
BandCombinationParameters-v1450

SupportedBandCombination-v1470 ::= SEQUENCE (SIZE (1..maxBandComb-r10)) OF
BandCombinationParameters-v1470

```

```

SupportedBandCombination-v14b0 ::= SEQUENCE (SIZE (1..maxBandComb-r10)) OF
BandCombinationParameters-v14b0

SupportedBandCombinationAdd-r11 ::= SEQUENCE (SIZE (1..maxBandComb-r11)) OF
BandCombinationParameters-r11

SupportedBandCombinationAdd-v11d0 ::= SEQUENCE (SIZE (1..maxBandComb-r11)) OF
BandCombinationParameters-v10i0

SupportedBandCombinationAdd-v1250 ::= SEQUENCE (SIZE (1..maxBandComb-r11)) OF
BandCombinationParameters-v1250

SupportedBandCombinationAdd-v1270 ::= SEQUENCE (SIZE (1..maxBandComb-r11)) OF
BandCombinationParameters-v1270

SupportedBandCombinationAdd-v1320 ::= SEQUENCE (SIZE (1..maxBandComb-r11)) OF
BandCombinationParameters-v1320

SupportedBandCombinationAdd-v1380 ::= SEQUENCE (SIZE (1..maxBandComb-r11)) OF
BandCombinationParameters-v1380

SupportedBandCombinationAdd-v1390 ::= SEQUENCE (SIZE (1..maxBandComb-r11)) OF
BandCombinationParameters-v1390

SupportedBandCombinationAdd-v1430 ::= SEQUENCE (SIZE (1..maxBandComb-r11)) OF
BandCombinationParameters-v1430

SupportedBandCombinationAdd-v1450 ::= SEQUENCE (SIZE (1..maxBandComb-r11)) OF
BandCombinationParameters-v1450

SupportedBandCombinationAdd-v1470 ::= SEQUENCE (SIZE (1..maxBandComb-r11)) OF
BandCombinationParameters-v1470

SupportedBandCombinationAdd-v14b0 ::= SEQUENCE (SIZE (1..maxBandComb-r11)) OF
BandCombinationParameters-v14b0

SupportedBandCombinationReduced-r13 ::= SEQUENCE (SIZE (1..maxBandComb-r13)) OF
BandCombinationParameters-r13

SupportedBandCombinationReduced-v1320 ::= SEQUENCE (SIZE (1..maxBandComb-r13)) OF
BandCombinationParameters-v1320

SupportedBandCombinationReduced-v1380 ::= SEQUENCE (SIZE (1..maxBandComb-r13)) OF
BandCombinationParameters-v1380

SupportedBandCombinationReduced-v1390 ::= SEQUENCE (SIZE (1..maxBandComb-r13)) OF
BandCombinationParameters-v1390

SupportedBandCombinationReduced-v1430 ::= SEQUENCE (SIZE (1..maxBandComb-r13)) OF
BandCombinationParameters-v1430

SupportedBandCombinationReduced-v1450 ::= SEQUENCE (SIZE (1..maxBandComb-r13)) OF
BandCombinationParameters-v1450

SupportedBandCombinationReduced-v1470 ::= SEQUENCE (SIZE (1..maxBandComb-r13)) OF
BandCombinationParameters-v1470

SupportedBandCombinationReduced-v14b0 ::= SEQUENCE (SIZE (1..maxBandComb-r13)) OF
BandCombinationParameters-v14b0

BandCombinationParameters-r10 ::= SEQUENCE (SIZE (1..maxSimultaneousBands-r10)) OF BandParameters-
r10

BandCombinationParametersExt-r10 ::= SEQUENCE {
    supportedBandwidthCombinationSet-r10 SupportedBandwidthCombinationSet-r10 OPTIONAL
}

BandCombinationParameters-v1090 ::= SEQUENCE (SIZE (1..maxSimultaneousBands-r10)) OF BandParameters-
v1090

BandCombinationParameters-v10i0 ::= SEQUENCE {
    bandParameterList-v10i0 SEQUENCE (SIZE (1..maxSimultaneousBands-r10)) OF
    BandParameters-v10i0 OPTIONAL
}

BandCombinationParameters-v1130 ::= SEQUENCE {
    multipleTimingAdvance-r11 ENUMERATED {supported} OPTIONAL,
    simultaneousRx-Tx-r11 ENUMERATED {supported} OPTIONAL,

```



```

    bandParameterList-r11          SEQUENCE (SIZE (1..maxSimultaneousBands-r10)) OF BandParameters-
v1130 OPTIONAL,
    ...
}

BandCombinationParameters-r11 ::= SEQUENCE {
    bandParameterList-r11          SEQUENCE (SIZE (1..maxSimultaneousBands-r10)) OF
        BandParameters-r11,
    supportedBandwidthCombinationSet-r11 SupportedBandwidthCombinationSet-r10 OPTIONAL,
    multipleTimingAdvance-r11      ENUMERATED {supported} OPTIONAL,
    simultaneousRx-Tx-r11          ENUMERATED {supported} OPTIONAL,
    bandInfoEUTRA-r11             BandInfoEUTRA,
    ...
}

BandCombinationParameters-v1250 ::= SEQUENCE {
    dc-Support-r12                SEQUENCE {
        asynchronous-r12          ENUMERATED {supported} OPTIONAL,
        supportedCellGrouping-r12 CHOICE {
            threeEntries-r12      BIT STRING (SIZE(3)),
            fourEntries-r12       BIT STRING (SIZE(7)),
            fiveEntries-r12       BIT STRING (SIZE(15))
        }
    }
    supportedNAICS-2CRS-AP-r12     BIT STRING (SIZE (1..maxNAICS-Entries-r12)) OPTIONAL,
    commSupportedBandsPerBC-r12    BIT STRING (SIZE (1.. maxBands)) OPTIONAL,
    ...
}

BandCombinationParameters-v1270 ::= SEQUENCE {
    bandParameterList-v1270       SEQUENCE (SIZE (1..maxSimultaneousBands-r10)) OF
        BandParameters-v1270
        OPTIONAL
}

BandCombinationParameters-r13 ::= SEQUENCE {
    differentFallbackSupported-r13 ENUMERATED {true} OPTIONAL,
    bandParameterList-r13         SEQUENCE (SIZE (1..maxSimultaneousBands-r10)) OF BandParameters-
r13,
    supportedBandwidthCombinationSet-r13 SupportedBandwidthCombinationSet-r10 OPTIONAL,
    multipleTimingAdvance-r13     ENUMERATED {supported} OPTIONAL,
    simultaneousRx-Tx-r13         ENUMERATED {supported} OPTIONAL,
    bandInfoEUTRA-r13            BandInfoEUTRA,
    dc-Support-r13               SEQUENCE {
        asynchronous-r13         ENUMERATED {supported} OPTIONAL,
        supportedCellGrouping-r13 CHOICE {
            threeEntries-r13     BIT STRING (SIZE(3)),
            fourEntries-r13      BIT STRING (SIZE(7)),
            fiveEntries-r13      BIT STRING (SIZE(15))
        }
    }
    supportedNAICS-2CRS-AP-r13    BIT STRING (SIZE (1..maxNAICS-Entries-r12)) OPTIONAL,
    commSupportedBandsPerBC-r13   BIT STRING (SIZE (1.. maxBands)) OPTIONAL
}

BandCombinationParameters-v1320 ::= SEQUENCE {
    bandParameterList-v1320       SEQUENCE (SIZE (1..maxSimultaneousBands-r10)) OF
        BandParameters-v1320
        OPTIONAL,
    additionalRx-Tx-PerformanceReq-r13 ENUMERATED {supported} OPTIONAL
}

BandCombinationParameters-v1380 ::= SEQUENCE {
    bandParameterList-v1380       SEQUENCE (SIZE (1..maxSimultaneousBands-r10)) OF
        BandParameters-v1380
        OPTIONAL
}

BandCombinationParameters-v1390 ::= SEQUENCE {
    ue-CA-PowerClass-N-r13       ENUMERATED {class2} OPTIONAL
}

BandCombinationParameters-v1430 ::= SEQUENCE {
    bandParameterList-v1430       SEQUENCE (SIZE (1..maxSimultaneousBands-r10)) OF
        BandParameters-v1430
        OPTIONAL,
    v2x-SupportedTxBandCombListPerBC-r14 BIT STRING (SIZE (1.. maxBandComb-r13))
    OPTIONAL,
    v2x-SupportedRxBandCombListPerBC-r14 BIT STRING (SIZE (1.. maxBandComb-r13))
    OPTIONAL
}

```

```

BandCombinationParameters-v1450 ::= SEQUENCE {
    bandParameterList-v1450 SEQUENCE (SIZE (1..maxSimultaneousBands-r10)) OF
        BandParameters-v1450 OPTIONAL
}

BandCombinationParameters-v1470 ::= SEQUENCE {
    bandParameterList-v1470 SEQUENCE (SIZE (1..maxSimultaneousBands-r10)) OF
        BandParameters-v1470 OPTIONAL,
    srs-MaxSimultaneousCCs-r14 INTEGER (1..31) OPTIONAL
}

BandCombinationParameters-v14b0 ::= SEQUENCE {
    bandParameterList-v14b0 SEQUENCE (SIZE (1..maxSimultaneousBands-r10)) OF
        BandParameters-v14b0 OPTIONAL
}

SupportedBandwidthCombinationSet-r10 ::= BIT STRING (SIZE (1..maxBandwidthCombSet-r10))

BandParameters-r10 ::= SEQUENCE {
    bandEUTRA-r10 FreqBandIndicator,
    bandParametersUL-r10 BandParametersUL-r10 OPTIONAL,
    bandParametersDL-r10 BandParametersDL-r10 OPTIONAL
}

BandParameters-v1090 ::= SEQUENCE {
    bandEUTRA-v1090 FreqBandIndicator-v9e0 OPTIONAL,
    ...
}

BandParameters-v10i0 ::= SEQUENCE {
    bandParametersDL-v10i0 SEQUENCE (SIZE (1..maxBandwidthClass-r10)) OF CA-MIMO-ParametersDL-
v10i0
}

BandParameters-v1130 ::= SEQUENCE {
    supportedCSI-Proc-r11 ENUMERATED {n1, n3, n4}
}

BandParameters-r11 ::= SEQUENCE {
    bandEUTRA-r11 FreqBandIndicator-r11,
    bandParametersUL-r11 BandParametersUL-r10 OPTIONAL,
    bandParametersDL-r11 BandParametersDL-r10 OPTIONAL,
    supportedCSI-Proc-r11 ENUMERATED {n1, n3, n4} OPTIONAL
}

BandParameters-v1270 ::= SEQUENCE {
    bandParametersDL-v1270 SEQUENCE (SIZE (1..maxBandwidthClass-r10)) OF CA-MIMO-
ParametersDL-v1270
}

BandParameters-r13 ::= SEQUENCE {
    bandEUTRA-r13 FreqBandIndicator-r11,
    bandParametersUL-r13 BandParametersUL-r13 OPTIONAL,
    bandParametersDL-r13 BandParametersDL-r13 OPTIONAL,
    supportedCSI-Proc-r13 ENUMERATED {n1, n3, n4} OPTIONAL
}

BandParameters-v1320 ::= SEQUENCE {
    bandParametersDL-v1320 MIMO-CA-ParametersPerBoBC-r13
}

BandParameters-v1380 ::= SEQUENCE {
    txAntennaSwitchDL-r13 INTEGER (1..32) OPTIONAL,
    txAntennaSwitchUL-r13 INTEGER (1..32) OPTIONAL
}

BandParameters-v1430 ::= SEQUENCE {
    bandParametersDL-v1430 MIMO-CA-ParametersPerBoBC-v1430 OPTIONAL,
    ul-256QAM-r14 ENUMERATED {supported} OPTIONAL,
    ul-256QAM-perCC-InfoList-r14 SEQUENCE (SIZE (2..maxServCell-r13)) OF UL-256QAM-perCC-
Info-r14 OPTIONAL,
    srs-CapabilityPerBandPairList-r14 SEQUENCE (SIZE (1..maxSimultaneousBands-r10)) OF
        SRS-CapabilityPerBandPair-r14 OPTIONAL
}

BandParameters-v1450 ::= SEQUENCE {
    must-CapabilityPerBand-r14 MUST-Parameters-r14 OPTIONAL
}

```

```

BandParameters-v1470 ::= SEQUENCE {
    bandParametersDL-v1470          MIMO-CA-ParametersPerBoBC-v1470 OPTIONAL
}

BandParameters-v14b0 ::= SEQUENCE {
    srs-CapabilityPerBandPairList-v14b0    SEQUENCE (SIZE (1..maxSimultaneousBands-r10)) OF
    SRS-CapabilityPerBandPair-v14b0        OPTIONAL
}

V2X-BandParameters-r14 ::= SEQUENCE {
    v2x-FreqBandEUTRA-r14          FreqBandIndicator-r11,
    bandParametersTxSL-r14          BandParametersTxSL-r14          OPTIONAL,
    bandParametersRxSL-r14          BandParametersRxSL-r14          OPTIONAL
}

BandParametersTxSL-r14 ::= SEQUENCE {
    v2x-BandwidthClassTxSL-r14      V2X-BandwidthClassSL-r14,
    v2x-eNB-Scheduled-r14           ENUMERATED {supported}          OPTIONAL,
    v2x-HighPower-r14               ENUMERATED {supported}          OPTIONAL
}

BandParametersRxSL-r14 ::= SEQUENCE {
    v2x-BandwidthClassRxSL-r14      V2X-BandwidthClassSL-r14,
    v2x-HighReception-r14           ENUMERATED {supported}          OPTIONAL
}

V2X-BandwidthClassSL-r14 ::= SEQUENCE (SIZE (1..maxBandwidthClass-r10)) OF V2X-BandwidthClass-r14

UL-256QAM-perCC-Info-r14 ::= SEQUENCE {
    ul-256QAM-perCC-r14             ENUMERATED {supported}          OPTIONAL
}

BandParametersUL-r10 ::= SEQUENCE (SIZE (1..maxBandwidthClass-r10)) OF CA-MIMO-ParametersUL-r10

BandParametersUL-r13 ::= CA-MIMO-ParametersUL-r10

CA-MIMO-ParametersUL-r10 ::= SEQUENCE {
    ca-BandwidthClassUL-r10          CA-BandwidthClass-r10,
    supportedMIMO-CapabilityUL-r10   MIMO-CapabilityUL-r10          OPTIONAL
}

BandParametersDL-r10 ::= SEQUENCE (SIZE (1..maxBandwidthClass-r10)) OF CA-MIMO-ParametersDL-r10

BandParametersDL-r13 ::= CA-MIMO-ParametersDL-r13

CA-MIMO-ParametersDL-r10 ::= SEQUENCE {
    ca-BandwidthClassDL-r10          CA-BandwidthClass-r10,
    supportedMIMO-CapabilityDL-r10   MIMO-CapabilityDL-r10          OPTIONAL
}

CA-MIMO-ParametersDL-v10i0 ::= SEQUENCE {
    fourLayerTM3-TM4-r10             ENUMERATED {supported}          OPTIONAL
}

CA-MIMO-ParametersDL-v1270 ::= SEQUENCE {
    intraBandContiguousCC-InfoList-r12 SEQUENCE (SIZE (1..maxServCell-r10)) OF
    IntraBandContiguousCC-Info-r12
}

CA-MIMO-ParametersDL-r13 ::= SEQUENCE {
    ca-BandwidthClassDL-r13          CA-BandwidthClass-r10,
    supportedMIMO-CapabilityDL-r13   MIMO-CapabilityDL-r10          OPTIONAL,
    fourLayerTM3-TM4-r13             ENUMERATED {supported}          OPTIONAL,
    intraBandContiguousCC-InfoList-r13 SEQUENCE (SIZE (1..maxServCell-r13)) OF
    IntraBandContiguousCC-Info-r12
}

IntraBandContiguousCC-Info-r12 ::= SEQUENCE {
    fourLayerTM3-TM4-perCC-r12       ENUMERATED {supported}          OPTIONAL,
    supportedMIMO-CapabilityDL-r12    MIMO-CapabilityDL-r10          OPTIONAL,
    supportedCSI-Proc-r12             ENUMERATED {n1, n3, n4}          OPTIONAL
}

CA-BandwidthClass-r10 ::= ENUMERATED {a, b, c, d, e, f, ...}

V2X-BandwidthClass-r14 ::= ENUMERATED {a, b, c, d, e, f, ...}

```

```

MIMO-CapabilityUL-r10 ::= ENUMERATED {twoLayers, fourLayers}
MIMO-CapabilityDL-r10 ::= ENUMERATED {twoLayers, fourLayers, eightLayers}

MUST-Parameters-r14 ::= SEQUENCE {
    must-TM234-UpTo2Tx-r14          ENUMERATED {supported}      OPTIONAL,
    must-TM89-UpToOneInterferingLayer-r14  ENUMERATED {supported}      OPTIONAL,
    must-TM10-UpToOneInterferingLayer-r14   ENUMERATED {supported}      OPTIONAL,
    must-TM89-UpToThreeInterferingLayers-r14  ENUMERATED {supported}      OPTIONAL,
    must-TM10-UpToThreeInterferingLayers-r14  ENUMERATED {supported}      OPTIONAL
}

SupportedBandListEUTRA ::= SEQUENCE (SIZE (1..maxBands)) OF SupportedBandEUTRA
SupportedBandListEUTRA-v9e0 ::= SEQUENCE (SIZE (1..maxBands)) OF SupportedBandEUTRA-v9e0
SupportedBandListEUTRA-v1250 ::= SEQUENCE (SIZE (1..maxBands)) OF SupportedBandEUTRA-v1250
SupportedBandListEUTRA-v1310 ::= SEQUENCE (SIZE (1..maxBands)) OF SupportedBandEUTRA-v1310
SupportedBandListEUTRA-v1320 ::= SEQUENCE (SIZE (1..maxBands)) OF SupportedBandEUTRA-v1320

SupportedBandEUTRA ::= SEQUENCE {
    bandEUTRA          FreqBandIndicator,
    halfDuplex         BOOLEAN
}

SupportedBandEUTRA-v9e0 ::= SEQUENCE {
    bandEUTRA-v9e0    FreqBandIndicator-v9e0    OPTIONAL
}

SupportedBandEUTRA-v1250 ::= SEQUENCE {
    dl-256QAM-r12     ENUMERATED {supported}      OPTIONAL,
    ul-64QAM-r12      ENUMERATED {supported}      OPTIONAL
}

SupportedBandEUTRA-v1310 ::= SEQUENCE {
    ue-PowerClass-5-r13  ENUMERATED {supported}      OPTIONAL
}

SupportedBandEUTRA-v1320 ::= SEQUENCE {
    intraFreq-CE-NeedForGaps-r13  ENUMERATED {supported}      OPTIONAL,
    ue-PowerClass-N-r13           ENUMERATED {class1, class2, class4}    OPTIONAL
}

MeasParameters ::= SEQUENCE {
    bandListEUTRA          BandListEUTRA
}

MeasParameters-v1020 ::= SEQUENCE {
    bandCombinationListEUTRA-r10    BandCombinationListEUTRA-r10
}

MeasParameters-v1130 ::= SEQUENCE {
    rsrqMeasWideband-r11           ENUMERATED {supported}      OPTIONAL
}

MeasParameters-v11a0 ::= SEQUENCE {
    benefitsFromInterruption-r11    ENUMERATED {true}          OPTIONAL
}

MeasParameters-v1250 ::= SEQUENCE {
    timerT312-r12                 ENUMERATED {supported}      OPTIONAL,
    alternativeTimeToTrigger-r12   ENUMERATED {supported}      OPTIONAL,
    incMonEUTRA-r12                ENUMERATED {supported}      OPTIONAL,
    incMonUTRA-r12                 ENUMERATED {supported}      OPTIONAL,
    extendedMaxMeasId-r12          ENUMERATED {supported}      OPTIONAL,
    extendedRSRQ-LowerRange-r12    ENUMERATED {supported}      OPTIONAL,
    rsrq-OnAllSymbols-r12          ENUMERATED {supported}      OPTIONAL,
    crs-DiscoverySignalsMeas-r12   ENUMERATED {supported}      OPTIONAL,
    csi-RS-DiscoverySignalsMeas-r12  ENUMERATED {supported}      OPTIONAL
}

MeasParameters-v1310 ::= SEQUENCE {
    rs-SINR-Meas-r13              ENUMERATED {supported}      OPTIONAL,
    whiteCellList-r13             ENUMERATED {supported}      OPTIONAL,
    extendedMaxObjectId-r13       ENUMERATED {supported}      OPTIONAL,
    ul-PDCP-Delay-r13            ENUMERATED {supported}      OPTIONAL,
    extendedFreqPriorities-r13    ENUMERATED {supported}      OPTIONAL,

```

multiBandInfoReport-r13	ENUMERATED {supported}	OPTIONAL,
rsi-AndChannelOccupancyReporting-r13	ENUMERATED {supported}	OPTIONAL
}		
MeasParameters-v1430 ::=	SEQUENCE {	
ceMeasurements-r14	ENUMERATED {supported}	OPTIONAL,
ncsg-r14	ENUMERATED {supported}	OPTIONAL,
shortMeasurementGap-r14	ENUMERATED {supported}	OPTIONAL,
perServingCellMeasurementGap-r14	ENUMERATED {supported}	OPTIONAL,
nonUniformGap-r14	ENUMERATED {supported}	OPTIONAL
}		
BandListEUTRA ::=	SEQUENCE (SIZE (1..maxBands)) OF BandInfoEUTRA	
BandCombinationListEUTRA-r10 ::=	SEQUENCE (SIZE (1..maxBandComb-r10)) OF BandInfoEUTRA	
BandInfoEUTRA ::=	SEQUENCE {	
interFreqBandList	InterFreqBandList,	
interRAT-BandList	InterRAT-BandList	OPTIONAL
}		
InterFreqBandList ::=	SEQUENCE (SIZE (1..maxBands)) OF InterFreqBandInfo	
InterFreqBandInfo ::=	SEQUENCE {	
interFreqNeedForGaps	BOOLEAN	
}		
InterRAT-BandList ::=	SEQUENCE (SIZE (1..maxBands)) OF InterRAT-BandInfo	
InterRAT-BandInfo ::=	SEQUENCE {	
interRAT-NeedForGaps	BOOLEAN	
}		
IRAT-ParametersUTRA-FDD ::=	SEQUENCE {	
supportedBandListUTRA-FDD	SupportedBandListUTRA-FDD	
}		
IRAT-ParametersUTRA-v920 ::=	SEQUENCE {	
e-RedirectionUTRA-r9	ENUMERATED {supported}	
}		
IRAT-ParametersUTRA-v9c0 ::=	SEQUENCE {	
voiceOverPS-HS-UTRA-FDD-r9	ENUMERATED {supported}	OPTIONAL,
voiceOverPS-HS-UTRA-TDD128-r9	ENUMERATED {supported}	OPTIONAL,
srvcc-FromUTRA-FDD-ToUTRA-FDD-r9	ENUMERATED {supported}	OPTIONAL,
srvcc-FromUTRA-FDD-ToGERAN-r9	ENUMERATED {supported}	OPTIONAL,
srvcc-FromUTRA-TDD128-ToUTRA-TDD128-r9	ENUMERATED {supported}	OPTIONAL,
srvcc-FromUTRA-TDD128-ToGERAN-r9	ENUMERATED {supported}	OPTIONAL
}		
IRAT-ParametersUTRA-v9h0 ::=	SEQUENCE {	
mfb-UTRA-r9	ENUMERATED {supported}	
}		
SupportedBandListUTRA-FDD ::=	SEQUENCE (SIZE (1..maxBands)) OF SupportedBandUTRA-FDD	
SupportedBandUTRA-FDD ::=	ENUMERATED {	
	bandI, bandII, bandIII, bandIV, bandV, bandVI,	
	bandVII, bandVIII, bandIX, bandX, bandXI,	
	bandXII, bandXIII, bandXIV, bandXV, bandXVI, ...,	
	bandXVII-8a0, bandXVIII-8a0, bandXIX-8a0, bandXX-8a0,	
	bandXXI-8a0, bandXXII-8a0, bandXXIII-8a0, bandXXIV-8a0,	
	bandXXV-8a0, bandXXVI-8a0, bandXXVII-8a0, bandXXVIII-8a0,	
	bandXXIX-8a0, bandXXX-8a0, bandXXXI-8a0, bandXXXII-8a0}	
IRAT-ParametersUTRA-TDD128 ::=	SEQUENCE {	
supportedBandListUTRA-TDD128	SupportedBandListUTRA-TDD128	
}		
SupportedBandListUTRA-TDD128 ::=	SEQUENCE (SIZE (1..maxBands)) OF SupportedBandUTRA-TDD128	
SupportedBandUTRA-TDD128 ::=	ENUMERATED {	
	a, b, c, d, e, f, g, h, i, j, k, l, m, n,	
	o, p, ...}	
IRAT-ParametersUTRA-TDD384 ::=	SEQUENCE {	
supportedBandListUTRA-TDD384	SupportedBandListUTRA-TDD384	
}		

```

SupportedBandListUTRA-TDD384 ::= SEQUENCE (SIZE (1..maxBands)) OF SupportedBandUTRA-TDD384
SupportedBandUTRA-TDD384 ::= ENUMERATED {
    a, b, c, d, e, f, g, h, i, j, k, l, m, n,
    o, p, ...}
IRAT-ParametersUTRA-TDD768 ::= SEQUENCE {
    supportedBandListUTRA-TDD768 SupportedBandListUTRA-TDD768
}
SupportedBandListUTRA-TDD768 ::= SEQUENCE (SIZE (1..maxBands)) OF SupportedBandUTRA-TDD768
SupportedBandUTRA-TDD768 ::= ENUMERATED {
    a, b, c, d, e, f, g, h, i, j, k, l, m, n,
    o, p, ...}
IRAT-ParametersUTRA-TDD-v1020 ::= SEQUENCE {
    e-RedirectionUTRA-TDD-r10 ENUMERATED {supported}
}
IRAT-ParametersGERAN ::= SEQUENCE {
    supportedBandListGERAN SupportedBandListGERAN,
    interRAT-PS-HO-ToGERAN BOOLEAN
}
IRAT-ParametersGERAN-v920 ::= SEQUENCE {
    dtm-r9 ENUMERATED {supported} OPTIONAL,
    e-RedirectionGERAN-r9 ENUMERATED {supported} OPTIONAL
}
SupportedBandListGERAN ::= SEQUENCE (SIZE (1..maxBands)) OF SupportedBandGERAN
SupportedBandGERAN ::= ENUMERATED {
    gsm450, gsm480, gsm710, gsm750, gsm810, gsm850,
    gsm900P, gsm900E, gsm900R, gsm1800, gsm1900,
    spare5, spare4, spare3, spare2, spare1, ...}
IRAT-ParametersCDMA2000-HRPD ::= SEQUENCE {
    supportedBandListHRPD SupportedBandListHRPD,
    tx-ConfigHRPD ENUMERATED {single, dual},
    rx-ConfigHRPD ENUMERATED {single, dual}
}
SupportedBandListHRPD ::= SEQUENCE (SIZE (1..maxCDMA-BandClass)) OF BandclassCDMA2000
IRAT-ParametersCDMA2000-1XRTT ::= SEQUENCE {
    supportedBandList1XRTT SupportedBandList1XRTT,
    tx-Config1XRTT ENUMERATED {single, dual},
    rx-Config1XRTT ENUMERATED {single, dual}
}
IRAT-ParametersCDMA2000-1XRTT-v920 ::= SEQUENCE {
    e-CSFB-1XRTT-r9 ENUMERATED {supported},
    e-CSFB-ConcPS-MoblXRTT-r9 ENUMERATED {supported} OPTIONAL
}
IRAT-ParametersCDMA2000-1XRTT-v1020 ::= SEQUENCE {
    e-CSFB-dual-1XRTT-r10 ENUMERATED {supported}
}
IRAT-ParametersCDMA2000-v1130 ::= SEQUENCE {
    cdma2000-NW-Sharing-r11 ENUMERATED {supported} OPTIONAL
}
SupportedBandList1XRTT ::= SEQUENCE (SIZE (1..maxCDMA-BandClass)) OF BandclassCDMA2000
IRAT-ParametersWLAN-r13 ::= SEQUENCE {
    supportedBandListWLAN-r13 SEQUENCE (SIZE (1..maxWLAN-Bands-r13)) OF WLAN-BandIndicator-r13
    OPTIONAL
}
CSG-ProximityIndicationParameters-r9 ::= SEQUENCE {
    intraFreqProximityIndication-r9 ENUMERATED {supported} OPTIONAL,
    interFreqProximityIndication-r9 ENUMERATED {supported} OPTIONAL,
    utran-ProximityIndication-r9 ENUMERATED {supported} OPTIONAL
}

```

```

NeighCellSI-AcquisitionParameters-r9 ::= SEQUENCE {
    intraFreqSI-AcquisitionForHO-r9 ENUMERATED {supported} OPTIONAL,
    interFreqSI-AcquisitionForHO-r9 ENUMERATED {supported} OPTIONAL,
    utran-SI-AcquisitionForHO-r9     ENUMERATED {supported} OPTIONAL
}

SON-Parameters-r9 ::= SEQUENCE {
    rach-Report-r9          ENUMERATED {supported} OPTIONAL
}

UE-BasedNetwPerfMeasParameters-r10 ::= SEQUENCE {
    loggedMeasurementsIdle-r10 ENUMERATED {supported} OPTIONAL,
    standaloneGNSS-Location-r10 ENUMERATED {supported} OPTIONAL
}

UE-BasedNetwPerfMeasParameters-v1250 ::= SEQUENCE {
    loggedMBSFNMeasurements-r12 ENUMERATED {supported}
}

UE-BasedNetwPerfMeasParameters-v1430 ::= SEQUENCE {
    locationReport-r14          ENUMERATED {supported} OPTIONAL
}

OTDOA-PositioningCapabilities-r10 ::= SEQUENCE {
    otdoa-UE-Assisted-r10      ENUMERATED {supported},
    interFreqRSTD-Measurement-r10 ENUMERATED {supported} OPTIONAL
}

Other-Parameters-r11 ::= SEQUENCE {
    inDeviceCoexInd-r11        ENUMERATED {supported} OPTIONAL,
    powerPrefInd-r11           ENUMERATED {supported} OPTIONAL,
    ue-Rx-TxTimeDiffMeasurements-r11 ENUMERATED {supported} OPTIONAL
}

Other-Parameters-v11d0 ::= SEQUENCE {
    inDeviceCoexInd-UL-CA-r11  ENUMERATED {supported} OPTIONAL
}

Other-Parameters-v1360 ::= SEQUENCE {
    inDeviceCoexInd-HardwareSharingInd-r13 ENUMERATED {supported} OPTIONAL
}

Other-Parameters-v1430 ::= SEQUENCE {
    bwPrefInd-r14              ENUMERATED {supported} OPTIONAL,
    rlm-ReportSupport-r14      ENUMERATED {supported} OPTIONAL
}

OtherParameters-v1450 ::= SEQUENCE {
    overheatingInd-r14         ENUMERATED {supported} OPTIONAL
}

Other-Parameters-v1460 ::= SEQUENCE {
    nonCSG-SI-Reporting-r14    ENUMERATED {supported} OPTIONAL
}

MBMS-Parameters-r11 ::= SEQUENCE {
    mbms-SCell-r11             ENUMERATED {supported} OPTIONAL,
    mbms-NonServingCell-r11    ENUMERATED {supported} OPTIONAL
}

MBMS-Parameters-v1250 ::= SEQUENCE {
    mbms-AsyncDC-r12           ENUMERATED {supported} OPTIONAL
}

MBMS-Parameters-v1430 ::= SEQUENCE {
    fembmsDedicatedCell-r14    ENUMERATED {supported} OPTIONAL,
    fembmsMixedCell-r14        ENUMERATED {supported} OPTIONAL,
    subcarrierSpacingMBMS-khz7dot5-r14 ENUMERATED {supported} OPTIONAL,
    subcarrierSpacingMBMS-khz1dot25-r14 ENUMERATED {supported} OPTIONAL
}

MBMS-Parameters-v1470 ::= SEQUENCE {
    mbms-MaxBW-r14             CHOICE {
        implicitValue          NULL,
        explicitValue          INTEGER(2..20)
    },
    mbms-ScalingFactor1dot25-r14 ENUMERATED {n3, n6, n9, n12} OPTIONAL,
    mbms-ScalingFactor7dot5-r14  ENUMERATED {n1, n2, n3, n4} OPTIONAL
}

```

```

}
FeMBMS-Unicast-Parameters-r14 ::= SEQUENCE {
    unicast-fembmsMixedSCell-r14          ENUMERATED {supported}          OPTIONAL,
    emptyUnicastRegion-r14                ENUMERATED {supported}          OPTIONAL
}

SCPTM-Parameters-r13 ::= SEQUENCE {
    scptm-ParallelReception-r13           ENUMERATED {supported}          OPTIONAL,
    scptm-SCell-r13                       ENUMERATED {supported}          OPTIONAL,
    scptm-NonServingCell-r13             ENUMERATED {supported}          OPTIONAL,
    scptm-AsyncDC-r13                    ENUMERATED {supported}          OPTIONAL
}

CE-Parameters-r13 ::= SEQUENCE {
    ce-ModeA-r13                          ENUMERATED {supported}          OPTIONAL,
    ce-ModeB-r13                          ENUMERATED {supported}          OPTIONAL
}

CE-Parameters-v1320 ::= SEQUENCE {
    intraFreqA3-CE-ModeA-r13             ENUMERATED {supported}          OPTIONAL,
    intraFreqA3-CE-ModeB-r13             ENUMERATED {supported}          OPTIONAL,
    intraFreqHO-CE-ModeA-r13            ENUMERATED {supported}          OPTIONAL,
    intraFreqHO-CE-ModeB-r13            ENUMERATED {supported}          OPTIONAL
}

CE-Parameters-v1350 ::= SEQUENCE {
    unicastFrequencyHopping-r13          ENUMERATED {supported}          OPTIONAL
}

CE-Parameters-v1370 ::= SEQUENCE {
    tm9-CE-ModeA-r13                     ENUMERATED {supported}          OPTIONAL,
    tm9-CE-ModeB-r13                     ENUMERATED {supported}          OPTIONAL
}

CE-Parameters-v1380 ::= SEQUENCE {
    tm6-CE-ModeA-r13                     ENUMERATED {supported}          OPTIONAL
}

CE-Parameters-v1430 ::= SEQUENCE {
    ce-SwitchWithoutHO-r14               ENUMERATED {supported}          OPTIONAL
}

LAA-Parameters-r13 ::= SEQUENCE {
    crossCarrierSchedulingLAA-DL-r13     ENUMERATED {supported}          OPTIONAL,
    csi-RS-DRS-RRM-MeasurementsLAA-r13  ENUMERATED {supported}          OPTIONAL,
    downlinkLAA-r13                      ENUMERATED {supported}          OPTIONAL,
    endingDwPTS-r13                       ENUMERATED {supported}          OPTIONAL,
    secondSlotStartingPosition-r13       ENUMERATED {supported}          OPTIONAL,
    tm9-LAA-r13                           ENUMERATED {supported}          OPTIONAL,
    tm10-LAA-r13                          ENUMERATED {supported}          OPTIONAL
}

LAA-Parameters-v1430 ::= SEQUENCE {
    crossCarrierSchedulingLAA-UL-r14     ENUMERATED {supported}          OPTIONAL,
    uplinkLAA-r14                        ENUMERATED {supported}          OPTIONAL,
    twoStepSchedulingTimingInfo-r14      ENUMERATED {nPlus1, nPlus2, nPlus3} OPTIONAL,
    uss-BlindDecodingAdjustment-r14     ENUMERATED {supported}          OPTIONAL,
    uss-BlindDecodingReduction-r14     ENUMERATED {supported}          OPTIONAL,
    outOfSequenceGrantHandling-r14      ENUMERATED {supported}          OPTIONAL
}

WLAN-IW-Parameters-r12 ::= SEQUENCE {
    wlan-IW-RAN-Rules-r12                ENUMERATED {supported}          OPTIONAL,
    wlan-IW-ANDSF-Policies-r12           ENUMERATED {supported}          OPTIONAL
}

LWA-Parameters-r13 ::= SEQUENCE {
    lwa-r13                               ENUMERATED {supported}          OPTIONAL,
    lwa-SplitBearer-r13                   ENUMERATED {supported}          OPTIONAL,
    wlan-MAC-Address-r13                   OCTET STRING (SIZE (6))          OPTIONAL,
    lwa-BufferSize-r13                     ENUMERATED {supported}          OPTIONAL
}

LWA-Parameters-v1430 ::= SEQUENCE {
    lwa-HO-WithoutWT-Change-r14          ENUMERATED {supported}          OPTIONAL,
    lwa-UL-r14                            ENUMERATED {supported}          OPTIONAL,
    wlan-PeriodicMeas-r14                 ENUMERATED {supported}          OPTIONAL
}

```



```

wlan-ReportAnyWLAN-r14          ENUMERATED {supported}      OPTIONAL,
wlan-SupportedDataRate-r14     INTEGER (1..2048)          OPTIONAL
}

LWA-Parameters-v1440 ::=      SEQUENCE {
    lwa-RLC-UM-r14             ENUMERATED {supported}      OPTIONAL
}

WLAN-IW-Parameters-v1310 ::= SEQUENCE {
    rclwi-r13                  ENUMERATED {supported}      OPTIONAL
}

LWIP-Parameters-r13 ::=      SEQUENCE {
    lwip-r13                   ENUMERATED {supported}      OPTIONAL
}

LWIP-Parameters-v1430 ::=      SEQUENCE {
    lwip-Aggregation-DL-r14    ENUMERATED {supported}      OPTIONAL,
    lwip-Aggregation-UL-r14    ENUMERATED {supported}      OPTIONAL
}

NAICS-Capability-List-r12 ::= SEQUENCE (SIZE (1..maxNAICS-Entries-r12)) OF NAICS-Capability-Entry-
r12

NAICS-Capability-Entry-r12 ::= SEQUENCE {
    numberOfNAICS-CapableCC-r12 INTEGER(1..5),
    numberOfAggregatedPRB-r12  ENUMERATED {
        n50, n75, n100, n125, n150, n175,
        n200, n225, n250, n275, n300, n350,
        n400, n450, n500, spare},
    ...
}

SL-Parameters-r12 ::=          SEQUENCE {
    commSimultaneousTx-r12     ENUMERATED {supported}      OPTIONAL,
    commSupportedBands-r12     FreqBandIndicatorListEUTRA-r12 OPTIONAL,
    discSupportedBands-r12     SupportedBandInfoList-r12  OPTIONAL,
    discScheduledResourceAlloc-r12 ENUMERATED {supported}      OPTIONAL,
    disc-UE-SelectedResourceAlloc-r12 ENUMERATED {supported}      OPTIONAL,
    disc-SLSS-r12              ENUMERATED {supported}      OPTIONAL,
    discSupportedProc-r12      ENUMERATED {n50, n400}          OPTIONAL
}

SL-Parameters-v1310 ::=      SEQUENCE {
    discSysInfoReporting-r13    ENUMERATED {supported}      OPTIONAL,
    commMultipleTx-r13          ENUMERATED {supported}      OPTIONAL,
    discInterFreqTx-r13        ENUMERATED {supported}      OPTIONAL,
    discPeriodicSLSS-r13       ENUMERATED {supported}      OPTIONAL
}

SL-Parameters-v1430 ::=      SEQUENCE {
    zoneBasedPoolSelection-r14  ENUMERATED {supported}      OPTIONAL,
    ue-AutonomousWithFullSensing-r14 ENUMERATED {supported}      OPTIONAL,
    ue-AutonomousWithPartialSensing-r14 ENUMERATED {supported}      OPTIONAL,
    sl-CongestionControl-r14    ENUMERATED {supported}      OPTIONAL,
    v2x-TxWithShortResvInterval-r14 ENUMERATED {supported}      OPTIONAL,
    v2x-numberTxRxTiming-r14    INTEGER(1..16)              OPTIONAL,
    v2x-nonAdjacentPSCCH-PSSCH-r14 ENUMERATED {supported}      OPTIONAL,
    slss-TxRx-r14              ENUMERATED {supported}      OPTIONAL,
    v2x-SupportedBandCombinationList-r14 V2X-SupportedBandCombination-r14 OPTIONAL
}

V2X-SupportedBandCombination-r14 ::= SEQUENCE (SIZE (1..maxBandComb-r13)) OF V2X-
BandCombinationParameters-r14

V2X-BandCombinationParameters-r14 ::= SEQUENCE (SIZE (1.. maxSimultaneousBands-r10)) OF V2X-
BandParameters-r14

SupportedBandInfoList-r12 ::= SEQUENCE (SIZE (1..maxBands)) OF SupportedBandInfo-r12

SupportedBandInfo-r12 ::=      SEQUENCE {
    support-r12                ENUMERATED {supported}      OPTIONAL
}

FreqBandIndicatorListEUTRA-r12 ::= SEQUENCE (SIZE (1..maxBands)) OF FreqBandIndicator-r11

MMTEL-Parameters-r14 ::=      SEQUENCE {

```

```

delayBudgetReporting-r14          ENUMERATED {supported}      OPTIONAL,
pusch-Enhancements-r14           ENUMERATED {supported}      OPTIONAL,
recommendedBitRate-r14           ENUMERATED {supported}      OPTIONAL,
recommendedBitRateQuery-r14      ENUMERATED {supported}      OPTIONAL
}

SRS-CapabilityPerBandPair-r14 ::= SEQUENCE {
  retuningInfo                    SEQUENCE {
    rf-RetuningTimeDL-r14         ENUMERATED {n0, n0dot5, n1, n1dot5, n2, n2dot5, n3,
                                                n3dot5, n4, n4dot5, n5, n5dot5, n6, n6dot5,
                                                n7, spare1}      OPTIONAL,
    rf-RetuningTimeUL-r14        ENUMERATED {n0, n0dot5, n1, n1dot5, n2, n2dot5, n3,
                                                n3dot5, n4, n4dot5, n5, n5dot5, n6, n6dot5,
                                                n7, spare1}      OPTIONAL
  }
}

SRS-CapabilityPerBandPair-v14b0 ::= SEQUENCE {
  srs-FlexibleTiming-r14          ENUMERATED {supported}      OPTIONAL,
  srs-HARQ-ReferenceConfig-r14    ENUMERATED {supported}      OPTIONAL
}

HighSpeedEnhParameters-r14 ::= SEQUENCE {
  measurementEnhancements-r14     ENUMERATED {supported}      OPTIONAL,
  demodulationEnhancements-r14    ENUMERATED {supported}      OPTIONAL,
  prach-Enhancements-r14          ENUMERATED {supported}      OPTIONAL
}

-- ASN1STOP

```

UE-EUTRA-Capability field descriptions	FDD/ TDD diff
accessStratumRelease Set to rel14 in this version of the specification. NOTE 7.	-
additionalRx-Tx-PerformanceReq Indicates whether the UE supports the additional Rx and Tx performance requirement for a given band combination as specified in TS 36.101 [42].	-
alternativeTBS-Indices Indicates whether the UE supports alternative TBS indices I_{TBS} 26A and 33A as specified in TS 36.213 [23].	-
alternativeTBS-Index Indicates whether the UE supports alternative TBS index I_{TBS} 33B as specified in TS 36.213 [23].	No
alternativeTimeToTrigger Indicates whether the UE supports alternativeTimeToTrigger.	No
aperiodicCSI-Reporting Indicates whether the UE supports aperiodic CSI reporting with 3 bits of the CSI request field size as specified in TS 36.213 [23, 7.2.1] and/or aperiodic CSI reporting mode 1-0 and mode 1-1 as specified in TS 36.213 [23, 7.2.1]. The first bit is set to "1" if the UE supports the aperiodic CSI reporting with 3 bits of the CSI request field size. The second bit is set to "1" if the UE supports the aperiodic CSI reporting mode 1-0 and mode 1-1.	No
bandCombinationListEUTRA One entry corresponding to each supported band combination listed in the same order as in <i>supportedBandCombination</i> .	-
BandCombinationParameters-v1090, BandCombinationParameters-v10i0, BandCombinationParameters-v1270 If included, the UE shall include the same number of entries, and listed in the same order, as in <i>BandCombinationParameters-r10</i> .	-
BandCombinationParameters-v1130 The field is applicable to each supported CA bandwidth class combination (i.e. CA configuration in TS 36.101 [42, Clause 5.6A.1]) indicated in the corresponding band combination. If included, the UE shall include the same number of entries, and listed in the same order, as in <i>BandCombinationParameters-r10</i> .	-
bandEUTRA E-UTRA band as defined in TS 36.101 [42]. In case the UE includes <i>bandEUTRA-v9e0</i> or <i>bandEUTRA-v1090</i> , the UE shall set the corresponding entry of <i>bandEUTRA</i> (i.e. without suffix) or <i>bandEUTRA-r10</i> respectively to <i>maxFBI</i> .	-
bandListEUTRA One entry corresponding to each supported E-UTRA band listed in the same order as in <i>supportedBandListEUTRA</i> .	-
bandParameterList-v1380 If included, the UE shall include the same number of entries listed in the same order as the band entries in the corresponding band combination.	-
bandParametersUL, bandParametersDL Indicates the supported parameters for the band. Each of <i>CA-MIMO-ParametersUL</i> and <i>CA-MIMO-ParametersDL</i> can be included only once for one band in a single band combination entry.	-
beamformed (in MIMO-CA-ParametersPerBoBCPerTM) If signalled, the field indicates for a particular transmission mode, the UE capabilities concerning beamformed EBF/ FD-MIMO operation (class B) applicable for the concerned band combination.	-
beamformed (in MIMO-UE-ParametersPerTM) Indicates for a particular transmission mode, the UE capabilities concerning beamformed EBF/ FD-MIMO operation (class B) applicable for band combinations for which the concerned capabilities are not signalled.	TBD
benefitsFromInterruption Indicates whether the UE power consumption would benefit from being allowed to cause interruptions to serving cells when performing measurements of deactivated SCell carriers for <i>measCycleSCell</i> of less than 640ms, as specified in TS 36.133 [16].	No
bwPrelnd Indicates whether the UE supports maximum PDSCH/PUSCH bandwidth preference indication.	-
ca-BandwidthClass The CA bandwidth class supported by the UE as defined in TS 36.101 [42, Table 5.6A-1]. The UE explicitly includes all the supported CA bandwidth class combinations in the band combination signalling. Support for one CA bandwidth class does not implicitly indicate support for another CA bandwidth class.	-

UE-EUTRA-Capability field descriptions	FDD/ TDD diff
<p><i>cch-InterfMitigation-RefRecTypeA, cch-InterfMitigation-RefRecTypeB, cch-InterfMitigation-MaxNumCCs</i> The field <i>cch-InterfMitigation-RefRecTypeA</i> defines whether the UE supports Type A downlink control channel interference mitigation (CCH-IM) receiver "LMMSE-IRC + CRS-IC" for PDCCH/PCFICH/PHICH/EPDCCH receive processing (Enhanced downlink control channel performance requirements Type A in the TS 36.101 [6]). The field <i>cch-InterfMitigation-RefRecTypeB</i> defines whether the UE supports Type B downlink CCH-IM receiver "E-LMMSE-IRC + CRS-IC" for PDCCH/PCFICH/PHICH receive processing in synchronous networks (Enhanced downlink control channel performance requirements Type B in the TS 36.101 [6]). The UE supporting the capability defined by <i>cch-InterfMitigation-RefRecTypeB-r13</i> shall also support the capability defined by <i>cch-InterfMitigation-RefRecTypeA-r13</i>.</p> <p>If the UE sets one or more of the fields <i>cch-InterfMitigation-RefRecTypeA</i> and <i>cch-InterfMitigation-RefRecTypeB</i> to "supported", the UE shall include the parameter <i>cch-InterfMitigation-MaxNumCCs</i> to indicate that the UE supports CCH-IM on at least one arbitrary downlink CC for up to <i>cch-InterfMitigation-MaxNumCCs</i> downlink CC CA configuration. The UE shall not include the parameter <i>cch-InterfMitigation-MaxNumCCs</i> if neither <i>cch-InterfMitigation-RefRecTypeA</i> nor <i>cch-InterfMitigation-RefRecTypeB</i> is present. The UE may not perform CCH-IM on more than 1 DL CCs. For example, the UE sets "<i>cch-InterfMitigation-MaxNumCCs</i> = 3" to indicate that UE supports CCH-IM on at least one DL CC for supported non-CA, 2DL CA and 3DL CA configurations. For CA scenarios, the CCH-IM is guaranteed to be supported on at least one arbitrary component carrier.</p>	-
<p><i>cdma2000-NW-Sharing</i> Indicates whether the UE supports network sharing for CDMA2000.</p>	-
<p><i>ce-ClosedLoopTxAntennaSelection</i> Indicates whether the UE supports UL closed-loop Tx antenna selection in CE mode A, as specified in TS 36.212 [22].</p>	Yes
<p><i>ce-HARQ-AckBundling</i> Indicates whether the UE supports HARQ-ACK bundling in half duplex FDD in CE mode A, as specified in TS 36.212 [22] and TS 36.213 [23].</p>	Yes
<p><i>ce-ModeA, ce-ModeB</i> Indicates whether the UE supports operation in CE mode A and/or B, as specified in TS 36.211 [21] and TS 36.213 [23].</p>	-
<p><i>ceMeasurements</i> Indicates whether the UE supports intra-frequency RSRQ measurements and inter-frequency RSRP and RSRQ measurements in RRC_CONNECTED, as specified in TS 36.133 [16] and TS 36.304 [4].</p>	-
<p><i>ce-PDSCH-PUSCH-Enhancement</i> Indicates whether the UE supports new numbers of repetitions for PUSCH and modulation restrictions for PDSCH/PUSCH in CE mode A as specified in TS 36.212 [22] and TS 36.213 [23].</p>	No
<p><i>ce-PDSCH-PUSCH-MaxBandwidth</i> Indicates the maximum supported PDSCH/PUSCH channel bandwidth in CE mode A and B, as specified in TS 36.212 [22] and TS 36.213 [23]. Value bw5 corresponds to 5 MHz and value bw20 corresponds to 20 MHz. If the field is absent the maximum PDSCH/PUSCH channel bandwidth in CE mode A and B is 1.4 MHz. If the setting of this parameter is 20 MHz, the max supported PUSCH channel bandwidth in CE mode A is 5 MHz. The maximum PUSCH channel bandwidth in CE mode B is 1.4 MHz regardless of the setting of this parameter. Parameter: transmission bandwidth configuration, see TS 36.101 [42, table 5.6-1].</p>	Yes
<p><i>ce-PDSCH-TenProcesses</i> Indicates whether the UE supports 10 DL HARQ processes in FDD in CE mode A.</p>	Yes
<p><i>ce-PUCCH-Enhancement</i> Indicates whether the UE supports repetition levels 64 and 128 for PUCCH in CE Mode B, as specified in TS 36.211 [21] and in TS 36.213 [23].</p>	No
<p><i>ce-PUSCH-NB-MaxTBS</i> Indicates whether the UE supports 2984 bits max UL TBS in 1.4 MHz in CE mode A operation, as specified in TS 36.212 [22] and TS 36.213 [23].</p>	Yes
<p><i>ce-RetuningSymbols</i> Indicates the number of retuning symbols in CE mode A and B as specified in TS 36.211 [21]. Value n0 corresponds to 0 retuning symbols and value n1 corresponds to 1 retuning symbol. If the field is absent the number of retuning symbols in CE mode A and B is 2.</p>	No
<p><i>ce-SchedulingEnhancement</i> Indicates whether the UE supports dynamic HARQ-ACK delay for HD-FDD in CE mode A as specified in TS 36.212 [22] and TS 36.213 [23].</p>	No

UE-EUTRA-Capability field descriptions	FDD/ TDD diff
ce-SRS-Enhancement Indicates whether the UE supports SRS coverage enhancement in TDD with support of SRS combs 2 and 4 as specified in TS 36.213 [23]. This field can be included only if <i>ce-SRS-EnhancementWithoutComb4</i> is not included.	Yes
ce-SRS-EnhancementWithoutComb4 Indicates whether the UE supports SRS coverage enhancement in TDD with support of SRS comb 2 but without support of SRS comb 4 as specified in TS 36.213 [23]. This field can be included only if <i>ce-SRS-Enhancement</i> is not included.	-
ce-SwitchWithoutHO Indicate whether the UE supports switching between normal mode and enhanced coverage mode without handover.	-
channelMeasRestriction Indicates for a particular transmission mode whether the UE supports channel measurement restriction.	TBD
codebook-HARQ-ACK Indicates whether the UE supports determining HARQ ACK codebook size based on the DAI-based solution and/or the number of configured CCs. The first bit is set to "1" if the UE supports the DAI-based codebook size determination. The second bit is set to "1" if the UE supports the codebook determination based on the number of configured CCs.	No
commMultipleTx Indicates whether the UE supports multiple transmissions of sidelink communication to different destinations in one SC period. If <i>commMultipleTx-r13</i> is set to supported then the UE support 8 transmitting sidelink processes.	-
commSimultaneousTx Indicates whether the UE supports simultaneous transmission of EUTRA and sidelink communication (on different carriers) in all bands for which the UE indicated sidelink support in a band combination (using <i>commSupportedBandsPerBC</i>).	-
commSupportedBands Indicates the bands on which the UE supports sidelink communication, by an independent list of bands i.e. separate from the list of supported E-UTRA band, as indicated in <i>supportedBandListEUTRA</i> .	-
commSupportedBandsPerBC Indicates, for a particular band combination, the bands on which the UE supports simultaneous reception of EUTRA and sidelink communication. If the UE indicates support simultaneous transmission (using <i>commSimultaneousTx</i>), it also indicates, for a particular band combination, the bands on which the UE supports simultaneous transmission of EUTRA and sidelink communication. The first bit refers to the first band included in <i>commSupportedBands</i> , with value 1 indicating sidelink is supported.	-
configN (in MIMO-CA-ParametersPerBoBCPerTM) If signalled, the field indicates for a particular transmission mode whether the UE supports non-precoded EBF/ FD-MIMO (class A) related configuration N for the concerned band combination.	-
configN (in MIMO-UE-ParametersPerTM) Indicates for a particular transmission mode whether the UE supports non-precoded EBF/ FD-MIMO (class A) related configuration N for band combinations for which the concerned capabilities are not signalled.	TBD
crossCarrierScheduling	Yes
crossCarrierScheduling-B5C Indicates whether the UE supports cross carrier scheduling beyond 5 DL CCs.	No
crossCarrierSchedulingLAA-DL Indicates whether the UE supports cross-carrier scheduling from a licensed carrier for LAA cell(s) for downlink. This field can be included only if <i>downlinkLAA</i> is included.	-
crossCarrierSchedulingLAA-UL Indicates whether the UE supports cross-carrier scheduling from a licensed carrier for LAA cell(s) for uplink. This field can be included only if <i>uplinkLAA</i> is included.	-
crs-DiscoverySignalsMeas Indicates whether the UE supports CRS based discovery signals measurement, and PDSCH/EPDCCH RE mapping with zero power CSI-RS configured for discovery signals.	FFS
crs-InterHandl Indicates whether the UE supports CRS interference handling.	Yes
crs-InterfMitigationTM10 The field defines whether the UE supports CRS interference mitigation in transmission mode 10. The UE supporting the <i>crs-InterfMitigationTM10</i> capability shall also support the <i>crs-InterfHandl</i> capability.	No

UE-EUTRA-Capability field descriptions	FDD/ TDD diff
<p><i>crs-InterfMitigationTM1toTM9</i> Indicates whether the UE supports CRS interference mitigation (IM) while operating in the following transmission modes (TM): TM 1, TM 2, ..., TM 8 and TM 9. The UE shall not include the field if it does not support CRS IM in TMs 1-9. If the field is present, the UE supports CRS-IM on at least one arbitrary downlink CC for up to <i>crs-InterfMitigationTM1toTM9-r13</i> downlink CC CA configuration. The UE signals <i>crs-InterfMitigationTM1toTM9-r13</i> value to indicate the maximum <i>crs-InterfMitigationTM1toTM9-r13</i> downlink CC CA configuration where UE may apply CRS IM. For example, the UE sets "<i>crs-InterfMitigationTM1toTM9-r13</i> = 3" to indicate that the UE supports CRS-IM on at least one DL CC for supported non-CA, 2DL CA and 3DL CA configurations. The UE supporting the <i>crs-InterfMitigationTM1toTM9-r13</i> capability shall also support the <i>crs-InterfHandl-r11</i> capability.</p>	-
<p><i>crs-LessDwPTS</i> Indicates whether the UE supports TDD special subframe configuration 10 without CRS transmission on the 5th symbol of DwPTS, i.e. <i>ssp10-CRS-LessDwPTS</i>, as specified in TS 36.211 [17].</p>	-
<p><i>csi-ReportingAdvanced, csi-ReportingAdvancedMaxPorts (in MIMO-CA-ParametersPerBoBCPerTM)</i> If signalled, the field indicates that for a particular transmission mode, the maximum number of CSI-RS ports supported by the UE for advanced CSI reporting is different in the concerned band of band combination than the value indicated by the field <i>csi-ReportingAdvanced</i> or <i>csi-ReportingAdvancedMaxPorts</i> in <i>MIMO-UE-ParametersPerTM</i>. The UE shall not include both <i>csi-ReportingAdvanced</i> and <i>csi-ReportingAdvancedMaxPorts</i> for a particular transmission mode in the concerned band of band combination.</p>	-
<p><i>csi-ReportingAdvanced, csi-ReportingAdvancedMaxPorts (in MIMO-UE-ParametersPerTM)</i> Indicates for a particular transmission mode the maximum number of CSI-RS ports supported by the UE for advanced CSI reporting. The field <i>csi-ReportingAdvanced</i> indicates 32 CSI-RS ports whereas <i>csi-ReportingAdvancedMaxPorts</i> indicates 8, 12, 16, 20, 24 or 28 CSI-RS ports. The UE shall not include both <i>csi-ReportingAdvanced</i> and <i>csi-ReportingAdvancedMaxPorts</i> for a particular transmission mode.</p>	FFS
<p><i>csi-ReportingNP (in MIMO-CA-ParametersPerBoBCPerTM)</i> If signalled, value <i>different</i> indicates that for a particular transmission mode, the CSI reporting on non-precoded CSI-RS with 20, 24, 28 or 32 antenna ports for the concerned band of band combination is different than the value indicated by field <i>csi-ReportingNP</i> in <i>MIMO-UE-ParametersPerTM</i>.</p>	-
<p><i>csi-ReportingNP (in MIMO-UE-ParametersPerTM)</i> Indicates for a particular transmission mode whether the UE supports CSI reporting on non-precoded CSI-RS with 20, 24, 28 or 32 antenna ports for band combinations for which the concerned capabilities are not signalled in <i>MIMO-CA-ParametersPerBoBCPerTM</i>, and the FD-MIMO processing capability condition as described in NOTE 8 is satisfied.</p>	FFS
<p><i>csi-RS-DiscoverySignalsMeas</i> Indicates whether the UE supports CSI-RS based discovery signals measurement. If this field is included, the UE shall also include <i>crs-DiscoverySignalsMeas</i>.</p>	FFS
<p><i>csi-RS-DRS-RRM-MeasurementsLAA</i> Indicates whether the UE supports performing RRM measurements on LAA cell(s) based on CSI-RS-based DRS. This field can be included only if <i>downlinkLAA</i> is included.</p>	-
<p><i>csi-RS-EnhancementsTDD</i> Indicates for a particular transmission mode whether the UE supports CSI-RS enhancements applicable for TDD.</p>	Yes
<p><i>csi-SubframeSet</i> Indicates whether the UE supports REL-12 DL CSI subframe set configuration, REL-12 DL CSI subframe set dependent CSI measurement/feedback, configuration of up to 2 CSI-IM resources for a CSI process with no more than 4 CSI-IM resources for all CSI processes of one frequency if the UE supports tm10, configuration of two ZP-CSI-RS for tm1 to tm9, PDSCH RE mapping with two ZP-CSI-RS configurations, and EPDCCH RE mapping with two ZP-CSI-RS configurations if the UE supports EPDCCH. This field is only applicable for UEs supporting TDD.</p>	Yes
<p><i>dataInactMon</i> Indicates whether the UE supports the data inactivity monitoring as specified in TS 36.321 [6].</p>	-

UE-EUTRA-Capability field descriptions	FDD/ TDD diff
dc-Support Including this field indicates that the UE supports synchronous DC and power control mode 1. Including this field for a band combination entry comprising of single band entry indicates that the UE supports intra-band contiguous DC. Including this field for a band combination entry comprising of two or more band entries, indicates that the UE supports DC for these bands and that the serving cells corresponding to a band entry shall belong to one cell group (i.e. MCG or SCG). Including field <i>asynchronous</i> indicates that the UE supports asynchronous DC and power control mode 2. Including this field for a TDD/FDD band combination indicates that the UE supports TDD/FDD DC for this band combination.	-
delayBudgetReporting Indicates whether the UE supports delay budget reporting.	No
demodulationEnhancements This field defines whether the UE supports advanced receiver in SFN scenario as specified in TS 36.101 [42].	-
densityReductionNP, densityReductionBF Indicates whether the UE supports CSI-RS density reduction with values 1, 1/2 and 1/3 for non-precoded CSI-RS and beamformed CSI-RS respectively.	FFS
deviceType UE may set the value to "noBenFromBatConsumpOpt" when it does not foresee to particularly benefit from NW-based battery consumption optimisation. Absence of this value means that the device does benefit from NW-based battery consumption optimisation.	-
diffFallbackCombReport Indicates that the UE supports reporting of UE radio access capabilities for the CA band combinations asked by the eNB as well as, if any, reporting of different UE radio access capabilities for their fallback band combination as specified in TS 36.331 [5]. The UE does not report fallback combinations if their UE radio access capabilities are the same as the ones for the CA band combination asked by the eNB.	-
differentFallbackSupported Indicates that the UE supports different capabilities for at least one fallback case of this band combination.	-
discInterFreqTx Indicates whether the UE support sidelink discovery announcements either a) on the primary frequency only or b) on other frequencies also, regardless of the UE configuration (e.g. CA, DC). The UE may set <i>discInterFreqTx</i> to supported when having a separate transmitter or if it can request sidelink discovery transmission gaps.	-
discoverySignalsInDeactSCell Indicates whether the UE supports the behaviour on DL signals and physical channels when SCell is deactivated and discovery signals measurement is configured as specified in TS 36.211 [21, 6.11A]. This field is included only if UE supports carrier aggregation and includes <i>crs-DiscoverySignalsMeas</i> .	FFS
discPeriodicSLSS Indicates whether the UE supports periodic (i.e. not just one time before sidelink discovery announcement) Sidelink Synchronization Signal (SLSS) transmission and reception for sidelink discovery.	-
discScheduledResourceAlloc Indicates whether the UE supports transmission of discovery announcements based on network scheduled resource allocation.	-
disc-UE-SelectedResourceAlloc Indicates whether the UE supports transmission of discovery announcements based on UE autonomous resource selection.	-
disc-SLSS Indicates whether the UE supports Sidelink Synchronization Signal (SLSS) transmission and reception for sidelink discovery.	-
discSupportedBands Indicates the bands on which the UE supports sidelink discovery. One entry corresponding to each supported E-UTRA band, listed in the same order as in <i>supportedBandListEUTRA</i> .	-
discSupportedProc Indicates the number of processes supported by the UE for sidelink discovery.	-
discSysInfoReporting Indicates whether the UE supports reporting of system information for inter-frequency/PLMN sidelink discovery.	-
dl-256QAM Indicates whether the UE supports 256QAM in DL on the band.	-

UE-EUTRA-Capability field descriptions	FDD/ TDD diff
dmrs-Enhancements (in MIMO-CA-ParametersPerBoBCPerTM) If signalled, the field indicates for a particular transmission mode, that for the concerned band combination the DMRS enhancements are different than the value indicated by field <i>dmrs-Enhancements</i> in <i>MIMO-UE-ParametersPerTM</i> .	-
dmrs-Enhancements (in MIMO-UE-ParametersPerTM) Indicates for a particular transmission mode whether the UE supports DMRS enhancements for the indicated transmission mode.	TBD
dmrs-LessUpPTS Indicates whether the UE supports not to transmit DMRS for PUSCH in UpPTS.	No
downlinkLAA Presence of the field indicates that the UE supports downlink LAA operation including identification of downlink transmissions on LAA cell(s) for full downlink subframes, decoding of common downlink control signalling on LAA cell(s), CSI feedback for LAA cell(s), RRM measurements on LAA cell(s) based on CRS-based DRS.	-
drb-TypeSCG Indicates whether the UE supports SCG bearer.	-
drb-TypeSplit Indicates whether the UE supports split bearer except for PDCP data transfer in UL.	-
dtm Indicates whether the UE supports DTM in GERAN.	-
e-CSFB-1XRTT Indicates whether the UE supports enhanced CS fallback to CDMA2000 1xRTT or not.	Yes
e-CSFB-ConcPS-Mob1XRTT Indicates whether the UE supports concurrent enhanced CS fallback to CDMA2000 1xRTT and PS handover/ redirection to CDMA2000 HRPD.	Yes
e-CSFB-dual-1XRTT Indicates whether the UE supports enhanced CS fallback to CDMA2000 1xRTT for dual Rx/Tx configuration. This bit can only be set to supported if <i>tx-Config1XRTT</i> and <i>rx-Config1XRTT</i> are both set to dual.	Yes
e-HARQ-Pattern-FDD Indicates whether the UE supports enhanced HARQ pattern for TTI bundling operation for FDD.	Yes
emptyUnicastRegion Indicates whether the UE supports unicast reception in subframes with empty unicast control region as described in TS 36.213 [23] Clause 12. This field can be included only if <i>unicast-fembsMixedSCell</i> and <i>crossCarrierScheduling</i> are included.	No
endingDwPTS Indicates whether the UE supports reception ending with a subframe occupied for a DwPTS-duration as described in TS 36.211 [21] and TS 36.213 [23]. This field can be included only if <i>downlinkLAA</i> is included.	-
Enhanced-4TxCodebook Indicates whether the UE supports enhanced 4Tx codebook.	No
enhancedDualLayerTDD Indicates whether the UE supports enhanced dual layer (PDSCH transmission mode 8) for TDD or not.	-
ePDCCH Indicates whether the UE can receive DCI on UE specific search space on Enhanced PDCCH.	Yes
e-RedirectionUTRA	Yes
e-RedirectionUTRA-TDD Indicates whether the UE supports enhanced redirection to UTRA TDD to multiple carrier frequencies both with and without using related SIB provided by <i>RRCCConnectionRelease</i> or not.	Yes
extendedFreqPriorities Indicates whether the UE supports extended E-UTRA frequency priorities indicated by <i>cellReselectionSubPriority</i> field.	-
extendedLongDRX Indicates whether the UE supports extended long DRX cycle values of 5.12s and 10.24s in RRC_CONNECTED.	-
extendedMAC-LengthField Indicates whether the UE supports the MAC header with L field of size 16 bits as specified in TS 36.321 [6, 6.2.1].	-
extendedMaxMeasId Indicates whether the UE supports extended number of measurement identities as defined by <i>maxMeasId-r12</i> .	No

UE-EUTRA-Capability field descriptions	FDD/ TDD diff
extendedMaxObjectId Indicates whether the UE supports extended number of measurement object identities as defined by <i>maxObjectId-r13</i> .	No
extendedPollByte Indicates whether the UE supports extended pollByte values as defined by <i>pollByte-r14</i> .	-
extended-RLC-LI-Field Indicates whether the UE supports 15 bit RLC length indicator.	-
extendedRLC-SN-SO-Field Indicates whether the UE supports 16 bits of RLC sequence number and segmentation offset.	-
extendedRSRQ-LowerRange Indicates whether the UE supports the extended RSRQ lower value range from -34dB to -19.5dB in measurement configuration and reporting as specified in TS 36.133 [16].	No
fdd-HARQ-TimingTDD Indicates whether UE supports FDD HARQ timing for TDD SCell when configured with TDD PCell.	Yes
featureGroupIndicators, featureGroupIndRel9Add, featureGroupIndRel10 The definitions of the bits in the bit string are described in Annex B.1 (for <i>featureGroupIndicators</i> and <i>featureGroupIndRel9Add</i>) and in Annex C.1 (for <i>featureGroupIndRel10</i>).	Yes
fembmsMixedCell Indicates whether the UE in RRC_CONNECTED supports MBMS reception with 15 kHz subcarrier spacings via MBSFN from FeMBMS/Unicast mixed cells on a frequency indicated in an <i>MBMSInterestIndication</i> message.	
fembmsDedicatedCell Indicates whether the UE in RRC_CONNECTED supports MBMS reception with 15 kHz subcarrier spacings via MBSFN from MBMS-dedicated cells on a frequency indicated in an <i>MBMSInterestIndication</i> message.	
fourLayerTM3-TM4 Indicates whether the UE supports 4-layer spatial multiplexing for TM3 and TM4.	-
fourLayerTM3-TM4-perCC Indicates whether the UE supports 4-layer spatial multiplexing for TM3 and TM4 for the component carrier.	-
freqBandPriorityAdjustment Indicates whether the UE supports the prioritization of frequency bands in <i>multiBandInfoList</i> over the band in <i>freqBandIndicator</i> as defined by <i>freqBandIndicatorPriority-r12</i> .	-
freqBandRetrieval Indicates whether the UE supports reception of <i>requestedFrequencyBands</i> .	-
halfDuplex If <i>halfDuplex</i> is set to true, only half duplex operation is supported for the band, otherwise full duplex operation is supported.	-
hybridCSI Indicates whether the UE supports hybrid CSI transmission as described in TS 36.213 [23].	FFS
incMonEUTRA Indicates whether the UE supports increased number of E-UTRA carrier monitoring in RRC_IDLE and RRC_CONNECTED, as specified in TS 36.133 [16].	No
incMonUTRA Indicates whether the UE supports increased number of UTRA carrier monitoring in RRC_IDLE and RRC_CONNECTED, as specified in TS 36.133 [16].	No
inDeviceCoexInd Indicates whether the UE supports in-device coexistence indication as well as autonomous denial functionality.	Yes
inDeviceCoexInd-HardwareSharingInd Indicates whether the UE supports indicating hardware sharing problems when sending the <i>InDeviceCoexIndication</i> , as well as omitting the TDM assistance information. A UE that supports hardware sharing indication shall also indicate support of LAA operation.	-
inDeviceCoexInd-UL-CA Indicates whether the UE supports UL CA related in-device coexistence indication. This field can be included only if <i>inDeviceCoexInd</i> is included. The UE supports <i>inDeviceCoexInd-UL-CA</i> in the same duplexing modes as it supports <i>inDeviceCoexInd</i> .	-

UE-EUTRA-Capability field descriptions	FDD/ TDD diff
interBandTDD-CA-WithDifferentConfig Indicates whether the UE supports inter-band TDD carrier aggregation with different UL/DL configuration combinations. The first bit indicates UE supports the configuration combination of SCell DL subframes are a subset of PCell and PSCell by SIB1 configuration and the configuration combination of SCell DL subframes are a superset of PCell and PSCell by SIB1 configuration; the second bit indicates UE supports the configuration combination of SCell DL subframes are neither superset nor subset of PCell and PSCell by SIB1 configuration. This field is included only if UE supports inter-band TDD carrier aggregation.	-
interferenceMeasRestriction Indicates whether the UE supports interference measurement restriction.	TBD
interFreqBandList One entry corresponding to each supported E-UTRA band listed in the same order as in <i>supportedBandListEUTRA</i> .	-
interFreqNeedForGaps Indicates need for measurement gaps when operating on the E-UTRA band given by the entry in <i>bandListEUTRA</i> or on the E-UTRA band combination given by the entry in <i>bandCombinationListEUTRA</i> and measuring on the E-UTRA band given by the entry in <i>interFreqBandList</i> .	-
interFreqProximityIndication Indicates whether the UE supports proximity indication for inter-frequency E-UTRAN CSG member cells.	-
interFreqRSTD-Measurement Indicates whether the UE supports inter-frequency RSTD measurements for OTDOA positioning [54].	Yes
interFreqSI-AcquisitionForHO Indicates whether the UE supports, upon configuration of si-RequestForHO by the network, acquisition and reporting of relevant information using autonomous gaps by reading the SI from a neighbouring inter-frequency cell.	Yes
interRAT-BandList One entry corresponding to each supported band of another RAT listed in the same order as in the <i>interRAT-Parameters</i> .	-
interRAT-NeedForGaps Indicates need for DL measurement gaps when operating on the E-UTRA band given by the entry in <i>bandListEUTRA</i> or on the E-UTRA band combination given by the entry in <i>bandCombinationListEUTRA</i> and measuring on the inter-RAT band given by the entry in the <i>interRAT-BandList</i> .	-
interRAT-ParametersWLAN Indicates whether the UE supports WLAN measurements configured by <i>MeasObjectWLAN</i> with corresponding quantity and report configuration in the supported WLAN bands.	-
interRAT-PS-HO-ToGERAN Indicates whether the UE supports inter-RAT PS handover to GERAN or not.	Yes
intraBandContiguousCC-InfoList Indicates, per serving carrier of which the corresponding bandwidth class includes multiple serving carriers (i.e. bandwidth class B, C, D and so on), the maximum number of supported layers for spatial multiplexing in DL and the maximum number of CSI processes supported. The number of entries is equal to the number of component carriers in the corresponding bandwidth class. The UE shall support the setting indicated in each entry of the list regardless of the order of entries in the list. The UE shall include the field only if it supports 4-layer spatial multiplexing in transmission mode3/4 for a subset of component carriers in the corresponding bandwidth class, or if the maximum number of supported layers for at least one component carrier is higher than <i>supportedMIMO-CapabilityDL-r10</i> in the corresponding bandwidth class, or if the number of CSI processes for at least one component carrier is higher than <i>supportedCSI-Proc-r11</i> in the corresponding band. This field may also be included for bandwidth class A but in such a case without including any sub-fields in <i>IntraBandContiguousCC-Info-r12</i> (see NOTE 6).	-
intraFreqA3-CE-ModeA Indicates whether the UE when operating in CE Mode A supports <i>eventA3</i> for intra-frequency neighbouring cells.	-
intraFreqA3-CE-ModeB Indicates whether the UE when operating in CE Mode B supports <i>eventA3</i> for intra-frequency neighbouring cells.	-
intraFreqCE-NeedForGaps Indicates need for measurement gaps when operating in CE on the E-UTRA band given by the entry in <i>supportedBandListEUTRA</i> .	-
intraFreqHO-CE-ModeA Indicates whether the UE when operating in CE Mode A supports intra-frequency handover.	-

UE-EUTRA-Capability field descriptions	FDD/ TDD diff
<i>intraFreqHO-CE-ModeB</i> Indicates whether the UE when operating in CE Mode B supports intra-frequency handover.	-
<i>intraFreqProximityIndication</i> Indicates whether the UE supports proximity indication for intra-frequency E-UTRAN CSG member cells.	-
<i>intraFreqSI-AcquisitionForHO</i> Indicates whether the UE supports, upon configuration of <i>si-RequestForHO</i> by the network, acquisition and reporting of relevant information using autonomous gaps by reading the SI from a neighbouring intra-frequency cell.	Yes
<i>k-Max (in MIMO-CA-ParametersPerBoBCPerTM)</i> If signalled, the field indicates for a particular transmission mode the maximum number of NZP CSI RS resource configurations supported within a CSI process applicable for the concerned band combination.	No
<i>k-Max (in MIMO-UE-ParametersPerTM)</i> Indicates for a particular transmission mode the maximum number of NZP CSI RS resource configurations supported within a CSI process applicable for band combinations for which the concerned capabilities are not signalled.	TBD
<i>locationReport</i> Indicates whether the UE supports reporting of its geographical location information to eNB.	-
<i>loggedMBSFNMeasurements</i> Indicates whether the UE supports logged measurements for MBSFN. A UE indicating support for logged measurements for MBSFN shall also indicate support for logged measurements in Idle mode.	-
<i>loggedMeasurementsIdle</i> Indicates whether the UE supports logged measurements in Idle mode.	-
<i>logicalChannelSR-ProhibitTimer</i> Indicates whether the UE supports the <i>logicalChannelSR-ProhibitTimer</i> as defined in TS 36.321 [6].	-
<i>longDRX-Command</i> Indicates whether the UE supports Long DRX Command MAC Control Element.	-
<i>lwa</i> Indicates whether the UE supports LTE-WLAN Aggregation (LWA). The UE which supports LWA shall also indicate support of <i>interRAT-ParametersWLAN-r13</i> .	-
<i>lwa-BufferSize</i> Indicates whether the UE supports the layer 2 buffer sizes for "with support for split bearers" as defined in Table 4.1-3 and 4.1A-3 of TS 36.306 [5] for LWA.	-
<i>lwa-HO-WithoutWT-Change</i> Indicates whether the UE supports handover where LWA configuration is retained without WT change and using LWA end-marker for PDCP key change indication for LWA operation.	-
<i>lwa-RLC-UM</i> Indicates whether the UE supports RLC UM for LWA bearer.	-
<i>lwa-SplitBearer</i> Indicates whether the UE supports the split LWA bearer (as defined in TS 36.300 [9]).	-
<i>lwa-UL</i> Indicates whether the UE supports UL transmission over WLAN for LWA bearer.	-
<i>lwip</i> Indicates whether the UE supports LTE/WLAN Radio Level Integration with IPsec Tunnel (LWIP). The UE which supports LWIP shall also indicate support of <i>interRAT-ParametersWLAN-r13</i> .	-
<i>lwip-Aggregation-DL, lwip-Aggregation-UL</i> Indicates whether the UE supports aggregation of LTE and WLAN over DL/UL LWIP. The UE that indicates support of LWIP aggregation over DL or UL shall also indicate support of <i>lwip</i> .	-
<i>makeBeforeBreak</i> Indicates whether the UE supports intra-frequency Make-Before-Break handover, and whether the UE which indicates <i>dc-Parameters</i> supports intra-frequency Make-Before-Break SeNB change, as defined in TS 36.300 [9].	-
<i>maximumCCsRetrieval</i> Indicates whether UE supports reception of <i>requestedMaxCCsDL</i> and <i>requestedMaxCCsUL</i> .	-
<i>maxLayersMIMO-Indication</i> Indicates whether the UE supports the network configuration of <i>maxLayersMIMO</i> . If the UE supports <i>fourLayerTM3-TM4</i> or <i>intraBandContiguousCC-InfoList</i> , UE supports the configuration of <i>maxLayersMIMO</i> for these two cases regardless of indicating <i>maxLayersMIMO-Indication</i> .	-

UE-EUTRA-Capability field descriptions	FDD/ TDD diff
<p>maxNumberDecoding Indicates the maximum number of blind decodes in UE-specific search space per UE in one subframe for CA with more than 5 CCs as defined in TS 36.213 [23] which is supported by the UE. The number of blind decodes supported by the UE is the field value * 32. Only values 5 to 32 can be used in this version of the specification.</p>	No
<p>maxNumberROHC-ContextSessions Set to the maximum number of concurrently active ROHC contexts supported by the UE, excluding context sessions that leave all headers uncompressed. cs2 corresponds with 2 (context sessions), cs4 corresponds with 4 and so on. The network ignores this field if the UE supports none of the ROHC profiles in <i>supportedROHC-Profiles</i>. If the UE indicates both <i>maxNumberROHC-ContextSessions</i> and <i>maxNumberROHC-ContextSessions-r14</i>, same value shall be indicated.</p>	-
<p>maxNumberUpdatedCSI-Proc Indicates the maximum number of CSI processes to be updated across CCs.</p>	No
<p>mbms-AsyncDC Indicates whether the UE in RRC_CONNECTED supports MBMS reception via MRB on a frequency indicated in an <i>MBMSInterestIndication</i> message, where (according to <i>supportedBandCombination</i>) the carriers that are or can be configured as serving cells in the MCG and the SCG are not synchronized. If this field is included, the UE shall also include <i>mbms-SCell</i> and <i>mbms-NonServingCell</i>. The field indicates that the UE supports the feature for xDD if <i>mbms-SCell</i> and <i>mbms-NonServingCell</i> are supported for xDD.</p>	-
<p>mbms-MaxBW Indicates maximum supported bandwidth (T) for MBMS reception, see TS 36.213 [23, 11.1]. If the value is set to <i>implicitValue</i>, the corresponding value of T is calculated as specified in TS 36.213 [23, 11.1]. If the value is set to <i>explicitValue</i>, the actual value of T = <i>explicitValue</i> * 40 MHz.</p>	-
<p>mbms-NonServingCell Indicates whether the UE in RRC_CONNECTED supports MBMS reception via MRB on a frequency indicated in an <i>MBMSInterestIndication</i> message, where (according to <i>supportedBandCombination</i> and to network synchronization properties) a serving cell may be additionally configured. If this field is included, the UE shall also include the <i>mbms-SCell</i> field.</p>	Yes
<p>mbms-ScalingFactor1dot25, mbms-ScalingFactor7dot5 Indicates parameter $A^{(1.25 / A^{(7.5)})}$, i.e., scaling factor for processing one unit of bandwidth corresponding to subcarrier spacing of 1.25 kHz / 7.5 kHz, with respect to one unit of bandwidth corresponding to subcarrier spacing of 15 kHz. See TS 36.213 [23, 11.1]. This field is included only if <i>subcarrierSpacingMBMS-khz1dot25 / subcarrierSpacingMBMS-khz7dot5</i> is included. This field shall be included if <i>mbms-MaxBW</i> and <i>subcarrierSpacingMBMS-khz1dot25 / subcarrierSpacingMBMS-khz7dot5</i> are included.</p>	-
<p>mbms-SCell Indicates whether the UE in RRC_CONNECTED supports MBMS reception via MRB on a frequency indicated in an <i>MBMSInterestIndication</i> message, when an SCell is configured on that frequency (regardless of whether the SCell is activated or deactivated).</p>	Yes
<p>measurementEnhancements This field defines whether UE supports measurement enhancements in high speed scenario as specified in TS 36.133 [16].</p>	-
<p>mbi-UTRA It indicates if the UE supports the signalling requirements of multiple radio frequency bands in a UTRA FDD cell, as defined in TS 25.307 [65].</p>	-
<p>MIMO-BeamformedCapabilityList A list of pairs of {k-Max, n-MaxList} values with the nth entry indicating the values that the UE supports for each CSI process in case n CSI processes would be configured.</p>	No
<p>MIMO-CapabilityDL The number of supported layers for spatial multiplexing in DL. The field may be absent for category 0 and category 1 UE in which case the number of supported layers is 1.</p>	-
<p>MIMO-CapabilityUL The number of supported layers for spatial multiplexing in UL. Absence of the field means that the number of supported layers is 1.</p>	-
<p>MIMO-CA-ParametersPerBoBC A set of MIMO parameters provided per band of a band combination. In case a subfield is absent, the concerned capabilities are the same as indicated at the per UE level (i.e. by MIMO-UE-ParametersPerTM).</p>	-

UE-EUTRA-Capability field descriptions	FDD/ TDD diff
<p>modifiedMPR-Behavior Field encoded as a bit map, where at least one bit N is set to "1" if UE supports modified MPR/A-MPR behaviour N, see TS 36.101 [42]. All remaining bits of the field are set to "0". The leading / leftmost bit (bit 0) corresponds to modified MPR/A-MPR behaviour 0, the next bit corresponds to modified MPR/A-MPR behaviour 1 and so on. Absence of this field means that UE does not support any modified MPR/A-MPR behaviour.</p>	-
<p>multiACK-CSI-reporting Indicates whether the UE supports multi-cell HARQ ACK and periodic CSI reporting and SR on PUCCH format 3.</p>	Yes
<p>multiBandInfoReport Indicates whether the UE supports the acquisition and reporting of multi band information for <i>reportCGI</i>.</p>	-
<p>multiClusterPUSCH-WithinCC</p>	Yes
<p>multiNS-Pmax Indicates whether the UE supports the mechanisms defined for cells broadcasting <i>NS-PmaxList</i>.</p>	-
<p>multipleTimingAdvance Indicates whether the UE supports multiple timing advances for each band combination listed in <i>supportedBandCombination</i>. If the band combination comprised of more than one band entry (i.e., inter-band or intra-band non-contiguous band combination), the field indicates that the same or different timing advances on different band entries are supported. If the band combination comprised of one band entry (i.e., intra-band contiguous band combination), the field indicates that the same or different timing advances across component carriers of the band entry are supported.</p>	-
<p>multipleUplinkSPS Indicates whether the UE supports multiple uplink SPS and reporting SPS assistance information. A UE indicating <i>multipleUplinkSPS</i> shall also support V2X communication via Uu, as defined in TS 36.300 [9].</p>	-
<p>must-CapabilityPerBand Indicates that UE supports MUST as specified in 36.212 [22 5.3.3.1] on the band in the band combination.</p>	-
<p>must-TM234-UpTo2Tx-r14 Indicates that the UE supports MUST operation for TM2/3/4 using up to 2Tx.</p>	-
<p>must-TM89-UpToOneInterferingLayer-r14 Indicates that the UE supports MUST operation for TM8/9 with assistance information for up to 1 interfering layer.</p>	-
<p>must-TM89-UpToThreeInterferingLayers-r14 Indicates that the UE supports MUST operation for TM8/9 with assistance information for up to 3 interfering layers.</p>	-
<p>must-TM10-UpToOneInterferingLayer-r14 Indicates that the UE supports MUST operation for TM10 with assistance information for up to 1 interfering layer.</p>	-
<p>must-TM10-UpToThreeInterferingLayers-r14 Indicates that the UE supports MUST operation for TM10 with assistance information for up to 3 interfering layers.</p>	-

UE-EUTRA-Capability field descriptions	FDD/ TDD diff
<p>naics-Capability-List Indicates that UE supports NAICS, i.e. receiving assistance information from serving cell and using it to cancel or suppress interference of neighbouring cell(s) for at least one band combination. If not present, UE does not support NAICS for any band combination. The field <i>numberOfNAICS-CapableCC</i> indicates the number of component carriers where the NAICS processing is supported and the field <i>numberOfAggregatedPRB</i> indicates the maximum aggregated bandwidth across these of component carriers (expressed as a number of PRBs) with the restriction that NAICS is only supported over the full carrier bandwidth. The UE shall indicate the combination of {<i>numberOfNAICS-CapableCC</i>, <i>numberOfNAICS-CapableCC</i>} for every supported <i>numberOfNAICS-CapableCC</i>, e.g. if a UE supports {x CC, y PRBs} and {x-n CC, y-m PRBs} where $n \geq 1$ and $m \geq 0$, the UE shall indicate both.</p> <ul style="list-style-type: none"> - For <i>numberOfNAICS-CapableCC</i> = 1, UE signals one value for <i>numberOfAggregatedPRB</i> from the range {50, 75, 100}; - For <i>numberOfNAICS-CapableCC</i> = 2, UE signals one value for <i>numberOfAggregatedPRB</i> from the range {50, 75, 100, 125, 150, 175, 200}; - For <i>numberOfNAICS-CapableCC</i> = 3, UE signals one value for <i>numberOfAggregatedPRB</i> from the range {50, 75, 100, 125, 150, 175, 200, 225, 250, 275, 300}; - For <i>numberOfNAICS-CapableCC</i> = 4, UE signals one value for <i>numberOfAggregatedPRB</i> from the range {50, 100, 150, 200, 250, 300, 350, 400}; - For <i>numberOfNAICS-CapableCC</i> = 5, UE signals one value for <i>numberOfAggregatedPRB</i> from the range {50, 100, 150, 200, 250, 300, 350, 400, 450, 500}. 	No
<p>ncsg Indicates whether the UE supports measurement NCSG Pattern Id 0, 1, 2 and 3, as specified in TS 36.133 [16]. If this field is included and the UE supports asynchronous DC, the UE shall support NCSG Pattern Id 0, 1, 2 and 3. If this field is included but the UE does not support asynchronous DC, only NCSG Pattern Id 0 and 1 shall be supported</p>	No
<p>n-MaxList (in MIMO-UE-ParametersPerTM) Indicates for a particular transmission mode the maximum number of NZP CSI RS ports supported within a CSI process applicable for band combinations for which the concerned capabilities are not signalled. For <i>k-Max</i> values exceeding 1, the UE shall include the field and signal <i>k-Max</i> minus 1 bits. The first bit indicates <i>n-Max2</i>, with value 0 indicating 8 and value 1 indicating 16. The second bit indicates <i>n-Max3</i>, with value 0 indicating 8 and value 1 indicating 16. The third bit indicates <i>n-Max4</i>, with value 0 indicating 8 and value 1 indicating 32. The fourth bit indicates <i>n-Max5</i>, with value 0 indicating 16 and value 1 indicating 32. The fifth bit indicates <i>n-Max6</i>, with value 0 indicating 16 and value 1 indicating 32. The sixth bit indicates <i>n-Max7</i>, with value 0 indicating 16 and value 1 indicating 32. The seventh bit indicates <i>n-Max8</i>, with value 0 indicating 16 and value 1 indicating 64.</p>	TBD
<p>n-MaxList (in MIMO-CA-ParametersPerBoBCPerTM) If signalled, the field indicates for a particular transmission mode the maximum number of NZP CSI RS ports supported within a CSI process applicable for band the concerned combination. Further details are as indicated for <i>n-MaxList</i> in <i>MIMO-UE-ParametersPerTM</i>.</p>	No
<p>NonContiguousUL-RA-WithinCC-List One entry corresponding to each supported E-UTRA band listed in the same order as in <i>supportedBandListEUTRA</i>.</p>	No
<p>nonPrecoded (in MIMO-UE-ParametersPerTM) Indicates for a particular transmission mode the UE capabilities concerning non-precoded EBF/ FD-MIMO operation (class A) for band combinations for which the concerned capabilities are not signalled in <i>MIMO-CA-ParametersPerBoBCPerTM</i>, and the FD-MIMO processing capability condition as described in NOTE 8 is satisfied.</p>	TBD
<p>nonPrecoded (in MIMO-CA-ParametersPerBoBCPerTM) If signalled, the field indicates for a particular transmission mode, the UE capabilities concerning non-precoded EBF/ FD-MIMO operation (class A) applicable for the concerned band combination.</p>	-

UE-EUTRA-Capability field descriptions	FDD/ TDD diff
nonUniformGap Indicates whether the UE supports measurement non uniform Pattern Id 1, 2, 3 and 4 as specified in TS 36.133 [16].	No
noResourceRestrictionForTTIBundling Indicate wheter the UE supports TTI bundling operation without resource allocation restriction.	No
nonCSG-SI-Reporting Indicates whether UE will report PLMN list from non-CSG cells.	-
otdoa-UE-Assisted Indicates whether the UE supports UE-assisted OTDOA positioning [54].	Yes
outOfSequenceGrantHandling Indicates whether the UE supports PUSCH transmissions with out of sequence UL grants as defined in TS 36.213 [22]. This field can be included only if uplinkLAA is included.	-
overheatingInd Indicates whether the UE supports overheating assistance information.	No
pdccch-CandidateReductions Indicates whether the UE supports PDCCH candidate reduction on UE specific search space as specified in TS 36.213 [23, 9.1.1].	No
pdcp-SN-Extension Indicates whether the UE supports 15 bit length of PDCP sequence number.	-
pdcp-SN-Extension-18bits Indicates whether the UE supports 18 bit length of PDCP sequence number.	-
pdcp-TransferSplitUL Indicates whether the UE supports PDCP data transfer split in UL for the <i>drb-TypeSplit</i> as specified in TS 36.323 [8].	-
pdsch-CollisionHandling Indicates whether the UE supports PDSCH collision handling as specified in TS 36.213 [23].	No
perServingCellMeasurementGap Indicates whether the UE supports per serving cell measurement gap indication, as specified in TS 36.133 [16].	-
phy-TDD-ReConfig-FDD-PCell Indicates whether the UE supports TDD UL/DL reconfiguration for TDD serving cell(s) via monitoring PDCCH with eIMTA-RNTI on a FDD PCell, and HARQ feedback according to UL and DL HARQ reference configurations. This bit can only be set to supported only if the UE supports FDD PCell and <i>phy-TDD-ReConfig-TDD-PCell</i> is set to supported.	No
phy-TDD-ReConfig-TDD-PCell Indicates whether the UE supports TDD UL/DL reconfiguration for TDD serving cell(s) via monitoring PDCCH with eIMTA-RNTI on a TDD PCell, and HARQ feedback according to UL and DL HARQ reference configurations, and PUCCH format 3.	Yes
pmi-Disabling	Yes
powerPrefInd Indicates whether the UE supports power preference indication.	No
prach-Enhancements This field defines whether the UE supports random access preambles generated from restricted set type B in high speed scenario as specified in TS 36.211 [21].	-
pucch-Format4 Indicates whether the UE supports PUCCH format 4.	Yes
pucch-Format5 Indicates whether the UE supports PUCCH format 5.	Yes
pucch-SCell Indicates whether the UE supports PUCCH on SCell.	No
pusch-Enhancements Indicates whether the UE supports the PUSCH enhancement mode as specified in TS 36.211 [21] and TS 36.213 [23].	Yes
pusch-FeedbackMode Indicates whether the UE supports PUSCH feedback mode 3-2.	No
pusch-SRS-PowerControl-SubframeSet Indicates whether the UE supports subframe set dependent UL power control for PUSCH and SRS. This field is only applicable for UEs supporting TDD.	Yes
rach-Less Indicates whether the UE supports RACH-less handover, and whether the UE which indicates <i>dc-Parameters</i> supports RACH-less SeNB change, as defined in TS 36.300 [9].	-
rach-Report Indicates whether the UE supports delivery of rachReport.	-

UE-EUTRA-Capability field descriptions	FDD/ TDD diff
rai-Support Defines whether the UE supports release assistance indication (RAI) as specified in TS 36.321 [6] for BL UEs.	No
rclwi Indicates whether the UE supports RCLWI, i.e. reception of <i>rclwi-Configuration</i> . The UE which supports RLCWI shall also indicate support of <i>interRAT-ParametersWLAN-r13</i> . The UE which supports RCLWI and <i>wlan-IW-RAN-Rules</i> shall also support applying WLAN identifiers received in <i>rclwi-Configuration</i> for the access network selection and traffic steering rules when in RRC_IDLE.	-
recommendedBitRate Indicates whether the UE supports the bit rate recommendation message from the eNB to the UE as specified in TS 36.321 [6, 6.1.3.13].	No
recommendedBitRateQuery Indicates whether the UE supports the bit rate recommendation query message from the UE to the eNB as specified in TS 36.321 [6, 6.1.3.13]. If this field is included, the UE shall also include the <i>recommendedBitRate</i> field.	No
reducedIntNonContComb Indicates whether the UE supports receiving <i>requestReducedIntNonContComb</i> that requests the UE to exclude supported intra-band non-contiguous CA band combinations other than included in capability signalling as specified in TS 36.306 [5, 4.3.5.21].	-
reducedIntNonContCombRequested Indicates that the UE excluded supported intra-band non-contiguous CA band combinations other than included in capability signalling as specified in TS 36.306 [5, 4.3.5.21].	-
relWeightTwoLayers/ relWeightFourLayers/ relWeightEightLayers Indicates relative weight of processing FD-MIMO with 2/ 4/ 8 layers with respect to non-FD-MIMO with the same number of layers, see NOTE 8. Value v1 corresponds to relative weight of 1, value v1dot25 corresponds to relative weight of 1.25 and so on. This field can be included only if the UE supports the corresponding number of layers (i.e., 2/ 4/ 8 layers).	-
srs-CapabilityPerBandPairList Indicates, for a particular pair of bands, the SRS carrier switching parameters when switching between the band pair to transmit SRS on a PUSCH-less SCell as specified in 36.212 [22] and 36.213 [23]. If included, the UE shall include a number of entries as indicated in the following, and listed in the same order, as in <i>bandParameterList</i> for the concerned band combination: <ul style="list-style-type: none"> - For the first band, the UE shall include the same number of entries as in <i>bandParameterList</i> i.e. first entry corresponds to first band in <i>bandParameterList</i> and so on, - For the second band, the UE shall include one entry less i.e. first entry corresponds to the second band in <i>bandParameterList</i> and so on - And so on. 	-
requestedBands Indicates the frequency bands requested by E-UTRAN.	-
requestedCCsDL, requestedCCsUL Indicates the maximum number of CCs requested by E-UTRAN.	-
requestedDiffFallbackCombList Indicates the CA band combinations for which report of different UE capabilities is requested by E-UTRAN.	-
rf-RetuningTimeDL Indicates the interruption time on DL reception within a band pair during the RF retuning for switching between the band pair to transmit SRS on a PUSCH-less SCell. n0 represents 0 OFDM symbols, n0dot5 represents 0.5 OFDM symbols, n1 represents 1 OFDM symbol and so on. This field is mandatory present if switching between the band pair is supported.	-
rf-RetuningTimeUL Indicates the interruption time on UL transmission within a band pair during the RF retuning for switching between the band pair to transmit SRS on a PUSCH-less SCell. n0 represents 0 OFDM symbols, n0dot5 represents 0.5 OFDM symbols, n1 represents 1 OFDM symbol and so on. This field is mandatory present if switching between the band pair is supported.	-
rlm-ReportSupport Indicates whether the UE supports RLM event and information reporting.	
rsrqMeasWideband Indicates whether the UE can perform RSRQ measurements with wider bandwidth.	Yes
rsrq-OnAllSymbols Indicates whether the UE can perform RSRQ measurement on all OFDM symbols and also support the extended RSRQ upper value range from -3dB to 2.5dB in measurement configuration and reporting as specified in TS 36.133 [16].	No

UE-EUTRA-Capability field descriptions	FDD/ TDD diff
rs-SINR-Meas Indicates whether the UE can perform RS-SINR measurements in RRC_CONNECTED as specified in TS 36.214 [48].	-
rsi-AndChannelOccupancyReporting Indicates whether the UE supports performing measurements and reporting of RSSI and channel occupancy. This field can be included only if <i>downlinkLAA</i> is included.	-
scptm-AsyncDC Indicates whether the UE in RRC_CONNECTED supports MBMS reception via SC-MRB on a frequency indicated in an <i>MBMSInterestIndication</i> message, where (according to <i>supportedBandCombination</i>) the carriers that are or can be configured as serving cells in the MCG and the SCG are not synchronized. If this field is included, the UE shall also include <i>scptm-SCell</i> and <i>scptm-NonServingCell</i> .	Yes
scptm-NonServingCell Indicates whether the UE in RRC_CONNECTED supports MBMS reception via SC-MRB on a frequency indicated in an <i>MBMSInterestIndication</i> message, where (according to <i>supportedBandCombination</i> and to network synchronization properties) a serving cell may be additionally configured. If this field is included, the UE shall also include the <i>scptm-SCell</i> field.	Yes
scptm-Parameters Presence of the field indicates that the UE supports SC-PTM reception as specified in TS 36.306 [5].	Yes
scptm-SCell Indicates whether the UE in RRC_CONNECTED supports MBMS reception via SC-MRB on a frequency indicated in an <i>MBMSInterestIndication</i> message, when an SCell is configured on that frequency (regardless of whether the SCell is activated or deactivated).	Yes
scptm-ParallelReception Indicates whether the UE in RRC_CONNECTED supports parallel reception in the same subframe of DL-SCH transport blocks transmitted using C-RNTI/Semi-Persistent Scheduling C-RNTI and using SC-RNTI/G-RNTI as specified in TS 36.306 [5].	Yes
secondSlotStartingPosition Indicates whether the UE supports reception of subframes with second slot starting position as described in TS 36.211 [21] and TS 36.213 [23]. This field can be included only if <i>downlinkLAA</i> is included.	-
semiOL Indicates whether the UE supports semi-open-loop transmission for the indicated transmission mode.	FFS
shortMeasurementGap Indicates whether the UE supports 3ms measurement gap lengths as specified in TS 36.133 [16].	No
shortSPS-IntervalFDD Indicates whether the UE supports uplink SPS intervals shorter than 10 subframes in FDD mode.	-
shortSPS-IntervalTDD Indicates whether the UE supports uplink SPS intervals shorter than 10 subframes in TDD mode.	-
simultaneousPUCCH-PUSCH	Yes
simultaneousRx-Tx Indicates whether the UE supports simultaneous reception and transmission on different bands for each band combination listed in <i>supportedBandCombination</i> . This field is only applicable for inter-band TDD band combinations. A UE indicating support of <i>simultaneousRx-Tx</i> and <i>dc-Support-r12</i> shall support different UL/DL configurations between PCell and PSCell.	-
skipFallbackCombinations Indicates whether UE supports receiving reception of <i>requestSkipFallbackComb</i> that requests UE to exclude fallback band combinations from capability signalling.	-
skipFallbackCombRequested Indicates whether <i>requestSkipFallbackComb</i> is requested by E-UTRAN.	-
skipMonitoringDCI-Format0-1A Indicates whether UE supports blind decoding reduction on UE specific search space by not monitoring DCI Format 0 and 1A as specified in TS 36.213 [23, 9.1.1].	No
skipUplinkDynamic Indicates whether the UE supports skipping of UL transmission for an uplink grant indicated on PDCCH if no data is available for transmission as described in TS 36.321 [6].	-
skipUplinkSPS Indicates whether the UE supports skipping of UL transmission for a configured uplink grant if no data is available for transmission as described in TS 36.321 [6].	-

UE-EUTRA-Capability field descriptions	FDD/ TDD diff
sl-CongestionControl Indicates whether the UE supports Channel Busy Ratio measurement and reporting of Channel Busy Ratio measurement results to eNB for V2X sidelink communication.	-
sIss-TxRx Indicates whether the UE supports SLSS/PSBCH transmission and reception in UE autonomous resource selection mode and eNB scheduled mode in a band for V2X sidelink communication.	-
spatialBundling-HARQ-ACK Indicates whether UE supports HARQ-ACK spatial bundling on PUCCH or PUSCH as specified in TS 36.213 [23, 7.3.1 and 7.3.2].	No
srs-Enhancements Indicates whether the UE supports SRS enhancements.	TBD
srs-EnhancementsTDD Indicates whether the UE supports TDD specific SRS enhancements.	Yes
srs-FlexibleTiming Indicates whether the UE supports configuration of <i>soundingRS-FlexibleTiming-r14</i> for the corresponding band pair. For a TDD-TDD band pair, UE shall include at least one of <i>srs-FlexibleTiming</i> and/or <i>srs-HARQ-ReferenceConfig</i> when <i>rf-RetuningTimeDL</i> or <i>rf-RetuningTimeUL</i> corresponding to the band pair is larger than 1 OFDM symbol.	-
srs-HARQ-ReferenceConfig Indicates whether the UE supports configuration of <i>harq-ReferenceConfig-r14</i> for the corresponding band pair. For a TDD-TDD band pair, UE shall include at least one of <i>srs-FlexibleTiming</i> and/or <i>srs-HARQ-ReferenceConfig</i> when <i>rf-RetuningTimeDL</i> or <i>rf-RetuningTimeUL</i> corresponding to the band pair is larger than 1 OFDM symbol.	-
srs-MaxSimultaneousCCs Indicates the maximum number of simultaneously configurable target CCs for SRS switching (i.e., CCs for which <i>srs-SwitchFromServCellIndex</i> is configured) supported by the UE.	-
srs-UpPTS-6sym Indicates whether the UE supports up to 6-symbol SRS in UpPTS.	-
srvcc-FromUTRA-FDD-ToGERAN Indicates whether UE supports SRVCC handover from UTRA FDD PS HS to GERAN CS.	-
srvcc-FromUTRA-FDD-ToUTRA-FDD Indicates whether UE supports SRVCC handover from UTRA FDD PS HS to UTRA FDD CS.	-
srvcc-FromUTRA-TDD128-ToGERAN Indicates whether UE supports SRVCC handover from UTRA TDD 1.28Mcps PS HS to GERAN CS.	-
srvcc-FromUTRA-TDD128-ToUTRA-TDD128 Indicates whether UE supports SRVCC handover from UTRA TDD 1.28Mcps PS HS to UTRA TDD 1.28Mcps CS.	-
ss-CCH-InterfHandl Indicates whether the UE supports synchronisation signal and common channel interference handling.	Yes
ssp10-TDD-Only Indicates the UE supports special subframe configuration 10 when operating only in TDD carriers (i.e., not in TDD/FDD CA or TDD/FS3 CA). A UE including this field shall not include <i>tdd-SpecialSubframe-r14</i> .	-
standaloneGNSS-Location Indicates whether the UE is equipped with a standalone GNSS receiver that may be used to provide detailed location information in RRC measurement report and logged measurements.	-
subcarrierSpacingMBMS-khz7dot5, subcarrierSpacingMBMS-khz1dot25 Indicates the supported subcarrier spacings for MBSFN subframes in addition to 15 kHz subcarrier spacing. <i>subcarrierSpacingMBMS-khz1dot25</i> and <i>subcarrierSpacingMBMS-khz7dot5</i> indicates that the UE supports 1.25 and 7.5 kHz respectively for MBSFN subframes as described in TS 36.211 [21, 6.12]. This field is included only if <i>fembmsMixedCell</i> or <i>fembmsDedicatedCell</i> is included.	-
supportedBandCombination Includes the supported CA band combinations, if any, and may include all the supported non-CA bands.	-
supportedBandCombinationAdd-r11 Includes additional supported CA band combinations in case maximum number of CA band combinations of <i>supportedBandCombination</i> is exceeded.	-

UE-EUTRA-Capability field descriptions	FDD/ TDD diff
<p>SupportedBandCombinationAdd-v11d0, SupportedBandCombinationAdd-v1250, SupportedBandCombinationAdd-v1270, SupportedBandCombinationAdd-v1320, SupportedBandCombinationAdd-v1380, SupportedBandCombinationAdd-v1390, SupportedBandCombinationAdd-v1430, SupportedBandCombinationAdd-v1450, SupportedBandCombinationAdd-v1470, SupportedBandCombinationAdd-v14b0</p> <p>If included, the UE shall include the same number of entries, and listed in the same order, as in <i>SupportedBandCombinationAdd-r11</i>.</p>	-
<p>SupportedBandCombinationExt, SupportedBandCombination-v1090, SupportedBandCombination-v10i0, SupportedBandCombination-v1130, SupportedBandCombination-v1250, SupportedBandCombination-v1270, SupportedBandCombination-v1320, SupportedBandCombination-v1380, SupportedBandCombination-v1390, SupportedBandCombination-v1430, SupportedBandCombination-v1450, SupportedBandCombination-v1470, SupportedBandCombination-v14b0</p> <p>If included, the UE shall include the same number of entries, and listed in the same order, as in <i>supportedBandCombination-r10</i>.</p>	-
<p>supportedBandCombinationReduced</p> <p>Includes the supported CA band combinations, and may include the fallback CA combinations specified in TS 36.101 [42, 4.3A]. This field also indicates whether the UE supports reception of <i>requestReducedFormat</i>.</p>	-
<p>SupportedBandCombinationReduced-v1320, SupportedBandCombinationReduced-v1380, SupportedBandCombinationReduced-v1390, SupportedBandCombinationReduced-v1430, SupportedBandCombinationReduced-v1450, SupportedBandCombinationReduced-v1470, SupportedBandCombinationReduced-v14b0</p> <p>If included, the UE shall include the same number of entries, and listed in the same order, as in <i>supportedBandCombinationReduced-r13</i>.</p>	-
<p>SupportedBandGERAN</p> <p>GERAN band as defined in TS 45.005 [20].</p>	No
<p>SupportedBandList1XRTT</p> <p>One entry corresponding to each supported CDMA2000 1xRTT band class.</p>	-
<p>SupportedBandListEUTRA</p> <p>Includes the supported E-UTRA bands. This field shall include all bands which are indicated in <i>BandCombinationParameters</i>.</p>	-
<p>SupportedBandListEUTRA-v9e0, SupportedBandListEUTRA-v1250, SupportedBandListEUTRA-v1310, SupportedBandListEUTRA-v1320</p> <p>If included, the UE shall include the same number of entries, and listed in the same order, as in <i>supportedBandListEUTRA</i> (i.e. without suffix).</p>	-
<p>SupportedBandListGERAN</p>	No
<p>SupportedBandListHRPD</p> <p>One entry corresponding to each supported CDMA2000 HRPD band class.</p>	-
<p>supportedBandListWLAN</p> <p>Indicates the supported WLAN bands by the UE.</p>	-
<p>SupportedBandUTRA-FDD</p> <p>UTRA band as defined in TS 25.101 [17].</p>	-
<p>SupportedBandUTRA-TDD128</p> <p>UTRA band as defined in TS 25.102 [18].</p>	-
<p>SupportedBandUTRA-TDD384</p> <p>UTRA band as defined in TS 25.102 [18].</p>	-
<p>SupportedBandUTRA-TDD768</p> <p>UTRA band as defined in TS 25.102 [18].</p>	-
<p>supportedBandwidthCombinationSet</p> <p>The <i>supportedBandwidthCombinationSet</i> indicated for a band combination is applicable to all bandwidth classes indicated by the UE in this band combination.</p> <p>Field encoded as a bit map, where bit N is set to "1" if UE support Bandwidth Combination Set N for this band combination, see 36.101 [42]. The leading / leftmost bit (bit 0) corresponds to the Bandwidth Combination Set 0, the next bit corresponds to the Bandwidth Combination Set 1 and so on. The UE shall neither include the field for a non-CA band combination, nor for a CA band combination for which the UE only supports Bandwidth Combination Set 0.</p>	-

UE-EUTRA-Capability field descriptions	FDD/ TDD diff
<p>supportedCellGrouping This field indicates for which mapping of serving cells to cell groups (i.e. MCG or SCG) the UE supports asynchronous DC. This field is only present for a band combination with more than two but less than six band entries where the UE supports asynchronous DC. If this field is not present but asynchronous operation is supported, the UE supports all possible mappings of serving cells to cell groups for the band combination. The bitmap size is selected based on the number of entries in the combinations, i.e., in case of three entries, the bitmap corresponding to <i>threeEntries</i> is selected and so on.</p> <p>A bit in the bit string set to 1 indicates that the UE supports asynchronous DC for the cell grouping option represented by the concerned bit position. Each bit position represents a different cell grouping option, as illustrated by a table, see NOTE 5. A cell grouping option is represented by a number of bits, each representing a particular band entry in the band combination with the left-most bit referring to the band listed first in the band combination, etc. Value 0 indicates that the carriers of the corresponding band entry are mapped to a first cell group, while value 1 indicates that the carriers of the corresponding band entry are mapped to a second cell group.</p> <p>It is noted that the mapping table does not include entries with all bits set to the same value (0 or 1) as this does not represent a DC scenario (i.e. indicating that the UE supports that all carriers of the corresponding band entry are in one cell group).</p>	-
<p>supportedCSI-Proc Indicates the maximum number of CSI processes supported on a component carrier within a band. Value n1 corresponds to 1 CSI process, value n3 corresponds to 3 CSI processes, and value n4 corresponds to 4 CSI processes. If this field is included, the UE shall include the same number of entries listed in the same order as in <i>BandParameters</i>. If the UE supports at least 1 CSI process on any component carrier, then the UE shall include this field in all bands in all band combinations.</p>	-
<p>supportedNAICS-2CRS-AP If included, the UE supports NAICS for the band combination. The UE shall include a bitmap of the same length, and in the same order, as in <i>naics-Capability-List</i>, to indicate 2 CRS AP NAICS capability of the band combination. The first/ leftmost bit points to the first entry of <i>naics-Capability-List</i>, the second bit points to the second entry of <i>naics-Capability-List</i>, and so on.</p> <p>For band combinations with a single component carrier, UE is only allowed to indicate $\{numberOfNAICS-CapableCC, numberOfAggregatedPRB\} = \{1, 100\}$ if NAICS is supported.</p>	-
<p>supportRohcContextContinue Indicates whether the UE supports ROHC context continuation operation where the UE does not reset the current ROHC context upon handover.</p>	-
<p>supportedROHC-Profiles Indicates the ROHC profiles that UE supports in both uplink and downlink.</p>	-
<p>supportedUplinkOnlyROHC-Profiles Indicates the ROHC profiles that UE supports in uplink and not in downlink, see TS 36.323 [8]</p>	-
<p>tdd-SpecialSubframe Indicates whether the UE supports TDD special subframe defined in TS 36.211 [21]. A UE shall indicate <i>tdd-SpecialSubframe-r11</i> if it supports the TDD special subframes ssp7 and ssp9. A UE shall indicate <i>tdd-SpecialSubframe-r14</i> if it supports the TDD special subframe ssp10, except when <i>ssp10-TDD-Only-r14</i> is included.</p>	Yes
<p>tdd-FDD-CA-PCellDuplex The presence of this field indicates that the UE supports TDD/FDD CA in any supported band combination including at least one FDD band with <i>bandParametersUL</i> and at least one TDD band with <i>bandParametersUL</i>. The first bit is set to "1" if UE supports the TDD PCell. The second bit is set to "1" if UE supports FDD PCell. This field is included only if the UE supports band combination including at least one FDD band with <i>bandParametersUL</i> and at least one TDD band with <i>bandParametersUL</i>. If this field is included, the UE shall set at least one of the bits as "1". If this field is included with DC, then it is applicable within a CG, and the presence of this field indicates the capability of the UE to support TDD/FDD CA with at least one FDD band and at least one TDD band in the same CG, with the value indicating the support for TDD/FDD PCell (PSCell).</p>	No
<p>tdd-TTI-Bundling The presence of this field indicates whether the UE supporting TDD special subframe configuration 10 also supports TTI bundling for TDD configuration 2 and 3 when PUSCH transmission in UpPTS is configured, see TS 36.213 [23, 8.0]. If this field is present, the <i>tdd-SpecialSubframe-r14</i> or <i>ssp10-TDD-Only-r14</i> shall be present.</p>	Yes
<p>timerT312 Indicates whether the UE supports T312.</p>	No
<p>tm5-FDD Indicates whether the UE supports the PDSCH transmission mode 5 in FDD.</p>	-

UE-EUTRA-Capability field descriptions	FDD/ TDD diff
tm5-TDD Indicates whether the UE supports the PDSCH transmission mode 5 in TDD.	-
tm6-CE-ModeA Indicates whether the UE supports tm6 operation in CE mode A, see TS 36.213 [23, 7.2.3]. This field can be included only if <i>ce-ModeA</i> is included.	Yes
tm9-CE-ModeA Indicates whether the UE supports tm9 operation in CE mode A, see TS 36.213 [23, 7.2.3]. This field can be included only if <i>ce-ModeA</i> is included.	Yes
tm9-CE-ModeB Indicates whether the UE supports tm9 operation in CE mode B, see TS 36.213 [23, 7.2.3]. This field can be included only if <i>ce-ModeB</i> is included.	Yes
tm9-LAA Indicates whether the UE supports tm9 operation on LAA cell(s). This field can be included only if <i>downlinkLAA</i> is included.	-
tm9-With-8Tx-FDD Indicates whether the UE supports PDSCH transmission mode 9 with 8 CSI reference signal ports for FDD when not operating in CE mode.	Yes
tm10-LAA Indicates whether the UE supports tm10 operation on LAA cell(s). This field can be included only if <i>downlinkLAA</i> is included.	-
totalWeightedLayers Indicates total number of weighted layers the UE can process for FD-MIMO. See NOTE 8.	-
twoAntennaPortsForPUCCH	No
twoStepSchedulingTimingInfo Presence of this field indicates that the UE supports uplink scheduling using PUSCH trigger A and PUSCH trigger B (as defined in TS 36.213 [23]). This field also indicates the timing between the PUSCH trigger B and the earliest time the UE supports performing the associated UL transmission. For reception of PUSCH trigger B in subframe N, value <i>nPlus1</i> indicates that the UE supports performing the UL transmission in subframe N+1, value <i>nPlus2</i> indicates that the UE supports performing the UL transmission in subframe N+2, and so on. This field can be included only if <i>uplinkLAA</i> is included.	-
txAntennaSwitchDL, txAntennaSwitchUL The presence of <i>txAntennaSwitchUL</i> indicates the UE supports transmit antenna selection for this UL band in the band combination as described in TS 36.213 [23, 8.2 and 8.7]. The field <i>txAntennaSwitchDL</i> indicates the entry number of the first-listed band with UL in the band combination that affects this DL. The field <i>txAntennaSwitchUL</i> indicates the entry number of the first-listed band with UL in the band combination that switches together with this UL. Value 1 means first entry, value 2 means second entry and so on. All DL and UL that switch together indicate the same entry number. For the case of carrier switching, the antenna switching capability for the target carrier configuration is indicated as follows: For UE configured with a set of component carriers belonging to a band combination $C_{baseline} = \{b_1(1), \dots, b_x(1), \dots, b_y(0), \dots\}$, where "1/0" denotes whether the corresponding band has an uplink, if a component carrier in b_x is to be switched to a component carrier in b_y (according to <i>srs-SwitchFromServCellIndex</i>), the antenna switching capability is derived based on band combination $C_{target} = \{b_1(1), \dots, b_x(0), \dots, b_y(1), \dots\}$.	-
txDiv-PUCCH1b-ChSelect Indicates whether the UE supports transmit diversity for PUCCH format 1b with channel selection.	Yes
uci-PUSCH-Ext Indicates whether the UE supports an extension of UCI delivering more than 22 HARQ-ACK bits on PUSCH as specified in TS 36.212 [22, 5.2.2.6] and TS 36.213 [23, 8.6.3].	No
ue-AutonomousWithFullSensing Indicates whether the UE supports transmitting PSCCH/PSSCH using UE autonomous resource selection mode with full sensing (i.e., continuous channel monitoring) for V2X sidelink communication and the UE supports maximum transmit power associated with Power class 3 V2X UE, see TS 36.101 [42].	-
ue-AutonomousWithPartialSensing Indicates whether the UE supports transmitting PSCCH/PSSCH using UE autonomous resource selection mode with partial sensing (i.e., channel monitoring in a limited set of subframes) for V2X sidelink communication and the UE supports maximum transmit power associated with Power class 3 V2X UE, see TS 36.101 [42].	-
ue-Category UE category as defined in TS 36.306 [5]. Set to values 1 to 12 in this version of the specification.	-

UE-EUTRA-Capability field descriptions	FDD/ TDD diff
ue-CategoryDL UE DL category as defined in TS 36.306 [5]. Value <i>n17</i> corresponds to UE category 17, value <i>m1</i> corresponds to UE category M1, value <i>oneBis</i> corresponds to UE category 1bis, value <i>m2</i> corresponds to UE category M2. For ASN.1 compatibility, a UE indicating DL category 0, <i>m1</i> or <i>m2</i> shall also indicate any of the categories (1..5) in <i>ue-Category</i> (without suffix), which is ignored by the eNB, a UE indicating UE category oneBis shall also indicate UE category 1 in <i>ue-Category</i> (without suffix), and a UE indicating UE category <i>m2</i> shall also indicate UE category <i>m1</i> . The field <i>ue-CategoryDL</i> is set to values 0, <i>m1</i> , <i>oneBis</i> , <i>m2</i> , 4, 6, 7, 9 to 16, <i>n17</i> , 18, 19, 20, 21 in this version of the specification.	-
ue-CategoryUL UE UL category as defined in TS 36.306 [5]. Value <i>n14</i> corresponds to UE category 14, value <i>m1</i> corresponds to UE category M1, value <i>oneBis</i> corresponds to UE category 1bis. The field <i>ue-CategoryUL</i> is set to values <i>m1</i> , 0, <i>oneBis</i> , 3, 5, 7, 8, 13, <i>n14</i> or 15 to 20 in this version of the specification. Value <i>n21</i> corresponds to UE category 21.	-
ue-CA-PowerClass-N Indicates whether the UE supports UE power class N in the E-UTRA band combination, see TS 36.101 [42] and TS 36.307 [78]. If <i>ue-CA-PowerClass-N</i> is not included, UE supports the default UE power class in the E-UTRA band combination, see TS 36.101 [42].	-
ue-CE-NeedUL Gaps Indicates whether the UE needs uplink gaps during continuous uplink transmission in FDD as specified in TS 36.211 [21] and TS 36.306 [5].	-
ue-PowerClass-N, ue-PowerClass-5 Indicates whether the UE supports UE power class 1, 2, 4 or 5 in the E-UTRA band, see TS 36.101 [42] and TS 36.307 [79]. UE includes either <i>ue-PowerClass-N</i> or <i>ue-PowerClass-5</i> . If neither <i>ue-PowerClass-N</i> nor <i>ue-PowerClass-5</i> is included, UE supports the default UE power class in the E-UTRA band, see TS 36.101 [42].	-
ue-Rx-TxTimeDiffMeasurements Indicates whether the UE supports Rx - Tx time difference measurements.	No
ue-SpecificRefSigsSupported	No
ue-SSTD-Meas Indicates whether the UE supports SSTD measurements between the PCell and the PSCell as specified in TS 36.214 [48] and TS 36.133 [16].	-
ue-TxAntennaSelectionSupported Except for the supported band combinations for which <i>bandParameterList-v1380</i> is included, TRUE indicates that the UE is capable of supporting UE transmit antenna selection such that all the supported bands in the band combination are affected by transmit antenna switching, as described in TS 36.213 [23, 8.7]. E-UTRAN ignores this field for band combinations for which <i>bandParameterList-v1380</i> is included.	Yes
ul-CoMP Indicates whether the UE supports UL Coordinated Multi-Point operation.	No
ul-64QAM Indicates whether the UE supports 64QAM in UL on the band. This field is only present when the field <i>ue-CategoryUL</i> indicates UL UE category that supports UL 64QAM, see TS 36.306 [5, Table 4.1A-2]. If the field is present for one band, the field shall be present for all bands including downlink only bands.	-
ul-256QAM Indicates whether the UE supports 256QAM in UL on the band in the band combination. This field is only present when the field <i>ue-CategoryUL</i> indicates UL UE category that supports 256QAM in UL, see TS 36.306 [5, Table 4.1A-2]. The UE includes this field only if the field <i>ul-256QAM-perCC-InfoList</i> is not included.	-
ul-256QAM-perCC-InfoList Indicates, per serving carrier of which the corresponding bandwidth class includes multiple serving carriers (i.e. bandwidth class B, C, D and so on), whether the UE supports 256QAM in the band combination. The number of entries is equal to the number of component carriers in the corresponding bandwidth class. The UE shall support the setting indicated in each entry of the list regardless of the order of entries in the list. This field is only present when the field <i>ue-CategoryUL</i> indicates UL UE category that supports 256QAM in UL, see TS 36.306 [5, Table 4.1A-2]. The UE includes this field only if the field <i>ul-256QAM</i> is not included.	-
ul-dmrs-Enhancements Indicates whether the UE supports UL DMRS enhancements as defined in TS 36.211 [21, clause 6.10.3A].	FFS
ul-PDCP-Delay Indicates whether the UE supports UL PDCP Packet Delay per QCI measurement as specified in TS 36.314 [71].	-
uplinkLAA Presence of the field indicates that the UE supports uplink LAA operation.	-

UE-EUTRA-Capability field descriptions	FDD/ TDD diff
uss-BlindDecodingAdjustment Indicates whether the UE supports blind decoding adjustment on UE specific search space as defined in TS 36.213 [22]. This field can be included only if uplinkLAA is included.	-
uss-BlindDecodingReduction Indicates whether the UE supports blind decoding reduction on UE specific search space by not monitoring DCI format 0A/0B/4A/4B as defined in TS 36.213 [22]. This field can be included only if uplinkLAA is included.	-
unicastFrequencyHopping Indicates whether the UE supports frequency hopping for unicast MPDCCH/PDSCH (configured by <i>mpdcch-pdsch-HoppingConfig</i>) and unicast PUSCH (configured by <i>pusch-HoppingConfig</i>).	-
unicast-fembmsMixedSCell Indicates whether the UE supports unicast reception from FeMBMS/Unicast mixed cell. This field is included only if UE supports carrier aggregation.	-
utran-ProximityIndication Indicates whether the UE supports proximity indication for UTRAN CSG member cells.	-
utran-SI-AcquisitionForHO Indicates whether the UE supports, upon configuration of si-RequestForHO by the network, acquisition and reporting of relevant information using autonomous gaps by reading the SI from a neighbouring UMTS cell.	Yes
v2x-BandwidthClassTxSL, v2x-BandwidthClassRxSL The bandwidth class for V2X sidelink transmission and reception supported by the UE as defined in TS 36.101 [42, Table 5.6G.1-3]. The UE explicitly includes all the supported bandwidth class combinations for V2X sidelink transmission or reception in the band combination signalling. Support for one bandwidth class does not implicitly indicate support for another bandwidth class.	-
v2x-eNB-Scheduled Indicates whether the UE supports transmitting PSCCH/PSSCH using dynamic scheduling, SPS in eNB scheduled mode for V2X sidelink communication, reporting SPS assistance information and the UE supports maximum transmit power associated with Power class 3 V2X UE, see TS 36.101 [42] in a band.	-
v2x-HighPower Indicates whether the UE supports maximum transmit power associated with Power class 2 V2X UE for V2X sidelink transmission in a band, see TS 36.101 [42].	-
v2x-HighReception Indicates whether the UE supports reception of 20 PSCCH in a subframe and decoding of 136 RBs per subframe counting both PSCCH and PSSCH in a band for V2X sidelink communication.	-
v2x-nonAdjacentPSCCH-PSSCH Indicates whether the UE supports transmission and reception in the configuration of non-adjacent PSCCH and PSSCH for V2X sidelink communication.	-
v2x-numberTxRxTiming Indicates the number of multiple reference TX/RX timings counted over all the configured sidelink carriers for V2X sidelink communication.	-
v2x-SupportedBandCombinationList Indicates the supported band combination list on which the UE supports simultaneous transmission and/or reception of V2X sidelink communication.	-
v2x-SupportedTxBandCombListPerBC, v2x-SupportedRxBandCombListPerBC Indicates, for a particular band combination of EUTRA, the supported band combination list among <i>v2x-SupportedBandCombinationList</i> on which the UE supports simultaneous transmission or reception of EUTRA and V2X sidelink communication respectively. The first bit refers to the first entry of <i>v2x-SupportedBandCombinationList</i> , with value 1 indicating V2X sidelink transmission/reception is supported.	-
v2x-TxWithShortResvInterval Indicates whether the UE supports 20 ms and 50 ms resource reservation periods for UE autonomous resource selection and eNB scheduled resource allocation for V2X sidelink communication.	-
voiceOverPS-HS-UTRA-FDD Indicates whether UE supports IMS voice according to GSMA IR.58 profile in UTRA FDD.	-
voiceOverPS-HS-UTRA-TDD128 Indicates whether UE supports IMS voice in UTRA TDD 1.28Mcps.	-
whiteCellList Indicates whether the UE supports EUTRA white cell listing to limit the set of cells applicable for measurements.	-

UE-EUTRA-Capability field descriptions	FDD/ TDD diff
wlan-IW-RAN-Rules Indicates whether the UE supports RAN-assisted WLAN interworking based on access network selection and traffic steering rules.	-
wlan-IW-ANDSF-Policies Indicates whether the UE supports RAN-assisted WLAN interworking based on ANDSF policies.	-
wlan-MAC-Address Indicates the WLAN MAC address of this UE.	-
wlan-PeriodicMeas Indicates whether the UE supports periodic reporting of WLAN measurements.	-
wlan-ReportAnyWLAN Indicates whether the UE supports reporting of WLANs not listed in the <i>measObjectWLAN</i> .	-
wlan-SupportedDataRate Indicates the maximum WLAN data rate supported by the UE over all LWA bearers. Actual value of supported data rate is field value * 10 Mbps (i.e., value 1 corresponds to 10 Mbps, value 2 corresponds to 20 Mbps and so on).	-
zp-CSI-RS-AperiodicInfo Indicates whether the UE supports aperiodic ZP-CSI-RS transmission for the indicated transmission mode.	FFS

NOTE 1: The IE *UE-EUTRA-Capability* does not include AS security capability information, since these are the same as the security capabilities that are signalled by NAS. Consequently, AS need not provide "man-in-the-middle" protection for the security capabilities.

NOTE 2: The column FDD/ TDD diff indicates if the UE is allowed to signal, as part of the additional capabilities for an XDD mode i.e. within *UE-EUTRA-CapabilityAddXDD-Mode-xNM*, a different value compared to the value signalled elsewhere within *UE-EUTRA-Capability* (i.e. the common value, supported for both XDD modes). A '-' is used to indicate that it is not possible to signal different values (used for fields for which the field description is provided for other reasons). Annex E specifies for which TDD and FDD serving cells a UE supporting TDD/FDD CA shall support a capability for which it indicates support within the capability signalling.

NOTE 3: The *BandCombinationParameters* for the same band combination can be included more than once.

NOTE 4: UE CA and measurement capabilities indicate the combinations of frequencies that can be configured as serving frequencies.

NOTE 5: The grouping of the cells to the first and second cell group, as indicated by *supportedCellGrouping*, is shown in the table below. The leading / leftmost bit of *supportedCellGrouping* corresponds to the Bit String Position 1.

Nr of Band Entries:	5	4	3
Length of Bit-String:	15	7	3
Bit String Position	Cell grouping option (0= first cell group, 1= second cell group)		
1	00001	0001	001
2	00010	0010	010
3	00011	0011	011
4	00100	0100	
5	00101	0101	
6	00110	0110	
7	00111	0111	
8	01000		
9	01001		
10	01010		
11	01011		
12	01100		
13	01101		
14	01110		
15	01111		

NOTE 6: UE includes the *intraBandContiguousCC-InfoList-r12* also for bandwidth class A because of the presence conditions in *BandCombinationParameters-v1270*. For example, if UE supports CA_1A_41D band combination, if UE includes the field *intraBandContiguousCC-InfoList-r12* for band 41, the UE includes *intraBandContiguousCC-InfoList-r12* also for band 1.

NOTE 7: For a UE that indicates release X in field *accessStratumRelease* but supports a feature specified in release X+ N (i.e. early UE implementation), the ASN.1 comprehension requirements are specified in Annex F.

NOTE 8: For a UE that does not include *mimo-WeightedLayersCapabilities-r13*, or for the case with no CC configured with FD-MIMO, the FD-MIMO processing capability condition is not applicable (i.e. considered as satisfied). For a UE that includes *mimo-WeightedLayersCapabilities-r13*, the FD-MIMO processing capability condition is satisfied if the equation 4.3.28.13-1 in TS 36.306 [5] is satisfied.

– UE-RadioPagingInfo

The *UE-RadioPagingInfo* IE contains UE capability information needed for paging.

UE-RadioPagingInfo information element

```
-- ASN1START
UE-RadioPagingInfo-r12 ::=
    ue-Category-v1250
    . . . .
    [ [ ue-CategoryDL-v1310
        ce-ModeA-r13
        ce-ModeB-r13
      ] ]
}
-- ASN1STOP
```

UE-RadioPagingInfo field descriptions
<p>ce-ModeA, ce-ModeB Indicates whether the UE supports operation in CE mode A and/or B, as specified in TS 36.211 [21] and TS 36.213 [23].</p>
<p>ue-Category, ue-CategoryDL UE category as defined in TS 36.306 [5]. A category M2 UE shall always include the field <i>ue-CategoryDL-v1310</i> in this version of the specification.</p>

– UE-TimersAndConstants

The IE *UE-TimersAndConstants* contains timers and constants used by the UE in either RRC_CONNECTED or RRC_IDLE.

UE-TimersAndConstants information element

```

-- ASN1START
UE-TimersAndConstants ::=
    SEQUENCE {
        t300          ENUMERATED {
            ms100, ms200, ms300, ms400, ms600, ms1000, ms1500,
            ms2000},
        t301          ENUMERATED {
            ms100, ms200, ms300, ms400, ms600, ms1000, ms1500,
            ms2000},
        t310          ENUMERATED {
            ms0, ms50, ms100, ms200, ms500, ms1000, ms2000},
        n310          ENUMERATED {
            n1, n2, n3, n4, n6, n8, n10, n20},
        t311          ENUMERATED {
            ms1000, ms3000, ms5000, ms10000, ms15000,
            ms20000, ms30000},
        n311          ENUMERATED {
            n1, n2, n3, n4, n5, n6, n8, n10},
        ...,
        [[ t300-v1310  ENUMERATED {
            ms2500, ms3000, ms3500, ms4000, ms5000, ms6000, ms8000,
            ms10000} OPTIONAL, -- Need OR
            t301-v1310  ENUMERATED {
            ms2500, ms3000, ms3500, ms4000, ms5000, ms6000, ms8000,
            ms10000} OPTIONAL -- Need OR
        ]],
        [[ t310-v1330  ENUMERATED {ms4000, ms6000}
            OPTIONAL -- Need OR
        ]],
    }
-- ASN1STOP

```

UE-TimersAndConstants field descriptions
<p>n3xy Constants are described in clause 7.4. n1 corresponds with 1, n2 corresponds with 2 and so on.</p>
<p>t3xy Timers are described in clause 7.3. Value ms0 corresponds with 0 ms, ms50 corresponds with 50 ms and so on. EUTRAN includes an extended value <i>t3xy-v1310</i> and <i>t3xy-v1330</i> only in the Bandwidth Reduced (BR) version of the SIB. UEs that support Coverage Enhancement (CE) mode B shall use the extended values <i>t3xy-v1310</i> and <i>t3xy-v1330</i>, if present, and ignore the value signaled by <i>t3xy</i> (without the suffix).</p>

– *VisitedCellInfoList*

The IE *VisitedCellInfoList* includes the mobility history information of maximum of 16 most recently visited cells or time spent outside E-UTRA. The most recently visited cell is stored first in the list. The list includes cells visited in RRC_IDLE and RRC_CONNECTED states.

***VisitedCellInfoList* information element**

```
-- ASN1START
VisitedCellInfoList-r12 ::= SEQUENCE (SIZE (1..maxCellHistory-r12)) OF VisitedCellInfo-r12
VisitedCellInfo-r12 ::=
    SEQUENCE {
        visitedCellId-r12          CHOICE {
            cellGlobalId-r12      CellGlobalIdEUTRA,
            pci-arfcn-r12          SEQUENCE {
                physCellId-r12    PhysCellId,
                carrierFreq-r12   ARFCN-ValueEUTRA-r9
            }
        }
        timeSpent-r12              INTEGER (0..4095),
        ...
    }
-- ASN1STOP
```

***VisitedCellInfoList* field descriptions**

timeSpent

This field indicates the duration of stay in the cell or outside E-UTRA approximated to the closest second. If the duration of stay exceeds 4095s, the UE shall set it to 4095s.

– *WLAN-OffloadConfig*

The IE *WLAN-OffloadConfig* includes information for traffic steering between E-UTRAN and WLAN. The fields are applicable to both RAN-assisted WLAN interworking based on access network selection and traffic steering rules and RAN-assisted WLAN interworking based on ANDSF policies unless stated otherwise in the field description.

***WLAN-OffloadConfig* information element**

```
-- ASN1START
WLAN-OffloadConfig-r12 ::=
    SEQUENCE {
        thresholdRSRP-r12          SEQUENCE {
            thresholdRSRP-Low-r12  RSRP-Range,
            thresholdRSRP-High-r12 RSRP-Range
        }
        thresholdRSRQ-r12          SEQUENCE {
            thresholdRSRQ-Low-r12  RSRQ-Range,
            thresholdRSRQ-High-r12 RSRQ-Range
        }
        thresholdRSRQ-OnAllSymbolsWithWB-r12 SEQUENCE {
            thresholdRSRQ-OnAllSymbolsWithWB-Low-r12 RSRQ-Range,
            thresholdRSRQ-OnAllSymbolsWithWB-High-r12 RSRQ-Range
        }
        thresholdRSRQ-OnAllSymbols-r12 SEQUENCE {
            thresholdRSRQ-OnAllSymbolsLow-r12 RSRQ-Range,
            thresholdRSRQ-OnAllSymbolsHigh-r12 RSRQ-Range
        }
        thresholdRSRQ-WB-r12       SEQUENCE {
            thresholdRSRQ-WB-Low-r12 RSRQ-Range,
            thresholdRSRQ-WB-High-r12 RSRQ-Range
        }
        thresholdChannelUtilization-r12 SEQUENCE {
            thresholdChannelUtilizationLow-r12 INTEGER (0..255),
            thresholdChannelUtilizationHigh-r12 INTEGER (0..255)
        }
        thresholdBackhaul-Bandwidth-r12 SEQUENCE {
            thresholdBackhaulDL-BandwidthLow-r12 WLAN-backhaulRate-r12,
            thresholdBackhaulDL-BandwidthHigh-r12 WLAN-backhaulRate-r12,
            thresholdBackhaulUL-BandwidthLow-r12 WLAN-backhaulRate-r12,
        }
    }
-- ASN1STOP
```

```

        thresholdBackhaulUL-BandwidthHigh-r12  WLAN-backhaulRate-r12
    }
    thresholdWLAN-RSSI-r12                      SEQUENCE {
        thresholdWLAN-RSSI-Low-r12              INTEGER (0..255),
        thresholdWLAN-RSSI-High-r12            INTEGER (0..255)
    }
    offloadPreferenceIndicator-r12              BIT STRING (SIZE (16))
    t-SteeringWLAN-r12                          T-Reselection
    ...
}

WLAN-backhaulRate-r12 ::=
    ENUMERATED
    {r0, r4, r8, r16, r32, r64, r128, r256, r512,
    r1024, r2048, r4096, r8192, r16384, r32768, r65536, r131072,
    r262144, r524288, r1048576, r2097152, r4194304, r8388608,
    r16777216, r33554432, r67108864, r134217728, r268435456,
    r536870912, r1073741824, r2147483648, r4294967296}

-- ASN1STOP

```

WLAN-OffloadConfig field descriptions
<p>offloadPreferenceIndicator Indicates the offload preference indicator. Parameter: OPI in TS 24.312 [66]. Only applicable to RAN-assisted WLAN interworking based on ANDSF policies.</p>
<p>thresholdBackhaulDLBandwidth-High Indicates the backhaul available downlink bandwidth threshold used by the UE for traffic steering to WLAN. Parameter: ThreshBackhRateDLWLAN, High in TS 36.304 [4]. Value in kilobits/second. Value rN corresponds to N kbps.</p>
<p>thresholdBackhaulDLBandwidth-Low Indicates the backhaul available downlink bandwidth threshold used by the UE for traffic steering to E-UTRAN. Parameter: ThreshBackhRateDLWLAN, Low in TS 36.304 [4]. Value in kilobits/second. Value rN corresponds to N kbps.</p>
<p>thresholdBackhaulULBandwidth-High Indicates the backhaul available uplink bandwidth threshold used by the UE for traffic steering to WLAN. Parameter: ThreshBackhRateULWLAN, High in TS 36.304 [4]. Value in kilobits/second. Value rN corresponds to N kbps.</p>
<p>thresholdBackhaulULBandwidth-Low Indicates the backhaul available uplink bandwidth threshold used by the UE for traffic steering to E-UTRAN. Parameter: ThreshBackhRateULWLAN, Low in TS 36.304 [4]. Value in kilobits/second. Value rN corresponds to N kbps.</p>
<p>thresholdChannelUtilization-High Indicates the WLAN channel utilization (BSS load) threshold used by the UE for traffic steering to E-UTRAN. Parameter: ThreshChUtilWLAN, High in TS 36.304 [4].</p>
<p>thresholdChannelUtilization-Low Indicates the WLAN channel utilization (BSS load) threshold used by the UE for traffic steering to WLAN. Parameter: ThreshChUtilWLAN, Low in TS 36.304 [4].</p>
<p>thresholdRSRP-High Indicates the RSRP threshold (in dBm) used by the UE for traffic steering to E-UTRAN. Parameter: ThreshServingOffloadWLAN, HighP in TS 36.304 [4].</p>
<p>thresholdRSRP-Low Indicates the RSRP threshold (in dBm) used by the UE for traffic steering to WLAN. Parameter: ThreshServingOffloadWLAN, LowP in TS 36.304 [4].</p>
<p>thresholdRSRQ-High, thresholdRSRQ-OnAllSymbolsHigh, thresholdRSRQ-WB-High, thresholdRSRQ-OnAllSymbolsWithWB-High Indicates the RSRQ threshold (in dB) used by the UE for traffic steering to E-UTRAN. Parameter: ThreshServingOffloadWLAN, HighQ in TS 36.304 [4]. The UE shall only apply one of threshold values of <i>thresholdRSRQ-OnAllSymbolsWithWB-High</i>, <i>thresholdRSRQ-OnAllSymbolsHigh</i>, <i>thresholdRSRQ-WB-High</i> and <i>thresholdRSRQ-High</i> as present in <i>wlan-OffloadConfigCommon</i> and forward this to upper layer. NOTE 1.</p>
<p>thresholdRSRQ-Low, thresholdRSRQ-OnAllSymbolsLow, thresholdRSRQ-WB-Low, thresholdRSRQ-OnAllSymbolsWithWB-Low Indicates the RSRQ threshold (in dB) used by the UE for traffic steering to WLAN. Parameter: ThreshServingOffloadWLAN, LowQ in TS 36.304 [4]. The UE shall only apply one of threshold values of <i>thresholdRSRQ-OnAllSymbolsWithWB-Low</i>, <i>thresholdRSRQ-OnAllSymbolsLow</i>, <i>thresholdRSRQ-WB-Low</i> and <i>thresholdRSRQ-Low</i> as present in <i>wlan-OffloadConfigCommon</i> and forward this to upper layer. NOTE 1.</p>
<p>thresholdWLAN-RSSI-High Indicates the WLAN RSSI threshold used by the UE for traffic steering to WLAN. Parameter: ThreshWLANRSSI, High in TS 36.304 [4]. Value 0 corresponds to -128dBm, 1 corresponds to -127dBm and so on.</p>
<p>thresholdWLAN-RSSI-Low Indicates the WLAN RSSI threshold used by the UE for traffic steering to E-UTRAN. Parameter: ThreshWLANRSSI, Low in TS 36.304 [4]. Value 0 corresponds to -128dBm, 1 corresponds to -127dBm and so on.</p>
<p>t-SteeringWLAN Indicates the timer value during which the rules should be fulfilled before starting traffic steering between E-UTRAN and WLAN. Parameter: TsteeringWLAN in TS 36.304 [4]. Only applicable to RAN-assisted WLAN interworking based on access network selection and traffic steering rules.</p>

NOTE 1: Within SIB17, E-UTRAN includes the fields corresponding to same RSRQ types as included in SIB1. E.g. if E-UTRAN includes *q-QualMinRSRQ-OnAllSymbols* in SIB1 it also includes *thresholdRSRQ-OnAllSymbols* in SIB17. Within the *RRCCONNECTIONRECONFIGURATION* message E-UTRAN only includes *thresholdRSRQ*, setting the value according to the RSRQ type used for E-UTRAN. The UE shall apply the RSRQ fields (RSRQ threshold, high and low) corresponding to one RSRQ type i.e. the same as it applies for E-UTRAN.

6.3.7 MBMS information elements

– *MBMS-NotificationConfig*

The IE *MBMS-NotificationConfig* specifies the MBMS notification related configuration parameters, that are applicable for all MBSFN areas.

***MBMS-NotificationConfig* information element**

```
-- ASN1START
MBMS-NotificationConfig-r9 ::=
    SEQUENCE {
        notificationRepetitionCoeff-r9    ENUMERATED {n2, n4},
        notificationOffset-r9             INTEGER (0..10),
        notificationSF-Index-r9           INTEGER (1..6)
    }
MBMS-NotificationConfig-v1430 ::=
    SEQUENCE {
        notificationSF-Index-v1430        INTEGER (7..10)
    }
-- ASN1STOP
```

***MBMS-NotificationConfig* field descriptions**

notificationOffset

Indicates, together with the *notificationRepetitionCoeff*, the radio frames in which the MCCH information change notification is scheduled i.e. the MCCH information change notification is scheduled in radio frames for which: SFN mod notification repetition period = *notificationOffset*.

notificationRepetitionCoeff

Actual change notification repetition period common for all MCCHs that are configured= shortest modification period/ *notificationRepetitionCoeff*. The 'shortest modification period' corresponds with the lowest value of *mcch-ModificationPeriod* of all MCCHs that are configured. Value n2 corresponds to coefficient 2, and so on.

notificationSF-Index

Indicates the subframe used to transmit MCCH change notifications on PDCCH. FDD: Value 1, 2, 3, 4, 5 and 6 correspond with subframe #1, #2, #3 #6, #7, and #8 respectively. Value 7, 8, 9 and 10 correspond with subframe #0, #4, #5 and #9 respectively. If *notificationSF-Index-v1430* is included, UE ignores *notificationSF-Index-r9*. TDD: Value 1, 2, 3, 4, and 5 correspond with subframe #3, #4, #7, #8, and #9 respectively.

– *MBMS-ServiceList*

The IE *MBMS-ServiceList* provides the list of MBMS services which the UE is receiving or interested to receive.

***MBMS-ServiceList* information element**

```
-- ASN1START
MBMS-ServiceList-r13 ::=
    SEQUENCE (SIZE (0..maxMBMS-ServiceListPerUE-r13)) OF MBMS-
    ServiceInfo-r13
MBMS-ServiceInfo-r13 ::=
    SEQUENCE {
        tmgi-r13          TMGI-r9
    }
-- ASN1STOP
```

– *MBSFN-AreaId*

The IE *MBSFN-AreaId* identifies an MBSFN area by means of a locally unique value at lower layers i.e. it concerns parameter N_{ID}^{MBSFN} in TS 36.211 [21, 6.10.2.1].

***MBSFN-AreaId* information element**

```
-- ASN1START
```

```
MBSFN-AreaId-r12 ::=
    INTEGER (0..255)
-- ASN1STOP
```

– MBSFN-AreaInfoList

The IE *MBSFN-AreaInfoList* contains the information required to acquire the MBMS control information associated with one or more MBSFN areas.

MBSFN-AreaInfoList information element

```
-- ASN1START
MBSFN-AreaInfoList-r9 ::=
    SEQUENCE (SIZE(1..maxMBSFN-Area)) OF MBSFN-AreaInfo-r9
MBSFN-AreaInfo-r9 ::=
    SEQUENCE {
        mbsfn-AreaId-r9          MBSFN-AreaId-r12,
        non-MBSFNregionLength    ENUMERATED {s1, s2},
        notificationIndicator-r9 INTEGER (0..7),
        mcch-Config-r9           SEQUENCE {
            mcch-RepetitionPeriod-r9    ENUMERATED {rf32, rf64, rf128, rf256},
            mcch-Offset-r9              INTEGER (0..10),
            mcch-ModificationPeriod-r9  ENUMERATED {rf512, rf1024},
            sf-AllocInfo-r9             BIT STRING (SIZE(6)),
            signallingMCS-r9            ENUMERATED {n2, n7, n13, n19}
        },
        ...,
        [[ mcch-Config-r14          SEQUENCE {
            mcch-RepetitionPeriod-v1430  ENUMERATED {rf1, rf2, rf4, rf8,
            rf16 } OPTIONAL, -- Need OR
            mcch-ModificationPeriod-v1430 ENUMERATED {rf1, rf2, rf4, rf8, rf16, rf32, rf64, rf128,
            rf256, spare7} OPTIONAL -- Need OR
        } OPTIONAL, -- Need OR
        subcarrierSpacingMBMS-r14      ENUMERATED {khz-7dot5, khz-1dot25} OPTIONAL -- Need OR
    ]]
    }
-- ASN1STOP
```

MBSFN-AreaInfoList field descriptions	
<i>mcch-ModificationPeriod</i>	Defines periodically appearing boundaries, i.e. radio frames for which $SFN \bmod mcch-ModificationPeriod = 0$. The contents of different transmissions of MCCH information can only be different if there is at least one such boundary in-between them. In case <i>mcch-ModificationPeriod-v1430</i> is configured, the UE shall ignore the <i>mcch-ModificationPeriod-r9</i> .
<i>mcch-Offset</i>	Indicates, together with the <i>mcch-RepetitionPeriod</i> , the radio frames in which MCCH is scheduled i.e. MCCH is scheduled in radio frames for which: $SFN \bmod mcch-RepetitionPeriod = mcch-Offset$.
<i>mcch-RepetitionPeriod</i>	Defines the interval between transmissions of MCCH information, in radio frames, Value rf32 corresponds to 32 radio frames, rf64 corresponds to 64 radio frames and so on. In case <i>mcch-RepetitionPeriod-v1430</i> is configured, the UE shall ignore the <i>mcch-RepetitionPeriod-r9</i> .
<i>non-MBSFNregionLength</i>	Indicates how many symbols from the beginning of the subframe constitute the non-MBSFN region. This value applies in all subframes of the MBSFN area used for PMCH transmissions as indicated in the MSI. The values s1 and s2 correspond with 1 and 2 symbols, respectively: see TS 36.211 [21, Table 6.7-1].
<i>notificationIndicator</i>	Indicates which PDCCH bit is used to notify the UE about change of the MCCH applicable for this MBSFN area. Value 0 corresponds with the least significant bit as defined in TS 36.212 [22, 5.3.3.1] and so on.
<i>sf-AllocInfo</i>	Indicates the subframes of the radio frames indicated by the <i>mcch-RepetitionPeriod</i> and the <i>mcch-Offset</i> , that may carry MCCH. Value "1" indicates that the corresponding subframe is allocated. The following mapping applies: FDD: The first/ leftmost bit defines the allocation for subframe #1 of the radio frame indicated by <i>mcch-RepetitionPeriod</i> and <i>mcch-Offset</i> , the second bit for #2, the third bit for #3, the fourth bit for #6, the fifth bit for #7 and the sixth bit for #8. TDD: The first/leftmost bit defines the allocation for subframe #3 of the radio frame indicated by <i>mcch-RepetitionPeriod</i> and <i>mcch-Offset</i> , the second bit for #4, third bit for #7, fourth bit for #8, fifth bit for #9. Uplink subframes are not allocated. The last bit is not used.
<i>signallingMCS</i>	Indicates the MCS applicable for the subframes indicated by the field <i>sf-AllocInfo</i> and for each (P)MCH that is configured for this MBSFN area, for the first subframe allocated to the (P)MCH within each MCH scheduling period (which may contain the MCH scheduling information provided by MAC). Value n2 corresponds with the value 2 for parameter I_{MCS} in TS 36.213 [23, Table 7.1.7.1-1], and so on.
<i>subcarrierSpacingMBMS</i>	The value indicates subcarrier spacing for MBSFN subframes and khz-7dot5 refers to 7.5kHz subcarrier spacing and khz-1dot25 refers to 1.25 kHz subcarrier spacing as defined in TS36.211 [21, 6.12]. These subframes do not have non-MBSFN region. If <i>subcarrierSpacingMBMS</i> is present, then <i>non-MBSFNregionLength</i> shall be ignored. EUTRAN configures parameter <i>subcarrierSpacingMBMS</i> only when the MBSFN subframes have subcarrier spacing other than 15kHz.

– MBSFN-SubframeConfig

The IE *MBSFN-SubframeConfig* defines subframes that are reserved for MBSFN in downlink.

MBSFN-SubframeConfig information element

```

-- ASN1START
MBSFN-SubframeConfig ::=
    SEQUENCE {
        radioframeAllocationPeriod    ENUMERATED {n1, n2, n4, n8, n16, n32},
        radioframeAllocationOffset    INTEGER (0..7),
        subframeAllocation            CHOICE {
            oneFrame                  BIT STRING (SIZE(6)),
            fourFrames                BIT STRING (SIZE(24))
        }
    }

MBSFN-SubframeConfig-v1430 ::=
    SEQUENCE {
        subframeAllocation-v1430     CHOICE {
            oneFrame-v1430           BIT STRING (SIZE(2)),
            fourFrames-v1430        BIT STRING (SIZE(8))
        }
    }
-- ASN1STOP

```

MBSFN-SubframeConfig field descriptions
<p>fourFrames A bit-map indicating MBSFN subframe allocation in four consecutive radio frames, "1" denotes that the corresponding subframe is allocated for MBSFN. The bitmap is interpreted as follows: FDD: Starting from the first radioframe and from the first/leftmost bit in the bitmap, the allocation applies to subframes #1, #2, #3, #6, #7, and #8 in the sequence of the four radio-frames. TDD: Starting from the first radioframe and from the first/leftmost bit in the bitmap, the allocation applies to subframes #3, #4, #7, #8, and #9 in the sequence of the four radio-frames. The last four bits are not used. E-UTRAN allocates uplink subframes only if <i>eimta-MainConfig</i> is configured.</p>
<p>fourFrames-v1430 A bit-map indicating MBSFN subframe allocation in four consecutive radio frames, "1" denotes that the corresponding subframe is allocated for MBSFN. The bitmap is interpreted as follows: FDD: Starting from the first radioframe and from the first/leftmost bit in the bitmap, the allocation applies to subframes #4 and #9 in the sequence of the four radio-frames.</p>
<p>oneFrame "1" denotes that the corresponding subframe is allocated for MBSFN. The following mapping applies: FDD: The first/leftmost bit defines the MBSFN allocation for subframe #1, the second bit for #2, third bit for #3, fourth bit for #6, fifth bit for #7, sixth bit for #8. TDD: The first/leftmost bit defines the allocation for subframe #3, the second bit for #4, third bit for #7, fourth bit for #8, fifth bit for #9. E-UTRAN allocates uplink subframes only if <i>eimta-MainConfig</i> is configured. The last bit is not used.</p>
<p>oneFrame-v1430 "1" denotes that the corresponding subframe is allocated for MBSFN. The following mapping applies: FDD: The first/leftmost bit defines the MBSFN allocation for subframe #4 and the second bit for #9.</p>
<p>radioFrameAllocationPeriod, radioFrameAllocationOffset Radio-frames that contain MBSFN subframes occur when equation $SFN \bmod radioFrameAllocationPeriod = radioFrameAllocationOffset$ is satisfied. Value $n1$ for <i>radioFrameAllocationPeriod</i> denotes value 1, $n2$ denotes value 2, and so on. When <i>fourFrames</i> is used for <i>subframeAllocation</i>, the equation defines the first radio frame referred to in the description below. Values $n1$ and $n2$ are not applicable when <i>fourFrames</i> is used.</p>
<p>subframeAllocation Defines the subframes that are allocated for MBSFN within the radio frame allocation period defined by the <i>radioFrameAllocationPeriod</i> and the <i>radioFrameAllocationOffset</i>.</p>

– PMCH-InfoList

The IE *PMCH-InfoList* specifies configuration of all PMCHs of an MBSFN area, while IE *PMCH-InfoListExt* includes additional PMCHs, i.e. extends the PMCH list using the general principles specified in 5.1.2. The information provided for an individual PMCH includes the configuration parameters of the sessions that are carried by the concerned PMCH. For all PMCH that E-UTRAN includes in *PMCH-InfoList*, the list of ongoing sessions has at least one entry.

PMCH-InfoList information element

```
-- ASN1START
PMCH-InfoList-r9 ::= SEQUENCE (SIZE (0..maxPMCH-PerMBSFN)) OF PMCH-Info-r9
PMCH-InfoListExt-r12 ::= SEQUENCE (SIZE (0..maxPMCH-PerMBSFN)) OF PMCH-InfoExt-r12
PMCH-Info-r9 ::= SEQUENCE {
    pmch-Config-r9          PMCH-Config-r9,
    mbms-SessionInfoList-r9 MBMS-SessionInfoList-r9,
    ...
}
PMCH-InfoExt-r12 ::= SEQUENCE {
    pmch-Config-r12        PMCH-Config-r12,
    mbms-SessionInfoList-r12 MBMS-SessionInfoList-r9,
    ...
}
MBMS-SessionInfoList-r9 ::= SEQUENCE (SIZE (0..maxSessionPerPMCH)) OF MBMS-SessionInfo-r9
MBMS-SessionInfo-r9 ::= SEQUENCE {
    tmgi-r9                TMGI-r9,
    sessionId-r9            OCTET STRING (SIZE (1)) OPTIONAL, -- Need OR
    logicalChannelIdentity-r9 INTEGER (0..maxSessionPerPMCH-1),
    ...
}
PMCH-Config-r9 ::= SEQUENCE {
```

```

sf-AllocEnd-r9          INTEGER (0..1535),
dataMCS-r9             INTEGER (0..28),
mch-SchedulingPeriod-r9 ENUMERATED {
    rf8, rf16, rf32, rf64, rf128, rf256, rf512, rf1024},
    ...
}

PMCH-Config-r12 ::=
    sf-AllocEnd-r12    INTEGER (0..1535),
    dataMCS-r12       CHOICE {
        normal-r12    INTEGER (0..28),
        higherOrder-r12 INTEGER (0..27)
    },
    mch-SchedulingPeriod-r12 ENUMERATED {
        rf4, rf8, rf16, rf32, rf64, rf128, rf256, rf512, rf1024},
    ...
    [[ mch-SchedulingPeriod-v1430 ENUMERATED {rf1, rf2} OPTIONAL -- Need OR
    ]]
}

TMGI-r9 ::=
    plmn-Id-r9          CHOICE {
        plmn-Index-r9  INTEGER (1..maxPLMN-r11),
        explicitValue-r9 PLMN-Identity
    },
    serviceId-r9       OCTET STRING (SIZE (3))
}

-- ASN1STOP

```

PMCH-InfoList field descriptions

dataMCS

Indicates the value for parameter I_{MCS} in TS 36.213 [23], which defines the MCS applicable for the subframes of this (P)MCH as indicated by the field *commonSF-Alloc*. Value *normal* corresponds to Table 7.1.7.1-1 and value *higherOrder* corresponds to Table 7.1.7.1-1A. The MCS does however neither apply to the subframes that may carry MCCH i.e. the subframes indicated by the field *sf-AllocInfo* within *SystemInformationBlockType13* nor for the first subframe allocated to this (P)MCH within each MCH scheduling period (which may contain the MCH scheduling information provided by MAC).

mch-SchedulingPeriod

Indicates the MCH scheduling period i.e. the periodicity used for providing MCH scheduling information at lower layers (MAC) applicable for an MCH. Value *rf8* corresponds to 8 radio frames, *rf16* corresponds to 16 radio frames and so on. The *mch-SchedulingPeriod* starts in the radio frames for which: $SFN \bmod mch-SchedulingPeriod = 0$. E-UTRAN configures *mch-SchedulingPeriod* of the (P)MCH listed first in *PMCH-InfoList* to be smaller than or equal to *mcch-RepetitionPeriod*. In case *mch-SchedulingPeriod-v1430* is configured, the UE shall ignore *mch-SchedulingPeriod-r12*.

plmn-Index

Index of the entry across the *plmn-IdentityList* fields within *SystemInformationBlockType1*.

sessionId

Indicates the optional MBMS Session Identity, which together with TMGI identifies a transmission or a possible retransmission of a specific MBMS session: see TS 29.061 [51, Clauses 20.5, 17.7.11, 17.7.15]. The field is included whenever upper layers have assigned a session identity i.e. one is available for the MBMS session in E-UTRAN.

serviceId

Uniquely identifies the identity of an MBMS service within a PLMN. The field contains octet 3- 5 of the IE Temporary Mobile Group Identity (TMGI) as defined in TS 24.008 [49]. The first octet contains the third octet of the TMGI, the second octet contains the fourth octet of the TMGI and so on.

sf-AllocEnd

Indicates the last subframe allocated to this (P)MCH within a period identified by field *commonSF-AllocPeriod*. The subframes allocated to (P)MCH corresponding with the n^{th} entry in *pmch-InfoList* are the subsequent subframes starting from either the next subframe after the subframe identified by *sf-AllocEnd* of the $(n-1)^{\text{th}}$ listed (P)MCH or, for $n=1$, the first subframe defined by field *commonSF-Alloc*, through the subframe identified by *sf-AllocEnd* of the n^{th} listed (P)MCH. Value 0 corresponds with the first subframe defined by field *commonSF-Alloc*.

6.3.7a SC-PTM information elements

– SC-MTCH-InfoList

The IE *SC-MTCH-InfoList* provides the list of ongoing MBMS sessions transmitted via SC-MRB and for each MBMS session, the associated G-RNTI and scheduling information.

SC-MTCH-InfoList information element

```

-- ASN1START
SC-MTCH-InfoList-r13 ::=          SEQUENCE (SIZE (0..maxSC-MTCH-r13)) OF SC-MTCH-Info-r13
SC-MTCH-Info-r13 ::=            SEQUENCE {
  mbmsSessionInfo-r13           MBMSSessionInfo-r13,
  g-RNTI-r13                    BIT STRING (SIZE (16)),
  sc-mtch-schedulingInfo-r13    SC-MTCH-SchedulingInfo-r13          OPTIONAL, -- Need
OP
  sc-mtch-neighbourCell-r13     BIT STRING (SIZE(maxNeighCell-SCPTM-r13))  OPTIONAL, --
Need OP
  ...,
  [[ p-a-r13                    ENUMERATED {
                                dB-6, dB-4dot77, dB-3, dB-1dot77,
                                dB0, dB1, dB2, dB3}          OPTIONAL  -- Need ON
  ]]
}
MBMSSessionInfo-r13 ::=        SEQUENCE {
  tmgi-r13                      TMGI-r9,
  sessionId-r13                 OCTET STRING (SIZE (1))          OPTIONAL  -- Need OR
}
SC-MTCH-SchedulingInfo-r13 ::= SEQUENCE {
  onDurationTimerSCPTM-r13     ENUMERATED {
                                psf1, psf2, psf3, psf4, psf5, psf6,
                                psf8, psf10, psf20, psf30, psf40,
                                psf50, psf60, psf80, psf100,
                                psf200},
  drx-InactivityTimerSCPTM-r13 ENUMERATED {
                                psf0, psf1, psf2, psf4, psf8,
                                psf10, psf20, psf40,
                                psf80, psf160, ps320,
                                psf640, psf960,
                                psf1280, psf1920, psf2560},
  schedulingPeriodStartOffsetSCPTM-r13 CHOICE {
    sf10                        INTEGER(0..9),
    sf20                        INTEGER(0..19),
    sf32                        INTEGER(0..31),
    sf40                        INTEGER(0..39),
    sf64                        INTEGER(0..63),
    sf80                        INTEGER(0..79),
    sf128                       INTEGER(0..127),
    sf160                       INTEGER(0..159),
    sf256                       INTEGER(0..255),
    sf320                       INTEGER(0..319),
    sf512                       INTEGER(0..511),
    sf640                       INTEGER(0..639),
    sf1024                      INTEGER(0..1023),
    sf2048                      INTEGER(0..2048),
    sf4096                      INTEGER(0..4096),
    sf8192                      INTEGER(0..8192)
  },
  ...
}
-- ASN1STOP

```

SC-MTCH-InfoList field descriptions	
drx-InactivityTimerSCPTM	Timer for SC-MTCH in TS 36.321 [6]. Value in number of PDCCH sub-frames. Value psf0 corresponds to 0 PDCCH sub-frame and behaviour as specified in 7.3.2 applies, psf1 corresponds to 1 PDCCH sub-frame, psf2 corresponds to 2 PDCCH sub-frames and so on.
g-RNTI	G-RNTI used to scramble the scheduling and transmission of a SC-MTCH.
mbmsSessionInfo	Indicates the ongoing MBMS session in a SC-MTCH.
onDurationTimerSCPTM	Timer for SC-MTCH reception in TS 36.321 [6]. Value in number of PDCCH sub-frames. Value psf1 corresponds to 1 PDCCH sub-frame, psf2 corresponds to 2 PDCCH sub-frames and so on.
p-a	Parameter: P_A'' , for the SC-MTCH per G-RNTI, see TS 36.213 [23, 5.2]. Value dB-6 corresponds to -6 dB, dB-4dot77 corresponds to -4.77 dB etc.
schedulingPeriodStartOffsetSCPTM	<i>SCPTM-SchedulingCycle</i> and <i>SCPTM-SchedulingOffset</i> in TS 36.321 [6]. The value of <i>SCPTM-SchedulingCycle</i> is in number of sub-frames. Value sf10 corresponds to 10 sub-frames, sf20 corresponds to 20 sub-frames and so on. The value of <i>SCPTM-SchedulingOffset</i> is in number of sub-frames. The E-UTRAN does not configure a maximum value 2048 for sf2048, 4096 for sf4096 or 8192 for sf8192.
sc-mtch-neighbourCell	Indicates neighbour cells which also provide this service on SC-MTCH. The first bit is set to 1 if the service is provided on SC-MTCH in the first cell in <i>scptmNeighbourCellList</i> , otherwise it is set to 0. The second bit is set to 1 if the service is provided on SC-MTCH in the second cell in <i>scptmNeighbourCellList</i> , and so on. If this field is absent, the UE shall assume that this service is not available on SC-MTCH in any neighbour cell.
sc-mtch-schedulingInfo	DRX information for the SC-MTCH. If this field is absent, the SC-MTCH may be scheduled in any subframe.

SC-MTCH-InfoList-BR

The IE *SC-MTCH-InfoList-BR* provides the list of ongoing MBMS sessions transmitted via SC-MRB and for each MBMS session, the associated G-RNTI and scheduling information.

SC-MTCH-InfoList-BR information element

```

-- ASN1START
SC-MTCH-InfoList-BR-r14 ::= SEQUENCE (SIZE (0..maxSC-MTCH-BR-r14)) OF SC-MTCH-Info-BR-r14

SC-MTCH-Info-BR-r14 ::= SEQUENCE {
    sc-mtch-CarrierFreq-r14 ARFCN-ValueEUTRA-r9,
    mbmsSessionInfo-r14 MBMSSessionInfo-r13,
    g-RNTI-r14 BIT STRING(SIZE(16)),
    sc-mtch-schedulingInfo-r14 SC-MTCH-SchedulingInfo-BR-r14 OPTIONAL, --
Need OP
    sc-mtch-neighbourCell-r14 BIT STRING (SIZE(maxNeighCell-SCPTM-r13)) OPTIONAL, --
Need OP
    mpdcch-Narrowband-SC-MTCH-r14 INTEGER (1.. maxAvailNarrowBands-r13),
    mpdcch-NumRepetition-SC-MTCH-r14 ENUMERATED {r1, r2, r4, r8, r16,
    r32, r64, r128, r256},
    mpdcch-StartSF-SC-MTCH-r14 CHOICE {
        fdd-r14 ENUMERATED {v1, v1dot5, v2, v2dot5, v4,
        v5, v8, v10},
        tdd-r14 ENUMERATED {v1, v2, v4, v5, v8, v10,
        v20}
    },
    mpdcch-PDSCH-HoppingConfig-SC-MTCH-r14 ENUMERATED {on, off},
    mpdcch-PDSCH-CEmodeConfig-SC-MTCH-r14 ENUMERATED {ce-ModeA, ce-ModeB},
    mpdcch-PDSCH-MaxBandwidth-SC-MTCH-r14 ENUMERATED {bw1dot4, bw5},
    mpdcch-Offset-SC-MTCH-r14 ENUMERATED {zero, oneEighth, oneQuarter,
    threeEighth, oneHalf, fiveEighth,
    threeQuarter, sevenEighth},
    p-a-r14 ENUMERATED { dB-6, dB-4dot77, dB-3,
    dB-1dot77, dB0, dB1, dB2,
    dB3} OPTIONAL,-- Need OR
    ...
}

SC-MTCH-SchedulingInfo-BR-r14 ::= SEQUENCE {

```

```
onDurationTimerSCPTM-r14      ENUMERATED {
                                psf300, psf400, psf500, psf600,
                                psf800, psf1000, psf1200, psf1600},
drx-InactivityTimerSCPTM-r14  ENUMERATED {
                                psf0, psf1, psf2, psf4, psf8, psf16,
                                psf32, psf64, psf128, psf256, ps512,
                                psf1024, psf2048, psf4096, psf8192, psf16384},
schedulingPeriodStartOffsetSCPTM-r14 CHOICE {
  sf10      INTEGER(0..9),
  sf20      INTEGER(0..19),
  sf32      INTEGER(0..31),
  sf40      INTEGER(0..39),
  sf64      INTEGER(0..63),
  sf80      INTEGER(0..79),
  sf128     INTEGER(0..127),
  sf160     INTEGER(0..159),
  sf256     INTEGER(0..255),
  sf320     INTEGER(0..319),
  sf512     INTEGER(0..511),
  sf640     INTEGER(0..639),
  sf1024    INTEGER(0..1023),
  sf2048    INTEGER(0..2047),
  sf4096    INTEGER(0..4095),
  sf8192    INTEGER(0..8191)
},
...
}
-- ASN1STOP
```

SC-MTCH-InfoList-BR field descriptions
drx-InactivityTimerSCPTM Timer for SC-MTCH in TS 36.321 [6]. Value in number of MPDCCH sub-frames. Value psf0 corresponds to 0 MPDCCH sub-frame and behaviour as specified in 7.3.2 applies, psf1 corresponds to 1 MPDCCH sub-frame, psf2 corresponds to 2 MPDCCH sub-frames and so on.
g-RNTI G-RNTI used to scramble the scheduling and transmission of a SC-MTCH
mbmsSessionInfo Indicates the ongoing MBMS session in a SC-MTCH.
mpdcch-Narrowband-SC-MTCH Narrowband for MPDCCH for SC-MTCH, see TS 36.213 [23].
mpdcch-NumRepetitions-SC-MTCH The maximum number of MPDCCH repetitions the UE needs to monitor for SC-MTCH, see TS 36.213 [23].
mpdcch-Offset-SC-MTCH Fractional period offset of starting subframes for MPDCCH search space for SC-MTCH, see TS 36.213 [23].
mpdcch-PDSCH-CEmodeConfig-SC-MTCH Coverage enhancement mode configuration for MPDCCH/PDSCH for SC-MTCH, see TS 36.213 [23].
mpdcch-PDSCH-HoppingConfig-SC-MTCH Frequency hopping configuration for MPDCCH/PDSCH for SC-MTCH, see TS 36.213 [23].
mpdcch-PDSCH-MaxBandwidth-SC-MTCH Maximum PDSCH channel bandwidth for SC-MTCH, see TS 36.213 [23]. Value <i>bw1dot4</i> corresponds to 1.4 MHz channel bandwidth and value <i>bw5</i> corresponds to 5 MHz channel bandwidth. Corresponding maximum TBS are specified in TS 36.213 [23, 7.1.7.2].
mpdcch-StartSF-SC-MTCH Starting subframes configuration of the MPDCCH search space for SC-MTCH, see TS 36.213 [23].
onDurationTimerSCPTM Timer for SC-MTCH reception in TS 36.321 [6]. Value in number of MPDCCH sub-frames. Value psf300 corresponds to 300 MPDCCH sub-frames, psf400 corresponds to 400 MPDCCH sub-frames and so on.
schedulingPeriodStartOffsetSCPTM <i>SCPTM-SchedulingCycle</i> and <i>SCPTM-SchedulingOffset</i> in TS 36.321 [6]. The value of <i>SCPTM-SchedulingCycle</i> is in number of sub-frames. Value sf10 corresponds to 10 sub-frames, sf20 corresponds to 20 sub-frames and so on. The value of <i>SCPTM-SchedulingOffset</i> is in number of sub-frames.
sc-mtch-CarrierFreq Downlink carrier used for multicast SC-MTCH transmissions.
sc-mtch-neighbourCell Indicates neighbour cells which also provide this service on SC-MTCH. The first bit is set to 1 if the service is provided on SC-MTCH in the first cell in <i>sctpMNeighbourCellList</i> , otherwise it is set to 0. The second bit is set to 1 if the service is provided on SC-MTCH in the second cell in <i>sctpMNeighbourCellList</i> , and so on. If this field is absent, the UE shall assume that this service is not available on SC-MTCH in any neighbour cell.
sc-mtch-schedulingInfo DRX information for the SC-MTCH. If this field is absent, DRX is not used for SC-MTCH reception.
p-a Parameter: P_A'' for the SC-MTCH per G-RNTI, see TS 36.213 [23, 5.2]. Value dB-6 corresponds to -6 dB, dB-4dot77 corresponds to -4.77 dB etc.

– SCPTM-NeighbourCellList

The IE *SCPTM-NeighbourCellList* indicates a list of neighbour cells where ongoing MBMS sessions provided via SC-MRB in the current cells are also provided.

```
-- ASN1START
SCPTM-NeighbourCellList-r13 ::= SEQUENCE (SIZE (1..maxNeighCell-SCPTM-r13)) OF PCI-ARFCN-r13
PCI-ARFCN-r13 ::= SEQUENCE {
    physCellId-r13          PhysCellId,
    carrierFreq-r13        ARFCN-ValueEUTRA-r9    OPTIONAL
}
-- ASN1STOP
```

SCPTM-NeighbourCellList field description**carrierFreq**

Indicates the frequency of the neighbour cell indicated by *physCellId*. Absence of the IE means that the neighbour cell is on the same frequency as the current cell.

6.3.8 Sidelink information elements

– *SL-AnchorCarrierFreqList-V2X*

The IE *SL-AnchorCarrierFreqList-V2X* specifies the SL V2X anchor frequencies i.e. frequencies that include inter-carrier resource configuration for V2X sidelink communication.

***SL-AnchorCarrierFreqList-V2X* information element**

```
-- ASN1START
SL-AnchorCarrierFreqList-V2X-r14 ::= SEQUENCE (SIZE (1..maxFreqV2X-r14)) OF ARFCN-ValueEUTRA-r9
-- ASN1STOP
```

– *SL-CBR-CommonTxConfigList*

The IE *SL-CBR-CommonTxConfigList* indicates the list of PSSCH transmission parameters (such as MCS, sub-channel number, retransmission number, CR limit) in *sl-CBR-PSSCH-TxConfigList*, and the list of CBR ranges in *cbr-RangeCommonConfigList*, to configure congestion control to the UE for V2X sidelink communication.

***SL-CBR-CommonTxConfigList* information element**

```
-- ASN1START
SL-CBR-CommonTxConfigList-r14 ::= SEQUENCE {
  cbr-RangeCommonConfigList-r14 SEQUENCE (SIZE (1..maxSL-V2X-CBRConfig-r14)) OF SL-CBR-Levels-
  Config-r14,
  sl-CBR-PSSCH-TxConfigList-r14 SEQUENCE (SIZE (1..maxSL-V2X-TxConfig-r14)) OF SL-CBR-PSSCH-
  TxConfig-r14
}
SL-CBR-Levels-Config-r14 ::= SEQUENCE (SIZE (1..maxCBR-Level-r14)) OF SL-CBR-r14
SL-CBR-PSSCH-TxConfig-r14 ::= SEQUENCE {
  cr-Limit-r14 INTEGER(0..10000),
  tx-Parameters-r14 SL-PSSCH-TxParameters-r14
}
SL-CBR-r14 ::= INTEGER(0..100)
-- ASN1STOP
```

SL-CBR-CommonTxConfigList field descriptions
<p>cbr-RangeCommonConfigList Indicates the list of CBR ranges. Each entry of the list indicates in <i>SL-CBR-Levels-Config</i> the upper bound of the CBR range for the respective entry. The upper bounds of the CBR ranges are configured in ascending order for consecutive entries of <i>cbr-RangeCommonConfigList</i>. For the first entry of <i>cbr-RangeCommonConfigList</i> the lower bound of the CBR range is 0.</p>
<p>cr-Limit Indicates the maximum limit on the occupancy ratio. Value 0 corresponds to 0, value 1 to 0.0001, value 2 to 0.0002, and so on (i.e. in steps of 0.0001) until value 10000, which corresponds to 1.</p>
<p>sl-CBR-PSSCH-TxConfigList Indicates the list of available PSSCH transmission parameters (such as MCS, sub-channel number, retransmission number and CR limit) configurations.</p>
<p>SL-CBR Value 0 corresponds to 0, value 1 to 0.01, value 2 to 0.02, and so on.</p>
<p>tx-Parameters Indicates PSSCH transmission parameters.</p>

– SL-CBR-PPPP-TxConfigList

The IE *SL-CBR-PPPP-TxConfigList* indicates the mapping between PSSCH transmission parameter (such as MCS, PRB number, retransmission number, CR limit) sets by using the indexes of the configurations provided in *sl-CBR-PSSCH-TxConfigList*, CBR ranges by an index to the entry of the CBR range configuration in *cbr-RangeCommonConfigList*, and PPPP ranges. It also indicates the default PSSCH transmission parameters to be used when CBR measurement results are not available.

SL-CBR-PPPP-TxConfigList information element

```

-- ASN1START
SL-CBR-PPPP-TxConfigList-r14 ::= SEQUENCE (SIZE (1..8)) OF SL-PPPP-TxConfigIndex-r14

SL-PPPP-TxConfigIndex-r14 ::= SEQUENCE {
    priorityThreshold-r14          SL-Priority-r13,
    defaultTxConfigIndex-r14      INTEGER(0..maxCBR-Level-1-r14),
    cbr-ConfigIndex-r14          INTEGER(0..maxSL-V2X-CBRConfig-1-r14),
    tx-ConfigIndexList-r14       SEQUENCE (SIZE (1..maxCBR-Level-r14)) OF Tx-ConfigIndex-r14
}

Tx-ConfigIndex-r14 ::= INTEGER(0..maxSL-V2X-TxConfig-1-r14)
-- ASN1STOP

```

SL-CBR-PPPP-TxConfigList field descriptions
<p>cbr-ConfigIndex Indicates the CBR ranges to be used by an index to the entry of the CBR range configuration in <i>cbr-RangeCommonConfigList</i>.</p>
<p>defaultTxConfigIndex Indicates the PSSCH transmission parameters to be used by the UEs which do not have available CBR measurement results, by means of an index to the corresponding entry in <i>tx-ConfigIndexList</i>. Value 0 indicates the first entry in <i>tx-ConfigIndexList</i>. The field is ignored if the UE has available CBR measurement results.</p>
<p>priorityThreshold Indicates the upper bound of PPPP range which is associated with the configurations in <i>cbr-ConfigIndex</i> and in <i>tx-ConfigIndexList</i>. The upper bounds of the PPPP ranges are configured in ascending order for consecutive entries of <i>SL-PPPP-TxConfigIndex</i> in <i>SL-CBR-PPPP-TxConfigList</i>. For the first entry of <i>SL-PPPP-TxConfigIndex</i>, the lower bound of the PPPP range is 1.</p>
<p>tx-ConfigIndexList Indicates the list of the PSSCH transmission parameters and CR limit by the indexes to the entries of the configurations in <i>sl-CBR-PSSCH-TxConfigList</i>. Each index in <i>tx-ConfigIndexList</i> sequentially maps to each CBR range indicated by <i>cbr-ConfigIndex</i>.</p>

– SL-CommConfig

The IE *SL-CommConfig* specifies the dedicated configuration information for sidelink communication. In particular it concerns the transmission resource configuration for sidelink communication on the primary frequency.

SL-CommConfig information element

```

-- ASN1START
SL-CommConfig-r12 ::= SEQUENCE {
  commTxResources-r12 CHOICE {
    release NULL,
    setup CHOICE {
      scheduled-r12 SEQUENCE {
        sl-RNTI-r12 C-RNTI,
        mac-MainConfig-r12 MAC-MainConfigSL-r12,
        sc-CommTxConfig-r12 SL-CommResourcePool-r12,
        mcs-r12 INTEGER (0..28) OPTIONAL -- Need OP
      },
      ue-Selected-r12 SEQUENCE {
        -- Pool for normal usage
        commTxPoolNormalDedicated-r12 SEQUENCE {
          poolToReleaseList-r12 SL-TxPoolToReleaseList-r12 OPTIONAL, -- Need
ON
          poolToAddModList-r12 SL-CommTxPoolToAddModList-r12 OPTIONAL -- Need
ON
        }
      }
    }
  } OPTIONAL, -- Need ON
  ...
  [[ commTxResources-v1310 CHOICE {
    release NULL,
    setup CHOICE {
      scheduled-v1310 SEQUENCE {
        logicalChGroupInfoList-r13 LogicalChGroupInfoList-r13,
        multipleTx-r13 BOOLEAN
      },
      ue-Selected-v1310 SEQUENCE {
        commTxPoolNormalDedicatedExt-r13 SEQUENCE {
          poolToReleaseListExt-r13 SL-TxPoolToReleaseListExt-r13 OPTIONAL,
-- Need ON
          poolToAddModListExt-r13 SL-CommTxPoolToAddModListExt-r13
OPTIONAL -- Need ON
        }
      }
    }
  } OPTIONAL, -- Need ON
  ] ]
}

LogicalChGroupInfoList-r13 ::= SEQUENCE (SIZE (1..maxLCG-r13)) OF SL-PriorityList-r13

SL-CommTxPoolToAddModList-r12 ::= SEQUENCE (SIZE (1..maxSL-TxPool-r12)) OF SL-
CommTxPoolToAddMod-r12

SL-CommTxPoolToAddModListExt-r13 ::= SEQUENCE (SIZE (1..maxSL-TxPool-v1310)) OF SL-
CommTxPoolToAddModExt-r13

SL-CommTxPoolToAddMod-r12 ::= SEQUENCE {
  poolIdentity-r12 SL-TxPoolIdentity-r12,
  pool-r12 SL-CommResourcePool-r12
}

SL-CommTxPoolToAddModExt-r13 ::= SEQUENCE {
  poolIdentity-v1310 SL-TxPoolIdentity-v1310,
  pool-r13 SL-CommResourcePool-r12
}

MAC-MainConfigSL-r12 ::= SEQUENCE {
  periodic-BSR-TimerSL PeriodicBSR-Timer-r12 OPTIONAL, -- Need ON
  retx-BSR-TimerSL RetxBSR-Timer-r12
}
-- ASN1STOP

```

SL-CommConfig field descriptions	
commTxAllowRelayDedicated	Indicates whether the UE is allowed to transmit relay related sidelink communication using the configured dedicated transmission resources i.e. either via scheduled or via UE selected resources.
commTxPoolNormalDedicated	Indicates a pool of transmission resources the UE is allowed to use while in RRC_CONNECTED.
logicalChGroupInfoList	Indicates for each logical channel group the list of associated priorities, used as specified in TS 36.321 [6], in order of increasing logical channel group identity.
mcs	Indicates the MCS as defined in TS 36.212 [23, 14.2.1]. If not configured, the selection of MCS is up to UE implementation.
multipleTx	Indicates whether the UE should perform multiple transmissions to different destinations in one SC period in accordance with TS 36.321 [6, 5.14.1.1]. Value TRUE indicates that multiple transmissions should be performed.
sc-CommTxConfig	Indicates a pool of resources for SC when E-UTRAN schedules Tx resources (i.e. when indices included in DCI format 5 indicate the actual data resources to be used as specified in TS 36.212 [22, 5.3.3.1.9]).
scheduled	Indicates the configuration for the case E-UTRAN schedules the transmission resources based on sidelink specific BSR from the UE.
ue-Selected	Indicates the configuration for the case the UE selects the transmission resources from a pool of resources configured by E-UTRAN.

– SL-CommResourcePool

The IE *SL-CommResourcePool* and *SL-CommResourcePoolV2X* specifies the configuration information for an individual pool of resources for sidelink communication and V2X sidelink communication respectively. The IE covers the configuration of both the sidelink control information and the data.

SL-CommResourcePool information element

```

-- ASN1START
SL-CommTxPoolList-r12 ::= SEQUENCE (SIZE (1..maxSL-TxPool-r12)) OF SL-CommResourcePool-r12
SL-CommTxPoolListExt-r13 ::= SEQUENCE (SIZE (1..maxSL-TxPool-v1310)) OF SL-CommResourcePool-r12
SL-CommTxPoolListV2X-r14 ::= SEQUENCE (SIZE (1..maxSL-V2X-TxPool-r14)) OF SL-
CommResourcePoolV2X-r14
SL-CommRxPoolList-r12 ::= SEQUENCE (SIZE (1..maxSL-RxPool-r12)) OF SL-CommResourcePool-r12
SL-CommRxPoolListV2X-r14 ::= SEQUENCE (SIZE (1..maxSL-V2X-RxPool-r14)) OF SL-
CommResourcePoolV2X-r14
SL-CommResourcePool-r12 ::= SEQUENCE {
    sc-CP-Len-r12 SL-CP-Len-r12,
    sc-Period-r12 SL-PeriodComm-r12,
    sc-TF-ResourceConfig-r12 SL-TF-ResourceConfig-r12,
    data-CP-Len-r12 SL-CP-Len-r12,
    dataHoppingConfig-r12 SL-HoppingConfigComm-r12,
    ue-SelectedResourceConfig-r12 SEQUENCE {
        data-TF-ResourceConfig-r12 SL-TF-ResourceConfig-r12,
        trpt-Subset-r12 SL-TRPT-Subset-r12 OPTIONAL -- Need OP
    }
    rxParametersNCell-r12 SEQUENCE {
        tdd-Config-r12 TDD-Config OPTIONAL, -- Need OP
        syncConfigIndex-r12 INTEGER (0..15) OPTIONAL, -- Need OR
    }
    txParameters-r12 SEQUENCE {
        sc-TxParameters-r12 SL-TxParameters-r12,
        dataTxParameters-r12 SL-TxParameters-r12
    }
    ...,
    [[ priorityList-r13 SL-PriorityList-r13 OPTIONAL -- Cond Tx
]]

```

```

}
SL-CommResourcePoolV2X-r14 ::= SEQUENCE {
  sl-OffsetIndicator-r14          SL-OffsetIndicator-r12          OPTIONAL, -- Need OR
  sl-Subframe-r14                SubframeBitmapSL-r14,
  adjacencyPSCCH-PSSCH-r14      BOOLEAN,
  sizeSubchannel-r14            ENUMERATED {
    n4, n5, n6, n8, n9, n10, n12, n15, n16, n18, n20, n25, n30,
    n48, n50, n72, n75, n96, n100, spare13, spare12, spare11,
    spare10, spare9, spare8, spare7, spare6, spare5, spare4,
    spare3, spare2, spare1},
  numSubchannel-r14             ENUMERATED {n1, n3, n5, n8, n10, n15, n20, spare1},
  startRB-Subchannel-r14        INTEGER (0..99),
  startRB-PSCCH-Pool-r14        INTEGER (0..99)                OPTIONAL, -- Need OR
  rxParametersNCell-r14         SEQUENCE {
    tdd-Config-r14              TDD-Config                OPTIONAL, -- Need OP
    syncConfigIndex-r14         INTEGER (0..15)
  }
  dataTxParameters-r14          SL-TxParameters-r12          OPTIONAL, -- Cond Tx
  zoneID-r14                    INTEGER (0..7)                OPTIONAL, -- Need OR
  threshS-RSSI-CBR-r14          INTEGER (0..45)                OPTIONAL, -- Need OR
  poolReportId-r14              SL-V2X-TxPoolReportIdentity-r14  OPTIONAL, -- Need OR
  cbr-pssch-TxConfigList-r14    SL-CBR-PPPP-TxConfigList-r14  OPTIONAL, -- Need OR
  resourceSelectionConfigP2X-r14 SL-P2X-ResourceSelectionConfig-r14  OPTIONAL, -- Cond P2X
  syncAllowed-r14               SL-SyncAllowed-r14                OPTIONAL, -- Need OR
  restrictResourceReservationPeriod-r14 SL-RestrictResourceReservationPeriodList-r14
  OPTIONAL, -- Need OR
  ...
}
SL-TRPT-Subset-r12 ::= BIT STRING (SIZE (3..5))
SL-V2X-TxPoolReportIdentity-r14 ::= INTEGER (1..maxSL-PoolToMeasure-r14)
-- ASN1STOP

```

SL-CommResourcePool field descriptions
<p>adjacencyPSCCH-PSSCH Indicates whether a UE shall always transmit PSCCH and PSSCH in adjacent RBs (indicated by TRUE) or in non-adjacent RBs (indicated by FALSE) (see TS 36.213 [23]).</p>
<p>cbr-pssch-TxConfigList Indicates the mapping between PPPPs, CBR ranges by using indexes of the entry in cbr-RangeCommonConfigList, and PSSCH transmission parameters and CR limit by using indexes of the entry in sl-CBR-PSSCH-TxConfigList. If <i>SL-CommResourcePoolV2X</i> is included in <i>MobilityControlInfoV2X</i>, it refers to <i>cbr-MobilityTxConfigList</i> for <i>cbr-RangeCommonConfigList</i> and <i>sl-CBR-PSSCH-TxConfigList</i>. If <i>SL-CommResourcePoolV2X</i> is included in <i>SL-V2X-ConfigDedicated</i>, it refers to <i>cbr-DedicatedTxConfigList</i> for <i>cbr-RangeCommonConfigList</i> and <i>sl-CBR-PSSCH-TxConfigList</i>. Otherwise, it refers to <i>cbr-CommonTxConfigList</i> included in the <i>SystemInformationBlockType21</i> of the serving cell / PCell for <i>cbr-RangeCommonConfigList</i> and <i>sl-CBR-PSSCH-TxConfigList</i>.</p>
<p>numSubchannel indicates the number of subchannels in the corresponding resource pool (see TS 36.213 [23]).</p>
<p>poolReportId The identity of the transmission resource pool used for CBR measurement reporting, which is corresponding to the <i>poolIdentity</i> reported in <i>measResultListCBR</i>. This field is only present in the transmission pools configured in <i>RRCCConnectionReconfiguration</i> and <i>v2x-CommTxPoolExceptional</i>, <i>p2x-CommTxPoolNormalCommon</i>, <i>v2x-CommTxPoolNormalCommon</i>, <i>v2x-CommTxPoolNormal</i> in <i>SystemInformationBlockType21</i>. Otherwise, the field is absent.</p>
<p>resourceSelectionConfigP2X Indicates the allowed resource selection mechanism(s), i.e. partial sensing and/or random selection, for P2X related V2X sidelink communication.</p>
<p>restrictResourceReservationPeriod If configured, the field <i>restrictResourceReservationPeriod</i> configured in <i>v2x-ResourceSelectionConfig</i> shall be ignored for transmission on this pool.</p>
<p>sc-Period Indicates the period over which resources are allocated in a cell for SC and over which scheduled and UE selected data transmissions occur, see PSCCH period in TS 36.213 [23]. Value in number of subframes. Value sf40 corresponds to 40 subframes, sf80 corresponds to 80 subframes and so on. E-UTRAN configures values sf40, sf80, sf160 and sf320 for FDD and for TDD config 1 to 5, values sf70, sf140 and sf280 for TDD config 0, and finally values sf60, sf120 and sf240 for TDD config 6.</p>
<p>sizeSubchannel Indicates the number of PRBs of each subchannel in the corresponding resource pool (see TS 36.213 [23]). The value n5 denotes 5 PRBs; n6 denotes 6 PRBs and so on. E-UTRAN configures values n5, n6, n10, n15, n20, n25, n50, n75 and n100 in the case of <i>adjacencyPSCCH-PSSCH</i> set to TRUE; otherwise, E-UTRAN configures values n4, n5, n6, n8, n9, n10, n12, n15, n16, n18, n20, n30, n48, n72 and n96 in the case of <i>adjacencyPSCCH-PSSCH</i> set to FALSE,</p>
<p>sl-OffsetIndicator Indicates the offset of the first subframe of a resource pool, i.e., the starting subframe of the repeating bitmap <i>sl-Subframe</i>, within a SFN cycle. If absent, the resource pool starts from first subframe of SFN=0. This field is not applicable to V2X sidelink communication.</p>
<p>sl-Subframe Indicates the bitmap of the resource pool, which is defined by repeating the bitmap within a SFN cycle (see TS 36.213 [23]).</p>
<p>startRB-PSCCH-Pool Indicates the lowest RB index of the PSCCH pool (see TS 36.213 [23]). This field is absent when a pool is (pre)configured such that a UE always transmits SC and data in adjacent RBs in the same subframe.</p>
<p>startRB-Subchannel Indicates the lowest RB index of the subchannel with the lowest index (see TS 36.213 [23]).</p>
<p>syncAllowed Indicates the allowed synchronization reference(s) which is (are) allowed to use the configured resource pool.</p>
<p>syncConfigIndex Indicates the synchronisation configuration that is associated with a reception pool, by means of an index to the corresponding entry of <i>commSyncConfig</i> in <i>SystemInformationBlockType18</i> for sidelink communication, or by means of an index to the corresponding entry of <i>v2x-SyncConfig</i> in <i>SystemInformationBlockType21</i> for V2X sidelink communication.</p>
<p>tdd-Config TDD configuration associated with the reception pool of the cell indicated by <i>syncConfigIndex</i>. Absence of the field indicates that the duplex mode is FDD and no TDD specific physical channel configuration is applicable.</p>
<p>threshS-RSSI-CBR Indicates the S-RSSI threshold for determining the contribution of a sub-channel to the CBR measurement, as specified in TS 36.214 [48]. Value 0 corresponds to -112 dBm, value 1 to -110 dBm, value n to (-112 + n*2) dBm, and so on.</p>
<p>trpt-Subset Indicates the subset of T-RPT available (see TS 36.213 [23, 14.1.1.1.1]). Consists of a bitmap which is used to indicate the set of available 'k' values to be used for sidelink communication (see TS 36.213 [23, 14.1.1.3]). If T-RPT subset configuration is not signaled/ preconfigured then UE assumes the whole T-RPT set is available.</p>

SL-CommResourcePool field descriptions	
adjacencyPSCCH-PSSCH	Indicates whether a UE shall always transmit PSCCH and PSSCH in adjacent RBs (indicated by TRUE) or in non-adjacent RBs (indicated by FALSE) (see TS 36.213 [23]).
zoneID	Indicates the zone ID for which the UE shall use this resource pool as described in 5.10.13.2. The field is absent in <i>v2x-CommTxPoolExceptional</i> , <i>p2x-CommTxPoolNormalCommon</i> , <i>p2x-CommTxPoolNormal</i> and <i>v2x-CommRxPool</i> in SIB21 or in <i>mobilityControlInfoV2X</i> .

Conditional presence	Explanation
<i>Tx</i>	The field is mandatory present when included in <i>commTxPoolNormalDedicated</i> , <i>commTxPoolNormalDedicatedExt</i> , <i>commTxPoolNormalCommon</i> , <i>commTxPoolNormalCommonExt</i> , <i>commTxPoolExceptional</i> , <i>sc-CommTxConfig</i> , <i>v2x-CommTxPoolNormalCommon</i> , <i>v2x-CommTxPoolExceptional</i> , <i>v2x-CommTxPoolNormalDedicated</i> , <i>p2x-CommTxPoolNormalCommon</i> or <i>v2x-CommTxPoolNormal</i> and <i>p2x-CommTxPoolNormal</i> in <i>v2x-InterFreqInfoList</i> . Otherwise the field is not present.
<i>P2X</i>	The field is mandatory present when included in <i>p2x-CommTxPoolNormalCommon</i> , <i>v2x-CommTxPoolNormalDedicated</i> in <i>sl-V2X-ConfigDedicated</i> for P2X related V2X sidelink communication or <i>p2x-CommTxPoolNormal</i> in <i>v2x-InterFreqInfoList</i> . Otherwise the field is not present.

– SL-CommTxPoolSensingConfig

The IE *SL-CommTxPoolSensingConfig* specifies V2X sidelink communication configurations used for UE autonomous resource selection.

SL-CommTxPoolSensingConfig information element

```
-- ASN1START
SL-CommTxPoolSensingConfig-r14 ::= SEQUENCE {
    pssch-TxConfigList-r14          SL-PSSCH-TxConfigList-r14,
    thresPSSCH-RSRP-List-r14       SL-ThresPSSCH-RSRP-List-r14,
    restrictResourceReservationPeriod-r14  SL-RestrictResourceReservationPeriodList-r14
    OPTIONAL, -- Need OR
    probResourceKeep-r14           ENUMERATED {v0, v0dot2, v0dot4, v0dot6, v0dot8,
                                                spare3, spare2, spare1},
    p2x-SensingConfig-r14          SEQUENCE {
        minNumCandidatesSF-r14     INTEGER (1..13),
        gapCandidateSensing-r14    BIT STRING (SIZE (10))
    }
    OPTIONAL, -- Need OR
    sl-ReselectAfter-r14          ENUMERATED {n1, n2, n3, n4, n5, n6, n7, n8, n9,
                                                spare7, spare6, spare5, spare4, spare3, spare2,
                                                spare1}
    OPTIONAL -- Need OR
}
-- ASN1STOP
```

<i>SL-CommTxPoolSensingConfig</i> field descriptions
<i>gapCandidateSensing</i> Indicates which subframe should be sensed when a certain subframe is considered as a candidate resource (see TS 36.213 [23]).
<i>minNumCandidateSF</i> Indicates the minimum number of subframes that are included in the possible candidate resources.
<i>p2x-SensingConfig</i> Indicates the sensing configuration for P2X related V2X sidelink communication transmission only.
<i>probResourceKeep</i> Indicates the probability with which the UE keeps the current resource when the resource reselection counter reaches zero for sensing based UE autonomous resource selection (see TS 36.321 [6]).
<i>pssch-TxConfigList</i> Indicates PSSCH TX parameters such as MCS, PRB number, retransmission number, associated to different UE absolute speeds and different synchronization reference types for UE autonomous resource selection (see TS 36.213 [23]).
<i>restrictResourceReservationPeriod</i> Indicates which values are allowed for the signaling of the resource reservation period in PSCCH.
<i>sl-ReselectAfter</i> Indicates the number of consecutive skipped transmissions before triggering resource reselection for V2X sidelink communication (see TS 36.321 [6]).
<i>thresPSSCH-RSRP-List</i> Indicates a list of 64 thresholds, and the threshold should be selected based on the priority in the decoded SCI and the priority in the SCI to be transmitted (see TS 36.213 [23]). A resource is excluded if it is indicated or reserved by a decoded SCI and PSSCH RSRP in the associated data resource is above a threshold.

– *SL-CP-Len*

The IE *SL-CP-Len* indicates the cyclic prefix length, see TS 36.211 [21].

***SL-CP-Len* information element**

```
-- ASN1START
SL-CP-Len-r12 ::=          ENUMERATED {normal, extended}
-- ASN1STOP
```

– *SL-DiscConfig*

The IE *SL-DiscConfig* specifies the dedicated configuration information for sidelink discovery.

***SL-DiscConfig* information element**

```
-- ASN1START
SL-DiscConfig-r12 ::=
    SEQUENCE {
        discTxResources-r12          CHOICE {
            release                  NULL,
            setup                    CHOICE {
                scheduled-r12       SEQUENCE {
                    discTxConfig-r12  SL-DiscResourcePool-r12 OPTIONAL, -- Need ON
                    discTF-IndexList-r12 SL-TF-IndexPairList-r12 OPTIONAL, -- Need ON
                    discHoppingConfig-r12 SL-HoppingConfigDisc-r12
                                          OPTIONAL -- Need ON
                },
                ue-Selected-r12      SEQUENCE {
                    discTxPoolDedicated-r12 SEQUENCE {
                        poolToReleaseList-r12 SL-TxPoolToReleaseList-r12 OPTIONAL, -- Need
ON
                        poolToAddModList-r12  SL-DiscTxPoolToAddModList-r12 OPTIONAL -- Need
ON
                    }
                }
            }
        },
        ...
        [[ discTF-IndexList-v1260      CHOICE {
            release                  NULL,

```

```

        setup
        discTF-IndexList-r12b          SEQUENCE {
            SL-TF-IndexPairList-r12b
        }
    },
    ],
    [[ discTxResourcesPS-r13          CHOICE {
        release                        NULL,
        setup                          CHOICE {
            scheduled-r13             SL-DiscTxConfigScheduled-r13,
            ue-Selected-r13          SEQUENCE {
                discTxPoolPS-Dedicated-r13    SL-DiscTxPoolDedicated-r13
            }
        }
    }
    ],
    discTxInterFreqInfo-r13          CHOICE {
        release                        NULL,
        setup                          SEQUENCE {
            discTxCarrierFreq-r13        ARFCN-ValueEUTRA-r9          OPTIONAL, -- Need
OR
            discTxRefCarrierDedicated-r13    SL-DiscTxRefCarrierDedicated-r13    OPTIONAL, --
Need OR
            discTxInfoInterFreqListAdd-r13    SL-DiscTxInfoInterFreqListAdd-r13    OPTIONAL
        }
    }
    ],
    gapRequestsAllowedDedicated-r13    BOOLEAN          OPTIONAL, -- Need ON
    discRxGapConfig-r13                CHOICE {
        release                        NULL,
        setup                          SL-GapConfig-r13
    }
    ],
    discTxGapConfig-r13                CHOICE {
        release                        NULL,
        setup                          SL-GapConfig-r13
    }
    ],
    discSysInfoToReportConfig-r13      CHOICE {
        release                        NULL,
        setup                          SL-DiscSysInfoToReportFreqList-r13
    }
    ],
    ]
}

SL-DiscSysInfoToReportFreqList-r13 ::= SEQUENCE (SIZE (1..maxFreq)) OF ARFCN-ValueEUTRA-r9

SL-DiscTxInfoInterFreqListAdd-r13 ::= SEQUENCE {
    discTxFreqToAddModList-r13        SEQUENCE (SIZE (1..maxFreq)) OF SL-
DiscTxResourceInfoPerFreq-r13    OPTIONAL, -- Need ON
    discTxFreqToReleaseList-r13      SEQUENCE (SIZE (1..maxFreq)) OF ARFCN-ValueEUTRA-r9
    ...
}

SL-DiscTxResourceInfoPerFreq-r13 ::= SEQUENCE {
    discTxCarrierFreq-r13            ARFCN-ValueEUTRA-r9,
    discTxResources-r13              SL-DiscTxResource-r13    OPTIONAL, -- Need OR
    discTxResourcesPS-r13            SL-DiscTxResource-r13    OPTIONAL, -- Need OR
    discTxRefCarrierDedicated-r13    SL-DiscTxRefCarrierDedicated-r13    OPTIONAL, -- Need
OR
    discCellSelectionInfo-r13        CellSelectionInfoNFreq-r13    OPTIONAL, --
Need OR
    ...
}

SL-DiscTxResource-r13 ::= CHOICE {
    release                        NULL,
    setup                          CHOICE {
        scheduled-r13             SL-DiscTxConfigScheduled-r13,
        ue-Selected-r13          SL-DiscTxPoolDedicated-r13
    }
}

SL-DiscTxPoolToAddModList-r12 ::= SEQUENCE (SIZE (1..maxSL-TxPool-r12)) OF SL-
DiscTxPoolToAddMod-r12

SL-DiscTxPoolToAddMod-r12 ::= SEQUENCE {
    poolIdentity-r12                SL-TxPoolIdentity-r12,
    pool-r12                         SL-DiscResourcePool-r12
}

```

```

SL-DiscTxConfigScheduled-r13 ::= SEQUENCE {
    discTxConfig-r13          SL-DiscResourcePool-r12 OPTIONAL, -- Need ON
    discTF-IndexList-r13     SL-TF-IndexPairList-r12b  OPTIONAL, -- Need ON
    discHoppingConfig-r13    SL-HoppingConfigDisc-r12   OPTIONAL, -- Need ON
    ...
}

SL-DiscTxPoolDedicated-r13 ::= SEQUENCE {
    poolToReleaseList-r13    SL-TxPoolToReleaseList-r12 OPTIONAL, -- Need ON
    poolToAddModList-r13    SL-DiscTxPoolToAddModList-r12 OPTIONAL -- Need ON
}

SL-TF-IndexPairList-r12 ::= SEQUENCE (SIZE (1..maxSL-TF-IndexPair-r12)) OF SL-TF-IndexPair-r12

SL-TF-IndexPair-r12 ::= SEQUENCE {
    discSF-Index-r12        INTEGER (1.. 200)          OPTIONAL, -- Need ON
    discPRB-Index-r12       INTEGER (1.. 50)           OPTIONAL  -- Need ON
}

SL-TF-IndexPairList-r12b ::= SEQUENCE (SIZE (1..maxSL-TF-IndexPair-r12)) OF SL-TF-IndexPair-r12b

SL-TF-IndexPair-r12b ::= SEQUENCE {
    discSF-Index-r12b       INTEGER (0..209)          OPTIONAL, -- Need ON
    discPRB-Index-r12b      INTEGER (0..49)           OPTIONAL  -- Need ON
}

SL-DiscTxRefCarrierDedicated-r13 ::= CHOICE {
    pCell                    NULL,
    sCell                    SCellIndex-r10
}
-- ASN1STOP

```

SL-DiscConfig field descriptions

discCellSelectionInfo

Parameters that may be used by the UE to select/ reselect a cell on the concerned non serving frequency. If absent, the UE acquires the information from the target cell on the concerned frequency. See TS 36.304 [4, 11.4].

discSysInfoToReportConfig

Indicates the request to start a *SidelinkUEInformation* procedure for reporting system information acquired during an inter-frequency discovery procedure.

discTF-IndexList

Indicates a list of time-frequency resource indices pair where each pair of indices corresponds to one discovery message. E-UTRAN only configures *discTF-IndexList-r12b* when configuring the UE with scheduled SL discovery Tx resources. When receiving *discTF-IndexList-r12b*, the UE shall only consider this field (and hence ignore *discTF-IndexList-r12*, if included or previously configured).

discTxConfig

Indicates the resources configuration used when E-UTRAN schedules Tx resources (i.e. the fields *discSF-Index* and *discPRB-Index* indicate the actual resources to be used).

discTxInterFreqInfo

Indicates frequency applicable for the resources indicated by *discTxResources-r12* (i.e. original resource field may cover first inter-frequency), and possibly resource allocations on additional frequencies as may be indicated by field *discTxInfoInterFreqListAdd*.

discTxRefCarrierDedicated

Indicates if the PCell or an SCell is to be used as reference for DL measurements and synchronization, instead of the DL frequency paired with the one used to transmit sidelink discovery announcements on, see TS 36.213 [23, 14.3.1].

discTxResources

Indicates the resources assigned to the UE for discovery announcements, which can either be a pool from which the UE may select or a set of resources specifically assigned for use by the UE.

discTxResourcesPS

Indicates the resources assigned to the UE for PS discovery announcements, which can either be a pool from which the UE may select or a set of resources specifically assigned for use by the UE.

SL-TF-IndexPair

A pair of indices, one for the time domain and one for the frequency domain, indicating the start of resources within the pool covered by *discTxConfig*, see TS 36.211 [21, 9.5.6] for one discovery message. The upper limits of *discSF-Index* and *discPRB-Index* are defined in TS 36.213 [23, 14.3.1].

– *SL-DiscResourcePool*

The IE *SL-DiscResourcePool* specifies the configuration information for an individual pool of resources for sidelink discovery.

SL-DiscResourcePool information element

```

-- ASN1START
SL-DiscTxPoolList-r12 ::= SEQUENCE (SIZE (1..maxSL-TxPool-r12)) OF SL-DiscResourcePool-r12
SL-DiscRxPoolList-r12 ::= SEQUENCE (SIZE (1..maxSL-RxPool-r12)) OF SL-DiscResourcePool-r12
SL-DiscResourcePool-r12 ::= SEQUENCE {
  cp-Len-r12 SL-CP-Len-r12,
  discPeriod-r12 ENUMERATED {rf32, rf64, rf128,
    rf256, rf512, rf1024, rf16-v1310, spare},
  numRetx-r12 INTEGER (0..3),
  numRepetition-r12 INTEGER (1..50),
  tf-ResourceConfig-r12 SL-TF-ResourceConfig-r12,
  txParameters-r12 SEQUENCE {
    txParametersGeneral-r12 SL-TxParameters-r12,
    ue-SelectedResourceConfig-r12 SEQUENCE {
      poolSelection-r12 CHOICE {
        rsrpBased-r12 SL-PoolSelectionConfig-r12,
        random-r12 NULL
      },
      txProbability-r12 ENUMERATED {p25, p50, p75, p100}
    }
  }
  OPTIONAL -- Need OR
  OPTIONAL -- Cond Tx
  rxParameters-r12 SEQUENCE {
    tdd-Config-r12 TDD-Config OPTIONAL, -- Need OR
    syncConfigIndex-r12 INTEGER (0..15) OPTIONAL, -- Need OR
    ...,
    [[ discPeriod-v1310 CHOICE {
      release NULL,
      setup ENUMERATED {rf4, rf6, rf7, rf8,
        rf12, rf14, rf24, rf28}
    }
    rxParamsAddNeighFreq-r13 CHOICE {
      release NULL,
      setup SEQUENCE {
        physCellId-r13 PhysCellIdList-r13
      }
    }
    OPTIONAL, -- Need ON
    txParamsAddNeighFreq-r13 CHOICE {
      release NULL,
      setup SEQUENCE {
        physCellId-r13 PhysCellIdList-r13,
        p-Max P-Max OPTIONAL, -- Need OP
        tdd-Config-r13 TDD-Config OPTIONAL, -- Cond TDD-OR
        tdd-Config-v1130 TDD-Config-v1130 OPTIONAL, -- Cond TDD-OR
        freqInfo SEQUENCE {
          ul-CarrierFreq ARFCN-ValueEUTRA OPTIONAL, -- Need OP
          ul-Bandwidth ENUMERATED {n6, n15, n25, n50, n75, n100}
            OPTIONAL, -- Need OP
        }
        additionalSpectrumEmission AdditionalSpectrumEmission
      },
      referenceSignalPower INTEGER (-60..50),
      syncConfigIndex-r13 INTEGER (0..15) OPTIONAL -- Need OR
    }
  }
  OPTIONAL -- Need ON
  ]],
  [[ txParamsAddNeighFreq-v1370 CHOICE {
    release NULL,
    setup SEQUENCE {
      freqInfo-v1370 SEQUENCE {
        additionalSpectrumEmission-v1370 AdditionalSpectrumEmission-v1010
      }
    }
  }
  OPTIONAL -- Need ON
  ]]
}
PhysCellIdList-r13 ::= SEQUENCE (SIZE (1.. maxSL-DiscCells-r13)) OF PhysCellId

```

```

SL-PoolSelectionConfig-r12 ::= SEQUENCE {
    threshLow-r12          RSRP-RangeSL2-r12,
    threshHigh-r12       RSRP-RangeSL2-r12
}
-- ASN1STOP

```

SL-DiscResourcePool field descriptions

discPeriod	Indicates the period over which resources are allocated in a cell for discovery message transmission/reception, see PSDCH period in TS 36.213 [23]. Value in number of radio frames. Value rf32 corresponds to 32 radio frames, rf64 corresponds to 64 radio frames and so on. The extended values apply for PS discovery (not only for sidelink relaying). When broadcasting an extended value, E-UTRAN sets the original field to spare to ensure legacy UEs ignore the concerned pool entry.
numRepetition	Indicates the number of times <i>subframeBitmap</i> is repeated for mapping to subframes that occurs within a <i>discPeriod</i> . The highest value E-UTRAN uses is value 5 for FDD and TDD configuration 0, value 13 for TDD configuration 1, value 25 for TDD configuration 2, value 17 for TDD configuration 3, value 25 for TDD configuration 4, value 50 for TDD configuration 5 and value 7 for TDD configuration 6. E-UTRAN configures <i>numRepetition</i> and <i>subframeBitmap</i> such that the mapped subframes do not exceed the <i>discPeriod</i> .
poolSelection	Indicates the mechanism for selecting a (transmission) pool when multiple candidates are provided. E-UTRAN configures the same value (i.e. a pool selection method) for all candidate pools within one pool list (<i>discTxPoolCommon</i> or <i>discTxPoolDedicated</i>) but the pool selection method in different pool lists may or may not be the same.
syncConfigIndex	Indicates the synchronisation configuration that is associated with a reception or transmission pool, by means of an index to the corresponding entry of <i>discSyncConfig</i> in <i>SystemInformationBlockType19</i> .
threshLow, threshHigh	Specifies the thresholds used to select a resource pool in RSRP based pool selection. The E-UTRAN should configure <i>threshLow</i> and <i>threshHigh</i> such that the UE selects only one resource pool upon RSRP based pool selection.
txProbability	Indicates the probability of transmitting announcement in a discovery period when configured with a pool of resources, see TS 36.321 [6].

Conditional presence	Explanation
TDD-OR	The field is optional present for TDD, need OR; it is not present for FDD.
Tx	The field is mandatory present when included in <i>discTxPoolDedicated</i> or <i>discTxPoolCommon</i> . Otherwise the field is not present.

SL-DiscSysInfoReport

The IE *SL-DiscSysInfoReport* contains the parameters related to sidelink discovery acquired from system information of inter-frequency cells (including inter-PLMN).

SL-DiscSysInfoReport information element

```

-- ASN1START
SL-DiscSysInfoReport-r13 ::= SEQUENCE {
    plmn-IdentityList-r13    PLMN-IdentityList          OPTIONAL,
    cellIdentity-13         CellIdentity              OPTIONAL,
    carrierFreqInfo-13     ARFCN-ValueEUTRA-r9         OPTIONAL,
    discRxResources-r13    SL-DiscRxPoolList-r12       OPTIONAL,
    discTxPoolCommon-r13   SL-DiscTxPoolList-r12    OPTIONAL,
    discTxPowerInfo-r13    SL-DiscTxPowerInfoList-r12  OPTIONAL,
    discSyncConfig-r13     SL-SyncConfigNFreq-r13    OPTIONAL,
    discCellSelectionInfo-r13 SEQUENCE {
        q-RxLevMin-r13      Q-RxLevMin,
        q-RxLevMinOffset-r13 INTEGER (1..8)          OPTIONAL
    }
    cellReselectionInfo-r13 SEQUENCE {
        q-Hyst-r13          ENUMERATED {
            dB0, dB1, dB2, dB3, dB4, dB5, dB6, dB8, dB10,
            dB12, dB14, dB16, dB18, dB20, dB22, dB24},
        q-RxLevMin-r13     Q-RxLevMin,

```

```

    t-ReselectionEUTRA-r13          T-Reselection
  }
  tdd-Config-r13                    TDD-Config          OPTIONAL,
  freqInfo-r13                      SEQUENCE {          OPTIONAL,
    ul-CarrierFreq-r13              ARFCN-ValueEUTRA          OPTIONAL,
    ul-Bandwidth-r13                ENUMERATED {n6, n15, n25, n50, n75, n100}
                                     OPTIONAL,
    additionalSpectrumEmission-r13  AdditionalSpectrumEmission  OPTIONAL,
                                     OPTIONAL,
  }
  p-Max-r13                          P-Max          OPTIONAL,
  referenceSignalPower-r13           INTEGER (-60..50)  OPTIONAL,
  ...
  [[
  freqInfo-v1370                     SEQUENCE {
    additionalSpectrumEmission-v1370  AdditionalSpectrumEmission-v1010
                                     OPTIONAL
  }
  ]]
}
-- ASN1STOP

```

SL-DiscSysInfoReport field descriptions

carrierFreqInfo

Indicates the frequency of the cell from which the UE acquired the system information relevant for discovery

cellIdentity

Indicated the identity of the cell from which the UE acquired the system information relevant for discovery

plmn-IdentityList

Indicates the list of PLMN identity of the cell from which the UE acquired the system information relevant for discovery

SL-DiscTxPowerInfo

The IE *SL-DiscTxPowerInfo* specifies power control parameters for one or more power classes.

SL-DiscTxPowerInfo information element

```

-- ASN1START
SL-DiscTxPowerInfoList-r12 ::= SEQUENCE (SIZE (maxSL-DiscPowerClass-r12)) OF SL-DiscTxPowerInfo-r12
SL-DiscTxPowerInfo-r12 ::= SEQUENCE {
  discMaxTxPower-r12          P-Max,
  ...
}
-- ASN1STOP

```

SL-DiscTxPowerInfo field descriptions

discMaxTxPower

Indicates the P-Max parameter used to calculate the maximum transmit power a UE configured with the concerned range class, see TS 24.333 [70, 4.2.11]. The first entry in *SL-DiscTxPowerInfoList* corresponds to UE range class 'short', the second entry corresponds to 'medium' and the third entry corresponds to 'long'.

SL-GapConfig

The IE *SL-GapConfig* indicates the gaps, requested or assigned, to enable the UE to receive or transmit sidelink discovery, intra or inter frequency (including inter-PLMN).

SL-GapConfig information element

```

-- ASN1START
SL-GapConfig-r13 ::= SEQUENCE {
  gapPatternList-r13      SL-GapPatternList-r13
}
SL-GapPatternList-r13 ::= SEQUENCE (SIZE (1..maxSL-GP-r13)) OF SL-GapPattern-r13

```

```

SL-GapPattern-r13 ::= SEQUENCE {
    gapPeriod-r13      ENUMERATED {sf40, sf60, sf70, sf80, sf120, sf140, sf160,
                                   sf240, sf280, sf320, sf640, sf1280, sf2560, sf5120,
                                   sf10240},
    gapOffset-r12     SL-OffsetIndicator-r12,
    gapSubframeBitmap-r13 BIT STRING (SIZE (1..10240)),
    ...
}
-- ASN1STOP

```

SL-GapConfig field descriptions

gapOffset

Indicates the offset from the start of SFN 0 to the start of the first *gapPeriod*. If the SFN period is not an integer multiple of *gapPeriod*, no subframes within this period (i.e. from SFN 0 to offset) are considered part of the gap.

gapPeriod

Indicates the period by which *gapSubframeBitmap* is repeated.

gapSubframeBitmap

Indicates the subframes of one or more individual gaps, not only covering the subframes of the associated discovery resources but also including e.g. re-tuning and synchronisation delays. The UE and E-UTRAN signal bit strings of valid sizes only i.e. sizes equal to or less than *gapPeriod*. Value 1 indicates that the UE is allowed to use the subframe for sidelink discovery.

– *SL-GapRequest*

The IE *SL-GapRequest* indicates the gaps requested by the UE to receive or transmit sidelink discovery, intra or inter frequency (including inter-PLMN).

SL-GapRequest information element

```

-- ASN1START
SL-GapRequest-r13 ::= SEQUENCE (SIZE (1..maxFreq)) OF SL-GapFreqInfo-r13
SL-GapFreqInfo-r13 ::= SEQUENCE {
    carrierFreq-r13 ARFCN-ValueEUTRA-r9 OPTIONAL,
    gapPatternList-r13 SL-GapPatternList-r13
}
-- ASN1STOP

```

– *SL-HoppingConfig*

The IE *SL-HoppingConfig* indicates the hopping configuration used for sidelink.

SL-HoppingConfig information element

```

-- ASN1START
SL-HoppingConfigComm-r12 ::= SEQUENCE {
    hoppingParameter-r12 INTEGER (0..504),
    numSubbands-r12     ENUMERATED {ns1, ns2, ns4},
    rb-Offset-r12       INTEGER (0..110)
}
SL-HoppingConfigDisc-r12 ::= SEQUENCE {
    a-r12 INTEGER (1..200),
    b-r12 INTEGER (1..10),
    c-r12 ENUMERATED {n1, n5}
}
-- ASN1STOP

```

SL-HoppingConfig field descriptions	
a	Per cell parameter: $N_{PSDCH}^{(1)}$ see TS 36.213 [23, 14.3.1].
b	Per UE parameter: $N_{PSDCH}^{(2)}$ see TS 36.213 [23, 14.3.1].
c	Per cell parameter: $N_{PSDCH}^{(3)}$ see TS 36.213 [23, 14.3.1]
hoppingParameter	Affects the hopping performed as specified in TS 36.213 [23, 14.1.1.2 and 14.1.1.4]. In case value 504 is received, the value used by the UE is 510.
numSubbands	Parameter: N_{sb} see TS 36.211 [21, 9.3.6].
rb-Offset	Parameter: N_{RB}^{HO} , see TS 36.211 [21, 9.3.6].

– **SL-InterFreqInfoListV2X**

The IE *SL-InterFreqInfoListV2X* indicates synchronization and resource allocation configurations of the neighboring frequency for V2X sidelink communication.

SL-InterFreqInfoListV2X information element

```

-- ASN1START
SL-InterFreqInfoListV2X-r14 ::= SEQUENCE (SIZE (0..maxFreqV2X-1-r14)) OF SL-InterFreqInfoV2X-r14
SL-InterFreqInfoV2X-r14 ::= SEQUENCE {
    plmn-IdentityList-r14          PLMN-IdentityList          OPTIONAL,      -- Need OP
    v2x-CommCarrierFreq-r14       ARFCN-ValueEUTRA-r9,
    sl-MaxTxPower-r14             P-Max                    OPTIONAL,      -- Need OR
    sl-Bandwidth-r14              ENUMERATED {n6, n15, n25, n50, n75, n100} OPTIONAL,      --
Need OR
    v2x-SchedulingPool-r14        SL-CommResourcePoolV2X-r14  OPTIONAL,      -- Need
OR
    v2x-UE-ConfigList-r14        SL-V2X-UE-ConfigList-r14  OPTIONAL,      -- Need OR
    ...
    [[ additionalSpectrumEmissionV2X-r14 CHOICE {
        additionalSpectrumEmission-r14  AdditionalSpectrumEmission,
        additionalSpectrumEmission-v1440 AdditionalSpectrumEmission-v1010
    }
    OPTIONAL -- Need ON
]]
}
-- ASN1STOP

```

SL-InterFreqInfoListV2X field descriptions
<p>plmn-IdentityList Indicates PLMN identities of this frequency for reception of V2X sidelink communication. If this field is not present, the UE considers this frequency for reception of V2X sidelink communication concerns the first PLMN entry in the <i>plmn-IdentityList</i> in <i>SystemInformationBlockType1</i>.</p>
<p>sl-MaxTxPower Indicates the maximum transmission power for transmitting V2X sidelink communication on the corresponding frequency.</p>
<p>additionalSpectrumEmissionV2X Indicates the <i>additionalSpectrumEmission</i> value defined in TS 36.101 [42, 6.2.4] for V2X sidelink communication.</p>
<p>v2x-SchedulingPool Indicates the resource pool for inter-carrier scheduled resource allocation. This field is configured in RRC dedicated signalling only when <i>scheduled</i> is configured in IE <i>SL-V2X-ConfigDedicated</i>.</p>
<p>v2x-UE-ConfigList Indicates the inter-carrier resource configuration. If there is only one entry in the list without <i>physCellId</i> configured, the configuration is applied to the frequency identified by <i>v2x-CommCarrierFreq</i> (i.e. carrier specific configuration); if the entry of this field includes <i>physCellIdList</i>, the configuration is applied to the cell(s) identified by <i>physCellIdList</i> (i.e. cell specific configuration).</p>

– SL-V2X-UE-ConfigList

The IE *SL-V2X-UE-ConfigList* indicates inter-frequency resource configuration per-carrier or per-cell.

SL-V2X-UE-ConfigList information element

```

-- ASN1START
SL-V2X-UE-ConfigList-r14 ::= SEQUENCE (SIZE (1.. maxCellIntra)) OF SL-V2X-InterFreqUE-Config-r14
SL-V2X-InterFreqUE-Config-r14 ::= SEQUENCE {
    physCellIdList-r14 PhysCellIdList-r13 OPTIONAL, -- Need OR
    typeTxSync-r14 SL-TypeTxSync-r14 OPTIONAL, -- Need OR
    v2x-SyncConfig-r14 SL-SyncConfigListNFreqV2X-r14 OPTIONAL, -- Need OR
    v2x-CommRxPool-r14 SL-CommRxPoolListV2X-r14 OPTIONAL, -- Need
OR
    v2x-CommTxPoolNormal-r14 SL-CommTxPoolListV2X-r14 OPTIONAL, --
Need OR
    p2x-CommTxPoolNormal-r14 SL-CommTxPoolListV2X-r14 OPTIONAL, --
Need OR
    v2x-CommTxPoolExceptional-r14 SL-CommResourcePoolV2X-r14 OPTIONAL, -- Need OR
    v2x-ResourceSelectionConfig-r14 SL-CommTxPoolSensingConfig-r14 OPTIONAL, -- Need OR
    zoneConfig-r14 SL-ZoneConfig-r14 OPTIONAL, -- Need OR
    offsetDFN-r14 INTEGER (0..1000) OPTIONAL, -- Need OR
    ...
}
-- ASN1STOP

```

SL-V2X-UE-ConfigList field descriptions
<p>offsetDFN Indicates the timing offset for the UE to determine DFN timing when GNSS is used for timing reference. Value 0 corresponds to 0 milliseconds, value 1 corresponds to 0.001 milliseconds, value 2 corresponds to 0.002 milliseconds, and so on.</p>
<p>p2x-CommTxPoolNormal Indicates the resources on a carrier frequency by which the UE may transmit P2X related V2X sidelink communication.</p>
<p>physCellIdList If configured, the resource configuration is applicable for the cell(s) identified by this field. Otherwise, the resource configuration is for a given carrier frequency.</p>
<p>typeTxSync Indicates the prioritized synchronization type (i.e. eNB or GNSS) for performing V2X sidelink communication on a carrier frequency.</p>
<p>v2x-CommRxPool Indicates the resources on a carrier frequency by which the UE may receive V2X sidelink communication. This field is absent within <i>v2x-InterFreqInfoList</i> included in <i>RRCConnectionReconfiguration</i> except if received with <i>MobilityControlInfo</i> or <i>MobilityControlInfoV2X</i>.</p>
<p>v2x-CommTxPoolExceptional Indicates the resources on a carrier frequency by which the UE may transmit V2X sidelink communication in exceptional conditions, as specified in 5.10.13.</p>
<p>v2x-CommTxPoolNormal Indicates the resources on a carrier frequency by which the UE may transmit V2X sidelink communication.</p>
<p>v2x-SyncConfig Indicates the synchronization configuration used for transmission/reception of SLSS on the given frequency.</p>

– SL-OffsetIndicator

The IE *SL-OffsetIndicator* indicates the offset of the pool of resources relative to SFN 0 of the cell from which it was obtained or, when out of coverage, relative to DFN 0.

SL-OffsetIndicator information element

```

-- ASN1START
SL-OffsetIndicator-r12 ::=          CHOICE {
    small-r12                    INTEGER (0..319),
    large-r12                     INTEGER (0..10239)
}
SL-OffsetIndicatorSync-r12 ::=      INTEGER (0..39)
SL-OffsetIndicatorSync-v1430 ::=    INTEGER (40..159)
SL-OffsetIndicatorSync-r14 ::=      INTEGER (0..159)
-- ASN1STOP

```

SL-OffsetIndicator field descriptions
<p>SL-OffsetIndicator In <i>sc-TF-ResourceConfig</i>, it indicates the offset of the first period of pool of resources within a SFN cycle. For <i>data-TF-ResourceConfig</i>, it corresponds to the <i>offsetIndicator</i> as defined in TS 36.213 [23, 14.1.3].</p>
<p>SL-OffsetIndicatorSync For sidelink discovery and sidelink communication, synchronisation resources are present in those SFN and subframes which satisfy the relation: $(SFN * 10 + \text{Subframe Number}) \bmod 40 = SL\text{-OffsetIndicatorSync}$. For V2X sidelink communication, synchronisation resources are present in those SFN and subframes which satisfy the relation: $(SFN * 10 + \text{Subframe Number}) \bmod 160 = SL\text{-OffsetIndicatorSync}$.</p>

– *SL-P2X-ResourceSelectionConfig*

The IE *SL-P2X-ResourceSelectionConfig* includes the configuration of resource selection for P2X related V2X sidelink communication. E-UTRAN configures at least one resource selection mechanism.

SL-P2X-ResourceSelectionConfig information element

```
-- ASN1START
SL-P2X-ResourceSelectionConfig-r14 ::= SEQUENCE {
    partialSensing-r14      ENUMERATED {true}      OPTIONAL, -- Need OR
    randomSelection-r14    ENUMERATED {true}      OPTIONAL, -- Need OR
}
-- ASN1STOP
```

SL-P2X-ResourceSelectionConfig field descriptions

partialSensing

Indicates that partial sensing is allowed for UE autonomous resource selection in a resource pool.

randomSelection

Indicates that random selection is allowed for UE autonomous resource selection in a resource pool.

– *SL-PeriodComm*

The IE *SL-PeriodComm* indicates the period over which resources allocated in a cell for sidelink communication.

SL-PeriodComm information element

```
-- ASN1START
SL-PeriodComm-r12 ::= ENUMERATED {sf40, sf60, sf70, sf80, sf120, sf140,
    sf160, sf240, sf280, sf320, spare6, spare5,
    spare4, spare3, spare2, spare}
-- ASN1STOP
```

– *SL-Priority*

The IE *SL-Priority* indicates the one or more priorities of resource pool used for sidelink communication, or of a logical channel group used in case of scheduled sidelink communication resources, see TS 36.321 [6].

SL-Priority information element

```
-- ASN1START
SL-PriorityList-r13 ::= SEQUENCE (SIZE (1..maxSL-Prio-r13)) OF SL-Priority-r13
SL-Priority-r13 ::= INTEGER (1..8)
-- ASN1STOP
```

– *SL-PSSCH-TxConfigList*

The IE *SL-PSSCH-TxConfigList* indicates PSSCH transmission parameters. When lower layers select parameters from the range indicated in IE *SL-PSSCH-TxConfigList*, the UE considers both configurations in IE *SL-PSSCH-TxConfigList* and the CBR-dependent configurations represented in IE *SL-CBR-PPPP-TxConfigList*. Only one IE *SL-PSSCH-TxConfig* is provided per *typeTxSync*.

SL-PSSCH-TxConfigList information element

```
-- ASN1START
SL-PSSCH-TxConfigList-r14 ::= SEQUENCE (SIZE (1..maxPSSCH-TxConfig-r14)) OF SL-PSSCH-TxConfig-r14
```



```

SL-PSSCH-TxConfig-r14 ::= SEQUENCE {
    typeTxSync-r14          SL-TypeTxSync-r14          OPTIONAL, -- Need OR
    thresUE-Speed-r14      ENUMERATED {kmph60, kmph80, kmph100, kmph120,
    kmph140, kmph160, kmph180, kmph200},
    parametersAboveThres-r14 SL-PSSCH-TxParameters-r14,
    parametersBelowThres-r14 SL-PSSCH-TxParameters-r14,
    ...
}

SL-PSSCH-TxParameters-r14 ::= SEQUENCE {
    minMCS-PSSCH-r14      INTEGER (0..31),
    maxMCS-PSSCH-r14      INTEGER (0..31),
    minSubChannel-NumberPSSCH-r14 INTEGER (1..20),
    maxSubchannel-NumberPSSCH-r14 INTEGER (1..20),
    allowedRetxNumberPSSCH-r14 ENUMERATED {n0, n1, both, spare1},
    maxTxPower-r14        SL-TxPower-r14              OPTIONAL -- Cond CBR
}

-- ASN1STOP

```

SL-PSSCH-TxConfigList field descriptions

allowedRetxNumberPSSCH	Indicates the allowed retransmission number for transmissions on PSSCH (see TS 36.213 [23]). The value n0 indicates no retransmission for a transport block allowed; the value n1 indicates that the UE shall perform one retransmission for a transport block; and the value both indicates that the UE may autonomously select no retransmission or one retransmission for a transport block.
maxTxPower	Indicates the maximum transmission power for transmission on PSSCH and PSCCH (see TS 36.213 [23]).
minMCS-PSSCH, maxMCS-PSSCH	Indicates the minimum and maximum MCS values used for transmissions on PSSCH (see TS 36.213 [23]).
minSubchannel-NumberPSSCH, maxSubchannel-NumberPSSCH	Indicates the minimum and maximum number of sub-channels which may be used for transmissions on PSSCH (see TS 36.213 [23]).
thresUE-Speed	Indicates a UE speed threshold.
typeTxSync	Indicates the synchronization reference type (see TS 36.213 [23]). For configurations by the eNB, only <i>gnss</i> and <i>enb</i> can be configured; and for pre-configuration, only <i>gnss</i> and <i>ue</i> can be configured. If the field is absent, the configuration is applicable for all synchronization reference types.
parametersAboveThres	Indicates TX parameters for the UE speed above <i>thresUE-Speed</i> .
parametersBelowThres	Indicates TX parameters for the UE speed below <i>thresUE-Speed</i> .

Conditional presence	Explanation
CBR	The field is optionally present, need OR, in IE <i>SL-CBR-CommonTxConfigList-r14</i> , or in IE <i>SL-CBR-PreconfigTxConfigList-r14</i> . Otherwise the field is not present. Need OR.

SL-RestrictResourceReservationPeriodList

The IE *SL-RestrictResourceReservationPeriodList* indicates which values are allowed for the signaling of the resource reservation period in PSCCH for V2X sidelink communication, see TS 36.321 [6].

SL-RestrictResourceReservationPeriodList information element

```

-- ASN1START

SL-RestrictResourceReservationPeriodList-r14 ::= SEQUENCE (SIZE (1..maxReservationPeriod-r14)) OF
SL-RestrictResourceReservationPeriod-r14

SL-RestrictResourceReservationPeriod-r14 ::= ENUMERATED {v0dot2, v0dot5, v1, v2, v3, v4, v5,
v6, v7, v8, v9, v10, spare4, spare3, spare2, spare1}

-- ASN1STOP

```

SL-RestrictResourceReservationPeriodList field descriptions**SL-RestrictResourceReservationPeriod**

Value *v0dot2* means *SL-RestrictResourceReservationPeriod* is set to 0.2, value *v0dot5* means *SL-RestrictResourceReservationPeriod* is set to 0.5, value *v1* means *SL-RestrictResourceReservationPeriod* is set to 1, and so on. Value *v0dot2* and value *v0dot5* are configured in a pool-specific manner only. E-UTRAN should not set value *v0dot2* and *v0dot5* for transmission pool for P2X related V2X sidelink communication.

SLSSID

The IE *SLSSID* identifies a cell and is used by the receiving UE to detect asynchronous neighbouring cells, and by transmitting UEs to extend the synchronisation signals beyond the cell's coverage area.

SLSSID information element

```
-- ASN1START
SLSSID-r12 ::=                INTEGER (0..167)
-- ASN1STOP
```

SL-SyncAllowed

The IE *SL-SyncAllowed* indicates the allowed the synchronization references for a transmission resource pool for V2X sidelink communication.

SL-SyncAllowed information element

```
-- ASN1START
SL-SyncAllowed-r14 ::=      SEQUENCE {
    gnss-Sync-r14             ENUMERATED {true}                OPTIONAL, -- Need OR
    enb-Sync-r14             ENUMERATED {true}                OPTIONAL, -- Need OR
    ue-Sync-r14             ENUMERATED {true}                OPTIONAL, -- Need OR
}
-- ASN1STOP
```

SL-SyncAllowed field descriptions**enb-Sync**

If configured, the (pre-) configured resources can be used if the UE is directly or indirectly synchronized to eNB (i.e., synchronized to a reference UE which is directly synchronized to eNB).

gnss-Sync

If configured, the (pre-) configured resources can be used if the UE is directly or indirectly synchronized to GNSS (i.e. synchronized to a reference UE which is directly synchronized to GNSS).

ue-Sync

If configured, the (pre-) configured resources can be used if the UE is synchronized to a reference UE which is synchronized to neither GNSS nor eNB directly or indirectly.

SL-SyncConfig

The IE *SL-SyncConfig* specifies the configuration information concerning reception of synchronisation signals from neighbouring cells as well as concerning the transmission of synchronisation signals for sidelink communication and sidelink discovery.

SL-SyncConfig information element

```
-- ASN1START
SL-SyncConfigList-r12 ::=    SEQUENCE (SIZE (1..maxSL-SyncConfig-r12)) OF SL-SyncConfig-r12
SL-SyncConfigListV2X-r14 ::= SEQUENCE (SIZE (1.. maxSL-V2X-SyncConfig-r14)) OF SL-SyncConfig-r12
SL-SyncConfig-r12 ::=        SEQUENCE {
```

```

syncCP-Len-r12                SL-CP-Len-r12,
syncOffsetIndicator-r12      SL-OffsetIndicatorSync-r12,
slssid-r12                   SLSSID-r12,
txParameters-r12             SEQUENCE {
    syncTxParameters-r12     SL-TxParameters-r12,
    syncTxThreshIC-r12      RSRP-RangeSL-r12,
    syncInfoReserved-r12    BIT STRING (SIZE (19)) OPTIONAL, -- Need OR
}                               OPTIONAL, -- Need OR
rxParamsNCell-r12           SEQUENCE {
    physCellId-r12          PhysCellId,
    discSyncWindow-r12      ENUMERATED {w1, w2}
}                               OPTIONAL, -- Need OR
...,
[[ syncTxPeriodic-r13        ENUMERATED {true}           OPTIONAL, -- Need OR
]],
[[ syncOffsetIndicator-v1430 SL-OffsetIndicatorSync-v1430 OPTIONAL, -- Need OR
   gns-Sync-r14              ENUMERATED {true}           OPTIONAL, -- Need OR
]],
[[ syncOffsetIndicator2-r14  SL-OffsetIndicatorSync-r14 OPTIONAL, -- Need OR
   syncOffsetIndicator3-r14  SL-OffsetIndicatorSync-r14 OPTIONAL, -- Need OR
]]
}

SL-SyncConfigListNFreq-r13 ::= SEQUENCE (SIZE (1..maxSL-SyncConfig-r12)) OF SL-SyncConfigNFreq-
r13

SL-SyncConfigListNFreqV2X-r14 ::= SEQUENCE (SIZE (1..maxSL-V2X-SyncConfig-r14)) OF SL-
SyncConfigNFreq-r13

SL-SyncConfigNFreq-r13 ::= SEQUENCE {
    asyncParameters-r13     SEQUENCE {
        syncCP-Len-r12     SL-CP-Len-r12,
        syncOffsetIndicator-r13 SL-OffsetIndicatorSync-r12,
        slssid-r12         SLSSID-r12
    }                               OPTIONAL, -- Need OR
    txParameters-r13       SEQUENCE {
        syncTxParameters-r13 SL-TxParameters-r12,
        syncTxThreshIC-r13  RSRP-RangeSL-r12,
        syncInfoReserved-r13 BIT STRING (SIZE (19)) OPTIONAL, -- Need OR
        syncTxPeriodic-r13  ENUMERATED {true}           OPTIONAL, -- Need OR
    }                               OPTIONAL, -- Need OR
    rxParameters-r13       SEQUENCE {
        discSyncWindow-r13  ENUMERATED {w1, w2}
    }                               OPTIONAL, -- Need OR
    ...,
    [[ syncOffsetIndicator-v1430 SL-OffsetIndicatorSync-v1430 OPTIONAL, -- Need OR
       gns-Sync-r14              ENUMERATED {true}           OPTIONAL, -- Need OR
    ]],
    [[ syncOffsetIndicator2-r14  SL-OffsetIndicatorSync-r14 OPTIONAL, -- Need OR
       syncOffsetIndicator3-r14  SL-OffsetIndicatorSync-r14 OPTIONAL, -- Need OR
    ]],
}

-- ASN1STOP

```

SL-SyncConfig field descriptions
<p>discSyncWindow Indicates the synchronization window over which the UE expects that SLSS or discovery resources indicated by the pool configuration (see TS 36.213 [23, 14.4]). The value <i>w1</i> denotes 5 milliseconds. The value <i>w2</i> denotes the length corresponding to normal cyclic prefix divided by 2.</p>
<p>gnss-Sync if configured, the synchronization configuration is used for SLSS transmission/reception when the UE is synchronized to GNSS, by using <i>slssid=0</i> and ignoring <i>slssid-r12</i> configured. If not configured, the synchronization configuration is used for SLSS transmission/reception when the UE is synchronized to eNB, by using the configured <i>slssid-r12</i>.</p>
<p>syncCP-Len In case of V2X sidelink communications this field is always configured to <i>normal</i>.</p>
<p>syncInfoReserved Reserved for future use.</p>
<p>syncOffsetIndicator, syncOffsetIndicator2, syncOffsetIndicator3 E-UTRAN should ensure <i>syncOffsetIndicator</i> is set to the same value as <i>syncOffsetIndicator1</i> or <i>syncOffsetIndicator2</i> in <i>preconfigSync</i> within <i>SL-Preconfiguration</i>, if configured. If <i>syncOffsetIndicator-v1430</i> is configured, the UE shall ignore the field <i>syncOffsetIndicator-r12</i>. E-UTRAN should ensure <i>syncOffsetIndicator</i> is set to the same value as <i>syncOffsetIndicator1</i> in <i>v2x-CommPreconfigSync</i> within <i>SL-V2X-Preconfiguration</i>, if configured. E-UTRAN should ensure <i>syncOffsetIndicator2</i> is set to the same value as <i>syncOffsetIndicator2</i> in <i>v2x-CommPreconfigSync</i> within <i>SL-V2X-Preconfiguration</i>, if configured. E-UTRAN should ensure <i>syncOffsetIndicator3</i> is set to the same value as <i>syncOffsetIndicator3</i> in <i>v2x-CommPreconfigSync</i> within <i>SL-V2X-Preconfiguration</i>, if configured.</p>
<p>syncTxPeriodic Indicates whether in each discovery period in which UE transmits discovery, the UE transmits SLSS once or periodically (i.e. every 40ms). In the latter case (periodic) the UE also transmits the <i>MasterInformationBlock-SL</i> message alongside. E-UTRAN configures this field only for synchronisation configurations applicable for PS discovery.</p>
<p>syncTxThreshIC Indicates the threshold used while in coverage. In case the RSRP measurement of the cell chosen for transmission of sidelink communication/ discovery announcements/ V2X sidelink communication, or of the cell used as reference for DL measurements and synchronization, is below the level indicated by this field, the UE may transmit SLSS (i.e. become synchronisation reference) when performing the corresponding sidelink transmission..</p>
<p>txParameters Includes parameters relevant only for transmission. E-UTRAN includes the field in one entry per list, as included in <i>commSyncConfig</i> or <i>discSyncConfig</i>.</p>

– SL-TF-ResourceConfig

The IE *SL-TF-ResourceConfig* specifies a set of time/ frequency resources used for sidelink.

SL-TF-ResourceConfig information element

```

-- ASN1START
SL-TF-ResourceConfig-r12 ::=          SEQUENCE {
    prb-Num-r12                INTEGER (1..100),
    prb-Start-r12              INTEGER (0..99),
    prb-End-r12                INTEGER (0..99),
    offsetIndicator-r12        SL-OffsetIndicator-r12,
    subframeBitmap-r12        SubframeBitmapSL-r12
}

SubframeBitmapSL-r12 ::=          CHOICE {
    bs4-r12                    BIT STRING (SIZE (4)),
    bs8-r12                    BIT STRING (SIZE (8)),
    bs12-r12                   BIT STRING (SIZE (12)),
    bs16-r12                   BIT STRING (SIZE (16)),
    bs30-r12                   BIT STRING (SIZE (30)),
    bs40-r12                   BIT STRING (SIZE (40)),
    bs42-r12                   BIT STRING (SIZE (42))
}

SubframeBitmapSL-r14 ::=          CHOICE {
    bs10-r14                   BIT STRING (SIZE (10)),
    bs16-r14                   BIT STRING (SIZE (16)),
    bs20-r14                   BIT STRING (SIZE (20)),
    bs30-r14                   BIT STRING (SIZE (30)),
    bs40-r14                   BIT STRING (SIZE (40)),
    bs50-r14                   BIT STRING (SIZE (50)),
    bs60-r14                   BIT STRING (SIZE (60)),
    bs100-r14                  BIT STRING (SIZE (100))
}

```

```
}
-- ASN1STOP
```

SL-TF-ResourceConfig field descriptions

prb-Start, prb-End, prb-Num

Sidelink transmissions on a sub-frame can occur on PRB with index greater than or equal to *prb-Start* and less than *prb-Start + prb-Num*, and on PRB with index greater than *prb-End - prb-Num* and less than or equal to *prb-End*. Even for neighbouring cells, *prb-Start* and *prb-End* are relative to PRB #0 of the cell from which it was obtained. See TS 36.213 [23, 14.1.3, 14.2.3, 14.3.3].

subframeBitmap

Indicates the subframe bitmap indicating resources used for sidelink. For sidelink communication, E-UTRAN configures value *bs40* for FDD and the following values for TDD: value *bs42* for configuration0, value *bs16* for configuration1, value *bs8* for configuration2, value *bs12* for configuration3, value *bs8* for configuration4, value *bs4* for configuration5 and value *bs30* for configuration6. For V2X sidelink communication, E-UTRAN configures value *bs16*, *bs20* or *bs100* for FDD or Frame Structure Type 1 as defined in TS 36.211 [21], and the following values for TDD or Frame Structure Type 2 as defined in TS 36.211 [21]: value *bs60* for configuration0, value *bs40* for configuration1, value *bs20* for configuration2, value *bs30* for configuration3, value *bs20* for configuration4, value *bs10* for configuration5 and value *bs50* for configuration6.

– SL-TxPower

The IE *SL-TxPower* is used to limit the UE's sidelink transmission power on a carrier frequency. The unit is dBm. Value *minusinfinity* corresponds to $-\infty$.

SL-TxPower information element

```
-- ASN1START
SL-TxPower-r14 ::= CHOICE {
    minusinfinity-r14      NULL,
    txPower-r14           INTEGER (-41..31)
}
-- ASN1STOP
```

– SL-TypeTxSync

The IE *SL-TypeTxSync* indicates the synchronization reference type.

SL-TypeTxSync information element

```
-- ASN1START
SL-TypeTxSync-r14 ::= ENUMERATED {gnss, enb, ue}
-- ASN1STOP
```

– SL-ThresPSSCH-RSRP-List

IE *SL-ThresPSSCH-RSRP-List* indicates a threshold used for sensing based UE autonomous resource selection (see TS 36.213 [23]). A resource is excluded if it is indicated or reserved by a decoded SCI and PSSCH RSRP in the associated data resource is above the threshold defined by IE *SL-ThresPSSCH-RSRP-List*.

SL-ThresPSSCH-RSRP-List information element

```
-- ASN1START
SL-ThresPSSCH-RSRP-List-r14 ::= SEQUENCE (SIZE (64)) OF SL-ThresPSSCH-RSRP-r14
SL-ThresPSSCH-RSRP-r14 ::= INTEGER (0..66)
-- ASN1STOP
```

SL-ThresPSSCH-RSRP-List field descriptions**SL-ThresPSSCH-RSRP**

Value 0 corresponds to minus infinity dBm, value 1 corresponds to -128dBm, value 2 corresponds to -126dBm, value n corresponds to $(-128 + (n-1)*2)$ dBm and so on, value 66 corresponds to infinity dBm.

– **SL-TxParameters**

The IE *SL-TxParameters* identifies a set of parameters configured for sidelink transmission, used for communication, discovery and synchronisation.

SL-TxParameters information element

```
-- ASN1START
SL-TxParameters-r12 ::=          SEQUENCE      {
    alpha-r12                    Alpha-r12,
    p0-r12                       P0-SL-r12
}
P0-SL-r12 ::=                   INTEGER (-126..31)
-- ASN1STOP
```

SL-TxParameters field descriptions**alpha**

Parameter(s): $\alpha_{PSSCH,1}$, $\alpha_{PSSCH,2}$, $\alpha_{PSSCH,3}$, $\alpha_{PSSCH,4}$, $\alpha_{PSCCH,1}$, $\alpha_{PSCCH,2}$, $\alpha_{PSDCH,1}$, α_{PSSS} See TS 36.213 [23, 14.1.1.5, 14.2.1.3, 14.3.1, 14.4] where al0 corresponds to 0, al04 corresponds to value 0.4, al05 to 0.5, al06 to 0.6, al07 to 0.7, al08 to 0.8, al09 to 0.9 and al1 corresponds to 1. This field applies for sidelink power control.

p0

Parameter: $P_{O_PSSCH,1}$, $P_{O_PSSCH,2}$, $P_{O_PSSCH,3}$, $P_{O_PSSCH,4}$, $P_{O_PSCCH,1}$, $P_{O_PSCCH,2}$, $P_{O_PSDCH,1}$, P_{O_PSSS} see TS 36.213 [23, 14.1.1.5, 14.2.1.3, 14.3.1, 14.4], unit dBm.

– **SL-TxPoolIdentity**

The IE *SL-TxPoolIdentity* identifies an individual pool entry configured for sidelink transmission, used for communication and discovery.

SL-TxPoolIdentity information element

```
-- ASN1START
SL-TxPoolIdentity-r12 ::=          INTEGER (1.. maxSL-TxPool-r12)
SL-TxPoolIdentity-v1310 ::=       INTEGER (maxSL-TxPool-r12Plus1-r13.. maxSL-TxPool-r13)
SL-V2X-TxPoolIdentity-r14 ::=     INTEGER (1.. maxSL-V2X-TxPool-r14)
-- ASN1STOP
```

– **SL-TxPoolToReleaseList**

The IE *SL-TxPoolToReleaseList* is used to release one or more individual pool entries used for sidelink transmission, for communication and discovery.

SL-TxPoolToReleaseList information element

```
-- ASN1START
SL-TxPoolToReleaseList-r12 ::= SEQUENCE (SIZE (1..maxSL-TxPool-r12)) OF SL-TxPoolIdentity-r12
SL-TxPoolToReleaseListExt-r13 ::= SEQUENCE (SIZE (1..maxSL-TxPool-v1310)) OF SL-TxPoolIdentity-v1310
-- ASN1STOP
```

```
-- ASN1STOP
```

– *SL-V2X-ConfigDedicated*

The IE *SL-V2X-ConfigDedicated* specifies the dedicated configuration information for V2X sidelink communication.

***SL-V2X-ConfigDedicated* information element**

```
-- ASN1START
SL-V2X-ConfigDedicated-r14 ::=
  commTxResources-r14      SEQUENCE {
    release                 CHOICE {
      NULL,
      setup                 CHOICE {
        scheduled-r14      SEQUENCE {
          sl-V-RNTI-r14    C-RNTI,
          mac-MainConfig-r14 MAC-MainConfigSL-r12,
          v2x-SchedulingPool-r14 SL-CommResourcePoolV2X-r14 OPTIONAL, -- Need ON
          mcs-r14          INTEGER (0..31) OPTIONAL, -- Need OR
          logicalChGroupInfoList-r14 LogicalChGroupInfoList-r13
        },
        ue-Selected-r14    SEQUENCE {
          -- Pool for normal usage
          v2x-CommTxPoolNormalDedicated-r14 SEQUENCE {
            poolToReleaseList-r14 SL-TxPoolToReleaseListV2X-r14 OPTIONAL, -- Need ON
            poolToAddModList-r14  SL-TxPoolToAddModListV2X-r14  OPTIONAL, --
Need ON
            v2x-CommTxPoolSensingConfig-r14 SL-CommTxPoolSensingConfig-r14
OPTIONAL -- Need ON
          }
        }
      }
    },
    v2x-InterFreqInfoList-r14 SL-InterFreqInfoListV2X-r14 OPTIONAL, -- Need ON
    thresSL-TxPrioritization-r14 SL-Priority-r13 OPTIONAL, -- Need
OR
    typeTxSync-r14 SL-TypeTxSync-r14 OPTIONAL, -- Need OR
    cbr-DedicatedTxConfigList-r14 SL-CBR-CommonTxConfigList-r14 OPTIONAL, -- Need OR
    ...
  }
SL-TxPoolToAddModListV2X-r14 ::= SEQUENCE (SIZE (1.. maxSL-V2X-TxPool-r14)) OF SL-
TxPoolToAddMod-r14
SL-TxPoolToAddMod-r14 ::= SEQUENCE {
  poolIdentity-r14 SL-V2X-TxPoolIdentity-r14,
  pool-r14 SL-CommResourcePoolV2X-r14
}
SL-TxPoolToReleaseListV2X-r14 ::= SEQUENCE (SIZE (1.. maxSL-V2X-TxPool-r14)) OF SL-V2X-
TxPoolIdentity-r14
-- ASN1STOP
```

SL-V2X-ConfigDedicated field descriptions
<p>cbr-DedicatedTxConfigList Indicates the dedicated list of CBR range division and the list of PSCCH TX configurations available to configure congestion control to the UE for V2X sidelink communication.</p>
<p>logicalChGroupInfoList Indicates for each logical channel group the list of associated priorities, used as specified in TS 36.321 [6], in order of increasing logical channel group identity.</p>
<p>mcs Indicates the MCS as defined in TS 36.213 [23, 14.2.1]. If not configured, the selection of MCS is up to UE implementation.</p>
<p>scheduled Indicates the configuration for the case E-UTRAN schedules the transmission resources based on sidelink specific BSR from the UE.</p>
<p>sl-V-RNTI Indicates the RNTI used for DCI dynamically scheduling sidelink resources for V2X sidelink communication.</p>
<p>thresSL-TxPrioritization Indicates the threshold used to determine whether SL V2X transmission is prioritized over uplink transmission if they overlap in time (see TS 36.321 [6]). This value shall overwrite <i>thresSL-TxPrioritization</i> configured in <i>SIB21</i> or <i>SL-V2X-Preconfiguration</i> if any.</p>
<p>typeTxSync Indicates the prioritized synchronization type (i.e. eNB or GNSS) for performing V2X sidelink communication on PCell.</p>
<p>ue-Selected Indicates the configuration for the case the UE selects the transmission resources from a pool of resources configured by E-UTRAN.</p>
<p>v2x-InterFreqInfoList Indicates synchronization and resource allocation configurations of other carrier frequencies than the serving carrier frequency for V2X sidelink communication. For inter-carrier scheduled resource allocation, CIF=1 in DCI-5A corresponds to the first entry in this frequency list, CIF=2 corresponds to the second entry, and so on (see TS 36.213 [23]). CIF=0 in DCI-5A corresponds to the frequency where the DCI is received.</p>
<p>v2x-SchedulingPool Indicates a pool of resources when E-UTRAN schedules Tx resources for V2X sidelink communications.</p>

– SL-ZoneConfig

The IE *SL-ZoneConfig* indicates zone configurations used for V2X sidelink communication.

SL-ZoneConfig information element

```

-- ASN1START
SL-ZoneConfig-r14 ::=          SEQUENCE {
    zoneLength-r14   ENUMERATED { m5, m10, m20, m50, m100, m200, m500, spare1},
    zoneWidth-r14    ENUMERATED { m5, m10, m20, m50, m100, m200, m500, spare1},
    zoneIdLongiMod-r14  INTEGER (1..4),
    zoneIdLatiMod-r14   INTEGER (1..4)
}
-- ASN1STOP

```

SL-ZoneConfig field descriptions
<p>zoneLength Indicates the length of each geographic zone. Value m5 corresponds to 5 meters, m10 corresponds to 10 meters and so on.</p>
<p>zoneWidth Indicates the width of each geographic zone. Value m5 corresponds to 5 meters, m10 corresponds to 10 meters and so on.</p>
<p>zoneIdLongiMod Indicates the total number of zones that is configured with respect to longitude.</p>
<p>zoneIdLatiMod Indicates the total number of zones that is configured with respect to latitude.</p>

6.4 RRC multiplicity and type constraint values

– Multiplicity and type constraint definitions

```

-- ASN1START
maxACDC-Cat-r13                INTEGER ::= 16 -- Maximum number of ACDC categories (per PLMN)
maxAvailNarrowBands-r13       INTEGER ::= 16 -- Maximum number of narrowbands
maxBandComb-r10               INTEGER ::= 128 -- Maximum number of band combinations.
maxBandComb-r11               INTEGER ::= 256 -- Maximum number of additional band combinations.
maxBandComb-r13               INTEGER ::= 384 -- Maximum number of band combinations in Rel-13
maxBands                       INTEGER ::= 64 -- Maximum number of bands listed in EUTRA UE caps
maxBandwidthClass-r10         INTEGER ::= 16 -- Maximum number of supported CA BW classes per band
maxBandwidthCombSet-r10       INTEGER ::= 32 -- Maximum number of bandwidth combination sets per
-- supported band combination
maxCBR-Level-r14              INTEGER ::= 16 -- Maximum number of CBR levels
maxCBR-Level-l-r14            INTEGER ::= 15
maxCBR-Report-r14             INTEGER ::= 72 -- Maximum number of CBR results in a report
maxCDMA-BandClass             INTEGER ::= 32 -- Maximum value of the CDMA band classes
maxCE-Level-r13               INTEGER ::= 4 -- Maximum number of CE levels
maxCellBlack                   INTEGER ::= 16 -- Maximum number of blacklisted physical cell identity
-- ranges listed in SIB type 4 and 5
maxCellHistory-r12             INTEGER ::= 16 -- Maximum number of visited EUTRA cells reported
maxCellInfoGERAN-r9           INTEGER ::= 32 -- Maximum number of GERAN cells for which system in-
-- formation can be provided as redirection assistance
maxCellInfoUTRA-r9            INTEGER ::= 16 -- Maximum number of UTRA cells for which system
-- information can be provided as redirection
-- assistance
maxCombIDC-r11                INTEGER ::= 128 -- Maximum number of reported UL CA combinations
maxCSI-IM-r11                  INTEGER ::= 3 -- Maximum number of CSI-IM configurations
-- (per carrier frequency)
maxCSI-IM-r12                  INTEGER ::= 4 -- Maximum number of CSI-IM configurations
-- (per carrier frequency)
minCSI-IM-r13                  INTEGER ::= 5 -- Minimum number of CSI IM configurations from which
-- REL-13 extension is used
maxCSI-IM-r13                  INTEGER ::= 24 -- Maximum number of CSI-IM configurations
-- (per carrier frequency)
maxCSI-IM-v1310                INTEGER ::= 20 -- Maximum number of additional CSI-IM configurations
-- (per carrier frequency)
maxCSI-Proc-r11                INTEGER ::= 4 -- Maximum number of CSI processes (per carrier
-- frequency)
maxCSI-RS-NZP-r11              INTEGER ::= 3 -- Maximum number of CSI RS resource
-- configurations using non-zero Tx power
-- (per carrier frequency)
minCSI-RS-NZP-r13              INTEGER ::= 4 -- Minimum number of CSI RS resource from which
-- REL-13 extension is used
maxCSI-RS-NZP-r13              INTEGER ::= 24 -- Maximum number of CSI RS resource
-- configurations using non-zero Tx power
-- (per carrier frequency)
maxCSI-RS-NZP-v1310            INTEGER ::= 21 -- Maximum number of additional CSI RS resource
-- configurations using non-zero Tx power
-- (per carrier frequency)
maxCSI-RS-ZP-r11               INTEGER ::= 4 -- Maximum number of CSI RS resource
-- configurations using zero Tx power(per carrier
-- frequency)
maxCQI-ProcExt-r11             INTEGER ::= 3 -- Maximum number of additional periodic CQI
-- configurations (per carrier frequency)
maxFreqUTRA-TDD-r10           INTEGER ::= 6 -- Maximum number of UTRA TDD carrier frequencies for
-- which system information can be provided as
-- redirection assistance
maxCellInter                   INTEGER ::= 16 -- Maximum number of neighbouring inter-frequency
-- cells listed in SIB type 5
maxCellIntra                   INTEGER ::= 16 -- Maximum number of neighbouring intra-frequency
-- cells listed in SIB type 4
maxCellListGERAN               INTEGER ::= 3 -- Maximum number of lists of GERAN cells
maxCellMeas                    INTEGER ::= 32 -- Maximum number of entries in each of the
-- cell lists in a measurement object
maxCellReport                  INTEGER ::= 8 -- Maximum number of reported cells/CSI-RS resources
maxConfigSPS-r14               INTEGER ::= 8 -- Maximum number of simultaneous SPS configurations
maxCSI-RS-Meas-r12             INTEGER ::= 96 -- Maximum number of entries in the CSI-RS list
-- in a measurement object
maxDRB                          INTEGER ::= 11 -- Maximum number of Data Radio Bearers
maxDS-Duration-r12             INTEGER ::= 5 -- Maximum number of subframes in a discovery signals
-- occasion
maxDS-ZTP-CSI-RS-r12           INTEGER ::= 5 -- Maximum number of zero transmission power CSI-RS for
-- a serving cell concerning discovery signals

```

maxEARFCN	INTEGER ::= 65535	-- Maximum value of EUTRA carrier frequency
maxEARFCN-Plus1	INTEGER ::= 65536	-- Lowest value extended EARFCN range
maxEARFCN2	INTEGER ::= 262143	-- Highest value extended EARFCN range
maxEPDCCH-Set-r11	INTEGER ::= 2	-- Maximum number of EPDCCH sets
maxFBI	INTEGER ::= 64	-- Maximum value of fequency band indicator
maxFBI-Plus1	INTEGER ::= 65	-- Lowest value extended FBI range
maxFBI2	INTEGER ::= 256	-- Highest value extended FBI range
maxFreq	INTEGER ::= 8	-- Maximum number of carrier frequencies
maxFreqIDC-r11	INTEGER ::= 32	-- Maximum number of carrier frequencies that are -- affected by the IDC problems
maxFreqMBMS-r11	INTEGER ::= 5	-- Maximum number of carrier frequencies for which an -- MBMS capable UE may indicate an interest
maxFreqV2X-r14	INTEGER ::= 8	-- Maximum number of carrier frequencies for which V2X -- sidelink communication can be configured
maxFreqV2X-l-r14	INTEGER ::= 7	-- Highest index of frequencies
maxGERAN-SI	INTEGER ::= 10	-- Maximum number of GERAN SI blocks that can be -- provided as part of NACC information
maxGNFG	INTEGER ::= 16	-- Maximum number of GERAN neighbour freq groups
maxLCG-r13	INTEGER ::= 4	-- Maximum number of logical channel groups
maxLogMeasReport-r10	INTEGER ::= 520	-- Maximum number of logged measurement entries -- that can be reported by the UE in one message
maxMBSFN-Allocations	INTEGER ::= 8	-- Maximum number of MBSFN frame allocations with -- different offset
maxMBSFN-Area	INTEGER ::= 8	
maxMBSFN-Area-1	INTEGER ::= 7	
maxMBMS-ServiceListPerUE-r13	INTEGER ::= 15	-- Maximum number of services which the UE can -- include in the MBMS interest indication
maxMeasId	INTEGER ::= 32	
maxMeasId-Plus1	INTEGER ::= 33	
maxMeasId-r12	INTEGER ::= 64	
maxMultiBands	INTEGER ::= 8	-- Maximum number of additional frequency bands -- that a cell belongs to
maxNS-Pmax-r10	INTEGER ::= 8	-- Maximum number of NS and P-Max values per band
maxNAICS-Entries-r12	INTEGER ::= 8	-- Maximum number of supported NAICS combination(s)
maxNeighCell-r12	INTEGER ::= 8	-- Maximum number of neighbouring cells in NAICS -- configuration (per carrier frequency)
maxNeighCell-SCPTM-r13	INTEGER ::= 8	-- Maximum number of SCPTM neighbour cells
maxObjectId	INTEGER ::= 32	
maxObjectId-Plus1-r13	INTEGER ::= 33	
maxObjectId-r13	INTEGER ::= 64	
maxP-a-PerNeighCell-r12	INTEGER ::= 3	-- Maximum number of power offsets for a neighbour cell -- in NAICS configuration
maxPageRec	INTEGER ::= 16	--
maxPhysCellIdRange-r9	INTEGER ::= 4	-- Maximum number of physical cell identity ranges
maxPLMN-r11	INTEGER ::= 6	-- Maximum number of PLMNs
maxPLMN-l-r14	INTEGER ::= 5	-- Maximum number of PLMNs minus one
maxPNOffset	INTEGER ::= 511	-- Maximum number of CDMA2000 PNOFFSETS
maxPMCH-PerMBSFN	INTEGER ::= 15	
maxPSSCH-TxConfig-r14	INTEGER ::= 16	-- Maximum number of PSSCH TX configurations
maxQCI-r13	INTEGER ::= 6	-- Maximum number of QCIs
maxRAT-Capabilities	INTEGER ::= 8	-- Maximum number of interworking RATs (incl EUTRA)
maxRE-MapQCL-r11	INTEGER ::= 4	-- Maximum number of PDSCH RE Mapping configurations -- (per carrier frequency)
maxReportConfigId	INTEGER ::= 32	
maxReservationPeriod-r14	INTEGER ::= 16	-- Maximum number of resource reservation periodicities -- for sidelink V2X communication
maxRSTD-Freq-r10	INTEGER ::= 3	-- Maximum number of frequency layers for RSTD -- measurement
maxSAI-MBMS-r11	INTEGER ::= 64	-- Maximum number of MBMS service area identities -- broadcast per carrier frequency
maxSCell-r10	INTEGER ::= 4	-- Maximum number of SCells
maxSCell-r13	INTEGER ::= 31	-- Highest value of extended number range of SCells
maxSC-MTCH-r13	INTEGER ::= 1023	-- Maximum number of SC-MTCHs in one cell
maxSC-MTCH-BR-r14	INTEGER ::= 128	-- Maximum number of SC-MTCHs in one cell for feMTC
maxSL-CommRxPoolNFreq-r13	INTEGER ::= 32	-- Maximum number of individual sidelink communication -- Rx resource pools on neighbouring freq
maxSL-CommRxPoolPreconf-v1310	INTEGER ::= 12	-- Maximum number of additional preconfigured -- sidelink communication Rx resource pool entries
maxSL-TxPool-r12Plus1-r13	INTEGER ::= 5	-- First additional individual sidelink -- Tx resource pool
maxSL-TxPool-v1310	INTEGER ::= 4	-- Maximum number of additional sidelink -- Tx resource pool entries
maxSL-TxPool-r13	INTEGER ::= 8	-- Maximum number of individual sidelink -- Tx resource pools
maxSL-CommTxPoolPreconf-v1310	INTEGER ::= 7	-- Maximum number of additional preconfigured -- sidelink Tx resource pool entries
maxSL-Dest-r12	INTEGER ::= 16	-- Maximum number of sidelink destinations
maxSL-DiscCells-r13	INTEGER ::= 16	-- Maximum number of cells with similar sidelink

```

-- configurations
maxSL-DiscPowerClass-r12    INTEGER ::= 3    -- Maximum number of sidelink power classes
maxSL-DiscRxPoolPreconf-r13 INTEGER ::= 16   -- Maximum number of preconfigured sidelink
-- discovery Rx resource pool entries
maxSL-DiscSysInfoReportFreq-r13 INTEGER ::= 8   -- Maximum number of frequencies to include in a
-- SidelinkUEInformation for SI reporting
maxSL-DiscTxPoolPreconf-r13 INTEGER ::= 4   -- Maximum number of preconfigured sidelink
-- discovery Tx resource pool entries
maxSL-GP-r13                INTEGER ::= 8    -- Maximum number of gap patterns that can be requested
-- for a frequency or assigned
maxSL-PoolToMeasure-r14    INTEGER ::= 72   -- Maximum number of TX resource pools for CBR
-- measurement and report
maxSL-Prio-r13             INTEGER ::= 8    -- Maximum number of entries in sidelink priority list
maxSL-RxPool-r12          INTEGER ::= 16   -- Maximum number of individual sidelink Rx resource
pools
maxSL-SyncConfig-r12       INTEGER ::= 16   -- Maximum number of sidelink Sync configurations
maxSL-TF-IndexPair-r12    INTEGER ::= 64   -- Maximum number of sidelink Time Freq resource index
-- pairs
maxSL-TxPool-r12          INTEGER ::= 4    -- Maximum number of individual sidelink Tx resource
pools
maxSL-V2X-RxPool-r14      INTEGER ::= 16   -- Maximum number of RX resource pools for
-- V2X sidelink communication
maxSL-V2X-RxPoolPreconf-r14 INTEGER ::= 16   -- Maximum number of RX resource pools for
-- V2X sidelink communication
maxSL-V2X-TxPool-r14      INTEGER ::= 8    -- Maximum number of TX resource pools for
-- V2X sidelink communication
maxSL-V2X-TxPoolPreconf-r14 INTEGER ::= 8   -- Maximum number of TX resource pools for
-- V2X sidelink communication
maxSL-V2X-SyncConfig-r14  INTEGER ::= 16   -- Maximum number of sidelink Sync configurations
-- for V2X sidelink communication
maxSL-V2X-CBRConfig-r14   INTEGER ::= 4    -- Maximum number of CBR range configurations
-- for V2X sidelink communication congestion
-- control
maxSL-V2X-CBRConfig-1-r14 INTEGER ::= 3    -- Maximum number of TX parameter configurations
-- for V2X sidelink communication congestion
-- control
maxSL-V2X-TxConfig-r14    INTEGER ::= 64   -- Maximum number of TX parameter configurations
-- for V2X sidelink communication congestion
-- control
maxSL-V2X-TxConfig-1-r14  INTEGER ::= 63   -- Maximum number of CBR range configurations in
-- pre-configuration for V2X sidelink
-- communication congestion control
maxSL-V2X-CBRConfig2-r14  INTEGER ::= 8    -- Maximum number of CBR range configurations in
-- pre-configuration for V2X sidelink
-- communication congestion control
maxSL-V2X-CBRConfig2-1-r14 INTEGER ::= 7    -- Maximum number of TX parameter
-- configurations in pre-configuration for V2X
-- sidelink communication congestion control
maxSL-V2X-TxConfig2-1-r14 INTEGER ::= 128  -- Maximum number of TX parameter
-- configurations in pre-configuration for V2X
-- sidelink communication congestion control
maxSL-V2X-TxConfig2-1-r14 INTEGER ::= 127
maxSTAG-r11               INTEGER ::= 3    -- Maximum number of STAGs
maxServCell-r10           INTEGER ::= 5    -- Maximum number of Serving cells
maxServCell-r13           INTEGER ::= 32   -- Highest value of extended number range of Serving
cells
maxServiceCount           INTEGER ::= 16   -- Maximum number of MBMS services that can be included
-- in an MBMS counting request and response
maxServiceCount-1        INTEGER ::= 15
maxSessionPerPMCH        INTEGER ::= 29
maxSessionPerPMCH-1      INTEGER ::= 28
maxSIB                    INTEGER ::= 32   -- Maximum number of SIBs
maxSIB-1                  INTEGER ::= 31
maxSI-Message             INTEGER ::= 32   -- Maximum number of SI messages
maxSimultaneousBands-r10  INTEGER ::= 64   -- Maximum number of simultaneously aggregated bands
maxSubframePatternIDC-r11 INTEGER ::= 8    -- Maximum number of subframe reservation patterns
-- that the UE can simultaneously recommend to the
-- E-UTRAN for use.
maxTrafficPattern-r14     INTEGER ::= 8    -- Maximum number of periodical traffic patterns
-- that the UE can simultaneously report to the
-- E-UTRAN.
maxUTRA-FDD-Carrier       INTEGER ::= 16   -- Maximum number of UTRA FDD carrier frequencies
maxUTRA-TDD-Carrier       INTEGER ::= 16   -- Maximum number of UTRA TDD carrier frequencies
maxWLAN-Id-r12            INTEGER ::= 16   -- Maximum number of WLAN identifiers
maxWLAN-Bands-r13         INTEGER ::= 8    -- Maximum number of WLAN bands
maxWLAN-Id-r13            INTEGER ::= 32   -- Maximum number of WLAN identifiers
maxWLAN-Channels-r13      INTEGER ::= 16   -- Maximum number of WLAN channels used in
-- WLAN-CarrierInfo
maxWLAN-CarrierInfo-r13   INTEGER ::= 8    -- Maximum number of WLAN Carrier Information
maxWLAN-Id-Report-r14     INTEGER ::= 32   -- Maximum number of WLAN IDs to report
-- ASN1STOP

```

NOTE: The value of maxDRB aligns with SA2.

– End of EUTRA-RRC-Definitions

```
-- ASN1START
END
-- ASN1STOP
```

6.5 PC5 RRC messages

NOTE: The messages included in this clause reflect the current status of the discussions. Additional messages may be included at a later stage.

6.5.1 General message structure

– *PC5-RRC-Definitions*

This ASN.1 segment is the start of the PC5 RRC PDU definitions.

```
-- ASN1START
PC5-RRC-Definitions DEFINITIONS AUTOMATIC TAGS ::=
BEGIN
IMPORTS
    TDD-ConfigSL-r12
FROM EUTRA-RRC-Definitions;
-- ASN1STOP
```

– *SBCCH-SL-BCH-Message*

The *SBCCH-SL-BCH-Message* class is the set of RRC messages that may be sent from the UE to the UE via SL-BCH on the SBCCH logical channel.

```
-- ASN1START
SBCCH-SL-BCH-Message ::= SEQUENCE {
    message                SBCCH-SL-BCH-MessageType
}
SBCCH-SL-BCH-MessageType ::=                               MasterInformationBlock-SL
-- ASN1STOP
```

– *SBCCH-SL-BCH-Message-V2X*

The *SBCCH-SL-BCH-Message-V2X* class is the set of RRC messages that may be sent from the UE to the UE via SL-BCH on the SBCCH logical channel for V2X sidelink communication.

```
-- ASN1START
SBCCH-SL-BCH-Message-V2X-r14 ::= SEQUENCE {
    message                SBCCH-SL-BCH-MessageType-V2X-r14
}
SBCCH-SL-BCH-MessageType-V2X-r14 ::=                       MasterInformationBlock-SL-V2X-r14
-- ASN1STOP
```

6.5.2 Message definitions

– *MasterInformationBlock-SL*

The *MasterInformationBlock-SL* includes the information transmitted by a UE transmitting SLSS, i.e. acting as synchronisation reference, via SL-BCH.

Signalling radio bearer: N/A

RLC-SAP: TM

Logical channel: SBCCH

Direction: UE to UE

MasterInformationBlock-SL

```
-- ASN1START
MasterInformationBlock-SL ::= SEQUENCE {
    sl-Bandwidth-r12          ENUMERATED {
                               n6, n15, n25, n50, n75, n100},
    tdd-ConfigSL-r12        TDD-ConfigSL-r12,
    directFrameNumber-r12   BIT STRING (SIZE (10)),
    directSubframeNumber-r12 INTEGER (0..9),
    inCoverage-r12         BOOLEAN,
    reserved-r12            BIT STRING (SIZE (19))
}
-- ASN1STOP
```

MasterInformationBlock-SL field descriptions

directFrameNumber

Indicates the frame number in which SLSS and SL-BCH are transmitted. The subframe in the frame corresponding to *directFrameNumber* is indicated by *directSubframeNumber*.

inCoverage

Value *TRUE* indicates that the UE transmitting the *MasterInformationBlock-SL* is in E-UTRAN coverage.

sl-Bandwidth

Parameter: transmission bandwidth configuration. n6 corresponds to 6 resource blocks, n15 to 15 resource blocks and so on.

– *MasterInformationBlock-SL-V2X*

The *MasterInformationBlock-SL-V2X* includes the information transmitted by a UE transmitting SLSS, i.e. acting as synchronisation reference, via SL-BCH for V2X sidelink communication.

Signalling radio bearer: N/A

RLC-SAP: TM

Logical channel: SBCCH

Direction: UE to UE

MasterInformationBlock-SL-V2X

```
-- ASN1START
MasterInformationBlock-SL-V2X-r14 ::= SEQUENCE {
    sl-Bandwidth-r14          ENUMERATED {
                               n6, n15, n25, n50, n75, n100},
    tdd-ConfigSL-r14        TDD-ConfigSL-r12,
    directFrameNumber-r14   BIT STRING (SIZE (10)),
    directSubframeNumber-r14 INTEGER (0..9),
    inCoverage-r14         BOOLEAN,
    reserved-r14            BIT STRING (SIZE (27))
}
-- ASN1STOP
```

```
}
-- ASN1STOP
```

MasterInformationBlock-SL-V2X field descriptions	
directFrameNumber	Indicates the frame number in which SLSS and SL-BCH for V2X sidelink communication are transmitted. The subframe in the frame corresponding to <i>directFrameNumber</i> is indicated by <i>directSubframeNumber</i> .
inCoverage	Value <i>TRUE</i> indicates that the UE transmitting the <i>MasterInformationBlock-SL-V2X</i> for V2X sidelink communication is in E-UTRAN coverage.
sl-Bandwidth	Parameter: transmission bandwidth configuration. n6 corresponds to 6 resource blocks, n15 to 15 resource blocks and so on.

— End of *PC5-RRC-Definitions*

```
-- ASN1START
END
-- ASN1STOP
```

6.6 Direct Indication Information

Direct Indication information is transmitted on MPDCCH using P-RNTI but without associated *Paging* message. Table 6.6-1 defines the Direct Indication information, see TS 36.212 [22, 5.3.3.1.14].

When bit *n* is set to 1, UE shall behave as if the corresponding field is set in the *Paging* message, see 5.3.2.3. Bit 1 is the least significant bit.

Table 6.6-1: Direct Indication information

Bit	Direct Indication information
1	<i>systemInfoModification</i>
2	<i>etws-Indication</i>
3	<i>emas-Indication</i>
4	<i>eab-ParamModification</i>
5	<i>systemInfoModification-eDRX</i>
6, 7, 8	Not used, and shall be ignored by UE if received.

6.6a Direct Indication FeMBMS

On MBMS-dedicated cell and on FeMBMS/Unicast-mixed cell, a Direct Indication FeMBMS is transmitted on PDCCH together with 8-bit MCCH change notification using M-RNTI, see TS 36.212 [22, 5.3.3.1.4]. Table 6.6a-1 defines the Direct Indication FeMBMS.

When the first bit is set to 1, UE shall behave as if *systemInfoModification* field is set in the *Paging* message and when the second bit is set to 1, UE shall behave as if both *etws-Indication* and *emas-Indication* are set in the *Paging* message, see 5.3.2.3. Bit 1 is the least significant bit.

Table 6.6a-1: Direct Indication FeMBMS

Bit	Direct Indication FeMBMS
1	<i>systemInfoModification</i>
2	<i>etws-Indication</i> and <i>cmas-Indication</i>

6.7 NB-IoT RRC messages

6.7.1 General NB-IoT message structure

```
-- ASN1START
NBIOT-RRC-Definitions DEFINITIONS AUTOMATIC TAGS ::=
BEGIN
IMPORTS
    RRCCONNECTIONREESTABLISHMENTREJECT,
    SECURITYMODECOMMAND,
    SECURITYMODECOMPLETE,
    SECURITYMODEFAILURE,
    ADDITIONALSPECTRUMEMISSION,
    ARFCN-VALUEEUTRA-r9,
    CELLIDENTITY,
    DEDICATEDINFO-NAS,
    DRB-IDENTITY,
    INITIALUE-IDENTITY,
    INTRAFREQBLACKCELLLIST,
    INTRAFREQNEIGHCELLLIST,
    MAXBANDS,
    MAXCELLBLACK,
    MAXCELLINTER,
    MAXFBI2,
    MAXFREQ,
    MAXMULTIBANDS,
    MAXPAGE-REC,
    MAXPLMN-r11,
    MAXSAI-MBMS-r11,
    MAXSIB,
    MAXSIB-1,
    MBMS-SAI-r11,
    MBMS-SAI-List-r11,
    MBMSSessionInfo-r13,
    NextHopChainingCount,
    PAGINGUE-IDENTITY,
    PLMN-IDENTITY,
    P-MAX,
    PowerRampingParameters,
    PreambleTransMax,
    PhysCellId,
    Q-OffsetRange,
    Q-QualMin-r9,
    Q-RxLevMin,
    REESTABUE-IDENTITY,
    REGISTEREDMME,
    RESELECTIONTHRESHOLD,
    RESUMEIDENTITY-r13,
    RRC-TransactionIdentifier,
    RSRP-Range,
    ShortMAC-I,
    S-TMSI,
    SystemInformationBlockType16-r11,
    SystemInfoValueTagSI-r13,
    T-Reordering,
    TimeAlignmentTimer,
    TMGI-r9,
    TrackingAreaCode,
    DataInactivityTimer-r14
FROM EUTRA-RRC-Definitions;
```

```
-- ASN1STOP
```

– *BCCH-BCH-Message-NB*

The *BCCH-BCH-Message-NB* class is the set of RRC messages that may be sent from the E-UTRAN to the UE via BCH on the BCCH logical channel.

```
-- ASN1START
BCCH-BCH-Message-NB ::= SEQUENCE {
    message          BCCH-BCH-MessageType-NB
}

BCCH-BCH-MessageType-NB ::= MasterInformationBlock-NB

-- ASN1STOP
```

– *BCCH-DL-SCH-Message-NB*

The *BCCH-DL-SCH-Message-NB* class is the set of RRC messages that may be sent from the E-UTRAN to the UE via DL-SCH on the BCCH logical channel.

```
-- ASN1START
BCCH-DL-SCH-Message-NB ::= SEQUENCE {
    message          BCCH-DL-SCH-MessageType-NB
}

BCCH-DL-SCH-MessageType-NB ::= CHOICE {
    c1              CHOICE {
        systemInformation-r13          SystemInformation-NB,
        systemInformationBlockType1-r13 SystemInformationBlockType1-NB
    },
    messageClassExtension SEQUENCE {}
}

-- ASN1STOP
```

– *PCCH-Message-NB*

The *PCCH-Message-NB* class is the set of RRC messages that may be sent from the E-UTRAN to the UE on the PCCH logical channel.

```
-- ASN1START
PCCH-Message-NB ::= SEQUENCE {
    message          PCCH-MessageType-NB
}

PCCH-MessageType-NB ::= CHOICE {
    c1              CHOICE {
        paging-r13          Paging-NB
    },
    messageClassExtension SEQUENCE {}
}

-- ASN1STOP
```

– *DL-CCCH-Message-NB*

The *DL-CCCH-Message-NB* class is the set of RRC messages that may be sent from the E-UTRAN to the UE on the downlink CCCH logical channel.

```

-- ASN1START
DL-CCCH-Message-NB ::= SEQUENCE {
    message          DL-CCCH-MessageType-NB
}

DL-CCCH-MessageType-NB ::= CHOICE {
    c1              CHOICE {
        rrcConnectionReestablishment-r13      RRCConnectionReestablishment-NB,
        rrcConnectionReestablishmentReject-r13 RRCConnectionReestablishmentReject,
        rrcConnectionReject-r13              RRCConnectionReject-NB,
        rrcConnectionSetup-r13              RRCConnectionSetup-NB,
        spare4 NULL, spare3 NULL, spare2 NULL, spare1 NULL
    },
    messageClassExtension SEQUENCE {}
}
-- ASN1STOP

```

– *DL-DCCH-Message-NB*

The *DL-DCCH-Message-NB* class is the set of RRC messages that may be sent from the E-UTRAN to the UE on the downlink DCCH logical channel.

```

-- ASN1START
DL-DCCH-Message-NB ::= SEQUENCE {
    message          DL-DCCH-MessageType-NB
}

DL-DCCH-MessageType-NB ::= CHOICE {
    c1              CHOICE {
        dlInformationTransfer-r13          DLInformationTransfer-NB,
        rrcConnectionReconfiguration-r13  RRCConnectionReconfiguration-NB,
        rrcConnectionRelease-r13         RRCConnectionRelease-NB,
        securityModeCommand-r13         SecurityModeCommand,
        ueCapabilityEnquiry-r13         UECapabilityEnquiry-NB,
        rrcConnectionResume-r13         RRCConnectionResume-NB,
        spare2 NULL, spare1 NULL
    },
    messageClassExtension SEQUENCE {}
}
-- ASN1STOP

```

– *UL-CCCH-Message-NB*

The *UL-CCCH-Message-NB* class is the set of RRC messages that may be sent from the UE to the E-UTRAN on the uplink CCCH logical channel.

```

-- ASN1START
UL-CCCH-Message-NB ::= SEQUENCE {
    message          UL-CCCH-MessageType-NB
}

UL-CCCH-MessageType-NB ::= CHOICE {
    c1              CHOICE {
        rrcConnectionReestablishmentRequest-r13 RRCConnectionReestablishmentRequest-NB,
        rrcConnectionRequest-r13              RRCConnectionRequest-NB,
        rrcConnectionResumeRequest-r13        RRCConnectionResumeRequest-NB,
        spare1 NULL
    },
    messageClassExtension SEQUENCE {}
}
-- ASN1STOP

```

– *SC-MCCH-Message-NB*

The *SC-MCCH-Message-NB* class is the set of RRC messages that may be sent from the E-UTRAN to the NB-IoT UE on the SC-MCCH logical channel.

```
-- ASN1START
SC-MCCH-Message-NB ::= SEQUENCE {
    message                SC-MCCH-MessageType-NB
}

SC-MCCH-MessageType-NB ::= CHOICE {
    c1                    CHOICE {
        scptmConfiguration-r14                SCPTMConfiguration-NB-r14
    },
    messageClassExtension SEQUENCE {}
}
-- ASN1STOP
```

– *UL-DCCH-Message-NB*

The *UL-DCCH-Message-NB* class is the set of RRC messages that may be sent from the UE to the E-UTRAN on the uplink DCCH logical channel.

```
-- ASN1START
UL-DCCH-Message-NB ::= SEQUENCE {
    message                UL-DCCH-MessageType-NB
}

UL-DCCH-MessageType-NB ::= CHOICE {
    c1                    CHOICE {
        rrcConnectionReconfigurationComplete-r13    RRCConnectionReconfigurationComplete-NB,
        rrcConnectionReestablishmentComplete-r13    RRCConnectionReestablishmentComplete-NB,
        rrcConnectionSetupComplete-r13              RRCConnectionSetupComplete-NB,
        securityModeComplete-r13                    SecurityModeComplete,
        securityModeFailure-r13                     SecurityModeFailure,
        ueCapabilityInformation-r13                  UECapabilityInformation-NB,
        ulInformationTransfer-r13                    ULInformationTransfer-NB,
        rrcConnectionResumeComplete-r13              RRCConnectionResumeComplete-NB,
        spare8 NULL, spare7 NULL,
        spare6 NULL, spare5 NULL, spare4 NULL,
        spare3 NULL, spare2 NULL, spare1 NULL
    },
    messageClassExtension SEQUENCE {}
}
-- ASN1STOP
```

6.7.2 NB-IoT Message definitions

– *DLInformationTransfer-NB*

The *DLInformationTransfer-NB* message is used for the downlink transfer of NAS dedicated information.

Signalling radio bearer: SRB1 or SRB1bis

RLC-SAP: AM

Logical channel: DCCH

Direction: E-UTRAN to UE

DLInformationTransfer-NB message

```

-- ASN1START
DLInformationTransfer-NB ::= SEQUENCE {
    rrc-TransactionIdentifier RRC-TransactionIdentifier,
    criticalExtensions CHOICE {
        cl CHOICE {
            dlInformationTransfer-r13 DLInformationTransfer-NB-r13-IEs,
            spare1 NULL
        },
        criticalExtensionsFuture SEQUENCE {}
    }
}

DLInformationTransfer-NB-r13-IEs ::= SEQUENCE {
    dedicatedInfoNAS-r13 DedicatedInfoNAS,
    lateNonCriticalExtension OCTET STRING OPTIONAL,
    nonCriticalExtension SEQUENCE {} OPTIONAL
}
-- ASN1STOP

```

MasterInformationBlock-NB

The *MasterInformationBlock-NB* includes the system information transmitted on BCH.

Signalling radio bearer: N/A

RLC-SAP: TM

Logical channel: BCCH

Direction: E-UTRAN to UE

MasterInformationBlock-NB

```

-- ASN1START
MasterInformationBlock-NB ::= SEQUENCE {
    systemFrameNumber-MSB-r13 BIT STRING (SIZE (4)),
    hyperSFN-LSB-r13 BIT STRING (SIZE (2)),
    schedulingInfoSIB1-r13 INTEGER (0..15),
    systemInfoValueTag-r13 INTEGER (0..31),
    ab-Enabled-r13 BOOLEAN,
    operationModeInfo-r13 CHOICE {
        inband-SamePCI-r13 Inband-SamePCI-NB-r13,
        inband-DifferentPCI-r13 Inband-DifferentPCI-NB-r13,
        guardband-r13 Guardband-NB-r13,
        standalone-r13 Standalone-NB-r13
    },
    spare BIT STRING (SIZE (11))
}

ChannelRasterOffset-NB-r13 ::= ENUMERATED {khz-7dot5, khz-2dot5, khz2dot5, khz7dot5}

Guardband-NB-r13 ::= SEQUENCE {
    rasterOffset-r13 ChannelRasterOffset-NB-r13,
    spare BIT STRING (SIZE (3))
}

Inband-SamePCI-NB-r13 ::= SEQUENCE {
    eutra-CRS-SequenceInfo-r13 INTEGER (0..31)
}

Inband-DifferentPCI-NB-r13 ::= SEQUENCE {
    eutra-NumCRS-Ports-r13 ENUMERATED {same, four},
    rasterOffset-r13 ChannelRasterOffset-NB-r13,
    spare BIT STRING (SIZE (2))
}

Standalone-NB-r13 ::= SEQUENCE {
    spare BIT STRING (SIZE (5))
}

```

```
}
-- ASN1STOP
```

MasterInformationBlock-NB field descriptions
<p>ab-Enabled Value TRUE indicates that access barring is enabled and that the UE shall acquire <i>SystemInformationBlockType14-NB</i> before initiating RRC connection establishment or resume.</p>
<p>eutra-CRS-SequenceInfo Information of the carrier containing NPSS/NSSS/NPBCH. Each value is associated with an E-UTRA PRB index as an offset from the middle of the LTE system sorted out by channel raster offset. See TS 36.211[21] and TS 36.213 [23].</p>
<p>eutra-NumCRS-Ports Number of E-UTRA CRS antenna ports, either the same number of ports as NRS or 4 antenna ports. See TS 36.211 [21], TS 36.212 [22], and TS 36.213 [23].</p>
<p>hyperSFN-LSB Indicates the 2 least significant bits of hyper SFN. The remaining bits are present in <i>SystemInformationBlockType1-NB</i>.</p>
<p>operationModeInfo Deployment scenario (in-band/guard-band/standalone) and related information. See TS 36.211 [21] and TS 36.213 [23]. <i>Inband-SamePCI</i> indicates an in-band deployment and that the NB-IoT and LTE cell share the same physical cell id and have the same number of NRS and CRS ports. <i>Inband-DifferentPCI</i> indicates an in-band deployment and that the NB-IoT and LTE cell have different physical cell id. <i>guardband</i> indicates a guard-band deployment. <i>standalone</i> indicates a standalone deployment.</p>
<p>rasterOffset NB-IoT offset from LTE channel raster. Unit in kHz in set { -7.5, -2.5, 2.5, 7.5} See TS 36.211[21] and TS 36.213 [23].</p>
<p>schedulingInfoSIB1 This field contains an index to a table specified in TS 36.213 [23, Table 16.4.1.3-3] that defines <i>SystemInformationBlockType1-NB</i> scheduling information.</p>
<p>systemFrameNumber-MSB Defines the 4 most significant bits of the SFN. As indicated in TS 36.211 [21], the 6 least significant bits of the SFN are acquired implicitly by decoding the NPBCH.</p>
<p>systemInfoValueTag Common for all SIBs other than MIB-NB, SIB14-NB and SIB16-NB.</p>

– *Paging-NB*

The *Paging-NB* message is used for the notification of one or more UEs.

Signalling radio bearer: N/A

RLC-SAP: TM

Logical channel: PCCH

Direction: E-UTRAN to UE

***Paging-NB* message**

```
-- ASN1START

Paging-NB ::=
    SEQUENCE {
        pagingRecordList-r13          PagingRecordList-NB-r13    OPTIONAL,  -- Need ON
        systemInfoModification-r13    ENUMERATED {true}          OPTIONAL,  -- Need ON
        systemInfoModification-eDRX-r13  ENUMERATED {true}          OPTIONAL,  -- Need ON
        nonCriticalExtension           SEQUENCE {}                OPTIONAL
    }

PagingRecordList-NB-r13 ::=
    SEQUENCE (SIZE (1..maxPageRec)) OF PagingRecord-NB-r13

PagingRecord-NB-r13 ::=
    SEQUENCE {
        ue-Identity-r13              PagingUE-Identity,
        ...
    }

-- ASN1STOP
```

-- ASN1STOP

Paging-NB field descriptions
<p>systemInfoModification If present: indication of a BCCH modification other than for <i>SystemInformationBlockType14-NB</i> (SIB14-NB) and <i>SystemInformationBlockType16-NB</i> (SIB16-NB). This indication does not apply to UEs using eDRX cycle longer than the BCCH modification period.</p>
<p>systemInfoModification-eDRX If present: indication of a BCCH modification other than for <i>SystemInformationBlockType14-NB</i> (SIB14-NB) and <i>SystemInformationBlockType16-NB</i> (SIB16-NB). This indication applies only to UEs using eDRX cycle longer than the BCCH modification period.</p>
<p>ue-Identity Provides the NAS identity of the UE that is being paged.</p>

– *RRCConnectionReconfiguration-NB*

The *RRCConnectionReconfiguration-NB* message is the command to modify an RRC connection. It may convey information for resource configuration (including RBs, MAC main configuration and physical channel configuration) including any associated dedicated NAS information.

Signalling radio bearer: SRB1

RLC-SAP: AM

Logical channel: DCCH

Direction: E-UTRAN to UE

***RRCConnectionReconfiguration-NB* message**

```
-- ASN1START
RRCConnectionReconfiguration-NB ::= SEQUENCE {
    rrc-TransactionIdentifier      RRC-TransactionIdentifier,
    criticalExtensions             CHOICE {
        c1                        CHOICE {
            rrcConnectionReconfiguration-r13      RRCConnectionReconfiguration-NB-r13-IEs,
            spare1 NULL
        },
        criticalExtensionsFuture      SEQUENCE {}
    }
}

RRCConnectionReconfiguration-NB-r13-IEs ::= SEQUENCE {
    dedicatedInfoNASList-r13      SEQUENCE (SIZE(1..maxDRB-NB-r13)) OF
                                     DedicatedInfoNAS                OPTIONAL, -- Need ON
    radioResourceConfigDedicated-r13  RadioResourceConfigDedicated-NB-r13  OPTIONAL, -- Need ON
    fullConfig-r13                  ENUMERATED {true}                OPTIONAL, -- Cond
    Reestab
        lateNonCriticalExtension      OCTET STRING                OPTIONAL,
        nonCriticalExtension          SEQUENCE {}                OPTIONAL
}
-- ASN1STOP
```

<i>RRCConnectionReconfiguration-NB</i> field descriptions
<p>dedicatedInfoNASList This field is used to transfer UE specific NAS layer information between the network and the UE. The RRC layer is transparent for each PDU in the list.</p>
<p>fullConfig Indicates the full configuration option is applicable for the RRC Connection Reconfiguration message.</p>

Conditional presence	Explanation
<i>Reestab</i>	This field is optionally present, need ON upon the first reconfiguration after RRC connection re-establishment; otherwise the field is not present.

– ***RRCConnectionReconfigurationComplete-NB***

The *RRCConnectionReconfigurationComplete-NB* message is used to confirm the successful completion of an RRC connection reconfiguration.

Signalling radio bearer: SRB1

RLC-SAP: AM

Logical channel: DCCH

Direction: UE to E-UTRAN

***RRCConnectionReconfigurationComplete-NB* message**

```
-- ASN1START
RRCConnectionReconfigurationComplete-NB ::= SEQUENCE {
  rrc-TransactionIdentifier      RRC-TransactionIdentifier,
  criticalExtensions             CHOICE {
    rrcConnectionReconfigurationComplete-r13  RRCConnectionReconfigurationComplete-NB-r13-IEs,
    criticalExtensionsFuture                 SEQUENCE {}
  }
}

RRCConnectionReconfigurationComplete-NB-r13-IEs ::= SEQUENCE {
  lateNonCriticalExtension      OCTET STRING          OPTIONAL,
  nonCriticalExtension          SEQUENCE {}           OPTIONAL
}
-- ASN1STOP
```

– ***RRCConnectionReestablishment-NB***

The *RRCConnectionReestablishment-NB* message is used to re-establish SRB1.

Signalling radio bearer: SRB0

RLC-SAP: TM

Logical channel: CCCH

Direction: E-UTRAN to UE

***RRCConnectionReestablishment-NB* message**

```
-- ASN1START
RRCConnectionReestablishment-NB ::= SEQUENCE {
  rrc-TransactionIdentifier      RRC-TransactionIdentifier,
  criticalExtensions             CHOICE {
    c1                           CHOICE {
      rrcConnectionReestablishment-r13  RRCConnectionReestablishment-NB-r13-IEs,
      spare1 NULL
    },
    criticalExtensionsFuture       SEQUENCE {}
  }
}

RRCConnectionReestablishment-NB-r13-IEs ::= SEQUENCE {
  radioResourceConfigDedicated-r13  RadioResourceConfigDedicated-NB-r13,
  nextHopChainingCount-r13          NextHopChainingCount,
  lateNonCriticalExtension           OCTET STRING          OPTIONAL,
  nonCriticalExtension               RRCConnectionReestablishment-NB-v1430-IEs  OPTIONAL
}

RRCConnectionReestablishment-NB-v1430-IEs ::= SEQUENCE {
  dl-NAS-MAC                        BIT STRING (SIZE (16))  OPTIONAL,  -- Cond Reestablish-CP
  nonCriticalExtension               SEQUENCE {}             OPTIONAL
}
-- ASN1STOP
```

```
-- ASN1STOP
```

***RRCCONNECTIONREESTABLISHMENT-NB* field descriptions**

dl-NAS-MAC

Downlink authentication token, see TS 33.401 [32]. If this field is present, the UE shall ignore the field *nextHopChainingCount*.

Conditional presence	Explanation
<i>Reestablish-CP</i>	This field is mandatory present for NB-IoT UE using the Control Plane CIoT EPS optimisation; otherwise the field is not present.

RRCCONNECTIONREESTABLISHMENTCOMPLETE-NB

The *RRCCONNECTIONREESTABLISHMENTCOMPLETE-NB* message is used to confirm the successful completion of an RRC connection re-establishment.

Signalling radio bearer: SRB1 or SRB1bis

RLC-SAP: AM

Logical channel: DCCH

Direction: UE to E-UTRAN

***RRCCONNECTIONREESTABLISHMENTCOMPLETE-NB* message**

```
-- ASN1START
RRCCONNECTIONREESTABLISHMENTCOMPLETE-NB ::= SEQUENCE {
  rrc-TransactionIdentifier      RRC-TransactionIdentifier,
  criticalExtensions              CHOICE {
    rrcConnectionReestablishmentComplete-r13  RRCCONNECTIONREESTABLISHMENTCOMPLETE-NB-r13-IEs,
    criticalExtensionsFuture                  SEQUENCE {}
  }
}

RRCCONNECTIONREESTABLISHMENTCOMPLETE-NB-r13-IEs ::= SEQUENCE {
  lateNonCriticalExtension      OCTET STRING          OPTIONAL,
  nonCriticalExtension          RRCCONNECTIONREESTABLISHMENTCOMPLETE-NB-v1470-IEs  OPTIONAL
}

RRCCONNECTIONREESTABLISHMENTCOMPLETE-NB-v1470-IEs ::= SEQUENCE {
  measResultServCell-r14      MeasResultServCell-NB-r14      OPTIONAL,
  nonCriticalExtension         SEQUENCE {}                    OPTIONAL
}
-- ASN1STOP
```

***RRCCONNECTIONREESTABLISHMENTCOMPLETE-NB* field descriptions**

measResultServCell

This field refers to the last idle mode measurement results taken of the serving cell.

RRCCONNECTIONREESTABLISHMENTREQUEST-NB

The *RRCCONNECTIONREESTABLISHMENTREQUEST-NB* message is used to request the reestablishment of an RRC connection.

Signalling radio bearer: SRB0

RLC-SAP: TM

Logical channel: CCCH

Direction: UE to E-UTRAN

***RRCCONNECTIONREESTABLISHMENTREQUEST-NB* message**

```
-- ASN1START
RRCCONNECTIONREESTABLISHMENTREQUEST-NB ::= SEQUENCE {
    criticalExtensions          CHOICE {
        rrcConnectionReestablishmentRequest-r13
        later                   RRCCONNECTIONREESTABLISHMENTREQUEST-NB-r13-IEs,
        rrcConnectionReestablishmentRequest-r14
        criticalExtensionsFuture RRCCONNECTIONREESTABLISHMENTREQUEST-NB-r14-IEs,
    }
}

RRCCONNECTIONREESTABLISHMENTREQUEST-NB-r13-IEs ::= SEQUENCE {
    ue-Identity-r13           ReestabUE-Identity,
    reestablishmentCause-r13  ReestablishmentCause-NB-r13,
    cqi-NPDCCH-r14           CQI-NPDCCH-NB-r14,
    earlyContentionResolution-r14  BOOLEAN,
    spare                     BIT STRING (SIZE (20))
}

RRCCONNECTIONREESTABLISHMENTREQUEST-NB-r14-IEs ::= SEQUENCE {
    ue-Identity-r14           ReestabUE-Identity-CP-NB-r14,
    reestablishmentCause-r14  ReestablishmentCause-NB-r13,
    cqi-NPDCCH-r14           CQI-NPDCCH-Short-NB-r14,
    earlyContentionResolution-r14  BOOLEAN,
    spare                     BIT STRING (SIZE (1))
}

ReestablishmentCause-NB-r13 ::= ENUMERATED {
    reconfigurationFailure, otherFailure,
    spare2, spare1}

ReestabUE-Identity-CP-NB-r14 ::= SEQUENCE {
    s-TMSI-r14               S-TMSI,
    ul-NAS-MAC-r14           BIT STRING (SIZE (16)),
    ul-NAS-Count-r14        BIT STRING (SIZE (5))
}

-- ASN1STOP
```

***RRCCONNECTIONREESTABLISHMENTREQUEST-NB* field descriptions**

earlyContentionResolution

Value TRUE indicates UE supports MAC PDU containing the UE contention resolution identity MAC control element without RRC response message.

reestablishmentCause

Indicates the failure cause that triggered the re-establishment procedure.
eNB is not expected to reject a *RRCCONNECTIONREESTABLISHMENTREQUEST* due to unknown cause value being used by the UE.

ue-Identity

UE identity included to retrieve UE context and to facilitate contention resolution by lower layers.

ul-NAS-Count

For description of this field see TS 33.401 [32].

ul-NAS-MAC

For description of this field see TS 33.401 [32].

– ***RRCCONNECTIONREJECT-NB***

The *RRCCONNECTIONREJECT-NB* message is used to reject the RRC connection establishment or RRC connection resume.

Signalling radio bearer: SRB0

RLC-SAP: TM

Logical channel: CCCH

Direction: E-UTRAN to UE

***RRConnectionReject-NB* message**

```
-- ASN1START
RRConnectionReject-NB ::= SEQUENCE {
  criticalExtensions      CHOICE {
    c1                    CHOICE {
      rrcConnectionReject-r13  RRConnectionReject-NB-r13-IEs,
      spare1 NULL
    },
    criticalExtensionsFuture  SEQUENCE {}
  }
}

RRConnectionReject-NB-r13-IEs ::= SEQUENCE {
  extendedWaitTime-r13      INTEGER (1..1800),
  rrc-SuspendIndication-r13  ENUMERATED {true}          OPTIONAL, -- Need ON
  lateNonCriticalExtension  OCTET STRING          OPTIONAL,
  nonCriticalExtension      SEQUENCE {}          OPTIONAL
}
-- ASN1STOP
```

***RRConnectionReject-NB* field descriptions**

extendedWaitTime

Value in seconds.

rrc-SuspendIndication

If present, this field indicates that the UE should remain suspended and not release its stored context.

RRConnectionRelease-NB

The *RRConnectionRelease-NB* message is used to command the release of an RRC connection.

Signalling radio bearer: SRB1 or SRB1bis

RLC-SAP: AM

Logical channel: DCCH

Direction: E-UTRAN to UE

***RRConnectionRelease-NB* message**

```
-- ASN1START
RRConnectionRelease-NB ::= SEQUENCE {
  rrc-TransactionIdentifier  RRC-TransactionIdentifier,
  criticalExtensions          CHOICE {
    c1                        CHOICE {
      rrcConnectionRelease-r13  RRConnectionRelease-NB-r13-IEs,
      spare1 NULL
    },
    criticalExtensionsFuture  SEQUENCE {}
  }
}

RRConnectionRelease-NB-r13-IEs ::= SEQUENCE {
  releaseCause-r13          ReleaseCause-NB-r13,
  resumeIdentity-r13        ResumeIdentity-r13          OPTIONAL, -- Need OR
  extendedWaitTime-r13     INTEGER (1..1800)          OPTIONAL, -- Need ON
  redirectedCarrierInfo-r13  RedirectedCarrierInfo-NB-r13  OPTIONAL, -- Need ON
  lateNonCriticalExtension  OCTET STRING          OPTIONAL,
}
-- ASN1STOP
```

```

    nonCriticalExtension                RRCCConnectionRelease-NB-v1430-IEs    OPTIONAL
}
RRCCConnectionRelease-NB-v1430-IEs ::= SEQUENCE {
    redirectedCarrierInfo-v1430        RedirectedCarrierInfo-NB-v1430    OPTIONAL,    -- Cond
Redirection
    extendedWaitTime-CPdata-r14        INTEGER (1..1800)                OPTIONAL,    -- Cond NoExtendedWaitTime
    nonCriticalExtension                SEQUENCE {}                      OPTIONAL
}
ReleaseCause-NB-r13 ::=                ENUMERATED {loadBalancingTAUrequired, other,
                                                rrc-Suspend, spare1}
RedirectedCarrierInfo-NB-r13 ::=        CarrierFreq-NB-r13
RedirectedCarrierInfo-NB-v1430 ::=      SEQUENCE {
    redirectedCarrierOffsetDedicated-r14 ENUMERATED{
        dB1, dB2, dB3, dB4, dB5, dB6, dB8, dB10,
        dB12, dB14, dB16, dB18, dB20, dB22, dB24, dB26},
    t322-r14                            ENUMERATED{
        min5, min10, min20, min30, min60, min120, min180,
        spare1}
}
-- ASN1STOP

```

RRCCConnectionRelease-NB field descriptions

extendedWaitTime	Value in seconds.
extendedWaitTime-CPdata	Wait time for data transfer using the Control Plane ClOT EPS optimisation. Value in seconds. See TS 24.301 [35].
redirectedCarrierInfo	The <i>redirectedCarrierInfo</i> indicates a carrier frequency (downlink for FDD) and is used to redirect the UE to a NB-IoT carrier frequency, by means of the cell selection upon leaving RRC_CONNECTED as specified in TS 36.304 [4].
redirectedCarrierOffsetDedicated	Parameter "Qoffsetdedicated _{frequency} " in TS 36.304 [4]. For NB-IoT carrier frequencies, a UE that supports multi-band cells considers the <i>redirectedCarrierOffsetDedicated</i> to be common for all overlapping bands (i.e. regardless of the EARFCN that is used).
releaseCause	The <i>releaseCause</i> is used to indicate the reason for releasing the RRC Connection. E-UTRAN should not set the <i>releaseCause</i> to <i>loadBalancingTAURequired</i> if the <i>extendedWaitTime</i> is present.
t322	Timer T322 as described in clause 7.3. Value minN corresponds to N minutes.

Conditional presence	Explanation
<i>NoExtendedWaitTime</i>	The field is optionally present, need ON, if the <i>extendedWaitTime</i> is not included; otherwise the field is not present.
<i>Redirection</i>	The field is optionally present, need ON, if <i>redirectedCarrierInfo</i> is included; otherwise the field is not present.

RRCCConnectionRequest-NB

The *RRCCConnectionRequest-NB* message is used to request the establishment of an RRC connection.

Signalling radio bearer: SRB0

RLC-SAP: TM

Logical channel: CCCH

Direction: UE to E-UTRAN

RRCCConnectionRequest-NB message

```

-- ASN1START
RRCCConnectionRequest-NB ::= SEQUENCE {
    criticalExtensions                CHOICE {
        rrcConnectionRequest-r13      RRCCConnectionRequest-NB-r13-IEs,

```

```

        criticalExtensionsFuture      SEQUENCE {}
    }
}
RRCConnectionRequest-NB-r13-IEs ::= SEQUENCE {
    ue-Identity-r13                InitialUE-Identity,
    establishmentCause-r13         EstablishmentCause-NB-r13,
    multiToneSupport-r13           ENUMERATED {true}           OPTIONAL,
    multiCarrierSupport-r13        ENUMERATED {true}           OPTIONAL,
    earlyContentionResolution-r14  BOOLEAN,
    cqi-NPDCCH-r14                 CQI-NPDCCH-NB-r14,
    spare                           BIT STRING (SIZE (17))
}
-- ASN1STOP

```

***RRCConnectionRequest-NB* field descriptions**

earlyContentionResolution

Value TRUE indicates UE supports MAC PDU containing the UE contention resolution identity MAC control element without RRC response message.

establishmentCause

Provides the establishment cause for the RRC connection request as provided by the upper layers. eNB is not expected to reject a *RRCConnectionRequest* due to unknown cause value being used by the UE.

multiCarrierSupport

If present, this field indicates that the UE supports multi-carrier operation.

multiToneSupport

If present, this field indicates that the UE supports UL multi-tone transmissions on NPUSCH.

ue-Identity

UE identity included to facilitate contention resolution by lower layers.

– *RRCConnectionResume-NB*

The *RRCConnectionResume-NB* message is used to resume the suspended RRC connection.

Signalling radio bearer: SRB1

RLC-SAP: AM

Logical channel: DCCH

Direction: E-UTRAN to UE

***RRCConnectionResume-NB* message**

```

-- ASN1START
RRCConnectionResume-NB ::= SEQUENCE {
    rrc-TransactionIdentifier      RRC-TransactionIdentifier,
    criticalExtensions              CHOICE {
        c1                          CHOICE {
            rrcConnectionResume-r13 RRCConnectionResume-NB-r13-IEs,
            spare1                     NULL
        },
        criticalExtensionsFuture    SEQUENCE {}
    }
}

RRCConnectionResume-NB-r13-IEs ::= SEQUENCE {
    radioResourceConfigDedicated-r13 RadioResourceConfigDedicated-NB-r13 OPTIONAL, --
Need ON
    nextHopChainingCount-r13         NextHopChainingCount,
    drb-ContinueROHC-r13             ENUMERATED {true}           OPTIONAL, -- Need OP
    lateNonCriticalExtension          OCTET STRING           OPTIONAL,
    nonCriticalExtension              SEQUENCE {}           OPTIONAL
}
-- ASN1STOP

```

RRCConnectionResume-NB field descriptions**drb-ContinueROHC**

This field indicates whether to continue or reset the header compression protocol context for the DRBs configured with the header compression protocol. Presence of the field indicates that the header compression protocol context continues while absence indicates that the header compression protocol context is reset.

RRCConnectionResumeComplete-NB

The *RRCConnectionResumeComplete-NB* message is used to confirm the successful completion of an RRC connection resumption

Signalling radio bearer: SRB1

RLC-SAP: AM

Logical channel: DCCH

Direction: UE to E-UTRAN

RRCConnectionResumeComplete-NB message

```
-- ASN1START
RRCConnectionResumeComplete-NB ::= SEQUENCE {
    rrc-TransactionIdentifier          RRC-TransactionIdentifier,
    criticalExtensions                 CHOICE {
        rrcConnectionResumeComplete-r13          RRCConnectionResumeComplete-NB-r13-IEs,
        criticalExtensionsFuture                 SEQUENCE {}
    }
}

RRCConnectionResumeComplete-NB-r13-IEs ::= SEQUENCE {
    selectedPLMN-Identity-r13          INTEGER (1..maxPLMN-r11)    OPTIONAL,
    dedicatedInfoNAS-r13              DedicatedInfoNAS          OPTIONAL,
    lateNonCriticalExtension           OCTET STRING             OPTIONAL,
    nonCriticalExtension               RRCConnectionResumeComplete-NB-v1470-IEs  OPTIONAL
}

RRCConnectionResumeComplete-NB-v1470-IEs ::= SEQUENCE {
    measResultServCell-r14            MeasResultServCell-NB-r14  OPTIONAL,
    nonCriticalExtension               SEQUENCE {}                OPTIONAL
}
-- ASN1STOP
```

RRCConnectionResumeComplete-NB field descriptions**measResultServCell**

This field refers to the last idle mode measurement results taken of the serving cell.

selectedPLMN-Identity

Index of the PLMN selected by the UE from the *plmn-IdentityList* included in *SystemInformationBlockType1-NB*. 1 if the 1st PLMN is selected from the *plmn-IdentityList* included in SIB1-NB, 2 if the 2nd PLMN is selected from the *plmn-IdentityList* included in SIB1-NB and so on.

RRCConnectionResumeRequest-NB

The *RRCConnectionResumeRequest-NB* message is used to request the resumption of a suspended RRC connection.

Signalling radio bearer: SRB0

RLC-SAP: TM

Logical channel: CCCH

Direction: UE to E-UTRAN

***RRConnectionResumeRequest-NB* message**

```
-- ASN1START
RRConnectionResumeRequest-NB ::= SEQUENCE {
    criticalExtensions          CHOICE {
        rrcConnectionResumeRequest-r13  RRConnectionResumeRequest-NB-r13-IEs,
        criticalExtensionsFuture         SEQUENCE {}
    }
}

RRConnectionResumeRequest-NB-r13-IEs ::= SEQUENCE {
    resumeID-r13                ResumeIdentity-r13,
    shortResumeMAC-I-r13        ShortMAC-I,
    resumeCause-r13             EstablishmentCause-NB-r13,
    earlyContentionResolution-r14 BOOLEAN,
    cqi-NPDCCH-r14              CQI-NPDCCH-NB-r14,
    spare                        BIT STRING (SIZE (4))
}
-- ASN1STOP
```

***RRConnectionResumeRequest-NB* field descriptions**

earlyContentionResolution

Value TRUE indicates UE supports MAC PDU containing the UE contention resolution identity MAC control element without RRC response message.

resumeCause

Provides the resume cause for the RRC connection resume request as provided by the upper layers. eNB is not expected to reject a *RRConnectionResumeRequest* due to unknown cause value being used by the UE.

resumeID

UE identity to facilitate UE context retrieval at eNB.

shortResumeMAC-I

Authentication token to facilitate UE authentication at eNB.

RRConnectionSetup-NB

The *RRConnectionSetup-NB* message is used to establish SRB1 and SRB1bis.

Signalling radio bearer: SRB0

RLC-SAP: TM

Logical channel: CCCH

Direction: E-UTRAN to UE

***RRConnectionSetup-NB* message**

```
-- ASN1START
RRConnectionSetup-NB ::= SEQUENCE {
    rrc-TransactionIdentifier    RRC-TransactionIdentifier,
    criticalExtensions           CHOICE {
        c1                       CHOICE {
            rrcConnectionSetup-r13  RRConnectionSetup-NB-r13-IEs,
            spare1 NULL
        },
        criticalExtensionsFuture    SEQUENCE {}
    }
}
-- ASN1STOP
```

```

RRCConnectionSetup-NB-r13-IEs ::= SEQUENCE {
    radioResourceConfigDedicated-r13      RadioResourceConfigDedicated-NB-r13,
    lateNonCriticalExtension                OCTET STRING OPTIONAL,
    nonCriticalExtension                    SEQUENCE {}      OPTIONAL
}
-- ASN1STOP

```

– *RRCConnectionSetupComplete-NB*

The *RRCConnectionSetupComplete-NB* message is used to confirm the successful completion of an RRC connection establishment.

Signalling radio bearer: SRB1bis

RLC-SAP: AM

Logical channel: DCCH

Direction: UE to E-UTRAN

***RRCConnectionSetupComplete-NB* message**

```

-- ASN1START
RRCConnectionSetupComplete-NB ::= SEQUENCE {
    rrc-TransactionIdentifier      RRC-TransactionIdentifier,
    criticalExtensions              CHOICE {
        rrcConnectionSetupComplete-r13  RRCConnectionSetupComplete-NB-r13-IEs,
        criticalExtensionsFuture         SEQUENCE {}
    }
}

RRCConnectionSetupComplete-NB-r13-IEs ::= SEQUENCE {
    selectedPLMN-Identity-r13      INTEGER (1..maxPLMN-r11),
    s-TMSI-r13                     S-TMSI OPTIONAL,
    registeredMME-r13              RegisteredMME OPTIONAL,
    dedicatedInfoNAS-r13           DedicatedInfoNAS,
    attachWithoutPDN-Connectivity-r13  ENUMERATED {true} OPTIONAL,
    up-CIoT-EPS-Optimisation-r13    ENUMERATED {true} OPTIONAL,
    lateNonCriticalExtension        OCTET STRING OPTIONAL,
    nonCriticalExtension            RRCConnectionSetupComplete-NB-v1430-IEs OPTIONAL
}

RRCConnectionSetupComplete-NB-v1430-IEs ::= SEQUENCE {
    gummei-Type-r14                ENUMERATED { mapped} OPTIONAL,
    dcn-ID-r14                     INTEGER (0..65535) OPTIONAL,
    nonCriticalExtension            RRCConnectionSetupComplete-NB-v1470-IEs OPTIONAL
}

RRCConnectionSetupComplete-NB-v1470-IEs ::= SEQUENCE {
    measResultServCell-r14         MeasResultServCell-NB-r14 OPTIONAL,
    nonCriticalExtension            SEQUENCE {}      OPTIONAL
}
-- ASN1STOP

```

<i>RRConnectionSetupComplete-NB</i> field descriptions
<i>attachWithoutPDN-Connectivity</i> This field is used to indicate that the UE performs an Attach without PDN connectivity procedure, as indicated by the upper layers, TS 24.301 [35].
<i>dcn-ID</i> The Dedicated Core Network Identity, see TS 23.401 [41].
<i>gummei-Type</i> This field is used to indicate that the GUMMEI included is mapped (from 2G/3G identifiers) as indicated by the upper layers, TS 24.301 [35].
<i>measResultServCell</i> This field refers to the last idle mode measurement results taken of the serving cell.
<i>registeredMME</i> This field is used to transfer the GUMMEI of the MME where the UE is registered, as provided by upper layers.
<i>selectedPLMN-Identity</i> Index of the PLMN selected by the UE from the <i>plmn-IdentityList</i> included in <i>SystemInformationBlockType1-NB</i> . 1 if the 1st PLMN is selected from the <i>plmn-IdentityList</i> included in SIB1, 2 if the 2nd PLMN is selected from the <i>plmn-IdentityList</i> included in SIB1 and so on.
<i>up-CIoT-EPS-Optimisation</i> This field is included when the UE supports S1-U data transfer or the User plane ClIoT EPS Optimisation, as indicated by the upper layers, see TS 24.301 [35].

– ***SCPTMConfiguration-NB***

The *SCPTMConfiguration-NB* message contains the control information applicable for MBMS services transmitted via SC-MRB.

Signalling radio bearer: N/A

RLC-SAP: UM

Logical channel: SC-MCCH

Direction: E-UTRAN to UE

SCPTMConfiguration-NB message

```
-- ASN1START
SCPTMConfiguration-NB-r14 ::= SEQUENCE {
    sc-mtch-InfoList-r14          SC-MTCH-InfoList-NB-r14,
    scptm-NeighbourCellList-r14 SCPTM-NeighbourCellList-NB-r14  OPTIONAL, -- Need OP
    lateNonCriticalExtension     OCTET STRING                OPTIONAL,
    nonCriticalExtension         SEQUENCE {}                  OPTIONAL
}
-- ASN1STOP
```

<i>SCPTMConfiguration-NB</i> field descriptions
<i>sc-mtch-InfoList</i> Provides the configuration of each SC-MTCH in the current cell.
<i>scptm-NeighbourCellList</i> List of neighbour cells providing MBMS services via SC-MRB. When absent, the UE shall assume that MBMS services listed in the <i>SCPTMConfiguration-NB</i> message are not provided via SC-MRB in any neighbour cell.

– ***SystemInformation-NB***

The *SystemInformation-NB* message is used to convey one or more System Information Blocks. All the SIBs included are transmitted with the same periodicity.

Signalling radio bearer: N/A

RLC-SAP: TM

Logical channel: BCCH

Direction: E-UTRAN to UE

SystemInformation-NB message

```
-- ASN1START
SystemInformation-NB ::= SEQUENCE {
    criticalExtensions          CHOICE {
        systemInformation-r13   SystemInformation-NB-r13-IEs,
        criticalExtensionsFuture SEQUENCE {}
    }
}
SystemInformation-NB-r13-IEs ::= SEQUENCE {
    sib-TypeAndInfo-r13        SEQUENCE (SIZE (1..maxSIB)) OF CHOICE {
        sib2-r13                SystemInformationBlockType2-NB-r13,
        sib3-r13                SystemInformationBlockType3-NB-r13,
        sib4-r13                SystemInformationBlockType4-NB-r13,
        sib5-r13                SystemInformationBlockType5-NB-r13,
        sib14-r13               SystemInformationBlockType14-NB-r13,
        sib16-r13               SystemInformationBlockType16-NB-r13,
        ...,
        sib15-v1430             SystemInformationBlockType15-NB-r14,
        sib20-v1430             SystemInformationBlockType20-NB-r14,
        sib22-v1430             SystemInformationBlockType22-NB-r14
    },
    lateNonCriticalExtension    OCTET STRING                                OPTIONAL,
    nonCriticalExtension        SEQUENCE {}                                OPTIONAL
}
-- ASN1STOP
```

SystemInformationBlockType1-NB

The *SystemInformationBlockType1-NB* message contains information relevant when evaluating if a UE is allowed to access a cell and defines the scheduling of other system information.

Signalling radio bearer: N/A

RLC-SAP: TM

Logical channel: BCCH

Direction: E-UTRAN to UE

SystemInformationBlockType1-NB message

```
-- ASN1START
SystemInformationBlockType1-NB ::= SEQUENCE {
    hyperSFN-MSB-r13           BIT STRING (SIZE (8)),
    cellAccessRelatedInfo-r13  SEQUENCE {
        plmn-IdentityList-r13   PLMN-IdentityList-NB-r13,
        trackingAreaCode-r13    TrackingAreaCode,
        cellIdentity-r13        CellIdentity,
        cellBarred-r13          ENUMERATED {barred, notBarred},
        intraFreqReselection-r13 ENUMERATED {allowed, notAllowed}
    },
    cellSelectionInfo-r13      SEQUENCE {
        q-RxLevMin-r13          Q-RxLevMin,
        q-QualMin-r13           Q-QualMin-r9
    },
    p-Max-r13                  P-Max                                OPTIONAL, -- Need OP
    freqBandIndicator-r13      FreqBandIndicator-NB-r13,
    freqBandInfo-r13           NS-PmaxList-NB-r13                    OPTIONAL, -- Need OR
    multiBandInfoList-r13     MultiBandInfoList-NB-r13    OPTIONAL, -- Need OR
    downlinkBitmap-r13        DL-Bitmap-NB-r13                    OPTIONAL, -- Need OP,

```



```

eutraControlRegionSize-r13      ENUMERATED {n1, n2, n3}          OPTIONAL, -- Cond inband
nrs-CRS-PowerOffset-r13        ENUMERATED {dB-6, dB-4dot77, dB-3,
                                         dB-1dot77, dB0, dB1,
                                         dB1dot23, dB2, dB3,
                                         dB4, dB4dot23, dB5,
                                         dB6, dB7, dB8,
                                         dB9}          OPTIONAL, -- Cond inband-SamePCI
schedulingInfoList-r13         SchedulingInfoList-NB-r13,
si-WindowLength-r13           ENUMERATED {ms160, ms320, ms480, ms640,
                                         ms960, ms1280, ms1600, spare1},
si-RadioFrameOffset-r13       INTEGER (1..15)          OPTIONAL, -- Need OP
systemInfoValueTagList-r13     SystemInfoValueTagList-NB-r13  OPTIONAL, -- Need OR
lateNonCriticalExtension       OCTET STRING            OPTIONAL,
nonCriticalExtension           SystemInformationBlockType1-NB-v1350  OPTIONAL
}

SystemInformationBlockType1-NB-v1350 ::= SEQUENCE {
    cellSelectionInfo-v1350      CellSelectionInfo-NB-v1350  OPTIONAL, -- Cond Qrxlevmin
    nonCriticalExtension         SystemInformationBlockType1-NB-v1430  OPTIONAL
}

SystemInformationBlockType1-NB-v1430 ::= SEQUENCE {
    cellSelectionInfo-v1430      CellSelectionInfo-NB-v1430  OPTIONAL, -- Need OR
    nonCriticalExtension         SystemInformationBlockType1-NB-v1450  OPTIONAL
}

SystemInformationBlockType1-NB-v1450 ::= SEQUENCE {
    nrs-CRS-PowerOffset-v1450    ENUMERATED {dB-6, dB-4dot77, dB-3,
                                         dB-1dot77, dB0, dB1,
                                         dB1dot23, dB2, dB3,
                                         dB4, dB4dot23, dB5,
                                         dB6, dB7, dB8,
                                         dB9}          OPTIONAL, -- Cond inband-SamePCI-
}

ExceptAnchor
nonCriticalExtension           SEQUENCE {}          OPTIONAL
}

PLMN-IdentityList-NB-r13 ::= SEQUENCE (SIZE (1..maxPLMN-r11)) OF PLMN-IdentityInfo-NB-r13

PLMN-IdentityInfo-NB-r13 ::= SEQUENCE {
    plmn-Identity-r13            PLMN-Identity,
    cellReservedForOperatorUse-r13  ENUMERATED {reserved, notReserved},
    attachWithoutPDN-Connectivity-r13  ENUMERATED {true}  OPTIONAL -- Need OP
}

SchedulingInfoList-NB-r13 ::= SEQUENCE (SIZE (1..maxSI-Message-NB-r13)) OF SchedulingInfo-NB-r13

SchedulingInfo-NB-r13 ::= SEQUENCE {
    si-Periodicity-r13          ENUMERATED {rf64, rf128, rf256, rf512,
                                         rf1024, rf2048, rf4096, spare},
    si-RepetitionPattern-r13    ENUMERATED {every2ndRF, every4thRF, every8thRF, every16thRF},
    sib-MappingInfo-r13        SIB-MappingInfo-NB-r13,
    si-TB-r13                  ENUMERATED {b56, b120, b208, b256, b328, b440, b552, b680}
}

SystemInfoValueTagList-NB-r13 ::= SEQUENCE (SIZE (1..maxSI-Message-NB-r13)) OF
SystemInfoValueTagSI-r13

SIB-MappingInfo-NB-r13 ::= SEQUENCE (SIZE (0..maxSIB-1)) OF SIB-Type-NB-r13

SIB-Type-NB-r13 ::= ENUMERATED {
    sibType3-NB-r13, sibType4-NB-r13, sibType5-NB-r13,
    sibType14-NB-r13, sibType16-NB-r13, sibType15-NB-r14,
    sibType20-NB-r14, sibType22-NB-r14}

CellSelectionInfo-NB-v1350 ::= SEQUENCE {
    delta-RxLevMin-v1350        INTEGER (-8..-1)
}

CellSelectionInfo-NB-v1430 ::= SEQUENCE {
    powerClass14dBm-Offset-r14  ENUMERATED {dB-6, dB-3, dB3, dB6, dB9, dB12}  OPTIONAL, --
    Need OP
    ce-authorisationOffset-r14  ENUMERATED {dB5, dB10, dB15, dB20, dB25, dB30, dB35}
    OPTIONAL -- Need OP
}

-- ASN1STOP

```

SystemInformationBlockType1-NB field descriptions
<p>attachWithoutPDN-Connectivity If present, the field indicates that attach without PDN connectivity as specified in TS 24.301 [35] is supported for this PLMN.</p>
<p>ce-authorisationOffset Parameter "Qoffset_{authorization}" in TS 36.304 [4]. Value in dB. Value dB5 corresponds to 5 dB, dB10 corresponds to 10 dB and so on. If the field is absent, the value of 0 dB shall be used for "Qoffset_{authorization}".</p>
<p>cellBarred Barred means the cell is barred, as defined in TS 36.304 [4].</p>
<p>cellIdentity Indicates the cell identity.</p>
<p>cellReservedForOperatorUse As defined in TS 36.304 [4].</p>
<p>cellSelectionInfo Cell selection information as specified in TS 36.304 [4].</p>
<p>downlinkBitmap NB-IoT downlink subframe configuration for downlink transmission. If the bitmap is not present, the UE shall assume that all subframes are valid (except for subframes carrying NPSS/NSSS/NPBCH/SIB1-NB) as specified in TS 36.213 [23, 16.4].</p>
<p>eutraControlRegionSize Indicates the control region size of the E-UTRA cell for the in-band operation mode, see TS 36.213 [23]. Unit is in number of OFDM symbols.</p>
<p>freqBandInfo A list of <i>additionalPmax</i> and <i>additionalSpectrumEmission</i> values as defined in TS 36.101 [42, 6.2.4F] for the frequency band in <i>freqBandIndicator</i>.</p>
<p>hyperSFN-MSB Indicates the 8 most significant bits of hyper-SFN. Together with hyperSFN-LSB in MIB-NB, the complete hyper-SFN is built up. hyper-SFN is incremented by one when the SFN wraps around.</p>
<p>intraFreqReselection Used to control cell reselection to intra-frequency cells when the highest ranked cell is barred, or treated as barred by the UE, as specified in TS 36.304 [4].</p>
<p>multiBandInfoList A list of additional frequency band indicators, <i>additionalPmax</i> and <i>additionalSpectrumEmission</i> values, as defined in TS 36.101 [42, table 5.5-1]. If the UE supports the frequency band in the <i>freqBandIndicator</i> IE it shall apply that frequency band. Otherwise, the UE shall apply the first listed band which it supports in the <i>multiBandInfoList</i> IE.</p>
<p>nrs-CRS-PowerOffset NRS power offset between NRS and E-UTRA CRS, see TS 36.213 [23, 16.2.2]. Unit in dB. Default value of 0.</p>
<p>plmn-IdentityList List of PLMN identities. The first listed <i>PLMN-Identity</i> is the primary PLMN.</p>
<p>powerClass14dBm-Offset Parameter "Poffset" in TS 36.304 [4]. Only applicable for UE supporting <i>powerClassNB-14dBm</i>. Value in dB. Value dB-6 corresponds to -6 dB, dB-3 corresponds to -3 dB and so on. If the field is absent, the UE applies the (default) value of 0 dB for "Poffset" in TS 36.304 [4].</p>
<p>p-Max Value applicable for the cell. If absent the UE applies the maximum power according to the UE capability.</p>
<p>q-QualMin Parameter "Q_{qualmin}" in TS 36.304 [4].</p>
<p>q-RxLevMin, delta-RxLevMin Parameter Q_{rxlevmin} in TS 36.304 [4]. If <i>delta-RxLevMin</i> is not included, actual value Q_{rxlevmin} = <i>q-RxLevMin</i> * 2 [dBm]. If <i>delta-RxLevMin</i> is included, actual value Q_{rxlevmin} = (<i>q-RxLevMin</i> + <i>delta-RxLevMin</i>) * 2 [dBm].</p>
<p>schedulingInfoList Indicates additional scheduling information of SI messages.</p>
<p>si-Periodicity Periodicity of the SI-message in radio frames, such that rf256 denotes 256 radio frames, rf512 denotes 512 radio frames, and so on.</p>
<p>si-RadioFrameOffset Offset in number of radio frames to calculate the start of the SI window. If the field is absent, no offset is applied.</p>
<p>si-RepetitionPattern Indicates the starting radio frames within the SI window used for SI message transmission. Value every2ndRF corresponds to every 2 radio frames, value every4thRF corresponds to every 4 radio frames and so on. The first transmission of the SI message is transmitted from the first radio frame of the SI window.</p>

SystemInformationBlockType1-NB field descriptions
<p>si-TB This field indicates the transport block size in number of bits and the corresponding number of consecutive NB-IoT downlink subframes that are used to broadcast the SI message. Value b56 corresponds to 56 bits, b120 corresponds to 120 bits and so on. TBS of 56 bits and 120 bits are transmitted over 2 sub-frames, other TBS are transmitted over 8 sub-frames, see TS 36.213 [23, Table 16.4.1.5.1-1].</p>
<p>si-WindowLength Common SI scheduling window for all SIs. Unit in milliseconds, where ms160 denotes 160 milliseconds, ms320 denotes 320 milliseconds and so on.</p>
<p>sib-MappingInfo List of the SIBs mapped to this <i>SystemInformation</i> message. There is no mapping information of SIB2-NB; it is always present in the first <i>SystemInformation</i> message listed in the <i>schedulingInfoList</i> list.</p>
<p>systemInfoValueTagList Indicates SI message specific value tags. It includes the same number of entries, and listed in the same order, as in <i>SchedulingInfoList</i>.</p>
<p>systemInfoValueTagSI SI message specific value tag as specified in Clause 5.2.1.3. Common for all SIBs within the SI message other than SIB14-NB.</p>
<p>trackingAreaCode A <i>trackingAreaCode</i> that is common for all the PLMNs listed.</p>

Conditional presence	Explanation
<i>inband</i>	The field is mandatory present if IE <i>operationModeInfo</i> in MIB-NB is set to <i>inband-SamePCI</i> or <i>inband-DifferentPCI</i> . Otherwise the field is not present.
<i>inband-SamePCI</i>	The field is mandatory present, if IE <i>operationModeInfo</i> in MIB-NB is set to <i>inband-SamePCI</i> . Otherwise the field is not present.
<i>inband-SamePCI-ExceptAnchor</i>	The field is optionally present if IE <i>operationModeInfo</i> in MIB-NB is set to a value other than <i>inband-SamePCI</i> , and at least one non-anchor carrier is inband carrier and uses the same PCI as the E-UTRA carrier. Otherwise the field is not present.
<i>Qrxlevmin</i>	This field is optionally present, Need OR, if <i>q-RxLevMin</i> is set to the minimum value. Otherwise the field is not present.

– UECapabilityEnquiry-NB

The *UECapabilityEnquiry-NB* message is used to request the transfer of UE radio access capabilities for NB-IoT.

Signalling radio bearer: SRB1 or SRB1bis

RLC-SAP: AM

Logical channel: DCCH

Direction: E-UTRAN to UE

UECapabilityEnquiry-NB message

```

-- ASN1START
UECapabilityEnquiry-NB ::= SEQUENCE {
    rrc-TransactionIdentifier    RRC-TransactionIdentifier,
    criticalExtensions           CHOICE {
        c1                      CHOICE {
            ueCapabilityEnquiry-r13    UECapabilityEnquiry-NB-r13-IEs,
            spare1                    NULL
        },
        criticalExtensionsFuture      SEQUENCE {}
    }
}

UECapabilityEnquiry-NB-r13-IEs ::= SEQUENCE {
    lateNonCriticalExtension    OCTET STRING                OPTIONAL,
    nonCriticalExtension        SEQUENCE {}                OPTIONAL
}
-- ASN1STOP

```

– *UECapabilityInformation-NB*

The *UECapabilityInformation-NB* message is used to transfer of UE radio access capabilities requested by the E-UTRAN.

Signalling radio bearer: SRB1 or SRB1bis

RLC-SAP: AM

Logical channel: DCCH

Direction: UE to E-UTRAN

***UECapabilityInformation-NB* message**

```
-- ASN1START
UECapabilityInformation-NB ::= SEQUENCE {
    rrc-TransactionIdentifier      RRC-TransactionIdentifier,
    criticalExtensions             CHOICE {
        ueCapabilityInformation-r13  UECapabilityInformation-NB-r13-IEs,
        criticalExtensionsFuture     SEQUENCE {}
    }
}

UECapabilityInformation-NB-r13-IEs ::= SEQUENCE {
    ue-Capability-r13             UE-Capability-NB-r13,
    ue-RadioPagingInfo-r13       UE-RadioPagingInfo-NB-r13,
    lateNonCriticalExtension      OCTET STRING OPTIONAL,
    nonCriticalExtension          UECapabilityInformation-NB-Ext-r14-IEs
                                OPTIONAL
}

UECapabilityInformation-NB-Ext-r14-IEs ::= SEQUENCE {
    ue-Capability-ContainerExt-r14 OCTET STRING (CONTAINING UE-Capability-NB-Ext-r14-IEs),
    nonCriticalExtension           SEQUENCE {} OPTIONAL
}
-- ASN1STOP
```

<i>UECapabilityInformation-NB</i> field descriptions
<i>ue-RadioPagingInfo</i> This field contains UE capability information used for paging.

– *ULInformationTransfer-NB*

The *ULInformationTransfer-NB* message is used for the uplink transfer of NAS information.

Signalling radio bearer: SRB1 or SRB1bis

RLC-SAP: AM

Logical channel: DCCH

Direction: UE to E-UTRAN

***ULInformationTransfer-NB* message**

```
-- ASN1START
ULInformationTransfer-NB ::= SEQUENCE {
    criticalExtensions             CHOICE {
        ulInformationTransfer-r13    ULInformationTransfer-NB-r13-IEs,
        criticalExtensionsFuture     SEQUENCE {}
    }
}

ULInformationTransfer-NB-r13-IEs ::= SEQUENCE {
    dedicatedInfoNAS-r13          DedicatedInfoNAS,
}
```

```

    lateNonCriticalExtension      OCTET STRING      OPTIONAL,
    nonCriticalExtension          SEQUENCE {}        OPTIONAL
}
-- ASN1STOP

```

6.7.3 NB-IoT information elements

6.7.3.1 NB-IoT System information blocks

– *SystemInformationBlockType2-NB*

The IE *SystemInformationBlockType2-NB* contains radio resource configuration information that is common for all UEs.

NOTE: UE timers and constants related to functionality for which parameters are provided in another SIB are included in the corresponding SIB.

***SystemInformationBlockType2-NB* information element**

```

-- ASN1START
SystemInformationBlockType2-NB-r13 ::= SEQUENCE {
    radioResourceConfigCommon-r13      RadioResourceConfigCommonSIB-NB-r13,
    ue-TimersAndConstants-r13          UE-TimersAndConstants-NB-r13,
    freqInfo-r13                       SEQUENCE {
        ul-CarrierFreq-r13              CarrierFreq-NB-r13      OPTIONAL, -- Need OP
        additionalSpectrumEmission-r13  AdditionalSpectrumEmission
    },
    timeAlignmentTimerCommon-r13       TimeAlignmentTimer,
    multiBandInfoList-r13              SEQUENCE (SIZE (1..maxMultiBands)) OF AdditionalSpectrumEmission
OPTIONAL, -- Need OR
    lateNonCriticalExtension           OCTET STRING      OPTIONAL,
    ...
[[ cp-Reestablishment-r14             ENUMERATED {true}      OPTIONAL      -- Need
OP
]],
[[ servingCellMeasInfo-r14            ENUMERATED {true}      OPTIONAL,      -- Need
OR
    cqi-Reporting-r14                  ENUMERATED {true}      OPTIONAL      -- Need
OR
]]
}
-- ASN1STOP

```

***SystemInformationBlockType2-NB* field descriptions**

additionalSpectrumEmission

The UE requirements related to IE *AdditionalSpectrumEmission* are defined in TS 36.101 [42, 6.2.4F].

cp-Reestablishment

This field indicates if the NB-IoT UE is allowed to trigger RRC connection re-establishment when AS security has not been activated.

cqi-Reporting

This field indicates if downlink channel quality reporting in *RRCConnectionReestablishmentRequest-NB*, *RRCConnectionRequest-NB* and *RRCConnectionResumeRequest-NB* message is allowed.

multiBandInfoList

A list of *additionalSpectrumEmission* i.e. one for each additional frequency band included in *multiBandInfoList* in *SystemInformationBlockType1-NB*, listed in the same order.

servingCellMeasInfo

This field indicates if serving cell idle mode measurement reporting in *RRCConnectionReestablishmentComplete-NB*, *RRCConnectionResumeComplete-NB* and *RRCConnectionSetupComplete-NB* is allowed.

ul-CarrierFreq

Uplink carrier frequency as defined in TS 36.101 [42, 5.7.3F]. If *operationModeInfo* in the MIB-NB is set to *standalone* and the field is absent, the value of the carrier frequency is determined by the TX-RX frequency separation defined in TS 36.101 [42, table 5.7.4-1] and the value of the carrier frequency offset is 0. If *operationModeInfo* in the MIB-NB is not set to *standalone*, the field is mandatory present.

SystemInformationBlockType3-NB

The IE *SystemInformationBlockType3-NB* contains cell re-selection information common for intra-frequency, and inter-frequency cell re-selection as well as intra-frequency cell re-selection information other than neighbouring cell related.

SystemInformationBlockType3-NB information element

```

-- ASN1START
SystemInformationBlockType3-NB-r13 ::= SEQUENCE {
  cellReselectionInfoCommon-r13      SEQUENCE {
    q-Hyst-r13                        ENUMERATED {
                                      dB0, dB1, dB2, dB3, dB4, dB5, dB6, dB8, dB10,
                                      dB12, dB14, dB16, dB18, dB20, dB22, dB24
                                      }
  },
  cellReselectionServingFreqInfo-r13 SEQUENCE {
    s-NonIntraSearch-r13              ReselectionThreshold
  },
  intraFreqCellReselectionInfo-r13   SEQUENCE {
    q-RxLevMin-r13                    Q-RxLevMin,
    q-QualMin-r13                     Q-QualMin-r9          OPTIONAL, -- Need OP
    p-Max-r13                         P-Max                OPTIONAL, -- Need OP
    s-IntraSearchP-r13                ReselectionThreshold,
    t-Reselection-r13                 T-Reselection-NB-r13
  },
  freqBandInfo-r13                   NS-PmaxList-NB-r13     OPTIONAL, -- Need OR
  multiBandInfoList-r13              SEQUENCE (SIZE (1..maxMultiBands)) OF
                                      NS-PmaxList-NB-r13     OPTIONAL, -- Need OR
  lateNonCriticalExtension            OCTET STRING        OPTIONAL,
  ...
  [[ intraFreqCellReselectionInfo-v1350 IntraFreqCellReselectionInfo-NB-v1350 OPTIONAL -- Cond
Qrxlevmin
  ]],
  OR
  [[ intraFreqCellReselectionInfo-v1360 IntraFreqCellReselectionInfo-NB-v1360 OPTIONAL -- Need
OR
  ]],
  OR
  [[ intraFreqCellReselectionInfo-v1430 IntraFreqCellReselectionInfo-NB-v1430 OPTIONAL -- Need
OR
  ]],
  OR
  [[ cellReselectionInfoCommon-v1450    CellReselectionInfoCommon-NB-v1450  OPTIONAL -- Need
OR
  ]]
}

IntraFreqCellReselectionInfo-NB-v1350 ::= SEQUENCE {
  delta-RxLevMin-v1350                INTEGER (-8..-1)
}

IntraFreqCellReselectionInfo-NB-v1360 ::= SEQUENCE {
  s-IntraSearchP-v1360                ReselectionThreshold-NB-v1360
}

IntraFreqCellReselectionInfo-NB-v1430 ::= SEQUENCE {
  powerClass14dBm-Offset-r14          ENUMERATED {dB-6, dB-3, dB3, dB6, dB9, dB12}  OPTIONAL, --
Need OP
  ce-AuthorisationOffset-r14          ENUMERATED {dB5, dB10, dB15, dB20, dB25, dB30, dB35}  OPTIONAL
-- Need OP
}

CellReselectionInfoCommon-NB-v1450 ::= SEQUENCE {
  s-SearchDeltaP-r14                  ENUMERATED {dB6, dB9, dB12, dB15}
}
-- ASN1STOP

```

SystemInformationBlockType3-NB field descriptions
<p>ce-AuthorisationOffset Parameter "Qoffset_{authorization}" in TS 36.304 [4]. Value in dB. Value dB5 corresponds to 5 dB, dB10 corresponds to 10 dB and so on. If the field is absent, the UE applies the value of <i>ce-authorizationOffset</i> in <i>SystemInformationBlockType1-NB</i>.</p>
<p>multiBandInfoList A list of <i>additionalPmax</i> and <i>additionalSpectrumEmission</i> values as defined in TS 36.101 [42, 6.2.4F] applicable for the intra-frequency neighbouring NB-IoT cells if the UE selects the frequency band from <i>freqBandIndicator</i> in <i>SystemInformationBlockType1-NB</i>.</p>
<p>powerClass14dBm-Offset Parameter "Poffset" in TS 36.304 [4], only applicable for UE supporting <i>powerClassNB-14dBm</i>. Value in dB. Value dB-6 corresponds to -6 dB, dB-3 corresponds to -3 dB and so on. If the field is absent, the UE applies the (default) value of 0 dB for "Poffset" in TS 36.304 [4].</p>
<p>p-Max Value applicable for the intra-frequency neighbouring E-UTRA cells. If absent the UE applies the maximum power according to the UE capability.</p>
<p>q-Hyst Parameter Q_{hyst} in TS 36.304 [4], Value in dB. Value dB1 corresponds to 1 dB, dB2 corresponds to 2 dB and so on.</p>
<p>q-QualMin Parameter "Q_{qualmin}" in TS 36.304 [4], applicable for intra-frequency neighbour cells. If the field is not present, the UE applies the (default) value of negative infinity for $Q_{qualmin}$.</p>
<p>q-RxLevMin, delta-RxLevMin Parameter "Q_{rxlevmin}" in TS 36.304 [4], applicable for intra-frequency neighbour cells. If <i>delta-RxLevMin</i> is not included, actual value $Q_{rxlevmin} = q-RxLevMin * 2$ [dBm]. If <i>delta-RxLevMin</i> is included, actual value $Q_{rxlevmin} = (q-RxLevMin + delta-RxLevMin) * 2$ [dBm].</p>
<p>s-IntraSearchP Parameter "S_{IntraSearchP}" in TS 36.304 [4]. In case <i>s-IntraSearchP-v1360</i> is included, the UE shall ignore <i>s-IntraSearchP</i> (i.e. without suffix).</p>
<p>s-NonIntraSearch Parameter "S_{nonIntraSearchP}" in TS 36.304 [4].</p>
<p>s-SearchDeltaP Parameter "S_{SearchDeltaP}" in TS 36.304 [4]. This parameter is only applicable for UEs supporting relaxed monitoring as specified in TS 36.306 [5]. Value dB6 corresponds to 6 dB, dB9 corresponds to 9 dB and so on.</p>
<p>t-Reselection Parameter "T_{reselectionNB-IoT_Intra}" in TS 36.304 [4].</p>

Conditional presence	Explanation
Qrxlevmin	This field is optionally present, Need OR, if <i>q-RxLevMin</i> is set to the minimum value. Otherwise the field is not present.

SystemInformationBlockType4-NB

The IE *SystemInformationBlockType4-NB* contains neighbouring cell related information relevant only for intra-frequency cell re-selection. The IE includes cells with specific re-selection parameters.

SystemInformationBlockType4-NB information element

```

-- ASN1START
SystemInformationBlockType4-NB-r13 ::= SEQUENCE {
    intraFreqNeighCellList-r13      IntraFreqNeighCellList  OPTIONAL,  -- Need OR
    intraFreqBlackCellList-r13     IntraFreqBlackCellList  OPTIONAL,  -- Need OR
    lateNonCriticalExtension        OCTET STRING           OPTIONAL,
    ...
}
-- ASN1STOP

```

SystemInformationBlockType4-NB field descriptions
<p>intraFreqBlackCellList List of blacklisted intra-frequency neighbouring cells.</p>
<p>intraFreqNeighCellList List of intra-frequency neighbouring cells with specific cell re-selection parameters.</p>

– *SystemInformationBlockType5-NB*

The IE *SystemInformationBlockType5-NB* contains information relevant only for inter-frequency cell re-selection i.e. information about other NB-IoT frequencies and inter-frequency neighbouring cells relevant for cell re-selection. The IE includes cell re-selection parameters common for a frequency.

***SystemInformationBlockType5-NB* information element**

```
-- ASN1START

SystemInformationBlockType5-NB-r13 ::= SEQUENCE {
    interFreqCarrierFreqList-r13      InterFreqCarrierFreqList-NB-r13,
    t-Reselection-r13                 T-Reselection-NB-r13,
    lateNonCriticalExtension           OCTET STRING                               OPTIONAL,
    . . .
    [[ sctpm-FreqOffset-r14            INTEGER (1..8)                               OPTIONAL   -- Need OP
    ]]
}

InterFreqCarrierFreqList-NB-r13 ::= SEQUENCE (SIZE (1..maxFreq)) OF InterFreqCarrierFreqInfo-NB-
r13

InterFreqCarrierFreqInfo-NB-r13 ::= SEQUENCE {
    dl-CarrierFreq-r13                CarrierFreq-NB-r13,
    q-RxLevMin-r13                    Q-RxLevMin,
    q-QualMin-r13                     Q-QualMin-r9                               OPTIONAL,   -- Need OP
    p-Max-r13                         P-Max                                       OPTIONAL,   -- Need OP
    q-OffsetFreq-r13                  Q-OffsetRange                             DEFAULT dB0,
    interFreqNeighCellList-r13        InterFreqNeighCellList-NB-r13              OPTIONAL,   -- Need OR
    interFreqBlackCellList-r13        InterFreqBlackCellList-NB-r13              OPTIONAL,   -- Need OR
    multiBandInfoList-r13             MultiBandInfoList-NB-r13                  OPTIONAL,   -- Need OR
    . . .
    [[ delta-RxLevMin-v1350            INTEGER (-8..-1)                            OPTIONAL   -- Cond Qrxlevmin
    ]],
    [[ powerClass14dBm-Offset-r14      ENUMERATED {dB-6, dB-3, dB3, dB6, dB9, dB12}
OPTIONAL,   -- Need OP
    ce-AuthorisationOffset-r14        ENUMERATED {dB5, dB10, dB15, dB20, dB25, dB30, dB35}
OPTIONAL   -- Need OP
    ]]
}

InterFreqNeighCellList-NB-r13 ::= SEQUENCE (SIZE (1..maxCellInter)) OF PhysCellId

InterFreqBlackCellList-NB-r13 ::= SEQUENCE (SIZE (1..maxCellBlack)) OF PhysCellId

-- ASN1STOP
```

SystemInformationBlockType5-NB field descriptions	
ce-AuthorisationOffset	Parameter "Qoffset _{authorization} " in TS 36.304 [4]. Value in dB. Value dB5 corresponds to 5 dB, dB10 corresponds to 10 dB and so on. If the field is absent, the UE applies the value of <i>ce-authorizationOffset</i> in <i>SystemInformationBlockType1-NB</i> .
interFreqBlackCellList	List of blacklisted inter-frequency neighbouring cells.
interFreqCarrierFreqList	List of neighbouring inter-frequencies. E-UTRAN does not configure more than one entry for the same physical frequency regardless of the E-ARFCN used to indicate this.
interFreqNeighCellList	List of inter-frequency neighbouring cells. The UE shall ignore this field in this version of the specification.
multiBandInfoList	Indicates the list of frequency bands, with the associated <i>additionalPmax</i> and <i>additionalSpectrumEmission</i> values as defined in TS 36.101 [42, 6.2.4], in addition to the band represented by <i>dl-CarrierFreq</i> for which cell reselection parameters are common.
powerClass14dBm-Offset	Parameter "Poffset" in TS 36.304 [4], only applicable for UE supporting <i>powerClassNB-14dBm</i> . Value in dB. Value dB-6 corresponds to -6 dB, dB-3 corresponds to -3 dB and so on. If the field is absent, the UE applies the (default) value of 0 dB for "Poffset" in TS 36.304 [4].
p-Max	Value applicable for the neighbouring NB-IoT cells on this carrier frequency. If absent the UE applies the maximum power according to the UE capability.
q-OffsetFreq	Parameter "Qoffset _{frequency} " in TS 36.304 [4].
q-QualMin	Parameter "Q _{qualmin} " in TS 36.304 [4]. If the field is not present, the UE applies the (default) value of negative infinity for <i>Q_{qualmin}</i> .
q-RxlevMin, delta-RxLevMin	Parameter "Q _{RxLevmin} " in TS 36.304 [4]. If <i>delta-RxLevMin</i> is not included, actual value <i>Q_{RxLevmin}</i> = <i>q-RxLevMin</i> * 2 [dBm]. If <i>delta-RxLevMin</i> is included, actual value <i>Q_{RxLevmin}</i> = (<i>q-RxLevMin</i> + <i>delta-RxLevMin</i>) * 2 [dBm].
scptm-FreqOffset	Parameter <i>Qoffset_{SCPTM}</i> in TS 36.304 [4]. Actual value <i>Qoffset_{SCPTM}</i> = field value * 2 [dB]. If the field is absent, the UE uses infinite dBs for the SC-PTM frequency offset with cell ranking as specified in TS 36.304 [4].
t-Reselection	Parameter "T _{reselectionNB-IoT_Inter} " in TS 36.304 [4].

Conditional presence	Explanation
Qrxlevmin	This field is optionally present, Need OR, if <i>q-RxLevMin</i> is set to the minimum value. Otherwise the field is not present.

– SystemInformationBlockType14-NB

The IE *SystemInformationBlockType14-NB* contains the AB parameters.

SystemInformationBlockType14-NB information element

```
-- ASN1START
SystemInformationBlockType14-NB-r13 ::= SEQUENCE {
    ab-Param-r13          CHOICE {
        ab-Common-r13    AB-Config-NB-r13,
        ab-PerPLMN-List-r13 SEQUENCE (SIZE (1..maxPLMN-r11)) OF AB-ConfigPLMN-NB-r13
    }
    lateNonCriticalExtension OCTET STRING
    ...
}
AB-ConfigPLMN-NB-r13 ::= SEQUENCE {
    ab-Config-r13          AB-Config-NB-r13
}
AB-Config-NB-r13 ::= SEQUENCE {
    ab-Category-r13      ENUMERATED {a, b, c},
    ab-BarringBitmap-r13 BIT STRING (SIZE(10)),
    ab-BarringForExceptionData-r13 ENUMERATED {true}
}
```

```

    ab-BarringForSpecialAC-r13      BIT STRING (SIZE(5))
  }
-- ASN1STOP

```

SystemInformationBlockType14-NB field descriptions

ab-BarringBitmap

Access class barring for AC 0-9. The first/ leftmost bit is for AC 0, the second bit is for AC 1, and so on.

ab-BarringForExceptionData

Indicates whether ExceptionData is subject to access barring.

ab-BarringForSpecialAC

Access class barring for AC 11-15. The first/ leftmost bit is for AC 11, the second bit is for AC 12, and so on.

ab-Category

Indicates the category of UEs for which AB applies. Value *a* corresponds to all UEs, value *b* corresponds to the UEs that are neither in their HPLMN nor in a PLMN that is equivalent to it, and value *c* corresponds to the UEs that are neither in the PLMN listed as most preferred PLMN of the country where the UEs are roaming in the operator-defined PLMN selector list on the USIM, nor in their HPLMN nor in a PLMN that is equivalent to their HPLMN, see TS 22.011 [10].

ab-Common

The AB parameters applicable for all PLMN(s).

ab-PerPLMN-List

The AB parameters per PLMN, listed in the same order as the PLMN(s) occur in *plmn-IdentityList* in *SystemInformationBlockType1-NB*.

SystemInformationBlockType15-NB

The IE *SystemInformationBlockType15-NB* contains the MBMS Service Area Identities (SAI) of the current and/ or neighbouring carrier frequencies.

SystemInformationBlockType15-NB information element

```

-- ASN1START
SystemInformationBlockType15-NB-r14 ::= SEQUENCE {
    mbms-SAI-IntraFreq-r14          MBMS-SAI-List-r11          OPTIONAL,  -- Need OR
    mbms-SAI-InterFreqList-r14     MBMS-SAI-InterFreqList-NB-r14  OPTIONAL,  -- Need OR
    lateNonCriticalExtension        OCTET STRING              OPTIONAL,
    ...
}
MBMS-SAI-InterFreqList-NB-r14 ::= SEQUENCE (SIZE (1..maxFreq)) OF MBMS-SAI-InterFreq-NB-r14
MBMS-SAI-InterFreq-NB-r14 ::= SEQUENCE {
    dl-CarrierFreq-r14             CarrierFreq-NB-r13,
    mbms-SAI-List-r14              MBMS-SAI-List-r11,
    multiBandInfoList-r14          AdditionalBandInfoList-NB-r14  OPTIONAL  -- Need OR
}
-- ASN1STOP

```

SystemInformationBlockType15-NB field descriptions

mbms-SAI-InterFreqList

Contains a list of neighboring frequencies including additional frequency bands, if any, that provide MBMS services and the corresponding MBMS SAIs.

mbms-SAI-IntraFreq

Contains the list of MBMS SAIs for the current frequency. A duplicate MBMS SAI indicates that this and all following SAIs are not offered by this cell but only by neighbour cells on the current frequency. For MBMS service continuity, the UE shall use all MBMS SAIs listed in *mbms-SAI-IntraFreq* to derive the MBMS frequencies of interest.

mbms-SAI-List

Contains a list of MBMS SAIs for a specific frequency.

multiBandInfoList

A list of additional frequency bands applicable for the cells participating in the SC-PTM transmission.

– SystemInformationBlockType16-NB

The IE *SystemInformationBlockType16-NB* contains information related to GPS time and Coordinated Universal Time (UTC). The UE may use the parameters provided in this system information block to obtain the UTC, the GPS and the local time.

```
-- ASN1START
SystemInformationBlockType16-NB-r13 ::= SystemInformationBlockType16-r11
-- ASN1STOP
```

– SystemInformationBlockType20-NB

The IE *SystemInformationBlockType20-NB* contains the information required to acquire the control information associated with transmission of MBMS using SC-PTM.

SystemInformationBlockType20-NB information element

```
-- ASN1START
SystemInformationBlockType20-NB-r14 ::= SEQUENCE {
  npdcch-SC-MCCH-Config-r14          NPDCCH-SC-MCCH-Config-NB-r14,
  sc-mcch-CarrierConfig-r14          CHOICE {
    dl-CarrierConfig-r14              DL-CarrierConfigCommon-NB-r14,
    dl-CarrierIndex-r14              INTEGER (0.. maxNonAnchorCarriers-NB-r14)
  },
  sc-mcch-RepetitionPeriod-r14       ENUMERATED {rf32, rf128, rf512, rf1024,
                                                    rf2048, rf4096, rf8192, rf16384},
  sc-mcch-Offset-r14                 INTEGER (0..10),
  sc-mcch-ModificationPeriod-r14     ENUMERATED { rf32, rf128, rf256, rf512, rf1024,
                                                    rf2048, rf4096, rf8192, rf16384, rf32768,
                                                    rf65536, rf131072, rf262144, rf524288,
                                                    rf1048576, spare1},
  sc-mcch-SchedulingInfo-r14         SC-MCCH-SchedulingInfo-NB-r14      OPTIONAL,  -- Need
OP
  lateNonCriticalExtension            OCTET STRING                      OPTIONAL,
  ...
}

NPDCCH-SC-MCCH-Config-NB-r14 ::= SEQUENCE {
  npdcch-NumRepetitions-SC-MCCH-r14  ENUMERATED {r1, r2, r4, r8, r16,
                                                    r32, r64, r128, r256,
                                                    r512, r1024, r2048},
  npdcch-StartSF-SC-MCCH-r14        ENUMERATED {v1dot5, v2, v4, v8,
                                                    v16, v32, v48, v64},
  npdcch-Offset-SC-MCCH-r14         ENUMERATED {zero, oneEighth, oneQuarter,
                                                    threeEighth, oneHalf, fiveEighth,
                                                    threeQuarter, sevenEighth}
}

SC-MCCH-SchedulingInfo-NB-r14 ::= SEQUENCE {
  onDurationTimerSCPTM-r14          ENUMERATED {
    pp1, pp2, pp3, pp4,
    pp8, pp16, pp32, spare},
  drx-InactivityTimerSCPTM-r14     ENUMERATED {
    pp0, pp1, pp2, pp3,
    pp4, pp8, pp16, pp32},
  schedulingPeriodStartOffsetSCPTM-r14 CHOICE {
    sf10          INTEGER(0..9),
    sf20          INTEGER(0..19),
    sf32          INTEGER(0..31),
    sf40          INTEGER(0..39),
    sf64          INTEGER(0..63),
    sf80          INTEGER(0..79),
    sf128         INTEGER(0..127),
    sf160         INTEGER(0..159),
    sf256         INTEGER(0..255),
    sf320         INTEGER(0..319),
    sf512         INTEGER(0..511),
    sf640         INTEGER(0..639),
    sf1024        INTEGER(0..1023),
    sf2048        INTEGER(0..2047),

```

```

        sf4096                INTEGER(0..4095) ,
        sf8192                INTEGER(0..8191)
    },
    ...
}
-- ASN1STOP

```

SystemInformationBlockType20-NB field descriptions
dl-CarrierConfig Downlink carrier used for SC-MCCH.
dl-CarrierIndex Index to a downlink carrier signalled in system information. Value '0' corresponds to the anchor carrier, value '1' corresponds to the first entry in <i>dl-ConfigList</i> in <i>SystemInformationBlockType22-NB</i> , value '2' corresponds to the second entry in <i>dl-ConfigList</i> and so on.
drx-InactivityTimerSCPTM Timer for SC-MCCH reception in TS 36.321 [6]. Value in number of NPDCCH periods. Value pp1 corresponds to 1 NPDCCH period, pp2 corresponds to 2 NPDCCH periods and so on.
npdcch-NumRepetitions-SC-MCCH The maximum number of NPDCCH repetitions the UE needs to monitor for SC-MCCH multicast search space, see TS 36.213 [23].
npdcch-Offset-SC-MCCH Fractional period offset of starting subframe for NPDCCH multicast search space for SC-MCCH, see TS 36.213 [23].
npdcch-StartSF-SC-MCCH Starting subframes configuration of the NPDCCH multicast search space for SC-MCCH, see TS 36.213 [23].
onDurationTimerSCPTM Timer for SC-MCCH reception in TS 36.321 [6]. Value in number of NPDCCH periods. Value pp1 corresponds to 1 NPDCCH period, pp2 corresponds to 2 NPDCCH periods and so on.
schedulingPeriodStartOffsetSCPTM <i>SCPTM-SchedulingCycle</i> and <i>SCPTM-SchedulingOffset</i> in TS 36.321 [6]. The value of <i>SCPTM-SchedulingCycle</i> is in number of sub-frames. Value sf10 corresponds to 10 sub-frames, sf20 corresponds to 20 sub-frames and so on. The value of <i>SCPTM-SchedulingOffset</i> is in number of sub-frames.
sc-mcch-CarrierConfig Downlink carrier that is used for SC-MCCH.
sc-mcch-ModificationPeriod Defines periodically appearing boundaries, i.e. radio frames for which $(H-SFN * 1024 + SFN) \bmod sc-mcch-ModificationPeriod = 0$. The contents of different transmissions of SC-MCCH information can only be different if there is at least one such boundary in-between them. Value rf32 corresponds to 32 radio frames, value rf128 corresponds to 128 radio frames and so on.
sc-mcch-Offset Indicates, together with the <i>sc-mcch-RepetitionPeriod</i> , the boundary of the repetition period: $(H-SFN * 1024 + SFN) \bmod sc-mcch-RepetitionPeriod = sc-mcch-Offset$.
sc-mcch-RepetitionPeriod Defines the interval between transmissions of SC-MCCH information, in radio frames. Value rf32 corresponds to 32 radio frames, rf128 corresponds to 128 radio frames and so on.
sc-mcch-SchedulingInfo DRX information for the SC-MCCH. If the field is absent, DRX is not used for SC-MCCH reception.

– SystemInformationBlockType22-NB

The IE *SystemInformationBlockType22-NB* contains radio resource configuration for paging and random access procedure on non-anchor carriers.

SystemInformationBlockType22-NB information element

```

-- ASN1START
SystemInformationBlockType22-NB-r14 ::= SEQUENCE {
    dl-ConfigList-r14          DL-ConfigCommonList-NB-r14  OPTIONAL,  -- Need OR
    ul-ConfigList-r14          UL-ConfigCommonList-NB-r14  OPTIONAL,  -- Need OR
    pagingWeightAnchor-r14     PagingWeight-NB-r14      OPTIONAL,  -- Cond pcch-config
    nprach-ProbabilityAnchorList-r14  NPRACH-ProbabilityAnchorList-NB-r14  OPTIONAL,  -- Cond
nprach-config
    lateNonCriticalExtension    OCTET STRING                OPTIONAL,
    ...
}

```

```

DL-ConfigCommonList-NB-r14 ::= SEQUENCE (SIZE (1.. maxNonAnchorCarriers-NB-r14)) OF
                                DL-ConfigCommon-NB-r14

UL-ConfigCommonList-NB-r14 ::= SEQUENCE (SIZE (1.. maxNonAnchorCarriers-NB-r14)) OF
                                UL-ConfigCommon-NB-r14

DL-ConfigCommon-NB-r14 ::= SEQUENCE {
    dl-CarrierConfig-r14          DL-CarrierConfigCommon-NB-r14,
    pcch-Config-r14              PCCH-Config-NB-r14           OPTIONAL, -- Need OR
    ...
}

PCCH-Config-NB-r14 ::= SEQUENCE {
    npdcch-NumRepetitionPaging-r14  ENUMERATED {
        r1, r2, r4, r8, r16, r32, r64, r128,
        r256, r512, r1024, r2048,
        spare4, spare3, spare2, spare1} OPTIONAL, -- Need OP
    pagingWeight-r14              PagingWeight-NB-r14 DEFAULT w1,
    ...
}

PagingWeight-NB-r14 ::= ENUMERATED {w1, w2, w3, w4, w5, w6, w7, w8,
                                       w9, w10, w11, w12, w13, w14, w15, w16}

UL-ConfigCommon-NB-r14 ::= SEQUENCE {
    ul-CarrierFreq-r14           CarrierFreq-NB-r13,
    nprach-ParametersList-r14    NPRACH-ParametersList-NB-r14  OPTIONAL, -- Need OR
    ...
}

NPRACH-ProbabilityAnchorList-NB-r14 ::= SEQUENCE (SIZE (1.. maxNPRACH-Resources-NB-r13)) OF
                                         NPRACH-ProbabilityAnchor-NB-r14

NPRACH-ProbabilityAnchor-NB-r14 ::= SEQUENCE {
    nprach-ProbabilityAnchor-r14  ENUMERATED {
        zero, oneSixteenth, oneFifteenth, oneFourteenth,
        oneThirteenth, oneTwelfth, oneEleventh, oneTenth,
        oneNinth, oneEighth, oneSeventh, oneSixth,
        oneFifth, oneFourth, oneThird, oneHalf}
    OPTIONAL -- Need OP
}

-- ASN1STOP

```

SystemInformationBlockType22-NB field descriptions	
dl-CarrierConfig	Provides the configuration of the DL non-anchor carrier.
dl-ConfigList	List of DL non-anchor carriers and associated configuration that can be used for paging and/or random access.
npdcch-NumRepetitionPaging	Maximum number of repetitions for NPDCCH common search space (CSS) for paging, see TS 36.213 [23, 16.6]. If the field is absent, the value of <i>npdcch-NumRepetitionPaging</i> configured in <i>SystemInformationBlockType2-NB</i> in IE <i>pcch-Config</i> applies.
nprach-ParametersList	Configure NPRACH parameters for each NPRACH resource on one non-anchor UL carrier. Up to three NPRACH resources can be configured on one non-anchor UL carrier. Each NPRACH resource is associated with a different number of NPRACH repetitions. E-UTRAN includes the same number of entries, and listed in the same order, as in <i>nprach-ParametersList</i> in <i>SystemInformationBlockType2-NB</i> .
nprach-ProbabilityAnchor	Configure the selection probability for the anchor carrier NPRACH resource, see TS 36.321 [6]. Value zero corresponds to a probability of 0, oneSixteenth corresponds to the probability of 1/16, oneFifteenth corresponds to the probability of 1/15, and so on. If the field is absent, the selection probability of the anchor carrier NPRACH resource is 1. All non-anchor carriers NPRACH resources have equal probability between them.
nprach-ProbabilityAnchorList	Configures the selection probability for each NPRACH resource on the anchor carrier. E-UTRAN includes the same number of entries, and listed in the same order, as in <i>nprach-ParametersList</i> in <i>SystemInformationBlockType2-NB</i> .
pagingWeight	Weight of the non-anchor paging carrier for uneven paging load distribution across the carriers. Value w1 corresponds to a relative weight of 1, w2 corresponds to a relative weight of 2, and so on. The paging load for a carrier 'i' is equal to $w(i)/W$ where i is equal to 0 for the anchor carrier and equal to the index of the carrier in the <i>dl-ConfigList</i> for a non-anchor carrier, W is the sum of the weights of all paging carriers. To avoid correlation between paging carrier and paging occasion, the weights should be assigned such that: $nB * W \leq 16384$.
pagingWeightAnchor	Weight of the anchor carrier for uneven paging load distribution across the carriers. Value w1 corresponds to a relative weight of 1, w2 corresponds to a relative weight of 2, and so on. If the field is absent, the (default) value of w0 is applied, i.e. the anchor carrier is not used for paging.
pcch-Config	Configure the PCCH parameters for the non-anchor DL carrier.
ul-CarrierFreq	UL carrier frequency of the non-anchor carrier as defined in TS 36.101 [42, 5.7.3F].
ul-ConfigList	List of UL non-anchor carriers and associated configuration that can be used for random access.

Conditional presence	Explanation
<i>pcch-Config</i>	This field is optionally present, Need OP, if the field <i>dl-ConfigList</i> is present and at least one of the carriers in <i>dl-ConfigList</i> is configured for paging. Otherwise the field is not present and only the anchor carrier is used for paging.
<i>nprach-config</i>	This field is mandatory present, if the field <i>ul-ConfigList</i> is present and at least one of the carriers in <i>ul-ConfigList</i> is configured for random access. Otherwise the field is not present and only the anchor carrier is used for random access.

6.7.3.2 NB-IoT Radio resource control information elements

– *CarrierConfigDedicated-NB*

The IE *CarrierConfigDedicated-NB* is used to specify a carrier in NB-IoT.

***CarrierConfigDedicated-NB* information elements**

```
-- ASN1START
```

```
CarrierConfigDedicated-NB-r13 ::= SEQUENCE {
```

```

dl-CarrierConfig-r13          DL-CarrierConfigDedicated-NB-r13,
ul-CarrierConfig-r13          UL-CarrierConfigDedicated-NB-r13
}

DL-CarrierConfigDedicated-NB-r13 ::= SEQUENCE {
  dl-CarrierFreq-r13           CarrierFreq-NB-r13,
  downlinkBitmapNonAnchor-r13 CHOICE {
    useNoBitmap-r13            NULL,
    useAnchorBitmap-r13       NULL,
    explicitBitmapConfiguration-r13 DL-Bitmap-NB-r13,
    spare                       NULL
  } OPTIONAL, -- Need ON
  dl-GapNonAnchor-r13         CHOICE {
    useNoGap-r13               NULL,
    useAnchorGapConfig-r13     NULL,
    explicitGapConfiguration-r13 DL-GapConfig-NB-r13,
    spare                       NULL
  } OPTIONAL, -- Need ON
  inbandCarrierInfo-r13       SEQUENCE {
    samePCI-Indicator-r13      CHOICE {
      samePCI-r13              SEQUENCE {
        indexToMidPRB-r13      INTEGER (-55..54)
      },
      differentPCI-r13         SEQUENCE {
        eutra-NumCRS-Ports-r13 ENUMERATED {same, four}
      }
    } OPTIONAL, -- Cond anchor-guardband
    eutraControlRegionSize-r13 ENUMERATED {n1, n2, n3}
  } OPTIONAL, -- Cond non-anchor-inband
  ...,
  [[ nrs-PowerOffsetNonAnchor-v1330 ENUMERATED {dB-12, dB-10, dB-8, dB-6,
    dB-4, dB-2, dB0, dB3}
  ]] OPTIONAL -- Need ON
]]
}

UL-CarrierConfigDedicated-NB-r13 ::= SEQUENCE {
  ul-CarrierFreq-r13          CarrierFreq-NB-r13 OPTIONAL, -- Need OP
  ...
}

-- ASN1STOP

```

CarrierConfigDedicated-NB field descriptions	
dl-CarrierConfig	Downlink carrier used for all unicast transmissions.
dl-CarrierFreq	DL carrier frequency. The downlink carrier is not in a E-UTRA PRB which contains E-UTRA PSS/SSS/PBCH.
dl-GapNonAnchor	Downlink transmission gap configuration for the anchor/ non-anchor carrier, see TS 36.211 [21, 10.2.3.4].
downlinkBitmapNonAnchor	NB-IoT downlink subframe configuration for downlink transmission on the anchor/ non-anchor carrier. See TS 36.213 [23, 16.4].
eutraControlRegionSize	Indicates the control region size of the E-UTRA cell for the in-band operation mode, see TS 36.213 [23]. Unit is in number of OFDM symbols. If <i>operationModeInfo</i> in MIB-NB is set to <i>inband-SamePCI</i> or <i>inband-DifferentPCI</i> , it should be set to the value broadcast in SIB1-NB.
eutra-NumCRS-Ports	Number of E-UTRA CRS antenna ports, either the same number of ports as NRS or 4 antenna ports. See TS 36.211 [21], TS 36.212 [22], and TS 36.213 [23].
inbandCarrierInfo	Provides the configuration of the anchor/ non-anchor inband carrier.
indexToMidPRB	The PRB index is signaled by offset from the middle of the EUTRA system.
nrs-PowerOffsetNonAnchor	Provides the power offset of the downlink narrowband reference-signal EPRE of the anchor/ non-anchor carrier relative to the anchor carrier, unit in dB. Value dB-12 corresponds to -12 dB, dB-10 corresponds to -10 dB and so on. See TS 36.213 [23, 16.2.2].
samePCI-Indicator	This parameter specifies whether the anchor/ non-anchor carrier reuses the same PCI as the EUTRA carrier.
ul-CarrierConfig	Uplink anchor/ non-anchor carrier used for all unicast transmissions.
ul-CarrierFreq	UL carrier frequency as defined in TS 36.101 [42, 5.7.3F]. If absent, the same TX-RX frequency separation and carrier frequency offset as for the anchor carrier applies.

Conditional presence	Explanation
<i>non-anchor-inband</i>	The field is mandatory present if the anchor/ non-anchor carrier is an inband carrier; otherwise it is not present.
<i>anchor-guardband</i>	The field is mandatory present if <i>operationModeInfo</i> is set to <i>guardband</i> in the MIB; otherwise it is not present.

CarrierFreq-NB

The IE *CarrierFreq-NB* is used to provide the NB-IoT carrier frequency, as defined in TS 36.101 [42].

CarrierFreq-NB information elements

```
-- ASN1START
CarrierFreq-NB-r13 ::= SEQUENCE {
    carrierFreq-r13 ARFCN-ValueEUTRA-r9,
    carrierFreqOffset-r13 ENUMERATED {
        v-10, v-9, v-8, v-7, v-6, v-5, v-4, v-3, v-2, v-1, v-0dot5,
        v0, v1, v2, v3, v4, v5, v6, v7, v8, v9
    } OPTIONAL -- Need ON
}
-- ASN1STOP
```

CarrierFreq-NB field descriptions	
carrierFreq	Provides the ARFCN applicable for the NB-IoT carrier frequency as defined in TS 36.101 [42, Table 5.7.3-1].
carrierFreqOffset	Offset of the NB-IoT channel number to EARFCN as defined in TS 36.101 [42, 5.7.3F]. Value v-10 means -10, v-9 means -9, and so on.

– *DL-Bitmap-NB*

The IE *DL-Bitmap-NB* is used to specify the set of NB-IoT downlink subframes for downlink transmission.

DL-Bitmap-NB information element

```
-- ASN1START
DL-Bitmap-NB-r13 ::= CHOICE {
  subframePattern10-r13 BIT STRING (SIZE (10)),
  subframePattern40-r13 BIT STRING (SIZE (40))
}
-- ASN1STOP
```

DL-Bitmap-NB field descriptions

subframePattern10, subframePattern40

NB-IoT downlink subframe configuration over 10ms or 40ms for inband and 10ms for standalone/guardband. The first/leftmost bit corresponds to the subframe #0 of the radio frame satisfying $SFN \bmod x = 0$, where x is the size of the bit string divided by 10. Value 0 in the bitmap indicates that the corresponding subframe is invalid for downlink transmission. Value 1 in the bitmap indicates that the corresponding subframe is valid for downlink transmission.

– *DL-CarrierConfigCommon-NB*

The IE *DL-CarrierConfigCommon-NB* is used to specify the common configuration of a DL non-anchor carrier in NB-IoT.

DL-CarrierConfigCommon-NB information elements

```
-- ASN1START
DL-CarrierConfigCommon-NB-r14 ::= SEQUENCE {
  dl-CarrierFreq-r14 CarrierFreq-NB-r13,
  downlinkBitmapNonAnchor-r14 CHOICE {
    useNoBitmap-r14 NULL,
    useAnchorBitmap-r14 NULL,
    explicitBitmapConfiguration-r14 DL-Bitmap-NB-r13
  },
  dl-GapNonAnchor-r14 CHOICE {
    useNoGap-r14 NULL,
    useAnchorGapConfig-r14 NULL,
    explicitGapConfiguration-r14 DL-GapConfig-NB-r13
  },
  inbandCarrierInfo-r14 SEQUENCE {
    samePCI-Indicator-r14 CHOICE {
      samePCI-r14 SEQUENCE {
        indexToMidPRB-r14 INTEGER (-55..54)
      },
      differentPCI-r14 SEQUENCE {
        eutra-NumCRS-Ports-r14 ENUMERATED {same, four}
      }
    }
  } OPTIONAL, -- Cond anchor-guardband
  eutraControlRegionSize-r14 ENUMERATED {n1, n2, n3}
} OPTIONAL, -- Cond non-anchor-inband
nrs-PowerOffsetNonAnchor-r14 ENUMERATED {dB-12, dB-10, dB-8, dB-6,
  dB-4, dB-2, dB0, dB3} DEFAULT dB0,
  ...
}
-- ASN1STOP
```

DL-CarrierConfigCommon-NB field descriptions
dl-CarrierFreq DL carrier frequency. The downlink carrier is not in a E-UTRA PRB which contains E-UTRA PSS/SSS/PBCH.
dl-GapNonAnchor Downlink transmission gap configuration for the non-anchor carrier, see TS 36.211 [21, 10.2.3.4].
downlinkBitmapNonAnchor NB-IoT downlink subframe configuration for downlink transmission on the non-anchor carrier. See TS 36.213 [23, 16.4].
eutraControlRegionSize Indicates the control region size of the E-UTRA cell for the in-band operation mode, see TS 36.213 [23]. Unit is in number of OFDM symbols. If <i>operationModeInfo</i> in MIB-NB is set to <i>inband-SamePCI</i> or <i>inband-DifferentPCI</i> , it should be set to the value broadcast in SIB1-NB.
eutra-NumCRS-Ports Number of E-UTRA CRS antenna ports, either the same number of ports as NRS or 4 antenna ports. See TS 36.211 [21], TS 36.212 [22], and TS 36.213 [23].
inbandCarrierInfo Provides the configuration of a non-anchor inband carrier.
indexToMidPRB The PRB index is signaled by offset from the middle of the EUTRA system.
nrs-PowerOffsetNonAnchor Provides the downlink narrowband reference-signal EPRE offset of the non-anchor carrier relative to the downlink narrowband reference-signal EPRE of the anchor carrier, unit in dB. Value dB-12 corresponds to -12 dB, dB-10 corresponds to -10 dB and so on. See TS 36.213 [23, 16.2.2].
samePCI-Indicator This parameter specifies whether the non-anchor carrier reuses the same PCI as the EUTRA carrier.

Conditional presence	Explanation
<i>non-anchor-inband</i>	The field is mandatory present if the non-anchor carrier is an inband carrier; otherwise it is not present.
<i>anchor-guardband</i>	The field is mandatory present, if <i>operationModeInfo</i> is set to <i>guardband</i> in the MIB; otherwise it is not present.

– DL-GapConfig-NB

The IE *DL-GapConfig-NB* is used to specify the downlink gap configuration for NPDCCH and NPDSCH. Downlink gaps apply to all NPDCCH/NPDSCH transmissions except for BCCH.

DL-GapConfig-NB information element

```
-- ASN1START
DL-GapConfig-NB-r13 ::= SEQUENCE {
    dl-GapThreshold-r13      ENUMERATED {n32, n64, n128, n256},
    dl-GapPeriodicity-r13   ENUMERATED {sf64, sf128, sf256, sf512},
    dl-GapDurationCoeff-r13 ENUMERATED {oneEighth, oneFourth, threeEighth, oneHalf}
}
-- ASN1STOP
```

DL-GapConfig-NB field descriptions
dl-GapDurationCoeff Coefficient to calculate the gap duration of a DL transmission: $dl\text{-}GapDurationCoeff * dl\text{-}GapPeriodicity$, Duration in number of subframes. See TS 36.211 [21, 10.2.3.4].
dl-GapPeriodicity Periodicity of a DL transmission gap in number of subframes. See TS 36.211 [21, 10.2.3.4].
dl-GapThreshold Threshold on the maximum number of repetitions configured for NPDCCH before application of DL transmission gap configuration. See TS 36.211 [21, 10.2.3.4].

– LogicalChannelConfig-NB

The IE *LogicalChannelConfig-NB* is used to configure the logical channel parameters.

LogicalChannelConfig-NB information element

```
-- ASN1START
LogicalChannelConfig-NB-r13 ::= SEQUENCE {
    priority-r13                INTEGER (1..16)          OPTIONAL,    -- Cond UL
    logicalChannelSR-Prohibit-r13  BOOLEAN                OPTIONAL,    -- Need ON
    ...
}
-- ASN1STOP
```

LogicalChannelConfig-NB field descriptions

logicalChannelSR-Prohibit

Value *TRUE* indicates that the *logicalChannelSR-ProhibitTimer* is enabled for the logical channel. If *logicalChannelSR-Prohibit* is configured (i.e. indicates value *TRUE*), E-UTRAN also configures *logicalChannelSR-ProhibitTimer*. See TS 36.321 [6].

priority

Logical channel priority in TS 36.321 [6]. Value is an integer.

Conditional presence	Explanation
UL	The field is mandatory present for UL logical channels; otherwise it is not present.

– MAC-MainConfig-NB

The IE *MAC-MainConfig-NB* is used to specify the MAC main configuration for signalling and data radio bearers.

MAC-MainConfig-NB information element

```
-- ASN1START
MAC-MainConfig-NB-r13 ::= SEQUENCE {
    ul-SCH-Config-r13          SEQUENCE {
        periodicBSR-Timer-r13  PeriodicBSR-Timer-NB-r13    OPTIONAL,    -- Need ON
        retxBsr-Timer-r13      RetxBsr-Timer-NB-r13
    }
    drx-Config-r13             DRX-Config-NB-r13                OPTIONAL,    -- Need ON
    timeAlignmentTimerDedicated-r13  TimeAlignmentTimer,
    logicalChannelSR-Config-r13 CHOICE {
        release                NULL,
        setup                   SEQUENCE {
            logicalChannelSR-ProhibitTimer-r13  ENUMERATED {
                pp2, pp8, pp32, pp128, pp512,
                pp1024, pp2048, spare
            }
        }
    }
    ...
    [[ rai-Activation-r14      ENUMERATED {true}                OPTIONAL,    -- Need OR
    dataInactivityTimerConfig-r14 CHOICE {
        release                NULL,
        setup                   SEQUENCE {
            dataInactivityTimer-r14             DataInactivityTimer-r14
        }
    }
    ]],
    [[ drx-Cycle-v1430        ENUMERATED {
        sf1280, sf2560, sf5120, sf10240
    }
    ]],
    [[ ra-CFRA-Config-r14     ENUMERATED {true}                OPTIONAL,    -- Need ON
    ]],
}
PeriodicBSR-Timer-NB-r13 ::= ENUMERATED {
```

```

    pp2, pp4, pp8, pp16, pp64, pp128, infinity, spare}
RetxBSR-Timer-NB-r13 ::=
    ENUMERATED {
        pp4, pp16, pp64, pp128, pp256, pp512, infinity, spare}
DRX-Config-NB-r13 ::=
    CHOICE {
        release
            NULL,
        setup
            SEQUENCE {
                onDurationTimer-r13
                    ENUMERATED {
                        pp1, pp2, pp3, pp4, pp8, pp16, pp32, spare},
                drx-InactivityTimer-r13
                    ENUMERATED {
                        pp0, pp1, pp2, pp3, pp4, pp8, pp16, pp32},
                drx-RetransmissionTimer-r13
                    ENUMERATED {
                        pp0, pp1, pp2, pp4, pp6, pp8, pp16, pp24,
                        pp33, spare7, spare6, spare5,
                        spare4, spare3, spare2, spare1},
                drx-Cycle-r13
                    ENUMERATED {
                        sf256, sf512, sf1024, sf1536, sf2048, sf3072,
                        sf4096, sf4608, sf6144, sf7680, sf8192, sf9216,
                        spare4, spare3, spare2, spare1},
                drx-StartOffset-r13
                    INTEGER (0..255),
                drx-ULRetransmissionTimer-r13
                    ENUMERATED {
                        pp0, pp1, pp2, pp4, pp6, pp8, pp16, pp24,
                        pp33, pp40, pp64, pp80, pp96,
                        pp112, pp128, pp160, pp320}
            }
    }
-- ASN1STOP
```

MAC-MainConfig-NB field descriptions
drx-Config Used to configure DRX as specified in TS 36.321 [6].
drx-Cycle <i>longDRX-Cycle</i> in TS 36.321 [6]. The value of <i>longDRX-Cycle</i> is in number of sub-frames. Value <i>sf256</i> corresponds to 256 sub-frames, <i>sf512</i> corresponds to 512 sub-frames and so on. In case <i>drx-Cycle-v1430</i> is signalled, the UE shall ignore <i>drx-Cycle-r13</i> .
drx-StartOffset <i>drxStartOffset</i> in TS 36.321 [6]. Value is in number of sub-frames by step of (<i>drx-cycle</i> / 256).
drx-InactivityTimer Timer for DRX in TS 36.321 [6]. Value in number of PDCCH periods. Value <i>pp0</i> corresponds to 0 PDCCH period and behaviour as specified in 7.3.2 applies, <i>pp1</i> corresponds to 1 PDCCH period, <i>pp2</i> corresponds to 2 PDCCH periods and so on.
drx-RetransmissionTimer Timer for DRX in TS 36.321 [6]. Value in number of PDCCH periods. Value <i>pp0</i> corresponds to 0 PDCCH period and behaviour as specified in 7.3.2 applies, <i>pp1</i> corresponds to 1 PDCCH period, <i>pp2</i> corresponds to 2 PDCCH periods and so on.
drx-ULRetransmissionTimer Timer for DRX in TS 36.321 [6]. Value in number of PDCCH periods. Value <i>pp0</i> corresponds to 0 PDCCH period and behaviour as specified in 7.3.2 applies, value <i>pp1</i> corresponds to 1 PDCCH period, <i>pp2</i> corresponds to 2 PDCCH periods and so on.
logicalChannelSR-ProhibitTimer Timer used to delay the transmission of an SR. See TS 36.321 [6]. Value in number of PDCCH periods. Value <i>pp2</i> corresponds to 2 PDCCH periods, <i>pp8</i> corresponds to 8 PDCCH periods and so on.
periodicBSR-Timer Timer for BSR reporting in TS 36.321 [6]. Value in number of PDCCH periods. Value <i>pp2</i> corresponds to 2 PDCCH periods, <i>pp4</i> corresponds to 4 PDCCH periods and so on.
ra-CFRA-Config Activation of contention free random access (CFRA), see TS 36.321 [6].
rai-Activation Activation of release assistance indication (RAI) in TS 36.321 [6].
retxBSR-Timer Timer for BSR reporting in TS 36.321 [6]. Value in number of PDCCH periods. Value <i>pp4</i> corresponds to 4 PDCCH periods, <i>pp16</i> corresponds to 16 PDCCH periods and so on.
onDurationTimer Timer for DRX in TS 36.321 [6]. Value in number of PDCCH periods. Value <i>pp1</i> corresponds to 1 PDCCH period, <i>pp2</i> corresponds to 2 PDCCH periods and so on.
timeAlignmentTimer Indicates the value of the time alignment timer, see TS 36.321 [6].

– NPDCCH-ConfigDedicated-NB

The IE *NPDCCH-ConfigDedicated-NB* specifies the subframes and resource blocks for NPDCCH monitoring.

NPDCCH-ConfigDedicated-NB information element

```

-- ASN1START
NPDCCH-ConfigDedicated-NB-r13 ::= SEQUENCE {
    npdcch-NumRepetitions-r13      ENUMERATED {r1, r2, r4, r8, r16, r32, r64, r128,
                                                    r256, r512, r1024, r2048,
                                                    spare4, spare3, spare2, spare1},
    npdcch-StartSF-USS-r13        ENUMERATED {v1dot5, v2, v4, v8, v16, v32, v48, v64},
    npdcch-Offset-USS-r13         ENUMERATED {zero, oneEighth, oneFourth, threeEighth}
}
-- ASN1STOP

```

<i>NPDCCH-ConfigDedicated-NB</i> field descriptions
<i>npdcch-NumRepetitions</i> Maximum number of repetitions for NPDCCH UE specific search space (USS), see TS 36.213 [23, 16.6]. UE monitors one set of values (consisting of aggregation level, number of repetitions and number of blind decodes) according to the configured maximum number of repetitions.
<i>npdcch-Offset-USS</i> Fractional period offset of starting subframe for NPDCCH UE specific search space (USS), see TS 36.213 [23, 16.6].
<i>npdcch-StartSF-USS</i> Starting subframe configuration for an NPDCCH UE-specific search space, see TS 36.213 [23, 16.6]. Value v1dot5 corresponds to 1.5, value 2 corresponds to 2 and so on.

– *NPDSCH-ConfigCommon-NB*

The IE *NPDSCH-ConfigCommon-NB* is used to specify the common NPDSCH configuration.

***NPDSCH-ConfigCommon-NB* information element**

```
-- ASN1START
NPDSCH-ConfigCommon-NB-r13 ::= SEQUENCE {
    nrs-Power-r13                INTEGER (-60..50)
}
-- ASN1STOP
```

<i>NPDSCH-ConfigCommon-NB</i> field descriptions
<i>nrs-Power</i> Provides the downlink narrowband reference-signal EPRE, see TS 36.213 [23, 16.2]. The actual value in dBm.

– *NPRACH-ConfigSIB-NB*

The IE *NPRACH-ConfigSIB-NB* is used to specify the NPRACH configuration for the anchor and non-anchor carriers.

***NPRACH-ConfigSIB-NB* information elements**

```
-- ASN1START
NPRACH-ConfigSIB-NB-r13 ::= SEQUENCE {
    nprach-CP-Length-r13          ENUMERATED {us66dot7, us266dot7},
    rsrp-ThresholdsPrachInfoList-r13 RSRP-ThresholdsNPRACH-InfoList-NB-r13 OPTIONAL, -- need
OR
    nprach-ParametersList-r13    NPRACH-ParametersList-NB-r13
}
NPRACH-ConfigSIB-NB-v1330 ::= SEQUENCE {
    nprach-ParametersList-v1330  NPRACH-ParametersList-NB-v1330
}
NPRACH-ConfigSIB-NB-v1450 ::= SEQUENCE {
    maxNumPreambleAttemptCE-r14  ENUMERATED {n3, n4, n5, n6, n7, n8, n10, spare1}
}
NPRACH-ParametersList-NB-r13 ::= SEQUENCE (SIZE (1.. maxNPRACH-Resources-NB-r13)) OF NPRACH-
Parameters-NB-r13
NPRACH-ParametersList-NB-v1330 ::= SEQUENCE (SIZE (1.. maxNPRACH-Resources-NB-r13)) OF NPRACH-
Parameters-NB-v1330
NPRACH-Parameters-NB-r13 ::= SEQUENCE {
    nprach-Periodicity-r13        ENUMERATED {ms40, ms80, ms160, ms240,
    ms320, ms640, ms1280, ms2560},
    nprach-StartTime-r13         ENUMERATED {ms8, ms16, ms32, ms64,
    ms128, ms256, ms512, ms1024},
    nprach-SubcarrierOffset-r13  ENUMERATED {n0, n12, n24, n36, n2, n18, n34, spare1},
    nprach-NumSubcarriers-r13    ENUMERATED {n12, n24, n36, n48},
    nprach-SubcarrierMSG3-RangeStart-r13 ENUMERATED {zero, oneThird, twoThird, one},
    maxNumPreambleAttemptCE-r13  ENUMERATED {n3, n4, n5, n6, n7, n8, n10, spare1},
}
```

```

numRepetitionsPerPreambleAttempt-r13      ENUMERATED {n1, n2, n4, n8, n16, n32, n64, n128},
npdcch-NumRepetitions-RA-r13              ENUMERATED {r1, r2, r4, r8, r16, r32, r64, r128,
                                             r256, r512, r1024, r2048,
                                             spare4, spare3, spare2, spare1},
npdcch-StartSF-CSS-RA-r13                 ENUMERATED {v1dot5, v2, v4, v8, v16, v32, v48, v64},
npdcch-Offset-RA-r13                       ENUMERATED {zero, oneEighth, oneFourth, threeEighth}
}

NPRACH-Parameters-NB-v1330 ::=            SEQUENCE {
  nprach-NumCBRA-StartSubcarriers-r13      ENUMERATED {n8, n10, n11, n12, n20, n22, n23, n24,
                                             n32, n34, n35, n36, n40, n44, n46, n48}
}

NPRACH-ParametersList-NB-r14 ::=          SEQUENCE (SIZE (1.. maxNPRACH-Resources-NB-r13)) OF
  NPRACH-Parameters-NB-r14

NPRACH-Parameters-NB-r14 ::=              SEQUENCE {
  nprach-Parameters-r14                     SEQUENCE {
    nprach-Periodicity-r14                  ENUMERATED {ms40, ms80, ms160, ms240,
                                             ms320, ms640, ms1280, ms2560}
                                          OPTIONAL, -- NEED OP
    nprach-StartTime-r14                    ENUMERATED {ms8, ms16, ms32, ms64,
                                             ms128, ms256, ms512, ms1024}
                                          OPTIONAL, -- NEED OP
    nprach-SubcarrierOffset-r14             ENUMERATED {n0, n12, n24, n36, n2, n18, n34, spare1}
                                          OPTIONAL, -- NEED OP
    nprach-NumSubcarriers-r14               ENUMERATED {n12, n24, n36, n48}
                                          OPTIONAL, -- NEED OP
    nprach-SubcarrierMSG3-RangeStart-r14    ENUMERATED {zero, oneThird, twoThird, one}
                                          OPTIONAL, -- NEED OP
    npdcch-NumRepetitions-RA-r14           ENUMERATED {r1, r2, r4, r8, r16, r32, r64, r128,
                                             r256, r512, r1024, r2048,
                                             spare4, spare3, spare2, spare1}
                                          OPTIONAL, -- NEED OP
    npdcch-StartSF-CSS-RA-r14              ENUMERATED {v1dot5, v2, v4, v8, v16, v32, v48, v64}
                                          OPTIONAL, -- NEED OP
    npdcch-Offset-RA-r14                    ENUMERATED {zero, oneEighth, oneFourth, threeEighth}
                                          OPTIONAL, -- NEED OP
    nprach-NumCBRA-StartSubcarriers-r14    ENUMERATED {n8, n10, n11, n12, n20, n22, n23, n24,
                                             n32, n34, n35, n36, n40, n44, n46, n48}
                                          OPTIONAL, -- NEED OP
    npdcch-CarrierIndex-r14                INTEGER (1..maxNonAnchorCarriers-NB-r14)
                                          OPTIONAL, -- Need OP
    ...
  } OPTIONAL -- Need OR
}

RSRP-ThresholdsNPRACH-InfoList-NB-r13 ::= SEQUENCE (SIZE(1..2)) OF RSRP-Range

-- ASN1STOP

```

NPRACH-ConfigSIB-NB field descriptions
<p><i>maxNumPreambleAttemptCE</i> Maximum number of preamble transmission attempts per NPRACH resource. See TS 36.321 [6]. If the UE supports enhanced random access power control and <i>maxNumPreambleAttemptCE-r14</i> is included, the UE shall use <i>maxNumPreambleAttemptCE-r14</i> instead of <i>maxNumPreambleAttemptCE-r13</i> for the first entry in <i>nprach-ParametersList</i>.</p>
<p><i>npdcch-CarrierIndex</i> Index of the carrier in the list of DL non anchor carriers. The first entry in the list has index '1', the second entry has index '2' and so on. If the field is absent, the DL anchor carrier is used.</p>
<p><i>npdcch-NumRepetitions-RA</i> Maximum number of repetitions for NPDCCH common search space (CSS) for RAR, Msg3 retransmission and Msg4, see TS 36.213 [23, 16.6]. See NOTE.</p>
<p><i>npdcch-Offset-RA</i> Fractional period offset of starting subframe for NPDCCH common search space (CSS Type 2), see TS 36.213 [23, 16.6]. See NOTE.</p>
<p><i>npdcch-StartSF-CSS-RA</i> Starting subframe configuration for NPDCCH common search space (CSS), including RAR, Msg3 retransmission, and Msg4, see TS 36.213 [23, 16.6]. See NOTE.</p>
<p><i>nprach-CP-Length</i> Cyclic prefix length for NPRACH transmission (T_{CP}), see TS 36.211 [21, 10.1.6]. Value <i>us66dot7</i> corresponds to 66.7 microseconds and value <i>us266dot7</i> corresponds to 266.7 microseconds.</p>
<p><i>nprach-NumCBRA-StartSubcarriers</i> The number of start subcarriers from which a UE can randomly select a start subcarrier as specified in TS 36.321 [6]. If <i>nprach-Config-v1330</i> is not included in <i>SystemInformationBlockType2-NB</i>, the UE sets the value of <i>nprach-NumCBRA-StartSubcarriers-r13</i> to the value signalled by <i>nprach-NumSubcarriers-r13</i> for the corresponding NPRACH resource. The start subcarrier indices that the UE is allowed to randomly select from, are given by: <i>nprach-SubcarrierOffset</i> + [0, <i>nprach-NumCBRA-StartSubcarriers</i> - 1] See NOTE.</p>
<p><i>nprach-NumSubcarriers</i> Number of sub-carriers in a NPRACH resource, see TS 36.211 [21, 10.1.6]. In number of subcarriers. See NOTE.</p>
<p><i>nprach-ParametersList</i> Configures NPRACH parameters for each NPRACH resource. Up to three PRACH resources can be configured in a cell. Each NPRACH resource is associated with a different number of NPRACH repetitions.</p>
<p><i>nprach-Periodicity</i> Periodicity of a NPRACH resource, see TS 36.211 [21, 10.1.6]. Unit in millisecond. See NOTE.</p>
<p><i>nprach-StartTime</i> Start time of the NPRACH resource in one period, see TS 36.211 [21, 10.1.6]. Unit in millisecond. See NOTE.</p>
<p><i>nprach-SubcarrierOffset</i> Frequency location of the NPRACH resource, see TS 36.211 [21, 10.1.6]. In number of subcarriers, offset from sub-carrier 0. See NOTE.</p>

NPRACH-ConfigSIB-NB field descriptions	
<i>nprach-SubcarrierMSG3-RangeStart</i>	<p>Fraction for calculating the starting subcarrier index of the range reserved for indication of UE support for multi-tone Msg3 transmission, within the NPRACH resource, see TS 36.211 [21, 10.1.6]. Multi-tone Msg3 transmission is not supported for {32, 64, 128} repetitions of NPRACH. For at least one of the NPRACH resources with the number of NPRACH repetitions other than {32, 64, 128}, the value of <i>nprach-SubcarrierMSG3-RangeStart</i> should not be 0. If <i>nprach-SubcarrierMSG3-RangeStart</i> is equal to zero, no start subcarrier index for the single-tone Msg3 NPRACH is allocated and the start subcarrier indexes for the multi-tone Msg3 NPRACH partition are given by <i>nprach-SubcarrierOffset</i> + [0, <i>nprach-NumCBRA-StartSubcarriers</i> - 1].</p> <p>If <i>nprach-SubcarrierMSG3-RangeStart</i> is equal to oneThird}or twoThird the start subcarrier indexes for the two partitions are given by:</p> <p><i>nprach-SubcarrierOffset</i> + [0, floor(<i>nprach-NumCBRA-StartSubcarriers</i> * <i>nprach-SubcarrierMSG3-RangeStart</i>) - 1] for the single-tone Msg3 NPRACH partition;</p> <p><i>nprach-SubcarrierOffset</i> + [floor(<i>nprach-NumCBRA-StartSubcarriers</i> * <i>nprach-SubcarrierMSG3-RangeStart</i>), <i>nprach-NumCBRA-StartSubcarriers</i> - 1] for the multi-tone Msg3 NPRACH partition;</p> <p>If <i>nprach-SubcarrierMSG3-RangeStart</i> is equal to one, the start subcarrier indexes for the single-tone Msg3 NPRACH are given by <i>nprach-SubcarrierOffset</i> + [0, <i>nprach-NumCBRA-StartSubcarriers</i> - 1] and no start subcarrier index for the multi-tone Msg3 NPRACH partition is allocated.</p> <p>See NOTE.</p>
<i>numRepetitionsPerPreambleAttempt</i>	Number of NPRACH repetitions per attempt for each NPRACH resource, See TS 36.211 [21, 10.1.6].
<i>rsrp-ThresholdsPrachInfoList</i>	<p>The criterion for UEs to select a NPRACH resource. Up to 2 RSRP threshold values can be signalled. The first element corresponds to RSRP threshold 1, the second element corresponds to RSRP threshold 2. See TS 36.321 [6]. If absent, there is only one NPRACH resource.</p> <p>A UE that supports <i>powerClassNB-14dBm-r14</i> shall correct the RSRP threshold values before applying them as follows:</p> <p>RSRP threshold = Signalled RSRP threshold - min{0, (14-min(23, P-Max))} where P-Max is the value of <i>p-Max</i> field in <i>SystemInformationBlockType1-NB</i>.</p>

NOTE: If the field is absent in an entry of *nprach-ParametersList* in *SystemInformationBlockType22-NB*, the value of the same field in the corresponding entry of *nprach-ParametersList* in *SystemInformationBlockType2-NB* applies.

– NPUSCH-Config-NB

The IE *NPUSCH-ConfigCommon-NB* is used to specify the common NPUSCH configuration. The IE *NPUSCH-ConfigDedicated-NB* is used to specify the UE specific NPUSCH configuration.

NPUSCH-Config-NB information element

```

-- ASN1START
NPUSCH-ConfigCommon-NB-r13 ::= SEQUENCE {
    ack-NACK-NumRepetitions-Msg4-r13 SEQUENCE (SIZE(1.. maxNPRACH-Resources-NB-r13)) OF
                                     ACK-NACK-NumRepetitions-NB-r13,
    srs-SubframeConfig-r13           ENUMERATED {
                                     sc0, sc1, sc2, sc3, sc4, sc5, sc6, sc7,
                                     sc8, sc9, sc10, sc11, sc12, sc13, sc14, sc15
                                     } OPTIONAL, -- Need OR
    dmrs-Config-r13                 SEQUENCE {
        threeTone-BaseSequence-r13  INTEGER (0..12)          OPTIONAL, -- Need OP
        threeTone-CyclicShift-r13   INTEGER (0..2),
        sixTone-BaseSequence-r13    INTEGER (0..14)          OPTIONAL, -- Need OP
        sixTone-CyclicShift-r13     INTEGER (0..3),
        twelveTone-BaseSequence-r13 INTEGER (0..30)          OPTIONAL, -- Need OP
    } OPTIONAL, -- Need OR
    ul-ReferenceSignalsNPUSCH-r13   UL-ReferenceSignalsNPUSCH-NB-r13
}

UL-ReferenceSignalsNPUSCH-NB-r13 ::= SEQUENCE {
    groupHoppingEnabled-r13         BOOLEAN,
    groupAssignmentNPUSCH-r13       INTEGER (0..29)
}

NPUSCH-ConfigDedicated-NB-r13 ::= SEQUENCE {

```

```

ack-NACK-NumRepetitions-r13      ACK-NACK-NumRepetitions-NB-r13  OPTIONAL,  -- Need ON
npusch-AllSymbols-r13           BOOLEAN                          OPTIONAL,  -- Cond SRS
groupHoppingDisabled-r13       ENUMERATED {true}               OPTIONAL,  -- Need OR
}

ACK-NACK-NumRepetitions-NB-r13 ::= ENUMERATED {r1, r2, r4, r8, r16, r32, r64, r128}

-- ASN1STOP

```

NPUSCH-Config-NB field descriptions

ack-NACK-NumRepetitions	Number of repetitions for the ACK NACK resource unit carrying HARQ response to NPDSCH, see TS 36.213 [23, 16.4.2]. If absent, the value of <i>ack-NACK-NumRepetitions-Msg4</i> signalled in SIB2 is used.
ack-NACK-NumRepetitions-Msg4	Number of repetitions for ACK/NACK HARQ response to NPDSCH containing Msg4 per NPRACH resource, see TS 36.213 [23, 16.4.2].
groupAssignmentNPUSCH	See TS 36.211 [21, 10.1.4.1.3].
groupHoppingDisabled	See TS 36.211 [21, 10.1.4.1.3].
groupHoppingEnabled	See TS 36.211 [21, 10.1.4.1.3].
npusch-AllSymbols	If set to TRUE, the UE shall use all NB-IoT symbols for NPUSCH transmission. If set to FALSE, the UE punctures the NPUSCH transmissions in the symbols that collides with SRS. If the field is not present, the UE uses all NB-IoT symbols for NPUSCH transmission. See TS 36.211 [21, 10.1.3.6].
sixTone-BaseSequence	The base sequence of DMRS sequence in a cell for 6 tones transmission; see TS 36.211 [21, 10.1.4.1.2]. If absent, it is given by NB-IoT CellID mod 14. Value 14 is not used.
sixTone-CyclicShift	Define 4 cyclic shifts for the 6-tone case, see TS 36.211 [21, 10.1.4.1.2].
srs-SubframeConfig	SRS SubframeConfiguration. See TS 36.211 [21, table 5.5.3.3-1]. Value sc0 corresponds to value 0, sc1 to value 1 and so on.
threeTone-BaseSequence	The base sequence of DMRS sequence in a cell for 3 tones transmission; see TS 36.211 [21, 10.1.4.1.2]. If absent, it is given by NB-IoT CellID mod 12. Value 12 is not used.
threeTone-CyclicShift	Define 3 cyclic shifts for the 3-tone case, see TS 36.211 [21, 10.1.4.1.2].
twelveTone-BaseSequence	The base sequence of DMRS sequence in a cell for 12 tones transmission; see TS 36.211 [21, 10.1.4.1.2]. If absent, it is given by NB-IoT CellID mod 30. Value 30 is not used.
ul-ReferenceSignalsNPUSCH	Used to specify parameters needed for the transmission on NPUSCH.

Conditional presence	Explanation
SRS	This field is optionally present, need OP, if <i>srs-SubframeConfig</i> is broadcasted. Otherwise, the IE is not present.

PDCP-Config-NB

The IE *PDCP-Config-NB* is used to set the configurable PDCP parameters for data radio bearers.

PDCP-Config-NB information element

```

-- ASN1START

PDCP-Config-NB-r13 ::= SEQUENCE {
  discardTimer-r13      ENUMERATED {
    ms5120, ms10240, ms20480, ms40960,
    ms81920, infinity, spare2, spare1
  } OPTIONAL, -- Cond Setup
  headerCompression-r13 CHOICE {
    notUsed      NULL,
    rohc         SEQUENCE {

```

```

maxCID-r13          INTEGER (1..16383)          DEFAULT 15,
profiles-r13       SEQUENCE {
  profile0x0002     BOOLEAN,
  profile0x0003     BOOLEAN,
  profile0x0004     BOOLEAN,
  profile0x0006     BOOLEAN,
  profile0x0102     BOOLEAN,
  profile0x0103     BOOLEAN,
  profile0x0104     BOOLEAN
},
...
},
...
}
-- ASN1STOP

```

PDCP-Config-NB field descriptions

discardTimer

Indicates the discard timer value specified in TS 36.323 [8]. Value in milliseconds. Value ms5120 means 5120 ms, ms10240 means 10240 ms and so on.

headerCompression

E-UTRAN does not reconfigure header compression except optionally upon RRC Connection Resumption.

maxCID

Indicates the value of the MAX_CID parameter as specified in TS 36.323 [8]. The total value of MAX_CIDs across all bearers for the UE should be less than or equal to the value of *maxNumberROHC-ContextSessions* parameter as indicated by the UE.

profiles

The profiles used by both compressor and decompressor in both UE and E-UTRAN. The field indicates which of the ROHC profiles specified in TS 36.323 [8] are supported, i.e. value *true* indicates that the profile is supported. Profile 0x0000 shall always be supported when the use of ROHC is configured. If support of two ROHC profile identifiers with the same 8 LSB's is signalled, only the profile corresponding to the highest value shall be applied.

Conditional presence	Explanation
<i>Setup</i>	The field is mandatory present in case of radio bearer setup. Otherwise the field is optionally present, need ON.

PhysicalConfigDedicated-NB

The IE *PhysicalConfigDedicated-NB* is used to specify the UE specific physical channel configuration.

PhysicalConfigDedicated-NB information element

```

-- ASN1START
PhysicalConfigDedicated-NB-r13 ::= SEQUENCE {
  carrierConfigDedicated-r13      CarrierConfigDedicated-NB-r13      OPTIONAL,  -- Need ON
  npdcch-ConfigDedicated-r13     NPDCCH-ConfigDedicated-NB-r13   OPTIONAL,  -- Need ON
  npusch-ConfigDedicated-r13     NPUSCH-ConfigDedicated-NB-r13   OPTIONAL,  -- Need ON
  uplinkPowerControlDedicated-r13 UplinkPowerControlDedicated-NB-r13 OPTIONAL,  -- Need ON
  ...,
  [[ twoHARQ-ProcessesConfig-r14  ENUMERATED {true}   OPTIONAL  -- Need OR
  ]],
  [[ interferenceRandomisationConfig-r14 ENUMERATED {true}   OPTIONAL  -- Need OR
  ]]
}
-- ASN1STOP

```

<i>PhysicalConfigDedicated-NB</i> field descriptions
<i>carrierConfigDedicated</i> Anchor/ non-anchor carrier used for all unicast transmissions.
<i>interferenceRandomisationConfig</i> Interference randomisation enabled in connected mode, except for random access procedure in connected mode, see TS 36.211 [21]. For random access in connected mode interference randomisation on non-anchor is used and is not used on anchor carrier, see TS 36.211 [21].
<i>npdcch-ConfigDedicated</i> NPDCCH configuration.
<i>npusch-ConfigDedicated</i> UL unicast configuration.
<i>twoHARQ-ProcessesConfig</i> Activation of two HARQ processes, see TS 36.212 [22] and TS 36.213 [23].
<i>uplink-PowerControlDedicated</i> UL power control parameter.

– *RACH-ConfigCommon-NB*

The IE *RACH-ConfigCommon-NB* is used to specify the generic random access parameters.

***RACH-ConfigCommon-NB* information element**

```

-- ASN1START
RACH-ConfigCommon-NB-r13 ::=          SEQUENCE {
  preambleTransMax-CE-r13              PreambleTransMax,
  powerRampingParameters-r13           PowerRampingParameters,
  rach-InfoList-r13                    RACH-InfoList-NB-r13,
  connEstFailOffset-r13                 INTEGER (0..15)                OPTIONAL,  -- Need OP
  . . . ,
  [[ powerRampingParameters-v1450      PowerRampingParameters-NB-v1450 OPTIONAL  -- Need OR
  ]]
}

RACH-InfoList-NB-r13 ::=          SEQUENCE (SIZE (1.. maxNPRACH-Resources-NB-r13)) OF RACH-Info-NB-r13

RACH-Info-NB-r13 ::=          SEQUENCE {
  ra-ResponseWindowSize-r13            ENUMERATED {
    pp2, pp3, pp4, pp5, pp6, pp7, pp8, pp10},
  mac-ContentionResolutionTimer-r13    ENUMERATED {
    pp1, pp2, pp3, pp4, pp8, pp16, pp32, pp64}
}

PowerRampingParameters-NB-v1450 ::= SEQUENCE {
  preambleInitialReceivedTargetPower-v1450  ENUMERATED {
    dBm-130, dBm-128, dBm-126, dBm-124, dBm-122,
    dBm-88, dBm-86, dBm-84, dBm-82, dBm-80}
    OPTIONAL,  -- Need OR
  powerRampingParametersCE1-r14            SEQUENCE {
    powerRampingStepCE1-r14                ENUMERATED {dB0, dB2, dB4, dB6},
    preambleInitialReceivedTargetPowerCE1-r14  ENUMERATED {
      dBm-130, dBm-128, dBm-126, dBm-124, dBm-122,
      dBm-120, dBm-118, dBm-116, dBm-114, dBm-112,
      dBm-110, dBm-108, dBm-106, dBm-104, dBm-102,
      dBm-100, dBm-98, dBm-96, dBm-94, dBm-92,
      dBm-90, dBm-88, dBm-86, dBm-84, dBm-82, dBm-80}
    } OPTIONAL  -- Need OR
}

-- ASN1STOP

```

RACH-ConfigCommon-NB field descriptions
<p>connEstFailOffset Parameter "Qoffset_{temp}" in TS 36.304 [4]. If the field is not present the value of infinity shall be used for "Qoffset_{temp}".</p>
<p>mac-ContentionResolutionTimer Timer for contention resolution in TS 36.321 [6]. Value in PDCCH periods. Value pp1 corresponds to 1 PDCCH period, pp2 corresponds to 2 PDCCH periods and so on. The value considered by the UE is: <i>mac-ContentionResolutionTimer</i> = Min (signaled value x PDCCH period, 10.24s).</p>
<p>powerRampingParameters, powerRampingParametersCE1 Power ramping step and preamble initial received target power – same as TS 36.213 [23] and TS 36.321 [6]. If the UE does not support enhanced random access power control and more than one repetition level is configured in the cell, then the UE transmits NPRACH with max power except for the lowest repetition level. Otherwise, the UE uses NPRACH power ramping. If the UE supports enhanced random access power control and <i>powerRampingParameters-v1450</i> is signalled, the UE uses NPRACH power ramping across repetition levels as specified in TS 36.321 [6]. If <i>preambleInitialReceivedTargetPower-v1450</i> is present, the UE shall use <i>preambleInitialReceivedTargetPower-v1450</i> instead of <i>preambleInitialReceivedTargetPower</i> (i.e. without suffix). If <i>powerRampingParametersCE1</i> is present, the UE shall use <i>powerRampingParametersCE1</i> instead of <i>powerRampingParameters</i> for NPRACH power ramping in the second repetition level.</p>
<p>preambleTransMax-CE Maximum number of preamble transmission in TS 36.321 [6]. Value is an integer.</p>
<p>ra-ResponseWindowSize Duration of the RA response window in TS 36.321 [6]. Value in PDCCH periods. Value pp2 corresponds to 2 PDCCH periods, pp3 corresponds to 3 PDCCH periods and so on. The value considered by the UE is: <i>ra-ResponseWindowSize</i> = Min (signaled value x PDCCH period, 10.24s).</p>

RadioResourceConfigCommonSIB-NB

The IE *RadioResourceConfigCommonSIB-NB* is used to specify common radio resource configurations in the system information, e.g., the random access parameters and the static physical layer parameters.

RadioResourceConfigCommonSIB-NB information element

```

-- ASN1START
RadioResourceConfigCommonSIB-NB-r13 ::= SEQUENCE {
    rach-ConfigCommon-r13          RACH-ConfigCommon-NB-r13,
    bccch-Config-r13              BCCCH-Config-NB-r13,
    pcch-Config-r13              PCCH-Config-NB-r13,
    nprach-Config-r13            NPRACH-ConfigSIB-NB-r13,
    npdsch-ConfigCommon-r13      NPDSCH-ConfigCommon-NB-r13,
    npusch-ConfigCommon-r13      NPUSCH-ConfigCommon-NB-r13,
    dl-Gap-r13                   DL-GapConfig-NB-r13          OPTIONAL,      -- Need OP
    uplinkPowerControlCommon-r13  UplinkPowerControlCommon-NB-r13,
    . . .
    [[ nprach-Config-v1330        NPRACH-ConfigSIB-NB-v1330  OPTIONAL      -- Need OR
    ]],
    [[ nprach-Config-v1450        NPRACH-ConfigSIB-NB-v1450  OPTIONAL      -- Cond
    ]]
EnhPowerControl
    ]
}

BCCCH-Config-NB-r13 ::=
    SEQUENCE {
        modificationPeriodCoeff-r13  ENUMERATED {n16, n32, n64, n128}
    }

PCCH-Config-NB-r13 ::=
    SEQUENCE {
        defaultPagingCycle-r13      ENUMERATED {rf128, rf256, rf512, rf1024},
        nB-r13                      ENUMERATED {
            fourT, twoT, oneT, halfT, quarterT, one8thT,
            one16thT, one32ndT, one64thT,
            one128thT, one256thT, one512thT, one1024thT,
            spare3, spare2, spare1},
        npdcch-NumRepetitionPaging-r13  ENUMERATED {
            r1, r2, r4, r8, r16, r32, r64, r128,
            r256, r512, r1024, r2048,
            spare4, spare3, spare2, spare1}
    }
-- ASN1STOP

```

RadioResourceConfigCommonSIB-NB field descriptions
<p>defaultPagingCycle Default paging cycle, used to derive 'T' in TS 36.304 [4]. Value rf128 corresponds to 128 radio frames, rf256 corresponds to 256 radio frames and so on.</p>
<p>dl-Gap Downlink transmission gap configuration for the anchor carrier. See TS 36.211 [21, 10.2.3.4]. If the field is absent, there is no gap.</p>
<p>modificationPeriodCoeff Actual modification period, expressed in number of radio frames= <i>modificationPeriodCoeff</i> * <i>defaultPagingCycle</i>. n16 corresponds to value 16, n32 corresponds to value 32, and so on. The BCCH modification period should be larger or equal to 40.96s.</p>
<p>nB Parameter: nB is used as one of parameters to derive the Paging Frame and Paging Occasion according to TS 36.304 [4]. Value in multiples of 'T' as defined in TS 36.304 [4]. A value of fourT corresponds to 4 * T, a value of twoT corresponds to 2 * T and so on.</p>
<p>npdcch-NumRepetitionPaging Maximum number of repetitions for NPDCCH common search space (CSS) for paging, see TS 36.213 [23, 16.6].</p>

Conditional presence	Explanation
<i>EnhPowerControl</i>	This field is optional present, need OR, if <i>PowerRampingParameters-NB-v1450</i> is included in SIB2-NB. Otherwise the field is not present.

RadioResourceConfigDedicated-NB

The IE *RadioResourceConfigDedicated-NB* is used to setup/modify/release RBs, to modify the MAC main configuration, and to modify dedicated physical configuration.

RadioResourceConfigDedicated-NB information element

```

-- ASN1START
RadioResourceConfigDedicated-NB-r13 ::= SEQUENCE {
    srb-ToAddModList-r13          SRB-ToAddModList-NB-r13          OPTIONAL,  -- Need ON
    drb-ToAddModList-r13          DRB-ToAddModList-NB-r13          OPTIONAL,  -- Need ON
    drb-ToReleaseList-r13         DRB-ToReleaseList-NB-r13         OPTIONAL,  -- Need ON
    mac-MainConfig-r13            CHOICE {
        explicitValue-r13         MAC-MainConfig-NB-r13,
        defaultValue-r13         NULL
    }
    physicalConfigDedicated-r13   PhysicalConfigDedicated-NB-r13 OPTIONAL,  -- Need ON
    rlf-TimersAndConstants-r13    RLF-TimersAndConstants-NB-r13 OPTIONAL,  -- Need ON
    ...
}

SRB-ToAddModList-NB-r13 ::=
    SEQUENCE (SIZE (1)) OF SRB-ToAddMod-NB-r13

SRB-ToAddMod-NB-r13 ::=
    SEQUENCE {
        rlc-Config-r13            CHOICE {
            explicitValue         RLC-Config-NB-r13,
            defaultValue          NULL
        }
        logicalChannelConfig-r13  CHOICE {
            explicitValue         LogicalChannelConfig-NB-r13,
            defaultValue          NULL
        }
        ...
        [[ rlc-Config-v1430        RLC-Config-NB-v1430          OPTIONAL  -- Need ON
        ]]
    }

DRB-ToAddModList-NB-r13 ::=
    SEQUENCE (SIZE (1..maxDRB-NB-r13)) OF DRB-ToAddMod-NB-r13

DRB-ToAddMod-NB-r13 ::=
    SEQUENCE {
        eps-BearerIdentity-r13    INTEGER (0..15)          OPTIONAL,  -- Cond DRB-Setup
        drb-Identity-r13          DRB-Identity,
        pdcp-Config-r13           PDCP-Config-NB-r13          OPTIONAL,  -- Cond Setup
        rlc-Config-r13            RLC-Config-NB-r13          OPTIONAL,  -- Cond Setup
        logicalChannelIdentity-r13 INTEGER (3..10)          OPTIONAL,  -- Cond DRB-Setup
        logicalChannelConfig-r13  LogicalChannelConfig-NB-r13 OPTIONAL,  -- Cond Setup
        ...
    }

```

```

[[ rlc-Config-v1430                RLC-Config-NB-v1430        OPTIONAL    -- Need ON
]]
}

DRB-ToReleaseList-NB-r13 ::=      SEQUENCE (SIZE (1..maxDRB-NB-r13)) OF DRB-Identity

-- ASN1STOP

```

RadioResourceConfigDedicated-NB field descriptions

logicalChannelConfig

For SRB a choice is used to indicate whether the logical channel configuration is signalled explicitly or set to the default logical channel configuration for SRB1 as specified in 9.2.1.1.

logicalChannelIdentity

The logical channel identity for both UL and DL for a DRB. Value 3 is not used.

mac-MainConfig

The default MAC MAIN configuration is specified in 9.2.2.

physicalConfigDedicated

The default dedicated physical configuration is specified in 9.2.4.

rlc-Config

For SRBs a choice is used to indicate whether the RLC configuration is signalled explicitly or set to the values defined in the default RLC configuration for SRB1 in 9.2.1.1. RLC AM is the only applicable RLC mode.

Conditional presence	Explanation
<i>DRB-Setup</i>	The field is mandatory present if the corresponding DRB is being set up; otherwise it is not present.
<i>Setup</i>	The field is mandatory present if the corresponding SRB/DRB is being setup; otherwise the field is optionally present, need ON.

– RLC-Config-NB

The IE *RLC-Config-NB* is used to specify the RLC configuration of SRBs and DRBs.

RLC-Config-NB information element

```

-- ASN1START

RLC-Config-NB-r13 ::= CHOICE {
    am          SEQUENCE {
        ul-AM-RLC-r13      UL-AM-RLC-NB-r13,
        dl-AM-RLC-r13      DL-AM-RLC-NB-r13
    },
    ...
}

RLC-Config-NB-v1430 ::= SEQUENCE {
    t-Reordering-r14      T-Reordering          OPTIONAL    -- Cond twoHARQ
}

UL-AM-RLC-NB-r13 ::= SEQUENCE {
    t-PollRetransmit-r13  T-PollRetransmit-NB-r13,
    maxRetxThreshold-r13  ENUMERATED {t1, t2, t3, t4, t6, t8, t16, t32}
}

DL-AM-RLC-NB-r13 ::= SEQUENCE {
    enableStatusReportSN-Gap-r13  ENUMERATED {true}    OPTIONAL
}

T-PollRetransmit-NB-r13 ::= ENUMERATED {
    ms250, ms500, ms1000, ms2000, ms3000, ms4000,
    ms6000, ms10000, ms15000, ms25000, ms40000, ms60000,
    ms90000, ms120000, ms180000, spare1}

-- ASN1STOP

```

RLC-Config-NB field descriptions	
enableStatusReportSN-Gap	Indicates that status reporting due to detection of reception failure is enabled, as specified in TS 36.322 [7].
maxRetxThreshold	Parameter for RLC AM in TS 36.322 [7]. Value t1 corresponds to 1 retransmission, t2 to 2 retransmissions and so on.
t-PollRetransmit	Timer for RLC AM in TS 36.322 [7], in milliseconds. Value msX means X ms, msY means Y ms and so on.
t-Reordering	Timer for reordering in TS 36.322 [7], in milliseconds.

Conditional presence	Explanation
<i>twoHARQ</i>	The field is mandatory present if <i>twoHARQ-ProcessesConfig</i> is set to TRUE. Otherwise, the field is not present and, if previously configured, the timer is released.

– *RLF-TimersAndConstants-NB*

The IE *RLF-TimersAndConstants-NB* contains UE specific timers and constants applicable for UEs in RRC_CONNECTED.

***RLF-TimersAndConstants-NB* information element**

```
-- ASN1START

RLF-TimersAndConstants-NB-r13 ::= CHOICE {
  release          NULL,
  setup           SEQUENCE {
    t301-r13      ENUMERATED {
      ms2500, ms4000, ms6000, ms10000,
      ms15000, ms25000, ms40000, ms60000},
    t310-r13      ENUMERATED {
      ms0, ms200, ms500, ms1000, ms2000, ms4000, ms8000},
    n310-r13      ENUMERATED {
      n1, n2, n3, n4, n6, n8, n10, n20},
    t311-r13      ENUMERATED {
      ms1000, ms3000, ms5000, ms10000, ms15000,
      ms20000, ms30000},
    n311-r13      ENUMERATED {
      n1, n2, n3, n4, n5, n6, n8, n10},
    ...,
    [[ t311-v1350  ENUMERATED {
      ms40000, ms60000, ms90000, ms120000}
      OPTIONAL -- Need OR
    ]]
  }
}

-- ASN1STOP
```

<i>RLF-TimersAndConstants-NB</i> field descriptions	
<i>n3xy</i>	Constants are described in clause 7.4. n1 corresponds with 1, n2 corresponds with 2 and so on.
<i>t3xy</i>	Timers are described in clause 7.3. Value ms0 corresponds with 0 ms, ms200 corresponds with 200 ms and so on. The UE shall use the extended value <i>t311-v1350</i> , if present, and ignore the value signaled by <i>t311-r13</i> .

– *UplinkPowerControl-NB*

The IE *UplinkPowerControlCommon-NB* and IE *UplinkPowerControlDedicated-NB* are used to specify parameters for uplink power control in the system information and in the dedicated signalling, respectively.

***UplinkPowerControl-NB* information elements**

```
-- ASN1START
```

```

UplinkPowerControlCommon-NB-r13 ::= SEQUENCE {
    p0-NominalNPUSCH-r13          INTEGER (-126..24),
    alpha-r13                     ENUMERATED {a10, a104, a105, a106, a107, a108, a109, a11},
    deltaPreambleMsg3-r13        INTEGER (-1..6)
}

UplinkPowerControlDedicated-NB-r13 ::= SEQUENCE {
    p0-UE-NPUSCH-r13             INTEGER (-8..7)
}

-- ASN1STOP

```

***UplinkPowerControl-NB* field descriptions**

alpha

Parameter: $\alpha_c(1)$. See TS 36.213 [23, 16.2.1.1] where a10 corresponds to 0, a104 corresponds to value 0.4, a105 to 0.5, a106 to 0.6, a107 to 0.7, a108 to 0.8, a109 to 0.9 and a11 corresponds to 1.

deltaPreambleMsg3

Parameter: $\Delta_{\text{PREAMBLE_Msg3}}$. See TS 36.213 [23, 16.2.1.1]. Actual value = IE value * 2 [dB].

p0-NominalNPUSCH

Parameter: $P_{\text{O_NOMINAL_NPUSCH},c}$ (1). See TS 36.213 [23, 16.2.1.1], unit dBm.

p0-UE-NPUSCH

Parameter: $P_{\text{O_UE_NPUSCH},c}$ (1). See TS 36.213 [23, 16.2.1.1], unit dB.

6.7.3.3 NB-IoT Security control information elements

Void

6.7.3.4 NB-IoT Mobility control information elements

– ***AdditionalBandInfoList-NB***

***AdditionalBandInfoList-NB* information element**

```

-- ASN1START
AdditionalBandInfoList-NB-r14 ::= SEQUENCE (SIZE (1..maxMultiBands)) OF FreqBandIndicator-NB-r13
-- ASN1STOP

```

– ***FreqBandIndicator-NB***

The IE *FreqBandIndicator-NB* indicates the E-UTRA operating band as defined in TS 36.101 [42, table 5.5-1].

***FreqBandIndicator-NB* information element**

```

-- ASN1START
FreqBandIndicator-NB-r13 ::= INTEGER (1.. maxFBI2)
-- ASN1STOP

```

– ***MultiBandInfoList-NB***

***MultiBandInfoList-NB* information element**

```

-- ASN1START
MultiBandInfoList-NB-r13 ::= SEQUENCE (SIZE (1..maxMultiBands)) OF MultiBandInfo-NB-r13

```

```

MultiBandInfo-NB-r13 ::=          SEQUENCE {
    freqBandIndicator-r13          FreqBandIndicator-NB-r13          OPTIONAL,  -- Need OR
    freqBandInfo-r13              NS-PmaxList-NB-r13              OPTIONAL  -- Need OR
}
-- ASN1STOP

```

– *NS-PmaxList-NB*

The IE *NS-PmaxList-NB* concerns a list of *additionalPmax* and *additionalSpectrumEmission* as defined in TS 36.101 [42, 6.2.4F] for a given frequency band. E-UTRAN does not include the same value of *additionalSpectrumEmission* in *SystemInformationBlockType2-NB* within this list.

***NS-PmaxList-NB* information element**

```

-- ASN1START
NS-PmaxList-NB-r13 ::=          SEQUENCE (SIZE (1..maxNS-Pmax-NB-r13)) OF NS-PmaxValue-NB-r13
NS-PmaxValue-NB-r13 ::=        SEQUENCE {
    additionalPmax-r13           P-Max                               OPTIONAL,  -- Need OR
    additionalSpectrumEmission-r13 AdditionalSpectrumEmission
}
-- ASN1STOP

```

– *ReselectionThreshold-NB*

The IE *ReselectionThreshold-NB* is used to indicate an Rx level threshold for cell reselection. Actual value of threshold = field value * 2 [dB].

***ReselectionThreshold-NB* information element**

```

-- ASN1START
ReselectionThreshold-NB-v1360 ::=          INTEGER (32..63)
-- ASN1STOP

```

– *T-Reselection-NB*

The IE *T-Reselection-NB* concerns the cell reselection timer $T_{\text{reselction}}_{\text{RAT}}$ for NB-IoT.

Value in seconds. s0 means 0 second and behaviour as specified in 7.3.2 applies, s3 means 3 seconds and so on.

***T-Reselection-NB* information element**

```

-- ASN1START
T-Reselection-NB-r13 ::=          ENUMERATED {s0, s3, s6, s9, s12, s15, s18, s21}
-- ASN1STOP

```

6.7.3.5 NB-IoT Measurement information elements

– *CQI-NPDCCH-NB*

The IE *CQI-NPDCCH-NB* represents the downlink channel quality measurement of the NB-IoT carrier where the random access response is received. The codepoints for the CQI-NPDCCH measurements are according to the mapping table in TS 36.133 [16]. The value *noMeasurements* indicates no measurement reporting.

CQI-NPDCCH-NB information element

```

-- ASN1START
CQI-NPDCCH-NB-r14 ::= ENUMERATED {
    noMeasurements, candidateRep-A, candidateRep-B, candidateRep-C,
    candidateRep-D, candidateRep-E, candidateRep-F, candidateRep-G,
    candidateRep-H, candidateRep-I, candidateRep-J, candidateRep-K,
    candidateRep-L}
-- ASN1STOP

```

CQI-NPDCCH-Short-NB

The IE *CQI-NPDCCH-Short-NB* represents the short version of the downlink channel quality measurement of the NB-IoT carrier where the random access response is received. The codepoints for the CQI-NPDCCH-Short measurements are according to the mapping table in TS 36.133 [16]. The value *noMeasurements* indicates no measurement reporting.

CQI-NPDCCH-Short-NB information element

```

-- ASN1START
CQI-NPDCCH-Short-NB-r14 ::= ENUMERATED {
    noMeasurements, candidateRep-1, candidateRep-2, candidateRep-3}
-- ASN1STOP

```

MeasResultServCell-NB

The IE *MeasResultServCell-NB* covers the measured results for the serving cell.

MeasResultServCell-NB information element

```

-- ASN1START
MeasResultServCell-NB-r14 ::= SEQUENCE {
    nrsrpResult-r14          NRSRP-Range-NB-r14,
    nrsrqResult-r14         NRSRQ-Range-NB-r14
}
-- ASN1STOP

```

NRSRP-Range-NB

The IE *NRSRP-Range-NB* specifies the value range used in NRSRP measurements and thresholds. Integer value for NRSRP measurements according to mapping table in TS 36.133 [16, Table 9.1.22.9-1].

NRSRP-Range-NB information element

```

-- ASN1START
NRSRP-Range-NB-r14 ::= INTEGER(0..113)
-- ASN1STOP

```

NRSRQ-Range-NB

The IE *NRSRQ-Range-NB* specifies the value range used in NRSRQ measurements and thresholds. Integer value for RSRQ measurements is according to mapping table in TS 36.133 [16, Table 9.1.22.14-1]. The UE shall not report values 0 and 34.

NRSRQ-Range-NB information element

```

-- ASN1START

```

```
NRSRQ-Range-NB-r14 ::= INTEGER(-30..46)
-- ASN1STOP
```

6.7.3.6 NB-IoT Other information elements

– *EstablishmentCause-NB*

The IE *EstablishmentCause-NB* provides the establishment cause for the RRC connection request or the RRC connection resume request as provided by the upper layers.

***EstablishmentCause-NB* information element**

```
-- ASN1START
EstablishmentCause-NB-r13 ::= ENUMERATED {
    mt-Access, mo-Signalling, mo-Data, mo-ExceptionData,
    delayTolerantAccess-v1330, spare3, spare2, spare1}
-- ASN1STOP
```

– *UE-Capability-NB*

The IE *UE-Capability-NB* is used to convey the NB-IoT UE Radio Access Capability Parameters, see TS 36.306 [5]. The IE *UE-Capability-NB* is transferred in NB-IoT only.

***UE-Capability-NB* information element**

```
-- ASN1START
UE-Capability-NB-r13 ::= SEQUENCE {
    accessStratumRelease-r13 AccessStratumRelease-NB-r13,
    ue-Category-NB-r13 ENUMERATED {nb1} OPTIONAL,
    multipleDRB-r13 ENUMERATED {supported} OPTIONAL,
    pdcp-Parameters-r13 PDCP-Parameters-NB-r13 OPTIONAL,
    phyLayerParameters-r13 PhyLayerParameters-NB-r13,
    rf-Parameters-r13 RF-Parameters-NB-r13,
    dummy SEQUENCE {} OPTIONAL
}
UE-Capability-NB-Ext-r14-IEs ::= SEQUENCE {
    ue-Category-NB-r14 ENUMERATED {nb2} OPTIONAL,
    mac-Parameters-r14 MAC-Parameters-NB-r14 OPTIONAL,
    phyLayerParameters-v1430 PhyLayerParameters-NB-v1430 OPTIONAL,
    rf-Parameters-v1430 RF-Parameters-NB-v1430,
    nonCriticalExtension UE-Capability-NB-v1440-IEs OPTIONAL
}
UE-Capability-NB-v1440-IEs ::= SEQUENCE {
    phyLayerParameters-v1440 PhyLayerParameters-NB-v1440 OPTIONAL,
    nonCriticalExtension UE-Capability-NB-v1480-IEs OPTIONAL
}
UE-Capability-NB-v1480-IEs ::= SEQUENCE {
    -- Following field is only to be used for late REL-14 extensions
    lateNonCriticalExtension OCTET STRING OPTIONAL,
    nonCriticalExtension SEQUENCE {} OPTIONAL
}
AccessStratumRelease-NB-r13 ::= ENUMERATED {rel13, rel14, spare6, spare5, spare4, spare3,
    spare2, spare1, ...}
PDCP-Parameters-NB-r13 ::= SEQUENCE {
    supportedROHC-Profiles-r13 SEQUENCE {
        profile0x0002 BOOLEAN,
        profile0x0003 BOOLEAN,
        profile0x0004 BOOLEAN,
        profile0x0006 BOOLEAN,
        profile0x0102 BOOLEAN,
    }
}
```

```

        profile0x0103                BOOLEAN,
        profile0x0104                BOOLEAN
    },
    maxNumberROHC-ContextSessions-r13  ENUMERATED {cs2, cs4, cs8, cs12}  DEFAULT cs2,
    ...
}

MAC-Parameters-NB-r14 ::= SEQUENCE {
    dataInactMon-r14          ENUMERATED {supported}                OPTIONAL,
    rai-Support-r14          ENUMERATED {supported}                OPTIONAL
}

PhyLayerParameters-NB-r13 ::= SEQUENCE {
    multiTone-r13            ENUMERATED {supported}                OPTIONAL,
    multiCarrier-r13        ENUMERATED {supported}                OPTIONAL
}

PhyLayerParameters-NB-v1430 ::= SEQUENCE {
    multiCarrier-NPRACH-r14  ENUMERATED {supported}                OPTIONAL,
    twoHARQ-Processes-r14   ENUMERATED {supported}                OPTIONAL
}

PhyLayerParameters-NB-v1440 ::= SEQUENCE {
    interferenceRandomisation-r14  ENUMERATED {supported}                OPTIONAL
}

RF-Parameters-NB-r13 ::= SEQUENCE {
    supportedBandList-r13      SupportedBandList-NB-r13,
    multiNS-Pmax-r13          ENUMERATED {supported}                OPTIONAL
}

RF-Parameters-NB-v1430 ::= SEQUENCE {
    powerClassNB-14dBm-r14    ENUMERATED {supported}                OPTIONAL
}

SupportedBandList-NB-r13 ::= SEQUENCE (SIZE (1..maxBands)) OF SupportedBand-NB-r13

SupportedBand-NB-r13 ::= SEQUENCE {
    band-r13                  FreqBandIndicator-NB-r13,
    powerClassNB-20dBm-r13   ENUMERATED {supported}                OPTIONAL
}

-- ASN1STOP

```

UE-Capability-NB field descriptions
accessStratumRelease Set to rel14 in this version of the specification.
dataInactMon Indicates whether the UE supports the data inactivity monitoring as specified in TS 36.321 [6].
dummy This field is not used in the specification. It shall not be sent by the UE.
interferenceRandomisation Indicates whether the UE supports interference randomisation in connected mode as defined in TS.36.211 [21].
maxNumberROHC-ContextSessions Set to the maximum number of concurrently active ROHC contexts supported by the UE, excluding context sessions that leave all headers uncompressed. cs2 corresponds with 2 (context sessions), cs4 corresponds with 4 and so on. The network ignores this field if the UE supports none of the ROHC profiles in <i>supportedROHC-Profiles</i> .
multiCarrier Defines whether the UE supports multi-carrier operation.
multicarrier-NPRACH Defines whether the UE supports NPRACH on non-anchor carrier as specified in TS 36.321 [6].
multipleDRB Defines whether the UE supports multiple DRBs.
multiNS-Pmax Defines whether the UE supports the mechanisms defined for NB-IoT cells broadcasting <i>NS-PmaxList-NB</i> .
multiTone Defines whether the UE supports UL multi-tone transmissions on NPUSCH.
powerClassNB-14dBm Defines whether the UE supports power class 14dBm in all the bands supported by the UE as specified in TS 36.101 [42]. If <i>powerClassNB-20dBm</i> is included, the UE shall not include the field <i>powerClassNB-14dBm</i> .
powerClassNB-20dBm Defines whether the UE supports power class 20dBm in NB-IoT for the band, as specified in TS 36.101 [42]. If neither <i>powerClassNB-14dBm</i> nor <i>powerClassNB-20dBm</i> is included, UE supports power class 23 dBm in the NB-IoT band.
rai-Support Defines whether the UE supports release assistance indication (RAI) as specified in TS 36.321 [6].
supportedBandList Includes the supported NB-IoT bands as defined in TS 36.101 [42].
supportedROHC-Profiles List of supported ROHC profiles as defined in TS 36.323 [8].
twoHARQ-Processes Defines whether the UE supports two HARQ processes operation in DL and UL as specified in TS 36.212 [22] and TS 36.213 [23].
ue-Category-NB UE category as defined in TS 36.306 [5]. Value nb1 corresponds to UE category NB1, value nb2 corresponds to UE category NB2. A UE shall always include the field <i>ue-Category-NB-r13</i> in this version of the specification.

NOTE 1: The IE *UE-Capability-NB* does not include AS security capability information, since these are the same as the security capabilities that are signalled by NAS. Consequently AS need not provide "man-in-the-middle" protection for the security capabilities.

– *UE-RadioPagingInfo-NB*

The IE *UE-RadioPagingInfo-NB* contains UE NB-IoT capability information needed for paging.

***UE-RadioPagingInfo-NB* information element**

```
-- ASN1START
UE-RadioPagingInfo-NB-r13 ::= SEQUENCE {
    ue-Category-NB-r13      ENUMERATED {nb1}           OPTIONAL,
    . . .
    [[ multiCarrierPaging-r14  ENUMERATED {true}       OPTIONAL
```

```

]]
}
-- ASN1STOP

```

UE-RadioPagingInfo-NB field descriptions

multiCarrierPaging

Indicates whether the UE supports paging on non-anchor carriers as defined in TS 36.304 [4].

ue-Category-NB

UE NB-IoT category as defined in TS 36.306 [5]. A UE shall always include the field *ue-Category-NB-r13* in this version of the specification.

UE-TimersAndConstants-NB

The IE *UE-TimersAndConstants-NB* contains timers and constants used by the UE in either RRC_CONNECTED or RRC_IDLE.

UE-TimersAndConstants-NB information element

```

-- ASN1START
UE-TimersAndConstants-NB-r13 ::= SEQUENCE {
  t300-r13      ENUMERATED {
    ms2500, ms4000, ms6000, ms10000,
    ms15000, ms25000, ms40000, ms60000},
  t301-r13      ENUMERATED {
    ms2500, ms4000, ms6000, ms10000,
    ms15000, ms25000, ms40000, ms60000},
  t310-r13      ENUMERATED {
    ms0, ms200, ms500, ms1000, ms2000, ms4000, ms8000},
  n310-r13      ENUMERATED {
    n1, n2, n3, n4, n6, n8, n10, n20},
  t311-r13      ENUMERATED {
    ms1000, ms3000, ms5000, ms10000, ms15000,
    ms20000, ms30000},
  n311-r13      ENUMERATED {
    n1, n2, n3, n4, n5, n6, n8, n10},
  ...,
  [[ t311-v1350  ENUMERATED {
    ms40000, ms60000, ms90000, ms120000}
    OPTIONAL -- Need OR
  ]]
}
-- ASN1STOP

```

UE-TimersAndConstants-NB field descriptions

n3xy

Constants are described in clause 7.4. n1 corresponds with 1, n2 corresponds with 2 and so on.

t3xy

Timers are described in clause 7.3. Value ms0 corresponds with 0 ms, ms200 corresponds with 200 ms and so on. The UE shall use the extended value *t311-v1350*, if present, and ignore the value signaled by *t311-r13*.

6.7.3.7 NB-IoT MBMS information elements

Void

6.7.3.7a NB-IoT SC-PTM information elements

– SC-MTCH-InfoList-NB

The IE *SC-MTCH-InfoList-NB* provides the list of ongoing MBMS sessions transmitted via SC-MRB and for each MBMS session, the associated G-RNTI and scheduling information.

SC-MTCH-InfoList-NB information element

```

-- ASN1START
SC-MTCH-InfoList-NB-r14 ::= SEQUENCE (SIZE (0.. maxSC-MTCH-NB-r14)) OF SC-MTCH-Info-NB-r14
SC-MTCH-Info-NB-r14 ::= SEQUENCE {
    sc-mtch-CarrierConfig-r14 CHOICE {
        dl-CarrierConfig-r14 DL-CarrierConfigCommon-NB-r14,
        dl-CarrierIndex-r14 INTEGER (0.. maxNonAnchorCarriers-NB-r14)
    },
    mbmsSessionInfo-r14 MBMSSessionInfo-r13,
    g-RNTI-r14 BIT STRING(SIZE(16)),
    sc-mtch-SchedulingInfo-r14 SC-MTCH-SchedulingInfo-NB-r14 OPTIONAL, -- Need OP
    sc-mtch-NeighbourCell-r14 BIT STRING (SIZE(maxNeighCell-SCPTM-NB-r14)) OPTIONAL, --
Need OP
    npdcch-NPDSCH-MaxTBS-SC-MTCH-r14 ENUMERATED {n680, n2536},
    npdcch-NumRepetitions-SC-MTCH-r14 ENUMERATED {r1, r2, r4, r8, r16,
        r32, r64, r128, r256,
        r512, r1024, r2048, spare4,
        spare3, spare2, spare1},
    npdcch-StartSF-SC-MTCH-r14 ENUMERATED {v1dot5, v2, v4, v8,
        v16, v32, v48, v64},
    npdcch-Offset-SC-MTCH-r14 ENUMERATED {zero, oneEighth, oneQuarter,
        threeEighth, oneHalf, fiveEighth,
        threeQuarter, sevenEighth},
    ...
}
SC-MTCH-SchedulingInfo-NB-r14 ::= SEQUENCE {
    onDurationTimerSCPTM-r14 ENUMERATED {
        pp1, pp2, pp3, pp4,
        pp8, pp16, pp32, spare},
    drx-InactivityTimerSCPTM-r14 ENUMERATED {
        pp0, pp1, pp2, pp3,
        pp4, pp8, pp16, pp32},
    schedulingPeriodStartOffsetSCPTM-r14 CHOICE {
        sf10 INTEGER(0..9),
        sf20 INTEGER(0..19),
        sf32 INTEGER(0..31),
        sf40 INTEGER(0..39),
        sf64 INTEGER(0..63),
        sf80 INTEGER(0..79),
        sf128 INTEGER(0..127),
        sf160 INTEGER(0..159),
        sf256 INTEGER(0..255),
        sf320 INTEGER(0..319),
        sf512 INTEGER(0..511),
        sf640 INTEGER(0..639),
        sf1024 INTEGER(0..1023),
        sf2048 INTEGER(0..2047),
        sf4096 INTEGER(0..4095),
        sf8192 INTEGER(0..8191)
    },
    ...
}
-- ASN1STOP

```

SC-MTCH-InfoList-NB field descriptions
dl-CarrierConfig Downlink carrier used for SC-MTCH.
dl-CarrierIndex Index to a downlink carrier signalled in system information. Value '0' corresponds to the anchor carrier, value '1' corresponds to the first entry in <i>dl-ConfigList</i> in <i>SystemInformationBlockType22-NB</i> , value '2' corresponds to the second entry in <i>dl-ConfigList</i> and so on.
drx-InactivityTimerSCPTM Timer for SC-MTCH reception in TS 36.321 [6]. Value in number of NPDCCH periods. Value pp1 corresponds to 1 NPDCCH period, pp2 corresponds to 2 NPDCCH periods and so on.
g-RNTI G-RNTI used to scramble the scheduling and transmission of a SC-MTCH.
mbmsSessionInfo Indicates the ongoing MBMS session in a SC-MTCH.
npdcch-NPDSCH-MaxTBS-SC-MTCH Maximum NPDSCH TBS for the SC-MTCH, see TS 36.213 [23]. Value <i>n680</i> corresponds to 680 bits and value <i>n2536</i> corresponds to 2536 bits.
npdcch-NumRepetition-SC-MTCH The maximum number of NPDCCH repetitions the UE needs to monitor for SC-MTCH multicast search space, see TS 36.213 [23].
npdcch-Offset-SC-MTCH Fractional period offset of starting subframe for NPDCCH multicast search space for SC-MTCH, see TS 36.213 [23].
npdcch-startSF-SC-MTCH Starting subframes configuration of the NPDCCH multicast search space for SC-MTCH, see TS 36.213 [23].
onDurationTimerSCPTM Timer for SC-MTCH reception in TS 36.321 [6]. Value in number of NPDCCH periods. Value pp1 corresponds to 1 NPDCCH period, pp2 corresponds to 2 NPDCCH periods and so on.
schedulingPeriodStartOffsetSCPTM <i>SCPTM-SchedulingCycle</i> and <i>SCPTM-SchedulingOffset</i> in TS 36.321 [6]. The value of <i>SCPTM-SchedulingCycle</i> is in number of sub-frames. Value sf10 corresponds to 10 sub-frames, sf20 corresponds to 20 sub-frames and so on. The value of <i>SCPTM-SchedulingOffset</i> is in number of sub-frames.
sc-mtch-CarrierConfig Downlink carrier that is used for SC-MTCH.
sc-mtch-NeighbourCell Indicates neighbour cells which also provide this service on SC-MTCH. The first bit is set to 1 if the service is provided on SC-MTCH in the first cell in <i>scptmNeighbourCellList</i> , otherwise it is set to 0. The second bit is set to 1 if the service is provided on SC-MTCH in the second cell in <i>scptmNeighbourCellList</i> , and so on. If this field is absent, the UE shall assume that this service is not available on SC-MTCH in any neighbour cell.
sc-mtch-SchedulingInfo DRX information for the SC-MTCH. If this field is absent, DRX is not used for the SC-MTCH.

– SCPTM-NeighbourCellList-NB

The IE *SCPTM-NeighbourCellList-NB* indicates a list of neighbour cells where ongoing MBMS sessions provided via SC-MRB in the current cells are also provided.

```

-- ASN1START
SCPTM-NeighbourCellList-NB-r14 ::= SEQUENCE (SIZE (1..maxNeighCell-SCPTM-NB-r14)) OF PCI-ARFCN-NB-r14
PCI-ARFCN-NB-r14 ::=
    SEQUENCE {
        physCellId-r14          PhysCellId,
        carrierFreq-r14         CarrierFreq-NB-r13    OPTIONAL  -- Need OP
    }
-- ASN1STOP

```

<i>SCPTM-NeighbourCellList-NB field descriptions</i>
physCellId Physical Cell Identity of the neighbour cell.
carrierFreq Carrier frequency of the neighbour cell. Absence of the IE means that the neighbour cell is on the same frequency as the current cell.

6.7.4 NB-IoT RRC multiplicity and type constraint values

– Multiplicity and type constraint definitions

```
-- ASN1START
maxNPRACH-Resources-NB-r13  INTEGER ::= 3  -- Maximum number of NPRACH resources for NB-IoT
maxNonAnchorCarriers-NB-r14  INTEGER ::= 15 -- Maximum number of non-anchor carriers for NB-IoT
maxDRB-NB-r13                INTEGER ::= 2  -- Maximum number of Data Radio Bearers for NB-IoT
maxNeighCell-SCPTM-NB-r14    INTEGER ::= 8  -- Maximum number of SCPTM neighbour cells
maxNS-Pmax-NB-r13           INTEGER ::= 4  -- Maximum number of NS and P-Max values per band
maxSC-MTCH-NB-r14           INTEGER ::= 64  -- Maximum number of SC-MTCHs in one cell for NB-IoT
maxSI-Message-NB-r13        INTEGER ::= 8  -- Maximum number of SI messages for NB-IoT
-- ASN1STOP
```

– End of NBIOT-RRC-Definitions

```
-- ASN1START
END
-- ASN1STOP
```

6.7.5 Direct Indication Information

Direct Indication information is transmitted on NPDCCH using P-RNTI but without associated *Paging-NB* message. Table 6.7.5-1 defines the Direct Indication information, see TS 36.212 [22, 6.4.3.3].

When bit *n* is set to 1, the UE shall behave as if the corresponding field is set in the *Paging-NB* message, see 5.3.2.3. Bit 1 is the least significant bit.

Table 6.7.5-1: Direct Indication information

Bit	Field in <i>Direct Indication information</i>
1	<i>systemInfoModification</i>
2	<i>systemInfoModification-eDRX</i>
3, 4, 5, 6, 7, 8	Not used, and shall be ignored by UE if received

7 Variables and constants

7.1 UE variables

NOTE: To facilitate the specification of the UE behavioural requirements, UE variables are represented using ASN.1. Unless explicitly specified otherwise, it is however up to UE implementation how to store the variables. The optionality of the IEs in ASN.1 is used only to indicate that the values may not always be available.

– *EUTRA-UE-Variables*

This ASN.1 segment is the start of the E-UTRA UE variable definitions.

```
-- ASN1START
EUTRA-UE-Variables DEFINITIONS AUTOMATIC TAGS ::=
BEGIN
IMPORTS
    AbsoluteTimeInfo-r10,
    AreaConfiguration-r10,
    AreaConfiguration-v1130,
    CarrierFreqGERAN,
    CellIdentity,
    ConnEstFailReport-r11,
    SpeedStateScaleFactors,
    C-RNTI,
    LoggingDuration-r10,
    LoggingInterval-r10,
    LogMeasInfo-r10,
    MeasCSI-RS-Id-r12,
    MeasId,
    MeasId-v1250,
    MeasIdToAddModList,
    MeasIdToAddModListExt-r12,
    MeasIdToAddModList-v1310,
    MeasIdToAddModListExt-v1310,
    MeasObjectToAddModList,
    MeasObjectToAddModList-v9e0,
    MeasObjectToAddModListExt-r13,
    MeasScaleFactor-r12,
    MobilityStateParameters,
    NeighCellConfig,
    PhysCellId,
    PhysCellIdCDMA2000,
    PhysCellIdGERAN,
    PhysCellIdUTRA-FDD,
    PhysCellIdUTRA-TDD,
    PLMN-Identity,
    PLMN-IdentityList3-r11,
    QuantityConfig,
    ReportConfigToAddModList,
    RLF-Report-r9,
    TargetMBSFN-AreaList-r12,
    TraceReference-r10,
    Tx-ResourcePoolMeasList-r14,
    VisitedCellInfoList-r12,
    maxCellMeas,
    maxCSI-RS-Meas-r12,
    maxMeasId,
    maxMeasId-r12,
    UL-DelayConfig-r13,
    WLAN-CarrierInfo-r13,
    WLAN-Identifiers-r12,
    WLAN-Id-List-r13,
    WLAN-Status-r13,
    WLAN-Status-v1430,
    WLAN-SuspendConfig-r14
FROM EUTRA-RRC-Definitions;
-- ASN1STOP
```

– *VarConnEstFailReport*

The UE variable *VarConnEstFailReport* includes the connection establishment failure information.

***VarConnEstFailReport* UE variable**

```
-- ASN1START
```

```

VarConnEstFailReport-r11 ::=          SEQUENCE {
    connEstFailReport-r11             ConnEstFailReport-r11,
    plmn-Identity-r11                 PLMN-Identity
}

-- ASN1STOP

```

– *VarLogMeasConfig*

The UE variable *VarLogMeasConfig* includes the configuration of the logging of measurements to be performed by the UE while in RRC_IDLE, covering intra-frequency, inter-frequency, inter-RAT mobility and MBSFN related measurements. If MBSFN logging is configured, the UE performs logging of measurements while in both RRC_IDLE and RRC_CONNECTED. Otherwise, the UE performs logging of measurements only while in RRC_IDLE.

VarLogMeasConfig UE variable

```

-- ASN1START

VarLogMeasConfig-r10 ::=          SEQUENCE {
    areaConfiguration-r10           AreaConfiguration-r10           OPTIONAL,
    loggingDuration-r10             LoggingDuration-r10,
    loggingInterval-r10             LoggingInterval-r10
}

VarLogMeasConfig-r11 ::=          SEQUENCE {
    areaConfiguration-r10           AreaConfiguration-r10           OPTIONAL,
    areaConfiguration-v1130         AreaConfiguration-v1130         OPTIONAL,
    loggingDuration-r10             LoggingDuration-r10,
    loggingInterval-r10             LoggingInterval-r10
}

VarLogMeasConfig-r12 ::=          SEQUENCE {
    areaConfiguration-r10           AreaConfiguration-r10           OPTIONAL,
    areaConfiguration-v1130         AreaConfiguration-v1130         OPTIONAL,
    loggingDuration-r10             LoggingDuration-r10,
    loggingInterval-r10             LoggingInterval-r10,
    targetMBSFN-AreaList-r12        TargetMBSFN-AreaList-r12        OPTIONAL
}

-- ASN1STOP

```

– *VarLogMeasReport*

The UE variable *VarLogMeasReport* includes the logged measurements information.

VarLogMeasReport UE variable

```

-- ASN1START

VarLogMeasReport-r10 ::=          SEQUENCE {
    traceReference-r10              TraceReference-r10,
    traceRecordingSessionRef-r10    OCTET STRING (SIZE (2)),
    tce-Id-r10                      OCTET STRING (SIZE (1)),
    plmn-Identity-r10               PLMN-Identity,
    absoluteTimeInfo-r10            AbsoluteTimeInfo-r10,
    logMeasInfoList-r10             LogMeasInfoList2-r10
}

VarLogMeasReport-r11 ::=          SEQUENCE {
    traceReference-r10              TraceReference-r10,
    traceRecordingSessionRef-r10    OCTET STRING (SIZE (2)),
    tce-Id-r10                      OCTET STRING (SIZE (1)),
    plmn-IdentityList-r11           PLMN-IdentityList3-r11,
    absoluteTimeInfo-r10            AbsoluteTimeInfo-r10,
    logMeasInfoList-r10             LogMeasInfoList2-r10
}

LogMeasInfoList2-r10 ::=          SEQUENCE (SIZE (1..maxLogMeas-r10)) OF LogMeasInfo-r10

-- ASN1STOP

```

– *VarMeasConfig*

The UE variable *VarMeasConfig* includes the accumulated configuration of the measurements to be performed by the UE, covering intra-frequency, inter-frequency and inter-RAT mobility related measurements.

NOTE: The amount of measurement configuration information, which a UE is required to store, is specified in clause 11.1. If the number of frequencies configured for a particular RAT exceeds the minimum performance requirements specified in [16], it is up to UE implementation which frequencies of that RAT are measured. If the total number of frequencies for all RATs provided to the UE in the measurement configuration exceeds the minimum performance requirements specified in [16], it is up to UE implementation which frequencies/RATs are measured.

VarMeasConfig UE variable

```
-- ASN1START
VarMeasConfig ::= SEQUENCE {
  -- Measurement identities
  measIdList MeasIdToAddModList OPTIONAL,
  measIdListExt-r12 MeasIdToAddModListExt-r12 OPTIONAL,
  measIdList-v1310 MeasIdToAddModList-v1310 OPTIONAL,
  measIdListExt-v1310 MeasIdToAddModListExt-v1310 OPTIONAL,
  -- Measurement objects
  measObjectList MeasObjectToAddModList OPTIONAL,
  measObjectListExt-r13 MeasObjectToAddModListExt-r13 OPTIONAL,
  measObjectList-v9i0 MeasObjectToAddModList-v9e0 OPTIONAL,
  -- Reporting configurations
  reportConfigList ReportConfigToAddModList OPTIONAL,
  -- Other parameters
  quantityConfig QuantityConfig OPTIONAL,
  measScaleFactor-r12 MeasScaleFactor-r12 OPTIONAL,
  s-Measure INTEGER (-140..-44) OPTIONAL,
  speedStatePars CHOICE {
    release NULL,
    setup SEQUENCE {
      mobilityStateParameters MobilityStateParameters,
      timeToTrigger-SF SpeedStateScaleFactors
    }
  } OPTIONAL,
  allowInterruptions-r11 BOOLEAN OPTIONAL
}
-- ASN1STOP
```

– *VarMeasReportList*

The UE variable *VarMeasReportList* includes information about the measurements for which the triggering conditions have been met.

VarMeasReportList UE variable

```
-- ASN1START
VarMeasReportList ::= SEQUENCE (SIZE (1..maxMeasId)) OF VarMeasReport
VarMeasReportList-r12 ::= SEQUENCE (SIZE (1..maxMeasId-r12)) OF VarMeasReport

VarMeasReport ::= SEQUENCE {
  -- List of measurement that have been triggered
  measId MeasId,
  measId-v1250 MeasId-v1250 OPTIONAL,
  cellsTriggeredList CellsTriggeredList OPTIONAL,
  csi-RS-TriggeredList-r12 CSI-RS-TriggeredList-r12 OPTIONAL,
  poolsTriggeredList-r14 Tx-ResourcePoolMeasList-r14 OPTIONAL,
  numberOfReportsSent INTEGER
}

CellsTriggeredList ::= SEQUENCE (SIZE (1..maxCellMeas)) OF CHOICE {
  physCellIdEUTRA PhysCellId,
  physCellIdUTRA CHOICE {
    fdd PhysCellIdUTRA-FDD,
    tdd PhysCellIdUTRA-TDD
  }
},
```

```

    physCellIdGERAN          SEQUENCE {
      carrierFreq            CarrierFreqGERAN,
      physCellId             PhysCellIdGERAN
    },
    physCellIdCDMA2000      PhysCellIdCDMA2000,
    wlan-Identifiers-r13    WLAN-Identifiers-r12
  }
CSI-RS-TriggeredList-r12 ::= SEQUENCE (SIZE (1..maxCSI-RS-Meas-r12)) OF MeasCSI-RS-Id-r12
-- ASN1STOP

```

– *VarMobilityHistoryReport*

The UE variable *VarMobilityHistoryReport* includes the mobility history information.

```

-- ASN1START
VarMobilityHistoryReport-r12 ::= VisitedCellInfoList-r12
-- ASN1STOP

```

– *VarRLF-Report*

The UE variable *VarRLF-Report* includes the radio link failure information or handover failure information.

***VarRLF-Report* UE variable**

```

-- ASN1START
VarRLF-Report-r10 ::= SEQUENCE {
  rlf-Report-r10      RLF-Report-r9,
  plmn-Identity-r10   PLMN-Identity
}
VarRLF-Report-r11 ::= SEQUENCE {
  rlf-Report-r10      RLF-Report-r9,
  plmn-IdentityList-r11 PLMN-IdentityList3-r11
}
-- ASN1STOP

```

– *VarShortMAC-Input*

The UE variable *VarShortMAC-Input* specifies the input used to generate the shortMAC-I.

***VarShortMAC-Input* UE variable**

```

-- ASN1START
VarShortMAC-Input ::= SEQUENCE {
  cellIdentity      CellIdentity,
  physCellId       PhysCellId,
  c-RNTI            C-RNTI
}
-- ASN1STOP

```

***VarShortMAC-Input* field descriptions**

cellIdentity

An input variable used to calculate the *shortMAC-I*. Set to CellIdentity included in *cellIdentity* (without suffix) in SIB1 of the current cell.

c-RNTI

Set to C-RNTI that the UE had in the PCell it was connected to prior to the failure.

physCellId

Set to the physical cell identity of the PCell the UE was connected to prior to the failure.

– *VarShortResumeMAC-Input*

The UE variable *VarShortResumeMAC-Input* specifies the input used to generate the *shortResumeMAC-I* during RRC Connection Resume procedure.

VarShortResumeMAC-Input UE variable

```
-- ASN1START
VarShortResumeMAC-Input-r13 ::= SEQUENCE {
    cellIdentity-r13           CellIdentity,
    physCellId-r13           PhysCellId,
    c-RNTI-r13                C-RNTI,
    resumeDiscriminator-r13   BIT STRING(SIZE(1))
}
-- ASN1STOP
```

VarShortResumeMAC-Input field descriptions

cellIdentity

An input variable used to calculate the *shortResumeMAC-I*. Set to CellIdentity included in *cellIdentity* (without suffix) in SIB1 of the current cell.

c-RNTI

Set to C-RNTI that the UE had in the PCell it was connected to prior to suspension of the RRC connection.

physCellId

Set to the physical cell identity of the PCell the UE was connected to prior to suspension of the RRC connection..

resumeDiscriminator

A constant that allows differentiation in the calculation of the MAC-I for *shortResumeMAC-I*. The resumeDiscriminator is set to '1'

– *VarWLAN-MobilityConfig*

The UE variable *VarWLAN-MobilityConfig* includes information about WLAN for access selection and mobility.

VarWLAN-MobilityConfig UE variable

```
-- ASN1START
VarWLAN-MobilityConfig ::= SEQUENCE {
    wlan-MobilitySet-r13           WLAN-Id-List-r13           OPTIONAL,
    successReportRequested         ENUMERATED {true}         OPTIONAL,
    wlan-SuspendConfig-r14        WLAN-SuspendConfig-r14  OPTIONAL
}
-- ASN1STOP
```

VarWLAN-MobilityConfig field descriptions

wlan-MobilitySet

Indicates the WLAN mobility set configured.

successReportRequested

Indicates whether the UE shall report successful connection to WLAN. Applicable to LWA and LWIP.

– *VarWLAN-Status*

The UE variable *VarWLAN-Status* includes information about the status of WLAN connection for LWA, RCLWI or LWIP.

VarWLAN-Status UE variable

```
-- ASN1START
VarWLAN-Status-r13 ::= SEQUENCE {
    status-r13           WLAN-Status-r13,
    status-r14           WLAN-Status-v1430  OPTIONAL
}
-- ASN1STOP
```



```
}
-- ASN1STOP
```

<i>VarWLAN-Status</i> field descriptions
<p>status Indicates the connection status to WLAN and causes for connection failures.</p>

– Multiplicity and type constraint definitions

This clause includes multiplicity and type constraints applicable (only) for UE variables.

```
-- ASN1START
maxLogMeas-r10          INTEGER ::= 4060-- Maximum number of logged measurement entries
                        -- that can be stored by the UE
-- ASN1STOP
```

– End of *EUTRA-UE-Variables*

```
-- ASN1START
END
-- ASN1STOP
```

7.1a NB-IoT UE variables

NOTE: To facilitate the specification of the UE behavioural requirements, UE variables are represented using ASN.1. Unless explicitly specified otherwise, it is however up to UE implementation how to store the variables. The optionality of the IEs in ASN.1 is used only to indicate that the values may not always be available.

– *NBIOT-UE-Variables*

This ASN.1 segment is the start of the NB-IoT UE variable definitions.

```
-- ASN1START
NBIOT-UE-Variables DEFINITIONS AUTOMATIC TAGS ::=
BEGIN
IMPORTS
    VarShortMAC-Input,
    VarShortResumeMAC-Input-r13
FROM EUTRA-UE-Variables;
VarShortMAC-Input-NB-r13      ::= VarShortMAC-Input
VarShortResumeMAC-Input-NB-r13 ::= VarShortResumeMAC-Input-r13
-- ASN1STOP
```

– End of *NBIOT-UE-Variables*

```
-- ASN1START
END
-- ASN1STOP
```

7.2 Counters

Counter	Reset	Incremented	When reaching max value

7.3 Timers

7.3.1 Timers (Informative)

Timer	Start	Stop	At expiry
T300 NOTE1	Transmission of <i>RRCCConnectionRequest</i> or <i>RRCCConnectionResumeRequest</i>	Reception of <i>RRCCConnectionSetup</i> , <i>RRCCConnectionReject</i> or <i>RRCCConnectionResume</i> message, cell re-selection and upon abortion of connection establishment by upper layers	Perform the actions as specified in 5.3.3.6
T301 NOTE1	Transmission of <i>RRCCConnectionReestablishmentRequest</i>	Reception of <i>RRCCConnectionReestablishment</i> or <i>RRCCConnectionReestablishmentReject</i> message as well as when the selected cell becomes unsuitable	Go to RRC_IDLE
T302	Reception of <i>RRCCConnectionReject</i> while performing RRC connection establishment	Upon entering RRC_CONNECTED and upon cell re-selection	Inform upper layers about barring alleviation as specified in 5.3.3.7
T303	Access barred while performing RRC connection establishment for mobile originating calls	Upon entering RRC_CONNECTED and upon cell re-selection	Inform upper layers about barring alleviation as specified in 5.3.3.7
T304	Reception of <i>RRCCConnectionReconfiguration</i> message including the <i>MobilityControlInfo</i> or reception of <i>MobilityFromEUTRACommand</i> message including <i>CellChangeOrder</i>	Criterion for successful completion of handover within E-UTRA, handover to E-UTRA or cell change order is met (the criterion is specified in the target RAT in case of inter-RAT)	In case of cell change order from E-UTRA or intra E-UTRA handover, initiate the RRC connection re-establishment procedure; In case of handover to E-UTRA, perform the actions defined in the specifications applicable for the source RAT.
T305	Access barred while performing RRC connection establishment for mobile originating signalling	Upon entering RRC_CONNECTED and upon cell re-selection	Inform upper layers about barring alleviation as specified in 5.3.3.7
T306	Access barred while performing RRC connection establishment for mobile originating CS fallback.	Upon entering RRC_CONNECTED and upon cell re-selection	Inform upper layers about barring alleviation as specified in 5.3.3.7
T307	Reception of <i>RRCCConnectionReconfiguration</i> message including <i>MobilityControlInfoSCG</i>	Successful completion of random access on the PSCell, upon initiating re-establishment and upon SCG release	Inform E-UTRAN about the SCG change failure by initiating the SCG failure information procedure as specified in 5.6.13.
T308	Access barred due to ACDC while performing RRC connection establishment subject to ACDC	Upon entering RRC_CONNECTED and upon cell re-selection	Inform upper layers about barring alleviation for ACDC as specified in 5.3.3.7
T310 NOTE1 NOTE2	Upon detecting physical layer problems for the PCell i.e. upon receiving N310 consecutive out-of-sync indications from lower layers	Upon receiving N311 consecutive in-sync indications from lower layers for the PCell, upon triggering the handover procedure and upon initiating the connection re-establishment procedure	If security is not activated and the UE is not a NB-IoT UE that supports RRC connection re-establishment for the Control Plane CloT EPS optimisation: go to RRC_IDLE else: initiate the connection re-establishment procedure
T311 NOTE1	Upon initiating the RRC connection re-establishment procedure	Selection of a suitable E-UTRA cell or a cell using another RAT.	Enter RRC_IDLE

Timer	Start	Stop	At expiry
T312 NOTE2	Upon triggering a measurement report for a measurement identity for which T312 has been configured, while T310 is running	Upon receiving N311 consecutive in-sync indications from lower layers, upon triggering the handover procedure, upon initiating the connection re-establishment procedure, and upon the expiry of T310	If security is not activated: go to RRC_IDLE else: initiate the connection re-establishment procedure
T313 NOTE2	Upon detecting physical layer problems for the PSCell i.e. upon receiving N313 consecutive out-of-sync indications from lower layers	Upon receiving N314 consecutive in-sync indications from lower layers for the PSCell, upon initiating the connection re-establishment procedure, upon SCG release and upon receiving <i>RRCConnectionReconfiguration</i> including <i>MobilityControlInfoSCG</i>	Inform E-UTRAN about the SCG radio link failure by initiating the SCG failure information procedure as specified in 5.6.13.
T320	Upon receiving <i>t320</i> or upon cell (re)selection to E-UTRA from another RAT with validity time configured for dedicated priorities (in which case the remaining validity time is applied).	Upon entering RRC_CONNECTED, when PLMN selection is performed on request by NAS, or upon cell (re)selection to another RAT (in which case the timer is carried on to the other RAT).	Discard the cell reselection priority information provided by dedicated signalling.
T321	Upon receiving <i>measConfig</i> including a <i>reportConfig</i> with the <i>purpose</i> set to <i>reportCGI</i>	Upon acquiring the information needed to set all fields of <i>cellGlobalId</i> for the requested cell, upon receiving <i>measConfig</i> that includes removal of the <i>reportConfig</i> with the <i>purpose</i> set to <i>reportCGI</i>	Initiate the measurement reporting procedure, stop performing the related measurements and remove the corresponding <i>measId</i>
T322 NOTE1	Upon receiving <i>redirectedCarrierOffsetDedicated</i> included in <i>RedirectedCarrierInfo</i>	Upon entering RRC_CONNECTED, when PLMN selection is performed on request by NAS, or upon cell (re)selection to another RAT.	Release <i>redirectedCarrierOffsetDedicated</i> .
T325	Timer (re)started upon receiving <i>RRCConnectionReject</i> message with <i>deprioritisationTimer</i> .		Stop deprioritisation of all frequencies or E-UTRA signalled by <i>RRCConnectionReject</i> .
T330	Upon receiving <i>LoggedMeasurementConfiguration</i> message	Upon log volume exceeding the suitable UE memory, upon initiating the release of <i>LoggedMeasurementConfiguration</i> procedure	Perform the actions specified in 5.6.6.4
T340 NOTE2	Upon transmitting <i>UEAssistanceInformation</i> message with <i>powerPrefIndication</i> set to <i>normal</i>	Upon initiating the connection re-establishment procedure	No action.
T341 NOTE2	Upon transmitting <i>UEAssistanceInformation</i> message with <i>bwPreference</i> .	Upon resuming an RRC connection or upon initiating the connection re-establishment procedure	No action.
T342 NOTE2	Upon transmitting <i>DelayBudgetReport</i> message.	Upon initiating the connection re-establishment and connection resume procedures	No action.
T350	Upon entering RRC_IDLE if <i>t350</i> has been received in <i>wlan-OffloadInfo</i> .	Upon entering RRC_CONNECTED, or upon cell reselection.	Perform the actions specified in 5.6.12.4.

Timer	Start	Stop	At expiry
T351	Reception of <i>RRCConnectionReconfiguration</i> message including the association <i>Timer</i> in <i>WLAN-MobilityConfig</i> .	Upon successful connection to WLAN, upon WLAN connection failure, upon leaving <i>RRC_CONNECTED</i> , upon triggering the handover procedure, or upon initiating the connection re-establishment procedure.	Perform WLAN Connection Status Reporting specified in 5.6.15.2.
T360	Upon performing the redistribution target selection as specified in TS 36.304 [4].	Upon entering <i>RRC_CONNECTED</i> , upon receiving a Paging message including <i>redistributionIndication</i> ; upon reselecting a cell not belonging to the redistribution target.	Stop considering a frequency or cell to be redistribution target, and perform the redistribution target selection if the condition specified in TS 36.304 [4] is met.
T370	Upon receiving <i>SL-DiscConfig</i> including a <i>discSysInfoToReportConfig</i> set to <i>setup</i> .	Upon initiating the transmission of <i>SidelinkUEInformation</i> including <i>discSysInfoReportFreqList</i> , upon receiving <i>SL-DiscConfig</i> including <i>discSysInfoToReportConfig</i> set to <i>release</i> , upon handover and re-establishment.	Release <i>discSysInfoToReportConfig</i> .
T314 NOTE2	Upon early detecting physical layer problems for the PCell i.e. upon receiving N310 consecutive "early-out-of-sync" indications from lower layers.	Upon receiving N311 consecutive in-sync indications from lower layers for the PCell, upon triggering the handover procedure and upon initiating the connection re-establishment procedure	Initiate the UE Assistance Information procedure to report early detection of physical layer problems in accordance with 5.6.10.
T315 NOTE2	Upon detecting physical layer improvements of the PCell i.e. upon receiving N311 consecutive "early-in-sync" indications from lower layers.	Upon receiving N310 consecutive "early-out-of-sync" indications from lower layers for the PCell.	Initiate the UE Assistance Information procedure to report detection of physical layer improvements in accordance with 5.6.10.
T343 NOTE2	Upon transmitting <i>UEAssistanceInformation</i> message with <i>RLM-Report</i> including <i>earlyOutOfSync</i> .	Upon initiating the connection re-establishment procedure	No action.
T344 NOTE2	Upon transmitting <i>UEAssistanceInformation</i> message with <i>RLM-Report</i> including <i>earlyInSync</i> .	Upon initiating the connection re-establishment procedure	No action.
T345	Upon transmitting <i>UEAssistanceInformation</i> message with <i>overheatingAssistance</i>	Upon initiating the connection re-establishment procedure	No action.
NOTE1: Only the timers marked with "NOTE1" are applicable to NB-IoT. NOTE2: The behaviour as specified in 7.3.2 applies.			

7.3.2 Timer handling

When the UE applies zero value for a timer, the timer shall be started and immediately expire unless explicitly stated otherwise.

7.4 Constants

Constant	Usage
N310	Maximum number of consecutive "out-of-sync" or "early-out-of-sync" indications for the PCell received from lower layers
N311	Maximum number of consecutive "in-sync" or "early-in-sync" indications for the PCell received from lower layers
N313	Maximum number of consecutive "out-of-sync" indications for the PSCell received from lower layers
N314	Maximum number of consecutive "in-sync" indications for the PSCell received from lower layers

8 Protocol data unit abstract syntax

8.1 General

The RRC PDU contents in clause 6, clause 9.3.2 and clause 10 are described using abstract syntax notation one (ASN.1) as specified in ITU-T Rec. X.680 [13] and X.681 [14]. Transfer syntax for RRC PDUs is derived from their ASN.1 definitions by use of Packed Encoding Rules, unaligned as specified in ITU-T Rec. X.691 [15].

The following encoding rules apply in addition to what has been specified in X.691:

- When a bit string value is placed in a bit-field as specified in 15.6 to 15.11 in X.691, the leading bit of the bit string value shall be placed in the leading bit of the bit-field, and the trailing bit of the bit string value shall be placed in the trailing bit of the bit-field.

NOTE: The terms 'leading bit' and 'trailing bit' are defined in ITU-T Rec. X.680. When using the 'bstring' notation, the leading bit of the bit string value is on the left, and the trailing bit of the bit string value is on the right.

- When decoding types constrained with the ASN.1 Contents Constraint ("CONTAINING"), automatic decoding of the contained type should not be performed because errors in the decoding of the contained type should not cause the decoding of the entire RRC message PDU to fail. It is recommended that the decoder first decodes the outer PDU type that contains the OCTET STRING or BIT STRING with the Contents Constraint, and then decodes the contained type that is nested within the OCTET STRING or BIT STRING as a separate step.
- When decoding a) RRC message PDUs, b) BIT STRING constrained with a Contents Constraint, or c) OCTET STRING constrained with a Contents Constraint, PER decoders are required to never report an error if there are extraneous zero or non-zero bits at the end of the encoded RRC message PDU, BIT STRING or OCTET STRING.

8.2 Structure of encoded RRC messages

An RRC PDU, which is the bit string that is exchanged between peer entities/ across the radio interface contains the basic production as defined in X.691.

RRC PDUs shall be mapped to and from PDCP SDUs (in case of DCCH) or RLC SDUs (in case of PCCH, BCCH, BR-BCCH, CCCH or MCCH) upon transmission and reception as follows:

- when delivering an RRC PDU as a PDCP SDU to the PDCP layer for transmission, the first bit of the RRC PDU shall be represented as the first bit in the PDCP SDU and onwards; and
- when delivering an RRC PDU as an RLC SDU to the RLC layer for transmission, the first bit of the RRC PDU shall be represented as the first bit in the RLC SDU and onwards; and

- upon reception of an PDCP SDU from the PDCP layer, the first bit of the PDCP SDU shall represent the first bit of the RRC PDU and onwards; and
- upon reception of an RLC SDU from the RLC layer, the first bit of the RLC SDU shall represent the first bit of the RRC PDU and onwards.

8.3 Basic production

The 'basic production' is obtained by applying UNALIGNED PER to the abstract syntax value (the ASN.1 description) as specified in X.691. It always contains a multiple of 8 bits.

8.4 Extension

The following rules apply with respect to the use of protocol extensions:

- A transmitter compliant with this version of the specification shall, unless explicitly indicated otherwise on a PDU type basis, set the extension part empty. Transmitters compliant with a later version may send non-empty extensions;
- A transmitter compliant with this version of the specification shall set spare bits to zero;

8.5 Padding

If the encoded RRC message does not fill a transport block, the RRC layer shall add padding bits. This applies to PCCH, BCCH and BR-BCCH.

Padding bits shall be set to 0 and the number of padding bits is a multiple of 8.

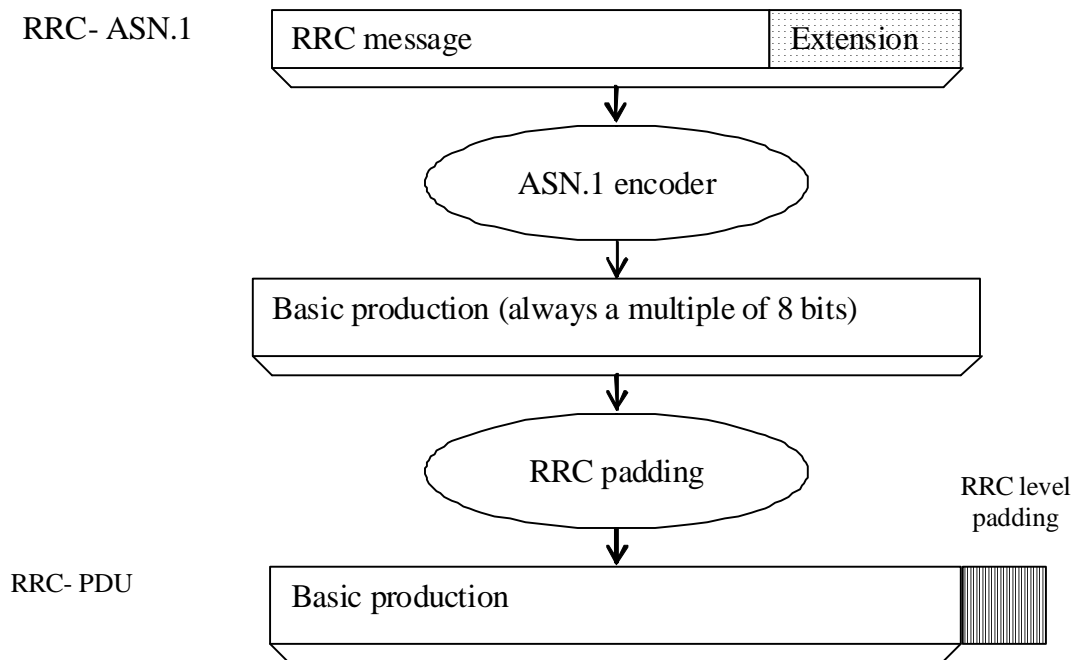

Figure 8.5-1: RRC level padding

9 Specified and default radio configurations

Specified and default configurations are configurations of which the details are specified in the standard. Specified configurations are fixed while default configurations can be modified using dedicated signalling.

9.1 Specified configurations

9.1.1 Logical channel configurations

9.1.1.1 BCCH configuration

Parameters

Name	Value	Semantics description	Ver
PDCP configuration	N/A		
RLC configuration	TM		
MAC configuration	TM		

NOTE: RRC will perform padding, if required due to the granularity of the TF signalling, as defined in 8.5.

9.1.1.2 CCCH configuration

Parameters

Name	Value	Semantics description	Ver
PDCP configuration	N/A		
RLC configuration	TM		
MAC configuration		Normal MAC headers are used	
Logical channel configuration			
<i>priority</i>	1	Highest priority	
<i>prioritisedBitRate</i>	infinity		
<i>bucketSizeDuration</i>	N/A		
<i>logicalChannelGroup</i>	0		
<i>logicalChannelSR-Mask-r9</i>	release		v920

9.1.1.3 PCCH configuration

Parameters

Name	Value	Semantics description	Ver
PDCP configuration	N/A		
RLC configuration	TM		
MAC configuration	TM		

NOTE: RRC will perform padding, if required due to the granularity of the TF signalling, as defined in 8.5.

9.1.1.4 MCCH and MTCH configuration

Parameters

Name	Value	Semantics description	Ver
PDCP configuration	N/A		
RLC configuration	UM		
<i>sn-FieldLength</i>	size5		
<i>t-Reordering</i>	0		

9.1.1.5 SBCCH configuration

Parameters

Name	Value	Semantics description	Ver
PDCP configuration	N/A		
RLC configuration	TM		
MAC configuration	TM		

NOTE: RRC will perform padding, if required due to the granularity of the TF signalling, as defined in 8.5.

9.1.1.6 STCH configuration

Parameters

Name	Value	Semantics description	Ver
PDCP configuration			
discardTimer	Undefined	Up to UE implementation	
pdcp-SN-Size	16		
maxCID	15		
profiles			
RLC configuration		Uni-directional UM RLC UM window size is set to 0	
		Uni-directional UM RLC UM window size is set to 0 for sidelink communication	v1440
<i>sn-FieldLength</i>	5		
logicalChannelIdentity	Undefined	Selected by the transmitting UE, up to UE implementation	
Logical channel configuration			
priority	Undefined	Selected by the transmitting UE, up to UE implementation	
prioritisedBitRate	Undefined	Selected by the transmitting UE, up to UE implementation	
bucketSizeDuration	Undefined	Selected by the transmitting UE, up to UE implementation	
logicalChannelGroup	3		
t-Reordering	Undefined	Only used for V2X sidelink communication. Selected by the receiving UE, up to UE implementation	v1440
MAC configuration			

9.1.1.7 SC-MCCH and SC-MTCH configuration

Parameters

Name	Value	Semantics description	Ver
PDCP configuration	N/A		

Name	Value	Semantics description	Ver
RLC configuration	UM		
<i>sn-FieldLength</i>	size5		
<i>t-Reordering</i>	0		

9.1.1.8 BR-BCCH configuration

Parameters

Name	Value	Semantics description	Ver
PDCP configuration	N/A		
RLC configuration	TM		
MAC configuration	TM		

NOTE: RRC will perform padding, if required due to the granularity of the TF signalling, as defined in 8.5.

9.1.2 SRB configurations

9.1.2.1 SRB1

Parameters

Name	Value	Semantics description	Ver
RLC configuration			
<i>logicalChannelIdentity</i>	1		

9.1.2.1a SRB1bis

Parameters

Name	Value	Semantics description	Ver
RLC configuration			
<i>logicalChannelIdentity</i>	3		

9.1.2.2 SRB2

Parameters

Name	Value	Semantics description	Ver
RLC configuration			
<i>logicalChannelIdentity</i>	2		

9.2 Default radio configurations

The following clauses only list default values for REL-8 parameters included in protocol version v8.5.0. For all fields introduced in a later protocol version, the default value is "released" unless explicitly specified otherwise. If UE is to apply default configuration while it is configured with some critically extended fields, the UE shall apply the original

version with only default values. For the following fields, introduced in a protocol version later than v8.5.0, the default corresponds with "value not applicable":

- *codeBookSubsetRestriction-v920*;
- *pmi-RI-Report*;

NOTE 1: Value "N/A" indicates that the UE does not apply a specific value (i.e. upon switching to a default configuration, E-UTRAN can not assume the UE keeps the previously configured value). This implies that E-UTRAN needs to configure a value before invoking the related functionality.

NOTE 2: In general, the signalling should preferably support a "release" option for fields introduced after v8.5.0. The "value not applicable" should be used restrictively, mainly limited to for fields which value is relevant only if another field is set to a value other than its default.

9.2.1 SRB configurations

9.2.1.1 SRB1

Parameters

Name	Value	NB-IoT	Semantics description	Ver
RLC configuration CHOICE	am	am		
<i>ul-RLC-Config</i>				
> <i>t-PollRetransmit</i>	ms45	ms25000		
> <i>pollPDU</i>	infinity	N/A		
> <i>pollByte</i>	infinity	N/A		
> <i>maxRetxThreshold</i>	t4	t4		
<i>dl-RLC-Config</i>				
> <i>t-Reordering</i>	ms35	released		
> <i>t-StatusProhibit</i>	ms0	N/A		
> <i>enableStatusReportSN-Gap</i>	N/A	disabled		
Logical channel configuration				
<i>priority</i>	1	1	Highest priority	
<i>prioritisedBitRate</i>	infinity	N/A		
<i>bucketSizeDuration</i>	N/A	N/A		
<i>logicalChannelGroup</i>	0	N/A		
<i>logicalChannelSR-Prohibit</i>	N/A	TRUE		

9.2.1.2 SRB2

Parameters

Name	Value	Semantics description	Ver
RLC configuration CHOICE	am		
<i>ul-RLC-Config</i>			

Name	Value	Semantics description	Ver
<i>>t-PollRetransmit</i>	ms45		
<i>>pollPDU</i>	infinity		
<i>>pollByte</i>	infinity		
<i>>maxRetxThreshold</i>	t4		
<i>dl-RLC-Config</i>			
<i>>t-Reordering</i>	ms35		
<i>>t-StatusProhibit</i>	ms0		
Logical channel configuration			
<i>priority</i>	3		
<i>prioritisedBitRate</i>	infinity		
<i>bucketSizeDuration</i>	N/A		
<i>logicalChannelGroup</i>	0		

9.2.2 Default MAC main configuration

Parameters

Name	Value	NB-IoT	Semantics description	Ver
MAC main configuration				
<i>maxHARQ-tx</i>	n5	N/A		
<i>periodicBSR-Timer</i>	infinity	pp8		
<i>retxBSR-Timer</i>	sf2560	infinity		
<i>ttiBundling</i>	FALSE	N/A		
<i>drx-Config</i>	release	N/A		
<i>phr-Config</i>	release	N/A		

9.2.3 Default semi-persistent scheduling configuration

<i>SPS-Config</i>			
<i>>sps-ConfigDL</i>	release		
<i>>sps-ConfigUL</i>	release		

9.2.4 Default physical channel configuration

Parameters (not applicable for NB-IoT)

Name	Value	Semantics description	Ver
<i>PDSCH-ConfigDedicated</i>			

Name	Value	Semantics description	Ver
>p-a	dB0		
<i>PUCCH-ConfigDedicated</i>			
>tdd-AckNackFeedbackMode	bundling	Only valid for TDD mode	
>ackNackRepetition	release		
<i>PUSCH-ConfigDedicated</i>			
>betaOffset-ACK-Index	10		
>betaOffset-RI-Index	12		
>betaOffset-CQI-Index	15		
<i>UplinkPowerControlDedicated</i>			
>p0-UE-PUSCH	0		
>deltaMCS-Enabled	en0 (disabled)		
>accumulationEnabled	TRUE		
>p0-UE-PUCCH	0		
>pSRS-Offset	7		
>filterCoefficient	fc4		
<i>tpc-pdcch-ConfigPUCCH</i>	release		
<i>tpc-pdcch-ConfigPUSCH</i>	release		
<i>CQI-ReportConfig</i>			
>CQI-ReportPeriodic	release		
>cqi-ReportModeAperiodic	N/A		
>nomPDSCH-RS-EPRE-Offset	N/A		
<i>SoundingRS-UL-ConfigDedicated</i>	release		
<i>AntennaInfoDedicated</i>			
>transmissionMode	tm1, tm2	If the number of PBCH antenna ports is one, tm1 is used as default; otherwise tm2 is used as default	
>codebookSubsetRestriction	N/A		
>ue-TransmitAntennaSelection	release		
<i>SchedulingRequestConfig</i>	release		

Parameters applicable for NB-IoT

Name	Value	Semantics description	Ver
<i>NPUSCH-ConfigDedicated-NB</i>			

Name	Value	Semantics description	Ver
<i>>ack-NACK-NumRepetitions</i>	N/A		
<i>>npusch-AllSymbols</i>	TRUE		
<i>UplinkPowerControlDedicated</i>			
<i>>p0-UE-NPUSCH</i>	0		

9.2.5 Default values timers and constants

Parameters

Name	Value	Semantics description	Ver
t310	ms1000		
n310	n1		
t311	ms1000		
n311	n1		

9.3 Sidelink pre-configured parameters

9.3.1 Specified parameters

This clause only list parameters which value is specified in the standard.

Parameters

Name	Value	Semantics description	Ver
<i>preconfigSync</i> <i>>syncTxParameters</i> <i>>>alpha</i>	0		
<i>preconfigComm</i> <i>>sc-TxParameters</i> <i>>>alpha</i> <i>>dataTxParameters</i> <i>>>alpha</i>	0 0		
<i>v2x-CommPreconfigSync</i> <i>>syncTxParameters</i> <i>>>alpha</i>	0		
<i>v2x-CommTxPoolList, p2x-CommTxPoolList</i> <i>>dataTxParameters</i> <i>>>alpha</i>	0		

9.3.2 Pre-configurable parameters

This ASN.1 segment is the start of the E-UTRA definitions of pre-configured sidelink parameters.

NOTE 1: Upper layers are assumed to provide a set of pre-configured parameters that are valid at the current UE location if any, see TS 24.334 [69, 10.2].

```
-- ASN1START
EUTRA-Sidelink-Preconf DEFINITIONS AUTOMATIC TAGS ::=
BEGIN
```

```

IMPORTS
  AdditionalSpectrumEmission,
  AdditionalSpectrumEmission-v1010,
  ARFCN-ValueEUTRA-r9,
  FilterCoefficient,
  maxCBR-Level-r14,
  maxCBR-Level-1-r14,
  maxFreq,
  maxFreqV2X-r14,
  maxSL-TxPool-r12,
  maxSL-CommRxPoolPreconf-v1310,
  maxSL-CommTxPoolPreconf-v1310,
  maxSL-DiscRxPoolPreconf-r13,
  maxSL-DiscTxPoolPreconf-r13,
  maxSL-V2X-CBRConfig2-r14,
  maxSL-V2X-CBRConfig2-1-r14,
  maxSL-V2X-RxPoolPreconf-r14,
  maxSL-V2X-TxConfig2-r14,
  maxSL-V2X-TxConfig2-1-r14,
  maxSL-V2X-TxPoolPreconf-r14,
  P-Max,
  ReselectionInfoRelay-r13,
  SL-AnchorCarrierFreqList-V2X-r14,
  SL-CBR-Levels-Config-r14,
  SL-CBR-PSSCH-TxConfig-r14,
  SL-CommTxPoolSensingConfig-r14,
  SL-CP-Len-r12,
  SL-HoppingConfigComm-r12,
  SL-OffsetIndicator-r12,
  SL-OffsetIndicatorSync-r12,
  SL-OffsetIndicatorSync-v1430,
  SL-PeriodComm-r12,
  RSRP-RangeSL3-r12,
  SL-PriorityList-r13,
  SL-TF-ResourceConfig-r12,
  SL-TRPT-Subset-r12,
  SL-TxParameters-r12,
  SL-ZoneConfig-r14,
  P0-SL-r12,
  TDD-ConfigSL-r12,
  SubframeBitmapSL-r14,
  SL-P2X-ResourceSelectionConfig-r14,
  SL-RestrictResourceReservationPeriodList-r14,
  SL-SyncAllowed-r14,
  SL-OffsetIndicatorSync-r14,
  SL-Priority-r13
FROM EUTRA-RRC-Definitions;

-- ASN1STOP

```

– *SL-Preconfiguration*

The IE *SL-Preconfiguration* includes the sidelink pre-configured parameters.

***SL-Preconfiguration* information elements**

```

-- ASN1START

SL-Preconfiguration-r12 ::= SEQUENCE {
  preconfigGeneral-r12          SL-PreconfigGeneral-r12,
  preconfigSync-r12            SL-PreconfigSync-r12,
  preconfigComm-r12            SL-PreconfigCommPoolList4-r12,
  ...,
  [[ preconfigComm-v1310        SEQUENCE {
    commRxPoolList-r13          SL-PreconfigCommRxPoolList-r13,
    commTxPoolList-r13          SL-PreconfigCommTxPoolList-r13      OPTIONAL
  }
  preconfigDisc-r13            SEQUENCE {
    discRxPoolList-r13          SL-PreconfigDiscRxPoolList-r13,
    discTxPoolList-r13          SL-PreconfigDiscTxPoolList-r13      OPTIONAL
  }
  preconfigRelay-r13           SL-PreconfigRelay-r13      OPTIONAL
]]

```



```

}

SL-PreconfigGeneral-r12 ::= SEQUENCE {
  -- PDCP configuration
  rohc-Profiles-r12 SEQUENCE {
    profile0x0001-r12 BOOLEAN,
    profile0x0002-r12 BOOLEAN,
    profile0x0004-r12 BOOLEAN,
    profile0x0006-r12 BOOLEAN,
    profile0x0101-r12 BOOLEAN,
    profile0x0102-r12 BOOLEAN,
    profile0x0104-r12 BOOLEAN
  },
  -- Physical configuration
  carrierFreq-r12 ARFCN-ValueEUTRA-r9,
  maxTxPower-r12 P-Max,
  additionalSpectrumEmission-r12 AdditionalSpectrumEmission,
  sl-bandwidth-r12 ENUMERATED {n6, n15, n25, n50, n75, n100},
  tdd-ConfigSL-r12 TDD-ConfigSL-r12,
  reserved-r12 BIT STRING (SIZE (19)),
  ...,
  [[ additionalSpectrumEmission-v1440 AdditionalSpectrumEmission-v1010 OPTIONAL
  ]]
}

SL-PreconfigSync-r12 ::= SEQUENCE {
  syncCP-Len-r12 SL-CP-Len-r12,
  syncOffsetIndicator1-r12 SL-OffsetIndicatorSync-r12,
  syncOffsetIndicator2-r12 SL-OffsetIndicatorSync-r12,
  syncTxParameters-r12 P0-SL-r12,
  syncTxThreshOoC-r12 RSRP-RangeSL3-r12,
  filterCoefficient-r12 FilterCoefficient,
  syncRefMinHyst-r12 ENUMERATED {dB0, dB3, dB6, dB9, dB12},
  syncRefDiffHyst-r12 ENUMERATED {dB0, dB3, dB6, dB9, dB12, dBInf},
  ...,
  [[ syncTxPeriodic-r13 ENUMERATED {true} OPTIONAL
  ]]
}

SL-PreconfigCommPoolList4-r12 ::= SEQUENCE (SIZE (1..maxSL-TxPool-r12)) OF SL-PreconfigCommPool-r12

SL-PreconfigCommRxPoolList-r13 ::= SEQUENCE (SIZE (1..maxSL-CommRxPoolPreconf-v1310)) OF SL-PreconfigCommPool-r12

SL-PreconfigCommTxPoolList-r13 ::= SEQUENCE (SIZE (1..maxSL-CommTxPoolPreconf-v1310)) OF SL-PreconfigCommPool-r12

SL-PreconfigCommPool-r12 ::= SEQUENCE {
  -- This IE is same as SL-CommResourcePool with rxParametersNCell absent
  sc-CP-Len-r12 SL-CP-Len-r12,
  sc-Period-r12 SL-PeriodComm-r12,
  sc-TF-ResourceConfig-r12 SL-TF-ResourceConfig-r12,
  sc-TxParameters-r12 P0-SL-r12,
  data-CP-Len-r12 SL-CP-Len-r12,
  data-TF-ResourceConfig-r12 SL-TF-ResourceConfig-r12,
  dataHoppingConfig-r12 SL-HoppingConfigComm-r12,
  dataTxParameters-r12 P0-SL-r12,
  trpt-Subset-r12 SL-TRPT-Subset-r12,
  ...,
  [[ priorityList-r13 SL-PriorityList-r13 OPTIONAL -- For Tx
  ]]
}

SL-PreconfigDiscRxPoolList-r13 ::= SEQUENCE (SIZE (1..maxSL-DiscRxPoolPreconf-r13)) OF SL-PreconfigDiscPool-r13

SL-PreconfigDiscTxPoolList-r13 ::= SEQUENCE (SIZE (1..maxSL-DiscTxPoolPreconf-r13)) OF SL-PreconfigDiscPool-r13

SL-PreconfigDiscPool-r13 ::= SEQUENCE {
  -- This IE is same as SL-DiscResourcePool with rxParameters absent
  cp-Len-r13 SL-CP-Len-r12,
  discPeriod-r13 ENUMERATED {rf4, rf6, rf7, rf8, rf12, rf14, rf16, rf24, rf28,
    rf32, rf64, rf128, rf256, rf512, rf1024, spare},
  numRetx-r13 INTEGER (0..3),
  numRepetition-r13 INTEGER (1..50),

```

```

    tf-ResourceConfig-r13          SL-TF-ResourceConfig-r12,
    txParameters-r13              SEQUENCE {
        txParametersGeneral-r13   P0-SL-r12,
        txProbability-r13         ENUMERATED {p25, p50, p75, p100}
    }
    ...
}
SL-PreconfigRelay-r13 ::= SEQUENCE {
    reselectionInfoOoC-r13        ReselectionInfoRelay-r13
}
-- ASN1STOP

```

SL-Preconfiguration field descriptions

carrierFreq

Indicates the carrier frequency for out of coverage sidelink communication and sidelink discovery. In case of FDD it is uplink carrier frequency and the corresponding downlink frequency can be determined from the default TX-RX frequency separation defined in TS 36.101 [42, table 5.7.3-1].

additionalSpectrumEmission

The UE requirements related to IE *AdditionalSpectrumEmission* are defined in TS 36.101 [42, 6.2.4]. If *additionalSpectrumEmissionExt-r14* is configured, the UE only considers *additionalSpectrumEmissionExt-r14* (and ignores *additionalSpectrumEmission-r12*).

commRxPoolList

Indicates a list of reception pools for sidelink communication in addition to the resource pools indicated by *preconfigComm*.

commTxPoolList

Indicates a list of transmission pools for sidelink communication in addition to the first resource pool within *preconfigComm*.

preconfigComm

Indicates a list of resource pools. The first resource pool in the list is used for both reception and transmission of sidelink communication. The other resource pools, if present, are only used for reception of sidelink communication.

syncRefDiffHyst

Hysteresis when evaluating a SyncRef UE using relative comparison. Value *dB0* corresponds to 0 dB, *dB3* to 3 dB and so on, value *dBinf* corresponds to infinite dB.

syncRefMinHyst

Hysteresis when evaluating a SyncRef UE using absolute comparison. Value *dB0* corresponds to 0 dB, *dB3* to 3 dB and so on.

NOTE 1: The network may configure one or more of the reception only resource pools in *preconfigComm* to cover reception from in coverage UEs using scheduled resource allocation. For such a resource pool the network should set all bits of *subframeBitmap* to 1 and *offsetIndicator* to indicate the subframe immediately following the sidelink control information.

NOTE 2: The network should ensure that the resources defined by the first entry in *preconfigComm* (used for transmission by an out of coverage UE) do not overlap with those of the pool(s) covering scheduled transmissions by in coverage UEs. Furthermore, the network should ensure that for none of the entries in *preconfigComm* the resources defined by *sc-TF-ResourceConfig* overlap.

SL-V2X-Preconfiguration

The IE *SL-V2X-Preconfiguration* includes the sidelink pre-configured parameters used for V2X sidelink communication.

SL-V2X-Preconfiguration information elements

```

-- ASN1START
SL-V2X-Preconfiguration-r14 ::= SEQUENCE {
    v2x-PreconfigFreqList-r14      SL-V2X-PreconfigFreqList-r14,
    anchorCarrierFreqList-r14     SL-AnchorCarrierFreqList-V2X-r14
    cbr-PreconfigList-r14         SL-CBR-PreconfigTxConfigList-r14
    ...
}
SL-CBR-PreconfigTxConfigList-r14 ::= SEQUENCE {

```

```

    cbr-RangeCommonConfigList-r14 SEQUENCE (SIZE (1..maxSL-V2X-CBRConfig2-r14)) OF SL-CBR-Levels-
    Config-r14,
    sl-CBR-PSSCH-TxConfigList-r14 SEQUENCE (SIZE (1..maxSL-V2X-TxConfig2-r14)) OF SL-CBR-PSSCH-
    TxConfig-r14
}

SL-V2X-PreconfigFreqList-r14 ::= SEQUENCE (SIZE (1..maxFreqV2X-r14)) OF SL-V2X-PreconfigFreqInfo-
r14

SL-V2X-PreconfigFreqInfo-r14 ::= SEQUENCE {
    v2x-CommPreconfigGeneral-r14 SL-PreconfigGeneral-r12,
    v2x-CommPreconfigSync-r14 SL-PreconfigV2X-Sync-r14 OPTIONAL,
    v2x-CommRxPoolList-r14 SL-PreconfigV2X-RxPoolList-r14,
    v2x-CommTxPoolList-r14 SL-PreconfigV2X-TxPoolList-r14,
    p2x-CommTxPoolList-r14 SL-PreconfigV2X-TxPoolList-r14,
    v2x-ResourceSelectionConfig-r14 SL-CommTxPoolSensingConfig-r14 OPTIONAL,
    zoneConfig-r14 SL-ZoneConfig-r14 OPTIONAL,
    syncPriority-r14 ENUMERATED {gnss, enb},
    thresSL-TxPrioritization-r14 SL-Priority-r13 OPTIONAL,
    offsetDFN-r14 INTEGER (0..1000) OPTIONAL,
    ...
}

SL-PreconfigV2X-RxPoolList-r14 ::= SEQUENCE (SIZE (1..maxSL-V2X-RxPoolPreconf-r14)) OF SL-V2X-
PreconfigCommPool-r14

SL-PreconfigV2X-TxPoolList-r14 ::= SEQUENCE (SIZE (1..maxSL-V2X-TxPoolPreconf-r14)) OF SL-V2X-
PreconfigCommPool-r14

SL-V2X-PreconfigCommPool-r14 ::= SEQUENCE {
-- This IE is same as SL-CommResourcePoolV2X with rxParametersNCell absent
    sl-OffsetIndicator-r14 SL-OffsetIndicator-r12 OPTIONAL,
    sl-Subframe-r14 SubframeBitmapSL-r14,
    adjacencyPSSCH-PSSCH-r14 BOOLEAN,
    sizeSubchannel-r14 ENUMERATED {
        n4, n5, n6, n8, n9, n10, n12, n15, n16, n18, n20, n25, n30,
        n48, n50, n72, n75, n96, n100, spare13, spare12, spare11,
        spare10, spare9, spare8, spare7, spare6, spare5, spare4,
        spare3, spare2, spare1},
    numSubchannel-r14 ENUMERATED {n1, n3, n5, n8, n10, n15, n20, spare1},
    startRB-Subchannel-r14 INTEGER (0..99),
    startRB-PSSCH-Pool-r14 INTEGER (0..99) OPTIONAL,
    dataTxParameters-r14 P0-SL-r12,
    zoneID-r14 INTEGER (0..7) OPTIONAL,
    threshS-RSSI-CBR-r14 INTEGER (0..45) OPTIONAL,
    cbr-pssch-TxConfigList-r14 SL-CBR-PPPP-TxPreconfigList-r14 OPTIONAL,
    resourceSelectionConfigP2X-r14 SL-P2X-ResourceSelectionConfig-r14 OPTIONAL,
    syncAllowed-r14 SL-SyncAllowed-r14 OPTIONAL,
    restrictResourceReservationPeriod-r14 SL-RestrictResourceReservationPeriodList-r14
    OPTIONAL, -- Need OR
    ...
}

SL-PreconfigV2X-Sync-r14 ::= SEQUENCE {
    syncOffsetIndicators-r14 SL-V2X-SyncOffsetIndicators-r14,
    syncTxParameters-r14 P0-SL-r12,
    syncTxThreshOoC-r14 RSRP-RangeSL3-r12,
    filterCoefficient-r14 FilterCoefficient,
    syncRefMinHyst-r14 ENUMERATED {dB0, dB3, dB6, dB9, dB12},
    syncRefDiffHyst-r14 ENUMERATED {dB0, dB3, dB6, dB9, dB12, dBinf},
    ...
}

SL-V2X-SyncOffsetIndicators-r14 ::= SEQUENCE {
    syncOffsetIndicator1-r14 SL-OffsetIndicatorSync-r14,
    syncOffsetIndicator2-r14 SL-OffsetIndicatorSync-r14,
    syncOffsetIndicator3-r14 SL-OffsetIndicatorSync-r14 OPTIONAL
}

SL-CBR-PPPP-TxPreconfigList-r14 ::= SEQUENCE (SIZE (1..8)) OF SL-PPPP-TxPreconfigIndex-r14

SL-PPPP-TxPreconfigIndex-r14 ::= SEQUENCE {
    priorityThreshold-r14 SL-Priority-r13,
    defaultTxConfigIndex-r14 INTEGER(0..maxCBR-Level-1-r14),
    cbr-ConfigIndex-r14 INTEGER(0..maxSL-V2X-CBRConfig2-1-r14),
    tx-ConfigIndexList-r14 SEQUENCE (SIZE (1..maxCBR-Level-r14)) OF Tx-PreconfigIndex-r14
}

```

```
Tx-PreconfigIndex-r14 ::= INTEGER(0..maxSL-V2X-TxConfig2-1-r14)
END
-- ASN1STOP
```

SL-V2X-Preconfiguration field descriptions
<p>adjacencyPSCCH-PSSCH Indicates whether a UE always transmits PSCCH and PSSCH in adjacent RBs (indicated by TRUE) or it may transmit PSCCH and PSSCH in non-adjacent RBs (indicated by FALSE). This parameter appears only when a pool is configured such that a UE transmits PSCCH and the associated PSSCH in the same subframe.</p>
<p>anchorCarrierFreqList Indicates carrier frequencies which may include inter-carrier resource configuration for V2X sidelink communication.</p>
<p>cbr-PreconfigList Indicates the preconfigured list of CBR ranges and the list of PSSCH transmission configurations available to configure congestion control to the UE for V2X sidelink communication.</p>
<p>cbr-pssch-TxConfigList Indicates the mapping between PPPPs, CBR ranges by using indexes of the entry in <i>cbr-RangeCommonConfigList</i> in <i>cbr-PreconfigList</i>, and PSSCH transmission parameters and CR limits by using indexes of the entry in <i>sl-CBR-PSSCH-TxConfigList</i> in <i>cbr-PreconfigList</i>.</p>
<p>numSubchannel Indicates the number of subchannels in the corresponding resource pool.</p>
<p>offsetDFN Indicates the timing offset for the UE to determine DFN timing when GNSS is used for timing reference. Value 0 corresponds to 0 milliseconds, value 1 corresponds to 0.001 milliseconds, value 2 corresponds to 0.002 milliseconds, and so on.</p>
<p>resourceSelectionConfigP2X Indicates the allowed resource selection mechanism(s), i.e. partial sensing and/or random selection, for P2X related V2X sidelink communication.</p>
<p>restrictResourceReservationPeriod If configured, the field <i>restrictResourceReservationPeriod</i> configured in <i>v2x-ResourceSelectionConfig</i> shall be ignored for transmission on this pool.</p>
<p>sizeSubchannel Indicates the number of PRBs of each subchannel in the corresponding resource pool. The value n5 denotes 5 PRBs; n6 denotes 6 PRBs and so on. The values n5, n6, n10, n15, n20, n25, n50, n75 and n100 apply in the case of <i>adjacencyPSCCH-PSSCH</i> set to TRUE; the values n4, n5, n6, n8, n9, n10, n12, n15, n16, n18, n20, n30, n48, n72 and n96 apply in the case of <i>adjacencyPSCCH-PSSCH</i> set to FALSE,</p>
<p>sl-OffsetIndicator Indicates the offset of the first subframe of a resource pool within a SFN cycle. If absent, the resource pool starts from first subframe of SFN=0. This field is not applicable to V2X sidelink communication.</p>
<p>sl-Subframe Indicates the bitmap of the resource pool, which is defined by repeating the bitmap within a SFN cycle (see TS 36.213 [23]).</p>
<p>startRB-Subchannel Indicates the lowest RB index of the subchannel with the lowest index.</p>
<p>startRB-PSCCH-Pool Indicates the lowest RB index of the PSCCH pool.</p>
<p>syncAllowed Indicates the allowed synchronization reference(s) which is (are) allowed to use the pre-configured resource pool.</p>
<p>syncPriority Indicates the synchronization priority order. In case the UE does not detect any cell which configures synchronization configuration on the carrier frequency in <i>anchorCarrierFreqList</i>, if this field is set to <i>gnss</i>, the UE shall prioritize GNSS over the UE directly synchronized to eNB; if this field is set to <i>enb</i>, the UE shall prioritize the UE directly synchronized to eNB over GNSS.</p>
<p>thresSL-TxPrioritization Indicates the threshold used to determine whether SL V2X transmission is prioritized over uplink transmission if they overlap in time (see TS 36.321 [6]).</p>
<p>threshS-RSSI-CBR Indicates the S-RSSI threshold for determining the contribution of a sub-channel to the CBR measurement, as specified in TS 36.214 [48]. Value 0 corresponds to -112 dBm, value 1 to -110 dBm, value n to (-112 + n*2) dBm, and so on.</p>
<p>v2x-CommRxPoolList Indicates a list of reception pools for V2X sidelink communication.</p>
<p>v2x-CommTxPoolList Indicates a list of transmission pools for V2X sidelink communication.</p>
<p>v2x-ResourceSelectionConfig Indicates V2X sidelink communication configurations used for UE autonomous resource selection.</p>
<p>zoneConfig Indicates zone configurations used for V2X sidelink communication in 5.10.13.2.</p>
<p>zoneID Indicates the zone ID for which the UE shall use this resource pool as described in 5.10.13.2. The field is absent in <i>v2x-CommRxPoolList</i> and <i>p2x-CommTxPoolList</i> in <i>SL-V2X-PreconfigFreqInfo</i>.</p>

10 Radio information related interactions between network nodes

10.1 General

This clause specifies RRC messages that are transferred between network nodes. These RRC messages may be transferred to or from the UE via another Radio Access Technology. Consequently, these messages have similar characteristics as the RRC messages that are transferred across the E-UTRA radio interface, i.e. the same transfer syntax and protocol extension mechanisms apply.

10.2 Inter-node RRC messages

10.2.1 General

This clause specifies RRC messages that are sent either across the X2- or the S1-interface, either to or from the eNB, i.e. a single 'logical channel' is used for all RRC messages transferred across network nodes. The information could originate from or be destined for another RAT.

– *EUTRA-InterNodeDefinitions*

This ASN.1 segment is the start of the E-UTRA inter-node PDU definitions.

```
-- ASN1START
EUTRA-InterNodeDefinitions DEFINITIONS AUTOMATIC TAGS ::=
BEGIN
IMPORTS
    AntennaInfoCommon,
    AntennaInfoDedicated-v10i0,
    ARFCN-ValueEUTRA,
    ARFCN-ValueEUTRA-v9e0,
    ARFCN-ValueEUTRA-r9,
    CellIdentity,
    C-RNTI,
    DL-DCCH-Message,
    DRB-Identity,
    DRB-ToReleaseList,
    FreqBandIndicator-r11,
    InDeviceCoexIndication-r11,
    LWA-Config-r13,
    MasterInformationBlock,
    maxBands,
    maxFreq,
    maxDRB,
    maxSCell-r10,
    maxSCell-r13,
    maxServCell-r10,
    maxServCell-r13,
    MBMSInterestIndication-r11,
    MeasConfig,
    MeasGapConfig,
    MeasGapConfigPerCC-List-r14,
    MeasResultForRSSI-r13,
    MeasResultListWLAN-r13,
    OtherConfig-r9,
    PhysCellId,
    P-Max,
    PowerCoordinationInfo-r12,
    SidelinkUEInformation-r12,
    SL-CommConfig-r12,
    SL-DiscConfig-r12,
    RadioResourceConfigDedicated,
    RadioResourceConfigDedicated-v1370,
    RadioResourceConfigDedicated-v13c0,
```

```

RCLWI-Configuration-r13,
RSRP-Range,
RSRQ-Range,
RSRQ-Range-v1250,
RS-SINR-Range-r13,
SCellToAddModList-r10,
SCellToAddModList-v13c0,
SCellToAddModListExt-r13,
SCellToAddModListExt-v13c0,
SCG-ConfigPartSCG-r12,
SCG-ConfigPartSCG-v12f0,
SCG-ConfigPartSCG-v13c0,
SecurityAlgorithmConfig,
SCellIndex-r10,
SCellIndex-r13,
SCellToReleaseList-r10,
SCellToReleaseListExt-r13,
ServCellIndex-r10,
ServCellIndex-r13,
ShortMAC-I,
MeasResultSSTD-r13,
SL-V2X-ConfigDedicated-r14,
SystemInformationBlockType1,
SystemInformationBlockType1-v890-IEs,
SystemInformationBlockType2,
UEAssistanceInformation-r11,
UECapabilityInformation,
UE-CapabilityRAT-ContainerList,
UE-RadioPagingInfo-r12,
WLANConnectionStatusReport-r13,
WLAN-OffloadConfig-r12
FROM EUTRA-RRC-Definitions;

-- ASN1STOP

```

10.2.2 Message definitions

– *HandoverCommand*

This message is used to transfer the handover command generated by the target eNB.

Direction: target eNB to source eNB/ source RAN

***HandoverCommand* message**

```

-- ASN1START
HandoverCommand ::=
    SEQUENCE {
        criticalExtensions
            CHOICE {
                c1
                    CHOICE {
                        handoverCommand-r8
                            HandoverCommand-r8-IEs,
                        spare7 NULL,
                        spare6 NULL, spare5 NULL, spare4 NULL,
                        spare3 NULL, spare2 NULL, spare1 NULL
                    },
                criticalExtensionsFuture
                    SEQUENCE {}
            }
    }

HandoverCommand-r8-IEs ::=
    SEQUENCE {
        handoverCommandMessage
            OCTET STRING (CONTAINING DL-DCCH-Message),
        nonCriticalExtension
            SEQUENCE {} OPTIONAL
    }
-- ASN1STOP

```

HandoverCommand field descriptions**handoverCommandMessage**

Contains the entire DL-DCCH-Message including the *RRCConnectionReconfiguration* message used to perform handover within E-UTRAN or handover to E-UTRAN, generated (entirely) by the target eNB.

NOTE: The source BSC, in case of inter-RAT handover from GERAN to E-UTRAN, expects that the HandoverCommand message includes DL-DCCH-Message only. Thus, *criticalExtensionsFuture*, *spare1-spare7* and *nonCriticalExtension* should not be used regardless whether the source RAT is E-UTRAN, UTRAN or GERAN.

HandoverPreparationInformation

This message is used to transfer the E-UTRA RRC information used by the target eNB during handover preparation, including UE capability information.

Direction: source eNB/ source RAN to target eNB

HandoverPreparationInformation message

```
-- ASN1START

HandoverPreparationInformation ::= SEQUENCE {
    criticalExtensions          CHOICE {
        c1                      CHOICE {
            handoverPreparationInformation-r8  HandoverPreparationInformation-r8-IEs,
            spare7 NULL,
            spare6 NULL, spare5 NULL, spare4 NULL,
            spare3 NULL, spare2 NULL, spare1 NULL
        },
        criticalExtensionsFuture          SEQUENCE {}
    }
}

HandoverPreparationInformation-r8-IEs ::= SEQUENCE {
    ue-RadioAccessCapabilityInfo  UE-CapabilityRAT-ContainerList,
    as-Config                      AS-Config                      OPTIONAL,      -- Cond HO
    rrm-Config                     RRM-Config                      OPTIONAL,
    as-Context                      AS-Context                      OPTIONAL,      -- Cond HO
    nonCriticalExtension            HandoverPreparationInformation-v920-IEs  OPTIONAL
}

HandoverPreparationInformation-v920-IEs ::= SEQUENCE {
    ue-ConfigRelease-r9           ENUMERATED {
        rel9, rel10, rel11, rel12, v10j0, v11e0,
        v1280, rel13, ..., rel14}          OPTIONAL,      -- Cond HO2
    nonCriticalExtension            HandoverPreparationInformation-v9d0-IEs  OPTIONAL
}

HandoverPreparationInformation-v9d0-IEs ::= SEQUENCE {
    lateNonCriticalExtension       OCTET STRING (CONTAINING HandoverPreparationInformation-
v9j0-IEs)  OPTIONAL,
    nonCriticalExtension            HandoverPreparationInformation-v9e0-IEs  OPTIONAL
}

-- Late non-critical extensions:
HandoverPreparationInformation-v9j0-IEs ::= SEQUENCE {
    -- Following field is only for pre REL-10 late non-critical extensions
    lateNonCriticalExtension       OCTET STRING                      OPTIONAL,
    nonCriticalExtension            HandoverPreparationInformation-v10j0-IEs  OPTIONAL
}

HandoverPreparationInformation-v10j0-IEs ::= SEQUENCE {
    as-Config-v10j0               AS-Config-v10j0           OPTIONAL,
    -- Following field is only for late non-critical extensions from REL-10
    nonCriticalExtension            HandoverPreparationInformation-v10x0-IEs  OPTIONAL
}

HandoverPreparationInformation-v10x0-IEs ::= SEQUENCE {
    -- Following field is only for late non-critical extensions from REL-10 to REL-12
    lateNonCriticalExtension       OCTET STRING                      OPTIONAL,
    -- Following field is only for late non-critical extensions from REL-13
    nonCriticalExtension            HandoverPreparationInformation-v13c0-IEs  OPTIONAL
}
```



```

}
HandoverPreparationInformation-v13c0-IEs ::= SEQUENCE {
    as-Config-v13c0                AS-Config-v13c0                OPTIONAL,
    nonCriticalExtension            SEQUENCE {}                  OPTIONAL
}

-- Regular non-critical extensions:
HandoverPreparationInformation-v9e0-IEs ::= SEQUENCE {
    as-Config-v9e0                AS-Config-v9e0                OPTIONAL, -- Cond HO2
    nonCriticalExtension            HandoverPreparationInformation-v1130-IEs  OPTIONAL
}

HandoverPreparationInformation-v1130-IEs ::= SEQUENCE {
    as-Context-v1130              AS-Context-v1130              OPTIONAL, -- Cond HO2
    nonCriticalExtension            HandoverPreparationInformation-v1250-IEs
    OPTIONAL
}

HandoverPreparationInformation-v1250-IEs ::= SEQUENCE {
    ue-SupportedEARFCN-r12        ARFCN-ValueEUTRA-r9          OPTIONAL, -- Cond HO3
    as-Config-v1250              AS-Config-v1250              OPTIONAL, -- Cond HO2
    nonCriticalExtension            HandoverPreparationInformation-v1320-IEs
    OPTIONAL
}

HandoverPreparationInformation-v1320-IEs ::= SEQUENCE {
    as-Config-v1320              AS-Config-v1320              OPTIONAL, -- Cond HO2
    as-Context-v1320              AS-Context-v1320              OPTIONAL, -- Cond HO2
    nonCriticalExtension            HandoverPreparationInformation-v1430-IEs
    OPTIONAL
}

HandoverPreparationInformation-v1430-IEs ::= SEQUENCE {
    as-Config-v1430              AS-Config-v1430              OPTIONAL, -- Cond HO2
    makeBeforeBreakReq-r14        ENUMERATED {true}            OPTIONAL, -- Cond HO2
    nonCriticalExtension            SEQUENCE {}                  OPTIONAL
}

-- ASN1STOP

```

HandoverPreparationInformation field descriptions

as-Config

The radio resource configuration. Applicable in case of intra-E-UTRA handover. If the target receives an incomplete *MeasConfig* and *RadioResourceConfigDedicated* in the *as-Config*, the target eNB may decide to apply the full configuration option based on the *ue-ConfigRelease*.

as-Context

Local E-UTRAN context required by the target eNB.

makeBeforeBreakReq

To request the target eNB to add the *makeBeforeBreak* indication in the *mobilityControlInfo* in case of intra-frequency handover.

rrm-Config

Local E-UTRAN context used depending on the target node's implementation, which is mainly used for the RRM purpose.

ue-ConfigRelease

Indicates the RRC protocol release or version applicable for the current UE configuration. This could be used by target eNB to decide if the full configuration approach should be used. If this field is not present, the target assumes that the current UE configuration is based on the release 8 version of RRC protocol. NOTE 1.

ue-RadioAccessCapabilityInfo

For E-UTRA radio access capabilities, it is up to E-UTRA how the backward compatibility among *supportedBandCombinationReduced*, *supportedBandCombination* and *supportedBandCombinationAdd* is ensured. If *supportedBandCombinationReduced* and *supportedBandCombination/supportedBandCombinationAdd* are included into *ueCapabilityRAT-Container*, it can be assumed that the value of fields, *requestedBands*, *reducedIntNonContCombRequested* and *requestedCCsXL* are consistent with all supported band combination fields. NOTE 2

ue-SupportedEARFCN

Includes UE supported EARFCN of the handover target E-UTRA cell if the target E-UTRA cell belongs to multiple frequency bands.

NOTE 1: The source typically sets the *ue-ConfigRelease* to the release corresponding with the current dedicated radio configuration. The source may however also consider the common radio resource configuration e.g. in case interoperability problems would appear if the UE temporary continues extensions of this part of the configuration in a target PCell not supporting them.

NOTE 2: The following table indicates per source RAT whether RAT capabilities are included or not.

Source RAT	E-UTRA capabilities	UTRA capabilities	GERAN capabilities
UTRAN	Included	May be included, ignored by eNB if received	May be included
GERAN CS	Excluded	May be included, ignored by eNB if received	Included
GERAN PS	Excluded	May be included, ignored by eNB if received	Included
E-UTRAN	Included	May be included	May be included

Conditional presence	Explanation
HO	The field is mandatory present in case of handover within E-UTRA; otherwise the field is not present.
HO2	The field is optional present in case of handover within E-UTRA; otherwise the field is not present.
HO3	The field is optional present in case of handover from GERAN to E-UTRA, otherwise the field is not present.

– SCG-Config

This message is used to transfer the SCG radio configuration generated by the SeNB.

Direction: Secondary eNB to master eNB

SCG-Config message

```
-- ASN1START
SCG-Config-r12 ::=
    SEQUENCE {
        criticalExtensions
            CHOICE {
                c1
                    CHOICE {
                        scg-Config-r12
                        SCG-Config-r12-IEs,
                        spare7 NULL,
                        spare6 NULL, spare5 NULL, spare4 NULL,
                        spare3 NULL, spare2 NULL, spare1 NULL
                    },
                criticalExtensionsFuture
                    SEQUENCE {}
            }
    }

SCG-Config-r12-IEs ::=
    SEQUENCE {
        scg-RadioConfig-r12
        SCG-ConfigPartSCG-r12
        nonCriticalExtension
        SCG-Config-v12x0-IEs
    }
    OPTIONAL,
    OPTIONAL

SCG-Config-v12x0-IEs ::=
    SEQUENCE {
        -- Following field is only for late non-critical extensions from REL-12
        lateNonCriticalExtension
        OCTET STRING (CONTAINING SCG-Config-v12i0-IEs)
        OPTIONAL,
        -- Following field is only for late non-critical extensions from REL-13 onwards
        nonCriticalExtension
        SCG-Config-v13c0-IEs
    }
    OPTIONAL

SCG-Config-v12i0-IEs ::=
    SEQUENCE {
        scg-RadioConfig-v12i0
        SCG-ConfigPartSCG-v12f0
        nonCriticalExtension
        SEQUENCE {}
    }
    OPTIONAL, -- Need ON
    OPTIONAL

SCG-Config-v13c0-IEs ::=
    SEQUENCE {
        scg-RadioConfig-v13c0
        SCG-ConfigPartSCG-v13c0
        nonCriticalExtension
        SEQUENCE {}
    }
    OPTIONAL,
    OPTIONAL
-- ASN1STOP
```

SCG-Config field descriptions**scg-RadioConfig-r12**

Includes the change of the dedicated SCG configuration and, upon addition of an SCG cell, the common SCG configuration.

The SeNB only includes a new SCG cell in response to a request from MeNB, but may include release of an SCG cell release or release of the SCG part of an SCG/Split DRB without prior request from MeNB. The SeNB does not use this field to initiate release of the SCG.

SCG-ConfigInfo

This message is used by MeNB to request the SeNB to perform certain actions e.g. to establish, modify or release an SCG, and it may include additional information e.g. to assist the SeNB with assigning the SCG configuration.

Direction: Master eNB to secondary eNB

SCG-ConfigInfo message

```
-- ASN1START
SCG-ConfigInfo-r12 ::=
    SEQUENCE {
        criticalExtensions
        CHOICE {
            c1
            CHOICE {
                scg-ConfigInfo-r12
                SCG-ConfigInfo-r12-IEs,
                spare7 NULL,
                spare6 NULL, spare5 NULL, spare4 NULL,
                spare3 NULL, spare2 NULL, spare1 NULL
            },
            criticalExtensionsFuture
            SEQUENCE {}
        }
    }

SCG-ConfigInfo-r12-IEs ::=
    SEQUENCE {
        radioResourceConfigDedMCG-r12
        RadioResourceConfigDedicated
        sCellToAddModListMCG-r12
        SCellToAddModList-r10
        measGapConfig-r12
        MeasGapConfig
        powerCoordinationInfo-r12
        PowerCoordinationInfo-r12
        scg-RadioConfig-r12
        SCG-ConfigPartSCG-r12
        eutra-CapabilityInfo-r12
        OCTET STRING (CONTAINING UECapabilityInformation)
        OPTIONAL,
        scg-ConfigRestrictInfo-r12
        SCG-ConfigRestrictInfo-r12
        OPTIONAL,
        mbmsInterestIndication-r12
        OCTET STRING (CONTAINING
            MBMSInterestIndication-r11)
        OPTIONAL,
        measResultServCellListSCG-r12
        MeasResultServCellListSCG-r12
        OPTIONAL,
        drb-ToAddModListSCG-r12
        DRB-InfoListSCG-r12
        OPTIONAL,
        drb-ToReleaseListSCG-r12
        DRB-ToReleaseList
        OPTIONAL,
        sCellToAddModListSCG-r12
        SCellToAddModListSCG-r12
        OPTIONAL,
        sCellToReleaseListSCG-r12
        SCellToReleaseList-r10
        OPTIONAL,
        p-Max-r12
        P-Max
        OPTIONAL,
        nonCriticalExtension
        SCG-ConfigInfo-v1310-IEs
        OPTIONAL
    }

SCG-ConfigInfo-v1310-IEs ::=
    SEQUENCE {
        measResultSSTD-r13
        MeasResultSSTD-r13
        OPTIONAL,
        sCellToAddModListMCG-Ext-r13
        SCellToAddModListExt-r13
        OPTIONAL,
        measResultServCellListSCG-Ext-r13
        MeasResultServCellListSCG-Ext-r13
        OPTIONAL,
        sCellToAddModListSCG-Ext-r13
        SCellToAddModListSCG-Ext-r13
        OPTIONAL,
        sCellToReleaseListSCG-Ext-r13
        SCellToReleaseListExt-r13
        OPTIONAL,
        nonCriticalExtension
        SCG-ConfigInfo-v1330-IEs
        OPTIONAL
    }

SCG-ConfigInfo-v1330-IEs ::=
    SEQUENCE {
        measResultListRSSI-SCG-r13
        MeasResultListRSSI-SCG-r13
        OPTIONAL,
        nonCriticalExtension
        SCG-ConfigInfo-v1430-IEs
        OPTIONAL
    }

SCG-ConfigInfo-v1430-IEs ::=
    SEQUENCE {
        makeBeforeBreakSCG-Req-r14
        ENUMERATED {true}
        OPTIONAL,
        measGapConfigPerCC-List
        MeasGapConfigPerCC-List-r14
        OPTIONAL,
        nonCriticalExtension
        SEQUENCE {}
        OPTIONAL
    }

DRB-InfoListSCG-r12 ::=
    SEQUENCE (SIZE (1..maxDRB)) OF DRB-InfoSCG-r12
```

```

DRB-InfoSCG-r12 ::= SEQUENCE {
  eps-BearerIdentity-r12    INTEGER (0..15)    OPTIONAL, -- Cond DRB-Setup
  drb-Identity-r12         DRB-Identity,
  drb-Type-r12             ENUMERATED {split, scg}    OPTIONAL, -- Cond DRB-Setup
  ...
}

SCellToAddModListSCG-r12 ::= SEQUENCE (SIZE (1..maxSCell-r10)) OF Cell-ToAddMod-r12

SCellToAddModListSCG-Ext-r13 ::= SEQUENCE (SIZE (1..maxSCell-r13)) OF Cell-ToAddMod-r12

Cell-ToAddMod-r12 ::= SEQUENCE {
  sCellIndex-r12           SCellIndex-r10,
  cellIdentification-r12   SEQUENCE {
    physCellId-r12        PhysCellId,
    dl-CarrierFreq-r12    ARFCN-ValueEUTRA-r9
  }
  measResultCellToAdd-r12 SEQUENCE {
    rsrpResult-r12        RSRP-Range,
    rsrqResult-r12        RSRQ-Range
  }
  ...
  [[ sCellIndex-r13           SCellIndex-r13           OPTIONAL,
     measResultCellToAdd-v1310 SEQUENCE {
       rs-sinr-Result-r13   RS-SINR-Range-r13
     }
  ]]
}

MeasResultServCellListSCG-r12 ::= SEQUENCE (SIZE (1..maxServCell-r10)) OF MeasResultServCellSCG-r12

MeasResultServCellListSCG-Ext-r13 ::= SEQUENCE (SIZE (1..maxServCell-r13)) OF MeasResultServCellSCG-r12

MeasResultServCellSCG-r12 ::= SEQUENCE {
  servCellId-r12          ServCellIndex-r10,
  measResultSCell-r12    SEQUENCE {
    rsrpResultSCell-r12   RSRP-Range,
    rsrqResultSCell-r12   RSRQ-Range
  },
  ...
  [[ servCellId-r13          ServCellIndex-r13          OPTIONAL,
     measResultSCell-v1310 SEQUENCE {
       rs-sinr-ResultSCell-r13 RS-SINR-Range-r13
     }
  ]]
}

MeasResultListRSSI-SCG-r13 ::= SEQUENCE (SIZE (1..maxServCell-r13)) OF MeasResultRSSI-SCG-r13

MeasResultRSSI-SCG-r13 ::= SEQUENCE {
  servCellId-r13          ServCellIndex-r13,
  measResultForRSSI-r13   MeasResultForRSSI-r13
}

SCG-ConfigRestrictInfo-r12 ::= SEQUENCE {
  maxSCH-TB-BitsDL-r12    INTEGER (1..100),
  maxSCH-TB-BitsUL-r12    INTEGER (1..100)
}

-- ASN1STOP

```

SCG-ConfigInfo field descriptions
drb-ToAddModListSCG Includes DRBs the SeNB is requested to establish or modify (DRB type change).
drb-ToReleaseListSCG Includes DRBs the SeNB is requested to release.
makeBeforeBreakSCG-Req To request the target eNB to add the <i>makeBeforeBreakSCG</i> indication in the <i>mobilityControlInfoSCG</i> in case of intra-frequency SCG change.
maxSCH-TB-BitsXL Indicates the maximum DL-SCH/UL-SCH TB bits that may be scheduled in a TTI. Specified as a percentage of the value defined for the applicable UE category.
measGapConfig Includes the current measurement gap configuration.
measResultListRSSI-SCG Includes RSSI measurement results of SCG (serving) cells
measResultSSTD Includes measurement results of UE SFN and Subframe Timing Difference between the PCell and the PSCell.
measResultServCellListSCG Includes measurement results of SCG (serving) cells.
radioResourceConfigDedMCG Includes the current dedicated MCG radio resource configuration.
sCellIndex If sCellIndex-r13 is present, sCellIndex-r12 shall be ignored.
sCellToAddModListMCG, sCellToAddModListMCG-Ext Includes the current MCG SCell configuration. Field <i>sCellToAddModListMCG</i> is used to add the first 4 SCells with <i>sCellIndex-r10</i> while <i>sCellToAddModListMCG-Ext</i> is used to add the rest.
sCellToAddModListSCG, sCellToAddModListSCG-Ext Includes SCG cells the SeNB is requested to establish. Measurement results may be provided for these cells. Field <i>sCellToAddModListSCG</i> is used to add the first 4 SCells with <i>sCellIndex-r12</i> while <i>sCellToAddModListSCG-Ext</i> is used to add the rest.
sCellToReleaseListSCG, sCellToReleaseListSCG-Ext Includes SCG cells the SeNB is requested to release.
scg-RadioConfig Includes the current dedicated SCG configuration.
scg-ConfigRestrictInfo Includes fields for which MeNB explicitly indicates the restriction to be observed by SeNB.
servCellId If servCellId-r13 is present, servCellId-r12 shall be ignored.
p-Max Cell specific value i.e. as broadcast by PCell.

Conditional presence	Explanation
<i>DRB-Setup</i>	The field is mandatory present in case DRB establishment is requested; otherwise the field is not present.
<i>SCellAdd</i>	The field is mandatory present in case SCG cell establishment is requested; otherwise the field is not present.
<i>SCellAdd2</i>	The field is optional present in case SCG cell establishment is requested; otherwise the field is not present.

– *UEPagingCoverageInformation*

This message is used to transfer UE paging coverage information, covering both upload to and download from the EPC.

Direction: eNB to/from EPC

***UEPagingCoverageInformation* message**

```
-- ASN1START
UEPagingCoverageInformation ::= SEQUENCE {
    criticalExtensions          CHOICE {
        c1                     CHOICE {
            uePagingCoverageInformation-r13
            spare7 NULL,

```

```

        spare6 NULL, spare5 NULL, spare4 NULL,
        spare3 NULL, spare2 NULL, spare1 NULL
    },
    criticalExtensionsFuture          SEQUENCE {}
}
}
UEPagingCoverageInformation-r13-IEs ::= SEQUENCE {
    mpdcch-NumRepetition-r13          INTEGER (1..256)    OPTIONAL,
    nonCriticalExtension              SEQUENCE {}          OPTIONAL
}
-- ASN1STOP

```

UEPagingCoverageInformation field descriptions

mpdcch-NumRepetition

Number of repetitions for MPDCCH. The value is an estimate of the required number of repetitions for MPDCCH for paging.

– **UERadioAccessCapabilityInformation**

This message is used to transfer UE radio access capability information, covering both upload to and download from the EPC.

Direction: eNB to/ from EPC

UERadioAccessCapabilityInformation message

```

-- ASN1START
UERadioAccessCapabilityInformation ::= SEQUENCE {
    criticalExtensions          CHOICE {
        c1                      CHOICE {
            ueRadioAccessCapabilityInformation-r8
                                UERadioAccessCapabilityInformation-r8-IEs,
            spare7 NULL,
            spare6 NULL, spare5 NULL, spare4 NULL,
            spare3 NULL, spare2 NULL, spare1 NULL
        },
        criticalExtensionsFuture SEQUENCE {}
    }
}
UERadioAccessCapabilityInformation-r8-IEs ::= SEQUENCE {
    ue-RadioAccessCapabilityInfo OCTET STRING (CONTAINING UECapabilityInformation),
    nonCriticalExtension         SEQUENCE {}          OPTIONAL
}
-- ASN1STOP

```

UERadioAccessCapabilityInformation field descriptions

ue-RadioAccessCapabilityInfo

Including E-UTRA, GERAN, and CDMA2000-1xRTT Bandclass radio access capabilities (separated). UTRA radio access capabilities are not included. For E-UTRA radio access capabilities, it is up to E-UTRA how the backward compatibility among *supportedBandCombinationReduced*, *supportedBandCombination* and *supportedBandCombinationAdd* is ensured. If *supportedBandCombinationReduced* and *supportedBandCombination/supportedBandCombinationAdd* are included into *ueCapabilityRAT-Container*, it can be assumed that the value of fields, *requestedBands*, *reducedIntNonContCombRequested* and *requestedCCsXL* are consistent with all supported band combination fields.

– **UERadioPagingInformation**

This message is used to transfer radio paging information, covering both upload to and download from the EPC.

Direction: eNB to/ from EPC

UERadioPagingInformation message

```

-- ASN1START
UERadioPagingInformation ::= SEQUENCE {
    criticalExtensions          CHOICE {
        c1                      CHOICE {
            ueRadioPagingInformation-r12          UERadioPagingInformation-r12-IEs,
            spare7 NULL,
            spare6 NULL, spare5 NULL, spare4 NULL,
            spare3 NULL, spare2 NULL, spare1 NULL
        },
        criticalExtensionsFuture          SEQUENCE {}
    }
}

UERadioPagingInformation-r12-IEs ::= SEQUENCE {
    ue-RadioPagingInfo-r12          OCTET STRING (CONTAINING UE-RadioPagingInfo-r12),
    nonCriticalExtension          UERadioPagingInformation-v1310-IEs          OPTIONAL
}

UERadioPagingInformation-v1310-IEs ::= SEQUENCE {
    supportedBandListEUTRAForPaging-r13          SEQUENCE (SIZE (1..maxBands)) OF FreqBandIndicator-r11
OPTIONAL,
    nonCriticalExtension          SEQUENCE {}          OPTIONAL
}
-- ASN1STOP

```

UERadioPagingInformation field descriptions

ue-RadioPagingInfo

The field is used to transfer UE capability information used for paging. The eNB generates the *ue-RadioPagingInfo* and the contained UE capability information is absent when not supported by the UE.

supportedBandListEUTRAForPaging

Indicates the UE supported frequency bands which is derived by the eNB from *UE-EUTRA-Capability*.

10.3 Inter-node RRC information element definitions

– *AS-Config*

The *AS-Config* IE contains information about RRC configuration information in the source eNB which can be utilized by target eNB to determine the need to change the RRC configuration during the handover preparation phase. The information can also be used after the handover is successfully performed or during the RRC connection re-establishment or resume.

AS-Config information element

```

-- ASN1START
AS-Config ::= SEQUENCE {
    sourceMeasConfig          MeasConfig,
    sourceRadioResourceConfig          RadioResourceConfigDedicated,
    sourceSecurityAlgorithmConfig          SecurityAlgorithmConfig,
    sourceUE-Identity          C-RNTI,
    sourceMasterInformationBlock          MasterInformationBlock,
    sourceSystemInformationBlockType1          SystemInformationBlockType1(WITH COMPONENTS
        {..., nonCriticalExtension ABSENT}),
    sourceSystemInformationBlockType2          SystemInformationBlockType2,
    antennaInfoCommon          AntennaInfoCommon,
    sourceDl-CarrierFreq          ARFCN-ValueEUTRA,
    ...,
    [[ sourceSystemInformationBlockType1Ext          OCTET STRING (CONTAINING
        SystemInformationBlockType1-v890-IEs)          OPTIONAL,
    sourceOtherConfig-r9          OtherConfig-r9
-- sourceOtherConfig-r9 should have been optional. A target eNB compliant with this transfer
-- syntax should support receiving an AS-Config not including this extension addition group

```

```

-- e.g. from a legacy source eNB
]],
[[ sourceSCellConfigList-r10          SCellToAddModList-r10          OPTIONAL
]],
[[ sourceConfigSCG-r12                SCG-Config-r12                OPTIONAL
]]
}

AS-Config-v9e0 ::= SEQUENCE {
  sourceDl-CarrierFreq-v9e0          ARFCN-ValueEUTRA-v9e0
}

AS-Config-v10j0 ::= SEQUENCE {
  antennaInfoDedicatedPCell-v10i0    AntennaInfoDedicated-v10i0    OPTIONAL
}

AS-Config-v1250 ::= SEQUENCE {
  sourceWlan-OffloadConfig-r12        WLAN-OffloadConfig-r12        OPTIONAL,
  sourceSL-CommConfig-r12             SL-CommConfig-r12             OPTIONAL,
  sourceSL-DiscConfig-r12             SL-DiscConfig-r12             OPTIONAL
}

AS-Config-v1320 ::= SEQUENCE {
  sourceSCellConfigList-r13           SCellToAddModListExt-r13      OPTIONAL,
  sourceRCLWI-Configuration-r13       RCLWI-Configuration-r13      OPTIONAL
}

AS-Config-v13c0 ::= SEQUENCE {
  radioResourceConfigDedicated-v13c01 RadioResourceConfigDedicated-v1370  OPTIONAL,
  radioResourceConfigDedicated-v13c02 RadioResourceConfigDedicated-v13c0  OPTIONAL,
  sCellToAddModList-v13c0             SCellToAddModList-v13c0      OPTIONAL,
  sCellToAddModListExt-v13c0          SCellToAddModListExt-v13c0   OPTIONAL
}

AS-Config-v1430 ::= SEQUENCE {
  sourceSL-V2X-CommConfig-r14         SL-V2X-ConfigDedicated-r14    OPTIONAL,
  sourceLWA-Config-r14                LWA-Config-r13                OPTIONAL,
  sourceWLAN-MeasResult-r14           MeasResultListWLAN-r13       OPTIONAL
}

-- ASN1STOP

```

NOTE: The *AS-Config* re-uses information elements primarily created to cover the radio interface signalling requirements. Consequently, the information elements may include some parameters that are not relevant for the target eNB e.g. the SFN as included in the *MasterInformationBlock*.

AS-Config field descriptions	
antennaInfoCommon	This field provides information about the number of antenna ports in the source PCell.
sourceDL-CarrierFreq	Provides the parameter Downlink EARFCN in the source PCell, see TS 36.101 [42]. If the source eNB provides AS-Config-v9e0, it sets <i>sourceDL-CarrierFreq</i> (i.e. without suffix) to <i>maxEARFCN</i> .
sourceLWA-Config	LWA configuration in the source PCell when handover is triggered.
sourceOtherConfig	Provides other configuration in the source PCell.
sourceMasterInformationBlock	<i>MasterInformationBlock</i> transmitted in the source PCell.
sourceMeasConfig	Measurement configuration in the source cell. The measurement configuration for all measurements existing in the source eNB when handover is triggered shall be included. See 10.5.
sourceRCLWI-Configuration	RCLWI Configuration in the source PCell.
sourceSL-CommConfig	This field covers the sidelink communication configuration.
sourceSL-DiscConfig	This field covers the sidelink discovery configuration.
sourceRadioResourceConfig	Radio configuration in the source PCell. The radio resource configuration for all radio bearers existing in the source PCell when handover is triggered shall be included. See 10.5.
sourceSCellConfigList	Radio resource configuration (common and dedicated) of the SCells configured in the source eNB.
sourceSecurityAlgorithmConfig	This field provides the AS integrity protection (SRBs) and AS ciphering (SRBs and DRBs) algorithm configuration used in the source PCell.
sourceSystemInformationBlockType1	<i>SystemInformationBlockType1</i> (or <i>SystemInformationBlockType1-BR</i>) transmitted in the source PCell.
sourceSystemInformationBlockType2	<i>SystemInformationBlockType2</i> transmitted in the source PCell.
sourceSL-V2X-CommConfig	Indicates the V2X sidelink communication related configurations configured in the source eNB.
sourceWLAN-MeasResult	WLAN measurement results in the source PCell when handover is triggered.

– AS-Context

The IE *AS-Context* is used to transfer local E-UTRAN context required by the target eNB.

AS-Context information element

```

-- ASN1START
AS-Context ::=
    SEQUENCE {
        reestablishmentInfo          REESTABLISHMENT-INFO        OPTIONAL  -- Cond HO
    }

AS-Context-v1130 ::=
    SEQUENCE {
        idc-Indication-r11          OCTET STRING (CONTAINING
            InDeviceCoexIndication-r11) OPTIONAL,  -- Cond HO2
        mbmsInterestIndication-r11 OCTET STRING (CONTAINING
            MBMSInterestIndication-r11) OPTIONAL,  -- Cond HO2
        powerPrefIndication-r11    OCTET STRING (CONTAINING
            UEAssistanceInformation-r11) OPTIONAL,  -- Cond HO2
        ...
        [[ sidelinkUEInformation-r12 OCTET STRING (CONTAINING
            SidelinkUEInformation-r12) OPTIONAL  -- Cond HO2
        ]]
    }

AS-Context-v1320 ::=
    SEQUENCE {
        wlanConnectionStatusReport-r13 OCTET STRING (CONTAINING

```

```

}
WLANConnectionStatusReport-r13) OPTIONAL -- Cond HO2
-- ASN1STOP

```

AS-Context field descriptions

idc-Indication

Including information used for handling the IDC problems.

reestablishmentInfo

Including information needed for the RRC connection re-establishment.

Conditional presence	Explanation
<i>HO</i>	The field is mandatory present in case of handover within E-UTRA; otherwise the field is not present.
<i>HO2</i>	The field is optional present in case of handover within E-UTRA; otherwise the field is not present.

– *ReestablishmentInfo*

The *ReestablishmentInfo* IE contains information needed for the RRC connection re-establishment.

ReestablishmentInfo information element

```

-- ASN1START
ReestablishmentInfo ::= SEQUENCE {
    sourcePhysCellId          PhysCellId,
    targetCellShortMAC-I     ShortMAC-I,
    additionalReestabInfoList AdditionalReestabInfoList OPTIONAL,
    ...
}
AdditionalReestabInfoList ::= SEQUENCE ( SIZE (1..maxReestabInfo) ) OF AdditionalReestabInfo
AdditionalReestabInfo ::= SEQUENCE{
    cellIdentity          CellIdentity,
    key-eNodeB-Star      Key-eNodeB-Star,
    shortMAC-I           ShortMAC-I
}
Key-eNodeB-Star ::= BIT STRING (SIZE (256))
-- ASN1STOP

```

ReestablishmentInfo field descriptions

additionalReestabInfoList

Contains a list of shortMAC-I and KeNB* for cells under control of the target eNB, required for potential re-establishment by the UE in these cells to succeed.

Key-eNodeB-Star

Parameter KeNB*: See TS 33.401 [32, 7.2.8.4]. If the cell identified by *cellIdentity* belongs to multiple frequency bands, the source eNB selects the DL-EARFCN for the KeNB* calculation using the same logic as UE uses when selecting the DL-EARFCN in IDLE as defined in clause 6.2.2. This parameter is only used for X2 handover, and for S1 handover, it shall be ignored by target eNB.

sourcePhyCellId

The physical cell identity of the source PCell, used to determine the UE context in the target eNB at re-establishment.

targetCellShortMAC-I

The ShortMAC-I for the handover target PCell, in order for potential re-establishment to succeed.

– *RRM-Config*

The *RRM-Config* IE contains information about UE specific RRM information before the handover which can be utilized by target eNB.

RRM-Config information element

```

-- ASN1START
RRM-Config ::=
  ue-InactiveTime          SEQUENCE {
    ENUMERATED {
      s1, s2, s3, s5, s7, s10, s15, s20,
      s25, s30, s40, s50, min1, min1s20c, min1s40,
      min2, min2s30, min3, min3s30, min4, min5, min6,
      min7, min8, min9, min10, min12, min14, min17, min20,
      min24, min28, min33, min38, min44, min50, hr1,
      hr1min30, hr2, hr2min30, hr3, hr3min30, hr4, hr5, hr6,
      hr8, hr10, hr13, hr16, hr20, day1, day1hr12, day2,
      day2hr12, day3, day4, day5, day7, day10, day14, day19,
      day24, day30, dayMoreThan30}          OPTIONAL,
    ...,
    [[ candidateCellInfoList-r10 CandidateCellInfoList-r10          OPTIONAL
    ]]
  }

CandidateCellInfoList-r10 ::= SEQUENCE (SIZE (1..maxFreq)) OF CandidateCellInfo-r10

CandidateCellInfo-r10 ::= SEQUENCE {
  -- cellIdentification
  physCellId-r10          PhysCellId,
  dl-CarrierFreq-r10      ARFCN-ValueEUTRA,
  -- available measurement results
  rsrpResult-r10          RSRP-Range          OPTIONAL,
  rsrqResult-r10          RSRQ-Range          OPTIONAL,
  ...,
  [[ dl-CarrierFreq-v1090          ARFCN-ValueEUTRA-v9e0          OPTIONAL
  ]],
  [[ rsrqResult-v1250          RSRQ-Range-v1250          OPTIONAL
  ]],
  [[ rs-sinr-Result-r13          RS-SINR-Range-r13          OPTIONAL
  ]]
}
-- ASN1STOP

```

RRM-Config field descriptions**candidateCellInfoList**

A list of the best cells on each frequency for which measurement information was available, in order of decreasing RSRP.

dl-CarrierFreq

The source includes *dl-CarrierFreq-v1090* if and only if *dl-CarrierFreq-r10* is set to *maxEARFCN*.

ue-InactiveTime

Duration while UE has not received or transmitted any user data. Thus the timer is still running in case e.g., UE measures the neighbour cells for the HO purpose. Value s1 corresponds to 1 second, s2 corresponds to 2 seconds and so on. Value min1 corresponds to 1 minute, value min1s20 corresponds to 1 minute and 20 seconds, value min1s40 corresponds to 1 minute and 40 seconds and so on. Value hr1 corresponds to 1 hour, hr1min30 corresponds to 1 hour and 30 minutes and so on.

10.4 Inter-node RRC multiplicity and type constraint values

– Multiplicity and type constraints definitions

```

-- ASN1START
maxReestabInfo          INTEGER ::= 32  -- Maximum number of KeNB* and shortMAC-I forwarded
                                -- at handover for re-establishment preparation
-- ASN1STOP

```

– End of *EUTRA-InterNodeDefinitions*

```

-- ASN1START

```

```
END
-- ASN1STOP
```

10.5 Mandatory information in *AS-Config*

The *AS-Config* transferred between source eNB and target-eNB shall include all IEs necessary to describe the AS context. The conditional presence in clause 6 is only applicable for eNB to UE communication.

The "need" or "cond" statements are not applied in case of sending the IEs from source eNB to target eNB. Some fields shall be included regardless of the "need" or "cond" e.g. *discardTimer*. The *AS-Config* re-uses information elements primarily created to cover the radio interface signalling requirements. The information elements may include some parameters that are not relevant for the target eNB e.g. the SFN as included in the *MasterInformationBlock*.

All the fields in the *AS-Config* as defined in 10.3 that are introduced after v9.2.0 and that are optional for eNB to UE communication shall be included, if the functionality is configured. The fields in the *AS-Config* that are defined before and including v9.2.0 shall be included as specified in the following.

Within the *sourceRadioResourceConfig*, *sourceMeasConfig* and *sourceOtherConfig*, the source eNB shall include fields that are optional for eNB to UE communication, if the functionality is configured unless explicitly specified otherwise in the following:

- in accordance with a condition that is explicitly stated to be applicable; or
- a default value is defined for the concerned field; and the configured value is the same as the default value that is defined; or
- the need of the field is OP and the current UE configuration corresponds with the behaviour defined for absence of the field;

The following fields, if the functionality is configured, are not mandatory for the source eNB to include in the *AS-Config* since delta signalling by the target eNB for these fields is not supported:

- *semiPersistSchedC-RNTI*
- *measGapConfig*

For the measurement configuration, a corresponding operation as 5.5.6.1 and 5.5.2.2a is executed by target eNB.

10.6 Inter-node NB-IoT messages

10.6.1 General

This clause specifies NB-IoT RRC messages that are sent either across the X2- or the S1-interface, either to or from the eNB, i.e. a single 'logical channel' is used for all NB-IoT RRC messages transferred across network nodes.

— *NB-IoT-InterNodeDefinitions*

This ASN.1 segment is the start of the NB-IoT inter-node PDU definitions.

```
-- ASN1START
NBIOT-InterNodeDefinitions DEFINITIONS AUTOMATIC TAGS ::=
BEGIN
IMPORTS
    C-RNTI,
    PhysCellId,
    SecurityAlgorithmConfig,
    ShortMAC-I
FROM EUTRA-RRC-Definitions
```

```

AdditionalReestabInfoList
FROM EUTRA-InterNodeDefinitions

CarrierFreq-NB-r13,
RadioResourceConfigDedicated-NB-r13,
UECapabilityInformation-NB,
UE-Capability-NB-r13,
UE-Capability-NB-Ext-r14-IEs,
UE-RadioPagingInfo-NB-r13
FROM NBIOT-RRC-Definitions;

-- ASN1STOP

```

10.6.2 Message definitions

– *HandoverPreparationInformation-NB*

This message is used to transfer the UE context from the eNB where the RRC connection has been suspended and transfer it to the eNB where the RRC Connection has been requested to be resumed.

Direction: source eNB to target eNB

***HandoverPreparationInformation-NB* message**

```

-- ASN1START
HandoverPreparationInformation-NB ::= SEQUENCE {
    criticalExtensions          CHOICE {
        c1                      CHOICE {
            handoverPreparationInformation-r13      HandoverPreparationInformation-NB-IEs,
            spare3 NULL, spare2 NULL, spare1 NULL
        },
        criticalExtensionsFuture          SEQUENCE {}
    }
}

HandoverPreparationInformation-NB-IEs ::= SEQUENCE {
    ue-RadioAccessCapabilityInfo-r13      UE-Capability-NB-r13,
    as-Config-r13                          AS-Config-NB,
    rrm-Config-r13                          RRM-Config-NB                      OPTIONAL,
    as-Context-r13                          AS-Context-NB                      OPTIONAL,
    nonCriticalExtension                     HandoverPreparationInformation-NB-v1380-IEs
    OPTIONAL
}

HandoverPreparationInformation-NB-v1380-IEs ::= SEQUENCE {
    lateNonCriticalExtension                OCTET STRING                      OPTIONAL,
    nonCriticalExtension                     HandoverPreparationInformation-NB-Ext-r14-IEs  OPTIONAL
}

HandoverPreparationInformation-NB-Ext-r14-IEs ::= SEQUENCE {
    ue-RadioAccessCapabilityInfoExt-r14     OCTET STRING (CONTAINING UE-Capability-NB-Ext-r14-IEs)
    OPTIONAL,
    nonCriticalExtension                     SEQUENCE {}                      OPTIONAL
}
-- ASN1STOP

```

***HandoverPreparationInformation-NB* field descriptions**

as-Config

The radio resource configuration.

as-Context

The local E-UTRAN context required by the target eNB.

rrm-Config

The local E-UTRAN context used depending on the target node's implementation, which is mainly used for the RRM purpose.

ue-RadioAccessCapabilityInfo, ue-RadioAccessCapabilityInfoExt

The NB-IoT UE Radio Access Capability Parameters, see TS 36.306 [5].

– *UEPagingCoverageInformation-NB*

This message is used to transfer UE paging coverage information for NB-IoT, covering both upload to and download from the EPC.

Direction: eNB to/from EPC

***UEPagingCoverageInformation-NB* message**

```
-- ASN1START
UEPagingCoverageInformation-NB ::= SEQUENCE {
    criticalExtensions          CHOICE {
        c1                      CHOICE {
            uePagingCoverageInformation-r13    UEPagingCoverageInformation-NB-IEs,
            spare3 NULL, spare2 NULL, spare1 NULL
        },
        criticalExtensionsFuture          SEQUENCE {}
    }
}

UEPagingCoverageInformation-NB-IEs ::= SEQUENCE {
-- the possible value(s) can differ from those sent on Uu
    npdcch-NumRepetitionPaging-r13          INTEGER (1..2048)    OPTIONAL,
    nonCriticalExtension                      SEQUENCE {}          OPTIONAL
}
-- ASN1STOP
```

***UEPagingCoverageInformation-NB* field descriptions**

npdcch-NumRepetitionPaging

Number of repetitions for NPDCCH, see TS 36.211 [21]. This value is an estimate of the required number of repetitions for NPDCCH.

– *UERadioAccessCapabilityInformation-NB*

This message is used to transfer UE NB-IoT Radio Access capability information, covering both upload to and download from the EPC.

Direction: eNB to/ from EPC

***UERadioAccessCapabilityInformation-NB* message**

```
-- ASN1START
UERadioAccessCapabilityInformation-NB ::= SEQUENCE {
    criticalExtensions          CHOICE {
        c1                      CHOICE {
            ueRadioAccessCapabilityInformation-r13    UERadioAccessCapabilityInformation-NB-IEs,
            spare3 NULL, spare2 NULL, spare1 NULL
        },
        criticalExtensionsFuture          SEQUENCE {}
    }
}

UERadioAccessCapabilityInformation-NB-IEs ::= SEQUENCE {
    ue-RadioAccessCapabilityInfo-r13          OCTET STRING (CONTAINING UE-Capability-NB-r13),
    nonCriticalExtension                      UERadioAccessCapabilityInformation-NB-v1380-IEs
    OPTIONAL
}

UERadioAccessCapabilityInformation-NB-v1380-IEs ::= SEQUENCE {
    lateNonCriticalExtension          OCTET STRING          OPTIONAL,
    nonCriticalExtension              UERadioAccessCapabilityInformation-NB-r14-IEs
    OPTIONAL
}

UERadioAccessCapabilityInformation-NB-r14-IEs ::= SEQUENCE {
    ue-RadioAccessCapabilityInfo-r14          OCTET STRING (CONTAINING UECapabilityInformation-NB)
    OPTIONAL,
}
```

```

    nonCriticalExtension          SEQUENCE {}          OPTIONAL
  }
-- ASN1STOP

```

UERadioAccessCapabilityInformation-NB field descriptions

ue-RadioAccessCapabilityInfo

The NB-IoT UE Radio Access Capability Parameters, see TS 36.306 [5].

– **UERadioPagingInformation-NB**

This message is used to transfer NB-IoT radio paging information, covering both upload to and download from the EPC.

Direction: eNB to/ from EPC

UERadioPagingInformation-NB message

```

-- ASN1START
UERadioPagingInformation-NB ::= SEQUENCE {
    criticalExtensions          CHOICE {
        c1                     CHOICE {
            ueRadioPagingInformation-r13    UERadioPagingInformation-NB-IEs,
            spare3 NULL, spare2 NULL, spare1 NULL
        },
        criticalExtensionsFuture          SEQUENCE {}
    }
}

UERadioPagingInformation-NB-IEs ::= SEQUENCE {
    ue-RadioPagingInfo-r13          OCTET STRING (CONTAINING UE-RadioPagingInfo-NB-r13),
    nonCriticalExtension            SEQUENCE {}          OPTIONAL
}
-- ASN1STOP

```

UERadioPagingInformation-NB field descriptions

ue-RadioPagingInfo

The field is used to transfer UE NB-IoT capability information used for paging. The eNB generates the *ue-RadioPagingInfo* and the contained UE capability information is absent when not supported by the UE.

10.7 Inter-node NB-IoT RRC information element definitions

– **AS-Config-NB**

The *AS-Config-NB* IE contains information about NB-IoT RRC configuration information in the source eNB which can be utilized by target eNB.

AS-Config-NB information element

```

-- ASN1START
AS-Config-NB ::=
    SEQUENCE {
        sourceRadioResourceConfig-r13    RadioResourceConfigDedicated-NB-r13,
        sourceSecurityAlgorithmConfig-r13 SecurityAlgorithmConfig,
        sourceUE-Identity-r13            C-RNTI,
        sourceDL-CarrierFreq-r13        CarrierFreq-NB-r13,
        ...
    }
-- ASN1STOP

```

AS-Config-NB field descriptions
sourceDL-CarrierFreq Provides the parameter Downlink EARFCN in the source PCell, see TS 36.101 [42].
sourceRadioResourceConfig Radio configuration in the source PCell. The radio resource configuration for all radio bearers existing in the source PCell shall be included. See 10.9.
sourceSecurityAlgorithmConfig This field provides the AS integrity protection (SRBs) and AS ciphering (SRBs and DRBs) algorithm configuration used in the source PCell.

– AS-Context-NB

The IE *AS-Context-NB* is used to transfer the UE context required by the target eNB.

AS-Context-NB information element

```
-- ASN1START
AS-Context-NB ::=
    SEQUENCE {
        reestablishmentInfo-r13          ReestablishmentInfo-NB          OPTIONAL,
        ...
    }
-- ASN1STOP
```

AS-Context-NB field descriptions
reestablishmentInfo Including information needed for the RRC connection re-establishment.

– ReestablishmentInfo-NB

The *ReestablishmentInfo-NB* IE contains information needed for the RRC connection re-establishment.

ReestablishmentInfo-NB information element

```
-- ASN1START
ReestablishmentInfo-NB ::=
    SEQUENCE {
        sourcePhysCellId-r13          PhysCellId,
        targetCellShortMAC-I-r13      ShortMAC-I,
        additionalReestabInfoList-r13 AdditionalReestabInfoList          OPTIONAL,
        ...
    }
-- ASN1STOP
```

ReestablishmentInfo-NB field descriptions
additionalReestabInfoList Contains a list of shortMAC-I and KeNB* for cells under control of the target eNB, required for potential re-establishment by the UE in these cells to succeed.
sourcePhyCellId The physical cell identity of the source PCell, used to determine the UE context in the target eNB at re-establishment.
targetCellShortMAC-I The ShortMAC-I for the target PCell, in order for potential re-establishment to succeed.

– RRM-Config-NB

The *RRM-Config-NB* IE contains information about UE specific RRM information which can be utilized by target eNB.

RRM-Config-NB information element

```

-- ASN1START
RRM-Config-NB ::=
  ue-InactiveTime
SEQUENCE {
  ENUMERATED {
    s1, s2, s3, s5, s7, s10, s15, s20,
    s25, s30, s40, s50, min1, min1s20, min1s40,
    min2, min2s30, min3, min3s30, min4, min5, min6,
    min7, min8, min9, min10, min12, min14, min17, min20,
    min24, min28, min33, min38, min44, min50, hr1,
    hr1min30, hr2, hr2min30, hr3, hr3min30, hr4, hr5, hr6,
    hr8, hr10, hr13, hr16, hr20, day1, day1hr12, day2,
    day2hr12, day3, day4, day5, day7, day10, day14, day19,
    day24, day30, dayMoreThan30} OPTIONAL,
    ...
  }
-- ASN1STOP

```

RRM-Config-NB field descriptions**ue-InactiveTime**

Duration while UE has not received or transmitted any user data. Value s1 corresponds to 1 second, s2 corresponds to 2 seconds and so on. Value min1 corresponds to 1 minute, value min1s20 corresponds to 1 minute and 20 seconds, value min1s40 corresponds to 1 minute and 40 seconds and so on. Value hr1 corresponds to 1 hour, hr1min30 corresponds to 1 hour and 30 minutes and so on.

10.8 Inter-node RRC multiplicity and type constraint values

- Multiplicity and type constraints definitions
- End of *NB-IoT-InterNodeDefinitions*

```

-- ASN1START
END
-- ASN1STOP

```

10.9 Mandatory information in *AS-Config-NB*

The *AS-Config-NB* transferred between source eNB and target-eNB shall include all IEs necessary to describe the AS context. The conditional presence in clause 6 is only applicable for eNB to UE communication.

The "Need" or "Cond" statements are not applied in case of sending the IEs from source eNB to target eNB. Some information elements shall be included regardless of the "Need" or "Cond" e.g. *discardTimer*. The *AS-Config-NB* re-uses information elements primarily created to cover the radio interface signalling requirements.

Within the *sourceRadioResourceConfig*, the source eNB shall include fields that are optional for eNB to UE communication, if the functionality is configured unless explicitly specified otherwise in the following:

- in accordance with a condition that is explicitly stated to be applicable; or
- a default value is defined for the concerned field; and the configured value is the same as the default value that is defined; or
- the need of the field is OP and the current UE configuration corresponds with the behaviour defined for absence of the field;

11 UE capability related constraints and performance requirements

11.1 UE capability related constraints

The following table lists constraints regarding the UE capabilities that E-UTRAN is assumed to take into account.

Parameter	Description	Value	NB-IoT
#DRBs	The number of DRBs that a UE shall support	8	(0, 1, 2) NOTE1
#RLC-AM	The number of RLC AM entities that a UE shall support	10	(2, 3) NOTE1
#minCellperMeasObjectEUTRA	The minimum number of neighbour cells (excluding black list cells) that a UE shall be able to store within a MeasObjectEUTRA. NOTE.	32	N/A
#minBlackCellRangesperMeasObjectEUTRA	The minimum number of blacklist cell PCI ranges that a UE shall be able to store within a MeasObjectEUTRA	32	N/A
#minCellperMeasObjectUTRA	The minimum number of neighbour cells that a UE shall be able to store within a MeasObjectUTRA. NOTE.	32	N/A
#minCellperMeasObjectGERAN	The minimum number of neighbour cells that a UE shall be able to store within a measObjectGERAN. NOTE.	32	N/A
#minCellperMeasObjectCDMA2000	The minimum number of neighbour cells that a UE shall be able to store within a measObjectCDMA2000. NOTE.	32	N/A
#minCellTotal	The minimum number of neighbour cells (excluding black list cells) that UE shall be able to store in total in all measurement objects configured	256	N/A
NOTE:	In case of CGI reporting, the limit regarding the cells E-UTRAN can configure includes the cell for which the UE is requested to report CGI i.e. the amount of neighbour cells that can be included is at most (# minCellperMeasObjectRAT - 1), where RAT represents EUTRA/UTRA/GERAN/CDMA2000 respectively.		
NOTE1:	#DRBs based on UE capability, #RLC-AM=#DRBs + 2.		

11.2 Processing delay requirements for RRC procedures

The UE performance requirements for RRC procedures are specified in the following tables, by means of a value N:

N = the number of 1ms subframes from the end of reception of the E-UTRAN -> UE message on the UE physical layer up to when the UE shall be ready for the reception of uplink grant for the UE -> E-UTRAN response message with no access delay other than the TTI-alignment (e.g. excluding delays caused by scheduling, the random access procedure or physical layer synchronisation).

NOTE: No processing delay requirements are specified for RN-specific procedures.

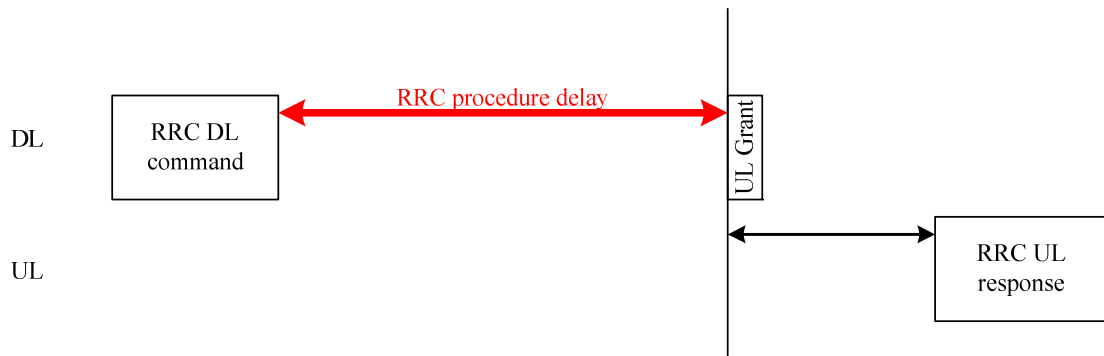

Figure 11.2-1: Illustration of RRC procedure delay

Table 11.2-1: UE performance requirements for RRC procedures for UEs other than NB-IoT UEs

Procedure title:	E-UTRAN -> UE	UE -> E-UTRAN	N	Notes
RRC Connection Control Procedures				
RRC connection establishment	<i>RRCCConnectionSetup</i> or <i>RRCCConnectionResume</i>	<i>RRCCConnectionSetupComplete</i> or <i>RRCCConnectionResumeComplete</i>	15	
RRC connection release	<i>RRCCConnectionRelease</i>		NA	
RRC connection re-configuration (radio resource configuration)	<i>RRCCConnectionReconfiguration</i>	<i>RRCCConnectionReconfigurationComplete</i>	15	
RRC connection re-configuration (measurement configuration)	<i>RRCCConnectionReconfiguration</i>	<i>RRCCConnectionReconfigurationComplete</i>	15	
RRC connection re-configuration (intra-LTE mobility)	<i>RRCCConnectionReconfiguration</i>	<i>RRCCConnectionReconfigurationComplete</i>	15	
RRC connection re-configuration (SCell addition/release)	<i>RRCCConnectionReconfiguration</i>	<i>RRCCConnectionReconfigurationComplete</i>	20	
RRC connection re-configuration (SCG establishment/ release, SCG cell addition/ release)	<i>RRCCConnectionReconfiguration</i>	<i>RRCCConnectionReconfigurationComplete</i>	20	
RRC connection re-establishment	<i>RRCCConnectionReestablishment</i>	<i>RRCCConnectionReestablishmentComplete</i>	15	
Initial security activation	<i>SecurityModeCommand</i>	<i>SecurityModeCommandComplete/SecurityModeCommandFailure</i>	10	
Initial security activation + RRC connection re-configuration (RB establishment)	<i>SecurityModeCommand</i> , <i>RRCCConnectionReconfiguration</i>	<i>RRCCConnectionReconfigurationComplete</i>	20	The two DL messages are transmitted in the same TTI
Paging	<i>Paging</i>		NA	
Inter RAT mobility				
Handover to E-UTRA	<i>RRCCConnectionReconfiguration (sent by other RAT)</i>	<i>RRCCConnectionReconfigurationComplete</i>	NA	The performance of this procedure is specified in [50] in case of handover from GSM and [29], [30] in case of handover from UTRA.
Handover from E-UTRA	<i>MobilityFromEUTRACommand</i>		NA	The performance of this procedure is specified in [16]
Handover from E-UTRA to CDMA2000	<i>HandoverFromEUTRAPreparationRequest (CDMA2000)</i>		NA	Used to trigger the handover preparation procedure with a CDMA2000 RAT. The performance of this procedure is specified in [16]
Measurement procedures				
Measurement Reporting		<i>MeasurementReport</i>	NA	
Other procedures				
UE capability transfer	<i>UECapabilityEnquiry</i>	<i>UECapabilityInformation</i>	10	
Counter check	<i>CounterCheck</i>	<i>CounterCheckResponse</i>	10	
Proximity indication		<i>ProximityIndication</i>	NA	

Procedure title:	E-UTRAN -> UE	UE -> E-UTRAN	N	Notes
UE information	<i>UEInformationRequest</i>	<i>UEInformationResponse</i>	15	
MBMS counting	<i>MBMSCountingRequest</i>	<i>MBMSCountingResponse</i>	NA	
MBMS interest indication		<i>MBMSInterestIndication</i>	NA	
In-device coexistence indication		<i>InDeviceCoexIndication</i>	NA	
UE assistance information		<i>UEAssistanceInformation</i>	NA	
SCG failure information		<i>SCGFailureInformation</i>	NA	
Sidelink UE information		<i>SidelinkUEInformation</i>	NA	
WLAN Connection Status Reporting		<i>WLANConnectionStatusReport</i>	NA	
Delay Budget Report		<i>DelayBudgetReport</i>	NA	

Table 11.2-2: UE performance requirements for RRC procedures for NB-IoT UEs

Procedure title:	E-UTRAN -> UE	UE -> E-UTRAN	N	Notes
RRC Connection Control Procedures				
RRC connection establishment	<i>RRCCConnectionSetup-p-NB or RRCCConnectionResume-NB</i>	<i>RRCCConnectionSetupComplete-NB or RRCCConnectionResumeComplete-NB</i>	45	
RRC connection release	<i>RRCCConnectionRelease-NB</i>		NA	
RRC connection re-configuration (radio resource configuration)	<i>RRCCConnectionReconfiguration-NB</i>	<i>RRCCConnectionReconfigurationComplete-NB</i>	45	
RRC connection re-establishment	<i>RRCCConnectionReestablishment-NB</i>	<i>RRCCConnectionReestablishmentComplete-NB</i>	45	
Initial security activation	<i>SecurityModeCommand</i>	<i>SecurityModeCommandComplete/SecurityModeCommandFailure</i>	35	
Initial security activation + RRC connection re-configuration (RB establishment)	<i>SecurityModeCommand, RRCCConnectionReconfiguration-NB</i>	<i>RRCCConnectionReconfigurationComplete-NB</i>	55	The two DL messages are transmitted in the same TTI
Paging	<i>Paging-NB</i>		NA	
Other procedures				
UE capability transfer	<i>UECapabilityEnquiry-NB</i>	<i>UECapabilityInformation-NB</i>	35	

11.3 Void

Annex A (informative): Guidelines, mainly on use of ASN.1

Editor's note No agreements have been reached concerning the extension of RRC PDUs so far. Any statements in this clause about the protocol extension mechanism should be considered as FFS.

A.1 Introduction

The following clauses contain guidelines for the specification of RRC protocol data units (PDUs) with ASN.1.

A.2 Procedural specification

A.2.1 General principles

The procedural specification provides an overall high level description regarding the UE behaviour in a particular scenario.

It should be noted that most of the UE behaviour associated with the reception of a particular field is covered by the applicable parts of the PDU specification. The procedural specification may also include specific details of the UE behaviour upon reception of a field, but typically this should be done only for cases that are not easy to capture in the PDU clause e.g. general actions, more complicated actions depending on the value of multiple fields.

Likewise, the procedural specification need not specify the UE requirements regarding the setting of fields within the messages that are send to E-UTRAN i.e. this may also be covered by the PDU specification.

A.2.2 More detailed aspects

The following more detailed conventions should be used:

- Bullets:
 - Capitals should be used in the same manner as in other parts of the procedural text i.e. in most cases no capital applies since the bullets are part of the sentence starting with 'The UE shall:'
 - All bullets, including the last one in a clause, should end with a semi-colon i.e. an ';'.
- Conditions
 - Whenever multiple conditions apply, a semi-colon should be used at the end of each conditions with the exception of the last one, i.e. as in 'if cond1; or cond2:'

A.3 PDU specification

A.3.1 General principles

A.3.1.1 ASN.1 sections

The RRC PDU contents are formally and completely described using abstract syntax notation (ASN.1), see X.680 [13], X.681 (02/2002) [14].

The complete ASN.1 code is divided into a number of ASN.1 sections in the specifications. In order to facilitate the extraction of the complete ASN.1 code from the specification, each ASN.1 section begins with a text paragraph consisting entirely of an *ASN.1 start tag*, which consists of a double hyphen followed by a single space and the text string "ASN1START" (in all upper case letters). Each ASN.1 section ends with a text paragraph consisting entirely of an *ASN.1 stop tag*, which consists of a double hyphen followed by a single space and the text "ASN1STOP" (in all upper case letters):

```
-- ASN1START
```

-- ASN1STOP

The text paragraphs containing the ASN.1 start and stop tags should not contain any ASN.1 code significant for the complete description of the RRC PDU contents. The complete ASN.1 code may be extracted by copying all the text paragraphs between an ASN.1 start tag and the following ASN.1 stop tag in the order they appear, throughout the specification.

NOTE: A typical procedure for extraction of the complete ASN.1 code consists of a first step where the entire RRC PDU contents description (ultimately the entire specification) is saved into a plain text (ASCII) file format, followed by a second step where the actual extraction takes place, based on the occurrence of the ASN.1 start and stop tags.

A.3.1.2 ASN.1 identifier naming conventions

The naming of identifiers (i.e., the ASN.1 field and type identifiers) should be based on the following guidelines:

- Message (PDU) identifiers should be ordinary mixed case without hyphenation. These identifiers, e.g., the *RRCConnectionModificationCommand*, should be used for reference in the procedure text. Abbreviated forms of these identifiers should not be used.
- Type identifiers other than PDU identifiers should be ordinary mixed case, with hyphenation used to set off acronyms only where an adjacent letter is a capital, e.g., *EstablishmentCause*, *SelectedPLMN* (not *Selected-PLMN*, since the "d" in "Selected" is lowercase), *InitialUE-Identity* and *MeasSFN-SFN-TimeDifference*.
- Field identifiers shall start with a lowercase letter and use mixed case thereafter, e.g., *establishmentCause*. If a field identifier begins with an acronym (which would normally be in upper case), the entire acronym is lowercase (*plmn-Identity*, not *pLMN-Identity*). The acronym is set off with a hyphen (*ue-Identity*, not *ueIdentity*), in order to facilitate a consistent search pattern with corresponding type identifiers.
- Identifiers that are likely to be keywords of some language, especially widely used languages, such as C++ or Java, should be avoided to the extent possible.
- Identifiers, other than PDU identifiers, longer than 25 characters should be avoided where possible. It is recommended to use abbreviations, which should be done in a consistent manner i.e. use 'Meas' instead of 'Measurement' for all occurrences. Examples of typical abbreviations are given in table A.3.1.2.1-1 below.
- *For future extension:* When an extension is introduced a suffix is added to the identifier of the concerned ASN.1 field and/ or type. A suffix of the form "-rX" is used, with X indicating the release, for ASN.1 fields or types introduced in a later release (i.e. a release later than the original/ first release of the protocol) as well as for ASN.1 fields or types for which a revision is introduced in a later release replacing a previous version, e.g., *Foo-r9* for the Rel-9 version of the ASN.1 type *Foo*. A suffix of the form "-rXb" is used for the first revision of a field that it appears in the same release (X) as the original version of the field, "-rXc" for a second intra-release revision and so on. A suffix of the form "-vXYZ" is used for ASN.1 fields or types that only are an extension of a corresponding earlier field or type (see clause A.4), e.g., *AnElement-v10b0* for the extension of the ASN.1 type *AnElement* introduced in version 10.11.0 of the specification. A number 0...9, 10, 11, etc. is used to represent the first part of the version number, indicating the release of the protocol. Lower case letters a, b, c, etc. are used to represent the second (and third) part of the version number if they are greater than 9. In the procedural specification, in field descriptions as well as in headings suffices are not used, unless there is a clear need to distinguish the extension from the original field.
- More generally, in case there is a need to distinguish different variants of an ASN.1 field or IE, a suffix should be added at the end of the identifiers e.g. *MeasObjectUTRA*, *ConfigCommon*. When there is no particular need to distinguish the fields (e.g. because the field is included in different IEs), a common field identifier name may be used. This may be attractive e.g. in case the procedural specification is the same for the different variants.

Table A.3.1.2-1: Examples of typical abbreviations used in ASN.1 identifiers

Abbreviation	Abbreviated word
Comm	Communication
Conf	Confirmation
Config	Configuration
Disc	Discovery
DL	Downlink
Ext	Extension
Freq	Frequency
Id	Identity
Ind	Indication
Info	Information
Meas	Measurement
Neigh	Neighbour(ing)
Param(s)	Parameter(s)
Persist	Persistent
Phys	Physical
Proc	Process
Reestab	Reestablishment
Req	Request
Rx	Reception
Sched	Scheduling
Sync	Synchronisation
Thresh	Threshold
Tx/ Transm	Transmission
UL	Uplink

NOTE: The table A.3.1.2.1-1 is not exhaustive. Additional abbreviations may be used in ASN.1 identifiers when needed.

A.3.1.3 Text references using ASN.1 identifiers

A text reference into the RRC PDU contents description from other parts of the specification is made using the ASN.1 field or type identifier of the referenced element. The ASN.1 field and type identifiers used in text references should be in the *italic font style*. The "do not check spelling and grammar" attribute in Word should be set. Quotation marks (i.e., " ") should not be used around the ASN.1 field or type identifier.

A reference to an RRC PDU type should be made using the corresponding ASN.1 type identifier followed by the word "message", e.g., a reference to the *RRCCConnectionRelease* message.

A reference to a specific part of an RRC PDU, or to a specific part of any other ASN.1 type, should be made using the corresponding ASN.1 field identifier followed by the word "field", e.g., a reference to the *prioritisedBitRate* field in the example below.

```
-- /example/ ASN1START
LogicalChannelConfig ::=
    ul-SpecificParameters
        priority
        prioritisedBitRate
        bucketSizeDuration
        logicalChannelGroup
    } OPTIONAL
SEQUENCE {
    SEQUENCE {
        Priority,
        PrioritisedBitRate,
        BucketSizeDuration,
        INTEGER (0..3)
    }
}
-- ASN1STOP
```

NOTE: All the ASN.1 start tags in the ASN.1 sections, used as examples in this annex to the specification, are deliberately distorted, in order not to include them when the ASN.1 description of the RRC PDU contents is extracted from the specification.

A reference to a specific type of information element should be made using the corresponding ASN.1 type identifier preceded by the acronym "IE", e.g., a reference to the IE *LogicalChannelConfig* in the example above.

References to a specific type of information element should only be used when those are generic, i.e., without regard to the particular context wherein the specific type of information element is used. If the reference is related to a particular context, e.g., an RRC PDU type (message) wherein the information element is used, the corresponding field identifier in that context should be used in the text reference.

A reference to a specific value of an ASN.1 field should be made using the corresponding ASN.1 value without using quotation marks around the ASN.1 value, e.g., 'if the *status* field is set to value *true*'.

A.3.2 High-level message structure

Within each logical channel type, the associated RRC PDU (message) types are alternatives within a CHOICE, as shown in the example below.

```
-- /example/ ASN1START
DL-DCCH-Message ::= SEQUENCE {
    message          DL-DCCH-MessageType
}
DL-DCCH-MessageType ::= CHOICE {
    c1               CHOICE {
        dlInformationTransfer          DLInformationTransfer,
        handoverFromEUTRAPreparationRequest  HandoverFromEUTRAPreparationRequest,
        mobilityFromEUTRACCommand        MobilityFromEUTRACCommand,
        rrcConnectionReconfiguration    RRCConnectionReconfiguration,
        rrcConnectionRelease            RRCConnectionRelease,
        securityModeCommand             SecurityModeCommand,
        ueCapabilityEnquiry            UECapabilityEnquiry,
        spare1 NULL
    },
    messageClassExtension SEQUENCE {}
}
-- ASN1STOP
```

A nested two-level CHOICE structure is used, where the alternative PDU types are alternatives within the inner level *c1* CHOICE.

Spare alternatives (i.e., *spare1* in this case) may be included within the *c1* CHOICE to facilitate future extension. The number of such spare alternatives should not extend the total number of alternatives beyond an integer-power-of-two number of alternatives (i.e., eight in this case).

Further extension of the number of alternative PDU types is facilitated using the *messageClassExtension* alternative in the outer level CHOICE.

A.3.3 Message definition

Each PDU (message) type is specified in an ASN.1 section similar to the one shown in the example below.

```
-- /example/ ASN1START
RRCConnectionReconfiguration ::= SEQUENCE {
    rrc-TransactionIdentifier      RRC-TransactionIdentifier,
    criticalExtensions             CHOICE {
        c1                         CHOICE {
            rrcConnectionReconfiguration-r8  RRCConnectionReconfiguration-r8-IEs,
            spare3 NULL, spare2 NULL, spare1 NULL
        },
        criticalExtensionsFuture SEQUENCE {}
    }
}
RRCConnectionReconfiguration-r8-IEs ::= SEQUENCE {
    -- Enter the IEs here.
    ...
}
-- ASN1STOP
```

Hooks for *critical* and *non-critical* extension should normally be included in the PDU type specification. How these hooks are used is further described in clause A.4.

Critical extensions are characterised by a redefinition of the PDU contents and need to be governed by a mechanism for protocol version agreement between the encoder and the decoder of the PDU, such that the encoder is prevented from sending a critically extended version of the PDU type, which is not comprehended by the decoder.

Critical extension of a PDU type is facilitated by a two-level CHOICE structure, where the alternative PDU contents are alternatives within the inner level *c1* CHOICE. Spare alternatives (i.e., *spare3* down to *spare1* in this case) may be included within the *c1* CHOICE. The number of spare alternatives to be included in the original PDU specification should be decided case by case, based on the expected rate of critical extension in the future releases of the protocol.

Further critical extension, when the spare alternatives from the original specifications are used up, is facilitated using the *criticalExtensionsFuture* in the outer level CHOICE.

In PDU types where critical extension is not expected in the future releases of the protocol, the inner level *c1* CHOICE and the spare alternatives may be excluded, as shown in the example below.

```
-- /example/ ASN1START
RRCConnectionReconfigurationComplete ::= SEQUENCE {
    rrc-TransactionIdentifier      RRC-TransactionIdentifier,
    criticalExtensions             CHOICE {
        rrcConnectionReconfigurationComplete-r8
        criticalExtensionsFuture   RRCConnectionReconfigurationComplete-r8-IEs,
    }
}
RRCConnectionReconfigurationComplete-r8-IEs ::= SEQUENCE {
    -- Enter the IEs here. --
    ...
}
-- ASN1STOP
```

Non-critical extensions are characterised by the addition of new information to the original specification of the PDU type. If not comprehended, a non-critical extension may be skipped by the decoder, whilst the decoder is still able to complete the decoding of the comprehended parts of the PDU contents.

Non-critical extensions at locations other than the end of the message or other than at the end of a field contained in a BIT or OCTET STRING are facilitated by use of the ASN.1 extension marker "...". The original specification of a PDU type should normally include the extension marker at the end of the sequence of information elements contained.

Non-critical extensions at the end of the message or at the end of a field that is contained in a BIT or OCTET STRING are facilitated by use of an empty sequence that is marked OPTIONAL e.g. as shown in the following example:

```
-- /example/ ASN1START
RRCMessage-r8-IEs ::=
    SEQUENCE {
        field1          InformationElement1,
        field2          InformationElement2,
        nonCriticalExtension SEQUENCE {} OPTIONAL
    }
-- ASN1STOP
```

The ASN.1 section specifying the contents of a PDU type may be followed by a *field description* table where a further description of, e.g., the semantic properties of the fields may be included. The general format of this table is shown in the example below. The field description table is absent in case there are no fields for which further description needs to be provided e.g. because the PDU does not include any fields, or because an IE is defined for each field while there is nothing specific regarding the use of this IE that needs to be specified.

%PDU-TypeIdentifier% field descriptions
%field identifier% Field description.
%field identifier% Field description.

The field description table has one column. The header row shall contain the ASN.1 type identifier of the PDU type.

The following rows are used to provide field descriptions. Each row shall include a first paragraph with a *field identifier* (in **bold and italic** font style) referring to the part of the PDU to which it applies. The following paragraphs at the same row may include (in regular font style), e.g., semantic description, references to other specifications and/ or specification of value units, which are relevant for the particular part of the PDU.

The parts of the PDU contents that do not require a field description shall be omitted from the field description table.

A.3.4 Information elements

Each IE (information element) type is specified in an ASN.1 section similar to the one shown in the example below.

```
-- /example/ ASN1START

PRACH-ConfigSIB ::=
    rootSequenceIndex
    prach-ConfigInfo
}

PRACH-Config ::=
    rootSequenceIndex
    prach-ConfigInfo
} OPTIONAL -- Need ON

PRACH-ConfigInfo ::=
    prach-ConfigIndex
    highSpeedFlag
    zeroCorrelationZoneConfig
}

-- ASN1STOP
```

IEs should be introduced whenever there are multiple fields for which the same set of values apply. IEs may also be defined for other reasons e.g. to break down a ASN.1 definition in to smaller pieces.

A group of closely related IE type definitions, like the IEs *PRACH-ConfigSIB* and *PRACH-Config* in this example, are preferably placed together in a common ASN.1 section. The IE type identifiers should in this case have a common base, defined as the *generic type identifier*. It may be complemented by a suffix to distinguish the different variants. The "*PRACH-Config*" is the generic type identifier in this example, and the "*SIB*" suffix is added to distinguish the variant. The clause heading and generic references to a group of closely related IEs defined in this way should use the generic type identifier.

The same principle should apply if a new version, or an extension version, of an existing IE is created for *critical* or *non-critical* extension of the protocol (see clause A.4). The new version, or the extension version, of the IE is included in the same ASN.1 section defining the original. A suffix is added to the type identifier, using the naming conventions defined in clause A.3.1.2, indicating the release or version of the where the new version, or extension version, was introduced.

Local IE type definitions, like the IE *PRACH-ConfigInfo* in the example above, may be included in the ASN.1 section and be referenced in the other IE types defined in the same ASN.1 section. The use of locally defined IE types should be encouraged, as a tool to break up large and complex IE type definitions. It can improve the readability of the code. There may also be a benefit for the software implementation of the protocol end-points, as these IE types are typically provided by the ASN.1 compiler as independent data elements, to be used in the software implementation.

An IE type defined in a local context, like the IE *PRACH-ConfigInfo*, should not be referenced directly from other ASN.1 sections in the RRC specification. An IE type which is referenced in more than one ASN.1 section should be defined in a separate clause, with a separate heading and a separate ASN.1 section (possibly as one in a set of closely

related IE types, like the IEs *PRACH-ConfigSIB* and *PRACH-Config* in the example above). Such IE types are also referred to as 'global IEs'.

NOTE: Referring to an IE type, that is defined as a local IE type in the context of another ASN.1 section, does not generate an ASN.1 compilation error. Nevertheless, using a locally defined IE type in that way makes the IE type definition difficult to find, as it would not be visible at an outline level of the specification. It should be avoided.

The ASN.1 section specifying the contents of one or more IE types, like in the example above, may be followed by a *field description* table, where a further description of, e.g., the semantic properties of the fields of the information elements may be included. This table may be absent, similar as indicated in clause A.3.3 for the specification of the PDU type. The general format of the *field description* table is the same as shown in clause A.3.3 for the specification of the PDU type.

A.3.5 Fields with optional presence

A field with optional presence may be declared with the keyword **DEFAULT**. It identifies a default value to be assumed, if the sender does not include a value for that field in the encoding:

```
-- /example/ ASN1START
PreambleInfo ::=
    numberOfRA-Preambles          SEQUENCE {
                                   INTEGER (1..64)          DEFAULT 1,
                                   ...
    }
-- ASN1STOP
```

Alternatively, a field with optional presence may be declared with the keyword **OPTIONAL**. It identifies a field for which a value can be omitted. The omission carries semantics, which is different from any normal value of the field:

```
-- /example/ ASN1START
PRACH-Config ::=
    rootSequenceIndex            SEQUENCE {
                                   INTEGER (0..1023),
                                   PRACH-ConfigInfo          OPTIONAL    -- Need ON
    }
-- ASN1STOP
```

The semantics of an optionally present field, in the case it is omitted, should be indicated at the end of the paragraph including the keyword **OPTIONAL**, using a short comment text with a need statement. The need statement includes the keyword "Need", followed by one of the predefined semantics tags (OP, ON or OR) defined in clause 6.1. If the semantics tag **OP** is used, the semantics of the absent field are further specified either in the field description table following the ASN.1 section, or in procedure text.

The addition of **OPTIONAL** keywords for capability groups is based on the following guideline. If there is more than one field in the lower level IE, then **OPTIONAL** keyword is added at the group level. If there is only one field in the lower level IE, **OPTIONAL** keyword is not added at the group level.

A.3.6 Fields with conditional presence

A field with conditional presence is declared with the keyword **OPTIONAL**. In addition, a short comment text shall be included at the end of the paragraph including the keyword **OPTIONAL**. The comment text includes the keyword "Cond", followed by a condition tag associated with the field ("UL" in this example):

```
-- /example/ ASN1START
LogicalChannelConfig ::=
    ul-SpecificParameters        SEQUENCE {
                                   SEQUENCE {
                                       priority          INTEGER (0),
                                       ...
                                   }          OPTIONAL          -- Cond UL
    }
-- ASN1STOP
```

When conditionally present fields are included in an ASN.1 section, the field description table after the ASN.1 section shall be followed by a *conditional presence* table. The conditional presence table specifies the conditions for including the fields with conditional presence in the particular ASN.1 section.

Conditional presence	Explanation
UL	Specification of the conditions for including the field associated with the condition tag = "UL". Semantics in case of optional presence under certain conditions may also be specified.

The conditional presence table has two columns. The first column (heading: "Conditional presence") contains the condition tag (in *italic* font style), which links the fields with a condition tag in the ASN.1 section to an entry in the table. The second column (heading: "Explanation") contains a text specification of the conditions and requirements for the presence of the field. The second column may also include semantics, in case of an optional presence of the field, under certain conditions i.e. using the same predefined tags as defined for optional fields in A.3.5.

Conditional presence should primarily be used when presence of a field depends on the presence and/ or value of other fields within the same message. If the presence of a field depends on whether another feature/ function has been configured, while this function can be configured independently e.g. by another message and/ or at another point in time, the relation is best reflected by means of a statement in the field description table.

If the ASN.1 section does not include any fields with conditional presence, the conditional presence table shall not be included.

Whenever a field is only applicable in specific cases e.g. TDD, use of conditional presence should be considered.

A.3.7 Guidelines on use of lists with elements of SEQUENCE type

Where an information element has the form of a list (the SEQUENCE OF construct in ASN.1) with the type of the list elements being a SEQUENCE data type, an information element shall be defined for the list elements even if it would not otherwise be needed.

For example, a list of PLMN identities with reservation flags is defined as in the following example:

```
-- /example/ ASN1START
PLMN-IdentityInfoList ::=                SEQUENCE (SIZE (1..6)) OF PLMN-IdentityInfo
PLMN-IdentityInfo ::=                   SEQUENCE {
    plmn-Identity                        PLMN-Identity,
    cellReservedForOperatorUse           ENUMERATED {reserved, notReserved}
}
-- ASN1STOP
```

rather than as in the following (bad) example, which may cause generated code to contain types with unpredictable names:

```
-- /bad example/ ASN1START
PLMN-IdentityList ::=                   SEQUENCE (SIZE (1..6)) OF SEQUENCE {
    plmn-Identity                        PLMN-Identity,
    cellReservedForOperatorUse           ENUMERATED {reserved, notReserved}
}
-- ASN1STOP
```

A.4 Extension of the PDU specifications

A.4.1 General principles to ensure compatibility

It is essential that extension of the protocol does not affect interoperability i.e. it is essential that implementations based on different versions of the RRC protocol are able to interoperate. In particular, this requirement applies for the following kind of protocol extensions:

- Introduction of new PDU types (i.e. these should not cause unexpected behaviour or damage).
- Introduction of additional fields in an extensible PDUs (i.e. it should be possible to ignore uncomprehended extensions without affecting the handling of the other parts of the message).
- Introduction of additional values of an extensible field of PDUs. If used, the behaviour upon reception of an uncomprehended value should be defined.

It should be noted that the PDU extension mechanism may depend on the logical channel used to transfer the message e.g. for some PDUs an implementation may be aware of the protocol version of the peer in which case selective ignoring of extensions may not be required.

The non-critical extension mechanism is the primary mechanism for introducing protocol extensions i.e. the critical extension mechanism is used merely when there is a need to introduce a 'clean' message version. Such a need appears when the last message version includes a large number of non-critical extensions, which results in issues like readability, overhead associated with the extension markers. The critical extension mechanism may also be considered when it is complicated to accommodate the extensions by means of non-critical extension mechanisms.

A.4.2 Critical extension of messages and fields

The mechanisms to critically extend a message are defined in A.3.3. There are both "outer branch" and "inner branch" mechanisms available. The "outer branch" consists of a CHOICE having the name *criticalExtensions*, with two values, *c1* and *criticalExtensionsFuture*. The *criticalExtensionsFuture* branch consists of an empty SEQUENCE, while the *c1* branch contains the "inner branch" mechanism.

The "inner branch" structure is a CHOICE with values of the form "*MessageName-rX-IEs*" (e.g., "*RRCConnectionReconfiguration-r8-IEs*") or "*spareX*", with the spare values having type NULL. The "-rX-IEs" structures contain the *complete* structure of the message IEs for the appropriate release; i.e., the critical extension branch for the Rel-10 version of a message includes all Rel-8 and Rel-9 fields (that are not obviated in the later version), rather than containing only the additional Rel-10 fields.

The following guidelines may be used when deciding which mechanism to introduce for a particular message, i.e. only an 'outer branch', or an 'outer branch' in combination with an 'inner branch' including a certain number of spares:

- For certain messages, e.g. initial uplink messages, messages transmitted on a broadcast channel, critical extension may not be applicable.
- An outer branch may be sufficient for messages not including any fields.
- The number of spares within inner branch should reflect the likelihood that the message will be critically extended in future releases (since each release with a critical extension for the message consumes one of the spare values). The estimation of the critical extension likelihood may be based on the number, size and changeability of the fields included in the message.
- In messages where an inner branch extension mechanism is available, all spare values of the inner branch should be used before any critical extensions are added using the outer branch.

The following example illustrates the use of the critical extension mechanism by showing the ASN.1 of the original and of a later release

```
-- /example/ ASN1START                                -- Original release
RRCMessage ::=                                        SEQUENCE {
  rrc-TransactionIdentifier                          RRC-TransactionIdentifier,
  criticalExtensions                                 CHOICE {
    c1                                               CHOICE{
```

```

        rrcMessage-r8                RRCMessage-r8-IEs,
        spare3 NULL, spare2 NULL, spare1 NULL
    },
    criticalExtensionsFuture          SEQUENCE {}
}
}
-- ASN1STOP

```

```

-- /example/ ASN1START                -- Later release
RRCMessage ::=                       SEQUENCE {
    rrc-TransactionIdentifier         RRC-TransactionIdentifier,
    criticalExtensions                CHOICE {
        c1                            CHOICE{
            rrcMessage-r8             RRCMessage-r8-IEs,
            rrcMessage-r10            RRCMessage-r10-IEs,
            rrcMessage-r11            RRCMessage-r11-IEs,
            rrcMessage-r14            RRCMessage-r14-IEs
        },
        later                          CHOICE {
            c2                          CHOICE{
                rrcMessage-r16         RRCMessage-r16-IEs,
                spare7 NULL, spare6 NULL, spare5 NULL, spare4 NULL,
                spare3 NULL, spare2 NULL, spare1 NULL
            },
            criticalExtensionsFuture    SEQUENCE {}
        }
    }
}
-- ASN1STOP

```

It is important to note that critical extensions may also be used at the level of individual fields i.e. a field may be replaced by a critically extended version. When sending the extended version, the original version may also be included (e.g. original field is mandatory, EUTRAN is unaware if UE supports the extended version). In such cases, a UE supporting both versions may be required to ignore the original field. The following example illustrates the use of the critical extension mechanism by showing the ASN.1 of the original and of a later release

```

-- /example/ ASN1START                -- Original release
RRCMessage ::=                       SEQUENCE {
    rrc-TransactionIdentifier         RRC-TransactionIdentifier,
    criticalExtensions                CHOICE {
        c1                            CHOICE{
            rrcMessage-r8             RRCMessage-r8-IEs,
            spare3 NULL, spare2 NULL, spare1 NULL
        },
        criticalExtensionsFuture       SEQUENCE {}
    }
}

RRCMessage-rN-IEs ::= SEQUENCE {
    field1-rN                         ENUMERATED {
        value1, value2, value3, value4} OPTIONAL, -- Need ON
    field2-rN                         InformationElement2-rN      OPTIONAL, -- Need ON
    nonCriticalExtension               RRCConnectionReconfiguration-vMxy-IEs OPTIONAL
}

RRCConnectionReconfiguration-vMxy-IEs ::= SEQUENCE {
    field2-rM                         InformationElement2-rM      OPTIONAL, -- Cond NoField2rN
    nonCriticalExtension               SEQUENCE {}                  OPTIONAL
}
-- ASN1STOP

```

Conditional presence	Explanation
<i>NoField2rN</i>	The field is optionally present, need ON, if <i>field2-rN</i> is absent. Otherwise the field is not present

Finally, it is noted that a critical extension may be introduced in the same release as the one in which the original field was introduced e.g. to correct an essential ASN.1 error. In such cases a UE capability may be introduced, to assist E-UTRAN in deciding whether or not to use the critically extension.

A.4.3 Non-critical extension of messages

A.4.3.1 General principles

The mechanisms to extend a message in a non-critical manner are defined in A.3.3. W.r.t. the use of extension markers, the following additional guidelines apply:

- When further non-critical extensions are added to a message that has been critically extended, the inclusion of these non-critical extensions in earlier critical branches of the message should be avoided when possible.
- The extension marker ("...") is the primary non-critical extension mechanism that is used unless a length determinant is not required. Examples of cases where a length determinant is not required:
 - at the end of a message,
 - at the end of a structure contained in a BIT STRING or OCTET STRING
- When an extension marker is available, non-critical extensions are preferably placed at the location (e.g. the IE) where the concerned parameter belongs from a logical/ functional perspective (referred to as the '*default extension location*')
- It is desirable to aggregate extensions of the same release or version of the specification into a group, which should be placed at the lowest possible level.
- In specific cases it may be preferable to place extensions elsewhere (referred to as the '*actual extension location*') e.g. when it is possible to aggregate several extensions in a group. In such a case, the group should be placed at the lowest suitable level in the message. <TBD: ref to separate example>
- In case placement at the default extension location affects earlier critical branches of the message, locating the extension at a following higher level in the message should be considered.
- In case an extension is not placed at the default extension location, an IE should be defined. The IE's ASN.1 definition should be placed in the same ASN.1 section as the default extension location. In case there are intermediate levels in-between the actual and the default extension location, an IE may be defined for each level. Intermediate levels are primarily introduced for readability and overview. Hence intermediate levels need not always be introduced e.g. they may not be needed when the default and the actual extension location are within the same ASN.1 section. <TBD: ref to separate example>

A.4.3.2 Further guidelines

Further to the general principles defined in the previous clause, the following additional guidelines apply regarding the use of extension markers:

- Extension markers within SEQUENCE
 - Extension markers are primarily, but not exclusively, introduced at the higher nesting levels
 - Extension markers are introduced for a SEQUENCE comprising several fields as well as for information elements whose extension would result in complex structures without it (e.g. re-introducing another list)
 - Extension markers are introduced to make it possible to maintain important information structures e.g. parameters relevant for one particular RAT
 - Extension markers are also used for size critical messages (i.e. messages on BCCH, BR-BCCH, PCCH and CCCH), although introduced somewhat more carefully
 - The extension fields introduced (or frozen) in a specific version of the specification are grouped together using double brackets.
- Extension markers within ENUMERATED

- Spare values are used until the number of values reaches the next power of 2, while the extension marker caters for extension beyond that limit
- A suffix of the form "vXYZ" is used for the identifier of each new value, e.g. "value-vXYZ".
- Extension markers within CHOICE:
 - Extension markers are introduced when extension is foreseen and when comprehension is not required by the receiver i.e. behaviour is defined for the case where the receiver cannot comprehend the extended value (e.g. ignoring an optional CHOICE field). It should be noted that defining the behaviour of a receiver upon receiving a not comprehended choice value is not required if the sender is aware whether or not the receiver supports the extended value.
 - A suffix of the form "vXYZ" is used for the identifier of each new choice value, e.g. "choice-vXYZ".

Non-critical extensions at the end of a message/ of a field contained in an OCTET or BIT STRING:

- When a nonCriticalExtension is actually used, a "Need" statement should not be provided for the field, which always is a group including at least one extension and a field facilitating further possible extensions. For simplicity, it is recommended not to provide a "Need" statement when the field is not actually used either.

Further, more general, guidelines:

- In case a need statement is not provided for a group, a "Need" statement is provided for all individual extension fields within the group i.e. including for fields that are not marked as OPTIONAL. The latter is to clarify the action upon absence of the whole group.

A.4.3.3 Typical example of evolution of IE with local extensions

The following example illustrates the use of the extension marker for a number of elementary cases (sequence, enumerated, choice). The example also illustrates how the IE may be revised in case the critical extension mechanism is used.

NOTE In case there is a need to support further extensions of release n while the ASN.1 of release (n+1) has been frozen, without requiring the release n receiver to support decoding of release (n+1) extensions, more advanced mechanisms are needed e.g. including multiple extension markers.

```
-- /example/ ASN1START
InformationElement1 ::=          SEQUENCE {
    field1                       ENUMERATED {
                                value1, value2, value3, value4-v880,
                                ..., value5-v960 },
    field2                       CHOICE {
        field2a                 BOOLEAN,
        field2b                 InformationElement2b,
        ...,
        field2c-v960            InformationElement2c-r9
    },
    ...,
    [[ field3-r9                 InformationElement3-r9          OPTIONAL          -- Need OR
    ]],
    [[ field3-v9a0              InformationElement3-v9a0        OPTIONAL,          -- Need OR
    field4-r9                   InformationElement4           OPTIONAL          -- Need OR
    ]]
}

InformationElement1-r10 ::=      SEQUENCE {
    field1                       ENUMERATED {
                                value1, value2, value3, value4-v880,
                                value5-v960, value6-v1170, spare2, spare1, ... },
    field2                       CHOICE {
        field2a                 BOOLEAN,
        field2b                 InformationElement2b,
        field2c-v960            InformationElement2c-r9,
        ...,
        field2d-v12b0           INTEGER (0..63)
    },
    field3-r9                    InformationElement3-r10        OPTIONAL,          -- Need OR
    field4-r9                    InformationElement4           OPTIONAL,          -- Need OR
    field5-r10                   BOOLEAN,
}
```

```

    field6-r10                InformationElement6-r10                OPTIONAL,    -- Need OR
    ...,
    [[ field3-v1170           InformationElement3-v1170           OPTIONAL    -- Need OR
    ]]
}
-- ASN1STOP

```

Some remarks regarding the extensions of *InformationElement1* as shown in the above example:

- The *InformationElement1* is initially extended with a number of non-critical extensions. In release 10 however, a critical extension is introduced for the message using this IE. Consequently, a new version of the IE *InformationElement1* (i.e. *InformationElement1-r10*) is defined in which the earlier non-critical extensions are incorporated by means of a revision of the original field.
- The *value4-v880* is replacing a spare value defined in the original protocol version for *field1*. Likewise *value6-v1170* replaces *spare3* that was originally defined in the r10 version of *field1*
- Within the critically extended release 10 version of *InformationElement1*, the names of the original fields/ IEs are not changed, unless there is a real need to distinguish them from other fields/ IEs. E.g. the *field1* and *InformationElement4* were defined in the original protocol version (release 8) and hence not tagged. Moreover, the *field3-r9* is introduced in release 9 and not re-tagged; although, the *InformationElement3* is also critically extended and therefore tagged *InformationElement3-r10* in the release 10 version of *InformationElement1*.

A.4.3.4 Typical examples of non critical extension at the end of a message

The following example illustrates the use of non-critical extensions at the end of the message or at the end of a field that is contained in a BIT or OCTET STRING i.e. when an empty sequence is used.

```

-- /example/ ASN1START
RRCMessage-r8-IEs ::=          SEQUENCE {
    field1                    InformationElement1,
    field2                    InformationElement2,
    field3                    InformationElement3                OPTIONAL,    -- Need ON
    nonCriticalExtension      RRCMessage-v860-IEs                OPTIONAL
}
RRCMessage-v860-IEs ::=       SEQUENCE {
    field4-v860               InformationElement4                OPTIONAL,    -- Need OP
    field5-v860               BOOLEAN                          OPTIONAL,    -- Cond C54
    nonCriticalExtension      RRCMessage-v940-IEs                OPTIONAL
}
RRCMessage-v940-IEs ::=       SEQUENCE {
    field6-v940               InformationElement6-r9                OPTIONAL,    -- Need OR
    nonCriticalExtensions     SEQUENCE {}                          OPTIONAL
}
-- ASN1STOP

```

Some remarks regarding the extensions shown in the above example:

- The *InformationElement4* is introduced in the original version of the protocol (release 8) and hence no suffix is used.

A.4.3.5 Examples of non-critical extensions not placed at the default extension location

The following example illustrates the use of non-critical extensions in case an extension is not placed at the default extension location.

– *ParentIE-WithEM*

The IE *ParentIE-WithEM* is an example of a high level IE including the extension marker (EM). The root encoding of this IE includes two lower level IEs *ChildIE1-WithoutEM* and *ChildIE2-WithoutEM* which not include the extension marker. Consequently, non-critical extensions of the Child-IEs have to be included at the level of the Parent-IE.

The example illustrates how the two extension IEs *ChildIE1-WithoutEM-vNx0* and *ChildIE2-WithoutEM-vNx0* (both in release N) are used to connect non-critical extensions with a default extension location in the lower level IEs to the actual extension location in this IE.

***ParentIE-WithEM* information element**

```
-- /example/ ASN1START
ParentIE-WithEM ::=                               SEQUENCE {
  -- Root encoding, including:
  childIE1-WithoutEM                               ChildIE1-WithoutEM           OPTIONAL,      -- Need ON
  childIE2-WithoutEM                               ChildIE2-WithoutEM           OPTIONAL,      -- Need ON
  . . .
  [[ childIE1-WithoutEM-vNx0                       ChildIE1-WithoutEM-vNx0     OPTIONAL,      -- Need ON
     childIE2-WithoutEM-vNx0                       ChildIE2-WithoutEM-vNx0     OPTIONAL,      -- Need ON
  ]]
}
-- ASN1STOP
```

Some remarks regarding the extensions shown in the above example:

- The fields *childIEx-WithoutEM-vNx0* may not really need to be optional (depends on what is defined at the next lower level).
- In general, especially when there are several nesting levels, fields should be marked as optional only when there is a clear reason.

– *ChildIE1-WithoutEM*

The IE *ChildIE1-WithoutEM* is an example of a lower level IE, used to control certain radio configurations including a configurable feature which can be setup or released using the local IE *ChIE1-ConfigurableFeature*. The example illustrates how the new field *chIE1-NewField* is added in release N to the configuration of the configurable feature. The example is based on the following assumptions:

- when initially configuring as well as when modifying the new field, the original fields of the configurable feature have to be provided also i.e. as if the extended ones were present within the setup branch of this feature.
- when the configurable feature is released, the new field should be released also.
- when omitting the original fields of the configurable feature the UE continues using the existing values (which is used to optimise the signalling for features that typically continue unchanged upon handover).
- when omitting the new field of the configurable feature the UE releases the existing values and discontinues the associated functionality (which may be used to support release of unsupported functionality upon handover to an eNB supporting an earlier protocol version).

The above assumptions, which affect the use of conditions and need codes, may not always apply. Hence, the example should not be re-used blindly.

***ChildIE1-WithoutEM* information elements**

```
-- /example/ ASN1START
ChildIE1-WithoutEM ::=                           SEQUENCE {
  -- Root encoding, including:
  chIE1-ConfigurableFeature                       ChIE1-ConfigurableFeature   OPTIONAL,      -- Need ON
}
-- ASN1STOP
```

```

ChildIE1-WithoutEM-vNx0 ::= SEQUENCE {
    chIE1-ConfigurableFeature-vNx0 ChIE1-ConfigurableFeature-vNx0 OPTIONAL -- Cond ConfigF
}

ChIE1-ConfigurableFeature ::= CHOICE {
    release NULL,
    setup SEQUENCE {
        -- Root encoding
    }
}

ChIE1-ConfigurableFeature-vNx0 ::= SEQUENCE {
    chIE1-NewField-rN INTEGER (0..31)
}

-- ASN1STOP
    
```

Conditional presence	Explanation
<i>ConfigF</i>	The field is optional present, need OR, in case of <i>chIE1-ConfigurableFeature</i> is included and set to "setup"; otherwise the field is not present and the UE shall delete any existing value for this field.

ChildIE2-WithoutEM

The IE *ChildIE2-WithoutEM* is an example of a lower level IE, typically used to control certain radio configurations. The example illustrates how the new field *chIE1-NewField* is added in release N to the configuration of the configurable feature.

ChildIE2-WithoutEM information element

```

-- /example/ ASN1START

ChildIE2-WithoutEM ::= CHOICE {
    release NULL,
    setup SEQUENCE {
        -- Root encoding
    }
}

ChildIE2-WithoutEM-vNx0 ::= SEQUENCE {
    chIE2-NewField-rN INTEGER (0..31) OPTIONAL -- Cond ConfigF
}

-- ASN1STOP
    
```

Conditional presence	Explanation
<i>ConfigF</i>	The field is optional present, need OR, in case of <i>chIE2-ConfigurableFeature</i> is included and set to "setup"; otherwise the field is not present and the UE shall delete any existing value for this field.

A.5 Guidelines regarding inclusion of transaction identifiers in RRC messages

The following rules provide guidance on which messages should include a Transaction identifier

- 1: DL messages on CCCH that move UE to RRC-Idle should not include the RRC transaction identifier.
- 2: All network initiated DL messages by default should include the RRC transaction identifier.
- 3: All UL messages that are direct response to a DL message with an RRC Transaction identifier should include the RRC Transaction identifier.
- 4: All UL messages that require a direct DL response message should include an RRC transaction identifier.

- 5: All UL messages that are not in response to a DL message nor require a corresponding response from the network should not include the RRC Transaction identifier.

A.6 Protection of RRC messages (informative)

The following list provides information which messages can be sent (unprotected) prior to security activation and which messages can be sent unprotected after security activation. Those messages indicated "-" in "P" column should never be sent unprotected by eNB or UE. Further requirements are defined in the procedural text.

P...Messages that can be sent (unprotected) prior to security activation

A - I...Messages that can be sent without integrity protection after security activation

A - C...Messages that can be sent unciphered after security activation

NA... Message can never be sent after security activation

Message	P	A-I	A-C	Comment
CSFBParametersRequestCDMA2000	+	-	-	
CSFBParametersResponseCDMA2000	+	-	-	
CounterCheck	-	-	-	
CounterCheckResponse	-	-	-	
DelayBudgetReport	-	-	-	
DLInformationTransfer	+	-	-	
HandoverFromEUTRAPreparationRequest (CDMA2000)	-	-	-	
InDeviceCoexIndication	-	-	-	
InterFreqRSTDMeasurementIndication	-	-	-	
LoggedMeasurementsConfiguration	-	-	-	
MasterInformationBlock	+	+	+	
MBMSCountingRequest	+	+	+	
MBMSCountingResponse	-	-	-	
MBMSInterestIndication	+	-	-	
MBSFNAreaConfiguration	+	+	+	
MeasurementReport	-	-	-	Measurement configuration may be sent prior to security activation. But: In order to protect privacy of UEs, MEASUREMENT REPORT is only sent from the UE after successful security activation.
MobilityFromEUTRACommand	-	-	-	
Paging	+	+	+	
ProximityIndication	-	-	-	
RNReconfiguration	-	-	-	
RNReconfigurationComplete	-	-	-	
RRCConnectionReconfiguration	+	-	-	The message shall not be sent unprotected before security activation if it is used to perform handover or to establish SRB2 and DRBs
RRCConnectionReconfigurationComplete	+	-	-	Unprotected, if sent as response to RRCConnectionReconfiguration which was sent before security activation
RRCConnectionReestablishment	-	+	+	This message is not protected by PDCP operation.
RRCConnectionReestablishmentComplete	-	-	-	
RRCConnectionReestablishmentReject	-	+	+	One reason to send this may be that the security context has been lost, therefore sent as unprotected.
RRCConnectionReestablishmentRequest	-	-	+	This message is not protected by PDCP operation. However, a short MAC-I is included.
RRCConnectionReject	+	NA	NA	
RRCConnectionRelease	+	-	-	Justification for P: If the RRC connection only for signalling not requiring DRBs or ciphered messages, or the signalling connection has to be released prematurely, this message is sent as unprotected.
RRCConnectionRequest	+	NA	NA	
RRCConnectionResume	-	-	+	When this message is transmitted, security is activated but suspended. Integrity verification is done after the message received by RRC.
RRCConnectionResumeRequest	-	-	+	This message is not protected by PDCP operation. However, a short MAC-I is included.
RRCConnectionResumeComplete	-	-	-	
RRCConnectionSetup	+	NA	NA	
RRCConnectionSetupComplete	+	NA	NA	
SCGFailureInformation	-	-	-	
SCPTMConfiguration	+	+	+	

Message	P	A-I	A-C	Comment
SecurityModeCommand	+	NA	NA	Integrity protection applied, but no ciphering (integrity verification done after the message received by RRC)
SecurityModeComplete	-	NA	NA	Integrity protection applied, but no ciphering. Ciphering is applied after completing the procedure.
SecurityModeFailure	+	NA	NA	Neither integrity protection nor ciphering applied.
SidelinkUEInformation	+	-	-	
SystemInformation	+	+	+	
SystemInformationBlockType1	+	+	+	
UEAssistanceInformation	-	-	-	
UECapabilityEnquiry	+	-	-	
UECapabilityInformation	+	-	-	
UEInformationRequest	-	-	-	
UEInformationResponse	-	-	-	In order to protect privacy of UEs, UEInformationResponse is only sent from the UE after successful security activation
ULHandoverPreparationTransfer (CDMA2000)	-	-	-	This message should follow HandoverFromEUTRAPreparationRequest
ULInformationTransfer	+	-	-	
WLANConnectionStatusReport	-	-	-	

A.7 Miscellaneous

The following miscellaneous conventions should be used:

- References: Whenever another specification is referenced, the specification number and optionally the relevant clause, table or figure, should be indicated in addition to the pointer to the References clause e.g. as follows: 'see TS 36.212 [22, 5.3.3.1.6]'.
- UE capabilities: TS 36.306 [5] specifies that E-UTRAN should in general respect the UE's capabilities. Hence there is no need to include statement clarifying that E-UTRAN, when setting the value of a certain configuration field, shall respect the related UE capabilities unless there is a particular need e.g. particularly complicated cases.

Annex B (normative): Release 8 and 9 AS feature handling

B.1 Feature group indicators

This annex contains the definitions of the bits in fields *featureGroupIndicators* (in Table B.1-1) and *featureGroupIndRel9Add* (in Table B.1-1a).

In this release of the protocol, the UE shall include the fields *featureGroupIndicators* in the IE *UE-EUTRA-Capability* and *featureGroupIndRel9Add* in the IE *UE-EUTRA-Capability-v9a0*. All the functionalities defined within the field *featureGroupIndicators* defined in Table B.1-1 or Table B.1-1a are mandatory for the UE (with exceptions for category M1 and M2 UEs), if the related capability (frequency band, RAT, SR-VCC or Inter-RAT ANR) is also supported. For a specific indicator, if all functionalities for a feature group listed in Table B.1-1 have been implemented and tested, the UE shall set the indicator as one (1), else (i.e. if any one of the functionalities in a feature group listed in Table B.1-1 or Table B.1-1a, which have not been implemented or tested), the UE shall set the indicator as zero (0).

The UE shall set all indicators that correspond to RATs not supported by the UE as zero (0).

The UE shall set all indicators, which do not have a definition in Table B.1-1 or Table B.1-1a, as zero (0).

If the optional fields *featureGroupIndicators* or *featureGroupIndRel9Add* are not included by a UE of a future release, the network may assume that all features pertaining to the RATs supported by the UE, respectively listed in Table B.1-1 or Table B.1-1a and deployed in the network, have been implemented and tested by the UE.

In Table B.1-1, a 'VoLTE capable UE' corresponds to a UE which is IMS voice capable and a 'MCPTT capable UE' corresponds to a UE which supports MCPTT voice application as defined in TS 23.179 [73].

The indexing in Table B.1-1a starts from index 33, which is the leftmost bit in the field *featureGroupIndRel9Add*.

Table B.1-1: Definitions of feature group indicators

Index of indicator (bit number)	Definition (description of the supported functionality, if indicator set to one)	Notes	If indicated "Yes" the feature shall be implemented and successfully tested for this version of the specification	FDD/TDD diff
1 (leftmost bit)	<ul style="list-style-type: none"> - Intra-subframe frequency hopping for PUSCH scheduled by UL grant - DCI format 3a (TPC commands for PUCCH and PUSCH with single bit power adjustments) - Aperiodic CQI/PMI/RI reporting on PUSCH: Mode 2-0 – UE selected subband CQI without PMI - Aperiodic CQI/PMI/RI reporting on PUSCH: Mode 2-2 – UE selected subband CQI with multiple PMI 	<ul style="list-style-type: none"> - set to 1 by category M1 and M2 UEs that have implemented and successfully tested "Aperiodic CQI/PMI/RI reporting on PUSCH: Mode 2-0 – UE selected subband CQI without PMI" 		Yes
2	<ul style="list-style-type: none"> - Simultaneous CQI and ACK/NACK on PUCCH, i.e. PUCCH format 2a and 2b - Absolute TPC command for PUSCH - Resource allocation type 1 for PDSCH - Periodic CQI/PMI/RI reporting on PUCCH: Mode 2-0 – UE selected subband CQI without PMI - Periodic CQI/PMI/RI reporting on PUCCH: Mode 2-1 – UE selected subband CQI with single PMI 	<ul style="list-style-type: none"> - If a category M1 or M2 UE does not support this feature group, this bit shall be set to 0. 		Yes
3	<ul style="list-style-type: none"> - 5bit RLC UM SN - 7bit PDCP SN 	<ul style="list-style-type: none"> - can only be set to 1 if the UE has set bit number 7 to 1. 	Yes, if UE supports VoLTE, MCPTT, or both.	No

			Yes, if UE supports SRVCC to EUTRAN from GERAN.	
--	--	--	---	--

4	- Short DRX cycle	- can only be set to 1 if the UE has set bit number 5 to 1. - not supported by category M1 or M2 UE		Yes
5	- Long DRX cycle - DRX command MAC control element		Yes	No
6	- Prioritised bit rate		Yes	No
7	- RLC UM	- can only be set to 0 if the UE does neither support VoLTE nor MCPTT	Yes, if UE supports VoLTE, MCPTT, or both. Yes, if UE supports SRVCC to EUTRAN from GERAN.	No
8	- EUTRA RRC_CONNECTED to UTRA FDD or UTRA TDD CELL_DCH PS handover, if the UE supports either only UTRAN FDD or only UTRAN TDD - EUTRA RRC_CONNECTED to UTRA FDD CELL_DCH PS handover, if the UE supports both UTRAN FDD and UTRAN TDD	- can only be set to 1 if the UE has set bit number 22 to 1	Yes (except for category M1 and M2 UEs) for FDD, if UE supports UTRA FDD.	Yes
9	- EUTRA RRC_CONNECTED to GERAN GSM_Dedicated handover	- related to SR-VCC - can only be set to 1 if the UE has set bit number 23 to 1	Yes (except for category M1 and M2 UEs), if UE supports SRVCC to EUTRAN from GERAN.	Yes
10	- EUTRA RRC_CONNECTED to GERAN (Packet_) Idle by Cell Change Order - EUTRA RRC_CONNECTED to GERAN (Packet_) Idle by Cell Change Order with NACC (Network Assisted Cell Change)			Yes
11	- EUTRA RRC_CONNECTED to CDMA2000 1xRTT CS Active handover	- related to SR-VCC - can only be set to 1 if the UE has sets bit number 24 to 1		Yes
12	- EUTRA RRC_CONNECTED to CDMA2000 HRPD Active handover	- can only be set to 1 if the UE has set bit number 26 to 1		Yes
13	- Inter-frequency handover (within FDD or TDD)	- can only be set to 1 if the UE has set bit number 25 to 1	Yes (except for category M1 and M2 UEs), unless UE only supports band 13	No
14	- Measurement reporting event: Event A4 – Neighbour > threshold - Measurement reporting event: Event A5 – Serving < threshold1 & Neighbour > threshold2		Yes (except for category M1 and M2 UEs)	No
15	- Measurement reporting event: Event B1 – Neighbour > threshold for UTRAN FDD or UTRAN TDD, if the UE supports either only UTRAN FDD or only UTRAN TDD and has set bit number 22 to 1 - Measurement reporting event: Event B1 – Neighbour > threshold for UTRAN FDD or UTRAN TDD, if the UE supports both UTRAN FDD and UTRAN TDD and has set bit number 22 or 39 to 1, respectively - Measurement reporting event: Event B1 – Neighbour > threshold for GERAN, 1xRTT or HRPD, if the UE has set bit number 23, 24 or 26 to 1, respectively	- can only be set to 1 if the UE has set at least one of the bit number 22, 23, 24, 26 or 39 to 1. - even if the UE sets bits 41, it shall still set bit 15 to 1 if measurement reporting event B1 is tested for all RATs supported by UE - If a category M1 or M2 UE does not support this feature group, this bit shall be set to 0.	Yes for FDD, if UE supports only UTRAN FDD and does not support UTRAN TDD or GERAN or 1xRTT or HRPD	Yes

16	<p>- Intra-frequency periodical measurement reporting where <i>triggerType</i> is set to <i>periodical</i> and <i>purpose</i> is set to <i>reportStrongestCells</i></p> <p>- Inter-frequency periodical measurement reporting where <i>triggerType</i> is set to <i>periodical</i> and <i>purpose</i> is set to <i>reportStrongestCells</i>, if the UE has set bit number 25 to 1</p> <p>- Inter-RAT periodical measurement reporting where <i>triggerType</i> is set to <i>periodical</i> and <i>purpose</i> is set to <i>reportStrongestCells</i> for UTRAN FDD or UTRAN TDD, if the UE supports either only UTRAN FDD or only UTRAN TDD and has set bit number 22 to 1</p> <p>- Inter-RAT periodical measurement reporting where <i>triggerType</i> is set to <i>periodical</i> and <i>purpose</i> is set to <i>reportStrongestCells</i> for UTRAN FDD or UTRAN TDD, if the UE supports both UTRAN FDD and UTRAN TDD and has set bit number 22 or 39 to 1, respectively</p> <p>- Inter-RAT periodical measurement reporting where <i>triggerType</i> is set to <i>periodical</i> and <i>purpose</i> is set to <i>reportStrongestCells</i> for GERAN, 1xRTT or HRPD, if the UE has set bit number 23, 24 or 26 to 1, respectively.</p> <p>NOTE: Event triggered periodical reporting (i.e., with <i>triggerType</i> set to <i>event</i> and with <i>reportAmount</i> > 1) is a mandatory functionality of event triggered reporting and therefore not the subject of this bit.</p>	- If a category M1 or M2 UE does not support this feature group, this bit shall be set to 0.	Yes	No
17	<p>Intra-frequency ANR features including:</p> <p>- Intra-frequency periodical measurement reporting where <i>triggerType</i> is set to <i>periodical</i> and <i>purpose</i> is set to <i>reportStrongestCells</i></p> <p>- Intra-frequency periodical measurement reporting where <i>triggerType</i> is set to <i>periodical</i> and <i>purpose</i> is set to <i>reportCGI</i></p>	<p>- can only be set to 1 if the UE has set bit number 5 to 1.</p> <p>- If a category M1 or M2 UE does not support this feature group, this bit shall be set to 0.</p>	Yes	No
18	<p>Intra-frequency ANR features including:</p> <p>- Inter-frequency periodical measurement reporting where <i>triggerType</i> is set to <i>periodical</i> and <i>purpose</i> is set to <i>reportStrongestCells</i></p> <p>- Inter-frequency periodical measurement reporting where <i>triggerType</i> is set to <i>periodical</i> and <i>purpose</i> is set to <i>reportCGI</i></p>	<p>- can only be set to 1 if the UE has set bit number 5 and bit number 25 to 1.</p> <p>- If a category M1 or M2 UE does not support this feature group, this bit shall be set to 0.</p>	Yes, unless UE only supports band 13	No

19	<p>Inter-RAT ANR features including:</p> <ul style="list-style-type: none"> - Inter-RAT periodical measurement reporting where <i>triggerType</i> is set to <i>periodical</i> and <i>purpose</i> is set to <i>reportStrongestCells</i> for GERAN, if the UE has set bit number 23 to 1 - Inter-RAT periodical measurement reporting where <i>triggerType</i> is set to <i>periodical</i> and <i>purpose</i> is set to <i>reportStrongestCellsForSON</i> for UTRAN FDD or UTRAN TDD, if the UE supports either only UTRAN FDD or only UTRAN TDD and has set bit number 22 to 1 - Inter-RAT periodical measurement reporting where <i>triggerType</i> is set to <i>periodical</i> and <i>purpose</i> is set to <i>reportStrongestCellsForSON</i> for UTRAN FDD or UTRAN TDD, if the UE supports both UTRAN FDD and UTRAN TDD and has set bit number 22 or 39 to 1, respectively - Inter-RAT periodical measurement reporting where <i>triggerType</i> is set to <i>periodical</i> and <i>purpose</i> is set to <i>reportStrongestCellsForSON</i> for 1xRTT or HRPD, if the UE has set bit number 24 or 26 to 1, respectively - Inter-RAT periodical measurement reporting where <i>triggerType</i> is set to <i>periodical</i> and <i>purpose</i> is set to <i>reportCGI</i> for UTRAN FDD or UTRAN TDD, if the UE supports either only UTRAN FDD or only UTRAN TDD and has set bit number 22 to 1 - Inter-RAT periodical measurement reporting where <i>triggerType</i> is set to <i>periodical</i> and <i>purpose</i> is set to <i>reportCGI</i> for UTRAN FDD or UTRAN TDD, if the UE supports both UTRAN FDD and UTRAN TDD and has set bit number 22 or 39 to 1, respectively - Inter-RAT periodical measurement reporting where <i>triggerType</i> is set to <i>periodical</i> and <i>purpose</i> is set to <i>reportCGI</i> for GERAN, 1xRTT or HRPD, if the UE has set bit number 23, 24 or 26 to 1, respectively 	<ul style="list-style-type: none"> - can only be set to 1 if the UE has set bit number 5 to 1 and the UE has set at least one of the bit number 22, 23, 24 or 26 to 1. - even if the UE sets bits 33 to 37, it shall still set bit 19 to 1 if inter-RAT ANR features are tested for all RATs for which inter-RAT measurement reporting is indicated as tested 		Yes
20	<p>If bit number 7 is set to 0:</p> <ul style="list-style-type: none"> - SRB1 and SRB2 for DCCH + 8x AM DRB <p>If bit number 7 is set to 1:</p> <ul style="list-style-type: none"> - SRB1 and SRB2 for DCCH + 8x AM DRB - SRB1 and SRB2 for DCCH + 5x AM DRB + 3x UM DRB <p>NOTE: UE which indicate support for a DRB combination also support all subsets of the DRB combination. Therefore, release of DRB(s) never results in an unsupported DRB combination.</p>	<ul style="list-style-type: none"> - Regardless of what bit number 7 and bit number 20 is set to, UE shall support at least SRB1 and SRB2 for DCCH + 4x AM DRB - Regardless of what bit number 20 is set to, if bit number 7 is set to 1, UE shall support at least SRB1 and SRB2 for DCCH + 4x AM DRB + 1x UM DRB 	Yes	No

21	<ul style="list-style-type: none"> - Predefined intra- and inter-subframe frequency hopping for PUSCH with $N_{sb} > 1$ - Predefined inter-subframe frequency hopping for PUSCH with $N_{sb} > 1$ 	- If a category M1 or M2 UE does not support this feature group, this bit shall be set to 0.		No
22	<ul style="list-style-type: none"> - UTRAN FDD or UTRAN TDD measurements, reporting and measurement reporting event B2 in E-UTRA connected mode, if the UE supports either only UTRAN FDD or only UTRAN TDD - UTRAN FDD measurements, reporting and measurement reporting event B2 in E-UTRA connected mode, if the UE supports both UTRAN FDD and UTRAN TDD 	- If a category M1 or M2 UE does not support this feature group, this bit shall be set to 0.	Yes for FDD, if UE supports UTRA FDD	Yes
23	- GERAN measurements, reporting and measurement reporting event B2 in E-UTRA connected mode	- If a category M1 or M2 UE does not support this feature group, this bit shall be set to 0.		Yes
24	- 1xRTT measurements, reporting and measurement reporting event B2 in E-UTRA connected mode	- If a category M1 or M2 UE does not support this feature group, this bit shall be set to 0.	Yes for FDD, if UE supports enhanced 1xRTT CSFB for FDD Yes for TDD, if UE supports enhanced 1xRTT CSFB for TDD	Yes
25	<ul style="list-style-type: none"> - Inter-frequency measurements and reporting in E-UTRA connected mode <p>NOTE: The UE setting this bit to 1 and indicating support for FDD and TDD frequency bands in the UE capability signalling implements and is tested for FDD measurements while the UE is in TDD, and for TDD measurements while the UE is in FDD.</p>	- A category M1 or M2 UE shall set this bit to 1 only if <i>ceMeasurements-r14</i> is supported.	Yes, unless UE only supports band 13	No
26	- HRPD measurements, reporting and measurement reporting event B2 in E-UTRA connected mode	- If a category M1 or M2 UE does not support this feature group, this bit shall be set to 0.	Yes for FDD, if UE supports HRPD	Yes
27	<ul style="list-style-type: none"> - EUTRA RRC_CONNECTED to UTRA FDD or UTRA TDD CELL_DCH CS handover, if the UE supports either only UTRAN FDD or only UTRAN TDD - EUTRA RRC_CONNECTED to UTRA FDD CELL_DCH CS handover, if the UE supports both UTRAN FDD and UTRAN TDD 	<ul style="list-style-type: none"> - related to SR-VCC - can only be set to 1 if the UE has set bit number 8 to 1 and supports SR-VCC from EUTRA defined in TS 24.008 [49] - If a category M1 or M2 UE does not support this feature group, this bit shall be set to 0. 	Yes for FDD, if UE supports VoLTE and UTRA FDD	Yes
28	- TTI bundling	- If a category M1 or M2 UE does not support this feature group, this bit shall be set to 0.	Yes for FDD	Yes
29	- Semi-Persistent Scheduling	- If a category M1 or M2 UE does not support this feature group, this bit shall be set to 0.		Yes
30	- Handover between FDD and TDD	- can only be set to 1 if the UE has set bit number 13 to 1		No

31	- Indicates whether the UE supports the mechanisms defined for cells broadcasting multi band information i.e. comprehending <i>multiBandInfoList</i> , disregarding in RRC_CONNECTED the related system information fields and understanding the EARFCN signalling for all bands, that overlap with the bands supported by the UE, and that are defined in the earliest version of TS 36.101 [42] that includes all UE supported bands.		Yes	No
32	Undefined			

NOTE: The column FDD/ TDD diff indicates if the UE is allowed to signal different values for FDD and TDD.

Table B.1-1a: Definitions of feature group indicators

Index of indicator (bit number)	Definition (description of the supported functionality, if indicator set to one)	Notes	If indicated "Yes" the feature shall be implemented and successfully tested for this version of the specification	FDD/ TDD diff
33 (leftmost bit)	Inter-RAT ANR features for UTRAN FDD including: - Inter-RAT periodical measurement reporting where <i>triggerType</i> is set to <i>periodical</i> and <i>purpose</i> is set to <i>reportStrongestCellsForSON</i> - Inter-RAT periodical measurement reporting where <i>triggerType</i> is set to <i>periodical</i> and <i>purpose</i> is set to <i>reportCGI</i>	- can only be set to 1 if the UE has set bit number 5 and bit number 22 to 1.		Yes
34	Inter-RAT ANR features for GERAN including: - Inter-RAT periodical measurement reporting where <i>triggerType</i> is set to <i>periodical</i> and <i>purpose</i> is set to <i>reportStrongestCells</i> - Inter-RAT periodical measurement reporting where <i>triggerType</i> is set to <i>periodical</i> and <i>purpose</i> is set to <i>reportCGI</i>	- can only be set to 1 if the UE has set bit number 5 and bit number 23 to 1.		Yes
35	Inter-RAT ANR features for 1xRTT including: - Inter-RAT periodical measurement reporting where <i>triggerType</i> is set to <i>periodical</i> and <i>purpose</i> is set to <i>reportStrongestCellsForSON</i> - Inter-RAT periodical measurement reporting where <i>triggerType</i> is set to <i>periodical</i> and <i>purpose</i> is set to <i>reportCGI</i>	- can only be set to 1 if the UE has set bit number 5 and bit number 24 to 1.		Yes
36	Inter-RAT ANR features for HRPD including: - Inter-RAT periodical measurement reporting where <i>triggerType</i> is set to <i>periodical</i> and <i>purpose</i> is set to <i>reportStrongestCellsForSON</i> - Inter-RAT periodical measurement reporting where <i>triggerType</i> is set to <i>periodical</i> and <i>purpose</i> is set to <i>reportCGI</i>	- can only be set to 1 if the UE has set bit number 5 and bit number 26 to 1.		Yes
37	Inter-RAT ANR features for UTRAN TDD including: - Inter-RAT periodical measurement reporting where <i>triggerType</i> is set to <i>periodical</i> and <i>purpose</i> is set to <i>reportStrongestCellsForSON</i> - Inter-RAT periodical measurement reporting where <i>triggerType</i> is set to <i>periodical</i> and <i>purpose</i> is set to <i>reportCGI</i>	- can only be set to 1 if the UE has set bit number 5 and at least one of the bit number 22 (for UEs supporting only UTRA TDD) or the bit number 39 to 1.		Yes
38	- EUTRA RRC_CONNECTED to UTRA TDD CELL_DCH PS handover, if the UE supports both UTRAN FDD and UTRAN TDD	- can only be set to 1 if the UE has set bit number 39 to 1		Yes
39	- UTRAN TDD measurements, reporting and measurement reporting event B2 in E-UTRA connected mode, if the UE supports both UTRAN FDD and UTRAN TDD	- If a category M1 or M2 UE does not support this feature group, this bit shall be set to 0.		Yes

40	- EUTRA RRC_CONNECTED to UTRA TDD CELL_DCH CS handover, if the UE supports both UTRAN FDD and UTRAN TDD	- related to SR-VCC - can only be set to 1 if the UE has set bit number 38 to 1		Yes
41	Measurement reporting event: Event B1 – Neighbour > threshold for UTRAN FDD, if the UE supports UTRAN FDD and has set bit number 22 to 1	- If a category M1 or M2 UE does not support this feature group, this bit shall be set to 0.	Yes for FDD, unless UE has set bit number 15 to 1	Yes
42	- DCI format 3a (TPC commands for PUCCH and PUSCH with single bit power adjustments)	- If a category M1 or M2 UE supports this feature group, this bit shall be set to 1. For a UE of all other categories, this bit shall be set to 0.		Yes
43	Undefined			
44	Undefined			
45	Undefined			
46	Undefined			
47	Undefined			
48	Undefined			
49	Undefined			
50	Undefined			
51	Undefined			
52	Undefined			
53	Undefined			
54	Undefined			
55	Undefined			
56	Undefined			
57	Undefined			
58	Undefined			
59	Undefined			
60	Undefined			
61	Undefined			
62	Undefined			
63	Undefined			
64	Undefined			

NOTE: The column FDD/ TDD diff indicates if the UE is allowed to signal different values for FDD and TDD. Annex E specifies for which TDD and FDD serving cells a UE supporting TDD/FDD CA shall support a feature for which it indicates support within the FGI signalling.

Clarification for mobility from EUTRAN and inter-frequency handover within EUTRAN

There are several feature groups related to mobility from E-UTRAN and inter-frequency handover within EUTRAN. The description of these features is based on the assumption that we have 5 main "functions" related to mobility from E-UTRAN:

- A. Support of measurements and cell reselection procedure in idle mode
- B. Support of RRC release with redirection procedure in connected mode
- C. Support of Network Assisted Cell Change in connected mode
- D. Support of measurements and reporting in connected mode
- E. Support of handover procedure in connected mode

All functions can be applied for mobility to Inter-frequency to EUTRAN, GERAN, UTRAN, CDMA2000 HRPD and CDMA2000 1xRTT except for function C) which is only applicable for mobility to GERAN. Table B.1-2 below summarises the mobility functions that are supported based on the UE capability signaling (band support) and the setting of the feature group support indicators.

Table B.1-2: Mobility from E-UTRAN

Feature	GERAN	UTRAN	HRPD	1xRTT	EUTRAN
A. Measurements and cell reselection procedure in E-UTRA idle mode	Supported if GERAN band support is indicated	Supported if UTRAN band support is indicated	Supported if CDMA2000 HRPD band support is indicated	Supported if CDMA2000 1xRTT band support is indicated	Supported for supported bands
B. RRC release with blind redirection procedure in E-UTRA connected mode	Supported if GERAN band support is indicated	Supported if UTRAN band support is indicated	Supported if CDMA2000 HRPD band support is indicated	Supported if CDMA2000 1xRTT band support is indicated	Supported for supported bands
C. Cell Change Order (with or without Network Assisted Cell Change) in E-UTRA connected mode	Group 10	N.A.	N.A.	N.A.	N.A.
D. Inter-frequency/RAT measurements, reporting and measurement reporting event B2 (for inter-RAT) in E-UTRA connected mode	Group 23	Group 22/39	Group 26	Group 24	Group 25
E. Inter-frequency/RAT handover procedure in E-UTRA connected mode	Group 9 (GSM_connected handover) Separate UE capability bit defined in TS 36.306 [5] for PS handover	Group 8/38 (PS handover) or Group 27/40 (SRVCC handover)	Group 12	Group 11	Group 13 (within FDD TDD) Group 30 (between FDD and TDD)

In case measurements and reporting function is not supported by UE, the network may still issue the mobility procedures redirection (B) and CCO (C) in a blind fashion.

B.2 CSG support

In this release of the protocol, it is mandatory for the UE to support a minimum set of CSG functionality consisting of:

- Identifying whether a cell is CSG or not;
- Ignoring CSG cells in cell selection/reselection.

Additional CSG functionality in AS, i.e. the requirement to detect and camp on CSG cells when the "CSG whitelist" is available or when manual CSG selection is triggered by the user, are related to the corresponding NAS features. This additional AS functionality consists of:

- Manual CSG selection;
- Autonomous CSG search;
- Implicit priority handling for cell reselection with CSG cells.

It is possible that this additional CSG functionality in AS is not supported or tested in early UE implementations.

Note that since the above AS features relate to idle mode operations, the capability support is not signalled to the network. For these reasons, no "feature group indicator" is assigned to this feature to indicate early support in Rel-8.

Annex C (normative):Release 10 AS feature handling

C.1 Feature group indicators

This annex contains the definitions of the bits in field *featureGroupIndRel10*.

In this release of the protocol, the UE shall include the field *featureGroupIndRel10* in the IE *UE-EUTRA-Capability-v1020-IEs*. All the functionalities defined within the field *featureGroupIndRel10* defined in Table C.1-1 are mandatory for the UE, if the related capability (spatial multiplexing in UL, PDSCH transmission mode 9, carrier aggregation, handover to EUTRA, or RAT) is also supported. For a specific indicator, if all functionalities for a feature group listed in Table C.1-1 have been implemented and tested, the UE shall set the indicator as one (1), else (i.e. if any one of the functionalities in a feature group listed in Table C.1-1 have not been implemented or tested), the UE shall set the indicator as zero (0).

The UE shall set all indicators that correspond to RATs not supported by the UE as zero (0).

The UE shall set all indicators, which do not have a definition in Table C.1-1, as zero (0).

If the optional field *featureGroupIndRel10* is not included by a UE of a future release, the network may assume that all features, listed in Table C.1-1 and deployed in the network, have been implemented and tested by the UE.

The indexing in Table C.1-1 starts from index 101, which is the leftmost bit in the field *featureGroupIndRel10*.

Table C.1-1: Definitions of feature group indicators

Index of indicator	Definition (description of the supported functionality, if indicator set to one)	Notes	If indicated "Yes" the feature shall be implemented and successfully tested for this version of the specification	FDD/TDD diff
101 (leftmost bit)	- DMRS with OCC (orthogonal cover code) and SGH (sequence group hopping) disabling	- if the UE supports two or more layers for spatial multiplexing in UL, this bit shall be set to 1. - If a category 0 or 1bis UE does not support this feature, this bit shall be set to 0.		No
102	- Trigger type 1 SRS (aperiodic SRS) transmission (Up to X ports) NOTE: X = number of supported layers on given band			Yes
103	- PDSCH transmission mode 9 when up to 4 CSI reference signal ports are configured and when not operating in CE mode	- for Category 8 UEs, this bit shall be set to 1.		Yes
104	- PDSCH transmission mode 9 for TDD when 8 CSI reference signal ports are configured and when not operating in CE mode	- if the UE does not support TDD, this bit is irrelevant (capability signalling exists for FDD for this feature), and this bit shall be set to 0. - for Category 8 UEs, this bit shall be set to 1.		No

105	<ul style="list-style-type: none">- Periodic CQI/PMI/RI reporting on PUCCH: Mode 2-0 – UE selected subband CQI without PMI, when PDSCH transmission mode 9 is configured- Periodic CQI/PMI/RI reporting on PUCCH: Mode 2-1 – UE selected subband CQI with single PMI, when PDSCH transmission mode 9 and up to 4 CSI reference signal ports are configured	<ul style="list-style-type: none">- this bit can be set to 1 only if indices 2 (Table B.1-1) and 103 are set to 1.- For UEs capable of TDD-FDD CA, this bit can be set to 1 for both FDD and TDD if index 2 is set to 1 for both FDD and TDD, and index 103 is set to 1 for at least one of FDD and TDD duplex modes.		Yes
-----	---	--	--	-----

106	- Periodic CQI/PMI/RI/PTI reporting on PUCCH: Mode 2-1 – UE selected subband CQI with single PMI, when PDSCH transmission mode 9 and 8 CSI reference signal ports are configured	- this bit can be set to 1 only if the UE supports PDSCH transmission mode 9 with 8 CSI reference signal ports (i.e., for TDD, if index 104 is set to 1, and for FDD, if <i>tm9-With-8Tx-FDD-r10</i> is set to 'supported') and if index 2 (Table B.1-1) is set to 1. - For UEs capable of TDD-FDD CA, this bit can be set to 1 for both FDD and TDD if at least one of index 104 and <i>tm9-With-8Tx-FDD-r10</i> is set to 1/'supported', and if index 2 is set to 1 for both FDD and TDD.		Yes
107	- Aperiodic CQI/PMI/RI reporting on PUSCH: Mode 2-0 – UE selected subband CQI without PMI, when PDSCH transmission mode 9 is configured - Aperiodic CQI/PMI/RI reporting on PUSCH: Mode 2-2 – UE selected subband CQI with multiple PMI, when PDSCH transmission mode 9 and up to 4 CSI reference signal ports are configured	- this bit can be set to 1 only if indices 1 (Table B.1-1) and 103 are set to 1. - For UEs capable of TDD-FDD CA, this bit can be set to 1 for both FDD and TDD if index 1 is set to 1 for both FDD and TDD, and index 103 is set to 1 for at least one of FDD and TDD duplex modes.		Yes
108	- Aperiodic CQI/PMI/RI reporting on PUSCH: Mode 2-2 – UE selected subband CQI with multiple PMI, when PDSCH transmission mode 9 and 8 CSI reference signal ports are configured	- this bit can be set to 1 only if the UE supports PDSCH transmission mode 9 with 8 CSI reference signal ports (i.e., for TDD, if index 104 is set to 1, and for FDD, if <i>tm9-With-8Tx-FDD-r10</i> is set to 'supported') and if index 1 (Table B.1-1) is set to 1. - For UEs capable of TDD-FDD CA, this bit can be set to 1 for both FDD and TDD if at least one of index 104 and <i>tm9-With-8Tx-FDD-r10</i> is set to 1/'supported', and if index 1 is set to 1 for both FDD and TDD.		Yes
109	- Periodic CQI/PMI/RI reporting on PUCCH Mode 1-1, submode 1	- this bit can be set to 1 only if the UE supports PDSCH transmission mode 9 with 8 CSI reference signal ports (i.e., for TDD, if index 104 is set to 1, and for FDD, if <i>tm9-With-8Tx-FDD-r10</i> is set to 'supported'). - For UEs capable of TDD-FDD CA, this bit can be set to 1 for both FDD and TDD if at least one of index 104 and <i>tm9-With-8Tx-FDD-r10</i> is set to 1/'supported'.		Yes

110	- Periodic CQI/PMI/RI reporting on PUCCH Mode 1-1, submode 2	- this bit can be set to 1 only if the UE supports PDSCH transmission mode 9 with 8 CSI reference signal ports (i.e., for TDD, if index 104 is set to 1, and for FDD, if <i>tm9-With-8Tx-FDD-r10</i> is set to 'supported'). - For UEs capable of TDD-FDD CA, this bit can be set to 1 for both FDD and TDD if at least one of index 104 and <i>tm9-With-8Tx-FDD-r10</i> is set to 1/'supported'.		Yes
111	- Measurement reporting trigger Event A6	- this bit can be set to 1 only if the UE supports carrier aggregation.		Yes
112	- SCell addition within the handover to EUTRA procedure	- this bit can be set to 1 only if the UE supports carrier aggregation and the handover to EUTRA procedure.		Yes
113	- Trigger type 0 SRS (periodic SRS) transmission on X Serving Cells NOTE: X = number of supported component carriers in a given band combination	- this bit can be set to 1 only if the UE supports carrier aggregation in UL.		Yes
114	- Reporting of both UTRA CPICH RSCP and Ec/N0 in a Measurement Report	- this bit can be set to 1 only if index 22 (Table B.1-1) is set to 1.		No
115	- time domain ICIC RLM/RRM measurement subframe restriction for the serving cell - time domain ICIC RRM measurement subframe restriction for neighbour cells - time domain ICIC CSI measurement subframe restriction	- If a category M1 or M2 UE does not support this feature group, this bit shall be set to 0.		Yes
116	- Relative transmit phase continuity for spatial multiplexing in UL	- this bit can be set to 1 only if the UE supports two or more layers for spatial multiplexing in UL.		Yes
117	Undefined			
118	Undefined			
119	Undefined			
120	Undefined			
121	Undefined			
122	Undefined			
123	Undefined			
124	Undefined			
125	Undefined			
126	Undefined			
127	Undefined			
128	Undefined			
129	Undefined			
130	Undefined			
131	Undefined			
132	Undefined			

NOTE: The column FDD/ TDD diff indicates if the UE is allowed to signal different values for FDD and TDD. Annex E specifies for which TDD and FDD serving cells a UE supporting TDD/FDD CA shall support a feature for which it indicates support within the FGI signalling.

Annex D (informative): Descriptive background information

D.1 Signalling of Multiple Frequency Band Indicators (Multiple FBI)

D.1.1 Mapping between frequency band indicator and multiple frequency band indicator

This clause describes the use of the Multiple Frequency Band Indicator (MFBI) lists and the E-UTRA frequency bands in *SystemInformationBlockType1* by means of an example as shown in Figure D.1.1-1. In this example:

- E-UTRAN cell belongs to band B90 and also bands B6, B7, B91, and B92.
- The *freqBandIndicatorPriority* field is not present in *SystemInformationBlockType1*.
- E-UTRAN uses B64 to indicate the presence of B90 in *freqBandIndicator-v9e0*.
- For the MFBI list of this cell, E-UTRAN uses B64 in *MultiBandInfoList* to indicate the position and priority of the bands in *MultiBandInfoList-v9e0*.
- The UE, after reading *SystemInformationBlockType1*, generates an MFBI list with priority of B91, B6, B92, and B7. If the UE supports the frequency band in the *freqBandIndicator-v9e0* IE it applies that frequency band. Otherwise, the UE applies the first listed band in the MFBI list which it supports.

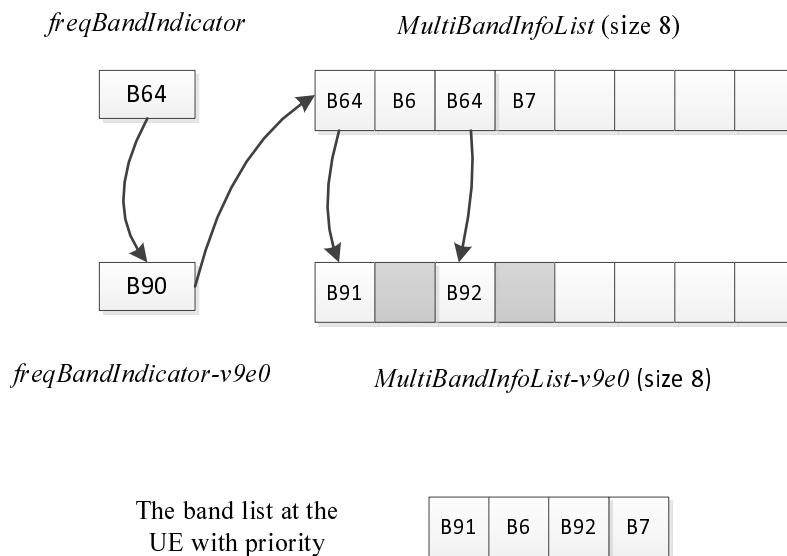

Figure D.1.1-1: Mapping of frequency bands to *MultiBandInfoList*/*MultiBandInfoList-v9e0*

D.1.2 Mapping between inter-frequency neighbour list and multiple frequency band indicator

This clause describes the use of the Multiple Frequency Band Indicator (MFBI) lists and the E-UTRA frequencies signalled in *SystemInformationBlockType5* by means of an example as shown in Figure D.1.2-1. In this example:

- E-UTRAN includes 4 frequencies (EARFCNs): the bands associated with f1 and f4 belong to bands lower than 64; the bands associated with f2 and f3 belong to bands larger than 64. The reserved EARFCN value of 65535 is used to indicate the presence of *ARFCN-ValueEUTRA-v9e0*.

- The band associated with f1 has two overlapping bands, B1 and B2 (lower than 64); the band associated with f2 has one overlapping band, B91; the band associated with f3 has four overlapping bands B3, B4, B92, and B93; the band associated with f4 does not have overlapping bands.
- E-UTRAN includes 4 lists in both *interFreqCarrierFreqList-v8h0* and *interFreqCarrierFreqList-v9e0* and ensure the order of the lists is matching. Each list corresponds to one EARFCN and contains up to 8 bands. The first list corresponds to f1, the second list corresponds to f2, and so on. The grey lists mean not including *MultiBandInfoList* or *MultiBandInfoList-v9e0*, i.e. the corresponding EARFCN does not have any overlapping frequency bands in *MultiBandInfoList* or *MultiBandInfoList-v9e0*.

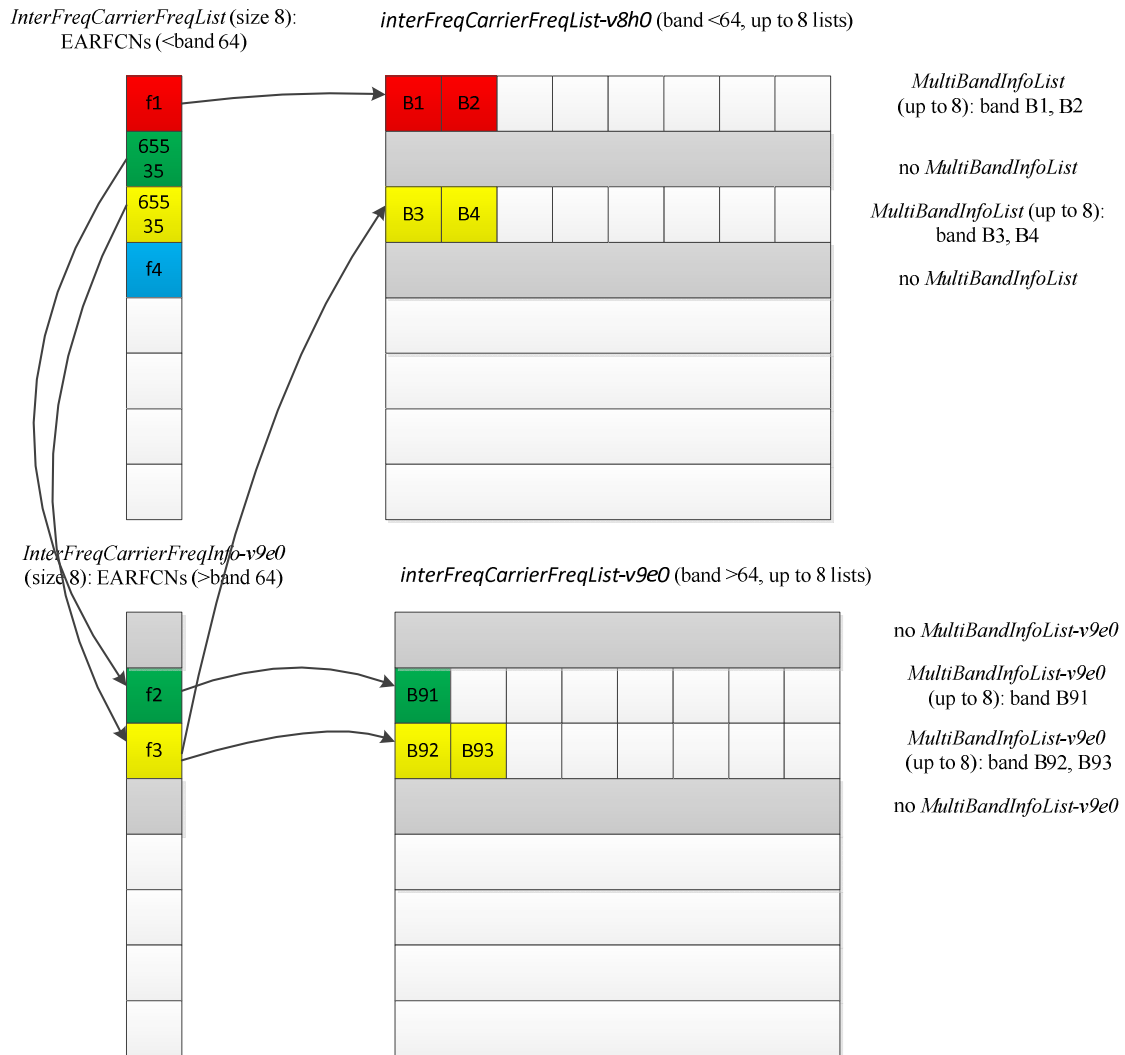

Figure D.1.2-1: Mapping of EARFCNs to MultiBandInfoList/MultiBandInfoList-v9e0

D.1.3 Mapping between UTRA FDD frequency list and multiple frequency band indicator

This clause describes the use of the Multiple Frequency Band Indicator (MFBI) lists and the UTRA FDD frequencies signalled in *SystemInformationBlockType6* by means of an example as shown in Figure D.1.3-1. In this example:

- E-UTRAN includes 4 UTRA FDD frequencies (UARFCNs).
- The bands associated with f1 and f4 have no overlapping bands. The band associated with f2 has two overlapping bands, B1 and B2. The band associated with f3 has one overlapping band, B3.
- E-UTRAN includes 4 lists in *carrierFreqListUTRA-FDD-v8h0* with the first and fourth entry not including *MultiBandInfoList*.

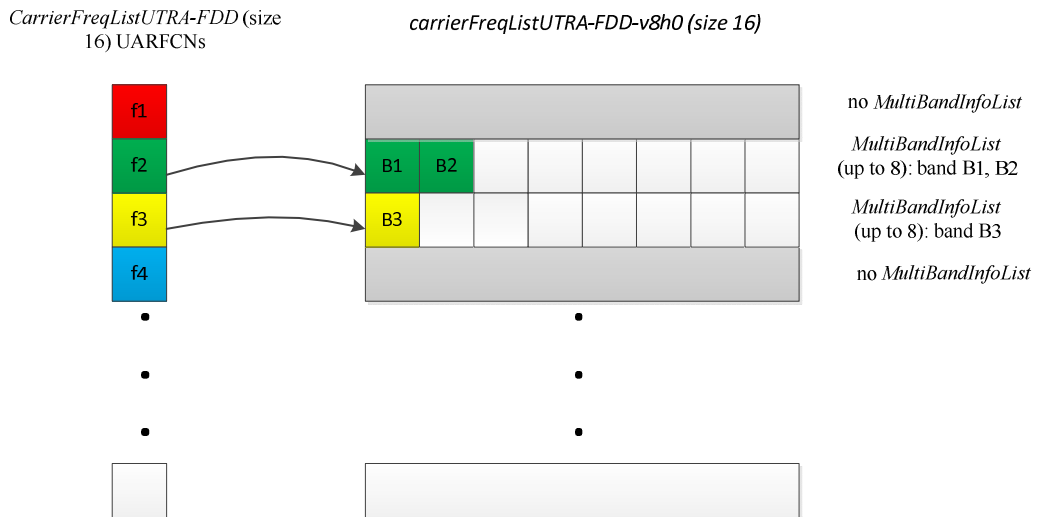

Figure D.1.3-1: Mapping of UARFCNs to *MultiBandInfoList*

Annex E (normative): TDD/FDD differentiation of FGIs/capabilities in TDD-FDD CA

Annex E specifies for which TDD and FDD serving cells a UE supporting TDD/FDD CA shall support a feature/capability for which it indicates support within the FGI/capability signalling.

A UE that indicates support for TDD/ FDD CA:

- For the fields for which the UE is allowed to indicate different support for FDD and TDD, the UE shall support the feature on the PCell and/or SCell(s), as specified in tables E-1, E-2 and E-3 in accordance to the following rules:
 - PCell: the UE shall support the feature for the PCell, if the UE indicates support of the feature for the PCell duplex mode;
 - SCell: the UE shall support the feature for SCell(s), if the UE indicates support of the feature for the SCell duplex mode;
 - Per serving cell: the UE shall support the feature for a serving cell if the UE indicates support of the feature for the serving cell's duplex mode;
 - All serving cells: UE shall support the feature if the UE indicates support of the feature for both TDD and FDD duplex modes;
- For the fields where the UE is not allowed to indicate different support for FDD and TDD, the UE shall support the feature for PCell and SCell(s) if the UE indicates support of the feature via the common FGI/capability bit.

Table E-1: Rel-8/9 FGIs for which FDD/TDD differentiation is allowed (from Annex B)

Index of indicator	Classification
1	Per serving cell
2	All serving cells
4	All serving cells
8	PCell
9	PCell
10	PCell
11	PCell
12	PCell
15	PCell
19	PCell
22	PCell
23	PCell
24	PCell
26	PCell
27	PCell
28	PCell
29	PCell
33	PCell
34	PCell
35	PCell
36	PCell
37	PCell
38	PCell
39	PCell
40	PCell
41	PCell

Table E-2: Rel-10 FGLs for which FDD/TDD differentiation is allowed (from Annex C)

Index of indicator	Classification
102	Per serving cell
103	Per serving cell
105	All serving cells
106	All serving cells
107	All serving cells
108	All serving cells
109	All serving cells
110	All serving cells
111	SCell
112	PCell
113	Per serving cell
115	PCell
116	Per serving cell

Table E-3: Rel-12 UE-EUTRA capabilities for which FDD/TDD differentiation is allowed

UE-EUTRA-Capability	Classification
crossCarrierScheduling	All serving cells
e-CSFB-1XRTT	PCell
e-CSFB-ConcPS-Mob1XRTT	PCell
e-CSFB-dual-1XRTT	PCell
ePDCCH	Per serving cell
e-RedirectionUTRA	PCell
e-RedirectionUTRA-TDD	PCell
inDeviceCoexInd	All serving cells
interFreqRSTD-Measurement	PCell
interFreqSI-AcquisitionForHO	PCell
interRAT-PS-HO-ToGERAN	PCell
intraFreqSI-AcquisitionForHO	PCell
mbms-Scell	SCell
mbms-NonServingCell	SCell
multiACK-CSlreporting	PCell
multiClusterPUSCH-WithinCC	Per serving cell
otdoa-UE-Assisted	PCell
pmi-Disabling	Per serving cell
rsrqMeasWideband	Per serving cell
simultaneousPUCCH-PUSCH	All serving cells
ss-CCH-InterfHandl	PCell
txDiv-PUCCH1b-ChSelect	PCell
ue-TxAntennaSelectionSupported	All serving cells
utran-SI-AcquisitionForHO	PCell

Annex F (normative): UE requirements on ASN.1 comprehension

This clause specifies UE requirements regarding the ASN.1 transfer syntax support i.e. the ASN.1 definitions to be comprehended by the UE.

A UE that indicates release X in field *accessStratumRelease* shall comprehend the entire transfer syntax (ASN.1) of release X, in particular at least the first version upon ASN.1 freeze. The UE is however not required to support dedicated signalling related transfer syntax associated with optional features it does not support.

In case a UE that indicates release X in field *accessStratumRelease* supports a feature specified in release X+ N (i.e. early UE implementation) additional requirements apply.

Critical extensions (dedicated signaling)

If the early implemented feature involves one or more critical extensions (i.e. case of dedicated signaling), the UE shall comprehend the parts of the transfer syntax (ASN.1) of release X+ N that are related to the feature implemented early. This in particular concerns the ASN.1 parts related to configuration of the feature. The UE obviously also has to support the ASN.1 parts related to indicating support of the feature (in UE capabilities).

If configuration of an early implemented feature introduced in release X+ N involves a message or field that has been critically extended, the UE shall support configuration of all features supported by the UE that are associated with sub-fields of this critical extension. Apart from the early implemented feature(s), the UE need however not support functionality beyond what is defined in the release the UE indicates in access stratum release.

Let's consider the example of a UE indicating value X in field *accessStratumRelease* that supports the features associated with fields A1, A3 and A5 of *InformationElementA* (see ASN.1 below). The feature implemented early is associated with field A5, and can only be configured by the -rX+N version of *InformationElementA*. In such case, the UE should support configuration of the features associated with fields A1, A3 and A5 by the -rX+N version of *InformationElementA*. If however one of the features was modified, e.g. the feature associated with *fieldA3*, E-UTRAN should assume the UE only supports the feature according to the release it indicated in field *accessStratumRelease* (X). I.e. UE is neither required to support the additional code-point (*n80-vX+N0*) nor the additional sub-field (*fieldA3a*).

```

InformationElementA-rX ::= SEQUENCE {
    fieldA1-rX          InformationElementA1-rX          OPTIONAL, -- Need ON
    fieldA2-rX          InformationElementA2-rX          OPTIONAL, -- Need OR
    fieldA3-rX          InformationElementA3-rX          OPTIONAL, -- Need OR
}

InformationElementA-rX+N ::= SEQUENCE {
    fieldA1-rX+N        InformationElementA1-rX          OPTIONAL, -- Need ON
    fieldA2-rX+N        InformationElementA2-rX          OPTIONAL, -- Need OR
    fieldA3-rX+N        InformationElementA3-rX+N        OPTIONAL, -- Need OR
    fieldA4-rX+N        InformationElementA4-rX+N        OPTIONAL, -- Need OR
    fieldA5-rX+N        InformationElementA5-rX+N        OPTIONAL, -- Need OR
}

InformationElementA3-rX+N ::= SEQUENCE {
    fieldA1a-rX+N      InformationElementA1a-rX          OPTIONAL, -- Need ON
    fieldA2a-rX+N      ENUMERATED {n10, n20, n40,
                                   n80-vX+N0}           OPTIONAL, -- Need OR
    fieldA3a-rX+N      InformationElementA3a-rX+N        OPTIONAL, -- Need OR
}

```

Non-critical extensions (broadcast signaling)

If the early implemented feature involves one or more non-critical extensions in broadcast signaling (i.e. system information), the UE shall comprehend the parts of the transfer syntax (ASN.1) of release X+ N that are related to the feature implemented early. The SIB(s) containing the release X+ N fields related to the early implemented features may also include other extensions concerning releases from X upto X+N. The UE shall comprehend such intermediate fields (but again is not required to support the functionality associated with these intermediate fields, in case this concerns optional features not supported by the UE).

Annex G (informative): Change history

Change history							
Date	TSG #	TSG Doc.	CR	Rev	Cat	Subject/Comment	New version
12/2007	RP-38	RP-070920	-			Approved at TSG-RAN #38 and placed under Change Control	8.0.0
03/2008	RP-39	RP-080163	0001	4		CR to 36.331 with Miscellaneous corrections	8.1.0
03/2008	RP-39	RP-080164	0002	2		CR to 36.331 to convert RRC to agreed ASN.1 format	8.1.0
05/2008	RP-40	RP-080361	0003	1		CR to 36.331 on Miscellaneous clarifications/ corrections	8.2.0
09/2008	RP-41	RP-080693	0005	-		CR on Miscellaneous corrections and clarifications	8.3.0
12/2008	RP-42	RP-081021	0006	-		Miscellaneous corrections and clarifications	8.4.0
03/2009	RP-43	RP-090131	0007	-		Correction to the Counter Check procedure	8.5.0
	RP-43	RP-090131	0008	-		CR to 36.331-UE Actions on Receiving SIB11	8.5.0
	RP-43	RP-090131	0009	1		Spare usage on BCCH	8.5.0
	RP-43	RP-090131	0010	-		Issues in handling optional IE upon absence in GERAN NCL	8.5.0
	RP-43	RP-090131	0011	-		CR to 36.331 on Removal of useless RLC re-establishment at RB release	8.5.0
	RP-43	RP-090131	0012	1		Clarification to RRC level padding at PCCH and BCCH	8.5.0
	RP-43	RP-090131	0013	-		Removal of Inter-RAT message	8.5.0
	RP-43	RP-090131	0014	-		Padding of the SRB-ID for security input	8.5.0
	RP-43	RP-090131	0015	-		Validity of ETWS SIB	8.5.0
	RP-43	RP-090131	0016	1		Configuration of the Two-Intervals-SPS	8.5.0
	RP-43	RP-090131	0017	-		Corrections on Scaling Factor Values of Qhyst	8.5.0
	RP-43	RP-090131	0018	1		Optionality of srsMaxUpts	8.5.0
	RP-43	RP-090131	0019	-		CR for discussion on field name for common and dedicated IE	8.5.0
	RP-43	RP-090131	0020	-		Corrections to Connected mode mobility	8.5.0
	RP-43	RP-090131	0021	-		Clarification regarding the measurement reporting procedure	8.5.0
	RP-43	RP-090131	0022	1		Corrections on s-Measure	8.5.0
	RP-43	RP-090131	0023	1		R1 of CR0023 (R2-091029) on combination of SPS and TTI bundling for TDD	8.5.0
	RP-43	RP-090131	0024	-		L3 filtering for path loss measurements	8.5.0
	RP-43	RP-090131	0025	1		S-measure handling for reportCGI	8.5.0
	RP-43	RP-090131	0026	1		Measurement configuration clean up	8.5.0
	RP-43	RP-090131	0027	-		Alignment of measurement quantities for UTRA	8.5.0
	RP-43	RP-090131	0028	-		CR to 36.331 on L1 parameters ranges alignment	8.5.0
	RP-43	RP-090131	0029	-		Default configuration for transmissionMode	8.5.0
	RP-43	RP-090131	0030	-		CR to 36.331 on RRC Parameters for MAC, RLC and PDCP	8.5.0
	RP-43	RP-090131	0031	1		CR to 36.331 - Clarification on Configured PRACH Freq Offset	8.5.0
	RP-43	RP-090131	0032	-		Clarification on TTI bundling configuration	8.5.0
	RP-43	RP-090131	0033	1		Update of R2-091039 on Inter-RAT UE Capability	8.5.0
	RP-43	RP-090133	0034	-		Feature Group Support Indicators	8.5.0
	RP-43	RP-090131	0036	-		Corrections to RLF detection	8.5.0
	RP-43	RP-090131	0037	-		Indication of Dedicated Priority	8.5.0
	RP-43	RP-090131	0038	2		Security Clean up	8.5.0
	RP-43	RP-090131	0039	-		Correction of TTT value range	8.5.0
	RP-43	RP-090131	0040	-		Correction on CDMA measurement result IE	8.5.0
	RP-43	RP-090131	0041	1		Clarification of Measurement Reporting	8.5.0
	RP-43	RP-090131	0042	-		Spare values in DL and UL Bandwidth in MIB and SIB2	8.5.0
	RP-43	RP-090131	0044	1		Clarifications to System Information Block Type 8	8.5.0
	RP-43	RP-090131	0045	-		Reception of ETWS secondary notification	8.5.0
	RP-43	RP-090131	0046	1		Validity time for ETWS message Id and Sequence No	8.5.0
	RP-43	RP-090131	0047	-		CR for Timers and constants values used during handover to E-UTRA	8.5.0
	RP-43	RP-090131	0048	-		Inter-RAT Security Clarification	8.5.0
	RP-43	RP-090131	0049	-		CR to 36.331 on consistent naming of 1xRTT identifiers	8.5.0
	RP-43	RP-090131	0050	-		Capturing RRC behavior regarding NAS local release	8.5.0
	RP-43	RP-090131	0051	-		Report CGI before T321 expiry and UE null reporting	8.5.0
	RP-43	RP-090131	0052	-		System Information and 3 hour validity	8.5.0
	RP-43	RP-090131	0053	1		Inter-Node AS Signalling	8.5.0
	RP-43	RP-090131	0054	-		Set of values for the parameter "messagePowerOffsetGroupB"	8.5.0
	RP-43	RP-090131	0055	-		CR to paging reception for ETWS capable UEs in RRC_CONNECTED	8.5.0
	RP-43	RP-090131	0056	1		CR for CSG related items in 36.331	8.5.0
	RP-43	RP-090131	0057	1		SRS common configuration	8.5.0
	RP-43	RP-090131	0058	-		RRC processing delay	8.5.0
	RP-43	RP-090131	0059	-		CR for HNB Name	8.5.0
	RP-43	RP-090131	0060	3		Handover to EUTRA delta configuration	8.5.0
	RP-43	RP-090131	0063	-		Delivery of Message Identifier and Serial Number to upper layers for ETWS	8.5.0
	RP-43	RP-090131	0066	-		Clarification on the maximum size of cell lists	8.5.0
	RP-43	RP-090131	0067	-		Missing RRC messages in 'Protection of RRC messages'	8.5.0

	RP-43	RP-090131	0069	1	Clarification on NAS Security Container	8.5.0
	RP-43	RP-090131	0071	-	Extension of range of CQI/PMI configuration index	8.5.0
	RP-43	RP-090131	0072	1	Access barring alleviation in RRC connection establishment	8.5.0
	RP-43	RP-090367	0077	6	Corrections to feature group support indicators	8.5.0
	RP-43	RP-090131	0078	-	CR from email discussion to capture DRX and TTT handling	8.5.0
	RP-43	RP-090131	0079	1	Need Code handling on BCCH messages	8.5.0
	RP-43	RP-090131	0080	-	Unification of T300 and T301 and removal of miscellaneous FFSs	8.5.0
	RP-43	RP-090131	0084	1	Proposed CR modifying the code-point definitions of neighbourCellConfiguration	8.5.0
	RP-43	RP-090131	0087	2	Remove Redundant Optionality in SIB8	8.5.0
	RP-43	RP-090131	0089	-	Corrections to the generic error handling	8.5.0
	RP-43	RP-090131	0090	-	Configurability of T301	8.5.0
	RP-43	RP-090131	0091	1	Correction related to TTT	8.5.0
	RP-43	RP-090131	0095	-	CR for 36.331 on SPS-config	8.5.0
	RP-43	RP-090131	0096	2	CR for Deactivation of periodical measurement	8.5.0
	RP-43	RP-090131	0099	2	SMC and reconfiguration	8.5.0
	RP-43	RP-090131	0101	-	TDD handover	8.5.0
	RP-43	RP-090131	0102	-	Corrections to system information acquisition	8.5.0
	RP-43	RP-090131	0106	-	Some Corrections and Clarifications to 36.331	8.5.0
	RP-43	RP-090131	0109	-	Clarification on the Maximum number of ROHC context sessions parameter	8.5.0
	RP-43	RP-090131	0110	-	Transmission of rrm-Config at Inter-RAT Handover	8.5.0
	RP-43	RP-090131	0111	1	Use of SameRefSignalsInNeighbor parameter	8.5.0
	RP-43	RP-090131	0112	-	Default serving cell offset for measurement event A3	8.5.0
	RP-43	RP-090131	0114	-	dl-EARFCN missing in HandoverPreparationInformation	8.5.0
	RP-43	RP-090131	0115	-	Cleanup of references to 36.101	8.5.0
	RP-43	RP-090131	0117	-	Correction to the value range of UE-Categories	8.5.0
	RP-43	RP-090131	0122	1	Correction on RRC connection re-establishment	8.5.0
	RP-43	RP-090131	0124	-	Performing Measurements to report CGI for CDMA2000	8.5.0
	RP-43	RP-090131	0125	-	CDMA2000-SystemTimeInfo in VarMeasurementConfiguration	8.5.0
	RP-43	RP-090131	0126	-	UE Capability Information for CDMA2000 1xRTT	8.5.0
	RP-43	RP-090131	0127	-	CDMA2000 related editorial changes	8.5.0
	RP-43	RP-090131	0128	-	Draft CR to 36.331 on State mismatch recovery at re-establishment	8.5.0
	RP-43	RP-090131	0129	1	Draft CR to 36.331 on Renaming of AC barring related IEs	8.5.0
	RP-43	RP-090131	0130	2	Draft CR to 36.331 on Inheriting of dedicated priorities at inter-RAT reselection	8.5.0
	RP-43	RP-090131	0135	-	Proposed CR to 36.331 Description alignment for paging parameter, nB	8.5.0
	RP-43	RP-090131	0139	2	Miscellaneous corrections and clarifications resulting from ASN.1 review	8.5.0
	RP-43	RP-090131	0141	1	Correction regarding Redirection Information fo GERAN	8.5.0
	RP-43	RP-090131	0142	-	Further ASN.1 review related issues	8.5.0
	RP-43	RP-090131	0143	-	Periodic measurements	8.5.0
	RP-43	RP-090131	0144	1	Further analysis on code point "OFF" for ri-ConfigIndex	8.5.0
	RP-43	RP-090131	0145	1	Adding and deleting same measurement or configuration in one message	8.5.0
	RP-43	RP-090131	0147	-	Corrections to IE dataCodingScheme in SIB11	8.5.0
	RP-43	RP-090131	0148	-	Clarification on Mobility from E-UTRA	8.5.0
	RP-43	RP-090131	0149	-	36.331 CR related to "not applicable"	8.5.0
	RP-43	RP-090131	0150	1	UE radio capability transfer	8.5.0
	RP-43	RP-090131	0151	-	CR to 36.331 on value of CDMA band classes	8.5.0
	RP-43	RP-090131	0152	-	Corrections to DRB modification	8.5.0
	RP-43	RP-090131	0153	-	Correction to presence condition for pdcp-config	8.5.0
	RP-43	RP-090131	0155	-	TDD HARQ-ACK feedback mode	8.5.0
	RP-43	RP-090275	0157	-	Corrections regarding use of carrierFreq for CDMA (SIB8) and GERAN (measObject)	8.5.0
	RP-43	RP-090321	0156	1	Sending of GERAN SI/PSI information at Inter-RAT Handover	8.5.0
	RP-43	RP-090339	0158	-	Clarification of CSG support	8.5.0
06/2009	RP-44	RP-090516	0159	-	Octet alignment of VarShortMAC-Input	8.6.0
	RP-44	RP-090516	0160	3	Minor corrections to the feature grouping	8.6.0
	RP-44	RP-090516	0161	-	Security clarification	8.6.0
	RP-44	RP-090516	0162	1	Sending of GERAN SI/PSI information at Inter-RAT Handover	8.6.0
	RP-44	RP-090516	0163	1	Correction of UE measurement model	8.6.0
	RP-44	RP-090516	0164	-	Restricting the reconfiguration of UM RLC SN field size	8.6.0
	RP-44	RP-090516	0165	1	36.331 CR on Clarification on cell change order from GERAN to E-UTRAN	8.6.0
	RP-44	RP-090516	0166	-	36.331 CR - Handling of expired TAT and failed D-SR	8.6.0
	RP-44	RP-090516	0167	1	Proposed CR to 36.331 Clarification on mandatory information in AS-Config	8.6.0
	RP-44	RP-090516	0168	2	Miscellaneous small corrections	8.6.0
	RP-44	RP-090516	0173	-	Clarification on the basis of delta signalling	8.6.0
	RP-44	RP-090516	0177	-	CR on Alignment of CCCH and DCCH handling of missing mandatory field	8.6.0
	RP-44	RP-090516	0180	2	Handling of Measurement Context During HO Preparation	8.6.0
	RP-44	RP-090516	0181	-	Clarification of key-eNodeB-Star in AdditionalReestabInfo	8.6.0
	RP-44	RP-090516	0182	1	UE Capability Transfer	8.6.0
	RP-44	RP-090516	0186	1	Clarification regarding mobility from E-UTRA in-between SMC and SRB2/DRB setup	8.6.0

	RP-44	RP-090516	0188	1		Correction and completion of specification conventions	8.6.0
	RP-44	RP-090516	0195	2		RB combination in feature group indicator	8.6.0
	RP-44	RP-090516	0196	1		CR for need code for fields in mobilityControllInfo	8.6.0
	RP-44	RP-090497	0197	-		Alignment of pusch-HoppingOffset with 36.211	8.6.0
	RP-44	RP-090570	0198	-		Explicit srb-Identity values for SRB1 and SRB2	8.6.0
	RP-44	RP-090516	0199	-		Removing use of defaultValue for mac-MainConfig	8.6.0
09/2009	RP-45	RP-090906	0200	-		Proposed update of the feature grouping	8.7.0
	RP-45	RP-090906	0201	-		Clarification on measurement object configuration for serving frequency	8.7.0
	RP-45	RP-090906	0202	-		Correction regarding SRVCC	8.7.0
	RP-45	RP-090906	0203	-		Indication of DRB Release during HO	8.7.0
	RP-45	RP-090906	0204	1		Correction regarding application of dedicated resource configuration upon handover	8.7.0
	RP-45	RP-090906	0205	-		REL-9 protocol extensions in RRC	8.7.0
	RP-45	RP-090906	0206	-		In-order delivery of NAS PDUs at RRC connection reconfiguration	8.7.0
	RP-45	RP-090906	0207	-		Correction on Threshold of Measurement Event	8.7.0
	RP-45	RP-090906	0210	-		Clarification on dedicated resource of RA procedure	8.7.0
	RP-45	RP-090906	0213	1		Cell barring when MasterInformationBlock or SystemInformationBlock1 is missing	8.7.0
	RP-45	RP-090915	0218	-		Security threat with duplicate detection for ETWS	8.7.0
	RP-45	RP-090906	0224	-		Clarification on supported handover types in feature grouping	8.7.0
	RP-45	RP-090906	0250	1		Handling of unsupported / non-comprehended frequency band and emission requirement	8.7.0
	RP-45	RP-090906	0251	-		RB combinations in feature group indicator 20	8.7.0
09/2009	RP-45	RP-090934	0220	1		Introduction of Per-QCI radio link failure timers (option 1)	9.0.0
	RP-45	RP-090926	0222	-		Null integrity protection algorithm	9.0.0
	RP-45	RP-090926	0223	-		Emergency Support Indicator in BCCH	9.0.0
	RP-45	RP-090934	0230	2		CR to 36.331 for Enhanced CSFB to 1xRTT with concurrent PS handover	9.0.0
	RP-45	RP-090934	0243	-		REL-9 on Miscellaneous editorial corrections	9.0.0
	RP-45	RP-090934	0247	-		Periodic CQI/PMI/RI masking	9.0.0
	RP-45	RP-090933	0252	-		Introduction of CMAS	9.0.0
12/2009	RP-46	RP-091346	0253	1		(Rel-9)-clarification on the description of redirectedCarrierInfo	9.1.0
	RP-46	RP-091346	0254	1		Adding references to RRC processing delay for inter-RAT mobility messages	9.1.0
	RP-46	RP-091314	0256	-		Alignment of srs-Bandwidth with 36.211	9.1.0
	RP-46	RP-091341	0257	5		Baseline CR capturing eMBMS agreements	9.1.0
	RP-46	RP-091343	0258	3		Capturing agreements on inbound mobility	9.1.0
	RP-46	RP-091314	0260	-		Clarification of preRegistrationZoneID/secondaryPreRegistrationZoneID	9.1.0
	RP-46	RP-091346	0261	-		Clarification on NCC for IRAT HO	9.1.0
	RP-46	RP-091314	0263	-		Clarification on P-max	9.1.0
	RP-46	RP-091314	0265	1		Clarification on the definition of maxCellMeas	9.1.0
	RP-46	RP-091346	0266	-		Correction of q-RxLevMin reference in SIB7	9.1.0
	RP-46	RP-091346	0267	-		Correction on SPS-Config field descriptions	9.1.0
	RP-46	RP-091346	0268	1		correction on the definition of CellsTriggeredList	9.1.0
	RP-46	RP-091345	0269	-		Correction relating to CMAS UE capability	9.1.0
	RP-46	RP-091314	0271	1		Feature grouping bit for SRVCC handover	9.1.0
	RP-46	RP-091314	0272	1		Correction and completion of extension guidelines	9.1.0
	RP-46	RP-091344	0273	-		RACH optimization Stage-3	9.1.0
	RP-46	RP-091345	0274	-		Stage 3 correction for CMAS	9.1.0
	RP-46	RP-091346	0276	1		SR prohibit mechanism for UL SPS	9.1.0
	RP-46	RP-091346	0277	-		Parameters used for enhanced 1xRTT CS fallback	9.1.0
	RP-46	RP-091346	0281	-		Correction on UTRAN UE Capability transfer	9.1.0
	RP-46	RP-091346	0285	-		Maximum number of CDMA2000 neighbors in SIB8	9.1.0
	RP-46	RP-091340	0288	1		Introduction of UE Rx-Tx Time Difference measurement	9.1.0
	RP-46	RP-091346	0297	-		Introduction of SR prohibit timer	9.1.0
	RP-46	RP-091346	0298	-		Remove FFSs from RAN2 specifications	9.1.0
	RP-46	RP-091343	0301	1		Renaming Allowed CSG List (36.331 Rel-9)	9.1.0
	RP-46	RP-091346	0305	-		Re-introduction of message segment discard time	9.1.0
	RP-46	RP-091346	0306	1		Application of ASN.1 extension guidelines	9.1.0
	RP-46	RP-091346	0309	1		Support for Dual Radio 1xCsFB	9.1.0
	RP-46	RP-091346	0311	-		Shorter SR periodicity	9.1.0
	RP-46	RP-091342	0316	-		CR to 36.331 for Introduction of Dual Layer Transmission	9.1.0
	RP-46	RP-091343	0318	1		Draft CR to 36.331 on Network ordered SI reporting	9.1.0
	RP-46	RP-091346	0322	-		UE e1xcfsb capabilities correction	9.1.0
	RP-46	RP-091331	0327	1		Clarification on coding of ETWS related IEs	9.1.0
03/2010	RP-47	RP-100285	0331	-		Clarification of CGI reporting	9.2.0
	RP-47	RP-100305	0332	-		Clarification on MCCH change notification	9.2.0
	RP-47	RP-100308	0333	-		Clarification on measurement for serving cell only	9.2.0
	RP-47	RP-100306	0334	-		Clarification on proximity indication configuraiton in handover to E-UTRA	9.2.0
	RP-47	RP-100308	0335	-		Clarification on radio resource configuration in handover to E-UTRA procedure	9.2.0
	RP-47	RP-100308	0336	-		Clarification on UE maximum transmission power	9.2.0
	RP-47	RP-100308	0337	-		Correction to field descriptions of UE-EUTRA-Capability	9.2.0
	RP-47	RP-100305	0338	-		Correction to MBMS scheduling terminology	9.2.0

	RP-47	RP-100308	0339	-		Corrections to SIB8	9.2.0
	RP-47	RP-100306	0340	-		CR 36.331 R9 for Unifying SI reading for ANR and inbound mobility	9.2.0
	RP-47	RP-100308	0341	1		CR to 36.331 for 1xRTT pre-registration information in SIB8	9.2.0
	RP-47	RP-100305	0342	-		CR to 36.331 on corrections for MBMS	9.2.0
	RP-47	RP-100306	0343	1		CR to 36.331 on CSG identity reporting	9.2.0
	RP-47	RP-100308	0344	2		CR to 36.331 on Optionality of Rel-9 UE features	9.2.0
	RP-47	RP-100308	0345	1		CR to 36.331 on Service Specific Acces Control (SSAC)	9.2.0
	RP-47	RP-100308	0346	-		Introduction of power-limited device indication in UE capability.	9.2.0
	RP-47	RP-100305	0347	-		Missing agreement in MCCH change notification.	9.2.0
	RP-47	RP-100305	0348	1		Corrections related to MCCH change notification and value ranges	9.2.0
	RP-47	RP-100306	0349	2		Prohibit timer for proximity indication	9.2.0
	RP-47	RP-100306	0350	1		Proximity Indication after handover and re-establishment	9.2.0
	RP-47	RP-100305	0351	-		Specifying the exact mapping of notificationIndicator in SIB13 to PDCCH bits	9.2.0
	RP-47	RP-100308	0352	-		Corrections out of ASN.1 review scope	9.2.0
	RP-47	RP-100308	0353	-		CR on clarification of system information change	9.2.0
	RP-47	RP-100285	0358	-		Measurement Result CDMA2000 Cell	9.2.0
	RP-47	RP-100304	0361	-		Correction on the range of UE Rx-Tx time difference measurement result	9.2.0
	RP-47	RP-100305	0362	-		Small clarifications regarding MBMS	9.2.0
	RP-47	RP-100308	0363	-		Introduction of REL-9 indication within field accessStratumRelease	9.2.0
	RP-47	RP-100306	0364	-		Extending mobility description to cover inbound mobility	9.2.0
	RP-47	RP-100308	0365	1		Clarification regarding enhanced CSFB to 1XRTT	9.2.0
	RP-47	RP-100308	0368	-		Handling of dedicated RLF timers	9.2.0
	RP-47	RP-100305	0370	1		Clarification on UE's behavior of receiving MBMS service	9.2.0
	RP-47	RP-100305	0371	-		MBMS Service ID and Session ID	9.2.0
	RP-47	RP-100305	0372	1		Inclusion of non-MBSFN region length in SIB13	9.2.0
	RP-47	RP-100309	0374	1		CR to 36.331 for e1xCsfb access class barring parameters in SIB8	9.2.0
	RP-47	RP-100308	0375	-		Multiple 1xRTT/HRPD target cells in MobilityFromEUTRACommand	9.2.0
	RP-47	RP-100308	0376	-		Independent support indicators for Dual-Rx CSFB and S102 in SIB8	9.2.0
	RP-47	RP-100285	0378	-		Clarification on DRX StartOffset for TDD	9.2.0
	RP-47	RP-100308	0379	1		Miscellaneous corrections from REL-9 ASN.1 review	9.2.0
	RP-47	RP-100308	0381	-		Need codes and missing conventions	9.2.0
	RP-47	RP-100308	0383	1		Introduction of Full Configuration Handover for handling earlier eNB releases	9.2.0
	RP-47	RP-100308	0385	-		Clarification to SFN reference in RRC	9.2.0
	RP-47	RP-100308	0390	-		RSRP and RSRQ based Thresholds	9.2.0
	RP-47	RP-100189	0392	3		Redirection enhancements to GERAN	9.2.0
	RP-47	RP-100308	0398	-		Cell reselection enhancements CR for 36.331	9.2.0
	RP-47	RP-100307	0401	3		CR on UE-originated RLF reporting for MRO SON use case	9.2.0
	RP-47	RP-100309	0402	3		CR to 36.331 on Redirection enhancements to UTRAN	9.2.0
	RP-47	RP-100306	0403	2		Proximity status indication handling at mobility	9.2.0
	RP-47	RP-100305	0404	-		Upper layer aspect of MBSFN area id	9.2.0
	RP-47	RP-100308	0405	-		Redirection for enhanced 1xRTT CS fallback with concurrent PSHO	9.2.0
	RP-47	RP-100301	0406	-		Avoiding interleaving transmission of CMAS notifications	9.2.0
	RP-47	RP-100308	0407	1		Introduction of UE GERAN DTM capability indicator	9.2.0
	RP-47	RP-100381	0408	2		Introducing provisions for late ASN.1 corrections	9.2.0
	RP-47	RP-100245	0411	-		Correction/ alignment of REL-9 UE capability signalling	9.2.0
06/2010	RP-48	RP-100553	0412	-		Clarification for mapping between warning message and CB-data	9.3.0
	RP-48	RP-100556	0413	-		Clarification of radio link failure related actions	9.3.0
	RP-48	RP-100554	0414	-		Clarification on UE actions upon leaving RRC_CONNECTED	9.3.0
	RP-48	RP-100553	0415	-		Correction on CMAS system information	9.3.0
	RP-48	RP-100554	0416	1		Corrections to MBMS	9.3.0
	RP-48	RP-100536	0418	-		Decoding of unknown future extensions	9.3.0
	RP-48	RP-100556	0419	1		Miscellaneous small corrections and clarifications	9.3.0
	RP-48	RP-100551	0420	-		Prohibit timer for proximity indication	9.3.0
	RP-48	RP-100556	0421	-		RLF report for MRO correction	9.3.0
	RP-48	RP-100546	0423	1		Missing UTRA bands in IRAT-ParametersUTRA-FDD	9.3.0
	RP-48	RP-100556	0424	-		Correction on handling of dedicated RLF timers	9.3.0
	RP-48	RP-100556	0431	1		Protection of RRC messages	9.3.0
	RP-48	RP-100556	0433	-		Handling missing Essential system information	9.3.0
	RP-48	RP-100551	0434	1		Clarification on UMTS CSG detected cell reporting in LTE	9.3.0
	RP-48	RP-100556	0436	-		Introducing provisions for late corrections	9.3.0
	RP-48	RP-100556	0437	-		Clarification regarding / alignment of REL-9 UE capabilities	9.3.0
09/2010	RP-49	RP-100845	0440	-		Correction to 3GPP2 reference for interworking with cdma2000 1x	9.4.0
	RP-49	RP-100851	0441	-		Clarification on UL handover preparation transfer	9.4.0
	RP-49	RP-100851	0442	1		Clarifications regarding fullConfiguration	9.4.0
	RP-49	RP-100851	0443	-		Clarifications regarding handover to E-UTRAN	9.4.0
	RP-49	RP-100854	0444	-		Correction on the table of conditionally mandatory Release 9 features	9.4.0
	RP-49	RP-100851	0445	-		Corrections to TS36.331 on MeasConfig IE	9.4.0
	RP-49	RP-100853	0446	2		CR to 36.331 on clarification for MBMS PTM RBs	9.4.0
	RP-49	RP-100851	0447	-		Introduction of late corrections container for E-UTRA UE capabilities	9.4.0
	RP-49	RP-100851	0448	-		Renaming of containers for late non-critical extensions	9.4.0
	RP-49	RP-100851	0452	-		Clarifications Regarding Redirection from LTE	9.4.0

	RP-49	RP-100845	0456	-	Description of multi-user MIMO functionality in feature group indicator table	9.4.0
	RP-49	RP-100845	0458	-	Correct the PEMAX_H to PEMAX	9.4.0
	RP-49	RP-100851	0460	-	Clarification for feature group indicator bit 11	9.4.0
	RP-49	RP-100851	0465	1	Clarification of FGI setting for inter-RAT features not supported by the UE	9.4.0
	RP-49	RP-101008	0475	1	FGI settings in Rel-9	9.4.0
12/2010	RP-50	RP-101197	0483	-	Clarification on Meaning of FGI Bits	9.5.0
	RP-50	RP-101197	0485	-	Clarification regarding reconfiguration of the quantityConfig	9.5.0
	RP-50	RP-101210	0486	1	Corrections to the presence of IE regarding DRX and CQI	9.5.0
	RP-50	RP-101210	0493	-	The field descriptions of MeasObjectEUTRA	9.5.0
	RP-50	RP-101197	0498	1	Clarification of FGI settings non ANR periodical measurement reporting	9.5.0
	RP-50	RP-101209	0500	-	Corrections to RLF Report	9.5.0
	RP-50	RP-101206	0519	1	T321 timer fix	9.5.0
	RP-50	RP-101197	0524	-	Restriction of AC barring parameter setting	9.5.0
	RP-50	RP-101210	0525	-	Removal of SEQUENCE OF SEQUENCE in UEInformationResponse	9.5.0
	RP-50	RP-101197	0526	1	Clarification regarding default configuration value N/A	9.5.0
	RP-50	RP-101431	0532	-	Splitting FGI bit 3	9.5.0
	RP-50	RP-101183	0476	4	36.331 CR on Introduction of Minimization of Drive Tests	10.0.0
	RP-50	RP-101293	0477	4	AC-Barring for Mobile Originating CSFB call	10.0.0
	RP-50	RP-101214	0478	-	Addition of UE-EUTRA-Capability descriptions	10.0.0
	RP-50	RP-101214	0481	-	Clarification on Default Configuration for CQI-ReportConfig	10.0.0
	RP-50	RP-101215	0487	-	CR to 36.331 adding e1xCsFB support for dual Rx/Tx UE	10.0.0
	RP-50	RP-101227	0488	1	Introduction of Carrier Aggregation and UL/ DL MIMO	10.0.0
	RP-50	RP-101228	0489	1	Introduction of relays in RRC	10.0.0
	RP-50	RP-101214	0490	1	Priority indication for CSFB with re-direction	10.0.0
	RP-50	RP-101214	0491	-	SIB Size Limitations	10.0.0
	RP-50	RP-101214	0513	-	Combined Quantity Report for IRAT measurement of UTRAN	10.0.0
	RP-50	RP-101214	0527	1	UE power saving and Local release	10.0.0
	RP-50	RP-101429	0530	1	Inclusion of new UE categories in Rel-10	10.0.0
03/2011	RP-51	RP-110282	0533	-	36331_CRxxx_Protection of Logged Measurements Configuration	10.1.0
	RP-51	RP-110294	0534	1	Stage-3 CR for MBMS enhancement	10.1.0
	RP-51	RP-110282	0535	-	Clean up MDT-related text	10.1.0
	RP-51	RP-110282	0536	-	Clear MDT configuration and logs when the UE is not registered	10.1.0
	RP-51	RP-110280	0537	-	Correction to the field description of nB	10.1.0
	RP-51	RP-110289	0538	-	CR on impact on UP with remove&add approach_2	10.1.0
	RP-51	RP-110282	0539	-	CR to 36.331 on corrections for MDT	10.1.0
	RP-51	RP-110290	0543	-	Introduction of CA/MIMO capability signalling and measurement capability signalling in CA	10.1.0
	RP-51	RP-110282	0544	-	MDT PDU related clarifications	10.1.0
	RP-51	RP-110282	0545	-	Correction on release of logged measurement configuration while in another RAT	10.1.0
	RP-51	RP-110289	0546	-	Miscellaneous Corrections for CA Running RRC CR	10.1.0
	RP-51	RP-110280	0547	1	Miscellaneous small clarifications and corrections	10.1.0
	RP-51	RP-110293	0548	4	Necessary changes for RLF reporting enhancements	10.1.0
	RP-51	RP-110282	0549	1	Memory size for logged measurements capable UE	10.1.0
	RP-51	RP-110289	0550	-	Parameters confusion of non-CA and CA configurations	10.1.0
	RP-51	RP-110272	0553	-	Presence condition for cellSelectionInfo-v920 in SIB1	10.1.0
	RP-51	RP-110282	0554	1	Removal of MDT configuration at T330 expiry	10.1.0
	RP-51	RP-110289	0556	1	Signalling aspects of existing LTE-A parameters	10.1.0
	RP-51	RP-110280	0557	1	Some Corrections on measurement	10.1.0
	RP-51	RP-110291	0558	-	Stored system information for RNs	10.1.0
	RP-51	RP-110291	0559	-	Support of Integrity Protection for Relay	10.1.0
	RP-51	RP-110290	0561	2	Updates of L1 parameters for CA and UL/DL MIMO	10.1.0
	RP-51	RP-110291	0571	1	Note for Dedicated SIB for RNs	10.1.0
	RP-51	RP-110272	0579	-	Correction to cs-fallbackIndicator field description	10.1.0
	RP-51	RP-110289	0580	-	Clarification to the default configuration of sCellDeactivationTimer	10.1.0
	RP-51	RP-110289	0581	-	Miscellaneous corrections to TS 36.331 on Carrier Aggregation	10.1.0
	RP-51	RP-110280	0584	-	Correction of configuration description in SIB2	10.1.0
	RP-51	RP-110265	0587	-	Clarification of band indicator in handover from E-UTRAN to GERAN	10.1.0
	RP-51	RP-110285	0588	1	36331_CRxxx Support of Delay Tolerant access requests	10.1.0
	RP-51	RP-110292	0590	-	Update of R2-110807 on CSI measurement resource restriction for time domain ICIC	10.1.0
	RP-51	RP-110292	0591	-	Update of R2-110821 on RRM/RLM resource restriction for time domain ICIC	10.1.0
	RP-51	RP-110290	0592	-	Corrections on UE capability related parameters	10.1.0
	RP-51	RP-110282	0596	-	Validity time for location information in Immediate MDT	10.1.0
	RP-51	RP-110280	0597	-	CR to 36.331 adding UE capability indicator for dual Rx/Tx e1xCsFB	10.1.0
	RP-51	RP-110289	0598	-	Miscellaneous corrections to CA	10.1.0
	RP-51	RP-110280	0599	-	Further correction to combined measurement report of UTRAN	10.1.0
	RP-51	RP-110280	0600	-	Correction to the reference of ETWS	10.1.0
	RP-51	RP-110269	0602	1	Introduction of OTDOA inter-freq RSTD measurement indication procedure	10.1.0
	RP-51	RP-110280	0603	-	Correction of use of RRCConnectionReestablishment message for contention resolution	10.1.0
	RP-51	RP-110282	0604	-	CR to 36.331 on MDT neighbour cell measurements logging	10.1.0

	RP-51	RP-110272	0609	-		Minor ASN.1 corrections for the UEInformationResponse message	10.1.0
	RP-51	RP-110280	0613	-		Clarification regarding dedicated RLF timers and constants	10.1.0
	RP-51	RP-110282	0615	-		Release of Logged Measurement Configuration	10.1.0
	RP-51	RP-110280	0616	-		Some corrections on TS 36.331	10.1.0
	RP-51	RP-110280	0623	-		AC barring procedure clean up	10.1.0
	RP-51	RP-110282	0624	-		Counter proposal to R2-110826 on UE capabilities for MDT	10.1.0
	RP-51	RP-110280	0628	1		UE information report for RACH	10.1.0
	RP-51	RP-110289	0629	2		Measurement on the deactivated SCells	10.1.0
	RP-51	RP-110282	0632	1		Trace configuration parameters for Logged MDT	10.1.0
	RP-51	RP-110282	0635	-		Clarification on stop condition for timer T3330	10.1.0
	RP-51	RP-110282	0637	-		User consent for MDT	10.1.0
	RP-51	RP-110280	0638	-		Correction on the range of CQI resource index	10.1.0
	RP-51	RP-110272	0640	1		Small corrections to ETWS & CMAS system information	10.1.0
	RP-51	RP-110290	0641	1		UE capability signaling structure w.r.t carrier aggregation, MIMO and measurement gap	10.1.0
	RP-51	RP-110289	0642	1		Normal PHR and the multiple uplink carriers	10.1.0
	RP-51	RP-110280	0643	1		Corrections to TS36.331 on SIB2 handling	10.1.0
	RP-51	RP-110280	0644	1		Adding a Power Management indication in PHR	10.1.0
	RP-51	RP-110289	0646	1		Clarification for CA and TTI bundling in RRC	10.1.0
	RP-51	RP-110443	0648	1		Updates to FGI settings	10.1.0
06/2011	RP-52	RP-110836	0651	-		Add MBMS counting procedure to processing delay requirement for RRC procedure Clause 11.2	10.2.0
	RP-52	RP-110830	0653	-		Add pre Rel-10 procedures to processing delay requirement for RRC procedure Clause 11.2	10.2.0
	RP-52	RP-110847	0654	1		Addition of a specific reference for physical configuration fields	10.2.0
	RP-52	RP-110839	0656	-		Clarification of inter-frequency RSTD measurement indication procedure	10.2.0
	RP-52	RP-110830	0658	-		Clarification of optionality of UE features without capability	10.2.0
	RP-52	RP-110839	0660	-		Clarification on the definition of maxCellBlack	10.2.0
	RP-52	RP-110839	0661	-		Clarification on upper layer requested connection release	10.2.0
	RP-52	RP-110850	0662	3		Clarification regarding eICIC measurements	10.2.0
	RP-52	RP-110839	0663	-		CR for s-measure handling	10.2.0
	RP-52	RP-110851	0664	1		CR on clarification of RLF Report in Carrier Aggregation	10.2.0
	RP-52	RP-110830	0669	-		FGI bit for handover between LTE FDD/TDD	10.2.0
	RP-52	RP-110847	0670	2		Further updates on L1 parameters	10.2.0
	RP-52	RP-110839	0671	2		General error handling for extension fields	10.2.0
	RP-52	RP-110851	0672	2		Additional information for RLF report	10.2.0
	RP-52	RP-110843	0673	-		Introduction of TCE ID for logged MDT	10.2.0
	RP-52	RP-110670	0674	4		Miscellaneous corrections (related to review in preparation for ASN.1 freeze)	10.2.0
	RP-52	RP-110843	0675	-		PLMN check for MDT logging	10.2.0
	RP-52	RP-110839	0677	-		UE actions upon leaving RRC_CONNECTED	10.2.0
	RP-52	RP-110847	0678	-		Clarification on bandEUTRA-r10 and supportedBandListEUTRA	10.2.0
	RP-52	RP-110837	0679	-		Updated value range for the Extended Wait Timer	10.2.0
	RP-52	RP-110839	0680	1		Value range of DRX-InactivityTimer	10.2.0
	RP-52	RP-110828	0693	1		Correction for SR-VCC and QCI usage	10.2.0
	RP-52	RP-110847	0694	-		Restructuring of CQI-ReportConfig-r10	10.2.0
	RP-52	RP-110839	0695	2		Correction on DL allocations in MBSFN subframes	10.2.0
	RP-52	RP-110850	0700	-		Reference SFN for MeasSubframePattern	10.2.0
	RP-52	RP-110846	0701	-		Clarifications to CA related field descriptions	10.2.0
	RP-52	RP-110847	0702	-		Corrections to codebookSubsetRestriction and SRS parameters	10.2.0
	RP-52	RP-110834	0704	-		Corrections to the handling of ri-ConfigIndex for TM9	10.2.0
	RP-52	RP-110715	0710	2		UE capabilities for Rel-10 LTE features with eICIC measurement restrictions as FGI (Alt.1)	10.2.0
	RP-52	RP-110839	0713	-		CR to 36.331 on redirected ultra-TDD carrier frequency	10.2.0
	RP-52	RP-110839	0714	-		Explicit AS signalling for mapped PTMSI/GUTI	10.2.0
	RP-52	RP-110847	0718	-		Counter proposal for Updates of mandatory information in AS-Config	10.2.0
	RP-52	RP-110839	0719	-		CR for Reconfiguration of discardTimer in PDCP-Config	10.2.0
	RP-52	RP-110847	0723	-		On the missing multiplicity of UE capability parameters	10.2.0
	RP-52	RP-110830	0735	-		Radio frame alignment of CSA and MSP	10.2.0
	RP-52	RP-110847	0740	-		Reconfiguration involving critically extended IEs (using fullFieldConfig i.e. option 2)	10.2.0
	RP-52	RP-110839	0744	-		Counter proposal to R2-112753 on CR to remove CSG Identity validity limited to CSG cell	10.2.0
	RP-52	RP-110839	0746	1		Increase of prioritisedBitRate	10.2.0
	RP-52	RP-110847	0747	-		CA and MIMO Capabilities in LTE Rel-10	10.2.0
09/2011	RP-53	RP-111297	0752	-		TS36.331 Correction	10.3.0
	RP-53	RP-111297	0754	-		maxNumberROHC-ContextSessions when no ROHC profile is supported	10.3.0
	RP-53	RP-111280	0757	-		Correction to Subframe Allocation End in PMCH-Info	10.3.0
	RP-53	RP-111288	0761	-		Correction on PUCCH configuration for Un interface	10.3.0
	RP-53	RP-111297	0762	-		Miscellaneous corrections to 36.331	10.3.0
	RP-53	RP-111278	0764	2		36.331 correction on CSG identity validity to allow introduction of CSG RAN sharing	10.3.0
	RP-53	RP-111283	0770	2		AdditionalSpectrumEmissions in CA	10.3.0
	RP-53	RP-111297	0773	-		CR to 36.331 on Small correction of PHR parameter	10.3.0

	RP-53	RP-111283	0775	2		Clarifications to P-max on CA	10.3.0
	RP-53	RP-111280	0784	-		Clarification on for which subframes signalling MCS applies	10.3.0
	RP-53	RP-111283	0792	-		Corrections in RRC	10.3.0
	RP-53	RP-111297	0793	-		Replace the tables with exception list in 10.5 AS-Config	10.3.0
	RP-53	RP-111297	0796	-		Corrections to the field descriptions	10.3.0
	RP-53	RP-111283	0798	-		Configuration of simultaneous PUCCH&PUSCH	10.3.0
	RP-53	RP-111297	0806	-		Corrections to release of csi-SubframePatternConfig and cqi-Mask	10.3.0
	RP-53	RP-111272	0810	-		GERAN SI format for cell change order&PS handover& enhanced redirection to GERAN	10.3.0
	RP-53	RP-111283	0811	-		Corrections to PUCCH-Config field descriptions	10.3.0
12/2011	RP-54	RP-111711	0812	1		Clarification of PCI range for CSG cells	10.4.0
	RP-54	RP-111716	0813	-		Clarifications to Default Radio Configurations	10.4.0
	RP-54	RP-111716	0814	1		Corrections to enhancedDualLayerTDD	10.4.0
	RP-54	RP-111716	0815	-		Miscellaneous small corrections	10.4.0
	RP-54	RP-111716	0816	1		Correction on notation of SRS transmission comb	10.4.0
	RP-54	RP-111706	0823	1		36.331 CR SPS reconfiguration	10.4.0
	RP-54	RP-111716	0827	2		Clarification of list sizes in measurement configuration stored by UE	10.4.0
	RP-54	RP-111706	0835	-		Clarification of the event B1 and ANR related FGI bits	10.4.0
	RP-54	RP-111714	0840	1		Clarification on MBSFN and measurement resource restrictions	10.4.0
	RP-54	RP-111706	0845	-		Clarification on parallel message transmission upon connection re-establishment	10.4.0
03/2012	RP-55	RP-120326	0855	1		Limiting MBMS counting responses to within the PLMN	10.5.0
	RP-55	RP-120321	0857	-		CR to 36.331 on cdma2000 band classes and references	10.5.0
	RP-55	RP-120326	0862	1		Clarification on MBSFN and measurement resource restrictions	10.5.0
	RP-55	RP-120325	0871	-		On SIB10/11 Reception Timing	10.5.0
	RP-55	RP-120326	0875	1		Clarification on MBMS counting for uncipherable services	10.5.0
	RP-55	RP-120325	0876	-		Minor correction regarding limited service access on non-CSG-member cell	10.5.0
	RP-55	RP-120326	0894	-		Time to keep RLF Reporting logs	10.5.0
	RP-55	RP-120356	0895	1		Introducing means to signal different FDD/TDD Capabilities/FGIs for Dual-xDD UE	10.5.0
	RP-55	RP-120321	0899	-		Clarification on SRB2 resumption upon connection re-establishment (parallel message transmission)	10.5.0
	RP-55	RP-120321	0900	1		Duplicated ASN.1 naming correction	10.5.0
06/2012	RP-56	RP-120805	0909	-		SPS Reconfiguration	10.6.0
	RP-56	RP-120805	0912	1		Change in Scheduling Information for ETWS	10.6.0
	RP-56	RP-120807	0914	-		Clarification of mch-SchedulingPeriod configuration	10.6.0
	RP-56	RP-120808	0916	1		Change in Scheduling Information for CMAS	10.6.0
	RP-56	RP-120814	0919	1		Introducing means to signal different REL-10 FDD/TDD Capabilities/FGIs for Dual-xDD UE	10.6.0
	RP-56	RP-120812	0920	1		Clarification on setting of dedicated NS value for CA by E-UTRAN	10.6.0
	RP-56	RP-120808	0931	-		T321 value for UTRA SI acquisition	10.6.0
	RP-56	RP-120813	0957	1		Korean Public Alert System (KPAS) in relation to CMAS	10.6.0
	RP-56	RP-120812	0969	1		Introduction of supported bandwidth combinations for CA	10.6.0
	RP-56	RP-120734	0970	1		Introduction of multiple frequency band indicator	10.6.0
	RP-56	RP-120825	0934	-		Introduction of a new security algorithm ZUC	11.0.0
	RP-56	RP-120813	0973	1		EU-Alert in relation to CMAS	11.0.0
09/2012	RP-57	RP-121371	0982	1		Introduction of EAB	11.1.0
	RP-57	RP-121381	0990	-		Additional special subframe configuration related correction	11.1.0
	RP-57	RP-121423	1000	4		36.331 CR introducing In-Device Coexistence (IDC)	11.1.0
	RP-57	RP-121359	1008	-		Voice support Capabilities	11.1.0
	RP-57	RP-121361	1013	-		Differentiating UTRAN modes in FGIs	11.1.0
	RP-57	RP-121368	1022	1		Introduction of absolute priority based measurements and reselection in CELL_FACH State in 36.331	11.1.0
	RP-57	RP-121370	1024	-		Introducing MDT enhancements for REL-11	11.1.0
	RP-57	RP-121349	1025	2		Introducing Carrier aggregation enhancements for REL-11	11.1.0
	RP-57	RP-121375	1026	-		Introducing MBMS enhancements for REL-11	11.1.0
	RP-57	RP-121376	1052	2		Signaling support for CRS interference management in eICIC	11.1.0
	RP-57	RP-121395	1055	-		CR on scell measurement cycle	11.1.0
	RP-57	RP-121395	1056	-		CR on measurement report	11.1.0
	RP-57	RP-121378	1057	3		Introduction of 'Power preference indication'	11.1.0
	RP-57	RP-121280	1060	-		Correction for PUCCH/SRS Release	11.1.0
12/2012	RP-58	RP-121933	1063	-		Correction related to differentiating UTRAN modes in FGIs	11.2.0
	RP-58	RP-121936	1065	-		Processing delay for RRCConnectionReconfiguration	11.2.0
	RP-58	RP-121953	1066	2		Addition of the stage-3 agreements on IDC	11.2.0
	RP-58	RP-121951	1067	3		Carrier Aggregation Enhancement RAN1 parameters	11.2.0
	RP-58	RP-121957	1068	1		Clarification of SR period	11.2.0
	RP-58	RP-121957	1069	1		Clarification on HandoverCommand message	11.2.0
	RP-58	RP-121957	1070	-		Clarification on mobility related issues	11.2.0
	RP-58	RP-121946	1071	1		Correction of the signaling for Uncertainty and Confidence	11.2.0
	RP-58	RP-121940	1072	2		Corrections to MBMS Service Continuity	11.2.0
	RP-58	RP-121940	1073	-		CR to 36.331 on SIB15 acquisition	11.2.0
	RP-58	RP-121957	1074	1		Handling of 1xCsFB failure	11.2.0

	RP-58	RP-121957	1075	-	Miscellaneous corrections	11.2.0
	RP-58	RP-121958	1076	1	RAN overload control using RRC connection Rejection	11.2.0
	RP-58	RP-121954	1077	-	RRC support for CoMP in UL	11.2.0
	RP-58	RP-121951	1078	-	Some clarification to Carrier aggregation enhancements	11.2.0
	RP-58	RP-121939	1079	1	Validity of EAB SIB and acquisition of SIB1	11.2.0
	RP-58	RP-121922	1085	-	Clarification for Multiple Frequency Band Indicators feature	11.2.0
	RP-58	RP-121924	1089	1	Moving the TM5 capability	11.2.0
	RP-58	RP-121959	1093	1	CR to 36.331 on introducing ROHC context continue for intra-ENB handover	11.2.0
	RP-58	RP-121946	1100	-	Correction on MDT multi-PLMN support	11.2.0
	RP-58	RP-121953	1102	-	Clarification and alignment of handling of other configuration	11.2.0
	RP-58	RP-121970	1103	6	Introducing support for Coordinated Multi-Point (CoMP) operation	11.2.0
	RP-58	RP-121922	1105	2	Introducing further UE aspects regarding multi band cells	11.2.0
	RP-58	RP-121947	1120	-	CR to 36.331 on additional information in RLF report for inter-RAT MRO	11.2.0
	RP-58	RP-121952	1125	1	Correction on Power preference indication	11.2.0
	RP-58	RP-121950	1127	1	SIB1 provisioning via dedicated signalling	11.2.0
	RP-58	RP-121936	1128	2	Measurement reporting of Scells	11.2.0
	RP-58	RP-121956	1129	1	Introduction of EPDCCH parameters in TS 36.331	11.2.0
	RP-58	RP-121961	1130	2	Introduction of Rel-11 UE capabilities	11.2.0
	RP-58	RP-121958	1131	-	Introduction of wideband RSRQ measurements	11.2.0
	RP-58	RP-121958	1146	-	Introduction of network sharing for CDMA2000 inter-working	11.2.0
	RP-58	RP-121960	1157	-	Broadcast of Time Info by Using a New SIB	11.2.0
	RP-58	RP-121957	1175	-	GERAN measurement object at ANR	11.2.0
03/2013	RP-59	RP-130246	1182	2	Miscellaneous corrections from review preceeding ASN.1 freeze	11.3.0
	RP-59	RP-130243	1186	2	DL COMP capability related correction	11.3.0
	RP-59	RP-130231	1193	1	Mandatory supporting of B1 measurement to UMTS FDD (FGI bit 15)	11.3.0
	RP-59	RP-130241	1197	-	Clarification on MBMS Service Continuity	11.3.0
	RP-59	RP-130241	1198	-	IDC Problem Reporting	11.3.0
	RP-59	RP-130247	1210	-	Corrections on definition of CSG member cell	11.3.0
	RP-59	RP-130237	1211	-	Extension of FBI and EARFCN	11.3.0
	RP-59	RP-130228	1220	-	Invalidation of ETWS with security feature	11.3.0
	RP-59	RP-130225	1224	-	Invalid measurement configuration with different (E)ARFCN	11.3.0
	RP-59	RP-130241	1231	2	PPI and IDC indication upon handover	11.3.0
	RP-59	RP-130227	1235	1	Correcting further UE aspects regarding multi band cells	11.3.0
	RP-59	RP-130248	1236	1	Behaviour in case of excessive dedicated priority information	11.3.0
	RP-59	RP-130225	1241	-	Clarification on EARFCN signalling in Mobility control info	11.3.0
	RP-59	RP-130241	1244	-	IDC-SubframePattern length for FDD	11.3.0
	RP-59	RP-130249	1252	-	Introduction of wideband RSRQ measurements in RRC_IDLE	11.3.0
	RP-59	RP-130240	1255	-	Optional support of RLF report for inter-RAT MRO	11.3.0
	RP-59	RP-130233	1258	2	The presence of bandcombination for non-CA capable UEs	11.3.0
	RP-59	RP-130248	1259	-	Correction for event A5	11.3.0
	RP-59	RP-130332	1265	-	Mandating the settings of FGI bit 14, 27 and 28 to true	11.3.0
06/2013	RP-60	RP-130805	1267	-	Clarification on the redirection to UTRA-TDD frequency in case of CSFB High Priority	11.4.0
	RP-60	RP-130804	1269	1	Correction of wrong reference	11.4.0
	RP-60	RP-130809	1270	-	Clarification to support of deprioritisation feature	11.4.0
	RP-60	RP-130809	1271	-	Clarification on KASME key usage	11.4.0
	RP-60	RP-130808	1272	-	Correction on multi-TA capability	11.4.0
	RP-60	RP-130808	1273	-	MBMS interest indication upon handover/ re-establishment	11.4.0
	RP-60	RP-130808	1274	-	Conditions RI reference inheriting CSI process (DL CoMP)	11.4.0
	RP-60	RP-130808	1275	-	Clarification on NZP CSI-RS resource configuration for UE supporting 1 CSI process	11.4.0
	RP-60	RP-130808	1276	-	Corrections to field description of pdsch-Start-r11	11.4.0
	RP-60	RP-130809	1277	-	Need code corrections in Rel-11 RRC	11.4.0
	RP-60	RP-130808	1278	-	Miscellaneous small corrections	11.4.0
	RP-60	RP-130809	1279	1	FDD/TDD diff column correction for FGI31	11.4.0
	RP-60	RP-130804	1282	-	measCycleSCell upon SCell configuration	11.4.0
	RP-60	RP-130809	1294	-	Clarification on RRC Connection Reconfiguration with Critical Extension	11.4.0
	RP-60	RP-130802	1298	-	Security key generation in case of MFBI	11.4.0
	RP-60	RP-130804	1303	1	Clarification on inclusion of non-CA band combinations	11.4.0
	RP-60	RP-130809	1308	-	CR on ROHC parameter configuration in Rel-11 RRC	11.4.0
	RP-60	RP-130804	1315	2	Clarification on UE CA capability	11.4.0
	RP-60	RP-130809	1321	-	Updating 3GPP2 specification references	11.4.0
	RP-60	RP-130805	1323	-	Clarification on the configuration of the extended PHR	11.4.0
	RP-60	RP-130805	1324	-	Clarifications on SystemTimeInfoCDMA2000 IE	11.4.0
	RP-60	RP-130808	1325	-	MFBI impact on MBMS service continuity	11.4.0
	RP-60	RP-130819	1329	1	MFBI aspects for dedicated signalling	11.4.0
09/2013	RP-61	RP-131311	1335	-	Clarification on PhysCellIdRange	11.5.0
	RP-61	RP-131311	1339	1	Correction on the first subframe of the measurement gap	11.5.0
	RP-61	RP-131319	1340	1	Correction for MFBI in SIB15 and SIB6	11.5.0
	RP-61	RP-131319	1343	-	Clarification of MFBI impact on MBMS service continuity	11.5.0
	RP-61	RP-131238	1344	2	Clarification of UE action for otherwise in conditions	11.5.0
	RP-61	RP-131311	1348	-	Corrections to the 3GPP2 specification references in 36.331	11.5.0

	RP-61	RP-131318	1353	-		Clarifications regarding the usage of "rf-Cause" in case of handover failure	11.5.0
12/2013	RP-62	RP-131986	1366	-		Introduction of capability bit for UTRA MFBI	11.6.0
	RP-62	RP-131984	1368	1		Addition of inter-frequency RSTD measurement capability indicator for OTDOA	11.6.0
	RP-62	RP-131989	1370	-		Clarification on supportedBand	11.6.0
	RP-62	RP-132003	1371	-		Capturing mandatory/optional agreements on Rel-11 UE features	11.6.0
	RP-62	RP-131995	1372	-		Clarification on otherwise behaviour	11.6.0
	RP-62	RP-131995	1373	-		Corrections of the 3GPP2 references in TS 36.331	11.6.0
	RP-62	RP-131991	1374	-		measResultLastServCell for SON-HOF report	11.6.0
	RP-62	RP-131729	1375	1		Clarification to timeInfoUTC field in SIB16	11.6.0
	RP-62	RP-131991	1389	-		Clarification on eRedirection to UMTS TDD with multiple UMTS TDD frequencies	11.6.0
	RP-62	RP-131995	1390	-		Delta signalling for critical extension	11.6.0
	RP-62	RP-132005	1391	-		Capability signalling for CSI processes	11.6.0
	RP-62	RP-131991	1395	1		Clarifications on Measurement	11.6.0
	RP-62	RP-131984	1397	-		Correction to InterFreqRSTDMMeasurementIndication field descriptions	11.6.0
	RP-62	RP-131984	1404	-		Correction of Inter-frequency RSTD indication for multiple frequencies	11.6.0
	RP-62	RP-131993	1405	1		Enabling SRVCC from GERAN without forwarding UE-EUTRA-Capability	11.6.0
	RP-62	RP-131995	1409	1		System information and change monitoring procedure	11.6.0
	RP-62	RP-131991	1410	1		Correction on presence of codebookSubsetRestriction-r10	11.6.0
	RP-62	RP-131998	1376	-		Introducing UE support for inbound mobility to a shared CSG cell	12.0.0
	RP-62	RP-132002	1378	2		Introduction of support of further DL MIMO enhancement	12.0.0
	RP-62	RP-131988	1379	-		CR for SSAC in CONNECTED	12.0.0
	RP-62	RP-132002	1406	-		Update of CMAS reference to E-UTRAN specific clauses in TS23.041	12.0.0
03/2014	RP-63	RP-140359	1424	1		CR on introduction of Cell-specific time-to-trigger	12.1.0
	RP-63	RP-140346	1435	-		UE autonomous modification of cellsTriggered upon serving cell addition/release	12.1.0
	RP-63	RP-140359	1436	1		Introduction of T312	12.1.0
	RP-63	RP-140362	1439	1		Introduction of UE-supported EARFCN list in handover preparation information for MFBI	12.1.0
	RP-63	RP-140352	1442	-		Correction of Connection Establishment Failure Report	12.1.0
	RP-63	RP-140356	1450	1		Clarification on the presence of TDD special subframe	12.1.0
	RP-63	RP-140359	1453	-		Introduction of UE mobility history reporting (option 2)	12.1.0
	RP-63	RP-140340	1455	1		Clarification regarding need codes, conditions and ASN.1 defaults for extension fields	12.1.0
	RP-63	RP-140340	1456	-		ASN.1 issue with inter-node signalling (AS-Config)	12.1.0
	RP-63	RP-140357	1457	1		Clarification for the SIB occurrence in a single SI message	12.1.0
	RP-63	RP-140364	1462	-		New UE categories for DL 450Mbps class	12.1.0
	RP-63	RP-140354	1463	-		IoT indication for inter-band TDD CA with different UL/DL configuration	12.1.0
06/2014	RP-64	RP-140869	1471	-		Removal of comment line from EUTRA-UE-Variables imports	12.2.0
	RP-64	RP-140871	1475	-		Correction on measObjectList in VarMeasConfig	12.2.0
	RP-64	RP-140879	1477	-		Minor correction inbound mobility to shared CSG cell	12.2.0
	RP-64	RP-140873	1478	-		Clarification on precedence of SCell SI provided dedicatedly	12.2.0
	RP-64	RP-140887	1479	-		Support of the enhancement for TTI bundling for FDD	12.2.0
	RP-64	RP-140885	1490	-		Corrections on timer T312	12.2.0
	RP-64	RP-140885	1486	-		Correction to the description of physCellIdRange in MeasObjectEUTRA	12.2.0
	RP-64	RP-140885	1506	-		Corrections to UE mobility history information	12.2.0
	RP-64	RP-140873	1489	-		ACK/NACK feedback mode on PUSCH	12.2.0
	RP-64	RP-140878	1556	-		SIB15 enhancement for service availability information	12.2.0
	RP-64	RP-140888	1557	-		Introduction of FDD/TDD CA UE capability	12.2.0
	RP-64	RP-140871	1545	-		Clarification of E-UTRA MFBI signalling	12.2.0
	RP-64	RP-140892	1520	1		Extended RLC LI field	12.2.0
	RP-64	RP-140873	1517	1		Network-requested CA Band Combination Capability Signalling	12.2.0
	RP-64	RP-140873	1554	1		Allowing TDD/FDD split for FGI111 and FGI112	12.2.0
	RP-64	RP-140871	1551	1		Inter-RAT ANR capability signalling in FGI33 when UE supports UTRA TDD only	12.2.0
	RP-64	RP-140884	1495	1		Introduction of TDD eIMTA	12.2.0
	RP-64	RP-140885	1499	1		Minor Corrections to T312	12.2.0
	RP-64	RP-140892	1510	1		Introduction of RRC Connection Establishment failure temporary Qoffset handling	12.2.0
	RP-64	RP-140849	1555	2		Introduction of UE capability for eMBMS reception on SCell and Non-Serving Cell	12.2.0
09/2014	RP-65	RP-141494	1632	-		FDD&TDD split for CA	12.3.0
	RP-65	RP-141505	1599	-		UE capabilities for Hetnet mobility in TS 36.331	12.3.0
	RP-65	RP-141499	1584	-		Introduction of UE eIMTA capabilities	12.3.0
	RP-65	RP-141511	1567	-		Corrections to extended RLC LI field	12.3.0
	RP-65	RP-141511	1603	-		TAI reporting of last serving cell	12.3.0
	RP-65	RP-141498	1630	1		Correction to Network-requested CA Band Combination Capability Signalling	12.3.0
	RP-65	RP-141496	1577	1		Clarification on double indication of SAI in SIB15	12.3.0
	RP-65	RP-141496	1597	-		Clarification on MBMSCountingResponse	12.3.0
	RP-65	RP-141496	1623	-		Clarification on the setting of SupportedBandCombination-v1130	12.3.0
	RP-65	RP-141489	1574	1		Correction of E-UTRAN UE capabilities description in HandoverPreparationInformation message field descriptions	12.3.0

	RP-65	RP-141507	1570	-		Introducing MBSFN measurement by extension of logged measurements	12.3.0
	RP-65	RP-141510	1572	1		Introduction of ACB skip for MMTEL voice/video and SMS	12.3.0
	RP-65	RP-141496	1615	1		Clarification on determining MBMS frequencies of interest in MBMSInterestIndication	12.3.0
	RP-65	RP-141506	1579	1		Introduction of signaling support for low complexity UEs	12.3.0
	RP-65	RP-141499	1601	1		Rel-12 ASN.1 correction	12.3.0
	RP-65	RP-141511	1560	1		Introduction of shorter MCH scheduling period	12.3.0
	RP-65	RP-141493	1611	-		Clarification for time-domain resource restriction pattern applicable to neighbour cell RSRQ measurements	12.3.0
	RP-65	RP-141511	1559	2		Correction to stop condition for "Chiba offset"	12.3.0
	RP-65	RP-141115	1636	-		Mandating the FGI bit 31 to true	12.3.0
	RP-65	RP-141618	1566	2		Connected mode procedures and RRC signaling of WLAN/3GPP Radio Interworking for LTE	12.3.0
12/2014	RP-66	RP-142122	1643	-		Clarification on WLAN interworking	12.4.0
	RP-66	RP-142122	1644	-		Correction on handling of dedicated parameters during re-establishment	12.4.0
	RP-66	RP-142122	1645	-		Corrections to WLAN/3GPP Radio Interworking for LTE	12.4.0
	RP-66	RP-142122	1646	-		Reduction of possible values for WLAN backhaul rate thresholds in LTE	12.4.0
	RP-66	RP-142140	1648	-		PDCP SN size change during HO for RLC-UM mode bearers	12.4.0
	RP-66	RP-142124	1651	-		Support of TTI bundling without resource allocation restriction for LTE coverage enhancements for Rel-12	12.4.0
	RP-66	RP-142123	1652	-		Corrections to eIMTA capabilities	12.4.0
	RP-66	RP-142140	1653	-		ACB, ACB-skip, CSFB and SSAC signalling per PLMN	12.4.0
	RP-66	RP-142122	1642	1		Minor corrections regarding WLAN interworking	12.4.0
	RP-66	RP-142115	1659	-		Correction of remaining TBD for Rel-10 FGIs	12.4.0
	RP-66	RP-142117	1663	-		New UE categories for DL 600Mbps	12.4.0
	RP-66	RP-142135	1687	-		Introduction of Dual Connectivity	12.4.0
	RP-66	RP-142140	1697	1		Prohibit timer for SR	12.4.0
	RP-66	RP-142133	1666	-		Support of 256QAM in TS 36.331 (per band 256QAM capability report)	12.4.0
	RP-66	RP-142128	1690	1		Introduction of increased number of frequencies to monitor	12.4.0
	RP-66	RP-142140	1696	2		Introduction of extended RSRQ value range and new RSRQ definition	12.4.0
	RP-66	RP-142115	1650	1		Introduction of signalling for serving cell interruptions	12.4.0
	RP-66	RP-142123	1655	-		Correction for p0-Persistent-SubframeSet2 Handling	12.4.0
	RP-66	RP-142134	1681	-		Introduction of missing Rel-12 UE capabilities	12.4.0
	RP-66	RP-142140	1647	1		Extended RLC LI field correction	12.4.0
	RP-66	RP-142140	1656	-		Outstanding Need OP for non-critical extension removal	12.4.0
	RP-66	RP-142140	1669	2		Clarification on statusReportRequired handling	12.4.0
	RP-66	RP-142131	1698	2		MCH BLER and RSRQ update for MBSFN MDT	12.4.0
	RP-66	RP-142130	1699	1		Optionality support of UE mandatory features for Category 0 UEs	12.4.0
	RP-66	RP-142123	1661	-		Further Clarifications on eIMTA and eCIC	12.4.0
	RP-66	RP-142113	1686	1		UE capability for modified MPR behavior	12.4.0
	RP-66	RP-142132	1664	1		Support of Discovery Signals measurement in TS 36.331	12.4.0
	RP-66	RP-142139	1670	2		RRC Parameters for NAICS	12.4.0
	RP-66	RP-141979	1700	-		UE capability signaling for WLAN/3GPP radio interworking	12.4.0
	RP-66	-	-	-		MCC editorial update	12.4.1
03/2015	RP-67	RP-150373	1737	-		Clarification on the setting of measScaleFactor without reducedMeasPerformance	12.5.0
	RP-67	RP-150371	1747	-		Clarification on Measurement Configuration handling	12.5.0
	RP-67	RP-150371	1765	-		Clarification on usage of field deltaTxD-OffsetPUCCH-Format1bCS-r11 in dedicated uplink power control parameter signalling	12.5.0
	RP-67	RP-150370	1751	-		Clarification on CSI measurement subframe set	12.5.0
	RP-67	RP-150368	1795	-		The absence of supportedMIMO-CapabilityUL-r10	12.5.0
	RP-67	RP-150370	1798	-		Presence of codebookSubsetRestriction	12.5.0
	RP-67	RP-150377	1768	2		Miscellaneous changes resulting from review for REL-12 ASN.1 freeze	12.5.0
	RP-67	RP-150374	1770	2		Introduction of ProSe	12.5.0
06/2015	RP-68	RP-150921	1800	-		Correction field description of networkControlledSyncTx	12.6.0
	RP-68	RP-150921	1801	-		Clarification on SCG reconfiguration	12.6.0
	RP-68	RP-150921	1802	-		Correction for aperiodic CSI trigger	12.6.0
	RP-68	RP-150920	1804	-		Correction on handling of wlan-OffloadConfigDedicated upon leaving RRC_CONNECTED	12.6.0
	RP-68	RP-150921	1805	-		Reconfiguration of SPS	12.6.0
	RP-68	RP-150916	1809	-		CR on Aperiodic CSI Reporting for 1.4MHz cell	12.6.0
	RP-68	RP-150921	1815	-		Clarification on PDCP reconfiguration	12.6.0
	RP-68	RP-150921	1816	-		Correction to SCG change	12.6.0
	RP-68	RP-150921	1817	-		Minor corrections for PSCell configuration in DC	12.6.0
	RP-68	RP-150921	1818	-		CR on ROHC for split bearer	12.6.0
	RP-68	RP-150921	1819	-		Clarification on FDD/TDD differentiation of FGIs/capabilities in TDD-FDD CA	12.6.0
	RP-68	RP-150921	1803	1		Correction to SCG and split bearer configuration	12.6.0
	RP-68	RP-150921	1810	1		Clarifications on use of preconfigComm for direct communication	12.6.0
	RP-68	RP-150921	1811	1		Miscellaneous corrections (a.o. Sidelink)	12.6.0
	RP-68	RP-150921	1813	1		Conditions for establishing RRC Connection for sidelink transmission	12.6.0
	RP-68	RP-150921	1814	1		Correction on field description on SL-TF-ResourceConfig	12.6.0
	RP-68	RP-150917	1806	1		Mandatory present of supportedMIMO-CapabilityDL-r10	12.6.0
	RP-68	RP-150923	1853	-		Clarification on Cell barring for downlink only bands	12.6.0

	RP-68	RP-150917	1852	-		Clarification regarding no MBMS sessions ongoing	12.6.0
	RP-68	RP-150917	1827	1		Correction to additionalSpectrumEmission	12.6.0
	RP-68	RP-150923	1820	4		Clarification on extended RSRQ range support	12.6.0
	RP-68	RP-150917	1838	-		Restriction to CA capability signalling	12.6.0
	RP-68	RP-150921	1823	-		Clarification on PUCCH and SRS	12.6.0
	RP-68	RP-150926	1849	-		Introduction of new DL UE categories 15&16	12.6.0
	RP-68	RP-150923	1824	-		Clean-up corrections to TS 36.331	12.6.0
	RP-68	RP-150918	1846	1		Correction to IDC signalling	12.6.0
	RP-68	RP-150921	1822	1		Change of LCID upon DC-specific DRB reconfiguration	12.6.0
	RP-68	RP-150921	1832	1		Correction to PHR format	12.6.0
	RP-68	RP-150921	1842	1		Correction on conditions for sidelink operation	12.6.0
	RP-68	RP-150811	1834	2		Correction on the SL-TF-IndexPair values for ProSe Direct Discovery	12.6.0
09/2015	RP-69	RP-151443	1866	-		Correction on UE band combination capability	12.7.0
	RP-69	RP-151438	1869	-		Correction on Restriction to CA capability signalling	12.7.0
	RP-69	RP-151443	1884	-		The support of UL64QAM	12.7.0
	RP-69	RP-151442	1889	-		Small corrections concerning RadioResourceConfig	12.7.0
	RP-69	RP-151441	1900	-		Sidelink discovery related corrections	12.7.0
	RP-69	RP-151440	1905	2		Clarification of Beacon RSSI Encoding	12.7.0
	RP-69	RP-151439	1911	1		CR for IDC signalling enhancement for UL CA	12.7.0
	RP-69	RP-151440	1880	2		Clarification on cell selection sequence upon leaving RRC_CONNECTED	12.7.0
	RP-69	RP-151438	1908	-		Correction to additionalSpectrumEmission - Option 1	12.7.0
	RP-69	RP-151439	1879	1		Correction on the reference of EPDCCH	12.7.0
	RP-69	RP-151441	1891	1		Introducing general handling and guidelines concerning critical extensions within a release	12.7.0
	RP-69	RP-151443	1909	1		Applicability of longCodeState1XRTT for 1xRTT IRAT ANR	12.7.0
	RP-69	RP-151441	1912	1		Sidelink terminology alignment in TS 36.331	12.7.0
	RP-69	RP-151442	1906	2		Clarification for NAICS capability signalling	12.7.0
	RP-69	RP-151467	1861	2		Additional MIMO/CSI capability for intra-band contiguous CA	12.7.0
	RP-69	RP-151466	1887	2		Signalling for 4-layer MIMO with TM3 and TM4	12.7.0
	RP-69	RP-151625	1914	2		Allowing NAICS with TM10	12.7.0
12/2015	RP-70	RP-152053	1916	-		Correction on SCG release	12.8.0
	RP-70	RP-152053	1932	-		Clarification to SCG RLF timers and constants reconfiguration	12.8.0
	RP-70	RP-152053	1933	-		Correction to triggerQuantityCSI-RS	12.8.0
	RP-70	RP-152053	1946	-		Correction to NAICS field descriptions	12.8.0
	RP-70	RP-152055	1947	-		Correction of need code definition terminology	12.8.0
	RP-70	RP-152050	1964	-		Clarification on FDD/TDD difference for UL CA IDC indication	12.8.0
	RP-70	RP-152046	1975	-		Correction to SystemTimelInfoCDMA2000 IE	12.8.0
	RP-70	RP-152053	1928	1		highPriorityAccess for MMTEL voice, MMTEL video and SMS	12.8.0
	RP-70	RP-152053	1986	1		Correction to the support of Mobility State reporting	12.8.0
	RP-70	RP-152046	1971	1		MaxLayerMIMO in HandoverPreparationInformation	12.8.0
	RP-70	RP-152046	1987	-		Correction to ASN.1 field names for 4-layer TM3/4	12.8.0
	RP-70	RP-152053	1969	1		Correction on measurement identity autonomous removal in dual connectivity	12.8.0
	RP-70	RP-152053	1979	1		Clarification on tdd-FDD-CA-PCellDuplex	12.8.0
	RP-70	RP-152049	1919	2		Alternative new maximum transport block sizes for DL 64QAM and 256QAM in TM9/10	12.8.0
	RP-70	RP-152050	1934	1		Some general RRC issues	12.8.0
	RP-70	RP-152055	1965	1		Correction on capability rsrq-OnAllSymbols	12.8.0
	RP-70	RP-152056	1931	2		Addition of establishment cause for mobile-originating VoLTE calls and network indication in SIB2	12.8.0
	RP-70	RP-152048	1927	2		CR to correct UE messages to be sent only after security activation	12.8.0
	RP-70	RP-152053	1973	3		Clarification of MCG	12.8.0
	RP-70	RP-152113	1923	4		Enabling multiple NS and P-Max operation per cell	12.8.0
12/2015	RP-70	RP-152084	1917	-		MCCH acquisition for 1.4MHz MBSFN	13.0.0
	RP-70	RP-152084	1937	-		Paging optimization	13.0.0
	RP-70	RP-152084	1972	-		White-list of cells for EUTRA measurement reporting	13.0.0
	RP-70	RP-152074	1920	1		Introduction of Dual Connectivity enhancements in Rel-13	13.0.0
	RP-70	RP-152078	1983	2		Introduction of Licensed-Assisted Access using LTE	13.0.0
	RP-70	RP-152075	1952	1		Extension of Frequency Priorities	13.0.0
	RP-70	RP-152075	1949	1		Introduction of RS-SINR measurements using non critical extension	13.0.0
	RP-70	RP-152079	1961	2		Introducing EBF FD MIMO parameters	13.0.0
	RP-70	RP-152081	1935	1		Removing SCG change restrictions regarding upon handover	13.0.0
	RP-70	RP-152066	1984	1		Introduction of Application specific Congestion control for Data Communication in LTE	13.0.0
	RP-70	RP-152071	1872	6		36331 CR for capturing B5C and SCell on PUCCH	13.0.0
	RP-70	RP-152073	1953	2		Introducing CRS interference mitigation on SCell	13.0.0
	RP-70	RP-152080	1939	3		Introduction of SC-PTM	13.0.0
	RP-70	RP-152082	1941	2		Introduction of Rel-13 MDT enhancements	13.0.0
	RP-70	RP-152075	1955	3		Introduction of load redistribution in RRC_IDLE	13.0.0
	RP-70	RP-152076	1988	-		Introducing extended DRX	13.0.0
	RP-70	RP-152084	1957	3		Clarification on FGI bits setting for MCPTT	13.0.0
	RP-70	RP-152072	1936	2		Introducing eSL	13.0.0
03/2016	RP-71	RP-160454	2001	2		eD2D changes resulting from review for ASN.1 freeze	13.1.0

	RP-71	RP-160468	2002	2	Miscellaneous changes resulting from review for ASN.1 freeze	13.1.0
	RP-71	RP-160470	2005	1	Corrections and missing agreement on the eCA	13.1.0
	RP-71	RP-160470	2006	2	corrections on RSSI measurement	13.1.0
	RP-71	RP-160457	2008	3	Introduction of LTE-WLAN Aggregation	13.1.0
	RP-71	RP-160470	2010	2	Corrections on SC-PTM	13.1.0
	RP-71	RP-160470	2016	-	Support of extended RLC AM SN for SCG	13.1.0
	RP-71	RP-160470	2017	1	Miscellaneous corrections for SC-PTM	13.1.0
	RP-71	RP-160519	2020	2	EBF/FD-MIMO changes related to remaining issues	13.1.0
	RP-71	RP-160467	2022	1	Correction on the RRC signalling configuration for 4Tx MIMO	13.1.0
	RP-71	RP-160462	2039	2	Applicability of longCodeState1XRTT	13.1.0
	RP-71	RP-160470	2040	1	Further clarifications on Rel-13 MDT enhancements	13.1.0
	RP-71	RP-160470	2042	3	Capability for CA enhancement	13.1.0
	RP-71	RP-160470	2043	1	Some corrections on CA enhancement	13.1.0
	RP-71	RP-160460	2048	1	The introduction of UE capability concerning extended E-UTRA frequency priorities	13.1.0
	RP-71	RP-160457	2051	2	Introduction of RAN controlled LTE-WLAN interworking	13.1.0
	RP-71	RP-160459	2054	4	Stage-3 text updates for bearer Identification within IPsec Tunnel and IPsec establishment parameters	13.1.0
	RP-71	RP-160459	2055	4	Introduction of LWIP UE capabilities	13.1.0
	RP-71	RP-160460	2061	1	UE capabilities for LAA	13.1.0
	RP-71	RP-160470	2062	1	Minor corrections for CA enhancements	13.1.0
	RP-71	RP-160467	2066	1	Maximum UL timing difference for DC	13.1.0
	RP-71	RP-160467	2068	1	T321 for Category 0 UE	13.1.0
	RP-71	RP-160503	2069	3	Addition of low complexity UEs and coverage enhancement features	13.1.0
	RP-71	RP-160454	2070	2	eD2D Capability	13.1.0
	RP-71	RP-160470	2072	1	SC-PTM corrections following ASN.1 review	13.1.0
	RP-71	RP-160467	2074	1	Procedural clarification on PSCell change involving PSCell release	13.1.0
	RP-71	RP-160464	2075	2	Modification of network requested CA band combination retrieval for intra-band non-contiguous CA	13.1.0
	RP-71	RP-160470	2087	1	ANR in case of MFBI	13.1.0
	RP-71	RP-160467	2090	-	Clarification on the leftmost bit for the supportedCellGrouping	13.1.0
	RP-71	RP-160467	2094	-	Clarification on the value range of guaranteed power for the MeNB and SeNB	13.1.0
	RP-71	RP-160455	2096	-	36.331 CR on TM10 CRS-IM UE capability report signalling introduction	13.1.0
	RP-71	RP-160456	2097	2	Miscellaneous corrections to TS 36.331 related to eDRX	13.1.0
	RP-71	RP-160470	2098	-	Guideline on handling of uplink spare values	13.1.0
	RP-71	RP-160465	2100	-	In-Device Coexistence for UL CA change of victim system	13.1.0
	RP-71	RP-160470	2101	-	Clarification on initial RSSI measurement reporting	13.1.0
	RP-71	RP-160470	2102	-	Introduction of capability on PDSCH collision handling	13.1.0
	RP-71	RP-160470	2103	1	Introduction of the extension of measObjectId range	13.1.0
	RP-71	RP-160470	2105	1	The correction on the description of 5.5.4.1	13.1.0
	RP-71	RP-160470	2106	-	Introduction of sf60 DRX cycle	13.1.0
	RP-71	RP-160467	2109	1	Clarification on NAICS subset capability	13.1.0
	RP-71	RP-160470	2110	-	SC-PTM reception on non-Pcell	13.1.0
	RP-71	RP-160470	2111	-	MBMS interest indication by SC-PTM capable UE	13.1.0
	RP-71	RP-160460	2112	1	Additional Layer 1 capabilities for Rel-13 CA enhancements	13.1.0
06/2016	RP-72	RP-161080	2114	-	Corrections to MTCe in TS 36.331	13.2.0
	RP-72	RP-161080	2115	2	Miscellaneous corrections to TS 36.331	13.2.0
	RP-72	RP-161080	2116	1	Inter-node signalling	13.2.0
	RP-72	RP-161080	2117	-	Clarification on SC-PTM	13.2.0
	RP-72	RP-161076	2118	1	UE capability of an additional Rx and Tx requirement for a CA band combination	13.2.0
	RP-72	RP-161073	2125	-	drb-identity change in full configuration	13.2.0
	RP-72	RP-161080	2126	-	Miscellaneous correction for sidelink	13.2.0
	RP-72	RP-161080	2127	-	Corrections for conditions of sidelink operation	13.2.0
	RP-72	RP-161080	2130	1	Correction on conditions for establishing RRC Connection for sidelink communication	13.2.0
	RP-72	RP-161080	2131	1	Corrections for sidelink communication transmission	13.2.0
	RP-72	RP-161080	2132	1	Correction to WLAN measurements	13.2.0
	RP-72	RP-161080	2133	1	Small corrections to LWIP	13.2.0
	RP-72	RP-161080	2134	1	Small eSL related corrections	13.2.0
	RP-72	RP-161080	2135	1	Alignment of RCLWI configuration	13.2.0
	RP-72	RP-161080	2136	1	Configuration of LWA and LWIP upon handover	13.2.0
	RP-72	RP-161080	2137	1	Introducing EBF/FD-MIMO capabilities	13.2.0
	RP-72	RP-161077	2140	-	Clarification regarding IDC indication upon change of UL CA affecting GNSS	13.2.0
	RP-72	RP-161080	2143	3	Correction of periodic CSI reporting and clarification on p-C and CBSR signalling	13.2.0
	RP-72	RP-161080	2144	-	CR on SI window combining for MTC	13.2.0
	RP-72	RP-161080	2145	-	Avoiding simultaneous configuration of LWA and DC for a UE	13.2.0
	RP-72	RP-161080	2146	-	Miscellaneous RRC corrections for LWA	13.2.0
	RP-72	RP-161080	2147	1	Autonomous WLAN measurement ID removal	13.2.0
	RP-72	RP-161080	2149	1	Correction to channel number range	13.2.0
	RP-72	RP-161080	2150	-	Correction of backhaul bandwidth description	13.2.0

	RP-72	RP-161080	2151	1	Correction on frequency hopping signaling	13.2.0
	RP-72	RP-161075	2152	1	Support of CRS-Assistance signaling for the DL Control Channel IM	13.2.0
	RP-72	RP-161078	2154	-	Correction on condition nonFullConfig in dual connectivity	13.2.0
	RP-72	RP-161080	2159	1	Correction on system information handling in eMTC	13.2.0
	RP-72	RP-161080	2160	1	Correction on essential system information missing	13.2.0
	RP-72	RP-161080	2162	-	Steering command during T350	13.2.0
	RP-72	RP-161080	2163	1	UE behaviours while configured with steeringCommandWLAN (release)	13.2.0
	RP-72	RP-161077	2166	1	Correction of IE name "systemInformationBlockType1Dedicated"	13.2.0
	RP-72	RP-161080	2167	-	Clarification of timer description for MCLD	13.2.0
	RP-72	RP-161080	2169	-	Clarification on the usage of threshold conditions for sidelink relay UE	13.2.0
	RP-72	RP-161080	2170	-	Corrections to LWA	13.2.0
	RP-72	RP-161080	2171	-	Variable Handling for RCLWI	13.2.0
	RP-72	RP-161080	2174	1	Correction on configuration of PRACH and MPDCCH for RA procedure for BL UEs or UEs in CE	13.2.0
	RP-72	RP-161080	2175	-	Clarification on LWA	13.2.0
	RP-72	RP-161080	2176	1	Miscellaneous corrections	13.2.0
	RP-72	RP-161080	2180	-	Correction on FDD/TDD differentiation for Rel-13 capabilities	13.2.0
	RP-72	RP-161080	2181	1	Correction on the definition of sc-mcch-duration	13.2.0
	RP-72	RP-161080	2182	-	System information acquisition for SC-PTM reception on non-Pcell	13.2.0
	RP-72	RP-161080	2183	-	Corrections on capability report for eCA	13.2.0
	RP-72	RP-161080	2185	1	Corrections to RS-SINR configuration	13.2.0
	RP-72	RP-161080	2186	1	UL UE Categories support for 64 QAM	13.2.0
	RP-72	RP-161080	2188	1	Correction on SI update for eDRX	13.2.0
	RP-72	RP-161080	2189	-	Add the field description for mpdcch-NarrowbandsToMonitor-r13	13.2.0
	RP-72	RP-161080	2192	-	WLAN measurements and user preference	13.2.0
	RP-72	RP-161080	2193	1	Miscellaneous corrections resulting from REL-13 ASN.1 review	13.2.0
	RP-72	RP-161080	2195	-	Correction to eMTC message classes and logical channels	13.2.0
	RP-72	RP-161080	2198	-	Some eCA related corrections	13.2.0
	RP-72	RP-161080	2199	1	PUCCH SCell corrections	13.2.0
	RP-72	RP-161080	2200	1	Small corrections of timer description for Sidelink	13.2.0
	RP-72	RP-161080	2201	-	Clarification of use of extended timer values for UEs that support CE mode B	13.2.0
	RP-72	RP-161080	2202	2	Correction to UL SPS operation	13.2.0
	RP-72	RP-161080	2203	1	UE Power Class in UE capability signaling	13.2.0
	RP-72	RP-161080	2204	-	Correction to FD-MIMO field descriptions	13.2.0
	RP-72	RP-161080	2205	1	Miscellaneous eMTC corrections	13.2.0
	RP-72	RP-161080	2206	-	Further miscellaneous eMTC corrections	13.2.0
	RP-72	RP-161080	2207	-	Correction to Initial CE Level	13.2.0
	RP-72	RP-161080	2209	2	Feature Group Indicators and UE capabilities for eMTC	13.2.0
	RP-72	RP-161080	2210	2	CR to capture CloT optimizations for non-NB-IoT UEs	13.2.0
	RP-72	RP-161080	2211	-	Valid subframes for FDD and TDD DL transmissions	13.2.0
	RP-72	RP-161080	2216	1	Avoiding conflict between rel13 LWA/LWIP and rel12 RALWI	13.2.0
	RP-72	RP-161078	2220	-	Clarification on the presence of ul-64QAM-r12 for DL-only bands	13.2.0
	RP-72	RP-161080	2221	-	Correction on keeping SCG upon inter eNB handover	13.2.0
	RP-72	RP-161080	2222	-	The granularity of LWAAP entity	13.2.0
	RP-72	RP-161080	2223	-	Clarification on WLAN measurement	13.2.0
	RP-72	RP-161080	2224	-	The handling of WLAN status monitoring	13.2.0
	RP-72	RP-161080	2226	1	Clarification on the handover from the MeNB to the SeNB	13.2.0
	RP-72	RP-161080	2230	1	Restricting Unattended Data Traffic	13.2.0
	RP-72	RP-161211	2231	7	Introduction of NB-IoT in 36.331	13.2.0
	RP-72	RP-161080	2233	-	Correction to T302 and T308 conflict issue	13.2.0
	RP-72	RP-161080	2234	1	Various corrections to MTC related ASN.1 code and field descriptions	13.2.0
	RP-72	RP-161080	2235	-	Clarification to field description for the timer T360	13.2.0
	RP-72	RP-161080	2236	-	Clarification to ordering of Rel13 Frequency priority lists	13.2.0
	RP-72	RP-161080	2238	1	Introduction of LWIP counter	13.2.0
	RP-72	RP-161080	2239	1	Clarification on EpcchSetConfig for eMTC	13.2.0
	RP-72	RP-161080	2240	2	Skipping fallback "2DL + 1UL" CA in UE capability report in Rel 13	13.2.0
	RP-72	RP-161270	2241	3	NAS timer settings for eMTC	13.2.0
09/2016	RP-73	RP-161758	2242	1	Correction to access barring checking for network sharing case	13.3.0
	RP-73	RP-161757	2244	1	Correction to LWIP and LWA	13.3.0
	RP-73	RP-161754	2245	2	Backward compatibility of CA band combination signalling	13.3.0
	RP-73	RP-161756	2248	1	Correction on measurement reporting for WLAN	13.3.0
	RP-73	RP-161756	2249	1	Correction on WLAN authentication	13.3.0
	RP-73	RP-161756	2250	2	Corrections to simultaneous configuration of LWA, RCLWI and LWIP	13.3.0
	RP-73	RP-161756	2253	-	Correction on WLAN connection management	13.3.0
	RP-73	RP-161758	2254	1	Corrections to TS36.331	13.3.0
	RP-73	RP-161758	2258	2	Issue on resume procedure	13.3.0
	RP-73	RP-161758	2262	-	Corrections to NB-IoT in 36.331	13.3.0
	RP-73	RP-161758	2263	-	Cleanup of the NB-IoT ASN.1	13.3.0
	RP-73	RP-161758	2266	3	Miscellaneous corrections to clause 4 and 5 for NB-IoT	13.3.0
	RP-73	RP-161751	2268	3	Clarification to intra-band contiguous CA capabilities	13.3.0
	RP-73	RP-161759	2269	-	Clarification on RRC processing delay for CloT	13.3.0
	RP-73	RP-161759	2270	2	Supporting new UE Rx - Tx time difference mapping table	13.3.0

	RP-73	RP-161758	2272	1	Alignment of procedure when handling up-CIoT-EPS-Optimisation	13.3.0
	RP-73	RP-161754	2273	1	Simplification of UE capability reporting procedure	13.3.0
	RP-73	RP-161752	2274	2	Corrections on system information acquisition for Sidelink discovery	13.3.0
	RP-73	RP-161756	2275	1	Small corrections regarding (WLAN) measurement reporting	13.3.0
	RP-73	RP-161758	2279	-	Correction on cell reslection procedure while T300 is running	13.3.0
	RP-73	RP-161758	2280	1	Correction on full configuration	13.3.0
	RP-73	RP-161758	2281	1	Correction on SRB addition and modification	13.3.0
	RP-73	RP-161756	2282	1	Clarifications on RCLWI	13.3.0
	RP-73	RP-161758	2283	1	Introduction of DelayTolerantAccess establishment cause in NB-IoT	13.3.0
	RP-73	RP-161762	2284	1	Maximum number of simultaneous UL PDCP delay measurements for FeMDT	13.3.0
	RP-73	RP-161762	2287	2	Clarification on DRX cycle used by the UE	13.3.0
	RP-73	RP-161755	2288	1	Invalidation of stored system information in connected mode	13.3.0
	RP-73	RP-161755	2289	1	Clarification on bit mapping of fdd-DownlinkOrTddSubframeBitmapLC and fdd-UplinkSubframeBitmapLC	13.3.0
	RP-73	RP-161759	2290	-	Correction on C-IoT optimizations for non-NB-IoT UE	13.3.0
	RP-73	RP-161749	2295	1	Clarification on timer handling for zero value	13.3.0
	RP-73	RP-161759	2299	-	Measurement configuration during RRC resume in Clot	13.3.0
	RP-73	RP-161755	2301	1	Correction on UEPagingCoverageInformation	13.3.0
	RP-73	RP-161749	2305	1	DRB re-setup in Full Configuration	13.3.0
	RP-73	RP-161755	2306	1	Rel-13 correction for eMTC parameter values	13.3.0
	RP-73	RP-161753	2307	1	CR on forwarding LAA measurement results for DC	13.3.0
	RP-73	RP-161756	2309	1	Clarification on associationTimer	13.3.0
	RP-73	RP-161756	2310	-	Clarification on PDCP-Config and statusFeedback for LWA	13.3.0
	RP-73	RP-161756	2311	1	Order of addition and removal of WLAN-Identifiers	13.3.0
	RP-73	RP-161756	2313	-	Multiple WLAN measurement objects on the same frequency	13.3.0
	RP-73	RP-161755	2315	-	Correction about eMTC frequency hopping parameters	13.3.0
	RP-73	RP-161753	2317	1	Handling of tdd-Config-r10 for LAA Scell	13.3.0
	RP-73	RP-161760	2318	1	Introduction of 1.2Gbps and 1.6Gbps UE categories in Rel-13	13.3.0
	RP-73	RP-161755	2320	2	Extended T310 timer values for eMTC	13.3.0
	RP-73	RP-161761	2323	1	Introducing UE capability of Rel 13 CCH IM	13.3.0
	RP-73	RP-161761	2324	1	Introducing UE capability of CRS-IM for TM 1-9	13.3.0
	RP-73	RP-161827	2325	2	Continuous uplink transmission in eMTC	13.3.0
	RP-73	RP-161755	2328	1	Correction on PUSCH repetition numbers for CE Mode A	13.3.0
	RP-73	RP-161755	2329	-	Frequency hopping configuration for paging	13.3.0
	RP-73	RP-161758	2334	2	Reservation of RA resources in NB-IoT	13.3.0
	RP-73	RP-161754	2336	1	Extended PHR corrections	13.3.0
	RP-73	RP-161756	2337	1	Corrections for LWA/LWIP	13.3.0
	RP-73	RP-161762	2338	3	Correction on 12/16-port CSI-RS resource configuration for FD-MIMO	13.3.0
	RP-73	RP-161755	2339	2	Corrections in Rel-13 eMTC SI acquisition	13.3.0
	RP-73	RP-161758	2342	-	Correction of downlink gap applicability for NB-IoT	13.3.0
	RP-73	RP-161751	2344	1	Indication of the maxLayersMIMO	13.3.0
	RP-73	RP-161758	2346	-	nrs-Power signaling for NB-IoT non-anchor carrier	13.3.0
09/2016	RP-73	RP-161746	2261	1	Introducing V2V to TS 36.331	14.0.0
	RP-73	RP-161745	2340	1	Introduction of enhanced LAA for LTE	14.0.0
	RP-73	RP-161747	2341	-	Introduction of L2 Latency reduction techniques	14.0.0
12/2016	RP-74	RP-162318	2362	-	Clarification on the RRC connection resume procedure	14.1.0
	RP-74	RP-162313	2364	1	Clarification on AS-Config	14.1.0
	RP-74	RP-162316	2366	1	Corrections to LWA release	14.1.0
	RP-74	RP-162327	2373	1	Signalling of LWIP aggregation	14.1.0
	RP-74	RP-162318	2375	1	Miscellaneous corrections to TS 36.331	14.1.0
	RP-74	RP-162317	2377	-	Clarification on valid value range of codebookConfigNx fields	14.1.0
	RP-74	RP-162321	2378	-	Miscellaneous corrections to eLAA	14.1.0
	RP-74	RP-162311	2381	-	FDD&TDD diff for mbms-AsyncDC	14.1.0
	RP-74	RP-162316	2386	-	Corrections to WLAN status monitoring	14.1.0
	RP-74	RP-162314	2389	-	Clarification to the security mode command procedure for NB-IoT	14.1.0
	RP-74	RP-162318	2391	-	Clarification on UE power class 2 indication	14.1.0
	RP-74	RP-162312	2394	-	Correction on UE behavior in Paging procedure	14.1.0
	RP-74	RP-162314	2396	-	Corrections to NB-IoT SystemInformationBlockType2 handling	14.1.0
	RP-74	RP-162314	2398	1	Data available for transmission	14.1.0
	RP-74	RP-162315	2400	1	Correction on Downlink power allocation for SC-PTM	14.1.0
	RP-74	RP-162328	2402	-	Corrections on V2V in TS 36.331	14.1.0
	RP-74	RP-162314	2403	-	Correction on field description of up/cp-CIoT-EPS-Optimisation	14.1.0
	RP-74	RP-162327	2404	-	Extension of PollByte	14.1.0
	RP-74	RP-162317	2407	-	Clarification on Rel-13 CCH-IM UE capability	14.1.0
	RP-74	RP-162317	2411	-	Configuration of DMTC for neighbour and serving cells in LAA carrier frequency	14.1.0
	RP-74	RP-162314	2413	-	Clarification on uplink carrier frequency	14.1.0
	RP-74	RP-162314	2415	-	NB-IoT RRC Processing Delays	14.1.0
	RP-74	RP-162314	2420	1	Correction of connection suspension related aspects	14.1.0
	RP-74	RP-162317	2422	-	Clarification regarding on CSI-RS resource configuration for FD-MIMO	14.1.0
	RP-74	RP-162316	2424	-	Clearing of measurements upon reporting WLAN unavailability	14.1.0
	RP-74	RP-162313	2428	-	Minor changes regarding UE category	14.1.0

	RP-74	RP-162309	2435	1		Correction of NOTE 3 in UE-EUTRA-Capability related to multiple CA-MIMO-ParametersDL/UL	14.1.0
	RP-74	RP-162311	2441	1		Clarification on reporting of the plmn-IdentityList	14.1.0
	RP-74	RP-162317	2446	2		Correction on SSTD Measurement Reporting	14.1.0
	RP-74	RP-162322	2448	1		Introduce Enhancements for High Speed in 36.331	14.1.0
	RP-74	RP-162312	2451	-		System information update for eDRX UEs	14.1.0
	RP-74	RP-162317	2453	1		Correction on ACDC handling	14.1.0
	RP-74	RP-162328	2457	1		Correction and Clarification to TS 36.331	14.1.0
	RP-74	RP-162313	2459	1		Correction to frequency hopping configuration	14.1.0
	RP-74	RP-162314	2461	-		Correction to non-anchor carrier configuration	14.1.0
	RP-74	RP-162329	2462	1		UE capabilities for Latency Reduction	14.1.0
	RP-74	RP-162311	2466	1		Conrections on sidelink pre-configurations and default configurations	14.1.0
	RP-74	RP-162317	2469	-		Minor corrections for Rel-13 eD2D	14.1.0
	RP-74	RP-162324	2471	3		Introduction of SRS switching for LTE	14.1.0
	RP-74	RP-162325	2473	1		Introduction of MUST	14.1.0
	RP-74	RP-162314	2474	-		Clarification on system information acquisition for NB-IoT	14.1.0
	RP-74	RP-162314	2476	-		Editorial correction for NB-IoT	14.1.0
	RP-74	RP-162314	2478	-		Acknowledgement delay of RRCConnectionRelease message in NB-IoT	14.1.0
	RP-74	RP-162320	2484	-		Introduction of new UL category in Rel-13	14.1.0
	RP-74	RP-162327	2485	-		Addition of eCall over IMS Indication in SIB1	14.1.0
	RP-74	RP-162313	2488	-		DMRS scrambling sequence initialization parameter for MPDCCH	14.1.0
	RP-74	RP-162313	2490	-		RSRP threshold when only CE level 0 is used	14.1.0
	RP-74	RP-162313	2492	-		Correction on fdd-DownlinkOrTddSubframeBitmapBR	14.1.0
	RP-74	RP-162313	2495	-		Correction to presence of uplink frequency hopping interval parameter	14.1.0
	RP-74	RP-162315	2497	1		Correction to SC-PTM scheduling period start offset	14.1.0
	RP-74	RP-162316	2504	-		Correction to WLAN measurement configuration	14.1.0
	RP-74	RP-162328	2509	1		Introducing Shorter Resource Reservation Periodicities for V2X	14.1.0
	RP-74	RP-162313	2519	1		Acknowledgement delay of RRCConnectionRelease message for eMTC UEs	14.1.0
	RP-74	RP-162314	2525	-		Correction on channel bandwidth definition for NB-IoT	14.1.0
	RP-74	RP-162316	2534	1		Clarifications on empty WLAN identifiers	14.1.0
	RP-74	RP-162316	2542	1		Clarifications on empty WLAN identifiers in Mobility Set for RCLWI	14.1.0
	RP-74	RP-162350	2546	-		timeInfoUTC in SIB16	14.1.0
	RP-74	RP-162313	2547	-		Clarification on fdd-DownlinkOrTddSubframeBitmapBR	14.1.0
	RP-74	RP-162321	2548	2		Introduction of capabilities for eLAA	14.1.0
	RP-74	RP-162309	2552	-		Clarification on prioritization of multiple Pmax values	14.1.0
	RP-74	RP-162329	2553	-		CR on RV setting with UL skipping	14.1.0
	RP-74	RP-162314	2555	1		Correction of default physical channel configuration for NB-IoT	14.1.0
03/2017	RP-75	RP-170639	2559	2	A	Signalling of 1Rx UE category	14.2.0
	RP-75	RP-170636	2560	1	B	Introducing Rel-14 FeMTC into RRC	14.2.0
	RP-75	RP-170643	2563	1	F	Correction on V2X sidelink communication in TS 36.331	14.2.0
	RP-75	RP-170668	2565	1	B	Introduction of a new special subframe configuration	14.2.0
	RP-75	RP-170652	2576	1	A	Providing SIB1-BR via dedicated RRC signalling	14.2.0
	RP-75	RP-170641	2577	1	B	Introduction of eDECOR	14.2.0
	RP-75	RP-170636	2578	1	B	Introduction of SC-PTM for FeMTC and NB-IoT enhancements	14.2.0
	RP-75	RP-170629	2580	1	B	Introducing RRC parameters for eFD-MIMO (REL-14)	14.2.0
	RP-75	RP-170657	2582	1	A	Indication of S1-U data transfer	14.2.0
	RP-75	RP-170650	2585	1	A	Addition of extended EARFCNs in SCGFailureInformation message	14.2.0
	RP-75	RP-170652	2587	-	A	Clarification on the configuration of the extended values for nB	14.2.0
	RP-75	RP-170652	2589	-	A	Clarification on the support of FGI 42 for category M1 UE	14.2.0
	RP-75	RP-170656	2591	1	A	Miscellaneous corrections to NB-IoT	14.2.0
	RP-75	RP-170643	2592	1	F	Corrections to resource reservation period for V2X	14.2.0
	RP-75	RP-170651	2598	-	A	Correction on the initiation of WLAN connection status report	14.2.0
	RP-75	RP-170654	2600	-	A	Correction on longDRX-CycleStartOffset	14.2.0
	RP-75	RP-170643	2601	2	F	Correction and Clarification to TS 36.331	14.2.0
	RP-75	RP-170653	2603	2	A	Correction on mpdcch-pdsch-HoppingConfig	14.2.0
	RP-75	RP-170636	2613	3	B	FeMTC UE CE mode and maximum PDSCH/PUSCH BW preference indication	14.2.0
	RP-75	RP-170635	2615	2	B	Introduce V2X in TS 36.331	14.2.0
	RP-75	RP-170643	2616	2	F	Introduce a new parameter for V2X resource reselection	14.2.0
	RP-75	RP-170656	2622	2	A	Extension of $Q_{R_{LevMin}}$ value range	14.2.0
	RP-75	RP-170655	2624	-	A	Clarification on prioritization of multiple Pmax values	14.2.0
	RP-75	RP-170637	2625	2	B	Introduction of NB-IoT Enhancements other than Multicast	14.2.0
	RP-75	RP-170651	2627	1	A	Corrections to WLAN status monitoring	14.2.0
	RP-75	RP-170642	2635	1	B	Introduction of data inactivity timer	14.2.0
	RP-75	RP-170654	2637	-	A	Correction of reference to GERAN specification	14.2.0
	RP-75	RP-170652	2641	1	A	IOT indication for unicast MPDCCH/PDSCH/PUSCH frequency hopping	14.2.0
	RP-75	RP-170632	2642	3	B	Introducing 256QAM in UL	14.2.0
	RP-75	RP-170654	2644	-	A	Correction CloT cell indications to UE NAS	14.2.0
	RP-75	RP-170633	2645	1	B	Introduction of FeMBMS to 36.331	14.2.0
	RP-75	RP-170643	2646	1	F	Corrections to the exceptional pool	14.2.0
	RP-75	RP-170653	2651	2	A	New S-criteria for enhanced coverage in idle mode	14.2.0
	RP-75	RP-170651	2655	-	A	Corrections in UE capability reporting	14.2.0

	RP-75	RP-170642	2660	2	C	Functional modification of retrieving different UE capabilities for a fallback band combination	14.2.0
	RP-75	RP-170638	2663	2	B	Introduction of Voice and Video enhancements for LTE	14.2.0
	RP-75	RP-170654	2665	1	A	The support of UL 64QAM	14.2.0
	RP-75	RP-170645	2666	1	F	Miscellaneous Corrections on SRS Switching	14.2.0
	RP-75	RP-170646	2667	1	B	Introduction of SRS switching capability for LTE	14.2.0
	RP-75	RP-170652	2671	-	A	Clarification for pucch-NumRepetitionCE-format2-r13 for CE mode B	14.2.0
	RP-75	RP-170643	2673	-	F	Correction on the preconfigured power control parameter for V2X sidelink communication	14.2.0
	RP-75	RP-170653	2675	2	A	Correction of pusch-hoppingOffset	14.2.0
	RP-75	RP-170628	2676	3	B	Introduction of Enhanced LTE-WLAN Aggregation (eLWA)	14.2.0
	RP-75	RP-170651	2678	-	A	Need behaviour of availableAdmissionCapacityRequestWLAN	14.2.0
	RP-75	RP-170644	2685	1	B	Addition of geographical location reporting in 36.331	14.2.0
	RP-75	RP-170630	2689	3	B	Introduction of mobility enhancement solutions in RRC	14.2.0
	RP-75	RP-170651	2694	-	A	Clarification on data handling for LWA bearer	14.2.0
	RP-75	RP-170634	2696	2	B	CR for introduction of NCSG and per CC measurement gap	14.2.0
	RP-75	RP-170634	2697	1	B	CR for introduction of NCSG, short measurement gaps and configuration of CC measurement gap	14.2.0
	RP-75	RP-170321	2698	-	F	Correction to PRACH resource configuration for high speed scenario	14.2.0
	RP-75	RP-170807	2701	1	A	Feature optionality for Cat.1bis UE	14.2.0
	RP-75	RP-170656	2703	-	A	Extension of timer T311	14.2.0
	RP-75					Fixed ASN.1 syntax check error ("PLMN-IdentityList-MBMS-14" -> "PLMN-IdentityList-MBMS-r14")	14.2.1
	RP-75					Updated the version number on the cover sheet	14.2.2
06/2017	RP-76	RP-171226	2705	2	F	Correction to exceptional pool usage in TS 36.331	14.3.0
	RP-76	RP-171237	2706	1	F	Support eDECOR for NB-IoT	14.3.0
	RP-76	RP-171231	2709	1	F	Correction on UE capabilities for eLAA	14.3.0
	RP-75	RP-171243	2711	3	A	Correction on WLAN connection status report monitoring for LWIP	14.3.0
	RP-76	RP-171236	2712	3	F	Correction on eLWA	14.3.0
	RP-76	RP-171225	2713	2	B	Introduction of new Transport Block Size for DL 256QAM	14.3.0
	RP-76	RP-171236	2714	2	F	UE capabilities for eLWA	14.3.0
	RP-76	RP-171227	2715	2	B	Introducing a new SL master information block for V2X sidelink communication	14.3.0
	RP-76	RP-171236	2720	2	F	Clarifications to eLWA	14.3.0
	RP-76	RP-171247	2728	2	B	Introduction of a new UL UE category for 300Mbps with 64QAM	14.3.0
	RP-76	RP-171425	2872	3	F	Miscellaneous general corrections and clarifications resulting from ASN.1 review	14.3.0
	RP-76	RP-171223	2734	2	F	Introduction of SFN indication in handover message	14.3.0
	RP-76	RP-171224	2737	1	F	Correction to SIB-Type-NB	14.3.0
	RP-76	RP-171233	2741	5	F	Clarification of intra-frequency applicability of makeBeforeBreak HO	14.3.0
	RP-76	RP-171224	2745	3	F	Correction to the value range of ce-AuthorisationOffset	14.3.0
	RP-76	RP-171224	2746	2	C	Introduction of Overload Control for Control plane data only	14.3.0
	RP-76	RP-171223	2748	2	F	SC-MCCH information change notification for FeMTC and NB-IoT enhancements	14.3.0
	RP-76	RP-171223	2749	1	F	Alignment of the parameter names for SC-PTM DRX for SC-MCCH and SC-MTCH	14.3.0
	RP-76	RP-171233	2752	3	F	Corrections to RACH-less handover and SCG change	14.3.0
	RP-76	RP-171222	2759	7	F	Corrections to per-CC measurement gap configuration and add the support for UE reporting of numFreqEffectiveReduced when frequencies are configured for reduced measurement performance	14.3.0
	RP-76	RP-171233	2760	1	F	Corrections to make before break mobility	14.3.0
	RP-76	RP-171243	2768	2	F	Clarification regarding requesting fallback combinations with different capabilities	14.3.0
	RP-76	RP-171226	2771	1	F	Leap second change for DFN timing	14.3.0
	RP-76	RP-171244	2773	1	A	Correction to RACH CE level info list	14.3.0
	RP-76	RP-171223	2775	2	C	CE mode configuration/deconfiguration without handover	14.3.0
	RP-76	RP-171227	2791	3	F	Correction on V2X Rx pool for inter-frequency configuration in 36.331	14.3.0
	RP-76	RP-171248	2795	1	A	Entry-Level UE Support UL 64QAM	14.3.0
	RP-76	RP-171235	2797	1	F	FDD TDD difference for VoLTE capability	14.3.0
	RP-76	RP-171242	2804	1	A	Setting of FGI 107 and 108 in case of TDD-FDD CA	14.3.0
	RP-76	RP-171226	2813	1	F	Correction of RRCConnectionReconfiguration reception for V2X	14.3.0
	RP-76	RP-171227	2820	-	F	CR on V2X miscellaneous RRC corrections	14.3.0
	RP-76	RP-171224	2823	2	B	Introduction of RRC connection re-establishment for NB-IoT control plane	14.3.0
	RP-76	RP-171243	2826	-	A	Miscellaneous corrections to CA enhancements	14.3.0
	RP-76	RP-171244	2828	2	A	Clarification to MIB repetitions	14.3.0
	RP-76	RP-171243	2830	3	A	LAA/WiFi sharing indication	14.3.0
	RP-76	RP-171225	2831	-	B	Enable Uplink-Only RoHC operations	14.3.0
	RP-76	RP-171245	2833	1	A	Clarification on contention based random access for NB-IoT	14.3.0
	RP-76	RP-171245	2836	-	A	Editorial correction on ab-Barring parameter	14.3.0
	RP-76	RP-171223	2842	-	F	Correction to FGI 25	14.3.0
	RP-76	RP-171223	2844	1	F	Correction to InterFreqRSTDMeasurementIndication message	14.3.0
	RP-76	RP-171223	2845	2	B	Introduction of enhanced RLM reporting	14.3.0
	RP-76	RP-171245	2848	1	A	Correction on the UE AS context handling	14.3.0
	RP-76	RP-171245	2849	1	A	Correction on attach without PDN connectivity	14.3.0

	RP-76	RP-171233	2851	1	F	Miscellaneous RRC corrections on mobility enhancement	14.3.0
	RP-76	RP-171245	2853	1	A	Clarification on logicalChannelSR-ProhibitTimer for NB-IOT	14.3.0
	RP-76	RP-171223	2854	2	F	Correction to SC-MCCH and SC-MTCH configuration without delta configuration	14.3.0
	RP-76	RP-171230	2869	1	F	Correction of SRS switching	14.3.0
	RP-76	RP-171223	2870	2	F	Miscellaneous FeMTC corrections and clarifications resulting from ASN.1 review	14.3.0
	RP-76	RP-171237	2871	-	F	Miscellaneous eDECOR corrections and clarifications resulting from ASN.1 review	14.3.0
	RP-76	RP-171221	2873	1	F	Miscellaneous FeMBMS corrections and clarifications resulting from ASN.1 review	14.3.0
	RP-76	RP-171221	2874	1	B	UE capabilities for FeMBMS	14.3.0
	RP-76	RP-171224	2876	1	F	Long DRX values with regular wake-up cycle – Option 1	14.3.0
	RP-76	RP-171244	2879	-	A	Correction on terminology of SI for eMTC	14.3.0
	RP-76	RP-171223	2882	1	F	Correction on the description of ce-srsEnhancement for FeMTC	14.3.0
	RP-76	RP-171223	2883	2	B	Measurement gap sharing for FeMTC intra- and inter-frequency measurement	14.3.0
	RP-76	RP-171223	2884	1	F	Minor correction in TS 36.331 for FeMTC	14.3.0
	RP-76	RP-171223	2885	2	F	Corrections on reconfiguration between CE mode and normal mode in eMTC	14.3.0
	RP-76	RP-171511	2887	1	F	Clarification regarding eFD-MIMO configuration (REL-14)	14.3.0
	RP-76	RP-171235	2889	1	F	Correction of issues related to ASN.1 review for eVoLTE	14.3.0
	RP-76	RP-171230	2890	1	F	Merging of retuningTimeBandPairList with regular supported BC capabilities (ASN.1 review issue S.059)	14.3.0
	RP-76	RP-171222	2891	-	F	Consistent gap pattern configuration for serving cells	14.3.0
	RP-76	RP-171407	2903	2	B	Introduction of UE capability for V2X in 36.331	14.3.0
	RP-76	RP-171227	2905	1	F	Correction on V2X behavior in 36.331	14.3.0
	RP-76	RP-171246	2912	2	B	EUTRAN sharing enhancement	14.3.0
	RP-76	RP-171244	2919	-	A	Clarification on additionalSpectrumEmission for eMTC	14.3.0
	RP-76	RP-171245	2920	-	A	Clarification on additionalSpectrumEmission for NB-IoT	14.3.0
	RP-76	RP-171224	2927	-	F	Correction to CarrierConfigDedicated-NB	14.3.0
	RP-76	RP-171224	2929	2	F	Miscellaneous NB-IoT corrections and clarifications resulting from ASN.1 review	14.3.0
	RP-76	RP-171245	2931	2	A	Extension of SintraSearchP value range	14.3.0
	RP-76	RP-171223	2932	-	F	Maximum PDSCH/PUSCH BW preference indication handling for handover	14.3.0
	RP-76	RP-171225	2938	3	F	Revert PDCP state variable HFN and SN back to the values used in the source cell	14.3.0
	RP-76	RP-171236	2942	1	F	ASN.1 corrections for eLWA	14.3.0
	RP-76	RP-171241	2943	-	A	Clarification on UE capability and early feature support	14.3.0
	RP-76	RP-171243	2944	-	A	Clarification regarding EBF-FDMIMO configuration (REL-13)	14.3.0
	RP-76	RP-171245	2945	1	A	Generic clarification of "first bit" as leftmost bit	14.3.0
	RP-76	RP-171229	2948	-	B	Introduction of UE capabilities for high speed	14.3.0
	RP-76	RP-171229	2949	-	F	Correction of high speed	14.3.0
	RP-76	RP-171227	2950	-	F	CR on reduction of SIB21 size	14.3.0
	RP-76	RP-171244	2952	1	A	Configuration of preamble groups for CE levels and preamble groups A/B	14.3.0
	RP-76	RP-171244	2954	1	A	Extension of RSRP range for eMTC	14.3.0
	RP-76	RP-171169	2958	-	C	FeMBMS/unicast-mixed carrier flag in measurement object	14.3.0
09/2017	RP-77	RP-171919	2807	4	A	Correction to PUCCH-ConfigDedication	14.4.0
	RP-77	RP-171914	2961	2	F	Correction on SPS assistance information in TS 36.331	14.4.0
	RP-77	RP-171914	2977	1	F	Miscellaneous correction to V2X in TS 36.331	14.4.0
	RP-77	RP-171914	2978	2	B	Introduction of new NS values for V2X sidelink communication	14.4.0
	RP-77	RP-171918	2980	3	A	Adding abstract syntax notation one chapter of sidelink pre-configuration.	14.4.0
	RP-77	RP-171914	2983	1	F	Correction on TTI bundling for TDD configurations 2 and 3	14.4.0
	RP-77	RP-171911	2984	2	F	Corrections on the use of plmn-IdentityList in field descriptions	14.4.0
	RP-77	RP-171915	2985	2	F	RRC Connection Re-establishment for Control Plane ClOT EPS Optimization	14.4.0
	RP-77	RP-171919	2989	-	A	Clarification that DL only bands are not supported in NB-IoT	14.4.0
	RP-77	RP-171915	2990	1	F	Cleanup for NB-IoT Enhancements	14.4.0
	RP-77	RP-171920	2992	2	A	Clarification on SI repetition pattern	14.4.0
	RP-77	RP-171914	2993	2	F	CR on conditon for RRC connection establishment and condition for sidelink UE information for V2X sidelink communication	14.4.0
	RP-77	RP-171913	2994	2	F	Correction on RACH-less SeNB Change	14.4.0
	RP-77	RP-171915	2995	-	F	Corrections on eVoLTE	14.4.0
	RP-77	RP-171914	2997	2	F	Corrections to random selection for P2X related V2X sidelink communication	14.4.0
	RP-77	RP-171916	3002	2	A	additionalSpectrumEmission extension	14.4.0
	RP-77	RP-171915	3008	1	F	Correction of field descriptions for recommendedBitRate and recommendedBitRateQuery	14.4.0
	RP-77	RP-171919	3014	2	A	RRM Measurement Clarification on Discovery Signals for LAA	14.4.0
	RP-77	RP-171919	3018	-	A	Correction in PUSCH Config description	14.4.0
	RP-77	RP-171913	3022	-	F	Cat-M1 indication by Cat-M2 UE	14.4.0
	RP-77	RP-171920	3025	1	A	Clarification on the freqHoppingParametersDL during handover	14.4.0
	RP-77	RP-171920	3027	1	A	Clarification on rsp-ThresholdsPrachInfoList during handover	14.4.0

	RP-77	RP-171913	3028	-	F	Clarification on systemInformationBlockType2Dedicated	14.4.0
	RP-77	RP-171920	3030	2	A	Clarification on Bandwidth Reduced operation	14.4.0
	RP-77	RP-171915	3036	-	F	Correction for connEstFailOffset	14.4.0
	RP-77	RP-171911	3040	-	F	Clarification on LWIP aggregation	14.4.0
	RP-77	RP-171913	3041	1	F	Correction to eLAA configuration	14.4.0
	RP-77	RP-171914	3042	2	C	Packet Reordering for Sidelink	14.4.0
	RP-77	RP-171920	3044	1	A	Corrections on TS 36.331 for Rel-13 MTC	14.4.0
	RP-77	RP-171913	3047	-	F	Corrections on Bandwidth preference indication for Rel-14 MTC	14.4.0
	RP-77	RP-171913	3048	1	F	Corrections on TS 36.331 for Rel-14 MTC	14.4.0
	RP-77	RP-171914	3051	2	F	Clarification on NCSG UE capability	14.4.0
	RP-77	RP-171914	3052	1	F	Corrections to UL 256 QAM capability field descriptions	14.4.0
	RP-77	RP-171914	3054	1	F	Clarification on per CC measurement gap	14.4.0
	RP-77	RP-171915	3055	1	C	Introduction of RLC UM support for LWA	14.4.0
	RP-77	RP-171919	3057	-	A	Correction on eCA with Dual Connectivity	14.4.0
	RP-77	RP-171913	3059	-	F	Clarification of the PTAG value for the RACH-less handover	14.4.0
	RP-77	RP-171920	3063	1	A	Clarification on number of RACH CE levels vs number of RSRP thresholds	14.4.0
	RP-77	RP-171915	3064	1	F	Correction to contention free random access	14.4.0
	RP-77	RP-171913	3065	2	C	Introduction of Release Assistance Indication	14.4.0
	RP-77	RP-171920	3067	2	A	TM9 capabilities in CE mode	14.4.0
	RP-77	RP-171915	3068	1	F	Introduction of interference randomisation in NB-IoT	14.4.0
	RP-77	RP-171919	3070	-	A	Clarification on PUCCH SCell change	14.4.0
12/2017	RP-78	RP-172615	2968	5	F	Cleaning up CQI and CSI-RS-related configurations (related to Rel-14 ASN.1 review issue N.099)	14.5.0
	RP-78	RP-172615	2982	8	B	Introduction of the overheating indication	14.5.0
	RP-78	RP-172616	3037	4	F	Target cell optional PBCH repetition status indication	14.5.0
	RP-78	RP-172624	3046	3	A	Corrections on paging monitoring in RRC_CONNECTED in Rel-13 eMTC	14.5.0
	RP-78	RP-172721	3071	3	B	Introduction of DL 2Gbps Category	14.5.0
	RP-78	RP-172617	3072	3	F	Correction to Inter-frequency reception for V2X sidelink communication	14.5.0
	RP-78	RP-172617	3073	4	F	CR on SIB21 reading	14.5.0
	RP-78	RP-172622	3081	2	A	UE capabilities for Tx antenna selection	14.5.0
	RP-78	RP-172617	3084	3	F	Transmission of P2X sidelink communication in Exceptional Pool	14.5.0
	RP-78	RP-172617	3085	2	F	Correction on SubframeBitmap Configuration in Band 47	14.5.0
	RP-78	RP-172616	3088	1	F	Correction on SRS switching capabilities field description	14.5.0
	RP-78	RP-172617	3090	2	F	Clarification on Interference Randomisation in NB-IoT in 36.331	14.5.0
	RP-78	RP-172616	3091	1	F	MUST capability	14.5.0
	RP-78	RP-172624	3096	4	A	Corrections on field description of cellSelectionInfoCE for eMTC	14.5.0
	RP-78	RP-172617	3107	2	F	Correction to UE capabilities	14.5.0
	RP-78	RP-172623	3108	1	A	Define requirement for reception of number of simultaneous SC-PTM services	14.5.0
	RP-78	RP-172616	3110	3	B	Signaling of NCSG Support for Inter-F Measurement	14.5.0
	RP-78	RP-172623	3112	2	A	Clarification on csi-RS-ConfigNZPId	14.5.0
	RP-78	RP-172617	3113	4	F	Correction to UE-Capability-NB extension and provision for late rel-13 corrections	14.5.0
	RP-78	RP-172624	3120	1	F	Alignment of FGI4 (Short DRX) for Cat M1 and M2	14.5.0
	RP-78	RP-172616	3127	-	F	UE capability for support of SRS enhancements without support of comb 4	14.5.0
	RP-78	RP-172624	3129	1	F	MBSFN subframes for target cell during handover to CE cell	14.5.0
	RP-78	RP-172615	3132	3	C	Reject of unprotected redirect to GERAN	14.5.0
	RP-78	RP-172616	3135	2	F	Correction to actions related to InterFreqRSTDMeasurementIndication message	14.5.0
	RP-78	RP-172616	3137	1	F	Clarification on srs-UpPtsAdd in SRS coverage enhancement	14.5.0
	RP-78	RP-172616	3138	1	F	Scheduling information of SIB1-BR when skipping MIB during HO	14.5.0
	RP-78	RP-172624	3140	1	A	Introducing a definition for the term UE in CE	14.5.0
	RP-78	RP-172617	3153	2	F	NRS-CRS power offset configuration for NB-IoT	14.5.0
	RP-78	RP-172617	3154	3	C	Introduction of relaxed monitoring in NB-IoT	14.5.0
	RP-78	RP-172617	3157	1	F	Successful acknowledgement of RRCConnectionRelease	14.5.0
	RP-78	RP-172624	3160	1	A	TM6 capabilities in CE mode	14.5.0
	RP-78	RP-172616	3169	1	F	Correction on the field description of ce-PDSCH-TenProcesses	14.5.0
	RP-78	RP-172617	3175	1	F	Small corrections to CarrierConfigDedicated, T322 and t-reordering default configuration	14.5.0
	RP-78	RP-172617	3176	1	F	Correction to random access power control in 36.331	14.5.0
	RP-78	RP-172616	3180	1	B	Introduction of a new configuration for ssp10 with less CRS	14.5.0
	RP-78	RP-172617	3184	-	F	Correction on zone configuration in transmission pool selection	14.5.0
	RP-78	RP-172622	3190	-	A	DCI monitoring subframes for eIMTA	14.5.0
	RP-78	RP-172623	3194	-	F	SFN desynchronization between eNB and eDRX UE	14.5.0
01/2018	RP-78					Removed revision marks (MCC)	14.5.1
03/2018	RP-79	RP-180443	3216	-	F	Correction on SRS carrier switching	14.6.0
	RP-79	RP-180443	3221	-	F	Correction to field description for HARQ-ACK delay for Rel-14 MTC	14.6.0
	RP-79	RP-180445	3223	1	F	Correction to RRCConnectionReestablishment message in 36.331	14.6.0
	RP-79	RP-180443	3237	2	C	Introduction of support of relaxed monitoring for BL and CE UE	14.6.0
	RP-79	RP-180448	3244	2	B	Introduction of LTE DL 1.4Gbps Category	14.6.0
	RP-79	RP-180442	3255	1	A	Correction to handling of p-Max procedure for high-power UEs	14.6.0
	RP-79	RP-180445	3257	-	F	Small correction on PhysicalConfigDedicated-NB	14.6.0

	RP-79	RP-180446	3262	2	F	Correction on Override of the highPriorityAccess Establishment Cause by the mo-VoiceCall value	14.6.0
	RP-79	RP-180442	3266	1	A	Different power class support for band combinations	14.6.0
	RP-79	RP-180444	3271	1	F	Clarifications on V2X resource selection in the absence of positioning information	14.6.0
	RP-79	RP-180446	3273	1	F	Correction to GERAN redirection without security	14.6.0
	RP-79	RP-180441	3276	1	A	Correction to pucch-ConfigDedicated for fallback configuration	14.6.0
	RP-79	RP-180446	3278	2	F	Signalling for reading shared PLMN information from non-CSG cells	14.6.0
	RP-79	RP-180443	3281	-	F	Clarification to PUCCH Configuration for LAA SCells	14.6.0
	RP-79	RP-180444	3292	1	F	Correction on SI-offsetIndicator for the sidelink resource pool	14.6.0
	RP-79	RP-180441	3295	2	F	Clarification on the NPRACH starting subcarrier partitioning for multi-tone Msg3 transmission	14.6.0
	RP-79	RP-180441	3305	-	A	RRC Corrections for RRC Resume	14.6.0
04/2018	RP-79					New version to fix ASN.1 formatting	14.6.1
	RP-79					To maintain the compatibility between Rel-14 and Rel-15 ASN.1, "OPTIONAL" is removed from otherParameters-1460 in UE-EUTRA-Capability-v1460-IEs.	14.6.2
06/2018	RP-80	RP-181230	3291	2	A	Removal of the FDD/TDD diff restriction for crs-InterfHandl IE	14.7.0
	RP-80	RP-181171	3302	4	C	Introduction of support for MAC PDU containing UE contention resolution identity MAC control element without RRC response message in NB-IoT	14.7.0
	RP-80	RP-181234	3311	2	F	Correction on SPS assistance information in TS 36.331	14.7.0
	RP-80	RP-181235	3326	2	F	Correction to T310 timer description and editorials	14.7.0
	RP-80	RP-181235	3327	3	C	Introduction of serving cell idle mode measurements reporting in 36.331	14.7.0
	RP-80	RP-181233	3344	3	F	Correction on extended RSRP measurement reporting for BL UE or UE in CE	14.7.0
	RP-80	RP-181233	3345	1	F	Clarification on RRC reconfiguration without handover for switching EC to NC	14.7.0
	RP-80	RP-181230	3356	2	A	Correction for IDC hardware sharing problems	14.7.0
	RP-80	RP-181234	3358	2	F	Corrections to syncOffsetIndicator Configuration	14.7.0
	RP-80	RP-181236	3364	3	F	Correction on UE capabilities	14.7.0
	RP-80	RP-181231	3369	1	A	Clarification on ue-TxAntennaSelectionSupported when bandParameterList-v1380 is included	14.7.0
	RP-80	RP-181229	3393	1	F	Handling of Pmax for PC2 and uplink intra-band contiguous CA capable UEs	14.7.0
	RP-80	RP-181236	3395	1	F	Correction for support of alternative TBS indices	14.7.0
	RP-80	RP-181233	3398	1	F	Clarification on RACH-less configuration release	14.7.0
	RP-80	RP-181415	3405	2	A	Corrections to additionalSpectrumEmission extension	14.7.0
	RP-80	RP-181232	3429	1	A	Correction to handling of p-Max procedure for high-power UEs	14.7.0
	RP-80	RP-181234	3431	2	F	Introduce the short value of sc-mcch repetition period and sc-mcch modification period out of 'br-BCCH-Config-r14'	14.7.0
	RP-80	RP-181236	3432	-	F	Clarification on cellIdentity for shortMAC-I	14.7.0
	RP-80	RP-181236	3438	2	C	Introduction of DL Channel Quality reporting	14.7.0
	RP-80	RP-181234	3452	2	C	Corrections to CBR Measurement Report Triggering	14.7.0
	RP-80	RP-181224	3465	2	A	Correction on delta-RxLevMinCE1	14.7.0
	RP-80	RP-181233	3469	1	F	Merged CR: UE capabilities for handling of multiple numerologies in FeMBMS, SRS carrier switching, and advanced CSI in FD-MIMO	14.7.0
09/2018	RP-81	RP-181962	3435	2	F	Correction on the field description of enable256QAM	14.8.0
	RP-81	RP-181961	3444	1	A	Clarification to Security mode failure in NB-IoT	14.8.0
	RP-81	RP-181962	3482	1	F	Correction for Zoning	14.8.0
	RP-81	RP-181961	3488	-	A	Correcting a typo in aperiodicCSI-Trigger	14.8.0
	RP-81	RP-181963	3496	1	F	Correction to RRC Connection Re-establishment for the control plane	14.8.0
	RP-81	RP-181961	3501	1	A	Radio resource configuration handling when resuming a suspended RRC connection	14.8.0
	RP-81	RP-181962	3515	1	F	Correction to the description of UE capability for V2X sidelink communication	14.8.0
	RP-81	RP-181962	3517	-	F	Correction on the duplex mode configuration for Rx pool	14.8.0
	RP-81	RP-181962	3530	-	F	Correction on V2X TX pool selection	14.8.0
	RP-81	RP-181962	3532	1	F	CR on Clarification of Configuring codebookConfigNx for Rel-14	14.8.0
	RP-81	RP-181962	3537	-	F	Clarification for the asynchronous HARQ with the LTE mobility enhancements	14.8.0
	RP-81	RP-181963	3540	-	F	Introduction of provision for late rel-14 capability	14.8.0
12/2018	RP-82	RP-182681	3494	3	F	Editorial restructuring of NPRACH resource configuration	14.9.0
	RP-82	RP-182680	3543	3	F	Correction for sidelink measurement periodical triggering condition	14.9.0
	RP-82	RP-182679	3556	3	F	Correction on maximum symbols for PUSCH transmission in UpPTS	14.9.0
	RP-82	RP-182677	3562	2	A	Corrections to eCA configuration	14.9.0
	RP-82	RP-182358	3672	3	F	CR to 36.331 on the ambiguity of CellIdentity in MAC-I calculation	14.9.0
	RP-82	RP-182680	3686	3	F	Discard the AS context and Resumeld when initiating the establishment of a RRC Connection	14.9.0
	RP-82	RP-182682	3696	-	F	Clarification for additional SRS symbols	14.9.0
	RP-82	RP-182677	3716	-	A	UL power control information for PUCCH format 4/5 in SIB	14.9.0
	RP-82	RP-182674	3726	-	F	Clarification on csi-RS-ConfigNRP-EMIMO configuration	14.9.0
	RP-82	RP-182677	3735	1	A	n1PUCCH-AN-CS-ListP1-r13 ASN.1 error correction	14.9.0
	RP-82	RP-182680	3762	1	A	Correction on interFreqNeighCellList	14.9.0
03/2019	RP-83	RP-190548	3829	-	A	Correction on interFreqNeighCellList	14.10.0

	RP-83	RP-190549	3838	1	F	Correction to systemInformationBlockType2Dedicated	14.10.0
	RP-83	RP-190547	3844	1	A	Missing inter-node SCG field	14.10.0
	RP-83	RP-190549	3859	-	F	Correction on UE capability signalling for simultaneous antenna and carrier switching	14.10.0
	RP-83	RP-190549	3867	-	F	Clarification to Permitted MaxCID for ROHC and Uplink-Only ROHC	14.10.0
	RP-83	RP-190549	3911	1	F	Clarification on ssp mapping rules for ssp10-CRS-LessDwPTS	14.10.0
	RP-83	RP-190549	3939	-	F	UE capability for support of special subframe configuration 10 with TDD-only CA	14.10.0
06/2019	RP-84	RP-191382	3950	2	A	Correction in the field description of aperiodicCSI-Trigger	14.11.0
	RP-84	RP-191383	3966	2	C	UE capability signalling for FD-MIMO processing capabilities	14.11.0
	RP-84	RP-191383	3971	-	F	Correction to NPRACH resource default configuration	14.11.0
	RP-84	RP-191383	3979	-	F	Additional UE capability signalling for SRS carrier switching	14.11.0
	RP-84	RP-191382	4000	1	A	Correction to dual connectivity	14.11.0
	RP-84	RP-191383	4014	1	F	Corrections on UE capability for eFD-MIMO	14.11.0
09/2019	RP-85	RP-192195	4063	1	F	Correction to the description of DL channel quality	14.12.0
12/2019	RP-86	RP-192940	4112	2	F	Correction on T322	14.13.0
	RP-86	RP-192939	4182	-	A	Clarification on sCellIndex and SCell lists	14.13.0

History

Document history		
V14.2.2	May 2017	Publication
V14.3.0	October 2017	Publication
V14.4.0	October 2017	Publication
V14.5.1	January 2018	Publication
V14.6.2	April 2018	Publication
V14.8.0	October 2018	Publication
V14.9.0	January 2019	Publication
V14.10.0	May 2019	Publication
V14.11.0	July 2019	Publication
V14.12.0	October 2019	Publication
V14.13.0	January 2020	Publication