

ETSI TS 136 331 V18.3.1 (2024-10)



**LTE;  
Evolved Universal Terrestrial Radio Access (E-UTRA);  
Radio Resource Control (RRC);  
Protocol specification  
(3GPP TS 36.331 version 18.3.1 Release 18)**



---

**Reference**

RTS/TSGR-0236331 vi31

---

**Keywords**

LTE

**ETSI**

---

650 Route des Lucioles  
F-06921 Sophia Antipolis Cedex - FRANCE

Tel.: +33 4 92 94 42 00 Fax: +33 4 93 65 47 16

Siret N° 348 623 562 00017 - APE 7112B  
Association à but non lucratif enregistrée à la  
Sous-Préfecture de Grasse (06) N° w061004871

---

**Important notice**

The present document can be downloaded from the  
ETSI [Search & Browse Standards application](#).

The present document may be made available in electronic versions and/or in print. The content of any electronic and/or print versions of the present document shall not be modified without the prior written authorization of ETSI. In case of any existing or perceived difference in contents between such versions and/or in print, the prevailing version of an ETSI deliverable is the one made publicly available in PDF format on [ETSI deliver](#).

Users should be aware that the present document may be revised or have its status changed,  
this information is available in the [Milestones listing](#).

If you find errors in the present document, please send your comments to  
the relevant service listed under [Committee Support Staff](#).

If you find a security vulnerability in the present document, please report it through our  
[Coordinated Vulnerability Disclosure \(CVD\)](#) program.

---

**Notice of disclaimer & limitation of liability**

The information provided in the present deliverable is directed solely to professionals who have the appropriate degree of experience to understand and interpret its content in accordance with generally accepted engineering or other professional standard and applicable regulations.

No recommendation as to products and services or vendors is made or should be implied.

No representation or warranty is made that this deliverable is technically accurate or sufficient or conforms to any law and/or governmental rule and/or regulation and further, no representation or warranty is made of merchantability or fitness for any particular purpose or against infringement of intellectual property rights.

In no event shall ETSI be held liable for loss of profits or any other incidental or consequential damages.

Any software contained in this deliverable is provided "AS IS" with no warranties, express or implied, including but not limited to, the warranties of merchantability, fitness for a particular purpose and non-infringement of intellectual property rights and ETSI shall not be held liable in any event for any damages whatsoever (including, without limitation, damages for loss of profits, business interruption, loss of information, or any other pecuniary loss) arising out of or related to the use of or inability to use the software.

---

**Copyright Notification**

No part may be reproduced or utilized in any form or by any means, electronic or mechanical, including photocopying and microfilm except as authorized by written permission of ETSI.

The content of the PDF version shall not be modified without the written authorization of ETSI.

The copyright and the foregoing restriction extend to reproduction in all media.

© ETSI 2024.  
All rights reserved.

---

# Intellectual Property Rights

## Essential patents

IPRs essential or potentially essential to normative deliverables may have been declared to ETSI. The declarations pertaining to these essential IPRs, if any, are publicly available for **ETSI members and non-members**, and can be found in ETSI SR 000 314: "*Intellectual Property Rights (IPRs); Essential, or potentially Essential, IPRs notified to ETSI in respect of ETSI standards*", which is available from the ETSI Secretariat. Latest updates are available on the ETSI Web server (<https://ipr.etsi.org/>).

Pursuant to the ETSI Directives including the ETSI IPR Policy, no investigation regarding the essentiality of IPRs, including IPR searches, has been carried out by ETSI. No guarantee can be given as to the existence of other IPRs not referenced in ETSI SR 000 314 (or the updates on the ETSI Web server) which are, or may be, or may become, essential to the present document.

## Trademarks

The present document may include trademarks and/or tradenames which are asserted and/or registered by their owners. ETSI claims no ownership of these except for any which are indicated as being the property of ETSI, and conveys no right to use or reproduce any trademark and/or tradename. Mention of those trademarks in the present document does not constitute an endorsement by ETSI of products, services or organizations associated with those trademarks.

**DECT™**, **PLUGTESTS™**, **UMTS™** and the ETSI logo are trademarks of ETSI registered for the benefit of its Members. **3GPP™** and **LTE™** are trademarks of ETSI registered for the benefit of its Members and of the 3GPP Organizational Partners. **oneM2M™** logo is a trademark of ETSI registered for the benefit of its Members and of the oneM2M Partners. **GSM®** and the GSM logo are trademarks registered and owned by the GSM Association.

---

# Legal Notice

This Technical Specification (TS) has been produced by ETSI 3rd Generation Partnership Project (3GPP).

The present document may refer to technical specifications or reports using their 3GPP identities. These shall be interpreted as being references to the corresponding ETSI deliverables.

The cross reference between 3GPP and ETSI identities can be found under <https://webapp.etsi.org/key/queryform.asp>.

---

# Modal verbs terminology

In the present document "**shall**", "**shall not**", "**should**", "**should not**", "**may**", "**need not**", "**will**", "**will not**", "**can**" and "**cannot**" are to be interpreted as described in clause 3.2 of the [ETSI Drafting Rules](#) (Verbal forms for the expression of provisions).

"**must**" and "**must not**" are **NOT** allowed in ETSI deliverables except when used in direct citation.

# Contents

Intellectual Property Rights .....	2
Legal Notice .....	2
Modal verbs terminology.....	2
Foreword.....	24
1 Scope .....	25
2 References .....	25
3 Definitions, symbols and abbreviations .....	30
3.1 Definitions .....	30
3.2 Abbreviations .....	33
4 General .....	37
4.1 Introduction .....	37
4.2 Architecture .....	38
4.2.1 UE states and state transitions including inter RAT .....	38
4.2.2 Signalling radio bearers .....	42
4.3 Services .....	43
4.3.1 Services provided to upper layers .....	43
4.3.2 Services expected from lower layers .....	44
4.4 Functions .....	44
4.5 Data available for transmission for NB-IoT .....	45
5 Procedures .....	45
5.1 General .....	45
5.1.1 Introduction.....	45
5.1.2 General requirements .....	46
5.1.3 Requirements for UE in MR-DC .....	47
5.2 System information .....	47
5.2.1 Introduction.....	47
5.2.1.1 General .....	47
5.2.1.2 Scheduling.....	48
5.2.1.2a Scheduling for NB-IoT .....	49
5.2.1.3 System information validity and notification of changes .....	50
5.2.1.4 Indication of ETWS notification .....	52
5.2.1.5 Indication of CMAS notification.....	52
5.2.1.6 Notification of EAB parameters change .....	53
5.2.1.7 Access Barring parameters change in NB-IoT .....	53
5.2.1.8 Notification of UAC parameters change .....	53
5.2.2 System information acquisition .....	54
5.2.2.1 General .....	54
5.2.2.2 Initiation.....	54
5.2.2.3 System information required by the UE.....	54
5.2.2.4 System information acquisition by the UE.....	56
5.2.2.5 Essential system information missing .....	60
5.2.2.6 Actions upon reception of the <i>MasterInformationBlock</i> message.....	61
5.2.2.7 Actions upon reception of the <i>SystemInformationBlockType1</i> message .....	61
5.2.2.8 Actions upon reception of <i>SystemInformation</i> messages .....	64
5.2.2.9 Actions upon reception of <i>SystemInformationBlockType2</i> .....	64
5.2.2.10 Actions upon reception of <i>SystemInformationBlockType3</i> .....	66
5.2.2.11 Actions upon reception of <i>SystemInformationBlockType4</i> .....	67
5.2.2.12 Actions upon reception of <i>SystemInformationBlockType5</i> .....	67
5.2.2.13 Actions upon reception of <i>SystemInformationBlockType6</i> .....	68
5.2.2.14 Actions upon reception of <i>SystemInformationBlockType7</i> .....	68
5.2.2.15 Actions upon reception of <i>SystemInformationBlockType8</i> .....	68
5.2.2.16 Actions upon reception of <i>SystemInformationBlockType9</i> .....	69
5.2.2.17 Actions upon reception of <i>SystemInformationBlockType10</i> .....	69

5.2.2.18	Actions upon reception of <i>SystemInformationBlockType11</i> .....	69
5.2.2.19	Actions upon reception of <i>SystemInformationBlockType12</i> .....	70
5.2.2.20	Actions upon reception of <i>SystemInformationBlockType13</i> .....	71
5.2.2.21	Actions upon reception of <i>SystemInformationBlockType14</i> .....	71
5.2.2.22	Actions upon reception of <i>SystemInformationBlockType15</i> .....	71
5.2.2.23	Actions upon reception of <i>SystemInformationBlockType16</i> .....	71
5.2.2.24	Actions upon reception of <i>SystemInformationBlockType17</i> .....	71
5.2.2.25	Actions upon reception of <i>SystemInformationBlockType18</i> .....	71
5.2.2.26	Actions upon reception of <i>SystemInformationBlockType19</i> .....	72
5.2.2.27	Actions upon reception of <i>SystemInformationBlockType20</i> .....	72
5.2.2.28	Actions upon reception of <i>SystemInformationBlockType21</i> .....	72
5.2.2.29	Actions upon reception of <i>SystemInformationBlockType22-NB</i> .....	73
5.2.2.30	Actions upon reception of <i>SystemInformationBlockType23-NB</i> .....	73
5.2.2.31	Actions upon reception of <i>SystemInformationBlockType24</i> .....	73
5.2.2.32	Actions upon reception of <i>SystemInformationBlockType25</i> .....	73
5.2.2.33	Actions upon reception of <i>SystemInformationBlockType26</i> .....	73
5.2.2.33a	Actions upon reception of <i>SystemInformationBlockType26a</i> .....	73
5.2.2.34	Actions upon reception of <i>SystemInformationBlockPos</i> .....	74
5.2.2.35	Actions upon reception of <i>SystemInformationBlockType27</i> .....	74
5.2.2.36	Actions upon reception of <i>SystemInformationBlockType28</i> .....	74
5.2.2.37	Actions upon reception of <i>SystemInformationBlockType29</i> .....	74
5.2.2.38	Actions upon reception of <i>SystemInformationBlockType30</i> .....	74
5.2.2.39	Actions upon reception of <i>SystemInformationBlockType31</i> .....	74
5.2.2.40	Actions upon reception of <i>SystemInformationBlockType32</i> .....	74
5.2.2.41	Actions upon reception of <i>SystemInformationBlockType33</i> .....	74
5.2.3	Acquisition of an SI message.....	75
5.2.3a	Acquisition of an SI message by BL UE or UE in CE or a NB-IoT UE.....	75
5.2.3b	Acquisition of an SI message from MBMS-dedicated cell.....	76
5.3	Connection control .....	77
5.3.1	Introduction.....	77
5.3.1.1	RRC connection control.....	77
5.3.1.2	Security .....	79
5.3.1.2a	RN security .....	81
5.3.1.3	Connected mode mobility .....	81
5.3.1.4	Connection control in NB-IoT .....	82
5.3.2	Paging .....	83
5.3.2.1	General .....	83
5.3.2.2	Initiation.....	84
5.3.2.3	Reception of the <i>Paging</i> message by the UE .....	84
5.3.3	RRC connection establishment .....	86
5.3.3.1	General .....	86
5.3.3.1a	Conditions for establishing RRC Connection for sidelink communication/ discovery/ V2X sidelink communication/ NR sidelink communication .....	89
5.3.3.1b	Conditions for initiating EDT .....	90
5.3.3.1c	Conditions for initiating transmission using PUR.....	91
5.3.3.1d	Condition for establishing RRC Connection in NTN.....	91
5.3.3.2	Initiation.....	91
5.3.3.3	Actions related to transmission of <i>RRCConnectionRequest</i> message .....	99
5.3.3.3a	Actions related to transmission of <i>RRCConnectionResumeRequest</i> message.....	100
5.3.3.3b	Actions related to transmission of <i>RRCEarlyDataRequest</i> message.....	104
5.3.3.3c	UE actions upon receiving EDT fallback indication from lower layers.....	104
5.3.3.4	Reception of the <i>RRCConnectionSetup</i> by the UE.....	105
5.3.3.4a	Reception of the <i>RRCConnectionResume</i> by the UE .....	111
5.3.3.4b	Reception of the <i>RRCEarlyDataComplete</i> by the UE.....	116
5.3.3.5	Cell re-selection or cell selection while T300, T302, T303, T305, T306, T308 or T309 is running... 118	
5.3.3.6	T300 expiry .....	119
5.3.3.7	T302, T303, T305, T306, or T308 expiry or stop .....	120
5.3.3.8	Reception of the <i>RRCConnectionReject</i> by the UE .....	121
5.3.3.9	Abortion of RRC connection establishment.....	122
5.3.3.9a	Abortion of early security reactivation.....	123
5.3.3.10	Handling of SSAC related parameters .....	123
5.3.3.11	Access barring check.....	124

5.3.3.12	EAB check .....	124
5.3.3.13	Access barring check for ACDC .....	126
5.3.3.14	Access Barring check for NB-IoT .....	126
5.3.3.15	Failure to deliver NAS information in RRCConnectionSetupComplete message .....	128
5.3.3.16	Integrity check failure from lower layers while T300 is running .....	128
5.3.3.17	Inability to comply with RRCConnectionResume .....	129
5.3.3.18	Early security reactivation .....	129
5.3.3.19	Timing alignment validation for transmission using PUR .....	129
5.3.3.20	Maintenance of PUR occasions .....	129
5.3.3.21	UE actions upon indication of out-of-date GNSS position .....	130
5.3.3.22	Void .....	131
5.3.3.23	UE actions upon detecting discontinuous coverage .....	131
5.3.3.24	T390 expiry .....	131
5.3.3.25	UE actions upon receiving UL transmission extension indication .....	131
5.3.4	Initial security activation .....	131
5.3.4.1	General .....	131
5.3.4.2	Initiation .....	132
5.3.4.3	Reception of the SecurityModeCommand by the UE .....	132
5.3.5	RRC connection reconfiguration .....	133
5.3.5.1	General .....	133
5.3.5.2	Initiation .....	133
5.3.5.3	Reception of an RRCConnectionReconfiguration not including the mobilityControlInfo by the UE .....	134
5.3.5.4	Reception of an RRCConnectionReconfiguration including the mobilityControlInfo by the UE (handover) .....	137
5.3.5.5	Reconfiguration failure .....	145
5.3.5.6	T304 expiry (handover failure) .....	146
5.3.5.7	Void .....	148
5.3.5.7a	T307 expiry (SCG change failure) .....	148
5.3.5.8	Radio Configuration involving full configuration option .....	148
5.3.5.9	Conditional reconfiguration .....	151
5.3.5.9.1	General .....	151
5.3.5.9.2	Conditional reconfiguration removal .....	151
5.3.5.9.3	Conditional reconfiguration addition/modification .....	151
5.3.5.9.4	Conditional reconfiguration evaluation .....	152
5.3.5.9.5	Conditional reconfiguration execution .....	153
5.3.5.9.6	VarConditionalReconfiguration remove .....	153
5.3.5.9.7	VarConditionalReconfiguration CPC remove .....	154
5.3.6	Counter check .....	154
5.3.6.1	General .....	154
5.3.6.2	Initiation .....	154
5.3.6.3	Reception of the CounterCheck message by the UE .....	154
5.3.7	RRC connection re-establishment .....	155
5.3.7.1	General .....	155
5.3.7.1a	Condition for re-establishing RRC Connection in NTN .....	156
5.3.7.2	Initiation .....	156
5.3.7.3	Actions following cell selection while T311 is running .....	158
5.3.7.4	Actions related to transmission of RRCConnectionReestablishmentRequest message .....	161
5.3.7.5	Reception of the RRCConnectionReestablishment by the UE .....	162
5.3.7.6	T311 expiry .....	165
5.3.7.7	T301 expiry or selected cell no longer suitable .....	165
5.3.7.8	Reception of RRCConnectionReestablishmentReject by the UE .....	166
5.3.8	RRC connection release .....	166
5.3.8.1	General .....	166
5.3.8.2	Initiation .....	166
5.3.8.3	Reception of the RRCConnectionRelease by the UE .....	166
5.3.8.4	T320 expiry .....	170
5.3.8.5	T322 expiry or stop .....	170
5.3.8.6	UE actions upon receiving the expiry of DataInactivityTimer .....	171
5.3.8.7	UE actions upon entering RRC_INACTIVE .....	171
5.3.8.8	T323 expiry .....	172
5.3.9	RRC connection release requested by upper layers .....	172

5.3.9.1	General .....	172
5.3.9.2	Initiation .....	172
5.3.10	Radio resource configuration .....	172
5.3.10.0	General .....	172
5.3.10.1	SRB addition/ modification .....	173
5.3.10.1a	SCG RLC bearer addition or reconfiguration for SRBs .....	174
5.3.10.2	DRB release .....	175
5.3.10.3	DRB addition/ modification .....	176
5.3.10.3a1	DC specific DRB addition or reconfiguration .....	178
5.3.10.3a2	LWA specific DRB addition or reconfiguration .....	180
5.3.10.3a3	LWIP specific DRB addition or reconfiguration .....	181
5.3.10.3a4	SCG RLC bearer addition or reconfiguration for DRBs in NE-DC .....	182
5.3.10.3a	SCell release .....	182
5.3.10.3b	SCell addition/ modification .....	183
5.3.10.3c	PSCell addition or modification .....	183
5.3.10.3d	SCell group release .....	184
5.3.10.3e	SCell group addition/ modification .....	184
5.3.10.4	MAC main reconfiguration .....	185
5.3.10.5	Semi-persistent scheduling reconfiguration .....	185
5.3.10.6	Physical channel reconfiguration .....	185
5.3.10.7	Radio Link Failure Timers and Constants reconfiguration .....	187
5.3.10.8	Time domain measurement resource restriction for serving cell .....	187
5.3.10.9	Other configuration .....	187
5.3.10.10	SCG reconfiguration .....	190
5.3.10.11	SCG dedicated resource configuration .....	192
5.3.10.12	Reconfiguration SCG or split DRB by <i>drb-ToAddModList</i> .....	193
5.3.10.13	Neighbour cell information reconfiguration .....	193
5.3.10.14	Void .....	194
5.3.10.15	Sidelink dedicated configuration .....	194
5.3.10.15a	V2X sidelink Communication dedicated configuration .....	195
5.3.10.16	T370 expiry .....	195
5.3.10.17	SRB release .....	196
5.3.10.18	Scheduling Request Configuration for NB-IoT .....	196
5.3.10.19	NE-DC release .....	196
5.3.11	Radio link failure related actions .....	197
5.3.11.1	Detection of physical layer problems in RRC_CONNECTED .....	197
5.3.11.1a	Early detection of physical layer problems in RRC_CONNECTED .....	197
5.3.11.1b	Detection of physical layer improvements in RRC_CONNECTED .....	197
5.3.11.2	Recovery of physical layer problems .....	197
5.3.11.2a	Recovery of early detection of physical layer problems .....	197
5.3.11.2b	Cancellation of physical layer improvements in RRC_CONNECTED .....	198
5.3.11.3	Detection of radio link failure .....	198
5.3.11.3a	Detection of early-out-of-sync event .....	201
5.3.11.3b	Detection of early-in-sync event .....	201
5.3.12	UE actions upon leaving RRC_CONNECTED or RRC_INACTIVE .....	201
5.3.13	UE actions upon PUCCH/ SPUCCH/ SRS release request .....	204
5.3.13a	UE actions upon SR release request for NB-IoT .....	204
5.3.13b	UE actions upon PUR release request .....	205
5.3.14	Proximity indication .....	205
5.3.14.1	General .....	205
5.3.14.2	Initiation .....	205
5.3.14.3	Actions related to transmission of <i>ProximityIndication</i> message .....	205
5.3.15	Void .....	206
5.3.16	Unified Access Control .....	206
5.3.16.1	General .....	206
5.3.16.2	Initiation .....	206
5.3.16.3	Void .....	210
5.3.16.4	T302, T309 expiry or stop (Barring alleviation) .....	210
5.3.16.5	Access barring check .....	210
5.3.17	RAN notification area update .....	211
5.3.17.1	General .....	211
5.3.17.2	Initiation .....	211

5.3.17.3	Inter RAT cell reselection or CN type change .....	212
5.3.18	T317 expiry.....	212
5.4	Inter-RAT mobility.....	212
5.4.1	Introduction.....	212
5.4.2	Handover to E-UTRA.....	213
5.4.2.1	General .....	213
5.4.2.2	Initiation.....	213
5.4.2.3	Reception of the <i>RRCConnectionReconfiguration</i> by the UE.....	213
5.4.2.4	Reconfiguration failure .....	217
5.4.2.5	T304 expiry (handover to E-UTRA failure).....	217
5.4.3	Mobility from E-UTRA .....	218
5.4.3.1	General .....	218
5.4.3.2	Initiation.....	218
5.4.3.3	Reception of the <i>MobilityFromEUTRACommand</i> by the UE .....	219
5.4.3.4	Successful completion of the mobility from E-UTRA.....	220
5.4.3.5	Mobility from E-UTRA failure.....	221
5.4.4	Handover from E-UTRA preparation request (CDMA2000) .....	222
5.4.4.1	General .....	222
5.4.4.2	Initiation.....	222
5.4.4.3	Reception of the <i>HandoverFromEUTRAPreparationRequest</i> by the UE .....	222
5.4.5	UL handover preparation transfer (CDMA2000) .....	223
5.4.5.1	General .....	223
5.4.5.2	Initiation.....	223
5.4.5.3	Actions related to transmission of the <i>ULHandoverPreparationTransfer</i> message.....	223
5.4.5.4	Failure to deliver the <i>ULHandoverPreparationTransfer</i> message.....	223
5.4.6	Inter-RAT cell change order to E-UTRAN.....	223
5.4.6.1	General .....	223
5.4.6.2	Initiation.....	224
5.4.6.3	UE fails to complete an inter-RAT cell change order .....	224
5.5	Measurements.....	224
5.5.1	Introduction.....	224
5.5.2	Measurement configuration .....	226
5.5.2.1	General .....	226
5.5.2.2	Measurement identity removal.....	227
5.5.2.2a	Measurement identity autonomous removal .....	228
5.5.2.3	Measurement identity addition/ modification .....	228
5.5.2.4	Measurement object removal .....	229
5.5.2.5	Measurement object addition/ modification.....	230
5.5.2.6	Reporting configuration removal .....	232
5.5.2.7	Reporting configuration addition/ modification.....	233
5.5.2.8	Quantity configuration .....	233
5.5.2.9	Measurement gap configuration.....	233
5.5.2.9a	Measurement gap configuration for RSTD measurements with dense PRS configuration.....	235
5.5.2.10	Discovery signals measurement timing configuration .....	235
5.5.2.11	RSSI measurement timing configuration .....	235
5.5.2.12	Measurement gap sharing configuration .....	236
5.5.2.13	NR measurement timing configuration .....	236
5.5.3	Performing measurements .....	237
5.5.3.1	General .....	237
5.5.3.2	Layer 3 filtering .....	242
5.5.3.3	Derivation of NR cell quality .....	242
5.5.3.4	Derivation of NR beam quality .....	243
5.5.4	Measurement report triggering .....	243
5.5.4.1	General .....	243
5.5.4.2	Event A1 (Serving becomes better than threshold) .....	249
5.5.4.3	Event A2 (Serving becomes worse than threshold) .....	250
5.5.4.4	Event A3 (Neighbour becomes offset better than PCell/ PSCell) .....	250
5.5.4.5	Event A4 (Neighbour becomes better than threshold) .....	251
5.5.4.6	Event A5 (PCell/ PSCell becomes worse than threshold1 and neighbour becomes better than threshold2) .....	252
5.5.4.6a	Event A6 (Neighbour becomes offset better than SCell) .....	253
5.5.4.7	Event B1 (Inter RAT neighbour becomes better than threshold).....	253



5.5.4.8	Event B2 (PCell becomes worse than threshold1 and inter RAT neighbour becomes better than threshold2) .....	254
5.5.4.9	Event C1 (CSI-RS resource becomes better than threshold) .....	255
5.5.4.10	Event C2 (CSI-RS resource becomes offset better than reference CSI-RS resource) .....	255
5.5.4.11	Event W1 (WLAN becomes better than a threshold) .....	256
5.5.4.12	Event W2 (All WLAN inside WLAN mobility set becomes worse than threshold1 and a WLAN outside WLAN mobility set becomes better than threshold2) .....	257
5.5.4.13	Event W3 (All WLAN inside WLAN mobility set becomes worse than a threshold) .....	257
5.5.4.14	Event V1 (The channel busy ratio is above a threshold) .....	258
5.5.4.15	Event V2 (The channel busy ratio is below a threshold) .....	258
5.5.4.16	Event H1 (The Aerial UE height is above a threshold) .....	259
5.5.4.17	Event H2 (The Aerial UE height is below a threshold) .....	259
5.5.4.18	Void .....	260
5.5.4.19	Void .....	260
5.5.4.20	Event D1 (Distance between UE and referenceLocation1 is above threshold1 and distance between UE and referenceLocation2 is below threshold2) .....	260
5.5.4.21	CondEvent T1 (Time measured at UE is within a duration from threshold) .....	261
5.5.4.22	Event D2 (Distance between UE and serving cell moving reference location is above threshold1 and distance between UE and neighbour cell moving reference location is below threshold2) .....	261
5.5.5	Measurement reporting .....	262
5.5.5.1	General .....	262
5.5.5.2	Determination of available NR measurement results .....	269
5.5.5.3	Selection of NR sorting quality .....	270
5.5.6	Measurement related actions .....	270
5.5.6.1	Actions upon handover and re-establishment .....	270
5.5.6.2	Speed dependant scaling of measurement related parameters .....	271
5.5.7	Inter-frequency RSTD measurement indication .....	272
5.5.7.1	General .....	272
5.5.7.2	Initiation .....	272
5.5.7.3	Actions related to transmission of <i>InterFreqRSTDMeasurementIndication</i> message .....	272
5.5.8	Measurements in NB-IoT .....	273
5.5.9	GNSS measurement triggering and reporting .....	274
5.6	Other .....	275
5.6.0	General .....	275
5.6.1	DL information transfer .....	275
5.6.1.1	General .....	275
5.6.1.2	Initiation .....	275
5.6.1.3	Reception of the <i>DLInformationTransfer</i> by the UE .....	275
5.6.2	UL information transfer .....	276
5.6.2.1	General .....	276
5.6.2.2	Initiation .....	276
5.6.2.3	Actions related to transmission of <i>ULInformationTransfer</i> message .....	276
5.6.2.4	Failure to deliver <i>ULInformationTransfer</i> message .....	277
5.6.2a	UL information transfer for MR-DC .....	277
5.6.2a.1	General .....	277
5.6.2a.2	Initiation .....	277
5.6.2a.3	Actions related to transmission of <i>ULInformationTransferMRDC</i> message .....	278
5.6.2a.4	Void .....	278
5.6.3	UE capability transfer .....	278
5.6.3.1	General .....	278
5.6.3.2	Initiation .....	278
5.6.3.3	Reception of the <i>UECapabilityEnquiry</i> by the UE .....	278
5.6.4	CSFB to 1x Parameter transfer .....	283
5.6.4.1	General .....	283
5.6.4.2	Initiation .....	283
5.6.4.3	Actions related to transmission of <i>CSFBParametersRequestCDMA2000</i> message .....	283
5.6.4.4	Reception of the <i>CSFBParametersResponseCDMA2000</i> message .....	283
5.6.5	UE Information .....	284
5.6.5.1	General .....	284
5.6.5.2	Initiation .....	284
5.6.5.3	Reception of the <i>UEInformationRequest</i> message .....	284
5.6.6	Logged Measurement Configuration .....	287

5.6.6.1	General .....	287
5.6.6.2	Initiation .....	287
5.6.6.3	Reception of the <i>LoggedMeasurementConfiguration</i> by the UE .....	287
5.6.6.4	T330 expiry .....	288
5.6.7	Release of Logged Measurement Configuration .....	288
5.6.7.1	General .....	288
5.6.7.2	Initiation .....	288
5.6.8	Measurements logging .....	288
5.6.8.1	General .....	288
5.6.8.2	Initiation .....	288
5.6.9	In-device coexistence indication .....	292
5.6.9.1	General .....	292
5.6.9.2	Initiation .....	293
5.6.9.3	Actions related to transmission of <i>InDeviceCoexIndication</i> message .....	294
5.6.10	UE Assistance Information .....	295
5.6.10.1	General .....	295
5.6.10.2	Initiation .....	295
5.6.10.3	Actions related to transmission of <i>UEAssistanceInformation</i> message .....	297
5.6.11	Mobility history information .....	300
5.6.11.1	General .....	300
5.6.11.2	Initiation .....	300
5.6.12	RAN-assisted WLAN interworking .....	300
5.6.12.1	General .....	300
5.6.12.2	Dedicated WLAN offload configuration .....	300
5.6.12.3	WLAN offload RAN evaluation .....	301
5.6.12.4	T350 expiry or stop .....	301
5.6.12.5	Cell selection/ re-selection while T350 is running .....	301
5.6.13	SCG failure information .....	302
5.6.13.1	General .....	302
5.6.13.2	Initiation .....	302
5.6.13.3	Actions related to transmission of <i>SCGFailureInformation</i> message .....	302
5.6.13.4	Failure type determination in NE-DC .....	303
5.6.13.5	Setting the contents of <i>MeasResultSCG-FailureMRDC</i> .....	303
5.6.13a	NR SCG failure information .....	304
5.6.13a.1	General .....	304
5.6.13a.2	Initiation .....	304
5.6.13a.3	Actions related to transmission of <i>SCGFailureInformationNR</i> message .....	304
5.6.14	LTE-WLAN Aggregation .....	305
5.6.14.1	Introduction .....	305
5.6.14.2	Reception of LWA configuration .....	305
5.6.14.3	Release of LWA configuration .....	306
5.6.15	WLAN connection management .....	306
5.6.15.1	Introduction .....	306
5.6.15.2	WLAN connection status reporting .....	307
5.6.15.2.1	General .....	307
5.6.15.2.2	Initiation .....	307
5.6.15.2.3	Actions related to transmission of <i>WLANConnectionStatusReport</i> message .....	307
5.6.15.3	T351 Expiry (WLAN connection attempt timeout) .....	307
5.6.15.4	WLAN status monitoring .....	307
5.6.16	RAN controlled LTE-WLAN interworking .....	308
5.6.16.1	General .....	308
5.6.16.2	WLAN traffic steering command .....	309
5.6.17	LTE-WLAN aggregation with IPsec tunnel .....	309
5.6.17.1	General .....	309
5.6.17.2	LWIP reconfiguration .....	309
5.6.17.3	LWIP release .....	310
5.6.18	Void .....	310
5.6.19	Application layer measurement reporting .....	310
5.6.19.1	General .....	310
5.6.19.2	Initiation .....	311
5.6.20	Idle/Inactive Measurements .....	311
5.6.20.1	General .....	311

5.6.20.1a	Measurement configuration.....	311
5.6.20.2	Performing measurements.....	312
5.6.20.3	T331 expiry or stop.....	314
5.6.20.4	Cell re-selection or selection while T331 is running.....	314
5.6.21	Failure information.....	315
5.6.21.1	General.....	315
5.6.21.2	Initiation.....	315
5.6.21.3	Actions related to transmission of <i>FailureInformation</i> message.....	315
5.6.22	UL message segment transfer.....	316
5.6.22.1	General.....	316
5.6.22.2	Initiation.....	316
5.6.22.3	Actions related to transmission of <i>ULDedicatedMessageSegment</i> message.....	316
5.6.23	PUR Configuration Request.....	317
5.6.23.1	General.....	317
5.6.23.2	Initiation.....	317
5.6.23.3	Actions related to transmission of <i>PURConfigurationRequest</i> message.....	317
5.6.24	Neighbour Relation Reporting for SON ANR in NB-IoT.....	318
5.6.24.0	General.....	318
5.6.24.1	Initiation.....	318
5.6.25	DL message segment transfer.....	319
5.6.25.1	General.....	319
5.6.25.2	Initiation.....	319
5.6.25.3	Reception of <i>DLDedicatedMessageSegment</i> by the UE.....	319
5.6.26	MCG failure information.....	320
5.6.26.1	General.....	320
5.6.26.2	Initiation.....	320
5.6.26.3	Failure type determination.....	320
5.6.26.4	Actions related to transmission of <i>MCGFailureInformation</i> message.....	321
5.6.26.5	T316 expiry.....	322
5.6.27	Void.....	322
5.6.28	UL transfer of IRAT information.....	322
5.6.28.1	General.....	322
5.6.28.2	Initiation.....	323
5.6.28.3	Actions related to transmission of <i>ULInformationTransferIRAT</i> message.....	323
5.7	Generic error handling.....	323
5.7.1	General.....	323
5.7.2	ASN.1 violation or encoding error.....	323
5.7.3	Field set to a not comprehended value.....	323
5.7.4	Mandatory field missing.....	324
5.7.5	Not comprehended field.....	325
5.8	MBMS.....	325
5.8.1	Introduction.....	325
5.8.1.1	General.....	325
5.8.1.2	Scheduling.....	325
5.8.1.3	MCCH information validity and notification of changes.....	326
5.8.2	MCCH information acquisition.....	327
5.8.2.1	General.....	327
5.8.2.2	Initiation.....	327
5.8.2.3	MCCH information acquisition by the UE.....	327
5.8.2.4	Actions upon reception of the <i>MBSFNAreaConfiguration</i> message.....	328
5.8.2.5	Actions upon reception of the <i>MBMSCountingRequest</i> message.....	328
5.8.3	MBMS PTM radio bearer configuration.....	328
5.8.3.1	General.....	328
5.8.3.2	Initiation.....	328
5.8.3.3	MRB establishment.....	328
5.8.3.4	MRB release.....	328
5.8.4	MBMS Counting Procedure.....	328
5.8.4.1	General.....	328
5.8.4.2	Initiation.....	329
5.8.4.3	Reception of the <i>MBMSCountingRequest</i> message by the UE.....	329
5.8.5	MBMS interest indication.....	330
5.8.5.1	General.....	330

5.8.5.2	Initiation.....	330
5.8.5.3	Determine MBMS frequencies of interest.....	331
5.8.5.3a	Determine MBMS services of interest .....	332
5.8.5.4	Actions related to transmission of <i>MBMSInterestIndication</i> message .....	332
5.8a	SC-PTM .....	333
5.8a.1	Introduction.....	333
5.8a.1.1	General .....	333
5.8a.1.2	SC-MCCH scheduling .....	333
5.8a.1.3	SC-MCCH information validity and notification of changes.....	333
5.8a.1.4	Procedures .....	334
5.8a.2	SC-MCCH information acquisition .....	334
5.8a.2.1	General .....	334
5.8a.2.2	Initiation.....	334
5.8a.2.3	SC-MCCH information acquisition by the UE .....	334
5.8a.2.4	Actions upon reception of the <i>SCPTMConfiguration</i> message.....	335
5.8a.3	SC-PTM radio bearer configuration .....	335
5.8a.3.1	General .....	335
5.8a.3.2	Initiation.....	335
5.8a.3.3	SC-MRB establishment.....	335
5.8a.3.4	SC-MRB release .....	336
5.9	RN procedures.....	336
5.9.1	RN reconfiguration .....	336
5.9.1.1	General .....	336
5.9.1.2	Initiation.....	336
5.9.1.3	Reception of the <i>RNReconfiguration</i> by the RN .....	336
5.10	Sidelink .....	337
5.10.1	Introduction.....	337
5.10.1a	Conditions for sidelink communication operation.....	337
5.10.1b	Conditions for PS related sidelink discovery operation.....	338
5.10.1c	Conditions for non-PS related sidelink discovery operation.....	338
5.10.1d	Conditions for V2X sidelink communication operation .....	338
5.10.2	Sidelink UE information.....	338
5.10.2.1	General .....	338
5.10.2.2	Initiation.....	339
5.10.2.3	Actions related to transmission of <i>SidelinkUEInformation</i> message .....	344
5.10.3	Sidelink communication monitoring.....	346
5.10.4	Sidelink communication transmission .....	348
5.10.5	Sidelink discovery monitoring.....	349
5.10.6	Sidelink discovery announcement .....	350
5.10.6a	Sidelink discovery announcement pool selection .....	353
5.10.6b	Sidelink discovery announcement reference carrier selection .....	353
5.10.7	Sidelink synchronisation information transmission .....	354
5.10.7.1	General .....	354
5.10.7.2	Initiation.....	355
5.10.7.3	Transmission of SLSS.....	357
5.10.7.4	Transmission of <i>MasterInformationBlock-SL</i> or <i>MasterInformationBlock-SL-V2X</i> message .....	359
5.10.7.5	Void.....	360
5.10.8	Sidelink synchronisation reference .....	360
5.10.8.1	General .....	360
5.10.8.2	Selection and reselection of synchronisation reference.....	360
5.10.8a	Selection and reselection of synchronisation carrier frequency .....	363
5.10.9	Sidelink common control information .....	366
5.10.9.1	General .....	366
5.10.9.2	Actions related to reception of <i>MasterInformationBlock-SL/ MasterInformationBlock-SL-V2X</i> message .....	366
5.10.10	Sidelink relay UE operation.....	366
5.10.10.1	General .....	366
5.10.10.2	AS-conditions for relay related sidelink communication transmission by sidelink relay UE .....	367
5.10.10.3	AS-conditions for relay PS related sidelink discovery transmission by sidelink relay UE .....	367
5.10.10.4	Sidelink relay UE threshold conditions.....	367
5.10.11	Sidelink remote UE operation.....	367
5.10.11.1	General .....	367

5.10.11.2	AS-conditions for relay related sidelink communication transmission by sidelink remote UE .....	368
5.10.11.3	AS-conditions for relay PS related sidelink discovery transmission by sidelink remote UE .....	368
5.10.11.4	Selection and reselection of sidelink relay UE .....	368
5.10.11.5	Sidelink remote UE threshold conditions .....	369
5.10.12	V2X sidelink communication monitoring .....	369
5.10.13	V2X sidelink communication transmission .....	370
5.10.13.1	Transmission of V2X sidelink communication .....	370
5.10.13.1a	Transmission of P2X related V2X sidelink communication .....	372
5.10.13.2	V2X sidelink communication transmission pool selection .....	373
5.10.13.3	V2X sidelink communication transmission reference cell selection .....	374
5.10.14	DFN derivation from GNSS .....	375
5.10.15	Void .....	375
5.10.16	Sidelink synchronisation information transmission for NR sidelink communication .....	375
6	Protocol data units, formats and parameters (tabular & ASN.1) .....	376
6.1	General .....	376
6.2	RRC messages .....	378
6.2.1	General message structure .....	378
-	<i>EUTRA-RRC-Definitions</i> .....	378
-	<i>BCCH-BCH-Message</i> .....	378
-	<i>BCCH-BCH-Message-MBMS</i> .....	378
-	<i>BCCH-DL-SCH-Message</i> .....	379
-	<i>BCCH-DL-SCH-Message-BR</i> .....	379
-	<i>BCCH-DL-SCH-Message-MBMS</i> .....	379
-	<i>MCCH-Message</i> .....	379
-	<i>PCCH-Message</i> .....	380
-	<i>DL-CCCH-Message</i> .....	380
-	<i>DL-DCCH-Message</i> .....	381
-	<i>UL-CCCH-Message</i> .....	381
-	<i>UL-DCCH-Message</i> .....	381
-	<i>SC-MCCH-Message</i> .....	382
6.2.2	Message definitions .....	383
-	<i>CounterCheck</i> .....	383
-	<i>CounterCheckResponse</i> .....	384
-	<i>CSFBParametersRequestCDMA2000</i> .....	385
-	<i>CSFBParametersResponseCDMA2000</i> .....	385
-	<i>DLDedicatedMessageSegment</i> .....	386
-	<i>DLInformationTransfer</i> .....	386
-	<i>FailureInformation</i> .....	387
-	<i>HandoverFromEUTRAPreparationRequest (CDMA2000)</i> .....	388
-	<i>InDeviceCoexIndication</i> .....	390
-	<i>InterFreqRSTDMeasurementIndication</i> .....	392
-	<i>LoggedMeasurementConfiguration</i> .....	394
-	<i>MasterInformationBlock</i> .....	396
-	<i>MasterInformationBlock-MBMS</i> .....	397
-	<i>MBMSCountingRequest</i> .....	398
-	<i>MBMSCountingResponse</i> .....	398
-	<i>MBMSInterestIndication</i> .....	399
-	<i>MBSFNAreaConfiguration</i> .....	400
-	<i>MCGFailureInformation</i> .....	401
-	<i>MeasReportAppLayer</i> .....	402
-	<i>MeasurementReport</i> .....	403
-	<i>MobilityFromEUTRACommand</i> .....	403
-	<i>Paging</i> .....	407
-	<i>ProximityIndication</i> .....	409
-	<i>PURConfigurationRequest</i> .....	410
-	<i>RNReconfiguration</i> .....	411
-	<i>RNReconfigurationComplete</i> .....	411
-	<i>RRCConnectionReconfiguration</i> .....	412
-	<i>RRCConnectionReconfigurationComplete</i> .....	422
-	<i>RRCConnectionReestablishment</i> .....	424
-	<i>RRCConnectionReestablishmentComplete</i> .....	425

–	<i>RRConnectionReestablishmentReject</i> .....	426
–	<i>RRConnectionReestablishmentRequest</i> .....	426
–	<i>RRConnectionReject</i> .....	427
–	<i>RRConnectionRelease</i> .....	428
–	<i>RRConnectionRequest</i> .....	435
–	<i>RRConnectionResume</i> .....	436
–	<i>RRConnectionResumeComplete</i> .....	439
–	<i>RRConnectionResumeRequest</i> .....	440
–	<i>RRConnectionSetup</i> .....	441
–	<i>RRConnectionSetupComplete</i> .....	441
–	<i>RRCEarlyDataComplete</i> .....	445
–	<i>RRCEarlyDataRequest</i> .....	445
–	<i>SCGFailureInformation</i> .....	446
–	<i>SCGFailureInformationNR</i> .....	447
–	<i>SCPTMConfiguration</i> .....	449
–	<i>SCPTMConfiguration-BR</i> .....	449
–	<i>SecurityModeCommand</i> .....	450
–	<i>SecurityModeComplete</i> .....	451
–	<i>SecurityModeFailure</i> .....	451
–	<i>SidelinkUEInformation</i> .....	452
–	<i>SystemInformation</i> .....	455
–	<i>SystemInformationBlockType1</i> .....	457
–	<i>SystemInformationBlockType1-MBMS</i> .....	467
–	<i>UEAssistanceInformation</i> .....	469
–	<i>UECapabilityEnquiry</i> .....	473
–	<i>UECapabilityInformation</i> .....	475
–	<i>ULDedicatedMessageSegment</i> .....	476
–	<i>UEInformationRequest</i> .....	477
–	<i>UEInformationResponse</i> .....	478
–	<i>ULHandoverPreparationTransfer (CDMA2000)</i> .....	486
–	<i>ULInformationTransfer</i> .....	487
–	<i>ULInformationTransferIRAT</i> .....	487
–	<i>ULInformationTransferMRDC</i> .....	488
–	<i>WLANConnectionStatusReport</i> .....	489
6.3	RRC information elements.....	489
6.3.0	Parameterized types.....	489
–	<i>SetupRelease</i> .....	489
6.3.1	System information blocks.....	490
–	<i>SystemInformationBlockPos</i> .....	490
–	<i>SystemInformationBlockType2</i> .....	490
–	<i>SystemInformationBlockType3</i> .....	496
–	<i>SystemInformationBlockType4</i> .....	501
–	<i>SystemInformationBlockType5</i> .....	502
–	<i>SystemInformationBlockType6</i> .....	509
–	<i>SystemInformationBlockType7</i> .....	511
–	<i>SystemInformationBlockType8</i> .....	512
–	<i>SystemInformationBlockType9</i> .....	517
–	<i>SystemInformationBlockType10</i> .....	517
–	<i>SystemInformationBlockType11</i> .....	518
–	<i>SystemInformationBlockType12</i> .....	519
–	<i>SystemInformationBlockType13</i> .....	520
–	<i>SystemInformationBlockType14</i> .....	520
–	<i>SystemInformationBlockType15</i> .....	521
–	<i>SystemInformationBlockType16</i> .....	522
–	<i>SystemInformationBlockType17</i> .....	523
–	<i>SystemInformationBlockType18</i> .....	524
–	<i>SystemInformationBlockType19</i> .....	524
–	<i>SystemInformationBlockType20</i> .....	527
–	<i>SystemInformationBlockType21</i> .....	530
–	<i>SystemInformationBlockType24</i> .....	531
–	<i>SystemInformationBlockType25</i> .....	535
–	<i>SystemInformationBlockType26</i> .....	537

–	<i>SystemInformationBlockType26a</i> .....	538
–	<i>SystemInformationBlockType27</i> .....	539
–	<i>SystemInformationBlockType28</i> .....	539
–	<i>SystemInformationBlockType29</i> .....	540
–	<i>SystemInformationBlockType30</i> .....	540
–	<i>SystemInformationBlockType31</i> .....	541
–	<i>SystemInformationBlockType32</i> .....	542
–	<i>SystemInformationBlockType33</i> .....	544
6.3.2	Radio resource control information elements .....	545
–	<i>Alpha</i> .....	545
–	<i>AntennaInfo</i> .....	545
–	<i>AntennaInfoUL</i> .....	549
–	<i>AUL-Config</i> .....	549
–	<i>CQI-ReportAperiodic</i> .....	550
–	<i>CQI-ReportBoth</i> .....	554
–	<i>CQI-ReportConfig</i> .....	555
–	<i>CQI-ReportPeriodic</i> .....	558
–	<i>CQI-ReportPeriodicProcExtId</i> .....	562
–	<i>CrossCarrierSchedulingConfig</i> .....	562
–	<i>CRS-ChEstMPDCCH-Config</i> .....	563
–	<i>CSI-IM-Config</i> .....	564
–	<i>CSI-IM-ConfigId</i> .....	564
–	<i>CSI-Process</i> .....	565
–	<i>CSI-ProcessId</i> .....	566
–	<i>CSI-RS-Config</i> .....	567
–	<i>CSI-RS-ConfigBeamformed</i> .....	568
–	<i>CSI-RS-ConfigEMIMO</i> .....	569
–	<i>CSI-RS-ConfigNonPrecoded</i> .....	570
–	<i>CSI-RS-ConfigNZP</i> .....	571
–	<i>CSI-RS-ConfigNZPId</i> .....	573
–	<i>CSI-RS-ConfigZP</i> .....	573
–	<i>CSI-RS-ConfigZPId</i> .....	573
–	<i>DataInactivityTimer</i> .....	574
–	<i>DMRS-Config</i> .....	574
–	<i>DRB-Identity</i> .....	574
–	<i>EPDCCH-Config</i> .....	574
–	<i>EIMTA-MainConfig</i> .....	577
–	<i>GWUS-Config</i> .....	577
–	<i>LogicalChannelConfig</i> .....	579
–	<i>LWA-Configuration</i> .....	581
–	<i>LWIP-Configuration</i> .....	582
–	<i>MAC-MainConfig</i> .....	582
–	<i>P-C-AndCBSR</i> .....	589
–	<i>PDCCH-ConfigSCell</i> .....	590
–	<i>PDCP-Config</i> .....	591
–	<i>PDSCH-Config</i> .....	596
–	<i>PDSCH-RE-MappingQCL-ConfigId</i> .....	600
–	<i>PerCC-GapIndicationList</i> .....	601
–	<i>PHICH-Config</i> .....	601
–	<i>PhysicalConfigDedicated</i> .....	601
–	<i>P-Max</i> .....	614
–	<i>PRACH-Config</i> .....	614
–	<i>PresenceAntennaPort1</i> .....	617
–	<i>PUCCH-Config</i> .....	617
–	<i>PUR-Config</i> .....	622
–	<i>PUR-ConfigID</i> .....	626
–	<i>PUR-PeriodicityAndOffset</i> .....	626
–	<i>PUSCH-Config</i> .....	626
–	<i>RACH-ConfigCommon</i> .....	632
–	<i>RACH-ConfigDedicated</i> .....	636
–	<i>RadioResourceConfigCommon</i> .....	636
–	<i>RadioResourceConfigDedicated</i> .....	643

–	<i>RCLWI-Configuration</i> .....	652
–	<i>ResourceReservationConfig</i> .....	653
–	<i>RLC-Config</i> .....	654
–	<i>RLF-TimersAndConstants</i> .....	657
–	<i>RN-SubframeConfig</i> .....	658
–	<i>RSS-Config</i> .....	660
–	<i>SchedulingRequestConfig</i> .....	661
–	<i>SlotOrSubslotPDSCH-Config</i> .....	662
–	<i>SlotOrSubslotPUSCH-Config</i> .....	663
–	<i>SoundingRS-UL-Config</i> .....	664
–	<i>SPDCCH-Config</i> .....	668
–	<i>SPS-Config</i> .....	669
–	<i>SPUCCH-Config</i> .....	675
–	<i>SRS-TPC-PDCCH-Config</i> .....	676
–	<i>TDD-Config</i> .....	677
–	<i>TDM-PatternConfig</i> .....	678
–	<i>TimeAlignmentTimer</i> .....	678
–	<i>TimeReferenceInfo</i> .....	679
–	<i>TPC-PDCCH-Config</i> .....	679
–	<i>TunnelConfigLWIP</i> .....	680
–	<i>UplinkPowerControl</i> .....	681
–	<i>WLAN-Id-List</i> .....	686
–	<i>WLAN-MobilityConfig</i> .....	686
–	<i>WUS-Config</i> .....	687
6.3.3	Security control information elements .....	688
–	<i>NextHopChainingCount</i> .....	688
–	<i>SecurityAlgorithmConfig</i> .....	688
–	<i>ShortMAC-I</i> .....	689
6.3.4	Mobility control information elements .....	689
–	<i>AdditionalSpectrumEmission</i> .....	689
–	<i>AdditionalSpectrumEmissionNR</i> .....	689
–	<i>ARFCN-ValueCDMA2000</i> .....	690
–	<i>ARFCN-ValueEUTRA</i> .....	690
–	<i>ARFCN-ValueGERAN</i> .....	690
–	<i>ARFCN-ValueNR</i> .....	691
–	<i>ARFCN-ValueUTRA</i> .....	691
–	<i>BandclassCDMA2000</i> .....	691
–	<i>BandIndicatorGERAN</i> .....	691
–	<i>CarrierFreqCDMA2000</i> .....	691
–	<i>CarrierFreqGERAN</i> .....	692
–	<i>CarrierFreqsGERAN</i> .....	692
–	<i>CarrierFreqListMBMS</i> .....	693
–	<i>CDMA2000-Type</i> .....	693
–	<i>CellGlobalIdNR</i> .....	693
–	<i>CellIdentity</i> .....	694
–	<i>CellIndexList</i> .....	694
–	<i>CellReselectionPriority</i> .....	694
–	<i>CellSelectionInfoCE</i> .....	694
–	<i>CellSelectionInfoCE1</i> .....	695
–	<i>CellReselectionSubPriority</i> .....	695
–	<i>CSFB-RegistrationParamIXRTT</i> .....	695
–	<i>CellGlobalIdEUTRA</i> .....	696
–	<i>CellGlobalIdUTRA</i> .....	697
–	<i>CellGlobalIdGERAN</i> .....	697
–	<i>CellGlobalIdCDMA2000</i> .....	697
–	<i>CellSelectionInfoNFreq</i> .....	698
–	<i>ConditionalReconfiguration</i> .....	698
–	<i>ConditionalReconfigurationId</i> .....	699
–	<i>CondReconfigurationToAddModList</i> .....	699
–	<i>CSG-Identity</i> .....	700
–	<i>EphemerisOrbitalParameters</i> .....	700
–	<i>EphemerisStateVectors</i> .....	701



-	<i>FreqBandIndicator</i> .....	701
-	<i>FreqBandIndicatorNR</i> .....	702
-	<i>MobilityControlInfo</i> .....	702
-	<i>MobilityParametersCDMA2000 (1xRTT)</i> .....	706
-	<i>MobilityStateParameters</i> .....	706
-	<i>MultiBandInfoList</i> .....	707
-	<i>MultiFrequencyBandListNR</i> .....	707
-	<i>NS-PmaxList</i> .....	707
-	<i>NS-PmaxListNR</i> .....	708
-	<i>PhysCellId</i> .....	708
-	<i>PhysCellIdCDMA2000</i> .....	708
-	<i>PhysCellIdGERAN</i> .....	709
-	<i>PhysCellIdNR</i> .....	709
-	<i>PhysCellIdRange</i> .....	709
-	<i>PhysCellIdRangeNR</i> .....	710
-	<i>PhysCellIdRangeUTRA-FDDList</i> .....	710
-	<i>PhysCellIdUTRA-FDD</i> .....	710
-	<i>PhysCellIdUTRA-TDD</i> .....	711
-	<i>PLMN-Identity</i> .....	711
-	<i>PLMN-IdentityList3</i> .....	711
-	<i>PmaxNR</i> .....	712
-	<i>PreRegistrationInfoHRPD</i> .....	712
-	<i>Q-QualMin</i> .....	712
-	<i>Q-RxLevMin</i> .....	713
-	<i>Q-OffsetRange</i> .....	713
-	<i>Q-OffsetRangeInterRAT</i> .....	713
-	<i>ReselectionThreshold</i> .....	713
-	<i>ReselectionThresholdQ</i> .....	714
-	<i>RSS-ConfigCarrierInfo</i> .....	714
-	<i>RSS-MeasPowerBias</i> .....	714
-	<i>SCellIndex</i> .....	715
-	<i>ServCellIndex</i> .....	715
-	<i>SpeedStateScaleFactors</i> .....	715
-	<i>SystemInfoListGERAN</i> .....	715
-	<i>SystemTimeInfoCDMA2000</i> .....	716
-	<i>ThresholdNR</i> .....	717
-	<i>TLE-EphemerisParameters</i> .....	717
-	<i>TrackingAreaCode</i> .....	718
-	<i>T-Reselection</i> .....	718
-	<i>T-ReselectionEUTRA-CE</i> .....	718
6.3.5	Measurement information elements.....	719
-	<i>AllowedMeasBandwidth</i> .....	719
-	<i>BT-NameList</i> .....	719
-	<i>CSI-RSRP-Range</i> .....	719
-	<i>Hysteresis</i> .....	719
-	<i>HysteresisLocation</i> .....	720
-	<i>LocationInfo</i> .....	720
-	<i>LogMeasResultListBT</i> .....	721
-	<i>LogMeasResultListWLAN</i> .....	721
-	<i>MaxRS-IndexCellQualNR</i> .....	722
-	<i>MBSFN-RSRQ-Range</i> .....	722
-	<i>MeasConfig</i> .....	722
-	<i>MeasDS-Config</i> .....	725
-	<i>MeasGapConfig</i> .....	726
-	<i>MeasGapConfigDensePRS</i> .....	727
-	<i>MeasGapConfigPerCC-List</i> .....	728
-	<i>MeasGapSharingConfig</i> .....	728
-	<i>MeasId</i> .....	729
-	<i>MeasIdleConfig</i> .....	729
-	<i>MeasIdToAddModList</i> .....	732
-	<i>MeasObjectCDMA2000</i> .....	732
-	<i>MeasObjectEUTRA</i> .....	733

-	<i>MeasObjectGERAN</i> .....	737
-	<i>MeasObjectId</i> .....	738
-	<i>MeasObjectNR</i> .....	738
-	<i>MeasObjectToAddModList</i> .....	740
-	<i>MeasObjectUTRA</i> .....	741
-	<i>MeasObjectWLAN</i> .....	742
-	<i>MeasResults</i> .....	743
-	<i>MeasResultCellSFTD</i> .....	751
-	<i>MeasResultSCG-FailureMRDC</i> .....	752
-	<i>MeasResultSSTD</i> .....	752
-	<i>MeasScaleFactor</i> .....	753
-	<i>MeasSensing-Config</i> .....	753
-	<i>MTC-SSB-NR</i> .....	754
-	<i>QuantityConfig</i> .....	754
-	<i>ReferenceLocation</i> .....	756
-	<i>ReportConfigEUTRA</i> .....	756
-	<i>ReportConfigId</i> .....	763
-	<i>ReportConfigInterRAT</i> .....	763
-	<i>ReportConfigToAddModList</i> .....	767
-	<i>ReportInterval</i> .....	768
-	<i>RS-IndexNR</i> .....	768
-	<i>RSRP-Range</i> .....	768
-	<i>RSRP-RangeNR</i> .....	769
-	<i>RSRQ-Range</i> .....	769
-	<i>RSRQ-RangeNR</i> .....	769
-	<i>RSRQ-Type</i> .....	770
-	<i>RS-SINR-Range</i> .....	770
-	<i>RS-SINR-RangeNR</i> .....	770
-	<i>RSSI-Range-r13</i> .....	770
-	<i>SS-RSSI-Measurement</i> .....	771
-	<i>SSB-PositionQCL-RelationNR</i> .....	771
-	<i>SSB-ToMeasure</i> .....	771
-	<i>TimeToTrigger</i> .....	772
-	<i>UL-DelayConfig</i> .....	772
-	<i>UL-DelayValueConfig</i> .....	773
-	<i>WLAN-CarrierInfo</i> .....	773
-	<i>WLAN-NameList</i> .....	773
-	<i>WLAN-RSSI-Range</i> .....	774
-	<i>WLAN-RTT</i> .....	774
-	<i>WLAN-Status</i> .....	775
-	<i>WLAN-SuspendConfig</i> .....	775
6.3.6	Other information elements.....	775
-	<i>AbsoluteTimeInfo</i> .....	775
-	<i>AMF-Identifier</i> .....	776
-	<i>AreaConfiguration</i> .....	776
-	<i>BandCombinationList</i> .....	776
-	<i>C-RNTI</i> .....	777
-	<i>DedicatedInfoCDMA2000</i> .....	777
-	<i>DedicatedInfoF1c</i> .....	777
-	<i>DedicatedInfoNAS</i> .....	777
-	<i>FilterCoefficient</i> .....	777
-	<i>FlightPathInfoReportConfig</i> .....	778
-	<i>GNSS-ID</i> .....	778
-	<i>GNSS-PositionFixDuration</i> .....	778
-	<i>GNSS-ValidityDuration</i> .....	778
-	<i>I-RNTI</i> .....	779
-	<i>LoggingDuration</i> .....	779
-	<i>LoggingInterval</i> .....	779
-	<i>MeasSubframePattern</i> .....	779
-	<i>MMEC</i> .....	780
-	<i>NeighCellConfig</i> .....	780
-	<i>NG-5G-S-TMSI</i> .....	780

–	<i>OtherConfig</i> .....	781
–	<i>RAN-AreaCode</i> .....	784
–	<i>RAND-CDMA2000 (1xRTT)</i> .....	784
–	<i>RAT-Type</i> .....	785
–	<i>Resumeldentity</i> .....	785
–	<i>RRC-TransactionIdentifier</i> .....	785
–	<i>SatelliteId</i> .....	785
–	<i>SBAS-ID</i> .....	785
–	<i>ShortI-RNTI</i> .....	786
–	<i>S-NSSAI</i> .....	786
–	<i>S-TMSI</i> .....	786
–	<i>TraceReference</i> .....	787
–	<i>UE-CapabilityRAT-ContainerList</i> .....	787
–	<i>UE-EUTRA-Capability</i> .....	788
–	<i>UE-RadioPagingInfo</i> .....	869
–	<i>UE-TimersAndConstants</i> .....	870
–	<i>VisitedCellInfoList</i> .....	871
–	<i>WLAN-OffloadConfig</i> .....	872
6.3.7	MBMS information elements .....	873
–	<i>MBMS-NotificationConfig</i> .....	874
–	<i>MBMS-ServiceList</i> .....	874
–	<i>MBSFN-AreaId</i> .....	874
–	<i>MBSFN-AreaInfoList</i> .....	875
–	<i>MBSFN-SubframeConfig</i> .....	876
–	<i>PMCH-InfoList</i> .....	878
6.3.7a	SC-PTM information elements .....	879
–	<i>SC-MTCH-InfoList</i> .....	879
–	<i>SC-MTCH-InfoList-BR</i> .....	880
–	<i>SCPTM-NeighbourCellList</i> .....	882
6.3.8	Sidelink information elements .....	883
–	<i>SL-AnchorCarrierFreqList-V2X</i> .....	883
–	<i>SL-CBR-CommonTxConfigList</i> .....	883
–	<i>SL-CBR-PPPP-TxConfigList</i> .....	884
–	<i>SL-CommConfig</i> .....	885
–	<i>SL-CommResourcePool</i> .....	886
–	<i>SL-CommTxPoolSensingConfig</i> .....	890
–	<i>SL-CP-Len</i> .....	891
–	<i>SL-DiscConfig</i> .....	891
–	<i>SL-DiscResourcePool</i> .....	894
–	<i>SL-DiscSysInfoReport</i> .....	895
–	<i>SL-DiscTxPowerInfo</i> .....	896
–	<i>SL-GapConfig</i> .....	896
–	<i>SL-GapRequest</i> .....	897
–	<i>SL-HoppingConfig</i> .....	897
–	<i>SL-InterFreqInfoListV2X</i> .....	898
–	<i>SL-NR-AnchorCarrierFreqList</i> .....	899
–	<i>SL-V2X-UE-ConfigList</i> .....	899
–	<i>SL-OffsetIndicator</i> .....	900
–	<i>SL-P2X-ResourceSelectionConfig</i> .....	901
–	<i>SL-PeriodComm</i> .....	901
–	<i>SL-Priority</i> .....	901
–	<i>SL-PSSCH-TxConfigList</i> .....	901
–	<i>SL-Reliability</i> .....	902
–	<i>SL-RestrictResourceReservationPeriodList</i> .....	903
–	<i>SLSSID</i> .....	903
–	<i>SL-SyncAllowed</i> .....	903
–	<i>SL-SyncConfig</i> .....	904
–	<i>SL-TF-ResourceConfig</i> .....	906
–	<i>SL-TxPower</i> .....	907
–	<i>SL-TypeTxSync</i> .....	907
–	<i>SL-ThresPSSCH-RSRP-List</i> .....	907
–	<i>SL-TxParameters</i> .....	908

–	<i>SL-TxPoolIdentity</i> .....	908
–	<i>SL-TxPoolToReleaseList</i> .....	909
–	<i>SL-V2X-ConfigDedicated</i> .....	909
–	<i>SL-V2X-FreqSelectionConfigList</i> .....	911
–	<i>SL-V2X-PacketDuplicationConfig</i> .....	911
–	<i>SL-V2X-SyncFreqList</i> .....	912
–	<i>SL-ZoneConfig</i> .....	912
6.4	RRC multiplicity and type constraint values .....	913
–	Multiplicity and type constraint definitions .....	913
–	End of EUTRA-RRC-Definitions .....	917
6.5	PC5 RRC messages .....	917
6.5.1	General message structure .....	917
–	<i>PC5-RRC-Definitions</i> .....	917
–	<i>SBCCH-SL-BCH-Message</i> .....	917
–	<i>SBCCH-SL-BCH-Message-V2X</i> .....	917
6.5.2	Message definitions .....	918
–	<i>MasterInformationBlock-SL</i> .....	918
–	<i>MasterInformationBlock-SL-V2X</i> .....	918
–	End of <i>PC5-RRC-Definitions</i> .....	919
6.6	Direct Indication Information .....	919
6.6a	Direct Indication FeMBMS .....	920
6.7	NB-IoT RRC messages .....	920
6.7.1	General NB-IoT message structure .....	920
–	<i>BCCH-BCH-Message-NB</i> .....	921
–	<i>BCCH-BCH-Message-TDD-NB</i> .....	921
–	<i>BCCH-DL-SCH-Message-NB</i> .....	922
–	<i>PCCH-Message-NB</i> .....	922
–	<i>DL-CCCH-Message-NB</i> .....	922
–	<i>DL-DCCH-Message-NB</i> .....	923
–	<i>UL-CCCH-Message-NB</i> .....	923
–	<i>SC-MCCH-Message-NB</i> .....	923
–	<i>UL-DCCH-Message-NB</i> .....	924
6.7.2	NB-IoT Message definitions .....	924
–	<i>DLInformationTransfer-NB</i> .....	924
–	<i>MasterInformationBlock-NB</i> .....	925
–	<i>MasterInformationBlock-TDD-NB</i> .....	926
–	<i>Paging-NB</i> .....	929
–	<i>PURConfigurationRequest-NB</i> .....	930
–	<i>RRCCConnectionReconfiguration-NB</i> .....	931
–	<i>RRCCConnectionReconfigurationComplete-NB</i> .....	932
–	<i>RRCCConnectionReestablishment-NB</i> .....	932
–	<i>RRCCConnectionReestablishmentComplete-NB</i> .....	933
–	<i>RRCCConnectionReestablishmentRequest-NB</i> .....	934
–	<i>RRCCConnectionReject-NB</i> .....	935
–	<i>RRCCConnectionRelease-NB</i> .....	936
–	<i>RRCCConnectionRequest-NB</i> .....	938
–	<i>RRCCConnectionResume-NB</i> .....	939
–	<i>RRCCConnectionResumeComplete-NB</i> .....	940
–	<i>RRCCConnectionResumeRequest-NB</i> .....	941
–	<i>RRCCConnectionSetup-NB</i> .....	942
–	<i>RRCCConnectionSetupComplete-NB</i> .....	942
–	<i>RRCEarlyDataComplete-NB</i> .....	944
–	<i>RRCEarlyDataRequest-NB</i> .....	945
–	<i>SCPTMConfiguration-NB</i> .....	946
–	<i>SystemInformation-NB</i> .....	947
–	<i>SystemInformationBlockType1-NB</i> .....	947
–	<i>UECapabilityEnquiry-NB</i> .....	952
–	<i>UECapabilityInformation-NB</i> .....	952
–	<i>UEInformationRequest-NB</i> .....	953
–	<i>UEInformationResponse-NB</i> .....	954
–	<i>ULInformationTransfer-NB</i> .....	955
6.7.3	NB-IoT information elements .....	955

6.7.3.1	NB-IoT System information blocks .....	955
–	<i>SystemInformationBlockType2-NB</i> .....	955
–	<i>SystemInformationBlockType3-NB</i> .....	957
–	<i>SystemInformationBlockType4-NB</i> .....	960
–	<i>SystemInformationBlockType5-NB</i> .....	960
–	<i>SystemInformationBlockType14-NB</i> .....	962
–	<i>SystemInformationBlockType15-NB</i> .....	964
–	<i>SystemInformationBlockType16-NB</i> .....	965
–	<i>SystemInformationBlockType20-NB</i> .....	965
–	<i>SystemInformationBlockType22-NB</i> .....	967
–	<i>SystemInformationBlockType23-NB</i> .....	972
–	<i>SystemInformationBlockType27-NB</i> .....	973
–	<i>SystemInformationBlockType31-NB</i> .....	974
–	<i>SystemInformationBlockType32-NB</i> .....	974
–	<i>SystemInformationBlockType33-NB</i> .....	975
6.7.3.2	NB-IoT Radio resource control information elements .....	975
–	<i>CarrierConfigDedicated-NB</i> .....	975
–	<i>CarrierFreq-NB</i> .....	977
–	<i>ChannelRasterOffset-NB</i> .....	977
–	<i>DL-Bitmap-NB</i> .....	977
–	<i>DL-CarrierConfigCommon-NB</i> .....	978
–	<i>DL-GapConfig-NB</i> .....	979
–	<i>GWUS-Config-NB</i> .....	980
–	<i>LogicalChannelConfig-NB</i> .....	981
–	<i>MAC-MainConfig-NB</i> .....	982
–	<i>NPDCCH-ConfigDedicated-NB</i> .....	983
–	<i>NPDSCH-Config-NB</i> .....	984
–	<i>NPRACH-ConfigSIB-NB</i> .....	985
–	<i>NPUSCH-Config-NB</i> .....	992
–	<i>PDCP-Config-NB</i> .....	993
–	<i>PhysicalConfigDedicated-NB</i> .....	994
–	<i>PUR-Config-NB</i> .....	996
–	<i>PUR-ConfigID-NB</i> .....	998
–	<i>PUR-PeriodicityAndOffset-NB</i> .....	999
–	<i>RACH-ConfigCommon-NB</i> .....	999
–	<i>RadioResourceConfigCommonSIB-NB</i> .....	1000
–	<i>RadioResourceConfigDedicated-NB</i> .....	1002
–	<i>ResourceReservationConfig-NB</i> .....	1004
–	<i>RLC-Config-NB</i> .....	1005
–	<i>RLF-TimersAndConstants-NB</i> .....	1006
–	<i>SchedulingRequestConfig-NB</i> .....	1007
–	<i>TDD-Config-NB</i> .....	1009
–	<i>TDD-UL-DL-AlignmentOffset-NB</i> .....	1010
–	<i>UplinkPowerControl-NB</i> .....	1010
–	<i>WUS-Config-NB</i> .....	1011
6.7.3.3	NB-IoT Security control information elements .....	1012
6.7.3.4	NB-IoT Mobility control information elements .....	1012
–	<i>AdditionalBandInfoList-NB</i> .....	1012
–	<i>FreqBandIndicator-NB</i> .....	1012
–	<i>MultiBandInfoList-NB</i> .....	1012
–	<i>NS-PmaxList-NB</i> .....	1013
–	<i>ReselectionThreshold-NB</i> .....	1013
–	<i>T-Reselection-NB</i> .....	1013
6.7.3.5	NB-IoT Measurement information elements .....	1013
–	<i>ANR-MeasConfig-NB</i> .....	1013
–	<i>ANR-MeasReport-NB</i> .....	1014
–	<i>CQI-NPDCCH-NB</i> .....	1015
–	<i>CQI-NPDCCH-Short-NB</i> .....	1015
–	<i>MeasResultServCell-NB</i> .....	1015
–	<i>NRSRP-Range-NB</i> .....	1016
–	<i>NRSRQ-Range-NB</i> .....	1016
–	<i>NSSS-RRM-Config-NB</i> .....	1016

6.7.3.6	NB-IoT Other information elements .....	1017
–	<i>EstablishmentCause-NB</i> .....	1017
–	<i>UE-Capability-NB</i> .....	1017
–	<i>UE-RadioPagingInfo-NB</i> .....	1024
–	<i>UE-TimersAndConstants-NB</i> .....	1025
6.7.3.7	NB-IoT MBMS information elements .....	1026
6.7.3.7a	NB-IoT SC-PTM information elements .....	1026
–	<i>SC-MTCH-InfoList-NB</i> .....	1026
–	<i>SCPTM-NeighbourCellList-NB</i> .....	1028
6.7.4	NB-IoT RRC multiplicity and type constraint values .....	1028
–	Multiplicity and type constraint definitions .....	1028
–	End of NBIOT-RRC-Definitions .....	1028
6.7.5	Direct Indication Information .....	1029
7	Variables and constants .....	1029
7.1	UE variables .....	1029
–	<i>EUTRA-UE-Variables</i> .....	1029
–	<i>VarConditionalReconfiguration</i> .....	1030
–	<i>VarConnEstFailReport</i> .....	1030
–	<i>VarLogMeasConfig</i> .....	1031
–	<i>VarLogMeasReport</i> .....	1031
–	<i>VarMeasConfig</i> .....	1032
–	<i>VarMeasIdleConfig</i> .....	1032
–	<i>VarMeasIdleReport</i> .....	1033
–	<i>VarMeasReportList</i> .....	1033
–	<i>VarMobilityHistoryReport</i> .....	1034
–	<i>VarPendingRnaUpdate</i> .....	1034
–	<i>VarRLF-Report</i> .....	1034
–	<i>VarShortINACTIVE-MAC-Input</i> .....	1034
–	<i>VarShortMAC-Input</i> .....	1035
–	<i>VarShortResumeMAC-Input</i> .....	1035
–	<i>VarWLAN-MobilityConfig</i> .....	1036
–	<i>VarWLAN-Status</i> .....	1036
–	Multiplicity and type constraint definitions .....	1036
–	End of <i>EUTRA-UE-Variables</i> .....	1037
7.1a	NB-IoT UE variables .....	1037
–	<i>NBIOT-UE-Variables</i> .....	1037
–	<i>VarANR-MeasConfig-NB</i> .....	1037
–	<i>VarANR-MeasReport-NB</i> .....	1038
–	<i>VarRLF-Report-NB</i> .....	1038
–	<i>VarShortMAC-Input-NB</i> .....	1038
–	<i>VarShortResumeMAC-Input-NB</i> .....	1038
–	End of <i>NBIOT-UE-Variables</i> .....	1039
7.2	Counters .....	1039
7.3	Timers .....	1040
7.3.1	Timers (Informative) .....	1040
7.3.2	Timer handling .....	1046
7.4	Constants .....	1046
8	Protocol data unit abstract syntax .....	1046
8.1	General .....	1046
8.2	Structure of encoded RRC messages .....	1047
8.3	Basic production .....	1047
8.4	Extension .....	1047
8.5	Padding .....	1047
9	Specified and default radio configurations .....	1048
9.1	Specified configurations .....	1048
9.1.1	Logical channel configurations .....	1048
9.1.1.1	BCCH configuration .....	1048
9.1.1.2	CCCH configuration .....	1048
9.1.1.3	PCCH configuration .....	1049
9.1.1.4	MCCH and MTCH configuration .....	1049

9.1.1.5	SBCCH configuration .....	1049
9.1.1.6	STCH configuration .....	1049
9.1.1.7	SC-MCCH and SC-MTCH configuration .....	1050
9.1.1.8	BR-BCCH configuration .....	1050
9.1.2	SRB configurations .....	1050
9.1.2.1	SRB1 .....	1050
9.1.2.1a	SRB1bis .....	1051
9.1.2.2	SRB2 .....	1051
9.1.2.3	SRB4 .....	1051
9.2	Default radio configurations .....	1051
9.2.1	SRB configurations .....	1052
9.2.1.1	SRB1 .....	1052
9.2.1.2	SRB2 .....	1052
9.2.2	Default MAC main configuration .....	1053
9.2.3	Default semi-persistent scheduling configuration .....	1053
9.2.4	Default physical channel configuration .....	1053
9.2.5	Default values timers and constants .....	1054
9.3	Sidelink pre-configured parameters .....	1055
9.3.1	Specified parameters .....	1055
9.3.2	Pre-configurable parameters .....	1055
-	<i>SL-Preconfiguration</i> .....	1056
-	<i>SL-V2X-Preconfiguration</i> .....	1058
10	Radio information related interactions between network nodes .....	1062
10.1	General .....	1062
10.2	Inter-node RRC messages .....	1062
10.2.1	General .....	1062
-	<i>EUTRA-InterNodeDefinitions</i> .....	1062
10.2.2	Message definitions .....	1063
-	<i>HandoverCommand</i> .....	1063
-	<i>HandoverPreparationInformation</i> .....	1064
-	<i>SCG-Config</i> .....	1067
-	<i>SCG-ConfigInfo</i> .....	1068
-	<i>UEPagingCoverageInformation</i> .....	1070
-	<i>UERadioAccessCapabilityInformation</i> .....	1071
-	<i>UERadioPagingInformation</i> .....	1072
10.3	Inter-node RRC information element definitions .....	1073
-	<i>AS-Config</i> .....	1073
-	<i>AS-Context</i> .....	1075
-	<i>ReestablishmentInfo</i> .....	1077
-	<i>RRM-Config</i> .....	1078
10.4	Inter-node RRC multiplicity and type constraint values .....	1079
-	Multiplicity and type constraints definitions .....	1079
-	End of <i>EUTRA-InterNodeDefinitions</i> .....	1079
10.5	Mandatory information in <i>AS-Config</i> .....	1079
10.6	Inter-node NB-IoT messages .....	1080
10.6.1	General .....	1080
-	<i>NB-IoT-InterNodeDefinitions</i> .....	1080
10.6.2	Message definitions .....	1080
-	<i>HandoverPreparationInformation-NB</i> .....	1080
-	<i>UEPagingCoverageInformation-NB</i> .....	1081
-	<i>UERadioAccessCapabilityInformation-NB</i> .....	1082
-	<i>UERadioPagingInformation-NB</i> .....	1083
10.7	Inter-node NB-IoT RRC information element definitions .....	1083
-	<i>AS-Config-NB</i> .....	1083
-	<i>AS-Context-NB</i> .....	1084
-	<i>ReestablishmentInfo-NB</i> .....	1084
-	<i>RRM-Config-NB</i> .....	1085
10.8	Inter-node RRC multiplicity and type constraint values .....	1085
-	Multiplicity and type constraints definitions .....	1085
-	End of <i>NB-IoT-InterNodeDefinitions</i> .....	1085
10.9	Mandatory information in <i>AS-Config-NB</i> .....	1085

11	UE capability related constraints and performance requirements .....	1086
11.1	UE capability related constraints .....	1086
11.2	Processing delay requirements for RRC procedures .....	1086
11.3	Void .....	1091
<b>Annex A (informative): Guidelines, mainly on use of ASN.1 .....</b>		<b>1092</b>
A.1	Introduction .....	1092
A.2	Procedural specification .....	1092
A.2.1	General principles .....	1092
A.2.2	More detailed aspects .....	1092
A.3	PDU specification .....	1092
A.3.1	General principles .....	1092
A.3.1.1	ASN.1 clauses .....	1092
A.3.1.2	ASN.1 identifier naming conventions .....	1093
A.3.1.3	Text references using ASN.1 identifiers .....	1094
A.3.2	High-level message structure .....	1095
A.3.3	Message definition .....	1095
A.3.4	Information elements .....	1097
A.3.5	Fields with optional presence .....	1098
A.3.6	Fields with conditional presence .....	1098
A.3.7	Guidelines on use of lists with elements of SEQUENCE type .....	1099
A.3.8	Guidelines on use of parameterised type SetupRelease .....	1099
A.4	Extension of the PDU specifications .....	1100
A.4.1	General principles to ensure compatibility .....	1100
A.4.2	Critical extension of messages and fields .....	1100
A.4.3	Non-critical extension of messages .....	1102
A.4.3.1	General principles .....	1102
A.4.3.2	Further guidelines .....	1103
A.4.3.3	Typical example of evolution of IE with local extensions .....	1103
A.4.3.4	Typical examples of non critical extension at the end of a message .....	1104
A.4.3.5	Examples of non-critical extensions not placed at the default extension location .....	1105
–	<i>ParentIE-WithoutEM</i> .....	1105
–	<i>ChildIE1-WithoutEM</i> .....	1106
–	<i>ChildIE2-WithoutEM</i> .....	1106
A.5	Guidelines regarding inclusion of transaction identifiers in RRC messages .....	1107
A.6	Protection of RRC messages (informative) .....	1107
A.7	Miscellaneous .....	1110
<b>Annex B (normative): Release 8 and 9 AS feature handling .....</b>		<b>1111</b>
B.1	Feature group indicators .....	1111
B.2	CSG support .....	1121
<b>Annex C (normative): Release 10 AS feature handling .....</b>		<b>1123</b>
C.1	Feature group indicators .....	1123
<b>Annex D (informative): Descriptive background information .....</b>		<b>1127</b>
D.1	Signalling of Multiple Frequency Band Indicators (Multiple FBI) .....	1127
D.1.1	Mapping between frequency band indicator and multiple frequency band indicator .....	1127
D.1.2	Mapping between inter-frequency neighbour list and multiple frequency band indicator .....	1127
D.1.3	Mapping between UTRA FDD frequency list and multiple frequency band indicator .....	1128
<b>Annex E (normative): TDD/FDD differentiation of FGIs/capabilities in TDD-FDD CA .....</b>		<b>1130</b>
<b>Annex F (normative): UE requirements on ASN.1 comprehension .....</b>		<b>1132</b>
<b>Annex G (normative): List of CRs Containing Early Implementable Features and Corrections .....</b>		<b>1133</b>
<b>Annex H (informative): Change history .....</b>		<b>1137</b>
History .....		1167



---

# Foreword

This Technical Specification has been produced by the 3<sup>rd</sup> Generation Partnership Project (3GPP).

The contents of the present document are subject to continuing work within the TSG and may change following formal TSG approval. Should the TSG modify the contents of the present document, it will be re-released by the TSG with an identifying change of release date and an increase in version number as follows:

Version x.y.z

where:

- x the first digit:
  - 1 presented to TSG for information;
  - 2 presented to TSG for approval;
  - 3 or greater indicates TSG approved document under change control.
- y the second digit is incremented for all changes of substance, i.e. technical enhancements, corrections, updates, etc.
- z the third digit is incremented when editorial only changes have been incorporated in the document.

---

# 1 Scope

The present document specifies the Radio Resource Control protocol for the radio interface between UE and E-UTRAN as well as for the radio interface between RN and E-UTRAN.

The scope of the present document also includes:

- the radio related information transported in a transparent container between source eNB and target eNB upon inter eNB handover;
- the radio related information transported in a transparent container between a source or target eNB and another system upon inter RAT handover.

The RRC protocol is also used to configure the radio interface between an IAB-node and its parent nodes as specified in TS 38.300 [106].

---

# 2 References

The following documents contain provisions which, through reference in this text, constitute provisions of the present document.

- References are either specific (identified by date of publication, edition number, version number, etc.) or non-specific.
- For a specific reference, subsequent revisions do not apply.
- For a non-specific reference, the latest version applies. In the case of a reference to a 3GPP document (including a GSM document), a non-specific reference implicitly refers to the latest version of that document *in the same Release as the present document*.

- [1] 3GPP TR 21.905: "Vocabulary for 3GPP Specifications".
- [2] Void.
- [3] 3GPP TS 36.302: "Evolved Universal Terrestrial Radio Access (E-UTRA); Services provided by the physical layer".
- [4] 3GPP TS 36.304: "Evolved Universal Terrestrial Radio Access (E-UTRA); UE Procedures in Idle Mode".
- [5] 3GPP TS 36.306 "Evolved Universal Terrestrial Radio Access (E-UTRA); UE Radio Access Capabilities".
- [6] 3GPP TS 36.321: "Evolved Universal Terrestrial Radio Access (E-UTRA); Medium Access Control (MAC) protocol specification".
- [7] 3GPP TS 36.322: "Evolved Universal Terrestrial Radio Access (E-UTRA); Radio Link Control (RLC) protocol specification".
- [8] 3GPP TS 36.323: "Evolved Universal Terrestrial Radio Access (E-UTRA); Packet Data Convergence Protocol (PDCP) Specification".
- [9] 3GPP TS 36.300: "Evolved Universal Terrestrial Radio Access (E-UTRA) and Evolved Universal Terrestrial Radio Access (E-UTRAN); Overall description; Stage 2".
- [10] 3GPP TS 22.011: "Service accessibility".
- [11] 3GPP TS 23.122: "Non-Access-Stratum (NAS) functions related to Mobile Station (MS) in idle mode".
- [12] 3GPP2 C.S0002-F v1.0: "Physical Layer Standard for cdma2000 Spread Spectrum Systems".

- [13] ITU-T Recommendation X.680 (07/2002) "Information Technology - Abstract Syntax Notation One (ASN.1): Specification of basic notation" (Same as the ISO/IEC International Standard 8824-1).
- [14] ITU-T Recommendation X.681 (07/2002) "Information Technology - Abstract Syntax Notation One (ASN.1): Information object specification" (Same as the ISO/IEC International Standard 8824-2).
- [15] ITU-T Recommendation X.691 (07/2002) "Information technology - ASN.1 encoding rules: Specification of Packed Encoding Rules (PER)" (Same as the ISO/IEC International Standard 8825-2).
- [16] 3GPP TS 36.133: "Evolved Universal Terrestrial Radio Access (E-UTRA); Requirements for support of radio resource management".
- [17] 3GPP TS 25.101: "Universal Terrestrial Radio Access (UTRA); User Equipment (UE) radio transmission and reception (FDD)".
- [18] 3GPP TS 25.102: "Universal Terrestrial Radio Access (UTRA); User Equipment (UE) radio transmission and reception (TDD)".
- [19] 3GPP TS 25.331: "Universal Terrestrial Radio Access (UTRA); Radio Resource Control (RRC); Protocol specification".
- [20] 3GPP TS 45.005: "Radio transmission and reception".
- [21] 3GPP TS 36.211: "Evolved Universal Terrestrial Radio Access (E-UTRA); Physical Channels and Modulation".
- [22] 3GPP TS 36.212: "Evolved Universal Terrestrial Radio Access (E-UTRA); Multiplexing and channel coding".
- [23] 3GPP TS 36.213: "Evolved Universal Terrestrial Radio Access (E-UTRA); Physical layer procedures".
- [24] 3GPP2 C.S0057-E v1.0: "Band Class Specification for cdma2000 Spread Spectrum Systems".
- [25] 3GPP2 C.S0005-F v1.0: "Upper Layer (Layer 3) Signaling Standard for cdma2000 Spread Spectrum Systems".
- [26] 3GPP2 C.S0024-C v2.0: "cdma2000 High Rate Packet Data Air Interface Specification".
- [27] 3GPP TS 23.003: "Numbering, addressing and identification".
- [28] 3GPP TS 45.008: "Radio subsystem link control".
- [29] 3GPP TS 25.133: "Requirements for Support of Radio Resource Management (FDD)".
- [30] 3GPP TS 25.123: "Requirements for Support of Radio Resource Management (TDD)".
- [31] 3GPP TS 36.401: "Evolved Universal Terrestrial Radio Access (E-UTRA); Architecture description".
- [32] 3GPP TS 33.401: "3GPP System Architecture Evolution (SAE); Security architecture".
- [33] 3GPP2 A.S0008-C v4.0: "Interoperability Specification (IOS) for High Rate Packet Data (HRPD) Radio Access Network Interfaces with Session Control in the Access Network"
- [34] 3GPP2 C.S0004-F v1.0: "Signaling Link Access Control (LAC) Standard for cdma2000 Spread Spectrum Systems"
- [35] 3GPP TS 24.301: "Non-Access-Stratum (NAS) protocol for Evolved Packet System (EPS); Stage 3".
- [36] 3GPP TS 44.060: "General Packet Radio Service (GPRS); Mobile Station (MS) - Base Station System (BSS) interface; Radio Link Control/Medium Access Control (RLC/MAC) protocol".

- [37] 3GPP TS 23.041: "Technical realization of Cell Broadcast Service (CBS)".
- [38] 3GPP TS 23.038: "Alphabets and Language".
- [39] 3GPP TS 36.413: "Evolved Universal Terrestrial Radio Access (E-UTRAN); S1 Application Protocol (S1 AP)".
- [40] 3GPP TS 25.304: "Universal Terrestrial Radio Access (UTRAN); User Equipment (UE) procedures in idle mode and procedures for cell reselection in connected mode".
- [41] 3GPP TS 23.401: "General Packet Radio Service (GPRS) enhancements for Evolved Universal Terrestrial Radio Access Network (E-UTRAN) access".
- [42] 3GPP TS 36.101: "Evolved Universal Terrestrial Radio Access (E-UTRA); User Equipment (UE) radio transmission and reception".
- [43] 3GPP TS 45.005: "GSM/EDGE Radio transmission and reception".
- [44] 3GPP2 C.S0087-A v2.0: "E-UTRAN - cdma2000 HRPD Connectivity and Interworking Air Interface Specification"
- [45] 3GPP TS 44.018: "Mobile radio interface layer 3 specification; Radio Resource Control (RRC) protocol".
- [46] 3GPP TS 25.223: "Spreading and modulation (TDD)".
- [47] 3GPP TS 36.104: "Evolved Universal Terrestrial Radio Access (E-UTRA); Base Station (BS) radio transmission and reception".
- [48] 3GPP TS 36.214: "Evolved Universal Terrestrial Radio Access (E-UTRA); Physical layer - Measurements".
- [49] 3GPP TS 24.008: "Mobile radio interface layer 3 specification; Core network protocols; Stage 3".
- [50] 3GPP TS 45.010: "Radio subsystem synchronization".
- [51] 3GPP TS 23.272: "Circuit Switched Fallback in Evolved Packet System; Stage 2".
- [52] 3GPP TS 29.061: "Interworking between the Public Land Mobile Network (PLMN) supporting packet based services and Packet Data Networks (PDN)".
- [53] 3GPP2 C.S0097-0 v3.0: "E-UTRAN - cdma2000 1x Connectivity and Interworking Air Interface Specification".
- [54] 3GPP TS 36.355: "LTE Positioning Protocol (LPP)".
- [55] 3GPP TS 36.216: "Evolved Universal Terrestrial Radio Access (E-UTRA); Physical layer for relaying operation".
- [56] 3GPP TS 23.246: "Multimedia Broadcast/Multicast Service (MBMS); Architecture and functional description".
- [57] 3GPP TS 26.346: "Multimedia Broadcast/Multicast Service (MBMS); Protocols and codecs".
- [58] 3GPP TS 32.422: "Telecommunication management; Subscriber and equipment trace; Trace control and configuration management".
- [59] 3GPP TS 22.368: "Service Requirements for Machine Type Communications; Stage 1".
- [60] 3GPP TS 37.320: "Universal Terrestrial Radio Access (UTRA) and Evolved Universal Terrestrial Radio Access (E-UTRA); Radio measurement collection for Minimization of Drive Tests (MDT); Overall description; Stage 2".
- [61] 3GPP TS 23.216: "Single Radio Voice Call Continuity (SRVCC); Stage 2".
- [62] 3GPP TS 22.146: "Multimedia Broadcast/Multicast Service (MBMS); Stage 1".

- [63] 3GPP TR 36.816: "Evolved Universal Terrestrial Radio Access (E-UTRA); Study on signalling and procedure for interference avoidance for in-device coexistence".
- [64] IS-GPS-200F: "Navstar GPS Space Segment/Navigation User Segment Interfaces".
- [65] 3GPP TS 25.307: "Requirement on User Equipments (UEs) supporting a release-independent frequency band".
- [66] 3GPP TS 24.312: "Access Network Discovery and Selection Function (ANDSF) Management Object (MO)".
- [67] IEEE 802.11-2012, Part 11: Wireless LAN Medium Access Control (MAC) and Physical Layer (PHY) specifications, IEEE Std.
- [68] 3GPP TS 23.303: "Proximity-based services (ProSe); Stage 2".
- [69] 3GPP TS 24.334: "Proximity-services (ProSe) User Equipment (UE) to ProSe function protocol aspects; Stage 3".
- [70] 3GPP TS 24.333: "Proximity-services (ProSe) Management Objects (MO)".
- [71] 3GPP TS 36.314: "Evolved Universal Terrestrial Radio Access (E-UTRA); Layer 2-Measurements".
- [72] 3GPP TS 24.105: "Application specific Congestion control for Data Communication (ACDC) Management Object (MO)".
- [73] 3GPP TS 23.179: "Functional architecture and information flows to support mission critical communication services; Stage 2".
- [74] 3GPP TS 24.302: "Access to the 3GPP Evolved Packet Core (EPC) via non-3GPP access networks".
- [75] 3GPP TS 23.402: "Architecture enhancements for non-3GPP accesses; Stage-2".
- [76] Wi-Fi Alliance® Technical Committee, Hotspot 2.0 Technical Task Group Hotspot 2.0 (Release 2) Technical Specification Version 3.11.
- [77] 3GPP TS 22.101: "Service aspects; Service principles".
- [78] 3GPP TS 23.285: "Technical Specification Group Services and System Aspects; Architecture enhancements for V2X services".
- [79] 3GPP TS 36.307: "Evolved Universal Terrestrial Radio Access (E-UTRA); Requirements on User Equipments (UEs) supporting a release-independent frequency band".
- [80] Military Standard WGS84 Metric MIL-STD-2401 (11 January 1994): "Military Standard Department of Defence World Geodetic System (WGS)".
- [81] 3GPP TS 37.340: "NR; Multi-connectivity; Overall description; Stage-2".
- [82] 3GPP TS 38.331: "NR; Radio Resource Control (RRC); Protocol specification".
- [83] 3GPP TS 38.323: "NR; Packet Data Convergence Protocol (PDCP) Specification".
- [84] 3GPP TS 38.133: "NR; Requirements for support of radio resource management".
- [85] 3GPP TS 38.101-1: "NR; User Equipment (UE) radio transmission and reception; Part 1: Range 1 Standalone".
- [86] 3GPP TS 33.501: "Security Architecture and Procedures for 5G System".
- [87] 3GPP TS 38.306: "NR; UE Radio Access Capabilities".
- [88] 3GPP TS 38.213: "NR; Physical layer procedures for control".
- [89] 3GPP TS 38.215: "NR; Physical layer measurements".

- [90] 3GPP TS 26.247: "Transparent end-to-end Packet-switched Streaming Service (PSS); Progressive Download and Dynamic Adaptive Streaming over HTTP (3GP-DASH)".
- [91] 3GPP TS 38.104: "NR; Base Station (BS) radio transmission and reception".
- [92] 3GPP TS 38.304: "NR; User Equipment (UE) procedures in Idle mode and RRC Inactive state".
- [93] Bluetooth Special Interest Group: "Bluetooth Core Specification v5.0", December 2016.
- [94] 3GPP TS 37.213: "Physical layer procedures for shared spectrum channel access".
- [95] 3GPP TS 24.501: "Non-Access-Stratum (NAS) protocol for 5G System (5GS); Stage 3".
- [96] 3GPP TS 22.261: "Service requirements for the 5G System".
- [97] 3GPP TS 37.324: "Service Data Adaptation Protocol (SDAP) specification".
- [98] ATIS 0700041: "WEA 3.0: Device-Based Geo-Fencing".
- [99] 3GPP TS 26.114: "IP Multimedia Subsystem (IMS); Multimedia Telephony; Media handling and interaction".
- [100] 3GPP TS 38.101-2: "NR; User Equipment (UE) radio transmission and reception; Part 2: Range 2 Standalone".
- [101] 3GPP TS 38.101-3: "NR; User Equipment (UE) radio transmission and reception; Part 3: Range 1 and Range 2 Interworking operation with other radios".
- [102] 3GPP TS 23.502: "Procedures for the 5G System; Stage 2".
- [103] 3GPP TS 38.314: "NR; layer 2 measurements".
- [104] 3GPP TS 23.287: "Architecture enhancements for 5G System (5GS) to support Vehicle-to-Everything (V2X) services".
- [105] 3GPP TS 38.472: "NG-RAN; F1 signalling transport".
- [106] 3GPP TS 38.300: "NR; Overall description; Stage 2".
- [107] 3GPP TS 38.174: "NR; Integrated access and backhaul radio transmission and reception".
- [108] 3GPP TS 36.423: "Evolved Universal Terrestrial Radio Access Network (E-UTRAN); X2 Application Protocol (X2AP)".
- [109] 3GPP TS 37.355: "LTE Positioning Protocol (LPP)".
- [110] NIMA TR 8350.2, Third Edition, Amendment 1, 3 January 2000: "DEPARTMENT OF DEFENSE WORLD GEODETIC SYSTEM 1984".
- [111] "Recommendation for Space Data System Standards: ORBIT DATA MESSAGES", BLUE BOOK CCSDS 502.0-B-2, The Consultative Committee for Space Data Systems, November 2009.
- [112] 3GPP TS 23.304: "Proximity based Services (ProSe) in the 5G System (5GS)".
- [113] 3GPP TS 36.102: "Evolved Universal Terrestrial Radio Access (E-UTRA); User Equipment (UE) radio transmission and reception for satellite access".
- [114] 3GPP TS 36.108: "Evolved Universal Terrestrial Radio Access (E-UTRA); Satellite Access Node radio transmission and reception".
- [115] 3GPP TS 23.256: "Support of Uncrewed Aerial Systems (UAS) connectivity, identification and tracking; Stage 2".
- [116] 3GPP TS 38.101-5: "User Equipment (UE) radio transmission and reception; Part 5: Satellite access Radio Frequency (RF) and performance requirements".
- [117] 3GPP TS 38.211: "NR; Physical channels and modulation".

## 3 Definitions, symbols and abbreviations

### 3.1 Definitions

For the purposes of the present document, the terms and definitions given in TR 21.905 [1] and the following apply. A term defined in the present document takes precedence over the definition of the same term, if any, in TR 21.905 [1].

**A2X communication:** A communication to support A2X services leveraging PC5 reference points, as defined in TS 23.256 [115]. A2X services are realized by various types of A2X applications, e.g., BRID or DAA.

**Aerial UE:** UE performing Aerial UE communication, as defined in TS 36.300 [9], clause 23.17 and TS 23.256 [115].

**Anchor carrier:** In NB-IoT, a carrier where the UE assumes that NPSS/NSSS/NPBCH/SIB-NB for FDD or NPSS/NSSS/NPBCH for TDD are transmitted.

**Bandwidth Reduced:** Refers to operation in downlink and uplink with a limited channel bandwidth of 6 PRBs.

**CEIL:** Mathematical function used to 'round up' i.e. to the nearest integer having a higher or equal value.

**Cellular IoT EPS Optimisation:** Provides improved support of small data transfer, as defined in TS 24.301 [35].

**Commercial Mobile Alert System:** Public Warning System that delivers *Warning Notifications* provided by *Warning Notification Providers* to CMAS capable UEs.

**Common access barring parameters:** The common access barring parameters refer to the access class barring parameters that are broadcast in *SystemInformationBlockType2* outside the list of PLMN specific parameters (i.e. in *ac-BarringPerPLMN-List*).

**Control plane CIoT 5GS optimisation:** Enables support of efficient transport of user data (IP, Ethernet or unstructured) or SMS messages over control plane via the AMF without triggering data radio bearer establishment, as defined in TS 24.501 [95].

**Control plane CIoT EPS optimisation:** Enables support of efficient transport of user data (IP, non-IP or SMS) over control plane via the MME without triggering data radio bearer establishment, as defined in TS 24.301 [35].

**Control plane EDT:** Early Data Transmission used with the Control plane CIoT EPS optimisation or Control plane CIoT 5GS optimisation.

**Coverage-based paging:** In NB-IoT allows UE to use paging carriers configured for lower levels of coverage enhancement than maximum coverage enhancement supported in the cell as described in TS 36.300 [9].

**CSG member cell:** A cell broadcasting the identity of the selected PLMN, registered PLMN or equivalent PLMN and for which the Permitted CSG list of the UE includes an entry comprising cell's CSG ID and the respective PLMN identity.

**DAPS bearer:** A bearer whose radio protocols are located in both the source eNB and the target eNB during a DAPS handover to use both source eNB and target eNB resources.

**Dual Connectivity:** A UE in RRC\_CONNECTED is configured with Dual Connectivity when configured with a Master and a Secondary Cell Group.

**Early Data Transmission:** Allows one uplink data transmission optionally followed by one downlink data transmission during the random access procedure as specified in TS 36.300 [9]. The S1 connection is established or resumed upon reception of the uplink data and may be released or suspended along with the transmission of the downlink data. Early data transmission refers to both CP-EDT and UP-EDT.

**Early Security Reactivation:** Re-activation of AS security prior to the transmission of *RRCConnectionResumeRequest* message when a UE is provided with an NCC value during suspension.

**Earth-moving cell:** An NTN cell moving on the ground. It can be provisioned by beam(s) whose coverage area slides over the Earth's surface (e.g., the case of NGSO satellites generating fixed or non-steerable beams).

**Ephemeris:** A set of parameters that describe the movement of an NTN node over time.

**E-UTRA-NR Dual Connectivity:** A form of dual connectivity in which a UE in RRC\_CONNECTED is configured with MCG cells using E-UTRA and SCG cells using NR as defined in TS 37.340 [81].

**EU-Alert:** Public Warning System that delivers Warning Notifications provided by Warning Notification Providers using the same AS mechanisms as defined for CMAS.

**Field:** The individual contents of an information element are referred as fields.

**FLOOR:** Mathematical function used to 'round down' i.e. to the nearest integer having a lower or equal value.

**FR1:** Frequency range 1 as defined in clause 5.1 of TS 38.101-1 [85].

**FR2:** Frequency range 2 as defined in clause 5.1 of TS 38.101-2 [100].

**Geosynchronous Orbit:** Earth-centred orbit at approximately 35,786 kilometres in altitude above Earth's surface and synchronised with Earth's rotation. A geostationary orbit is a non-inclined geosynchronous orbit, i.e. in the Earth's equator plane.

**Information element:** A structural element containing a single or multiple fields is referred as information element.

**Korean Public Alert System (KPAS):** Public Warning System that delivers Warning Notifications provided by Warning Notification Providers using the same AS mechanisms as defined for CMAS.

**Master Cell Group:** For a UE not configured with DC, the MCG comprises all serving cells. For a UE configured with DC, the MCG concerns a subset of the serving cells comprising of the PCell and zero or more secondary cells.

**Mixed Operation Mode:** In NB-IoT FDD, multi-carrier operation where the anchor carrier is in standalone mode while the non-anchor carrier is in inband or guardband mode, and vice versa. See TS 36.300 [9].

**MBMS service:** MBMS bearer service as defined in TS 23.246 [56] (i.e. provided via an MRB or an SC-MRB).

**NB-IoT:** NB-IoT allows access to network services via E-UTRA with a channel bandwidth limited to 200 kHz.

**NB-IoT UE:** A UE that uses NB-IoT.

**NCSG:** Network controlled small gap as defined in TS 36.133 [16].

**Non-geosynchronous orbit:** Earth-centred orbit with an orbital period that does not match Earth's rotation on its axis. This includes Low Earth Orbit (LEO) and Medium Earth Orbit (MEO).

**Non-terrestrial networks:** An E-UTRAN consisting of eNBs, which provide non-terrestrial LTE access to UEs by means of an NTN payload embarked on a space-borne NTN vehicle and an NTN Gateway.

**NR-E-UTRA Dual Connectivity (NE-DC):** A form of dual connectivity in which a UE in RRC\_CONNECTED is configured with MCG cells using NR and SCG cells using E-UTRA as defined in TS 37.340 [81].

**Non-anchor carrier:** In NB-IoT, a carrier where the UE does not assume that NPSS/NSSS/NPBCH/SIB-NB for FDD or NPSS/NSSS/NPBCH for TDD are transmitted.

**NR Carrier Frequency:** Frequency referring to the position of resource element RE=#0 (subcarrier #0) of resource block RB#10 of the SS block.

**NR sidelink communication:** AS functionality enabling at least V2X Communication as defined in TS 23.287 [104] and/or A2X Communication as defined in TS 23.256 [115], between two or more nearby UEs, using NR technology but not traversing any network node.

**Primary Cell:** The cell, operating on the primary frequency, in which the UE either performs the initial connection establishment procedure or initiates the connection re-establishment procedure, or the cell indicated as the primary cell in the handover procedure.

**Primary Secondary Cell:** The SCG cell in which the UE is instructed to perform random access or initial PUSCH transmission if random access procedure is skipped when performing the SCG change procedure.

**Primary Timing Advance Group:** Timing Advance Group containing the PCell or the PSCell.

**PUCCH SCell:** An SCell configured with PUCCH.



**Quasi-earth fixed cell:** An NTN cell fixed with respect to a certain geographic area on the earth during a certain time duration. This can be provided by beam(s) covering one geographic area for a finite period and a different geographic area during another period (e.g., the case of NGSO satellites generating steerable beams).

**RLC bearer configuration:** The lower layer part of the radio bearer configuration comprising the RLC and logical channel configurations.

**Satellite:** A space-borne vehicle orbiting the Earth that carries the NTN payload.

**Secondary Cell:** A cell, operating on a secondary frequency, which may be configured once an RRC connection is established and which may be used to provide additional radio resources. Except for the case of (NG)EN-DC, the PSCell is considered to be an SCell.

**Secondary Cell Group:** For a UE configured with DC, the subset of serving cells not part of the MCG, i.e. comprising of the PSCell and zero or more other secondary cells.

**Secondary Timing Advance Group:** Timing Advance Group neither containing the PCell nor the PSCell. A secondary timing advance group contains at least one cell with configured uplink.

**Serving Cell:** For a UE in RRC\_CONNECTED not configured with CA/ DC there is only one serving cell comprising of the primary cell. For a UE in RRC\_CONNECTED configured with CA/ DC the term 'serving cells' is used to denote the set of one or more cells comprising of the primary cell and all secondary cells.

**Sidelink:** UE to UE interface for sidelink communication, V2X sidelink communication, A2X sidelink communication and sidelink discovery. The sidelink corresponds to the PC5 interface as defined in TS 23.303 [68].

**Sidelink communication:** AS functionality enabling ProSe Direct Communication as defined in TS 23.303 [68], between two or more nearby UEs, using E-UTRA technology but not traversing any network node. In this version, the terminology "sidelink communication" without "V2X" or "A2X" prefix only concerns PS unless specifically stated otherwise.

**Sidelink discovery:** AS functionality enabling ProSe Direct Discovery as defined in TS 23.303 [68], using E-UTRA technology but not traversing any network node.

**Sidelink operation:** Includes sidelink communication, V2X sidelink communication, A2X sidelink communication and sidelink discovery.

**Split SRB:** in MR-DC, an SRB between the MN and the UE, allowing selection of either the direct path or the path via the SN as well as duplication of RRC PDUs across both paths as defined in TS 37.340 [81].

**Timing Advance Group:** A group of serving cells that is configured by RRC and that, for the cells with an UL configured, use the same timing reference cell and the same Timing Advance value. A Timing Advance Group only includes cells of the same cell group i.e. it either includes MCG cells or SCG cells.

**Transmission using PUR:** Allows one uplink data transmission using preconfigured uplink resource from RRC\_IDLE mode as specified in TS 36.300 [9]. Transmission using PUR refers to both CP transmission using PUR and UP transmission using PUR.

**UE Inactive AS Context:** UE Inactive AS Context is stored when the connection is suspended and restored when the connection is resumed. It includes information as defined in clause 5.3.8.7.

**UE in CE:** Refers to a UE that is capable of using coverage enhancement, and requires coverage enhancement mode to access a cell or is configured in a coverage enhancement mode.

**User plane CIoT 5GS optimisation:** Enables support for change from 5GMM-IDLE mode to 5GMM-CONNECTED mode without the need for using the Service Request procedure, as defined in TS 24.501 [95].

**User plane CIoT EPS optimisation:** Enables support for change from EMM-IDLE mode to EMM-CONNECTED mode without the need for using the Service Request procedure, as defined in TS 24.301 [35].

**User plane EDT:** Early Data Transmission used with the User plane CIoT EPS optimisation or User plane CIoT 5GS optimisation.

**V2X sidelink communication:** AS functionality enabling V2X Communication as defined in TS 23.285 [78], between nearby UEs, using E-UTRA technology but not traversing any network node.

## 3.2 Abbreviations

For the purposes of the present document, the abbreviations given in TR 21.905 [1], TS 36.300 [9] and the following apply. An abbreviation defined in the present document takes precedence over the definition of the same abbreviation, if any, in TR 21.905 [1] or TS 36.300 [9].

1xRTT	CDMA2000 1x Radio Transmission Technology
A2X	Aircraft-to-Everything
AB	Access Barring
ACDC	Application specific Congestion control for Data Communication
ACK	Acknowledgement
AILC	Assistance Information bit for Local Cache
AM	Acknowledged Mode
ANDSF	Access Network Discovery and Selection Function
ARQ	Automatic Repeat Request
AS	Access Stratum
ASN.1	Abstract Syntax Notation One
AUL	Autonomous Uplink
BCCH	Broadcast Control Channel
BCD	Binary Coded Decimal
BCH	Broadcast Channel
BL	Bandwidth reduced Low complexity
BLER	Block Error Rate
BR	Bandwidth Reduced
BR-BCCH	Bandwidth Reduced Broadcast Control Channel
BRID	Broadcast Remote Identification
CA	Carrier Aggregation
CAS	Cell Acquisition Subframes
CBP	Coverage-Based Paging
CBR	Channel Busy Ratio
CCCH	Common Control Channel
CCO	Cell Change Order
CE	Coverage Enhancement
CFI	Control Format Indicator
CG	Cell Group
CHO	Conditional Handover
CIoT	Cellular IoT
CMAS	Commercial Mobile Alert Service
CP	Control Plane
CPA	Conditional PSCell Addition
CPC	Conditional PSCell Change
CP-EDT	Control Plane EDT
C-RNTI	Cell RNTI
CRS	Cell-specific Reference Signal
CSFB	CS fallback
CSG	Closed Subscriber Group
CSI	Channel State Information
DAA	Detect And Avoid
DAPS	Dual Active Protocol Stack
DC	Dual Connectivity
DCCH	Dedicated Control Channel
DCI	Downlink Control Information
DCN	Dedicated Core Networks
DFN	Direct Frame Number
DL	Downlink
DL-SCH	Downlink Shared Channel
DRB	(user) Data Radio Bearer
DRX	Discontinuous Reception
DTCH	Dedicated Traffic Channel
EAB	Extended Access Barring
ECEF	Earth-Centered, Earth-Fixed

ECI	Earth-Centered Inertial
eDRX	Extended DRX
EDT	Early Data Transmission
EHPLMN	Equivalent Home Public Land Mobile Network
eIMTA	Enhanced Interference Management and Traffic Adaptation
ENB	Evolved Node B
EN-DC	E-UTRA NR Dual Connectivity with E-UTRAN connected to EPC
EPC	Evolved Packet Core
EPDCCH	Enhanced Physical Downlink Control Channel
EPS	Evolved Packet System
ETWS	Earthquake and Tsunami Warning System
E-UTRA	Evolved Universal Terrestrial Radio Access
E-UTRA/5GC	E-UTRA connected to 5GC
E-UTRA/EPC	E-UTRA connected to EPC
E-UTRAN	Evolved Universal Terrestrial Radio Access Network
FDD	Frequency Division Duplex
FFS	For Further Study
GERAN	GSM/EDGE Radio Access Network
GNSS	Global Navigation Satellite System
G-RNTI	Group RNTI
GSM	Global System for Mobile Communications
GSO	Geosynchronous Orbit
GWUS	Group Wake Up Signal
HARQ	Hybrid Automatic Repeat Request
HFN	Hyper Frame Number
HPLMN	Home Public Land Mobile Network
HRPD	CDMA2000 High Rate Packet Data
HSDN	High Speed Dedicated Network
H-SFN	Hyper SFN
IAB	Integrated Access and Backhaul
IAB-DU	IAB-node DU
IAB-MT	IAB Mobile Termination
IDC	In-Device Coexistence
IE	Information element
IMEI	International Mobile Equipment Identity
IMSI	International Mobile Subscriber Identity
IoT	Internet of Things
ISM	Industrial, Scientific and Medical
kB	Kilobyte (1000 bytes)
L1	Layer 1
L2	Layer 2
L3	Layer 3
LAA	Licensed-Assisted Access
LWA	LTE-WLAN Aggregation
LWAAP	LTE-WLAN Aggregation Adaptation Protocol
LWIP	LTE-WLAN Radio Level Integration with IPsec Tunnel
MAC	Medium Access Control
MBMS	Multimedia Broadcast Multicast Service
MBSFN	Multimedia Broadcast multicast service Single Frequency Network
MCG	Master Cell Group
MCOT	Maximum Channel Occupancy Time
MCPTT	Mission Critical Push To Talk
MDT	Minimization of Drive Tests
MIB	Master Information Block
MO	Mobile Originating
MPDCCH	MTC Physical Downlink Control Channel
MRB	MBMS Point to Multipoint Radio Bearer
MR-DC	Multi-Radio Dual Connectivity
MRO	Mobility Robustness Optimisation
MSI	MCH Scheduling Information
MT	Mobile Terminating
MTSI	Multimedia Telephony Service for IMS

MUSIM	Multi-Universal Subscriber Identity Module
MUST	MultiUser Superposition Transmission
N/A	Not Applicable
NACC	Network Assisted Cell Change
NAICS	Network Assisted Interference Cancellation/Suppression
NAS	Non Access Stratum
NB-IoT	NarrowBand Internet of Things
NE-DC	NR E-UTRA Dual Connectivity
(NG)EN-DC	E-UTRA NR Dual Connectivity (i.e. covering both EN-DC and NGEN-DC)
NGEN-DC	E-UTRA NR Dual Connectivity with E-UTRAN connected to 5GC
NGSO	Non-Geosynchronous Orbit
NPBCH	Narrowband Physical Broadcast channel
NPDCCH	Narrowband Physical Downlink Control channel
NPDSCH	Narrowband Physical Downlink Shared channel
NPRACH	Narrowband Physical Random Access channel
NPSS	Narrowband Primary Synchronization Signal
NPUSCH	Narrowband Physical Uplink Shared channel
NR	NR Radio Access
NRS	Narrowband Reference Signal
NSSAI	Network Slice Selection Assistance Information
NSSS	Narrowband Secondary Synchronization Signal
NTN	Non-Terrestrial Network
OS	OFDM Symbol
P2X	Pedestrian-to-Everything
PCCH	Paging Control Channel
PCell	Primary Cell
PDCCH	Physical Downlink Control Channel
PDCP	Packet Data Convergence Protocol
PDU	Protocol Data Unit
PLMN	Public Land Mobile Network
PMK	Pairwise Master Key
PO	Paging Occasion
posSIB	Positioning SIB
ProSe	Proximity based Services
PS	Public Safety (in context of sidelink), Packet Switched (otherwise)
PSCell	Primary Secondary Cell
PSK	Pre-Shared Key
PTAG	Primary Timing Advance Group
PUCCH	Physical Uplink Control Channel
PUR	Preconfigured Uplink Resource
QCI	QoS Class Identifier
QoE	Quality of Experience
QoS	Quality of Service
RACH	Random Access CHannel
RAI	Release Assistance Indication
RAT	Radio Access Technology
RB	Radio Bearer
RCLWI	RAN Controlled LTE-WLAN Integration
RLC	Radio Link Control
RLOS	Restricted Local Operator Services
RMTC	RSSI Measurement Timing Configuration
RN	Relay Node
RNA	RAN-based Notification Area
RNAU	RAN-based Notification Area Update
RNTI	Radio Network Temporary Identifier
ROHC	RObust Header Compression
RPLMN	Registered Public Land Mobile Network
RRC	Radio Resource Control
RSCP	Received Signal Code Power
RSRP	Reference Signal Received Power
RSRQ	Reference Signal Received Quality
RSS	Resynchronisation signal

RSSI	Received Signal Strength Indicator
SAE	System Architecture Evolution
SAP	Service Access Point
SBAS	Satellite Based Augmentation System
SC	Sidelink Control
SCell	Secondary Cell
SCG	Secondary Cell Group
SC-MRB	Single Cell MRB
SC-RNTI	Single Cell RNTI
SD-RSRP	Sidelink Discovery Reference Signal Received Power
SFN	System Frame Number
SHR	Successful Handover Report
SI	System Information
SIB	System Information Block
SI-RNTI	System Information RNTI
SL	Sidelink
SLSS	Sidelink Synchronisation Signal
SMC	Security Mode Control
SMTC	SS/PBCH Block Measurement Timing Configuration
SPDCCH	Short PDCCH
SPS	Semi-Persistent Scheduling
SPT	Short Processing Time
SPUCCH	Short PUCCH
SR	Scheduling Request
SRB	Signalling Radio Bearer
S-RSRP	Sidelink Reference Signal Received Power
SSAC	Service Specific Access Control
SSTD	SFN and Subframe Timing Difference
STAG	Secondary Timing Advance Group
S-TMSI	SAE Temporary Mobile Station Identifier
STTI	Short TTI
TA	Tracking Area
TAG	Timing Advance Group
TDD	Time Division Duplex
TDM	Time Division Multiplexing
TLE	Two-Line Element
TM	Transparent Mode
TN	Terrestrial Network
TPC-RNTI	Transmit Power Control RNTI
T-RPT	Time Resource Pattern of Transmission
TTI	Transmission Time Interval
TTT	Time To Trigger
UDC	Uplink Data Compression
UE	User Equipment
UICC	Universal Integrated Circuit Card
UL	Uplink
UL-SCH	Uplink Shared Channel
UM	Unacknowledged Mode
UP	User Plane
UP-EDT	User Plane EDT
UTC	Coordinated Universal Time
UTRAN	Universal Terrestrial Radio Access Network
V2X	Vehicle-to-Everything
VoLTE	Voice over Long Term Evolution
WLAN	Wireless Local Area Network
WT	WLAN Termination
WUS	Wake-up Signal

In the ASN.1, lower case may be used for some (parts) of the above abbreviations e.g. c-RNTI.

---

## 4 General

### 4.1 Introduction

In this specification, (parts of) procedures and messages specified for the UE equally apply to the RN for functionality necessary for the RN. There are also (parts of) procedures and messages which are only applicable to the RN in its communication with the E-UTRAN, in which case the specification denotes the RN instead of the UE. Such RN-specific aspects are not applicable to the UE.

This specification covers MR-DC i.e. the case in which the UE is configured with resources belonging to another node using NR RAT. The NR related configuration is performed using NR RRC as specified in TS 38.331 [82].

NB-IoT is a non backward compatible variant of E-UTRAN supporting a reduced set of functionality. In this specification, (parts of) procedures and messages specified for the UE equally apply to the UE in NB-IoT. There are also some features and related procedures and messages that are not supported by UEs in NB-IoT.

In particular, the following features are not supported in NB-IoT and corresponding procedures and messages do not apply to the UE in NB-IoT:

- Connected mode mobility (Handover and measurement reporting);
- Inter-RAT cell reselection or inter-RAT mobility in connected mode;
- RRC\_INACTIVE;
- CSG;
- Relay Node (RN);
- Carrier Aggregation (CA);
- Dual connectivity (DC);
- Multi-Radio Dual Connectivity (MR-DC);
- PDCP duplication;
- GBR (QoS);
- ACB, EAB, SSAC and ACDC;
- MBMS, except for MBMS via SC-PTM in Idle mode;
- Measurement logging and reporting for network performance optimisation;
- Public warning systems e.g. CMAS, ETWS and PWS;
- Broadcast of positioning assistance data;
- Real time services (including emergency call);
- CS services and CS fallback;
- In-device coexistence;
- RAN assisted WLAN interworking;
- Network-assisted interference cancellation/suppression;
- Sidelink (including direct communication and direct discovery).

NOTE: In regard to mobility, NB-IoT is a separate RAT from E-UTRAN.

In this specification, there are also (parts of) procedures and messages which are only applicable to UEs in NB-IoT, in which case this is stated explicitly.

This specification is organised as follows:

- clause 4.2 describes the RRC protocol model;
- clause 4.3 specifies the services provided to upper layers as well as the services expected from lower layers;
- clause 4.4 lists the RRC functions;
- clause 5 specifies RRC procedures, including UE state transitions;
- clause 6 specifies the RRC message in a mixed format (i.e. tabular & ASN.1 together);
- clause 7 specifies the variables (including protocol timers and constants) and counters to be used by the UE;
- clause 8 specifies the encoding of the RRC messages;
- clause 9 specifies the specified and default radio configurations;
- clause 10 specifies the RRC messages transferred across network nodes;
- clause 11 specifies the UE capability related constraints and performance requirements.

## 4.2 Architecture

### 4.2.1 UE states and state transitions including inter RAT

A UE is in RRC\_CONNECTED when an RRC connection has been established or in RRC\_INACTIVE (if the UE is connected to 5GC) when RRC connection is suspended. If this is not the case, i.e. no RRC connection is established, the UE is in RRC\_IDLE state. The RRC states can further be characterised as follows:

- **RRC\_IDLE:**
  - A UE specific DRX may be configured by upper layers;
  - UE controlled mobility;
  - The UE:
    - Monitors a Paging channel to detect incoming calls (by CN paging), system information change, for ETWS capable UEs, ETWS notification, and for CMAS capable UEs, CMAS notification;
    - Performs neighbouring cell measurements and cell (re-)selection;
    - Acquires system information;
    - Performs logging of available measurements together with location and time for logged measurement configured UEs;
    - May perform EDT;
    - May perform transmission using PUR;
    - Performs idle/inactive measurements for idle/inactive measurement configured UEs.
- **RRC\_INACTIVE:**
  - A UE specific DRX may be configured by upper layers or by RRC layer;
  - A RAN-based notification area is configured by RRC layer;
  - The UE stores the UE Inactive AS context;
  - The UE:
    - Applies RRC\_IDLE procedures unless specified otherwise;

- Monitors a Paging channel for CN paging using 5G-S-TMSI and RAN paging using fullI-RNTI;
- Performs periodic RAN-based notification area update;
- Performs RAN-based notification area update when moving out of the configured RAN-based notification area.
- **RRC\_CONNECTED:**
  - Transfer of unicast data to/from UE;
  - At lower layers, the UE may be configured with a UE specific DRX;
  - For UEs supporting CA, use of one or more SCells, aggregated with the PCell, for increased bandwidth;
  - For UEs supporting DC, use of one SCG, aggregated with the MCG, for increased bandwidth;
  - For UEs supporting (NG)EN-DC, option to configure one NR SCG in conjunction with the MCG for DRBs and SRBs, for improved performance (SRBs) and increased bandwidth (DRBs);
  - For UEs supporting NE-DC, option to configure one SCG in conjunction with the NR MCG for DRBs and SRBs, for improved performance (SRBs) and increased bandwidth (DRBs);
  - Network controlled mobility, i.e. handover and cell change order with optional network assistance (NACC) to GERAN (not applicable for NB-IoT);
  - The UE:
    - Monitors a Paging channel and/ or System Information Block Type 1 contents to detect system information change, for ETWS capable UEs, ETWS notification, and for CMAS capable UEs, CMAS notification (not applicable for BL UEs, UEs in CE and NB-IoT UEs);
    - Monitors control channels associated with the shared data channel to determine if data is scheduled for it;
    - For UEs in CE supporting reception of ETWS/CMAS indication in RRC\_CONNECTED mode, monitors control channels associated with the shared data channel to acquire ETWS notification and/or CMAS notification;
    - Provides channel quality and feedback information (not applicable for NB-IoT);
    - Performs neighbouring cell measurements and measurement reporting (not applicable for NB-IoT);
    - Acquires system information (not applicable for BL UEs, UEs in CE and NB-IoT UEs), except for ETWS/CMAS reception where applicable.

NOTE: The term "UE is connected to 5GC" covers the scenarios that the UE is connected to 5GC and the UE is requesting to connect with 5GC.

Figure 4.2.1-1 not only provides an overview of the RRC states in E-UTRA/EPC, but also illustrates the mobility support between E-UTRA/EPC, UTRAN and GERAN.



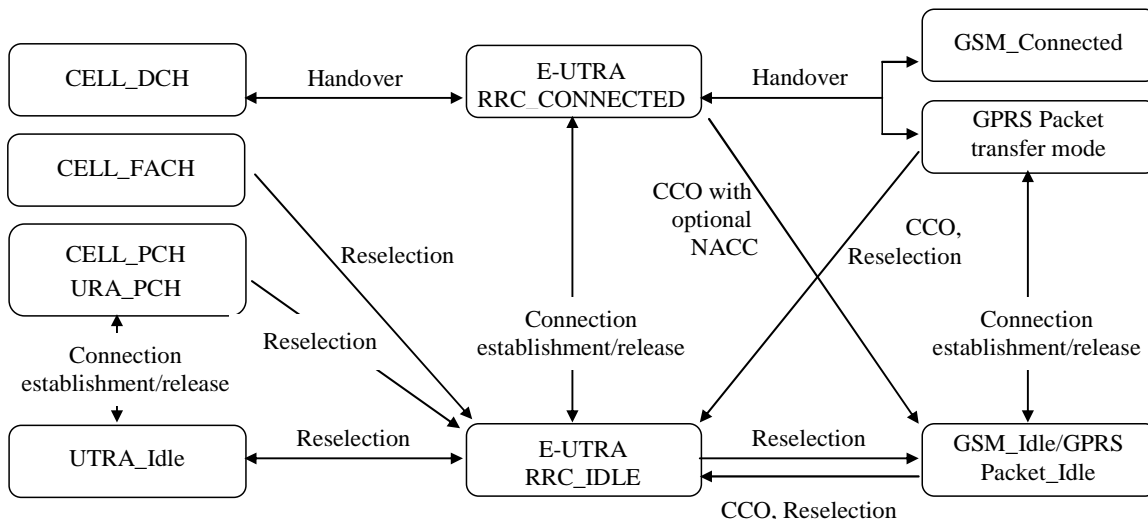

Figure 4.2.1-1: E-UTRA/EPC states and inter RAT mobility procedures, 3GPP

Figure 4.2.1-2 illustrates the mobility support between E-UTRA/EPC, CDMA2000 1xRTT and CDMA2000 HRPD. The details of the CDMA2000 state models are out of the scope of this specification.

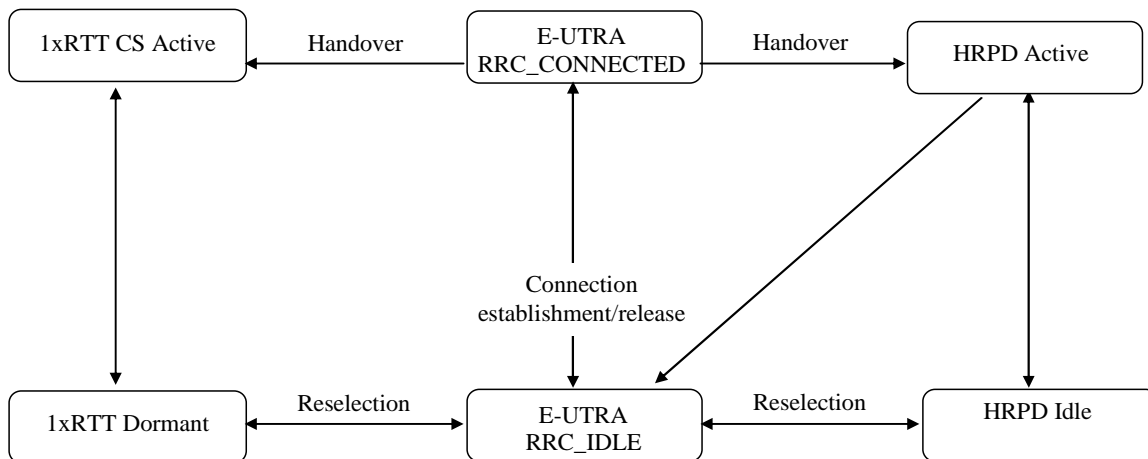

Figure 4.2.1-2: Mobility procedures between E-UTRA/EPC and CDMA2000

Figure 4.2.1-3 not only provides an overview of the RRC states in E-UTRA/5GC, but also illustrates the mobility support between E-UTRA/5GC, UTRAN and GERAN.

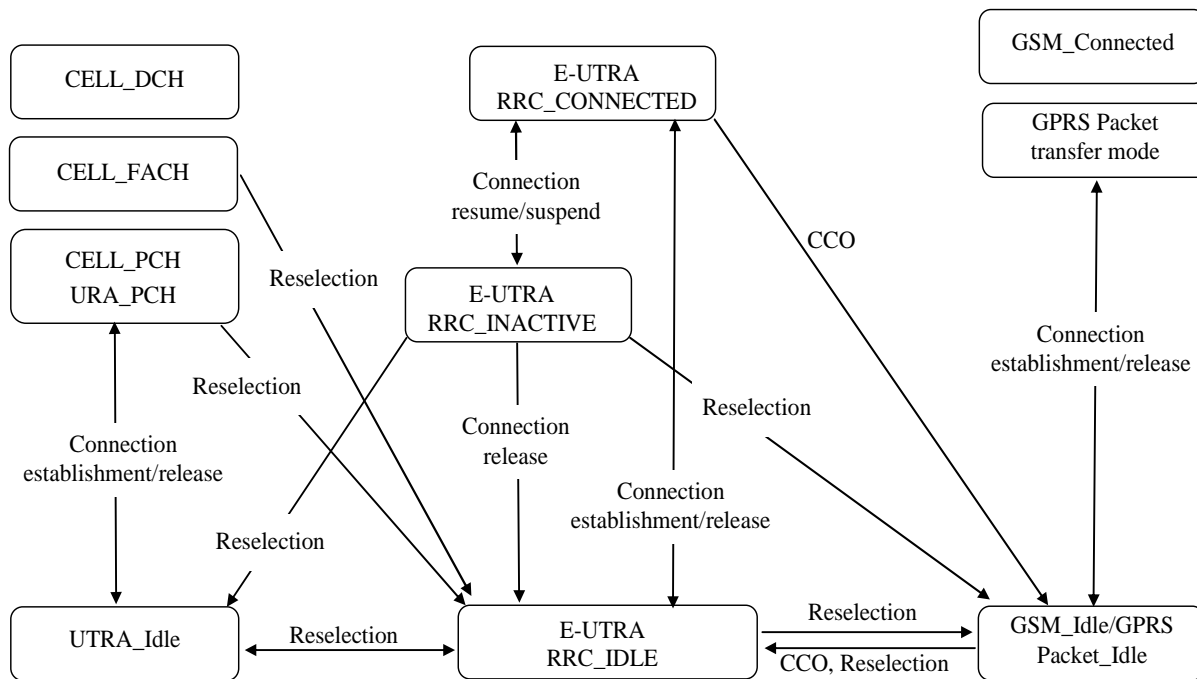

Figure 4.2.1-3: E-UTRA/5GC states and inter RAT mobility procedures, 3GPP

Figure 4.2.1-4 illustrates the mobility procedures supported between E-UTRA/5GC, CDMA2000 1xRTT and CDMA2000 HRPD. The details of the CDMA2000 state models are out of the scope of this specification.

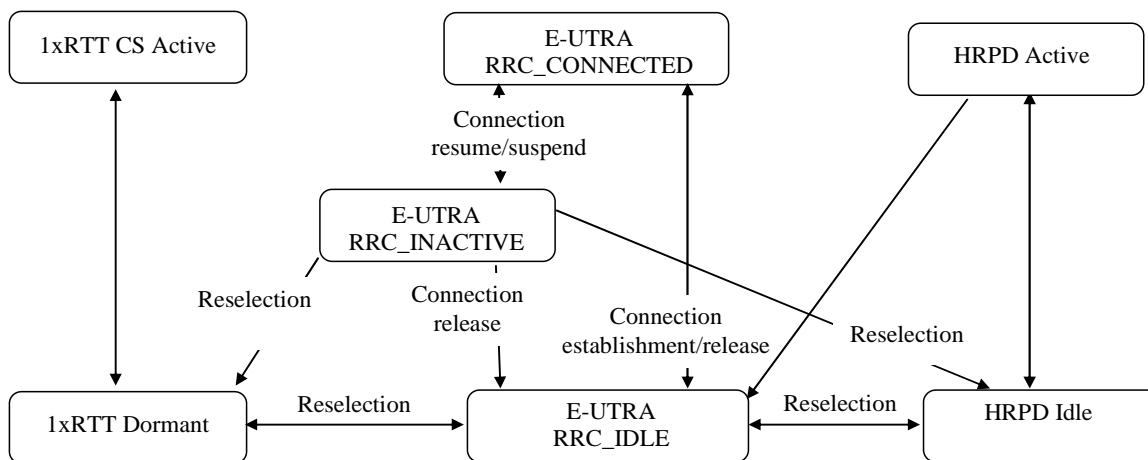
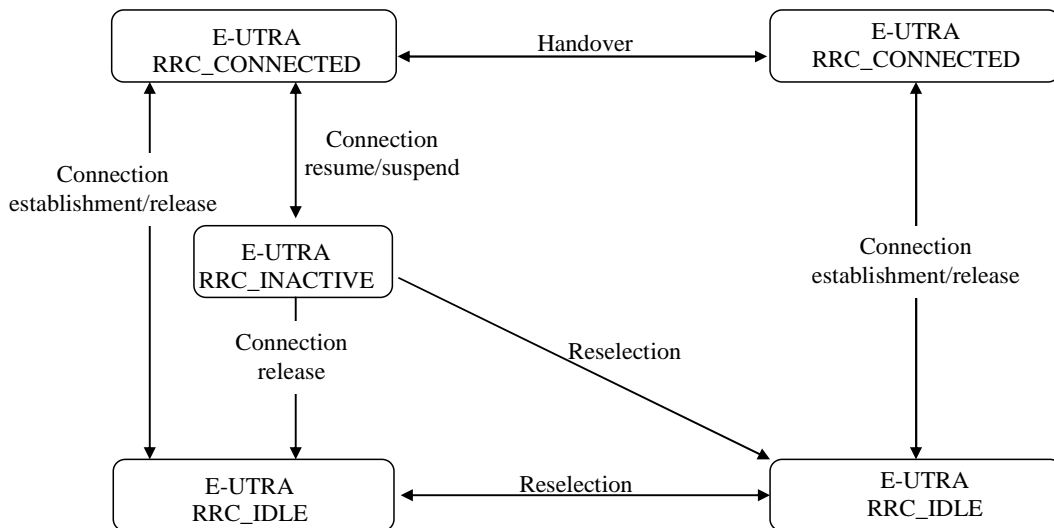

Figure 4.2.1-4: Mobility procedures between E-UTRA/5GC and CDMA2000

Figure 4.2.1-5 illustrates the mobility procedures supported between E-UTRA/5GC and E-UTRA/EPC.



**Figure 4.2.1-5: Mobility procedures between E-UTRA/5GC and E-UTRA/EPC**

Figure 4.2.1-6 illustrates the mobility procedures supported between E-UTRA/EPC, E-UTRA/5GC and NR.

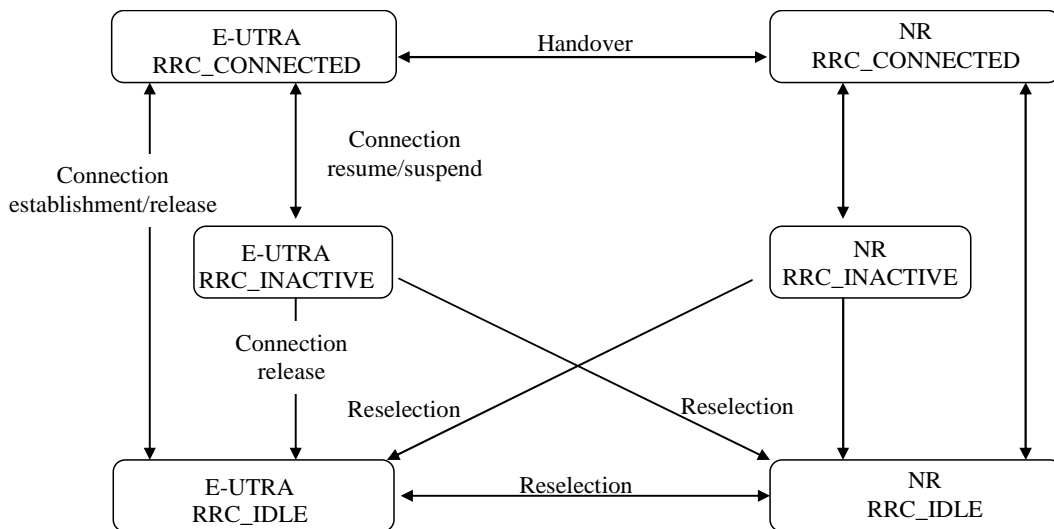

**Figure 4.2.1-6: Mobility procedures between E-UTRA/EPC, E-UTRA/5GC and NR**

The inter-RAT handover procedure(s) supports the case of signalling, conversational services, non-conversational services and combinations of these.

In addition to the state transitions shown in figures above, there is support for connection release with redirection information from E-UTRA RRC\_CONNECTED to GERAN, UTRAN, CDMA2000 (HRPD Idle/ 1xRTT Dormant mode) and NR. A UE in RRC\_INACTIVE enters RRC\_IDLE when it enters another RAT or switches to another CN type.

For NB-IoT, mobility between E-UTRA and UTRAN, GERAN and between E-UTRA and CDMA2000 1xRTT and CDMA2000 HRPD is not supported at AS level and hence only the E-UTRA states depicted in Figure 4.2.1-1 are applicable.

## 4.2.2 Signalling radio bearers

"Signalling Radio Bearers" (SRBs) are defined as Radio Bearers (RB) that are used only for the transmission of RRC and NAS messages. More specifically, the following SRBs are defined:

- SRB0 is for RRC messages using the CCCH logical channel;
- SRB1 is for RRC messages (which may include a piggybacked NAS message) as well as for NAS messages prior to the establishment of SRB2, all using DCCH logical channel;
- For NB-IoT, SRB1bis is for RRC messages (which may include a piggybacked NAS message) as well as for NAS messages prior to the activation of security, all using DCCH logical channel;
- SRB2 is for RRC messages which include logged measurement information as well as for NAS messages and messages which include IAB-DU specific F1-C related information, all using DCCH logical channel. SRB2 has a lower-priority than SRB1 and is always configured by E-UTRAN after security activation. SRB2 is not applicable for NB-IoT;
- SRB4 is for RRC messages which include application layer measurement reporting information, all using DCCH logical channel. SRB4 can only be configured by E-UTRAN after security activation. SRB4 is not applicable for NB-IoT.

In downlink piggybacking of NAS messages is used only for one dependant (i.e. with joint success/ failure) procedure: bearer establishment/ modification/ release. In uplink NAS message piggybacking is used only for transferring the initial NAS message during connection setup.

NOTE 1: The NAS messages transferred via SRB2 are also contained in RRC messages, which however do not include any RRC protocol control information.

Once security is activated, all RRC messages on SRB1, SRB2 and SRB4, including those containing NAS or non-3GPP messages, are integrity protected and ciphered by PDCP. NAS independently applies integrity protection and ciphering to the NAS messages.

For a UE configured with DC, all RRC messages, regardless of the SRB used and both in downlink and uplink, are transferred via the MCG. In case of EN-DC, after connection establishment NR PDCP may be configured for both SRB1 and SRB2 and if so, these SRBs may be configured as split SRB. In case of NGEN-DC and NE-DC, NR PDCP is always configured. For a split SRB, the UE receives RRC messages via both MCG and NR SCG i.e. handles out of order and duplicate PDUs as specified in TS 38.323 [83]. For a split SRB, the network configures via which cell group(s) the UE sends uplink RRC messages.

NOTE 2: In case of (NG)EN-DC, SRB3 may be configured for the transfer of some NR RRC messages between UE and SgNB via the NR radio interface, see TS 38.331 [82].

An SRB can be configured with PDCP duplication, either by two logical channels within the same CG (CA duplication) or by two logical channels each within a different CG (DC duplication).

## 4.3 Services

### 4.3.1 Services provided to upper layers

The RRC protocol offers the following services to upper layers:

- Broadcast of common control information;
- Broadcast of positioning assistance data;
- Notification of UEs in RRC\_IDLE and RRC\_INACTIVE, e.g. about a terminating call, for ETWS, for CMAS;
- Transfer of dedicated control information, i.e. information for one specific UE.

## 4.3.2 Services expected from lower layers

In brief, the following are the main services that RRC expects from lower layers:

- PDCP: integrity protection and ciphering;
- RLC: reliable and in-sequence transfer of information, without introducing duplicates and with support for segmentation and concatenation.

Further details about the services provided by Packet Data Convergence Protocol layer (e.g. integrity and ciphering) are provided in TS 36.323 [8]. The services provided by Radio Link Control layer (e.g. the RLC modes) are specified in TS 36.322 [7]. Further details about the services provided by Medium Access Control layer (e.g. the logical channels) are provided in TS 36.321 [6]. The services provided by physical layer (e.g. the transport channels) are specified in TS 36.302 [3].

## 4.4 Functions

The RRC protocol includes the following main functions:

- Broadcast of system information:
  - Including NAS common information;
  - Information applicable for UEs in RRC\_IDLE, e.g. cell (re-)selection parameters, neighbouring cell information and information (also) applicable for UEs in RRC\_CONNECTED, e.g. common channel configuration information;
  - Including ETWS notification, CMAS notification (not applicable for NB-IoT);
  - Including positioning assistance data.
- RRC connection control:
  - Paging;
  - Establishment/ modification/ suspension / resumption / release of RRC connection, including e.g. assignment/ modification of UE identity (C-RNTI), establishment/ modification/ suspension/ resumption/ release of SRB1, SRB1bis, SRB2 and SRB4, access class barring;
  - Initial security activation, i.e. initial configuration of AS integrity protection (SRBs) and AS ciphering (SRBs, DRBs);
  - For RNs, configuration of AS integrity protection for DRBs;
  - RRC connection mobility including e.g. intra-frequency and inter-frequency handover, associated security handling, i.e. key/ algorithm change, specification of RRC context information transferred between network nodes;

NOTE 1: In NB-IoT, only key change (but no re-keying) at RRC Connection Resumption and RRC context information transfer are applicable.

- Establishment/ modification/ release of RBs carrying user data (DRBs);
- Radio configuration control including e.g. assignment/ modification of ARQ configuration, HARQ configuration, DRX configuration;
- For RNs, RN-specific radio configuration control for the radio interface between RN and E-UTRAN;
- In case of CA, cell management including e.g. change of PCell, addition/ modification/ release of SCell(s) and addition/modification/release of STAG(s);
- In case of DC, cell management including e.g. change of PSCell, addition/ modification/ release of SCG cell(s) and addition/modification/release of SCG TAG(s);

- In case of (NG)EN-DC, transparent transfer of NR RRC messages (e.g. DL: reconfiguration messages used to add or modify the NR SCG configuration or to (re-)configure measurements; configure conditional PSCell change; UL: measurement reports and reconfiguration complete messages) and of configurations of radio bearers using NR PDCP;
- QoS control including assignment/ modification of semi-persistent scheduling (SPS) configuration information for DL and UL, assignment/ modification of parameters for UL rate control in the UE, i.e. allocation of a priority and a prioritised bit rate (PBR) for each RB (not applicable for NB-IoT);
- Recovery from radio link failure;
- In case of LWA, RCLWI and LWIP, WLAN mobility set management including e.g. addition/ modification/ release of WLAN(s) from the WLAN mobility set;
- Inter-RAT mobility including e.g. security activation, transfer of RRC context information (not applicable for NB-IoT);
- Measurement configuration and reporting (not applicable for NB-IoT):
  - Establishment/ modification/ release of measurements (e.g. intra-frequency, inter-frequency and inter- RAT measurements);
  - Setup and release of measurement gaps;
  - Measurement reporting;
- Other functions including e.g. transfer of dedicated NAS information and non-3GPP dedicated information, transfer of UE radio access capability information, support for E-UTRAN sharing (multiple PLMN identities);
- Generic protocol error handling;
- Support of self-configuration and self-optimisation (not applicable for NB-IoT);
- Support of measurement logging and reporting for network performance optimisation, as specified in TS 37.320 [60] (not applicable for NB-IoT).

NOTE 2: Random access is specified entirely in the MAC including initial transmission power estimation.

## 4.5 Data available for transmission for NB-IoT

For the purpose of MAC Data Volume and Power Headroom reporting, the NB-IoT UE shall consider the following as data available for transmission in the RRC layer:

- For SDUs to be submitted to lower layers:
  - the SDU itself, if the SDU has not yet been processed by RRC; or
  - the PDU if the SDU has been processed by RRC;
- The data available for transmission in upper layers not submitted to the RRC layer.

---

# 5 Procedures

## 5.1 General

### 5.1.1 Introduction

The procedural requirements are structured according to the main functional areas: system information (5.2), connection control (5.3), inter-RAT mobility (5.4) and measurements (5.5). In addition, clause 5.6 covers other aspects e.g. NAS dedicated information transfer, UE capability transfer, clause 5.7 specifies the generic error handling, clause 5.8 covers

MBMS (i.e. MBMS service reception via MRB), clause 5.8a covers SC-PTM (i.e. MBMS service reception via SC-MRB), clause 5.9 covers RN-specific procedures and clause 5.10 covers sidelink.

For NB-IoT, only a subset of the above procedural requirements applies: system information (5.2), connection control (5.3), measurements (5.5), other (5.6), general error handling (5.7), and SC-PTM (5.8a). Clauses inter-RAT mobility (5.4), MBMS (5.8), RN procedures (5.9) and Sidelink (5.10) are not applicable in NB-IoT.

## 5.1.2 General requirements

The UE shall:

- 1> process the received messages in order of reception by RRC, i.e. the processing of a message shall be completed before starting the processing of a subsequent message;

NOTE 1: E-UTRAN may initiate a subsequent procedure prior to receiving the UE's response of a previously initiated procedure.

- 1> within a clause execute the steps according to the order specified in the procedural description;
- 1> consider the term 'radio bearer' (RB) to cover SRBs and DRBs but not MRBs or SC-MRBs unless explicitly stated otherwise;
- 1> set the *rrc-TransactionIdentifier* in the response message, if included, to the same value as included in the received RRC message that triggered the response message;
- 1> upon receiving a choice value set to *setup*:
  - 2> apply the corresponding received configuration and start using the associated resources, unless explicitly specified otherwise;

- 1> upon receiving a choice value set to *release*:

- 2> clear the corresponding configuration and stop using the associated resources;

NOTE 1a: Following receipt of choice value set to release, the UE considers the field as if it was never configured.

- 1> upon handover to E-UTRA; or

- 1> upon receiving an *RRCConnectionReconfiguration* message including the *fullConfig*:

- 2> apply the Conditions in the ASN.1 for inclusion of the fields for the DRB/PDCP/RLC setup during the reconfiguration of the DRBs included in the *drb-ToAddModList*;

NOTE 2: At each point in time, the UE keeps a single value for each field except for during handover when the UE temporarily stores the previous configuration so it can revert back upon handover failure. In other words: when the UE reconfigures a field, the existing value is released except for during handover.

NOTE 3: Although not explicitly stated, the UE initially considers all functionality to be deactivated/ released until it is explicitly stated that the functionality is setup/ activated. Correspondingly, the UE initially considers lists to be empty e.g. the list of radio bearers, the list of measurements.

- 1> upon receiving an extension field comprising the entries in addition to the ones carried by the original field (regardless of whether E-UTRAN may signal more entries in total); apply the following generic behaviour if explicitly stated to be applicable:
  - 2> create a combined list by concatenating the additional entries included in the extension field to the original field while maintaining the order among both the original and the additional entries;
  - 2> for the combined list, created according to the previous, apply the same behaviour as defined for the original field;

NOTE 4: A field comprising a list of entries normally includes 'list' in the field name. The typical way to extend (the size of) such a list is to introduce a field comprising the additional entries, which should include 'listExt' in the name of the field/ IE. E.g. *field1List-RAT*, *field1ListExt-RAT*.

1> consider the term DC to cover the case of an E-UTRA MCG and SCG; Likewise, MCG covers the case of an E-UTRA MCG, SCG covers the case of an E-UTRA SCG, serving cell covers the case of an E-UTRA serving cell, PDCP covers the case of PDCP defined by E-UTRA specifications;

NOTE 5: In this specification, UE configuration refers to the parameters configured by E-UTRA RRC unless stated otherwise. Likewise, when a procedure is mentioned, this concerns the procedure defined by E-UTRA RRC unless stated otherwise.

### 5.1.3 Requirements for UE in MR-DC

In this specification, the UE considers itself to be configured with;

- EN-DC if and only if it is configured with *nr-SecondaryCellGroupConfig* and it is connected to EPC,
- NGEN-DC if and only if it is configured with *nr-SecondaryCellGroupConfig* and it is connected to 5GC,
- NE-DC if and only if it is configured with *mrdc-SecondaryCellGroup* set to *eutra-SCG* according to TS 38.331[82],
- MR-DC if and only if it is configured with (NG)EN-DC or NE-DC.

NOTE 1: The above deviates from the definition in TS 37.340 [81] (and some other specifications) i.e. according to TS 37.340 [81] a UE that is not configured with an SCG is in MR-DC when one or more bearers are terminated in the secondary node (i.e. using NR PDCP).

NOTE 2: MR-DC includes NR-DC, but that option is not relevant for this specification.

The UE configured with NE-DC only executes a subclause of clause 5 from this specification when the concerned subclause:

- is referenced from a subclause, either in this specification or in TS 38.331 [82], that is executed by the UE; or
- covers actions upon (re-)configuration of field(s), IE(s), UE variable(s) or timer(s) applicable for NE-DC;

When executing a subclause of clause 5 in this specification, the UE also follows the related general requirements as defined in clause 5.1.2 and other subclauses of this specification e.g. message processing delay requirements.

## 5.2 System information

### 5.2.1 Introduction

#### 5.2.1.1 General

System information is divided into the *MasterInformationBlock* (MIB) and a number of *SystemInformationBlocks* (SIBs) and *SystemInformationBlockPos* (posSIBs). The MIB includes a limited number of most essential and most frequently transmitted parameters that are needed to acquire other information from the cell, and is transmitted on BCH. SIBs other than *SystemInformationBlockType1* and posSIBs are carried in *SystemInformation* (SI) messages. The mapping of SIBs and posSIBs to SI messages is flexibly configurable by *schedulingInfoList* and *posSchedulingInfoList*, respectively, included in *SystemInformationBlockType1*, with restrictions that: each SIB is contained only in a single SI message and each SIB and posSIB is contained at most once in that SI message; only SIBs and posSIBs having the same scheduling requirement (periodicity) can be mapped to the same SI message; *SystemInformationBlockType2* is always mapped to the SI message that corresponds to the first entry in the list of SI messages in *schedulingInfoList*. There may be multiple SI messages transmitted with the same periodicity. *SystemInformationBlockType1* and all SI messages are transmitted on DL-SCH.

The Bandwidth reduced Low Complexity (BL) UEs and UEs in Coverage Enhancement (CE) apply Bandwidth Reduced (BR) version of the SIB, posSIB or SI messages. A UE considers itself in enhanced coverage as specified in TS 36.304 [4]. In this and subsequent clauses, anything applicable for a particular SIB, posSIB or SI message equally applies to the corresponding BR version unless explicitly stated otherwise.

For NB-IoT, a reduced set of system information block with similar functionality but different content is defined; the UE applies the NB-IoT (NB) version of the MIB and the SIBs. These are denoted *MasterInformationBlock-NB*,



*MasterInformationBlock-TDD-NB* and *SystemInformationBlockTypeX-NB* in this specification. All other system information blocks (without NB suffix) are not applicable to NB-IoT; this is not further stated in the corresponding text.

NOTE 1: The physical layer imposes a limit to the maximum size a SIB can take. When DCI format 1C is used the maximum allowed by the physical layer is 1736 bits (217 bytes) while for format 1A the limit is 2216 bits (277 bytes), see TS 36.212 [22] and TS 36.213 [23]. For BL UEs and UEs in CE, the maximum SIB and SI message size is 936 bits, see TS 36.213 [23]. For NB-IoT, the maximum SIB and SI message size is 680 bits, see TS 36.213 [23].

In addition to broadcasting, E-UTRAN may provide *SystemInformationBlockType1*, *SystemInformationBlockType2* and/or *SystemInformationBlockType31*, including the same parameter values, via dedicated signalling i.e., within an *RRCConnectionReconfiguration* message.

The UE applies the system information acquisition and change monitoring procedures for the PCell, except when being a BL UE or a UE in CE or a NB-IoT UE in RRC\_CONNECTED mode while T311 is not running. For an SCell, E-UTRAN provides, via dedicated signalling, all system information relevant for operation in RRC\_CONNECTED when adding the SCell. However, a UE that is configured with DC shall acquire the *MasterInformationBlock* of the PCell but use it only to determine the SFN timing of the SCG, which may be different from the MCG. Upon change of the relevant system information of a configured SCell, E-UTRAN releases and subsequently adds the concerned SCell, which may be done with a single *RRCConnectionReconfiguration* message. If the UE is receiving or interested to receive an MBMS service in a cell, the UE shall apply the system information acquisition and change monitoring procedure to acquire parameters relevant for MBMS operation and apply the parameters acquired from system information only for MBMS operation for this cell.

NOTE 2: E-UTRAN may configure via dedicated signalling different parameter values than the ones broadcast in the concerned SCell.

In MBMS-dedicated cell, non-MBSFN subframes are used for providing *MasterInformationBlock-MBMS* (MIB-MBMS) and *SystemInformationBlockType1-MBMS*. SIBs other than *SystemInformationBlockType1-MBMS* are carried in *SystemInformation-MBMS* message which is also provided on non-MBSFN subframes.

An RN configured with an RN subframe configuration does not need to apply the system information acquisition and change monitoring procedures. Upon change of any system information relevant to an RN, E-UTRAN provides the system information blocks containing the relevant system information to an RN configured with an RN subframe configuration via dedicated signalling using the *RNReconfiguration* message. For RNs configured with an RN subframe configuration, the system information contained in this dedicated signalling replaces any corresponding stored system information and takes precedence over any corresponding system information acquired through the system information acquisition procedure. The dedicated system information remains valid until overridden.

NOTE 3: E-UTRAN may configure an RN, via dedicated signalling, with different parameter values than the ones broadcast in the concerned cell.

### 5.2.1.2 Scheduling

The MIB uses a fixed schedule with a periodicity of 40 ms and repetitions made within 40 ms. The first transmission of the MIB is scheduled in subframe #0 of radio frames for which the SFN mod 4 = 0, and repetitions are scheduled in subframe #0 of all other radio frames. For TDD/FDD system with a bandwidth larger than 1.4 MHz that supports BL UEs or UEs in CE, MIB transmission may additionally be repeated in subframe#0 of the same radio frame, and in subframe#9 of the previous radio frame for FDD and subframe #5 of the same radio frame for TDD.

NOTE: The UE may assume the scheduling of MIB repetitions does not change. E-UTRAN may indicate in *MobilityControlInfo* whether optional MIB repetitions are enabled or not.

The MIB-MBMS uses a fixed schedule with a periodicity of 160 ms and repetitions made within 160 ms. The first transmission of the MIB-MBMS is scheduled in subframe #0 of radio frames for which the SFN mod 16 = 0, and repetitions are scheduled in subframe #0 of all other radio frames for which the SFN mod 4 = 0.

The *SystemInformationBlockType1* uses a fixed schedule with a periodicity of 80 ms and repetitions made within 80 ms. The first transmission of *SystemInformationBlockType1* is scheduled in subframe #5 of radio frames for which the SFN mod 8 = 0, and repetitions are scheduled in subframe #5 of all other radio frames for which SFN mod 2 = 0.

For BL UEs or UEs in CE, MIB is applied which may be provided with additional repetitions, while for SIB1 and further SI messages, separate messages are used which are scheduled independently and with content that may differ. The separate instance of SIB1 is named as *SystemInformationBlockType1-BR*. The *SystemInformationBlockType1-BR*

uses a schedule with a periodicity of 80ms. TBS for *SystemInformationBlockType1-BR* and the repetitions made within 80ms are indicated via *schedulingInfoSIB1-BR* in MIB or optionally in the *RRCConnectionReconfiguration* message including the *MobilityControlInfo*.

The *SystemInformationBlockType1-MBMS* uses fixed schedule with a periodicity of 160 ms. The first transmission of *SystemInformationBlockType1-MBMS* is scheduled in subframe #0 of radio frames for which the SFN mod 16 = 0, and repetitions are scheduled in subframe #0 of all other radio frames for which SFN mod 8 = 0. Additionally, the *SystemInformationBlockType1-MBMS* and other system informations blocks may be scheduled in additional non-MBSFN subframes indicated in *MasterInformationBlock-MBMS*.

The SI messages are transmitted within periodically occurring time domain windows (referred to as SI-windows) using dynamic scheduling. Each SI message is associated with a SI-window and the SI-windows of different SI messages do not overlap. That is, within one SI-window only the corresponding SI is transmitted. The length of the SI-window is common for all SI messages, and is configurable. Within the SI-window, the corresponding SI message can be transmitted a number of times in any subframe other than MBSFN subframes, uplink subframes in TDD, and subframe #5 of radio frames for which SFN mod 2 = 0. The UE acquires the detailed time-domain scheduling (and other information, e.g. frequency-domain scheduling, used transport format) from decoding SI-RNTI on PDCCH (see TS 36.321 [6]). For a BL UE or a UE in CE, the detailed time/frequency domain scheduling information for the SI messages is provided in *SystemInformationBlockType1-BR*.

For UEs other than BL UE or UEs in CE SI-RNTI is used to address *SystemInformationBlockType1* as well as all SI messages. On MBMS-dedicated cell and on FeMBMS/Unicast-mixed cell, SI-RNTI with value in accordance with TS 36.321 [6] is used to address all SI messages whereas SI-RNTI with value in accordance with TS 36.321 [6] is used to address *SystemInformationBlockType1-MBMS*.

*SystemInformationBlockType1* configures the SI-window length and the transmission periodicity for the SI messages.

### 5.2.1.2a Scheduling for NB-IoT

The *MasterInformationBlock-NB* (MIB-NB) uses a fixed schedule with a periodicity of 640 ms and repetitions made within 640 ms. The first transmission of the MIB-NB is scheduled in subframe #0 of radio frames for which the SFN mod 64 = 0 and repetitions are scheduled in subframe #0 of all other radio frames. The transmissions are arranged in 8 independently decodable blocks of 80 ms duration.

The *MasterInformationBlock-TDD-NB* (MIB-TDD-NB) uses a fixed schedule with a periodicity of 640 ms and repetitions made within 640 ms. The first transmission of the MIB-TDD-NB is scheduled in subframe #9 of radio frames for which the SFN mod 64 = 0 and repetitions are scheduled in subframe #9 of all other radio frames. The transmissions are arranged in 8 independently decodable blocks of 80 ms duration.

The *SystemInformationBlockType1-NB* (SIB1-NB) uses a fixed schedule with a periodicity of 2560 ms.

For FDD, SIB1-NB transmission occurs in subframe #4 of every other frame in 16 continuous frames. The starting frame for the first transmission of the SIB1-NB is derived from the cell PCID and the number of repetitions within the 2560 ms period and repetitions are made, equally spaced, within the 2560 ms period (see TS 36.213 [23]). TBS for *SystemInformationBlockType1-NB* and the repetitions made within the 2560 ms are indicated by *schedulingInfoSIB1* field in the MIB-NB. If *additionalTransmissionSIB1* is set to TRUE in the MIB-NB, additional SIB1-NB transmission occurs in subframe #3 of the same radio frames where SIB1-NB transmission occurs with the same number of repetitions.

For TDD, SIB1-NB transmission on the anchor carrier occurs in either subframe #0 or subframe #4 of every other frame in 16 continuous frames and SIB1-NB transmission on a non-anchor carrier occurs in subframe #0 and next in subframe #5 of every other frame in 16 continuous frames. The starting frame for the first transmission of the SIB1-NB is derived from the cell PCID and the number of repetitions within the 2560 ms period and repetitions are made, equally spaced, within the 2560 ms period (see TS 36.213 [23]). TBS for *SystemInformationBlockType1-NB*, the repetitions made within the 2560 ms, and the subframe index (#0 or #4) are indicated by *schedulingInfoSIB1* field in the MIB-TDD-NB.

The SI messages are transmitted within periodically occurring time domain windows (referred to as SI-windows) using scheduling information provided in *SystemInformationBlockType1-NB*. Each SI message is associated with a SI-window and the SI-windows of different SI messages do not overlap. That is, within one SI-window only the corresponding SI is transmitted. The length of the SI-window is common for all SI messages, and is configurable.

Within the SI-window, the corresponding SI message can be transmitted a number of times over 2 or 8 consecutive NB-IoT downlink subframes depending on TBS. The UE acquires the detailed time/frequency domain scheduling

information and other information, e.g. used transport format for the SI messages from *schedulingInfoList* field in *SystemInformationBlockType1-NB*. The UE is not required to accumulate several SI messages in parallel but may need to accumulate a SI message across multiple SI windows, depending on coverage condition.

*SystemInformationBlockType1-NB* configures the SI-window length and the transmission periodicity for all SI messages.

### 5.2.1.3 System information validity and notification of changes

Change of system information (other than for ETWS, CMAS, EAB, UAC, and satellite assistance information parameters except for discontinuous coverage scenarios and for NB-IoT, other than for AB parameters and satellite assistance information parameters except for discontinuous coverage scenarios) only occurs at specific radio frames, i.e. the concept of a modification period is used. System information may be transmitted a number of times with the same content within a modification period, as defined by its scheduling. The modification period boundaries are defined by SFN values for which  $\text{SFN} \bmod m = 0$ , where  $m$  is the number of radio frames comprising the modification period. The modification period is configured by system information. If H-SFN is provided in *SystemInformationBlockType1-BR*, modification period boundaries for BL UEs and UEs in CE are defined by SFN values for which  $(\text{H-SFN} * 1024 + \text{SFN}) \bmod m = 0$ . For NB-IoT, H-SFN is always provided and the modification period boundaries are defined by SFN values for which  $(\text{H-SFN} * 1024 + \text{SFN}) \bmod m = 0$ .

To enable system information update notification for RRC\_IDLE UEs configured to use a DRX cycle longer than the modification period, an eDRX acquisition period is defined. The boundaries of the eDRX acquisition period are determined by H-SFN values for which  $\text{H-SFN} \bmod 256 = 0$ . For NB-IoT, the boundaries of the eDRX acquisition period are determined by H-SFN values for which  $\text{H-SFN} \bmod 1024 = 0$ .

NOTE 1: If the UE in RRC\_IDLE is configured to use extended DRX cycle, e.g., in the order of several minutes or longer, in case the eNB is reset the UE SFN may not be synchronized to the new eNB SFN. The UE is expected to recover, e.g., acquire MIB within a reasonable time, to avoid repeated paging failures.

NOTE 1a: For the UE in RRC\_INACTIVE, the idle mode extended DRX cycle, if configured, is used to compare with the modification period.

When the network changes (some of the) system information, it first notifies the UEs about this change, i.e. this may be done throughout a modification period. In the next modification period, the network transmits the updated system information. During a modification period where ETWS or CMAS transmission is started or stopped, the SI messages carrying the SIBs scheduled in *schedulingInfoListExt* and/or SI messages carrying the posSIBs scheduled in *posSchedulingInfoList* may change, so the UE might not be able to successfully receive those SIBs and/or posSIBs in the remainder of the current modification period and next modification period according to the scheduling information received prior to the change. These general principles are illustrated in figure 5.2.1.3-1, in which different colours indicate different system information. Upon receiving a change notification, the UE not configured to use a DRX cycle that is longer than the modification period acquires the new system information immediately from the start of the next modification period. Upon receiving a change notification applicable to eDRX, a UE in RRC\_IDLE configured to use a DRX cycle that is longer than the modification period acquires the updated system information immediately from the start of the next eDRX acquisition period. The UE applies the previously acquired system information until the UE acquires the new system information. The possible boundaries of modification for *SystemInformationBlockType1-BR* are defined by SFN values for which  $\text{SFN} \bmod 512 = 0$  except for notification of ETWS/CMAS for which the eNB may change *SystemInformationBlockType1-BR* content at any time. For NB-IoT, the possible boundaries of modification for *SystemInformationBlockType1-NB* are defined by SFN values for which  $(\text{H-SFN} * 1024 + \text{SFN}) \bmod 4096 = 0$ .

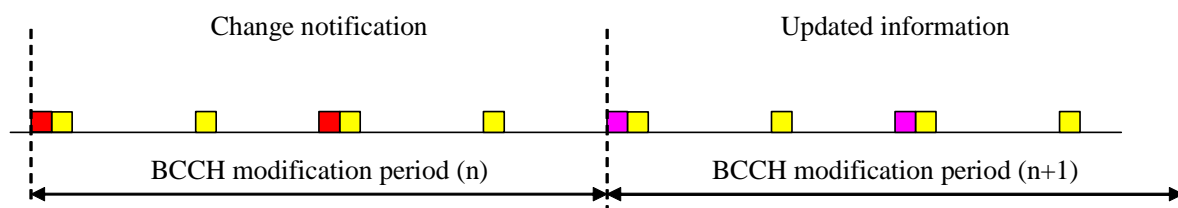

Figure 5.2.1.3-1: Change of system Information

The *Paging* message is used to inform UEs in RRC\_IDLE and UEs in RRC\_CONNECTED about a system information change. If the UE is in RRC\_CONNECTED or is not configured to use a DRX cycle longer than the modification

period in RRC\_IDLE, and receives a *Paging* message including the *systemInfoModification*, it knows that the system information will change at the next modification period boundary. A UE in RRC\_IDLE that is configured to use a DRX cycle longer than the modification period, and receives in an eDRX acquisition period at least one *Paging* message including the *systemInfoModification-eDRX*, shall acquire the updated system information at the next eDRX acquisition period boundary. Although the UE may be informed about changes in system information, no further details are provided e.g. regarding which system information will change, except if *systemInfoValueTagSI* is received by BL UEs or UEs in CE.

In RRC\_CONNECTED, BL UEs or UEs in CE or NB-IoT UEs are not required to acquire system information except when T311 is running, or upon handover where the UE is only required to acquire the *MasterInformationBlock* in the target PCell, or for UEs in CE to receive ETWS/CMAS information, or upon expiry of T317 where the UE is only required to acquire the *SystemInformationBlockType31* (*SystemInformationBlockType31-NB* in NB-IoT). In RRC\_IDLE, E-UTRAN may notify BL UEs or UEs in CE or NB-IoT UEs about SI update, and except for NB-IoT, ETWS and CMAS notification, EAB modification and UAC modification, using Direct Indication information, as specified in 6.6 (or 6.7.5 in NB-IoT) and TS 36.212 [22].

NOTE 2: Upon system information change essential for BL UEs, UEs in CE, or NB-IoT UEs in RRC\_CONNECTED, E-UTRAN may initiate connection release.

NOTE 3: When acquiring SIB31(-NB) in RRC\_CONNECTED, UE may assume that the scheduling is unchanged.

*SystemInformationBlockType1* (or *MasterInformationBlock-NB/ MasterInformationBlock-TDD-NB* in NB-IoT) includes a value tag *systemInfoValueTag*, that indicates if a change has occurred in the SI messages. UEs may use *systemInfoValueTag*, e.g. upon return from out of coverage, to verify if the previously stored SI messages are still valid. *MasterInformationBlock* and RSS (if transmitted, see TS 36.211 [21]) may indicate using *systemInfoUnchanged-BR* that a change has not occurred in the SIB1-BR and SI messages of the current cell at least over the SI validity time, and the BL UEs or UEs in CE may use the *systemInfoUnchanged-BR*, e.g. upon return from out of coverage, to verify if the previously stored SIB1-BR and SI messages are still valid. Additionally, for other than BL UEs or UEs in CE or NB-IoT UEs, the UE considers stored system information to be invalid after 3 hours from the moment it was successfully confirmed as valid, unless specified otherwise. BL UE or UE in CE considers stored system information to be invalid after 24 hours from the moment it was successfully confirmed as valid, unless the UE is configured by parameter *si-ValidityTime* to consider stored system information to be invalid 3 hours after validity confirmation. NB-IoT UE considers stored system information to be invalid after 24 hours from the moment it was successfully confirmed as valid. If a BL UE, UE in CE or NB-IoT UE in RRC\_CONNECTED state considers the stored system information invalid, the UE shall continue using the stored system information while in RRC\_CONNECTED state in the serving cell.

For BL UEs or UEs in CE or NB-IoT UEs, the change of specific SI message can additionally be indicated by a SI message specific value tag *systemInfoValueTagSI*. If *systemInfoValueTag* included in the *SystemInformationBlockType1-BR* (or *MasterInformationBlock-NB/ MasterInformationBlock-TDD-NB* in NB-IoT) is different from the one of the stored system information and if *systemInfoValueTagSI* is included in the *SystemInformationBlockType1-BR* (or *SystemInformationBlockType1-NB* in NB-IoT) for a specific SI message and is different from the stored one, the UE shall consider this specific SI message to be invalid. If only *systemInfoValueTag* is included and is different from the stored one, the BL UE or UE in CE should consider any stored system information except *SystemInformationBlockType10*, *SystemInformationBlockType11*, *SystemInformationBlockType12*, *SystemInformationBlockType14*, *SystemInformationBlockType25*, *SystemInformationBlockType31* and *SystemInformationBlockType33* to be invalid; the NB-IoT UE should consider any stored system information except *SystemInformationBlockType14-NB*, *SystemInformationBlockType31-NB* and *SystemInformationBlockType33-NB* to be invalid.

On MBMS-dedicated cell and on FeMBMS/Unicast-mixed cell, the change of system information and ETWS/CMAS notification is indicated by using Direct Indication FeMBMS defined in 6.6a. The modification periodicity follows MCCH modification periodicity as defined in 5.8.1.3.

E-UTRAN may not update *systemInfoValueTag* upon change of some system information e.g. ETWS information, CMAS information, RLOS indication (i.e., *rlos-Enabled*), regularly changing parameters like time information (*SystemInformationBlockType8*, *SystemInformationBlockType16*, *hyperSFN-MSB* in *SystemInformationBlockType1-NB*), EAB and AB parameters, UAC parameters, positioning system information blocks, or satellite assistance information. Similarly, E-UTRAN may not include the *systemInfoModification* within the *Paging* message upon change of some system information.

NOTE 4: UE connected to NTN is expected to re-acquire SIB32(-NB) based on its own decision regardless of *systemInfoValueTag* change.

The UE that is not configured to use a DRX cycle longer than the modification period verifies that stored system information remains valid by either checking *systemInfoValueTag* in *SystemInformationBlockType1* (or *MasterInformationBlock-NB/ MasterInformationBlock-TDD-NB* in NB-IoT) after the modification period boundary, or attempting to find the *systemInfoModification* indication at least *modificationPeriodCoeff* times during the modification period in case no paging is received, in every modification period. If no paging message is received by the UE during a modification period, the UE may assume that no change of system information will occur at the next modification period boundary. If UE in RRC\_CONNECTED, during a modification period, receives one paging message, it may deduce from the presence/ absence of *systemInfoModification* whether a change of system information other than ETWS information, CMAS information, EAB and UAC parameters will occur in the next modification period or not.

When the RRC\_IDLE UE is configured with a DRX cycle that is longer than the modification period, and at least one modification period boundary has passed since the UE last verified validity of stored system information, the UE verifies that stored system information remains valid by checking the *systemInfoValueTag* before establishing or resuming an RRC connection.

ETWS and/or CMAS capable UEs in RRC\_CONNECTED, other than BL UEs and UEs in CE, shall attempt to read paging at least once every *defaultPagingCycle* to check whether ETWS and/or CMAS notification is present or not.

#### 5.2.1.4 Indication of ETWS notification

ETWS primary notification and/ or ETWS secondary notification can occur at any point in time. The *Paging* message is used to inform ETWS capable UEs in RRC\_IDLE and UEs not in CE in RRC\_CONNECTED about presence of an ETWS primary notification and/ or ETWS secondary notification. For UEs in CE supporting reception of ETWS indication in RRC\_CONNECTED mode, control channels associated with the shared data channel are used to inform the UE about the presence of an ETWS primary notification and/or ETWS secondary notification. If the UE receives a *Paging* message or control channels associated with the shared data channel including the *etws-Indication*, it shall start receiving the ETWS primary notification and/ or ETWS secondary notification according to *schedulingInfoList* contained in *SystemInformationBlockType1*. If the UE receives *Paging* message or control channels associated with the shared data channel including the *etws-Indication* while it is acquiring ETWS notification(s), the UE shall continue acquiring ETWS notification(s) based on the previously acquired *schedulingInfoList* until it re-acquires *schedulingInfoList* in *SystemInformationBlockType1*.

NOTE: The UE is not required to periodically check *schedulingInfoList* contained in *SystemInformationBlockType1*, but *Paging* message including the *etws-Indication* triggers the UE to re-acquire *schedulingInfoList* contained in *SystemInformationBlockType1* for scheduling changes for *SystemInformationBlockType10* and *SystemInformationBlockType11*. The UE may or may not receive a *Paging* message including the *etws-Indication* and/or *systemInfoModification* when ETWS is no longer scheduled.

ETWS primary notification is contained in *SystemInformationBlockType10* and ETWS secondary notification is contained in *SystemInformationBlockType11*. Segmentation can be applied for the delivery of a secondary notification. The segmentation is fixed for transmission of a given secondary notification within a cell (i.e. the same segment size for a given segment with the same *messageIdentifier*, *serialNumber* and *warningMessageSegmentNumber*). An ETWS secondary notification corresponds to a single *CB data* IE as defined according to TS 23.041 [37].

#### 5.2.1.5 Indication of CMAS notification

CMAS notification can occur at any point in time. The *Paging* message is used to inform CMAS capable UEs in RRC\_IDLE and UEs not in CE in RRC\_CONNECTED about presence of one or more CMAS notifications. For UEs in CE supporting reception of CMAS indication in RRC\_CONNECTED mode, control channels associated with the shared data channel are used to inform the UE about the presence of one or more CMAS notifications. If the UE receives a *Paging* message including the *cmas-Indication*, it shall start receiving the CMAS notifications according to *schedulingInfoList* contained in *SystemInformationBlockType1*. If the UE receives *Paging* message or control channels associated with the shared data channel including the *cmas-Indication* while it is acquiring CMAS notification(s), the UE shall continue acquiring CMAS notification(s) based on the previously acquired *schedulingInfoList* until it re-acquires *schedulingInfoList* in *SystemInformationBlockType1*.

NOTE: The UE is not required to periodically check *schedulingInfoList* contained in *SystemInformationBlockType1*, but *Paging* message including the *cmas-Indication* triggers the UE to re-acquire *schedulingInfoList* contained in *SystemInformationBlockType1* for scheduling changes for *SystemInformationBlockType12*. The UE may or may not receive a *Paging* message including the *cmas-Indication* and/or *systemInfoModification* when *SystemInformationBlockType12* is no longer scheduled.

CMAS notification is contained in *SystemInformationBlockType12*. A CMAS notification corresponds to a single *CB data* IE as defined according to TS 23.041 [37]. A CMAS notification may optionally have associated warning area coordinates. Segmentation can be applied for the delivery of a CMAS notification and, if present, the associated warning area coordinates. The segmentation is fixed for transmission of a given CMAS notification and, if present, any associated warning area coordinates within a cell (i.e. the same segment size for a given segment with the same *messageIdentifier*, *serialNumber* and *warningMessageSegmentNumber*). E-UTRAN does not interleave transmissions of CMAS notifications, i.e. all segments of a given CMAS notification transmission are transmitted prior to those of another CMAS notification.

### 5.2.1.6 Notification of EAB parameters change

Change of EAB parameters can occur at any point in time. The EAB parameters are contained in *SystemInformationBlockType14*. The *Paging* message is used to inform EAB capable UEs in RRC\_IDLE about a change of EAB parameters or that *SystemInformationBlockType14* is no longer scheduled. If the UE receives a *Paging* message including the *eab-ParamModification*, it shall acquire *SystemInformationBlockType14* according to *schedulingInfoList* contained in *SystemInformationBlockType1*. If the UE receives a *Paging* message including the *eab-ParamModification* while it is acquiring *SystemInformationBlockType14*, the UE shall continue acquiring *SystemInformationBlockType14* based on the previously acquired *schedulingInfoList* until it re-acquires *schedulingInfoList* in *SystemInformationBlockType1*.

NOTE: The EAB capable UE is not expected to periodically check *schedulingInfoList* contained in *SystemInformationBlockType1*.

### 5.2.1.7 Access Barring parameters change in NB-IoT

Change of Access Barring (AB) parameters can occur at any point in time. The AB parameters are contained in *SystemInformationBlockType14-NB*. Update of the AB parameters does not impact the *systemInfoValueTag* in the *MasterInformationBlock-NB/ MasterInformationBlock-TDD-NB* or the *systemInfoValueTagSI* in *SystemInformationBlockType1-NB*.

If *SystemInformationBlockType14-NB* is scheduled, a NB-IoT UE connected to EPC is required to acquire *MasterInformationBlock-NB/ MasterInformationBlock-TDD-NB* before initiating RRC connection establishment / resume for all access causes except mobile terminating calls to check *ab-Enabled* indication. If access barring is enabled the UE shall not initiate the RRC connection establishment / resume for all access causes except mobile terminating calls until the UE has acquired the *SystemInformationBlockType14-NB*.

If *SystemInformationBlockType14-NB* is scheduled, a NB-IoT UE connected to 5GC is required to acquire *MasterInformationBlock-NB/ MasterInformationBlock-TDD-NB* before initiating RRC connection establishment / resume / re-establishment to check *ab-Enabled-5GC* indication. If access barring is enabled the UE shall not initiate the RRC connection establishment / resume / re-establishment until the UE has acquired the *SystemInformationBlockType14-NB*.

### 5.2.1.8 Notification of UAC parameters change

Change of UAC parameters can occur at any point in time. The UAC parameters are contained in *SystemInformationBlockType25*. The *Paging* message is used to inform BL UEs or UEs in CE in RRC\_INACTIVE or RRC\_IDLE connected to 5GC about a change of UAC parameters or that *SystemInformationBlockType25* is no longer scheduled. If the UE receives a *Paging* message including the *uac-ParamModification*, it shall acquire *SystemInformationBlockType25* according to *schedulingInfoList* contained in *SystemInformationBlockType1*. If the UE receives a *Paging* message including the *uac-ParamModification* while it is acquiring *SystemInformationBlockType25*, the UE shall continue acquiring *SystemInformationBlockType25* based on the previously acquired *schedulingInfoList* until it re-acquires *schedulingInfoList* in *SystemInformationBlockType1*.

NOTE: The BL UE or UE in CE is not expected to periodically check *schedulingInfoList* contained in *SystemInformationBlockType1*.

## 5.2.2 System information acquisition

### 5.2.2.1 General

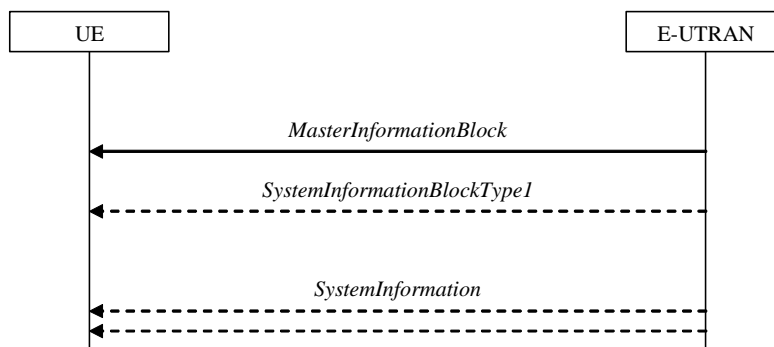

**Figure 5.2.2.1-1: System information acquisition, normal**

The UE applies the system information acquisition procedure to acquire the AS- and NAS- and positioning-system information that is broadcasted by the E-UTRAN. The procedure applies to UEs in RRC\_IDLE and UEs in RRC\_CONNECTED.

For BL UE, UE in CE and NB-IoT UE, specific conditions apply, as specified below.

### 5.2.2.2 Initiation

The UE shall apply the system information acquisition procedure upon selecting (e.g. upon power on) and upon re-selecting a cell, after handover completion, after entering E-UTRA from another RAT, upon return from out of coverage, upon receiving a notification that the system information has changed, upon receiving an indication about the presence of an ETWS notification, upon receiving an indication about the presence of a CMAS notification, upon receiving a notification that the EAB parameters have changed, upon receiving a request from CDMA2000 upper layers, upon receiving a request from positioning upper layers, upon receiving a notification that the UAC parameters have changed and upon exceeding the maximum validity duration. Unless explicitly stated otherwise in the procedural specification, the system information acquisition procedure overwrites any stored system information, i.e. delta configuration is not applicable for system information and the UE discontinues using a field if it is absent in system information unless explicitly specified otherwise.

In RRC\_CONNECTED, BL UEs and UEs in CE are required to acquire system information when T311 is running or upon handover where the UE is only required to acquire the *MasterInformationBlock* in the target PCell.

**NOTE:** Upon handover, E-UTRAN provides system information required by the UE in RRC\_CONNECTED except MIB with RRC signalling, i.e. *systemInformationBlockType1Dedicated* and *mobilityControlInfo*.

### 5.2.2.3 System information required by the UE

The UE shall:

- 1> ensure having a valid version, as defined below, of (at least) the following system information, also referred to as the 'required' system information:
  - 2> if in RRC\_IDLE:
    - 3> if the UE is a NB-IoT UE:
      - 4> the *MasterInformationBlock-NB/ MasterInformationBlock-TDD-NB* and *SystemInformationBlockType1-NB* as well as *SystemInformationBlockType2-NB* through *SystemInformationBlockType5-NB*, *SystemInformationBlockType22-NB*;
    - 3> else:
      - 4> the *MasterInformationBlock* and *SystemInformationBlockType1* (or *SystemInformationBlockType1-BR* depending on whether the UE is a BL UE or the UE in CE) as well as *SystemInformationBlockType2*

through *SystemInformationBlockType8* and *SystemInformationBlockType24* (depending on support of the concerned RATs), *SystemInformationBlockType17* (depending on support of RAN-assisted WLAN interworking when the UE is connected to EPC), *SystemInformationBlockType25* (depending on support of E-UTRA/5GC), *SystemInformationBlockType29* (only for BL UE or the UE in CE depending on support of resource reservation), *SystemInformationBlockType21*, *SystemInformationBlockType26* (if UE is capable of V2X sidelink communication and is configured by upper layers to receive or transmit V2X sidelink communication), and *SystemInformationBlockType28* (if UE is capable of NR sidelink communication and is configured by upper layers to receive or transmit NR sidelink communication), *SystemInformationBlockType30* (if UE is configured by upper layers to report disaster roaming related information);

- 3> if initiating a RRC connection establishment/resume procedure; and
- 3> the UE is NTN capable:
  - 4> *SystemInformationBlockType31* (*SystemInformationBlockType31-NB* in NB-IoT), if scheduled;
- 2> if in RRC\_INACTIVE:
  - 3> the *MasterInformationBlock* and *SystemInformationBlockType1* as well as *SystemInformationBlockType2* through *SystemInformationBlockType8* (depending on support of the concerned RATs), *SystemInformationBlockType24* (depending on support of the concerned RATs), *SystemInformationBlockType25*, *SystemInformationBlockType29* (only for BL UE or the UE in CE depending on support of resource reservation), *SystemInformationBlockType21*, *SystemInformationBlockType26* (if UE is capable of V2X sidelink communication and is configured by upper layers to receive or transmit V2X sidelink communication), and *SystemInformationBlockType28* (if UE is capable of NR sidelink communication and is configured by upper layers to receive or transmit NR sidelink communication), *SystemInformationBlockType30* (if UE is configured by upper layers to report disaster roaming related information);
- 2> if in RRC\_CONNECTED; and
- 2> the UE is not a BL UE; and
- 2> the UE is not in CE; and
- 2> the UE is not a NB-IoT UE:
  - 3> the *MasterInformationBlock*, *SystemInformationBlockType1* and *SystemInformationBlockType2* as well as *SystemInformationBlockType8* (depending on support of CDMA2000), *SystemInformationBlockType17* (depending on support of RAN-assisted WLAN interworking when the UE is connected to EPC), *SystemInformationBlockType25* (depending on support of E-UTRA/5GC);
- 2> if in RRC\_CONNECTED and T311 is running; and
- 2> the UE is a BL UE or the UE is in CE or the UE is a NB-IoT UE:
  - 3> the *MasterInformationBlock* (or *MasterInformationBlock-NB/ MasterInformationBlock-TDD-NB* in NB-IoT), *SystemInformationBlockType1-BR* (or *SystemInformationBlockType1-NB* in NB-IoT) and *SystemInformationBlockType2* (or *SystemInformationBlockType2-NB* in NB-IoT), *SystemInformationBlockType25* (only for BL UE or the UE in CE depending on support of E-UTRA/5GC), *SystemInformationBlockType29* (only for BL UE or the UE in CE depending on support of resource reservation), *SystemInformationBlockType31* (*SystemInformationBlockType31-NB* in NB-IoT) (only for NTN capable UE) if scheduled, and for NB-IoT *SystemInformationBlockType22-NB*;
- 2> if in RRC\_CONNECTED and T317 is not running; and
- 2> the UE is NTN capable:
  - 3> *SystemInformationBlockType31* (*SystemInformationBlockType31-NB* in NB-IoT), if scheduled;
- 1> delete any stored system information after 3 hours or 24 hours from the moment it was confirmed to be valid as defined in 5.2.1.3, unless specified otherwise;
- 1> consider any stored system information except *SystemInformationBlockType10*, *SystemInformationBlockType11*, *SystemInformationBlockType12*, *SystemInformationBlockType14* (*SystemInformationBlockType14-NB* in NB-



IoT), *systemInformationBlockType25* and *systemInformationBlockType31* (*systemInformationBlockType31-NB* in NB-IoT), to be invalid if *systemInfoValueTag* included in the *SystemInformationBlockType1* (*MasterInformationBlock-NB/ MasterInformationBlock-TDD-NB* in NB-IoT) is different from the one of the stored system information and in case of NB-IoT UEs, BL UEs and UEs in CE, *systemInfoValueTagSI* is not broadcasted. Otherwise consider system information validity as defined in 5.2.1.3;

#### 5.2.2.4 System information acquisition by the UE

The UE shall:

- 1> apply the specified BCCH configuration defined in 9.1.1.1 or BR-BCCH configuration defined in 9.1.1.8;
- 1> if the procedure is triggered by a system information change notification:
  - 2> if the UE uses an idle DRX cycle longer than the modification period:
    - 3> start acquiring the required system information, as defined in 5.2.2.3, from the next eDRX acquisition period boundary;
  - 2> else
    - 3> start acquiring the required system information, as defined in 5.2.2.3, from the beginning of the modification period following the one in which the change notification was received;

NOTE 1: The UE continues using the previously received system information until the new system information has been acquired.

- 1> if the UE is in RRC\_IDLE and enters a cell for which the UE does not have stored a valid version of the system information required in RRC\_IDLE, as defined in 5.2.2.3:
  - 2> acquire, using the system information acquisition procedure as defined in 5.2.3, the system information required in RRC\_IDLE, as defined in 5.2.2.3;
- 1> following successful handover completion to a PCell for which the UE does not have stored a valid version of the system information required in RRC\_CONNECTED, as defined in 5.2.2.3:
  - 2> acquire, using the system information acquisition procedure as defined in 5.2.3, the system information required in RRC\_CONNECTED, as defined in 5.2.2.3;
  - 2> upon acquiring the concerned system information:
    - 3> discard the corresponding radio resource configuration information included in the *radioResourceConfigCommon* previously received in a dedicated message, if any;
- 1> following a request from CDMA2000 upper layers:
  - 2> acquire *SystemInformationBlockType8*, as defined in 5.2.3;
- 1> neither initiate the RRC connection establishment/resume procedure nor initiate transmission of the *RRCConnectionReestablishmentRequest* message until the UE has a valid version of the *MasterInformationBlock* (*MasterInformationBlock-NB/ MasterInformationBlock-TDD-NB* in NB-IoT) and *SystemInformationBlockType1* (*SystemInformationBlockType1-NB* in NB-IoT) messages as well as *SystemInformationBlockType2* (*SystemInformationBlockType2-NB* in NB-IoT), and for NB-IoT, *SystemInformationBlockType22-NB*;
- 1> not initiate the RRC connection establishment/resume procedure subject to EAB until the UE has a valid version of *SystemInformationBlockType14*, if broadcast;
- 1> if the UE is ETWS capable:
  - 2> upon entering a cell during RRC\_IDLE, following successful handover or upon connection re-establishment:
    - 3> discard any previously buffered *warningMessageSegment*;
    - 3> clear, if any, the current values of *messageIdentifier* and *serialNumber* for *SystemInformationBlockType11*;

2> when the UE acquires *SystemInformationBlockType1* following ETWS indication, upon entering a cell during RRC\_IDLE, following successful handover or upon connection re-establishment:

3> if *schedulingInfoList* indicates that *SystemInformationBlockType10* is present:

4> if the UE is in CE:

5> start acquiring *SystemInformationBlockType10*;

4> else

5> start acquiring *SystemInformationBlockType10* immediately;

3> if *schedulingInfoList* indicates that *SystemInformationBlockType11* is present:

4> start acquiring *SystemInformationBlockType11* immediately;

NOTE 2: UEs shall start acquiring *SystemInformationBlockType10* and *SystemInformationBlockType11* as described above even when *systemInfoValueTag* in *SystemInformationBlockType1* has not changed.

1> if the UE is CMAS capable:

2> upon entering a cell during RRC\_IDLE, following successful handover or upon connection re-establishment:

3> discard any previously buffered *warningMessageSegment*;

3> clear, if any, stored values of *messageIdentifier* and *serialNumber* for *SystemInformationBlockType12* associated with the discarded *warningMessageSegment*;

2> when the UE acquires *SystemInformationBlockType1* following CMAS indication, upon entering a cell during RRC\_IDLE, following successful handover and upon connection re-establishment:

3> if *schedulingInfoList* indicates that *SystemInformationBlockType12* is present:

4> acquire *SystemInformationBlockType12*;

NOTE 3: UEs shall start acquiring *SystemInformationBlockType12* as described above even when *systemInfoValueTag* in *SystemInformationBlockType1* has not changed.

1> if the UE is interested to receive MBMS services:

2> if the UE is capable of MBMS reception as specified in 5.8:

3> if *schedulingInfoList* indicates that *SystemInformationBlockType13* is present and the UE does not have stored a valid version of this system information block:

4> acquire *SystemInformationBlockType13*;

3> else if *SystemInformationBlockType13* is present in *SystemInformationBlockType1-MBMS* and the UE does not have stored a valid version of this system information block:

4> acquire *SystemInformationBlockType13* from *SystemInformationBlockType1-MBMS*;

2> if the UE is capable of SC-PTM reception as specified in 5.8a:

3> if *schedulingInfoList* indicates that *SystemInformationBlockType20* (*SystemInformationBlockType20-NB* in NB-IoT) is present and the UE does not have stored a valid version of this system information block:

4> acquire *SystemInformationBlockType20* (*SystemInformationBlockType20-NB* in NB-IoT);

2> if the UE is capable of MBMS Service Continuity:

3> if *schedulingInfoList* indicates that *SystemInformationBlockType15* (*SystemInformationBlockType15-NB* in NB-IoT) is present and the UE does not have stored a valid version of this system information block:

4> acquire *SystemInformationBlockType15* (*SystemInformationBlockType15-NB* in NB-IoT);

1> if the UE is EAB capable:

2> when the UE does not have stored a valid version of *SystemInformationBlockType14* upon entering RRC\_IDLE, or when the UE acquires *SystemInformationBlockType1* following EAB parameters change notification, or upon entering a cell during RRC\_IDLE, or before establishing an RRC connection if using eDRX with DRX cycle longer than the modification period:

3> if *schedulingInfoList* indicates that *SystemInformationBlockType14* is present:

4> start acquiring *SystemInformationBlockType14* immediately;

3> else:

4> discard *SystemInformationBlockType14*, if previously received;

NOTE 4: EAB capable UEs start acquiring *SystemInformationBlockType14* as described above even when *systemInfoValueTag* in *SystemInformationBlockType1* has not changed.

NOTE 5: EAB capable UEs maintain an up to date *SystemInformationBlockType14* in RRC\_IDLE.

1> if the UE is capable of sidelink communication and is configured by upper layers to receive or transmit sidelink communication:

2> if the cell used for sidelink communication meets the S-criteria as defined in TS 36.304 [4]; and

2> if *schedulingInfoList* indicates that *SystemInformationBlockType18* is present and the UE does not have stored a valid version of this system information block:

3> acquire *SystemInformationBlockType18*;

1> if the UE is capable of sidelink discovery and is configured by upper layers to receive or transmit sidelink discovery announcements on the primary frequency:

2> if *schedulingInfoList* of the serving cell/ PCell indicates that *SystemInformationBlockType19* is present and the UE does not have stored a valid version of this system information block:

3> acquire *SystemInformationBlockType19*;

1> if the UE is capable of sidelink discovery and, for each of the one or more frequencies included in *discInterFreqList*, if included in *SystemInformationBlockType19* and for which the UE is configured by upper layers to receive sidelink discovery announcements on:

2> if *SystemInformationBlockType19* of the serving cell/ PCell does not provide the corresponding reception resources; and

2> if *schedulingInfoList* of the cell on the concerned frequency indicates that *SystemInformationBlockType19* is present and the UE does not have stored a valid version of this system information block:

3> acquire *SystemInformationBlockType19*;

1> if the UE is capable of sidelink discovery and, for each of the one or more frequencies included in *discInterFreqList*, if included in *SystemInformationBlockType19* and for which the UE is configured by upper layers to transmit sidelink discovery announcements on:

2> if *SystemInformationBlockType19* of the serving cell/ PCell includes *discTxResourcesInterFreq* which is set to *acquireSI-FromCarrier*; and

2> if *schedulingInfoList* of the cell on the concerned frequency indicates that *SystemInformationBlockType19* is present and the UE does not have stored a valid version of this system information block:

3> acquire *SystemInformationBlockType19*;

1> if the UE is a NB-IoT UE connected to EPC and if *ab-Enabled* included in *MasterInformationBlock-NB/ MasterInformationBlock-TDD-NB* is set to *TRUE*:

2> not initiate the RRC connection establishment/resume procedure for all access causes except mobile terminating calls until the UE has acquired the *SystemInformationBlockType14-NB*;

- 1> if the UE is capable of V2X sidelink communication and is configured by upper layers to receive or transmit V2X sidelink communication on a frequency:
  - 2> if *schedulingInfoList* on the serving cell/PCell indicates that *SystemInformationBlockType21* is present and the UE does not have stored valid version of this system information block:
    - 3> acquire *SystemInformationBlockType21* from serving cell/PCell;
  - 2> if *schedulingInfoList* on the serving cell/PCell indicates that *SystemInformationBlockType26* is present and the UE does not have stored valid version of this system information block;
    - 3> acquire *SystemInformationBlockType26* from serving cell/PCell;
- 1> if the UE is capable of V2X sidelink communication and is configured by upper layers to receive V2X sidelink communication on a frequency, which is not primary frequency:
  - 2> if neither *SystemInformationBlockType21* nor *SystemInformationBlockType26* of the serving cell/PCell provide reception resource pool for V2X sidelink communication for the concerned frequency; and
  - 2> if the cell used for V2X sidelink communication on the concerned frequency meets the S-criteria as defined in TS 36.304 [4]:
    - 3> if *schedulingInfoList* on the concerned frequency indicates that *SystemInformationBlockType21* is present and the UE does not have stored a valid version of this system information block:
      - 4> acquire *SystemInformationBlockType21* from the concerned frequency;
    - 3> if *schedulingInfoList* on the concerned frequency indicates that *SystemInformationBlockType26* is present and the UE does not have stored a valid version of this system information block:
      - 4> acquire *SystemInformationBlockType26* from the concerned frequency;
- 1> if the UE is capable of V2X sidelink communication and is configured by upper layers to transmit V2X sidelink communication on a frequency, which is not primary frequency and is not included in *v2x-InterFreqInfoList* in *SystemInformationBlockType21* nor *SystemInformationBlockType26* of the serving cell/PCell:
  - 2> if the cell used for V2X sidelink communication on the concerned frequency meets the S-criteria as defined in TS 36.304 [4]:
    - 3> if *schedulingInfoList* on the concerned frequency indicates that *SystemInformationBlockType21* is present and the UE does not have stored a valid version of this system information block:
      - 4> acquire *SystemInformationBlockType21* from the concerned frequency;
    - 3> if *schedulingInfoList* on the concerned frequency indicates that *SystemInformationBlockType26* is present and the UE does not have stored a valid version of this system information block:
      - 4> acquire *SystemInformationBlockType26* from the concerned frequency;
- 1> if the NB-IoT UE supports NPRACH resources using preamble format 2:
  - 2> if *schedulingInfoList* indicates that *SystemInformationBlockType23-NB* is present and the UE does not have stored a valid version of this system information block:
    - 3> acquire *SystemInformationBlockType23-NB*;
- 1> following a request from positioning upper layers:
  - 2> acquire *SystemInformationBlockPos*, as defined in 5.2.3;
- 1> if the UE is capable of NR sidelink communication and is configured by upper layers to receive or transmit NR sidelink communication on a frequency:
  - 2> if *schedulingInfoList* on the serving cell/PCell indicates that *SystemInformationBlockType28* is present and the UE does not have stored valid version of this system information block:
    - 3> acquire *SystemInformationBlockType28* from serving cell/PCell;

- 1> if the UE connected to 5GC is a BL UE or a UE in CE:
  - 2> when the UE does not have stored a valid version of *SystemInformationBlockType25* upon entering RRC\_IDLE, or when the UE acquires *SystemInformationBlockType1-BR* following UAC parameters change notification, or upon entering a cell during RRC\_IDLE, or before establishing, resuming or re-establishing an RRC connection if using an eDRX cycle longer than the modification period:
    - 3> if *schedulingInfoList* indicates that *SystemInformationBlockType25* is present:
      - 4> start acquiring *SystemInformationBlockType25* immediately before establishing, resuming or re-establishing an RRC connection;
    - 3> else:
      - 4> discard *SystemInformationBlockType25*, if previously received;

NOTE 5a: When connected to 5GC, BL UEs or a UEs in CE start acquiring *SystemInformationBlockType25* as described above even when *systemInfoValueTag* in *SystemInformationBlockType1-BR* has not changed.

NOTE 5b: When connected to 5GC, BL UEs or a UEs in CE maintain an up to date *SystemInformationBlockType25* in RRC\_IDLE.

- 1> if the UE is a NB-IoT UE connected to 5GC and if *ab-Enabled5GC* included in *MasterInformationBlock-NB/ MasterInformationBlock-TDD-NB* is set to *TRUE*:
  - 2> not initiate the RRC connection establishment/ resume/ re-establishment procedure for all access causes until the UE has acquired the *SystemInformationBlockType14-NB*;
- 1> if the UE is NTN capable:
  - 2> if *schedulingInfoList* indicates that *SystemInformationBlockType31* (*SystemInformationBlockType31-NB* in NB-IoT) is present:
    - 3> immediately before establishing, resuming or re-establishing an RRC connection; or
    - 3> immediately before EDT or transmission using PUR; or
    - 3> if in RRC\_CONNECTED and T317 is not running:
      - 4> acquire *SystemInformationBlockType31* (*SystemInformationBlockType31-NB* in NB-IoT);
  - 2> if the UE supports discontinuous coverage; and
  - 2> if *schedulingInfoList* indicates that *SystemInformationBlockType32* (*SystemInformationBlockType32-NB* in NB-IoT) is present and the UE does not have a valid version of this system information block:
    - 3> acquire *SystemInformationBlockType32* (*SystemInformationBlockType32-NB* in NB-IoT);

The UE may apply the received SIBs or posSIBs immediately, i.e. the UE does not need to delay using a SIB or posSIB until all SI messages have been received. The UE may delay applying the received SIBs until completing lower layer procedures associated with a received or a UE originated RRC message, e.g. an ongoing random access procedure.

NOTE 6: While attempting to acquire a particular SIB/posSIB, if the UE detects from *schedulingInfoList/ posSchedulingInfoList* that it is no longer present, the UE should stop trying to acquire the particular SIB/posSIB.

### 5.2.2.5 Essential system information missing

The UE shall:

- 1> if in RRC\_IDLE, RRC\_INACTIVE or in RRC\_CONNECTED while T311 is running:
  - 2> if the UE is unable to acquire the *MasterInformationBlock* (*MasterInformationBlock-NB/ MasterInformationBlock-TDD-NB* in NB-IoT); or
  - 2> if the UE is neither a BL UE nor in CE nor in NB-IoT and the UE is unable to acquire the *SystemInformationBlockType1*; or

- 2> if the BL UE or UE in CE is unable to acquire *SystemInformationBlockType1-BR* or *SystemInformationBlockType1-BR* is not scheduled; or
- 2> if the NB-IoT UE is unable to acquire the *SystemInformationBlockType1-NB*:
  - 3> consider the cell as barred in accordance with TS 36.304 [4]; and
  - 3> perform barring as if *intraFreqReselection* is set to *allowed*, and as if the *csg-Indication* is set to *FALSE*;
- 2> else:
  - 3> if the UE is unable to acquire the *SystemInformationBlockType2* (or *SystemInformationBlockType2-NB* in NB-IoT) and for NB-IoT, *SystemInformationBlockType22-NB* if scheduled; or
  - 3> if *SystemInformationBlockType25* is broadcast and if the UE is connected to 5GC and is unable to acquire the *SystemInformationBlockType25*; or
  - 3> if the UE is NTN capable, *SystemInformationBlockType31* (*SystemInformationBlockType31-NB* in NB-IoT) is broadcast and if the UE is unable to acquire the *SystemInformationBlockType31* (*SystemInformationBlockType31-NB* in NB-IoT):
    - 4> treat the cell as barred in accordance with TS 36.304 [4];

### 5.2.2.6 Actions upon reception of the *MasterInformationBlock* message

Upon receiving the *MasterInformationBlock* message the UE shall:

- 1> apply the radio resource configuration included in the *phich-Config*;
- 1> if the UE is in RRC\_IDLE or if the UE is in RRC\_CONNECTED while T311 is running:
  - 2> if the UE has no valid system information stored according to 5.2.2.3 for the concerned cell:
    - 3> apply the received value of *dl-Bandwidth* to the *ul-Bandwidth* until *SystemInformationBlockType2* is received;

Upon receiving the *MasterInformationBlock-NB* or *MasterInformationBlock-TDD-NB* message the UE shall:

- 1> apply the radio resource configuration included in accordance with the *operationModeInfo*.

No UE requirements related to the contents of *MasterInformationBlock-MBMS* apply other than those specified elsewhere e.g. within procedures using the concerned system information, and/ or within the corresponding field descriptions.

### 5.2.2.7 Actions upon reception of the *SystemInformationBlockType1* message

Upon receiving the *SystemInformationBlockType1* or *SystemInformationBlockType1-BR* either via broadcast or via dedicated signalling, the UE shall:

- 1> if the upper layers indicate the selected core network type as 5GC:
  - 2> if the *cellAccessRelatedInfoList-5GC* contains an entry with the *plmn-Identity* or *plmn-Index* of the selected PLMN:
    - 3> in the remainder of the procedures use *plmn-IdentityList*, *trackingAreaCode*, and *cellIdentity* for the cell as received in the corresponding *cellAccessRelatedInfoList-5GC* containing the selected PLMN;
- 1> else if the *cellAccessRelatedInfoList* contains an entry with the *PLMN-Identity* of the selected PLMN:
  - 2> in the remainder of the procedures use *plmn-IdentityList*, *trackingAreaCode*, *trackingAreaList* and *cellIdentity* for the cell as received in the corresponding *cellAccessRelatedInfoList* containing the selected PLMN;
- 1> if in RRC\_IDLE or in RRC\_CONNECTED while T311 is running; and
- 1> if the UE is a category 0 UE according to TS 36.306 [5]; and

- 1> if *category0Allowed* is not included in *SystemInformationBlockType1*:
  - 2> consider the cell as barred in accordance with TS 36.304 [4];
- 1> if in RRC\_CONNECTED while T311 is not running, and the UE supports multi-band cells as defined by bit 31 in *featureGroupIndicators*:
  - 2> disregard the *freqBandIndicator* and *multiBandInfoList*, if received, while in RRC\_CONNECTED;
  - 2> forward the *cellIdentity* to upper layers;
  - 2> forward the *trackingAreaCode* to upper layers;
  - 2> forward the *trackingAreaList* to upper layers, if present;
- 1> else:
  - 2> if UE is IAB-MT and if *iab-Support* is not provided for the selected PLMN nor the registered PLMN nor PLMN of the equivalent PLMN list:
    - 3> consider the cell as barred for IAB-MT in accordance with TS 36.304 [4];
    - 3> perform barring as if *intraFreqReselection* is set to allowed, and as if the *csg-Indication* is set to *FALSE*;
  - 2> else:
    - 3> if the frequency band indicated in the *freqBandIndicator* or *freqBandIndicatorAerial* is part of the frequency bands supported by the UE and it is not a downlink only band; or
    - 3> if the UE supports *multiBandInfoList*, and if one or more of the frequency bands indicated in the *multiBandInfoList* or *multiBandInfoListAerial* are part of the frequency bands supported by the UE and they are not downlink only bands:
      - 4> forward the *cellIdentity* to upper layers;
      - 4> forward the *trackingAreaCode* to upper layers;
      - 4> forward the *trackingAreaList* to upper layers, if present;
      - 4> forward the PLMN identity to upper layers;
    - 4> if in RRC\_INACTIVE and the forwarded information does not trigger message transmission by upper layers:
      - 5> if the serving cell does not belong to the configured *ran-NotificationAreaInfo*:
        - 6> initiate an RNA update as specified in 5.3.17.2;
    - 4> forward the *ims-EmergencySupport* to upper layers, if present;
    - 4> forward the *eCallOverIMS-Support* to upper layers, if present;
    - 4> if the UE is capable of 5G NAS:
      - 5> forward the *ims-EmergencySupport5GC* to upper layers, if present;
      - 5> forward the *eCallOverIMS-Support5GC* to upper layers, if present;
      - 5> forward *cp-CIoT-5GS-Optimisation* to upper layers, if present for the selected PLMN;
      - 5> forward *up-CIoT-5GS-Optimisation* to upper layers, if present for the selected PLMN;
    - 4> if the UE is aerial UE and for the frequency band selected by the UE (from *freqBandIndicatorAerial* or *multiBandInfoListAerial*), the *freqBandInfoAerial* or the *multiBandInfoListAerial* is present and the UE capable of *multiNS-Pmax* does not support any of the *additionalSpectrumEmission* in the *NS-PmaxListAerial* within the *freqBandInfoAerial* or *multiBandInfoListAerial*:
      - 5> consider the cell as barred in accordance with TS 36.304 [4];

- 5> perform barring as if *intraFreqReselection* is set to *notAllowed*, and as if the *csg-Indication* is set to *FALSE*, upon which the procedure ends;
- 4> else if the UE is aerial UE and for the frequency band selected by the UE (from *freqBandIndicatorAerial* or *multiBandInfoListAerial*), the *freqBandInfoAerial* or the *multiBandInfoListAerial* is present and the UE capable of *multiNS-Pmax* supports at least one *additionalSpectrumEmission* in the *NS-PmaxListAerial* within the *freqBandInfoAerial* or *multiBandInfoListAerial*:
  - 5> apply the first listed *additionalSpectrumEmission* which it supports among the values included in *NS-PmaxListAerial* within *freqBandInfoAerial* or *multiBandInfoListAerial*;
  - 5> if the *additionalPmax* is present in the same entry of the selected *additionalSpectrumEmission* within *NS-PmaxListAerial*:
    - 6> apply the *additionalPmax*;
  - 5> else:
    - 6> apply the *p-Max*;
- 4> else if, for the frequency band selected by the UE (from *freqBandIndicator* or *multiBandInfoList*), the *freqBandInfo* or the *multiBandInfoList-v10j0* is present and the UE capable of *multiNS-Pmax* supports at least one *additionalSpectrumEmission* in the *NS-PmaxList* within the *freqBandInfo* or *multiBandInfoList-v10j0*:
  - 5> apply the first listed *additionalSpectrumEmission* which it supports among the values included in *NS-PmaxList* within *freqBandInfo* or *multiBandInfoList-v10j0*;
  - 5> if the *additionalPmax* is present in the same entry of the selected *additionalSpectrumEmission* within *NS-PmaxList*:
    - 6> apply the *additionalPmax*;
  - 5> else:
    - 6> apply the *p-Max*;
- 4> else:
  - 5> apply the *additionalSpectrumEmission* in *SystemInformationBlockType2* and the *p-Max*;
- 3> else:
  - 4> consider the cell as barred in accordance with TS 36.304 [4]; and
  - 4> perform barring as if *intraFreqReselection* is set to *notAllowed*, and as if the *csg-Indication* is set to *FALSE*;

Upon receiving the *SystemInformationBlockType1-NB*, the UE shall:

- 1> if the upper layers indicate the selected core network type as 5GC:
  - 2> in the remainder of the procedures use *plmn-IdentityList*, *trackingAreaCode*, and *cellIdentity* for the cell as received in the *cellAccessRelatedInfo-5GC*;
- 1> else:
  - 2> in the remainder of the procedures use *plmn-IdentityList*, *trackingAreaCode*, *trackingAreaList* and *cellIdentity* for the cell as received in the *cellAccessRelatedInfo*;
- 1> if the frequency band indicated in the *freqBandIndicator* is part of the frequency bands supported by the UE; or
- 1> if one or more of the frequency bands indicated in the *multiBandInfoList* are part of the frequency bands supported by the UE:
  - 2> forward the *cellIdentity* to upper layers;



- 2> forward the *trackingAreaCode* to upper layers;
- 2> forward the *trackingAreaList* to upper layers, if present;
- 2> if *attachWithoutPDN-Connectivity* is received for the selected PLMN:
  - 3> forward the *attachWithoutPDN-Connectivity* to upper layers;
- 2> else:
  - 3> indicate to upper layers that *attachWithoutPDN-Connectivity* is not present;
- 2> if the UE is capable of 5G NAS:
  - 3> forward *ng-U-DataTransfer* to upper layers, if present for the selected PLMN;
  - 3> forward *up-CIoT-5GS-Optimisation* to upper layers, if present for the selected PLMN;
- 2> if, for the frequency band selected by the UE (from *freqBandIndicator* or *multiBandInfoList*), the *freqBandInfo* is present and the UE capable of *multiNS-Pmax* supports at least one *additionalSpectrumEmission* in the *NS-PmaxList* within the *freqBandInfo*:
  - 3> apply the first listed *additionalSpectrumEmission* which it supports among the values included in *NS-PmaxList* within *freqBandInfo*;
  - 3> if the *additionalPmax* is present in the same entry of the selected *additionalSpectrumEmission* within *NS-PmaxList*:
    - 4> apply the *additionalPmax*;
  - 3> else:
    - 4> apply the *p-Max*;
- 2> else:
  - 3> apply the *additionalSpectrumEmission* in *SystemInformationBlockType2-NB* and the *p-Max*;
- 1> else:
  - 2> consider the cell as barred in accordance with TS 36.304 [4]; and
  - 2> perform barring as if *intraFreqReselection* is set to *notAllowed*.

No UE requirements related to the contents of *SystemInformationBlockType1-MBMS* apply other than those specified elsewhere e.g. within procedures using the concerned system information, and/ or within the corresponding field descriptions.

#### 5.2.2.8 Actions upon reception of *SystemInformation* messages

No UE requirements related to the contents of the *SystemInformation* messages apply other than those specified elsewhere e.g. within procedures using the concerned system information, and/ or within the corresponding field descriptions.

#### 5.2.2.9 Actions upon reception of *SystemInformationBlockType2*

Upon receiving *SystemInformationBlockType2*, the UE shall:

- 1> apply the configuration included in the *radioResourceConfigCommon*;
- 1> derive the DRX cycle as specified in TS 36.304 [4], clause 7.1;
- 1> if the *mbsfn-SubframeConfigList* is included:
  - 2> consider that DL assignments may occur in the MBSFN subframes indicated in the *mbsfn-SubframeConfigList* under the conditions specified in TS 36.213 [23], clause 7.1;

- 1> apply the specified PCCH configuration defined in 9.1.1.3;
- 1> not apply the *timeAlignmentTimerCommon*;
- 1> if in RRC\_CONNECTED and UE is configured with RLF timers and constants values received within *rlf-TimersAndConstants*:
  - 2> not update its values of the timers and constants in *ue-TimersAndConstants* except for the value of timer T300;
- 1> if in RRC\_CONNECTED while T311 is not running; and the UE supports multi-band cells as defined by bit 31 in *featureGroupIndicators* or *multipleNS-Pmax*:
  - 2> disregard the *additionalSpectrumEmission* and *ul-CarrierFreq*, if received, while in RRC\_CONNECTED;
- 1> if *attachWithoutPDN-Connectivity* is received for the selected PLMN:
  - 2> forward *attachWithoutPDN-Connectivity* to upper layers;
- 1> else:
  - 2> indicate to upper layers that *attachWithoutPDN-Connectivity* is not present;
- 1> if *cp-CIoT-EPS-Optimisation* is received for the selected PLMN:
  - 2> forward *cp-CIoT-EPS-Optimisation* to upper layers;
- 1> else:
  - 2> indicate to upper layers that *cp-CIoT-EPS-Optimisation* is not present;
- 1> if *up-CIoT-EPS-Optimisation* is received for the selected PLMN:
  - 2> forward *up-CIoT-EPS-Optimisation* to upper layers;
- 1> else:
  - 2> indicate to upper layers that *up-CIoT-EPS-Optimisation* is not present;
- 1> if *SystemInformationBlockType26a* is not present:
  - 2> to upper layers either forward *upperLayerIndication*, if present for the selected PLMN, or otherwise indicate absence of this field;

NOTE: *upperLayerIndication* is an indication to upper layers that the UE has entered a coverage area that offers 5G capabilities.

- 1> to upper layers either forward *rls-Enabled*, if present, or otherwise indicate absence of this field;

Upon receiving *SystemInformationBlockType2-NB*, the UE shall:

- 1> apply the configuration included in the *radioResourceConfigCommon*;
- 1> derive the DRX cycle as specified in TS 36.304 [4], clause 7.1;
- 1> if *SystemInformationBlockType22-NB* is scheduled:
  - 2> read and act on information sent in *SystemInformationBlockType22-NB*;
- 1> apply the specified PCCH configuration defined in 9.1.1.3.
- 1> if in RRC\_CONNECTED and UE is configured with RLF timers and constants values received within *rlf-TimersAndConstants*:
  - 2> not update its values of the timers and constants in *ue-TimersAndConstants* except for the value of timer T300;

Upon receiving *SystemInformationBlockType2* (*SystemInformationBlockType2-NB* in NB-IoT), the UE shall:

- 1> if *up-PUR-5GC* is not included and the UE connected to 5GC in RRC\_IDLE with a suspended RRC connection is configured with *pur-Config*; or
- 1> if *up-PUR-EPC* is not included and the UE connected to EPC in RRC\_IDLE with a suspended RRC connection is configured with *pur-Config*; or
- 1> if *cp-PUR-5GC* is not included and the UE connected to 5GC in RRC\_IDLE without a suspended RRC connection is configured with *pur-Config*; or
- 1> if *cp-PUR-EPC* is not included and the UE connected to EPC in RRC\_IDLE without a suspended RRC connection is configured with *pur-Config*:
  - 2> if *pur-TimeAlignmentTimer* is configured, indicate to lower layers that *pur-TimeAlignmentTimer* is released;
  - 2> release *pur-Config*;
  - 2> discard previously stored *pur-Config*.

### 5.2.2.10 Actions upon reception of *SystemInformationBlockType3*

Upon receiving *SystemInformationBlockType3*, the UE shall:

- 1> if in RRC\_IDLE, the *redistributionServingInfo* is included and the UE is redistribution capable:
  - 2> perform E-UTRAN inter-frequency redistribution procedure as specified in TS 36.304 [4], clause 5.2.4.10;
- 1> if in RRC\_IDLE, or in RRC\_CONNECTED while T311 is running:
  - 2> if, for the frequency band selected by the UE (from the procedure in clause 5.2.2.7) to represent the serving cell's carrier frequency, the *freqBandInfo* or the *multiBandInfoList-v10j0* (for aerial UE the *freqBandInfoAerial* or the *multiBandInfoListAerial*) is present in *SystemInformationBlockType3* and the UE capable of *multiNS-Pmax* supports at least one *additionalSpectrumEmission* in the *NS-PmaxList* within the *freqBandInfo* or *multiBandInfoList-v10j0* (for aerial UE the *NS-PmaxListAerial* within the *freqBandInfoAerial* or the *multiBandInfoListAerial*):
    - 3> if the UE is aerial UE:
      - 4> apply the first listed *additionalSpectrumEmission* which it supports among the values included in *NS-PmaxListAerial* within *freqBandInfoAerial* or *multiBandInfoListAerial*;
    - 3> else:
      - 4> apply the first listed *additionalSpectrumEmission* which it supports among the values included in *NS-PmaxList* within *freqBandInfo* or *multiBandInfoList-v10j0*;
    - 3> if the *additionalPmax* is present in the same entry of the selected *additionalSpectrumEmission* within *NS-PmaxList* (for aerial UE the *NS-PmaxListAerial*):
      - 4> apply the *additionalPmax*;
    - 3> else:
      - 4> apply the *p-Max*;
  - 2> else:
    - 3> apply the *p-Max*;

Upon receiving *SystemInformationBlockType3-NB*, the UE shall:

- 1> if in RRC\_IDLE, or in RRC\_CONNECTED while T311 is running:
  - 2> if, for the frequency band selected by the UE (from the procedure in clause 5.2.2.7) to represent the serving cell's carrier frequency, the *freqBandInfo* or the *multiBandInfoList* is present in *SystemInformationBlockType3-NB* and the UE capable of *multiNS-Pmax* supports at least one *additionalSpectrumEmission* in the *NS-PmaxList* within the *freqBandInfo* or the *multiBandInfoList*:

- 3> apply the first listed *additionalSpectrumEmission* which it supports among the values included in *NS-PmaxList* within *freqBandInfo* or *multiBandInfoList*;
- 3> if the *additionalPmax* is present in the same entry of the selected *additionalSpectrumEmission* within *NS-PmaxList*:
  - 4> apply the *additionalPmax*;
- 3> else:
  - 4> apply the *p-Max*;
- 2> else:
  - 3> apply the *p-Max*;

#### 5.2.2.11 Actions upon reception of *SystemInformationBlockType4*

No UE requirements related to the contents of this *SystemInformationBlock* (*SystemInformationBlockType4* or *SystemInformationBlockType4-NB*) apply other than those specified elsewhere e.g. within procedures using the concerned system information, and/ or within the corresponding field descriptions.

#### 5.2.2.12 Actions upon reception of *SystemInformationBlockType5*

Upon receiving *SystemInformationBlockType5*, the UE shall:

- 1> if in RRC\_IDLE, the *redistributionInterFreqInfo* is included and the UE is redistribution capable:
  - 2> perform E-UTRAN inter-frequency redistribution procedure as specified in TS 36.304 [4], clause 5.2.4.10;
- 1> if in RRC\_IDLE, or in RRC\_CONNECTED while T311 is running:
  - 2> if the frequency band selected by the UE to represent a non-serving E UTRA carrier frequency is not a downlink only band:
    - 3> if, for the selected frequency band, the *freqBandInfo* or the *multiBandInfoList-v10j0* (for aerial UE the *freqBandInfoAerial* or the *multiBandInfoListAerial*) is present and the UE capable of *multiNS-Pmax* supports at least one *additionalSpectrumEmission* in the *NS-PmaxList* within *freqBandInfo* or *multiBandInfoList-v10j0* (for aerial UE the *NS-PmaxListAerial* within the *freqBandInfoAerial* or the *multiBandInfoListAerial*):
      - 4> if the UE is aerial UE:
        - 5> apply the first listed *additionalSpectrumEmission* which it supports among the values included in *NS-PmaxListAerial* within *freqBandInfoAerial* or *multiBandInfoListAerial*;
      - 4> else:
        - 5> apply the first listed *additionalSpectrumEmission* which it supports among the values included in *NS-PmaxList* within *freqBandInfo* or *multiBandInfoList-v10j0*;
      - 4> if the *additionalPmax* is present in the same entry of the selected *additionalSpectrumEmission* within *NS-PmaxList* (for aerial UE the *NS-PmaxListAerial*):
        - 5> apply the *additionalPmax*;
      - 4> else:
        - 5> apply the *p-Max*;
    - 3> else:
      - 4> apply the *p-Max*;
- 1> if in RRC\_IDLE or RRC\_INACTIVE, and T331 is running:

2> perform the actions as specified in 5.6.20.1a;

Upon receiving *SystemInformationBlockType5-NB*, the UE shall:

- 1> if in RRC\_IDLE, or in RRC\_CONNECTED while T311 is running:
  - 2> if, for the frequency band selected by the UE (from *multiBandInfoList*) to represent a non-serving NB-IoT carrier frequency, the *freqBandInfo* is present and the UE capable of *multiNS-Pmax* supports at least one *additionalSpectrumEmission* in the *NS-PmaxList* within the *freqBandInfo*:
    - 3> apply the first listed *additionalSpectrumEmission* which it supports among the values included in *NS-PmaxList* within *freqBandInfo*;
    - 3> if the *additionalPmax* is present in the same entry of the selected *additionalSpectrumEmission* within *NS-PmaxList*:
      - 4> apply the *additionalPmax*;
    - 3> else:
      - 4> apply the *p-Max*;
  - 2> else:
    - 3> apply the *p-Max*;

#### 5.2.2.13 Actions upon reception of *SystemInformationBlockType6*

No UE requirements related to the contents of this *SystemInformationBlock* apply other than those specified elsewhere e.g. within procedures using the concerned system information, and/ or within the corresponding field descriptions.

#### 5.2.2.14 Actions upon reception of *SystemInformationBlockType7*

No UE requirements related to the contents of this *SystemInformationBlock* apply other than those specified elsewhere e.g. within procedures using the concerned system information, and/ or within the corresponding field descriptions.

#### 5.2.2.15 Actions upon reception of *SystemInformationBlockType8*

Upon receiving *SystemInformationBlockType8*, the UE shall:

- 1> if *sib8-PerPLMN-List* is included and the UE is capable of network sharing for CDMA2000:
  - 2> apply the CDMA2000 parameters below corresponding to the RPLMN;
- 1> if the *systemTimeInfo* is included:
  - 2> forward the *systemTimeInfo* to CDMA2000 upper layers;
- 1> if the UE is in RRC\_IDLE and if *searchWindowSize* is included:
  - 2> forward the *searchWindowSize* to CDMA2000 upper layers;
- 1> if *parametersHRPD* is included:
  - 2> forward the *preRegistrationInfoHRPD* to CDMA2000 upper layers only if the UE has not received the *preRegistrationInfoHRPD* within an *RRCCONNECTIONRECONFIGURATION* message after entering this cell;
  - 2> if the *cellReselectionParametersHRPD* is included:
    - 3> forward the *neighCellList* to the CDMA2000 upper layers;
- 1> if the *parametersIXRTT* is included:
  - 2> if the *csfb-RegistrationParamIXRTT* is included:

- 3> forward the *csfb-RegistrationParam1XRTT* to the CDMA2000 upper layers which will use this information to determine if a CS registration/re-registration towards CDMA2000 1xRTT in the EUTRA cell is required;
- 2> else:
  - 3> indicate to CDMA2000 upper layers that CSFB Registration to CDMA2000 1xRTT is not allowed;
- 2> if the *longCodeState1XRTT* is included:
  - 3> forward the *longCodeState1XRTT* to CDMA2000 upper layers;
- 2> if the *cellReselectionParameters1XRTT* is included:
  - 3> forward the *neighCellList* to the CDMA2000 upper layers;
- 2> if the *csfb-SupportForDualRxUEs* is included:
  - 3> forward *csfb-SupportForDualRxUEs* to the CDMA2000 upper layers;
- 2> else:
  - 3> forward *csfb-SupportForDualRxUEs*, with its value set to *FALSE*, to the CDMA2000 upper layers;
- 2> if *ac-BarringConfig1XRTT* is included:
  - 3> forward *ac-BarringConfig1XRTT* to the CDMA2000 upper layers;
- 2> if the *csfb-DualRxTxSupport* is included:
  - 3> forward *csfb-DualRxTxSupport* to the CDMA2000 upper layers;
- 2> else:
  - 3> forward *csfb-DualRxTxSupport*, with its value set to *FALSE*, to the CDMA2000 upper layers;

#### 5.2.2.16 Actions upon reception of *SystemInformationBlockType9*

Upon receiving *SystemInformationBlockType9*, the UE shall:

- 1> if *hnb-Name* is included, forward the *hnb-Name* to upper layers;

#### 5.2.2.17 Actions upon reception of *SystemInformationBlockType10*

Upon receiving *SystemInformationBlockType10*, the UE shall:

- 1> forward the received *warningType*, *messageIdentifier* and *serialNumber* to upper layers;

#### 5.2.2.18 Actions upon reception of *SystemInformationBlockType11*

Upon receiving *SystemInformationBlockType11*, the UE shall:

- 1> if there is no current value for *messageIdentifier* and *serialNumber* for *SystemInformationBlockType11*; or
- 1> if either the received value of *messageIdentifier* or of *serialNumber* or of both are different from the current values of *messageIdentifier* and *serialNumber* for *SystemInformationBlockType11*:
  - 2> use the received values of *messageIdentifier* and *serialNumber* for *SystemInformationBlockType11* as the current values of *messageIdentifier* and *serialNumber* for *SystemInformationBlockType11*;
  - 2> discard any previously buffered *warningMessageSegment*;
  - 2> if all segments of a warning message have been received:
    - 3> assemble the warning message from the received *warningMessageSegment*;

- 3> forward the received warning message, *messageIdentifier*, *serialNumber* and *dataCodingScheme* to upper layers;
- 3> stop reception of *SystemInformationBlockType11*;
- 3> discard the current values of *messageIdentifier* and *serialNumber* for *SystemInformationBlockType11*;
- 2> else:
  - 3> store the received *warningMessageSegment*;
  - 3> continue reception of *SystemInformationBlockType11*;
- 1> else if all segments of a warning message have been received:
  - 2> assemble the warning message from the received *warningMessageSegment*;
  - 2> forward the received complete warning message, *messageIdentifier*, *serialNumber* and *dataCodingScheme* to upper layers;
  - 2> stop reception of *SystemInformationBlockType11*;
  - 2> discard the current values of *messageIdentifier* and *serialNumber* for *SystemInformationBlockType11*;
- 1> else:
  - 2> store the received *warningMessageSegment*;
  - 2> continue reception of *SystemInformationBlockType11*;

The UE should discard any stored *warningMessageSegment* and the current value of *messageIdentifier* and *serialNumber* for *SystemInformationBlockType11* if the complete warning message has not been assembled within a period of 3 hours.

### 5.2.2.19 Actions upon reception of *SystemInformationBlockType12*

Upon receiving *SystemInformationBlockType12*, the UE shall:

- 1> if the *SystemInformationBlockType12* contains a complete warning message and the complete geographical area coordinates (if any):
  - 2> forward the received warning message, *messageIdentifier*, *serialNumber*, *dataCodingScheme* and the geographical area coordinates (if any) to upper layers;
  - 2> continue reception of *SystemInformationBlockType12*;
- 1> else:
  - 2> if the received values of *messageIdentifier* and *serialNumber* are the same (each value is the same) as a pair for which a warning message and the geographical area coordinates (if any) are currently being assembled:
    - 3> store the received *warningMessageSegment*;
    - 3> store the received *warningAreaCoordinatesSegment* (if any);
  - 3> if all segments of a warning message and geographical area coordinates (if any) have been received:
    - 4> assemble the warning message from the received *warningMessageSegment*;
    - 4> assemble the geographical area coordinates from the received *warningAreaCoordinatesSegment* (if any);
    - 4> forward the received warning message, *messageIdentifier*, *serialNumber*, *dataCodingScheme* and geographical area coordinates (if any) to upper layers;
    - 4> stop assembling a warning message and warning area coordinates (if any) for this *messageIdentifier* and *serialNumber* and delete all stored information held for it;

- 3> continue reception of *SystemInformationBlockType12*;
- 2> else if the received values of *messageIdentifier* and/or *serialNumber* are not the same as any of the pairs for which a warning message is currently being assembled:
  - 3> start assembling a warning message for this *messageIdentifier* and *serialNumber* pair;
  - 3> start assembling the geographical area coordinates (if any) for this *messageIdentifier* and *serialNumber* pair;
  - 3> store the received *warningMessageSegment*;
  - 3> store the received *warningAreaCoordinatesSegment* (if any);
  - 3> continue reception of *SystemInformationBlockType12*;

The UE should discard *warningMessageSegment* and *warningAreaCoordinatesSegment* (if any) and the associated values of *messageIdentifier* and *serialNumber* for *SystemInformationBlockType12* if the complete warning message and the warning area coordinates (if any) have not been assembled within a period of 3 hours.

NOTE: The number of warning messages that a UE can re-assemble simultaneously is a function of UE implementation.

#### 5.2.2.20 Actions upon reception of *SystemInformationBlockType13*

No UE requirements related to the contents of this *SystemInformationBlock* apply other than those specified elsewhere e.g. within procedures using the concerned system information, and/ or within the corresponding field descriptions.

#### 5.2.2.21 Actions upon reception of *SystemInformationBlockType14*

No UE requirements related to the contents of this *SystemInformationBlock* (*SystemInformationBlockType14* or *SystemInformationBlockType14-NB*) apply other than those specified elsewhere e.g. within procedures using the concerned system information, and/ or within the corresponding field descriptions.

#### 5.2.2.22 Actions upon reception of *SystemInformationBlockType15*

No UE requirements related to the contents of this *SystemInformationBlock* (*SystemInformationBlockType15* or *SystemInformationBlockType15-NB*) apply other than those specified elsewhere e.g. within procedures using the concerned system information, and/ or within the corresponding field descriptions.

#### 5.2.2.23 Actions upon reception of *SystemInformationBlockType16*

Upon receiving *SystemInformationBlockType16* with *timeReferenceInfo*, the UE may perform the related actions as specified in clause 5.6.1.3.

#### 5.2.2.24 Actions upon reception of *SystemInformationBlockType17*

Upon receiving *SystemInformationBlockType17*, the UE shall:

- 1> if *wlan-OffloadConfigCommon* corresponding to the RPLMN is included:
  - 2> if the UE is not configured with *rclwi-Configuration* with *command* set to *steerToWLAN*:
    - 3> apply the *wlan-Id-List* corresponding to the RPLMN;
  - 2> if not configured with the *wlan-OffloadConfigDedicated*:
    - 3> apply the *wlan-OffloadConfigCommon* corresponding to the RPLMN;

#### 5.2.2.25 Actions upon reception of *SystemInformationBlockType18*

Upon receiving *SystemInformationBlockType18*, the UE shall:



- 1> if *SystemInformationBlockType18* message includes the *commConfig*:
  - 2> if configured to receive sidelink communication:
    - 3> from the next SC period, as defined by *sc-Period*, use the resource pool indicated by *commRxPool* for sidelink communication monitoring, as specified in 5.10.3;
  - 2> if configured to transmit sidelink communication:
    - 3> from the next SC period, as defined by *sc-Period*, use the resource pool indicated by *commTxPoolNormalCommon*, *commTxPoolNormalCommonExt* or by *commTxPoolExceptional* for sidelink communication transmission, as specified in 5.10.4;

#### 5.2.2.26 Actions upon reception of *SystemInformationBlockType19*

Upon receiving *SystemInformationBlockType19*, the UE shall:

- 1> if *SystemInformationBlockType19* message includes the *discConfig* or *discConfigPS*:
  - 2> from the next discovery period, as defined by *discPeriod*, use the resources indicated by *discRxPool*, *discRxResourcesInterFreq* or *discRxPoolPS* for sidelink discovery monitoring, as specified in 5.10.5;
- 2> if *SystemInformationBlockType19* message includes the *discTxPoolCommon* or *discTxPoolPS-Common*; and the UE is in RRC\_IDLE:
  - 3> from the next discovery period, as defined by *discPeriod*, use the resources indicated by *discTxPoolCommon* or *discTxPoolPS-Common* for sidelink discovery announcement, as specified in 5.10.6;
- 2> if the *SystemInformationBlockType19* message includes the *discTxPowerInfo*:
  - 3> use the power information included in *discTxPowerInfo* for sidelink discovery transmission on the serving frequency, as specified in TS 36.213 [23];
- 1> if *SystemInformationBlockType19* message includes the *discConfigRelay*:
  - 2> if the *SystemInformationBlockType19* message includes the *txPowerInfo*:
    - 3> use the power information included in *txPowerInfo* for sidelink discovery transmission on the corresponding non-serving frequency, as specified in TS 36.213 [23];

#### 5.2.2.27 Actions upon reception of *SystemInformationBlockType20*

No UE requirements related to the contents of this *SystemInformationBlock* (*SystemInformationBlockType20* or *SystemInformationBlockType20-NB*) apply other than those specified elsewhere e.g. within procedures using the concerned system information, and/ or within the corresponding field descriptions.

#### 5.2.2.28 Actions upon reception of *SystemInformationBlockType21*

Upon receiving *SystemInformationBlockType21*, the UE shall:

- 1> if *SystemInformationBlockType21* message includes *sl-A2X-ConfigCommon*:
  - 2> if configured to receive A2X sidelink communication:
    - 3> in the remainder of the procedures, consider *sl-V2X-ConfigCommon* as included and use the resource pool indicated by *a2x-CommRxPool* and *a2x-CommTxPool* in *sl-A2X-ConfigCommon* for sidelink communication for A2X instead of *v2x-CommRxPool* and *v2x-CommTxPoolNormalCommon* in *sl-V2XConfigCommon*;
- 1> if *SystemInformationBlockType21* message includes *sl-V2X-ConfigCommon*:
  - 2> if configured to receive V2X sidelink communication:

- 3> use the resource pool indicated by *v2x-CommRxPool* in *sl-V2X-ConfigCommon* for V2X sidelink communication monitoring, as specified in 5.10.12;
- 2> if configured to transmit V2X sidelink communication:
  - 3> use the resource pool indicated by *v2x-CommTxPoolNormalCommon*, *p2x-CommTxPoolNormalCommon*, *v2x-CommTxPoolNormal*, *p2x-CommTxPoolNormal* or by *v2x-CommTxPoolExceptional* for V2X sidelink communication transmission, as specified in 5.10.13;
  - 3> perform CBR measurement on the transmission resource pool(s) indicated by *v2x-CommTxPoolNormalCommon*, *v2x-CommTxPoolNormal* and *v2x-CommTxPoolExceptional* for V2X sidelink communication transmission, as specified in 5.5.3;

#### 5.2.2.29 Actions upon reception of *SystemInformationBlockType22-NB*

No UE requirements related to the contents of this *SystemInformationBlock* apply other than those specified elsewhere e.g. within procedures using the concerned system information, and/ or within the corresponding field descriptions.

#### 5.2.2.30 Actions upon reception of *SystemInformationBlockType23-NB*

No UE requirements related to the contents of this *SystemInformationBlock* apply other than those specified elsewhere e.g. within procedures using the concerned system information, and/ or within the corresponding field descriptions.

#### 5.2.2.31 Actions upon reception of *SystemInformationBlockType24*

Upon receiving *SystemInformationBlockType24*, the UE shall:

- 1> if in RRC\_IDLE or RRC\_INACTIVE, and T331 is running:
- 2> perform the actions as specified in 5.6.20.1a;

#### 5.2.2.32 Actions upon reception of *SystemInformationBlockType25*

No UE requirements related to the contents of this *SystemInformationBlock* apply other than those specified elsewhere e.g. within procedures using the concerned system information, and/ or within the corresponding field descriptions.

#### 5.2.2.33 Actions upon reception of *SystemInformationBlockType26*

Upon receiving *SystemInformationBlockType26*, the UE shall:

- 1> if configured to receive V2X sidelink communication:
  - 2> use the resource pool indicated by *v2x-CommRxPool* for V2X sidelink communication monitoring, as specified in 5.10.12;
- 1> if configured to transmit V2X sidelink communication:
  - 2> use the resource pool indicated by *v2x-CommTxPoolNormal*, *p2x-CommTxPoolNormal* or by *v2x-CommTxPoolExceptional* for V2X sidelink communication transmission, as specified in 5.10.13;
  - 2> perform CBR measurement on the transmission resource pool(s) indicated by *v2x-CommTxPoolNormal* and *v2x-CommTxPoolExceptional* for V2X sidelink communication transmission, as specified in 5.5.3;

#### 5.2.2.33a Actions upon reception of *SystemInformationBlockType26a*

Upon receiving *SystemInformationBlockType26a* the UE shall:

- 1> if *nrBandList* is included for the selected PLMN and the UE supports to operate in EN-DC using the serving cell and at least one of NR bands in *nrBandList*:
  - 2> forward *upperLayerIndication*, as if the UE receives this field from SIB2, to upper layers;
- 1> else:

2> indicate upper layers absence of *upperLayerIndication*;

#### 5.2.2.34 Actions upon reception of *SystemInformationBlockPos*

No UE requirements related to the contents of the *SystemInformationBlockPos* apply other than those specified elsewhere e.g. within TS 36.355 [54], and/or within the corresponding field descriptions.

#### 5.2.2.35 Actions upon reception of *SystemInformationBlockType27*

No UE requirements related to the contents of this *SystemInformationBlock* (*SystemInformationBlockType27* or *SystemInformationBlockType27-NB*) apply other than those specified elsewhere e.g. within procedures using the concerned system information, and/ or within the corresponding field descriptions.

#### 5.2.2.36 Actions upon reception of *SystemInformationBlockType28*

- 1> if the UE has stored at least one segment of *SIB28* and the value tag of *SIB28* has changed since a previous segment was stored:
  - 2> discard all stored segments;
- 1> store the segment;
- 1> if all segments have been received:
  - 2> assemble *SIB12-IEs* from the received segments;
  - 2> perform actions as specified in 5.2.2.4.13 in TS 38.331 [82].

The UE should discard any stored segments for *SIB28* if the complete *SIB28* has not been assembled within a period of 3 hours. The UE shall discard any stored segments for *SIB 28* upon cell (re-)selection.

#### 5.2.2.37 Actions upon reception of *SystemInformationBlockType29*

No UE requirements related to the contents of this *SystemInformationBlock* apply other than those specified elsewhere e.g. within procedures using the concerned system information, and/ or within the corresponding field descriptions.

#### 5.2.2.38 Actions upon reception of *SystemInformationBlockType30*

Upon receiving *SystemInformationBlockType30*, the UE shall:

- 1> forward the applicable disaster roaming information for each PLMN sharing the cell to upper layers.

#### 5.2.2.39 Actions upon reception of *SystemInformationBlockType31*

Upon receiving *SystemInformationBlockType31* (*SystemInformationBlockType31-NB*), the UE shall:

- 1> start or restart timer T317 with the duration *ul-SyncValidityDuration* from the subframe indicated by *epochTime*.

#### 5.2.2.40 Actions upon reception of *SystemInformationBlockType32*

No UE requirements related to the contents of this *SystemInformationBlock* (*SystemInformationBlockType32* or *SystemInformationBlockType32-NB*) apply other than those specified elsewhere e.g. within procedures using the concerned system information, and/ or within the corresponding field descriptions.

#### 5.2.2.41 Actions upon reception of *SystemInformationBlockType33*

No UE requirements related to the contents of this *SystemInformationBlock* (*SystemInformationBlockType33* or *SystemInformationBlockType33-NB*) apply other than those specified elsewhere e.g. within procedures using the concerned system information, or within the corresponding field descriptions.

### 5.2.3 Acquisition of an SI message

When acquiring an SI message, the UE shall:

- 1> determine the start of the SI-window for the concerned SI message as follows:
  - 2> if the concerned SI message is configured in the *schedulingInfoList*, *schedulingInfoListExt* (if present) or if the concerned SI message is configured in the *posSchedulingInfoList* and *si-posOffset* is not configured;
  - 3> for the concerned SI message, determine the number  $n$  which corresponds to the order of entry in the concatenated list of SI messages configured by *schedulingInfoList*, *schedulingInfoListExt* (if present) and *posSchedulingInfoList* in *SystemInformationBlockType1*;
  - 3> determine the integer value  $x = (n - 1) * w$ , where  $w$  is the *si-WindowLength*;
  - 3> the SI-window starts at the subframe  $\#a$ , where  $a = x \bmod 10$ , in the radio frame for which  $\text{SFN} \bmod T = \text{FLOOR}(x/10)$ , where  $T$  is the *si-Periodicity* or the *posSI-Periodicity* of the concerned SI message;
- 2> else if the concerned SI message is configured by the *posSchedulingInfoList* and *si-posOffset* is configured determine the start of the SI-window for the concerned SI message as follows:
  - 3> determine the number  $m$  which corresponds to the number of SI messages with an associated *si-Periodicity* of 8 radio frames (80 ms), configured by *schedulingInfoList* and *schedulingInfoListExt* (if present) in *SystemInformationBlockType1*;
  - 3> for the concerned SI message, determine the number  $n$  which corresponds to the order of entry in the list of SI messages configured by *posSchedulingInfoList* in *SystemInformationBlockType1*;
  - 3> determine the integer value  $x = m * w + (n - 1) * w$ , where  $w$  is the *si-WindowLength*
  - 3> the SI-window starts at the subframe  $\#a$ , where  $a = x \bmod 10$ , in the radio frame for which  $\text{SFN} \bmod T = \text{FLOOR}(x/10) + 8$ , where  $T$  is the *posSI-Periodicity* of the concerned SI message;

NOTE: E-UTRAN should configure an SI-window of 1 ms only if all SIs are scheduled before subframe #5 in radio frames for which  $\text{SFN} \bmod 2 = 0$ .

- 1> receive DL-SCH using the SI-RNTI from the start of the SI-window and continue until the end of the SI-window whose absolute length in time is given by *si-WindowLength*, or until the SI message was received, excluding the following subframes:
  - 2> subframe #5 in radio frames for which  $\text{SFN} \bmod 2 = 0$ ;
  - 2> any MBSFN subframes;
  - 2> any uplink subframes in TDD;
- 1> if the SI message was not received by the end of the SI-window, repeat reception at the next SI-window occasion for the concerned SI message;

#### 5.2.3a Acquisition of an SI message by BL UE or UE in CE or a NB-IoT UE

When acquiring an SI message, the BL UE or UE in CE or NB-IoT UE shall:

- 1> determine the start of the SI-window for the concerned SI message as follows:
  - 2> if the concerned SI message is configured in the *schedulingInfoList*, *schedulingInfoListExt* (if present) or if the concerned SI message is configured in the *posSchedulingInfoList* and *si-posOffset* is not configured;
  - 3> for the concerned SI message, determine the number  $n$  which corresponds to the order of entry in the concatenated list of SI messages configured by *schedulingInfoList*, *schedulingInfoListExt* (if present) in *SystemInformationBlockType1-BR* (or *SystemInformationBlockType1-NB* in NB-IoT) and *posSchedulingInfoList* in *SystemInformationBlockType1-BR*;
  - 3> determine the integer value  $x = (n - 1) * w$ , where  $w$  is the *si-WindowLength-BR* (or *si-WindowLength* in NB-IoT);

- 3> if the UE is a NB-IoT UE:
  - 4> the SI-window starts at the subframe #0 in the radio frame for which  $(H\text{-SFN} * 1024 + \text{SFN}) \bmod T = \text{FLOOR}(x/10) + \text{Offset}$ , where  $T$  is the *si-Periodicity* of the concerned SI message and, Offset is the offset of the start of the SI-Window (*si-RadioFrameOffset*);
- 3> else:
  - 4> the SI-window starts at the subframe #0 in the radio frame for which  $\text{SFN} \bmod T = \text{FLOOR}(x/10)$ , where  $T$  is the *si-Periodicity* or the *posSI-Periodicity* of the concerned SI message;
- 2> else if the concerned SI message is configured by the *posSchedulingInfoList* and *si-posOffset* is configured determine the start of the SI-window for the concerned SI message as follows:
  - 3> determine the number  $m$  which corresponds to the number of SI messages with an associated *si-Periodicity* of 8 radio frames (80 ms), configured by *schedulingInfoList* and *schedulingInfoListExt* (if present) in *SystemInformationBlockType1-BR*;
  - 3> for the concerned SI message, determine the number  $n$  which corresponds to the order of entry in the list of SI messages configured by *posSchedulingInfoList* in *SystemInformationBlockType1-BR*;
  - 3> determine the integer value  $x = m*w + (n - 1)*w$ , where  $w$  is the *si-WindowLength-BR*;
  - 3> the SI-window starts at the subframe #0 in the radio frame for which  $\text{SFN} \bmod T = \text{FLOOR}(x/10) + 8$ , where  $T$  is the *posSI-Periodicity* of the concerned SI message;
- 1> if the UE is a NB-IoT UE:
  - 2> receive and accumulate SI message transmissions on DL-SCH from the start of the SI-window and continue until the end of the SI-window whose absolute length in time is given by *si-WindowLength*, starting from the radio frames as provided in *si-RepetitionPattern* and in subframes as provided in *downlinkBitmap*, or until successful decoding of the accumulated SI message transmissions excluding the subframes used for transmission of NPSS, NSSS, *MasterInformationBlock-NB/ MasterInformationBlock-TDD-NB* and *SystemInformationBlockType1-NB*. If there are not enough subframes for one SI message transmission in the radio frames as provided in *si-RepetitionPattern*, the UE shall continue to receive the SI message transmission in the radio frames following the radio frame indicated in *si-RepetitionPattern*;
- 1> else:
  - 2> receive and accumulate SI message transmissions on DL-SCH on narrowband provided by *si-Narrowband*, from the start of the SI-window and continue until the end of the SI-window whose absolute length in time is given by *si-WindowLength-BR*, only in radio frames as provided in *si-RepetitionPattern* and subframes as provided in *fdd-DownlinkOrTddSubframeBitmapBR* in *bandwidthReducedAccessRelatedInfo*, or until successful decoding of the accumulated SI message transmissions;
- 1> if the SI message was not possible to decode from the accumulated SI message transmissions by the end of the SI-window, continue reception and accumulation of SI message transmissions on DL-SCH in the next SI-window occasion for the concerned SI message;

### 5.2.3b Acquisition of an SI message from MBMS-dedicated cell

When acquiring an SI message, the UE shall:

- 1> determine the start of the SI-window for the concerned SI message as follows:
  - 2> for the concerned SI message, determine the number  $n$  which corresponds to the order of entry in the list of SI messages configured by *schedulingInfoList* in *SystemInformationBlockType1-MBMS*;
  - 2> determine the integer value  $x = (n - 1)*w$ , where  $w$  is the *si-WindowLength*;
  - 2> the SI-window starts always at the subframe # $a$ , where  $a = x \bmod 10$ , in the radio frame for which  $\text{SFN} \bmod T = \text{FLOOR}(x/10)$ , where  $T$  is the *si-Periodicity* of the concerned SI message;

- 1> receive DL-SCH using SI-RNTI with value in accordance with 36.321 [6] from the start of the SI-window and continue until the end of the SI-window whose absolute length in time is given by *si-WindowLength*, or until the SI message was received, excluding the following subframes:
  - 2> any MBSFN subframes;
- 1> if the SI message was not received by the end of the SI-window, repeat reception at the next SI-window occasion for the concerned SI message;

## 5.3 Connection control

### 5.3.1 Introduction

#### 5.3.1.1 RRC connection control

RRC connection establishment involves the establishment of SRB1. Except for EDT and transmission using PUR, E-UTRAN completes RRC connection establishment prior to completing the establishment of the S1 connection, i.e. prior to receiving the UE context information from the EPC. Consequently, AS security is not activated during the initial phase of the RRC connection. During this initial phase of the RRC connection, the E-UTRAN may configure the UE to perform measurement reporting, but the UE only sends the corresponding measurement reports after successful security activation. However, the UE only accepts a handover message when security has been activated.

NOTE 1: In case the serving frequency broadcasts multiple overlapping bands, E-UTRAN can only configure measurements after having obtained the UE capabilities, as the measurement configuration needs to be set according to the band selected by the UE.

Upon receiving the UE context from the EPC, E-UTRAN activates security (both ciphering and integrity protection) using the initial security activation procedure. The RRC messages to activate security (command and successful response) are integrity protected, while ciphering is started only after completion of the procedure. That is, the response to the message used to activate security is not ciphered, while the subsequent messages (e.g. used to establish SRB2 and DRBs) are both integrity protected and ciphered.

After having initiated the initial security activation procedure, E-UTRAN initiates the establishment of SRB2 and DRBs, i.e. E-UTRAN may do this prior to receiving the confirmation of the initial security activation from the UE. In any case, E-UTRAN will apply both ciphering and integrity protection for the RRC connection reconfiguration messages used to establish SRB2 and DRBs. E-UTRAN should release the RRC connection if the initial security activation and/ or the radio bearer establishment fails (i.e. security activation and DRB establishment are triggered by a joint S1-procedure, which does not support partial success).

For SRB2 and DRBs, security is always activated from the start, i.e. the E-UTRAN does not establish these bearers prior to activating security.

For some radio configuration fields, a critical extension has been defined. A switch from the original version of the field to the critically extended version is allowed using any connection reconfiguration. The UE reverts to the original version of some critically extended fields upon handover and re-establishment as specified elsewhere in this specification. Otherwise, switching a field from the critically extended version to the original version is only possible using the handover or re-establishment procedure with the full configuration option. This also applies for fields that are critically extended within a release (i.e. original and extended version defined in same release).

After having initiated the initial security activation procedure, E-UTRAN may configure a UE that supports CA, with one or more SCells in addition to the PCell that was initially configured during connection establishment. The PCell is used to provide the security inputs and upper layer system information (i.e. the NAS mobility information e.g. TAI). SCells are used to provide additional downlink and optionally uplink radio resources. When not configured with any kind of DC, all SCells the UE is configured with, if any, are part of the MCG.

When configured with DC, some of the SCells are part of a SCG. In this case, user data carried by a DRB may either be transferred via MCG (i.e. MCG-DRB), via SCG (SCG-DRB) or via both MCG and SCG in DL while E-UTRAN configures the CG used in UL (split DRB). An RRC connection reconfiguration message may be used to change the DRB type from MCG-DRB to SCG-DRB or to split DRB, as well as from SCG-DRB or split DRB to MCG-DRB.

DC employs SCG change, which is a synchronous SCG reconfiguration procedure (i.e. involving RA to the PSCell) including reset/ re-establishment of layer 2 and, if SCG DRBs are configured, refresh of security. The procedure is used

in a number of different scenarios e.g. SCG establishment, PSCell change, Key refresh, change of DRB type. The UE performs the SCG change related actions upon receiving an *RRCConnectionReconfiguration* message including *mobilityControlInfoSCG*, see 5.3.10.10.

In case of MR-DC, the cells of one CG use another RAT, namely NR. The configuration of an NR CG is specified in TS 38.331 [82]. When configured with MR-DC, user data carried by a DRB may either be transferred via MCG, via NR SCG or via both MCG and NR SCG. Also RRC signalling carried by a SRB may either be transferred via MCG or via both MCG and NR SCG. When DRBs and SRBs are configured with transmission via both MCG and SCG, duplication may be used in both DL and UL.

When connected to EPC, change to NR PDCP or vice versa can be done for both SRBs and DRBs as follows. For DRBs, it can be performed using an *RRCConnectionReconfiguration* message either with or without the *mobilityControlInfo* (handover) by release and addition of the concerned RB. For SRBs, it can be performed using an *RRCConnectionReconfiguration* message with the *mobilityControlInfo* (handover) by release and addition of the concerned PDCP entity. For SRBs and DRBs, it can also be performed using the full configuration option. The same *RRCConnectionReconfiguration* message may be used to make changes regarding the CG(s) used for transmission. For SRB1, change from E-UTRA PDCP to NR PDCP type may, before initial security activation, also be performed using an *RRCConnectionReconfiguration* message not including the *mobilityControlInfo*.

In case of (NG)EN-DC, there are three types of NR SCG reconfigurations:

- Reconfiguration with sync and key change i.e. a procedure involving RA to the PSCell, including NR MAC reset, re-establishment of NR RLC and NR PDCP and refresh of NR SCG security; and
- Reconfiguration with sync but without key change i.e. a procedure involving RA to the PSCell, including NR MAC reset and NR RLC re-establishment and PDCP data recovery (for AM DRB); and
- Regular NR SCG reconfiguration neither involving refresh of NR SCG security, nor RA to the PSCell, NR MAC reset or NR RLC re-establishment;

The network is only required to use the NR SCG reconfiguration with sync and key change in case the NR SCG security key changes (i.e. handover, change of SNs, S-KgNB refresh). Further details are specified in NR RRC TS 38.331 [82].

NOTE 2: In case of MR-DC, E-UTRA RRC configuration parameters should only affect E-UTRA operation. E.g., *s-Measure* only affects measurements configured by parameters defined in this specification. Should an E-UTRA RRC configuration change require a change of NR RRC configuration, the network should indicate such NR change by NR RRC signalling. E.g. a specific indication is used to trigger RLC re-establishment upon reconfigurations changing the CG(s) used for transmission (in DL or UL) that otherwise would only involve NR RRC signalling.

In this release of the specification, change between DC and MR-DC as well as change between DC and E-UTRA configured with SN terminated DRB without SCG are not supported (i.e. neither the direct reconfiguration nor specific measurement events). Likewise, the direct transition between (NG)EN-DC and NR DC or NE-DC is not supported in this release of the specification.

The release of the RRC connection normally is initiated by E-UTRAN. The procedure may be used to re-direct the UE to an E-UTRA frequency or an inter-RAT carrier frequency. Only in exceptional cases, as specified within this specification, TS 36.300 [9], TS 36.304 [4] or TS 24.301 [35], may the UE abort the RRC connection, i.e. move to RRC\_IDLE without notifying E-UTRAN.

The suspension of the RRC connection is initiated by E-UTRA/EPC or E-UTRA/5GC. When the RRC connection is suspended, the UE stores the UE AS context and the *resumeIdentity* (EPC) or I-RNTI (5GC), and transitions to RRC\_IDLE state. The RRC message to suspend the RRC connection is integrity protected and ciphered. Suspension can only be performed when at least 1 DRB is successfully established.

The resumption of a suspended RRC connection is initiated by upper layers when the UE has a stored UE AS context, RRC connection resume is permitted by E-UTRA/EPC or E-UTRA/5GC and the UE needs to transit from RRC\_IDLE state to RRC\_CONNECTED state. When the RRC connection is resumed, RRC configures the UE according to the RRC connection resume procedure based on the stored UE AS context and any RRC configuration received from E-UTRA/EPC or E-UTRA/5GC. The RRC connection resume procedure re-activates security and re-establishes SRB(s) and DRB(s). The request to resume the RRC connection includes the *resumeIdentity* (EPC) or I-RNTI (5GC). The request is not ciphered, but protected with a message authentication code.

In response to a request to resume the RRC connection, E-UTRA/EPC or E-UTRA/5GC may resume the suspended RRC connection, reject the request to resume and instruct the UE to either keep or discard the stored context, or setup a new RRC connection.

In case of CP-EDT or CP transmission using PUR, the data are appended in the *RRCEarlyDataRequest* and *RRCEarlyDataComplete* messages, if available, and sent over SRB0. In case of UP-EDT or UP transmission using PUR, security is re-activated prior to transmission of RRC message using the *nextHopChainingCount* provided in the *RRCConnectionRelease* message with suspend indication during the preceding suspend procedure and the radio bearers are re-established. The uplink data are transmitted ciphered on DTCH multiplexed with the *RRCConnectionResumeRequest* message on CCCH. In the downlink, the data, if available, are transmitted on DTCH multiplexed with the *RRCConnectionRelease* message on DCCH. In response to a request for EDT or transmission using PUR, E-UTRA/EPC or E-UTRA/5GC may also choose to establish or resume the RRC connection.

A UE in RRC\_CONNECTED enters RRC\_INACTIVE when the network indicates RRC connection suspension in *RRCConnectionRelease* message. When entering RRC\_INACTIVE, the UE stores the UE Inactive AS context and any RRC configuration received from the network.

The resumption of an RRC connection from RRC\_INACTIVE is initiated by upper layers when the UE needs to transit from RRC\_INACTIVE state to RRC\_CONNECTED state or by RRC layer for, e.g. RNAU or reception of RAN paging. When the RRC connection is resumed, network configures the UE according to the RRC connection resume procedure based on the stored UE Inactive AS context and any RRC configuration received from the network. The RRC connection resume procedure re-activates security and re-establishes SRB(s) and DRB(s).

In response to a request to resume the RRC connection from RRC\_INACTIVE, the network may resume the suspended RRC connection and UE enters to RRC\_CONNECTED, or reject the request to resume using RRC message without security protection and send UE to RRC\_INACTIVE with wait time, or directly re-suspend the RRC connection and send UE to RRC\_INACTIVE, or directly release the RRC connection and send UE to RRC\_IDLE, or instruct the UE to initiate NAS level recovery.

NOTE 3: In case the configurations for V2X sidelink communication are acquired from NR, the configurations for V2X sidelink communication in *SystemInformationBlockType21*, *SystemInformationBlockType26*, *SL-V2X-ConfigDedicated* within *RRCConnectionReconfiguration* used in this clause can be provided by *SIB13*, *SIB14*, *sl-ConfigDedicatedEUTRA* within *RRCReconfiguration* as specified in TS 38.331 [82], respectively.

### 5.3.1.2 Security

AS security comprises of the integrity protection of RRC signalling (SRBs) as well as the ciphering of RRC signalling (SRBs) and user data (DRBs). Integrity protection is optionally supported for DRBs when using NR PDCP configured with *nr-RadioBearerConfig1* or *nr-RadioBearerConfig2*.

RRC handles the configuration of the security parameters which are part of the AS configuration: the integrity protection algorithm, the ciphering algorithm and two parameters, namely the *keyChangeIndicator* and the *nextHopChainingCount*, which are used by the UE to determine the AS security keys upon handover, connection re-establishment, connection resume, UP-EDT and/ or UP transmission using PUR.

The integrity protection algorithm is common for signalling radio bearers SRB1, SRB2 and SRB4. The integrity protection algorithm signalled in *nr-RadioBearerConfig1*/*nr-RadioBearerConfig2* for the DRBs configured to apply integrity protection of user data and *keyToUse* set to *master* as defined in TS 38.331 [82] is the same as the one signalled in *securityAlgorithmConfig*. When configured with MCG only, the ciphering algorithm is common for all radio bearers (i.e. SRB1, SRB2, SRB4 and DRBs). Neither integrity protection nor ciphering applies for SRB0.

RRC integrity and ciphering are always activated together, i.e. in one message/ procedure. RRC integrity and ciphering are never de-activated. However, it is possible to switch to a 'NULL' ciphering algorithm (eea0).

The 'NULL' integrity protection algorithm (eia0) is used only for the UE in limited service mode, as specified in TS 33.401 [32]. In case the 'NULL' integrity protection algorithm is used, 'NULL' ciphering algorithm is also used.

NOTE 1: Lower layers discard RRC messages for which the integrity check has failed and indicate the integrity verification check failure to RRC.

The AS applies different security keys: one for the integrity protection of RRC signalling ( $K_{\text{RRCint}}$ ), one for the ciphering of RRC signalling ( $K_{\text{RRCenc}}$ ) and one for the ciphering of user data ( $K_{\text{UPenc}}$ ). For the UE capable of user plane integrity protection when it is connected to E-UTRA/EPC (TS 33.401 [32]), the AS applies a security key for integrity protection



of user data ( $K_{UPint}$ ) for the DRBs that are configured to apply integrity protection of user data. All AS keys are derived from the  $K_{eNB}$  key. The  $K_{eNB}$  is based on the  $K_{ASME}$  key for E-UTRA/EPC, or  $K_{AMF}$  for E-UTRA/5GC, which is handled by upper layers.

Upon connection establishment new AS keys are derived. No AS-parameters are exchanged to serve as inputs for the derivation of the new AS keys at connection establishment.

The integrity and ciphering of the RRC message used to perform handover is based on the security configuration used prior to the handover and is performed by the source eNB.

The integrity and ciphering algorithms can only be changed upon handover. The AS keys ( $K_{eNB}$ ,  $K_{RRCint}$ ,  $K_{RRCenc}$ ,  $K_{UPenc}$  and  $K_{UPint}$ ) change upon every handover, connection re-establishment, connection resume, UP-EDT and UP transmission using PUR. The *keyChangeIndicator* is used upon handover and indicates whether the UE should use the keys associated with the  $K_{ASME}$  key for E-UTRA/EPC, or  $K_{AMF}$  for E-UTRA/5GC, taken into use with the latest successful NAS SMC procedure. The *nextHopChainingCount* parameter is used upon handover, connection re-establishment, connection resume, UP-EDT and UP transmission using PUR by the UE when deriving the new  $K_{eNB}$  that is used to generate  $K_{RRCint}$ ,  $K_{RRCenc}$  and  $K_{UPenc}$  (see TS 33.401 [32]). An intra cell handover procedure may be used to change the keys in RRC\_CONNECTED.

For each radio bearer an independent counter (COUNT, as specified in TS 36.323 [8] for E-UTRA/EPC, and TS 38.323 [83] for E-UTRA/5GC) is maintained for each direction. For each DRB, the COUNT is used as input for ciphering. For each SRB, the COUNT is used as input for both ciphering and integrity protection. It is not allowed to use the same COUNT value more than once for a given security key. At connection resume the COUNT is reset. As specified in TS 33.401 clause 7.2.9.1 [32], the eNB is responsible for avoiding reuse of the COUNT with the same RB identity and with the same  $K_{eNB}$ , e.g. due to the transfer of large volumes of data, release and establishment of new RBs, and multiple termination point changes for RLC-UM bearers, multiple termination point changes for RLC-AM bearer with SN terminated PDCP re-establishment (COUNT reset) due to SN only full configuration whilst the key stream inputs (i.e. bearer ID, security key) at MN have not been updated. In order to avoid such re-use, the eNB may e.g. use different RB identities for successive RB establishments, trigger an intra cell handover or by triggering a transition from RRC\_CONNECTED to RRC\_IDLE or RRC\_INACTIVE and then back to RRC\_CONNECTED.

In order to limit the signalling overhead, individual messages/ packets include a short sequence number (PDCP SN, as specified in TS 36.323 [8] for E-UTRA/EPC, and TS 38.323 [83] for E-UTRA/5GC). In addition, an overflow counter mechanism is used: the hyper frame number (TX\_HFN and RX\_HFN, as specified in TS 36.323 [8] for E-UTRA/EPC, and HFN as specified in TS 38.323 [83] for E-UTRA/5GC). The HFN needs to be synchronized between the UE and the eNB.

For each SRB, the value provided by RRC to lower layers to derive the 5-bit BEARER parameter used as input for ciphering and for integrity protection is the value of the corresponding *srb-Identity* with the MSBs padded with zeroes.

With E-UTRA/5GC for a UE not capable of NGEN-DC, the same ciphering algorithm signalled at SMC or handover is used for all radio bearers. Likewise, the same integrity algorithm signalled at SMC or handover is used for all SRBs.

In case of DC, a separate  $K_{eNB}$  is used for SCG-DRBs (S- $K_{eNB}$ ). This key is derived from the key used for the MCG ( $K_{eNB}$ ) and an SCG counter that is used to ensure freshness. To refresh the S- $K_{eNB}$  e.g. when the COUNT will wrap around, E-UTRAN employs an SCG change, i.e. an *RRCConnectionReconfiguration* message including *mobilityControlInfoSCG*. When performing handover, while at least one SCG-DRB remains configured, both  $K_{eNB}$  and S- $K_{eNB}$  are refreshed. In such case E-UTRAN performs handover with SCG change i.e. an *RRCConnectionReconfiguration* message including both *mobilityControlInfo* and *mobilityControlInfoSCG*. The ciphering algorithm is common for all radio bearers within a CG but may be different between MCG and SCG. The ciphering algorithm for SCG DRBs can only be changed upon SCG change.

In case of (NG)EN-DC or of SN terminated RB without SCG, the network indicates whether the UE shall use either  $K_{eNB}$  or S- $K_{gNB}$  for a particular DRB. In case of NE-DC, the network indicates whether the UE shall use either  $K_{gNB}$  or S- $K_{eNB}$  for a particular DRB. S- $K_{gNB}$ /S- $K_{eNB}$  is derived from  $K_{eNB}/K_{gNB}$  as defined in TS 33.501 [86], uses a different counter (*sk-Counter*) and is used only for DRBs using NR PDCP. Whenever there is a need to refresh S- $K_{gNB}$ /S- $K_{eNB}$ , e.g. upon change of MN or SN, the NR SCG reconfiguration with sync and key change is used for S- $K_{gNB}$  refresh (see 5.3.1.1) and the *RRCConnectionReconfiguration* message including *mobilityControlInfoSCG* is used for S- $K_{eNB}$  refresh (see 5.3.10.10). E-UTRAN provides a UE configured with (NG)EN-DC with an *sk-Counter* even when no DRB is setup using S- $K_{gNB}$  i.e. to facilitate configuration of SRB3. The same ciphering algorithm as signalled by *nr-RadioBearerConfig1* and *nr-RadioBearerConfig2* as defined in TS 38.331 [82] is used for all radio bearers using the same key (i.e.  $K_{eNB}$  or S- $K_{gNB}$ ). Likewise, the same integrity algorithm as signalled by *nr-RadioBearerConfig1* and *nr-RadioBearerConfig2* as defined in TS 38.331 [82] is used for all SRBs, and DRBs configured to apply integrity protection of user data, using the same key. Although NR RRC uses different values for the security algorithms than E-

UTRA, the actual algorithms are the same in case of (NG)EN-DC and NE-DC in this version of the specification. Hence, for such algorithms, the security capabilities supported by a UE are consistent across these RATs. For MR-DC with 5GC, integrity protection is not enabled for DRBs terminated on ng-eNB or when the master node is an ng-eNB.

NOTE 2: The network ensures that different values are used for the SCG counter and for the *sk-Counter* when deriving  $S-K_{gNB}$  and/or  $S-K_{eNB}$  from the same master key.

### 5.3.1.2a RN security

For RNs, AS security follows the procedures in 5.3.1.2. Furthermore, E-UTRAN may configure per DRB whether or not integrity protection is used. The use of integrity protection may be configured only upon DRB establishment and reconfigured only upon handover or upon the first reconfiguration following RRC connection re-establishment.

To provide integrity protection on DRBs between the RN and the E-UTRAN, the  $K_{UPint}$  key is derived from the  $K_{eNB}$  key as described in TS 33.401 [32]. The same integrity protection algorithm used for SRBs also applies to the DRBs. The  $K_{UPint}$  changes at every handover and RRC connection re-establishment and is based on an updated  $K_{eNB}$  which is derived by taking into account the *nextHopChainingCount*. The COUNT value maintained for DRB ciphering is also used for integrity protection, if the integrity protection is configured for the DRB.

### 5.3.1.3 Connected mode mobility

In RRC\_CONNECTED, the network controls UE mobility, i.e. the network decides when the UE shall connect to which E-UTRA cell(s), or inter-RAT cell. For network controlled mobility in RRC\_CONNECTED, the PCell can be changed using an *RRCConnectionReconfiguration* message including the *mobilityControlInfo* (handover), whereas the SCell(s) can be changed using the *RRCConnectionReconfiguration* message either with or without the *mobilityControlInfo*.

In DC, an SCG can be established, reconfigured or released by using an *RRCConnectionReconfiguration* message with or without the *mobilityControlInfo*. In case Random Access to the PCell or initial PUSCH transmission to the PCell if *rach-SkipSCG* is configured is required upon SCG reconfiguration, E-UTRAN employs the SCG change procedure (i.e. an *RRCConnectionReconfiguration* message including the *mobilityControlInfoSCG*). The PCell can only be changed using the SCG change procedure and by release and addition of the PCell.

In (NG)EN-DC, an NR SCG can be established or reconfigured by using an *RRCConnectionReconfiguration* message containing *nr-secondaryCellGroupConfig* and *nr-RadioBearerConfig*. The contents of *nr-secondaryCellGroupConfig* and *nr-RadioBearerConfig*, of other (NG)EN-DC fields as well as the associated procedures are specified in TS 38.331 [82]. In (NG)EN-DC, the PCell can only be changed using the Reconfiguration with sync procedure, with or without MR-DC release and addition.

The network triggers the handover procedure e.g. based on radio conditions, load. To facilitate this, the network may configure the UE to perform measurement reporting (possibly including the configuration of measurement gaps). The network may also initiate handover blindly, i.e. without having received measurement reports from the UE.

Before sending the handover message to the UE, the source eNB prepares one or more target cells. The source eNB selects the target PCell. The source eNB may also provide the target eNB with a list of best cells on each frequency for which measurement information is available, in order of decreasing RSRP. The source eNB may also include available measurement information for the cells provided in the list. The target eNB decides which SCells are configured for use after handover, which may include cells other than the ones indicated by the source eNB. If an SCG is configured, handover involves either SCG release or either SCG change (in case of DC) or an NR SCG reconfiguration with sync and key change (in case of EN-DC and NGEN-DC). In case the UE was configured with (EN-) DC or NGEN-DC, the target eNB indicates in the handover message whether the UE shall release the entire (NR) SCG configuration. Upon connection re-establishment, the UE releases the entire SCG configuration except for the DRB configuration, while E-UTRAN in the first reconfiguration message following the re-establishment either releases the DRB(s) or reconfigures the DRB(s) to MCG DRB(s).

The target eNB generates the message used to perform the handover, i.e. the message including the AS-configuration to be used in the target cell(s). The source eNB transparently (i.e. does not alter values/ content) forwards the handover message/ information received from the target to the UE. When appropriate, the source eNB may initiate data forwarding for (a subset of) the DRBs.

After receiving the handover message, the UE attempts to access the target PCell at the first available RACH occasion according to Random Access resource selection defined in TS 36.321 [6], i.e. the handover is asynchronous, or at the first available PUSCH occasion if *rach-Skip* is configured. Consequently, when allocating a dedicated preamble for the

random access in the target PCell, E-UTRA shall ensure it is available from the first RACH occasion the UE may use. The first available PUSCH occasion is provided by *ul-ConfigInfo*, if configured, otherwise UE shall monitor the PDCCH of target eNB. Upon successful completion of the handover, the UE sends a message used to confirm the handover.

If the target eNB does not support the release of RRC protocol which the source eNB used to configure the UE, the target eNB may be unable to comprehend the UE configuration provided by the source eNB. In this case, the target eNB should use the full configuration option to reconfigure the UE for Handover and Re-establishment. Full configuration option includes an initialization of the radio configuration, which makes the procedure independent of the configuration used in the source cell(s) with the exception that the security algorithms are continued for the RRC re-establishment.

The same behavior applies in (NG)EN-DC, if upon handover the target eNB is unable to comprehend the MCG part of the UE configuration i.e. the target eNB uses the full configuration option which involves release and configuration of (most of the) MCG and NR SCG configuration. In case of (NG)EN-DC, the target SgNB may be unable to comprehend the NR SCG configuration provided by the source SgNB. In such a case, release and addition may be applied for the NR SCG part of the configuration.

NOTE 1: When using release and addition for the NR SCG configuration during handover or SN change, E-UTRAN includes *drb-ToReleaseList* for the SN terminated RBs. For SN modification case, see TS 37.340 [81].

After the successful completion of handover, PDCP SDUs may be re-transmitted in the target cell(s). This only applies for DRBs using RLC-AM mode and for handovers not involving full configuration option. The further details are specified in TS 36.323 [8]. After the successful completion of handover not involving full configuration option, the SN and the HFN are reset except for the DRBs using RLC-AM mode (for which both SN and HFN continue). For reconfigurations involving the full configuration option, the PDCP entities are newly established (SN and HFN do not continue) for all DRBs irrespective of the RLC mode. The further details are specified in TS 36.323 [8].

One UE behaviour to be performed upon handover is specified, i.e. this is regardless of the handover procedures used within the network (e.g. whether the handover includes X2 or S1 signalling procedures).

The source eNB should, for some time, maintain a context to enable the UE to return in case of handover failure. After having detected handover failure, the UE attempts to resume the RRC connection either in the source PCell or in another cell using the RRC re-establishment procedure. This connection resumption succeeds only if the accessed cell is prepared, i.e. concerns a cell of the source eNB or of another eNB towards which handover preparation has been performed. The cell in which the re-establishment procedure succeeds becomes the PCell while SCells and STAGs, if configured, are released.

Normal measurement and mobility procedures are used to support handover to cells broadcasting a CSG identity. In addition, E-UTRAN may configure the UE to report that it is entering or leaving the proximity of cell(s) included in its Permitted CSG list. Furthermore, E-UTRAN may request the UE to provide additional information broadcast by the handover candidate cell e.g. global cell identity, CSG identity, CSG membership status.

NOTE 2: E-UTRAN may use the 'proximity report' to configure measurements as well as to decide whether or not to request additional information broadcast by the handover candidate cell. The additional information is used to verify whether or not the UE is authorised to access the target PCell and may also be needed to identify handover candidate cell (*PCI confusion* i.e. when the physical layer identity that is included in the measurement report does not uniquely identify the cell).

#### 5.3.1.4 Connection control in NB-IoT

In NB-IoT, during the RRC connection establishment procedure, SRB1bis is established implicitly with SRB1. SRB1bis uses the logical channel identity defined in 9.1.2a, with the same configuration as SRB1 but no PDCP entity. SRB1bis is used until security is activated. The RRC messages to activate security (command and successful response) are sent over SRB1 being integrity protected and ciphering is started after completion of the procedure. In case of unsuccessful security activation, the failure message is sent over SRB1 and subsequent messages are sent over SRB1bis. Once security is activated, new RRC messages shall be transmitted using SRB1. A NB-IoT UE that only supports the Control Plane CIoT EPS optimisation (see TS 24.301 [35]) or the Control Plane CIoT 5GS optimisation (see TS 24.501 [95]) only establishes SRB1bis.

A NB-IoT UE only supports 0, 1 or 2 DRBs, depending on its capability. A NB-IoT UE that only supports the Control Plane CIoT EPS optimisation (see TS 24.301 [35]) or the Control Plane CIoT 5GS optimisation (see TS 24.501 [95]) does not need to support any DRBs and associated procedures.

Table 5.3.1.4-1 lists the procedures that are applicable for NB-IoT. All other procedures are not applicable; this is not further stated in the corresponding procedures.

**Table 5.3.1.4-1: Connection control procedures applicable to a NB-IoT UE**

Clause	Procedures
5.3.2	Paging
5.3.3	RRC connection establishment
	RRC connection resume (see NOTE)
	CP-EDT
	UP-EDT (see NOTE)
	CP transmission using PUR
	UP transmission using PUR (see NOTE)
5.3.4	Initial security activation (see NOTE)
5.3.5	RRC connection reconfiguration (see NOTE)
5.3.7	RRC connection re-establishment
5.3.8	RRC connection release
5.3.9	RRC connection release requested by upper layers
5.3.10	Radio resource configuration
5.3.11	Radio link failure related actions
5.3.12	UE actions upon leaving RRC_CONNECTED
5.3.13b	Action upon receiving PUR release request
5.3.16	Unified Access Control

NOTE: Not applicable for a UE that only supports the Control Plane CIoT EPS optimisation (see TS 24.301 [35]) or the Control Plane CIoT 5GS optimisation (see TS 24.501 [95]).

## 5.3.2 Paging

### 5.3.2.1 General



**Figure 5.3.2.1-1: Paging**

The purpose of this procedure is:

- to transmit CN initiated paging information to a UE in RRC\_IDLE or RRC\_INACTIVE and/ or;
- to transmit RAN initiated paging information to a UE in RRC\_INACTIVE and/or;
- to inform UEs in RRC\_IDLE, UEs in RRC\_INACTIVE and UEs in RRC\_CONNECTED other than NB-IoT UEs, BL UEs and UEs in CE, about a system information change and/ or;
- to inform UEs in RRC\_IDLE other than NB-IoT UEs, UEs in RRC\_INACTIVE and UEs in RRC\_CONNECTED other than NB-IoT UEs, BL UEs and UEs in CE, about an ETWS primary notification and/ or ETWS secondary notification and/ or;
- to inform UEs in RRC\_IDLE other than NB-IoT UEs, UEs in RRC\_INACTIVE and UEs in RRC\_CONNECTED other than NB-IoT UEs, BL UEs and UEs in CE, about a CMAS notification and/ or;
- to inform UEs other than NB-IoT UEs in RRC\_IDLE, and other than UEs connected to 5GC about an EAB parameters modification and/ or;
- to inform UEs other than NB-IoT UEs in RRC\_IDLE, and UEs in RRC\_INACTIVE to perform E-UTRAN inter-frequency redistribution procedure.

The paging information of CN initiated paging is provided to upper layers, which in response may initiate RRC connection establishment, e.g. to receive an incoming call.

### 5.3.2.2 Initiation

E-UTRAN initiates the paging procedure by transmitting the *Paging* message at the UE's paging occasion as specified in TS 36.304 [4]. E-UTRAN may address multiple UEs within a *Paging* message by including one *PagingRecord* for each UE. E-UTRAN may also indicate a change of system information, and/ or provide an ETWS notification or a CMAS notification in the *Paging* message.

### 5.3.2.3 Reception of the *Paging* message by the UE

Upon receiving the *Paging* message, the UE shall:

- 1> if in RRC\_IDLE, for each of the *PagingRecord*, if any, included in the *Paging* message:
  - 2> if the *ue-Identity* included in the *PagingRecord* matches one of the UE identities allocated by upper layers:
    - 3> except for NB-IoT, if upper layers indicate the support of paging cause:
      - 4> forward the *ue-Identity*, *accessType* (if present), paging cause (if determined) and the *cn-Domain* to the upper layers;
    - 3> else:
      - 4> forward the *ue-Identity*, *accessType* (if present) and, except for NB-IoT, the *cn-Domain* to the upper layers;
    - 3> store *mt-EDT*, if present;
  - 1> if in RRC\_INACTIVE, for each of the *PagingRecord*, if any, included in the *Paging* message:
    - 2> if the *ue-Identity* included in the *PagingRecord* matches the stored *fullI-RNTI*:
      - 3> if UE is configured with one or more access identities equal to 1, 2 or 11-15 applicable in the selected PLMN:
        - 4> initiate RRC connection resume procedure in 5.3.3.2 with cause value set to 'highPriorityAccess';
      - 3> else:
        - 4> initiate the RRC connection resumption procedure according to 5.3.3.2 with cause value set to 'mt-access';

NOTE 1: A MUSIM UE may not initiate the RRC connection resumption procedure, e.g. when it decides not to respond to the *Paging* message due to UE implementation constraints as specified in TS 24.501 [95].2> else if the *ue-Identity* included in the *PagingRecord* matches one of the UE identities allocated by upper layers:

- 3> if upper layers indicate the support of paging cause:
  - 4> forward the *ue-Identity*, *accessType* (if present), paging cause (if determined) and the *cn-Domain* to the upper layers;
- 3> else:
  - 4> forward the *ue-Identity*, *accessType* (if present) and the *cn-Domain* to the upper layers;
- 3> perform the actions upon leaving RRC\_INACTIVE as specified in 5.3.12, with release cause 'other';
- 1> if the UE is not configured with a DRX cycle longer than the modification period and the *systemInfoModification* is included; or
- 1> if the UE is configured with a DRX cycle longer than the modification period and the *systemInfoModification-eDRX* is included:

2> re-acquire the required system information using the system information acquisition procedure as specified in 5.2.2;

1> if the *etws-Indication* is included and the UE is ETWS capable:

2> re-acquire *SystemInformationBlockType1* immediately, i.e., without waiting until the next system information modification period boundary;

2> if the *schedulingInfoList* indicates that *SystemInformationBlockType10* is present:

3> acquire *SystemInformationBlockType10*;

NOTE 2: If the UE is in CE, it is up to UE implementation when to start acquiring *SystemInformationBlockType10*.

2> if the *schedulingInfoList* indicates that *SystemInformationBlockType11* is present:

3> acquire *SystemInformationBlockType11*;

1> if the *cmass-Indication* is included and the UE is CMAS capable:

2> re-acquire *SystemInformationBlockType1* immediately, i.e., without waiting until the next system information modification period boundary as specified in 5.2.1.5;

2> if the *schedulingInfoList* indicates that *SystemInformationBlockType12* is present:

3> acquire *SystemInformationBlockType12*;

1> if in RRC\_IDLE, the *eab-ParamModification* is included and the UE is EAB capable:

2> consider previously stored *SystemInformationBlockType14* as invalid;

2> re-acquire *SystemInformationBlockType1* immediately, i.e., without waiting until the next system information modification period boundary as specified in 5.2.1.6;

2> re-acquire *SystemInformationBlockType14* using the system information acquisition procedure as specified in 5.2.2.4;

1> if in RRC\_IDLE, the *uac-ParamModification* is included and the UE connected to 5GC is a BL UE or UE in CE:

2> consider previously stored *SystemInformationBlockType25* as invalid;

2> re-acquire *SystemInformationBlockType1* immediately, i.e., without waiting until the next system information modification period boundary as specified in 5.2.1.6;

2> re-acquire *SystemInformationBlockType25* using the system information acquisition procedure as specified in 5.2.2.4;

1> if in RRC\_IDLE, the *redistributionIndication* is included and the UE is redistribution capable:

2> perform E-UTRAN inter-frequency redistribution procedure as specified in TS 36.304 [4], clause 5.2.4.10;

### 5.3.3 RRC connection establishment

#### 5.3.3.1 General

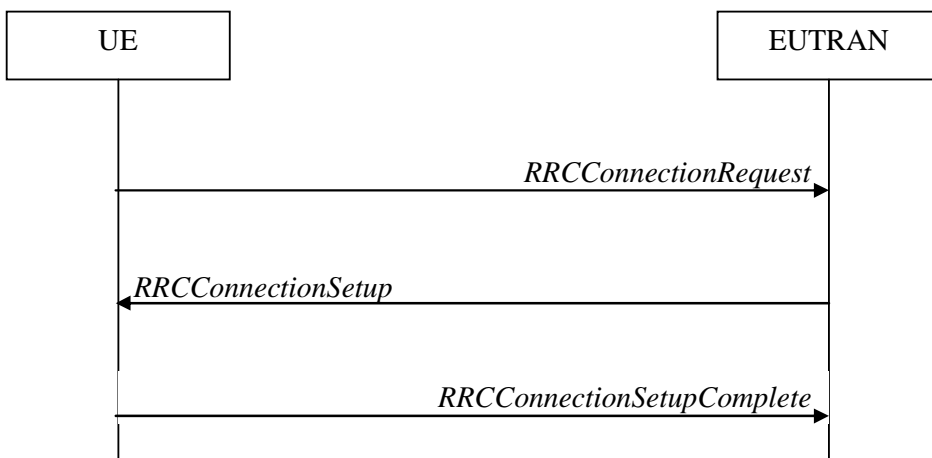

Figure 5.3.3.1-1: RRC connection establishment, successful

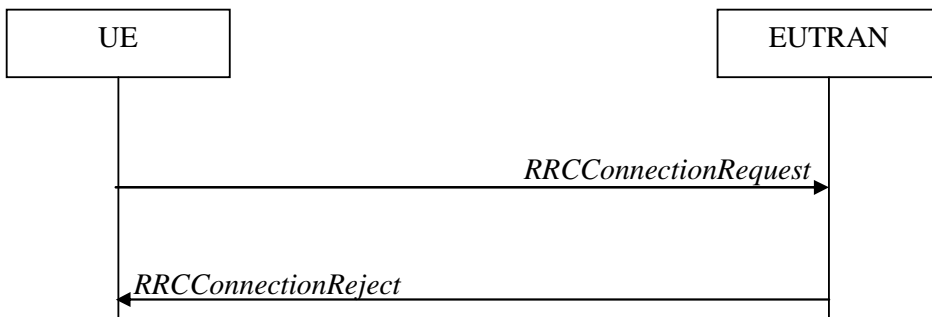

Figure 5.3.3.1-2: RRC connection establishment, network reject

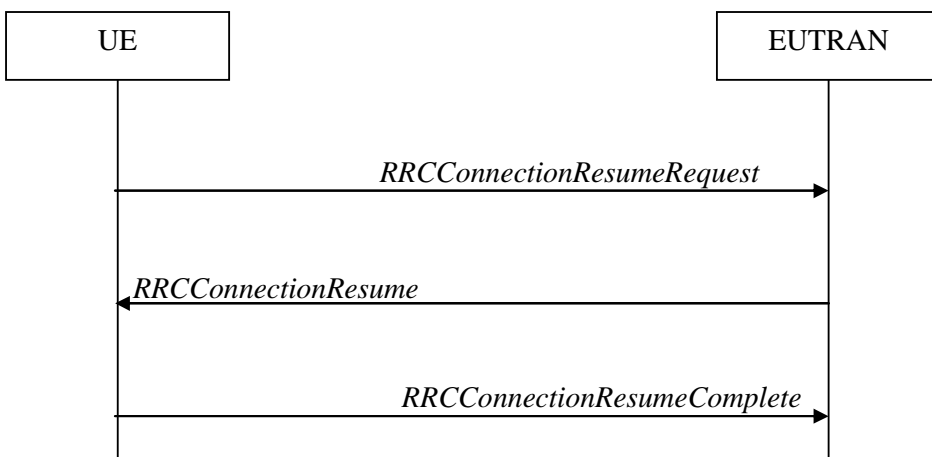

Figure 5.3.3.1-3: RRC connection resume (suspended RRC connection or RRC\_INACTIVE), or UP-EDT fallback or fallback from UP transmission using PUR to RRC connection resume, successful

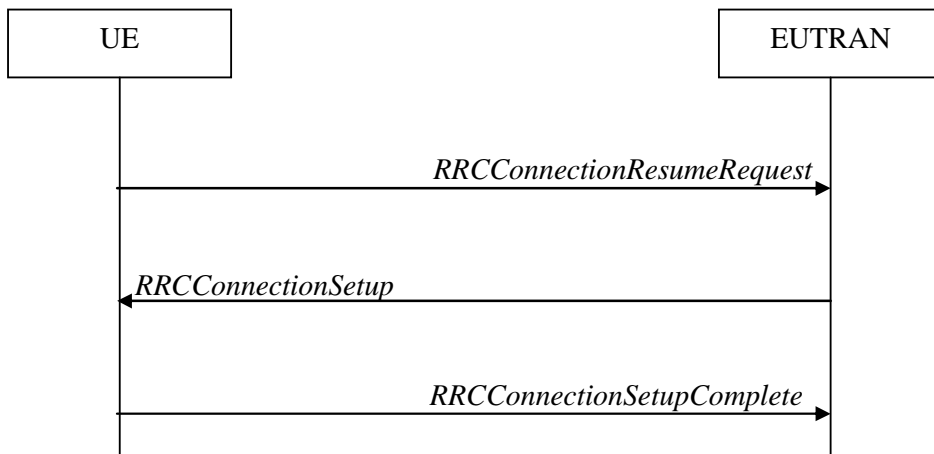

Figure 5.3.3.1-4: RRC connection resume (suspended RRC connection or RRC\_INACTIVE) or UP-EDT fallback or fallback from UP transmission using PUR to RRC connection establishment, successful

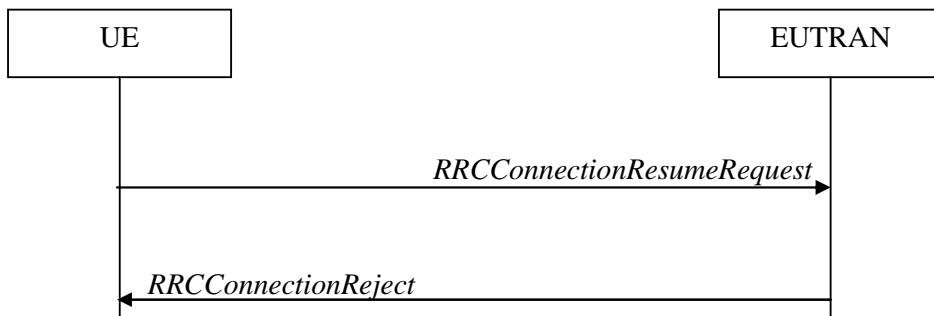

Figure 5.3.3.1-5: RRC connection resume or UP-EDT or UP transmission using PUR, network reject (suspended RRC connection or RRC\_INACTIVE) or release (suspended RRC connection)

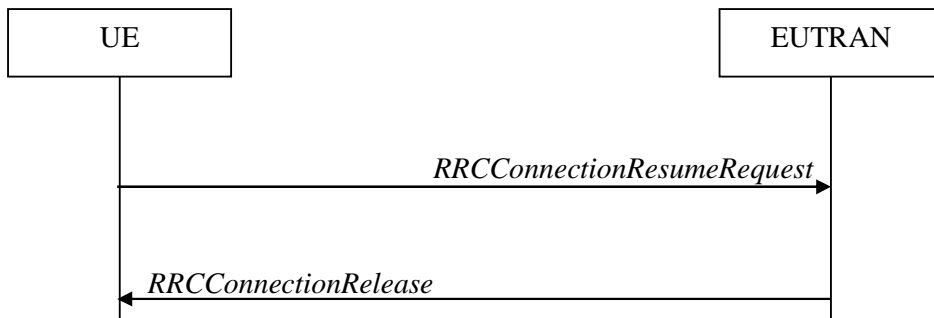

Figure 5.3.3.1-6: RRC connection resume (RRC\_INACTIVE), network release or suspend or UP-EDT or UP transmission using PUR, successful

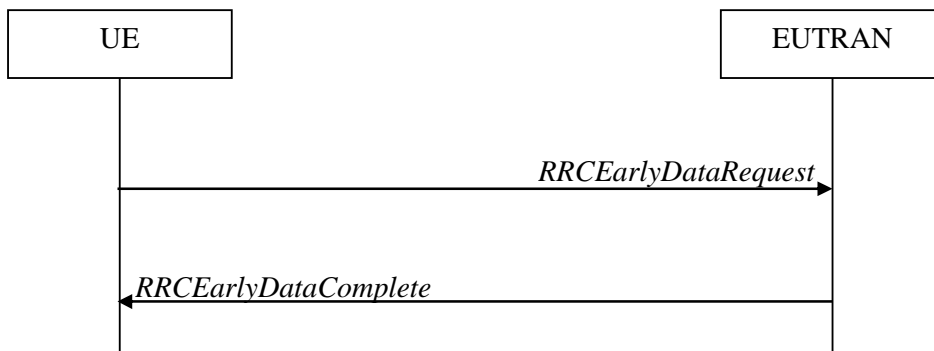

Figure 5.3.3.1-7: CP-EDT or CP transmission using PUR, successful



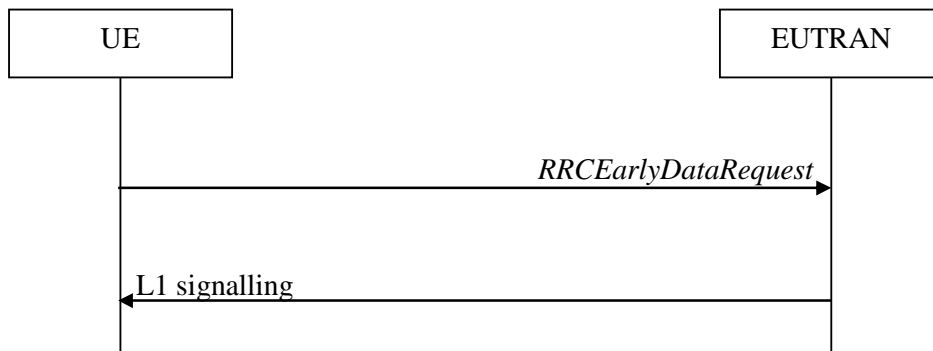

Figure 5.3.3.1-7a: CP transmission using PUR, successful

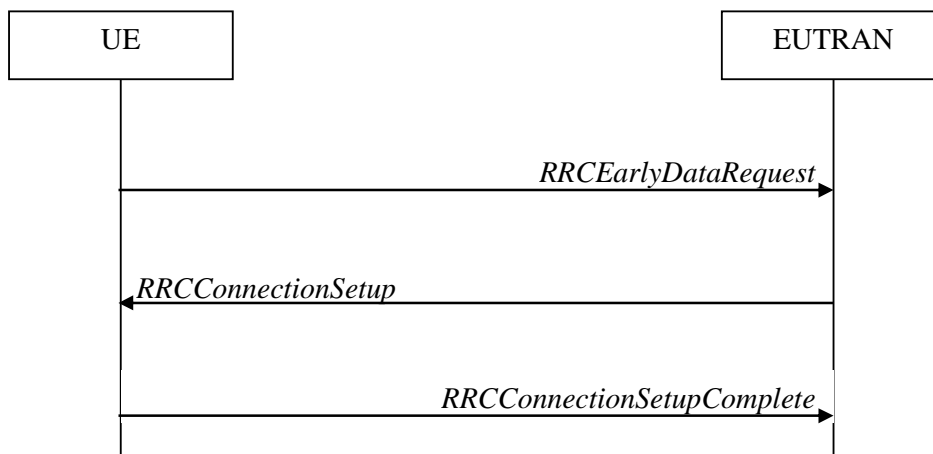

Figure 5.3.3.1-8: CP-EDT fallback or fallback from CP transmission using PUR to RRC connection establishment, successful

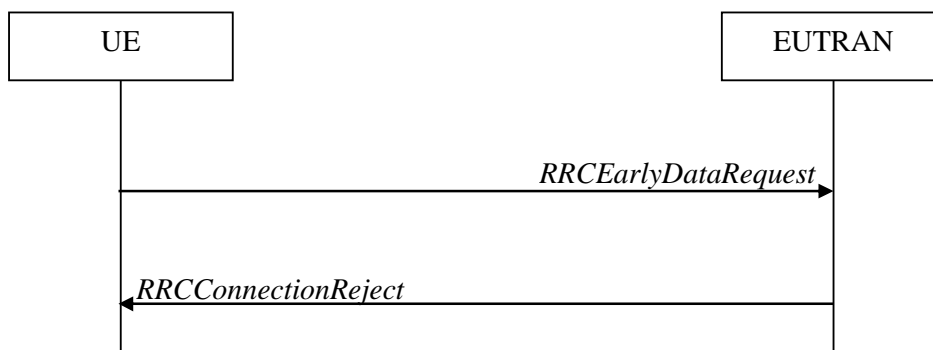

Figure 5.3.3.1-9: CP-EDT or CP transmission using PUR, network reject

The purpose of this procedure is to establish an RRC connection, to resume a suspended RRC connection, to move the UE from RRC\_INACTIVE to RRC\_CONNECTED, to perform EDT or to perform transmission using PUR. RRC connection establishment involves SRB1 (and SRB1bis for NB-IoT) establishment. The procedure is also used to transfer the initial NAS dedicated information/ message from the UE to E-UTRAN.

E-UTRAN applies the procedure as follows:

- When establishing an RRC connection:
  - to establish SRB1 and, for NB-IoT, SRB1bis;
- When resuming an RRC connection from a suspended RRC connection or from RRC\_INACTIVE:
  - to restore the AS configuration from a stored context including resuming SRB(s) and DRB(s);
- When performing EDT;

- When performing transmission using PUR.

### 5.3.3.1a Conditions for establishing RRC Connection for sidelink communication/ discovery/ V2X sidelink communication/ NR sidelink communication

For sidelink communication an RRC connection is initiated only in the following case:

- 1> if configured by upper layers to transmit non-relay related sidelink communication and related data is available for transmission:
  - 2> if *SystemInformationBlockType18* is broadcast by the cell on which the UE camps; and if the valid version of *SystemInformationBlockType18* does not include *commTxPoolNormalCommon*;
- 1> if configured by upper layers to transmit relay related sidelink communication:
  - 2> if the UE is acting as sidelink relay UE; and if *SystemInformationBlockType18* is broadcast by the cell on which the UE camps; or
  - 2> if the UE has a selected sidelink relay UE; and if the sidelink remote UE threshold conditions as specified in 5.10.11.5 are met and if *SystemInformationBlockType18* is broadcast by the cell on which the UE camps; and if the valid version of *SystemInformationBlockType18* does not include *commTxPoolNormalCommon* or *commTxAllowRelayCommon*;

For V2X sidelink communication an RRC connection is initiated only in the following case:

- 1> if configured by upper layers to transmit non-P2X related V2X sidelink communication and related data is available for transmission:
  - 2> if the frequency on which the UE is configured to transmit non-P2X related V2X sidelink communication concerns the camped frequency; and if *SystemInformationBlockType21* is broadcast by the cell on which the UE camps; and if the valid version of *SystemInformationBlockType21* includes *sl-V2X-ConfigCommon*; and *sl-V2X-ConfigCommon* does not include *v2x-CommTxPoolNormalCommon*; or
  - 2> if the frequency on which the UE is configured to transmit non-P2X related V2X sidelink communication is included in *v2x-InterFreqInfoList* within *SystemInformationBlockType21* or *SystemInformationBlockType26* broadcast by the cell on which the UE camps; and if neither the valid version of *SystemInformationBlockType21* nor that of *SystemInformationBlockType26* includes *v2x-CommTxPoolNormal* for the concerned frequency;
- 1> if configured by upper layers to transmit P2X related V2X sidelink communication and related data is available for transmission:
  - 2> if the frequency on which the UE is configured to transmit P2X related V2X sidelink communication concerns the camped frequency; and if *SystemInformationBlockType21* is broadcast by the cell on which the UE camps; and if the valid version of *SystemInformationBlockType21* includes *sl-V2X-ConfigCommon*; and *sl-V2X-ConfigCommon* does not include *p2x-CommTxPoolNormalCommon*; or
  - 2> if the frequency on which the UE is configured to transmit P2X related V2X sidelink communication is included in *v2x-InterFreqInfoList* within *SystemInformationBlockType21* or *SystemInformationBlockType26* broadcast by the cell on which the UE camps; and if neither the valid version of *SystemInformationBlockType21* nor that of *SystemInformationBlockType26* includes *p2x-CommTxPoolNormal* for the concerned frequency;

For NR sidelink communication an RRC connection is initiated only when the conditions for NR sidelink communication specified in clause 5.3.3.1a of TS 38.331 [82] are met;

NOTE 1: *SIB12* specified in clause 5.3.3.1a of TS 38.331 is provided in *SystemInformationBlockType28*.

For sidelink discovery an RRC connection is initiated only in the following case:

- 1> if configured by upper layers to transmit non-PS related sidelink discovery announcements:
  - 2> if the frequency on which the UE is configured to transmit non-PS related sidelink discovery announcements concerns the camped frequency; and *SystemInformationBlockType19* of the cell on which the UE camps does not include *discTxPoolCommon-r12*; or

- 2> if the frequency on which the UE is configured to transmit non-PS related sidelink discovery announcements is included in *discInterFreqList* in *SystemInformationBlockType19* broadcast by the cell on which the UE camps, with *discTxResourcesInterFreq* included within *discResourcesNonPS* and set to *requestDedicated*;
- 1> if configured by upper layers to transmit non-relay PS related sidelink discovery announcements:
  - 2> if the frequency on which the UE is configured to transmit non-relay PS related sidelink discovery announcements concerns the camped frequency; and *SystemInformationBlockType19* of the cell on which the UE camps includes *discConfigPS* but does not include *discTxPoolPS-Common*; or
  - 2> if the frequency on which the UE is configured to transmit non-relay PS related sidelink discovery announcements (e.g. group member discovery) is included in *discInterFreqList* in *SystemInformationBlockType19* broadcast by the cell on which the UE camps, with *discTxResourcesInterFreq* within *discResourcesPS* included and set to *requestDedicated*;
- 1> if configured by upper layers to transmit relay PS related sidelink discovery announcements:
  - 2> if the UE is acting as sidelink relay UE; and if the sidelink relay UE threshold conditions as specified in 5.10.10.4 are met; or
  - 2> if the UE is selecting a sidelink relay UE / has a selected sidelink relay UE; and if the sidelink remote UE threshold conditions as specified in 5.10.11.5 are met:
    - 3> if the frequency on which the UE is configured to transmit relay PS related sidelink discovery announcements concerns the camped frequency; and *SystemInformationBlockType19* of the cell on which the UE camps includes *discConfigRelay* and *discConfigPS* but does not include *discTxPoolPS-Common*;

NOTE: Upper layers initiate an RRC connection. The interaction with NAS is left to UE implementation.

### 5.3.3.1b Conditions for initiating EDT

A BL UE, UE in CE or NB-IoT UE can initiate EDT when all of the following conditions are fulfilled:

- 1> if the UE is connected to EPC:
  - 2> for CP-EDT, the upper layers request establishment of an RRC connection, the UE supports CP-EDT, and *SystemInformationBlockType2* (*SystemInformationBlockType2-NB* in NB-IoT) includes *cp-EDT*; or
  - 2> for UP-EDT, the upper layers request resumption of an RRC connection, the UE supports UP-EDT, *SystemInformationBlockType2* (*SystemInformationBlockType2-NB* in NB-IoT) includes *up-EDT*, and the UE has a stored value of the *nextHopChainingCount* provided in the *RRCCConnectionRelease* message with suspend indication during the preceding suspend procedure;
- 1> else if the UE is connected to 5GC:
  - 2> for CP-EDT, the upper layers request establishment of an RRC connection, the UE connected to 5GC supports CP-EDT, and *SystemInformationBlockType2* (*SystemInformationBlockType2-NB* in NB-IoT) includes *cp-EDT-5GC*; or
  - 2> for UP-EDT, the upper layers request resumption of an RRC connection, the UE connected to 5GC supports UP-EDT, *SystemInformationBlockType2* (*SystemInformationBlockType2-NB* in NB-IoT) includes *up-EDT-5GC*, and the UE has a stored value of the *nextHopChainingCount* provided in the *RRCCConnectionRelease* message with suspend indication during the preceding suspend procedure;
- 1> the establishment or resumption request is for mobile originating calls and the establishment cause is *mo-Data* or *mo-ExceptionData* or *delayTolerantAccess*; or
- 1> the establishment or resumption request is for mobile terminating calls, the UE has a stored *mt-EDT* indication and the establishment cause is *mt-Access*;
- 1> the establishment or resumption request is suitable for EDT as specified in TS 36.300 [9], clause 7.3b.1;
- 1> *SystemInformationBlockType2* (*SystemInformationBlockType2-NB* in NB-IoT) includes *edt-Parameters*;

1> for mobile originating calls, the size of the resulting MAC PDU including the total UL data is expected to be smaller than or equal to the TBS signalled in *edt-TBS* as specified in TS 36.321 [6], clause 5.1.1;

1> EDT fallback indication has not been received from lower layers for this establishment or resumption procedure;

NOTE 1: Upper layers request or resume an RRC connection. The interaction with NAS is up to UE implementation.

NOTE 2: It is up to UE implementation how the UE determines whether the size of UL data is suitable for EDT.

### 5.3.3.1c Conditions for initiating transmission using PUR

A BL UE, UE in CE or NB-IoT UE can initiate transmission using PUR when all of the following conditions are fulfilled:

1> the UE has a valid PUR configuration for the serving cell as specified in 5.3.3.20;

1> the UE has a valid timing alignment value as specified in 5.3.3.19;

1> the upper layers request establishment of an RRC connection; or the upper layers request resumption of an RRC connection and the UE has a stored value of the *nextHopChainingCount* provided in the *RRCConnectionRelease* message with suspend indication during the preceding suspend procedure;

1> the establishment or resumption request is for mobile originating calls and the establishment cause is *mo-Data* or *mo-ExceptionData* or *delayTolerantAccess*;

1> for CP transmission using PUR, the size of the resulting MAC PDU including the total UL data is expected to be smaller than or equal to the TBS configured for PUR.

NOTE 1: Upper layers request or resume an RRC connection. The interaction with NAS is up to UE implementation.

NOTE 2: It is up to UE implementation how the UE determines whether the establishment or resumption request is suitable for transmission using PUR.

### 5.3.3.1d Condition for establishing RRC Connection in NTN

If *systemInformationBlockType31* (*systemInformationBlockType31-NB* in NB-IoT) is broadcast, a RRC connection is initiated only if the UE has a valid GNSS position.

NOTE: The UE may need to re-acquire the GNSS position before establishing the connection to avoid interruption during the connection.

### 5.3.3.2 Initiation

The UE initiates the procedure when upper layers request establishment or resume of an RRC connection while the UE is in RRC\_IDLE or when upper layers request resume of an RRC connection or RRC layer requests resume of an RRC connection for, e.g. RNAU or reception of RAN paging while the UE is in RRC\_INACTIVE.

Except for NB-IoT, upon initiation of the procedure, if the UE is connected to EPC, the UE shall:

1> if *SystemInformationBlockType2* includes *ac-BarringPerPLMN-List* and the *ac-BarringPerPLMN-List* contains an *AC-BarringPerPLMN* entry with the *plmn-IdentityIndex* corresponding to the PLMN selected by upper layers (see TS 23.122 [11], TS 24.301 [35]):

2> select the *AC-BarringPerPLMN* entry with the *plmn-IdentityIndex* corresponding to the PLMN selected by upper layers;

2> in the remainder of this procedure, use the selected *AC-BarringPerPLMN* entry (i.e. presence or absence of access barring parameters in this entry) irrespective of the common access barring parameters included in *SystemInformationBlockType2*;

1> else

- 2> in the remainder of this procedure use the common access barring parameters (i.e. presence or absence of these parameters) included in *SystemInformationBlockType2*;
- 1> if *SystemInformationBlockType2* contains *acdc-BarringPerPLMN-List* and the *acdc-BarringPerPLMN-List* contains an *ACDC-BarringPerPLMN* entry with the *plmn-IdentityIndex* corresponding to the PLMN selected by upper layers (see TS 23.122 [11], TS 24.301 [35]):
  - 2> select the *ACDC-BarringPerPLMN* entry with the *plmn-IdentityIndex* corresponding to the PLMN selected by upper layers;
  - 2> in the remainder of this procedure, use the selected *ACDC-BarringPerPLMN* entry for ACDC barring check (i.e. presence or absence of access barring parameters in this entry) irrespective of the *acdc-BarringForCommon* parameters included in *SystemInformationBlockType2*;
- 1> else:
  - 2> in the remainder of this procedure use the *acdc-BarringForCommon* (i.e. presence or absence of these parameters) included in *SystemInformationBlockType2* for ACDC barring check;
- 1> if upper layers indicate that the RRC connection is subject to EAB (see TS 24.301 [35]):
  - 2> if the result of the EAB check, as specified in 5.3.3.12, is that access to the cell is barred:
    - 3> inform upper layers about the failure to establish the RRC connection or failure to resume the RRC connection with suspend indication and that EAB is applicable, upon which the procedure ends;
- 1> if upper layers indicate that the RRC connection is subject to ACDC (see TS 24.301 [35]), *SystemInformationBlockType2* contains *BarringPerACDC-CategoryList*, and *acdc-HPLMNonly* indicates that ACDC is applicable for the UE:
  - 2> if the *BarringPerACDC-CategoryList* contains a *BarringPerACDC-Category* entry corresponding to the ACDC category selected by upper layers:
    - 3> select the *BarringPerACDC-Category* entry corresponding to the ACDC category selected by upper layers;
  - 2> else:
    - 3> select the last *BarringPerACDC-Category* entry in the *BarringPerACDC-CategoryList*;
  - 2> stop timer T308, if running;
  - 2> perform access barring check as specified in 5.3.3.13, using T308 as "Tbarring" and *acdc-BarringConfig* in the *BarringPerACDC-Category* as "ACDC barring parameter";
  - 2> if access to the cell is barred:
    - 3> inform upper layers about the failure to establish the RRC connection or failure to resume the RRC connection with suspend indication and that access barring is applicable due to ACDC, upon which the procedure ends;
- 1> else if the UE is establishing the RRC connection for mobile terminating calls:
  - 2> if timer T302 is running:
    - 3> inform upper layers about the failure to establish the RRC connection or failure to resume the RRC connection with suspend indication and that access barring for mobile terminating calls is applicable, upon which the procedure ends;
- 1> else if the UE is establishing the RRC connection for emergency calls:
  - 2> if *SystemInformationBlockType2* includes the *ac-BarringInfo*:
    - 3> if the *ac-BarringForEmergency* is set to *TRUE*:
      - 4> if the UE has one or more Access Classes, as stored on the USIM, with a value in the range 11..15, which is valid for the UE to use according to TS 22.011 [10] and TS 23.122 [11]:

NOTE 1: ACs 12, 13, 14 are only valid for use in the home country and ACs 11, 15 are only valid for use in the HPLMN/ EHPLMN.

- 5> if the *ac-BarringInfo* includes *ac-BarringForMO-Data*, and for all of these valid Access Classes for the UE, the corresponding bit in the *ac-BarringForSpecialAC* contained in *ac-BarringForMO-Data* is set to *one*:
  - 6> consider access to the cell as barred;
- 4> else:
  - 5> consider access to the cell as barred;
- 2> if access to the cell is barred:
  - 3> inform upper layers about the failure to establish the RRC connection or failure to resume the RRC connection with suspend indication, upon which the procedure ends;
- 1> else if the UE is establishing the RRC connection for mobile originating calls:
  - 2> perform access barring check as specified in 5.3.3.11, using T303 as "Tbarring" and *ac-BarringForMO-Data* as "AC barring parameter";
  - 2> if access to the cell is barred:
    - 3> if *SystemInformationBlockType2* includes *ac-BarringForCSFB* or the UE does not support CS fallback:
      - 4> inform upper layers about the failure to establish the RRC connection or failure to resume the RRC connection with suspend indication and that access barring for mobile originating calls is applicable, upon which the procedure ends;
    - 3> else (*SystemInformationBlockType2* does not include *ac-BarringForCSFB* and the UE supports CS fallback):
      - 4> if timer T306 is not running, start T306 with the timer value of T303;
      - 4> inform upper layers about the failure to establish the RRC connection or failure to resume the RRC connection with suspend indication and that access barring for mobile originating calls and mobile originating CS fallback is applicable, upon which the procedure ends;
- 1> else if the UE is establishing the RRC connection for mobile originating signalling:
  - 2> perform access barring check as specified in 5.3.3.11, using T305 as "Tbarring" and *ac-BarringForMO-Signalling* as "AC barring parameter";
  - 2> if access to the cell is barred:
    - 3> inform upper layers about the failure to establish the RRC connection or failure to resume the RRC connection with suspend indication and that access barring for mobile originating signalling is applicable, upon which the procedure ends;
- 1> else if the UE is establishing the RRC connection for mobile originating CS fallback:
  - 2> if *SystemInformationBlockType2* includes *ac-BarringForCSFB*:
    - 3> perform access barring check as specified in 5.3.3.11, using T306 as "Tbarring" and *ac-BarringForCSFB* as "AC barring parameter";
    - 3> if access to the cell is barred:
      - 4> inform upper layers about the failure to establish the RRC connection or failure to resume the RRC connection with suspend indication and that access barring for mobile originating CS fallback is applicable, due to *ac-BarringForCSFB*, upon which the procedure ends;
  - 2> else:

- 3> perform access barring check as specified in 5.3.3.11, using T306 as "Tbarring" and *ac-BarringForMO-Data* as "AC barring parameter";
- 3> if access to the cell is barred:
  - 4> if timer T303 is not running, start T303 with the timer value of T306;
  - 4> inform upper layers about the failure to establish the RRC connection or failure to resume the RRC connection with suspend indication and that access barring for mobile originating CS fallback and mobile originating calls is applicable, due to *ac-BarringForMO-Data*, upon which the procedure ends;
- 1> else if the UE is establishing the RRC connection for mobile originating MMTEL voice, mobile originating MMTEL video, mobile originating SMSoIP or mobile originating SMS; or
- 1> if the UE is establishing the RRC connection after EPS fallback for IMS voice (see TS 23.502 [102]) was triggered in NR via *RRCRelease* with *voiceFallbackIndication* (see TS 38.331 [82]):
  - 2> if the UE is establishing the RRC connection for mobile originating MMTEL voice and *SystemInformationBlockType2* includes *ac-BarringSkipForMMTELVoice*; or
  - 2> if the UE is establishing the RRC connection for mobile originating MMTEL video and *SystemInformationBlockType2* includes *ac-BarringSkipForMMTELVideo*; or
  - 2> if the UE is establishing the RRC connection for mobile originating SMSoIP or SMS and *SystemInformationBlockType2* includes *ac-BarringSkipForSMS*:
    - 3> consider access to the cell as not barred;
- 2> else:
  - 3> if *establishmentCause* received from higher layers is set to *mo-Signalling* (including the case that *mo-Signalling* is replaced by *highPriorityAccess* according to TS 24.301 [35] or by *mo-VoiceCall* according to the clause 5.3.3.3):
    - 4> perform access barring check as specified in 5.3.3.11, using T305 as "Tbarring" and *ac-BarringForMO-Signalling* as "AC barring parameter";
    - 4> if access to the cell is barred:
      - 5> inform upper layers about the failure to establish the RRC connection or failure to resume the RRC connection with suspend indication and that access barring for mobile originating signalling is applicable, upon which the procedure ends;
  - 3> if *establishmentCause* received from higher layers is set to *mo-Data* (including the case that *mo-Data* is replaced by *highPriorityAccess* according to TS 24.301 [35] or by *mo-VoiceCall* according to the clause 5.3.3.3):
    - 4> perform access barring check as specified in 5.3.3.11, using T303 as "Tbarring" and *ac-BarringForMO-Data* as "AC barring parameter";
    - 4> if access to the cell is barred:
      - 5> if *SystemInformationBlockType2* includes *ac-BarringForCSFB* or the UE does not support CS fallback:
        - 6> inform upper layers about the failure to establish the RRC connection or failure to resume the RRC connection with suspend indication and that access barring for mobile originating calls is applicable, upon which the procedure ends;
      - 5> else (*SystemInformationBlockType2* does not include *ac-BarringForCSFB* and the UE supports CS fallback):
        - 6> if timer T306 is not running, start T306 with the timer value of T303;

- 6> inform upper layers about the failure to establish the RRC connection or failure to resume the RRC connection with suspend indication and that access barring for mobile originating calls and mobile originating CS fallback is applicable, upon which the procedure ends;

Upon initiation of the procedure, if the UE is connected to 5GC, the UE shall:

- 1> if the upper layers provide an Access Category and one or more Access Identities upon requesting establishment of an RRC connection:
  - 2> perform the unified access control procedure as specified in 5.3.16 using the Access Category and Access Identities provided by upper layers;
  - 3> if the access attempt is barred, the procedure ends;
- 1> if the resumption of the RRC connection is triggered by response to NG-RAN paging:
  - 2> select '0' as the Access Category;
  - 2> perform the unified access control procedure as specified in 5.3.16 using the selected Access Category and one or more Access Identities provided by upper layers;
  - 3> if the access attempt is barred, the procedure ends;
- 1> else if the resumption of the RRC connection is triggered by upper layers:
  - 2> if the upper layers provide an Access Category and one or more Access Identities:
    - 3> perform the unified access control procedure as specified in 5.3.16 using the Access Category and Access Identities provided by upper layers;
    - 4> if the access attempt is barred, the procedure ends;
  - 2> set the *resumeCause* in accordance with the information received from upper layers;
- 1> else if the resumption of the RRC connection is triggered due to an RNAU:
  - 2> if an emergency service is ongoing:
    - 3> select '2' as the Access Category;
    - 3> set the *resumeCause* to *emergency*;
  - 2> else:
    - 3> select '8' as the Access Category;
    - 2> perform the unified access control procedure as specified in 5.3.16 using the selected Access Category and one or more Access Identities to be applied as specified in TS 24.501 [95];
    - 3> if the access attempt is barred:
      - 4> set the variable *pendingRnaUpdate* to 'TRUE';
      - 4> the procedure ends;

Except for NB-IoT, upon initiating the procedure, if connected to EPC or 5GC, the UE shall:

- 1> if the UE is resuming an RRC connection from a suspended RRC connection or from RRC\_INACTIVE:
  - 2> if the UE was configured with (NG)EN-DC:
    - 3> if the UE does not support maintaining SCG configuration upon connection resumption:
      - 4> perform MR-DC release, as specified in TS 38.331 [82], clause 5.3.5.10;
      - 4> release *p-MaxEUTRA*, if configured;
      - 4> release *p-MaxUE-FRI*, if configured;



- 4> release *tdm-PatternConfig* or *tdm-PatternConfig2*, if configured;
- 3> release *otherConfig* associated with the SCG, if configured;
- 3> stop timers T346a, T346b, T346c, T346d and T346e associated with the SCG (see TS 38.331 [82], clause 7.1.1), if running;
- 2> if the UE does not support maintaining the MCG SCell configurations upon connection resumption:
  - 3> release the MCG SCell(s), if configured, in accordance with 5.3.10.3a;
- 2> release *powerPrefIndicationConfig*, if configured and stop timer T340, if running;
- 2> release *reportProximityConfig* and clear any associated proximity status reporting timer;
- 2> release *obtainLocationConfig*, if configured;
- 2> release *bt-NameListConfig*, if configured;
- 2> release *wlan-NameListConfig*, if configured;
- 2> release *measUncomBarPre*, if configured;
- 2> release *idc-Config*, if configured;
- 2> release *sps-AssistanceInfoReport*, if configured;
- 2> release *scg-DeactivationPreferenceConfig*, if configured and stop timer T346, if running;
- 2> release *measSubframePatternPCell*, if configured;
- 2> if the UE was configured with DC:
  - 3> release the entire SCG configuration, if configured, except for the DRB configuration (as configured by *drb-ToAddModListSCG*);
- 2> release *naics-Info* for the PCell, if configured;
- 2> release the LWA configuration, if configured, as described in 5.6.14.3;
- 2> release the LWIP configuration, if configured, as described in 5.6.17.3;
- 2> release *bw-PreferenceIndicationTimer*, if configured and stop timer T341, if running;
- 2> release *delayBudgetReportingConfig*, if configured and stop timer T342, if running;
- 2> release *ailc-BitConfig*, if configured;
- 2> release *uplinkDataCompression*, if configured;
- 2> release *overheatingAssistanceConfig* and *overheatingAssistanceConfigForSCG*, if configured and stop timer T345, if running;

NOTE 1a: The parameters and configurations are released from the UE Inactive AS context if the UE is resuming an RRC connection from RRC\_INACTIVE.

- 1> if the UE is establishing or resuming an RRC connection from a suspended RRC connection:
  - 2> if the UE has a stored *pur-Config* and the cell is different from the cell where *pur-Config* was provided:
    - 3> if *pur-TimeAlignmentTimer* is configured, indicate to lower layers that *pur-TimeAlignmentTimer* is released;
    - 3> release *pur-Config*;
    - 3> discard previously stored *pur-Config*;
- 1> apply the default physical channel configuration as specified in 9.2.4;

- 1> apply the default semi-persistent scheduling configuration as specified in 9.2.3;
- 1> apply the default MAC main configuration as specified in 9.2.2;
- 1> apply the CCCH configuration as specified in 9.1.1.2;
- 1> apply the *timeAlignmentTimerCommon* included in *SystemInformationBlockType2*;
- 1> if UE supports timing advance reporting and *ta-Report* is included in *SystemInformationBlockType2*:
  - 2> instruct the associated MAC entity to trigger Timing Advance reporting;
- 1> start timer T300;
- 1> if the UE is resuming an RRC connection from a suspended RRC connection:
  - 2> initiate transmission of the *RRCCONNECTIONRESUMEREQUEST* message in accordance with 5.3.3.3a;
- 1> else if the UE is resuming an RRC connection from RRC\_INACTIVE:
  - 2> set the variable *pendingRnaUpdate* to 'FALSE';
  - 2> initiate transmission of the *RRCCONNECTIONRESUMEREQUEST* message in accordance with 5.3.3.3a;
- 1> else:
  - 2> if stored, discard the UE AS context, UE Inactive AS context and *resumeIdentity*;
  - 2> release *rrc-InactiveConfig*, if configured;
  - 2> if the UE is initiating CP-EDT in accordance with conditions in 5.3.3.1b; or
  - 2> if the UE is initiating CP transmission using PUR in accordance with conditions in 5.3.3.1c:
    - 3> initiate transmission of the *RRCEarlyDataRequest* message in accordance with 5.3.3.3b;
  - 2> else:
    - 3> initiate transmission of the *RRCCONNECTIONREQUEST* message in accordance with 5.3.3.3;
- 1> if stored, discard *mt-EDT*;

NOTE 2: Upon initiating the connection establishment procedure, the UE is not required to ensure it maintains up to date system information applicable only for UEs in RRC\_IDLE state or UEs in RRC\_INACTIVE. However, the UE needs to perform system information acquisition upon cell re-selection.

For NB-IoT, upon initiation of the procedure, the UE shall:

- 1> if the UE is connected to EPC:
  - 2> if the UE is establishing or resuming the RRC connection for mobile originating exception data; or
  - 2> if the UE is establishing or resuming the RRC connection for mobile originating data; or
  - 2> if the UE is establishing or resuming the RRC connection for delay tolerant access; or
  - 2> if the UE is establishing or resuming the RRC connection for mobile originating signalling:
    - 3> perform access barring check as specified in 5.3.3.14;
    - 3> if access to the cell is barred:
      - 4> inform upper layers about the failure to establish the RRC connection or failure to resume the RRC connection with suspend indication and that access barring is applicable, upon which the procedure ends;
- 1> if the UE is connected to 5GC:
  - 2> if the Access Category provided by the upper layers is different from '0':

- 3> perform access barring check for per-NRSRP barring as specified in 5.3.3.14;
- 3> if access to the cell is barred:
  - 4> inform upper layers about the failure to establish the RRC connection or failure to resume the RRC connection with suspend indication, upon which the procedure ends;
- 3> else:
  - 4> perform the unified access control procedure as specified in 5.3.16 using the Access Category and Access Identities provided by upper layers;
  - 4> if the access attempt is barred, the procedure ends;
- 1> if the UE is establishing or resuming an RRC connection:
  - 2> if the UE has a stored *pur-Config* and the cell is different from the cell where *pur-Config* was provided:
    - 3> if *pur-TimeAlignmentTimer* is configured, indicate to lower layers that *pur-TimeAlignmentTimer* is released;
    - 3> release *pur-Config*;
    - 3> discard previously stored *pur-Config*;
  - 2> release *obtainLocationNB*, if configured;
- 1> apply the default physical channel configuration as specified in 9.2.4;
- 1> apply the default MAC main configuration as specified in 9.2.2;
- 1> apply the CCCH configuration as specified in 9.1.1.2;
- 1> if UE supports timing advance reporting and *ta-Report* is included in *SystemInformationBlockType2-NB*:
  - 2> instruct the associated MAC entity to trigger Timing Advance reporting;
- 1> start timer T300;
- 1> if the UE is establishing an RRC connection:
  - 2> if stored, discard the UE AS context and *resumeIdentity*;
  - 2> if the UE is initiating CP-EDT in accordance with conditions in 5.3.3.1b; or
  - 2> if the UE is initiating CP transmission using PUR in accordance with conditions in 5.3.3.1c:
    - 3> initiate transmission of the *RRCEarlyDataRequest* message in accordance with 5.3.3.3b;
  - 2> else:
    - 3> initiate transmission of the *RRCCConnectionRequest* message in accordance with 5.3.3.3;
- 1> else if the UE is resuming an RRC connection:
  - 2> release *schedulingRequestConfig*, if configured;
  - 2> initiate transmission of the *RRCCConnectionResumeRequest* message in accordance with 5.3.3.3a;
- 1> if stored, discard *mt-EDT*;

NOTE 3: Upon initiating the connection establishment or resumption procedure, the UE is not required to ensure it maintains up to date system information applicable only for UEs in RRC\_IDLE state. However, the UE needs to perform system information acquisition upon cell re-selection.

NOTE 4: For EDT and transmission using PUR, upon initiating the connection establishment or resumption procedure, it is up to UE implementation whether to continue cell re-selection related measurements as well as cell re-selection evaluation and, if the conditions for cell re-selection are fulfilled, whether to perform cell re-selection as specified in 5.3.3.5.

### 5.3.3.3 Actions related to transmission of *RRCConnectionRequest* message

The UE shall set the contents of *RRCConnectionRequest* message as follows:

1> if the UE is connected to EPC:

2> set the *ue-Identity* as follows:

3> if upper layers provide an S-TMSI:

4> set the *ue-Identity* to the value received from upper layers;

3> else:

4> draw a random value in the range  $0 \dots 2^{40}-1$  and set the *ue-Identity* to this value;

NOTE 1: Upper layers provide the S-TMSI if the UE is registered in the TA of the current cell.

2> if the establishment of the RRC connection is the result of release with redirect with *mpsPriorityIndication* (either in NR or E-UTRAN):

3> set the *establishmentCause* to *highPriorityAccess*;

2> else:

3> if the UE supports *mo-VoiceCall* establishment cause and UE is establishing the RRC connection for mobile originating MMTEL voice and *SystemInformationBlockType2* includes *voiceServiceCauseIndication* and the establishment cause received from upper layers is not set to *highPriorityAccess*; or

3> if the UE supports *mo-VoiceCall* establishment cause and EPS fallback for IMS voice (see TS 23.502 [102]) was triggered in NR via *RRCRelease* with *voiceFallbackIndication* (see TS 38.331 [82]) and *SystemInformationBlockType2* includes *voiceServiceCauseIndication* and the establishment cause received from upper layers is not set to *highPriorityAccess* or *emergency*:

4> set the *establishmentCause* to *mo-VoiceCall*;

3> else if the UE supports *mo-VoiceCall* establishment cause for mobile originating MMTEL video and UE is establishing the RRC connection for mobile originating MMTEL video and *SystemInformationBlockType2* includes *videoServiceCauseIndication* and the establishment cause received from upper layers is not set to *highPriorityAccess*:

4> set the *establishmentCause* to *mo-VoiceCall*;

3> else:

4> set the *establishmentCause* in accordance with the information received from upper layers;

1> if the UE is connected to 5GC:

2> set the *ue-Identity* as follows:

3> if upper layers provide a 5G-S-TMSI:

4> except for NB-IoT, set the *ue-Identity* to *ng-5G-S-TMSI-Part1*;

4> for NB-IoT, set the *ue-Identity* to *ng-5G-S-TMSI*;

3> else:

4> draw a random value in the range  $0 \dots 2^{40}-1$  and set the *ue-Identity* to this value;

- 2> if the establishment of the RRC connection is the result of release with redirect with *mpsPriorityIndication* (either in NR or E-UTRAN);
  - 3> set the *establishmentCause* to *highPriorityAccess*;
- 2> else:
  - 3> set the *establishmentCause* in accordance with the information received from upper layers;
- 2> except for NB-IoT, apply the default NR PDCP configuration as specified in TS 38.331 [82], clause 9.2.1.1 for SRB1;
- 2> except for NB-IoT, use NR PDCP for all subsequent messages received and sent by the UE via SRB1;
- 1> if the UE is a NB-IoT UE:
  - 2> if the UE is connected to EPC:
    - 3> if the UE supports multi-tone transmission, include *multiToneSupport*;
    - 3> if the UE supports multi-carrier operation, include *multiCarrierSupport*;
    - 3> set *earlyContentionResolution* to TRUE;
  - 2> if the UE supports DL channel quality reporting in MSG3 and *cqi-Reporting* is present in *SystemInformationBlockType2-NB*:
    - 3> set the *cqi-NPDCCH* to include the latest results of the downlink channel quality measurements of the carrier where the random access response is received as specified in TS 36.133 [16];

NOTE 2: The downlink channel quality measurements use measurement period T1 or T2, as defined in TS 36.133 [16].

- 1> if the UE is initiating transmission using PUR in accordance with conditions in 5.3.3.1c:
  - 2> configure, except *pur-TimeAlignmentTimer*, the lower layers to use transmission using PUR;
  - 2> deliver the UL grant for transmission using PUR to the MAC entity;

The UE shall submit the *RRCConnectionRequest* message to lower layers for transmission.

The UE shall continue cell re-selection related measurements as well as cell re-selection evaluation. If the conditions for cell re-selection are fulfilled, the UE shall perform cell re-selection as specified in 5.3.3.5.

### 5.3.3.3a Actions related to transmission of *RRCConnectionResumeRequest* message

If the UE is resuming the RRC connection from a suspended RRC connection, the UE shall set the contents of *RRCConnectionResumeRequest* message as follows:

- 1> if the UE is a NB-IoT UE; or
- 1> if the UE is initiating UP-EDT for mobile originating calls in accordance with conditions in 5.3.3.1b; or
- 1> if the UE is initiating UP transmission using PUR in accordance with conditions in 5.3.3.1c; or
- 1> if field *useFullResumeID* is signalled in *SystemInformationBlockType2*:
  - 2> if the UE connected to 5GC is a BL UE or UE in CE:
    - 3> set the *fullI-RNTI* to the stored *fullI-RNTI*;
  - 2> else:
    - 3> set the *resumeID* to the stored *resumeIdentity*;
- 1> else:

- 2> if the UE connected to 5GC is a BL UE or UE in CE:
- 3> set the *shortI-RNTI* to the stored *shortI-RNTI*;
- 2> else:
- 3> set the *truncatedResumeID* to include bits in bit position 9 to 20 and 29 to 40 from the left in the stored *resumeIdentity*.
- 1> if the UE is resuming the RRC connection after release with redirect with *mpsPriorityIndication*:
- 2> set the *resumeCause* to *highPriorityAccess*;
- 1> else if the UE supports *mo-VoiceCall* establishment cause and UE is resuming the RRC connection for mobile originating MMTEL voice and *SystemInformationBlockType2* includes *voiceServiceCauseIndication* and the establishment cause received from upper layers is not set to *highPriorityAccess*:
- 2> set the *resumeCause* to *mo-VoiceCall*;
- 1> else if the UE supports *mo-VoiceCall* establishment cause for mobile originating MMTEL video and UE is resuming the RRC connection for mobile originating MMTEL video and *SystemInformationBlockType2* includes *videoServiceCauseIndication* and the establishment cause received from upper layers is not set to *highPriorityAccess*:
- 2> set the *resumeCause* to *mo-VoiceCall*;
- 1> else if the UE is initiating UP-EDT for mobile terminating calls in accordance with conditions in 5.3.3.1b:
- 2> set the *resumeCause* to *mt-EDT*;
- 1> else:
- 2> set the *resumeCause* in accordance with the information received from upper layers;
- 1> set the *shortResumeMAC-I* to the 16 least significant bits of the MAC-I calculated:
- 2> over the ASN.1 encoded as per clause 8 (i.e., a multiple of 8 bits) *VarShortResumeMAC-Input* (or *VarShortResumeMAC-Input-NB* in NB-IoT);
- 2> with the  $K_{RRCint}$  key and the previously configured integrity protection algorithm; and
- 2> with all input bits for COUNT, BEARER and DIRECTION set to binary ones;
- 1> if the UE is a NB-IoT UE:
- 2> if the UE supports DL channel quality reporting in MSG3 and *cqi-Reporting* is present in *SystemInformationBlockType2-NB*:
- 3> set the *cqi-NPDCCH* to include the latest results of the downlink channel quality measurements of the carrier where the random access response is received as specified in TS 36.133 [16];
- NOTE 0: The downlink channel quality measurements use measurement period T1 or T2, as defined in TS 36.133 [16].
- 2> if the UE is connected to EPC, set *earlyContentionResolution* to TRUE;
- 1> restore the RRC configuration and security context from the stored UE AS context, except for the following:
- MCG SCell(s) configuration, if stored,
  - *nr-SecondaryCellGroupConfig*, if stored;
- 1> if the UE is initiating UP-EDT for mobile originating calls in accordance with conditions in 5.3.3.1b:
- 2> if the UE is a NB-IoT UE connected to EPC:
- 3> if the UE has ANR measurements information available in *VarANR-MeasReport-NB* and if the RPLMN is included in *plmn-IdentityList* stored in *VarANR-MeasReport-NB*:

- 4> set *anr-InfoAvailable* to TRUE;
- 1> if the UE is resuming an RRC connection after early security reactivation in accordance with conditions in 5.3.3.18:
  - 2> if the UE is initiating UP-EDT in accordance with conditions in 5.3.3.1b; or
  - 2> if the UE is initiating UP transmission using PUR in accordance with conditions in 5.3.3.1c:
    - 3> restore the PDCP state and re-establish PDCP entities for all SRBs and all DRBs;
    - 3> if *drb-ContinueROHC* has been provided in immediately preceding RRC connection release message, and the UE is requesting to resume RRC connection in the same cell:
      - 4> indicate to lower layers that stored UE AS context is used and that *drb-ContinueROHC* is configured;
      - 4> continue the header compression protocol context for the DRBs configured with the header compression protocol;
    - 3> else:
      - 4> indicate to lower layers that stored UE AS context is used;
      - 4> reset the header compression protocol context for the DRBs configured with the header compression protocol;
    - 3> resume all SRBs and all DRBs;
  - 2> else:
    - 3> if the UE is a NB-IoT UE or the UE is connected to EPC, restore the PDCP state and re-establish the PDCP entity for SRB1;
    - 3> if the UE is connected to 5GC:
      - 4> apply the default configuration for SRB1 as specified in 9.2.1.1;
      - 4> except for NB-IoT, apply the default NR PDCP configuration as specified in TS 38.331 [82], clause 9.2.1 for SRB1;
    - 3> resume SRB1;
  - 2> derive the  $K_{eNB}$  key based on the  $K_{ASME}$  key to which the current  $K_{eNB}$  is associated, using the stored value of *nextHopChainingCount* received in the *RRCConnectionRelease* message in the preceding connection, as specified in TS 33.401 [32] for EPC and TS 33.501 [86] for 5GC;
  - 2> derive the  $K_{RRCint}$  key associated with the previously configured integrity algorithm, as specified in TS 33.401 [32] for EPC and TS 33.501 [86] for 5GC;
  - 2> derive the  $K_{RRCenc}$  key and the  $K_{UPenc}$  key associated with the previously configured ciphering algorithm, as specified in TS 33.401 [32] for EPC and TS 33.501 [86] for 5GC;
  - 2> configure lower layers to resume integrity protection using the previously configured algorithm and the  $K_{RRCint}$  key derived in this clause to all subsequent messages received and sent by the UE;
  - 2> configure lower layers to resume ciphering and to apply the ciphering algorithm and the  $K_{RRCenc}$  key derived in this clause to all subsequent messages received and sent by the UE;
  - 2> configure lower layers to resume ciphering and to apply the ciphering algorithm and the  $K_{UPenc}$  key derived in this clause immediately to the user data sent and received by the UE;
  - 2> if the UE is initiating UP-EDT for mobile originated calls in accordance with conditions in 5.3.3.1b:
    - 3> configure the lower layers to use EDT;
  - 2> else if the UE is initiating UP transmission using PUR in accordance with conditions in 5.3.3.1c:

- 3> configure, except *pur-TimeAlignmentTimer*, the lower layers to use transmission using PUR;
- 3> deliver the UL grant for transmission using PUR to the MAC entity;

1> else:

2> if SRB1 was configured with NR PDCP:

- 3> for SRB1, release the NR PDCP entity and establish an E-UTRA PDCP entity with the current (MCG) security configuration;

NOTE 1: The UE applies the LTE ciphering and integrity protection algorithms that are equivalent to the previously configured NR security algorithms.

2> else:

- 3> for SRB1, restore the PDCP state and re-establish the PDCP entity;

If the UE is resuming the RRC connection from RRC\_INACTIVE, the UE shall set the contents of *RRCConnectionResumeRequest* message as follows:

2> if field *useFullResumeID* is signalled in *SystemInformationBlockType2*:

- 3> set the *fullI-RNTI* to the stored *fullI-RNTI* value provided in suspend;

2> else:

- 3> set the *shortI-RNTI* to the stored *shortI-RNTI* value provided in suspend;

2> restore the RRC configuration, RoHC state, the stored QoS flow to DRB mapping rules and the  $K_{eNB}$  and  $K_{RRcint}$  keys from the UE Inactive AS context except for the following:

- MCG physical layer,
- MCG MAC configuration,
- NR *pdcp-Config*,
- MCG SCell configurations, if stored,
- *nr-SecondaryCellGroupConfig*, if stored;

2> set the *shortResumeMAC-I* to the 16 least significant bits of the MAC-I calculated:

- 3> over the ASN.1 encoded as per clause 8 (i.e., a multiple of 8 bits) *VarShortINACTIVE-MAC-Input*;

- 3> with the  $K_{RRcint}$  key in the UE Inactive AS Context and the previously configured integrity protection algorithm; and

- 3> with all input bits for COUNT, BEARER and DIRECTION set to binary ones;

2> derive the  $K_{eNB}$  key based on the current  $K_{eNB}$  or the NH, using the stored *nextHopChainingCount* value, as specified in TS 33.501 [86];

2> derive the  $K_{RRcenc}$  key, the  $K_{RRcint}$  and the  $K_{UPenc}$  key, as specified in TS 33.401 [32];

2> apply the default configuration for SRB1 as specified in 9.2.1.1;

2> apply the default NR PDCP configuration as specified in TS 38.331 [82], clause 9.2.1 for SRB1;

2> configure lower layers to resume integrity protection for all SRBs except SRB0 using the configured algorithm and the  $K_{RRcint}$  key derived in this clause immediately, i.e., integrity protection shall be applied to all subsequent messages received and sent by the UE;

2> configure lower layers to resume ciphering for all radio bearers except SRB0 and to apply the configured ciphering algorithm, the  $K_{RRcenc}$  key and the  $K_{UPenc}$  key derived in this clause, i.e. the ciphering configuration shall be applied to all subsequent messages received and sent by the UE;



Following procedures are applied for both suspended RRC connection and RRC\_INACTIVE:

- 2> resume SRB1;

NOTE 2: Until successful connection resumption, the default physical layer configuration and the default MAC Main configuration are applied for the transmission of SRB0 and SRB1, and SRB1 is used only for the transfer of *RRConnectionResume* message, and *RRConnectionRelease* message if security has been re-activated.

The UE shall submit the *RRConnectionResumeRequest* message to lower layers for transmission.

The UE shall continue cell re-selection related measurements as well as cell re-selection evaluation.

If the UE is resuming the RRC connection from RRC\_INACTIVE and if lower layers indicate an integrity check failure while T300 is running, the UE shall perform actions specified in 5.3.3.16.

### 5.3.3.3b Actions related to transmission of *RRCEarlyDataRequest* message

The UE shall set the contents of *RRCEarlyDataRequest* message as follows:

- 1> if upper layers provide an S-TMSI:
  - 2> set the *s-TMSI* to the value received from upper layers;
- 1> else if upper layers provide a 5G-S-TMSI:
  - 2> set the *ng-5G-S-TMSI* to the value received from upper layers;
- 1> set the *establishmentCause* in accordance with the information received from upper layers;
- 1> if the UE is a NB-IoT UE:
  - 2> if the UE supports DL channel quality reporting and *cqi-Reporting* is present in *SystemInformationBlockType2-NB*:
    - 3> set the *cqi-NPDCCH* to include the latest results of the downlink channel quality measurements of the carrier where the random access response is received as specified in TS 36.133 [16];

NOTE: The downlink channel quality measurements may use measurement period T1 or T2, as defined in TS 36.133 [16]. In case period T2 is used the RRC-MAC interactions are left to UE implementation.

- 1> set the *dedicatedInfoNAS* to include the information received from upper layers;

The UE shall:

- 1> if the UE is initiating CP-EDT in accordance with conditions in 5.3.3.1b:
  - 2> configure the lower layers to use EDT;
- 1> else if the UE is initiating CP transmission using PUR in accordance with conditions in 5.3.3.1c:
  - 2> configure, except *pur-TimeAlignmentTimer*, the lower layers to use transmission using PUR;
  - 2> deliver the UL grant for transmission using PUR to the MAC entity;
- 1> submit the *RRCEarlyDataRequest* message to the lower layers for transmission.

### 5.3.3.3c UE actions upon receiving EDT fallback indication from lower layers

Upon indication from lower layers that EDT is cancelled, the UE shall:

- 1> start or restart timer T300;
- 1> if the fallback is indicated by lower layers in response to the *RRCEarlyDataRequest*:
  - 2> initiate transmission of *RRConnectionRequest* message in accordance with 5.3.3.3;

- 1> else if the fallback is indicated by lower layers in response to the *RRCCONNECTIONRESUMEREQUEST* for EDT when connected to EPC and the fallback is not due to the UL grant provided in Random Access Response not being for EDT:
  - 2> perform the actions as specified in 5.3.3.9a;
  - 2> initiate transmission of the *RRCCONNECTIONRESUMEREQUEST* message in accordance with 5.3.3.3a;

NOTE: It is up to UE implementation to avoid data loss due to EDT fallback.

### 5.3.3.3d UE actions upon receiving PUR indications from lower layers

The UE shall:

- 1> if repetition adjustment is indicated by lower layers:
  - 2> update *numRepetitions* (*npusch-NumRepetitionsIndex* in NB-IoT) in previously stored *pur-Config* in accordance with the received indication;
- 1> if *pur-RSRP-ChangeThreshold* (*pur-NRSRP-ChangeThreshold* in NB-IoT) is configured and timing advance adjustment is indicated by lower layers:
  - 2> replace the serving cell reference (N)RSRP value with the current serving cell (N)RSRP value (see 5.3.3.19);

For CP transmission using PUR, upon indication from lower layers that transmission using PUR is successfully completed, the UE shall perform the actions as specified in 5.3.3.4b as if an empty *RRCEarlyDataComplete* message was received.

Upon reception of PUR fallback or PUR failure indication from lower layers, the procedure ends.

NOTE: For transmission using PUR, further UE actions upon reception of PUR fallback or PUR failure indication from lower layers (see TS 36.321 [6]) is left up to implementation.

### 5.3.3.4 Reception of the *RRCCONNECTIONSETUP* by the UE

NOTE 1: Prior to this, lower layer signalling is used to allocate a C-RNTI. For further details see TS 36.321 [6];

The UE shall:

- 1> except when the UE connected to 5GC is a BL UE or UE in CE, if the *RRCCONNECTIONSETUP* is received in response to an *RRCCONNECTIONRESUMEREQUEST* from a suspended RRC connection:
  - 2> if the UE is resuming an RRC connection after early security reactivation in accordance with conditions in 5.3.3.18:
    - 3> discard any current AS security context including the  $K_{RRCEnc}$  key, the  $K_{RRCint}$  key, the  $K_{UPint}$  key and the  $K_{UPenc}$  key;
  - 2> release all radio resources, including release of the RLC entity, the MAC configuration and the associated PDCP entity for all established or suspended RBs, except for SRB0;
  - 2> discard the stored UE AS context and *resumeIdentity*;
  - 2> if stored, discard the stored *nextHopChainingCount*;
  - 2> if stored, discard the stored *drb-ContinueROHC*;
  - 2> indicate to upper layers fallback of the RRC connection;
- 1> if the *RRCCONNECTIONSETUP* is received in response to an *RRCCONNECTIONRESUMEREQUEST* from RRC\_INACTIVE:
  - 2> stop T380 if running;
  - 2> discard the stored UE Inactive AS context;

- 2> release *rrc-InactiveConfig*, if configured;
- 1> if the UE connected to 5GC is a BL UE or UE in CE, and the *RRCCConnectionSetup* is received in response to an *RRCCConnectionResumeRequest* from a suspended RRC connection:
  - 2> discard the stored UE AS context and *resumeIdentity*;
  - 2> if stored, discard the stored *nextHopChainingCount*;
  - 2> if stored, discard the stored *drb-ContinueROHC*;
- 1> if the *RRCCConnectionSetup* is received in response to an *RRCCConnectionResumeRequest* from RRC\_INACTIVE; or
- 1> if the UE connected to 5GC is a BL UE or UE in CE, and the *RRCCConnectionSetup* is received in response to an *RRCCConnectionResumeRequest* from a suspended RRC connection:
  - 2> discard any current AS security context including the  $K_{RRCEnc}$  key, the  $K_{RRCint}$  key, the  $K_{UPint}$  key and the  $K_{UPenc}$  key;
  - 2> release radio resources for all established RBs except SRB0, including release of the RLC entities, of the associated PDCP entities and of SDAP entities;
  - 2> release the RRC configuration except for the default L1 parameter values, default MAC main configuration and CCCH;
  - 2> apply the default NR PDCP configuration as specified in TS 38.331 [82], clause 9.2.1.1 for SRB1;
  - 2> use NR PDCP for all subsequent messages received and sent by the UE via SRB1;
  - 2> indicate to upper layers fallback of the RRC connection;
- 1> if the *RRCCConnectionSetup* is received in response to an *RRCEarlyDataRequest* or *RRCCConnectionResumeRequest* for transmission using PUR:
  - 2> instruct the associated MAC entity to start *timeAlignmentTimer*;
- 1> perform the radio resource configuration procedure in accordance with the received *radioResourceConfigDedicated* and as specified in 5.3.10.0;
- 1> if stored, discard the cell reselection priority information provided by the *idleModeMobilityControlInfo* or inherited from another RAT;
- 1> if stored, discard the *altFreqPriorities* provided by the *RRCCConnectionRelease*;
- 1> if stored, discard the dedicated offset provided by the *redirectedCarrierOffsetDedicated*;
- 1> stop timer T300;
- 1> if T302 is running:
  - 2> stop timer T302;
  - 2> if the UE is connected to 5GC:
    - 3> perform the actions as specified in 5.3.16.4;
- 1> stop timer T303, if running;
- 1> stop timer T305, if running;
- 1> stop timer T306, if running;
- 1> stop timer T308, if running;
- 1> perform the actions as specified in 5.3.3.7;
- 1> stop timer T320, if running;

- 1> stop timer T350, if running;
- 1> perform the actions as specified in 5.6.12.4;
- 1> release *rclwi-Configuration*, if configured, as specified in 5.6.16.2;
- 1> stop timer T360, if running;
- 1> stop timer T322, if running;
- 1> if timer T331 is running:
  - 2> stop timer T331;
  - 2> perform the actions as specified in 5.6.20.3;
- 1> stop timer T323, if running;
- 1> forward the *dedicatedInfoNAS*, if received, to the upper layers;
- 1> if T309 is running:
  - 2> stop timer T309 for all access categories;
  - 2> perform the actions as specified in 5.3.16.4.
- 1> enter RRC\_CONNECTED;
- 1> stop the cell re-selection procedure;
- 1> consider the current cell to be the PCell;
- 1> except for NB-IoT:
  - 2> if the UE supports RLF report for inter-RAT MRO EUTRA as defined in TS 38.306 [87], and if the UE has radio link failure or handover failure information available in *VarRLF-Report* of TS 38.331 [82] and if the RPLMN is included in *plmn-IdentityList* stored in *VarRLF-Report* of TS 38.331 [82]:
    - 3> if *reconnectCellId* in *VarRLF-Report* of TS 38.331 [82] is not set, and if the UE failed to perform reestablishment; or
    - 3> if *reconnectCellId* in *VarRLF-Report* of TS 38.331 [82] is not set, and if the UE selected the current PCell immediately after failure in performing *MobilityFromNRCommand*:
      - 4> if the selected PCell is an acceptable cell as defined in TS 36.304 [4]:
        - 5> set *timeUntilReconnection* in *VarRLF-Report* of TS 38.331 [82] to the time that elapsed since the *MobilityFromNRCommand* failure;
      - 4> if the selected PCell is a suitable cell as defined in TS 36.304 [4]:
        - 5> set *timeUntilReconnection* in *VarRLF-Report* of TS 38.331 [82] to the time that elapsed since the last radio link failure or handover failure;
        - 5> set *eutraReconnectCellId* in *reconnectCellId* in *VarRLF-Report* of TS 38.331 [82] to the global cell identity and the tracking area code of the PCell;
  - 2> if the UE radio link failure or handover failure information available in *VarRLF-Report* and if the RPLMN is included in *plmn-IdentityList* stored in *VarRLF-Report*:
    - 3> if *reconnectCellId* in *VarRLF-Report* is not set, and if the UE failed to perform reestablishment:
      - 4> set *timeUntilReconnection* in *VarRLF-Report* to the time that elapsed since the last radio link failure or handover failure;
      - 4> set *eutraReconnectCellId* in *reconnectCellId* in *VarRLF-Report* to the global cell identity and the tracking area code of the PCell;

- 1> set the content of *RRCCONNECTIONSETUPCOMPLETE* message as follows:
  - 2> if the *RRCCONNECTIONSETUP* is received in response to an *RRCCONNECTIONRESUMEREQUEST*:
    - 3> if upper layers provide an S-TMSI:
      - 4> set the *s-TMSI* to the value received from upper layers;
    - 3> else if upper layers provide a 5G-S-TMSI:
      - 4> if the UE is a NB-IoT UE:
        - 5> set the *ng-5G-S-TMSI* to the value received from upper layers;
      - 4> else:
        - 5> set the *ng-5G-S-TMSI-Bits* to *ng-5G-S-TMSI* with the value received from upper layers;
  - 2> else if upper layers provide a 5G-S-TMSI:
    - 3> except for NB-IoT, set the *ng-5G-S-TMSI-Bits* to *ng-5G-S-TMSI-Part2* to the leftmost 8 bits of 5G-S-TMSI received from upper layers;
  - 2> set the *selectedPLMN-Identity* to the PLMN selected by upper layers (see TS 23.122 [11], TS 24.301 [35] for E-UTRA/EPC and TS 24.501 [95] for E-UTRA/5GC) from the PLMN(s) included in the *plmn-IdentityList* in *SystemInformationBlockType1* (or *SystemInformationBlockType1-NB* in NB-IoT);
  - 2> if upper layers provide the 'Registered MME', include and set the *registeredMME* as follows:
    - 3> if the PLMN identity of the 'Registered MME' is different from the PLMN selected by the upper layers:
      - 4> include the *plmnIdentity* in the *registeredMME* and set it to the value of the PLMN identity in the 'Registered MME' received from upper layers;
    - 3> set the *mmegi* and the *mmec* to the value received from upper layers;
  - 2> if upper layers provided the 'Registered MME':
    - 3> include and set the *gummei-Type* to the value provided by the upper layers;
  - 2> if upper layers provide the 'Registered AMF', include and set the *registeredAMF* as follows:
    - 3> if the PLMN identity of the 'Registered AMF' is different from the PLMN selected by the upper layers:
      - 4> include the *plmnIdentity* in the *registeredAMF* and set it to the value of the PLMN identity in the 'Registered AMF' received from upper layers;
    - 3> set the *amf-Identifier* to AMF Identifier of the 'Registered AMF' received from upper layers;
  - 2> if upper layers provided the 'Registered AMF':
    - 3> include and set the *guami-Type* to the value provided by the upper layers;
  - 2> if upper layers provide one or more S-NSSAI (see TS 23.003 [27]):
    - 3> include the *s-NSSAI-list* and set the content to the values provided by the upper layers;
  - 2> if the UE supports CIoT EPS optimisation(s):
    - 3> include *attachWithoutPDN-Connectivity* if received from upper layers;
    - 3> include *up-CIoT-EPS-Optimisation* if received from upper layers;
    - 3> except for NB-IoT, include *cp-CIoT-EPS-Optimisation* if received from upper layers;
  - 2> if the UE supports CIoT 5GS optimisation(s):
    - 3> for NB-IoT, include *ng-U-DataTransfer* if received from upper layers;

- 3> except for NB-IoT, include *cp-CIoT-5GS-Optimisation* if received from upper layers;
- 2> if connecting as an RN:
  - 3> include the *rn-SubframeConfigReq*;
- 2> if the *RRConnectionSetup* is received in response to *RRCEarlyDataRequest*:
  - 3> set the *dedicatedInfoNAS* to a zero-length octet string;
- 2> else:
  - 3> set the *dedicatedInfoNAS* to include the information received from upper layers;
- 2> if the *RRConnectionSetup* is not in response to transmission using PUR and the UE has a stored *pur-Config* including *pur-ConfigID*:
  - 3> include the stored *pur-ConfigID*;
- 2> if the UE is connected to EPC:
  - 3> except for NB-IoT:
    - 4> include the *mobilityState* and set it to the mobility state (as specified in TS 36.304 [4]) of the UE just prior to entering RRC\_CONNECTED state;
  - 3> for NB-IoT:
    - 4> if the UE has radio link failure information available in *VarRLF-Report-NB* and if the RPLMN is included in *plmn-IdentityList* stored in *VarRLF-Report-NB*:
      - 5> include *rlf-InfoAvailable*;
    - 4> if the UE has ANR measurements information available in *VarANR-MeasReport-NB* and if the RPLMN is included in *plmn-IdentityList* stored in *VarANR-MeasReport-NB*:
      - 5> include *anr-InfoAvailable*;
  - 3> include *dcn-ID* if a DCN-ID value (see TS 23.401 [41]) is received from upper layers;
- 2> else (i.e. the UE is connected to 5GC):
  - 3> if the UE is a BL UE:
    - 4> include *lte-M*;
- 2> except for NB-IoT:
  - 3> if the UE has radio link failure or handover failure information available in *VarRLF-Report* and if the RPLMN is included in *plmn-IdentityList* stored in *VarRLF-Report*:
    - 4> include *rlf-InfoAvailable*;
  - 3> if the UE has MBSFN logged measurements available for E-UTRA and if the RPLMN is included in *plmn-IdentityList* stored in *VarLogMeasReport*:
    - 4> include *logMeasAvailableMBSFN*;
  - 3> if the UE has logged measurements available for E-UTRA and if the RPLMN is included in *plmn-IdentityList* stored in *VarLogMeasReport*:
    - 4> include *logMeasAvailable*;
    - 4> if Bluetooth measurement results are included in the logged measurements the UE has available:
      - 5> include *logMeasAvailableBT*;
    - 4> if WLAN measurement results are included in the logged measurements the UE has available:

- 5> include *logMeasAvailableWLAN*;
  - 3> if the UE has connection establishment failure information available in *VarConnEstFailReport* and if the RPLMN is equal to *plmn-Identity* stored in *VarConnEstFailReport*:
    - 4> include *connEstFailInfoAvailable*;
  - 3> if the UE has flight path information available:
    - 4> include *flightPathInfoAvailable*;
  - 3> if the UE supports storage of mobility history information and the UE has mobility history information available in *VarMobilityHistoryReport*:
    - 4> include the *mobilityHistoryAvail*;
  - 3> if the SIB2 contains *idleModeMeasurements* and the UE has E-UTRA idle/inactive measurement information concerning cells other than the PCell available in *VarMeasIdleReport*; or
  - 3> if the SIB2 contains *idleModeMeasurementsNR* and the UE has NR idle/inactive measurement information available in *VarMeasIdleReport*:
    - 4> include the *idleMeasAvailable*;
  - 3> if upper layers indicate that access to RLOS is initiated (see TS 23.401 [41] clause 4.3.8.3):
    - 4> set *rlos-Request* to *true*;
  - 2> if UE needs UL gaps during continuous uplink transmission:
    - 3> include *ue-CE-NeedULGaps*;
  - 2> for NB-IoT:
    - 3> if the UE supports serving cell idle mode measurements reporting and *-servingCellMeasInfo* is present in *SystemInformationBlockType2-NB*:
      - 4> set the *measResultServCell* to include the measurements of the serving cell;
- NOTE 2: The UE includes the latest results of the serving cell measurements as used for cell selection/ reselection evaluation, which are performed in accordance with the performance requirements as specified in TS 36.133 [16].
- 2> if connecting as an IAB-node:
    - 3> include *iab-NodeIndication*;
  - 2> if the UE is connected to NTN:
    - 3> include *gnss-validityDuration* in accordance with the remaining time of the GNSS validity duration;
    - 3> if UE supports GNSS position fix in RRC\_CONNECTED and *gnss-PositionFixDurationReporting* is present in *SystemInformationBlockType2(-NB)*:
      - 4> include *gnss-PositionFixDuration* in accordance with the time duration required for the UE to acquire a GNSS position;
  - 2> if UE supports uplink RRC Segmentation of *UECapabilityInformation*:
    - 3> except for NB-IoT, may include *ul-RRC-Segmentation* if upper layers indicate that they are performing an Attach or TA Update;
  - 1> submit the *RRCConnectionSetupComplete* message to lower layers for transmission;
  - 1> for NB-IoT:
    - 2> if the UE supports connected mode measurements and *connMeasConfig* is present in *SystemInformationBlockType3-NB*:

3> perform measurements as specified in 5.5.8.

1> the procedure ends.

#### 5.3.3.4a Reception of the *RRCConnectionResume* by the UE

The UE shall:

1> stop timer T300;

1> if T309 is running:

2> stop timer T309 for all access categories;

2> perform the actions as specified in 5.3.16.4.

1> stop T380 if running;

1> if the *RRCConnectionResume* is received in response to an *RRCConnectionResumeRequest* for EDT or for transmission using PUR:

2> discard the stored UE AS context and *resumeIdentity*;

2> if the *RRCConnectionResume* is received in response to an *RRCConnectionResumeRequest* for transmission using PUR:

3> instruct the associated MAC entity to start *timeAlignmentTimer*;

1> else:

2> if resuming an RRC connection from a suspended RRC connection in EPC; or

2> for NB-IoT, if resuming an RRC connection from a suspended RRC connection in 5GC and *fullConfig* is not present in the *RRCConnectionResume* message:

3> restore the PDCP state and re-establish PDCP entities for SRB2, if configured with E-UTRA PDCP, and for all DRBs that are configured with E-UTRA PDCP;

3> if *drb-ContinueROHC* is included:

4> indicate to lower layers that stored UE AS context is used and that *drb-ContinueROHC* is configured;

4> continue the header compression protocol context for the DRBs configured with the header compression protocol;

3> else:

4> indicate to lower layers that stored UE AS context is used;

4> reset the header compression protocol context for the DRBs configured with the header compression protocol;

3> if *restoreMCG-SCells* is included:

4> restore the MCG SCell(s) configuration, if stored;

3> else:

4> release the MCG SCell(s) from the UE AS context, if stored;

3> if *restoreSCG* is included:

4> restore *nr-SecondaryCellGroupConfig*, if stored;

3> else if the UE was configured with EN-DC:

4> perform MR-DC release, as specified in TS 38.331 [82], clause 5.3.5.10;



- 4> release *tdm-PatternConfig* or *tdm-PatternConfig2*, if configured;
- 3> discard the stored UE AS context and *resumeIdentity*;
- 3> configure lower layers to consider the restored MCG and SCG SCell(s) (if any) to be in deactivated state;
- 2> else if the *RRCConnectionResume* message includes the *fullConfig* (i.e., for resuming an RRC connection from RRC\_INACTIVE or for resuming a suspended RRC connection in 5GC):
  - 3> perform the radio configuration procedure as specified in 5.3.5.8;
- 2> else if resuming an RRC connection from RRC\_INACTIVE:
  - 3> restore the following from the stored UE Inactive AS context:
    - MCG physical layer configuration,
    - MCG MAC configuration,
    - MCG RLC configuration,
    - PDCP configuration;
  - 3> if *restoreMCG-SCells* is included:
    - 4> restore the MCG SCell(s) configuration, if stored;
  - 3> else:
    - 4> release the MCG SCell(s) from the UE Inactive AS context, if stored;
  - 3> if *restoreSCG* is included:
    - 4> restore *nr-SecondaryCellGroupConfig*, if stored;
  - 3> else if the UE was configured with NGEN-DC:
    - 4> perform MR-DC release, as specified in TS 38.331 [82], clause 5.3.5.10;
    - 4> release *tdm-PatternConfig* or *tdm-PatternConfig2*, if configured;
  - 3> discard the stored UE Inactive AS context;
  - 3> configure lower layers to consider the restored MCG and SCG SCell(s) (if any) to be in deactivated state;
  - 3> release the *rrc-InactiveConfig*, except *ran-NotificationAreaInfo*;
- 2> else (i.e., except for NB-IoT for resuming a suspended RRC connection in 5GC):
  - 3> restore the physical layer configuration, the MAC configuration, the RLC configuration and the PDCP configuration from the stored UE AS context;
  - 3> discard the stored UE AS context and *resumeIdentity*;
- 1> perform the radio resource configuration procedure in accordance with the received *radioResourceConfigDedicated* and as specified in 5.3.10.0;

NOTE 1: When performing the radio resource configuration procedure, for the physical layer configuration and the MAC Main configuration, the restored RRC configuration from the stored UE AS context is used as basis for the reconfiguration.

- 1> if the received *RRCConnectionResume* includes the *sCellToReleaseList*:
  - 2> perform SCell release as specified in 5.3.10.3a;
- 1> if the received *RRCConnectionResume* includes the *sCellToAddModList*:
  - 2> perform SCell addition or modification as specified in 5.3.10.3b;

- 1> if the received *RRCConnectionResume* includes the *sCellGroupToReleaseList*:
  - 2> perform SCell group release as specified in 5.3.10.3d;
- 1> if the received *RRCConnectionResume* includes the *sCellGroupToAddModList*:
  - 2> perform SCell group addition or modification as specified in 5.3.10.3e;
- 1> if the received *RRCConnectionResume* message includes the *nr-SecondaryCellGroupConfig*:
  - 2> perform NR RRC Reconfiguration as specified in TS 38.331 [82], clause 5.3.5.3;
- 1> if the received *RRCConnectionResume* message includes the *sk-Counter*:
  - 2> perform key update procedure as specified in TS 38.331 [82], clause 5.3.5.8;
- 1> if the received *RRCConnectionResume* message includes the *nr-RadioBearerConfig1*:
  - 2> perform radio bearer configuration as specified in TS 38.331 [82], clause 5.3.5.6;
- 1> if the received *RRCConnectionResume* message includes the *nr-RadioBearerConfig2*:
  - 2> perform radio bearer configuration as specified in TS 38.331 [82], clause 5.3.5.6;
- 1> except if the *RRCConnectionResume* is received in response to an *RRCConnectionResumeRequest* for EDT or for transmission using PUR:
  - 2> resume SRB2, SRB3 (if configured), and all DRBs, if any, including RBs configured with NR PDCP;

NOTE 1a: If the NR SCG is deactivated, resuming SRB3 and all DRBs does not imply that PDCP or RRC PDUs can be transmitted or received on SCG RLC bearers.

- 1> if stored, discard the cell reselection priority information provided by the *idleModeMobilityControlInfo* or inherited from another RAT;
- 1> if stored, discard the *altFreqPriorities* provided by the *RRCConnectionRelease*;
- 1> if stored, discard the dedicated offset provided by the *redirectedCarrierOffsetDedicated*;
- 1> if the *RRCConnectionResume* message includes the *measConfig*:
  - 2> perform the measurement configuration procedure as specified in 5.5.2;
- 1> if the *RRCConnectionResume* message includes the *otherConfig*:
  - 2> perform the other configuration procedure as specified in 5.3.10.9;
- 1> if T302 is running:
  - 2> stop timer T302;
  - 2> if the UE is connected to 5GC:
    - 3> perform the actions as specified in 5.3.16.4;
- 1> stop timer T303, if running;
- 1> stop timer T305, if running;
- 1> stop timer T306, if running;
- 1> stop timer T308, if running;
- 1> perform the actions as specified in 5.3.3.7;
- 1> stop timer T320, if running;
- 1> stop timer T350, if running;

- 1> perform the actions as specified in 5.6.12.4;
- 1> stop timer T360, if running;
- 1> stop timer T322, if running;
- 1> stop timer T323, if running;
- 1> if timer T331 is running:
  - 2> stop timer T331;
  - 2> perform the actions as specified in 5.6.20.3;
- 1> if the UE is resuming an RRC connection after early security reactivation in accordance with conditions in 5.3.3.18 or *RRCCConnectionResume* is received in response to an *RRCCConnectionResumeRequest* from RRC\_INACTIVE:
  - 2> ignore the *nextHopChainingCount* value indicated in the *RRCCConnectionResume* message;
- 1> else:
  - 2> if resuming an RRC connection from a suspended RRC connection in EPC:
    - 3> update the  $K_{eNB}$  key based on the  $K_{ASME}$  key to which the current  $K_{eNB}$  is associated, using the *nextHopChainingCount* value indicated in the *RRCCConnectionResume* message, as specified in TS 33.401 [32];
    - 3> store the *nextHopChainingCount* value;
    - 3> derive the  $K_{RRCint}$  key associated with the previously configured integrity algorithm, as specified in TS 33.401 [32];
    - 3> request lower layers to verify the integrity protection of the *RRCCConnectionResume* message, using the previously configured algorithm and the  $K_{RRCint}$  key;
    - 3> if the integrity protection check of the *RRCCConnectionResume* message fails:
      - 4> perform the actions upon leaving RRC\_CONNECTED as specified in 5.3.12, with release cause 'other', upon which the procedure ends;
    - 3> derive the  $K_{RRCenc}$  key and the  $K_{UPenc}$  key associated with the previously configured ciphering algorithm, as specified in TS 33.401 [32];
    - 3> configure lower layers to resume integrity protection using the previously configured algorithm and the  $K_{RRCint}$  key immediately, i.e., integrity protection shall be applied to all subsequent messages received and sent by the UE;
    - 3> configure lower layers to resume ciphering and to apply the ciphering algorithm, the  $K_{RRCenc}$  key and the  $K_{UPenc}$  key, i.e. the ciphering configuration shall be applied to all subsequent messages received and sent by the UE;
- 1> enter RRC\_CONNECTED;
- 1> indicate to upper layers that the suspended RRC connection has been resumed;
- 1> stop the cell re-selection procedure;
- 1> consider the current cell to be the PCell;
- 1> set the content of *RRCCConnectionResumeComplete* message as follows:
  - 2> set the *selectedPLMN-Identity* to the PLMN selected by upper layers (see TS 23.122 [11], TS 24.301 [35] for E-UTRA/EPC and TS 24.501 [95] for E-UTRA/5GC) from the PLMN(s) included in the *plmn-IdentityList* in *SystemInformationBlockType1*;
  - 2> set the *dedicatedInfoNAS* to include the information received from upper layers;

- 2> except for NB-IoT:
  - 3> if resuming an RRC connection from a suspended RRC connection:
    - 4> if the UE has radio link failure or handover failure information available in *VarRLF-Report* and if the RPLMN is included in *plmn-IdentityList* stored in *VarRLF-Report*:
      - 5> include *rlf-InfoAvailable*;
    - 4> if the UE has MBSFN logged measurements available for E-UTRA and if the RPLMN is included in *plmn-IdentityList* stored in *VarLogMeasReport*:
      - 5> include *logMeasAvailableMBSFN*;
    - 4> else if the UE has logged measurements available for E-UTRA and if the RPLMN is included in *plmn-IdentityList* stored in *VarLogMeasReport*:
      - 5> include *logMeasAvailable*;
      - 5> if Bluetooth measurement results are included in the logged measurements the UE has available:
        - 6> include *logMeasAvailableBT*;
      - 5> if WLAN measurement results are included in the logged measurements the UE has available:
        - 6> include *logMeasAvailableWLAN*;
    - 4> if the UE has connection establishment failure information available in *VarConnEstFailReport* and if the RPLMN is equal to *plmn-Identity* stored in *VarConnEstFailReport*:
      - 5> include *connEstFailInfoAvailable*;
    - 4> include the *mobilityState* and set it to the mobility state (as specified in TS 36.304 [4]) of the UE just prior to entering RRC\_CONNECTED state;
    - 4> if the UE has flight path information available:
      - 5> include *flightPathInfoAvailable*;
  - 3> if the UE supports storage of mobility history information and the UE has mobility history information available in *VarMobilityHistoryReport*:
    - 4> include *mobilityHistoryAvail*;
  - 3> if the *idleModeMeasurementReq* is included in the *RRCCConnectionResume* message:
    - 4> if the UE has idle/inactive measurement information concerning cells other than the PCell available in *VarMeasIdleReport*:
      - 5> set the *measResultListIdle-r16* in the *RRCCConnectionResumeComplete* message to the value of *measReportIdle-r15* in the *VarMeasIdleReport*;
      - 5> set the *measResultListExtIdle* in the *RRCCConnectionResumeComplete* message to the value of *measReportIdle-r16* in the *VarMeasIdleReport*, if available;
      - 5> set the *measResultListIdleNR* in the *RRCCConnectionResumeComplete* message to the value of *measReportIdleNR* in the *VarMeasIdleReport*, if available;
      - 5> discard the *VarMeasIdleReport* upon successful delivery of the *RRCCConnectionResumeComplete* message is confirmed by lower layers;
  - 3> else:
    - 4> if the SIB2 contains *idleModeMeasurements* and the UE has E-UTRA idle/inactive measurement information concerning cells other than the PCell available in *VarMeasIdleReport*; or

- 4> if the SIB2 contains *idleModeMeasurementsNR* and the UE has NR idle/inactive measurement information available in *VarMeasIdleReport*:
    - 5> include the *idleMeasAvailable*;
  - 3> if the *RRCCConnectionResume* message includes *nr-SecondaryCellGroupConfig*:
    - 4> include *scg-ConfigResponseNR* in accordance with TS 38.331 [82], clause 5.3.5.3;
  - 2> for NB-IoT:
    - 3> if the UE supports serving cell idle mode measurements reporting and *servingCellMeasInfo* is present in *SystemInformationBlockType2-NB*:
      - 4> set the *measResultServCell* to include the measurements of the serving cell;
- NOTE 2: The UE includes the latest results of the serving cell measurements as used for cell selection/ reselection evaluation, which are performed in accordance with the performance requirements as specified in TS 36.133 [16].
- 3> if the UE is connected to EPC:
    - 4> if the UE has radio link failure information available in *VarRLF-Report-NB* and if the RPLMN is included in *plmn-IdentityList* stored in *VarRLF-Report-NB*:
      - 5> include *rlf-InfoAvailable*;
    - 4> if the UE has ANR measurements information available in *VarANR-MeasReport-NB* and if the RPLMN is included in *plmn-IdentityList* stored in *VarANR-MeasReport-NB*:
      - 5> include *anr-InfoAvailable*;
  - 2> if the UE is connected to NTN:
    - 3> include *gnss-validityDuration* in accordance with the remaining time of the GNSS validity duration;
    - 3> if UE supports GNSS position fix in *RRC\_CONNECTED* and *gnss-PositionFixDurationReporting* is present in *SystemInformationBlockType2(-NB)*:
      - 4> include *gnss-PositionFixDuration* in accordance with the time duration required for the UE to acquire a GNSS position;
  - 1> if the UE is configured to operate in EN-DC as result of this procedure, forward *upperLayerIndication* to upper layers as if the UE has received this field from SIB2, otherwise indicate to upper layers the absence of this field;
  - 1> submit the *RRCCConnectionResumeComplete* message to lower layers for transmission;
  - 1> for NB-IoT:
    - 2> if the UE supports connected mode measurements and *connMeasConfig* is present in *SystemInformationBlockType3-NB*:
      - 3> perform measurements as specified in 5.5.8.
    - 2> if the received *RRCCConnectionResume* message includes the *obtainLocationNB*:
      - 3> attempt to have detailed location information available for any RLF report;
- NOTE 3: The UE is requested to attempt to have valid detailed location information available at the time of RLF. The UE may not succeed e.g. because the user manually disabled the GPS hardware, due to no/poor satellite coverage. Further details, e.g. regarding when to activate GNSS, are up to UE implementation.
- 1> the procedure ends.

#### 5.3.3.4b Reception of the *RRCEarlyDataComplete* by the UE

The UE shall:

- 1> indicate to upper layers that the RRC connection has been established;
- 1> if stored, discard the cell reselection priority information provided by the *idleModeMobilityControlInfo* or inherited from another RAT;
- 1> if stored, discard the *altFreqPriorities* provided by the *RRCConnectionRelease*;
- 1> if stored, discard the dedicated offset provided by the *redirectedCarrierOffsetDedicated*;
- 1> stop timer T300;
- 1> stop timer T302, if running;
- 1> stop timer T303, if running;
- 1> stop timer T305, if running;
- 1> stop timer T306, if running;
- 1> stop timer T308, if running;
- 1> perform the actions as specified in 5.3.3.7;
- 1> stop timer T320, if running;
- 1> stop timer T322, if running;
- 1> stop timer T323, if running;
- 1> reset MAC and release the MAC configuration;
- 1> if the *RRCEarlyDataComplete* message includes *redirectedCarrierInfo* indicating redirection to *geran*, *utra-FDD* or *utra-TDD*; or
- 1> if the *RRCEarlyDataComplete* message includes *idleModeMobilityControlInfo* including *freqPriorityListGERAN* or *freqPriorityListUTRA-FDD* or *freqPriorityListUTRA-TDD*:
  - 2> if upper layers indicate that redirect to GERAN or UTRAN without AS security is not allowed:
    - 3> ignore the content of *RRCEarlyDataComplete*;
    - 3> perform the actions upon leaving RRC\_CONNECTED as specified in 5.3.12, with release cause 'other', upon which the procedure ends;
- 1> forward the *dedicatedInfoNAS*, if received, to the upper layers;
- 1> if the *RRCEarlyDataComplete* message includes *idleModeMobilityControlInfo*:
  - 2> store the cell reselection priority information provided by the *idleModeMobilityControlInfo*;
  - 2> if the *t320* is included:
    - 3> start timer T320, with the timer value set according to the value of *t320*;
- 1> else:
  - 2> apply the cell reselection priority information broadcast in the system information;
- 1> for NB-IoT, if the *RRCEarlyDataComplete* message includes *redirectedCarrierInfo*:
  - 2> if the *redirectedCarrierOffsetDedicated* is included in the *redirectedCarrierInfo*:
    - 3> store the dedicated offset for the frequency in *redirectedCarrierInfo*;
    - 3> start timer T322, with the timer value set according to the value of *T322* in *redirectedCarrierInfo*;
- 1> if the *extendedWaitTime* is present; and
- 1> if the UE supports delay tolerant access or the UE is a NB-IoT UE:

2> forward the *extendedWaitTime* to upper layers;

1> indicate the release of the RRC connection to upper layers together with the release cause 'other', upon which the procedure ends;

### 5.3.3.5 Cell re-selection or cell selection while T300, T302, T303, T305, T306, T308 or T309 is running

The UE shall:

1> if cell selection or reselection occurs while T309 or T302 is running and if the UE is connected to 5GC:

2> stop timer T309 for all access categories, if running;

2> if in RRC\_INACTIVE and T302 is running:

3> perform the actions upon leaving RRC\_INACTIVE as specified in 5.3.12 with release cause 'RRC Resume failure';

2> else:

3> stop timer T302, if running;

3> perform the actions as specified in 5.3.16.4;

1> if in RRC\_INACTIVE:

2> if cell reselection occurs while T300 is running:

3> perform the actions upon leaving RRC\_INACTIVE as specified in 5.3.12 with release cause 'RRC Resume failure';

1> else if cell reselection occurs while T300, T302, T303, T305, T306, or T308 is running:

2> if timer T302, T303, T305, T306, and/or T308 is running and if the UE is connected to EPC:

3> stop timer T302, T303, T305, T306, and T308, whichever ones were running;

3> perform the actions as specified in 5.3.3.7;

2> if timer T300 is running:

3> stop timer T300;

3> if UE has sent *RRCCConnectionResumeRequest* message and has not received *RRCCConnectionResume* message:

4> reset MAC;

4> if UE is resuming an RRC connection after early security reactivation in accordance with conditions in 5.3.3.18:

5> perform the actions as specified in 5.3.3.9a;

4> else:

5> re-establish RLC for all RBs that are established;

5> suspend SRB1;

3> else:

4> reset MAC, release the MAC configuration and re-establish RLC for all RBs that are established;

3> inform upper layers about the failure to establish the RRC connection or failure to resume the RRC connection with suspend indication;

### 5.3.3.6 T300 expiry

The UE shall:

- 1> if timer T300 expires:
  - 2> if UE has sent *RRCConnectionResumeRequest* message and has not received *RRCConnectionResume* message:
    - 3> reset MAC;
    - 3> if UE is resuming an RRC connection after early security reactivation in accordance with conditions in 5.3.3.18:
      - 4> perform the actions as specified in 5.3.3.9a;
    - 3> else:
      - 4> re-establish RLC for all RBs that are established;
      - 4> suspend SRB1;
  - 2> else:
    - 3> reset MAC, release the MAC configuration and re-establish RLC for all RBs that are established;

2> if the UE is a NB-IoT UE:

- 3> if *connEstFailOffset* is included in *SystemInformationBlockType2-NB*:
  - 4> use *connEstFailOffset* for the parameter  $Q_{\text{offset}_{\text{temp}}}$  for the concerned cell when performing cell selection and reselection according to TS 36.304 [4];
- 3> else:
  - 4> use value of infinity for the parameter  $Q_{\text{offset}_{\text{temp}}}$  for the concerned cell when performing cell selection and reselection according to TS 36.304 [4];

NOTE 0: For NB-IoT, the number of times that the UE detects T300 expiry on the same cell before applying *connEstFailOffset* and the amount of time that the UE applies *connEstFailOffset* before removing the offset from evaluation of the cell is up to UE implementation.

2> else if the UE supports RRC Connection Establishment failure temporary  $Q_{\text{offset}}$  and T300 has expired a consecutive *connEstFailCount* times on the same cell for which *txFailParams* is included in *SystemInformationBlockType2*:

- 3> for a period as indicated by *connEstFailOffsetValidity*:
  - 4> use *connEstFailOffset* for the parameter  $Q_{\text{offset}_{\text{temp}}}$  for the concerned cell when performing cell selection and reselection according to TS 36.304 [4] and TS 25.304 [40];

NOTE 1: When performing cell selection, if no suitable or acceptable cell can be found, it is up to UE implementation whether to stop using *connEstFailOffset* for the parameter  $Q_{\text{offset}_{\text{temp}}}$  during *connEstFailOffsetValidity* for the concerned cell.

2> except for NB-IoT, store the following connection establishment failure information in the *VarConnEstFailReport* by setting its fields as follows:

- 3> clear the information included in *VarConnEstFailReport*, if any;
- 3> set the *plmn-Identity* to the PLMN selected by upper layers (see TS 23.122 [11], TS 24.301 [35]) from the PLMN(s) included in the *plmn-IdentityList* in *SystemInformationBlockType1*;
- 3> set the *failedCellId* to the global cell identity of the cell where connection establishment failure is detected;



- 3> set the *measResultFailedCell* to include the RSRP and RSRQ, if available, of the cell where connection establishment failure is detected and based on measurements collected up to the moment the UE detected the failure;
- 3> if available, set the *measResultNeighCells*, in order of decreasing ranking-criterion as used for cell reselection, to include neighbouring cell measurements for at most the following number of neighbouring cells: 6 intra-frequency and 3 inter-frequency neighbours per frequency as well as 3 inter-RAT neighbours, per frequency/ set of frequencies (GERAN) per RAT and according to the following:
  - 4> for each neighbour cell included, include the optional fields that are available;

NOTE 2: The UE includes the latest results of the available measurements as used for cell reselection evaluation, which are performed in accordance with the performance requirements as specified in TS 36.133 [16].

- 3> if available, set the *logMeasResultListWLAN* to include the WLAN measurement results, in order of decreasing RSSI for WLAN APs;
- 3> if available, set the *logMeasResultListBT* to include the Bluetooth measurement results, in order of decreasing RSSI for Bluetooth beacons;
- 3> if detailed location information is available, set the content of the *locationInfo* as follows:
  - 4> include the *locationCoordinates*;
  - 4> include the *horizontalVelocity*, if available;

NOTE 3: Which location information related configuration is used by the UE to make the *logMeasResultListWLAN*, *logMeasResultListBT* and *locationInfo* available for inclusion in the *VarConnEstFailReport* is left to UE implementation.

- 3> set the *numberOfPreamblesSent* to indicate the number of preambles sent by MAC for the failed random access procedure;
- 3> set *contentionDetected* to indicate whether contention resolution was not successful as specified in TS 36.321 [6] for at least one of the transmitted preambles for the failed random access procedure;
- 3> set *maxTxPowerReached* to indicate whether or not the maximum power level was used for the last transmitted preamble, see TS 36.321 [6];
- 2> if in RRC\_INACTIVE:
  - 3> perform the actions upon leaving RRC\_INACTIVE as specified in 5.3.12, with release cause 'RRC Resume failure';
- 2> else inform upper layers about the failure to establish the RRC connection or failure to resume the RRC connection with suspend indication, upon which the procedure ends;

The UE may discard the connection establishment failure information, i.e. release the UE variable *VarConnEstFailReport*, 48 hours after the failure is detected, upon power off or upon detach.

### 5.3.3.7 T302, T303, T305, T306, or T308 expiry or stop

If the UE is connected to EPC, the UE shall:

- 1> if timer T302 expires or is stopped:
  - 2> inform upper layers about barring alleviation for mobile terminating access;
- 2> if timer T303 is not running:
  - 3> inform upper layers about barring alleviation for mobile originating calls;
- 2> if timer T305 is not running:
  - 3> inform upper layers about barring alleviation for mobile originating signalling;

- 2> if timer T306 is not running:
  - 3> inform upper layers about barring alleviation for mobile originating CS fallback;
- 2> if timer T308 is not running:
  - 3> inform upper layers about barring alleviation for ACDC;
- 1> if timer T303 expires or is stopped:
  - 2> if timer T302 is not running:
    - 3> inform upper layers about barring alleviation for mobile originating calls;
- 1> if timer T305 expires or is stopped:
  - 2> if timer T302 is not running:
    - 3> inform upper layers about barring alleviation for mobile originating signalling;
- 1> if timer T306 expires or is stopped:
  - 2> if timer T302 is not running:
    - 3> inform upper layers about barring alleviation for mobile originating CS fallback;
- 1> if timer T308 expires or is stopped:
  - 2> if timer T302 is not running:
    - 3> inform upper layers about barring alleviation for ACDC;

### 5.3.3.8 Reception of the *RRConnectionReject* by the UE

The UE shall:

- 1> stop timer T300;
- 1> stop timer T302, if running;
- 1> reset MAC;
- 1> except for NB-IoT, start timer T302, with the timer value set to the *waitTime*;
- 1> if the UE is a NB-IoT UE; or
- 1> if the *extendedWaitTime* is present and the UE supports delay tolerant access:
  - 2> forward the *extendedWaitTime* to upper layers;
- 1> if *deprioritisationReq* is included and the UE supports RRC Connection Reject with deprioritisation:
  - 2> start or restart timer T325 with the timer value set to the *deprioritisationTimer* signalled;
  - 2> store the *deprioritisationReq* until T325 expiry;

NOTE: The UE stores the deprioritisation request irrespective of any cell reselection absolute priority assignments (by dedicated or common signalling) and regardless of RRC connections in E-UTRAN or other RATs unless specified otherwise.

- 1> if the *RRConnectionReject* is received in response to an *RRConnectionResumeRequest* sent to resume a suspended RRC connection:
  - 2> if the *rrc-SuspendIndication* is not present:
    - 3> release all radio resources, including release of the RLC entity, the MAC configuration and the associated PDCP entity for all established or suspended RBs;

- 3> discard the stored UE AS context and *resumeIdentity*;
- 3> inform upper layers about the failure to resume the RRC connection without suspend indication and that access barring for mobile originating calls, mobile originating signalling, mobile terminating access and except for NB-IoT for mobile originating CS fallback is applicable, upon which the procedure ends;
- 2> else:
  - 3> if the *RRCConnectionReject* is received in response to an *RRCConnectionResumeRequest* sent after early security reactivation in accordance with conditions in 5.3.3.18:
    - 4> perform the actions as specified in 5.3.3.9a;
  - 3> else:
    - 4> suspend SRB1;
  - 3> inform upper layers about the failure to resume the RRC connection with suspend indication and that access barring for mobile originating calls, mobile originating signalling, mobile terminating access and except for NB-IoT for mobile originating CS fallback is applicable, upon which the procedure ends;
- 1> else if the *RRCConnectionReject* is received in response to an *RRCConnectionResumeRequest* sent while in RRC\_INACTIVE:
  - 2> release the default MAC configuration;
  - 2> if *RRCConnectionReject* is received in response to a request from upper layers:
    - 3> inform the upper layer that access barring is applicable for all access categories except categories '0' and '2';
  - 2> if *RRCConnectionReject* is received in response to an *RRCConnectionResumeRequest*:
    - 3> if resume is triggered by upper layers:
      - 4> inform upper layers about the failure to resume the RRC connection;
    - 3> if resume is triggered due to an RNA update:
      - 4> set the variable *pendingRnaUpdate* to 'TRUE';
    - 3> discard the current  $K_{eNB}$ ,  $K_{RRcenc}$  key,  $K_{RRcint}$ ,  $K_{UPint}$  key and  $K_{UPenc}$  key;
    - 3> suspend SRB1, upon which the procedure ends;
  - 2> The UE shall continue to monitor RAN and CN paging while the timer T302 is running.
- 1> else:
  - 2> release the default MAC configuration;
  - 2> inform upper layers about the failure to establish the RRC connection and that access barring for mobile originating calls, mobile originating signalling, mobile terminating access and except for NB-IoT, for mobile originating CS fallback is applicable, upon which the procedure ends;

### 5.3.3.9 Abortion of RRC connection establishment

If upper layers abort the RRC connection establishment procedure while the UE has not yet entered RRC\_CONNECTED, the UE shall:

- 1> stop timer T300, if running;
- 1> reset MAC, release the MAC configuration and re-establish RLC for all RBs that are established;

### 5.3.3.9a Abortion of early security reactivation

The UE shall:

- 1> delete the  $K_{eNB}$ ,  $K_{RRCCint}$ ,  $K_{RRCCenc}$  and  $K_{UPenc}$  keys derived in accordance with 5.3.3.3a;
- 1> re-establish RLC entities for all SRBs and DRBs;
- 1> suspend all SRB(s) and DRB(s) except SRB0;
- 1> configure lower layers to suspend integrity protection and ciphering.

### 5.3.3.10 Handling of SSAC related parameters

Upon request from the upper layers, the UE shall:

- 1> if *SystemInformationBlockType2* includes *ac-BarringPerPLMN-List* and the *ac-BarringPerPLMN-List* contains an *AC-BarringPerPLMN* entry with the *plmn-IdentityIndex* corresponding to the PLMN selected by upper layers (see TS 23.122 [11], TS 24.301 [35]):
  - 2> select the *AC-BarringPerPLMN* entry with the *plmn-IdentityIndex* corresponding to the PLMN selected by upper layers;
  - 2> in the remainder of this procedure, use the selected *AC-BarringPerPLMN* entry (i.e. presence or absence of access barring parameters in this entry) irrespective of the common access barring parameters included in *SystemInformationBlockType2*;
- 1> else:
  - 2> in the remainder of this procedure use the common access barring parameters (i.e. presence or absence of these parameters) included in *SystemInformationBlockType2*;
- 1> set the local variables *BarringFactorForMMTEL-Voice* and *BarringTimeForMMTEL-Voice* as follows:
  - 2> if *ssac-BarringForMMTEL-Voice* is present:
    - 3> if the UE has one or more Access Classes, as stored on the USIM, with a value in the range 11..15, which is valid for the UE to use according to TS 22.011 [10] and TS 23.122 [11], and

NOTE: ACs 12, 13, 14 are only valid for use in the home country and ACs 11, 15 are only valid for use in the HPLMN/ EHPLMN.

- 3> if, for at least one of these Access Classes, the corresponding bit in the *ac-BarringForSpecialAC* contained in *ssac-BarringForMMTEL-Voice* is set to zero:
      - 4> set *BarringFactorForMMTEL-Voice* to one and *BarringTimeForMMTEL-Voice* to zero;
    - 3> else:
      - 4> set *BarringFactorForMMTEL-Voice* and *BarringTimeForMMTEL-Voice* to the value of *ac-BarringFactor* and *ac-BarringTime* included in *ssac-BarringForMMTEL-Voice*, respectively;
    - 2> else set *BarringFactorForMMTEL-Voice* to one and *BarringTimeForMMTEL-Voice* to zero;
  - 1> set the local variables *BarringFactorForMMTEL-Video* and *BarringTimeForMMTEL-Video* as follows:
    - 2> if *ssac-BarringForMMTEL-Video* is present:
      - 3> if the UE has one or more Access Classes, as stored on the USIM, with a value in the range 11..15, which is valid for the UE to use according to TS 22.011 [10] and TS 23.122 [11], and
      - 3> if, for at least one of these Access Classes, the corresponding bit in the *ac-BarringForSpecialAC* contained in *ssac-BarringForMMTEL-Video* is set to zero:
        - 4> set *BarringFactorForMMTEL-Video* to one and *BarringTimeForMMTEL-Video* to zero;
      - 3> else:

- 4> set *BarringFactorForMMTEL-Video* and *BarringTimeForMMTEL-Video* to the value of *ac-BarringFactor* and *ac-BarringTime* included in *ssac-BarringForMMTEL-Video*, respectively;
- 2> else set *BarringFactorForMMTEL-Video* to one and *BarringTimeForMMTEL-Video* to zero;
- 1> forward the variables *BarringFactorForMMTEL-Voice*, *BarringTimeForMMTEL-Voice*, *BarringFactorForMMTEL-Video* and *BarringTimeForMMTEL-Video* to the upper layers;

### 5.3.3.11 Access barring check

- 1> if timer T302 or "Tbarring" is running:
  - 2> consider access to the cell as barred;
- 1> else if *SystemInformationBlockType2* includes "AC barring parameter":
  - 2> if the UE has one or more Access Classes, as stored on the USIM, with a value in the range 11..15, which is valid for the UE to use according to TS 22.011 [10] and TS 23.122 [11], and

NOTE: ACs 12, 13, 14 are only valid for use in the home country and ACs 11, 15 are only valid for use in the HPLMN/ EHPLMN.

- 2> for at least one of these valid Access Classes the corresponding bit in the *ac-BarringForSpecialAC* contained in "AC barring parameter" is set to *zero*:
  - 3> consider access to the cell as not barred;
- 2> else if the establishment of the RRC connection is the result of release with redirect with *mpsPriorityIndication* (either in NR or E-UTRAN); and
- 2> if the corresponding bit for any of the Access Classes 12, 13 or 14 in the *ac-BarringForSpecialAC* contained in "AC barring parameter" is set to *zero*:
  - 3> consider access to the cell as not barred;
- 2> else:
  - 3> draw a random number '*rand*' uniformly distributed in the range:  $0 \leq rand < 1$ ;
  - 3> if '*rand*' is lower than the value indicated by *ac-BarringFactor* included in "AC barring parameter":
    - 4> consider access to the cell as not barred;
  - 3> else:
    - 4> consider access to the cell as barred;
- 1> else:
  - 2> consider access to the cell as not barred;
- 1> if access to the cell is barred and both timers T302 and "Tbarring" are not running:
  - 2> draw a random number '*rand*' that is uniformly distributed in the range  $0 \leq rand < 1$ ;
  - 2> start timer "Tbarring" with the timer value calculated as follows, using the *ac-BarringTime* included in "AC barring parameter":
 
$$\text{"Tbarring"} = (0.7 + 0.6 * rand) * ac\text{-}BarringTime;$$

### 5.3.3.12 EAB check

The UE shall:

- 1> if *SystemInformationBlockType14* is present:

- 2> if *eab-PerRSRP* is included:
  - 3> if the *establishmentCause* received from higher layers is set to a value other than *emergency*; and
  - 3> if the UE has no Access Class, as stored on the USIM, with a value in the range 11..15, which is valid for the UE to use according to TS 22.011 [10] and TS 23.122 [11] :
    - 4> if *eab-PerRSRP* is set to *thresh0*:
      - 5> consider access to the cell as barred when in enhanced coverage as specified in TS 36.304 [4];
    - 4> else if *eab-PerRSRP* is set to *thresh1*:
      - 5> if the measured RSRP is less than the first entry in *rsrp-ThresholdsPrachInfoList*:
        - 6> consider access to the cell as barred;
      - 5> else:
        - 6> consider that only the resources indicated for the first CE level are configured;
    - 4> else if *eab-PerRSRP* is set to *thresh2*:
      - 5> if the measured RSRP is less than the second entry in *rsrp-ThresholdsPrachInfoList*:
        - 6> consider access to the cell as barred;
      - 5> else:
        - 6> consider that only the resources indicated for the first and second CE levels are configured;
    - 4> else if *eab-PerRSRP* is set to *thresh3*:
      - 5> if the measured RSRP is less than the third entry in *rsrp-ThresholdsPrachInfoList*:
        - 6> consider access to the cell as barred;
      - 5> else:
        - 6> consider that only the resources indicated for the first, second, and third CE levels are configured;
- 2> if access to the cell is not barred due to *eab-PerRSRP* and *eab-Param* is included:
  - 3> if the *eab-Common* is included in the *eab-Param*:
    - 4> if the UE belongs to the category of UEs as indicated in the *eab-Category* contained in *eab-Common*; and
    - 4> if for the Access Class of the UE, as stored on the USIM and with a value in the range 0..9, the corresponding bit in the *eab-BarringBitmap* contained in *eab-Common* is set to *one*:
      - 5> consider access to the cell as barred;
    - 4> else:
      - 5> consider access to the cell as not barred due to EAB;
  - 3> else (the *eab-PerPLMN-List* is included in the *eab-Param*):
    - 4> select the entry in the *eab-PerPLMN-List* corresponding to the PLMN selected by upper layers (see TS 23.122 [11], TS 24.301 [35]);
    - 4> if the *eab-Config* for that PLMN is included:
      - 5> if the UE belongs to the category of UEs as indicated in the *eab-Category* contained in *eab-Config*; and

- 5> if for the Access Class of the UE, as stored on the USIM and with a value in the range 0..9, the corresponding bit in the *eab-BarringBitmap* contained in *eab-Config* is set to *one*:
  - 6> consider access to the cell as barred;
- 5> else:
  - 6> consider access to the cell as not barred due to EAB;
- 4> else:
  - 5> consider access to the cell as not barred due to EAB;
- 1> else:
  - 2> consider access to the cell as not barred due to EAB;

### 5.3.3.13 Access barring check for ACDC

The UE shall:

- 1> if timer T302 is running:
  - 2> consider access to the cell as barred;
- 1> else if *SystemInformationBlockType2* includes "ACDC barring parameter":
  - 2> draw a random number '*rand*' uniformly distributed in the range:  $0 \leq rand < 1$ ;
  - 2> if '*rand*' is lower than the value indicated by *ac-BarringFactor* included in "ACDC barring parameter":
    - 3> consider access to the cell as not barred;
  - 2> else:
    - 3> consider access to the cell as barred;
- 1> else:
  - 2> consider access to the cell as not barred;
- 1> if access to the cell is barred and timer T302 is not running:
  - 2> draw a random number '*rand*' that is uniformly distributed in the range  $0 \leq rand < 1$ ;
  - 2> start timer "Tbarring" with the timer value calculated as follows, using the *ac-BarringTime* included in "ACDC barring parameter":
 
$$\text{"Tbarring"} = (0.7 + 0.6 * rand) * ac\text{-}BarringTime.$$

### 5.3.3.14 Access Barring check for NB-IoT

The UE shall:

- 1> if the UE is connected to 5GC, *ab-Enabled-5GC* included in *MasterInformationBlock-NB* / *MasterInformationBlock-TDD-NB* is set to *TRUE* and *SystemInformationBlockType14-NB* is broadcast, or
- 1> if the UE is connected to EPC, *ab-Enabled* included in *MasterInformationBlock-NB* / *MasterInformationBlock-TDD-NB* is set to *TRUE* and *SystemInformationBlockType14-NB* is broadcast:
  - 2> if *ab-PerNRSRP* is included:
    - 3> if the *establishmentCause* received from higher layers is set to a value other than *mo-ExceptionData*; and
    - 3> if the UE has no Access Class, as stored on the USIM, with a value in the range 11..15, which is valid for the UE to use according to TS 22.011 [10] and TS 23.122 [11]:

- 4> if *ab-PerNRSRP* is set to *thresh1*:
    - 5> if the measured RSRP is less than the first entry in *rsrp-ThresholdsPrachInfoList*;
      - 6> consider access to the cell as barred;
    - 5> else:
      - 6> consider that only the resources indicated for the first NPRACH repetition level are configured;
  - 4> if *ab-PerNRSRP* is set to *thresh2*:
    - 5> if the measured RSRP is less than the second entry in *rsrp-ThresholdsPrachInfoList*;
      - 6> consider access to the cell as barred;
    - 5> else:
      - 6> consider that only the resources indicated for the first and second NPRACH repetition levels are configured;
  - 1> if the UE is connected to EPC, *ab-Enabled* included in *MasterInformationBlock-NB* / *MasterInformationBlock-TDD-NB* is set to *TRUE* and *SystemInformationBlockType14-NB* is broadcast:
    - 2> if access to the cell is not barred due to *ab-PerNRSRP* and *ab-Param* is included:
      - 3> if the *ab-Common* is included in *ab-Param*:
        - 4> if the UE belongs to the category of UEs as indicated in the *ab-Category* contained in *ab-Common*; and
        - 4> if for the Access Class of the UE, as stored on the USIM and with a value in the range 0..9, the corresponding bit in the *ab-BarringBitmap* contained in *ab-Common* is set to *one*:
          - 5> if the *establishmentCause* received from higher layers is set to *mo-ExceptionData* and *ab-BarringForExceptionData* is set to *FALSE* in the *ab-Common*:
            - 6> consider access to the cell as not barred;
          - 5> else:
            - 6> if the UE has one or more Access Classes, as stored on the USIM, with a value in the range 11..15, which is valid for the UE to use according to TS 22.011 [10] and TS 23.122 [11] and for at least one of these valid Access Classes for the UE, the corresponding bit in the *ab-BarringForSpecialAC* contained in *ab-Common* is set to *zero*:
- NOTE 1: ACs 12, 13, 14 are only valid for use in the home country and ACs 11, 15 are only valid for use in the HPLMN/ EHPLMN.
- 7> consider access to the cell as not barred;
  - 6> else:
    - 7> consider access to the cell as barred;
  - 4> else:
    - 5> consider access to the cell as not barred;
  - 3> else (the *ab-PerPLMN-List* is included in the *ab-Param*):
    - 4> select the *ab-PerPLMN* entry in *ab-PerPLMN-List* corresponding to the PLMN selected by upper layers (see TS 23.122 [11], TS 24.301 [35]);
    - 4> if the *ab-Config* for that PLMN is included:
      - 5> if the UE belongs to the category of UEs as indicated in the *ab-Category* contained in *ab-Config*; and



- 5> if for the Access Class of the UE, as stored on the USIM and with a value in the range 0..9, the corresponding bit in the *ab-BarringBitmap* contained in *ab-Config* is set to *one*:
- 6> if the *establishmentCause* received from higher layers is set to *mo-ExceptionData* and *ab-BarringForExceptionData* is set to *FALSE* in the *ab-Config*:
  - 7> consider access to the cell as not barred;
- 6> else:
  - 7> if the UE has one or more Access Classes, as stored on the USIM, with a value in the range 11..15, which is valid for the UE to use according to TS 22.011 [10] and TS 23.122 [11] and for at least one of these valid Access Classes for the UE, the corresponding bit in the *ab-BarringForSpecialAC* contained in *ab-Config* is set to *zero*:

NOTE 2: ACs 12, 13, 14 are only valid for use in the home country and ACs 11, 15 are only valid for use in the HPLMN/ EHPLMN.

- 8> consider access to the cell as not barred;
- 7> else:
  - 8> consider access to the cell as barred;
- 5> else:
  - 6> consider access to the cell as not barred;
- 4> else:
  - 5> consider access to the cell as not barred;
- 1> else:
  - 2> consider access to the cell as not barred;

### 5.3.3.15 Failure to deliver NAS information in RRCConnectionSetupComplete message

The UE shall:

- 1> if the UE is a NB-IoT UE and radio link failure occurs before the successful delivery of *RRCConnectionSetupComplete* message has been confirmed by lower layers:
  - 2> inform upper layers about the possible failure to deliver the NAS information contained in the *RRCConnectionSetupComplete* message;

### 5.3.3.16 Integrity check failure from lower layers while T300 is running

The UE shall:

- 1> upon receiving integrity check failure indication from lower layers concerning SRB1 or SRB2 while T300 is running and if the UE is resuming the RRC connection after early security reactivation in accordance with conditions in 5.3.3.18:
  - 2> discard the stored UE AS context and *resumeIdentity*;
  - 2> perform the actions upon leaving RRC\_CONNECTED as specified in 5.3.12, with release cause 'other';
- 1> upon receiving integrity check failure indication from lower layers while T300 is running and if the UE is resuming the RRC connection from RRC\_INACTIVE:
  - 2> perform the actions upon leaving RRC\_INACTIVE as specified in 5.3.12, with release cause 'RRC Resume failure';

### 5.3.3.17 Inability to comply with *RRCConnectionResume*

The UE shall:

- 1> if the UE is unable to comply with (part of) the configuration included in the *RRCConnectionResume* message;
- 2> perform the actions upon leaving *RRC\_INACTIVE* as specified in 5.3.12 with release cause 'RRC Resume failure'.

NOTE 1: The UE may apply above failure handling also in case the *RRCConnectionResume* message causes a protocol error for which the generic error handling as defined in 5.7 specifies that the UE shall ignore the message.

NOTE 2: If the UE is unable to comply with part of the configuration, it does not apply any part of the configuration, i.e. there is no partial success/failure.

### 5.3.3.18 Early security reactivation

The UE shall use early security reactivation when resuming a suspended RRC connection and at least one of the following conditions is met:

- the UE is initiating UP-EDT in accordance with conditions in 5.3.3.1b;
- the UE is initiating UP transmission using PUR in accordance with conditions in 5.3.3.1c;
- the UE is resuming a suspended RRC connection in 5GC;
- the UE supports early security reactivation, *SystemInformationBlockType2* (*SystemInformationBlockType2-NB* in NB-IoT) includes *earlySecurityReactivation*, and the UE has a stored value of the *nextHopChainingCount* provided in the *RRCConnectionRelease* message with suspend indication during the preceding suspend procedure;

### 5.3.3.19 Timing alignment validation for transmission using PUR

The UE shall consider the timing alignment value for transmission using PUR to be valid when the following conditions are fulfilled:

- 1> either *pur-TimeAlignmentTimer* is not configured or *pur-TimeAlignmentTimer* is running as confirmed by lower layers; and
- 1> either *pur-RSRP-ChangeThreshold* (*pur-NRSRP-ChangeThreshold* in NB-IoT) is not configured or the following conditions are fulfilled:
  - 2> compared to the stored serving cell reference (N)RSRP value, the serving cell (N)RSRP has not increased by more than *increaseThresh*; and
  - 2> compared to the stored serving cell reference (N)RSRP value, the serving cell (N)RSRP has not decreased by more than *decreaseThresh*;

### 5.3.3.20 Maintenance of PUR occasions

The UE configured with *pur-Config* shall:

- 1> consider that the first PUR occasion occurs at the H-SFN/SFN/subframe given by:
  - $H\text{-SFN} = (H\text{-SFN}_{\text{Ref}} + \text{offset}) \bmod 1024$  occurring after FLOOR ( $\text{offset}/1024$ ) H-SFN cycles;
  - SFN and subframe indicated by *startSFN* and *startSubframe*;

where:

- offset is given by *periodicityAndOffset*;
- $H\text{-SFN}_{\text{Ref}}$  corresponds to the last subframe of the first transmission of *RRCConnectionRelease* message containing *pur-Config*, taking into account *hsfn-LSB-Info*;

- H-SFN cycle corresponds to the duration of 1024 H-SFNs;
- 1> if the *pur-NumOccasions* is set to *one*, for the first PUR occasion:
  - 2> if transmission using PUR in accordance with conditions in 5.3.3.1c is not initiated; or
  - 2> if transmission using PUR in accordance with conditions in 5.3.3.1c has been initiated, after the completion of the transmission using PUR:
    - 3> if *pur-TimeAlignmentTimer* is configured, indicate to lower layers that *pur-TimeAlignmentTimer* is released;
    - 3> release *pur-Config*;
    - 3> discard previously stored *pur-Config*;
- 1> else:
  - 2> consider that the subsequent PUR occasions occur periodically after the occurrence of the first PUR occasion at the SFN/subframe indicated by *startSubframe* and *startSFN* and periodicity given by *periodicityAndOffset*;
  - 2> if the *pur-ImplicitReleaseAfter* is configured, for each PUR occasion occurring while the UE is in RRC\_IDLE:
    - 3> if transmission using PUR in accordance with conditions in 5.3.3.1c is not initiated; or
    - 3> if PUR failure indication is received from lower layers:
      - 4> consider the PUR occasion as skipped;
      - 4> if *pur-ImplicitReleaseAfter* number of consecutive PUR occasions have been skipped:
        - 5> if *pur-TimeAlignmentTimer* is configured, indicate to lower layers that *pur-TimeAlignmentTimer* is released;
        - 5> release *pur-Config*;
        - 5> discard previously stored *pur-Config*.

### 5.3.3.21 UE actions upon indication of out-of-date GNSS position

Upon indication that the GNSS position has become out-of-date while in RRC\_CONNECTED, the UE shall:

- 1> if the UE does not support performing GNSS position fix in RRC\_CONNECTED and *ul-TransmissionExtensionEnabled* is not configured:
  - 2> perform the actions upon leaving RRC\_CONNECTED as specified in 5.3.12, with release cause 'other';
- 1> else if *ul-TransmissionExtensionEnabled* is configured:
  - 2> if *timeAlignmentTimer* is configured to be *infinity*:
    - 3> start timer T390 with the timer value set to *ul-TransmissionExtensionValue*;
  - 2> else:
    - 3> start timer T390 with the timer value set to the remaining time of *timeAlignmentTimer*;
- 1> else if *ul-TransmissionExtensionEnabled* is not configured and no indication of network triggered GNSS measurement is received from lower layers:
  - 2> if *gnss-AutonomousEnabled* is configured:
    - 3> perform GNSS measurement using autonomous gaps as specified in clause 5.5.9;
  - 2> else:

3> perform the actions upon leaving RRC\_CONNECTED as specified in 5.3.12, with release cause 'other'.

### 5.3.3.22 Void

### 5.3.3.23 UE actions upon detecting discontinuous coverage

In discontinuous coverage scenario, upon expiry of *t-Service* or being out of the current serving cell coverage, the UE shall:

1> if timer T310 is running:

2> stop timer T310, and perform the actions upon leaving RRC\_CONNECTED as specified in 5.3.12, with release cause 'other'.

### 5.3.3.24 T390 expiry

The UE shall:

1> if timer T390 expires and no indication of network triggered GNSS measurement has been received from lower layers:

2> if *gnss-AutonomousEnabled* is configured:

3> perform GNSS measurement using autonomous gaps as specified in clause 5.5.9;

2> else:

3> perform the actions upon leaving RRC\_CONNECTED as specified in 5.3.12, with release cause 'other'.

### 5.3.3.25 UE actions upon receiving UL transmission extension indication

Upon indication from lower layers to extend the UL transmission, the UE shall:

1> if *ul-TransmissionExtensionEnabled* is configured:

2> if *timeAlignmentTimer* is configured to be *infinity*:

3> restart timer T390 with the timer value set to *ul-TransmissionExtensionValue*, if running;

2> else:

3> restart timer T390 with the timer value set to the configured value of *timeAlignmentTimer*, if running.

## 5.3.4 Initial security activation

### 5.3.4.1 General

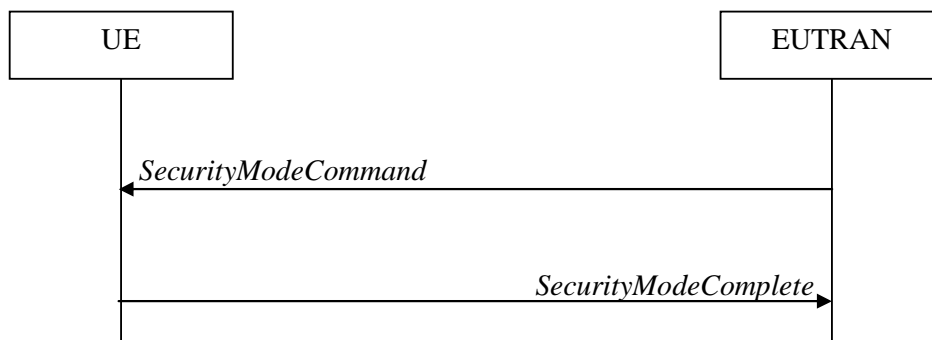
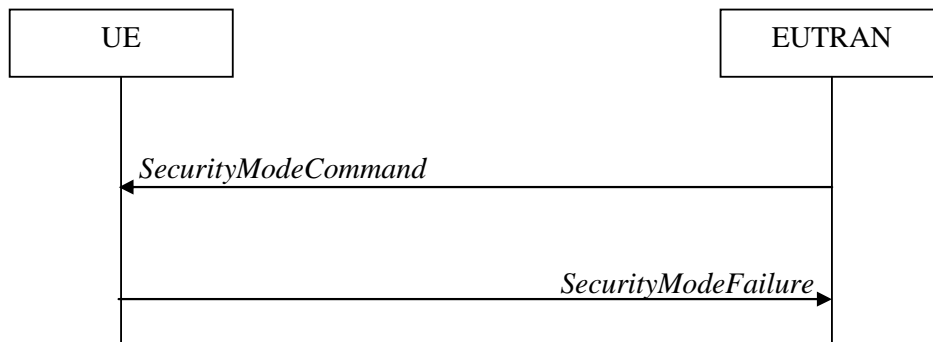

Figure 5.3.4.1-1: Security mode command, successful



**Figure 5.3.4.1-2: Security mode command, failure**

The purpose of this procedure is to activate AS security upon RRC connection establishment.

### 5.3.4.2 Initiation

E-UTRAN initiates the security mode command procedure to a UE in RRC\_CONNECTED. Moreover, E-UTRAN applies the procedure as follows:

- when only SRB1, or for NB-IoT SRB1 and SRB1bis, is established, i.e. prior to establishment of SRB2 and/ or DRBs.

### 5.3.4.3 Reception of the *SecurityModeCommand* by the UE

The UE shall:

- 1> derive the  $K_{eNB}$  key, as specified in TS 33.401 [32] for E-UTRA/EPC, and TS 33.501 [86] for E-UTRA/5GC;
- 1> derive the  $K_{RRCint}$  key associated with the *integrityProtAlgorithm* indicated in the *SecurityModeCommand* message, as specified in TS 33.401 [32];
- 1> request lower layers to verify the integrity protection of the *SecurityModeCommand* message, using the algorithm indicated by the *integrityProtAlgorithm* as included in the *SecurityModeCommand* message and the  $K_{RRCint}$  key;
- 1> if the *SecurityModeCommand* message passes the integrity protection check:
  - 2> derive the  $K_{RRCenc}$  key and the  $K_{UPenc}$  key associated with the *cipheringAlgorithm* indicated in the *SecurityModeCommand* message, as specified in TS 33.401 [32];
  - 2> if connected as an RN; or
  - 2> if capable of user plane integrity protection:
    - 3> derive the  $K_{UPint}$  key associated with the *integrityProtAlgorithm* indicated in the *SecurityModeCommand* message, as specified in TS 33.401 [32];
  - 2> configure lower layers to apply integrity protection using the indicated algorithm and the  $K_{RRCint}$  key immediately, i.e. integrity protection shall be applied to all subsequent messages received and sent by the UE, including the *SecurityModeComplete* message;
  - 2> configure lower layers to apply ciphering using the indicated algorithm, the  $K_{RRCenc}$  key and the  $K_{UPenc}$  key after completing the procedure, i.e. ciphering shall be applied to all subsequent messages received and sent by the UE, except for the *SecurityModeComplete* message which is sent unciphered;
  - 2> if connected as an RN:
    - 3> configure lower layers to apply integrity protection using the indicated algorithm and the  $K_{UPint}$  key, for DRBs that are subsequently configured to apply integrity protection, if any;
  - 2> consider AS security to be activated;

- 2> upon RRC connection establishment, if UE does not need UL gaps during continuous uplink transmission:
- 3> configure lower layers to stop using UL gaps during continuous uplink transmission in FDD for *SecurityModeComplete* message and subsequent uplink transmission in RRC\_CONNECTED except for UL transmissions as specified in TS 36.211 [21];
- 2> submit the *SecurityModeComplete* message to lower layers for transmission, upon which the procedure ends;
- 1> else:
- 2> continue using the configuration used prior to the reception of the *SecurityModeCommand* message, i.e. neither apply integrity protection nor ciphering.
- 2> submit the *SecurityModeFailure* message to lower layers for transmission, upon which the procedure ends;

## 5.3.5 RRC connection reconfiguration

### 5.3.5.1 General

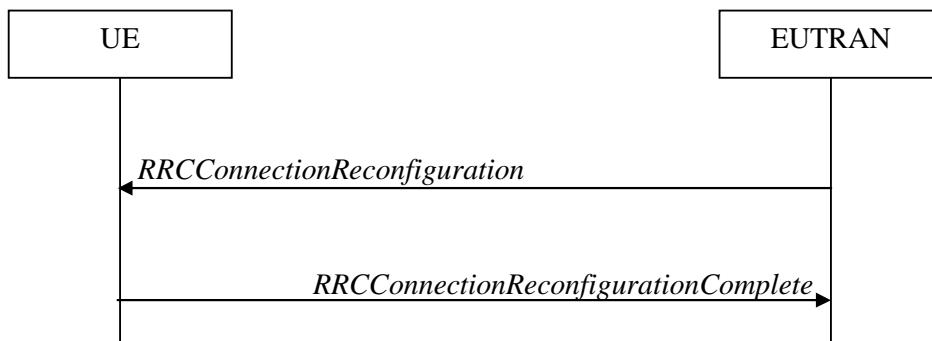

**Figure 5.3.5.1-1: RRC connection reconfiguration, successful**

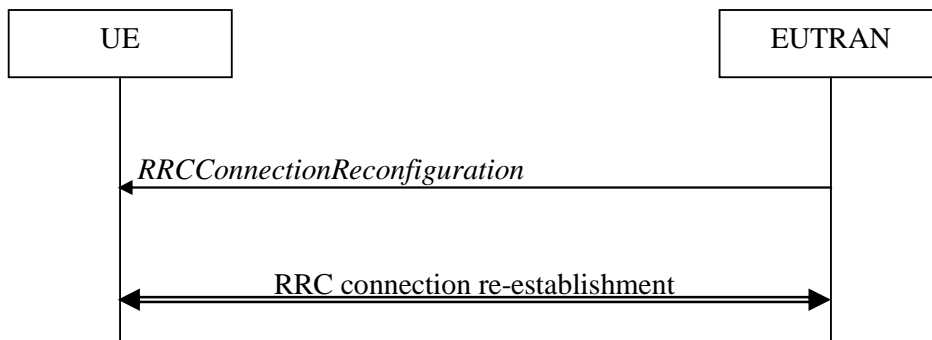

**Figure 5.3.5.1-2: RRC connection reconfiguration, failure**

The purpose of this procedure is to modify an RRC connection, e.g. to establish/ modify/ release RBs, to perform handover, to setup/ modify/ release measurements, to add/ modify/ release SCells, to add/modify/release conditional reconfigurations. As part of the procedure, NAS dedicated information may be transferred from E-UTRAN to the UE.

### 5.3.5.2 Initiation

E-UTRAN may initiate the RRC connection reconfiguration procedure to a UE in RRC\_CONNECTED. E-UTRAN applies the procedure as follows:

- the *mobilityControlInfo* is included only when AS-security has been activated, and SRB2 with at least one DRB are setup and not suspended;
- the establishment of RBs (other than SRB1, that is established during RRC connection establishment) is included only when AS security has been activated;

- the addition of SCells is performed only when AS security has been activated;
- the addition, release or modification of conditional reconfigurations is performed only when AS security has been activated, and SRB2 with at least one DRB are setup and not suspended;

The UE initiates the RRC connection reconfiguration procedure while in RRC\_CONNECTED when a conditional reconfiguration (e.g. CHO, CPA, or inter-SN CPC) is executed i.e. upon the fulfilment of an execution condition, an associated *RRCCConnectionReconfiguration* that is stored is applied.

NOTE: Embedding in an NR Reconfiguration is used for the transfer of IRAT DL DCCH information as used for V2X sidelink communication related information specified by NR RRC e.g. to configure dedicated pool related information, CBR measurements, provision of grant assistance.

### 5.3.5.3 Reception of an *RRCCConnectionReconfiguration* not including the *mobilityControlInfo* by the UE

If the *RRCCConnectionReconfiguration* message does not include the *mobilityControlInfo* and the UE is able to comply with the configuration included in this message, the UE shall:

- 1> if the UE is in (NG)EN-DC and;
  - 1> if the *RRCCConnectionReconfiguration* does not include the *nr-SecondaryCellGroupConfig*:
    - 2> if the *RRCCConnectionReconfiguration* includes the *scg-State*:
      - 3> perform SCG deactivation as specified in TS 38.331 [82], clause 5.3.5.13b;
    - 2> else:
      - 3> perform SCG activation without SN message as specified in TS 38.331 [82], clause 5.3.5.13b1;
  - 1> if the received *RRCCConnectionReconfiguration* includes the *daps-SourceRelease*:
    - 2> reset source MCG MAC and release the source MCG MAC configuration;
    - 2> for each DAPS bearer:
      - 3> re-establish the RLC entity or entities for the source PCell;
      - 3> release the RLC entity or entities and the associated DTCH logical channel for the source PCell;
      - 3> reconfigure the PDCP entity to release DAPS, as specified in TS 36.323 [8];
    - 2> for each SRB:
      - 3> release the PDCP entity for the source PCell;
      - 3> release the RLC entity and the associated DCCH logical channel for the source PCell;
    - 2> release the physical channel configuration for the source PCell;
  - 1> if this is the first *RRCCConnectionReconfiguration* message after successful completion of the RRC connection re-establishment procedure:
    - 2> re-establish PDCP for SRB2 configured with E-UTRA PDCP entity and for all DRBs that are established and configured with E-UTRA PDCP, if any;
    - 2> re-establish RLC for SRB2 and for all DRBs that are established and configured with E-UTRA RLC, if any;
    - 2> if the *RRCCConnectionReconfiguration* message includes the *fullConfig*:
      - 3> perform the radio configuration procedure as specified in 5.3.5.8;
    - 2> if the *RRCCConnectionReconfiguration* message includes the *radioResourceConfigDedicated*:
      - 3> perform the radio resource configuration procedure as specified in 5.3.10.0;

NOTE 1: Void

NOTE 2: Void

1> else:

2> if the *RRCCConnectionReconfiguration* message includes the *radioResourceConfigDedicated*:

3> perform the radio resource configuration procedure as specified in 5.3.10.0;

NOTE 3: If the *RRCCConnectionReconfiguration* message includes the establishment of radio bearers other than SRB1, the UE may start using these radio bearers immediately, i.e. there is no need to wait for an outstanding acknowledgment of the *SecurityModeComplete* message.

1> if the received *RRCCConnectionReconfiguration* includes the *sCellToReleaseList*:

2> perform SCell release as specified in 5.3.10.3a;

1> if the received *RRCCConnectionReconfiguration* includes the *sCellToAddModList*:

2> perform SCell addition or modification as specified in 5.3.10.3b;

1> if the received *RRCCConnectionReconfiguration* includes the *sCellGroupToReleaseList*:

2> perform SCell group release as specified in 5.3.10.3d;

1> if the received *RRCCConnectionReconfiguration* includes the *sCellGroupToAddModList*:

2> perform SCell group addition or modification as specified in 5.3.10.3e;

1> if the received *RRCCConnectionReconfiguration* includes the *scg-Configuration*; or

1> if the current UE configuration includes one or more split DRBs configured with *pdcp-Config* and the received *RRCCConnectionReconfiguration* includes *radioResourceConfigDedicated* including *drb-ToAddModList*:

2> perform SCG reconfiguration as specified in 5.3.10.10;

1> if the received *RRCCConnectionReconfiguration* includes the *nr-Config* and it is set to *release*: or

1> if the received *RRCCConnectionReconfiguration* includes *endc-ReleaseAndAdd* and it is set to *TRUE*:

2> perform MR-DC release as specified in TS 38.331 [82], clause 5.3.5.10;

1> if the received *RRCCConnectionReconfiguration* includes the *sk-Counter*:

2> perform key update procedure as specified in TS 38.331 [82], clause 5.3.5.7;

1> if the received *RRCCConnectionReconfiguration* includes the *nr-SecondaryCellGroupConfig*:

2> perform NR RRC Reconfiguration as specified in TS 38.331 [82], clause 5.3.5.3;

1> if the received *RRCCConnectionReconfiguration* includes the *nr-RadioBearerConfig1*:

2> perform radio bearer configuration as specified in TS 38.331 [82], clause 5.3.5.6;

1> if the received *RRCCConnectionReconfiguration* includes the *nr-RadioBearerConfig2*:

2> perform radio bearer configuration as specified in TS 38.331 [82], clause 5.3.5.6;

1> if this is the first *RRCCConnectionReconfiguration* message after successful completion of the RRC connection re-establishment procedure:

2> resume SRB2 and all DRBs that are suspended, if any, including RBs configured with NR PDCP;

NOTE 4: The handling of the radio bearers after the successful completion of the PDCP re-establishment, e.g. the re-transmission of unacknowledged PDCP SDUs (as well as the associated status reporting), the handling of the SN and the HFN, is specified in TS 36.323 [8].



NOTE 5: The UE may discard SRB2 messages and data that it receives prior to completing the reconfiguration used to resume these bearers.

1> if the received *RRCCConnectionReconfiguration* includes the *systemInformationBlockType1Dedicated*:

2> perform the actions upon reception of the *SystemInformationBlockType1* message as specified in 5.2.2.7;

1> if the received *RRCCConnectionReconfiguration* includes the *systemInformationBlockType2Dedicated*:

2> perform the actions upon reception of the *SystemInformationBlockType2* message as specified in 5.2.2.9;

1> if the received *RRCCConnectionReconfiguration* includes the *systemInformationBlockType31Dedicated*:

2> perform the actions upon reception of the *SystemInformationBlockType31* message as specified in 5.2.2.39;

1> if the *RRCCConnectionReconfiguration* message includes the *dedicatedInfoNASList*:

2> forward each element of the *dedicatedInfoNASList* to upper layers in the same order as listed;

1> if the *RRCCConnectionReconfiguration* message includes the *measConfig*:

2> perform the measurement configuration procedure as specified in 5.5.2;

1> perform the measurement identity autonomous removal as specified in 5.5.2.2a;

1> if the *RRCCConnectionReconfiguration* message includes the *otherConfig*:

2> perform the other configuration procedure as specified in 5.3.10.9;

1> if the received *RRCCConnectionReconfiguration* message includes the *obtainLocationNB*:

2> attempt to have detailed location information available for any RLF report;

NOTE 5a1: The UE is requested to attempt to have valid detailed location information available at the time of RLF. The UE may not succeed e.g. because the user manually disabled the GPS hardware, due to no/poor satellite coverage. Further details, e.g. regarding when to activate GNSS, are up to UE implementation.

1> if the *RRCCConnectionReconfiguration* message includes the *sl-DiscConfig* or *sl-CommConfig*:

2> perform the sidelink dedicated configuration procedure as specified in 5.3.10.15;

1> if the *RRCCConnectionReconfiguration* message includes the *sl-V2X-ConfigDedicated*:

2> perform the V2X sidelink communication dedicated configuration procedure as specified in 5.3.10.15a;

NOTE 5a: If the *sl-V2X-ConfigDedicated* was received embedded within an NR *RRCCReconfiguration* message, the UE does not build an E-UTRA *RRCCConnectionReconfigurationComplete* message for the received *sl-V2X-ConfigDedicated*.

1> if the *RRCCConnectionReconfiguration* message includes the *sl-ConfigDedicatedForNR*:

2> perform the related procedures for NR sidelink communication in accordance with TS 38.331 [82], clause 5.3.5.14 and clause 5.5.2;

1> if the *RRCCConnectionReconfiguration* message includes *wlan-OffloadInfo*:

2> perform the dedicated WLAN offload configuration procedure as specified in 5.6.12.2;

1> if the *RRCCConnectionReconfiguration* message includes *rclwi-Configuration*:

2> perform the WLAN traffic steering command procedure as specified in 5.6.16.2;

1> if the *RRCCConnectionReconfiguration* message includes *lwa-Configuration*:

2> perform the LWA configuration procedure as specified in 5.6.14.2;

1> if the *RRCCConnectionReconfiguration* message includes *lwip-Configuration*:

- 2> perform the LWIP reconfiguration procedure as specified in 5.6.17.2;
- 1> upon RRC connection establishment, if UE does not need UL gaps during continuous uplink transmission:
  - 2> configure lower layers to stop using UL gaps during continuous uplink transmission in FDD for *RRCConnectionReconfigurationComplete* message and subsequent uplink transmission in RRC\_CONNECTED except for UL transmissions as specified in TS36.211 [21];
- 1> if the *RRCConnectionReconfiguration* message includes the *conditionalReconfiguration*:
  - 2> perform conditional reconfiguration as specified in 5.3.5.9;

NOTE 6: In case of conditional reconfiguration the text "if the received *RRCConnectionReconfiguration*. . ." corresponds to applying the stored *RRCConnectionReconfiguration* message (according to 5.3.5.9.5).

- 1> set the content of *RRCConnectionReconfigurationComplete* message as follows:
  - 2> if the *RRCConnectionReconfiguration* message includes *perCC-GapIndicationRequest*:
    - 3> include *perCC-GapIndicationList* and *numFreqEffective*;
  - 2> if the frequencies are configured for reduced measurement performance:
    - 3> include *numFreqEffectiveReduced*;
  - 2> if the received *RRCConnectionReconfiguration* message included *nr-SecondaryCellGroupConfig*:
    - 3> include *scg-ConfigResponseNR* in accordance with TS 38.331 [82], clause 5.3.5.3;
    - 3> if the *RRCConnectionReconfiguration* message is applied due to a conditional reconfiguration execution and the *RRCConnectionReconfiguration* message does not include the *mobilityControlInfo*:
      - 4> include in *selectedCondReconfigurationToApply* the *condReconfigurationId* of the conditional reconfiguration which has been executed;
  - 1> if the UE is configured to operate in EN-DC as result of this procedure, forward *upperLayerIndication*, as if the UE receives this field from SIB2, to upper layers, otherwise indicate upper layers absence of this field;
  - 1> if the UE is configured with NE-DC:
    - 2> if the received *RRCConnectionReconfiguration* message was included in an NR *RRCResume* message:
      - 3> transfer the *RRCConnectionReconfigurationComplete* message via SRB1 embedded in NR RRC message *RRCResumeComplete* as specified in TS 38.331 [82], clause 5.3.13.4;
    - 2> else:
      - 3> transfer the *RRCConnectionReconfigurationComplete* message via SRB1 embedded in NR RRC message *RRCReconfigurationComplete* as specified in TS 38.331 [82], clause 5.3.5.3;
  - 1> else:
    - 2> submit the *RRCConnectionReconfigurationComplete* message to lower layers for transmission using the new configuration, upon which the procedure ends;

#### 5.3.5.4 Reception of an *RRCConnectionReconfiguration* including the *mobilityControlInfo* by the UE (handover)

If the *RRCConnectionReconfiguration* message includes the *mobilityControlInfo* and the UE is able to comply with the configuration included in this message, the UE shall:

- 1> if the *RRCConnectionReconfiguration* is applied due to a conditional reconfiguration execution upon cell selection performed while timer T311 was running, as defined in 5.3.7.3:
  - 2> remove all the entries within *VarConditionalReconfiguration*, if any;
- 1> if *daps-HO* is not configured for any DRB:

- 2> stop timer T310, if running;
- 2> if timer T316 is running:
  - 3> stop timer T316;
  - 3> clear the information included in *VarRLF-Report*, if any;
- 2> resume MCG transmission, if suspended;
- 1> stop timer T312, if running;
- 1> stop timer T317, if running;
- 1> start timer T304 with the timer value set to *t304*, as included in the *mobilityControlInfo*;
- 1> stop timer T370, if running;
- 1> if the *carrierFreq* is included:
  - 2> consider the target PCell to be one on the frequency indicated by the *carrierFreq* with a physical cell identity indicated by the *targetPhysCellId*;
- 1> else:
  - 2> consider the target PCell to be one on the frequency of the source PCell with a physical cell identity indicated by the *targetPhysCellId*;
- 1> if T309 is running:
  - 2> stop timer T309 for all access categories;
  - 2> perform the actions as specified in 5.3.16.4.
- 1> start synchronising to the DL of the target PCell;

NOTE 1: The UE should perform the handover as soon as possible following the reception of the RRC message triggering the handover, which could be before confirming successful reception (HARQ and ARQ) of this message.

- 1> if BL UE or UE in CE:
  - 2> if *sameSFN-Indication* is not present in *mobilityControlInfo*:
    - 3> acquire the *MasterInformationBlock* in the target PCell;
- 1> if *makeBeforeBreak* is configured:
  - 2> perform the remainder of this procedure including and following resetting MAC after the UE has stopped the uplink transmission/downlink reception with the source PCell;

NOTE 1a: It is up to UE implementation when to stop the uplink transmission/ downlink reception with the source PCell to initiate re-tuning for connection to the target cell, as specified in TS 36.133 [16], if *makeBeforeBreak* is configured.

NOTE 1b: It is up to UE implementation when to stop the uplink transmission/ downlink reception with the source SCell(s) after receiving *RRCCONNECTIONRECONFIGURATION* message.

- 1> if *daps-HO* is configured for any DRB:
  - 2> establish a MAC entity for the target PCell, with the same configuration as the MAC entity for the source PCell;
  - 2> for each DRB configured with *daps-HO*:
    - 3> establish the RLC entity or entities and the associated DTCH logical channel for the target PCell, with the same configurations as for the source PCell;

- 3> reconfigure the PDCP entity to configure DAPS as specified in TS36.323 [8].
- 2> for each DRB not configured with *daps-HO*:
  - 3> re-establish PDCP;
  - 3> re-establish the RLC entity and associate it, and the associated DTCH logical channel, to the target PCell;
- 2> for each SRB:
  - 3> establish a PDCP entity for the target PCell, with the same configuration as the PDCP entity for the source PCell;
  - 3> establish an RLC entity and an associated DCCH logical channel for the target PCell, with the same configuration as for the source PCell;
- 2> suspend the SRBs for the source PCell;

NOTE 1c: In order to understand if a *daps-HO* is configured, the UE needs to check the presence of the field *daps-HO* within the received *RadioResourceConfigDedicated* IE.

NOTE 1d: In DAPS handover, the UE may re-establish PDCP and RLC entity for a DRB not configured with *daps-HO* when MAC successfully completes the random access procedure. In this case, the UE suspends data transmission and reception for all DRBs not configured with *daps-HO* in the source PCell for the duration of the DAPS handover.

- 1> else (if *daps-HO* is not configured):
  - 2> reset MCG MAC and SCG MAC, if configured;
  - 2> release *uplinkDataCompression*, if configured;
  - 2> re-establish PDCP for all RBs configured with *pdcp-config* that are established;

NOTE 2: The handling of the radio bearers after the successful completion of the PDCP re-establishment, e.g. the re-transmission of unacknowledged PDCP SDUs (as well as the associated status reporting), the handling of the SN and the HFN, is specified in TS 36.323 [8].

NOTE 2a: At handover the *reestablishPDCP* flag will be set for all RBs configured with NR PDCP in *nr-RadioBearerConfig1* or *nr-RadioBearerConfig2* TS 38.331 [82] which will cause the PDCP entity to be re-established also for these RBs.

- 2> re-establish MCG RLC and SCG RLC, if configured, for all RBs that are established;
- 1> for each SCell configured for the UE other than the PCell:
  - 2> if the received *RRCCConnectionReconfiguration* message includes *sCellState* for the SCell and indicates *activated*:
    - 3> configure lower layers to consider the SCell to be in activated state;
  - 2> else if the received *RRCCConnectionReconfiguration* message includes *sCellState* for the SCell and indicates *dormant*:
    - 3> configure lower layers to consider the SCell to be in dormant state;
  - 2> else:
    - 3> configure lower layers to consider the SCell to be in deactivated state;
- 1> apply the value of the *newUE-Identity* as the C-RNTI in the target MCG;
- 1> if the *RRCCConnectionReconfiguration* message includes the *fullConfig*:
  - 2> perform the radio configuration procedure as specified in 5.3.5.8;
- 1> configure lower layers in accordance with the received *radioResourceConfigCommon*;

- 1> if the received *RRConnectionReconfiguration* message includes the *rach-Skip*:
  - 2> configure lower layers to apply the *rach-Skip* for the target MCG, as specified in TS 36.213 [23] and 36.321 [6];
- 1> if UE supports timing advance reporting and the received *radioResourceConfigCommon* includes the *ta-Report*:
  - 2> instruct the associated MAC entity to trigger Timing Advance reporting;
- 1> configure lower layers in accordance with any additional fields, not covered in the previous, if included in the received *mobilityControlInfo*;
- 1> if the received *RRConnectionReconfiguration* includes the *sCellToReleaseList*:
  - 2> perform SCell release as specified in 5.3.10.3a;
- 1> if the received *RRConnectionReconfiguration* includes the *sCellGroupToReleaseList*:
  - 2> perform SCell group release as specified in 5.3.10.3d;
- 1> if the received *RRConnectionReconfiguration* includes the *scg-Configuration*; or
- 1> if the current UE configuration includes one or more split DRBs and the received *RRConnectionReconfiguration* includes *radioResourceConfigDedicated* including *drb-ToAddModList*:
  - 2> perform SCG reconfiguration as specified in 5.3.10.10;
- 1> if the *RRConnectionReconfiguration* message includes the *radioResourceConfigDedicated*:
  - 2> perform the radio resource configuration procedure as specified in 5.3.10.0;
- 1> if the *securityConfigHO* (without suffix) is included in the *RRConnectionReconfiguration*:
  - 2> if the *keyChangeIndicator* received in the *securityConfigHO* is set to *TRUE*:
    - 3> update the  $K_{eNB}$  key based on the  $K_{ASME}$  key taken into use with the latest successful NAS SMC procedure, as specified in TS 33.401 [32];
  - 2> else:
    - 3> update the  $K_{eNB}$  key based on the current  $K_{eNB}$  or the NH, using the *nextHopChainingCount* value indicated in the *securityConfigHO*, as specified in TS 33.401 [32];

NOTE 2b: If the UE needs to update the S- $K_{eNB}$  key as specified in 5.3.10.10, the UE updates the S- $K_{eNB}$  after updating the  $K_{eNB}$  key.

- 2> store the *nextHopChainingCount* value;
- 2> if the *securityAlgorithmConfig* is included in the *securityConfigHO*:
  - 3> derive the  $K_{RRCint}$  key associated with the *integrityProtAlgorithm*, as specified in TS 33.401 [32];
  - 3> if connected as an RN; or
  - 3> if capable of user plane integrity protection:
    - 4> derive the  $K_{UPint}$  key associated with the *integrityProtAlgorithm*, as specified in TS 33.401 [32];
  - 3> derive the  $K_{RRCenc}$  key and the  $K_{UPenc}$  key associated with the *cipheringAlgorithm*, as specified in TS 33.401 [32];
- 2> else:
  - 3> derive the  $K_{RRCint}$  key associated with the current integrity algorithm, as specified in TS 33.401 [32];
  - 3> if connected as an RN; or
  - 3> if capable of user plane integrity protection:

- 4> derive the  $K_{UPint}$  key associated with the current integrity algorithm, as specified in TS 33.401 [32];
  - 3> derive the  $K_{RRCEnc}$  key and the  $K_{UPenc}$  key associated with the current ciphering algorithm, as specified in TS 33.401 [32];
  - 2> configure lower layers to apply the integrity protection algorithm and the  $K_{RRCint}$  key, i.e. the integrity protection configuration shall be applied to all subsequent messages received and sent by the UE, including the message used to indicate the successful completion of the procedure;
  - 2> configure lower layers to apply the ciphering algorithm, the  $K_{RRCEnc}$  key and the  $K_{UPenc}$  key, i.e. the ciphering configuration shall be applied to all subsequent messages received and sent by the UE, including the message used to indicate the successful completion of the procedure;
- NOTE 2c: For a DRB configured for DAPS HO, the new ciphering algorithm and the  $K_{UPenc}$  key is applied for traffic exchange between the UE and the target MCG while the old ciphering algorithm and  $K_{UPenc}$  key is applied for traffic exchange between the UE and the source MCG.
- 1> else if the *securityConfigHO-v1530* is included in the *RRCCONNECTIONRECONFIGURATION*:
    - 2> if the *nas-Container* is received:
      - 3> forward the *nas-Container* to upper layers;
    - 2> if the *keyChangeIndicator-r15* is received and is set to *TRUE*:
      - 3> update the  $K_{eNB}$  key based on the  $K_{AMF}$  key, as specified in TS 33.501 [86];
    - 2> else:
      - 3> update the  $K_{eNB}$  key based on the current  $K_{eNB}$  or the NH, using the received *nextHopChainingCount-r15*, as specified in TS 33.501 [86];
    - 2> store the *nextHopChainingCount-r15* value;
    - 2> if the *securityAlgorithmConfig-r15* is received:
      - 3> derive the  $K_{RRCint}$  key associated with the *integrityProtAlgorithm*, as specified in TS 33.401 [32];
      - 3> derive the  $K_{RRCEnc}$  key and the  $K_{UPenc}$  key associated with the *cipheringAlgorithm*, as specified in TS 33.401 [32];
    - 2> else:
      - 3> derive the  $K_{RRCint}$  key associated with the current integrity algorithm, as specified in TS 33.401 [32];
      - 3> derive the  $K_{RRCEnc}$  key and the  $K_{UPenc}$  key associated with the current ciphering algorithm, as specified in TS 33.401 [32];
  - 1> if the received *RRCCONNECTIONRECONFIGURATION* includes the *nr-Config* and it is set to *release*; or
  - 1> if the received *RRCCONNECTIONRECONFIGURATION* includes *endc-ReleaseAndAdd* and it is set to *TRUE*:
    - 2> perform MR-DC release as specified in TS 38.331 [82], clause 5.3.5.10;
  - 1> if the received *RRCCONNECTIONRECONFIGURATION* includes the *sk-Counter*:
    - 2> perform key update procedure as specified in in TS 38.331 [82], clause 5.3.5.7;
  - 1> if the received *RRCCONNECTIONRECONFIGURATION* includes the *nr-SecondaryCellGroupConfig*:
    - 2> perform NR RRC Reconfiguration as specified in TS 38.331 [82], clause 5.3.5.3.
  - 1> if the received *RRCCONNECTIONRECONFIGURATION* includes the *nr-RadioBearerConfig1*:
    - 2> perform radio bearer configuration as specified in TS 38.331 [82], clause 5.3.5.6;
  - 1> if the received *RRCCONNECTIONRECONFIGURATION* includes the *nr-RadioBearerConfig2*:

- 2> perform radio bearer configuration as specified in TS 38.331 [82], clause 5.3.5.6.
- 1> if connected as an RN:
  - 2> configure lower layers to apply the integrity protection algorithm and the  $K_{UPint}$  key, for current or subsequently established DRBs that are configured to apply integrity protection, if any;
- 1> if the received *RRCConnectionReconfiguration* includes the *sCellToAddModList*:
  - 2> perform SCell addition or modification as specified in 5.3.10.3b;
- 1> if the received *RRCConnectionReconfiguration* includes the *sCellGroupToAddModList*:
  - 2> perform SCell group addition or modification as specified in 5.3.10.3e;
- 1> if the received *RRCConnectionReconfiguration* includes the *systemInformationBlockType1Dedicated*:
  - 2> perform the actions upon reception of the *SystemInformationBlockType1* message as specified in 5.2.2.7;
- 1> if the received *RRCConnectionReconfiguration* includes the *systemInformationBlockType31Dedicated*:
  - 2> perform the actions upon reception of the *SystemInformationBlockType31* message as specified in 5.2.2.39;
- 1> perform the measurement related actions as specified in 5.5.6.1;
- 1> if the *RRCConnectionReconfiguration* message includes the *measConfig*:
  - 2> perform the measurement configuration procedure as specified in 5.5.2;
- 1> perform the measurement identity autonomous removal as specified in 5.5.2.2a;
- 1> release *reportProximityConfig* and clear any associated proximity status reporting timer;
- 1> if the *RRCConnectionReconfiguration* message includes the *otherConfig*:
  - 2> perform the other configuration procedure as specified in 5.3.10.9;
- 1> if the *RRCConnectionReconfiguration* message includes the *sl-DiscConfig* or *sl-CommConfig*:
  - 2> perform the sidelink dedicated configuration procedure as specified in 5.3.10.15;
- 1> if the *RRCConnectionReconfiguration* message includes *wlan-OffloadInfo*:
  - 2> perform the dedicated WLAN offload configuration procedure as specified in 5.6.12.2;
- 1> if *handoverWithoutWT-Change* is not configured:
  - 2> release the LWA configuration, if configured, as described in 5.6.14.3;
- 1> release the LWIP configuration, if configured, as described in 5.6.17.3;
- 1> if the *RRCConnectionReconfiguration* message includes *rclwi-Configuration*:
  - 2> perform the WLAN traffic steering command procedure as specified in 5.6.16.2;
- 1> if the *RRCConnectionReconfiguration* message includes *lwa-Configuration*:
  - 2> perform the LWA configuration procedure as specified in 5.6.14.2;
- 1> if the *RRCConnectionReconfiguration* message includes *lwip-Configuration*:
  - 2> perform the LWIP reconfiguration procedure as specified in 5.6.17.2;
- 1> if the *RRCConnectionReconfiguration* message includes the *sl-V2X-ConfigDedicated* or *mobilityControlInfoV2X*:
  - 2> perform the V2X sidelink communication dedicated configuration procedure as specified in 5.3.10.15a;

NOTE 2d: In case of conditional reconfiguration the text "if the received *RRCCConnectionReconfiguration*. . ." corresponds to applying the stored *RRCCConnectionReconfiguration* message (according to 5.3.5.9.5).

- 1> if the UE is configured to operate in EN-DC as result of this procedure, forward *upperLayerIndication*, as if the UE receives this field from SIB2, to upper layers, otherwise indicate upper layers absence of this field;
- 1> set the content of *RRCCConnectionReconfigurationComplete* message as follows:
  - 2> if the UE has radio link failure or handover failure information available in *VarRLF-Report* and if the RPLMN is included in *plmn-IdentityList* stored in *VarRLF-Report*:
    - 3> include *rlf-InfoAvailable*;
  - 2> if the UE has MBSFN logged measurements available for E-UTRA and if the RPLMN is included in *plmn-IdentityList* stored in *VarLogMeasReport* and if T330 is not running:
    - 3> include *logMeasAvailableMBSFN*;
  - 2> else if the UE has logged measurements available for E-UTRA and if the RPLMN is included in *plmn-IdentityList* stored in *VarLogMeasReport*:
    - 3> include the *logMeasAvailable*;
    - 3> if Bluetooth measurement results are included in the logged measurements the UE has available:
      - 4> include *logMeasAvailableBT*;
    - 3> if WLAN measurement results are included in the logged measurements the UE has available:
      - 4> include *logMeasAvailableWLAN*;
  - 2> if the UE has connection establishment failure information available in *VarConnEstFailReport* and if the RPLMN is equal to *plmn-Identity* stored in *VarConnEstFailReport*:
    - 3> include *connEstFailInfoAvailable*;
  - 2> if the *RRCCConnectionReconfiguration* message includes *perCC-GapIndicationRequest*:
    - 3> include *perCC-GapIndicationList* and *numFreqEffective*;
  - 2> if the frequencies are configured for reduced measurement performance:
    - 3> include *numFreqEffectiveReduced*;
  - 2> if the UE has flight path information available:
    - 3> include *flightPathInfoAvailable*;
  - 2> if the received *RRCCConnectionReconfiguration* message included *nr-SecondaryCellGroupConfig*:
    - 3> include *scg-ConfigResponseNR* in accordance with TS 38.331 [82], clause 5.3.5.3;
  - 2> if the target cell is an NTN cell:
    - 3> include *gnss-validityDuration* in accordance with the remaining time of the GNSS validity duration;
    - 3> if the *RRCCConnectionReconfiguration* message includes *gnss-PositionFixDurationReporting*:
      - 4> include *gnss-PositionFixDuration* in accordance with the time duration required for the UE to acquire a GNSS position;
- 1> submit the *RRCCConnectionReconfigurationComplete* message to lower layers for transmission;
- 1> if MAC successfully completes the random access procedure; or
- 1> if MAC indicates the successful reception of a PDCCH transmission addressed to C-RNTI and if *rach-Skip* is configured;



- 2> stop timer T304;
- 2> if *daps-HO* is configured for any DRB:
  - 3> stop timer T310 for the source PCell, if running;
  - 3> for each DAPS bearer trigger UL data switching, as specified in TS 36.323 [8];
- 2> release *rach-Skip*;
- 2> apply the parts of the CQI reporting configuration, the scheduling request configuration and the sounding RS configuration that do not require the UE to know the SFN of the target PCell, if any;
- 2> apply the parts of the measurement and the radio resource configuration that require the UE to know the SFN of the target PCell (e.g. measurement gaps, periodic CQI reporting, scheduling request configuration, sounding RS configuration), if any, upon acquiring the SFN of the target PCell;

NOTE 3: Whenever the UE shall setup or reconfigure a configuration in accordance with a field that is received it applies the new configuration, except for the cases addressed by the above statements.

- 2> if the UE is configured to provide IDC indications:
  - 3> if the UE has initiated the transmission of an *InDeviceCoexIndication* message during the last 1 second preceding reception of the *RRCCoexIndication* message including *mobilityControlInfo*; or
  - 3> if the *RRCCoexIndication* message is applied due to a conditional reconfiguration execution and the UE has initiated transmission of an *InDeviceCoexIndication* message since it was configured to do so in accordance with 5.6.9.2:
    - 4> initiate transmission of the *InDeviceCoexIndication* message in accordance with 5.6.9.3;
- 2> if the UE is configured to provide power preference indications, overheating assistance information, SPS assistance information, delay budget report or maximum bandwidth preference indications:
  - 3> if the UE has initiated the transmission of a *UEAssistanceInformation* message during the last 1 second preceding reception of the *RRCCoexIndication* message including *mobilityControlInfo*; or
  - 3> if the *RRCCoexIndication* message is applied due to a conditional reconfiguration execution, and the UE has initiated transmission of a *UEAssistanceInformation* message for the corresponding cell group since it was configured to do so in accordance with 5.6.10.2:
    - 4> initiate transmission of the *UEAssistanceInformation* message in accordance with 5.6.10.3;
- 2> if *SystemInformationBlockType15* is broadcast by the PCell:
  - 3> if the UE has initiated the transmission of a *MBMSInterestIndication* message during the last 1 second preceding reception of the *RRCCoexIndication* message including *mobilityControlInfo*; or
  - 3> if the *RRCCoexIndication* message is applied due to a conditional reconfiguration execution and the UE supports MBMS reception and the UE has initiated transmission of an *MBMSInterestIndication* message since it was configured to do so in accordance with 5.8.5.2:
    - 4> ensure having a valid version of *SystemInformationBlockType15* for the PCell;
    - 4> determine the set of MBMS frequencies of interest in accordance with 5.8.5.3;
    - 4> determine the set of MBMS services of interest in accordance with 5.8.5.3a;
    - 4> initiate transmission of the *MBMSInterestIndication* message in accordance with 5.8.5.4;
- 2> if *SystemInformationBlockType18* is broadcast by the target PCell; and the UE initiated the transmission of a *SidelinkUEInformation* message indicating a change of sidelink communication related parameters relevant in target PCell (i.e. change of *commRxInterestedFreq* or *commTxResourceReq*, *commTxResourceReqUC* if *SystemInformationBlockType18* includes *commTxResourceUC-ReqAllowed* or *commTxResourceInfoReqRelay* if PCell broadcasts *SystemInformationBlockType19* including *discConfigRelay*) during the last 1 second preceding reception of the *RRCCoexIndication* message including *mobilityControlInfo*; or

- 2> if *SystemInformationBlockType19* is broadcast by the target PCell; and the UE initiated the transmission of a *SidelinkUEInformation* message indicating a change of sidelink discovery related parameters relevant in target PCell (i.e. change of *discRxInterest* or *discTxResourceReq*, *discTxResourceReqPS* if *SystemInformationBlockType19* includes *discConfigPS* or *discRxGapReq* or *discTxGapReq* if the UE is configured with *gapRequestsAllowedDedicated* set to *true* or if the UE is not configured with *gapRequestsAllowedDedicated* and *SystemInformationBlockType19* includes *gapRequestsAllowedCommon*) during the last 1 second preceding reception of the *RRCConnectionReconfiguration* message including *mobilityControlInfo*; or
- 2> if *SystemInformationBlockType21* is broadcast by the target PCell; and the UE initiated the transmission of a *SidelinkUEInformation* message indicating a change of V2X sidelink communication related parameters relevant in target PCell (i.e. change of *v2x-CommRxInterestedFreqList* or *v2x-CommTxResourceReq*) during the last 1 second preceding reception of the *RRCConnectionReconfiguration* message including *mobilityControlInfo*; or
- 2> if the *RRCConnectionReconfiguration* message is applied due to a conditional reconfiguration execution, and at least one of *SystemInformationBlockType18*, *SystemInformationBlockType19*, and *SystemInformationBlockType21* is broadcast by the target PCell, and the UE has initiated transmission of a *SidelinkUEInformation* message since it was configured to do so in accordance with 5.10.2.2:
  - 3> initiate transmission of the *SidelinkUEInformation* message in accordance with 5.10.2.3;
  - 2> remove all the entries within *VarConditionalReconfiguration*, if any;
  - 2> for each *measId*, if the associated *reportConfig* is *condReconfigurationTriggerEUTRA*:
    - 3> remove the entry with the matching *measId* from the *measIdList* within the *VarMeasConfig*;
    - 3> remove the entry with the matching *reportConfigId* from the *reportConfigList* within the *VarMeasConfig*;
    - 3> if the *measObjectId* is only included in a *MeasIdToAddMod*:
      - 4> remove the entry with the matching *measObjectId* from the *measObjectList* within the *VarMeasConfig*;
  - 2> the procedure ends;

NOTE 4: The UE is not required to determine the SFN of the target PCell by acquiring system information from that cell before performing RACH access in the target PCell, except for BL UEs or UEs in CE when *sameSFN-Indication* is not present in *mobilityControlInfo*.

### 5.3.5.5 Reconfiguration failure

The UE shall:

- 1> if the UE is unable to comply with (part of) the configuration included in the *RRCConnectionReconfiguration* message or if the upper layers indicate that the *nas-Container* is invalid:
  - 2> continue using the configuration used prior to the reception of *RRCConnectionReconfiguration* message;
  - 2> if the UE is in NE-DC:
    - 3> perform the actions as specified in TS 38.331 [82], clause 5.3.7;
  - 2> else if security has not been activated:
    - 3> perform the actions upon leaving RRC\_CONNECTED as specified in 5.3.12, with release cause other;
  - 2> else:
    - 3> initiate the connection re-establishment procedure as specified in 5.3.7, upon which the connection reconfiguration procedure ends;

NOTE 1: The UE may apply above failure handling also in case the *RRCConnectionReconfiguration* message causes a protocol error for which the generic error handling as defined in 5.7 specifies that the UE shall ignore the message.

NOTE 2: If the UE is unable to comply with part of the configuration, it does not apply any part of the configuration, i.e. there is no partial success/ failure.

NOTE 3: The compliance also covers the NR configuration carried within octet strings e.g. field *nr-SecondaryCellGroupConfig*. I.e. the failure behaviour defined also applies in case the UE cannot comply with the NR configuration or with the combination of (parts of) the LTE and NR configurations.

NOTE 4: The compliance also covers the NR sidelink configuration carried within an octet string, e.g. field *sl-ConfigDedicatedNR*, i.e. the failure behaviour defined also applies in case the UE cannot comply with the embedded NR sidelink configuration.

### 5.3.5.6 T304 expiry (handover failure)

If T304 expires (handover failure), the UE shall:

NOTE 1: Following T304 expiry any dedicated preamble, if provided within the *rach-ConfigDedicated*, is not available for use by the UE anymore.

1> if no DAPS bearer is configured; or

1> if any DAPS bearer is configured and radio link failure has been detected for the source MCG in accordance with 5.3.11.3:

2> if *attemptCondReconf* is not configured:

3> revert back to the configuration used in the source PCell, excluding the configuration configured by the *physicalConfigDedicated*, the *mac-MainConfig* and the *sps-Config*;

2> else:

3> revert back to the configuration used in the source PCell;

NOTE 1a: In the context above, "the configuration" includes state variables and parameters of each radio bearer. PDCP entities associated with RLC UM and SRB bearers are reset after the successful RRC connection re-establishment procedure according to clause 5.2 in TS 36.323 [8]. In the above, "the configuration" includes the RB configuration using NR PDCP, if configured (i.e. by *nr-RadioBearerConfig1* and *nr-RadioBearerConfig2*).

2> store the following handover failure information in *VarRLF-Report* by setting its fields as follows:

3> clear the information included in *VarRLF-Report*, if any;

3> set the *plmn-IdentityList* to include the list of EPLMNs stored by the UE (i.e. includes the RPLMN);

3> set the *measResultLastServCell* to include the RSRP and RSRQ, if available, of the source PCell based on measurements collected up to the moment the UE detected handover failure and in accordance with the following;

4> if the UE includes *rsrqResult*, include the *lastServCellRSRQ-Type*;

3> set the *measResultNeighCells* to include the best measured cells, other than the source PCell, ordered such that the best cell is listed first, and based on measurements collected up to the moment the UE detected handover failure, and set its fields as follows;

4> if the UE was configured to perform measurements for one or more EUTRA frequencies, include the *measResultListEUTRA*;

4> if the UE includes *rsrqResult*, include the *rsrq-Type*;

4> if the UE was configured to perform measurement reporting for one or more neighbouring UTRA frequencies, include the *measResultListUTRA*;

4> if the UE was configured to perform measurement reporting for one or more neighbouring GERAN frequencies, include the *measResultListGERAN*;

- 4> if the UE was configured to perform measurement reporting for one or more neighbouring CDMA2000 frequencies, include the *measResultsCDMA2000*;
- 4> if the UE was configured to perform measurement reporting, not related to NR sidelink communication, for one or more neighbouring NR frequencies, include the *measResultListNR*;
- 4> for each neighbour cell included, include the optional fields that are available;

NOTE 2: The measured quantities are filtered by the L3 filter as configured in the mobility measurement configuration. The measurements are based on the time domain measurement resource restriction, if configured. Exclude-listed cells are not required to be reported.

- 3> if available, set the *logMeasResultListWLAN* to include the WLAN measurement results, in order of decreasing RSSI for WLAN APs;
- 3> if available, set the *logMeasResultListBT* to include the Bluetooth measurement results, in order of decreasing RSSI for Bluetooth beacons;
- 3> if detailed location information is available, set the content of the *locationInfo* as follows:
  - 4> include the *locationCoordinates*;
  - 4> include the *horizontalVelocity*, if available;
- 3> if last *RRConnectionReconfiguration* message including *mobilityControlInfo* concerned a failed intra-RAT handover (E-UTRA to E-UTRA):
  - 4> set the *failedPCellId* to the global cell identity, if available, and otherwise to the physical cell identity and carrier frequency of the target PCell of the failed handover;
  - 4> include *previousPCellId* and set it to the global cell identity of the PCell where the last *RRConnectionReconfiguration* message including *mobilityControlInfo* was received;
  - 4> set the *timeConnFailure* to the elapsed time since reception of the last *RRConnectionReconfiguration* message including the *mobilityControlInfo*;
- 3> else if last *MobilityFromEUTRACommand* concerned a failed inter-RAT handover from E-UTRA to NR:
  - 4> set the *failedNR-PCellId* to the global cell identity and tracking area code, if available, and otherwise to the physical cell identity and carrier frequency of the target PCell of the failed handover;
  - 4> include *previousPCellId* and set it to the global cell identity of the PCell where the last *MobilityFromEUTRACommand* message was received;
  - 4> set the *timeConnFailure* to the elapsed time since reception of the last *MobilityFromEUTRACommand* message;
- 3> set the *connectionFailureType* to 'hof';
- 3> set the *c-RNTI* to the C-RNTI used in the source PCell;
- 2> initiate the connection re-establishment procedure as specified in 5.3.7, upon which the RRC connection reconfiguration procedure ends;
- 1> else (any DAPS bearer is configured and radio link failure has not been detected for the source MCG):
  - 2> release the MAC entity for the target PCell;
  - 2> for each DAPS bearer:
    - 3> re-establish the RLC entity for the target PCell;
    - 3> release the RLC entity or entities and the associated DTCH logical channel for the target PCell;
    - 3> reconfigure the PDCP entity to release DAPS as specified in TS 36.323 [8];
  - 2> for each non-DAPS bearer:

- 3> revert back to the configuration used for the DRB in the source PCell, including PDCP and RLC states and the security configuration;
- 2> for each SRB:
  - 3> discard any PDCP SDUs along with the PDCP data PDUs for the source PCell;
  - 3> re-establish the RLC entity for the source PCell;
  - 3> release the PDCP entity for the target PCell;
  - 3> release the RLC entity and the associated DCCH logical channel for the target PCell;
- 2> release the physical channel configuration for the target PCell;
- 2> resume the SRBs for the source PCell;
- 2> initiate the failure information procedure as specified in 5.6.21 to report a DAPS HO failure.

The UE may discard the handover failure information, i.e. release the UE variable *VarRLF-Report*, 48 hours after the failure is detected, upon power off or upon detach.

NOTE 3: E-UTRAN may retrieve the handover failure information using the UE information procedure with *rlf-ReportReq* set to *true*, as specified in 5.6.5.3.

### 5.3.5.7 Void

#### 5.3.5.7a T307 expiry (SCG change failure)

The UE shall:

- 1> if T307 expires:

NOTE 1: Following T307 expiry any dedicated preamble, if provided within the *rach-ConfigDedicatedSCG*, is not available for use by the UE anymore.

- 2> if the UE is configured with DC; or
- 2> if the UE is configured with NE-DC and MCG transmission is not suspended:
  - 3> initiate the SCG failure information procedure as specified in 5.6.13 to report SCG change failure;
- 2> else:
  - 3> initiate the connection re-establishment procedure as specified in TS 38.331 [82] 5.3.7;

### 5.3.5.8 Radio Configuration involving full configuration option

The UE shall:

- 1> if the UE is connected to EPC:
  - 2> release/ clear all current dedicated radio configurations except for the following:
    - the MCG C-RNTI,
    - the MCG security configuration,
    - the PDCP, RLC, logical channel configurations for the RBs,
    - the logged measurement configuration;
    - the *serviceType*;
- 1> else if the UE is connected to 5GC:

2> release/ clear all current dedicated radio configurations except for the following:

- the MCG C-RNTI,
- the MCG security configuration,
- the configurations (SDAP if configured, PDCP, RLC and logical channel) for the RBs;
- the logged measurement configuration;

NOTE 1: Radio configuration is not just the resource configuration but includes other configurations like *MeasConfig* and *OtherConfig*. In case (NG)EN-DC is configured, this also includes the entire NR SCG configuration. Such NR SCG configuration does not include the DRB configuration as configured by *nr-RadioBearerConfig1* and *nr-RadioBearerConfig2*).

1> if the *RRCCConnectionReconfiguration* message includes the *measConfigAppLayer* set to *setup* and the *measConfigAppLayer* includes the *serviceType* stored in the current UE configuration:

- 2> discard the *measConfigAppLayer*;
- 2> consider the *measConfigAppLayer* as not received;

1> else if a *serviceType* is stored in the current UE configuration:

- 2> release the stored *serviceType*;
- 2> inform upper layers to clear the stored application layer measurement configuration;
- 2> discard received application layer measurement report information from upper layers;
- 2> consider itself not to be configured to send application layer measurement report;

1> if the *RRCCConnectionReconfiguration* message includes the *mobilityControlInfo*:

- 2> release/ clear all current common radio configurations;
- 2> use the default values specified in 9.2.5 for timer T310, T311 and constant N310, N311;

1> else:

- 2> use values for timers T301, T310, T311 and constants N310, N311, as included in *ue-TimersAndConstants* received in *SystemInformationBlockType2* (or *SystemInformationBlockType2-NB* in NB-IoT);

1> apply the default physical channel configuration as specified in 9.2.4;

1> apply the default semi-persistent scheduling configuration as specified in 9.2.3;

1> apply the default MAC main configuration as specified in 9.2.2;

1> if the UE is a NB-IoT UE; or

1> for each *srb-Identity* value included in the *srb-ToAddModList* (SRB reconfiguration):

- 2> apply the specified configuration defined in 9.1.2 for the corresponding SRB;
- 2> apply the corresponding default RLC configuration for the SRB specified in 9.2.1.1 for SRB1 or in 9.2.1.2 for SRB2;
- 2> apply the corresponding default logical channel configuration for the SRB as specified in 9.2.1.1 for SRB1 or in 9.2.1.2 for SRB2;
- 2> if the corresponding SRB was configured with NR PDCP and the UE is connected to EPC:
  - 3> release the NR PDCP entity and establish it with an E-UTRA PDCP entity and with the current (MCG) security configuration;

NOTE 1a: The UE applies the LTE ciphering and integrity protection algorithms that are equivalent to the previously configured NR security algorithms.

3> associate the RLC bearer of this SRB with the established PDCP entity;

NOTE 2: This is to get the SRBs (SRB1 and SRB2 for handover and SRB2 for reconfiguration after reestablishment) to a known state from which the reconfiguration message can do further configuration.

2> else if the UE is connected to 5GC:

3> apply the corresponding default PDCP configuration for the SRB as specified in TS 38.331 [82], clause 9.2.1;

1> for each *srb-Identity* value which was configured in the *srb-ToAddModListExt* but is not added in the RRC message configuring the full configuration:

2> release the RLC entity or entities;

2> release the DCCH logical channel;

2> release the PDCP entity;

1> if the UE is connected to EPC:

2> for each *eps-BearerIdentity* value included in the *drb-ToAddModList* or *nr-RadioBearerConfig1* or *nr-RadioBearerConfig2* that is part of the current E-UTRA and NR UE configuration:

3> release the E-UTRA or NR PDCP entity;

3> release the RLC entity or entities;

3> release the DTCH logical channel;

3> release the *drb-identity*;

NOTE 3: This will retain the *eps-bearerIdentity* but remove the DRBs including *drb-identity* of these bearers from the current UE configuration and trigger the setup of the DRBs within the AS in clause 5.3.10.3 using the new configuration. The *eps-bearerIdentity* acts as the anchor for associating the released and re-setup DRB. In the AS the DRB re-setup is equivalent with a new DRB setup (including new PDCP and logical channel configurations).

2> for each *eps-BearerIdentity* value that is part of the current E-UTRA and NR UE configuration but not added with same *eps-BearerIdentity* in *drb-ToAddModList* nor in *nr-RadioBearerConfig1* nor in *nr-RadioBearerConfig2*:

3> perform DRB release as specified in 5.3.10.2;

1> if the UE is connected to 5GC:

2> except for NB-IoT:

3> for each *pdu-Session* that is part of the current NR UE configuration:

4> release the SDAP entity (clause 5.1.2 in TS 37.324 [97]);

4> release the NR PDCP entity for each DRB associated to the *pdu-Session*;

4> release the RLC entity or entities for each DRB associated to the *pdu-Session*;

4> release the DTCH logical channel for each DRB associated to the *pdu-Session*;

4> release the *drb-identity* for each DRB associated to the *pdu-Session*;

NOTE 4: This will retain the *pdu-Session* but remove the DRBs including *drb-identity* of these bearers from the current NR UE configuration and trigger the setup of the DRBs within the AS in clause 5.3.10.3 using the new configuration. The *pdu-Session* acts as the anchor for associating the released and re-setup DRB. In the AS the DRB re-setup is equivalent with a new DRB setup (including new PDCP and logical channel configurations).

- 3> for each *pdu-Session* that is part of the current NR UE configuration but not added with same *pdu-Session* in *nr-RadioBearerConfig1* nor in *nr-RadioBearerConfig2*:
  - 4> if the procedure was triggered due to handover:
    - 5> indicate the release of the user plane resources for the *pdu-Session* to upper layers after successful handover;
  - 4> else:
    - 5> indicate the release of the user plane resources for the *pdu-Session* to upper layers immediately;
- 2> for NB-IoT UE:
  - 3> for each *pdu-Session* that is part of the current UE configuration:
    - 4> release the PDCP entity for the DRB associated to the *pdu-Session*;
    - 4> release the RLC entity for the DRB associated to the *pdu-Session*;
    - 4> release the DTCH logical channel for the DRB associated to the *pdu-Session*;
    - 4> release the *drb-identity* for the DRB associated to the *pdu-Session*;
  - 3> for each *pdu-Session* that is part of the current UE configuration but not added with same *pdu-Session* in *drb-ToAddModList*:
    - 4> indicate the release of the user plane resources for the *pdu-Session* to upper layers;

### 5.3.5.9 Conditional reconfiguration

#### 5.3.5.9.1 General

The network configures the UE with conditional reconfiguration (i.e. conditional handover, conditional PSCell addition, or inter-SN conditional PSCell change) including per candidate target cell an *RRCConditionReconfiguration* to be stored and to be applied upon the fulfilment of an associated execution condition.

The UE shall:

- 1> if the received *conditionalReconfiguration* includes the *condReconfigurationToRemoveList*:
  - 2> perform the conditional reconfiguration removal procedure as specified in 5.3.5.9.2;
- 1> if the received *conditionalReconfiguration* includes the *condReconfigurationToAddModList*:
  - 2> perform the conditional reconfiguration addition/modification procedure as specified in 5.3.5.9.3;

#### 5.3.5.9.2 Conditional reconfiguration removal

The UE shall:

- 1> for each *CondReconfigurationId* included in the *condReconfigurationToRemoveList* that is part of the current UE configuration in *VarConditionalReconfiguration*:
  - 2> remove the entry with the matching *condReconfigurationId* from the *condReconfigurationList* within the *VarConditionalReconfiguration*.

NOTE: The UE does not consider the message as erroneous if the *condReconfigurationToRemoveList* includes any *CondReconfigurationId* value that is not part of the current UE configuration.

#### 5.3.5.9.3 Conditional reconfiguration addition/modification

The UE shall:

- 1> for each *condReconfigurationId* included in the *condReconfigurationToAddModList*:



- 2> if an entry with the matching *condReconfigurationId* exists in the *condReconfigurationList* within the *VarConditionalReconfiguration*:
  - 3> if the entry in *condReconfigurationToAddModList* includes a *triggerCondition* or *triggerConditionSN*;
    - 4> replace *triggerCondition* or *triggerConditionSN* within the *VarConditionalReconfiguration* with the value received for this *condReconfigurationId*
  - 3> if the entry in *condReconfigurationToAddModList* includes an *condReconfigurationToApply*;
    - 4> replace *condReconfigurationToApply* within the *VarConditionalReconfiguration* with the value received for this *condReconfigurationId*;
- 2> else:
  - 3> add a new entry for this *condReconfigurationId* within the *VarConditionalReconfiguration*;
  - 3> store the associated *RRCConnectionReconfiguration* in *VarConditionalReconfiguration*.

#### 5.3.5.9.4 Conditional reconfiguration evaluation

If AS security has been activated successfully, the UE shall:

- 1> if *VarConditionalReconfiguration* includes at least one *condReconfigurationId*:
  - 2> perform conditional reconfiguration evaluation;
- 1> for each *condReconfigurationId* within the *VarConditionalReconfiguration*:
  - 2> if the *RRCConnectionReconfiguration* within *condReconfigurationToApply* includes the *MobilityControlInfo*:
    - 3> consider the cell which has a physical cell identity matching the value indicated in the *MobilityControlInfo* within *condReconfigurationToApply* to be an applicable cell;
  - 2> else if the *RRCConnectionReconfiguration* within *condReconfigurationToApply* includes the *nr-SecondaryCellGroupConfig*:
    - 3> consider the cell which has a physical cell identity matching the value indicated in the *nr-SecondaryCellGroupConfig* within the received *condReconfigurationToApply* to be an applicable cell;
  - 2> if *triggerConditionSN* is configured (in case of SN initiated inter-SN CPC for EN-DC):
    - 3> perform the conditional reconfiguration evaluation as specified in TS 38.331 [82], clause 5.3.5.13.4a;
    - 3> the procedure ends;
  - 2> for each *measId* included in the *measIdList* within *VarMeasConfig* indicated in the *triggerCondition* associated to *condReconfigurationId*:
    - 3> if the *condEventId* is associated with *condEventD1* or *condEventD2*, and if the entry conditions applicable for this event associated with the *condReconfigurationId*, i.e. the event corresponding with the *condEventId* of the corresponding *condReconfigurationTriggerEUTRA* within *VarConditionalReconfiguration*, are fulfilled for the applicable cell during the corresponding *timeToTrigger* defined for this event within the *VarConditionalReconfig*; or
    - 3> if the *condEventId* is associated with *condEventT1*, and if the entry condition applicable for this event associated with the *condReconfigurationId*, i.e. the event corresponding with the *condEventId* of the corresponding *condReconfigurationTriggerEUTRA* within *VarConditionalReconfiguration*, is fulfilled for the applicable cell; or
    - 3> if the *condEventId* is associated with *condEventA3*, *condEventA4*, *condEventA5* or *condEventB1*, and if the entry condition(s) applicable for this event associated with the *condReconfigurationId*, i.e. the event corresponding with the *condEventId* of the corresponding *condReconfigurationTriggerEUTRA* within *VarConditionalReconfiguration*, or the event corresponding with the *condEventId* of the corresponding *condReconfigurationTriggerNR* within *VarConditionalReconfiguration*, is fulfilled for the applicable cell

for all measurements after layer 3 filtering taken during the corresponding *timeToTrigger* defined for this event within the *VarConditionalReconfiguration*:

- 4> consider the entry condition for the associated *measId* within *triggerCondition* as fulfilled;
- 3> if the *measId* for this event associated with the *condReconfigurationId* has been modified; or
- 3> if the *condEventId* is associated with *condEventD1* or *condEventD2*, and if the leaving condition(s) applicable for this event associated with the *condReconfigurationId*, i.e. the event corresponding with the *condEventId* of the corresponding *condReconfigurationTriggerEUTRA* within *VarConditionalReconfiguration*, is fulfilled for the applicable cell during the corresponding *timeToTrigger* defined for this event within the *VarConditionalReconfig*; or
- 3> if the *condEventId* is associated with *condEventT1*, and if the leaving condition applicable for this event associated with the *condReconfigurationId*, i.e. the event corresponding with the *condEventId* of the corresponding *condReconfigurationTriggerEUTRA* within *VarConditionalReconfiguration*, is fulfilled for the applicable cell; or
- 3> if the *condEventId* is associated with *condEventA3*, *condEventA4*, *condEventA5* or *condEventB1*, and if the leaving condition(s) applicable for this event associated with the *condReconfigurationId*, i.e. the event corresponding with the *condEventId(s)* of the corresponding *condReconfigurationTriggerEUTRA* within *VarConditionalReconfiguration*, or the event corresponding with the *condEventId* of the corresponding *condReconfigurationTriggerNR* within *VarConditionalReconfiguration*, is fulfilled for the applicable cells for all measurements after layer 3 filtering taken during the corresponding *timeToTrigger* defined for this event within the *VarConditionalReconfiguration*:
  - 4> consider the event associated to that *measId* to be not fulfilled;
- 2> if trigger conditions for all associated *measId(s)* within *triggerCondition* are fulfilled:
  - 3> consider the target cell candidate within the stored *condReconfigurationToApply*, associated to that *condReconfigurationId*, as a triggered cell;
  - 3> initiate the conditional reconfiguration execution, as specified in 5.3.5.9.5;

#### 5.3.5.9.5 Conditional reconfiguration execution

The UE shall:

- 1> if more than one triggered cell exists:
  - 2> select one of the triggered cells as the selected cell for conditional reconfiguration;
- 1> else:
  - 2> consider the triggered cell as the selected cell for conditional reconfiguration;
- 1> for the selected cell of conditional reconfiguration:
  - 2> apply the stored *condReconfigurationToApply* associated to that *condReconfigurationId* and perform the actions as specified in 5.3.5.4, or perform the actions as specified in 5.3.5.3;

#### 5.3.5.9.6 VarConditionalReconfiguration remove

The UE shall:

- 1> remove all the entries within *VarConditionalReconfiguration*;
- 1> for each *measId*, that is part of the current UE configuration in *VarMeasConfig*, if the associated *reportConfig* has *condReconfigurationTriggerEUTRA/condReconfigurationTriggerNR* configured:
  - 2> remove the entry with the matching *reportConfigId* from the *reportConfigList* within the *VarMeasConfig*;
  - 2> if the associated *measObjectId* is only associated with *condReconfigurationTriggerEUTRA/condReconfigurationTriggerNR*:

- 3> remove the entry with the matching *measObjectId* from the *measObjectList* within the *VarMeasConfig*;
- 2> remove the entry with the matching *measId* from the *measIdList* within the *VarMeasConfig*;

### 5.3.5.9.7 VarConditionalReconfiguration CPC remove

The UE shall:

- 1> remove all the entries within *VarConditionalReconfiguration* for which the *RRCConnectionReconfiguration* within *condReconfigurationToApply* does not include the *MobilityControlInfo*.

## 5.3.6 Counter check

### 5.3.6.1 General

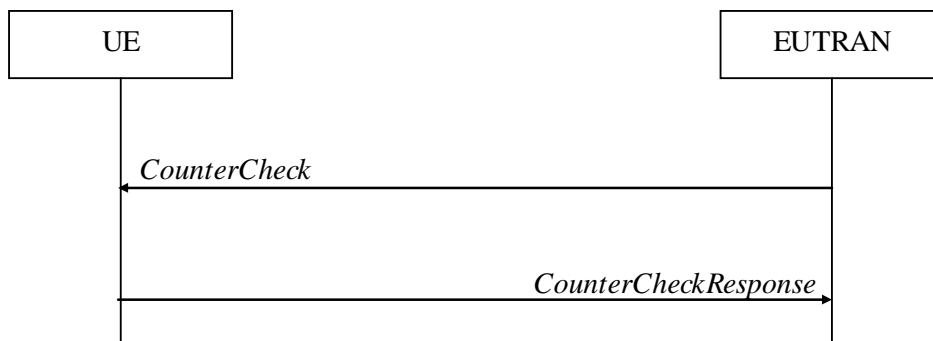

**Figure 5.3.6.1-1: Counter check procedure**

The counter check procedure is used by E-UTRAN to request the UE to verify the amount of data sent/ received on each DRB. More specifically, the UE is requested to check if, for each DRB, the most significant bits of the COUNT match with the values indicated by E-UTRAN.

NOTE: The procedure enables E-UTRAN to detect packet insertion by an intruder (a 'man in the middle').

### 5.3.6.2 Initiation

E-UTRAN initiates the procedure by sending a *CounterCheck* message.

NOTE: E-UTRAN may initiate the procedure when any of the COUNT values reaches a specific value.

### 5.3.6.3 Reception of the *CounterCheck* message by the UE

Upon receiving the *CounterCheck* message, the UE shall:

- 1> for each DRB that is established:
  - 2> if no COUNT exists for a given direction (uplink or downlink) because it is a uni-directional bearer configured only for the other direction:
    - 3> assume the COUNT value to be 0 for the unused direction;
  - 2> if the *drb-Identity* is not included in the *drb-CountMSB-InfoList*:
    - 3> if the DRB is configured with E-UTRA PDCP:
      - 4> include the DRB in the *drb-CountInfoList* in the *CounterCheckResponse* message by including the *drb-Identity*, the *count-Uplink* and the *count-Downlink* set to the value of the corresponding COUNT;
    - 3> else if the DRB is configured with NR PDCP:

- 4> include the DRB in the *drb-CountInfoList* in the *CounterCheckResponse* message by including the *drb-Identity*, the *count-Uplink* and the *count-Downlink* set to the value of TX\_NEXT – 1 and RX\_NEXT – 1 (specified in TS 38.323 [83]), respectively;
- 2> else if, for at least one direction, the most significant bits of the COUNT are different from the value indicated in the *drb-CountMSB-InfoList*:
  - 3> if the DRB is configured with E-UTRA PDCP:
    - 4> include the DRB in the *drb-CountInfoList* in the *CounterCheckResponse* message by including the *drb-Identity*, the *count-Uplink* and the *count-Downlink* set to the value of the corresponding COUNT;
  - 3> else if the DRB is configured with NR PDCP:
    - 4> include the DRB in the *drb-CountInfoList* in the *CounterCheckResponse* message by including the *drb-Identity*, the *count-Uplink* and the *count-Downlink* set to the value of TX\_NEXT – 1 and RX\_NEXT – 1 (specified in TS 38.323 [83]), respectively;
- 1> for each DRB that is included in the *drb-CountMSB-InfoList* in the *CounterCheck* message that is not established:
  - 2> include the DRB in the *drb-CountInfoList* in the *CounterCheckResponse* message by including the *drb-Identity*, the *count-Uplink* and the *count-Downlink* with the most significant bits set identical to the corresponding values in the *drb-CountMSB-InfoList* and the least significant bits set to zero;
- 1> submit the *CounterCheckResponse* message to lower layers for transmission upon which the procedure ends;

### 5.3.7 RRC connection re-establishment

#### 5.3.7.1 General

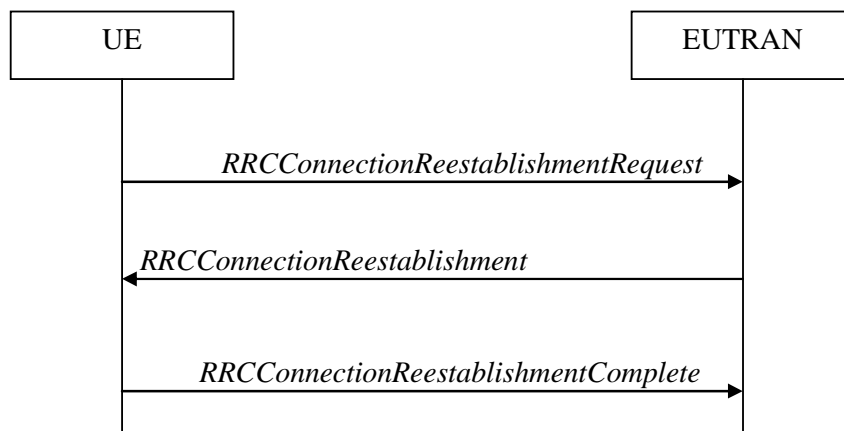

Figure 5.3.7.1-1: RRC connection re-establishment, successful

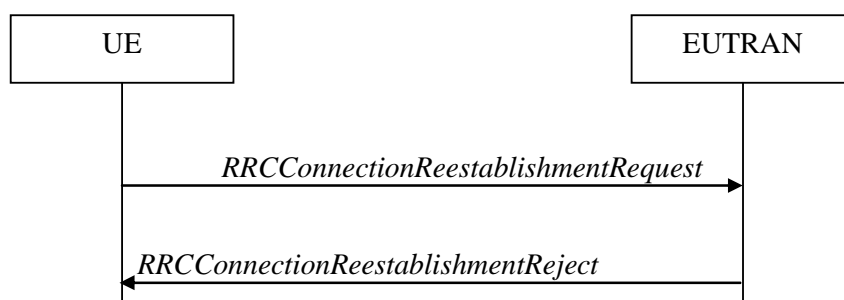

Figure 5.3.7.1-2: RRC connection re-establishment, failure

The purpose of this procedure is to re-establish the RRC connection, which involves the resumption of SRB1 (SRB1bis for a NB-IoT UE for which AS security has not been activated) operation, the re-activation of security (except for a NB-IoT UE for which AS security has not been activated) and the configuration of only the PCell.

Except for a NB-IoT UE for which AS security has not been activated, a UE in RRC\_CONNECTED, for which security has been activated, may initiate the procedure in order to continue the RRC connection. The connection re-establishment succeeds only if the concerned cell is prepared i.e. has a valid UE context. In case E-UTRAN accepts the re-establishment, SRB1 operation resumes while the operation of other radio bearers remains suspended. If AS security has not been activated, the UE does not initiate the procedure but instead moves to RRC\_IDLE directly.

When AS security has not been activated, a NB-IoT UE supporting RRC connection re-establishment for the Control Plane CIoT EPS/5GS optimisation in RRC\_CONNECTED may initiate the procedure in order to continue the RRC connection.

E-UTRAN applies the procedure as follows:

- When AS security has been activated:
  - to reconfigure SRB1 and to resume data transfer only for this RB;
  - to re-activate AS security without changing algorithms.
- For a NB-IoT UE supporting RRC connection re-establishment for the Control Plane CIoT EPS/5GS optimisation, when AS security has not been activated:
  - to re-establish SRB1bis and to continue data transfer for this RB.

### 5.3.7.1a Condition for re-establishing RRC Connection in NTN

If *systemInformationBlockType31* (*systemInformationBlockType31-NB* in NB-IoT) is broadcast, a RRC connection re-establishment is initiated only if the UE has a valid GNSS position.

NOTE: The UE may need to re-acquire the GNSS position before re-establishing the connection to avoid interruption during the connection.

### 5.3.7.2 Initiation

The UE shall only initiate the procedure either when AS security has been activated or for a NB-IoT UE supporting RRC connection re-establishment for the Control Plane CIoT EPS/5GS optimisation. The UE initiates the procedure when one of the following conditions is met:

- 1> upon detecting radio link failure and T316 is not configured, in accordance with 5.3.11; or
- 1> upon detecting radio link failure of the MCG while SCG transmission is suspended, in accordance with 5.3.11; or
- 1> upon detecting radio link failure of the MCG while NR PSCell change or PSCell addition is ongoing, in accordance with 5.3.11; or
- 1> upon handover failure, in accordance with 5.3.5.6; or
- 1> upon mobility from E-UTRA failure, in accordance with 5.4.3.5; or
- 1> except when resuming an RRC connection after early security reactivation in accordance with conditions in 5.3.3.18, upon integrity check failure indication from lower layers concerning SRB1 or SRB2; or
- 1> upon an RRC connection reconfiguration failure, in accordance with 5.3.5.5; or
- 1> upon an RRC connection reconfiguration failure, in accordance with TS38.331 [82], clause 5.3.5.8; or
- 1> upon detecting radio link failure for the SCG while MCG transmission is suspended, in accordance with TS 38.331 [82] clause 5.3.10.3 in (NG)EN-DC; or
- 1> upon SCG change failure while MCG transmission is suspended, in accordance with TS 38.331 [82] clause 5.3.5.8.3 in (NG)EN-DC; or

- 1> upon SCG configuration failure while MCG transmission is suspended in accordance with clause TS 38.331 [82] clause 5.3.5.8.2 in (NG)EN-DC; or
- 1> upon integrity check failure indication from SCG lower layers concerning SRB3 while MCG transmission is suspended; or
- 1> upon T316 expiry, in accordance with clause 5.6.26.5.

NOTE: When resuming an RRC connection after early security reactivation in accordance with conditions in 5.3.3.18, integrity check failure indication from lower layers is handled in accordance with clause 5.3.3.16.

Upon initiation of the procedure, the UE shall:

- 1> stop timer T310, if running;
- 1> stop timer T312, if running;
- 1> stop timer T313, if running;
- 1> stop timer T316, if running;
- 1> stop timer T307, if running;
- 1> start timer T311;
- 1> stop timer T370, if running;
- 1> stop timer T390, if running;
- 1> if the UE is not configured with *attemptCondReconf*:
  - 2> release *uplinkDataCompression*, if configured;
  - 2> suspend all RBs, including RBs configured with NR PDCP, except SRB0;
  - 2> reset MAC;
  - 2> release the MCG SCell(s), if configured, in accordance with 5.3.10.3a;
  - 2> release the SCell group(s), if configured, in accordance with 5.3.10.3d;
  - 2> apply the default physical channel configuration as specified in 9.2.4;
  - 2> except for NB-IoT, for the MCG, apply the default semi-persistent scheduling configuration as specified in 9.2.3;
  - 2> for NB-IoT, release *schedulingRequestConfig*, if configured;
  - 2> for NB-IoT, release *obtainLocationNB*, if configured;
  - 2> for the MCG, apply the default MAC main configuration as specified in 9.2.2;
  - 2> release *powerPrefIndicationConfig*, if configured and stop timer T340, if running;
  - 2> release *reportProximityConfig*, if configured and clear any associated proximity status reporting timer;
  - 2> release *obtainLocationConfig*, if configured;
  - 2> release *idc-Config*, if configured;
  - 2> release *sps-AssistanceInfoReport*, if configured;
  - 2> release *scg-DeactivationPreferenceConfig*, if configured and stop timer T346, if running;
  - 2> release *measSubframePatternPCell*, if configured;

- 2> release the entire SCG configuration, if configured, except for the DRB configuration (as configured by *drb-ToAddModListSCG*);
- 2> if (NG)EN-DC is configured:
  - 3> perform MR-DC release, as specified in TS 38.331[82], clause 5.3.5.10;
  - 3> release *p-MaxEUTRA*, if configured;
  - 3> release *p-MaxUE-FR1*, if configured;
  - 3> release *tdm-PatternConfig* or *tdm-PatternConfig2*, if configured;
- 2> release *naics-Info* for the PCell, if configured;
- 2> if connected as an RN and configured with an RN subframe configuration:
  - 3> release the RN subframe configuration;
- 2> release the LWA configuration, if configured, as described in 5.6.14.3;
- 2> release the LWIP configuration, if configured, as described in 5.6.17.3;
- 2> release *delayBudgetReportingConfig*, if configured and stop timer T342, if running;
- 2> release *bw-PreferenceIndicationTimer*, if configured and stop timer T341, if running;
- 2> release *overheatingAssistanceConfig* and *overheatingAssistanceConfigForSCG*, if configured and stop timer T345, if running;
- 2> release *ailc-BitConfig*, if configured;
- 2> if the UE has a stored *pur-Config* and the cell is different from the cell where *pur-Config* was provided:
  - 3> if *pur-TimeAlignmentTimer* is configured, indicate to lower layers that *pur-TimeAlignmentTimer* is released;
  - 3> release *pur-Config*;
  - 3> discard previously stored *pur-Config*.
- 1> if any DAPS bearer is configured:
  - 2> release the MAC entity for the source PCell;
  - 2> for each DAPS bearer:
    - 3> re-establish the RLC entity for the source PCell;
    - 3> release the RLC entity and the associated DTCH logical channel for the source PCell;
    - 3> reconfigure the PDCP entity to release DAPS, as specified in TS 36.323 [8];
  - 2> for each SRB:
    - 3> release the PDCP entity for the source PCell;
    - 3> release the RLC entity and the associated DCCH logical channel for the source PCell;
  - 2> release the physical channel configuration for the source PCell;
- 1> perform cell selection in accordance with the cell selection process as specified in TS 36.304 [4];

### 5.3.7.3 Actions following cell selection while T311 is running

Upon selecting a suitable E-UTRA cell, the UE shall:

- 1> if T309 is running:

- 2> stop timer T309 for all access categories;
- 2> perform the actions as specified in 5.3.16.4.
- 1> if the UE is connected to 5GC and the selected cell is only connected to EPC; or
- 1> if the UE is connected to EPC and the selected cell is only connected to 5GC:
  - 2> perform the actions upon leaving RRC\_CONNECTED as specified in 5.3.12, with release cause 'RRC connection failure';
- 1> else:
  - 2> stop timer T311;
  - 2> if the cell selection is triggered by detecting radio link failure of the MCG or handover failure (including intra-E-UTRA handover and mobility from E-UTRA); and
  - 2> if *attemptCondReconf* is configured; and
  - 2> if the selected cell is not configured with *condEventT1*, or the selected cell is configured with *condEventT1* and leaving condition has not been fulfilled; and
  - 2> if the selected cell is one of the target candidate cells in *VarConditionalReconfiguration*:
    - 3> apply the stored *condReconfigurationToApply* of the selected cell and perform the actions as specified in 5.3.5.4;
  - 2> else:
    - 3> if the UE is configured with *attemptCondReconf*:
      - 4> release *uplinkDataCompression*, if configured;
      - 4> suspend all RBs, including RBs configured with NR PDCP, except SRB0;
      - 4> reset MAC;
      - 4> release the MCG SCell(s), if configured, in accordance with 5.3.10.3a;
      - 4> release the SCell group(s), if configured, in accordance with 5.3.10.3d;
      - 4> apply the default physical channel configuration as specified in 9.2.4;
      - 4> for the MCG, apply the default semi-persistent scheduling configuration as specified in 9.2.3;
      - 4> for the MCG, apply the default MAC main configuration as specified in 9.2.2;
      - 4> release *powerPrefIndicationConfig*, if configured and stop timer T340, if running;
      - 4> release *reportProximityConfig*, if configured and clear any associated proximity status reporting timer;
      - 4> release *obtainLocationConfig*, if configured;
      - 4> release *idc-Config*, if configured;
      - 4> release *sps-AssistanceInfoReport*, if configured;
      - 4> release *scg-DeactivationPreferenceConfig*, if configured and stop timer T346, if running;
      - 4> release *measSubframePatternPCell*, if configured;
      - 4> release the entire SCG configuration, if configured, except for the DRB configuration (as configured by *drb-ToAddModListSCG*);
      - 4> if (NG)EN-DC is configured:
        - 5> perform MR-DC release, as specified in TS 38.331[82], clause 5.3.5.10;



- 5> release *p-MaxEUTRA*, if configured;
- 5> release *p-MaxUE-FR1*, if configured;
- 5> release *tdm-PatternConfig* or *tdm-PatternConfig2*, if configured;
- 4> release *naics-Info* for the PCell, if configured;
- 4> if connected as an RN and configured with an RN subframe configuration:
  - 5> release the RN subframe configuration;
- 4> release the LWA configuration, if configured, as described in 5.6.14.3;
- 4> release the LWIP configuration, if configured, as described in 5.6.17.3;
- 4> release *delayBudgetReportingConfig*, if configured and stop timer T342, if running;
- 4> release *bw-PreferenceIndicationTimer*, if configured and stop timer T341, if running;
- 4> release *overheatingAssistanceConfig* and *overheatingAssistanceConfigForSCG*, if configured and stop timer T345, if running;
- 4> release *ailc-BitConfig*, if configured;
- 3> remove all the entries within *VarConditionalReconfiguration*, if any;
- 3> for each *measId*, that is part of the current UE configuration in *VarMeasConfig*, if the associated *reportConfig* has *condReconfigurationTriggerEUTRA/condReconfigurationTriggerNR* configured:
  - 4> remove the entry with the matching *reportConfigId* from the *reportConfigList* within the *VarMeasConfig*;
  - 4> if the associated *measObjectId* is only associated with *condReconfigurationTriggerEUTRA/condReconfigurationTriggerNR*:
    - 5> remove the entry with the matching *measObjectId* from the *measObjectList* within the *VarMeasConfig*;
  - 4> remove the entry with the matching *measId* from the *measIdList* within the *VarMeasConfig*;
- 3> start timer T301;
- 3> apply the *timeAlignmentTimerCommon* included in *SystemInformationBlockType2*;
- 3> if UE supports timing advance reporting and *ta-Report* is included in *SystemInformationBlockType2* (*SystemInformationBlockType2-NB* in NB-IoT):
  - 4> instruct the associated MAC entity to trigger Timing Advance reporting;
- 3> if the UE is a NB-IoT UE connected to EPC, the UE supports RRC connection re-establishment for the Control Plane CIoT EPS optimisation and AS security has not been activated; and
- 3> if *cp-reestablishment* is not included in *SystemInformationBlockType2-NB*:
  - 4> perform the actions upon leaving RRC\_CONNECTED as specified in 5.3.12, with release cause 'RRC connection failure';
- 3> else:
  - 4> initiate transmission of the *RRCConnectionReestablishmentRequest* message in accordance with 5.3.7.4;

NOTE: This procedure applies also if the UE returns to the source PCell.

Upon selecting an inter-RAT cell, the UE shall:

- 1> if the selected cell is a UTRA cell, and if the UE supports Radio Link Failure Report for Inter-RAT MRO, include *selectedUTRA-CellId* in the *VarRLF-Report* and set it to the physical cell identity and carrier frequency of the selected UTRA cell;
- 1> perform the actions upon leaving RRC\_CONNECTED as specified in 5.3.12, with release cause 'RRC connection failure';

#### 5.3.7.4 Actions related to transmission of *RRCCConnectionReestablishmentRequest* message

If the procedure was initiated due to radio link failure or handover failure, the UE shall:

- 1> set the *reestablishmentCellId* in the *VarRLF-Report* (*VarRLF-Report-NB* in NB-IoT) to the global cell identity of the selected cell;

The UE shall set the contents of *RRCCConnectionReestablishmentRequest* message as follows:

- 1> except for a NB-IoT UE for which AS security has not been activated, set the *ue-Identity* as follows:
  - 2> set the *c-RNTI* to the C-RNTI used in the source PCell (handover and mobility from E-UTRA failure) or used in the PCell in which the trigger for the re-establishment occurred (other cases);
  - 2> set the *physCellId* to the physical cell identity of the source PCell (handover and mobility from E-UTRA failure) or of the PCell in which the trigger for the re-establishment occurred (other cases);
  - 2> set the *shortMAC-I* to the 16 least significant bits of the MAC-I calculated:
    - 3> over the ASN.1 encoded as per clause 8 (i.e., a multiple of 8 bits) *VarShortMAC-Input* (or *VarShortMAC-Input-NB* in NB-IoT);
    - 3> with the  $K_{RRCCint}$  key and integrity protection algorithm that was used in the source PCell (handover and mobility from E-UTRA failure) or of the PCell in which the trigger for the re-establishment occurred (other cases); and
    - 3> with all input bits for COUNT, BEARER and DIRECTION set to binary ones;
- 1> for a NB-IoT UE for which AS security has not been activated, set the *ue-Identity* as follows:
  - 2> request upper layers for calculated ul-NAS-MAC and ul-NAS-Count using the *cellIdentity* indicated in *SystemInformationBlockType1-NB* of the current cell;
  - 2> if the UE is connected to 5GC:
    - 3> set the *truncated5G-S-TMSI* to the truncated 5G-S-TMSI provided by higher layers;
  - 2> else:
    - 3> set the *s-TMSI* to the S-TMSI provided by upper layers;
  - 2> set the *ul-NAS-MAC* to the ul-NAS-MAC value provided by upper layers;
  - 2> set the *ul-NAS-Count* to the ul-NAS-Count value provided by upper layers;
- 1> set the *reestablishmentCause* as follows:
  - 2> if the re-establishment procedure was initiated due to reconfiguration failure as specified in 5.3.5.5 (the UE is unable to comply with the reconfiguration):
    - 3> set the *reestablishmentCause* to the value *reconfigurationFailure*;
  - 2> else if the re-establishment procedure was initiated due to handover failure as specified in 5.3.5.6 (intra-LTE handover failure) or 5.4.3.5 (inter-RAT mobility from EUTRA failure):
    - 3> set the *reestablishmentCause* to the value *handoverFailure*;
  - 2> else:

3> set the *reestablishmentCause* to the value *otherFailure*;

1> if the UE is a NB-IoT UE:

2> if the UE supports DL channel quality reporting in MSG3 and *cqi-Reporting* is present in *SystemInformationBlockType2-NB*:

3> set the *cqi-NPDCCH* to include the latest results of the downlink channel quality measurements of the carrier where the random access response is received as specified in TS 36.133 [16];

NOTE: The downlink channel quality measurements use measurement period T1 or T2, as defined in TS 36.133 [16].

2> if the UE is connected to EPC, set *earlyContentionResolution* to TRUE;

The UE shall submit the *RRCCConnectionReestablishmentRequest* message to lower layers for transmission.

### 5.3.7.5 Reception of the *RRCCConnectionReestablishment* by the UE

NOTE 1: Prior to this, lower layer signalling is used to allocate a C-RNTI. For further details see TS 36.321 [6];

The UE shall:

1> stop timer T301;

1> consider the current cell to be the PCell;

1> except for a NB-IoT UE for which AS security has not been activated:

2> if SRB1 was configured with NR PDCP and the UE is connected to EPC:

3> for SRB1, release the NR PDCP entity and establish an E-UTRA PDCP entity with the current (MCG) security configuration;

NOTE 1a: The UE applies the LTE ciphering and integrity protection algorithms that are equivalent to the previously configured NR security algorithms.

2> else:

3> for SRB1, re-establish the PDCP entity;

2> re-establish RLC for SRB1;

2> perform the radio resource configuration procedure in accordance with the received *radioResourceConfigDedicated* and as specified in 5.3.10.0;

2> resume SRB1;

NOTE 2: E-UTRAN should not transmit any message on SRB1 prior to receiving the *RRCCConnectionReestablishmentComplete* message.

2> if UE is connected to EPC, update the  $K_{eNB}$  key based on the  $K_{ASME}$  key to which the current  $K_{eNB}$  is associated, using the *nextHopChainingCount* value indicated in the *RRCCConnectionReestablishment* message, as specified in TS 33.401 [32];

2> else if UE is connected to 5GC, update the  $K_{eNB}$  key based on the  $K_{AMF}$  key to which the current  $K_{eNB}$  is associated, using the *nextHopChainingCount* value indicated in the *RRCCConnectionReestablishment* message, as specified in TS 33.501 [86];

2> store the *nextHopChainingCount* value;

2> derive the  $K_{RRCint}$  key associated with the previously configured integrity algorithm, as specified in TS 33.401 [32];

2> derive the  $K_{RRCenc}$  key and the  $K_{UPenc}$  key associated with the previously configured ciphering algorithm, as specified in TS 33.401 [32];

- 2> if connected as an RN; or
- 2> if capable of user plane integrity protection:
  - 3> derive the  $K_{UPint}$  key associated with the previously configured integrity algorithm, as specified in TS 33.401 [32];
- 2> configure lower layers to activate integrity protection using the previously configured algorithm and the  $K_{RRCint}$  key immediately, i.e., integrity protection shall be applied to all subsequent messages received and sent by the UE, including the message used to indicate the successful completion of the procedure;
- 2> if connected as an RN:
  - 3> configure lower layers to apply integrity protection using the previously configured algorithm and the  $K_{UPint}$  key, for subsequently resumed or subsequently established DRBs that are configured to apply integrity protection, if any;
- 2> configure lower layers to apply ciphering using the previously configured algorithm, the  $K_{RRCenc}$  key and the  $K_{UPenc}$  key immediately, i.e., ciphering shall be applied to all subsequent messages received and sent by the UE, including the message used to indicate the successful completion of the procedure;
- 2> if the UE is not a NB-IoT UE:
  - 3> set the content of *RRCConnectionReestablishmentComplete* message as follows:
    - 4> if the UE has radio link failure or handover failure information available in *VarRLF-Report* and if the RPLMN is included in *plmn-IdentityList* stored in *VarRLF-Report*:
      - 5> include the *rlf-InfoAvailable*;
    - 4> if the UE has MBSFN logged measurements available for E-UTRA and if the RPLMN is included in *plmn-IdentityList* stored in *VarLogMeasReport* and if T330 is not running:
      - 5> include *logMeasAvailableMBSFN*;
    - 4> else if the UE has logged measurements available for E-UTRA and if the RPLMN is included in *plmn-IdentityList* stored in *VarLogMeasReport*:
      - 5> include the *logMeasAvailable*;
      - 5> if Bluetooth measurement results are included in the logged measurements the UE has available:
        - 6> include the *logMeasAvailableBT*;
      - 5> if WLAN measurement results are included in the logged measurements the UE has available:
        - 6> include the *logMeasAvailableWLAN*;
    - 4> if the UE has connection establishment failure information available in *VarConnEstFailReport* and if the RPLMN is equal to *plmn-Identity* stored in *VarConnEstFailReport*:
      - 5> include the *connEstFailInfoAvailable*;
    - 4> if the UE has flight path information available:
      - 5> include *flightPathInfoAvailable*;
  - 3> perform the measurement related actions as specified in 5.5.6.1;
  - 3> perform the measurement identity autonomous removal as specified in 5.5.2.2a;
- 2> else:
  - 3> if the UE supports serving cell idle mode measurements reporting and *servingCellMeasInfo* is present in *SystemInformationBlockType2-NB*:
    - 4> set the *measResultServCell* to include the measurements of the serving cell;

NOTE 2a: The UE includes the latest results of the serving cell measurements as used for cell selection/ reselection evaluation, which are performed in accordance with the performance requirements as specified in TS 36.133 [16].

- 3> if the UE is connected to EPC:
  - 4> if the UE has radio link failure information available in *VarRLF-Report-NB* and if the RPLMN is included in *plmn-IdentityList* stored in *VarRLF-Report-NB*:
    - 5> include the *rlf-InfoAvailable*;
  - 4> if the UE has ANR measurements information available in *VarANR-MeasurementReport-NB* and if the RPLMN is included in *plmn-IdentityList* stored in *VarANR-MeasurementReport-NB*:
    - 5> include the *anr-InfoAvailable*;
- 2> if the UE is connected to NTN:
  - 3> include *gnss-validityDuration* in accordance with the remaining time of the GNSS validity duration;
  - 3> if UE supports GNSS position fix in *RRC\_CONNECTED* and *gnss-PositionFixDurationReporting* is present in *SystemInformationBlockType2(-NB)*:
    - 4> include *gnss-PositionFixDuration* in accordance with the time duration required for the UE to acquire a GNSS position;
- 2> submit the *RRCConnectionReestablishmentComplete* message to lower layers for transmission;
- 2> if *SystemInformationBlockType15* is broadcast by the PCell:
  - 3> if the UE has transmitted an *MBMSInterestIndication* message during the last 1 second preceding detection of radio link failure:
    - 4> ensure having a valid version of *SystemInformationBlockType15* for the PCell;
    - 4> determine the set of MBMS frequencies of interest in accordance with 5.8.5.3;
    - 4> determine the set of MBMS services of interest in accordance with 5.8.5.3a;
    - 4> initiate transmission of the *MBMSInterestIndication* message in accordance with 5.8.5.4;
- 2> if *SystemInformationBlockType18* is broadcast by the PCell; and the UE transmitted a *SidelinkUEInformation* message indicating a change of sidelink communication related parameters relevant in PCell (i.e. change of *commRxInterestedFreq* or *commTxResourceReq*, *commTxResourceReqUC* if *SystemInformationBlockType18* includes *commTxResourceUC-ReqAllowed* or *commTxResourceInfoReqRelay* if PCell broadcasts *SystemInformationBlockType19* including *discConfigRelay*) during the last 1 second preceding detection of radio link failure; or
- 2> if *SystemInformationBlockType19* is broadcast by the PCell; and the UE transmitted a *SidelinkUEInformation* message indicating a change of sidelink discovery related parameters relevant in PCell (i.e. change of *discRxInterest* or *discTxResourceReq*, *discTxResourceReqPS* if *SystemInformationBlockType19* includes *discConfigPS* or *discRxGapReq* or *discTxGapReq* if the UE is configured with *gapRequestsAllowedDedicated* set to *true* or if the UE is not configured with *gapRequestsAllowedDedicated* and *SystemInformationBlockType19* includes *gapRequestsAllowedCommon*) during the last 1 second preceding detection of radio link failure; or
- 2> if *SystemInformationBlockType21* including *sl-V2X-ConfigCommon* is broadcast by the PCell; and the UE transmitted a *SidelinkUEInformation* message indicating a change of V2X sidelink communication related parameters relevant in PCell (i.e. change of *v2x-CommRxInterestedFreqList* or *v2x-CommTxResourceReq*) during the last 1 second preceding detection of radio link failure:
  - 3> initiate transmission of the *SidelinkUEInformation* message in accordance with 5.10.2.3;
- 1> for a NB-IoT UE for which AS security has not been activated:
  - 2> validate *dl-NAS-MAC*, as specified in TS 33.401 [32];

- 2> if *dl-NAS-MAC* check fails:
  - 3> perform the actions upon leaving *RRC\_CONNECTED* as specified in 5.3.12, with release cause 'RRC connection failure', upon which the procedure ends;
- 2> except for a UE that only supports the Control Plane ClOT EPS/5GS optimisation:
  - 3> re-establish PDCP for SRB1;
  - 3> re-establish RLC for SRB1;
- 2> re-establish RLC for SRB1bis;
- 2> perform the radio resource configuration procedure in accordance with the received *radioResourceConfigDedicated* and as specified in 5.3.10.0;
- 2> except for a UE that only supports the Control Plane ClOT EPS/5GS optimisation:
  - 3> resume SRB1;
- 2> resume SRB1bis;

NOTE 3: E-UTRAN should not transmit any message on SRB1bis prior to receiving the *RRCConnectionReestablishmentComplete* message.

- 2> if the UE supports serving cell idle mode measurements reporting and *servingCellMeasInfo* is present in *SystemInformationBlockType2-NB*:
  - 3> set the *measResultServCell* to include the measurements of the serving cell;

NOTE 4: The UE includes the latest results of the serving cell measurements as used for cell selection/ reselection evaluation, which are performed in accordance with the performance requirements as specified in TS 36.133 [16].

- 2> if the UE is connected to NTN:
  - 3> include *gnss-validityDuration* in accordance with the remaining time of the GNSS validity duration;
  - 3> if UE supports GNSS position fix in *RRC\_CONNECTED* and *gnss-PositionFixDurationReporting* is present in *SystemInformationBlockType2(-NB)*:
    - 4> include *gnss-PositionFixDuration* in accordance with the time duration required for the UE to acquire a GNSS position;
- 2> submit the *RRCConnectionReestablishmentComplete* message to lower layers for transmission;

1> for NB-IoT:

- 2> if the UE supports connected mode measurements and *connMeasConfig* is present in *SystemInformationBlockType3-NB*:
  - 3> perform measurements as specified in 5.5.8.

1> the procedure ends;

### 5.3.7.6 T311 expiry

Upon T311 expiry, the UE shall:

- 1> perform the actions upon leaving *RRC\_CONNECTED* as specified in 5.3.12, with release cause 'RRC connection failure';

### 5.3.7.7 T301 expiry or selected cell no longer suitable

The UE shall:

- 1> if timer T301 expires; or

- 1> if the selected cell becomes no longer suitable according to the cell selection criteria as specified in TS 36.304 [4]:
- 2> perform the actions upon leaving RRC\_CONNECTED as specified in 5.3.12, with release cause 'RRC connection failure';

### 5.3.7.8 Reception of *RRCConnectionReestablishmentReject* by the UE

Upon receiving the *RRCConnectionReestablishmentReject* message, the UE shall:

- 1> perform the actions upon leaving RRC\_CONNECTED as specified in 5.3.12, with release cause 'RRC connection failure';

## 5.3.8 RRC connection release

### 5.3.8.1 General

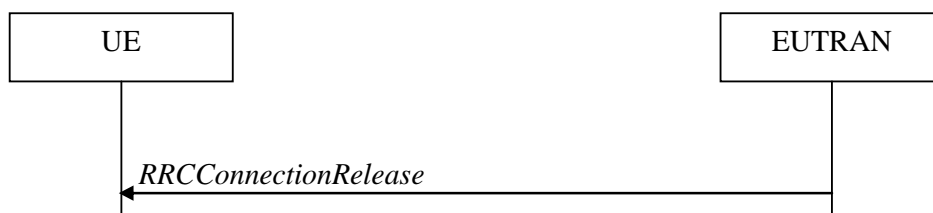

**Figure 5.3.8.1-1: RRC connection release, successful**

The purpose of this procedure is:

- to release the RRC connection, which includes the release of the established radio bearers as well as all radio resources; or
- to suspend the RRC connection for both suspended RRC connection or RRC\_INACTIVE, which includes the suspension of the established radio bearers;
- to configure, reconfigure or release radio resources for transmission using PUR;
- to complete the UP-EDT procedure and UP transmission using PUR, which includes the release or suspension of the established radio bearers.

### 5.3.8.2 Initiation

E-UTRAN initiates the RRC connection release procedure to a UE in RRC\_CONNECTED or in RRC\_INACTIVE or to complete UP-EDT or UP transmission using PUR.

### 5.3.8.3 Reception of the *RRCConnectionRelease* by the UE

The UE shall:

- 1> except for NB-IoT, BL UEs or UEs in CE, delay the following actions defined in this clause 60 ms from the moment the *RRCConnectionRelease* message was received or optionally when lower layers indicate that the receipt of the *RRCConnectionRelease* message has been successfully acknowledged, whichever is earlier;
- 1> for BL UEs or UEs in CE, delay the following actions defined in this clause 1.25 seconds from the moment the *RRCConnectionRelease* message was received or optionally when lower layers indicate that the receipt of the *RRCConnectionRelease* message has been successfully acknowledged, whichever is earlier;
- 1> for NB-IoT, delay the following actions defined in this clause 10 seconds from the moment the *RRCConnectionRelease* message was received or optionally when lower layers indicate that the receipt of the *RRCConnectionRelease* message has been successfully acknowledged, whichever is earlier.

NOTE 0: For BL UEs, UEs in CE and NB-IoT, when STATUS reporting, as defined in TS 36.322 [7], has not been triggered and the UE has sent positive HARQ feedback (ACK), as defined in TS 36.321 [6], the lower layers can be considered to have indicated that the receipt of the *RRConnectionRelease* message has been successfully acknowledged.

NOTE 0a: For BL UEs, UEs in CE and NB-IoT, when the *RRConnectionRelease* message is received on a HARQ process with disabled HARQ feedback, and when STATUS reporting, as defined in TS 36.322 [7], has not been triggered, the lower layers can be considered to have indicated that the receipt of the *RRConnectionRelease* message has been successfully acknowledged.

1> stop T380, if running;

1> if timer T316 is running;

2> stop timer T316;

2> clear the information included in *VarRLF-Report*, if any;

1> for NB-IoT:

2> if the UE has reported *anr-InfoAvailable*, clear *VarANR-MeasConfig-NB* and *VarANR-MeasReport-NB*;

2> if the UE has reported *rlf-InfoAvailable*, clear *VarRLF-Report-NB*;

1> if the *RRConnectionRelease* message is received in response to an *RRConnectionResumeRequest* for EDT or for UP transmission using PUR:

2> indicate to upper layers that the suspended RRC connection has been resumed;

2> discard the stored UE AS context and *resumeIdentity*;

2> stop timer T300;

2> stop timer T302, if running;

2> stop timer T303, if running;

2> stop timer T305, if running;

2> stop timer T306, if running;

2> stop timer T308, if running;

2> perform the actions as specified in 5.3.3.7;

2> stop timer T320, if running;

2> stop timer T322, if running;

2> stop timer T323, if running;

1> except for UEs using the Control Plane CIoT 5GS optimisation, if AS security is not activated and if UE is connected to 5GC:

2> ignore any field included in *RRConnectionRelease* message except *waitTime*;

2> perform the actions upon leaving RRC\_CONNECTED or RRC\_INACTIVE as specified in 5.3.12 with the release cause 'other' upon which the procedure ends;

1> if the *RRConnectionRelease* message includes *redirectedCarrierInfo* indicating redirection to *geran*, *utra-FDD*, *utra-TDD* or *utra-TDD-r10*; or

1> if the *RRConnectionRelease* message includes *idleModeMobilityControlInfo* including *freqPriorityListGERAN* or *freqPriorityListUTRA-FDD* or *freqPriorityListUTRA-TDD*:

2> if AS security has not been activated; and



- 2> if upper layers indicate that redirect to GERAN or UTRAN without AS security is not allowed (see TS 24.301 [35]):
    - 3> ignore the content of the *RRCConnectionRelease*;
    - 3> perform the actions upon leaving RRC\_CONNECTED or RRC\_INACTIVE as specified in 5.3.12, with release cause 'other', upon which the procedure ends;
  - 1> if AS security has not been activated:
    - 2> ignore the content of *redirectedCarrierInfo*, if included and indicating redirection to *nr*;
    - 2> ignore the content of *idleModeMobilityControlInfo*, if included and including *freqPriorityListNR*;
    - 2> ignore the *altFreqPriorities* and T323, if included;
    - 2> if the UE ignores the content of *redirectedCarrierInfo* or of *idleModeMobilityControlInfo*, or of *altFreqPriorities* and T323:
      - 3> perform the actions upon leaving RRC\_CONNECTED as specified in 5.3.12, with release cause 'other', upon which the procedure ends;
  - 1> if the *RRCConnectionRelease* message includes *redirectedCarrierInfo* indicating redirection to *eutra* and if UE is connected to 5GC:
    - 2> if *cn-Type* is included:
      - 3> after the cell selection, indicate the available CN Type(s) and the received *cn-Type* to upper layers;
- NOTE 1: Handling the case if the E-UTRA cell selected after the redirection does not support the core network type specified by the *cn-Type*, is up to UE implementation.
- 1> if the *RRCConnectionRelease* message includes the *idleModeMobilityControlInfo*:
    - 2> store the cell reselection priority information provided by the *idleModeMobilityControlInfo*;
    - 2> if the *t320* is included:
      - 3> start timer T320, with the timer value set according to the value of *t320*;
  - 1> else if the *RRCConnectionRelease* message includes the *altFreqPriorities*:
    - 2> store the received *altFreqPriorities*;
    - 2> for E-UTRA frequency, apply the alternative cell reselection priority information broadcast in the system information if available, otherwise apply the cell reselection priority broadcast in the system information;
    - 2> for inter-RAT frequency, apply the cell reselection priority broadcast in the system information;
    - 2> if the *t323* is included:
      - 3> start timer T323, with the timer value set according to the value of *t323*;
  - 1> else:
    - 2> apply the cell reselection priority information broadcast in the system information;
  - 1> if the *RRCConnectionRelease* message includes the *releaseMeasIdleConfig*:
    - 2> if timer T331 is running:
      - 3> stop timer T331;
      - 3> perform the actions as specified in 5.6.20.3;
  - 1> if the *RRCConnectionRelease* message includes the *measIdleConfig*:
    - 2> clear *VarMeasIdleConfig* and *VarMeasIdleReport*;

- 2> store the received *measIdleDuration* in *VarMeasIdleConfig*;
- 2> start or restart T331 with the value of *measIdleDuration*;
- 2> if the *measIdleConfig* contains *measIdleCarrierListEUTRA*:
  - 3> store the received *measIdleCarrierListEUTRA* in *VarMeasIdleConfig*;
- 2> if the *measIdleConfig* contains *measIdleCarrierListNR*:
  - 3> store the received *measIdleCarrierListNR* in *VarMeasIdleConfig*;
- 2> if the *measIdleConfig* contains *validityAreaList*:
  - 3> store the received *validityAreaList* in *VarMeasIdleConfig*;

NOTE 2: If the *measIdleConfig* contains neither *measIdleCarrierListEUTRA* nor *measIdleCarrierListNR*, UE may receive *measIdleCarrierListEUTRA* and/or *measIdleCarrierListNR* as specified in 5.6.20.1a.

- 1> for NB-IoT, if the *RRCConnectionRelease* message includes the *anr-MeasConfig*:
  - 2> clear *VarANR-MeasConfig-NB* and *VarANR-MeasReport-NB*;
  - 2> store the received *anr-QualityThreshold* in *VarANR-MeasConfig-NB*;
  - 2> if the *anr-MeasConfig* contains *anr-CarrierList*:
    - 3> store the received *anr-CarrierList* in *VarANR-MeasConfig-NB*;
  - 2> set *plmn-IdentityList* in *VarANR-MeasReport-NB* to include the list of EPLMNs stored by the UE (i.e. includes the RPLMN);
  - 2> set *servCellIdentity* in *VarANR-MeasReport-NB* to the global cell identity of the Pcell;
  - 2> start performing ANR measurements as specified in 5.6.24;
- 1> if the *RRCConnectionRelease* message includes the *pur-Config*:
  - 2> if *pur-Config* is set to *setup*:
    - 3> store or replace the PUR configuration provided by the *pur-Config*;
    - 3> if *pur-TimeAlignmentTimer* is included in the received *pur-Config*:
      - 4> configure lower layers in accordance with *pur-TimeAlignmentTimer*;
    - 3> else:
      - 4> if *pur-TimeAlignmentTimer* is configured, indicate to lower layers that *pur-TimeAlignmentTimer* is released;
    - 3> if *pur-RSRP-ChangeThreshold* (*pur-NRSRP-ChangeThreshold* in NB-IoT) is included in the received *pur-Config* and set to *setup*; or
    - 3> if *pur-RSRP-ChangeThreshold* (*pur-NRSRP-ChangeThreshold* in NB-IoT) is configured and *pur-TimeAlignmentTimer* is included in the received *pur-Config*:
      - 4> store or replace the serving cell reference (N)RSRP value with the current serving cell (N)RSRP value (see 5.3.3.19);
    - 3> start maintenance of PUR occasions as specified in 5.3.3.20;
  - 2> else:
    - 3> if *pur-TimeAlignmentTimer* is configured, indicate to lower layers that *pur-TimeAlignmentTimer* is released;
    - 3> release *pur-Config*, if configured;

- 3> discard previously stored *pur-Config*;
- 1> for NB-IoT, if the *RRCConnectionRelease* message includes the *redirectedCarrierInfo*:
  - 2> if the *redirectedCarrierOffsetDedicated* is included in the *redirectedCarrierInfo*:
    - 3> store the dedicated offset for the frequency in *redirectedCarrierInfo*;
    - 3> start timer T322, with the timer value set according to the value of *T322* in *redirectedCarrierInfo*;
  - 1> if the *releaseCause* received in the *RRCConnectionRelease* message indicates *loadBalancingTAURequired*:
    - 2> perform the actions upon leaving RRC\_CONNECTED as specified in 5.3.12, with release cause 'load balancing TAU required';
  - 1> else if the *releaseCause* received in the *RRCConnectionRelease* message indicates *cs-FallbackHighPriority*:
    - 2> perform the actions upon leaving RRC\_CONNECTED as specified in 5.3.12, with release cause 'CS Fallback High Priority';
  - 1> else:
    - 2> if the *extendedWaitTime* is present; and
    - 2> if the UE supports delay tolerant access or the UE is a NB-IoT UE:
      - 3> forward the *extendedWaitTime* to upper layers;
    - 2> if the *extendedWaitTime-CPdata* is present and the NB-IoT UE only supports the Control Plane CIoT EPS optimisation:
      - 3> forward the *extendedWaitTime-CPdata* to upper layers;
    - 2> if the *releaseCause* received in the *RRCConnectionRelease* message indicates *rrc-Suspend*:
      - 3> perform the actions upon leaving RRC\_CONNECTED as specified in 5.3.12, with release cause 'RRC suspension';
    - 2> else if *rrc-InactiveConfig* is included:
      - 3> perform the actions upon entering RRC\_INACTIVE as specified in 5.3.8.7;
    - 2> else:
      - 3> perform the actions upon leaving RRC\_CONNECTED or RRC\_INACTIVE as specified in 5.3.12, with release cause 'other';

#### 5.3.8.4 T320 expiry

The UE shall:

- 1> if T320 expires:
  - 2> if stored, discard the cell reselection priority information provided by the *idleModeMobilityControlInfo* or inherited from another RAT;
  - 2> apply the cell reselection priority information broadcast in the system information;

#### 5.3.8.5 T322 expiry or stop

The UE shall:

- 1> if T322 expires or is stopped:
  - 2> discard the *redirectedCarrierOffsetDedicated* provided in *RRCConnectionRelease* message;

### 5.3.8.6 UE actions upon receiving the expiry of *DataInactivityTimer*

Upon receiving the expiry of *DataInactivityTimer* from lower layers while in RRC\_CONNECTED, the UE shall:

- 1> perform the actions upon leaving RRC\_CONNECTED as specified in 5.3.12, with release cause 'RRC connection failure';

### 5.3.8.7 UE actions upon entering RRC\_INACTIVE

Upon entering RRC\_INACTIVE, the UE shall:

- 1> reset MAC and release the default MAC configuration if any;
- 1> stop all timers that are running except T302, T309, T320, T323, T325 and T330;
- 1> re-establish RLC entities for all SRBs and DRBs;
- 1> if the *RRCConnectionRelease* message is including the *waitTime*:
  - 2> start timer T302, with the timer value set according to the *waitTime*;
  - 2> inform the upper layer that access barring is applicable for all access categories except categories '0' and '2';
- 1> if T309 is running:
  - 2> stop timer T309 for all access categories;
  - 2> perform the actions as specified in 5.3.16.4.
- 1> apply the received *rrc-InactiveConfig*;
- 1> derive the DRX cycle as specified in TS 36.304 [4], clause 7.1;
- 1> if the *RRCConnectionRelease* message was received in response to an *RRCConnectionResumeRequest*:
  - 2> in the stored UE Inactive AS context:
    - 3> replace the  $K_{eNB}$  and  $K_{RRCint}$  keys with the current  $K_{eNB}$  and  $K_{RRCint}$  keys;
    - 3> replace the C-RNTI with the temporary C-RNTI which the UE has used to receive the *RRCConnectionRelease* message;
    - 3> replace the *cellIdentity* with the *cellIdentity* of the PCell at the time the UE has received the *RRCConnectionRelease* message;
    - 3> replace the previously stored physical cell identity with the physical cell identity of the PCell at the time the UE has received the *RRCConnectionRelease* message;
- 1> else:
  - 2> store in the UE Inactive AS Context, the current  $K_{eNB}$  and  $K_{RRCint}$  keys, the ROHC state, the stored QoS flow to DRB mapping rules, the C-RNTI used in the source PCell, the *cellIdentity* and the physical cell identity of the source PCell, the *spCellConfigCommon* within *ReconfigurationWithSync* of the PSCell (if configured), and all other parameters configured;
- 1> if the *periodic-RNAU-timer* is included:
  - 2> start timer T380, with the timer value set to the *periodic-RNAU-timer*;
- 1> suspend all SRB(s) and DRB(s), except SRB0;
- 1> indicate PDCP suspend to lower layers of all DRBs;
- 1> indicate the suspension of the RRC connection to upper layers;
- 1> enter RRC\_INACTIVE and perform procedures as specified in TS 36.304 [4], clause 5.2.7;

Upon selecting to an inter-RAT cell or switching to another CN type, the UE shall:

- 1> perform the actions upon leaving RRC\_INACTIVE as specified in 5.3.12, with release cause 'other';

### 5.3.8.8 T323 expiry

The UE shall:

- 1> if T323 expires:
  - 2> if stored, discard the *altFreqPriorities* provided by the *RRCConnectionRelease*;
  - 2> apply the cell reselection priority information broadcast in the system information via *cellReselectionPriority* and *cellReselectionSubPriority*;

## 5.3.9 RRC connection release requested by upper layers

### 5.3.9.1 General

The purpose of this procedure is to release the RRC connection. Access to the current PCell may be barred as a result of this procedure.

### 5.3.9.2 Initiation

The UE initiates the procedure when upper layers request the release of the RRC connection as specified in TS 24. 301 [35] for E-UTRA/EPC and TS 24.501 [95] for E-UTRA/5GC. The UE shall not initiate the procedure for power saving purposes.

The UE shall:

- 1> if the upper layers indicate barring of the PCell:
  - 2> treat the PCell used prior to entering RRC\_IDLE as barred according to TS 36.304 [4];
- 1> perform the actions upon leaving RRC\_CONNECTED as specified in 5.3.12, with release cause 'other';

## 5.3.10 Radio resource configuration

### 5.3.10.0 General

The UE shall:

- 1> if the received *radioResourceConfigDedicated* includes the *srb-ToAddModList*:
  - 2> perform the SRB addition or reconfiguration as specified in 5.3.10.1;
- 1> if the received *radioResourceConfigDedicated* includes the *drb-ToReleaseList*:
  - 2> perform DRB release as specified in 5.3.10.2;
- 1> if the received *radioResourceConfigDedicated* includes the *drb-ToAddModList*:
  - 2> perform DRB addition or reconfiguration as specified in 5.3.10.3;
- 1> if the received *radioResourceConfigDedicated* includes the *mac-MainConfig*:
  - 2> perform MAC main reconfiguration as specified in 5.3.10.4;
- 1> if the received *radioResourceConfigDedicated* includes *sps-Config*:
  - 2> perform SPS reconfiguration according to 5.3.10.5;
- 1> if the received *radioResourceConfigDedicated* includes the *physicalConfigDedicated*:

- 2> reconfigure the physical channel configuration as specified in 5.3.10.6.
- 1> if the received *radioResourceConfigDedicated* includes the *rlf-TimersAndConstants* or the *rlf-TimersAndConstantsMCG-Failure*:
  - 2> reconfigure the values of timers and constants as specified in 5.3.10.7;
- 1> if the received *radioResourceConfigDedicated* includes the *measSubframePatternPCell*:
  - 2> reconfigure the time domain measurement resource restriction for the serving cell as specified in 5.3.10.8;
- 1> if the received *radioResourceConfigDedicated* includes the *naics-Info*:
  - 2> perform NAICS neighbour cell information reconfiguration for the PCell as specified in 5.3.10.13;
- 1> if the received *RadioResourceConfigDedicatedPSCell* includes the *naics-Info*:
  - 2> perform NAICS neighbour cell information reconfiguration for the PSCell as specified in 5.3.10.13;
- 1> if the received *RadioResourceConfigDedicatedSCell-r10* includes the *naics-Info*:
  - 2> perform NAICS neighbour cell information reconfiguration for the SCell as specified in 5.3.10.13;
- 1> if the received *radioResourceConfigDedicated* includes the *srb-ToReleaseList*:
  - 2> perform SRB release as specified in 5.3.10.17;
- 1> if the received *radioResourceConfigDedicated* includes the *schedulingRequestConfig*:
  - 2> perform scheduling request reconfiguration for the SCell as specified in 5.3.10.18;
- 1> if the UE has initiated transmission using PUR in accordance with conditions in 5.3.3.1c:
  - 2> if the received *radioResourceConfigDedicated* includes *newUE-Identity*:
    - 3> apply the value of the *newUE-Identity* as the C-RNTI;
  - 2> else:
    - 3> apply the value of the *pur-RNTI* as the C-RNTI.

### 5.3.10.1 SRB addition/ modification

The UE shall:

- 1> if the UE is a NB-IoT UE and SRB1 is not established; or
- 1> for each *srb-Identity* value included in the *srb-ToAddModList* that is not part of the current UE configuration (SRB establishment):
  - 2> if the UE is not a NB-IoT UE that only supports the Control Plane CIoT EPS optimisation or the Control Plane CIoT 5GS optimisation:
    - 3> apply the specified configuration defined in 9.1.2 for the corresponding SRB;
    - 3> establish a primary (MCG) RLC entity in accordance with the received *rlc-Config*;
    - 3> establish a primary (MCG) DCCH logical channel in accordance with the received *logicalChannelConfig* and with the logical channel identity set in accordance with 9.1.2;
  - 3> if the same *srb-Identity* is included in NR *srb-ToAddModList*:
    - 4> after processing *nr-RadioBearerConfig1* and *nr-RadioBearerConfig2* if present in the *RRConnectionReconfiguration* message which triggered the execution of the SRB addition/modification procedure, associate MCG RLC bearer with the NR PDCP entity associated with the same value of *srb-Identity* in the current UE configuration as specified in TS 38.331 [82];

- 3> else:
    - 4> establish a PDCP entity and configure it with the current (MCG) security configuration, if applicable;
  - 3> if *rlc-BearerConfigSecondary* is received with value *setup*:
    - 4> establish a secondary MCG RLC entity or entities and an associated DCCH logical channel in accordance with the received *rlc-BearerConfigSecondary* and associate these with the E-UTRA PDCP entity with the same value of *srb-Identity* within the current UE configuration;
    - 4> configure the E-UTRA PDCP entity to activate duplication with *t-Reordering* set to *infinity*;
  - 2> if the UE is a NB-IoT UE:
    - 3> apply the specified configuration defined in 9.1.2 for SRB1bis;
    - 3> establish an (MCG) RLC entity in accordance with the received *rlc-Config*;
    - 3> establish a (MCG) DCCH logical channel in accordance with the received *logicalChannelConfig* and with the logical channel identity set in accordance with 9.1.2.1a;
  - 1> if the UE is a NB-IoT UE and SRB1 is established; or
  - 1> for each *srb-Identity* value included in the *srb-ToAddModList* that is part of the current UE configuration (SRB reconfiguration):
    - 2> if *pdcp-verChange* is included (i.e, NR PDCP to E-UTRA PDCP change):
      - 3> establish an (E-UTRA) PDCP entity and configure it with the current (MCG) security configuration;
- NOTE 1: The UE applies the LTE ciphering and integrity protection algorithms that are equivalent to the previously configured NR security algorithms.
- 3> associate the primary RLC bearer of this SRB with the established PDCP entity;
  - 3> release the NR PDCP entity of this SRB;
  - 2> reconfigure the primary RLC entity in accordance with the received *rlc-Config*;
  - 2> reconfigure the primary DCCH logical channel in accordance with the received *logicalChannelConfig*;
  - 2> if *rlc-BearerConfigSecondary* is included with value *release*:
    - 3> release the secondary MCG RLC entity or entities as well as the associated DCCH logical channel;
  - 2> if *rlc-BearerConfigSecondary* is received with value *setup*:
    - 3> if the current SRB configuration does not include a secondary RLC bearer:
      - 4> establish a secondary MCG RLC entity or entities and an associated DCCH logical channel in accordance with the received *rlc-BearerConfigSecondary* and associate these with the E-UTRA PDCP entity with the same value of *srb-Identity* within the current UE configuration;
      - 4> configure the E-UTRA PDCP entity to activate duplication with *t-Reordering* set to *infinity*;
    - 3> else:
      - 4> reconfigure the secondary MCG RLC entity or entities and the associated DCCH logical channel in accordance with the received *rlc-BearerConfigSecondary*;
- NOTE 2: In case of SRB reconfiguration at a DAPS HO, the reconfiguration is applied to the entities/resources for the target MCG.

### 5.3.10.1a SCG RLC bearer addition or reconfiguration for SRBs

The UE shall:

- 1> for each *srb-Identity* value included in the *srb-ToAddModListSCG* that is not part of the current UE E-UTRA SCG configuration (i.e. SCG RLC bearer establishment):
  - 2> apply the specified configuration defined in 9.1.2 for the corresponding SRB;
  - 2> establish an (SCG) RLC entity in accordance with the received *rlc-Config*;
  - 2> establish a (SCG) DCCH logical channel in accordance with the received *logicalChannelConfig* and with the logical channel identity set in accordance with 9.1.2;
  - 2> if the UE is configured with DC:
    - 3> associate the established SCG RLC bearer and DCCH logical channel with the E-UTRA PDCP entity with the same value of *srb-Identity* within the current UE configuration;
    - 3> configure the E-UTRA PDCP entity to activate duplication with *t-Reordering* set to *infinity*;
  - 2> else (i.e. the UE is configured with NE-DC):
    - 3> associate the SCG RLC bearer and DCCH logical channel with the NR PDCP entity, i.e. as configured by NR see TS 38.331 [82], identified with the same *srb-Identity* within the current UE configuration;
- 1> for each *srb-Identity* value included in the *srb-ToAddModListSCG* that is part of the current UE SCG configuration (SCG RLC bearer reconfiguration):
  - 2> re-establish the SCG RLC entity, if *reestablishRLC* is included;
  - 2> reconfigure the RLC entity in accordance with the received *rlc-Config*;
  - 2> reconfigure the DCCH logical channel in accordance with the received *logicalChannelConfig*;

### 5.3.10.2 DRB release

The UE shall:

- 1> for each *drb-Identity* value included in the *drb-ToReleaseList* or *drb-ToReleaseListSCG* that is part of the current UE configuration (DRB or RLC bearer release); or
- 1> for each *drb-identity* value that is to be released as the result of full configuration option according to 5.3.5.8:
  - 2> if release of this DRB is result of full configuration option according to 5.3.5.8:
    - 3> release the E-UTRA or NR PDCP entity;
  - 2> else if this DRB is configured with *pdcp-config*:
    - 3> release the E-UTRA PDCP entity;
  - 2> else (release the RLC bearer configuration of MCG or of SCG):
    - 3> re-establish the RLC entity as specified in 36.322 for this DRB;
  - 2> release the RLC entity or entities;
  - 2> release the DTCH logical channel;
  - 2> if the UE is connected to EPC:
    - 3> if the DRB was configured with *pdcp-config* and new DRB is not added with same *eps-BearerIdentity* in *drb-ToAddModList* nor *nr-radioBearerConfig1* nor in *nr-radioBearerConfig2*:
      - 4> if the procedure was triggered due to handover:
        - 5> indicate the release of the DRB and the *eps-BearerIdentity* of the released DRB to upper layers after successful handover;
    - 4> else:



5> indicate the release of the DRB and the *eps-BearerIdentity* of the released DRB to upper layers immediately.

2> if the UE is a NB-IoT UE connected to 5GC:

3> if the DRB was configured with *pdu-session* and new DRB is not added with same *pdu-Session* in *drb-ToAddModList*:

4> indicate the release of the DRB and the *pdu-Session* of the released DRB to upper layers immediately;

NOTE 1: The UE does not consider the message as erroneous if the *drb-ToReleaseList* includes any *drb-Identity* value that is not part of the current UE configuration.

NOTE 2: The association of *eps-BearerIdentity* to an NR PDCP configuration as defined in TS 38.331 [82] can be included in the same message that releases an DRB associated to the same *eps-BearerIdentity*.

### 5.3.10.3 DRB addition/ modification

The UE shall:

1> for each *drb-Identity* value included in the *drb-ToAddModList* that is not part of the current UE configuration (DRB establishment including the case when full configuration option is used):

2> if the concerned entry of *drb-ToAddModList* includes the *drb-TypeLWA* set to *TRUE* (i.e. add LWA DRB):

3> perform the LWA specific DRB addition or reconfiguration as specified in 5.3.10.3a2;

2> if the concerned entry of *drb-ToAddModList* includes the *drb-TypeLWIP* (i.e. add LWIP DRB):

3> perform LWIP specific DRB addition or reconfiguration as specified in 5.3.10.3a3;

2> else if *drb-ToAddModListSCG* is not received or does not include the *drb-Identity* value (i.e. add MCG DRB or MCG RLC bearer):

3> if *pdcp-Config* is received, establish a PDCP entity and configure it with the current MCG security configuration and in accordance with the received *pdcp-Config*;

3> if *rlc-Config* is received, establish a (primary) MCG RLC entity or entities in accordance with the received *rlc-Config*;

3> if *logicalChannelIdentity* and *logicalChannelConfig* are received, establish a (primary) MCG DTCH logical channel in accordance with the received *logicalChannelIdentity* and the received *logicalChannelConfig*;

3> if *rlc-BearerConfigSecondary* is received with value *setup*:

4> establish a secondary MCG RLC entity or entities and an associated DTCH logical channel in accordance with the received *rlc-BearerConfigSecondary* and associate these with the E-UTRA PDCP entity with the same value of *drb-Identity* within the current UE configuration;

3> if *pdcp-Config* is not received, after processing *nr-RadioBearerConfig1* and *nr-RadioBearerConfig2* if present in the *RRCConnectionReconfiguration* message which triggered the execution of the DRB addition/modification procedure, associate MCG RLC bearer with the NR PDCP entity associated with the same value of *drb-Identity* in the current UE configuration as specified in TS 38.331 [82];

2> if the UE is a NB-IoT UE connected to 5GC:

3> if *cipheringDisabled* is included in *pdcp-Config*:

4> instruct the PDCP entity not to apply ciphering;

3> if a DRB was configured with the same *pdu-Session* (fullConfig):

4> associate the established DRB with corresponding included *pdu-Session*;

3> else if the entry of *drb-ToAddModList* includes *pdcp-config* (establishment of bearer):

- 4> indicate the establishment of the DRB(s) and the *pdu-Session* of the established DRB(s) to upper layers;
- 2> else:
  - 3> if a DRB was configured with the same *eps-BearerIdentity* (fullConfig or change to E-UTRA PDCP):
    - 4> associate the established DRB with corresponding included *eps-BearerIdentity*;
  - 3> else if the entry of *drb-ToAddModList* includes *pdcpc-config* (establishment of bearer with E-UTRA PDCP):
    - 4> indicate the establishment of the DRB(s) and the *eps-BearerIdentity* of the established DRB(s) to upper layers;
- 1> for each *drb-Identity* value included in the *drb-ToAddModList* that is part of the current UE configuration (DRB reconfiguration):
  - 2> if the DRB indicated by *drb-Identity* is an LWA DRB (i.e. LWA to LTE only or reconfigure LWA DRB):
    - 3> perform the LWA specific DRB reconfiguration as specified in 5.3.10.3a2;
  - 2> else if the concerned entry of *drb-ToAddModList* includes the *drb-TypeLWA* set to *TRUE* (i.e. LTE only to LWA DRB):
    - 3> perform the LWA specific DRB reconfiguration as specified in 5.3.10.3a2;
  - 2> if the concerned entry of *drb-ToAddModList* includes the *drb-TypeLWIP* (i.e. add or reconfigure LWIP DRB):
    - 3> perform LWIP specific DRB addition or reconfiguration as specified in 5.3.10.3a3;
  - 2> if *drb-ToAddModListSCG* is not received or does not include the *drb-Identity* value:
    - 3> if the DRB indicated by *drb-Identity* is an MCG DRB or configured with MCG RLC bearer (reconfigure MCG RLC bearer or reconfigure MCG DRB):
      - 4> if the *pdcpc-Config* is included:
        - 5> reconfigure the PDCP entity in accordance with the received *pdcpc-Config*;
      - 4> if the *rlc-Config* is included:
        - 5> if *reestablishRLC* is received:
          - 6> re-establish the primary RLC entity of this DRB;
          - 6> if the *logicalChannelIdentity* is included and the DRB indicated by *drb-Identity* is configured with MCG RLC bearer (reconfigure logical channel identity of MCG RLC bearer):
            - 7> reconfigure the primary DTCH logical channel identity in accordance with the received *logicalChannelIdentity*;
        - 5> reconfigure the primary RLC entity or entities in accordance with the received *rlc-Config*;
      - 4> if the *logicalChannelConfig* is included:
        - 5> reconfigure the primary DTCH logical channel in accordance with the received *logicalChannelConfig*;
    - 4> if *rlc-BearerConfigSecondary* is included with value *release*:
      - 5> release the secondary MCG RLC entity or entities as well as the associated DTCH logical channel;
    - 4> if *rlc-BearerConfigSecondary* is included with value *setup*:
      - 5> if the current DRB configuration does not include a secondary RLC bearer:

6> establish a secondary MCG RLC entity or entities and an associated DTCH logical channel in accordance with the received *rlc-BearerConfigSecondary* and associate these with the E-UTRA PDCP entity with the same value of *drb-Identity* within the current UE configuration;

5> else:

6> reconfigure the secondary MCG RLC entity or entities and the associated DTCH logical channel in accordance with the received *rlc-BearerConfigSecondary*;

NOTE 1: Removal and addition of DRB with *pdcp-Config* with the same *drb-Identity* in a single *radioResourceConfigDedicated* is not supported. In case *drb-Identity* is removed and added due to handover or re-establishment with the full configuration option, the eNB can use the same value of *drb-Identity*.

NOTE 2: In case of DRB reconfiguration at a DAPS HO, the reconfiguration is applied to the entities/resources for the target MCG

### 5.3.10.3a1 DC specific DRB addition or reconfiguration

For the *drb-Identity* value for which this procedure is initiated, the UE shall:

- 1> if *drb-ToAddModListSCG* is received and includes the *drb-Identity* value; and *drb-Identity* value is not part of the current UE configuration (i.e. DC specific DRB establishment):
  - 2> if *drb-ToAddModList* is received and includes the *drb-Identity* value (i.e. add split DRB):
    - 3> establish a PDCP entity and configure it with the current MCG security configuration and in accordance with the *pdcp-Config* included in *drb-ToAddModList*;
    - 3> establish an MCG RLC entity and an MCG DTCH logical channel in accordance with the *rlc-Config*, *logicalChannelIdentity* and *logicalChannelConfig* included in *drb-ToAddModList*;
    - 3> establish an SCG RLC entity and an SCG DTCH logical channel in accordance with the *rlc-ConfigSCG*, *logicalChannelIdentitySCG* and *logicalChannelConfigSCG* included in *drb-ToAddModListSCG*;
  - 2> else (i.e. add SCG DRB):
    - 3> establish a PDCP entity and configure it with the current SCG security configuration and in accordance with the *pdcp-Config* included in *drb-ToAddModListSCG*;
    - 3> establish a primary SCG RLC entity or entities and a primary SCG DTCH logical channel in accordance with the *rlc-ConfigSCG*, *logicalChannelIdentitySCG* and *logicalChannelConfigSCG* included in *drb-ToAddModListSCG*;
    - 3> if *rlc-BearerConfigSecondary* is included with value *setup*:
      - 4> establish a secondary SCG RLC entity or entities and an associated DTCH logical channel in accordance with the received *rlc-BearerConfigSecondary* and associate these with the E-UTRA PDCP entity with the same value of *drb-Identity* within the current UE configuration;
  - 2> indicate the establishment of the DRB(s) and the *eps-BearerIdentity* of the established DRB(s) to upper layers;
- 1> else (i.e. DC specific DRB modification; *drb-ToAddModList* and/ or *drb-ToAddModListSCG* received):
  - 2> if the DRB indicated by *drb-Identity* is a split DRB:
    - 3> if *drb-ToAddModList* is received and includes the *drb-Identity* value, while for this entry *drb-TypeChange* is included and set to *toMCG* (i.e. split to MCG):
      - 4> release the SCG RLC entity or entities and the SCG DTCH logical channel(s);
      - 4> reconfigure the PDCP entity in accordance with the *pdcp-Config*, if included in *drb-ToAddModList*;
      - 4> reconfigure the primary MCG RLC entity and/ or the primary MCG DTCH logical channel in accordance with the *rlc-Config* and *logicalChannelConfig*, if included in *drb-ToAddModList*;

- 4> if *rlc-BearerConfigSecondary* is included with value *setup*;
  - 5> establish a secondary MCG RLC entity or entities and an associated DTCH logical channel in accordance with the received *rlc-BearerConfigSecondary* and associate these with the E-UTRA PDCP entity with the same value of *srb-Identity* within the current UE configuration;
- 3> else (i.e. reconfigure split):
  - 4> reconfigure the PDCP entity in accordance with the *pdcp-Config*, if included in *drb-ToAddModList*;
  - 4> reconfigure the MCG RLC entity and/ or the MCG DTCH logical channel in accordance with the *rlc-Config* and *logicalChannelConfig*, if included in *drb-ToAddModList*;
  - 4> reconfigure the SCG RLC entity and/ or the SCG DTCH logical channel in accordance with the *rlc-ConfigSCG* and *logicalChannelConfigSCG*, if included in *drb-ToAddModListSCG*;
- 2> if the DRB indicated by *drb-Identity* is an SCG DRB:
  - 3> if *drb-ToAddModList* is received and includes the *drb-Identity* value, while for this entry *drb-TypeChange* is included and set to *toMCG* (i.e. SCG to MCG):
    - 4> reconfigure the PDCP entity with the current MCG security configuration and in accordance with the *pdcp-Config*, if included in *drb-ToAddModList*;
    - 4> reconfigure the SCG RLC entity or entities (both primary and secondary, if configured) and the SCG DTCH logical channel (both primary and secondary, if configured) to be an MCG RLC entity or entities and an MCG DTCH logical channel;
    - 4> reconfigure the primary MCG RLC entity or entities and/ or the primary MCG DTCH logical channel in accordance with the *rlc-Config*, *logicalChannelIdentity* and *logicalChannelConfig*, if included in *drb-ToAddModList*;
    - 4> if *rlc-BearerConfigSecondary* is included with value *release*:
      - 5> release the secondary MCG RLC entity or entities as well as the associated DTCH logical channel;
    - 4> if *rlc-BearerConfigSecondary* is included with value *setup*;
      - 5> if the current DRB configuration does not include a secondary RLC bearer:
        - 6> establish a secondary MCG RLC entity or entities and an associated DTCH logical channel in accordance with the received *rlc-BearerConfigSecondary* and associate these with the E-UTRA PDCP entity with the same value of *srb-Identity* within the current UE configuration;
      - 5> else:
        - 6> reconfigure the secondary MCG RLC entity or entities and the associated DTCH logical channel in accordance with the received *rlc-BearerConfigSecondary*;
  - 3> else (i.e. *drb-ToAddModListSCG* is received and includes the *drb-Identity* value i.e. reconfigure SCG):
    - 4> reconfigure the PDCP entity in accordance with the *pdcp-Config*, if included in *drb-ToAddModListSCG*;
    - 4> reconfigure the primary SCG RLC entity or entities and/ or the primary SCG DTCH logical channel in accordance with the *rlc-ConfigSCG* and *logicalChannelConfigSCG*, if included in *drb-ToAddModListSCG*;
    - 4> if *rlc-BearerConfigSecondary* is included with value *release*:
      - 5> release the secondary SCG RLC entity or entities as well as the associated DTCH logical channel;
    - 4> if *rlc-BearerConfigSecondary* is included with value *setup*;
      - 5> if the current DRB configuration does not include a secondary RLC bearer:

- 6> establish a secondary SCG RLC entity or entities and an associated DTCH logical channel in accordance with the received *rlc-BearerConfigSecondary* and associate these with the E-UTRA PDCP entity with the same value of *srb-Identity* within the current UE configuration;
- 5> else:
  - 6> reconfigure the secondary SCG RLC entity or entities and the associated DTCH logical channel in accordance with the received *rlc-BearerConfigSecondary*;
- 2> if the DRB indicated by *drb-Identity* is an MCG DRB:
  - 3> if *drb-ToAddModListSCG* is received and includes the *drb-Identity* value, while for this entry *drb-Type* is included and set to *split* (i.e. MCG to split):
    - 4> reconfigure the PDCP entity in accordance with the *pdcp-Config*, if included in *drb-ToAddModList*;
    - 4> reconfigure the primary MCG RLC entity and/ or the primary MCG DTCH logical channel in accordance with the *rlc-Config* and *logicalChannelConfig*, if included in *drb-ToAddModList*;
    - 4> if *rlc-BearerConfigSecondary* is included with value *release*:
      - 5> release the secondary MCG RLC entity or entities as well as the associated DTCH logical channel;
    - 4> establish an SCG RLC entity and an SCG DTCH logical channel in accordance with the *rlc-ConfigSCG*, *logicalChannelIdentitySCG* and *logicalChannelConfigSCG*, included in *drb-ToAddModListSCG*;
  - 3> else (i.e. *drb-Type* is included and set to *scg* i.e. MCG to SCG):
    - 4> reconfigure the PDCP entity with the current SCG security configuration and in accordance with the *pdcp-Config*, if included in *drb-ToAddModListSCG*;
    - 4> reconfigure the MCG RLC entity or entities (both primary and secondary, if configured) and the MCG DTCH logical channel (both primary and secondary, if configured) to be an SCG RLC entity or entities and an SCG DTCH logical channel;
    - 4> reconfigure the primary SCG RLC entity or entities and/ or the primary SCG DTCH logical channel in accordance with the *rlc-ConfigSCG*, *logicalChannelIdentitySCG* and *logicalChannelConfigSCG*, if included in *drb-ToAddModListSCG*;
    - 4> if *rlc-BearerConfigSecondary* is included with value *release*:
      - 5> release the secondary SCG RLC entity or entities as well as the associated DTCH logical channel;
    - 4> if *rlc-BearerConfigSecondary* is included with value *setup*:
      - 5> if the current DRB configuration does not include a secondary RLC bearer:
        - 6> establish a secondary SCG RLC entity or entities and an associated DTCH logical channel in accordance with the received *rlc-BearerConfigSecondary* and associate these with the E-UTRA PDCP entity with the same value of *srb-Identity* within the current UE configuration;
    - 5> else:
      - 6> reconfigure the secondary SCG RLC entity or entities and the associated DTCH logical channel in accordance with the received *rlc-BearerConfigSecondary*;

### 5.3.10.3a2 LWA specific DRB addition or reconfiguration

For the *drb-Identity* value for which this procedure is initiated, the UE shall:

- 1> if the *drb-Identity* value is not part of the current UE configuration (i.e. add LWA DRB):
  - 2> establish a PDCP entity and configure it with the current security configuration and in accordance with the *pdcp-Config* included in *drb-ToAddModList*;

- 2> establish an RLC entity and an DTCH logical channel in accordance with the *rlc-Config*, *logicalChannelIdentity* and *logicalChannelConfig* included in *drb-ToAddModList*;
- 2> enable data handling for this DRB at the LWAAP entity;
- 2> if *lwa-WLAN-AC* is configured:
  - 3> apply the received *lwa-WLAN-AC* when performing transmissions of packets for this DRB over WLAN;
- 2> indicate the establishment of the DRB and the *eps-BearerIdentity* of the established DRB to upper layers;
- 1> else if the DRB indicated by *drb-Identity* is not an LWA DRB (i.e. LTE only to LWA DRB):
  - 2> reconfigure the PDCP entity in accordance with the *pdcp-Config*, if included in *drb-ToAddModList*;
  - 2> reconfigure the RLC entity and/ or the DTCH logical channel in accordance with the *rlc-Config* and *logicalChannelConfig*, if included in *drb-ToAddModList*;
  - 2> enable data handling for this DRB at the LWAAP entity;
  - 2> if *lwa-WLAN-AC* is configured:
    - 3> apply the received *lwa-WLAN-AC* when performing transmissions of packets for this DRB over WLAN;
- 1> else if the concerned entry of *drb-ToAddModList* includes the *drb-TypeLWA* set to *FALSE* (i.e. LWA to LTE only DRB):
  - 2> reconfigure the PDCP entity in accordance with the *pdcp-Config*, if included in *drb-ToAddModList*;
  - 2> reconfigure the RLC entity and/ or the DTCH logical channel in accordance with the *rlc-Config* and *logicalChannelConfig*, if included in *drb-ToAddModList*;
  - 2> perform PDCP data recovery as specified in TS 36.323 [8] if bearer is configured with RLC AM;
  - 2> disable data handling for this DRB at the LWAAP entity;
- 1> else (i.e. reconfigure LWA DRB):
  - 2> reconfigure the PDCP entity in accordance with the *pdcp-Config*, if included in *drb-ToAddModList*;
  - 2> reconfigure the RLC entity and/ or the DTCH logical channel in accordance with the *rlc-Config* and *logicalChannelConfig*, if included in *drb-ToAddModList*;
  - 2> if *lwa-WLAN-AC* is configured:
    - 3> apply the received *lwa-WLAN-AC* when performing transmissions of packets for this DRB over WLAN;

### 5.3.10.3a3 LWIP specific DRB addition or reconfiguration

For the *drb-Identity* value for which this procedure is initiated, the UE shall:

- 1> if the *drb-TypeLWIP* is set to *lwip*:
  - 2> indicate to higher layers to use LWIP resources in both UL and DL for the DRB associated with the *drb-Identity*;
  - 2> if *lwip-DL-Aggregation* is set to TRUE:
    - 3> indicate to higher layers to apply decoding of LWIPEP header with GRE sequence number for both LTE and WLAN DL reception for the DRB associated with the *drb-Identity*;
  - 2> if *lwip-DL-Aggregation* is set to FALSE:
    - 3> indicate to higher layers to stop decoding of LWIPEP header with GRE sequence number for both LTE and WLAN DL reception for the DRB associated with the *drb-Identity*;
  - 2> if *lwip-UL-Aggregation* is set to TRUE:

- 3> indicate to higher layers to insert LWIPEP header with GRE sequence number for both LTE and WLAN UL transmissions for the DRB associated with the *drb-Identity*;
- 2> if *lwip-UL-Aggregation* is set to FALSE:
  - 3> indicate to higher layers to stop inserting LWIPEP header with GRE sequence number for both LTE and WLAN UL transmissions for the DRB associated with the *drb-Identity*;
- 1> if the *drb-TypeLWIP* is set to *lwip-DL-only*:
  - 2> indicate to higher layers to use LWIP resources in the DL only for the DRB associated with the *drb-Identity*;
  - 2> if *lwip-DL-Aggregation* is set to TRUE:
    - 3> indicate to higher layers to apply decoding of LWIPEP header with GRE sequence number for both LTE and WLAN DL reception for the DRB associated with the *drb-Identity*;
- 1> if the *drb-TypeLWIP* is set to *lwip-UL-only*:
  - 2> indicate to higher layers to use LWIP resources in the UL only for the DRB associated with the *drb-Identity*;
  - 2> if *lwip-UL-Aggregation* is set to TRUE:
    - 3> indicate to higher layers to insert LWIPEP header with GRE sequence number for both LTE and WLAN UL transmissions for the DRB associated with the *drb-Identity*;
- 1> if the *drb-TypeLWIP* is set to *eutran*:
  - 2> indicate to higher layers to stop using LWIP resources for the DRB associated with the *drb-Identity*;

#### 5.3.10.3a4 SCG RLC bearer addition or reconfiguration for DRBs in NE-DC

The UE shall:

- 1> for each *drb-Identity* value included in *drb-ToAddModListSCG*:
  - 2> if *drb-Identity* value is not part of the current UE E-UTRA SCG configuration (SCG RLC bearer establishment):
    - 3> establish an SCG RLC entity or entities and an SCG DTCH logical channel in accordance with the *rlc-ConfigSCG*, *logicalChannelIdentitySCG* and *logicalChannelConfigSCG* included in *drb-ToAddModListSCG*;
    - 3> associate the SCG RLC bearer and DTCH logical channel with the NR PDCP entity, i.e. as configured by NR see TS 38.331 [82], identified with the same *drb-Identity* within the current UE configuration;
  - 2> else:
    - 3> re-establish the SCG RLC entity of this DRB, if *reestablishRLC* is included in *rlc-Config*;
    - 3> reconfigure the SCG RLC entity or entities and/ or the SCG DTCH logical channel in accordance with the *rlc-ConfigSCG* and *logicalChannelConfigSCG*, if included in *drb-ToAddModListSCG*;

#### 5.3.10.3a SCell release

The UE shall:

- 1> if the release is triggered by reception of the *sCellToReleaseList* or the *sCellToReleaseListSCG*:
  - 2> for each *sCellIndex* value included either in the *sCellToReleaseList* or in the *sCellToReleaseListSCG*:
    - 3> if the current UE configuration includes an SCell with value *sCellIndex*:
      - 4> release the SCell;
- 1> if the release is triggered by RRC connection re-establishment; or

- 1> if the release is triggered when the UE is resuming an RRC connection from a suspended RRC connection or from RRC\_INACTIVE as specified in clause 5.3.3.2:
- 2> release all SCells that are part of the current UE configuration;

### 5.3.10.3b SCell addition/ modification

The UE shall:

- 1> for each *sCellIndex* value included either in the *sCellToAddModList* or in the *sCellToAddModListSCG* that is not part of the current UE configuration (SCell addition):
  - 2> add the SCell, corresponding to the *cellIdentification*, in accordance with the *radioResourceConfigCommonSCell* and *radioResourceConfigDedicatedSCell*, both included either in the *sCellToAddModList* or in the *sCellToAddModListSCG*;
  - 2> if *sCellState* is configured for the SCell and indicates *activated*:
    - 3> configure lower layers to consider the SCell to be in activated state;
  - 2> else if *sCellState* is configured for the SCell and indicates *dormant*:
    - 3> configure lower layers to consider the SCell to be in dormant state;
  - 2> else:
    - 3> configure lower layers to consider the SCell to be in deactivated state;
  - 2> for each *measId* included in the *measIdList* within *VarMeasConfig*:
    - 3> if SCells are not applicable for the associated measurement; and
    - 3> if the concerned SCell is included in *cellsTriggeredList* defined within the *VarMeasReportList* for this *measId*:
      - 4> remove the concerned SCell from *cellsTriggeredList* defined within the *VarMeasReportList* for this *measId*;
- 1> for each *sCellIndex* value included either in the *sCellToAddModList* or in the *sCellToAddModListSCG* that is part of the current UE configuration (SCell modification):
  - 2> modify the SCell configuration in accordance with the *radioResourceConfigDedicatedSCell*, included either in the *sCellToAddModList* or in the *sCellToAddModListSCG*;
  - 2> if the *sCellToAddModList* was received within an *RRCConnectionResume* or *sCellToAddModListSCG* was received within *RRCConnectionReconfiguration* with *mobilityControlInfoSCG* embedded in an NR *RRCResume* or embedded in an NR *RRCReconfiguration* message:
    - 3> if the *sCellState* is configured for the SCell and indicates *activated*:
      - 4> configure lower layers to consider the SCell to be in activated state;
    - 3> else if *sCellState* is configured for the SCell and indicates *dormant*:
      - 4> configure lower layers to consider the SCell to be in dormant state;
    - 3> else:
      - 4> configure lower layers to consider the SCell to be in deactivated state;

### 5.3.10.3c PSCell addition or modification

The UE shall:

- 1> if the PSCell is not part of the current UE configuration (i.e. PSCell addition):



- 2> add the PSCell, corresponding to the *cellIdentification*, in accordance with the received *radioResourceConfigCommonPSCell* and *radioResourceConfigDedicatedPSCell*;
- 2> configure lower layers to consider the PSCell to be in activated state;
- 1> if the PSCell is part of the current UE configuration (i.e. PSCell modification):
  - 2> modify the PSCell configuration in accordance with the received *radioResourceConfigDedicatedPSCell*;

### 5.3.10.3d SCell group release

The UE shall:

- 1> if the release is triggered by reception of the *sCellGroupToReleaseList*:
  - 2> for each *sCellGroupIndex* value included in the *sCellGroupToReleaseList*:
    - 3> if the current UE configuration includes an SCell with value *sCellGroupIndex*:
      - 4> consider the SCell not to be part of the SCell group indicated by *sCellGroupIndex*;
      - 4> consider the *sCellConfigCommon* of the SCell group to be not applicable for the SCell;
    - 3> release the SCell group;
  - 1> if the release is triggered by RRC connection re-establishment:
    - 2> release all SCell groups that are part of the current UE configuration;

### 5.3.10.3e SCell group addition/ modification

The UE shall:

- 1> for each *sCellGroupIndex* value included in the *sCellGroupToAddModList* that is part of the current UE configuration (SCell group modification):
  - 2> for each *sCellIndex* value included in the *sCellToReleaseList* that is part of the SCell group indicated by *sCellGroupIndex* (SCell deletion from SCell group):
    - 3> consider the *sCellConfigCommon* of the SCell group to be not applicable for the SCell;
    - 3> consider the SCell not to be part of the SCell group indicated by *sCellGroupIndex*
  - 2> for each *sCellIndex* value included in the *sCellToAddModList* that is not part of the SCell group indicated by *sCellGroupIndex* (SCell addition to SCell group):
    - 3> consider the SCell to be part of the SCell group indicated by *sCellGroupIndex*;
    - 3> apply the SCell configuration for parameters not already configured as part of the current SCell configuration in accordance with the *sCellConfigCommon* for the SCell group;
  - 2> if *sCellConfigCommon* is included (modify the SCell group configuration):
    - 3> for each SCell that is part of the current SCell group indicated by *sCellGroupIndex*:
      - 4> apply the SCell configuration for parameters not already configured as part of the current SCell configuration in accordance with the *sCellConfigCommon* for the SCell group;
- 1> for each *sCellGroupIndex* value included in the *sCellGroupToAddModList* that is not part of the current UE configuration (SCell group addition):
  - 2> for each *sCellIndex* value included in the *sCellToAddModList* (SCell addition to the group):
    - 3> consider the SCell to be part of the SCell group indicated by *sCellGroupIndex*

- 3> apply the SCell configuration for parameters not already configured as part of the current SCell configuration in accordance with the *sCellConfigCommon* for the SCell group;

#### 5.3.10.4 MAC main reconfiguration

Except for NB-IoT, the UE shall:

- 1> if the procedure is triggered to perform SCG MAC main reconfiguration:
  - 2> if SCG MAC is not part of the current UE configuration (i.e. SCG establishment):
    - 3> create an SCG MAC entity;
    - 2> reconfigure the SCG MAC main configuration as specified in the following i.e. assuming it concerns the SCG MAC whenever MAC main configuration is referenced and that it is based on the received *mac-MainConfigSCG* instead of *mac-MainConfig*:
  - 1> reconfigure the MAC main configuration in accordance with the received *mac-MainConfig* other than *stag-ToReleaseList* and *stag-ToAddModList*;
- 1> if the received *mac-MainConfig* includes the *stag-ToReleaseList*:
  - 2> for each *STAG-Id* value included in the *stag-ToReleaseList* that is part of the current UE configuration:
    - 3> release the STAG indicated by *STAG-Id*;
- 1> if the received *mac-MainConfig* includes the *stag-ToAddModList*:
  - 2> for each *stag-Id* value included in *stag-ToAddModList* that is not part of the current UE configuration (STAG addition):
    - 3> add the STAG, corresponding to the *stag-Id*, in accordance with the received *timeAlignmentTimerSTAG*;
  - 2> for each *stag-Id* value included in *stag-ToAddModList* that is part of the current UE configuration (STAG modification):
    - 3> reconfigure the STAG, corresponding to the *stag-Id*, in accordance with the received *timeAlignmentTimerSTAG*;

NOTE: In case of MAC main reconfiguration at a DAPS HO, the reconfiguration is applied to the MAC entity for the target MCG.

For NB-IoT, the UE shall:

- 1> reconfigure the MAC main configuration in accordance with the received *mac-MainConfig*;

#### 5.3.10.5 Semi-persistent scheduling reconfiguration

The UE shall:

- 1> reconfigure the semi-persistent scheduling in accordance with the received *sps-Config*;

#### 5.3.10.6 Physical channel reconfiguration

Except for NB-IoT, the UE shall:

- 1> if the *antennaInfo-r10* is included in the received *physicalConfigDedicated* and the previous version of this field that was received by the UE was *antennaInfo* (without suffix i.e. the version defined in REL-8):
  - 2> apply the default antenna configuration as specified in 9.2.4;
- 1> if the *cqi-ReportConfig-r10* is included in the received *physicalConfigDedicated* and the previous version of this field that was received by the UE was *cqi-ReportConfig* (without suffix i.e. the version defined in REL-8):
  - 2> apply the default CQI reporting configuration as specified in 9.2.4;

NOTE 1: Application of the default configuration involves release of all extensions introduced in REL-9 and later.

- 1> reconfigure the physical channel configuration in accordance with the received *physicalConfigDedicated*;
- 1> if the *antennaInfo* is included and set to *explicitValue*:
  - 2> if the configured *transmissionMode* is *tm1*, *tm2*, *tm5*, *tm6* or *tm7*; or
  - 2> if the configured *transmissionMode* is *tm8* and *pmi-RI-Report* is not present; or
  - 2> if the configured *transmissionMode* is *tm9* and *pmi-RI-Report* is not present; or
  - 2> if the configured *transmissionMode* is *tm9* and *pmi-RI-Report* is present and *antennaPortsCount* within *csi-RS* is set to *an1*:
    - 3> release *ri-ConfigIndex* in *cqi-ReportPeriodic*, if previously configured;
- 1> else if the *antennaInfo* is included and set to *defaultValue*:
  - 2> release *ri-ConfigIndex* in *cqi-ReportPeriodic*, if previously configured;
- 1> if the *pusch-EnhancementsConfig* is included in the received *physicalConfigDedicated*, for the associated serving cell:
  - 2> if PUSCH enhancement mode is previously released or not configured and *pusch-EnhancementsConfig* is set to *setup*, or
  - 2> if PUSCH enhancement mode is previously configured and *pusch-EnhancementConfig* is set to *release*:
    - 3> instruct the associated MAC entity to perform partial reset;
- 1> if the procedure was not triggered due to handover and *ce-Mode* is included in the received *physicalConfigDedicated*, for the associated serving cell:
  - 2> if *ce-Mode* is not currently configured and *ce-Mode* is set to *setup*, or
  - 2> if *ce-Mode* is currently configured and *ce-Mode* is set to *release*:
    - 3> instruct the associated MAC entity to perform partial reset;

For NB-IoT, the UE shall:

- 1> if the *carrierConfigDedicated* is not included in the received *physicalConfigDedicated*:
  - 2> if the UE is configured with a carrier configuration previously received in *carrierConfigDedicated*:
    - 3> use the carrier configuration received in *carrierConfigDedicated*;
  - 2> else:
    - 3> use the carrier configuration received in system information for the uplink and downlink carrier used during the random access procedure;
- 1> else:
  - 2> if *schedulingRequestConfig* is not received or does not include the *sr-SPS-BSR-Config*:
    - 3> instruct lower layers to clear existing configured uplink grants for BSR (if any);
  - 2> use the carrier configuration received in *carrierConfigDedicated*;
  - 2> start to use the new carrier immediately after the last transport block carrying the RRC message has been acknowledged by the MAC layer, and any subsequent RRC response message sent for the current RRC procedure is therefore sent on the new carrier;
- 1> reconfigure the physical channel configuration in accordance with the received *physicalConfigDedicated*.

NOTE 2: In case of physical channel reconfiguration at a DAPS HO, the reconfiguration is applied for the target PCell.

### 5.3.10.7 Radio Link Failure Timers and Constants reconfiguration

The UE shall:

- 1> if the received *rlf-TimersAndConstants* is set to *release*:
  - 2> use values for timers T301, T310, T311 and constants N310, N311, as included in *ue-TimersAndConstants* received in *SystemInformationBlockType2* (or *SystemInformationBlockType2-NB* in NB-IoT);

1> else:

- 2> reconfigure the value of timers and constants in accordance with received *rlf-TimersAndConstants*;

NOTE: In case of a DAPS HO, the timer and constant values are to be applied in the target MCG after timer T304 has been stopped.

1> if the received *rlf-TimersAndConstantsSCG* is set to *release*:

- 2> stop timer T313, if running, and
- 2> release the value of timer *t313* as well as constants *n313* and *n314*;

1> else:

- 2> reconfigure the value of timers and constants in accordance with received *rlf-TimersAndConstantsSCG*;

1> if the received *rlf-TimersAndConstantsMCG-Failure* is set to *release*:

- 2> stop timer T316, if running, and
- 2> release the value of timer *t316*;

1> else:

- 2> reconfigure the value of the timer in accordance with received *rlf-TimersAndConstantsMCG-Failure*;

### 5.3.10.8 Time domain measurement resource restriction for serving cell

The UE shall:

- 1> if the received *measSubframePatternPCell* is set to *release*:
  - 2> release the time domain measurement resource restriction for the PCell, if previously configured;

1> else:

- 2> apply the time domain measurement resource restriction for the PCell in accordance with the received *measSubframePatternPCell*;

### 5.3.10.9 Other configuration

The UE shall:

- 1> if the received *otherConfig* includes the *reportProximityConfig*:
  - 2> if *proximityIndicationEUTRA* is set to *enabled*:
    - 3> consider itself to be configured to provide proximity indications for E-UTRA frequencies in accordance with 5.3.14;
  - 2> else:
    - 3> consider itself not to be configured to provide proximity indications for E-UTRA frequencies;

2> if *proximityIndicationUTRA* is set to *enabled*:

3> consider itself to be configured to provide proximity indications for UTRA frequencies in accordance with 5.3.14;

2> else:

3> consider itself not to be configured to provide proximity indications for UTRA frequencies;

1> if the received *otherConfig* includes the *obtainLocation*:

2> attempt to have detailed location information available for any subsequent measurement report;

NOTE 1: The UE is requested to attempt to have valid detailed location information available whenever sending a measurement report for which it is configured to include available detailed location information. The UE may not succeed e.g. because the user manually disabled the GPS hardware, due to no/poor satellite coverage. Further details, e.g. regarding when to activate GNSS, are up to UE implementation.

NOTE 1a: Any subsequent measurement report includes RLF report and SCGFailureInformationNR.

1> if the received *otherConfig* includes the *bt-NameListConfig*:

2> if *bt-NameListConfig* is set to *setup*, attempt to have Bluetooth measurement results available for subsequent measurement report;

1> if the received *otherConfig* includes the *wlan-NameListConfig*:

2> if *wlan-NameListConfig* is set to *setup*, attempt to have WLAN measurement results available for subsequent measurement report;

1> if the received *otherConfig* includes the *measUncomBarPre*:

2> if *measUncomBarPre* is set to *true*, attempt to have barometer measurement results available for subsequent measurement report;

NOTE 2: The UE is requested to attempt to have valid Bluetooth measurements, WLAN measurements and Uncompensated Barometric Pressure Sensor measurements whenever sending a measurement report for which it is configured to include these measurements. The UE may not succeed e.g. because the user manually disabled the WLAN, Bluetooth or Sensor hardware. Further details, e.g. regarding when to activate WLAN, Bluetooth or Sensor, are up to UE implementation.

1> if the received *otherConfig* includes the *idc-Config*:

2> if *idc-Indication* is included (i.e. set to *setup*):

3> consider itself to be configured to provide IDC indications in accordance with 5.6.9;

3> if *idc-Indication-UL-CA* is included (i.e. set to *setup*):

4> consider itself to be configured to indicate UL CA related information in IDC indications in accordance with 5.6.9;

3> if *idc-HardwareSharingIndication* is included (i.e. set to *setup*):

4> consider itself to be configured to indicate IDC hardware sharing problem indications in IDC indications in accordance with 5.6.9;

3> if *idc-Indication-MRDC* is included (i.e. set to *setup*):

4> consider itself to be configured to provide IDC indications for MR-DC in accordance with 5.6.9;

2> else:

3> consider itself not to be configured to provide IDC indications;

2> if *autonomousDenialParameters* is included:

- 3> consider itself to be allowed to deny any transmission in a particular UL subframe if during the number of subframes indicated by *autonomousDenialValidity*, preceding and including this particular subframe, it autonomously denied fewer UL subframes than indicated by *autonomousDenialSubframes*;
- 2> else:
  - 3> consider itself not to be allowed to deny any UL transmission;
- 1> if the received *otherConfig* includes the *powerPrefIndicationConfig*:
  - 2> if *powerPrefIndicationConfig* is set to *setup*:
    - 3> consider itself to be configured to provide power preference indications in accordance with 5.6.10;
  - 2> else:
    - 3> consider itself not to be configured to provide power preference indications;
- 1> if the received *otherConfig* includes the *sps-AssistanceInfoReport*:
  - 2> if *sps-AssistanceInfoReport* is set to TRUE:
    - 3> consider itself to be configured to provide SPS assistance information in accordance with 5.6.10;
  - 2> else:
    - 3> consider itself not to be configured to provide SPS assistance information;
- 1> if the received *otherConfig* includes the *bw-PreferenceIndicationTimer*:
  - 2> consider itself to be configured to provide maximum PDSCH/PUSCH bandwidth preference indication in accordance with 5.6.10;
- 1> else:
  - 2> consider itself not to be configured to provide maximum PDSCH/PUSCH bandwidth indication preference;
- 1> if the received *otherConfig* includes the *delayBudgetReportingConfig*:
  - 2> if *delayBudgetReportingConfig* is set to *setup*:
    - 3> consider itself to be configured to send delay budget reports in accordance with 5.6.10;
  - 2> else:
    - 3> consider itself not to be configured to send delay budget reports and stop timer T342, if running;
- 1> if the received *otherConfig* includes the *overheatingAssistanceConfig*:
  - 2> if *overheatingAssistanceConfig* is set to *setup*:
    - 3> consider itself to be configured to provide overheating assistance information in accordance with 5.6.10;
    - 3> if *overheatingAssistanceConfigForSCG* is included:
      - 4> if *overheatingAssistanceConfigForSCG* is set to true:
        - 5> consider itself to be configured to provide overheating assistance information for NR SCG in accordance with 5.6.10;
      - 4> else if *overheatingAssistanceConfigForSCG* is set to false:
        - 5> consider itself not to be configured to provide overheating assistance information for NR SCG and stop timer T345, if running;
  - 2> else:

- 3> consider itself not to be configured to provide overheating assistance information and stop timer T345, if running;
- 1> for BL UEs or UEs in CE, if the received *otherConfig* includes the *rlm-ReportConfig*:
  - 2> if *rlm-ReportConfig* is set to *setup*:
    - 3> consider itself to be configured to detect "early-out-of-sync" and "early-in-sync" RLM events as specified in 5.3.11;
    - 3> if *rlmReportRep-MPDCCH* is set to *setup*:
      - 4> consider itself to be configured to report *rlmReportRep-MPDCCH* in accordance with 5.6.10;
  - 2> else:
    - 3> consider itself not to be configured to detect "early-out-of-sync" and "early-in-sync" RLM events and stop timer T343, timer T344, timer T314 and timer T315 if running;
- 1> if the received *otherConfig* includes the *measConfigAppLayer*:
  - 2> if *measConfigAppLayer* is set to *setup*:
    - 3> forward *measConfigAppLayerContainer* to upper layers considering the *serviceType*;
    - 3> consider itself to be configured to send application layer measurement report in accordance with 5.6.19;
  - 2> else:
    - 3> inform upper layers to clear the stored application layer measurement configuration;
    - 3> discard received application layer measurement report information from upper layers;
    - 3> consider itself not to be configured to send application layer measurement report.
- 1> if the received *otherConfig* includes the *ailc-BitConfig*:
  - 2> if *ailc-BitConfig* is set to TRUE:
    - 3> consider itself to be configured to provide assistance information bit for local cache as specified in TS 36.323 [8], clause 6.2.3;
  - 2> else:
    - 3> consider itself not to be configured to provide assistance information bit for local cache;

### 5.3.10.10 SCG reconfiguration

The UE shall:

- 1> if *makeBeforeBreakSCG* is configured:
  - 2> stop timer T313, if running;
  - 2> start timer T307 with the timer value set to *t307*, as included in the *mobilityControlInfoSCG*;
  - 2> start synchronising to the DL of the target PSCell, if needed;
  - 2> perform the remainder of this procedure including and following resetting MAC after the UE has stopped the uplink transmission/downlink reception with the source PSCell;

NOTE 0a: It is up to UE implementation when to stop the uplink transmission/ downlink reception with the source PSCell to initiate re-tuning for the connection to the target cell, as specified in TS 36.133 [16], if *makeBeforeBreakSCG* is configured.

NOTE 0b: It is up to UE implementation when to stop the uplink transmission/ downlink reception with the source SCG SCell(s) after receiving *mobilityControlInfoSCG*.

- 1> if *scg-Configuration* is received and is set to *release* or includes the *mobilityControlInfoSCG* (i.e. SCG release/change):
  - 2> if *mobilityControlInfo* is not received (i.e. SCG release/change without HO):
    - 3> reset SCG MAC, if configured;
    - 3> if the UE is not configured with NE-DC:
      - 4> for each *drb-Identity* value that is part of the current UE configuration:
        - 5> if the DRB indicated by *drb-Identity* is an SCG DRB:
          - 6> re-establish the PDCP entity and the SCG RLC entity or entities;
        - 5> if the DRB indicated by *drb-Identity* is a split DRB:
          - 6> perform PDCP data recovery and re-establish the SCG RLC entity;
        - 5> if the DRB indicated by *drb-Identity* is an MCG DRB; and
        - 5> *drb-ToAddModListSCG* is received and includes the *drb-Identity* value, while for this entry *drb-Type* is included and set to *scg* (i.e. MCG to SCG):
          - 6> re-establish the PDCP entity and the MCG RLC entity or entities;
    - 3> configure lower layers to consider the SCG SCell(s), except for the PSCell, to be in deactivated state;
  - 1> if *scg-Configuration* is received and is set to *release*:
    - 2> release the entire SCG configuration, except for the DRB configuration (i.e. as configured by *drb-ToAddModListSCG*);
    - 2> if the current UE configuration includes one or more split or SCG DRBs and the received *RRConnectionReconfiguration* message includes *radioResourceConfigDedicated* including *drb-ToAddModList*:
      - 3> reconfigure the SCG or split DRB by *drb-ToAddModList* as specified in 5.3.10.12;
    - 2> stop timer T313, if running;
    - 2> stop timer T307, if running;
  - 1> else:
    - 2> if *scg-ConfigPartMCG* is received and includes the *scg-Counter*:
      - 3> update the  $S\text{-}K_{eNB}$  key based on the  $K_{eNB}$  key and using the received *scg-Counter* value, as specified in TS 33.401 [32];
      - 3> derive the  $K_{UPenc}$  key associated with the *cipheringAlgorithmSCG* included in *mobilityControlInfoSCG* within the received *scg-ConfigPartSCG*, as specified in TS 33.401 [32];
      - 3> configure lower layers to apply the ciphering algorithm and the  $K_{UPenc}$  key;
    - 2> if *scg-ConfigPartSCG* is received and includes the *radioResourceConfigDedicatedSCG*:
      - 3> reconfigure the dedicated radio resource configuration for the SCG as specified in 5.3.10.11;
    - 2> if the current UE configuration includes one or more split or SCG DRBs and the received *RRConnectionReconfiguration* message includes *radioResourceConfigDedicated* including *drb-ToAddModList*:
      - 3> reconfigure the SCG or split DRB by *drb-ToAddModList* as specified in 5.3.10.12;
    - 2> if *scg-ConfigPartSCG* is received and includes *measConfigSN*:



3> for *measConfigSN* perform the actions as specified in 5.5.2 for *measConfig* unless explicitly stated otherwise;

2> if *scg-ConfigPartSCG* is received and includes the *sCellToReleaseListSCG*:

3> perform SCell release for the SCG as specified in 5.3.10.3a;

2> if *scg-ConfigPartSCG* is received and includes the *pSCellToAddMod*:

3> perform PSCell addition or modification as specified in 5.3.10.3c;

NOTE 0: This procedure is also used to release the PSCell e.g. PSCell change, SI change for the PSCell.

2> if *scg-ConfigPartSCG* is received and includes the *sCellToAddModListSCG*:

3> perform SCell addition or modification as specified in 5.3.10.3b;

2> configure lower layers in accordance with *mobilityControlInfoSCG*, if received;

2> if *rach-SkipSCG* is configured:

3> configure lower layers to apply the *rach-SkipSCG* for the target SCG, as specified in TS 36.213 [23] and TS 36.321 [6];

2> if *scg-ConfigPartSCG* is received and includes the *mobilityControlInfoSCG* (i.e. SCG change):

3> resume all SCG DRBs and resume SCG transmission for split DRBs, if suspended;

3> stop timer T313, if running;

3> start timer T307 with the timer value set to *t307*, as included in the *mobilityControlInfoSCG*, if *makeBeforeBreakSCG* is not configured;

3> start synchronising to the DL of the target PSCell;

3> initiate the random access procedure on the PSCell, as specified in TS 36.321 [6], if *rach-SkipSCG* is not configured:

NOTE 1: The UE is not required to determine the SFN of the target PSCell by acquiring system information from that cell before performing RACH access in the target PSCell.

3> the procedure ends, except that the following actions are performed when MAC successfully completes the random access procedure on the PSCell or when MAC indicates the successful reception of a PDCCCH transmission addressed to C-RNTI and if *rach-skipSCG* is configured:

4> stop timer T307;

4> release *rach-SkipSCG*;

4> apply the parts of the CQI reporting configuration, the scheduling request configuration and the sounding RS configuration that do not require the UE to know the SFN of the target PSCell, if any;

4> apply the parts of the measurement and the radio resource configuration that require the UE to know the SFN of the target PSCell (e.g. periodic CQI reporting, scheduling request configuration, sounding RS configuration), if any, upon acquiring the SFN of the target PSCell;

NOTE 2: Whenever the UE shall setup or reconfigure a configuration in accordance with a field that is received it applies the new configuration, except for the cases addressed by the above statements.

### 5.3.10.11 SCG dedicated resource configuration

The UE shall:

1> if the received *radioResourceConfigDedicatedSCG* includes the *srb-ToReleaseListSCG*:

2> for each *srb-Identity* value included in the *srb-ToReleaseListSCG* perform the SCG RLC bearer release as specified in 5.3.10.17;

- 1> if the received *radioResourceConfigDedicatedSCG* includes the *srb-ToAddModListSCG*:
  - 2> for each *srb-Identity* value included in the *srb-ToAddModListSCG* perform the SCG RLC bearer addition or reconfiguration as specified in 5.3.10.1a;
- 1> if the received *radioResourceConfigDedicatedSCG* includes *drb-ToReleaseListSCG*:
  - 2> perform the DRB release as specified in 5.3.10.2;
- 1> if the received *radioResourceConfigDedicatedSCG* includes the *drb-ToAddModListSCG*:
  - 2> if the UE is configured with NE-DC:
    - 3> for each *drb-Identity* value included in the *drb-ToAddModListSCG* perform the SCG RLC bearer addition or reconfiguration for DRBs in NE-DC as specified in 5.3.10.3a4;
  - 2> else:
    - 3> for each *drb-Identity* value included in the *drb-ToAddModListSCG* perform the DC specific DRB addition or reconfiguration as specified in 5.3.10.3a1;
- 1> if the received *radioResourceConfigDedicatedSCG* includes the *mac-MainConfigSCG*:
  - 2> perform the SCG MAC main reconfiguration as specified in 5.3.10.4;
- 1> if the received *radioResourceConfigDedicatedSCG* includes the *rlf-TimersAndConstantsSCG*:
  - 2> reconfigure the values of timers and constants as specified in 5.3.10.7;

### 5.3.10.12 Reconfiguration SCG or split DRB by *drb-ToAddModList*

The UE shall:

- 1> for each split or SCG DRBs that is part of the current configuration:
  - 2> if the corresponding *drb-Identity* value is included in the received *drb-ToAddModList*; and
  - 2> if the corresponding *drb-Identity* value is not included in the received *drb-ToAddModListSCG* (i.e. reconfigure split, split to MCG or SCG to MCG):
  - 3> perform the DC specific DRB addition or reconfiguration as specified in 5.3.10.3a1;

### 5.3.10.13 Neighbour cell information reconfiguration

The UE shall:

- 1> if the received *naics-Info* is set to *release*:
  - 2> instruct lower layer to release all the NAICS neighbour cell information for the concerned cell, if previously configured;
- 1> if the received *naics-Info* includes the *neighCellsToReleaseList-r12*:
  - 2> for each *physCellId-r12* value included in the *neighCellsToReleaseList-r12* that is part of the current NAICS neighbour cell information of the concerned cell:
    - 3> instruct lower layer to release the NAICS neighbour cell information for the concerned cell;
- 1> if the received *naics-Info* includes the *NeighCellsToAddModList-r12*:
  - 2> for each *physCellId-r12* value included in the *neighCellsToAddModList-r12* that is not part of the current NAICS neighbour cell information of the concerned cell:
    - 3> instruct lower layer to add the NAICS neighbour cell information for the concerned cell;

- 2> for each *physCellId-r12* value included in the *neighCellsToAddModList-r12* that is part of the current NAICS neighbour cell information of the concerned cell:
- 3> instruct lower layer to modify the NAICS neighbour cell information in accordance with the received *NeighCellsInfo* for the concerned cell;

#### 5.3.10.14 Void

#### 5.3.10.15 Sidelink dedicated configuration

The UE shall:

- 1> if the *RRCCONNECTIONRECONFIGURATION* message includes the *sl-CommConfig*:
  - 2> if *commTxResources* is included and set to *setup*:
    - 3> from the next SC period use the resources indicated by *commTxResources* for sidelink communication transmission, as specified in 5.10.4;
  - 2> else if *commTxResources* is included and set to *release*:
    - 3> from the next SC period, release the resources allocated for sidelink communication transmission previously configured by *commTxResources*;
- 1> if the *RRCCONNECTIONRECONFIGURATION* message includes the *sl-DiscConfig*:
  - 2> if *discTxResources* is included and set to *setup*:
    - 3> from the next discovery period, as defined by *discPeriod*, use the resources indicated by *discTxResources* for sidelink discovery announcement, as specified in 5.10.6;
  - 2> else if *discTxResources* is included and set to *release*:
    - 3> from the next discovery period, as defined by *discPeriod*, release the resources allocated for sidelink discovery announcement previously configured by *discTxResources*;
  - 2> if *discTxResourcesPS* is included and set to *setup*:
    - 3> from the next discovery period, as defined by *discPeriod*, use the resources indicated by *discTxResourcesPS* for sidelink discovery announcement, as specified in 5.10.6;
  - 2> else if *discTxResourcesPS* is included and set to *release*:
    - 3> from the next discovery period, as defined by *discPeriod*, release the resources allocated for sidelink discovery announcement previously configured by *discTxResourcesPS*;
  - 2> if *discTxInterFreqInfo* is included and set to *setup*:
    - 3> from the next discovery period, as defined by *discPeriod*, use the resources indicated by *discTxInterFreqInfo* for sidelink discovery announcement, as specified in 5.10.6;
  - 2> else if *discTxInterFreqInfo* is included and set to *release*:
    - 3> from the next discovery period, as defined by *discPeriod*, release the resources allocated for sidelink discovery announcement previously configured by *discTxInterFreqInfo*;
  - 2> if *discRxGapConfig* is included and set to *setup*:
    - 3> from the next gap period, as defined by *gapPeriod*, use the gaps indicated by *discRxGapConfig* for sidelink discovery monitoring, as specified in 5.10.5;
  - 2> else if *discRxGapConfig* is included and set to *release*:
    - 3> from the next gap period, as defined by *gapPeriod*, release the gaps configured for sidelink discovery monitoring previously configured by *discRxGapConfig*;

- 2> if *discTxGapConfig* is included and set to *setup*:
  - 3> from the next gap period, as defined by *gapPeriod*, use the gaps indicated by *discTxGapConfig* for sidelink discovery announcement, as specified in 5.10.6;
- 2> else if *discTxGapConfig* is included and set to *release*:
  - 3> from the next gap period, as defined by *gapPeriod*, release the gaps configured for sidelink discovery announcement previously configured by *discTxGapConfig*;
- 2> if *discSysInfoToReportConfig* is included and set to *setup*:
  - 3> start timer T370 with the timer value set to 60s;
- 2> else if *discSysInfoToReportConfig* is included and set to *release*:
  - 3> stop timer T370 and release *discSysInfoToReportConfig*;

### 5.3.10.15a V2X sidelink Communication dedicated configuration

The UE shall:

- 1> if the *RRCConnectionReconfiguration* message includes the *sl-V2X-ConfigDedicated*:
  - 2> if *commTxResources* is included and set to *setup*:
    - 3> use the resources indicated by *commTxResources* for V2X sidelink communication transmission, as specified in 5.10.13;
    - 3> perform CBR measurement on the transmission resource pool indicated in *commTxResources* for V2X sidelink communication transmission, as specified in 5.5.3;
  - 2> else if *commTxResources* is included and set to *release*:
    - 3> release the resources allocated for V2X sidelink communication transmission previously configured by *commTxResources*;
  - 2> if *v2x-InterFreqInfoList* is included:
    - 3> use the synchronization configuration and resource configuration parameters for V2X sidelink communication on frequencies included in *v2x-InterFreqInfoList*, as specified in 5.10.13;
    - 3> perform CBR measurement on the transmission resource pool indicated in *v2x-InterFreqInfoList* for V2X sidelink communication transmission, as specified in 5.5.3;
- 1> if the *RRCConnectionReconfiguration* message includes the *mobilityControlInfoV2X*:
  - 2> if *v2x-CommRxPool* is included:
    - 3> use the resources indicated by *v2x-CommRxPool* for V2X sidelink communication reception, as specified in 5.10.12;
  - 2> if *v2x-CommTxPoolExceptional* is included:
    - 3> use the resources indicated by *v2x-CommTxPoolExceptional* for V2X sidelink communication transmission, as specified in 5.10.13;
    - 3> perform CBR measurement on the transmission resource pool indicated by *v2x-CommTxPoolExceptional* for V2X sidelink communication transmission, as specified in 5.5.3;

### 5.3.10.16 T370 expiry

The UE shall:

- 1> if T370 expires:

- 2> release *discSysInfoToReportConfig*;

### 5.3.10.17 SRB release

The UE shall:

- 1> for each *srb-Identity* value included in *srb-ToReleaseList* or in *srb-ToReleaseListSCG* that is part of the current UE configuration:
  - 2> if the SRB configuration does not include an E-UTRA PDCP entity (release the SCG RLC bearer configuration):
    - 3> re-establish the RLC entity as specified in TS 36.322 [7] for this SRB;
    - 3> configure the E-UTRA PDCP entity to deactivate duplication;
  - 2> release the RLC entity or entities;
  - 2> release the DCCH logical channel;
  - 2> if *srb-Identity* value is set to 4, release the PDCP entity;

### 5.3.10.18 Scheduling Request Configuration for NB-IoT

The UE shall:

- 1> apply *sr-WithHARQ-ACK-Config*, if included;
- 1> apply *sr-WithoutHARQ-ACK-Config*, if included;
- 1> if *sr-SPS-BSR-Config* is included:
  - 2> instruct lower layers to clear existing configured uplink grants for BSR (if any);
  - 2> apply *sr-SPS-BSR-Config*.

### 5.3.10.19 NE-DC release

The UE shall:

- 1> if NE-DC release is triggered by NR:
  - 2> reset SCG MAC, if configured;
  - 2> for each RLC bearer that is part of the SCG configuration:
    - 3> perform RLC bearer release procedure as specified in 5.3.10.17 (SRBs) and in 5.3.10.2 (DRBs);
  - 2> release the measurement configuration;
  - 2> release the SCG configuration i.e. release the MAC and physical configuration for each cell that is part of the SCG configuration;
  - 2> stop timer T313 for the corresponding PSCell, if running;
  - 2> stop timer T307 for the corresponding PSCell, if running.

NOTE: Upon NE-DC release the UE releases all fields configured by the *RRCConnectionReconfiguration* message.

## 5.3.11 Radio link failure related actions

### 5.3.11.1 Detection of physical layer problems in RRC\_CONNECTED

The UE shall:

1> if any DAPS bearer is configured, upon receiving N310 consecutive "out-of-sync" indications for the source PCell from lower layers and T304 is running:

2> start timer T310 for the source PCell;

1> upon receiving N310 consecutive "out-of-sync" indications for the PCell from lower layers while neither T300, T301, T304, T311, nor T316 is running:

2> start timer T310;

1> upon receiving N313 consecutive "out-of-sync" indications for the PSCell from lower layers while T307 is not running:

2> start T313;

NOTE: Physical layer monitoring and related autonomous actions do not apply to SCells except for the PSCell.

#### 5.3.11.1a Early detection of physical layer problems in RRC\_CONNECTED

The UE shall:

1> upon receiving N310 consecutive "early-out-of-sync" indications for the PCell from lower layers:

2> start timer T314 with the timer value set to the value of T310;

#### 5.3.11.1b Detection of physical layer improvements in RRC\_CONNECTED

The UE shall:

1> upon receiving N311 consecutive "early-in-sync" indications for the PCell from lower layers:

2> start timer T315 with the timer value set to the value of T310;

### 5.3.11.2 Recovery of physical layer problems

Upon receiving N311 consecutive "in-sync" indications for the PCell from lower layers while T310 is running, the UE shall:

1> stop timer T310;

1> stop timer T312, if running;

NOTE 1: In this case, the UE maintains the RRC connection without explicit signalling, i.e. the UE maintains the entire radio resource configuration.

NOTE 2: Periods in time where neither "in-sync" nor "out-of-sync" is reported by layer 1 do not affect the evaluation of the number of consecutive "in-sync" or "out-of-sync" indications.

Upon receiving N314 consecutive "in-sync" indications for the PSCell from lower layers while T313 is running, the UE shall:

1> stop timer T313;

#### 5.3.11.2a Recovery of early detection of physical layer problems

Upon receiving N311 consecutive "in-sync" indications for the PCell from lower layers while T314 is running, the UE shall:

1> stop timer T314;

### 5.3.11.2b Cancellation of physical layer improvements in RRC\_CONNECTED

Upon receiving N311 consecutive "in-sync" indications for the PCell from lower layers while T315 is running, the UE shall:

1> stop timer T315;

### 5.3.11.3 Detection of radio link failure

The UE shall:

1> in case any DAPS bearer is configured, only the target PCell is considered in the following;

1> upon T310 expiry; or

1> upon T312 expiry; or

1> upon T318 expiry and *SystemInformationBlockType31* (*SystemInformationBlockType31-NB* in NB-IoT) not acquired; or

1> upon reaching *t-Service* if *t-Service* is broadcast; or

1> upon random access problem indication from MCG MAC while neither T300, T301, T304 nor T311 is running; or

1> upon indication from MCG RLC, which is allowed to be sent on PCell, that the maximum number of retransmissions has been reached for an SRB or DRB:

2> consider radio link failure to be detected for the MCG i.e. RLF;

2> discard any segments of segmented RRC messages received;

2> if the last *RRCConnectionReconfiguration* message including the *mobilityControlInfo* concerned a handover to E-UTRA from NR and if the UE supports successful handover report for Inter-RAT SHR NR and if the UE has successful handover related information available in *VarSuccessHO-Report* of TS 38.331 [82]:

3> set the *utra-C-RNTI* in the *successHO-Report* in *VarSuccessHO-Report* of TS 38.331 [82] to the C-RNTI used in the PCell;

2> store the following radio link failure information in the *VarRLF-Report* (*VarRLF-Report-NB* in NB-IoT) by setting its fields as follows:

3> clear the information included in *VarRLF-Report* (*VarRLF-Report-NB* in NB-IoT), if any;

3> set the *plmn-IdentityList* to include the list of EPLMNs stored by the UE (i.e. includes the RPLMN);

3> set the *measResultLastServCell* to include the RSRP and RSRQ, if available, of the PCell based on measurements collected up to the moment the UE detected radio link failure;

3> except for NB-IoT, set the *measResultNeighCells* to include the best measured cells, other than the PCell, ordered such that the best cell is listed first, and based on measurements collected up to the moment the UE detected radio link failure, and set its fields as follows;

4> if the UE was configured to perform measurements for one or more EUTRA frequencies, include the *measResultListEUTRA*;

4> if the UE was configured to perform measurement reporting for one or more neighbouring UTRA frequencies, include the *measResultListUTRA*;

4> if the UE was configured to perform measurement reporting for one or more neighbouring GERAN frequencies, include the *measResultListGERAN*;

4> if the UE was configured to perform measurement reporting for one or more neighbouring CDMA2000 frequencies, include the *measResultsCDMA2000*;

- 4> if the UE was configured to perform measurement reporting, not related to NR sidelink communication, for one or more neighbouring NR frequencies, include the *measResultListNR*;
- 4> for each neighbour cell included, include the optional fields that are available;

NOTE 1: The measured quantities are filtered by the L3 filter as configured in the mobility measurement configuration. The measurements are based on the time domain measurement resource restriction, if configured. Exclude-listed cells are not required to be reported.

- 3> except for NB-IoT, if available, set the *logMeasResultListWLAN* to include the WLAN measurement results, in order of decreasing RSSI for WLAN APs;
- 3> except for NB-IoT, if available, set the *logMeasResultListBT* to include the Bluetooth measurement results, in order of decreasing RSSI for Bluetooth beacons;
- 3> if detailed location information is available, set the content of the *locationInfo* as follows:
  - 4> include the *locationCoordinates*;
  - 4> include the *horizontalVelocity*, if available;
- 3> set the *failedPCellId* to the global cell identity, if available, and otherwise, except for NB-IoT, to the physical cell identity and carrier frequency of the PCell where radio link failure is detected;
- 3> except for NB-IoT, set the *tac-FailedPCell* to the tracking area code, if available, of the PCell where radio link failure is detected;
- 3> except for NB-IoT, if an *RRCCongestionReconfiguration* message including the *mobilityControlInfo* was received before the connection failure:
  - 4> if the last *RRCCongestionReconfiguration* message including the *mobilityControlInfo* concerned an intra E-UTRA handover:
    - 5> include the *previousPCellId* and set it to the global cell identity of the PCell where the last *RRCCongestionReconfiguration* message including *mobilityControlInfo* was received;
    - 5> set the *timeConnFailure* to the elapsed time since reception of the last *RRCCongestionReconfiguration* message including the *mobilityControlInfo*;
  - 4> if the last *RRCCongestionReconfiguration* message including the *mobilityControlInfo* concerned a handover to E-UTRA from UTRA and if the UE supports Radio Link Failure Report for Inter-RAT MRO:
    - 5> include the *previousUTRA-CellId* and set it to the physical cell identity, the carrier frequency and the global cell identity, if available, of the UTRA Cell in which the last *RRCCongestionReconfiguration* message including *mobilityControlInfo* was received;
    - 5> set the *timeConnFailure* to the elapsed time since reception of the last *RRCCongestionReconfiguration* message including the *mobilityControlInfo*;
- 4> if the last *RRCCongestionReconfiguration* message including the *mobilityControlInfo* concerned a handover to E-UTRA from NR and if the UE supports Radio Link Failure Report for Inter-RAT MRO NR:
  - 5> include the *previousNR-PCellId* and set it to the global cell identity of the PCell where the last *RRCCongestionReconfiguration* message including *mobilityControlInfo* was received embedded in NR RRC message *MobilityFromNRCommand* message as specified in TS 38.331 [82] clause 5.4.3.3;
  - 5> set the *timeConnFailure* to the elapsed time since reception of the last *RRCCongestionReconfiguration* message including the *mobilityControlInfo* embedded in NR RRC message *MobilityFromNRCommand* message as specified in TS 38.331 [82] clause 5.4.3.3.
  - 5> if the UE supports RLF Report for Inter-system HO for Voice Fallback as defined in TS 38.306 [87], and *voiceFallbackIndication* is included in the *MobilityFromNRCommand*:



- 6> include the *voiceFallbackHO*;
- 3> except for NB-IoT, if the UE supports QCI1 indication in Radio Link Failure Report and has a DRB for which QCI is 1:
  - 4> include the *drb-EstablishedWithQCI-1*;
- 3> except for NB-IoT, set the *connectionFailureType* to *rlf*;
- 3> except for NB-IoT, set the *c-RNTI* to the C-RNTI used in the PCell;
- 3> except for NB-IoT, set the *rlf-Cause* to the trigger for detecting radio link failure;
- 2> if the UE is configured with (NG)EN-DC; and
- 2> if T316 is configured; and
- 2> if SCG transmission is not suspended; and
- 2> if the SCG is not deactivated; and
- 2> if neither NR PSCell change nor NR PSCell addition is ongoing (i.e. T304 for the NR PSCell is not running as specified in TS 38.331 [82], clause 5.3.5.5.2, in (NG)EN-DC):
  - 3> initiate the MCG failure information procedure as specified in 5.6.26 to report MCG radio link failure;
- 2> else:
  - 3> if AS security has not been activated:
    - 4> if the UE is a NB-IoT UE:
      - 5> if the UE is connected to EPC and the UE supports RRC connection re-establishment for the Control Plane CIoT EPS optimisation; or
      - 5> if the UE is connected to 5GC, the UE supports RRC connection re-establishment for the Control Plane CIoT 5GS optimisation and the UE is configured with a truncated 5G-S-TMSI:
        - 6> initiate the RRC connection re-establishment procedure as specified in 5.3.7;
      - 5> else:
        - 6> perform the actions upon leaving RRC\_CONNECTED as specified in 5.3.12, with release cause 'RRC connection failure';
    - 4> else:
      - 5> perform the actions upon leaving RRC\_CONNECTED as specified in 5.3.12, with release cause 'other';
  - 3> else:
    - 4> initiate the connection re-establishment procedure as specified in 5.3.7;

NOTE 2: BL UEs or UEs in CE or NB-IoT UEs that are connected to NTN may perform the actions upon leaving RRC\_CONNECTED as specified in 5.3.12, with release cause 'other' if the UE determines by implementation there is not enough time to finish the procedure of reestablishment due to the discontinuous coverage.

In case of DC or NE-DC, the UE shall:

- 1> upon T313 expiry; or
- 1> upon random access problem indication from SCG MAC; or
- 1> upon indication from SCG RLC, which is allowed to be sent on PSCell, that the maximum number of retransmissions has been reached for an SCG, for a split DRB or for a split SRB:

- 2> consider radio link failure to be detected for the SCG i.e. SCG-RLF;
- 2> if the UE is configured with DC; or
- 2> if the UE is configured with NE-DC and MCG transmission is not suspended:
  - 3> initiate the SCG failure information procedure as specified in 5.6.13 to report SCG radio link failure;
- 2> else:
  - 3> initiate the connection re-establishment procedure as specified in TS 38.331 [82], clause 5.3.7.

In case of CA PDCP duplication, the UE shall:

- 1> upon indication from an RLC entity, which is restricted to be sent on SCell only, that the maximum number of retransmissions has been reached:
- 2> initiate the failure information procedure as specified in 5.6.21 to report RLC failure of type duplication;

If any DAPS bearer is configured and T304 is running, the UE shall:

- 1> upon T310 expiry for the source PCell; or
- 1> upon random access problem indication from source MCG MAC; or
- 1> upon indication from source MCG RLC, which is allowed to be sent on source PCell, that the maximum number of retransmissions has been reached for an DRB:
  - 2> consider radio link failure to be detected for the source MCG;
  - 2> suspend the transmission of all DRBs in the source MCG;
  - 2> reset MAC for the source MCG;
  - 2> release the source connection;

The UE may discard the radio link failure information, i.e. release the UE variable *VarRLF-Report* (*VarRLF-Report-NB* in NB-IoT), 48 hours after the radio link failure is detected, upon power off or upon detach, and for NB-IoT, upon entering another RAT.

### 5.3.11.3a Detection of early-out-of-sync event

The UE shall:

- 1> upon T314 expiry;
- 2> consider "early-out-of-sync" event to be detected and initiate transmission of the *UEAssistanceInformation* message in accordance with 5.6.10;

### 5.3.11.3b Detection of early-in-sync event

The UE shall:

- 1> upon T315 expiry;
- 2> consider "early-in-sync" event to be detected and initiate transmission of the *UEAssistanceInformation* message in accordance with 5.6.10;

## 5.3.12 UE actions upon leaving RRC\_CONNECTED or RRC\_INACTIVE

Upon leaving RRC\_CONNECTED or RRC\_INACTIVE, the UE shall:

- 1> reset MAC;
- 1> if leaving RRC\_INACTIVE was not triggered by the reception of *RRCConnectionRelease* including *idleModeMobilityControlInfo* or *altFreqPriorities*:

- 2> stop the timer T320 and T323, if running;
- 2> if stored, discard the cell reselection priority information provided by the *idleModeMobilityControlInfo*;
- 2> if stored, discard the *altFreqPriorities* provided by the *RRCConnectionRelease*;
- 1> if entering RRC\_IDLE was triggered by reception of the *RRCConnectionRelease* message including a *waitTime*:
  - 2> start timer T302, with the timer value set according to the *waitTime*;
  - 2> inform the upper layer that access barring is applicable for all access categories except categories '0' and '2';
- 1> else if T302 is running:
  - 2> stop timer T302;
  - 2> if the UE is connected to 5GC:
    - 3> perform the actions as specified in 5.3.16.4;
- 1> if T309 is running:
  - 2> stop timer T309 for all access categories;
  - 2> perform the actions as specified in 5.3.16.4.
- 1> stop all timers that are running except T302, T320, T322, T323, T325, T330, T331;
- 1> release *crs-ChEstMPDCCH-ConfigDedicated*, if configured;
- 1> if leaving RRC\_CONNECTED was triggered by suspension of the RRC:
  - 2> re-establish RLC entities for all SRBs and DRBs, including RBs configured with NR PDCP;
  - 2> remove all entries within *VarConditionalReconfiguration*, if any;
  - 2> for each *measId*, that is part of the current UE configuration in *VarMeasConfig*, if the associated *reportConfig* has *condReconfigurationTriggerEUTRA/condReconfigurationTriggerNR* configured:
    - 3> remove the entry with the matching *reportConfigId* from the *reportConfigList* within the *VarMeasConfig*;
    - 3> if the associated *measObjectId* is only associated with *condReconfigurationTriggerEUTRA/condReconfigurationTriggerNR*:
      - 4> remove the entry with the matching *measObjectId* from the *measObjectList* within the *VarMeasConfig*;
    - 3> remove the entry with the matching *measId* from the *measIdList* within the *VarMeasConfig*;
  - 2> store the UE AS Context including the current RRC configuration, the current security context, the PDCP state including ROHC state, C-RNTI used in the source PCell, the *cellIdentity* and the physical cell identity of the source PCell, and the *spCellConfigCommon* within *ReconfigurationWithSync* of the PCell (if configured);
  - 2> store the following information provided by E-UTRAN:
    - 3> if the UE connected to 5GC is a BL UE or UE in CE:
      - 4> the *fullI-RNTI*, if present;
      - 4> the *shortI-RNTI*, if present;
    - 3> else:
      - 4> the *resumeIdentity*;
    - 3> the *nextHopChainingCount*, if present. Otherwise discard any stored *nextHopChainingCount* that does not correspond to stored key  $K_{RRCint}$ ;

- 3> the *drb-ContinueROHC*, if present. Otherwise discard any stored *drb-ContinueROHC*;
- 2> suspend all SRB(s) and DRB(s), including RBs configured with NR PDCP, except SRB0;
- 2> if the UE connected to 5GC is a BL UE or UE in CE, indicate PDCP suspend to lower layers of all DRBs;
- 2> if the UE is connected to 5GC:
  - 3> indicate the idle suspension of the RRC connection to upper layers;
- 2> else:
  - 3> indicate the suspension of the RRC connection to upper layers;
- 2> configure lower layers to suspend integrity protection and ciphering;

NOTE 1: Except when resuming an RRC connection after early security reactivation in accordance with conditions in 5.3.3.18, ciphering is not applied for the subsequent *RRCConnectionResume* message used to resume the connection and an integrity check is performed by lower layers, but merely upon request from RRC.

- 1> else:
  - 2> upon leaving *RRC\_INACTIVE*:
    - 3> discard the UE Inactive AS context;
    - 3> discard the  $K_{eNB}$ , the  $K_{RRCenc}$  key, the  $K_{RRCint}$  and the  $K_{UPenc}$  key;
  - 2> release *rrc-InactiveConfig*, if configured;
  - 2> remove all entries within *VarConditionalReconfiguration*, if any;
  - 2> for each *measId*, that is part of the current UE configuration in *VarMeasConfig*, if the associated *reportConfig* has *condReconfigurationTriggerEUTRA/condReconfigurationTriggerNR* configured:
    - 3> remove the entry with the matching *reportConfigId* from the *reportConfigList* within the *VarMeasConfig*;
    - 3> if the associated *measObjectId* is only associated with *condReconfigurationTriggerEUTRA/condReconfigurationTriggerNR*:
      - 4> remove the entry with the matching *measObjectId* from the *measObjectList* within the *VarMeasConfig*;
    - 3> remove the entry with the matching *measId* from the *measIdList* within the *VarMeasConfig*;
  - 2> release all radio resources, including release of the MAC configuration, the RLC entity and the associated PDCP entity and SDAP (if any) for all established RBs, except for the following:
    - *pur-Config*, if stored;
  - 2> indicate the release of the RRC connection to upper layers together with the release cause;
- 1> release the stored *serviceType*, if any;
- 1> inform upper layers to clear the stored application layer measurement configuration;
- 1> discard received application layer measurement report information from upper layers, if any;
- 1> consider itself not to be configured to send application layer measurement report;
- 1> if leaving *RRC\_CONNECTED* was triggered neither by reception of the *MobilityFromEUTRACommand* message nor by selecting an inter-RAT cell while T311 was running; or
- 1> if leaving *RRC\_INACTIVE* was not triggered by the inter-RAT cell reselection:
  - 2> if timer T350 is configured:
    - 3> start timer T350;

3> apply *rclwi-Configuration* if configured, otherwise apply the *wlan-Id-List* corresponding to the RPLMN included in *SystemInformationBlockType17*;

2> else:

3> release the *wlan-OffloadConfigDedicated*, if received;

3> if the *wlan-OffloadConfigCommon* corresponding to the RPLMN is broadcast by the cell:

4> apply the *wlan-OffloadConfigCommon* corresponding to the RPLMN included in *SystemInformationBlockType17*;

4> apply *steerToWLAN* if configured, otherwise apply the *wlan-Id-List* corresponding to the RPLMN included in *SystemInformationBlockType17*;

2> enter RRC\_IDLE and perform procedures as specified in TS 36.304 [4], clause 5.2.7;

1> else:

2> release the *wlan-OffloadConfigDedicated*, if received;

NOTE 2: BL UEs or UEs in CE verifies validity of SI when released to RRC\_IDLE.

1> discard any segments of segmented RRC messages received;

1> release the LWA configuration, if configured, as described in 5.6.14.3;

1> release the LWIP configuration, if configured, as described in 5.6.17.3;

### 5.3.13 UE actions upon PUCCH/ SPUCCH/ SRS release request

Upon receiving a PUCCH release request from lower layers, for an indicated serving cell the UE shall:

1> apply the default physical channel configuration for *cqi-ReportConfig* for the indicated serving cell as specified in 9.2.4 and release *cqi-ReportConfigSCell*, for each SCell that sends HARQ feedback on the indicated serving cell, if any;

1> apply the default physical channel configuration for *schedulingRequestConfig* as specified in 9.2.4, for the concerned CG;

Upon receiving a sPUCCH release request from lower layers, the UE shall:

1> for each serving cell in the UE configuration:

2> apply the value *release* to the field *schedulingRequest-SPUCCH*;

Upon receiving an SRS release request from lower layers, for an indicated serving cell the UE shall:

1> apply the default physical channel configuration for *soundingRS-UL-ConfigDedicated*, as specified in 9.2.4;

NOTE: Upon PUCCH/ SRS release request, the UE does not modify the *soundingRS-UL-ConfigDedicatedAperiodic* i.e. it does not apply the default for this field (release).

#### 5.3.13a UE actions upon SR release request for NB-IoT

Upon receiving a SR release request from lower layers, the UE shall:

1> apply the value *FALSE* for *sr-WithHARQ-ACK-Config* and release *sr-WithHARQ-ACK-Config*, if configured;

1> apply the value *release* for *sr-WithoutHARQ-ACK-Config* and release *sr-WithoutHARQ-ACK-Config*, if configured;

1> apply the value *release* for *sr-SPS-BSR-Config* and release *sr-SPS-BSR-Config*, if configured;

## 5.3.13b UE actions upon PUR release request

Upon receiving a PUR release request from lower layers, the UE shall:

- 1> release *pur-Config*, if configured;
- 1> discard previously stored *pur-Config*, if any.

## 5.3.14 Proximity indication

### 5.3.14.1 General

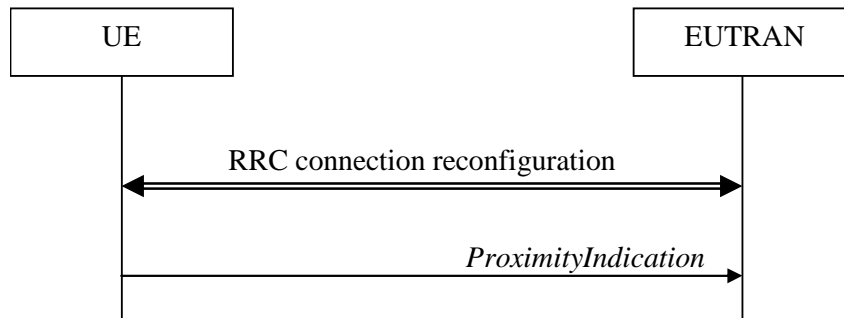

**Figure 5.3.14.1-1: Proximity indication**

The purpose of this procedure is to indicate that the UE is entering or leaving the proximity of one or more CSG member cells. The detection of proximity is based on an autonomous search function as defined in TS 36.304 [4].

### 5.3.14.2 Initiation

A UE in RRC\_CONNECTED shall:

- 1> if the UE enters the proximity of one or more CSG member cell(s) on an E-UTRA frequency while proximity indication is enabled for such E-UTRA cells; or
- 1> if the UE enters the proximity of one or more CSG member cell(s) on an UTRA frequency while proximity indication is enabled for such UTRA cells; or
- 1> if the UE leaves the proximity of all CSG member cell(s) on an E-UTRA frequency while proximity indication is enabled for such E-UTRA cells; or
- 1> if the UE leaves the proximity of all CSG member cell(s) on an UTRA frequency while proximity indication is enabled for such UTRA cells:
  - 2> if the UE has previously not transmitted a *ProximityIndication* for the RAT and frequency during the current RRC connection, or if more than 5 s has elapsed since the UE has last transmitted a *ProximityIndication* (either entering or leaving) for the RAT and frequency:
    - 3> initiate transmission of the *ProximityIndication* message in accordance with 5.3.14.3;

**NOTE:** In the conditions above, "if the UE enters the proximity of one or more CSG member cell(s)" includes the case of already being in the proximity of such cell(s) at the time proximity indication for the corresponding RAT is enabled.

### 5.3.14.3 Actions related to transmission of *ProximityIndication* message

The UE shall set the contents of *ProximityIndication* message as follows:

- 1> if the UE applies the procedure to report entering the proximity of CSG member cell(s):
  - 2> set *type* to *entering*;

- 1> else if the UE applies the procedure to report leaving the proximity of CSG member cell(s):
  - 2> set *type* to *leaving*;
- 1> if the proximity indication was triggered for one or more CSG member cell(s) on an E-UTRA frequency:
  - 2> set the *carrierFreq* to *eutra* with the value set to the E-ARFCN value of the E-UTRA cell(s) for which proximity indication was triggered;
- 1> else if the proximity indication was triggered for one or more CSG member cell(s) on a UTRA frequency:
  - 2> set the *carrierFreq* to *utra* with the value set to the ARFCN value of the UTRA cell(s) for which proximity indication was triggered;

The UE shall submit the *ProximityIndication* message to lower layers for transmission.

## 5.3.15 Void

## 5.3.16 Unified Access Control

### 5.3.16.1 General

The purpose of this procedure is to perform access barring check for an access attempt associated with a given Access Category and one or more Access Identities upon request from upper layers according to TS 24.501 [95] or the RRC layer.

BL UE or UE in CE in RRC\_CONNECTED uses *SystemInformationBlockType25*, if broadcasted, acquired when entering RRC\_CONNECTED or acquired while T311 is running.

Except for BL UE and UE in CE, after a handover resulting in change of PCell in RRC\_CONNECTED the UE shall defer access barring checks until it has obtained valid UAC information (from *SystemInformationBlockType25*) from the target cell if the *SystemInformationBlockType25* is broadcasted. For BL UE or UE in CE after a handover resulting in change of PCell, the UE shall consider *systemInformationBlockType25* is not broadcast in the target cell until the UE leaves RRC\_CONNECTED.

In NB-IoT, in RRC\_CONNECTED, the UE uses *MasterInformationBlock-NB* / *MasterInformationBlock-TDD-NB* and *SystemInformationBlockType14-NB*, if broadcasted, acquired when entering RRC\_CONNECTED or acquired while T311 is running.

### 5.3.16.2 Initiation

Except for NB-IoT, upon initiation of the procedure, the UE shall:

- 1> if T309 is running for the Access Category:
  - 2> consider the access attempt as barred;
- 1> else if timer T302 is running and the Access Category is neither '2' nor '0':
  - 2> consider the access attempt as barred;
- 1> else:
  - 2> if the Access Category is '0':
    - 3> consider the access attempt as allowed;
  - 2> else if *SystemInformationBlockType25* is not broadcasted:
    - 3> consider the access attempt as allowed;
  - 2> else if *ab-PerRSRP* is included:
    - 3> if the *establishmentCause* received from higher layers is set to a value other than *emergency*:

- 4> if *ab-PerRSRP* is set to *thresh0*:
  - 5> consider access to the cell as barred when in enhanced coverage as specified in TS 36.304 [4];
- 4> else if *ab-PerRSRP* is set to *thresh1*:
  - 5> if the measured RSRP is less than the first entry in *rsrp-ThresholdsPrachInfoList*:
    - 6> consider access to the cell as barred;
  - 5> else:
    - 6> consider that only the resources indicated for the first CE level are configured;
- 4> else if *ab-PerRSRP* is set to *thresh2*:
  - 5> if the measured RSRP is less than the second entry in *rsrp-ThresholdsPrachInfoList*:
    - 6> consider access to the cell as barred;
  - 5> else:
    - 6> consider that only the resources indicated for the first and second CE levels are configured;
- 4> else if *ab-PerRSRP* is set to *thresh3*:
  - 5> if the measured RSRP is less than the third entry in *rsrp-ThresholdsPrachInfoList*:
    - 6> consider access to the cell as barred;
  - 5> else:
    - 6> consider that only the resources indicated for the first, second, and third CE levels are configured;
- 2> if the Access Category is not '0', and *SystemInformationBlockType25* is broadcasted, and access to the cell is not barred due to *ab-PerRSRP*:
  - 3> if *SystemInformationBlockType25* includes *uac-BarringPerPLMN-List* and the *uac-BarringPerPLMN-List* contains an *UAC-BarringPerPLMN* entry with the *plmn-IdentityIndex* corresponding to the PLMN selected by upper layers (see TS 24.501 [95]):
    - 4> select the *UAC-BarringPerPLMN* entry with the *plmn-IdentityIndex* corresponding to the PLMN selected by upper layers;
    - 4> in the remainder of this procedure, use the selected *UAC-BarringPerPLMN* entry (i.e. presence or absence of access barring parameters in this entry) irrespective of the *uac-BarringForCommon* included in *SystemInformationBlockType25*;
  - 3> else if *SystemInformationBlockType25* includes *uac-BarringForCommon*:
    - 4> in the remainder of this procedure use the *uac-BarringForCommon* (i.e. presence or absence of these parameters) included in *SystemInformationBlockType25*;
  - 3> else:
    - 4> consider the access attempt as allowed;
  - 3> if *uac-BarringForCommon* is applicable or the *uac-AC-BarringListType* indicated that *uac-ExplicitAC-BarringList* is used:
    - 4> if the corresponding *UAC-BarringPerCatList* contains a *UAC-BarringPerCat* entry corresponding to the Access Category:
      - 5> select the *UAC-BarringPerCat* entry;
      - 5> if the *uac-BarringInfoSetList* contain a *UAC-BarringInfoSet* entry corresponding to the *uac-barringInfoSetIndex* in the *UAC-BarringPerCat*:



- 6> select the *UAC-BarringInfoSet* entry;
- 6> perform access barring check for the Access Category as specified in 5.3.16.5, using the *UAC-BarringInfoSet* as "UAC barring parameter";
- 5> else:
  - 6> consider the access attempt as allowed;
- 4> else:
  - 5> consider the access attempt as allowed;
- 3> else if the *uac-AC-BarringListType* indicated that *uac-ImplicitAC-BarringList* is indicated:
  - 4> select the *uac-BarringInfoSetIndex* corresponding to the Access Category in the *uac-ImplicitACBarringList*;
  - 4> if the *uac-BarringInfoSetList* contain the *UAC-BarringInfoSet* entry corresponding to the selected *uac-BarringInfoSetIndex*:
    - 5> select the *UAC-BarringInfoSet* entry;
    - 5> perform access barring check for the Access Category as specified in 5.3.16.5, using the *UAC-BarringInfoSet* as "UAC barring parameter";
  - 4> else:
    - 5> consider the access attempt as allowed;
- 3> else:
  - 4> consider the access attempt as allowed;
- 1> if the access barring check was requested by upper layers:
  - 2> if the access attempt is considered as barred:
    - 3> if timer T302 is running:
      - 4> if timer T309 is running for Access Category '2':
        - 5> inform the upper layer that access barring is applicable for all access categories except categories '0', upon which the procedure ends;
      - 4> else:
        - 5> inform the upper layer that access barring is applicable for all access categories except categories '0' and '2', upon which the procedure ends;
    - 3> else:
      - 4> inform upper layers that the access attempt for the Access Category is barred, upon which the procedure ends;
  - 2> else:
    - 3> inform upper layers that the access attempt for the Access Category is allowed, upon which the procedure ends;
- 1> else:
  - 2> the procedure ends;

For NB-IoT, upon initiation of the procedure, the UE shall:

- 1> if T309 is running for the Access Category:

- 2> consider the access attempt as barred;
- 1> else:
  - 2> if the Access Category is '0':
    - 3> consider the access attempt as allowed;
  - 2> else if *ab-Barring-5GC* in *MasterInformationBlock-NB* / *MasterInformationBlock-TDD-NB* is set to *FALSE*:
    - 3> consider the access attempt as allowed;
  - 2> else:
    - 3> if *SystemInformationBlockType14-NB* includes *uac-BarringCommon*:
      - 4> in the remainder of this procedure, use the *UAC-BarringCommon* as *UAC-Barring*;
    - 3> else if *SystemInformationBlockType14-NB* includes *uac-BarringPerPLMN-List* and the *uac-BarringPerPLMN-List* contains an *UAC-Barring* entry with the *plmn-IdentityIndex* corresponding to the PLMN selected by upper layers (see TS 24.501 [95]):
      - 4> select the *UAC-Barring* entry with the *plmn-IdentityIndex* corresponding to the PLMN selected by upper layers;
      - 4> in the remainder of this procedure, use the selected *UAC-Barring* entry as *UAC-Barring*;
    - 3> else:
      - 4> consider the access attempt as allowed;
    - 3> if *UAC-Barring* is applicable:
      - 4> if one or more Access Identities are indicated according to TS 24.501 [95]; and
      - 4> if for at least one of these Access Identities the corresponding bit in the *uac-BarringForAccessIdentity* is set to zero:
        - 5> consider the access attempt as allowed;
      - 4> else if the *UAC-BarringPerCatList* contains a *UAC-BarringPerCat* entry corresponding to the Access Category:
        - 5> select the *UAC-BarringPerCat* entry;
          - 6> perform access barring check for the Access Category as specified in 5.3.16.5, using the *uac-BarringForAccessIdentity* and the *UAC-BarringPerCat* entry as "UAC barring parameter";
        - 5> else:
          - 6> consider the access attempt as allowed;
- 1> if the access barring check was requested by upper layers:
  - 2> if the access attempt is considered as barred:
    - 3> inform upper layers that the access attempt for the Access Category is barred, upon which the procedure ends;
  - 2> else:
    - 3> inform upper layers that the access attempt for the Access Category is allowed, upon which the procedure ends;
- 1> else:
  - 2> the procedure ends;

### 5.3.16.3 Void

### 5.3.16.4 T302, T309 expiry or stop (Barring alleviation)

Except for NB-IoT, if the UE is connected to 5GC, the UE shall:

- 1> if timer T302 expires or is stopped:
  - 2> for each Access Category for which T309 is not running:
    - 3> consider the barring for this Access Category to be alleviated:
- 1> else if timer T309 corresponding to an Access Category other than '2' expires or is stopped, and if timer T302 is not running:
  - 2> consider the barring for this Access Category to be alleviated;
- 1> else if timer T309 corresponding to the Access Category '2' expires or is stopped:
  - 2> consider the barring for this Access Category to be alleviated;
- 1> When barring for an access category is considered being alleviated:
  - 2> if the Access Category was informed to upper layers as barred:
    - 3> inform upper layers about barring alleviation for the Access Category;
  - 2> if barring is alleviated for Access Category '8'; or
  - 2> if barring is alleviated for Access Category '2':
    - 3> perform actions specified in 5.3.17;

For NB-IoT, if the UE is connected to 5GC, the UE shall:

- 1> if timer T309 expires or is stopped for one Access Category:
  - 2> consider the barring for this Access Category to be alleviated;
  - 2> if the Access Category was informed to upper layers as barred:
    - 3> inform upper layers about barring alleviation for the Access Category;

### 5.3.16.5 Access barring check

The UE shall:

- 1> if one or more Access Identities equal to 1, 2, 11, 12, 13, 14, or 15 are indicated according to TS 24.501 [95], and
- 1> if for at least one of these Access Identities the corresponding bit in the *uac-BarringForAccessIdentity* contained in "UAC barring parameter" is set to *zero*:
  - 2> consider the access attempt as allowed;
- 1> else:
  - 2> if the establishment of the RRC connection is the result of release with redirect with *mpsPriorityIndication* (either in NR or E-UTRAN); and
  - 2> if the bit corresponding to Access Identity 1 in the *uac-BarringForAccessIdentity* contained in the "UAC barring parameter" is set to *zero*:
    - 3> consider the access attempt as allowed;
  - 2> else if Access Identity 3 is indicated:

- 3> draw a random number '*rand*' uniformly distributed in the range:  $0 \leq \text{rand} < 1$ ;
- 3> if '*rand*' is lower than the value indicated by *uac-BarringFactorForAI3* included in "UAC barring parameter":
  - 4> consider the access attempt as allowed;
- 3> else:
  - 4> consider the access attempt as barred;
- 2> else:
  - 3> draw a random number '*rand*' uniformly distributed in the range:  $0 \leq \text{rand} < 1$ ;
  - 3> if '*rand*' is lower than the value indicated by *uac-BarringFactor* included in "UAC barring parameter":
    - 4> consider the access attempt as allowed;
  - 3> else:
    - 4> consider the access attempt as barred;
- 1> if the access attempt is considered as barred:
  - 2> draw a random number '*rand*' that is uniformly distributed in the range  $0 \leq \text{rand} < 1$ ;
  - 2> start timer T309 for the Access Category with the timer value calculated as follows, using the *uac-BarringTime* included in "UAC barring parameter":
 
$$\text{"Tbarring"} = (0.7 + 0.6 * \text{rand}) * \text{uac-BarringTime};$$

## 5.3.17 RAN notification area update

### 5.3.17.1 General

The purpose of this procedure is:

- to notify the network that a UE in RRC\_INACTIVE has re-selected to a cell not belonging to the configured RAN notification area; or
- to periodically notify the network by a UE in RRC\_INACTIVE;

### 5.3.17.2 Initiation

When in RRC\_INACTIVE state, the UE shall:

- 1> if T380 expires, or:
  - 1> if RNA Update is triggered at reception of *SystemInformationBlockType1*, as specified in 5.2.2.7:
    - 2> initiate RRC connection resume procedure in 5.3.3 with cause value set to 'rna-Update';
- 1> if barring is alleviated for Access Category '8' or Access Category '2', as specified in 5.3.16.4:
  - 2> if upper layers do not request RRC the resumption of an RRC connection, and
  - 2> if the variable *pendingRnaUpdate* is set to 'TRUE':
    - 3> initiate RRC connection resume procedure in 5.3.3 with cause value set to 'rna-Update';

If the UE in RRC\_INACTIVE state fails to find a suitable cell and camps on the acceptable cell to obtain limited service as defined in TS 36.304 [4], the UE shall:

- 1> perform the actions upon leaving RRC\_INACTIVE as specified in 5.3.12 with release cause 'other'.

### 5.3.17.3 Inter RAT cell reselection or CN type change

Upon reselecting to an inter-RAT cell or to another CN type, the UE shall:

- 1> perform the actions upon leaving RRC\_INACTIVE as specified in 5.3.12, with release cause 'other'.

### 5.3.18 T317 expiry

The UE in RRC\_CONNECTED shall:

- 1> if T317 expires and the UE is not performing GNSS measurement; or
- 1> if indication is received that new GNSS position becomes valid and T317 has expired during the GNSS measurement; or
- 1> if indication is received that new GNSS position becomes valid, and T317 has expired before the GNSS measurement, and timer T318 has been stopped upon the GNSS measurement:
  - 2> inform lower layers that the UL synchronisation is lost;
  - 2> start timer T318;
  - 2> acquire *SystemInformationBlockType31* (*SystemInformationBlockType31-NB* in NB-IoT) as specified in 5.2.2;
  - 2> if the UE acquires *SystemInformationBlockType33* (*SystemInformationBlockType33-NB* in NB-IoT) as specified in 5.2.2:
    - 3> inform lower layers when UL synchronisation is restored upon successful acquisition of *SystemInformationBlockType31* (*SystemInformationBlockType31-NB* in NB-IoT);
    - 3> stop timer T318 when both *SystemInformationBlockType31* (*SystemInformationBlockType31-NB* in NB-IoT) and *SystemInformationBlockType33* (*SystemInformationBlockType33-NB* in NB-IoT) are acquired;
  - 2> else:
    - 3> upon successful acquisition of *SystemInformationBlockType31* (*SystemInformationBlockType31-NB* in NB-IoT):
      - 4> stop timer T318;
      - 4> inform lower layers when UL synchronisation is restored.

NOTE 1: *SystemInformationBlockType31* (*SystemInformationBlockType31-NB* in NB-IoT) may be broadcast on a different narrowband or different NB-IoT carrier than the one configured to the UE.

NOTE 2: The exact time when UL synchronisation is restored (after *SystemInformationBlockType31* or *SystemInformationBlockType31-NB* in NB-IoT is acquired) is left to UE implementation, which can be from the subframe indicated by *epochTime* and optionally before the subframe indicated by *epochTime*.

NOTE 3: For UEs not capable of performing system information acquisition and GNSS measurement at the same time, if the UE cannot complete acquisition of *SystemInformationBlockType31* (*SystemInformationBlockType31-NB*) before the start of GNSS measurement gap, acquisition of *SystemInformationBlockType31* (*SystemInformationBlockType31-NB*) may be postponed until GNSS measurement is completed, and T318 is restarted after GNSS measurement is completed.

## 5.4 Inter-RAT mobility

### 5.4.1 Introduction

The general principles of connected mode mobility are described in 5.3.1.3. The general principles of the security handling upon connected mode mobility are described in 5.3.1.2.

For the (network controlled) inter RAT mobility from E-UTRA for a UE in RRC\_CONNECTED, a single procedure is defined that supports both handover, cell change order with optional network assistance (NACC) and enhanced CS fallback to CDMA2000 1xRTT. The same procedure also supports inter-system handover between E-UTRA/EPC and E-UTRA/5GC. In case of mobility to CDMA2000, the eNB decides when to move to the other RAT while the target RAT determines to which cell the UE shall move.

## 5.4.2 Handover to E-UTRA

### 5.4.2.1 General

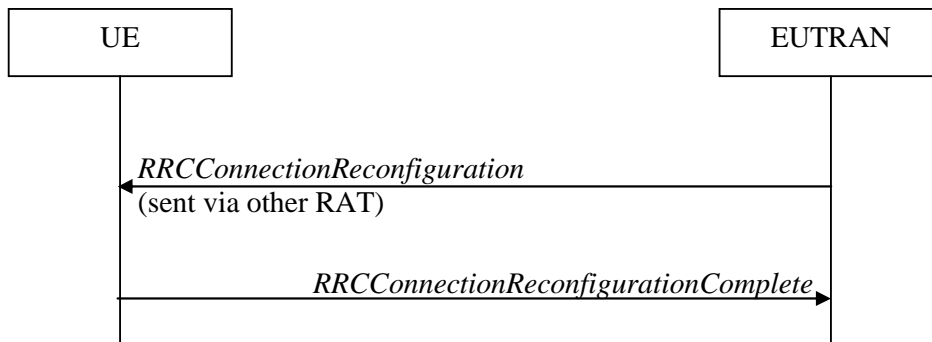

Figure 5.4.2.1-1: Handover to E-UTRA, successful

The purpose of this procedure is to, under the control of the network, transfer a connection between the UE and another Radio Access Network (e.g. GERAN, UTRAN or NR) to E-UTRAN, or transfer a connection between the UE and the E-UTRAN with one type of CN to the E-UTRAN with a different type of CN.

The handover to E-UTRA procedure applies when SRBs, possibly in combination with DRBs, are established in another RAT or in E-UTRA connected to another type of CN. Handover from UTRAN to E-UTRAN applies only after integrity has been activated in UTRAN. Handover to E-UTRA connected to a different type of CN applies only after integrity has been activated in E-UTRAN. Handover from NR to E-UTRAN applies only after integrity has been activated in NR.

### 5.4.2.2 Initiation

The RAN using another RAT or the E-UTRA connected to a different type of CN initiates the handover to E-UTRA procedure, in accordance with the specifications applicable for the other RAT or for the E-UTRA connected to a different type of CN, by sending the *RRCConnectionReconfiguration* message via the radio access technology from which the inter-RAT handover is performed.

E-UTRAN applies the procedure as follows:

- to activate ciphering, possibly using NULL algorithm, if not yet activated in the other RAT or in the E-UTRA connected to a different type of CN;
- to establish SRB1, SRB2 and one or more DRBs, i.e. at least the DRB associated with the default EPS bearer is established if the target CN is EPC and at least one DRB is established if the target CN is 5GC.

### 5.4.2.3 Reception of the *RRCConnectionReconfiguration* by the UE

If the UE is able to comply with the configuration included in the *RRCConnectionReconfiguration* message, the UE shall:

- 1> if the *RRCConnectionReconfiguration* message does not include the *fullConfig* and the UE is connected to 5GC (i.e., delta signalling during intra 5GC handover):
- 2> re-use the source SDAP and PDCP configurations (i.e., current SDAP/PDCP configurations for all RBs from source RAT prior to the reception of the inter-RAT handover *RRCConnectionReconfiguration* message);

- 1> if the *RRCConnectionReconfiguration* message includes the *fullConfig* and the source RAT was E-UTRA (i.e., intra-RAT inter-system handover):
  - 2> except the MCG C-RNTI, release/ clear all current dedicated radio resources and configurations, including all SDAP (if configured), PDCP, RLC, logical channel configurations for the DRBs and the logged measurement configuration (if configured);
  - 2> release/ clear all current common radio configurations;
  - 2> for each *srb-Identity* value included in the *srb-ToAddModList* (SRB reconfiguration):
    - 3> apply the specified configuration defined in 9.1.2 for the corresponding SRB;
    - 3> apply the corresponding default RLC configuration for the SRB specified in 9.2.1.1 for SRB1 or in 9.2.1.2 for SRB2;
    - 3> apply the corresponding default logical channel configuration for the SRB as specified in 9.2.1.1 for SRB1 or in 9.2.1.2 for SRB2;
    - 3> if the *handoverType* in *securityConfigHO* is set to *fivegc-ToEPC* (i.e., the UE is connecting to EPC):
      - 4> release the PDCP entity and establish it with an E-UTRA PDCP entity;
    - 3> else if the *handoverType* in *securityConfigHO* is set to *epc-To5GC* (i.e., the UE is connecting to 5GC):
      - 4> release the PDCP entity and establish it with an NR PDCP and apply the corresponding default PDCP configuration for the SRB as specified in TS 38.331 [82], clause 9.2.1;
    - 3> associate the RLC bearer of this SRB with the established PDCP entity;
  - 1> apply the default physical channel configuration as specified in 9.2.4;
  - 1> apply the default semi-persistent scheduling configuration as specified in 9.2.3;
  - 1> apply the default MAC main configuration as specified in 9.2.2;
  - 1> start timer T304 with the timer value set to *t304*, as included in the *mobilityControlInfo*;
  - 1> consider the target PCell to be one on the frequency indicated by the *carrierFreq* with a physical cell identity indicated by the *targetPhysCellId*;
  - 1> start synchronising to the DL of the target PCell;
  - 1> set the C-RNTI to the value of the *newUE-Identity*;
  - 1> for the target PCell, apply the downlink bandwidth indicated by the *dl-Bandwidth*;
  - 1> for the target PCell, apply the uplink bandwidth indicated by (the absence or presence of) the *ul-Bandwidth*;
  - 1> configure lower layers in accordance with the received *radioResourceConfigCommon*;
  - 1> configure lower layers in accordance with any additional fields, not covered in the previous, if included in the received *mobilityControlInfo*;
  - 1> perform the radio resource configuration procedure as specified in 5.3.10.0;
  - 1> if the *handoverType* in *securityConfigHO* is set to *fivegc-ToEPC*:
    - 2> indicate to higher layer that the CN has changed from 5GC to EPC;
    - 2> derive the key  $K_{eNB}$  based on the mapped  $K_{ASME}$  key as specified for interworking between EPS and 5GS in TS 33.501 [86];
    - 2> store the *nextHopChainingCount-r15* value;
  - 1> else if the *handoverType* in *securityConfigHO* is set to *intra5GC*:
    - 2> if the *keyChangeIndicator-r15* received in the *securityConfigHO* is set to *TRUE*:

- 3> forward *nas-Container* to the upper layers, if included;
- 3> update the  $K_{eNB}$  key based on the  $K_{AMF}$  key, as specified in TS 33.501 [86];
- 2> else:
  - 3> update the  $K_{eNB}$  key based on the current  $K_{gNB}$  or the NH, using the *nextHopChainingCount-r15* value indicated in the *SecurityConfigHO*, as specified in TS 33.501 [86];
  - 2> store the *nextHopChainingCount-r15* value;
- 1> else if the *handoverType* in *securityConfigHO* is set to *epc-To5GC*:
  - 2> forward the *nas-Container* to the upper layers;
  - 2> derive the  $K_{eNB}$  key, as specified in TS 33.501 [86];
- 1> else:
  - 2> forward the *nas-SecurityParamToEUTRA* to the upper layers;
  - 2> derive the  $K_{eNB}$  key, as specified in TS 33.401 [32];
- 1> derive the  $K_{RRcInt}$  key associated with the *integrityProtAlgorithm*, as specified in TS 33.401 [32];
- 1> derive the  $K_{RRcEnc}$  key and the  $K_{UPenc}$  key associated with the *cipheringAlgorithm*, as specified in TS 33.401 [32];
- 1> if capable of user plane integrity protection:
  - 2> derive the  $K_{UPint}$  key associated with the *integrityProtAlgorithm*, as specified in TS 33.401 [32];
- 1> if the received *RRCConnectionReconfiguration* includes the *sk-Counter*:
  - 2> perform key update procedure as specified in in TS 38.331 [82], clause 5.3.5.7;
- 1> if the received *RRCConnectionReconfiguration* includes the *nr-SecondaryCellGroupConfig*:
  - 2> perform NR RRC Reconfiguration as specified in TS 38.331 [82], clause 5.3.5.3;
- 1> if the received *RRCConnectionReconfiguration* includes the *nr-RadioBearerConfig1*:
  - 2> perform radio bearer configuration as specified in TS 38.331 [82], clause 5.3.5.6;
- 1> if the received *RRCConnectionReconfiguration* includes the *nr-RadioBearerConfig2*:
  - 2> perform radio bearer configuration as specified in TS 38.331 [82], clause 5.3.5.6;
- 1> if the *handoverType* in *securityConfigHO* is set to *fivegc-ToEPC* or if the *handoverType-v1530* is not present:
  - 2> configure lower layers to apply the indicated integrity protection algorithm and the  $K_{RRcInt}$  key immediately, i.e. the indicated integrity protection configuration shall be applied to all subsequent messages received and sent by the UE, including the message used to indicate the successful completion of the procedure;
  - 2> configure lower layers to apply the indicated ciphering algorithm, the  $K_{RRcEnc}$  key and the  $K_{UPenc}$  key immediately, i.e. the indicated ciphering configuration shall be applied to all subsequent messages received and sent by the UE, including the message used to indicate the successful completion of the procedure;
- 1> if the received *RRCConnectionReconfiguration* includes the *sCellToAddModList*:
  - 2> perform SCell addition as specified in 5.3.10.3b;
- 1> if the *RRCConnectionReconfiguration* message includes the *measConfig*:
  - 2> perform the measurement configuration procedure as specified in 5.5.2;
- 1> perform the measurement identity autonomous removal as specified in 5.5.2.2a;
- 1> if the *RRCConnectionReconfiguration* message includes the *otherConfig*:



- 2> perform the other configuration procedure as specified in 5.3.10.9;
- 1> if the *RRCCConnectionReconfiguration* message includes *wlan-OffloadInfo*:
  - 2> perform the dedicated WLAN offload configuration procedure as specified in 5.6.12.2;
- 1> if the *RRCCConnectionReconfiguration* message includes *rclwi-Configuration*:
  - 2> perform the WLAN traffic steering command procedure as specified in 5.6.16.2;
- 1> if the *RRCCConnectionReconfiguration* message includes *lwa-Configuration*:
  - 2> perform the LWA configuration procedure as specified in 5.6.14.2;
- 1> if the *RRCCConnectionReconfiguration* message includes *lwip-Configuration*:
  - 2> perform the LWIP reconfiguration procedure as specified in 5.6.17.2;
- 1> set the content of *RRCCConnectionReconfigurationComplete* message as follows:
  - 2> if the UE has radio link failure or handover failure information available in *VarRLF-Report* and if the RPLMN is included in *plmn-IdentityList* stored in *VarRLF-Report*:
    - 3> include *rlf-InfoAvailable*;
  - 2> if the UE has MBSFN logged measurements available for E-UTRA and if the RPLMN is included in *plmn-IdentityList* stored in *VarLogMeasReport* and if T330 is not running:
    - 3> include *logMeasAvailableMBSFN*;
  - 2> else if the UE has logged measurements available for E-UTRA and if the RPLMN is included in *plmn-IdentityList* stored in *VarLogMeasReport*:
    - 3> include the *logMeasAvailable*;
    - 3> if Bluetooth measurement results are included in the logged measurements the UE has available:
      - 4> include the *logMeasAvailableBT*;
    - 3> if WLAN measurement results are included in the logged measurements the UE has available:
      - 4> include the *logMeasAvailableWLAN*;
  - 2> if the UE has connection establishment failure information available in *VarConnEstFailReport* and if the RPLMN is equal to *plmn-Identity* stored in *VarConnEstFailReport*:
    - 3> include *connEstFailInfoAvailable*;
  - 2> if the received *RRCCConnectionReconfiguration* message included *nr-SecondaryCellGroupConfig*:
    - 3> include *scg-ConfigResponseNR* in accordance with TS 38.331 [82], clause 5.3.5.3;
- 1> submit the *RRCCConnectionReconfigurationComplete* message to lower layers for transmission using the new configuration;
- 1> if the *RRCCConnectionReconfiguration* message does not include *rlf-TimersAndConstants* set to *setup*:
  - 2> use the default values specified in 9.2.5 for timer T310, T311 and constant N310, N311;
- 1> if MAC successfully completes the random access procedure:
  - 2> stop timer T304;
  - 2> apply the parts of the CQI reporting configuration, the scheduling request configuration and the sounding RS configuration that do not require the UE to know the SFN of the target PCell, if any;

- 2> apply the parts of the measurement and the radio resource configuration that require the UE to know the SFN of the target PCell (e.g. measurement gaps, periodic CQI reporting, scheduling request configuration, sounding RS configuration), if any, upon acquiring the SFN of the target PCell;

NOTE 1: Whenever the UE shall setup or reconfigure a configuration in accordance with a field that is received it applies the new configuration, except for the cases addressed by the above statements.

- 2> enter E-UTRA RRC\_CONNECTED, upon which the procedure ends;

NOTE 2: The UE is not required to determine the SFN of the target PCell by acquiring system information from that cell before performing RACH access in the target PCell.

NOTE 3: If the handover is from NR and target CN is 5GC, the delta configuration on PDCP and SDAP can be used for intra-system inter-RAT handover. For other cases, source RAT configuration is not considered when the UE applies the reconfiguration message of target RAT.

#### 5.4.2.4 Reconfiguration failure

The UE shall:

- 1> if the UE is unable to comply with (part of) the configuration included in the *RRCCConnectionReconfiguration* message or if the upper layers indicate that the *nas-Container* is invalid:
  - 2> if the source RAT is E-UTRA:
    - 3> perform the actions as specified in 5.3.5.5;
  - 2> else:
    - 3> perform the actions defined for this failure case as defined in the specifications applicable for the other RAT;

NOTE 1: The UE may apply above failure handling also in case the *RRCCConnectionReconfiguration* message causes a protocol error for which the generic error handling as defined in 5.7 specifies that the UE shall ignore the message.

NOTE 2: If the UE is unable to comply with part of the configuration, it does not apply any part of the configuration, i.e. there is no partial success/ failure.

#### 5.4.2.5 T304 expiry (handover to E-UTRA failure)

The UE shall:

- 1> upon T304 expiry (handover to E-UTRA failure):
  - 2> if the source RAT is E-UTRA:
    - 3> perform the actions as specified in 5.3.5.6;
  - 2> else:
    - 3> reset MAC;
    - 3> perform the actions defined for this failure case as defined in the specifications applicable for the other RAT;

## 5.4.3 Mobility from E-UTRA

### 5.4.3.1 General

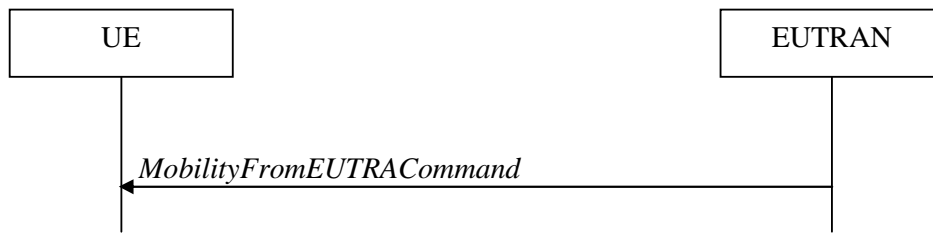

**Figure 5.4.3.1-1: Mobility from E-UTRA, successful**

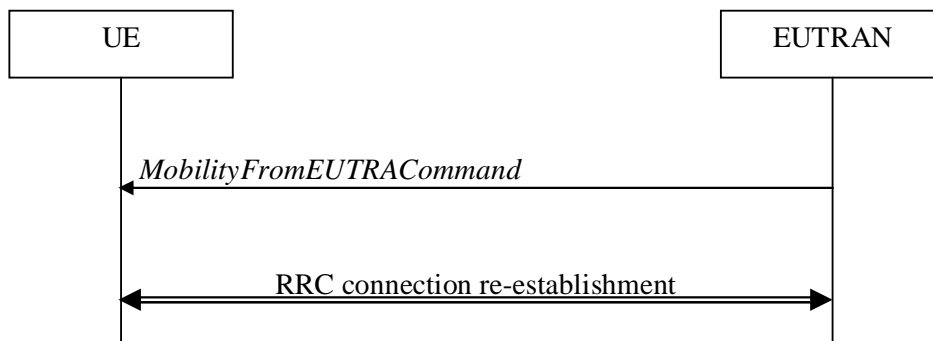

**Figure 5.4.3.1-2: Mobility from E-UTRA, failure**

The purpose of this procedure is to move a UE in RRC\_CONNECTED to a cell using another Radio Access Technology (RAT), e.g. GERAN, UTRA, CDMA2000 systems, NR, or handover a UE to an E-UTRA cell connected to another type of CN. The mobility from E-UTRA procedure covers the following type of mobility:

- handover, i.e. the *MobilityFromEUTRACCommand* message includes radio resources that have been allocated for the UE in the target cell;
- cell change order, i.e. the *MobilityFromEUTRACCommand* message may include information facilitating access of and/ or connection establishment in the target cell, e.g. system information. Cell change order is applicable only to GERAN; and
- enhanced CS fallback to CDMA2000 1xRTT, i.e. the *MobilityFromEUTRACCommand* message includes radio resources that have been allocated for the UE in the target cell. The enhanced CS fallback to CDMA2000 1xRTT may be combined with concurrent handover or redirection to CDMA2000 HRPD.

NOTE: For the case of dual receiver/transmitter enhanced CS fallback to CDMA2000 1xRTT, the *DLInformationTransfer* message is used instead of the *MobilityFromEUTRACCommand* message (see TS 36.300 [9]).

### 5.4.3.2 Initiation

E-UTRAN initiates the mobility from E-UTRA procedure to a UE in RRC\_CONNECTED, possibly in response to a *MeasurementReport* message, in response to reception of CS fallback indication for the UE from MME, or in response to an *MCGFailureInformation* message by sending a *MobilityFromEUTRACCommand* message. E-UTRAN applies the procedure as follows:

- the procedure is initiated only when AS-security has been activated, and SRB2 with at least one DRB are setup and not suspended;
- the procedure is not initiated if any DAPS bearer is configured;

### 5.4.3.3 Reception of the *MobilityFromEUTRACommand* by the UE

The UE shall be able to receive a *MobilityFromEUTRACommand* message and perform a cell change order to GERAN, even if no prior UE measurements have been performed on the target cell.

The UE shall:

- 1> stop timer T310, if running;
- 1> stop timer T312, if running;
- 1> if timer T316 is running:
  - 2> stop timer T316;
  - 2> clear the information included in *VarRLF-Report*, if any;
- 1> if T309 is running:
  - 2> stop timer T309 for all access categories;
  - 2> perform the actions as specified in 5.3.16.4.
- 1> if the *MobilityFromEUTRACommand* message includes the *purpose* set to *handover*:
  - 2> if the *targetRAT-Type* is set to *utra* or *geran*:
    - 3> consider inter-RAT mobility as initiated towards the RAT indicated by the *targetRAT-Type* included in the *MobilityFromEUTRACommand* message;
    - 3> forward the *nas-SecurityParamFromEUTRA* to the upper layers;
    - 3> access the target cell indicated in the inter-RAT message in accordance with the specifications of the target RAT;
    - 3> if the *targetRAT-Type* is set to *geran*:
      - 4> use the contents of *systemInformation*, if provided for PS Handover, as the system information to begin access on the target GERAN cell;

NOTE 1: If there are DRBs for which no radio bearers are established in the target RAT as indicated in the *targetRAT-MessageContainer* in the message, the E-UTRA RRC part of the UE does not indicate the release of the concerned DRBs to the upper layers. Upper layers may derive which bearers are not established from information received from the AS of the target RAT.

NOTE 2: In case of SR-VCC, the DRB to be replaced is specified in TS 23.216 [61].

- 2> else if the *targetRAT-Type* is set to *utra*:
  - 3> consider inter-system mobility as initiated towards E-UTRA;
  - 3> forward the *nas-SecurityParamFromEUTRA* to the upper layers, if included;
  - 3> access the target cell indicated in the inter-RAT message in accordance with clause 5.4.2.3;
- 2> else if the *targetRAT-Type* is set to *nr*:
  - 3> consider inter-RAT mobility as initiated towards NR;
  - 3> access the target cell indicated in the inter-RAT message in accordance with the specifications in TS 38.331 [82];
- 2> else if the *targetRAT-Type* is set to *cdma2000-1XRTT* or *cdma2000-HRPD*:
  - 3> forward the *targetRAT-Type* and the *targetRAT-MessageContainer* to the CDMA2000 upper layers for the UE to access the cell(s) indicated in the inter-RAT message in accordance with the specifications of the CDMA2000 target-RAT;

- 1> else if the *MobilityFromEUTRACommand* message includes the *purpose* set to *cellChangeOrder*:
  - 2> start timer T304 with the timer value set to *t304*, as included in the *MobilityFromEUTRACommand* message;
  - 2> if the *targetRAT-Type* is set to *geran*:
    - 3> if *networkControlOrder* is included in the *MobilityFromEUTRACommand* message:
      - 4> apply the value as specified in TS 44.060 [36];
    - 3> else:
      - 4> acquire *networkControlOrder* and apply the value as specified in TS 44.060 [36];
    - 3> use the contents of *systemInformation*, if provided, as the system information to begin access on the target GERAN cell;
  - 2> establish the connection to the target cell indicated in the *CellChangeOrder*;

NOTE 3: The criteria for success or failure of the cell change order to GERAN are specified in TS 44.060 [36].

- 1> if the *MobilityFromEUTRACommand* message includes the *purpose* set to *e-CSFB*:
  - 2> if *messageContCDMA2000-1XRTT* is present:
    - 3> forward the *messageContCDMA2000-1XRTT* to the CDMA2000 upper layers for the UE to access the cell(s) indicated in the inter-RAT message in accordance with the specification of the target RAT;
  - 2> if *mobilityCDMA2000-HRPD* is present and is set to *handover*:
    - 3> forward the *messageContCDMA2000-HRPD* to the CDMA2000 upper layers for the UE to access the cell(s) indicated in the inter-RAT message in accordance with the specification of the target RAT;
  - 2> if *mobilityCDMA2000-HRPD* is present and is set to *redirection*:
    - 3> forward the *redirectCarrierCDMA2000-HRPD* to the CDMA2000 upper layers;

NOTE 4: When the CDMA2000 upper layers in the UE receive both the *messageContCDMA2000-1XRTT* and *messageContCDMA2000-HRPD* the UE performs concurrent access to both CDMA2000 1xRTT and CDMA2000 HRPD RAT.

NOTE 5: The UE should perform the handover, the cell change order or enhanced 1xRTT CS fallback as soon as possible following the reception of the RRC message *MobilityFromEUTRACommand*, which could be before confirming successful reception (HARQ and ARQ) of this message.

#### 5.4.3.4 Successful completion of the mobility from E-UTRA

Upon successfully completing the handover, the cell change order or enhanced 1xRTT CS fallback, the UE shall:

- 1> if the *targetRAT-Type* in the received *MobilityFromEUTRACommand* is set to *eutra* (intra-E-UTRA inter-system HO):
  - 2> indicate to the upper layers associated to the source system the release of the RRC connection together with the release cause 'other';
  - 2> the procedure ends;
- 1> else if the UE was connected to 5GC prior to the reception of the *MobilityFromEUTRACommand* and the *targetRAT-Type* in the received *MobilityFromEUTRACommand* is set to *nr*:
  - 2> reset MAC;
  - 2> stop all timers that are running except T325, T330;
  - 2> release *ran-NotificationAreaInfo*, if stored;

- 2> release the AS security context including the  $K_{RRCenc}$  key, the  $K_{RRCint}$ , the  $K_{UPint}$  key and the  $K_{UPenc}$  key, if stored;
- 2> release all radio resources, including release of the RLC entity, the MAC configuration and the associated PDCP entity and SDAP entity for all established RBs;

NOTE 1: PDCP and SDAP configured by the source configurations RAT prior to the handover that are reconfigured and re-used by target RAT when delta signalling (i.e., during inter-RAT intra-system handover when *fullConfig* is not present) is used, are not released as part of this procedure.

1> else:

- 2> perform the actions upon leaving RRC\_CONNECTED as specified in 5.3.12, with release cause 'other';

NOTE 2: If the UE performs enhanced 1xRTT CS fallback along with concurrent mobility to CDMA2000 HRPD and the connection to either CDMA2000 1xRTT or CDMA2000 HRPD succeeds, then the mobility from E-UTRA is considered successful.

### 5.4.3.5 Mobility from E-UTRA failure

The UE shall:

- 1> if T304 configured in the *MobilityFromEUTRACommand* message expires (mobility from E-UTRA failure); or
- 1> if the UE does not succeed in establishing the connection to the target radio access technology; or
- 1> if the UE is unable to comply with (part of) the configuration included in the *MobilityFromEUTRACommand* message; or
- 1> if there is a protocol error in the inter RAT information included in the *MobilityFromEUTRACommand* message, causing the UE to fail the procedure according to the specifications applicable for the target RAT (i.e. according to clause 5.3.5.6 if the *targetRAT-Type* in the received *MobilityFromEUTRACommand* is set to *eutra*):
  - 2> stop T304, if running;
  - 2> if the *cs-FallbackIndicator* in the *MobilityFromEUTRACommand* message was set to *TRUE* or *e-CSFB* was present:
    - 3> indicate to upper layers that the CS fallback procedure has failed;
  - 2> revert back to the configuration used in the source PCell, excluding the configuration configured by the *physicalConfigDedicated*, *mac-MainConfig* and *sps-Config*;
  - 2> if *MobilityFromEUTRACommand* concerned a failed inter-RAT handover from E-UTRA to NR and if the UE supports Radio Link Failure Report for Inter-RAT MRO NR:
    - 3> store handover failure information in *VarRLF-Report* according to 5.3.5.6;
  - 2> initiate the connection re-establishment procedure as specified in 5.3.7;

NOTE: For enhanced CS fallback to CDMA2000 1xRTT, the above UE behavior applies only when the UE is attempting the enhanced 1xRTT CS fallback and connection to the target radio access technology fails or if the UE is attempting enhanced 1xRTT CS fallback along with concurrent mobility to CDMA2000 HRPD and connection to both the target radio access technologies fails.

## 5.4.4 Handover from E-UTRA preparation request (CDMA2000)

### 5.4.4.1 General

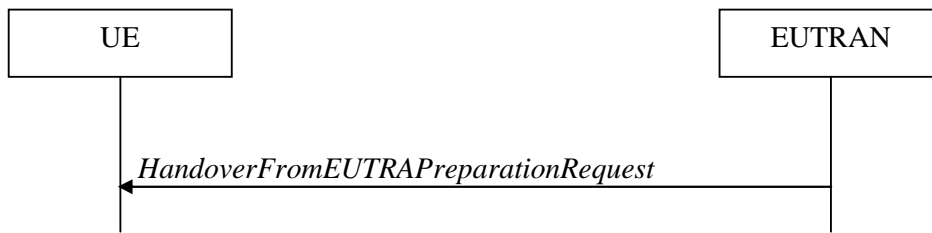

**Figure 5.4.4.1-1: Handover from E-UTRA preparation request**

The purpose of this procedure is to trigger the UE to prepare for handover or enhanced 1xRTT CS fallback to CDMA2000 by requesting a connection with this network. The UE may use this procedure to concurrently prepare for handover to CDMA2000 HRPD along with preparation for enhanced CS fallback to CDMA2000 1xRTT. This procedure applies to CDMA2000 capable UEs only.

This procedure is also used to trigger the UE which supports dual Rx/Tx enhanced 1xCSFB to redirect its second radio to CDMA2000 1xRTT.

The handover from E-UTRA preparation request procedure applies when signalling radio bearers are established.

### 5.4.4.2 Initiation

E-UTRAN initiates the handover from E-UTRA preparation request procedure to a UE in RRC\_CONNECTED, possibly in response to a *MeasurementReport* message or CS fallback indication for the UE, by sending a *HandoverFromEUTRAPreparationRequest* message. E-UTRAN initiates the procedure only when AS security has been activated.

### 5.4.4.3 Reception of the *HandoverFromEUTRAPreparationRequest* by the UE

Upon reception of the *HandoverFromEUTRAPreparationRequest* message, the UE shall:

- 1> if *dualRxTxRedirectIndicator* is present in the received message:
  - 2> forward *dualRxTxRedirectIndicator* to the CDMA2000 upper layers;
  - 2> forward *redirectCarrierCDMA2000-1XRTT* to the CDMA2000 upper layers, if included;
- 1> else:
  - 2> indicate the request to prepare handover or enhanced 1xRTT CS fallback and forward the *cdma2000-Type* to the CDMA2000 upper layers;
  - 2> if *cdma2000-Type* is set to *type1XRTT*:
    - 3> forward the *rand* and the *mobilityParameters* to the CDMA2000 upper layers;
  - 2> if *concurrPrepCDMA2000-HRPD* is present in the received message:
    - 3> forward *concurrPrepCDMA2000-HRPD* to the CDMA2000 upper layers;
  - 2> else:
    - 3> forward *concurrPrepCDMA2000-HRPD*, with its value set to *FALSE*, to the CDMA2000 upper layers;

## 5.4.5 UL handover preparation transfer (CDMA2000)

### 5.4.5.1 General



**Figure 5.4.5.1-1: UL handover preparation transfer**

The purpose of this procedure is to tunnel the handover related CDMA2000 dedicated information or enhanced 1xRTT CS fallback related CDMA2000 dedicated information from UE to E-UTRAN when requested by the higher layers. The procedure is triggered by the higher layers on receipt of *HandoverFromEUTRAPreparationRequest* message. If preparing for enhanced CS fallback to CDMA2000 1xRTT and handover to CDMA2000 HRPD, the UE sends two consecutive *ULHandoverPreparationTransfer* messages to E-UTRAN, one per addressed CDMA2000 RAT Type. This procedure applies to CDMA2000 capable UEs only.

### 5.4.5.2 Initiation

A UE in RRC\_CONNECTED initiates the UL handover preparation transfer procedure whenever there is a need to transfer handover or enhanced 1xRTT CS fallback related non-3GPP dedicated information. The UE initiates the UL handover preparation transfer procedure by sending the *ULHandoverPreparationTransfer* message.

### 5.4.5.3 Actions related to transmission of the *ULHandoverPreparationTransfer* message

The UE shall set the contents of the *ULHandoverPreparationTransfer* message as follows:

- 1> include the *cdma2000-Type* and the *dedicatedInfo*;
- 1> if the *cdma2000-Type* is set to *type1XRTT*:
  - 2> include the *meid* and set it to the value received from the CDMA2000 upper layers;
- 1> submit the *ULHandoverPreparationTransfer* message to lower layers for transmission, upon which the procedure ends;

### 5.4.5.4 Failure to deliver the *ULHandoverPreparationTransfer* message

The UE shall:

- 1> if the UE is unable to guarantee successful delivery of *ULHandoverPreparationTransfer* messages:
  - 2> inform upper layers about the possible failure to deliver the information contained in the concerned *ULHandoverPreparationTransfer* message;

## 5.4.6 Inter-RAT cell change order to E-UTRAN

### 5.4.6.1 General

The purpose of the inter-RAT cell change order to E-UTRAN procedure is to transfer, under the control of the source radio access technology, a connection between the UE and another radio access technology (e.g. GSM/ GPRS) to E-UTRAN.



### 5.4.6.2 Initiation

The procedure is initiated when a radio access technology other than E-UTRAN, e.g. GSM/GPRS, using procedures specific for that RAT, orders the UE to change to an E-UTRAN cell. In response, upper layers request the establishment of an RRC connection as specified in clause 5.3.3.

NOTE: Within the message used to order the UE to change to an E-UTRAN cell, the source RAT should specify the identity of the target E-UTRAN cell as specified in the specifications for that RAT.

The UE shall:

- 1> upon receiving an *RRCConnectionSetup* message;
- 2> consider the inter-RAT cell change order procedure to have completed successfully;

### 5.4.6.3 UE fails to complete an inter-RAT cell change order

If the inter-RAT cell change order fails the UE shall return to the other radio access technology and proceed as specified in the appropriate specifications for that RAT.

The UE shall:

- 1> upon failure to establish the RRC connection as specified in clause 5.3.3;
- 2> consider the inter-RAT cell change order procedure to have failed;

NOTE: The cell change was network ordered. Therefore, failure to change to the target PCell should not cause the UE to move to UE-controlled cell selection.

## 5.5 Measurements

### 5.5.1 Introduction

For NB-IoT in RRC\_CONNECTED state measurements see clause 5.5.8.

For BL UEs or UEs in CE or NB-IoT UEs that are connected to NTN, GNSS measurement triggering and reporting related procedures are defined in 5.5.9.

The UE reports measurement information in accordance with the measurement configuration and performs conditional reconfiguration evaluation in accordance with conditional reconfiguration as provided by E-UTRAN. E-UTRAN provides the measurement configuration or the conditional reconfiguration applicable for a UE in RRC\_CONNECTED by means of dedicated signalling, i.e. using the *RRCConnectionReconfiguration* or *RRCConnectionResume* message.

The UE can be requested to perform the following types of measurements:

- Intra-frequency measurements: measurements at the downlink carrier frequency(ies) of the serving cell(s).
- Inter-frequency measurements: measurements at frequencies that differ from any of the downlink carrier frequency(ies) of the serving cell(s).
- Inter-RAT measurements of NR frequencies.
- Inter-RAT measurements of UTRA frequencies.
- Inter-RAT measurements of GERAN frequencies.
- Inter-RAT measurements of CDMA2000 HRPD or CDMA2000 1xRTT or WLAN frequencies.
- CBR measurements for V2X sidelink communication.
- Sensing measurements for V2X sidelink communication.

The measurement configuration includes the following parameters:

1. **Measurement objects:** The objects on which the UE shall perform the measurements.

- For intra-frequency and inter-frequency measurements a measurement object is a single E-UTRA carrier frequency. Associated with this carrier frequency, E-UTRAN can configure a list of cell specific offsets, a list of 'exclude-listed' cells and a list of 'allow-listed' cells. Exclude-listed cells are not considered in event evaluation or measurement reporting.
- For inter-RAT NR measurements a measurement object is a single NR carrier frequency. Associated with this carrier frequency, E-UTRAN can configure a list of 'exclude-listed' cells. Exclude-listed cells are not considered in event evaluation or measurement reporting.
- For inter-RAT UTRA measurements a measurement object is a set of cells on a single UTRA carrier frequency.
- For inter-RAT GERAN measurements a measurement object is a set of GERAN carrier frequencies.
- For inter-RAT CDMA2000 measurements a measurement object is a set of cells on a single (HRPD or 1xRTT) carrier frequency.
- For inter-RAT WLAN measurements a measurement object is a set of WLAN identifiers and optionally a set of WLAN frequencies.
- For CBR measurements and sensing measurements a measurement object is a set of transmission resource pools for V2X sidelink communication.

NOTE 1: Some measurements using the above mentioned measurement objects, only concern a single cell, e.g. measurements used to report neighbouring cell system information, PCell UE Rx-Tx time difference, or a pair of cells, e.g. SSTD measurements between the PCell and the PSCell.

2. **Reporting configurations:** A list of measurement reporting configurations where each measurement reporting configuration consists of the following:

- Reporting criterion: The criterion that triggers the UE to send a measurement report. This can either be periodical or a single event description.
- Reporting format: The quantities that the UE includes in the measurement report and associated information (e.g. number of cells to report).

In case of conditional handover, conditional PSCell addition or MN initiated inter-SN conditional PSCell change triggering configuration, each configuration consists of the following:

- Execution criteria: The criteria that triggers the UE to perform conditional handover, conditional PSCell addition or MN initiated inter-SN conditional PSCell change.

3. **Measurement identities:** For measurement reporting, a list of measurement identities where each measurement identity links one measurement object with one measurement reporting configuration. By configuring multiple measurement identities it is possible to link more than one measurement object to the same reporting configuration, as well as to link more than one reporting configuration to the same measurement object. The measurement identity is used as a reference number in the measurement report. For conditional reconfiguration triggering, one measurement identity links to exactly one conditional reconfiguration trigger configuration. And up to two measurement identities can be linked to one conditional reconfiguration execution condition.

4. **Quantity configurations:** One quantity configuration is configured per RAT type. The quantity configuration defines the measurement quantities and associated filtering used for all event evaluation and related reporting of that measurement type. One filter can be configured per measurement quantity, except for NR where the network may configure up to 2 sets of quantity configurations each comprising per measurement quantity separate filters for cell and RS index measurement results. The quantity configuration set that applies for a given measurement is indicated within the NR measurement object.

5. **Measurement gaps:** Periods that the UE may use to perform measurements, i.e. no (UL, DL) transmissions are scheduled.

E-UTRAN only configures a single measurement object for a given frequency (except for WLAN and except for CBR measurements), i.e. it is not possible to configure two or more measurement objects for the same frequency with

different associated parameters, e.g. different offsets and/ or exclude-lists. E-UTRAN may configure multiple instances of the same event e.g. by configuring two reporting configurations with different thresholds.

The UE maintains a single measurement object list, a single reporting configuration list, and a single measurement identities list. The measurement object list includes measurement objects, that are specified per RAT type, possibly including intra-frequency object(s) (i.e. the object(s) corresponding to the serving frequency(ies)), inter-frequency object(s) and inter-RAT objects. Similarly, the reporting configuration list includes E-UTRA and inter-RAT reporting configurations. Any measurement object can be linked to any reporting configuration of the same RAT type. Some reporting configurations may not be linked to a measurement object. Likewise, some measurement objects may not be linked to a reporting configuration.

The measurement procedures distinguish the following types of cells:

1. The serving cell(s) - these are the PCell and one or more SCells, if configured for a UE supporting CA or DC. Likewise, NR serving cell(s) are the NR PCell, NR PSCell and NR SCells, if the UE is configured with MR-DC.
2. Listed cells - these are cells listed within the measurement object(s) or, for inter-RAT WLAN, the WLANs matching the WLAN identifiers configured in the measurement object or the WLAN the UE is connected to.
3. Detected cells - these are cells that are not listed within the measurement object(s) but are detected by the UE on the carrier frequency(ies) indicated by the measurement object(s) or, for inter-RAT WLAN, the WLANs not included in the *measObjectWLAN* but meeting the triggering requirements.

For E-UTRA, the UE measures and reports on the serving cell(s), listed cells, detected cells, transmission resource pools for V2X sidelink communication, and, for RSSI and channel occupancy measurements, the UE measures and reports on any reception on the indicated frequency. For inter-RAT NR, the UE measures and reports on detected cells and, if configured with MR-DC, on NR serving cell(s) and, for RSSI and channel occupancy measurements, the UE measures and reports on the indicated frequency. For inter-RAT UTRA, the UE measures and reports on listed cells and optionally on cells that are within a range for which reporting is allowed by E-UTRAN. For inter-RAT GERAN, the UE measures and reports on detected cells. For inter-RAT CDMA2000, the UE measures and reports on listed cells. For inter-RAT WLAN, the UE measures and reports on listed cells.

NOTE 2: For inter-RAT UTRA and CDMA2000, the UE measures and reports also on detected cells for the purpose of SON.

NOTE 3: This specification is based on the assumption that typically CSG cells of home deployment type are not indicated within the neighbour list. Furthermore, the assumption is that for non-home deployments, the physical cell identity is unique within the area of a large macro cell (i.e. as for UTRAN).

Whenever the procedural specification, other than contained in clause 5.5.2, refers to a field it concerns a field included in the *VarMeasConfig* unless explicitly stated otherwise i.e. only the measurement configuration procedure covers the direct UE action related to the received *measConfig*.

## 5.5.2 Measurement configuration

### 5.5.2.1 General

E-UTRAN applies the procedure as follows:

- to ensure that, whenever the UE has a *measConfig*, it includes a *measObject* for each LTE serving frequency;
- to configure at most one measurement identity using a reporting configuration with the *purpose* set to *reportCGI*;
- for E-UTRA serving frequencies, set the EARFCN within the corresponding *measObject* according to the band as used for reception/ transmission;
- to configure at most one measurement identity using a reporting configuration with *ul-DelayConfig*;
- to configure at most one measurement identity using a reporting configuration with *ul-DelayValueConfig*;
- to configure at most one measurement identity using a reporting configuration with *reportSFTD-Meas*;
- to configure at most one *MeasObjectNR* with the same *carrierFreq*;

The UE shall:

- 1> if the received *measConfig* includes the *measObjectToRemoveList*:
  - 2> perform the measurement object removal procedure as specified in 5.5.2.4;
- 1> if the received *measConfig* includes the *measObjectToAddModList*:
  - 2> perform the measurement object addition/ modification procedure as specified in 5.5.2.5;
- 1> if the received *measConfig* includes the *reportConfigToRemoveList*:
  - 2> perform the reporting configuration removal procedure as specified in 5.5.2.6;
- 1> if the received *measConfig* includes the *reportConfigToAddModList*:
  - 2> perform the reporting configuration addition/ modification procedure as specified in 5.5.2.7;
- 1> if the received *measConfig* includes the *quantityConfig*:
  - 2> perform the quantity configuration procedure as specified in 5.5.2.8;
- 1> if the received *measConfig* includes the *measIdToRemoveList*:
  - 2> perform the measurement identity removal procedure as specified in 5.5.2.2;
- 1> if the received *measConfig* includes the *measIdToAddModList*:
  - 2> perform the measurement identity addition/ modification procedure as specified in 5.5.2.3;
- 1> if the received *measConfig* includes the *measGapConfig* or *measGapConfigPerCC-List*:
  - 2> perform the measurement gap configuration procedure as specified in 5.5.2.9;
- 1> if the received *measConfig* includes the *measGapConfigDensePRS*:
  - 2> perform the measurement gap configuration procedure for RSTD measurements with dense PRS configuration as specified in 5.5.2.9a;
- 1> if the received *measConfig* includes the *measGapSharingConfig*:
  - 2> perform the measurement gap sharing configuration procedure as specified in 5.5.2.12;
- 1> if the received *measConfig* includes the *s-Measure*:
  - 2> set the parameter *s-Measure* within *VarMeasConfig* to the lowest value of the RSRP ranges indicated by the received value of *s-Measure*;
- 1> if the received *measConfig* includes the *preRegistrationInfoHRPD*:
  - 2> forward the *preRegistrationInfoHRPD* to CDMA2000 upper layers;
- 1> if the received *measConfig* includes the *speedStatePars*:
  - 2> set the parameter *speedStatePars* within *VarMeasConfig* to the received value of *speedStatePars*;
- 1> if the received *measConfig* includes the *allowInterruptions*:
  - 2> set the parameter *allowInterruptions* within *VarMeasConfig* to the received value of *allowInterruptions*;

### 5.5.2.2 Measurement identity removal

The UE shall:

- 1> for each *measId* included in the received *measIdToRemoveList* that is part of the current UE configuration in *VarMeasConfig*:
  - 2> remove the entry with the matching *measId* from the *measIdList* within the *VarMeasConfig*;

- 2> remove the measurement reporting entry for this *measId* from the *VarMeasReportList*, if included;
- 2> stop the periodical reporting timer or timer T321, whichever one is running, and reset the associated information (e.g. *timeToTrigger*) for this *measId*;

NOTE: The UE does not consider the message as erroneous if the *measIdToRemoveList* includes any *measId* value that is not part of the current UE configuration.

### 5.5.2.2a Measurement identity autonomous removal

The UE shall:

- 1> for each *measId* included in the *measIdList* within *VarMeasConfig*:
  - 2> if the associated *reportConfig* concerns an event involving a serving cell while the concerned serving cell is not configured; or
  - 2> if the associated *reportConfig* concerns an event involving a WLAN mobility set while the concerned WLAN mobility set is not configured; or
  - 2> if the associated *reportConfig* concerns an event involving a transmission resource pool for V2X sidelink communication while the concerned resource pool is not configured; or
  - 2> if the associated *reportConfig* concerns an event involving *reportSFTD-Meas* set to *pSCell* while the *nr-Config* is not configured:
    - 3> remove the *measId* from the *measIdList* within the *VarMeasConfig*;
    - 3> remove the measurement reporting entry for this *measId* from the *VarMeasReportList*, if included;
    - 3> stop the periodical reporting timer if running, and reset the associated information (e.g. *timeToTrigger*) for this *measId*;

NOTE 1: The above UE autonomous removal of *measId*'s applies only for measurement events A1, A2, A6, and also applies for events A3 and A5 if configured for PSCell and W2 and W3 and V1 and V2 and event involving *reportSFTD-Meas* set to *pSCell*, if configured.

NOTE 2: When performed during re-establishment, the UE is only configured with a primary frequency (i.e. the SCell(s) and WLAN mobility set are released, if configured).

### 5.5.2.3 Measurement identity addition/ modification

E-UTRAN applies the procedure as follows:

- configure a *measId* only if the corresponding measurement object, the corresponding reporting configuration and the corresponding quantity configuration, are configured;

The UE shall:

- 1> for each *measId* included in the received *measIdToAddModList*:
  - 2> if an entry with the matching *measId* exists in the *measIdList* within the *VarMeasConfig*:
    - 3> replace the entry with the value received for this *measId*;
  - 2> else:
    - 3> add a new entry for this *measId* within the *VarMeasConfig*;
  - 2> remove the measurement reporting entry for this *measId* from the *VarMeasReportList*, if included;
  - 2> stop the periodical reporting timer or timer T321, whichever one is running, and reset the associated information (e.g. *timeToTrigger*) for this *measId*;

NOTE: If the *measId* associated with *reportConfig* for conditional reconfiguration is modified, the conditions need to be set to non-fulfilled as specified in 5.3.5.9.4.

- 2> if the *triggerType* is set to *periodical* and the *purpose* is set to *reportCGI* in the *reportConfig* associated with this *measId*:
  - 3> if the *measObject* associated with this *measId* concerns E-UTRA:
    - 4> if the *si-RequestForHO* is included in the *reportConfig* associated with this *measId*:
      - 5> if the UE is a category 0 UE according to TS 36.306 [5]:
        - 6> start timer T321 with the timer value set to 190 ms for this *measId*;
      - 5> else:
        - 6> start timer T321 with the timer value set to 150 ms for this *measId*;
    - 4> else:
      - 5> start timer T321 with the timer value set to 1 second for this *measId*;
  - 3> else if the *measObject* associated with this *measId* concerns UTRA:
    - 4> if the *si-RequestForHO* is included in the *reportConfig* associated with this *measId*:
      - 5> for UTRA FDD, start timer T321 with the timer value set to 2 seconds for this *measId*;
      - 5> for UTRA TDD, start timer T321 with the timer value set to [1 second] for this *measId*;
    - 4> else:
      - 5> start timer T321 with the timer value set to 8 seconds for this *measId*;
  - 3> else if the *measObject* associated with this *measId* concerns NR:
    - 4> if the *measObject* associated with this *measId* concerns FR1:
      - 5> start timer T321 with the timer value set to 2 seconds for this *measId*;
    - 4> if the *measObject* associated with this *measId* concerns FR2:
      - 5> if the *useAutonomousGapsNR* is included in the *reportConfig* associated with this *measId*:
        - 6> start timer T321 with the timer value set to 5 seconds for this *measId*;
      - 5> else:
        - 6> start timer T321 with the timer value set to 16 seconds for this *measId*;
  - 3> else:
    - 4> start timer T321 with the timer value set to 8 seconds for this *measId*;

#### 5.5.2.4 Measurement object removal

The UE shall:

- 1> for each *measObjectId* included in the received *measObjectToRemoveList* that is part of the current UE configuration in *VarMeasConfig*:
  - 2> remove the entry with the matching *measObjectId* from the *measObjectList* within the *VarMeasConfig*;
  - 2> remove all *measId* associated with this *measObjectId* from the *measIdList* within the *VarMeasConfig*, if any;
  - 2> if a *measId* is removed from the *measIdList*:
    - 3> remove the measurement reporting entry for this *measId* from the *VarMeasReportList*, if included;
    - 3> stop the periodical reporting timer or timer T321, whichever one is running, and reset the associated information (e.g. *timeToTrigger*) for this *measId*;

NOTE: The UE does not consider the message as erroneous if the *measObjectToRemoveList* includes any *measObjectId* value that is not part of the current UE configuration.

### 5.5.2.5 Measurement object addition/ modification

The UE shall:

- 1> for each *measObjectId* included in the received *measObjectToAddModList*:
  - 2> if an entry with the matching *measObjectId* exists in the *measObjectList* within the *VarMeasConfig*, for this entry:
    - 3> reconfigure the entry with the value received for this *measObject*, except for the fields *cellsToAddModList*, *excludedCellsToAddModList*, *allowedCellsToAddModList*, *altTTT-CellsToAddModList*, *cellsToRemoveList*, *excludedCellsToRemoveList*, *allowedCellsToRemoveList*, *altTTT-CellsToRemoveList*, *measSubframePatternConfigNeigh*, *measDS-Config*, *wlan-ToAddModList*, *wlan-ToRemoveList*, *tx-ResourcePoolToRemoveList*, *tx-ResourcePoolToAddList*, *ssb-PositionQCL-CellsToAddModListNR*, and *ssb-PositionQCL-CellsToRemoveListNR*;
    - 3> if the received *measObject* includes the *cellsToRemoveList*:
      - 4> for each *cellIndex* included in the *cellsToRemoveList*:
        - 5> remove the entry with the matching *cellIndex* from the *cellsToAddModList*;
    - 3> if the received *measObject* includes the *cellsToAddModList*:
      - 4> for each *cellIndex* value included in the *cellsToAddModList*:
        - 5> if an entry with the matching *cellIndex* exists in the *cellsToAddModList*:
          - 6> replace the entry with the value received for this *cellIndex*;
        - 5> else:
          - 6> add a new entry for the received *cellIndex* to the *cellsToAddModList*;
    - 3> if the received *measObject* includes the *excludedCellsToRemoveList*:
      - 4> for each *cellIndex* included in the *excludedCellsToRemoveList*:
        - 5> remove the entry with the matching *cellIndex* from the *excludedCellsToAddModList*;

NOTE 1: For each *cellIndex* included in the *excludedCellsToRemoveList* that concerns overlapping ranges of cells, a cell is removed from the exclude-listed cells only if all cell indexes containing it are removed.

- 3> if the received *measObject* includes the *excludedCellsToAddModList*:
  - 4> for each *cellIndex* included in the *excludedCellsToAddModList*:
    - 5> if an entry with the matching *cellIndex* is included in the *excludedCellsToAddModList*:
      - 6> replace the entry with the value received for this *cellIndex*;
    - 5> else:
      - 6> add a new entry for the received *cellIndex* to the *excludedCellsToAddModList*;
  - 3> if the received *measObject* includes the *allowedCellsToRemoveList*:
    - 4> for each *cellIndex* included in the *allowedCellsToRemoveList*:
      - 5> remove the entry with the matching *cellIndex* from the *allowedCellsToAddModList*;

NOTE 2: For each *cellIndex* included in the *allowedCellsToRemoveList* that concerns overlapping ranges of cells, a cell is removed from the allow-listed cells only if all cell indexes containing it are removed.

- 3> if the received *measObject* includes the *allowedCellsToAddModList*:
  - 4> for each *cellIndex* included in the *allowedCellsToAddModList*:
    - 5> if an entry with the matching *cellIndex* is included in the *allowedCellsToAddModList*:
      - 6> replace the entry with the value received for this *cellIndex*;
    - 5> else:
      - 6> add a new entry for the received *cellIndex* to the *allowedCellsToAddModList*;

- 3> if the received *measObject* includes the *altTTT-CellsToRemoveList*:

- 4> for each *cellIndex* included in the *altTTT-CellsToRemoveList*:
  - 5> remove the entry with the matching *cellIndex* from the *altTTT-CellsToAddModList*;

NOTE 3: For each *cellIndex* included in the *altTTT-CellsToRemoveList* that concerns overlapping ranges of cells, a cell is removed from the list of cells only if all cell indexes containing it are removed.

- 3> if the received *measObject* includes the *altTTT-CellsToAddModList*:

- 4> for each *cellIndex* value included in the *altTTT-CellsToAddModList*:
  - 5> if an entry with the matching *cellIndex* exists in the *altTTT-CellsToAddModList*:
    - 6> replace the entry with the value received for this *cellIndex*;
  - 5> else:
    - 6> add a new entry for the received *cellIndex* to the *altTTT-CellsToAddModList*;

- 3> if the received *measObject* includes *measSubframePatternConfigNeigh*:

- 4> set *measSubframePatternConfigNeigh* within the *VarMeasConfig* to the value of the received field

- 3> if the received *measObject* includes *measDS-Config*:

- 4> if *measDS-Config* is set to *setup*:
  - 5> if the received *measDS-Config* includes the *measCSI-RS-ToRemoveList*:
    - 6> for each *measCSI-RS-Id* included in the *measCSI-RS-ToRemoveList*:
      - 7> remove the entry with the matching *measCSI-RS-Id* from the *measCSI-RS-ToAddModList*;
  - 5> if the received *measDS-Config* includes the *measCSI-RS-ToAddModList*, for each *measCSI-RS-Id* value included in the *measCSI-RS-ToAddModList*:
    - 6> if an entry with the matching *measCSI-RS-Id* exists in the *measCSI-RS-ToAddModList*:
      - 7> replace the entry with the value received for this *measCSI-RS-Id*;
    - 6> else:
      - 7> add a new entry for the received *measCSI-RS-Id* to the *measCSI-RS-ToAddModList*;
  - 5> set other fields of the *measDS-Config* within the *VarMeasConfig* to the value of the received fields;
  - 5> perform the discovery signals measurement timing configuration procedure as specified in 5.5.2.10;
- 4> else:
  - 5> release the discovery signals measurement configuration;

- 3> if the received *measObject* modifies fields other than *cellsForWhichToReportSFTD*:



- 4> for each *measId* associated with this *measObjectId* in the *measIdList* within the *VarMeasConfig*, if any:
  - 5> remove the measurement reporting entry for this *measId* from the *VarMeasReportList*, if included;
  - 5> stop the periodical reporting timer or timer T321, whichever one is running, and reset the associated information (e.g. *timeToTrigger*) for this *measId*;
- 3> if the received *measObject* includes the *wlan-ToRemoveList*:
  - 4> for each *WLAN-Identifiers* included in the *wlan-ToRemoveList*:
    - 5> remove the entry with the matching *WLAN-Identifiers* from the *wlan-ToAddModList*;

NOTE 3a: Matching of *WLAN-Identifiers* requires that all WLAN identifier fields should be same.

- 3> if the received *measObject* includes the *wlan-ToAddModList*:
  - 4> for each *WLAN-Identifiers* included in the *wlan-ToAddModList*:
    - 5> add a new entry for the received *WLAN-Identifiers* to the *wlan-ToAddModList*;
- 3> if the received *measObject* includes the *tx-ResourcePoolToRemoveList*:
  - 4> for each transmission resource pool indicated in *tx-ResourcePoolToRemoveList*:
    - 5> remove the entry with the matching identity of the transmission resource pool from the *tx-ResourcePoolToAddList*;
- 3> if the received *measObject* includes the *tx-ResourcePoolToAddList*:
  - 4> for each transmission resource pool indicated in *tx-ResourcePoolToAddList*:
    - 5> add a new entry for the received identity of the transmission resource pool to the *tx-ResourcePoolToAddList*;
- 3> if the received *measObject* includes the *ssb-PositionQCL-CellsToRemoveListNR*:
  - 4> for each *physCellId* included in the *ssb-PositionQCL-CellsToRemoveListNR*:
    - 5> remove the entry with the matching *physCellId* from the *ssb-PositionQCL-CellsToAddModListNR*;
- 3> if the received *measObject* includes the *ssb-PositionQCL-CellsToAddModListNR*:
  - 4> for each *physCellId* included in the *ssb-PositionQCL-CellsToAddModListNR*:
    - 5> if an entry with the matching *physCellId* exists in the *ssb-PositionQCL-CellsToAddModListNR*:
      - 6> replace the entry with the value received for this *physCellId*;
    - 5> else:
      - 6> add a new entry for the received *physCellId* to the *ssb-PositionQCL-CellsToAddModListNR*;
- 2> else:
  - 3> add a new entry for the received *measObject* to the *measObjectList* within *VarMeasConfig*;

NOTE 4: UE does not need to retain *cellForWhichToReportCGI* in the *measObject* after reporting *cgi-Info*.

### 5.5.2.6 Reporting configuration removal

The UE shall:

- 1> for each *reportConfigId* included in the received *reportConfigToRemoveList* that is part of the current UE configuration in *VarMeasConfig*:
- 2> remove the entry with the matching *reportConfigId* from the *reportConfigList* within the *VarMeasConfig*;

- 2> remove all *measId* associated with the *reportConfigId* from the *measIdList* within the *VarMeasConfig*, if any;
- 2> if a *measId* is removed from the *measIdList*:
  - 3> remove the measurement reporting entry for this *measId* from the *VarMeasReportList*, if included;
  - 3> stop the periodical reporting timer or timer T321, whichever one is running, and reset the associated information (e.g. *timeToTrigger*) for this *measId*;

NOTE: The UE does not consider the message as erroneous if the *reportConfigToRemoveList* includes any *reportConfigId* value that is not part of the current UE configuration.

### 5.5.2.7 Reporting configuration addition/ modification

The UE shall:

- 1> for each *reportConfigId* included in the received *reportConfigToAddModList*:
  - 2> if an entry with the matching *reportConfigId* exists in the *reportConfigList* within the *VarMeasConfig*, for this entry:
    - 3> reconfigure the entry with the value received for this *reportConfig*;
    - 3> for each *measId* associated with this *reportConfigId* included in the *measIdList* within the *VarMeasConfig*, if any:
      - 4> remove the measurement reporting entry for this *measId* from in *VarMeasReportList*, if included;
      - 4> stop the periodical reporting timer or timer T321, whichever one is running, and reset the associated information (e.g. *timeToTrigger*) for this *measId*;
  - 2> else:
    - 3> add a new entry for the received *reportConfig* to the *reportConfigList* within the *VarMeasConfig*;

### 5.5.2.8 Quantity configuration

The UE shall:

- 1> for each RAT for which the received *quantityConfig* includes parameter(s):
  - 2> set the corresponding parameter(s) in *quantityConfig* within *VarMeasConfig* to the value of the received *quantityConfig* parameter(s);
- 1> for each *measId* included in the *measIdList* within *VarMeasConfig*:
  - 2> remove the measurement reporting entry for this *measId* from the *VarMeasReportList*, if included;
  - 2> stop the periodical reporting timer or timer T321, whichever one is running, and reset the associated information (e.g. *timeToTrigger*) for this *measId*;

### 5.5.2.9 Measurement gap configuration

The UE shall:

- 1> if *measGapConfig* is set to *setup*:
  - 2> if a measurement gap configuration *measGapConfig* or *measGapConfigPerCC-List* is already setup, release the measurement gap configuration;
  - 2> if the *gapOffset* in *measGapConfig* indicates a non-uniform gap pattern:
    - 3> setup the measurement gap configuration indicated by the *measGapConfig* in accordance with the received *gapOffset*, i.e., the first subframe of the first gap of each non-uniform gap pattern occurs at an SFN and subframe meeting the following condition (SFN and subframe of MCG cells):

$SFN \bmod T = \text{FLOOR}(gapOffset/10);$

subframe =  $gapOffset \bmod 10;$

with  $T = LMGRP/10$  as defined in TS 36.133 [16];

2> else:

3> setup the measurement gap configuration indicated by the *measGapConfig* in accordance with the received *gapOffset*, i.e., the first subframe of each gap occurs at an SFN and subframe meeting the following condition (SFN and subframe of MCG cells):

$SFN \bmod T = \text{FLOOR}(gapOffset/10);$

subframe =  $gapOffset \bmod 10;$

with  $T = MGRP/10$  as defined in TS 36.133 [16];

2> if (NG)EN-DC is configured:

3> if the UE is configured with *fr1-Gap* set to *TRUE*:

4> apply the gap configuration for LTE serving cells and for NR serving cells on FR1;

3> else:

4> apply the gap configuration for all LTE and NR serving cells;

2> if *mgta* is set to *TRUE*, apply a timing advance value of 0.5ms to the gap occurrences calculated above according to TS 38.133 [84];

NOTE 1: The UE applies a single gap, which timing is relative to the MCG cells, even when configured with DC. In case of (NG)EN-DC, the UE may either be configured with a single (common) gap or with two separate gaps i.e. a first one for FR1 (configured by E-UTRA RRC) and a second one for FR2 (configured by NR RRC).

1> else if *measGapConfig* is set to *release*:

2> release the measurement gap configuration *measGapConfig*;

1> if *measGapConfigPerCC-List* is set to *setup*:

2> if a measurement gap configuration *measGapConfig* is already setup, release *measGapConfig*;

2> if *measGapConfigToRemoveList* is included:

3> for each *ServCellIndex* included in the *measGapConfigToRemoveList*:

4> release *measGapConfigCC* for the serving cell indicated by *servCellId*;

2> if *measGapConfigToAddModList* is included:

3> for each *ServCellIndex* included in the *measGapConfigToAddModList*:

4> store *measGapConfigCC* for the serving cell indicated by *servCellId*;

2> for each serving cell with stored *measGapConfigCC* indicating a non-uniform gap pattern, setup the measurement gap configuration indicated by the *measGapConfigCC* in accordance with the received *gapOffset*, i.e., the first subframe of the first gap of each non-uniform gap pattern occurs at an SFN and subframe meeting the following condition (SFN and subframe of MCG cells):

$SFN \bmod T = \text{FLOOR}(gapOffset/10);$

subframe =  $gapOffset \bmod 10;$

with  $T = LMGRP/10$  as defined in TS 36.133 [16];

- 2> for each serving cell with stored *measGapConfigCC* not indicating a non-uniform gap pattern, setup the measurement gap configuration indicated by the *measGapConfigCC* in accordance with the received *gapOffset*, i.e., the first subframe of each gap occurs at an SFN and subframe meeting the following condition (SFN and subframe of MCG cells):

$$\text{SFN mod } T = \text{FLOOR}(\text{gapOffset}/10);$$

$$\text{subframe} = \text{gapOffset mod } 10;$$

with  $T = \text{MGRP}/10$  as defined in TS 36.133 [16];

NOTE 2: The UE applies gap timing relative to the MCG cells, even when configured with DC.

- 1> else (*measGapConfigPerCC-List* is set to *release*):

- 2> release the measurement gap configuration *measGapConfigPerCC-List*;

NOTE 3: When a SCell is released, the UE is not required to apply a per CC measurement gap configuration associated to the SCell.

### 5.5.2.9a Measurement gap configuration for RSTD measurements with dense PRS configuration

The UE shall:

- 1> if *measGapConfigDensePRS* is set to *setup*:

- 2> setup the measurement gap configuration indicated by the *measGapConfigDensePRS* in accordance with the received *gapOffsetDensePRS*, i.e., the first subframe of each gap occurs at an SFN and subframe meeting the following condition:

$$\text{SFN mod } T = \text{FLOOR}(\text{gapOffsetDensePRS}/10);$$

$$\text{subframe} = \text{gapOffsetDensePRS mod } 10;$$

with  $T = \text{MGRP}/10$  as defined in TS 36.133 [16];

### 5.5.2.10 Discovery signals measurement timing configuration

The UE shall setup the discovery signals measurement timing configuration (DMTC) in accordance with the received *dmtc-PeriodOffset*, i.e., the first subframe of each DMTC occasion occurs at an SFN and subframe of the PCell meeting the following condition:

$$\text{SFN mod } T = \text{FLOOR}(\text{dmtc-Offset}/10);$$

$$\text{subframe} = \text{dmtc-Offset mod } 10;$$

with  $T = \text{dmtc-Periodicity}/10$ ;

On the concerned frequency, the UE shall not consider discovery signals transmission in subframes outside the DMTC occasion for measurements including RRM measurements.

### 5.5.2.11 RSSI measurement timing configuration

The UE shall setup the RSSI measurement timing configuration (RMTC) in accordance with the received *rmtc-Period*, *rmtc-SubframeOffset* if configured otherwise determined by the UE randomly, i.e. the first symbol of each RMTC occasion occurs at first symbol of an SFN and subframe of the PCell meeting the following condition:

$$\text{SFN mod } T = \text{FLOOR}(\text{rmtc-SubframeOffset}/10);$$

$$\text{subframe} = \text{rmtc-SubframeOffset mod } 10;$$

with  $T = \text{rmtc-Period}/10$ ;

On the concerned frequency, the UE shall not consider RSSI measurements outside the configured RMTC occasion which lasts for *measDuration* for RSSI and channel occupancy measurements.

For inter-RAT NR measurements, the UE shall setup the RMTC in accordance with the received *rmtc-PeriodicityNR*, and, if configured, with *rmtc-SubframeOffsetNR*, i.e. the first symbol of each RMTC occasion occurs at first symbol of an SFN and subframe of the PCell meeting the following condition:

$$\text{SFN mod } T = \text{FLOOR}(\text{rmtc-SubframeOffsetNR}/10);$$

$$\text{subframe} = \text{rmtc-SubframeOffsetNR mod } 10;$$

$$\text{with } T = \text{rmtc-PeriodicityNR}/10;$$

The UE derives the RSSI measurement duration from a combination of *measDurationNR* and *refSCS-CP-NR*. On the frequency configured by *rmtc-FrequencyNR*, the UE shall not consider RSSI measurements outside the configured RMTC occasion which lasts for *measDurationNR* for RSSI and channel occupancy measurements.

### 5.5.2.12 Measurement gap sharing configuration

The UE shall:

- 1> if *measGapSharingConfig* is set to *setup*:
  - 2> if a measurement gap sharing configuration is already setup, release the measurement gap sharing configuration;
  - 2> setup the measurement gap sharing configuration indicated by the *measGapSharingConfig* in accordance with the received *measGapSharingScheme* as defined in TS 36.133 [16];

NOTE: In case of (NG)EN-DC, the UE may either be configured with a single (common) gap sharing or with two separate gap sharing configurations, i.e. a first one for FR1 (configured by E-UTRA RRC) and a second one for FR2 (configured by NR RRC). For the case of per FR gap configuration, the gap sharing configured here (i.e. E-UTRA RRC) is applicable only for FR1 gap.

1> else:

- 2> release the measurement gap sharing configuration;

### 5.5.2.13 NR measurement timing configuration

The UE shall setup the first SS/PBCH block measurement timing configuration (SMTC) in accordance with the received *periodicityAndOffset* (providing *Periodicity* and *Offset* value for the following condition) in the *MTC-SSB-NR* configuration i.e., the first subframe of each SMTC occasion occurs at an SFN and subframe of the PCell meeting the following condition:

$$\text{SFN mod } T = \text{FLOOR}(\text{Offset}/10);$$

if the *Periodicity* is larger than *sf5*:

$$\text{subframe} = \text{Offset mod } 10;$$

else:

$$\text{subframe} = \text{Offset or } (\text{Offset} + 5);$$

with  $T = \text{CEIL}(\text{Periodicity}/10)$ .

On the concerned frequency, the UE shall not consider SS/PBCH block transmission in subframes outside the SMTC occasion which lasts for *ssb-Duration* for measurements including RRM measurements except for SFTD measurement (see TS 36.133 [16], clause 8.1.2.4.25.2 and 8.1.2.4.26.1).

If *smtc2-LP* is present, for cells indicated in the *pci-List* parameter in *smtc2-LP* for inter-RAT cell reselection, the UE shall setup an additional SS/PBCH block measurement timing configuration (SMTC) in accordance with the received *periodicity* parameter in the *smtc2-LP* configuration and use the *Offset* (derived from parameter *periodicityAndOffset*) and *ssb-Duration* parameter from the *measTimingConfig* configuration for that frequency. The first subframe of each

SMTTC occasion occurs at an SFN and subframe of the NR SpCell or serving cell (for cell reselection) meeting the above condition.

## 5.5.3 Performing measurements

### 5.5.3.1 General

For all measurements, except for UE Rx–Tx time difference measurements, RSSI, UL PDCP Packet Delay per QCI measurement, UL PDCP Packet Delay Value per DRB measurement, channel occupancy measurements, CBR measurement, sensing measurement and except for WLAN measurements of Band, Carrier Info, Available Admission Capacity, Backhaul Bandwidth, Channel Utilization, and Station Count, the UE applies the layer 3 filtering as specified in 5.5.3.2, before using the measured results for evaluation of reporting criteria, for measurement reporting or for evaluation of fulfilment of the criteria to trigger conditional reconfiguration execution. When performing measurements on NR carriers, the UE derives the cell quality as specified in 5.5.3.3 and the beam quality as specified in 5.5.3.4.

The UE shall:

- 1> whenever the UE has a *measConfig*, perform RSRP and RSRQ measurements for each serving cell as follows:
  - 2> for the PCell, apply the time domain measurement resource restriction in accordance with *measSubframePatternPCell*, if configured;
  - 2> if the UE supports CRS based discovery signals measurement:
    - 3> for each SCell in deactivated state, apply the discovery signals measurement timing configuration in accordance with *measDS-Config*, if configured within the *measObject* corresponding to the frequency of the SCell;
- 1> if the UE has a *measConfig* with *rs-sinr-Config* configured, perform RS-SINR (as indicated in the associated *reportConfig*) measurements as follows:
  - 2> perform the corresponding measurements on the frequency indicated in the associated *measObject* using available idle periods or using autonomous gaps as necessary;
- 1> for each *measId* included in the *measIdList* within *VarMeasConfig*:
  - 2> if the *purpose* for the associated *reportConfig* is set to *reportCGI*:
    - 3> if the RAT indicated in the associated *measObject* is not NR:
      - 4> if *si-RequestForHO* is configured for the associated *reportConfig*:
        - 5> perform the corresponding measurements on the frequency and RAT indicated in the associated *measObject* using autonomous gaps as necessary;
      - 4> else:
        - 5> perform the corresponding measurements on the frequency and RAT indicated in the associated *measObject* using available idle periods or using autonomous gaps as necessary;
    - 3> else:
      - 4> if *useAutonomousGapsNR* is configured for the associated *reportConfig*:
        - 5> perform the corresponding measurements on the NR frequency indicated in the associated *measObject* using autonomous gaps as necessary;
      - 4> else:
        - 5> perform the corresponding measurements on the NR frequency indicated in the associated *measObject* using available idle periods;

NOTE 1: If autonomous gaps are used to perform measurements, the UE is allowed to temporarily abort communication with all serving cell(s), i.e. create autonomous gaps to perform the corresponding measurements within the limits specified in TS 36.133 [16]. Otherwise, the UE only supports the measurements with the purpose set to *reportCGI* only if E-UTRAN has provided sufficient idle periods.

- 3> try to acquire the global cell identity of the cell indicated by the *cellForWhichToReportCGI* in the associated *measObject* by acquiring the relevant system information from the concerned cell;
- 3> if an entry in the *cellAccessRelatedInfoList* includes the selected PLMN, acquire the relevant system information from the concerned cell;
- 3> if the cell indicated by the *cellForWhichToReportCGI* included in the associated *measObject* is an E-UTRAN cell:
  - 4> try to acquire the CSG identity, if the CSG identity is broadcast in the concerned cell;
  - 4> try to acquire the *trackingAreaCode* in the concerned cell;
  - 4> try to acquire the list of additional PLMN Identities, as included in the *plmn-IdentityList*, if multiple PLMN identities are broadcast in the concerned cell;
  - 4> if *cellAccessRelatedInfoList* is included, use *trackingAreaCode* and *plmn-IdentityList* from the entry of *cellAccessRelatedInfoList* containing the selected PLMN;
  - 4> if the *includeMultiBandInfo* is configured:
    - 5> try to acquire the *freqBandIndicator* in the *SystemInformationBlockType1* of the concerned cell;
    - 5> try to acquire the list of additional frequency band indicators, as included in the *multiBandInfoList*, if multiple frequency band indicators are included in the *SystemInformationBlockType1* of the concerned cell;
    - 5> try to acquire the *freqBandIndicatorPriority*, if the *freqBandIndicatorPriority* is included in the *SystemInformationBlockType1* of the concerned cell;
  - 4> if *cellAccessRelatedInfoList-5GC* is broadcast in the concerned cell and the UE is E-UTRA/5GC capable:
    - 5> try to acquire the *cellAccessRelatedInfoList-5GC*;

NOTE 2: The 'primary' PLMN is part of the global cell identity.

- 3> if the cell indicated by the *cellForWhichToReportCGI* included in the associated *measObject* is a UTRAN cell:
  - 4> try to acquire the LAC, the RAC and the list of additional PLMN Identities, if multiple PLMN identities are broadcast in the concerned cell;
  - 4> try to acquire the CSG identity, if the CSG identity is broadcast in the concerned cell;
- 3> if the cell indicated by the *cellForWhichToReportCGI* included in the associated *measObject* is a GERAN cell:
  - 4> try to acquire the RAC in the concerned cell;
- 3> if the cell indicated by the *cellForWhichToReportCGI* included in the associated *measObject* is a CDMA2000 cell and the *cdma2000-Type* included in the *measObject* is *typeHRPD*:
  - 4> try to acquire the Sector ID in the concerned cell;
- 3> if the cell indicated by the *cellForWhichToReportCGI* included in the associated *measObject* is a CDMA2000 cell and the *cdma2000-Type* included in the *measObject* is *type1XRTT*:
  - 4> try to acquire the BASE ID, SID and NID in the concerned cell;
- 3> if the cell indicated by the *cellForWhichToReportCGI* included in the associated *MeasObject* is an NR cell:

- 4> if the indicated cell is broadcasting *SIB1* (see TS 38.213 [88], clause 13):
  - 5> try to acquire the *plmn-IdentityInfoList* including *plmn-IdentityList*, *trackingAreaCode* (if available), *ran-AreaCode* (if available) and *cellIdentity* for each entry of the *plmn-IdentityInfoList*;
  - 5> try to acquire the *frequencyBandList*, if multiple frequency bands are broadcasted in the concerned cell;
- 2> if the *ul-DelayConfig* is configured for the associated *reportConfig*:
  - 3> ignore the *measObject*;
  - 3> configure the PDCP layer to perform UL PDCP Packet Delay per QCI measurement;
- 2> if the *ul-DelayValueConfig* is configured for the associated *reportConfig*:
  - 3> ignore the *measObject*;
  - 3> configure the PDCP layer to perform UL PDCP Packet Delay value per DRB measurement;
- 2> else:
  - 3> if a measurement gap configuration is setup; or
  - 3> if the UE does not require measurement gaps to perform the concerned measurements:
    - 4> if *s-Measure* is not configured; or
    - 4> if the UE is not in NE-DC and the PCell RSRP, after layer 3 filtering, is lower than *s-Measure*; or
    - 4> if the UE is in NE-DC and the PSCell RSRP, after layer 3 filtering, is lower than *s-Measure*; or
    - 4> if the associated *measObject* concerns NR; or
    - 4> if *timeMeasConfig* is configured and *t-Service* is configured in *SystemInformationBlockType3*; or
    - 4> if *locationMeasConfig* is configured and *referenceLocation* and *distanceThresh* are present in *SystemInformationBlockType31*, and the distance between UE and serving cell *referenceLocation* is above *distanceThresh*; or
    - 4> if *measDS-Config* is configured in the associated *measObject*:
      - 5> if the UE supports CSI-RS based discovery signals measurement; and
      - 5> if the *eventId* in the associated *reportConfig* is set to *eventC1* or *eventC2*, or if *reportStrongestCSI-RSs* is set to *true* in the associated *reportConfig*:
        - 6> perform the corresponding measurements of CSI-RS resources on the frequency indicated in the concerned *measObject*, applying the discovery signals measurement timing configuration in accordance with *measDS-Config* in the concerned *measObject*;
        - 6> if *reportCRS-Meas* is set to *true* in the associated *reportConfig*, perform the corresponding measurements of neighbouring cells on the frequencies indicated in the concerned *measObject* as follows:
          - 7> for neighbouring cells on the primary frequency, apply the time domain measurement resource restriction in accordance with *measSubframePatternConfigNeigh*, if configured in the concerned *measObject*;
          - 7> apply the discovery signals measurement timing configuration in accordance with *measDS-Config* in the concerned *measObject*;
    - 5> else:
      - 6> perform the corresponding measurements of neighbouring cells on the frequencies and RATs indicated in the concerned *measObject* as follows:



- 7> for neighbouring cells on the primary frequency, apply the time domain measurement resource restriction in accordance with *measSubframePatternConfigNeigh*, if configured in the concerned *measObject*;
- 7> if the UE supports CRS based discovery signals measurement, apply the discovery signals measurement timing configuration in accordance with *measDS-Config*, if configured in the concerned *measObject*;

NOTE 2A: If *timeMeasConfig* is configured and *t-Service* is configured in *SystemInformationBlockType3*, the exact time to start measurements before *t-Service* is left up to UE implementation and *t-ServiceStartNeigh* may be used to decide when to start measurements.

- 4> if the *ue-RxTxTimeDiffPeriodical* is configured in the associated *reportConfig*:
  - 5> perform the UE Rx–Tx time difference measurements on the PCell;
- 4> if the *reportSSTD-Meas* is set to *true* or *pSCell* in the associated *reportConfig*:
  - 5> perform SSTD measurements between the PCell and the PSCell;
- 4> if the *reportSFTD-Meas* is set to *pSCell* in the associated *reportConfig*:
  - 5> perform SFTD measurements between the PCell and the NR PSCell;
- 4> if the *reportSFTD-Meas* is set to *neighborCells* in the associated *reportConfig*:
  - 5> perform SFTD measurements between the PCell and NR cell(s) on the frequency indicated in the associated *measObject*;
- 4> if the *measRSSI-ReportConfig* is configured in the associated *reportConfig*:
  - 5> perform the RSSI and channel occupancy measurements on the frequency indicated in the associated *measObject*;
- 2> perform the evaluation of reporting criteria as specified in 5.5.4, except if *reportConfig* is *condReconfigurationTriggerEUTRA* or *condReconfigurationTriggerNR*;

NOTE 2c: The evaluation of conditional reconfiguration execution criteria is specified in 5.3.5.9.4.

The UE capable of CBR measurement when configured to transmit non-P2X related V2X sidelink communication shall:

- 1> if in coverage on the frequency used for V2X sidelink communication transmission as defined in TS 36.304 [4], clause 11.4; or
- 1> if the concerned frequency is included in *v2x-InterFreqInfoList* in *RRCConnectionReconfiguration* or in *v2x-InterFreqInfoList* within *SystemInformationBlockType21* or *SystemInformationBlockType26*:
- 2> if the UE is in RRC\_IDLE:
  - 3> if the concerned frequency is the camped frequency:
    - 4> perform CBR measurement on the pools in *v2x-CommTxPoolNormalCommon* and *v2x-CommTxPoolExceptional* if included in *SystemInformationBlockType21*;
  - 3> else if *v2x-CommTxPoolNormal* or *v2x-CommTxPoolExceptional* is included in *v2x-InterFreqInfoList* for the concerned frequency within *SystemInformationBlockType21* or *SystemInformationBlockType26*:
    - 4> perform CBR measurement on pools in *v2x-CommTxPoolNormal* and *v2x-CommTxPoolExceptional* in *v2x-InterFreqInfoList* for the concerned frequency in *SystemInformationBlockType21* or *SystemInformationBlockType26*;
  - 3> else if the concerned frequency broadcasts *SystemInformationBlockType21*:
    - 4> perform CBR measurement on pools in *v2x-CommTxPoolNormalCommon* and *v2x-CommTxPoolExceptional* if included in *SystemInformationBlockType21* broadcast on the concerned frequency;

- 2> if the UE is in RRC\_CONNECTED:
  - 3> if *tx-ResourcePoolToAddList* is included in *VarMeasConfig*:
    - 4> perform CBR measurements on each resource pool indicated in *tx-ResourcePoolToAddList*;
  - 3> if the concerned frequency is the PCell's frequency:
    - 4> perform CBR measurement on the pools in *v2x-CommTxPoolNormalDedicated* or *v2x-SchedulingPool* if included in *RRCConnectionReconfiguration*, *v2x-CommTxPoolExceptional* if included in *SystemInformationBlockType21* for the concerned frequency and *v2x-CommTxPoolExceptional* if included in *mobilityControlInfoV2X*;
  - 3> else if *v2x-CommTxPoolNormal*, *v2x-SchedulingPool* or *v2x-CommTxPoolExceptional* is included in *v2x-InterFreqInfoList* for the concerned frequency within *RRCConnectionReconfiguration*:
    - 4> perform CBR measurement on pools in *v2x-CommTxPoolNormal*, *v2x-SchedulingPool*, and *v2x-CommTxPoolExceptional* if included in *v2x-InterFreqInfoList* for the concerned frequency in *RRCConnectionReconfiguration*;
  - 3> else if the concerned frequency broadcasts *SystemInformationBlockType21*:
    - 4> perform CBR measurement on pools in *v2x-CommTxPoolNormalCommon* and *v2x-CommTxPoolExceptional* if included in *SystemInformationBlockType21* for the concerned frequency;
- 1> else:
  - 2> perform CBR measurement on pools in *v2x-CommTxPoolList* in *SL-V2X-Preconfiguration* for the concerned frequency;

The UE capable of sensing measurement, with *commTxResources* set to *scheduled*, shall:

- 1> for each *measId* included in the *measIdList* within *VarMeasConfig*:
  - 2> if *measSensing-Config* is configured in the associated *measObject*
    - 3> perform the sensing measurement in accordance with TS 36.213 [23] on the pools of *v2x-SchedulingPool* and also indicated in *tx-ResourcePoolToAddList* in the associated *measObject*, using *sensingSubchannelNumber*, *sensingPeriodicity*, *sensingReselectionCounter* and *sensingPriority*.

If a UE that is configured by upper layers to transmit NR sidelink communication is configured by EUTRA with transmission resource pool(s) in *SystemInformationBlockType28* or by *sl-ConfigDedicatedForNR* and the measurements concerning NR sidelink communication (i.e. by *sl-ConfigDedicatedForNR*), it shall perform CBR measurement as specified in clause 5.5.3 of TS 38.331 [82], based on the transmission resource pool(s) in *SystemInformationBlockType28* or *sl-ConfigDedicatedForNR*.

NOTE 2a: *SIB12* specified in clause 5.5.3 of TS 38.331 is provided in *SystemInformationBlockType28*.

NOTE 2b: For NR sidelink communication, each of the CBR measurement results is associated with a resource pool, as indicated by the *sl-poolReportIdentity* (see TS 38.331 [82]), that refers to a pool as included in *sl-ConfigDedicatedForNR* or *SystemInformationBlockType28*.

NOTE 3: The *s-Measure* defines when the UE is required to perform measurements. The UE is however allowed to perform measurements also when the PCell RSRP (or PSCell RSRP, if the UE is in NE-DC) exceeds *s-Measure*, e.g., to measure cells broadcasting a CSG identity following use of the autonomous search function as defined in TS 36.304 [4].

NOTE 4: The UE may not perform the WLAN measurements it is configured with e.g. due to connection to another WLAN based on user preferences as specified in TS 23.402 [75] or due to turning off WLAN.

NOTE 5: In case the configurations for V2X sidelink communication are acquired from NR, the configurations for V2X sidelink communication in *SystemInformationBlockType21*, *SystemInformationBlockType26*, *SL-V2X-ConfigDedicated* within *RRCConnectionReconfiguration* used in this clause can be provided by *SIB13*, *SIB14*, *sl-ConfigDedicatedEUTRA* within *RRCReconfiguration* as specified in TS 38.331 [82], respectively.

### 5.5.3.2 Layer 3 filtering

The UE shall:

- 1> for each measurement quantity that the UE performs measurements according to 5.5.3.1:

NOTE 1: This does not include quantities configured solely for UE Rx-Tx time difference, SSTD measurements and RSSI, channel occupancy measurements, WLAN measurements of Band, Carrier Info, Available Admission Capacity, Backhaul Bandwidth, Channel Utilization, and Station Count, CBR measurement, sensing measurement, UL PDCP Packet Delay per QCI measurement and UL PDCP Packet Delay Value per DRB measurement i.e. for those types of measurements the UE ignores the *triggerQuantity* and *reportQuantity*.

- 2> filter the measured result, before using for evaluation of reporting criteria or for measurement reporting, by the following formula:

$$F_n = (1 - a) \cdot F_{n-1} + a \cdot M_n$$

where

$M_n$  is the latest received measurement result from the physical layer;

$F_n$  is the updated filtered measurement result, that is used for evaluation of reporting criteria or for measurement reporting;

$F_{n-1}$  is the old filtered measurement result, where  $F_0$  is set to  $M_1$  when the first measurement result from the physical layer is received; and

except for NR,  $a = 1/2^{(k/4)}$ , where  $k$  is the *filterCoefficient* for the corresponding measurement quantity received by the *quantityConfig*; for NR,  $a = 1/2^{(k_i/4)}$ , where  $k_i$  is the *filterCoefficient* for the corresponding measurement quantity of the  $i$ :th *QuantityConfigNR* in *quantityConfigNRList*, and  $i$  is indicated by *quantityConfigSet* in *MeasObjectNR*;

- 2> adapt the filter such that the time characteristics of the filter are preserved at different input rates, observing that the *filterCoefficient*  $k$  assumes a sample rate equal to 200 ms;

NOTE 2: If  $k$  is set to 0, no layer 3 filtering is applicable.

NOTE 3: The filtering is performed in the same domain as used for evaluation of reporting criteria or for measurement reporting, i.e., logarithmic filtering for logarithmic measurements.

NOTE 4: The filter input rate is implementation dependent, to fulfil the performance requirements set in TS 36.133 [16]. For further details about the physical layer measurements, see TS 36.133 [16].

### 5.5.3.3 Derivation of NR cell quality

The UE shall:

- 1> if the associated *measObject*, in RRC\_CONNECTED, or the associated entry in *measIdleCarrierListNR* within *VarMeasIdleConfig*, for measurements performed according to 5.6.20.2 in RRC\_IDLE or RRC\_INACTIVE, includes *maxRS-IndexCellQual*; and
- 1> if there are multiple detected NR-SS beams associated to the cell; and
- 1> if *threshRS-Index* is configured and if for more than one of the NR-SS beams the measured result exceeds this threshold:
  - 2> consider the cell quality to be the linear average of the power values of the, up to *maxRS-IndexCellQual*, best of the detected NR-SS beams exceeding *threshRS-Index*;
- 1> else:
  - 2> consider the cell quality to be the measurement result of the detected NR-SS beam, associated to the cell, with the highest measurement result;

### 5.5.3.4 Derivation of NR beam quality

The UE shall:

- 1> consider the beam quality to be the value resulting after layer 3 filtering, as specified in 5.5.3.2, of the measurement results of the concerned beam, where each result is averaged as described in TS 38.215 [89];

## 5.5.4 Measurement report triggering

### 5.5.4.1 General

If security has been activated successfully, the UE shall:

- 1> for each *measId* included in the *measIdList* within *VarMeasConfig*:
  - 2> if the corresponding *reportConfig* includes a purpose set to *reportStrongestCellsForSON*:
    - 3> consider any neighbouring cell detected on the associated frequency to be applicable;
  - 2> else if the corresponding *reportConfig* includes a purpose set to *reportCGI*:
    - 3> consider any neighbouring cell detected on the associated frequency/ set of frequencies (GERAN) which has a physical cell identity matching the value of the *cellForWhichToReportCGI* included in the corresponding *measObject* within the *VarMeasConfig* to be applicable;
  - 2> else:
    - 3> if the corresponding *measObject* concerns E-UTRA:
      - 4> if the *ue-RxTxTimeDiffPeriodical* is configured in the corresponding *reportConfig*:
        - 5> consider only the PCell to be applicable;
      - 4> else if the *reportSSTD-Meas* is set to *true* in the corresponding *reportConfig*:
        - 5> consider the PSCell to be applicable;
      - 4> else if the *eventA1* or *eventA2* is configured in the corresponding *reportConfig*:
        - 5> consider only the serving cell to be applicable;
      - 4> else if *eventC1* or *eventC2* is configured in the corresponding *reportConfig*; or if *reportStrongestCSI-RSs* is set to *true* in the corresponding *reportConfig*:
        - 5> consider a CSI-RS resource on the associated frequency to be applicable when the concerned CSI-RS resource is included in the *measCSI-RS-ToAddModList* defined within the *VarMeasConfig* for this *measId*;
      - 4> else if *measRSSI-ReportConfig* is configured in the corresponding *reportConfig*:
        - 5> consider the resource indicated by the *rmtc-Config* on the associated frequency to be applicable;
      - 4> else if the corresponding *reportConfig* includes *reportType* set to *periodical* or the *eventId* is set to measurement events other than *eventD1* and *eventD2*:
        - 5> if *useAllowedCellList* is set to *TRUE*:
          - 6> consider any neighbouring cell detected on the associated frequency to be applicable when the concerned cell is included in the *allowedCellsToAddModList* defined within the *VarMeasConfig* for this *measId*;
        - 5> else:
          - 6> consider any neighbouring cell detected on the associated frequency to be applicable when the concerned cell is not included in the *excludedCellsToAddModList* defined within the *VarMeasConfig* for this *measId*;

- 5> for events involving a serving cell on one frequency and neighbours on another frequency, consider the serving cell on the other frequency as a neighbouring cell;
- 4> if the corresponding *reportConfig* includes *alternativeTimeToTrigger* and if the UE supports *alternativeTimeToTrigger*:
  - 5> use the value of *alternativeTimeToTrigger* as the time to trigger instead of the value of *timeToTrigger* in the corresponding *reportConfig* for cells included in the *altTTT-CellsToAddModList* of the corresponding *measObject*;
- 3> else if the corresponding *measObject* concerns UTRA or CDMA2000:
  - 4> consider a neighbouring cell on the associated frequency to be applicable when the concerned cell is included in the *cellsToAddModList* defined within the *VarMeasConfig* for this *measId* (i.e. the cell is included in the allow-list);

NOTE 0: The UE may also consider a neighbouring cell on the associated UTRA frequency to be applicable when the concerned cell is included in the *csg-allowedReportingCells* within the *VarMeasConfig* for this *measId*, if configured in the corresponding *measObjectUTRA* (i.e. the cell is included in the range of physical cell identities for which reporting is allowed).

- 3> else if the corresponding *measObject* concerns GERAN:
  - 4> consider a neighbouring cell on the associated set of frequencies to be applicable when the concerned cell matches the *ncc-Permitted* defined within the *VarMeasConfig* for this *measId*;
- 3> else if the corresponding *measObject* concerns WLAN:
  - 4> consider a WLAN on the associated set of frequencies, as indicated by *carrierFreq* or on all WLAN frequencies when *carrierFreq* is not present, to be applicable if the WLAN matches all WLAN identifiers of at least one entry within *wlan-Id-List* for this *measId*;
- 3> else if the corresponding *measObject* concerns NR:
  - 4> if the *reportSFTD-Meas* is set to *pSCell* in the corresponding *reportConfigInterRAT*:
    - 5> consider the PSCell to be applicable;
  - 4> else if the *reportSFTD-Meas* is set to *neighborCells* in the corresponding *reportConfigInterRAT*:
    - 5> if *cellsForWhichToReportSFTD* is configured in the corresponding *measObjectNR*:
      - 6> consider any neighbouring NR cell on the associated frequency that is included in *cellsForWhichToReportSFTD* to be applicable;
    - 5> else:
      - 6> consider up to 3 strongest neighbouring NR cells detected on the associated frequency to be applicable when the concerned cells are not included in the *excludedCellsToAddModList* defined within the *VarMeasConfig* for this *measId*;
  - 4> else if *measRSSI-ReportConfigNR* is configured in the corresponding *reportConfigInterRAT*:
    - 5> consider the resource indicated by the *rmtc-ConfigNR* on the associated frequency to be applicable;
  - 4> else:
    - 5> if the *eventB1* or *eventB2* is configured in the corresponding *reportConfig*:
      - 6> consider a serving cell, if any, on the associated NR frequency as neighbouring cell;
    - 5> consider any neighbouring cell detected on the associated frequency to be applicable when the concerned cell is not included in the *excludedCellsToAddModList* defined within the *VarMeasConfig* for this *measId*;

- 2> if *tx-ResourcePoolToAddList* is configured in the *measObject*, and if the corresponding *reportConfig* includes a purpose set to *sidelink* or includes *eventV1* or *eventV2*:
  - 3> consider the transmission resource pools indicated by the *tx-ResourcePoolToAddList* defined within the *VarMeasConfig* for this *measId* to be applicable;
- 2> if the corresponding *reportConfig* includes a purpose set to *reportLocation*:
  - 3> consider only the PCell to be applicable;
- 2> if the *triggerType* is set to *event*, and if the corresponding *reportConfig* does not include *numberOfTriggeringCells*, and if the entry condition applicable for this event, i.e. the event corresponding with the *eventId* of the corresponding *reportConfig* within *VarMeasConfig*, is fulfilled for one or more applicable cells for all measurements after layer 3 filtering taken during *timeToTrigger* defined for this event within the *VarMeasConfig*, while the *VarMeasReportList* does not include a measurement reporting entry for this *measId* (a first cell triggers the event):
  - 3> include a measurement reporting entry within the *VarMeasReportList* for this *measId*;
  - 3> set the *numberOfReportsSent* defined within the *VarMeasReportList* for this *measId* to 0;
  - 3> include the concerned cell(s) in the *cellsTriggeredList* defined within the *VarMeasReportList* for this *measId*;
  - 3> if the UE supports T312 and if *useT312* is set to *true* for this event and if T310 is running:
    - 4> if T312 is not running:
      - 5> start timer T312 with the value configured in the corresponding *measObject*;
  - 3> initiate the measurement reporting procedure, as specified in 5.5.5;
- 2> if the *triggerType* is set to *event*, and if the corresponding *reportConfig* does not include *numberOfTriggeringCells*, and if the entry condition applicable for this event, i.e. the event corresponding with the *eventId* of the corresponding *reportConfig* within *VarMeasConfig*, is fulfilled for one or more applicable cells not included in the *cellsTriggeredList* for all measurements after layer 3 filtering taken during *timeToTrigger* defined for this event within the *VarMeasConfig* (a subsequent cell triggers the event):
  - 3> set the *numberOfReportsSent* defined within the *VarMeasReportList* for this *measId* to 0;
  - 3> include the concerned cell(s) in the *cellsTriggeredList* defined within the *VarMeasReportList* for this *measId*;
  - 3> if the UE supports T312 and if *useT312* is set to *true* for this event and if T310 is running:
    - 4> if T312 is not running:
      - 5> start timer T312 with the value configured in the corresponding *measObject*;
  - 3> initiate the measurement reporting procedure, as specified in 5.5.5;
- 2> if the *triggerType* is set to *event* and if the corresponding *reportConfig* includes *numberOfTriggeringCells*, and if the entry condition applicable for this event, i.e. the event corresponding with the *eventId* of the corresponding *reportConfig* within *VarMeasConfig*, is fulfilled for one or more applicable cells for all measurements after layer 3 filtering taken during *timeToTrigger* defined for this event within the *VarMeasConfig*:
  - 3> If the *VarMeasReportList* does not include a measurement reporting entry for this *measId* (a first cell triggers the event):
    - 4> include a measurement reporting entry within the *VarMeasReportList* for this *measId*;
  - 3> If the number of cell(s) in the *cellsTriggeredList* is larger than or equal to *numberOfTriggeringCells*:
    - 4> include the concerned cell(s) in the *cellsTriggeredList* defined within the *VarMeasReportList* for this *measId*;

- 3> else:
  - 4> include the concerned cell(s) in the *cellsTriggeredList* defined within the *VarMeasReportList* for this *measId*;
  - 4> If the number of cell(s) in the *cellsTriggeredList* is larger than or equal to *numberOfTriggeringCells*:
    - 5> set the *numberOfReportsSent* defined within the *VarMeasReportList* for this *measId* to 0;
    - 5> initiate the measurement reporting procedure, as specified in 5.5.5;
- 2> if the *triggerType* is set to *event* and if the leaving condition applicable for this event is fulfilled for one or more of the cells included in the *cellsTriggeredList* defined within the *VarMeasReportList* for this *measId* for all measurements after layer 3 filtering taken during *timeToTrigger* defined within the *VarMeasConfig* for this event:
  - 3> remove the concerned cell(s) in the *cellsTriggeredList* defined within the *VarMeasReportList* for this *measId*;
  - 3> if *reportOnLeave* is set to *TRUE* for the corresponding reporting configuration or if *a6-ReportOnLeave* is set to *TRUE* or if *a4-a5-ReportOnLeave* is set to *TRUE* for the corresponding reporting configuration:
    - 4> initiate the measurement reporting procedure, as specified in 5.5.5;
  - 3> if the *cellsTriggeredList* defined within the *VarMeasReportList* for this *measId* is empty:
    - 4> remove the measurement reporting entry within the *VarMeasReportList* for this *measId*;
    - 4> stop the periodical reporting timer for this *measId*, if running;
- 2> if the *triggerType* is set to *event* and if the entry condition applicable for this event, i.e. the event corresponding with the *eventId* of the corresponding *reportConfig* within *VarMeasConfig*, is fulfilled for one or more applicable CSI-RS resources for all measurements after layer 3 filtering taken during *timeToTrigger* defined for this event within the *VarMeasConfig*, while the *VarMeasReportList* does not include a measurement reporting entry for this *measId* (i.e. a first CSI-RS resource triggers the event):
  - 3> include a measurement reporting entry within the *VarMeasReportList* for this *measId*;
  - 3> set the *numberOfReportsSent* defined within the *VarMeasReportList* for this *measId* to 0;
  - 3> include the concerned CSI-RS resource(s) in the *csi-RS-TriggeredList* defined within the *VarMeasReportList* for this *measId*;
  - 3> initiate the measurement reporting procedure, as specified in 5.5.5;
- 2> if the *triggerType* is set to *event* and if the entry condition applicable for this event, i.e. the event corresponding with the *eventId* of the corresponding *reportConfig* within *VarMeasConfig*, is fulfilled for one or more applicable CSI-RS resources not included in the *csi-RS-TriggeredList* for all measurements after layer 3 filtering taken during *timeToTrigger* defined for this event within the *VarMeasConfig* (i.e. a subsequent CSI-RS resource triggers the event):
  - 3> set the *numberOfReportsSent* defined within the *VarMeasReportList* for this *measId* to 0;
  - 3> include the concerned CSI-RS resource(s) in the *csi-RS-TriggeredList* defined within the *VarMeasReportList* for this *measId*;
  - 3> initiate the measurement reporting procedure, as specified in 5.5.5;
- 2> if the *triggerType* is set to *event* and if the leaving condition applicable for this event is fulfilled for one or more of the CSI-RS resources included in the *csi-RS-TriggeredList* defined within the *VarMeasReportList* for this *measId* for all measurements after layer 3 filtering taken during *timeToTrigger* defined within the *VarMeasConfig* for this event:
  - 3> remove the concerned CSI-RS resource(s) in the *csi-RS-TriggeredList* defined within the *VarMeasReportList* for this *measId*;

- 3> if *c1-ReportOnLeave* is set to *TRUE* for the corresponding reporting configuration or if *c2-ReportOnLeave* is set to *TRUE* for the corresponding reporting configuration:
  - 4> initiate the measurement reporting procedure, as specified in 5.5.5;
- 3> if the *csi-RS-TriggeredList* defined within the *VarMeasReportList* for this *measId* is empty:
  - 4> remove the measurement reporting entry within the *VarMeasReportList* for this *measId*;
  - 4> stop the periodical reporting timer for this *measId*, if running;
- 2> if the *triggerType* is set to *event* and if the entry condition applicable for this event, i.e. the event corresponding with the *eventId* of the corresponding *reportConfig* within *VarMeasConfig*, is fulfilled for one or more applicable transmission resource pools for all measurements taken during *timeToTrigger* defined for this event within the *VarMeasConfig*, while the *VarMeasReportList* does not include a measurement reporting entry for this *measId* (a first transmission resource pool triggers the event):
  - 3> include a measurement reporting entry within the *VarMeasReportList* for this *measId*;
  - 3> set the *numberOfReportsSent* defined within the *VarMeasReportList* for this *measId* to 0;
  - 3> include the concerned transmission resource pool(s) in the *poolsTriggeredList* defined within the *VarMeasReportList* for this *measId*;
  - 3> initiate the measurement reporting procedure, as specified in 5.5.5;
- 2> if the *triggerType* is set to *event* and if the entry condition applicable for this event, i.e. the event corresponding with the *eventId* of the corresponding *reportConfig* within *VarMeasConfig*, is fulfilled for one or more applicable transmission resource pools not included in the *poolsTriggeredList* for all measurements taken during *timeToTrigger* defined for this event within the *VarMeasConfig* (a subsequent transmission resource pool triggers the event):
  - 3> set the *numberOfReportsSent* defined within the *VarMeasReportList* for this *measId* to 0;
  - 3> include the concerned transmission resource pool(s) in the *poolsTriggeredList* defined within the *VarMeasReportList* for this *measId*;
  - 3> initiate the measurement reporting procedure, as specified in 5.5.5;
- 2> if the *triggerType* is set to *event* and if the leaving condition applicable for this event is fulfilled for one or more applicable transmission resource pools included in the *poolsTriggeredList* defined within the *VarMeasReportList* for this *measId* for all measurements taken during *timeToTrigger* defined within the *VarMeasConfig* for this event:
  - 3> remove the concerned transmission resource pool(s) from the *poolsTriggeredList* defined within the *VarMeasReportList* for this *measId*;
  - 3> if the *poolsTriggeredList* defined within the *VarMeasReportList* for this *measId* is empty:
    - 4> remove the measurement reporting entry within the *VarMeasReportList* for this *measId*;
    - 4> stop the periodical reporting timer for this *measId*, if running;

NOTE 1: Void.

- 2> if the *triggerType* is set to *event* and if the *eventId* is set to *eventD1* or *eventD2* or *eventH1* or *eventH2* and if the entering condition applicable for this event, i.e. the event corresponding with the *eventId* of the corresponding *reportConfig* within *VarMeasConfig*, is fulfilled during *timeToTrigger* defined within the *VarMeasConfig* for this event, while the *VarMeasReportList* does not include a measurement reporting entry for this *measId*:
  - 3> include a measurement reporting entry within the *VarMeasReportList* for this *measId*;
  - 3> set the *numberOfReportsSent* defined within the *VarMeasReportList* for this *measId* to 0;
  - 3> initiate the measurement reporting procedure, as specified in 5.5.5;



- 2> if the *triggerType* is set to *event* and if the *eventId* is set to *eventD1* or *eventD2* or *eventH1* or *eventH2* and if the leaving condition applicable for this event, i.e. the event corresponding with the *eventId* of the corresponding *reportConfig* within *VarMeasConfig*, is fulfilled during *timeToTrigger* defined within the *VarMeasConfig* for this event:
  - 3> if the *eventId* is set to *eventD1* or *eventD2* and *reportOnLeave* is set to *TRUE* for the corresponding reporting configuration:
    - 4> initiate the measurement reporting procedure, as specified in 5.5.5;
  - 3> remove the measurement reporting entry within the *VarMeasReportList* for this *measId*;
  - 3> stop the periodical reporting timer for this *measId*, if running;
- 2> if *measRSSI-ReportConfig* is included and if a (first) measurement result is available:
  - 3> include a measurement reporting entry within the *VarMeasReportList* for this *measId*;
  - 3> set the *numberOfReportsSent* defined within the *VarMeasReportList* for this *measId* to 0;
  - 3> initiate the measurement reporting procedure as specified in 5.5.5 immediately when RSSI sample values are reported by the physical layer after the first L1 measurement duration;
- 2> if *measRSSI-ReportConfigNR* is included and if a (first) measurement result is available:
  - 3> include a measurement reporting entry within the *VarMeasReportList* for this *measId*;
  - 3> set the *numberOfReportsSent* defined within the *VarMeasReportList* for this *measId* to 0;
  - 3> initiate the measurement reporting procedure as specified in 5.5.5 immediately when RSSI sample values are reported by the physical layer after the first L1 measurement duration;
- 2> else if the *purpose* is included and set to *reportStrongestCells*, *reportStrongestCellsForSON*, *reportLocation*, *sidelink* or *sensing* and if a (first) measurement result is available:
  - 3> include a measurement reporting entry within the *VarMeasReportList* for this *measId*;
  - 3> set the *numberOfReportsSent* defined within the *VarMeasReportList* for this *measId* to 0;
  - 3> if the *purpose* is set to *reportStrongestCells* and *reportStrongestCSI-RSs* is set to *FALSE*:
    - 4> if the *triggerType* is set to *periodical* and the corresponding *reportConfig* includes the *ul-DelayConfig*:
      - 5> initiate the measurement reporting procedure, as specified in 5.5.5, immediately after a first measurement result is provided by lower layers;
    - 4> if the *triggerType* is set to *periodical* and the corresponding *reportConfig* includes the *ul-DelayValueConfig*:
      - 5> initiate the measurement reporting procedure, as specified in 5.5.5, immediately after a first measurement result is provided by lower layers of the associated DRB identity;
  - 4> else if the corresponding measurement object concerns WLAN:
    - 5> initiate the measurement reporting procedure, as specified in 5.5.5, immediately after the quantity to be reported becomes available for the PCell and for the applicable WLAN(s);
- 4> else if the *reportAmount* exceeds 1:
  - 5> initiate the measurement reporting procedure, as specified in 5.5.5, immediately after the quantity to be reported becomes available for the PCell;
- 4> else (i.e. the *reportAmount* is equal to 1):
  - 5> initiate the measurement reporting procedure, as specified in 5.5.5, immediately after the quantity to be reported becomes available for the PCell and for the strongest cell among the applicable

cells, or becomes available for the pair of PCell and the PSCell in case of SSTD measurements, or becomes available for each requested pair of PCell and NR cell or the maximal measurement reporting delay as specified in TS 36.133 [16], clause 8.17.2.3 in case of SFTD measurements;

- 3> if the *purpose* is set to *reportLocation*, *sidelink* or *sensing*:
  - 4> if the *purpose* is set to *reportLocation*:
    - 5> initiate the measurement reporting procedure, as specified in 5.5.5, immediately after both the quantity to be reported for the PCell and the location information become available;
  - 4> else if the *purpose* is set to *sidelink*:
    - 5> initiate the measurement reporting procedure as specified in 5.5.5 immediately after both the quantity to be reported for the PCell and the CBR measurement result become available;
  - 4> else if the *purpose* is set to *sensing*:
    - 5> initiate the measurement reporting procedure as specified in 5.5.5 immediately after both the quantity to be reported for the PCell and the sensing measurement result become available;
- 3> else if the *purpose* is not set to *reportStrongestCells* or *reportStrongestCSI-RSs* is set to *true*:
  - 4> initiate the measurement reporting procedure, as specified in 5.5.5, when it has determined the strongest cells on the associated frequency;
- 2> upon expiry of the periodical reporting timer for this *measId*:
  - 3> initiate the measurement reporting procedure, as specified in 5.5.5;
- 2> if the *purpose* is included and set to *reportCGI*:
  - 3> if the UE acquired the information needed to set all fields of *cgi-Info* for the requested cell; or
  - 3> if the UE detects that the requested NR cell is not transmitting *SIB1*:
    - 4> include a measurement reporting entry within the *VarMeasReportList* for this *measId*;
    - 4> set the *numberOfReportsSent* defined within the *VarMeasReportList* for this *measId* to 0;
    - 4> stop timer T321;
    - 4> initiate the measurement reporting procedure, as specified in 5.5.5;
- 2> upon expiry of the T321 for this *measId*:
  - 3> include a measurement reporting entry within the *VarMeasReportList* for this *measId*;
  - 3> set the *numberOfReportsSent* defined within the *VarMeasReportList* for this *measId* to 0;
  - 3> initiate the measurement reporting procedure, as specified in 5.5.5;

NOTE 2: The UE does not stop the periodical reporting with *triggerType* set to *event* or to *periodical* while the corresponding measurement is not performed due to the PCell RSRP (or PSCell RSRP, if the UE is in NE-DC) being equal to or better than *s-Measure* or due to the measurement gap not being setup.

NOTE 3: If the UE is configured with DRX, the UE may delay the measurement reporting for event triggered and periodical triggered measurements until the Active Time, which is defined in TS 36.321 [6].

#### 5.5.4.2 Event A1 (Serving becomes better than threshold)

The UE shall:

- 1> consider the entering condition for this event to be satisfied when condition A1-1, as specified below, is fulfilled;
- 1> consider the leaving condition for this event to be satisfied when condition A1-2, as specified below, is fulfilled;

- 1> for this measurement, consider the primary or secondary cell that is configured on the frequency indicated in the associated *measObjectEUTRA* to be the serving cell;

Inequality A1-1 (Entering condition)

$$Ms - Hys > Thresh$$

Inequality A1-2 (Leaving condition)

$$Ms + Hys < Thresh$$

The variables in the formula are defined as follows:

***Ms*** is the measurement result of the serving cell, not taking into account any offsets.

***Hys*** is the hysteresis parameter for this event (i.e. *hysteresis* as defined within *reportConfigEUTRA* for this event).

***Thresh*** is the threshold parameter for this event (i.e. *a1-Threshold* as defined within *reportConfigEUTRA* for this event).

***Ms*** is expressed in dBm in case of RSRP, or in dB in case of RSRQ and RS-SINR.

***Hys*** is expressed in dB.

***Thresh*** is expressed in the same unit as ***Ms***.

#### 5.5.4.3 Event A2 (Serving becomes worse than threshold)

The UE shall:

- 1> consider the entering condition for this event to be satisfied when condition A2-1, as specified below, is fulfilled;
- 1> consider the leaving condition for this event to be satisfied when condition A2-2, as specified below, is fulfilled;
- 1> for this measurement, consider the primary or secondary cell that is configured on the frequency indicated in the associated *measObjectEUTRA* to be the serving cell;

Inequality A2-1 (Entering condition)

$$Ms + Hys < Thresh$$

Inequality A2-2 (Leaving condition)

$$Ms - Hys > Thresh$$

The variables in the formula are defined as follows:

***Ms*** is the measurement result of the serving cell, not taking into account any offsets.

***Hys*** is the hysteresis parameter for this event (i.e. *hysteresis* as defined within *reportConfigEUTRA* for this event).

***Thresh*** is the threshold parameter for this event (i.e. *a2-Threshold* as defined within *reportConfigEUTRA* for this event).

***Ms*** is expressed in dBm in case of RSRP, or in dB in case of RSRQ and RS-SINR.

***Hys*** is expressed in dB.

***Thresh*** is expressed in the same unit as ***Ms***.

#### 5.5.4.4 Event A3 (Neighbour becomes offset better than PCell/ PSCell)

The UE shall:

- 1> consider the entering condition for this event to be satisfied when condition A3-1, as specified below, is fulfilled;
- 1> consider the leaving condition for this event to be satisfied when condition A3-2, as specified below, is fulfilled;

- 1> if *usePSCell* of the corresponding *reportConfig* is set to *true*:
- 2> use the PSCell for *Mp*, *Ofp* and *Ocp*;
- 1> else:

- 2> use the PCell for *Mp*, *Ofp* and *Ocp*;

NOTE 1: The cell(s) that triggers the event is on the frequency indicated in the associated *measObject* which may be different from the frequency used by the PCell/ PSCell.

Inequality A3-1 (Entering condition)

$$Mn + Ofn + Ocn - Hys > Mp + Ofp + Ocp + Off$$

Inequality A3-2 (Leaving condition)

$$Mn + Ofn + Ocn + Hys < Mp + Ofp + Ocp + Off$$

The variables in the formula are defined as follows:

***Mn*** is the measurement result of the neighbouring cell, not taking into account any offsets.

***Ofn*** is the frequency specific offset of the frequency of the neighbour cell (i.e. *offsetFreq* as defined within *measObjectEUTRA* corresponding to the frequency of the neighbour cell).

***Ocn*** is the cell specific offset of the neighbour cell (i.e. *cellIndividualOffset* as defined within *measObjectEUTRA* corresponding to the frequency of the neighbour cell), and set to zero if not configured for the neighbour cell.

***Mp*** is the measurement result of the PCell/ PSCell, not taking into account any offsets.

***Ofp*** is the frequency specific offset of the frequency of the PCell/ PSCell (i.e. *offsetFreq* as defined within *measObjectEUTRA* corresponding to the frequency of the PCell/ PSCell).

***Ocp*** is the cell specific offset of the PCell/ PSCell (i.e. *cellIndividualOffset* as defined within *measObjectEUTRA* corresponding to the frequency of the PCell/ PSCell), and is set to zero if not configured for the PCell/ PSCell.

***Hys*** is the hysteresis parameter for this event (i.e. *hysteresis* as defined within *reportConfigEUTRA* for this event).

***Off*** is the offset parameter for this event (i.e. *a3-Offset* as defined within *reportConfigEUTRA* for this event).

***Mn*, *Mp*** are expressed in dBm in case of RSRP, or in dB in case of RSRQ and RS-SINR.

***Ofn*, *Ocn*, *Ofp*, *Ocp*, *Hys*, *Off*** are expressed in dB.

NOTE 2: The definition of Event A3 also applies to CondEvent A3.

#### 5.5.4.5 Event A4 (Neighbour becomes better than threshold)

The UE shall:

- 1> consider the entering condition for this event to be satisfied when condition A4-1, as specified below, is fulfilled;
- 1> consider the leaving condition for this event to be satisfied when condition A4-2, as specified below, is fulfilled;

Inequality A4-1 (Entering condition)

$$Mn + Ofn + Ocn - Hys > Thresh$$

Inequality A4-2 (Leaving condition)

$$Mn + Ofn + Ocn + Hys < Thresh$$

The variables in the formula are defined as follows:

***Mn*** is the measurement result of the neighbouring cell, not taking into account any offsets.

**Ofn** is the frequency specific offset of the frequency of the neighbour cell (i.e. *offsetFreq* as defined within *measObjectEUTRA* corresponding to the frequency of the neighbour cell).

**Ocn** is the cell specific offset of the neighbour cell (i.e. *cellIndividualOffset* as defined within *measObjectEUTRA* corresponding to the frequency of the neighbour cell), and set to zero if not configured for the neighbour cell.

**Hys** is the hysteresis parameter for this event (i.e. *hysteresis* as defined within *reportConfigEUTRA* for this event).

**Thresh** is the threshold parameter for this event (i.e. *a4-Threshold* as defined within *reportConfigEUTRA* for this event).

**Mn** is expressed in dBm in case of RSRP, or in dB in case of RSRQ and RS-SINR.

**Ofn, Ocn, Hys** are expressed in dB.

**Thresh** is expressed in the same unit as **Mn**.

NOTE : The definition of Event A4 also applies to CondEvent A4.

#### 5.5.4.6 Event A5 (PCell/ PSCell becomes worse than threshold1 and neighbour becomes better than threshold2)

The UE shall:

- 1> consider the entering condition for this event to be satisfied when both condition A5-1 and condition A5-2, as specified below, are fulfilled;
- 1> consider the leaving condition for this event to be satisfied when condition A5-3 or condition A5-4, i.e. at least one of the two, as specified below, is fulfilled;
- 1> if *usePSCell* of the corresponding *reportConfig* is set to *true*:
  - 2> use the PSCell for *Mp*;
- 1> else:
  - 2> use the PCell for *Mp*;

NOTE 1: The cell(s) that triggers the event is on the frequency indicated in the associated *measObject* which may be different from the frequency used by the PCell/ PSCell.

Inequality A5-1 (Entering condition 1)

$$M_p + H_{ys} < Thresh_1$$

Inequality A5-2 (Entering condition 2)

$$M_n + O_{fn} + O_{cn} - H_{ys} > Thresh_2$$

Inequality A5-3 (Leaving condition 1)

$$M_p - H_{ys} > Thresh_1$$

Inequality A5-4 (Leaving condition 2)

$$M_n + O_{fn} + O_{cn} + H_{ys} < Thresh_2$$

The variables in the formula are defined as follows:

**Mp** is the measurement result of the PCell/ PSCell, not taking into account any offsets.

**Mn** is the measurement result of the neighbouring cell, not taking into account any offsets.

**Ofn** is the frequency specific offset of the frequency of the neighbour cell (i.e. *offsetFreq* as defined within *measObjectEUTRA* corresponding to the frequency of the neighbour cell).

**Ocn** is the cell specific offset of the neighbour cell (i.e. *cellIndividualOffset* as defined within *measObjectEUTRA* corresponding to the frequency of the neighbour cell), and set to zero if not configured for the neighbour cell.

**Hys** is the hysteresis parameter for this event (i.e. *hysteresis* as defined within *reportConfigEUTRA* for this event).

**Thresh1** is the threshold parameter for this event (i.e. *a5-Threshold1* as defined within *reportConfigEUTRA* for this event).

**Thresh2** is the threshold parameter for this event (i.e. *a5-Threshold2* as defined within *reportConfigEUTRA* for this event).

**Mn, Mp** are expressed in dBm in case of RSRP, or in dB in case of RSRQ and RS-SINR.

**Ofn, Ocn, Hys** are expressed in dB.

**Thresh1** is expressed in the same unit as **Mp**.

**Thresh2** is expressed in the same unit as **Mn**.

NOTE 2: The definition of Event A5 also applies to CondEvent A5.

#### 5.5.4.6a Event A6 (Neighbour becomes offset better than SCell)

The UE shall:

1> consider the entering condition for this event to be satisfied when condition A6-1, as specified below, is fulfilled;

1> consider the leaving condition for this event to be satisfied when condition A6-2, as specified below, is fulfilled;

1> for this measurement, consider the (secondary) cell that is configured on the frequency indicated in the associated *measObjectEUTRA* to be the serving cell;

NOTE: The neighbour(s) is on the same frequency as the SCell i.e. both are on the frequency indicated in the associated *measObject*.

Inequality A6-1 (Entering condition)

$$Mn + Ocn - Hys > Ms + Ocs + Off$$

Inequality A6-2 (Leaving condition)

$$Mn + Ocn + Hys < Ms + Ocs + Off$$

The variables in the formula are defined as follows:

**Mn** is the measurement result of the neighbouring cell, not taking into account any offsets.

**Ocn** is the cell specific offset of the neighbour cell (i.e. *cellIndividualOffset* as defined within *measObjectEUTRA* corresponding to the frequency of the neighbour cell), and set to zero if not configured for the neighbour cell.

**Ms** is the measurement result of the serving cell, not taking into account any offsets.

**Ocs** is the cell specific offset of the serving cell (i.e. *cellIndividualOffset* as defined within *measObjectEUTRA* corresponding to the serving frequency), and is set to zero if not configured for the serving cell.

**Hys** is the hysteresis parameter for this event (i.e. *hysteresis* as defined within *reportConfigEUTRA* for this event).

**Off** is the offset parameter for this event (i.e. *a6-Offset* as defined within *reportConfigEUTRA* for this event).

**Mn, Ms** are expressed in dBm in case of RSRP, or in dB in case of RSRQ and RS-SINR.

**Ocn, Ocs, Hys, Off** are expressed in dB.

#### 5.5.4.7 Event B1 (Inter RAT neighbour becomes better than threshold)

The UE shall:

- 1> for UTRA and CDMA2000, only trigger the event for cells included in the corresponding measurement object;
- 1> consider the entering condition for this event to be satisfied when condition B1-1, as specified below, is fulfilled;
- 1> consider the leaving condition for this event to be satisfied when condition B1-2, as specified below, is fulfilled;

Inequality B1-1 (Entering condition)

$$Mn + Ofn + Ocn - Hys > Thresh$$

Inequality B1-2 (Leaving condition)

$$Mn + Ofn + Ocn + Hys < Thresh$$

The variables in the formula are defined as follows:

**Mn** is the measurement result of the inter-RAT neighbour cell, not taking into account any offsets. For CDMA 2000 measurement result, *pilotStrength* is divided by -2.

**Ofn** is the frequency specific offset of the frequency of the inter-RAT neighbour cell (i.e. *offsetFreq* as defined within the *measObject* corresponding to the frequency of the neighbour inter-RAT cell).

**Ocn** is the cell specific offset of the inter-RAT NR neighbour cell (i.e. *cellIndividualOffset* as defined within the *measObjectNR* corresponding to the neighbour inter-RAT cell), and set to zero if not configured for the neighbour cell.

**Hys** is the hysteresis parameter for this event (i.e. *hysteresis* as defined within *reportConfigInterRAT* for this event).

**Thresh** is the threshold parameter for this event (i.e. *b1-Threshold* as defined within *reportConfigInterRAT* for this event). For CDMA2000, *b1-Threshold* is divided by -2.

**Mn** is expressed in dBm or in dB, depending on the measurement quantity of the inter-RAT neighbour cell.

**Ofn, Ocn, Hys** are expressed in dB.

**Thresh** is expressed in the same unit as **Mn**.

#### 5.5.4.8 Event B2 (PCell becomes worse than threshold1 and inter RAT neighbour becomes better than threshold2)

The UE shall:

- 1> for UTRA and CDMA2000, only trigger the event for cells included in the corresponding measurement object;
- 1> consider the entering condition for this event to be satisfied when both condition B2-1 and condition B2-2, as specified below, are fulfilled;
- 1> consider the leaving condition for this event to be satisfied when condition B2-3 or condition B2-4, i.e. at least one of the two, as specified below, is fulfilled;

Inequality B2-1 (Entering condition 1)

$$Mp + Hys < Thresh1$$

Inequality B2-2 (Entering condition 2)

$$Mn + Ofn + Ocn - Hys > Thresh2$$

Inequality B2-3 (Leaving condition 1)

$$Mp - Hys > Thresh1$$

Inequality B2-4 (Leaving condition 2)

$$Mn + Ofn + Ocn + Hys < Thresh2$$

The variables in the formula are defined as follows:

***M<sub>p</sub>*** is the measurement result of the PCell, not taking into account any offsets.

***M<sub>n</sub>*** is the measurement result of the inter-RAT neighbour cell, not taking into account any offsets. For CDMA2000 measurement result, *pilotStrength* is divided by -2.

***Ofn*** is the frequency specific offset of the frequency of the inter-RAT neighbour cell (i.e. *offsetFreq* as defined within the *measObject* corresponding to the frequency of the inter-RAT neighbour cell).

***Ocn*** is the cell specific offset of the inter-RAT NR neighbour cell (i.e. *cellIndividualOffset* as defined within the *measObjectNR* corresponding to the neighbour inter-RAT cell), and set to zero if not configured for the neighbour cell.

***Hys*** is the hysteresis parameter for this event (i.e. *hysteresis* as defined within *reportConfigInterRAT* for this event).

***Thresh1*** is the threshold parameter for this event (i.e. *b2-Threshold1* as defined within *reportConfigInterRAT* for this event).

***Thresh2*** is the threshold parameter for this event (i.e. *b2-Threshold2* as defined within *reportConfigInterRAT* for this event). For CDMA2000, *b2-Threshold2* is divided by -2.

***M<sub>p</sub>*** is expressed in dBm in case of RSRP, or in dB in case of RSRQ.

***M<sub>n</sub>*** is expressed in dBm or dB, depending on the measurement quantity of the inter-RAT neighbour cell.

***Ofn, Ocn, Hys*** are expressed in dB.

***Thresh1*** is expressed in the same unit as ***M<sub>p</sub>***.

***Thresh2*** is expressed in the same unit as ***M<sub>n</sub>***.

#### 5.5.4.9 Event C1 (CSI-RS resource becomes better than threshold)

The UE shall:

1> consider the entering condition for this event to be satisfied when condition C1-1, as specified below, is fulfilled;

1> consider the leaving condition for this event to be satisfied when condition C1-2, as specified below, is fulfilled;

Inequality C1-1 (Entering condition)

$$Mcr + Ocr - Hys > Thresh$$

Inequality C1-2 (Leaving condition)

$$Mcr + Ocr + Hys < Thresh$$

The variables in the formula are defined as follows:

***M<sub>cr</sub>*** is the measurement result of the CSI-RS resource, not taking into account any offsets.

***Ocr*** is the CSI-RS specific offset (i.e. *csi-RS-IndividualOffset* as defined within *measObjectEUTRA* corresponding to the frequency of the CSI-RS resource), and set to zero if not configured for the CSI-RS resource.

***Hys*** is the hysteresis parameter for this event (i.e. *hysteresis* as defined within *reportConfigEUTRA* for this event).

***Thresh*** is the threshold parameter for this event (i.e. *c1-Threshold* as defined within *reportConfigEUTRA* for this event).

***M<sub>cr</sub>, Thresh*** are expressed in dBm.

***Ocr, Hys*** are expressed in dB.

#### 5.5.4.10 Event C2 (CSI-RS resource becomes offset better than reference CSI-RS resource)

The UE shall:



1> consider the entering condition for this event to be satisfied when condition C2-1, as specified below, is fulfilled;

1> consider the leaving condition for this event to be satisfied when condition C2-2, as specified below, is fulfilled;

NOTE: The CSI-RS resource(s) that triggers the event is on the same frequency as the reference CSI-RS resource, i.e. both are on the frequency indicated in the associated *measObject*.

Inequality C2-1 (Entering condition)

$$Mcr + Ocr - Hys > Mref + Oref + Off$$

Inequality C2-2 (Leaving condition)

$$Mcr + Ocr + Hys < Mref + Oref + Off$$

The variables in the formula are defined as follows:

***Mcr*** is the measurement result of the CSI-RS resource, not taking into account any offsets.

***Ocr*** is the CSI-RS specific offset of the CSI-RS resource (i.e. *csi-RS-IndividualOffset* as defined within *measObjectEUTRA* corresponding to the frequency of the CSI-RS resource), and set to zero if not configured for the CSI-RS resource.

***Mref*** is the measurement result of the reference CSI-RS resource (i.e. *c2-RefCSI-RS* as defined within *reportConfigEUTRA* for this event), not taking into account any offsets.

***Oref*** is the CSI-RS specific offset of the reference CSI-RS resource (i.e. *csi-RS-IndividualOffset* as defined within *measObjectEUTRA* corresponding to the frequency of the reference CSI-RS resource), and is set to zero if not configured for the reference CSI-RS resource.

***Hys*** is the hysteresis parameter for this event (i.e. *hysteresis* as defined within *reportConfigEUTRA* for this event).

***Off*** is the offset parameter for this event (i.e. *c2-Offset* as defined within *reportConfigEUTRA* for this event).

***Mcr***, ***Mref*** are expressed in dBm.

***Ocr***, ***Oref***, ***Hys***, ***Off*** are expressed in dB.

#### 5.5.4.11 Event W1 (WLAN becomes better than a threshold)

The UE shall:

1> consider the entering condition for this event to be satisfied when *wlan-MobilitySet* within *VarWLAN-MobilityConfig* does not contain any entries and condition W1-1, as specified below, is fulfilled;

1> consider the leaving condition for this event to be satisfied when condition W1-2, as specified below, is fulfilled;

Inequality W1-1 (Entering condition)

$$Mn - Hys > Thresh$$

Inequality W1-2 (Leaving condition)

$$Mn + Hys < Thresh$$

The variables in the formula are defined as follows:

***Mn*** is the measurement result of WLAN(s) configured in the measurement object, not taking into account any offsets.

***Hys*** is the hysteresis parameter for this event.

***Thresh*** is the threshold parameter for this event (i.e. *w1-Threshold* as defined within *reportConfigInterRAT* for this event).

***Mn*** is expressed in dBm.

*Hys* is expressed in dB.

*Thresh* is expressed in the same unit as *Mn*.

#### 5.5.4.12 Event W2 (All WLAN inside WLAN mobility set becomes worse than threshold1 and a WLAN outside WLAN mobility set becomes better than threshold2)

The UE shall:

1> consider the entering condition for this event to be satisfied when both conditions W2-1 and W2-2 as specified below are fulfilled;

1> consider the leaving condition for this event to be satisfied when condition W2-3 or condition W2-4, i.e. at least one of the two, as specified below is fulfilled;

Inequality W2-1 (Entering condition 1)

$$Ms + Hys < Thresh1$$

Inequality W2-2 (Entering condition 2)

$$Mn - Hys > Thresh2$$

Inequality W2-3 (Leaving condition 1)

$$Ms - Hys > Thresh1$$

Inequality W2-4 (Leaving condition 2)

$$Mn + Hys < Thresh2$$

The variables in the formula are defined as follows:

*Ms* is the measurement result of WLAN(s) which matches all WLAN identifiers of at least one entry within *wlan-MobilitySet* in *VarWLAN-MobilityConfig*, not taking into account any offsets.

*Mn* is the measurement result of WLAN(s) configured in the measurement object which does not match all WLAN identifiers of any entry within *wlan-MobilitySet* in *VarWLAN-MobilityConfig*, not taking into account any offsets.

*Hys* is the hysteresis parameter for this event.

*Thresh1* is the threshold parameter for this event (i.e. *w2-Threshold1* as defined within *reportConfigInterRAT* for this event).

*Thresh2* is the threshold parameter for this event (i.e. *w2-Threshold2* as defined within *reportConfigInterRAT* for this event).

*Mn*, *Ms* are expressed in dBm.

*Hys* is expressed in dB.

*Thresh1* is expressed in the same unit as *Ms*.

*Thresh2* is expressed in the same unit as *Mn*.

#### 5.5.4.13 Event W3 (All WLAN inside WLAN mobility set becomes worse than a threshold)

The UE shall:

1> consider the entering condition for this event to be satisfied when condition W3-1, as specified below, is fulfilled;

1> consider the leaving condition for this event to be satisfied when condition W3-2, as specified below, is fulfilled;

Inequality W3-1 (Entering condition)

$$Ms + Hys < Thresh$$

Inequality W3-2 (Leaving condition)

$$Ms - Hys > Thresh$$

The variables in the formula are defined as follows:

***Ms*** is the measurement result of WLAN(s) which matches all WLAN identifiers of at least one entry within *wlan-MobilitySet* in *VarWLAN-MobilityConfig*, not taking into account any offsets.

***Hys*** is the hysteresis parameter for this event.

***Thresh*** is the threshold parameter for this event (i.e. *w3-Threshold* as defined within *reportConfigInterRAT* for this event).

***Ms*** is expressed in dBm.

***Hys*** is expressed in dB.

***Thresh*** is expressed in the same unit as ***Ms***.

#### 5.5.4.14 Event V1 (The channel busy ratio is above a threshold)

The UE shall:

1> consider the entering condition for this event to be satisfied when condition V1-1, as specified below, is fulfilled;

1> consider the leaving condition for this event to be satisfied when condition V1-2, as specified below, is fulfilled;

Inequality V1-1 (Entering condition)

$$Ms - Hys > Thresh$$

Inequality V1-2 (Leaving condition)

$$Ms + Hys < Thresh$$

The variables in the formula are defined as follows:

***Ms*** is the measurement result of channel busy ratio of the transmission resource pool, not taking into account any offsets.

***Hys*** is the hysteresis parameter for this event (i.e. *hysteresis* as defined within *reportConfigEUTRA* for this event).

***Thresh*** is the threshold parameter for this event (i.e. *v1-Threshold* as defined within *ReportConfigEUTRA*).

***Ms*** is expressed in decimal from 0 to 1 in steps of 0.01.

***Hys*** is expressed in the same unit as ***Ms***.

***Thresh*** is expressed in the same unit as ***Ms***.

#### 5.5.4.15 Event V2 (The channel busy ratio is below a threshold)

The UE shall:

1> consider the entering condition for this event to be satisfied when condition V2-1, as specified below, is fulfilled;

1> consider the leaving condition for this event to be satisfied when condition V2-2, as specified below, is fulfilled;

Inequality V2-1 (Entering condition)

$$Ms + Hys < Thresh$$

Inequality V2-2 (Leaving condition)

$$Ms - Hys > Thresh$$

The variables in the formula are defined as follows:

***Ms*** is the measurement result of channel busy ratio of the transmission resource pool, not taking into account any offsets.

***Hys*** is the hysteresis parameter for this event (i.e. *hysteresis* as defined within *reportConfigEUTRA* for this event).

***Thresh*** is the threshold parameter for this event (i.e. *v2-Threshold* as defined within *ReportConfigEUTRA*).

***Ms*** is expressed in decimal from 0 to 1 in steps of 0.01.

***Hys*** is expressed in the same unit as ***Ms***.

***Thresh*** is expressed in the same unit as ***Ms***.

#### 5.5.4.16 Event H1 (The Aerial UE height is above a threshold)

The UE shall:

1> consider the entering condition for this event to be satisfied when condition H1-1, as specified below, is fulfilled;

1> consider the leaving condition for this event to be satisfied when condition H1-2, as specified below, is fulfilled;

Inequality H1-1 (Entering condition)

$$Ms - Hys > Thresh + Offset$$

Inequality H1-2 (Leaving condition)

$$Ms + Hys < Thresh + Offset$$

The variables in the formula are defined as follows:

***Ms*** is the Aerial UE height, not taking into account any offsets.

***Hys*** is the hysteresis parameter (i.e. *h1-Hysteresis* as defined within *ReportConfigEUTRA*) for this event.

***Thresh*** is the reference threshold parameter for this event given in *MeasConfig* (i.e. *heightThreshRef* as defined within *MeasConfig*).

***Offset*** is the offset value to *heightThreshRef* to obtain the absolute threshold for this event. (i.e. *h1-ThresholdOffset* as defined within *ReportConfigEUTRA*)

***Ms*** is expressed in meters.

***Thresh*** is expressed in the same unit as ***Ms***.

#### 5.5.4.17 Event H2 (The Aerial UE height is below a threshold)

The UE shall:

1> consider the entering condition for this event to be satisfied when condition H2-1, as specified below, is fulfilled;

1> consider the leaving condition for this event to be satisfied when condition H2-2, as specified below, is fulfilled;

Inequality H2-1 (Entering condition)

$$Ms + Hys < Thresh + Offset$$

Inequality H2-2 (Leaving condition)

$$Ms - Hys > Thresh + Offset$$

The variables in the formula are defined as follows:

***Ms*** is the Aerial UE height, not taking into account any offsets.

***Hys*** is the hysteresis parameter (i.e. *h2-Hysteresis* as defined within *ReportConfigEUTRA*) for this event.

***Thresh*** is the reference threshold parameter for this event given in *MeasConfig* (i.e. *heightThreshRef* as defined within *MeasConfig*).

***Offset*** is the offset value to *heightThreshRef* to obtain the absolute threshold for this event. (i.e. *h2-ThresholdOffset* as defined within *ReportConfigEUTRA*)

***Ms*** is expressed in meters.

***Thresh*** is expressed in the same unit as ***Ms***.

5.5.4.18 Void

5.5.4.19 Void

5.5.4.20 Event D1 (Distance between UE and referenceLocation1 is above threshold1 and distance between UE and referenceLocation2 is below threshold2)

The UE shall:

1> consider the entering condition for this event to be satisfied when both condition D1-1 and condition D1-2, as specified below, are fulfilled;

1> consider the leaving condition for this event to be satisfied when condition D1-3 or condition D1-4, i.e. at least one of the two, as specified below, is fulfilled;

Inequality D1-1 (Entering condition 1)

$$M1 - Hys > Thresh1$$

Inequality D1-2 (Entering condition 2)

$$M12 + Hys < Thresh2$$

Inequality D1-3 (Leaving condition 1)

$$M1 + Hys < Thresh1$$

Inequality D1-4 (Leaving condition 2)

$$M12 - Hys > Thresh2$$

The variables in the formula are defined as follows:

***M1*** is the distance between UE and a reference location for this event (i.e. *referenceLocation1* as defined within *reportConfigEUTRA* for this event), not taking into account any offsets.

***M12*** is the distance between UE and a reference location for this event (i.e. *referenceLocation2* as defined within *reportConfigEUTRA* for this event), not taking into account any offsets.

***Hys*** is the hysteresis parameter for this event (i.e. *hysteresisLocation* as defined within *reportConfigEUTRA* for this event).

***Thresh1*** is the threshold for this event defined as a distance, configured with parameter *distanceThreshFromReference1*, from a reference location configured with parameter *referenceLocation1* within *reportConfigEUTRA* for this event.

**Thresh2** is the threshold for this event defined as a distance, configured with parameter *distanceThreshFromReference2*, from a reference location configured with parameter *referenceLocation2* within *reportConfigEUTRA* for this event.

**MI1** is expressed in meters.

**MI2, Hys, Thresh1, Thresh2** are expressed in the same unit as **MI1**.

NOTE: The definition of Event D1 also applies to CondEvent D1.

#### 5.5.4.21 CondEvent T1 (Time measured at UE is within a duration from threshold)

The UE shall:

1> consider the entering condition for this event to be satisfied when condition T1-1, as specified below, is fulfilled;

1> consider the leaving condition for this event to be satisfied when condition T1-2, as specified below, is fulfilled;

Inequality T1-1 (Entering condition)

$$Mt > Thresh1$$

Inequality T1-2 (Leaving condition)

$$Mt > Thresh1 + Duration$$

The variables in the formula are defined as follows:

**Mt** is the time measured at UE.

**Thresh1** is the threshold parameter for this event (i.e. *t1-Threshold* as defined within *reportConfigEUTRA* for this event).

**Duration** is the duration parameter for this event (i.e. *duration* as defined within *reportConfigEUTRA* for this event).

**Mt** is expressed in *ms*.

**Thresh1, Duration** are expressed in the same unit as **Mt**.

#### 5.5.4.22 Event D2 (Distance between UE and serving cell moving reference location is above threshold1 and distance between UE and neighbour cell moving reference location is below threshold2)

The UE shall:

1> consider the entering condition for this event to be satisfied when both condition D2-1 and condition D2-2, as specified below, are fulfilled;

1> consider the leaving condition for this event to be satisfied when condition D2-3 or condition D2-4, i.e. at least one of the two, as specified below, is fulfilled;

Inequality D2-1 (Entering condition 1)

$$Ml1 - Hys > Thresh1$$

Inequality D2-2 (Entering condition 2)

$$Ml2 + Hys < Thresh2$$

Inequality D2-3 (Leaving condition 1)

$$Ml1 + Hys < Thresh1$$

Inequality D2-4 (Leaving condition 2)

$M12 - Hys > Thresh2$

The variables in the formula are defined as follows:

***M11*** is the distance between UE and a moving reference location of serving cell for this event, not taking into account any offsets. The moving reference location is determined based on *movingReferenceLocation*, serving cell ephemeris information, and the corresponding epoch time broadcast in *SystemInformationBlockType31*.

***M12*** is the distance between UE and a moving reference location of candidate target cell for this event, not taking into account any offsets. The moving reference location is determined based on *referenceLocation*, ephemeris information (provided in *ephemerisInfo* or indicated by *satelliteId*) and epoch time provided in the associated *measObjectEUTRA*.

***Hys*** is the hysteresis parameter for this event (i.e. *hysteresisLocation* as defined within *reportConfigEUTRA* for this event).

***Thresh1*** is the threshold for this event defined as a distance, configured with parameter *distanceThreshFromReference1*, from a moving reference location determined based on *movingReferenceLocation*, serving cell ephemeris information, and the corresponding epoch time broadcast in *SystemInformationBlockType31*.

***Thresh2*** is the threshold for this event defined as a distance, configured with parameter *distanceThreshFromReference2*, from a moving reference location determined based on *referenceLocation*, ephemeris information (provided in *ephemerisInfo* or indicated by *satelliteId*) and epoch time provided in the associated *measObjectEUTRA*.

***M11*** is expressed in meters.

***M12*, *Hys*, *Thresh1*, *Thresh2*** are expressed in the same unit as ***M11***.

NOTE: The definition of Event D2 also applies to CondEvent D2.

## 5.5.5 Measurement reporting

### 5.5.5.1 General

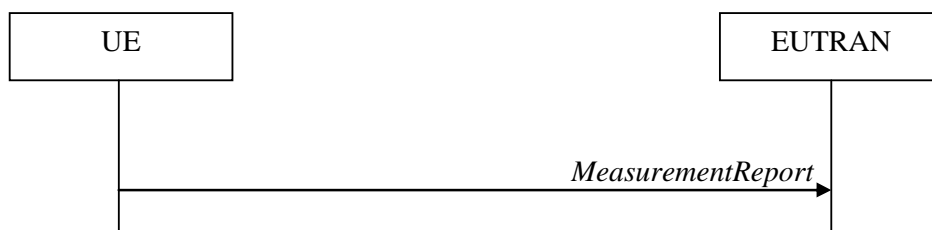

**Figure 5.5.5.1-1: Measurement reporting**

The purpose of this procedure is to transfer measurement results from the UE to E-UTRAN. The UE shall initiate this procedure only after successful security activation.

For the *measId* for which the measurement reporting procedure was triggered, the UE shall set the *measResults* within the *MeasurementReport* message as follows:

- 1> set the *measId* to the measurement identity that triggered the measurement reporting;
- 1> set the *measResultPCell* to include the quantities of the PCell;
- 1> set the *measResultServFreqList* to include for each E-UTRA SCell that is configured, if any, within *measResultSCell* the quantities of the concerned SCell, if available according to performance requirements in TS 36.133 [16], except if *purpose* for the *reportConfig* associated with the *measId* that triggered the measurement reporting is set to *reportLocation*;
- 1> if the *reportConfig* associated with the *measId* that triggered the measurement reporting includes *reportAddNeighMeas*:

- 2> for each E-UTRA serving frequency for which *measObjectId* is referenced in the *measIdList*, other than the frequency corresponding with the *measId* that triggered the measurement reporting:
  - 3> set the *measResultServFreqList* to include within *measResultBestNeighCell* the *physCellId* and the quantities of the best non-serving cell, based on RSRP, on the concerned serving frequency;
- 1> if the *triggerType* is set to *event*; and if the corresponding *measObject* concerns NR; and if *eventId* is set to *eventB1-NR* or *eventB2-NR*; or
- 1> if the *triggerType* is set to *event*; and if *eventId* is set to *eventA3* or *eventA4* or *eventA5*:
  - 2> if (NG)EN-DC is configured, and if *purpose* for the *reportConfig* or *reportConfigInterRAT* associated with the *measId* that triggered the measurement reporting is set to a value other than *reportLocation* or if *purpose* is not configured:
    - 3> set the *measResultServFreqListNR* to include for each NR serving frequency that the UE is configured to measure according to TS 38.331 [82], if any, the following:
      - 4> set *measResultSCell* to include the available results of the NR serving cell, as specified in 5.5.5.2;
      - 4> if the *reportConfig* associated with the *measId* that triggered the measurement reporting includes *reportAddNeighMeas* and if *eventId* is set to *eventA3* or *eventA4* or *eventA5*:
        - 5> set *measResultBestNeighCell* to include the available results, as specified in 5.5.5.2, of the non-serving cell with the highest sorting quantity determined as specified in 5.5.5.3;
    - 3> for each (serving or neighbouring) cell for which the UE reports results according to the previous, additionally include available beam results according to the following:
      - 4> if *maxReportRS-Index* is configured, set *measResultRS-IndexList* to include available results, as specified in 5.5.5.2, of up to *maxReportRS-Index* beams, ordered based on the quantity determined as specified in 5.5.5.3;
  - 1> if there is at least one applicable neighbouring cell to report:
    - 2> set the *measResultNeighCells* to include the best neighbouring cells up to *maxReportCells* in accordance with the following:
      - 3> if the *triggerType* is set to *event* and *eventId* is not set to *eventD1* or *eventD2*:
        - 4> include the cells included in the *cellsTriggeredList* as defined within the *VarMeasReportList* for this *measId*;
      - 3> else:
        - 4> include the applicable cells for which the new measurement results became available since the last periodical reporting or since the measurement was initiated or reset;

NOTE 1: The reliability of the report (i.e. the certainty it contains the strongest cells on the concerned frequency) depends on the measurement configuration i.e. the *reportInterval*. The related performance requirements are specified in TS 36.133 [16].

- 3> for each cell that is included in the *measResultNeighCells*, include the *physCellId*;
- 3> if the *triggerType* is set to *event*; or the *purpose* is set to *reportStrongestCells* or to *reportStrongestCellsForSON*:
  - 4> for each included cell, include the layer 3 filtered measured results in accordance with the *reportConfig* for this *measId*, ordered as follows:
    - 5> if the *measObject* associated with this *measId* concerns E-UTRA:
      - 6> set the *measResult* to include the quantity(ies) indicated in the *reportQuantity* within the concerned *reportConfig*;
      - 6> sort the included cells in order of decreasing *triggerQuantity*, i.e. the best cell is included first;



- 5> if the *measObject* associated with this *measId* concerns NR:
    - 6> set the *measResultCell* to include the quantity(ies) indicated in the *reportQuantityCellNR* within the concerned *reportConfig*;
    - 6> if *maxReportRS-Index* and *reportQuantityRS-IndexNR* are configured, set *measResultRS-IndexList* to include the result of the best beam if *threshRS-Index* is included in the *VarMeasConfig* for the corresponding *measObject*, and the remaining beams whose quantity is above *threshRS-Index*, up to *maxReportRS-Index* beams in total:
      - 7> order beams based on the sorting quantity determined as specified in 5.5.5.3;
      - 7> for each included beam:
        - 8> include *ssbIndex*;
        - 8> if *reportRS-IndexResultsNR* is set to TRUE, for each quantity indicated, include the corresponding measurement result in *measResultSSB-Index* for each *ssb-Index*;
    - 6> sort the included cells in order of decreasing sorting quantity determined as specified in 5.5.5.3;
  - 5> if the *measObject* associated with this *measId* concerns UTRA FDD and if *ReportConfigInterRAT* includes the *reportQuantityUTRA-FDD*:
    - 6> set the *measResult* to include the quantities indicated by the *reportQuantityUTRA-FDD* in order of decreasing *measQuantityUTRA-FDD* within the *quantityConfig*, i.e. the best cell is included first;
  - 5> if the *measObject* associated with this *measId* concerns UTRA FDD and if *ReportConfigInterRAT* does not include the *reportQuantityUTRA-FDD*; or
  - 5> if the *measObject* associated with this *measId* concerns UTRA TDD, GERAN or CDMA2000:
    - 6> set the *measResult* to the quantity as configured for the concerned RAT within the *quantityConfig* in order of either decreasing quantity for UTRA and GERAN or increasing quantity for CDMA2000 *pilotStrength*, i.e. the best cell is included first;
- 3> else if the *purpose* is set to *reportCGI* and the corresponding *measObject* concerns a RAT other than NR:
- 4> if the mandatory present fields of the *cgi-Info* for the cell indicated by the *cellForWhichToReportCGI* in the associated *measObject* have been obtained:
    - 5> if the *includeMultiBandInfo* is configured:
      - 6> include the *freqBandIndicator*;
      - 6> if the cell broadcasts the *multiBandInfoList*, include the *multiBandInfoList*;
      - 6> if the cell broadcasts the *freqBandIndicatorPriority*, include the *freqBandIndicatorPriority*;
    - 5> if the cell broadcasts a CSG identity:
      - 6> include the *csg-Identity*;
      - 6> include the *csg-MemberStatus* and set it to *member* if the cell is a CSG member cell;
    - 5> if the *si-RequestForHO* is configured within the *reportConfig* associated with this *measId*:
      - 6> include the *cgi-Info* containing all the fields other than the *plmn-IdentityList* that have been successfully acquired;
      - 6> include, within the *cgi-Info*, the field *plmn-IdentityList* in accordance with the following:
        - 7> if the cell is a CSG member cell, determine the subset of the PLMN identities, starting from the second entry of PLMN identities in the broadcast information, that meet the following conditions:

- a) equal to the RPLMN or an EPLMN; and
  - b) the Permitted CSG list of the UE includes an entry comprising of the concerned PLMN identity and the CSG identity broadcast by the cell;
- 7> if the subset of PLMN identities determined according to the previous includes at least one PLMN identity, include the *plmn-IdentityList* and set it to include this subset of the PLMN identities;
  - 7> if the cell is a CSG member cell, include the *primaryPLMN-Suitable* if the primary PLMN meets conditions a) and b) specified above;
  - 7> if the cell does not broadcast *csg-Identity* and the UE is capable of reporting the *plmn-IdentityList* from cells not broadcasting *csg-Identity*:
    - 8> include in the *plmn-IdentityList* the list of identities starting from the second entry of PLMN identities in the broadcast information;
  - 5> else:
    - 6> include the *cgi-Info* containing all the fields that have been successfully acquired and in accordance with the following:
      - 7> include in the *plmn-IdentityList* the list of identities starting from the second entry of PLMN Identities in the broadcast information;
  - 4> if the *cellAccessRelatedInfoList-5GC* has been acquired:
    - 5> include *cgi-Info-5GC*;

NOTE 1a: The UE may include the *cgi-Info-5GC* even when the N1 mode is disabled.

- 3> else if the *purpose* is set to *reportCGI* and the corresponding *measObject* concerns NR RAT:
  - 4> if the Cell information of *cgi-Info* for the cell indicated by the *cellForWhichToReportCGI* in the associated *measObject* has been obtained:
    - 5> include *plmn-IdentityInfoList* including *plmn-IdentityList*, *trackingAreaCode* (if available), *ran-AreaCode* (if available) and *cellIdentity* for each entry of the *plmn-IdentityInfoList*;
    - 5> include *frequencyBandList* if broadcasted;
    - 5> for each entry in *plmn-IdentityInfoList*, if the *gNB-ID-Length* is broadcasted:
      - 6> include *gNB-ID-Length*;
  - 4> else if MIB associated with the concerned *measObject* indicates that SIB1 is not broadcast:
    - 5> include the *noSIB1* field;
- 1> for the cells included according to the previous (i.e. covering the PCell, the SCells, the best non-serving cells on serving frequencies as well as neighbouring EUTRA cells) include results according to the extended RSRQ if corresponding results are available according to the associated performance requirements defined in TS 36.133 [16];
- 1> if there is at least one applicable CSI-RS resource to report:
  - 2> set the *measResultCSI-RS-List* to include the best CSI-RS resources up to *maxReportCells* in accordance with the following:
    - 3> if the *triggerType* is set to *event*:
      - 4> include the CSI-RS resources included in the *csi-RS-TriggeredList* as defined within the *VarMeasReportList* for this *measId*;
  - 3> else:

- 4> include the applicable CSI-RS resources for which the new measurement results became available since the last periodical reporting or since the measurement was initiated or reset;

NOTE 2: The reliability of the report (i.e. the certainty it contains the strongest CSI-RS resources on the concerned frequency) depends on the measurement configuration i.e. the *reportInterval*. The related performance requirements are specified in TS 36.133 [16].

- 3> for each CSI-RS resource that is included in the *measResultCSI-RS-List*:
  - 4> include the *measCSI-RS-Id*;
  - 4> include the layer 3 filtered measured results in accordance with the *reportConfig* for this *measId*, ordered as follow:
    - 5> set the *csi-RSRP-Result* to include the quantity indicated in the *reportQuantity* within the concerned *reportConfig* in order of decreasing *triggerQuantityCSI-RS*, i.e. the best CSI-RS resource is included first;
    - 4> if *reportCRS-Meas* is set to *true* within the associated *reportConfig*, and the cell indicated by *physCellId* of this CSI-RS resource is not a serving cell:
      - 5> set the *measResultNeighCells* to include the cell indicated by *physCellId* of this CSI-RS resource, and include the *physCellId*;
      - 5> set the *rsrpResult* to include the RSRP of the concerned cell, if available according to performance requirements in TS 36.133 [16];
      - 5> set the *rsrqResult* to include the RSRQ of the concerned cell, if available according to performance requirements in TS 36.133 [16];
- 1> if the *ue-RxTxTimeDiffPeriodical* is configured within the corresponding *reportConfig* for this *measId*:
  - 2> set the *ue-RxTxTimeDiffResult* to the measurement result provided by lower layers;
  - 2> set the *currentSFN*;
- 1> if the *measRSSI-ReportConfig* is configured within the corresponding *reportConfig* for this *measId*:
  - 2> set the *rsi-Result* to the average of sample value(s) provided by lower layers in the *reportInterval*;
  - 2> set the *channelOccupancy* to the rounded percentage of sample values which are beyond to the *channelOccupancyThreshold* within all the sample values in the *reportInterval*;
- 1> if the *measRSSI-ReportConfigNR* is configured within the corresponding *reportConfigInterRAT* for this *measId*:
  - 2> set the *rsi-ResultNR* to the average of sample value(s) provided by lower layers in the *reportInterval*;
  - 2> set the *channelOccupancyNR* to the rounded percentage of sample values which are beyond to the *channelOccupancyThresholdNR* within all the sample values in the *reportInterval*;
- 1> if uplink PDCP delay results are available:
  - 2> set the *ul-PDCP-DelayResultList* to include the uplink PDCP delay results available;
- 1> if uplink PDCP delay value results are available:
  - 2> set the *ul-PDCP-DelayValueResultList* to include the corresponding average uplink PDCP delay values;
- 1> if the *includeLocationInfo* is configured in the corresponding *reportConfig* for this *measId* or if *purpose* for the *reportConfig* associated with the *measId* that triggered the measurement reporting is set to *reportLocation*; and detailed location information that has not been reported is available, set the content of the *locationInfo* as follows:
  - 2> include the *locationCoordinates*;
  - 2> if available, include the *gnss-TOD-msec*, except if *purpose* for the *reportConfig* associated with the *measId* that triggered the measurement reporting is set to *reportLocation*;

- 2> include the *verticalVelocityInfo*, if available;
- 1> if the *coarseLocationReq* is set to *true* in the corresponding *reportConfig* for this *measId*:
  - 2> if available, include the *coarseLocationInfo*;
- 1> if the *includeWLAN-Meas* is configured in the corresponding *reportConfig* for this *measId*, set the *measResults* as follows:
  - 2> if available, include the *logMeasResultListWLAN*, in order of decreasing RSSI for WLAN APs;
- 1> if the *includeBT-Meas* is configured in the corresponding *reportConfig* for this *measId*, set the *measResults* as follows:
  - 2> if available, include the *logMeasResultListBT*, in order of decreasing RSSI for Bluetooth beacons;
- 1> if the *includeUncomBarPreMeas* is configured in the corresponding *reportConfig* for this *measId* and if *includeUncomBarPreMeas* is set to *true*, set the *measResults* as follows:
  - 2> if available, include the *uncomBarPreMeasResult*;
- 1> if the *reportSSTD-Meas* is set to *true* or *pSCell* within the corresponding *reportConfig* for this *measId*:
  - 2> set the *measResultSSTD* to the measurement results provided by lower layers;
- 1> if the *reportSFTD-Meas* is set to *neighborCells* or *pSCell* within the corresponding *reportConfigInterRAT* for this *measId*, for each applicable cell for which results are available:
  - 2> set *sfm-OffsetResult* and *frameBoundaryOffsetResult* to the measurement results provided by lower layers;
  - 2> if the *ss-rsrp* in the *reportQuantityCellNR* is set to *TRUE* within the corresponding *reportConfigInterRAT* for this *measId*:
    - 3> include *rsrpResult* set to the RSRP of the concerned cell;
- 1> if there is at least one applicable transmission resource pool to report:
  - 2> set the *measResultListCBR* to include the CBR measurement results in accordance with the following:
    - 3> if the *triggerType* is set to *event*:
      - 4> include the transmission resource pools included in the *poolsTriggeredList* as defined within the *VarMeasReportList* for this *measId*;
    - 3> else:
      - 4> include the applicable transmission resource pools for which the new measurement results became available since the last periodical reporting or since the measurement was initiated or reset;
    - 3> for each transmission resource pool to be reported:
      - 4> set the *poolIdentity* to the *poolReportId* of this transmission resource pool;
      - 4> if *adjacencyPSCCH-PSSCH* is set to *TRUE* for this transmission resource pool:
        - 5> set the *cbr-PSSCH* to the CBR measurement result on PSSCH and PSCCH of this transmission resource pool provided by lower layers;
      - 4> else:
        - 5> set the *cbr-PSSCH* to the CBR measurement result on PSSCH of this transmission resource pool provided by lower layers if available;
        - 5> set the *cbr-PSCCH* to the CBR measurement result on PSCCH of this transmission resource pool provided by lower layers if available;
  - 2> set the *measResultSensing* to include the sensing measurement results in accordance with the following:

- 3> include the applicable transmission resource pools for which the new measurement results became available since the last periodical reporting or since the measurement was initiated or reset;
- 3> for each transmission resource pool to be reported:
  - 4> set the *sensingResult* to the sensing measurement results provided by the lower layers;
- 1> if the *triggerType* is set to *event*; and if *eventId* is set to *eventH1* or *eventH2*:
  - 2> set the *heightUE* to include the altitude of the UE;
- 1> increment the *numberOfReportsSent* as defined within the *VarMeasReportList* for this *measId* by 1;
- 1> stop the periodical reporting timer, if running;
- 1> if the *numberOfReportsSent* as defined within the *VarMeasReportList* for this *measId* is less than the *reportAmount* as defined within the corresponding *reportConfig* for this *measId*:
  - 2> start the periodical reporting timer with the value of *reportInterval* as defined within the corresponding *reportConfig* for this *measId*;
- 1> else:
  - 2> if the *triggerType* is set to *periodical*:
    - 3> remove the entry within the *VarMeasReportList* for this *measId*;
    - 3> remove this *measId* from the *measIdList* within *VarMeasConfig*;
- 1> if the measured results are for CDMA2000 HRPD:
  - 2> set the *preRegistrationStatusHRPD* to the UE's CDMA2000 upper layer's HRPD *preRegistrationStatus*;
- 1> if the measured results are for CDMA2000 1xRTT:
  - 2> set the *preRegistrationStatusHRPD* to *FALSE*;
- 1> if the measured results are for WLAN:
  - 2> set the *measResultListWLAN* to include the quantities within the *quantityConfigWLAN* for up to *maxReportCells* WLAN(s), determined according to the following:
    - 3> include WLAN the UE is connected to, if any;
    - 3> if *reportAnyWLAN* is set to *TRUE*:
      - 4> consider WLAN with any WLAN identifiers to be applicable for measurement reporting;
    - 3> else:
      - 4> consider only WLANs which do not match all WLAN identifiers of any entry within *wlan-MobilitySet* in *VarWLAN-MobilityConfig* to be applicable for measurement reporting;
    - 3> include applicable WLAN in order of decreasing WLAN RSSI, i.e. the best WLAN is included first;
  - 2> for each included WLAN:
    - 3> set *wlan-Identifiers* to include all WLAN identifiers that can be acquired for the WLAN measured;
    - 3> set *connectedWLAN* to *TRUE* if the UE is connected to the WLAN measured;
    - 3> if *reportQuantityWLAN* exists within the *ReportConfigInterRAT* within the *VarMeasConfig* for this *measId*:
      - 4> if *bandRequestWLAN* is set to *TRUE*:
        - 5> set *bandWLAN* to include WLAN band of the WLAN measured;

- 4> if *carrierInfoRequestWLAN* is set to *TRUE*:
  - 5> set *carrierInfoWLAN* to include WLAN carrier information of the WLAN measured if it can be acquired;
- 4> if *availableAdmissionCapacityRequestWLAN* is set to *TRUE*:
  - 5> set the *measResult* to include *availableAdmissionCapacityWLAN* if it can be acquired;
- 4> if *backhaulDL-BandwidthRequestWLAN* is set to *TRUE*:
  - 5> set the *measResult* to include *backhaulDL-BandwidthWLAN* if it can be acquired;
- 4> if *backhaulUL-BandwidthRequestWLAN* is set to *TRUE*:
  - 5> set the *measResult* to include *backhaulUL-BandwidthWLAN* if it can be acquired;
- 4> if *channelUtilizationRequestWLAN* is set to *TRUE*:
  - 5> set the *measResult* to include *channelUtilizationWLAN* if it can be acquired;
- 4> if *stationCountRequestWLAN* is set to *TRUE*:
  - 5> set the *measResult* to include *stationCountWLAN* if it can be acquired;
- 1> if the measurement configuration that triggered the measurement reporting procedure was configured by an *sl-ConfigDedicatedEUTRA* that was received within an NR *RRCReconfiguration* message:
  - 2> submit the *MeasurementReport* message via SRB1 embedded in NR RRC message *ULInformationTransferIRAT* as specified in TS 38.331 [82].
- 1> else if the UE is configured with NE-DC:
  - 2> submit the *MeasurementReport* message via SRB1 embedded in NR RRC message *ULInformationTransferMRDC* as specified in TS 38.331 [82].
- 1> else:
  - 2> submit the *MeasurementReport* message to lower layers for transmission, upon which the procedure ends;

### 5.5.5.2 Determination of available NR measurement results

When configured to report measurement results of the serving and the best neighbouring cells on NR serving frequencies, the UE shall consider NR measurement results to be available as follows:

- 1> only SSB based results are available and only if configured to measure these for the concerned serving frequency;
- 1> for the serving cell:
  - 2> include cell quantities RSRP and RSRQ while SINR is included if the UE is configured to measure this quantity on an NR frequency, possibly different from the concerned serving frequency, but only if configured by NR *measConfig*;
  - 2> include beam results and beam quantities if the UE is configured to measure these on an NR frequency, possibly different from the concerned serving frequency, but only if configured by NR *measConfig*;
- 1> for a neighbouring cell:
  - 2> include cell quantities, beam results and beam quantities if the UE is configured to measure these on an NR frequency, possibly different from the concerned serving frequency, but only if configured by NR *measConfig*.
- 1> filter available results according to the applicable field in NR *quantityConfig*:

### 5.5.5.3 Selection of NR sorting quality

When configured to report the best cells or beams, the UE shall determine the quantity that is used to order and select as follows:

- 1> for cells on the frequency associated with the *measId* that triggered the measurement reporting, if the *reportTrigger* is set to *event*, consider the quantity used in *bN-ThresholdYNR* to be the sorting quantity;
- 1> for other cases, determine the sorting quantity as follows:
  - 2> consider the following quantities as candidate sorting quantities:
    - 3> for cells on the frequency associated with the *measId* that triggered the measurement reporting (for a *triggerType* set to *periodical*):
      - 4> the quantities defined by *reportQuantityCellNR*, when used for sorting cells;
      - 4> the quantities defined by *reportQuantityRS-IndexNR*, when used for sorting beams;
    - 3> for cells, serving or non-serving (i.e. within *reportAddNeighMeas*), on NR serving frequencies other than the one associated with the *measId* triggering reporting:
      - 4> the available quantities of available NR measurement results as specified in 5.5.5.2;
  - 2> if there is a single candidate sorting quantity;
    - 3> consider the concerned quantity to be the sorting quantity;
  - 2> else:
    - 3> if RSRP is one of the candidate sorting quantities;
      - 4> consider RSRP to be the sorting quantity;
    - 3> else:
      - 4> consider RSRQ to be the sorting quantity;

## 5.5.6 Measurement related actions

### 5.5.6.1 Actions upon handover and re-establishment

E-UTRAN applies the handover procedure as follows:

- when performing the handover procedure, as specified in 5.3.5.4, ensure that a *measObjectId* corresponding to each handover target serving frequency is configured as a result of the procedures described in this clause and in 5.3.5.4;
- when changing the band while the physical frequency remains unchanged, E-UTRAN releases the *measObject* corresponding to the source frequency and adds a *measObject* corresponding to the target frequency (i.e. it does not reconfigure the *measObject*);

E-UTRAN applies the re-establishment procedure as follows:

- when performing the connection re-establishment procedure, as specified in 5.3.7, ensure that a *measObjectId* corresponding each target serving frequency is configured as a result of the procedure described in this clause and the subsequent connection reconfiguration procedure immediately following the re-establishment procedure;
- in the first reconfiguration following the re-establishment when changing the band while the physical frequency remains unchanged, E-UTRAN releases the *measObject* corresponding to the source frequency and adds a *measObject* corresponding to the target frequency (i.e. it does not reconfigure the *measObject*);

The UE shall:

- 1> for each *measId* included in the *measIdList* within *VarMeasConfig*:

- 2> if the *triggerType* is set to *periodical*:
  - 3> remove this *measId* from the *measIdList* within *VarMeasConfig*:
- 1> if the procedure was triggered due to a handover or successful re-establishment and the procedure involves a change of primary frequency, update the *measId* values in the *measIdList* within *VarMeasConfig* as follows:
  - 2> if a *measObjectId* value corresponding to the target primary frequency exists in the *measObjectList* within *VarMeasConfig*:
    - 3> for each *measId* value in the *measIdList*:
      - 4> if the *measId* value is linked to the *measObjectId* value corresponding to the source primary frequency:
        - 5> link this *measId* value to the *measObjectId* value corresponding to the target primary frequency;
      - 4> else if the *measId* value is linked to the *measObjectId* value corresponding to the target primary frequency:
        - 5> link this *measId* value to the *measObjectId* value corresponding to the source primary frequency;
  - 2> else:
    - 3> remove all *measId* values that are linked to the *measObjectId* value corresponding to the source primary frequency;
- 1> remove all measurement reporting entries within *VarMeasReportList*;
- 1> stop the periodical reporting timer or timer T321, whichever one is running, as well as associated information (e.g. *timeToTrigger*) for all *measId*;
- 1> release the measurement gaps (configured by E-UTRA RRC), if activated;

NOTE 1: If the UE requires measurement gaps to perform inter-frequency or inter-RAT measurements, the UE resumes the inter-frequency and inter-RAT measurements after the E-UTRAN has setup the measurement gaps.

NOTE 2: In this procedure, the UE may or may not release the *measGapSharingConfig*.

### 5.5.6.2 Speed dependant scaling of measurement related parameters

The UE shall adjust the value of the following parameter configured by the E-UTRAN depending on the UE speed: *timeToTrigger*. The UE shall apply 3 different levels, which are selected as follows:

The UE shall:

- 1> perform mobility state detection using the mobility state detection as specified in TS 36.304 [4] with the following modifications:
  - 2> counting handovers instead of cell reselections;
  - 2> applying the parameter applicable for RRC\_CONNECTED as included in *speedStatePars* within *VarMeasConfig*;
- 1> if high mobility state is detected:
  - 2> use the *timeToTrigger* value multiplied by *sf-High* within *VarMeasConfig*;
- 1> else if medium mobility state is detected:
  - 2> use the *timeToTrigger* value multiplied by *sf-Medium* within *VarMeasConfig*;
- 1> else:
  - 2> no scaling is applied;



## 5.5.7 Inter-frequency RSTD measurement indication

### 5.5.7.1 General

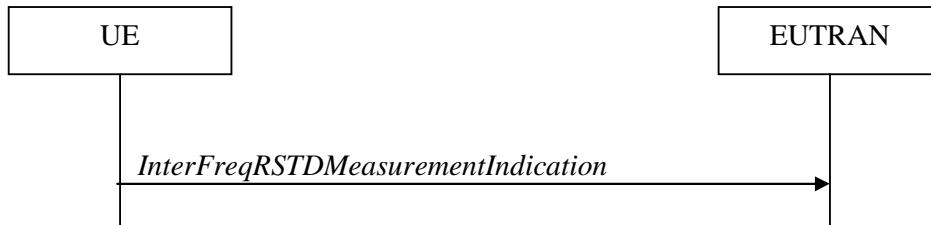

**Figure 5.5.7.1-1: Inter-frequency RSTD measurement indication**

The purpose of this procedure is to indicate to the network that the UE is going to start/stop OTDOA inter-frequency RSTD measurements which require measurement gaps as specified in TS 36.133 [16], clause 8.1.2.6. The procedure is also used to indicate to the network that the UE is going to start/stop OTDOA intra-frequency RSTD measurements which require measurement gaps. This procedure is also used to indicate to the network the measurement gap that the category M1 or M2 UE prefers to perform RSTD measurements with dense PRS configuration, as specified in TS 36.133 [16], Table 8.1.2.1-3.

NOTE: It is a network decision to configure the measurement gap.

### 5.5.7.2 Initiation

The UE shall:

- 1> if and only if upper layers indicate to start performing inter-frequency RSTD measurements and the UE requires measurement gaps for these measurements while measurement gaps are either not configured or not sufficient:
- 2> initiate the procedure to indicate start;

NOTE 1: The UE verifies the measurement gap situation only upon receiving the indication from upper layers. If at this point in time sufficient gaps are available, the UE does not initiate the procedure. Unless it receives a new indication from upper layers, the UE is only allowed to further repeat the procedure in the same PCell once per frequency if the provided measurement gaps are insufficient.

- 1> if and only if upper layers indicate to stop performing inter-frequency RSTD measurements:
- 2> initiate the procedure to indicate stop;

NOTE 2: The UE may initiate the procedure to indicate stop even if it did not previously initiate the procedure to indicate start.

### 5.5.7.3 Actions related to transmission of *InterFreqRSTDMeasurementIndication* message

The UE shall set the contents of *InterFreqRSTDMeasurementIndication* message as follows:

- 1> if the procedure is initiated to indicate start or stop of inter-frequency RSTD measurements:
  - 2> set the *rstd-InterFreqIndication* as follows:
    - 3> if the procedure is initiated to indicate start of inter-frequency RSTD measurements:
      - 4> set the *rstd-InterFreqInfoList* according to the information received from upper layers;
      - 4> for category M1 or M2 UE, if the procedure is initiated to indicate the measurement gap that the UE prefers to perform RSTD measurements with dense PRS configuration:
        - 5> set the *measPRS-Offset-r15* according to the UE preference;

- 3> else if the procedure is initiated to indicate stop of inter-frequency RSTD measurements:
  - 4> set the *rstd-InterFreqIndication* to the value *stop*;
- 1> else:
  - 2> set the *rstd-InterFreqIndication* as follows:
    - 3> if the procedure is initiated to indicate start of intra-frequency RSTD measurements:
      - 4> set the *carrierFreq* in the *rstd-InterFreqInfoList* to the carrier frequency of the serving cell;
      - 4> for category M1 or M2 UE, if the procedure is initiated to indicate the measurement gap that the UE prefers to perform RSTD measurements with dense PRS configuration:
        - 5> set the *measPRS-Offset-r15* according to the UE preference;
    - 3> else if the procedure is initiated to indicate stop of intra-frequency RSTD measurements:
      - 4> set the *rstd-InterFreqIndication* to the value *stop*;
- 1> submit the *InterFreqRSTDMeasurementIndication* message to lower layers for transmission, upon which the procedure ends;

## 5.5.8 Measurements in NB-IoT

Upon transition to RRC\_CONNECTED mode, the UE shall:

- 1> if *neighCellMeasCriteria* is present in *SystemInformationBlockType3-NB*:
  - 2> set  $\text{NRSRP}_{\text{Ref}}$  to the latest result of the serving cell measurement as used for cell selection/reselection evaluation;
- 2> if the relaxed monitoring criterion defined in TS 36.304 [4] was not fulfilled:
  - 3> start T326 with the value *t-MeasureDeltaP*;

While in RRC\_CONNECTED mode, after performing a measurement, the UE shall:

- 1> in the following use the NRSRP measurement for the measured carrier and *nrs-PowerOffsetNonAnchor* corresponding to the measured carrier;
- 1> if *neighCellMeasCriteria* is present in *SystemInformationBlockType3-NB*:
  - 2> if  $(\text{NRSRP}_{\text{Ref}} - (\text{NRSRP} - \text{nrs-PowerOffsetNonAnchor})) > s\text{-MeasureDeltaP}$ :
    - 3> set  $\text{NRSRP}_{\text{Ref}} = (\text{NRSRP} - \text{nrs-PowerOffsetNonAnchor})$ ;
    - 3> start or restart T326 with the value *t-MeasureDeltaP*;
- 1> if *neighCellMeasCriteria* is not present in *SystemInformationBlockType3-NB*; or
- 1> if T326 is running:
  - 2> if  $(\text{NRSRP} - \text{nrs-PowerOffsetNonAnchor}) < s\text{-MeasureIntra}$ , perform intra-frequency measurements as defined in TS 36.133 [16];
  - 2> if  $(\text{NRSRP} - \text{nrs-PowerOffsetNonAnchor}) < s\text{-MeasureInter}$ , perform inter-frequency measurements as defined in TS 36.133 [16];

While in RRC\_CONNECTED mode, the UE shall:

- 1> if *t-Service* is present in *SystemInformationBlockType3-NB*:
  - 2> perform intra-frequency measurements or inter-frequency measurements before *t-Service*;

NOTE: The exact time to start measurements is left up to UE implementation and *t-ServiceStartNeigh* may be used to decide when to start measurements.

1> if *referenceLocation* and *distanceThresh* are present in *SystemInformationBlockType31-NB*:

2> if *referenceLocation* is set to *fixedReferenceLocation*:

3> perform intra-frequency measurements or inter-frequency measurements when the distance between UE and *referenceLocation* is above *distanceThresh*;

2> if *referenceLocation* is set to *movingReferenceLocation*:

3> perform intra-frequency measurements or inter-frequency measurements when the distance between UE and serving cell reference location derived from serving cell ephemeris, *epochTime* and *referenceLocation* in *SystemInformationBlockType31-NB* is above *distanceThresh*.

## 5.5.9 GNSS measurement triggering and reporting

For BL UEs or UEs in CE or NB-IoT UEs that are connected to NTN, GNSS measurement can be triggered aperiodically by the GNSS Measurement Command MAC CE (see TS 36.321 [6]), or triggered by the UE autonomously if enabled by the network, or triggered by the UE using available idle periods.

The UE shall:

1> if an indication to perform GNSS measurement is received from lower layers:

2> perform GNSS measurement using the measurement gap with a gap length indicated by lower layers, as specified in TS 36.213 [23];

2> stop timer T390, if running;

1> if *gnss-AutonomousEnabled* is configured:

2> if the gap length is indicated by lower layers:

3> set the autonomous gap length to the gap length indicated by lower layers;

2> else:

3> set the autonomous gap length to the latest reported time duration required for the UE to acquire a GNSS position;

2> perform GNSS measurement using the autonomous gap starting from T390 expiry if *ul-TransmissionExtensionEnabled* is configured, otherwise starting from GNSS validity duration expiry;

NOTE: UE can autonomously start GNSS measurements during available idle periods in RRC\_CONNECTED to keep GNSS valid and stop T390 upon indication that a new GNSS position becomes valid. The exact time of starting GNSS measurements during available idle periods is left to UE implementation.

1> upon starting GNSS measurement:

2> stop timer T318, if running;

1> upon indication that a new GNSS position becomes valid:

2> instruct lower layers to report the remaining GNSS validity duration (see TS 36.321 [6]);

1> upon indication that GNSS measurement has failed:

2> if GNSS position is out-of-date; and

2> if *ul-TransmissionExtensionEnabled* is not configured or T390 is not running:

3> perform the actions upon leaving RRC\_CONNECTED as specified in 5.3.12, with release cause 'other'.

## 5.6 Other

### 5.6.0 General

For NB-IoT, only a subset of the procedures described in this clause apply.

Table 5.6.0-1 specifies the procedures that are applicable to NB-IoT. All other procedures are not applicable to NB-IoT; this is not further stated in the corresponding procedures.

**Table 5.6.0-1: "Other" Procedures applicable to a NB-IoT UE**

Clause	Procedures
5.6.1	DL information transfer
5.6.2	UL information transfer
5.6.3	UE Capability transfer
5.6.5	UE information (see NOTE)
5.6.23	PUR Configuration Request
5.6.24	Neighbour Relation Reporting for SON ANR in NB-IoT

NOTE: Not applicable for a UE that only supports the Control Plane CIoT EPS optimisation (see TS 24.301 [35]).

### 5.6.1 DL information transfer

#### 5.6.1.1 General

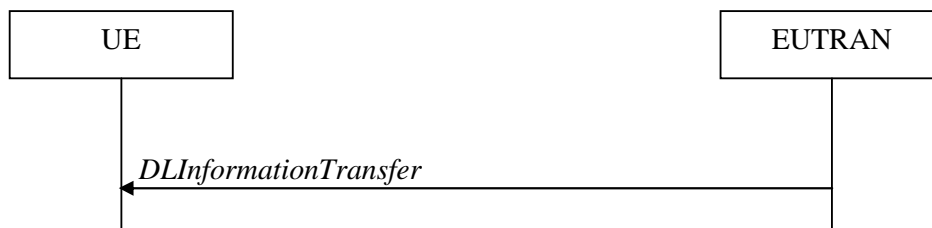

**Figure 5.6.1.1-1: DL information transfer**

The purpose of this procedure is to transfer NAS, (tunnelled) non-3GPP dedicated information or time reference information from E-UTRAN to a UE in RRC\_CONNECTED, or to transfer F1-C related information from IAB-donor-CU to IAB-DU via IAB-MT in RRC\_CONNECTED.

#### 5.6.1.2 Initiation

E-UTRAN initiates the DL information transfer procedure whenever there is a need to transfer NAS, non-3GPP dedicated information, time reference information or F1-C related information. E-UTRAN initiates the DL information transfer procedure by sending the *DLInformationTransfer* message.

#### 5.6.1.3 Reception of the *DLInformationTransfer* by the UE

Upon receiving *DLInformationTransfer* message, the UE shall:

- 1> if the UE is a NB-IoT UE; or
- 1> if the *dedicatedInfoType* is present and set to *dedicatedInfoNAS*:
  - 2> forward the *dedicatedInfoNAS* to the NAS upper layers.
- 1> if the *dedicatedInfoType* is present and set to *dedicatedInfoCDMA2000-1XRTT* or to *dedicatedInfoCDMA2000-HRPD*:

- 2> forward the *dedicatedInfoCDMA2000* to the CDMA2000 upper layers;
- 1> if *timeReferenceInfo* is included:
  - 2> calculate the time reference based on the included *time*, *timeInfoType* and *referenceSFN* in *timeReferenceInfo*;
  - 2> calculate the inaccuracy of the time reference based on the *uncertainty* and other implementation-related inaccuracies, if *uncertainty* is included in *timeReferenceInfo*;
  - 2> inform upper layers of the time reference and, if *uncertainty* is included in *timeReferenceInfo*, of the inaccuracy of the time reference.

Upon receiving *DLInformationTransfer* message, the IAB-MT shall:

- 1> if *dedicatedInfoF1c* is included:
  - 2> forward *dedicatedInfoF1c* to the IAB-DU.

## 5.6.2 UL information transfer

### 5.6.2.1 General

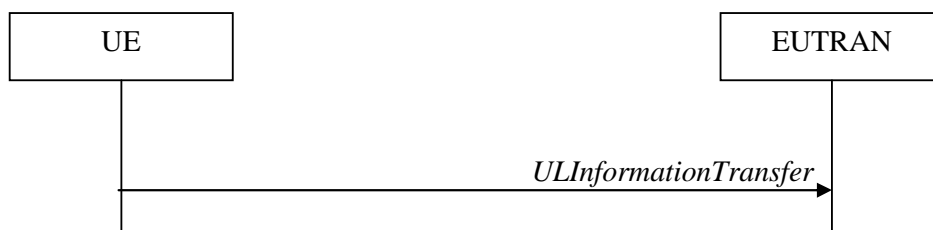

**Figure 5.6.2.1-1: UL information transfer**

The purpose of this procedure is to transfer NAS or (tunnelled) non-3GPP dedicated information from the UE to E-UTRAN, or to transfer F1-C related information from IAB-DU to IAB-donor-CU via IAB-MT in RRC\_CONNECTED.

### 5.6.2.2 Initiation

A UE in RRC\_CONNECTED initiates the UL information transfer procedure whenever there is a need to transfer NAS, non-3GPP dedicated information, except at RRC connection establishment or resume in which case the NAS information is piggybacked to the *RRCConnectionSetupComplete* or *RRCConnectionResumeComplete* message correspondingly. In addition, an IAB-MT in RRC\_CONNECTED may initiate the UL information transfer procedure whenever there is a need to transfer F1-C related information. The UE initiates the UL information transfer procedure by sending the *ULInformationTransfer* message. When CDMA2000 information has to be transferred, the UE shall initiate the procedure only if SRB2 is established. When F1-C related information has to be transferred, the IAB-MT shall initiate the procedure only if SRB2 is established.

### 5.6.2.3 Actions related to transmission of *ULInformationTransfer* message

The UE shall set the contents of the *ULInformationTransfer* message as follows:

- 1> if there is a need to transfer NAS information:
  - 2> if the UE is a NB-IoT UE:
    - 3> set the *dedicatedInfoNAS* to include the information received from upper layers;
  - 2> else:
    - 3> set the *dedicatedInfoType* to include the *dedicatedInfoNAS*;
- 1> if there is a need to transfer CDMA2000 1XRTT information:

- 2> set the *dedicatedInfoType* to include the *dedicatedInfoCDMA2000-1XRTT*;
- 1> if there is a need to transfer CDMA2000 HRPD information:
  - 2> set the *dedicatedInfoType* to include the *dedicatedInfoCDMA2000-HRPD*;
- 1> upon RRC connection establishment, if UE supports the Control Plane CIoT EPS/5GS optimisation and UE does not need UL gaps during continuous uplink transmission:
  - 2> configure lower layers to stop using UL gaps during continuous uplink transmission in FDD for *ULInformationTransfer* message and subsequent uplink transmission in RRC\_CONNECTED except for UL transmissions as specified in TS 36.211 [21];
- 1> if there is a need to transfer F1-C related information (applies only to IAB-MT):
  - 2> include the *dedicatedInfoF1c*;
- 1> submit the *ULInformationTransfer* message to lower layers for transmission, upon which the procedure ends;

### 5.6.2.4 Failure to deliver *ULInformationTransfer* message

The UE shall:

- 1> if the UE is a NB-IoT UE, AS security is not started and radio link failure occurs before the successful delivery of *ULInformationTransfer* messages has been confirmed by lower layers; or
- 1> if mobility (i.e. handover, RRC connection re-establishment) occurs before the successful delivery of *ULInformationTransfer* messages has been confirmed by lower layers:
  - 2> inform upper layers about the possible failure to deliver the information contained in the concerned *ULInformationTransfer* messages, unless the messages include *dedicatedInfoF1c* and no *dedicatedInfoType* is included;

### 5.6.2a UL information transfer for MR-DC

#### 5.6.2a.1 General

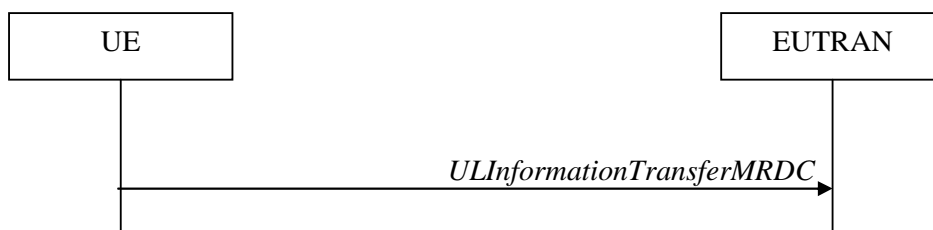

**Figure 5.6.2a.1-1: UL information transfer MR-DC**

The purpose of this procedure is to transfer from the UE to E-UTRAN MR-DC dedicated information e.g. the NR RRC *MeasurementReport*, the NR RRC *UEAssistanceInformation*, the NR RRC *IABOtherInformation*, NR RRC *FailureInformation* or an NR RRC *ReconfigurationComplete* (transmitted upon intra-SN CPC without MN involvement execution if NR RRC *Reconfiguration* with *conditionalReconfiguration* for CPC was received via SRB1 and the UE is operating in EN-DC) messages.

#### 5.6.2a.2 Initiation

A UE in RRC\_CONNECTED initiates the UL information transfer procedure whenever there is a need to transfer MR DC dedicated information as specified in TS 38.331 [82]. I.e. the procedure is not used during an RRC connection reconfiguration involving NR connection reconfiguration, in which case the MR DC information is piggybacked to the *RRCCConnectionReconfigurationComplete* message, except in the case the UE executes an intra-SN Conditional PSCell Change without MN involvement.

### 5.6.2a.3 Actions related to transmission of *ULInformationTransferMRDC* message

The UE shall set the contents of the *ULInformationTransferMRDC* message as follows:

- 1> if there is a need to transfer MR DC dedicated information:
  - 2> set the *ul-DCCH-MessageNR* to include the MR DC dedicated information to be transferred;
- 1> submit the *ULInformationTransferMRDC* message to lower layers for transmission, upon which the procedure ends;

### 5.6.2a.4 Void

## 5.6.3 UE capability transfer

### 5.6.3.1 General

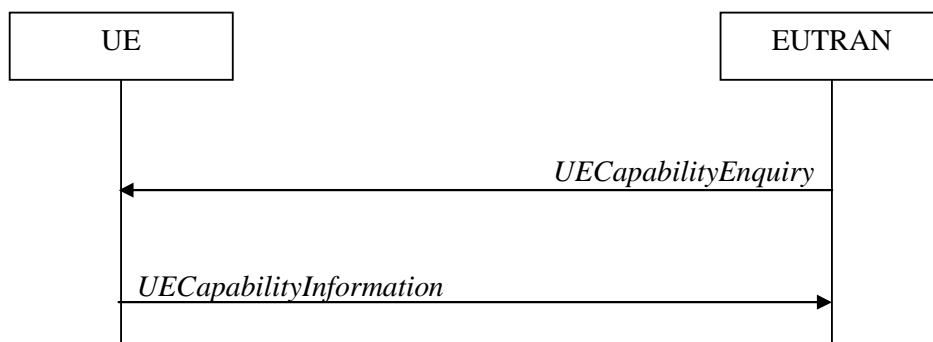

**Figure 5.6.3.1-1: UE capability transfer**

The purpose of this procedure is to transfer UE radio access capability information from the UE to E-UTRAN.

If the UE is NTN capable, the UE reports its E-UTRAN radio access capabilities for the network type (TN or NTN) to which it is connected.

If the UE has changed its E-UTRAN radio access capabilities, the UE shall request higher layers to initiate the necessary NAS procedures (see TS 23.401 [41]) that would result in the update of UE radio access capabilities using a new RRC connection.

NOTE: Change of the UE's GERAN UE radio capabilities in RRC\_IDLE is supported by use of Tracking Area Update.

### 5.6.3.2 Initiation

E-UTRAN initiates the procedure to a UE in RRC\_CONNECTED when it needs (additional) UE radio access capability information. Except if the UE is using Control plane CIoT EPS optimisation, E-UTRAN should retrieve UE capabilities only after AS security activation and E-UTRAN does not forward capabilities that were retrieved before AS security activation to the CN.

### 5.6.3.3 Reception of the *UECapabilityEnquiry* by the UE

The UE shall:

- 1> for NB-IoT, set the contents of *UECapabilityInformation* message as follows:
  - 2> include the UE Radio Access Capability Parameters within the *ue-Capability*;
  - 2> include *ue-RadioPagingInfo*;
  - 2> submit the *UECapabilityInformation* message to lower layers for transmission, upon which the procedure ends;

1> else, set the contents of *UECapabilityInformation* message as follows:

2> if the *ue-CapabilityRequest* includes *eutra*:

3> include the *UE-EUTRA-Capability* within a *ue-CapabilityRAT-Container* and with the *rat-Type* set to *eutra*;

3> if the UE supports FDD and TDD:

4> set all fields of *UECapabilityInformation*, except field *fdd-Add-UE-EUTRA-Capabilities* and *tdd-Add-UE-EUTRA-Capabilities* (including their sub-fields), to include the values applicable for both FDD and TDD (i.e. functionality supported by both modes);

4> if (some of) the UE capability fields have a different value for FDD and TDD:

5> if for FDD, the UE supports additional functionality compared to what is indicated by the previous fields of *UECapabilityInformation*:

6> include field *fdd-Add-UE-EUTRA-Capabilities* and set it to include fields reflecting the additional functionality applicable for FDD;

5> if for TDD, the UE supports additional functionality compared to what is indicated by the previous fields of *UECapabilityInformation*:

6> include field *tdd-Add-UE-EUTRA-Capabilities* and set it to include fields reflecting the additional functionality applicable for TDD;

NOTE 1: The UE includes fields of *XDD-Add-UE-EUTRA-Capabilities* in accordance with the following:

- The field is included only if one or more of its sub-fields (or bits in the feature group indicators string) has a value that is different compared to the value signalled elsewhere within *UE-EUTRA-Capability*; (this value signalled elsewhere is also referred to as the *Common value*, that is supported for both XDD modes)
- For the fields that are included in *XDD-Add-UE-EUTRA-Capabilities*, the UE sets:
  - the sub-fields (or bits in the feature group indicators string) that are not allowed to be different to the same value as the *Common value*;
  - the sub-fields (or bits in the feature group indicators string) that are allowed to be different to a value indicating at least the same functionality as indicated by the *Common value*;

3> else (UE supports single xDD mode):

4> set all fields of *UECapabilityInformation*, except field *fdd-Add-UE-EUTRA-Capabilities* and *tdd-Add-UE-EUTRA-Capabilities* (including their sub-fields), to include the values applicable for the xDD mode supported by the UE;

3> compile a list of band combinations, candidate for inclusion in the *UECapabilityInformation* message, comprising of band combinations supported by the UE according to the following priority order (i.e. listed in order of decreasing priority):

4> include all non-CA bands, regardless of whether UE supports carrier aggregation, only:

- if the UE includes *ue-Category-v1020* (i.e. indicating category 6 to 8); or
- if for at least one of the non-CA bands, the UE supports more MIMO layers with TM9 and TM10 than implied by the UE category; or
- if the UE supports TM10 with one or more CSI processes; or
- if the UE supports 1024QAM in DL;

4> if the *UECapabilityEnquiry* message includes *requestedFrequencyBands* and UE supports *requestedFrequencyBands*:

5> include all 2DL+1UL CA band combinations, only consisting of bands included in *requestedFrequencyBands*;



- 5> include all other CA band combinations, only consisting of bands included in *requestedFrequencyBands*, and prioritized in the order of *requestedFrequencyBands*, (i.e. first include remaining band combinations containing the first-listed band, then include remaining band combinations containing the second-listed band, and so on);
- 4> else (no requested frequency bands):
  - 5> include all 2DL+1UL CA band combinations;
  - 5> include all other CA band combinations;
- 4> if UE supports *maximumCCsRetrieval* and if the *UECapabilityEnquiry* message includes the *requestedMaxCCsDL* and the *requestedMaxCCsUL* (i.e. both UL and DL maximums are given):
  - 5> remove from the list of candidates the band combinations for which the number of CCs in DL exceeds the value indicated in the *requestedMaxCCsDL* or for which the number of CCs in UL exceeds the value indicated in the *requestedMaxCCsUL*;
  - 5> indicate in *requestedCCsUL* the same value as received in *requestedMaxCCsUL*;
  - 5> indicate in *requestedCCsDL* the same value as received in *requestedMaxCCsDL*;
- 4> else if UE supports *maximumCCsRetrieval* and if the *UECapabilityEnquiry* message includes the *requestedMaxCCsDL* (i.e. only DL maximum limit is given):
  - 5> remove from the list of candidates the band combinations for which the number of CCs in DL exceeds the value indicated in the *requestedMaxCCsDL*;
  - 5> indicate value in *requestedCCsDL* the same value as received in *requestedMaxCCsDL*;
- 4> else if UE supports *maximumCCsRetrieval* and if the *UECapabilityEnquiry* message includes the *requestedMaxCCsUL* (i.e. only UL maximum limit is given):
  - 5> remove from the list of candidates the band combinations for which the number of CCs in UL exceeds the value indicated in the *requestedMaxCCsUL*;
  - 5> indicate in *requestedCCsUL* the same value as received in *requestedMaxCCsUL*;
- 4> if the UE supports *reducedIntNonContComb* and the *UECapabilityEnquiry* message includes *requestReducedIntNonContComb*:
  - 5> set *reducedIntNonContCombRequested* to true;
  - 5> remove from the list of candidates the intra-band non-contiguous CA band combinations which support is implied by another intra-band non-contiguous CA band combination included in the list of candidates as specified in TS 36.306 [5], clause 4.3.5.21;
- 4> if the UE supports *requestReducedFormat* and UE supports *skipFallbackCombinations* and *UECapabilityEnquiry* message includes *requestSkipFallbackComb*:
  - 5> set *skipFallbackCombRequested* to true;
  - 5> for each band combination included in the list of candidates (including 2DL+1UL CA band combinations), starting with the ones with the lowest number of DL and UL carriers, that concerns a fallback band combination of another band combination included in the list of candidates as specified in TS 36.306 [5]:
    - 6> remove the band combination from the list of candidates;
    - 6> include *differentFallbackSupported* in the band combination included in the list of candidates whose fallback concerns the removed band combination, if its capabilities differ from the removed band combination;
- 4> if the UE supports *requestReducedFormat* and *diffFallbackCombReport*, and *UECapabilityEnquiry* message includes *requestDiffFallbackCombList*:

- 5> if the UE does not support *skipFallbackCombinations* or *UECapabilityEnquiry* message does not include *requestSkipFallbackComb*:
  - 6> remove all band combination from the list of candidates;
- 5> for each CA band combination indicated in *requestDiffFallbackCombList*:
  - 6> include the CA band combination, if not already in the list of candidates;
  - 6> include the fallback combinations for which the supported UE capabilities are different from the capability of the CA band combination;
- 5> include CA band combinations indicated in *requestDiffFallbackCombList* into *requestedDiffFallbackCombList*;
- 3> if the *UECapabilityEnquiry* message includes *requestReducedFormat* and UE supports *requestReducedFormat*:
  - 4> include in *supportedBandCombinationReduced* as many as possible of the band combinations included in the list of candidates, including the non-CA combinations, determined according to the rules and priority order defined above;
- 3> else:
  - 4> if the *UECapabilityEnquiry* message includes *requestedFrequencyBands* and UE supports *requestedFrequencyBands*:
    - 5> include in *supportedBandCombination* as many as possible of the band combinations included in the list of candidates, including the non-CA combinations and up to 5DL+5UL CA band combinations, determined according to the rules and priority order defined above;
    - 5> include in *supportedBandCombinationAdd* as many as possible of the remaining band combinations included in the list of candidates, (i.e. the candidates not included in *supportedBandCombination*), up to 5DL+5UL CA band combinations, determined according to the rules and priority order defined above;
  - 4> else:
    - 5> include in *supportedBandCombination* as many as possible of the band combinations included in the list of candidates, including the non-CA combinations and up to 5DL+5UL CA band combinations, determined according to the rules defined above;
    - 5> if it is not possible to include in *supportedBandCombination* all the band combinations to be included according to the above, selection of the subset of band combinations to be included is left up to UE implementation;
- 3> indicate in *requestedBands* the same bands and in the same order as included in *requestedFrequencyBands*, if received;
- 3> if the UE is a category 0, M1 or M2 UE, or supports any UE capability information in *ue-RadioPagingInfo*, according to TS 36.306 [5]:
  - 4> include *ue-RadioPagingInfo* and set the fields according to TS 36.306 [5];
- 3> if the UE supports (NG)EN-DC or NE-DC and if *requestedFreqBandsNR-MRDC* is included in the request:
  - 4> include into *featureSetsEUTRA* the feature sets that are applicable for the received *requestedFreqBandsNR-MRDC* and *requestedCapabilityCommon* as specified in TS 38.331 [82], clause 5.6.1.4.

NOTE 2: The network must include the *requestedFreqBandsNR-MRDC* in order to obtain feature sets for E-UTRA and MR-DC.

NOTE 3: Even if the network requests (only) capabilities for *eutra*, it may include NR band numbers in the *requestedFreqBandsNR-MRDC* in order to ensure that the UE includes all necessary feature sets (i.e. E-UTRA and NR) needed for subsequently requested *eutra-nr* capabilities.

- 3> if the *UECapabilityEnquiry* message includes *requestSTTI-SPT-Capability* and if the UE supports short TTI and/or SPT (i.e., *stti-SPT-Supported*):
  - 4> for each band combination the UE included in a field of the *UECapabilityInformation* message in accordance with the previous:
    - 5> if the UE supports short TTI, include the short TTI capabilities for each of the band combinations using the *stti-SPT-BandParameters*;
    - 5> if the UE supports SPT, include the SPT capabilities for each of the band combinations using the *stti-SPT-BandParameters*;

NOTE 4: The UE may have to add/repeat the band combinations to the list of band combinations included earlier, to include short TTI capabilities and/or SPT capabilities.

- 3> if the *UECapabilityEnquiry* message includes *sidelinkRequest*:
  - 4> for a sidelink band combination the UE included in *v2x-SupportedBandCombinationListEUTRA-NR*:
    - 5> if the UE supports partial sensing for a band of the sidelink band combination, include the partial sensing capabilities for the band using the *v2x-BandParametersEUTRA-NR-v1710*;
  - 4> set *sidelinkRequested* to true;
- 2> if the *ue-CapabilityRequest* includes *geran-cs* and if the UE supports GERAN CS domain:
  - 3> include the UE radio access capabilities for GERAN CS within a *ue-CapabilityRAT-Container* and with the *rat-Type* set to *geran-cs*;
- 2> if the *ue-CapabilityRequest* includes *geran-ps* and if the UE supports GERAN PS domain:
  - 3> include the UE radio access capabilities for GERAN PS within a *ue-CapabilityRAT-Container* and with the *rat-Type* set to *geran-ps*;
- 2> if the *ue-CapabilityRequest* includes *utra* and if the UE supports UTRA:
  - 3> include the UE radio access capabilities for UTRA within a *ue-CapabilityRAT-Container* and with the *rat-Type* set to *utra*;
- 2> if the *ue-CapabilityRequest* includes *cdma2000-1XRTT* and if the UE supports CDMA2000 1xRTT:
  - 3> include the UE radio access capabilities for CDMA2000 within a *ue-CapabilityRAT-Container* and with the *rat-Type* set to *cdma2000-1XRTT*;
- 2> if the *ue-CapabilityRequest* includes *nr* and if the UE supports NR:
  - 3> include the UE radio access capabilities for NR within a *ue-CapabilityRAT-Container*, with the *rat-Type* set to *nr*;
  - 3> include band combinations and feature sets as specified in TS 38.331 [82], clause 5.6.1.4, considering the included *requestedFreqBandsNR-MRDC*, *requestedCapabilityNR*, the *eutra-nr-only* flag and *requestedCapabilityCommon* (if present);
- 2> if the *ue-CapabilityRequest* includes *eutra-nr* and if the UE supports (NG)EN-DC or NE-DC:
  - 3> include the UE radio access capabilities for EUTRA-NR within a *ue-CapabilityRAT-Container*, with the *rat-Type* set to *eutra-nr*;
  - 3> include band combinations as specified in TS 38.331 [82], clause 5.6.1.4, considering the included *requestedFreqBandsNR-MRDC*, *requestedCapabilityNR* (if present) and *requestedCapabilityCommon* (if included);

- 1> if the RRC message segmentation is enabled based on the field *rrc-SegAllowed* received, and the encoded RRC message is larger than the maximum supported size of a PDCP SDU specified in TS 36.323 [8];
  - 2> initiate the UL message segment transfer procedure as specified in clause 5.6.22;
- 1> else:
- 2> submit the *UECapabilityInformation* message to lower layers for transmission, upon which the procedure ends;

## 5.6.4 CSFB to 1x Parameter transfer

### 5.6.4.1 General

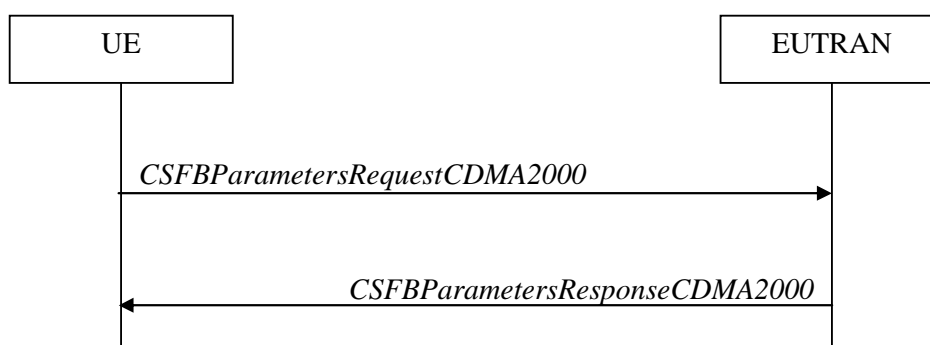

**Figure 5.6.4.1-1: CSFB to 1x Parameter transfer**

The purpose of this procedure is to transfer the CDMA2000 1xRTT parameters required to register the UE in the CDMA2000 1xRTT network for CSFB support.

### 5.6.4.2 Initiation

A UE in RRC\_CONNECTED initiates the CSFB to 1x parameter transfer procedure upon request from the CDMA2000 upper layers. The UE initiates the CSFB to 1x parameter transfer procedure by sending the *CSFBParametersRequestCDMA2000* message.

### 5.6.4.3 Actions related to transmission of *CSFBParametersRequestCDMA2000* message

The UE shall:

- 1> submit the *CSFBParametersRequestCDMA2000* message to lower layers for transmission using the current configuration;

### 5.6.4.4 Reception of the *CSFBParametersResponseCDMA2000* message

Upon reception of the *CSFBParametersResponseCDMA2000* message, the UE shall:

- 1> forward the *rand* and the *mobilityParameters* to the CDMA2000 1xRTT upper layers;

## 5.6.5 UE Information

### 5.6.5.1 General

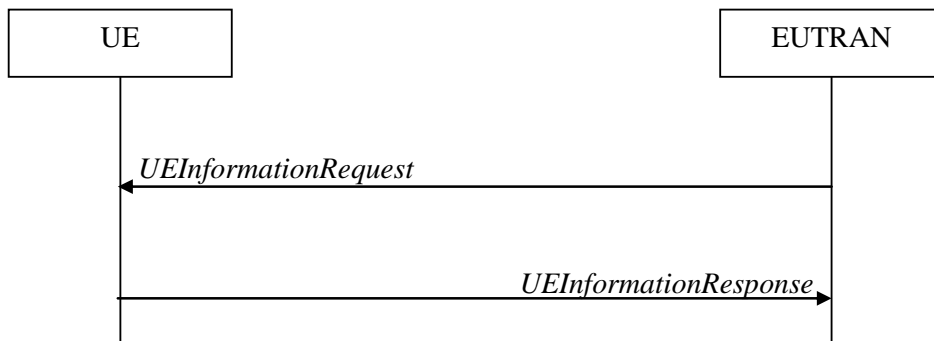

**Figure 5.6.5.1-1: UE information procedure**

The UE information procedure is used by E-UTRAN to request the UE to report information.

### 5.6.5.2 Initiation

E-UTRAN initiates the procedure by sending the *UEInformationRequest* message. E-UTRAN should initiate this procedure only after successful security activation.

### 5.6.5.3 Reception of the *UEInformationRequest* message

Upon receiving the *UEInformationRequest* message, the UE shall, only after successful security activation:

- 1> if *rach-ReportReq* is set to *true*, set the contents of the *rach-Report* in the *UEInformationResponse* message as follows:
  - 2> set the *numberOfPreamblesSent* to indicate the number of preambles sent by MAC for the last successfully completed random access procedure;
  - 2> if contention resolution was not successful as specified in TS 36.321 [6] for at least one of the transmitted preambles for the last successfully completed random access procedure:
    - 3> set the *contentionDetected* to *true*;
  - 2> else:
    - 3> set the *contentionDetected* to *false*;
  - 2> if the UE is a BL UE or UE in CE:
    - 3> set the *initialCEL* to indicate the initial CE level used for the last successfully completed random access procedure;
  - 2> if the UE is a NB-IoT UE:
    - 3> set the *initialNRSRP-Level* to indicate the NRSRP level of the NPRACH resource selected for the first preamble transmission for the last successfully completed random access procedure;
  - 2> if the UE is a BL UE, UE in CE or NB-IoT UE:
    - 3> if the last successfully completed random access procedure was initiated with EDT PRACH resource and succeeded after receiving EDT fallback indication from lower layers:
      - 4> set the *edt-Fallback* to *true*;
    - 3> else:
      - 4> set the *edt-Fallback* to *false*;

- 1> if *rlf-ReportReq* is set to *true* and the UE has radio link failure information or handover failure information available in *VarRLF-Report* (*VarRLF-Report-NB* in NB-IoT) and if the RPLMN is included in *plmn-IdentityList* stored in *VarRLF-Report*:
  - 2> for NB-IoT, if the global cell identity of the selected cell is the same as the *reestablishmentCellId* in the *VarRLF-Report-NB*:
    - 3> remove the *reestablishmentCellId* from the *VarRLF-Report-NB*;
  - 2> set *timeSinceFailure* in *VarRLF-Report* (*VarRLF-Report-NB* in NB-IoT) to the time that elapsed since the last radio link or handover failure in E-UTRA;
  - 2> set the *rlf-Report* in the *UEInformationResponse* message to the value of *rlf-Report* in *VarRLF-Report* (*VarRLF-Report-NB* in NB-IoT);
  - 2> discard the *rlf-Report* from *VarRLF-Report* (*VarRLF-Report-NB* in NB-IoT) upon successful delivery of the *UEInformationResponse* message confirmed by lower layers;
- 1> except for NB-IoT, if *connEstFailReportReq* is set to *true* and the UE has connection establishment failure information in *VarConnEstFailReport* and if the RPLMN is equal to *plmn-Identity* stored in *VarConnEstFailReport*:
  - 2> set *timeSinceFailure* in *VarConnEstFailReport* to the time that elapsed since the last connection establishment failure in E-UTRA;
  - 2> set the *connEstFailReport* in the *UEInformationResponse* message to the value of *connEstFailReport* in *VarConnEstFailReport*;
  - 2> discard the *connEstFailReport* from *VarConnEstFailReport* upon successful delivery of the *UEInformationResponse* message confirmed by lower layers;
- 1> except for NB-IoT, if the *logMeasReportReq* is present and if the RPLMN is included in *plmn-IdentityList* stored in *VarLogMeasReport*:
  - 2> if *VarLogMeasReport* includes one or more logged measurement entries, set the contents of the *logMeasReport* in the *UEInformationResponse* message as follows:
    - 3> include the *absoluteTimeStamp* and set it to the value of *absoluteTimeInfo* in the *VarLogMeasReport*;
    - 3> include the *traceReference* and set it to the value of *traceReference* in the *VarLogMeasReport*;
    - 3> include the *traceRecordingSessionRef* and set it to the value of *traceRecordingSessionRef* in the *VarLogMeasReport*;
    - 3> include the *tce-Id* and set it to the value of *tce-Id* in the *VarLogMeasReport*;
    - 3> include the *logMeasInfoList* and set it to include one or more entries from the *VarLogMeasReport* starting from the entries logged first, and for each entry of the *logMeasInfoList* that is included, include all information stored in the corresponding *logMeasInfoList* entry in *VarLogMeasReport*;
    - 3> if the *VarLogMeasReport* includes one or more additional logged measurement entries that are not included in the *logMeasInfoList* within the *UEInformationResponse* message:
      - 4> include the *logMeasAvailable*;
      - 4> if *logMeasResultListBT* is included in one or more of the additional logged measurement entries in *VarLogMeasReport* that are not included in the *logMeasInfoList* within the *UEInformationResponse* message:
        - 5> include the *logMeasAvailableBT*;
      - 4> if *logMeasResultListWLAN* is included in one or more of the additional logged measurement entries in *VarLogMeasReport* that are not included in the *logMeasInfoList* within the *UEInformationResponse* message:
        - 5> include the *logMeasAvailableWLAN*;

- 1> except for NB-IoT, if *mobilityHistoryReportReq* is set to *true*:
  - 2> include the *mobilityHistoryReport* and set it to include entries from *VarMobilityHistoryReport*;
  - 2> include in the *mobilityHistoryReport* an entry for the current cell, possibly after removing the oldest entry if required, and set its fields as follows:
    - 3> set *visitedCellId* to the global cell identity or the physical cell identity and carrier frequency of the current cell;
    - 3> set field *timeSpent* to the time spent in the current cell;
- 1> except for NB-IoT, if the *idleModeMeasurementReq* is included in the *UEInformationRequest* and the UE has stored *VarMeasIdleReport* that contains measurement information concerning cells other than the PCell:
  - 2> set the *measResultListIdle-r15* in the *UEInformationResponse* message to the value of *measReportIdle-r15* in the *VarMeasIdleReport*;
  - 2> set the *measResultListExtIdle* in the *UEInformationResponse* message to the value of *measReportIdle-r16* in the *VarMeasIdleReport*, if available;
  - 2> set the *measResultListIdleNR* in the *UEInformationResponse* message to the value of *measReportIdleNR* in the *VarMeasIdleReport*, if available;
  - 2> discard the *VarMeasIdleReport* upon successful delivery of the *UEInformationResponse* message confirmed by lower layers;
- 1> except for NB-IoT, if *flightPathInfoReq* field is present and the UE has flight path information available:
  - 2> include the *flightPathInfoReport* and set it to include the list of waypoints along the flight path;
  - 2> if the *includeTimeStamp* is set to *TRUE*:
    - 3> set the field *timeStamp* to the time when UE intends to arrive to each waypoint if this information is available at the UE;
- 1> for NB-IoT, if *anr-ReportReq* is set to *true* and the UE has *measResultList* available in *VarANR-MeasReport-NB*:
  - 2> set the *anr-MeasReport* in the *UEInformationResponse* message as follows:
    - 3> if the global cell identity of the PCell is different from *servCellIdentity* in the *VarANR-MeasReport-NB*;
      - 4> include the *servCellIdentity* and set it to the value of *servCellIdentity* in the *VarANR-MeasReport-NB*;
    - 3> set *measResultServCell* to the value of *measResultServCell* in the *VarANR-MeasReport-NB*;
    - 3> set *relativeTimeStamp* to the value of *relativeTimeStamp* in the *VarANR-MeasReport-NB*;
    - 3> set *measResultList* to the value of *measResultList* in the *VarANR-MeasReport-NB*;
  - 2> discard the *VarANR-MeasReport-NB* upon successful delivery of the *UEInformationResponse* message confirmed by lower layers;
- 1> except for NB-IoT, if the *coarseLocationReq* is set to *true*:
  - 2> if available, include the *coarseLocationInfo*;
- 1> if *rach-ReportReqNR* is included, and if the UE has NR RACH report information available in *VarRA-Report* of TS 38.331 [82] that is stored and the RPLMN is included in *plmn-IdentityList* stored in *VarRA-Report* of TS 38.331 [82], set the content of *rach-ReportNR* in the *UEInformationResponse* message as below:
  - 2> for each *RA-Report* of *ra-ReportList* in *VarRA-Report* of TS 38.331 [82]:
    - 3> include it as part of *rach-ReportListNR*;
    - 3> if the *cellIdListNR* is not set or the *cellId* of *RA-Report* has not been included in *cellIdListNR*:

- 4> add a new entry in *cellIdListNR* and set the *cellIdNR* to the global cell identity and the tracking area code, if available, otherwise to the physical cell identity and carrier frequency, as indicated in the *cellId* of *RA-Report*;
- 2> discard the *RA-Report* that was included in *rach-ReportListNR* from *ra-ReportList* in *VarRA-Report* of TS 38.331[82] upon successful delivery of the *UEInformationResponse* message as confirmed by lower layers;
- 1> if the *logMeasReport* is included in the *UEInformationResponse*:
  - 2> submit the *UEInformationResponse* message to lower layers for transmission via SRB2;
  - 2> discard the logged measurement entries included in the *logMeasInfoList* from *VarLogMeasReport* upon successful delivery of the *UEInformationResponse* message confirmed by lower layers;
- 1> else:
  - 2> submit the *UEInformationResponse* message to lower layers for transmission via SRB1.

## 5.6.6 Logged Measurement Configuration

### 5.6.6.1 General

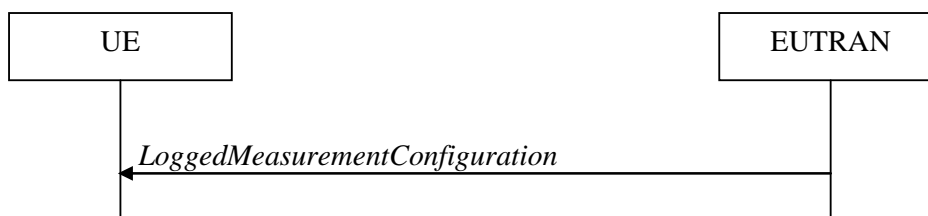

**Figure 5.6.6.1-1: Logged measurement configuration**

The purpose of this procedure is to configure the UE to perform logging of measurement results while in RRC\_IDLE and to perform logging of measurement results for MBSFN in both RRC\_IDLE and RRC\_CONNECTED. The procedure applies to logged measurements capable UEs that are in RRC\_CONNECTED.

NOTE: E-UTRAN may retrieve stored logged measurement information by means of the UE information procedure.

### 5.6.6.2 Initiation

E-UTRAN initiates the logged measurement configuration procedure to UE in RRC\_CONNECTED by sending the *LoggedMeasurementConfiguration* message.

### 5.6.6.3 Reception of the *LoggedMeasurementConfiguration* by the UE

Upon receiving the *LoggedMeasurementConfiguration* message the UE shall:

- 1> discard the logged measurement configuration as well as the logged measurement information as specified in 5.6.7;
- 1> store the received *loggingDuration*, *loggingInterval* and *areaConfiguration*, if included, in *VarLogMeasConfig*;
- 1> if the *LoggedMeasurementConfiguration* message includes *plmn-IdentityList*:
  - 2> set *plmn-IdentityList* in *VarLogMeasReport* to include the RPLMN as well as the PLMNs included in *plmn-IdentityList*;



1> else:

2> set *plmn-IdentityList* in *VarLogMeasReport* to include the RPLMN;

1> store the received *absoluteTimeInfo*, *traceReference*, *traceRecordingSessionRef* and *tce-Id* in *VarLogMeasReport*;

1> store the received *targetMBSFN-AreaList*, if included, in *VarLogMeasConfig*;

1> store the received *bt-NameList*, if included, in *VarLogMeasConfig*;

1> store the received *wlan-NameList*, if included, in *VarLogMeasConfig*;

1> store the received *loggedEventTriggerConfig*, if included, in *VarLogMeasConfig*;

1> store the received *measUncomBarPre*, if included, in *VarLogMeasConfig*;

1> start timer T330 with the timer value set to the *loggingDuration*;

1> store the received *sigLoggedMeasType*, if included, in *VarLogMeasReport*;

#### 5.6.6.4 T330 expiry

Upon expiry of T330 the UE shall:

1> release *VarLogMeasConfig*;

The UE is allowed to discard stored logged measurements, i.e. to release *VarLogMeasReport*, 48 hours after T330 expiry.

### 5.6.7 Release of Logged Measurement Configuration

#### 5.6.7.1 General

The purpose of this procedure is to release the logged measurement configuration as well as the logged measurement information.

#### 5.6.7.2 Initiation

The UE shall initiate the procedure upon receiving a logged measurement configuration in another RAT. The UE shall also initiate the procedure upon power off or detach.

The UE shall:

1> stop timer T330, if running;

1> if stored, discard the logged measurement configuration as well as the logged measurement information, i.e. release the UE variables *VarLogMeasConfig* and *VarLogMeasReport*;

### 5.6.8 Measurements logging

#### 5.6.8.1 General

This procedure specifies the logging of available measurements by a UE in RRC\_IDLE that has a logged measurement configuration and the logging of available measurements by a UE in both RRC\_IDLE and RRC\_CONNECTED if *targetMBSFN-AreaList* is included in *VarLogMeasConfig*.

When UE is configured to perform logging of measurements, measurements are performed with CRS.

#### 5.6.8.2 Initiation

While T330 is running, the UE shall:

- 1> if measurement logging is suspended:
  - 2> if during the last logging interval the IDC problems detected by the UE is resolved, resume measurement logging;
- 1> if not suspended, perform the logging in accordance with the following:
  - 2> if *targetMBSFN-AreaList* is included in *VarLogMeasConfig*:
    - 3> if the UE is camping normally on an E-UTRA cell or is connected to E-UTRA; and
    - 3> if the RPLMN is included in *plmn-IdentityList* stored in *VarLogMeasReport*; and
    - 3> if the PCell (in RRC\_CONNECTED) or cell where the UE is camping (in RRC\_IDLE) is part of the area indicated by *areaConfiguration* if configured in *VarLogMeasConfig*:
      - 4> for MBSFN areas, indicated in *targetMBSFN-AreaList*, from which the UE is receiving MBMS service:
        - 5> perform MBSFN measurements in accordance with the performance requirements as specified in TS 36.133 [16];

NOTE 1: When configured to perform MBSFN measurement logging by *targetMBSFN-AreaList*, the UE is not required to receive additional MBSFN subframes, i.e. logging is based on the subframes corresponding to the MBMS services the UE is receiving.

- 5> perform logging at regular time intervals as defined by the *loggingInterval* in *VarLogMeasConfig*, but only for those intervals for which MBSFN measurement results are available as specified in TS 36.133 [16];
- 2> else:
  - 3> if the *loggedEventTriggerConfig* is configured in *VarLogMeasConfig*, and *eventType* is set to *outOfCoverage*:
    - 4> perform the logging at regular time intervals as defined by the *loggingInterval* in *VarLogMeasConfig* only when the UE is in *any cell selection* state;
    - 4> upon transition from *any cell selection* state to *camped normally* state in E-UTRA:
      - 5> if the RPLMN is included in *plmn-IdentityList* stored in *VarLogMeasReport*; and
      - 5> if *areaConfiguration* is not included in *VarLogMeasConfig* or if the current camping cell is part of the area indicated by *areaConfiguration* in *VarLogMeasConfig*:
        - 6> perform the logging;
  - 3> else if the *loggedEventTriggerConfig* is configured in *VarLogMeasConfig* and *eventType* is set to *eventL1*:
    - 4> if the UE is in *camped normally* state on an E-UTRA cell and if the RPLMN is included in *plmn-IdentityList* stored in *VarLogMeasReport*:
      - 5> if *areaConfiguration* is not included in *VarLogMeasConfig*; or
      - 5> if the serving cell is part of the area indicated by *areaConfiguration* in *VarLogMeasConfig*:
        - 6> perform the logging at regular time intervals as defined by the *loggingInterval* in *VarLogMeasConfig* only when the conditions indicated by the *eventL1* are met;
  - 3> else if the UE is in *any cell selection* state (as specified in TS 36.304 [4]):
    - 4> perform the logging at regular time intervals, as defined by the *loggingInterval* in *VarLogMeasConfig*;
  - 3> else if the UE is camping normally on an E-UTRA cell and if the RPLMN is included in *plmn-IdentityList* stored in *VarLogMeasReport* and, if the cell is part of the area indicated by *areaConfiguration* if configured in *VarLogMeasConfig*:

- 4> perform the logging at regular time intervals, as defined by the *loggingInterval* in *VarLogMeasConfig*;
- 2> when adding a logged measurement entry in *VarLogMeasReport*, include the fields in accordance with the following:
  - 3> if the UE detected IDC problems during the last logging interval:
    - 4> if *measResultServCell* in *VarLogMeasReport* is not empty:
      - 5> include *inDeviceCoexDetected*;
      - 5> suspend measurement logging from the next logging interval;
    - 4> else:
      - 5> suspend measurement logging;

NOTE 1A: The UE may detect the start of IDC problems as early as Phase 1 as described in clause 23.4 of TS 36.300 [9].

- 3> set the *relativeTimeStamp* to indicate the elapsed time since the moment at which the logged measurement configuration was received;
- 3> if detailed location information became available during the last logging interval, set the content of the *locationInfo* as follows:
  - 4> include the *locationCoordinates*;
- 3> if *wlan-NameList* is included in *VarLogMeasConfig*:
  - 4> if detailed WLAN measurements are available:
    - 5> include *logMeasResultListWLAN*, in order of decreasing RSSI for WLAN APs;
- 3> if *bt-NameList* is included in *VarLogMeasConfig*:
  - 4> if detailed Bluetooth measurements are available:
    - 5> include *logMeasResultListBT*, in order of decreasing RSSI for Bluetooth beacons;
- 3> if *measUncomBarPre* is included in *VarLogMeasConfig*:
  - 4> if available, include the *uncomBarPreMeasResult*;
- 3> if *targetMBSFN-AreaList* is included in *VarLogMeasConfig*:
  - 4> for each MBSFN area, for which the mandatory measurements result fields became available during the last logging interval:
    - 5> set the *rsrpResultMBSFN*, *rsrqResultMBSFN* to include measurement results that became available during the last logging interval;
    - 5> include the fields *signallingBLER-Result* or *dataBLER-MCH-ResultList* if the concerned BLER results are available,
    - 5> set the *mbsfn-AreaId* and *carrierFreq* to indicate the MBSFN area in which the UE is receiving MBSFN transmission;
- 4> if in RRC\_CONNECTED:
  - 5> set the *servCellIdentity* to indicate global cell identity of the PCell;
  - 5> set the *measResultServCell* to include the layer 3 filtered measured results of the PCell;
  - 5> if available, set the *measResultNeighCells* to include the layer 3 filtered measured results of SCell(s) and neighbouring cell(s) measurements that became available during the last logging interval, in order of decreasing RSRP, for at most the following number of cells: 6 intra-frequency and 3 inter-frequency cells per frequency and according to the following:

- 6> for each cell included, include the optional fields that are available;
- 5> if available, optionally set the *measResultNeighCells* to include the layer 3 filtered measured results of neighbouring cell(s) measurements that became available during the last logging interval, in order of decreasing RSCP(UTRA)/RSSI(GERAN)/PilotStrength(cdma2000), for at most the following number of cells: 3 inter-RAT cells per frequency/set of frequencies (GERAN), and according to the following:
  - 6> for each cell included, include the optional fields that are available;
- 4> if in RRC\_IDLE:
  - 5> set the *servCellIdentity* to indicate global cell identity of the serving cell;
  - 5> set the *measResultServCell* to include the quantities of the serving cell;
  - 5> if available, set the *measResultNeighCells*, in order of decreasing ranking-criterion as used for cell re-selection, to include neighbouring cell measurements that became available during the last logging interval for at most the following number of neighbouring cells: 6 intra-frequency and 3 inter-frequency neighbours per frequency and according to the following:
    - 6> for each neighbour cell included, include the optional fields that are available;
  - 5> if available, optionally set the *measResultNeighCells*, in order of decreasing ranking-criterion as used for cell re-selection, to include neighbouring cell measurements that became available during the last logging interval, for at most the following number of cells: 3 inter-RAT cells per frequency/set of frequencies (GERAN), and according to the following:
    - 6> for each cell included, include the optional fields that are available;
  - 4> for the cells included according to the previous (i.e. covering previous and current serving cells as well as neighbouring EUTRA cells) include results according to the extended RSRQ if corresponding results are available according to the associated performance requirements defined in TS 36.133 [16];
  - 4> for the cells included according to the previous (i.e. covering previous and current serving cells as well as neighbouring EUTRA cells) include RSRQ type if the result was based on measurements using a wider band or using all OFDM symbols;

NOTE 2: The UE includes the latest results in accordance with the performance requirements as specified in TS 36.133 [16]. E.g. RSRP and RSRQ results are available only if the UE has a sufficient number of results/ receives a sufficient number of subframes during the logging interval.

- 3> else:
  - 4> if the UE is in *any cell selection* state (as specified in TS 36.304 [4]):
    - 5> set *anyCellSelectionDetected* to indicate the detection of no suitable or no acceptable cell found;
    - 5> if the *loggedEventTriggerConfig* is not configured in the *VarLogMeasConfig*;
      - 6> set the *servCellIdentity* to indicate global cell identity of the last logged cell that the UE was camping on;
      - 6> set the *measResultServCell* to include the quantities of the last logged cell the UE was camping on;
    - 5> else if the RPLMN at the time of entering the *any cell selection* state is included in *plmn-IdentityList* stored in *VarLogMeasReport*; and
    - 5> if *areaConfiguration* is not included in *VarLogMeasConfig* or if the last suitable cell that the UE was camping on is part of the area indicated by *areaConfiguration* in *VarLogMeasConfig*:
      - 6> set the *servCellIdentity* to indicate global cell identity of the last suitable cell that the UE was camping on;

- 6> set the *measResultServingCell* to include the quantities of the last suitable cell the UE was camping on;
- 5> else:
- 6> set the fields within the *servCellIdentity* and *measResultServingCell* to all zeros to indicate unavailability of the *servCellIdentity* and *measResultServCell*.
- 4> else:
- 5> set the *servCellIdentity* to indicate global cell identity of the cell the UE is camping on;
- 5> set the *measResultServCell* to include the quantities of the cell the UE is camping on;
- 4> if available, set the *measResultNeighCells*, in order of decreasing ranking-criterion as used for cell reselection, to include neighbouring cell measurements that became available during the last logging interval for at most the following number of neighbouring cells: 6 intra-frequency and 3 inter-frequency neighbours per frequency as well as 3 inter-RAT neighbours, per frequency/ set of frequencies (GERAN) per RAT and according to the following:
- 5> for each neighbour cell included, include the optional fields that are available;
- 4> for the cells included according to the previous (i.e. covering previous and current serving cells as well as neighbouring EUTRA cells) include results according to the extended RSRQ if corresponding results are available according to the associated performance requirements defined in TS 36.133 [16];
- 4> for the cells included according to the previous (i.e. covering previous and current serving cells as well as neighbouring EUTRA cells) include RSRQ type if the result was based on measurements using a wider band or using all OFDM symbols;
- NOTE 3: The UE includes the latest results of the available measurements as used for cell reselection evaluation in RRC\_IDLE or as used for evaluation of reporting criteria or for measurement reporting according to 5.5.3 in RRC\_CONNECTED, which are performed in accordance with the performance requirements as specified in TS 36.133 [16].
- 2> when the memory reserved for the logged measurement information becomes full, stop timer T330 and perform the same actions as performed upon expiry of T330, as specified in 5.6.6.4;

## 5.6.9 In-device coexistence indication

### 5.6.9.1 General

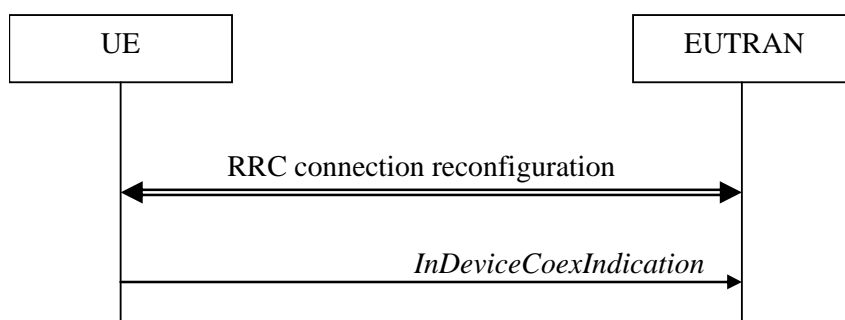

**Figure 5.6.9.1-1: In-device coexistence indication**

The purpose of this procedure is to inform E-UTRAN about (a change of) the In-Device Coexistence (IDC) problems experienced by the UE in RRC\_CONNECTED, as described in TS 36.300 [9], and to provide the E-UTRAN with information in order to resolve them.

### 5.6.9.2 Initiation

A UE capable of providing IDC indications may initiate the procedure when it is configured to provide IDC indications and upon change of IDC problem information.

Upon initiating the procedure, the UE shall:

- 1> if configured to provide IDC indications:
  - 2> if the UE did not transmit an *InDeviceCoexIndication* message since it was configured to provide IDC indications:
    - 3> if on one or more frequencies for which a *measObjectEUTRA* is configured, the UE is experiencing IDC problems that it cannot solve by itself; or
    - 3> if configured to provide IDC indications for UL CA; and if on one or more supported UL CA combination comprising of carrier frequencies for which a measurement object is configured, the UE is experiencing IDC problems that it cannot solve by itself; or
    - 3> if configured to provide IDC indications for MR-DC, and if on one or more supported MR-DC combination comprising of at least one E-UTRA carrier frequency for which a measurement object is configured and at least one NR carrier frequency included in *candidateServingFreqListNR*, the UE is experiencing IDC problems that it cannot solve by itself:
      - 4> initiate transmission of the *InDeviceCoexIndication* message in accordance with 5.6.9.3;
  - 2> else:
    - 3> if the set of frequencies, for which a *measObjectEUTRA* is configured and on which the UE is experiencing IDC problems that it cannot solve by itself, is different from the set indicated in the last transmitted *InDeviceCoexIndication* message; or
    - 3> if for one or more of the frequencies in the previously reported set of frequencies, the *interferenceDirection* is different from the value indicated in the last transmitted *InDeviceCoexIndication* message; or
    - 3> if the TDM assistance information is different from the assistance information included in the last transmitted *InDeviceCoexIndication* message; or
    - 3> if configured to provide IDC indications for UL CA; and if the *victimSystemType* is different from the value indicated in the last transmitted *InDeviceCoexIndication* message; or
    - 3> if configured to provide IDC indications for UL CA; and if the set of supported UL CA combinations on which the UE is experiencing IDC problems that it cannot solve by itself and that the UE includes in *affectedCarrierFreqCombList* according to 5.6.9.3, is different from the set indicated in the last transmitted *InDeviceCoexIndication* message; or
    - 3> if configured to provide IDC indications for MR-DC, and if the *victimSystemType* is different from the value indicated in the last transmitted *InDeviceCoexIndication* message; or
    - 3> if configured to provide IDC indications for MR-DC, for one or more of the frequencies in the previously reported set of frequencies, if *interferenceDirectionMRDC* is different from the value indicated in the last transmitted *InDeviceCoexIndication* message; or
    - 3> if configured to provide IDC indications for MR-DC, and if the set of supported MR-DC combinations on which the UE is experiencing IDC problems that it cannot solve by itself and that the UE includes in *affectedCarrierFreqCombInfoListMRDC* according to 5.6.9.3, is different from the set indicated in the last transmitted *InDeviceCoexIndication* message:
      - 4> initiate transmission of the *InDeviceCoexIndication* message in accordance with 5.6.9.3;

NOTE 1: The term "IDC problems" refers to interference issues applicable across several subframes/slots where not necessarily all the subframes/slots are affected.

NOTE 2: For the frequencies on which a serving cell or serving cells is configured that is activated, IDC problems consist of interference issues that the UE cannot solve by itself, during either active data exchange or upcoming data activity which is expected in up to a few hundred milliseconds.  
 For frequencies on which a SCell or SCells is configured that is deactivated, reporting IDC problems indicates an anticipation that the activation of the SCell or SCells would result in interference issues that the UE would not be able to solve by itself.  
 For a non-serving frequency, reporting IDC problems indicates an anticipation that if the non-serving frequency or frequencies became a serving frequency or serving frequencies then this would result in interference issues that the UE would not be able to solve by itself.

### 5.6.9.3 Actions related to transmission of *InDeviceCoexIndication* message

The UE shall set the contents of the *InDeviceCoexIndication* message as follows:

- 1> if there is at least one E-UTRA carrier frequency, for which a measurement object is configured, that is affected by IDC problems:
  - 2> include the field *affectedCarrierFreqList* with an entry for each affected E-UTRA carrier frequency for which a measurement object is configured;
  - 2> for each E-UTRA carrier frequency included in the field *affectedCarrierFreqList*, include *interferenceDirection* and set it accordingly;
  - 2> include Time Domain Multiplexing (TDM) based assistance information, unless *idc-HardwareSharingIndication* is configured and the UE has no Time Domain Multiplexing based assistance information that could be used to resolve the IDC problems:
    - 3> if the UE has DRX related assistance information that could be used to resolve the IDC problems:
      - 4> include *drx-CycleLength*, *drx-Offset* and *drx-ActiveTime*;
    - 3> else (the UE has desired subframe reservation patterns related assistance information that could be used to resolve the IDC problems):
      - 4> include *idc-SubframePatternList*;
    - 3> use the MCG as timing reference if TDM based assistance information regarding the SCG is included;
- 1> if the UE is configured to provide UL CA information and there is a supported UL CA combination comprising of carrier frequencies for which a measurement object is configured, that is affected by IDC problems:
  - 2> include *victimSystemType* in *ul-CA-AssistanceInfo*;
  - 2> if the UE sets *victimSystemType* to *wlan* or *Bluetooth*:
    - 3> include *affectedCarrierFreqCombList* in *ul-CA-AssistanceInfo* with an entry for each supported UL CA combination comprising of carrier frequencies for which a measurement object is configured, that is affected by IDC problems;
  - 2> else:
    - 3> optionally include *affectedCarrierFreqCombList* in *ul-CA-AssistanceInfo* with an entry for each supported UL CA combination comprising of carrier frequencies for which a measurement object is configured, that is affected by IDC problems;
- 1> if *idc-HardwareSharingIndication* is configured, and there is at least one E-UTRA carrier frequency, for which a measurement object is configured, the UE is experiencing hardware sharing problems that it cannot solve by itself:
  - 2> include the *hardwareSharingProblem* and set it accordingly;
- 1> if the UE is configured to provide IDC indications for MR-DC and there is a supported MR-DC band combination comprising of at least one E-UTRA carrier frequency for which a measurement object is configured and at least one NR carrier frequency included in *candidateServingFreqListNR*, that is affected by IDC problems; and

- 1> if the IDC problem does not only concern the E-UTRA band combination as the UE already included in *affectedCarrierFreqCombList*:
  - 2> for each entry of *affectedCarrierFreqCombInfoListMRDC* in *mrdc-AssistanceInfo*;
    - 3> include *victimSystemType*;
    - 3> include *interferenceDirectionMRDC*;
    - 3> if the UE sets *victimSystemType* to *wlan* or *Bluetooth*:
      - 4> include a set of at least one NR carrier frequency included in *candidateServingFreqListNR* and optionally one or more E-UTRA carrier frequency for which a measurement object is configured, that is affected by IDC problems;
  - 3> else:
    - 4> optionally include a set of at least one NR carrier frequency included in *candidateServingFreqListNR* and optionally one or more E-UTRA carrier frequency for which a measurement object is configured, that is affected by IDC problems;

NOTE 1: When sending an *InDeviceCoexIndication* message to inform E-UTRAN the IDC problems, the UE includes all assistance information (rather than providing e.g. the changed part(s) of the assistance information).

NOTE 2: Upon not anymore experiencing a particular IDC problem that the UE previously reported, the UE provides an IDC indication with the modified contents of the *InDeviceCoexIndication* message (e.g. by an empty message).

The UE shall submit the *InDeviceCoexIndication* message to lower layers for transmission.

## 5.6.10 UE Assistance Information

### 5.6.10.1 General

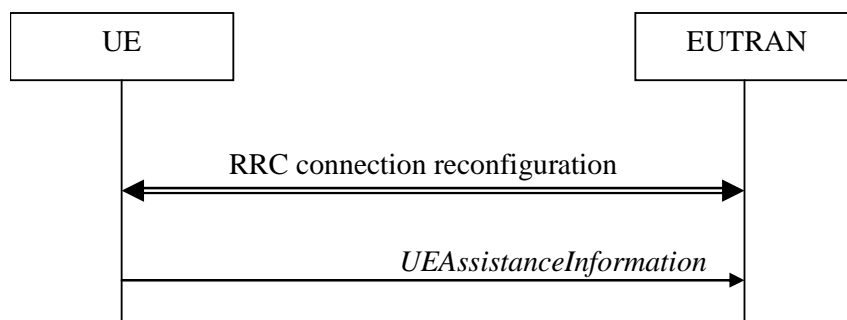

Figure 5.6.10.1-1: UE Assistance Information

The purpose of this procedure is to inform E-UTRAN of the UE's power saving preference and SPS assistance information, maximum PDSCH/PUSCH bandwidth configuration preference, overheating assistance information, or the UE's delay budget report carrying desired increment/decrement in the Uu air interface delay or connected mode DRX cycle length and for BL UEs or UEs in CE of the RLM event ("early-out-of-sync" or "early-in-sync") and RLM information or the UE preference for the NR SCG deactivation or that the UE with a deactivated NR SCG has uplink data to send on a DRB for which there is no MCG RLC bearer. Upon configuring the UE to provide power preference indications E-UTRAN may consider that the UE does not prefer a configuration primarily optimised for power saving until the UE explicitly indicates otherwise.

### 5.6.10.2 Initiation

A UE capable of providing power preference indications in RRC\_CONNECTED may initiate the procedure in several cases including upon being configured to provide power preference indications and upon change of power preference.



A UE capable of providing SPS assistance information in RRC\_CONNECTED may initiate the procedure in several cases including upon being configured to provide SPS assistance information and upon change of SPS assistance information.

A UE capable of providing delay budget report in RRC\_CONNECTED may initiate the procedure in several cases, including upon being configured to provide delay budget report and upon change of delay budget preference.

A UE capable of CE mode and providing maximum PDSCH/PUSCH bandwidth preference in RRC\_CONNECTED may initiate the procedure upon being configured to provide maximum PDSCH/PUSCH bandwidth preference and/or upon change of maximum PDSCH/PUSCH bandwidth preference.

A UE capable of providing overheating assistance information in RRC\_CONNECTED may initiate the procedure if it was configured to do so, upon detecting internal overheating, or upon detecting that it is no longer experiencing an overheating condition.

A UE supporting NR SCG deactivation may initiate the procedure in several cases including upon being configured to provide its preference for NR SCG deactivation and upon change of its preference for NR SCG deactivation.

A UE in EN-DC that has uplink data to transmit for a DRB for which there is no MCG RLC bearer while the SCG is deactivated shall initiate the procedure.

Upon initiating the procedure, the UE shall:

1> if configured to provide power preference indications:

- 2> if the UE did not transmit a *UEAssistanceInformation* message with *powerPrefIndication* since it was configured to provide power preference indications; or
- 2> if the current power preference is different from the one indicated in the last transmission of the *UEAssistanceInformation* message and timer T340 is not running:
  - 3> start or restart timer T340 with the timer value set to the *powerPrefIndicationTimer*, if the UE does not prefer a configuration primarily optimised for power saving;
  - 3> initiate transmission of the *UEAssistanceInformation* message in accordance with 5.6.10.3;

1> if configured to provide maximum PDSCH/PUSCH bandwidth preference:

- 2> if the UE did not transmit a *UEAssistanceInformation* message with *bw-Preference* since it was configured to provide maximum PDSCH/PUSCH bandwidth preference; or
- 2> if the current maximum PDSCH/PUSCH bandwidth preference is different from the one indicated in the last transmission of the *UEAssistanceInformation* message and timer T341 is not running:
  - 3> start timer T341 with the timer value set to the *bw-PreferenceIndicationTimer*;
  - 3> initiate transmission of the *UEAssistanceInformation* message in accordance with 5.6.10.3;

1> if configured to provide SPS assistance information:

- 2> if the UE did not transmit a *UEAssistanceInformation* message with *sps-AssistanceInformation* since it was configured to provide SPS assistance information; or
- 2> if the current SPS assistance information is different from the one indicated in the last transmission of the *UEAssistanceInformation* message:
  - 3> initiate transmission of the *UEAssistanceInformation* message in accordance with 5.6.10.3;

1> if configured to report RLM events:

- 2> if "early-out-of-sync" event has been detected (T314 has expired) and T343 is not running:
  - 3> start timer T343 with the timer value set to the *rlmReportTimer*;
  - 3> initiate transmission of the *UEAssistanceInformation* message in accordance with 5.6.10.3;
- 2> if "early-in-sync" event has been detected (T315 has expired) and T344 is not running:

- 3> start timer T344 with the timer value set to the *rlmReportTimer*;
  - 3> initiate transmission of the *UEAssistanceInformation* message in accordance with 5.6.10.3;
  - 1> if configured to provide delay budget report:
    - 2> if the UE did not transmit a *UEAssistanceInformation* message with *delayBudgetReport* since it was configured to provide delay budget report; or
    - 2> if the current delay budget is different from the one indicated in the last transmission of the *UEAssistanceInformation* message and timer T342 is not running:
      - 3> start or restart timer T342 with the timer value set to the *delayBudgetReportingProhibitTimer*;
      - 3> initiate transmission of the *UEAssistanceInformation* message in accordance with 5.6.10.3;
  - 1> if configured to provide overheating assistance information:
    - 2> if the overheating condition has been detected and T345 is not running; or
    - 2> if the current overheating assistance information is different from the one indicated in the last transmission of the *UEAssistanceInformation* message and timer T345 is not running:
      - 3> start timer T345 with the timer value set to the *overheatingIndicationProhibitTimer*;
      - 3> initiate transmission of the *UEAssistanceInformation* message in accordance with 5.6.10.3;
- NOTE: In case overheating assistance for NR SCG is released while the regular overheating assistance remains configured, a UE that included SCG overheating parameters in the last reported overheating assistance considers overheating assistance information to be different regardless whether or not its preferences for the regular overheating assistance changed.
- 1> if configured to provide its preference for NR SCG deactivation:
    - 2> if the UE did not transmit a *UEAssistanceInformation* message with *scg-DeactivationPreference* since it was configured to provide its preference for NR SCG deactivation and the UE prefers the NR SCG to be deactivated; or
    - 2> if the UE preference for NR SCG deactivation is different from the one indicated in the last transmission of the *UEAssistanceInformation* message and timer T346 is not running:
      - 3> start or restart timer T346 with the timer value set to the *scg-DeactivationPreferenceProhibitTimer*;
      - 3> initiate transmission of the *UEAssistanceInformation* message in accordance with 5.6.10.3;
  - 1> if the UE is configured with a deactivated NR SCG and there are uplink data to send on a DRB for which *rlc-Config* is not configured in *drb-ToAddModList*; and
  - 1> if the UE previously did not have any uplink data to send for any SCG RLC entity:
    - 2> initiate transmission of the *UEAssistanceInformation* message in accordance with 5.6.10.3.

### 5.6.10.3 Actions related to transmission of *UEAssistanceInformation* message

The UE shall set the contents of the *UEAssistanceInformation* message for power preference indications:

- 1> if configured to provide power preference indication and if the UE prefers a configuration primarily optimised for power saving:
  - 2> set *powerPrefIndication* to *lowPowerConsumption*;
- 1> else if configured to provide power preference indication:
  - 2> set *powerPrefIndication* to *normal*;

The UE shall set the contents of the *UEAssistanceInformation* message for SPS assistance information:

- 1> if configured to provide SPS assistance information:
  - 2> if there is any traffic for V2X sidelink communication which needs to report SPS assistance information:
    - 3> include *trafficPatternInfoListSL* in the *UEAssistanceInformation* message;
  - 2> if there is any traffic for uplink communication which needs to report SPS assistance information:
    - 3> include *trafficPatternInfoListUL* in the *UEAssistanceInformation* message;

The UE shall set the contents of the *UEAssistanceInformation* message for bandwidth preference indications:

- 1> set *bw-Preference* to its preferred configuration;

The UE shall set the contents of the *UEAssistanceInformation* message for delay budget report:

- 1> if configured to provide delay budget report:
  - 2> if the UE prefers an adjustment in the connected mode DRX cycle length:
    - 3> set *delayBudgetReport* to *type1* according to a desired value;
  - 2> else if the UE prefers coverage enhancement configuration change:
    - 3> set *delayBudgetReport* to *type2* according to a desired value;

The UE shall set the contents of the *UEAssistanceInformation* message for the RLM report:

- 1> if configured to provide RLM report:
  - 2> if T314 has expired:
    - 3> set *rlm-event* to *earlyOutOfSync*;
  - 2> if T315 has expired:
    - 3> set *rlm-event* to *earlyInSync*;
    - 3> if configured to report *rlmReportRep-MPDCCH*:
      - 4> set *excessRep-MPDCCH* to the value indicated by lower layers;

The UE shall set the contents of the *UEAssistanceInformation* message for overheating assistance indication:

- 1> if configured to provide overheating assistance indication:
  - 2> if the UE experiences internal overheating:
    - 3> if the UE prefers to temporarily reduce its DL category and UL category:
      - 4> include *reducedUE-Category* in the *OverheatingAssistance* IE;
      - 4> set *reducedUE-CategoryDL* to the number to which the UE prefers to temporarily reduce its DL category;
      - 4> set *reducedUE-CategoryUL* to the number to which the UE prefers to temporarily reduce its UL category;
    - 3> if the UE prefers to temporarily reduce the number of maximum secondary component carriers:
      - 4> include *reducedMaxCCs* in the *OverheatingAssistance* IE;
      - 4> set *reducedCCsDL* to the number of maximum SCells the UE prefers to be temporarily configured in downlink;
      - 4> set *reducedCCsUL* to the number of maximum SCells the UE prefers to be temporarily configured in uplink;
  - 3> if configured to provide overheating assistance indication for NR SCG:

- 4> include *overheatingAssistanceForSCG* in the *OverheatingAssistance* IE;
- 4> if configured with serving cells operating on FR2-2 for NR SCG
  - 5> include *overheatingAssistanceForSCG-FR2-2* in the *OverheatingAssistance* IE;
- 4> set *overheatingAssistanceForSCG* and if applicable, *overheatingAssistanceForSCG-FR2-2*, in accordance with clause 5.7.4.3a as specified in TS 38.331 [82];
- 2> else (if the UE no longer experiences an overheating condition):
  - 3> if the UE had a preference for the *OverheatingAssistance*:
    - 4> do not include *reducedUE-Category*, *reducedMaxCCs* in *OverheatingAssistance* IE;
  - 3> if the UE had a preference for the *overheatingAssistanceForSCG*:
    - 4> do not include *overheatingAssistance-v1610* in the *UEAssistanceInformation-v1610* IE; or
    - 4> do not include *UEAssistanceInformation-v1610* IE in the *UEAssistanceInformation-v1530* IE; or
    - 4> do not include *UEAssistanceInformation-v1530* IEs in *UEAssistanceInformation-v1450* IEs;
    - 4> if configured with serving cells operating on FR2-2 for NR SCG
      - 5> do not include *OverheatingAssistance-v1710* in the *UEAssistanceInformation-v1710* IE;

NOTE 0: It is up to UE implementation to whether include an empty *OverheatingAssistance* IE or not, for the case where UE only had a preference for the *overheatingAssistanceForSCG*.

The UE shall set the contents of the *UEAssistanceInformation* message for NR SCG deactivation:

- 1> if configured to provide its preference for NR SCG deactivation;
  - 2> if the UE prefers NR SCG to be deactivated
    - 3> include the *scg-DeactivationPreference* and set it to *scgDeactivationPreferred*:
  - 2> else:
    - 3> include the *scg-DeactivationPreference* and set it to *noPreference*:

The UE shall:

- 1> if the UE is configured with a deactivated NR SCG and there are uplink data to send on a DRB for which *rlc-Config* is not configured in *drb-ToAddModList*; and
- 1> if the UE previously did not have any uplink data to send for any SCG RLC entity:
  - 2> include *uplinkData* in the *UEAssistanceInformation* message;
- 1> if the procedure was triggered to provide SPS assistance information and the related configuration was provided by an *RRCConnectionReconfiguration* message that was received embedded within an NR *RRCReconfiguration* message:
  - 2> submit the *UEAssistanceInformation* message via SRB1 embedded in NR RRC message *ULInformationTransferIRAT* as specified in TS 38.331 [82];
- 1> else:
  - 2> submit the *UEAssistanceInformation* message to lower layers for transmission.

NOTE 1: It is up to UE implementation when and how to trigger SPS assistance information.

NOTE 2: It is up to UE implementation to set the content of *trafficPatternInfoListSL* and *trafficPatternInfoListUL*.

NOTE 3: Traffic patterns for different Destination Layer 2 IDs are provided in different entries in *trafficPatternInfoListSL*.

NOTE 4: Although not recommended, UE may start or restart the following timers whenever it sends the *UEAssistanceInformation* message (i.e. even if the message was not triggered for the concerned feature): T340, T341, T342, T343, T344 and T345.

## 5.6.11 Mobility history information

### 5.6.11.1 General

This procedure specifies how the mobility history information is stored by the UE, covering RRC\_CONNECTED and RRC\_IDLE.

### 5.6.11.2 Initiation

If the UE supports storage of mobility history information, the UE shall:

- 1> Upon change of cell, consisting of PCell in RRC\_CONNECTED or serving cell in RRC\_IDLE, to another E-UTRA or inter-RAT cell or when entering out of service:
  - 2> include an entry in variable *VarMobilityHistoryReport* possibly after removing the oldest entry, if necessary, according to following:
    - 3> if the global cell identity of the previous PCell/ serving cell is available:
      - 4> include the global cell identity of that cell in the field *visitedCellId* of the entry;
    - 3> else:
      - 4> include the physical cell identity and carrier frequency of that cell in the field *visitedCellId* of the entry;
    - 3> set the field *timeSpent* of the entry as the time spent in the previous PCell/ serving cell;
  - 1> upon entering E-UTRA (in RRC\_CONNECTED or RRC\_IDLE) while previously out of service and/ or using another RAT:
    - 2> include an entry in variable *VarMobilityHistoryReport* possibly after removing the oldest entry, if necessary, according to following:
      - 3> set the field *timeSpent* of the entry as the time spent outside E-UTRA;

## 5.6.12 RAN-assisted WLAN interworking

### 5.6.12.1 General

The purpose of this procedure is to facilitate access network selection and traffic steering between E-UTRAN and WLAN.

If required by upper layers (see TS 24.312 [66]), the UE shall provide an up-to-date set of the applicable parameters provided by *wlan-OffloadConfigCommon* or *wlan-OffloadConfigDedicated* to upper layers, and inform upper layers when no parameters are configured. The parameter set from either *wlan-OffloadConfigCommon* or *wlan-OffloadConfigDedicated* is selected as specified in clauses 5.2.2.24, 5.3.12, 5.6.12.2 and 5.6.12.4.

### 5.6.12.2 Dedicated WLAN offload configuration

The UE shall:

- 1> if the received *wlan-OffloadInfo* is set to *release*:
  - 2> release *wlan-OffloadConfigDedicated* and *t350*;
  - 2> if the *wlan-OffloadConfigCommon* corresponding to the RPLMN is broadcast by the cell:

3> apply the *wlan-OffloadConfigCommon* corresponding to the RPLMN included in *SystemInformationBlockType17*;

1> else:

2> apply the received *wlan-OffloadConfigDedicated*:

### 5.6.12.3 WLAN offload RAN evaluation

The UE shall:

1> if the UE is configured with either *wlan-OffloadConfigCommon* or *wlan-OffloadConfigDedicated*; and

1> if the UE is in RRC\_IDLE or none of *rclwi-Configuration*, *lwa-Configuration* and *lwip-Configuration* is configured:

2> provide measurement results required for the evaluation of the network selection and traffic steering rules as defined in TS 24.312 [66] to upper layers;

2> evaluate the network selection and traffic steering rules as defined in TS 36.304 [4] using WLAN identifiers as indicated in other clauses (either provided in *steerToWLAN* included in *rclwi-Configuration* or in *wlan-Id-List* included in *SystemInformationBlockType17*);

### 5.6.12.4 T350 expiry or stop

The UE shall:

1> if T350 expires or is stopped:

2> release the *wlan-OffloadConfigDedicated* and *t350*;

2> release *rclwi-Configuration* if configured;

2> if the *wlan-OffloadConfigCommon* corresponding to the RPLMN is broadcast by the cell:

3> apply the *wlan-OffloadConfigCommon* and the *wlan-Id-List* corresponding to the RPLMN included in *SystemInformationBlockType17*;

### 5.6.12.5 Cell selection/ re-selection while T350 is running

The UE shall:

1> if, while T350 is running, the UE selects/ reselects a cell which is not the PCell when the *wlan-OffloadDedicated* was configured:

2> stop timer T350;

2> perform the actions as specified in 5.6.12.4;

## 5.6.13 SCG failure information

### 5.6.13.1 General

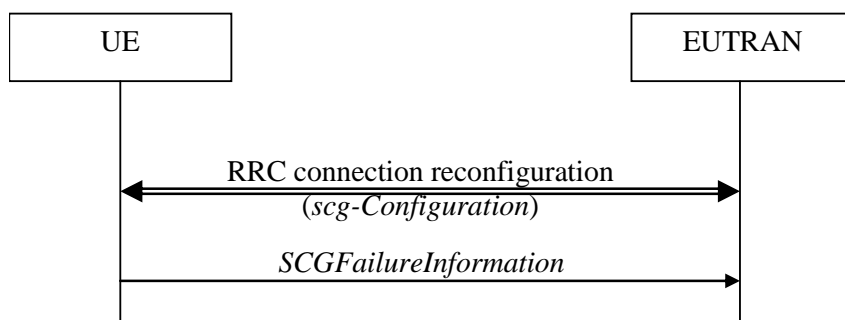

**Figure 5.6.13.1-1: SCG failure information**

The purpose of this procedure is to inform E-UTRAN about an SCG failure the UE has experienced i.e. SCG radio link failure, SCG change failure.

### 5.6.13.2 Initiation

A UE initiates the procedure to report SCG failures when neither MCG nor SCG transmission is suspended and when one of the following conditions is met:

- 1> upon detecting radio link failure for the SCG, in accordance with 5.3.11; or
- 1> upon SCG change failure, in accordance with 5.3.5.7a; or
- 1> upon stopping uplink transmission towards the PSCell due to exceeding the maximum uplink transmission timing difference when *powerControlMode* is configured to 1, in accordance with clause 7.17.2 of TS 36.133 [29].

In case of DC, upon initiating the procedure, the UE shall:

- 1> suspend all SCG DRBs and suspend SCG transmission for split DRBs;
- 1> reset SCG-MAC;
- 1> stop T307;
- 1> if the UE is configured with NE-DC:
  - 2> initiate transmission of the *SCGFailureInformationEUTRA* message via the NR MCG as specified in TS 38.331 [82], clause 5.7.3a;
- 1> else:
  - 2> initiate transmission of the *SCGFailureInformation* message in accordance with 5.6.13.3;

### 5.6.13.3 Actions related to transmission of *SCGFailureInformation* message

The UE shall set the contents of the *SCGFailureInformation* message as follows:

- 1> if the UE initiates transmission of the *SCGFailureInformation* message to provide SCG radio link failure information:
  - 2> include *failureType* and set it to the trigger for detecting SCG radio link failure;
- 1> else if the UE initiates transmission of the *SCGFailureInformation* message to provide SCG change failure information:
  - 2> include *failureType* and set it to scg-ChangeFailure;

- 1> else if the UE initiates transmission of the *SCGFailureInformation* message due to exceeding maximum uplink transmission timing difference:
    - 2> include *failureType* and set it to *maxUL-TimingDiff*;
  - 1> set the *measResultServFreqList* to include for each E-UTRA SCG cell that is configured, if any, within *measResultSCell* the quantities of the concerned SCell, if available according to performance requirements in TS 36.133 [16];
  - 1> for each E-UTRA SCG serving frequency included in *measResultServFreqList*, include within *measResultBestNeighCell* the *physCellId* and the quantities of the best non-serving cell, based on RSRP, on the concerned serving frequency;
  - 1> set the *measResultNeighCells* to include the best measured cells on non-serving E-UTRA frequencies, ordered such that the best cell is listed first, and based on measurements collected up to the moment the UE detected the failure, and set its fields as follows:
    - 2> if the UE was configured to perform measurements for one or more non-serving EUTRA frequencies and measurement results are available, include the *measResultListEUTRA*;
    - 2> for each neighbour cell included, include the optional fields that are available;
- NOTE 1: The measured quantities are filtered by the L3 filter as configured in the mobility measurement configuration. The measurements are based on the time domain measurement resource restriction, if configured. Exclude-listed cells are not required to be reported.

The UE shall submit the *SCGFailureInformation* message to lower layers for transmission.

#### 5.6.13.4 Failure type determination in NE-DC

The UE shall:

- 1> if SCG failure is due to T313 expiry:
  - 2> consider the *failureType* to be *t313-Expiry*;
- 1> else if SCG failure is due to indication from SCG MAC that a random access problem was detected:
  - 2> consider the *failureType* to be *randomAccessProblem*;
- 1> else if SCG failure is due to indication from SCG RLC that the maximum number of retransmissions was reached:
  - 2> consider the *failureType* to be *rlc-MaxNumRetx*;
- 1> else if SCG failure is due to SCG change failure:
  - 2> consider the *failureType* to be *scg-ChangeFailure*;

#### 5.6.13.5 Setting the contents of *MeasResultSCG-FailureMRDC*

The UE shall:

- 1> set the contents of the *MeasResultSCG-FailureMRDC* as follows:
  - 2> for each *measObjectEUTRA* for which a *measId* is configured and for which measurement results are available;
  - 3> include an entry in *measResultsFreqListEUTRA*;
  - 3> if a serving cell is associated with the *MeasObjectEUTRA*:
    - 4> set *measResultServingCell* to include the available quantities of the concerned cell and in accordance with the performance requirements in TS 36.133 [16];



- 3> set the *measResultNeighCellList* to include the best measured cells, ordered such that the best cell is listed first, and based on measurements collected up to the moment the UE detected the failure, and set its fields as follows;
  - 4> ordering the cells with sorting as follows:
    - 5> using RSRP if RSRP measurement results are available, otherwise using RSRQ if RSRQ measurement results are available, otherwise using SINR;
  - 4> for each neighbour cell included:
    - 5> include the optional fields for which measurement results are available;
- 2> if detailed location information is available, set the content of the *locationInfo* as follows;
  - 3> include the *locationCoordinates*;
  - 3> include the *horizontalVelocity*, if available;
- 2> if available, set the *logMeasResultListWLAN* to include the WLAN measurement results, in order of decreasing RSSI for WLAN APs;
- 2> if available, set the *logMeasResultListBT* to include the Bluetooth measurement results, in order of decreasing RSSI for Bluetooth beacons;

NOTE: The measured quantities are filtered by the L3 filter as configured in the mobility measurement configuration. The measurements are based on the time domain measurement resource restriction, if configured. Exclude-listed cells are not required to be reported.

## 5.6.13a NR SCG failure information

### 5.6.13a.1 General

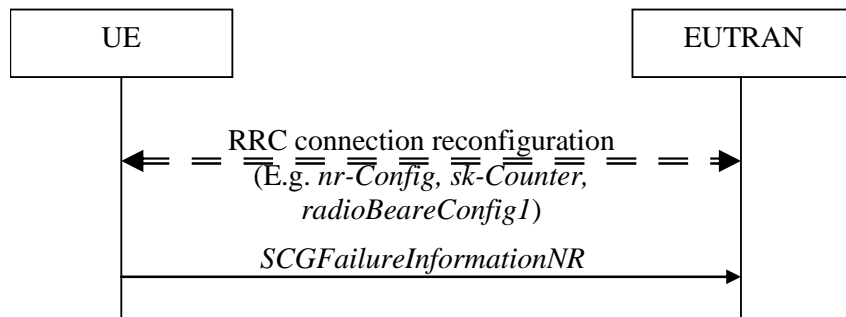

Figure 5.6.13a.1-1: NR SCG failure information

The purpose of this procedure is to inform E-UTRAN about an SCG failure the UE has experienced (e.g. SCG radio link failure, failure to successfully complete an SCG reconfiguration with sync), as specified in TS 38.331 [82], clause 5.7.3.2.

### 5.6.13a.2 Initiation

A UE initiates the procedure to report NR SCG failures when neither E-UTRA MCG nor NR SCG transmission is not suspended and in accordance with TS 38.331 [82], clause 5.7.3.2. Actions the UE shall perform upon initiating the procedure, other than related to the transmission of the *SCGFailureInformationNR* message are specified in TS 38.331 [82], clause 5.7.3.2.

### 5.6.13a.3 Actions related to transmission of *SCGFailureInformationNR* message

The UE shall set the contents of the *SCGFailureInformationNR* message as follows:

1> include *failureType* within *failureReportSCG-NR* and set it to indicate the SCG failure in accordance with TS 38.331 [82], clause 5.7.3.3;

NOTE 1: This may involve including both *failureType-r15* and *failureType-v1610*, see TS 38.331 [82], clause 5.7.3.3.

1> include and set *measResultSCG* in accordance with TS 38.331 [82], clause 5.7.3.4:

1> for each NR frequency the UE is configured to measure by *measConfig* for which measurement results are available:

2> set the *measResultFreqListNR* to include the best measured cells, ordered such that the best cell is listed first using RSRP to order if RSRP measurement results are available for cells on this frequency, otherwise using RSRQ to order if RSRQ measurement results are available for cells on this frequency, otherwise using SINR to order, and based on measurements collected up to the moment the UE detected the failure, and for each cell that is included, include the optional fields that are available;

NOTE 2: Field *measResultSCG* is used to report available results for NR frequencies the UE is configured to measure by NR RRC signalling.

1> if detailed location information is available, set the content of the *locationInfo* as follows:

2> include the *locationCoordinates*;

2> include the *horizontalVelocity*, if available;

1> if available, set the *logMeasResultListWLAN* to include the WLAN measurement results, in order of decreasing RSSI for WLAN APs;

1> if available, set the *logMeasResultListBT* to include the Bluetooth measurement results, in order of decreasing RSSI for Bluetooth beacons;

The UE shall submit the *SCGFailureInformationNR* message to lower layers for transmission.

## 5.6.14 LTE-WLAN Aggregation

### 5.6.14.1 Introduction

E-UTRAN can configure the UE to connect to a WLAN and configure bearers for LWA (referred to as LWA DRBs). The UE uses the WLAN parameters received from E-UTRAN in performing WLAN measurements. The UE also performs WLAN connection management as described in 5.6.15 while LWA is configured.

### 5.6.14.2 Reception of LWA configuration

Upon reception of LWA configuration, the UE shall:

1> if the received *lwa-Configuration* is set to *release*:

2> release the LWA configuration as described in 5.6.14.3;

1> else:

2> if the received *lwa-Config* includes *lwa-WT-Counter*:

3> determine the S-K<sub>WT</sub> key based on the K<sub>eNB</sub> key and received *lwa-WT-Counter* value, as specified in TS 33.401 [32];

3> forward the S-K<sub>WT</sub> key to upper layers to be used as a PMK or PSK for WLAN authentication;

2> if the received *lwa-Config* includes *lwa-MobilityConfig*:

3> if the received *lwa-MobilityConfig* includes *wlan-ToReleaseList*:

4> for each *WLAN-Identifiers* included in *wlan-ToReleaseList*:

- 5> remove the *WLAN-Identifiers* if already part of the current *wlan-MobilitySet* in *VarWLAN-MobilityConfig*;
- 3> if the received *lwa-MobilityConfig* includes *wlan-ToAddList*:
  - 4> for each *WLAN-Identifiers* included in *wlan-ToAddList*:
    - 5> add the *WLAN-Identifiers* to the current *wlan-MobilitySet* in *VarWLAN-MobilityConfig*;
- 3> if the received *lwa-MobilityConfig* includes *associationTimer*:
  - 4> start or restart timer T351 with the timer value set to the *associationTimer*;
- 3> if the received *lwa-MobilityConfig* includes *successReportRequested*:
  - 4> set *successReportRequested* in *VarWLAN-MobilityConfig* to the value of *successReportRequested*;
- 3> if the received *lwa-MobilityConfig* includes *wlan-SuspendConfig*:
  - 4> set the field(s) in *wlan-SuspendConfig* within *VarWLAN-MobilityConfig* to the value(s) of field(s) included in *wlan-SuspendConfig*;
- 2> start WLAN Status Monitoring as described in 5.6.15.4;

### 5.6.14.3 Release of LWA configuration

To release the LWA configuration, the UE shall:

- 1> for each LWA DRB that is part of the current UE configuration:
  - 2> disable data handling for this DRB at the LWAAP entity;
  - 2> perform PDCP data recovery as specified in TS 36.323 [8];
- 1> delete any existing values in *VarWLAN-MobilityConfig* and *VarWLAN-Status*;
- 1> stop timer T351, if running;
- 1> stop WLAN status monitoring and WLAN connection attempts for LWA;
- 1> indicate the release of LWA configuration, if configured, to upper layers;

## 5.6.15 WLAN connection management

### 5.6.15.1 Introduction

WLAN connection management procedures in this clause are triggered as specified in other clauses where the UE is using a WLAN connection for LWA, RCLWI or LWIP.

The UE stores the current WLAN mobility set, which is a set of one or more WLAN identifier(s) (e.g. BSSID, SSID, HESSID) in *wlan-MobilitySet* in *VarWLAN-MobilityConfig*. This WLAN mobility set can be configured and updated by the eNB. A WLAN is considered to be inside the WLAN mobility set if its identifiers match all WLAN identifiers of at least one entry in *wlan-MobilitySet* and outside the WLAN mobility set otherwise. When the UE receives a new or updated WLAN mobility set, it initiates connection to a WLAN inside the WLAN mobility set, if not already connected to such a WLAN, and starts WLAN status monitoring as described in 5.6.15.4. The UE can perform WLAN mobility within the WLAN mobility set (connect or reconnect to a WLAN inside the WLAN mobility set) without any signalling to E-UTRAN.

The UE reports the WLAN connection status information to E-UTRAN as described in 5.6.15.2. The information in this report is based on the monitoring of WLAN connection as described in 5.6.15.4.

## 5.6.15.2 WLAN connection status reporting

### 5.6.15.2.1 General



**Figure 5.6.15.2.1-1: WLAN connection status reporting**

The purpose of this procedure is to inform E-UTRAN about the status of WLAN connection for LWA, RCLWI, or LWIP.

### 5.6.15.2.2 Initiation

The UE in RRC\_CONNECTED initiates the WLAN status reporting procedure when:

- 1> it connects successfully to a WLAN inside WLAN mobility set while T351 is running after a WLAN mobility set change; or
- 1> after a *lwa-WT-Counter* update or after a *lwip-Counter* update (if success report is requested by the eNB); or
- 1> its connection or connection attempts to all WLAN(s) inside WLAN mobility set fails in accordance with WLAN Status Monitoring described in 5.6.15.4; or
- 1> T351 expires; or
- 1> its WLAN connection to all WLAN(s) inside WLAN mobility set becomes temporarily unavailable; or
- 1> its WLAN connection to a WLAN inside the WLAN mobility set is successfully established after its previous WLAN Connection Status Report indicating WLAN temporary suspension;

Upon initiating the procedure, the UE shall:

- 1> initiate transmission of the *WLANConnectionStatusReport* message in accordance with 5.6.15.2.3;

### 5.6.15.2.3 Actions related to transmission of *WLANConnectionStatusReport* message

The UE shall set the contents of the *WLANConnectionStatusReport* message as follows:

- 1> set *wlan-status* to *status* in *VarWLAN-Status*;
- 1> submit the *WLANConnectionStatusReport* message to lower layers for transmission, upon which the procedure ends;

### 5.6.15.3 T351 Expiry (WLAN connection attempt timeout)

Upon T351 expiry, the UE shall:

- 1> set the *status* in *VarWLAN-Status* to *failureTimeout*;
- 1> perform WLAN connection status reporting procedure in 5.6.15.2;
- 1> stop WLAN status monitoring and WLAN connection attempts;

### 5.6.15.4 WLAN status monitoring

To perform WLAN status monitoring, the UE shall:

- 1> if UE is not configured with *rclwi-Configuration* and WLAN connection to a WLAN inside the WLAN mobility set is successfully established or maintained after a WLAN mobility set configuration update, after a *lwa-WT-Counter* update or after a *lwip-Counter* update:
    - 2> set the *status* in *VarWLAN-Status* to *successfulAssociation*;
    - 2> stop timer T351, if running;
    - 2> if *successReportRequested* in *VarWLAN-MobilityConfig* is set to *TRUE*:
      - 3> perform WLAN Connection Status Reporting procedure in 5.6.15.2;
  - 1> if WLAN connection or connection attempts to all WLAN(s) inside WLAN mobility set fails:
    - 2> if the failure is due to WLAN radio link issues:
      - 3> set the *status* in *VarWLAN-Status* to *failureWlanRadioLink*;
    - 2> else if the failure is due to UE internal problems related to WLAN:
      - 3> set the *status* in *VarWLAN-Status* to *failureWlanUnavailable*;
- NOTE 1: The UE internal problems related to WLAN include connection to another WLAN based on user preferences or turning off WLAN connection or connection rejection from WLAN or other WLAN problems.
- 3> remove all WLAN related measurement reporting entries within *VarMeasReportList*;
  - 2> stop timer T351, if running;
  - 2> perform WLAN Connection Status Reporting procedure in 5.6.15.2;
  - 2> if the UE is configured with *rclwi-Configuration*:
    - 3> release *rclwi-Configuration* and inform upper layers of a move-traffic-from-WLAN indication (see TS 24.302 [74]);
  - 2> stop WLAN Status Monitoring and WLAN connection attempts;
- 1> if *wlan-SuspendResumeAllowed* in *wlan-SuspendConfig* within *VarWLAN-MobilityConfig* is set to *TRUE*:
  - 2> if WLAN connection to all WLAN(s) inside WLAN mobility set becomes temporarily unavailable:
    - 3> set the *status* in *VarWLAN-Status* to *suspended*;
    - 3> if *wlan-SuspendTriggersStatusReport* in *wlan-SuspendConfig* within *VarWLAN-MobilityConfig* is set to *TRUE*:
      - 4> trigger PDCP Status Report as specified in TS 36.323 [8];
    - 3> perform WLAN Connection Status Reporting procedure in 5.6.15.2;
  - 2> if the *status* in *VarWLAN-Status* in the last WLAN Connection Status Report by this UE was *suspended* and WLAN connection to a WLAN inside the WLAN mobility set is successfully established:
    - 3> set the *status* in *VarWLAN-Status* to *resumed*;
    - 3> perform WLAN Connection Status Reporting procedure in 5.6.15.2;

## 5.6.16 RAN controlled LTE-WLAN interworking

### 5.6.16.1 General

The purpose of this procedure is to perform RAN-controlled LTE-WLAN interworking (RCLWI) i.e. control access network selection and traffic steering between E-UTRAN and WLAN.

## 5.6.16.2 WLAN traffic steering command

The UE shall:

- 1> if the received *rclwi-Configuration* is set to *setup*:
  - 2> if the *command* is set to *steerToWLAN*:
    - 3> inform the upper layers of a move-traffic-to-WLAN indication along with the WLAN identifier lists in *steerToWLAN* (see TS 24.302 [74]);
    - 3> store *steerToWLAN* in *wlan-MobilitySet* in *VarWLAN-MobilityConfig*;
    - 3> perform the WLAN status monitoring procedure as specified in 5.6.15.4 using *steerToWLAN* as the WLAN mobility set;
  - 2> else:
    - 3> inform the upper layers of a move-traffic-from-WLAN indication (see TS 24.302 [74]);
    - 3> clear *wlan-MobilitySet* in *VarWLAN-MobilityConfig*;
    - 3> stop performing the WLAN status monitoring procedure as specified in 5.6.15.4;
    - 3> delete any existing values in *VarWLAN-Status*;
- 1> else (the *rclwi-Configuration* is released):
  - 2> clear *wlan-MobilitySet* in *VarWLAN-MobilityConfig*;
  - 2> stop performing the WLAN status monitoring procedure as specified in 5.6.15.4;
  - 2> delete any existing values in *VarWLAN-Status*;
  - 2> inform the upper layers of release of the *rclwi-Configuration*.

## 5.6.17 LTE-WLAN aggregation with IPsec tunnel

### 5.6.17.1 General

The WLAN resources that are used over the LWIP tunnel as described in TS 36.300 [9] established as part of LWIP procedures are referred to as 'LWIP resources'. The purpose of this clause is to specify procedures to indicate to higher layers to initiate the establishment/ release of the LWIP tunnel over WLAN and to indicate which DRB(s) shall use the LWIP resources.

### 5.6.17.2 LWIP reconfiguration

The UE shall:

- 1> if the received *lwip-Configuration* is set to *release*:
  - 2> release the LWIP configuration, if configured, as described in 5.6.17.3;
- 1> else:
  - 2> if *lwip-MobilityConfig* is included:
    - 3> if the received *lwip-MobilityConfig* includes *wlan-ToReleaseList*:
      - 4> for each *WLAN-Identifiers* included in *wlan-ToReleaseList*:
        - 5> remove the *WLAN-Identifiers* if already part of the current *wlan-MobilitySet* in *VarWLAN-MobilityConfig*;
    - 3> if the received *lwip-MobilityConfig* includes *wlan-ToAddList*:

- 4> for each *WLAN-Identifiers* included in *wlan-ToAddList*:
  - 5> add the *WLAN-Identifiers* to the current *wlan-MobilitySet* in *VarWLAN-MobilityConfig*;
- 3> if the received *lwip-MobilityConfig* includes *associationTimer*:
  - 4> start timer T351 with the timer value set according to the value of *associationTimer*;
- 3> if the received *lwip-MobilityConfig* includes *successReportRequested*:
  - 4> set *successReportRequested* in *VarWLAN-MobilityConfig* to the value of *successReportRequested*;
- 2> if *tunnelConfigLWIP* is included:
  - 3> indicate to higher layers to configure the LWIP tunnel according to the received *tunnelConfigLWIP*, as specified in TS 33.401 [32];
  - 3> if *lwip-Counter* is included:
    - 4> determine the LWIP-PSK based on the  $K_{eNB}$  key and received *lwip-Counter* value, as specified in TS 33.401 [32];
    - 4> forward the LWIP-PSK to upper layers for LWIP tunnel establishment;
- 2> start WLAN Status Monitoring as described in 5.6.15.4;

### 5.6.17.3 LWIP release

The UE shall:

- 1> delete any existing values in *VarWLAN-MobilityConfig* and *VarWLAN-Status*;
- 1> stop timer T351, if running;
- 1> release the *lwip-Configuration*;
- 1> indicate to higher layers to stop all DRBs from using the LWIP resources;
- 1> indicate to higher layers to release the LWIP tunnel, as specified in TS 33.401 [32];
- 1> stop WLAN status monitoring and WLAN connection attempts for LWIP;

### 5.6.18 Void

### 5.6.19 Application layer measurement reporting

#### 5.6.19.1 General

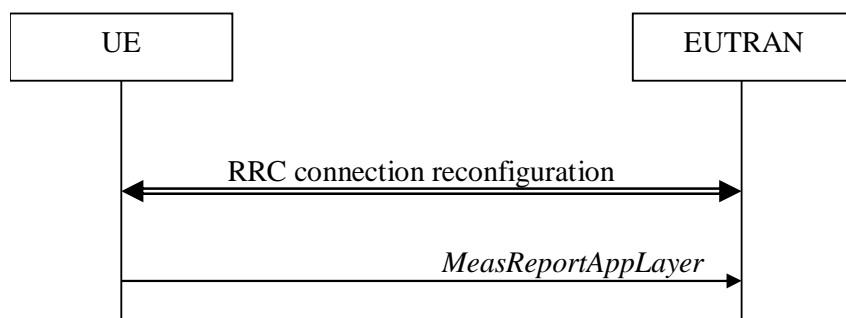

**Figure 5.6.19.1-1: Application layer measurement reporting**

The purpose of this procedure is to inform E-UTRAN about application layer measurement report.

## 5.6.19.2 Initiation

A UE capable of application layer measurement reporting in RRC\_CONNECTED may initiate the procedure when configured with application layer measurement, i.e. when *measConfigAppLayer* has been configured by E-UTRAN.

Upon initiating the procedure, the UE shall:

- 1> if configured with application layer measurement, and SRB4 is configured, and the UE has received application layer measurement report information from upper layers:
  - 2> set the *measReportAppLayerContainer* in the *MeasReportAppLayer* message to the value of the application layer measurement report information;
  - 2> set the *serviceType* in the *MeasReportAppLayer* message to the type of the application layer measurement report information;
  - 2> submit the *MeasReportAppLayer* message to lower layers for transmission via SRB4.

## 5.6.20 Idle/Inactive Measurements

### 5.6.20.1 General

This procedure specifies the measurements to be performed and stored by a UE in RRC\_IDLE or RRC\_INACTIVE when it has an idle/inactive measurement configuration.

#### 5.6.20.1a Measurement configuration

The purpose of this procedure is to update the idle/inactive measurement configuration.

The UE initiates this procedure while T331 is running and one of the following conditions is met:

- 1> upon selecting a cell when entering RRC\_IDLE or RRC-INACTIVE from RRC\_CONNECTED; or
- 1> upon update of system information (*SIB5*, or *SIB24*), e.g. due to intra-RAT cell (re)selection;

While in RRC\_IDLE or RRC\_INACTIVE and T331 is running, the UE shall:

- 1> if *VarMeasIdleConfig* includes neither a *measIdleCarrierListEUTRA* nor a *measIdleCarrierListNR* received from the *RRCConnectionRelease* message:
  - 2> if the UE is capable of idle/inactive measurements for E-UTRA:
    - 3> if the *SIB5* includes the *measIdleConfigSIB*:
      - 4> store or replace the *measIdleCarrierListEUTRA* of *measIdleConfigSIB* of *SIB5* within *VarMeasIdleConfig*;
    - 3> else:
      - 4> remove the *measIdleCarrierListEUTRA* in *VarMeasIdleConfig*, if stored;
  - 2> if the UE is capable of idle/inactive measurements for NR:
    - 3> if the *SIB5* includes the *measIdleConfigSIB-NR*:
      - 4> store or replace the *measIdleCarrierListNR* of *measIdleConfigSIB-NR* of *SIB5* within *VarMeasIdleConfig*;
    - 3> else:
      - 4> remove the *measIdleCarrierListNR* in *VarMeasIdleConfig*, if stored;
- 1> for each entry in the *measIdleCarrierListNR* within *VarMeasIdleConfig* that does not contain an *ssb-MeasConfig* received from the *RRCConnectionRelease* message:



- 2> if there is an entry in *measIdleCarrierListNR* in *measIdleConfigSIB-NR* of *SIB5* that has the same carrier frequency and subcarrier spacing as the entry in the *measIdleCarrierListNR* within *VarMeasIdleConfig* and that contains *ssb-MeasConfig*:
  - 3> delete the *ssb-MeasConfig* of the corresponding entry in the *measIdleCarrierListNR* within *VarMeasIdleConfig*;
  - 3> store the SSB measurement configuration from *SIB5* into *maxRS-IndexCellQual*, *threshRS-Index*, *measTimingConfig*, *ssb-ToMeasure*, *deriveSSB-IndexFromCell*, and *ss-RSSI-Measurement* within *ssb-MeasConfig* of the corresponding entry in the *measIdleCarrierListNR* within *VarMeasIdleConfig*;
- 2> else if there is an entry in *carrierFreqListNR* of *SIB24* with the same carrier frequency and subcarrier spacing as the entry in *measIdleCarrierListNR* within *VarMeasIdleConfig*:
  - 3> delete the *ssb-MeasConfig* of the corresponding entry in the *measIdleCarrierListNR* within *VarMeasIdleConfig*;
  - 3> store the SSB measurement configuration from *SIB24* into *maxRS-IndexCellQual*, *threshRS-Index*, *measTimingConfig*, *ssb-ToMeasure*, *deriveSSB-IndexFromCell*, and *ss-RSSI-Measurement* within *ssb-MeasConfig* of the corresponding entry in *measIdleCarrierListNR* within *VarMeasIdleConfig*;
- 2> else:
  - 3> remove the *ssb-MeasConfig* of the corresponding entry in the *measIdleCarrierListNR* within *VarMeasIdleConfig*, if stored;

### 5.6.20.2 Performing measurements

When performing measurements on NR carriers according to this clause, the UE shall derive the cell quality as specified in 5.5.3.3 and consider the beam quality to be the value of the measurement results of the concerned beam, where each result is averaged as described in TS 38.215 [89].

While in RRC\_IDLE or RRC\_INACTIVE, and T331 is running, the UE shall:

- 1> perform the measurements in accordance with the following:
  - 2> if the SIB2 contains *idleModeMeasurements*, for each entry in *measIdleCarrierListEUTRA* within *VarMeasIdleConfig*:
    - 3> if UE supports carrier aggregation between serving carrier and the carrier frequency and bandwidth indicated by *carrierFreq* and *allowedMeasBandwidth* within the corresponding entry;
    - 4> perform measurements in the carrier frequency and bandwidth indicated by *carrierFreq* and *allowedMeasBandwidth* within the corresponding entry;

NOTE 1: How the UE performs the idle/inactive measurements is up to UE implementation as long as the requirements in TS 36.133 [16] are met for measurement reporting.

- 4> if the *reportQuantities* is set to *rsrq*:
  - 5> consider RSRQ as the sorting quantity;
- 4> else:
  - 5> consider RSRP as the sorting quantity;
- 4> if the *measCellList* is included:
  - 5> consider cells identified by each entry within the *measCellList* to be applicable for idle /inactive measurement reporting;
- 4> else:
  - 5> consider up to *maxCellMeasIdle* strongest identified cells, according to the sorting quantity, to be applicable for idle/inactive measurement reporting;

- 4> for all cells applicable for idle/inactive measurement reporting and for the serving cell, derive measurement results for the measurement quantities indicated by *reportQuantities*;
- 4> store the derived measurement result as indicated by *reportQuantities* for the serving cell within *measResultServingCell* in the *measReportIdle* in *VarMeasIdleReport*;
- 4> store the derived measurement results as indicated by *reportQuantities* for cells applicable for idle/inactive measurement reporting within *measResultNeighCells* in the *measReportIdle* in *VarMeasIdleReport* in decreasing order of the sorting quantity, i.e. the best cell is included first, as follows:
  - 5> if *qualityThreshold* is configured:
    - 6> include the measurement results from the cells applicable for idle/inactive measurement reporting whose RSRP/RSRQ measurement results are above the value(s) provided in *qualityThreshold*;
  - 5> else:
    - 6> include the measurement results from all cells applicable for idle/inactive measurement reporting;
- 2> if the SIB2 contains *idleModeMeasurementsNR* and *VarMeasIdleConfig* includes the *measIdleCarrierListNR*:
  - 3> for each entry in *measIdleCarrierListNR* within *VarMeasIdleConfig* that contains *ssb-MeasConfig*:
    - 4> if UE supports (NG)EN-DC between serving carrier and the carrier frequency and subcarrier spacing indicated by *carrierFreqNR* and *subCarrierSpacingSSB* within the corresponding entry:
      - 5> perform measurements in the carrier frequency and subcarrier spacing indicated by *carrierFreqNR* and *subCarrierSpacingSSB* within the corresponding entry;
      - 5> if the *reportQuantitiesNR* is set to *rsrq*:
        - 6> consider RSRQ as the cell sorting quantity;
      - 5> else:
        - 6> consider RSRP as the cell sorting quantity;
      - 5> if the *measCellListNR* is included:
        - 6> consider cells identified by each entry within the *measCellListNR* to be applicable for idle/inactive measurement reporting;
      - 5> else:
        - 6> consider up to *maxCellMeasIdle* strongest identified cells, according to the sorting quantity, to be applicable for idle/inactive measurement reporting;
      - 5> for all cells applicable for idle/inactive measurement reporting, derive the cell measurement results for the measurement quantities indicated by *reportQuantitiesNR*;
      - 5> store the derived measurement results as indicated by *reportQuantitiesNR* within the *measReportIdleNR* in *VarMeasIdleReport* in decreasing order of the cell sorting quantity, i.e. the best cell is included first, as follows:
        - 6> if *qualityThresholdNR* is configured:
          - 7> include the measurement results from the cells applicable for idle/inactive measurement reporting whose RSRP/RSRQ measurement results are above the value(s) provided in *qualityThresholdNR*;
        - 6> else:

- 7> include the measurement results from all cells applicable for idle/inactive measurement reporting;
- 5> if *beamMeasConfigIdle* is included in the associated entry in *measIdleCarrierListNR* and if UE supports *nr-IdleInactiveBeamMeasFR1* or *nr-IdleInactiveBeamMeasFR2* for the FR of the carrier frequency indicated by *carrierFreqNR* within the associated entry, for each cell in the measurement results:
  - 6> derive beam measurements based on SS/PBCH block for each measurement quantity indicated in *reportQuantityRS-IndexNR*, as described in TS 38.215 [89];
  - 6> if the *reportQuantityRS-IndexNR* is set to *rsrq*:
    - 7> consider RSRQ as the beam sorting quantity;
  - 6> else:
    - 7> consider RSRP as the beam sorting quantity;
  - 6> set *resultRS-IndexList* to include up to *maxReportRS-Index* SS/PBCH block indexes in order of decreasing sorting quantity as follows:
    - 7> include the index associated to the best beam for the sorting quantity and if *threshRS-Index* is included, the remaining beams whose sorting quantity is above *threshRS-Index*;
  - 6> if the *reportRS-IndexResultsNR* is set to true:
    - 7> include the beam measurement results as indicated by *reportQuantityRS-IndexNR*;
- 3> if, as the result of the procedure in this clause, the UE performs measurements in one or more carrier frequency indicated by *measIdleCarrierListNR*:
  - 4> store the cell measurement results for RSRP and RSRQ for the serving cell within *measResultServingCell* in the *measReportIdle* in *VarMeasIdleReport*;

NOTE 2: The UE is not required to perform idle/inactive measurements on a given carrier if the SSB configuration of that carrier provided via dedicated signaling is different from the SSB configuration broadcasted in the serving cell, if any.

NOTE 3: How the UE prioritizes which frequencies to measure or report (in case it is configured with more frequencies than it can measure or report) is left to UE implementation.

### 5.6.20.3 T331 expiry or stop

The UE shall:

- 1> if T331 expires or is stopped:
  - 2> release the *VarMeasIdleConfig*;

NOTE: It is up to UE implementation whether to continue idle/inactive measurements according to SIB5 and SIB24 configuration or according to NR SIB11 and NR SIB4 configuration as specified in TS 38.331 [82] upon inter-RAT cell reselection to NR, after T331 has expired or stopped.

### 5.6.20.4 Cell re-selection or selection while T331 is running

The UE shall:

- 1> if intra-RAT cell selection or reselection occurs while T331 is running:
  - 2> if *validityAreaList* is configured in *VarMeasIdleConfig*:
    - 3> if the serving cell frequency does not match with the *carrierFreq* of any entry in the *validityAreaList*; or

- 3> if the serving frequency matches with the *carrierFreq* of an entry in the *validityAreaList*, the *validityCellList* is included in that entry, and the physical cell identity of the serving cell does not match with any entry in *validityCellList*:
  - 4> stop timer T331;
  - 4> perform the actions as specified in 5.6.20.3, upon which the procedure ends;
- 2> else if *validityArea* is configured in *VarMeasIdleConfig* and UE reselects to a serving cell whose physical cell identity does not match any entry in *validityArea* for the corresponding carrier frequency:
  - 3> stop timer T331;
  - 3> perform the actions as specified in 5.6.20.3, upon which the procedure ends;
- 1> if inter-RAT cell selection or reselection occurs while timer T331 is running;
  - 2> stop timer T331;
  - 2> perform the actions as specified in 5.6.20.3;

## 5.6.21 Failure information

### 5.6.21.1 General

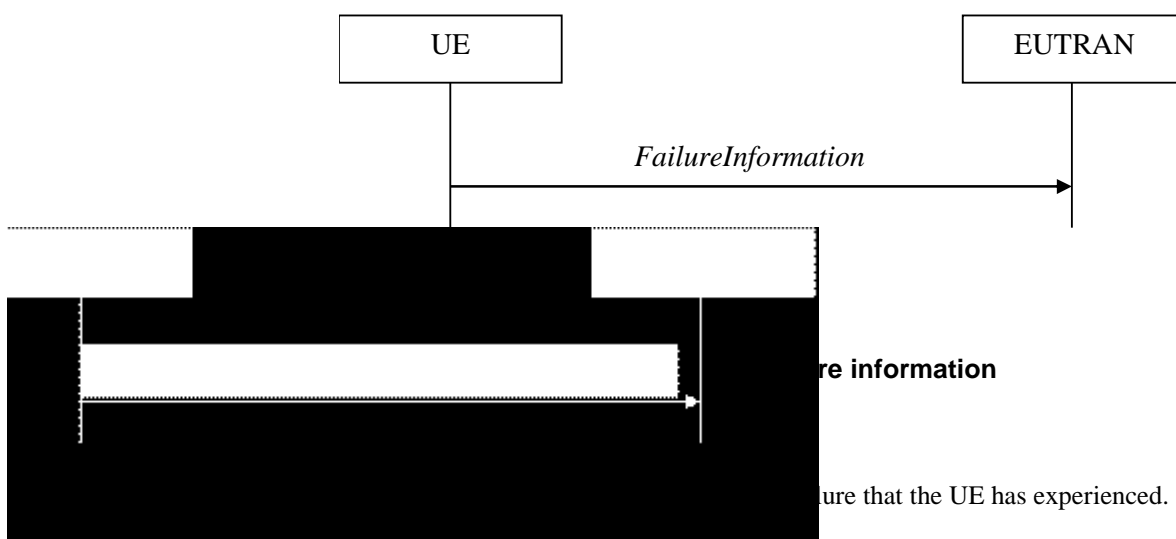

Failure information

Failure information

### 5.6.21.2 Initiation

A UE initiates the procedure to report failures when one of the following conditions is met:

- 1> upon detecting RLC failure, in accordance with 5.3.11;
- 1> upon detecting a DAPS HO failure, in accordance with 5.3.5.6.

Upon initiating the procedure, the UE shall:

- 1> initiate transmission of the *FailureInformation* message in accordance with 5.6.21.3;

### 5.6.21.3 Actions related to transmission of *FailureInformation* message

When initiating the procedure according to 5.6.21.2, the UE shall:

- 1> set the contents of the *FailureInformation* message as follows:
  - 2> if the procedure is initiated to report RLC failure:
    - 3> set *logicalChannelIdentity* to the logical channel identity of the RLC entity;

- 3> set *cellGroupIndication* to the cell group where the RLC entity is located;
- 3> set *failureType* to the type of failure that has been detected;
- 2> if the procedure is initiated to report a DAPS HO failure:
  - 3> set *failureType* to *dapsHO-failure*;
- 1> submit the *FailureInformation* message to lower layers for transmission.

## 5.6.22 UL message segment transfer

### 5.6.22.1 General

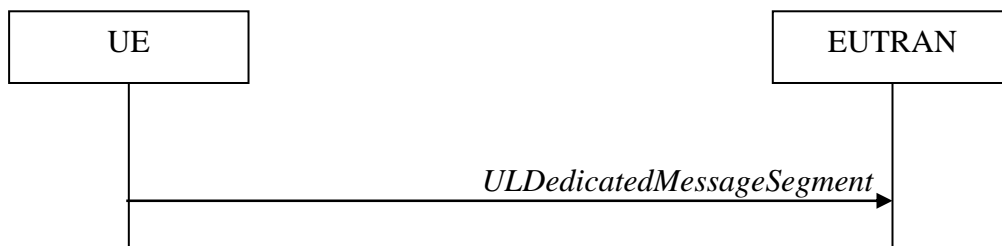

**Figure 5.6.22.1-1: UL message segment transfer**

The purpose of this procedure is to transfer segments of UL DCCH messages from UE to E-UTRAN in RRC\_CONNECTED.

NOTE: The segmentation of UL DCCH message is only applicable to *UECapabilityInformation* in this release.

### 5.6.22.2 Initiation

A UE capable of UL RRC message segmentation in RRC\_CONNECTED will initiate the procedure when the following conditions are met:

- 1> if the RRC message segmentation is enabled based on the field *rrc-SegAllowed* received, and
- 1> if the encoded RRC message is larger than the maximum supported size of a PDCP SDU specified in TS 36.323 [8];

Upon initiating the procedure, the UE shall:

- 1> initiate transmission of the *ULDedicatedMessageSegment* message as specified in 5.6.22.3;

### 5.6.22.3 Actions related to transmission of *ULDedicatedMessageSegment* message

The UE shall segment the encoded RRC PDU based on the maximum supported size of a PDCP SDU specified in TS 36.323 [8]. UE shall minimize the number of segments and set the contents of the *ULDedicatedMessageSegment* messages as follows:

- 1> For each new UL DCCH message, set the *segmentNumber* to 0 for the first message segment and increment the *segmentNumber* for each subsequent RRC message segment;
- 1> set *rrc-MessageSegmentContainer* to include the segment of the UL DCCH message corresponding to the *segmentNumber*;
- 1> if the segment included in the *rrc-MessageSegmentContainer* is the last segment of the UL DCCH message:
  - 2> set the *rrc-MessageSegmentType* to *lastSegment*;
- 1> else:
  - 2> set the *rrc-MessageSegmentType* to *notLastSegment*;

- 1> submit all the *ULDedicatedMessageSegment* messages generated for the segmented RRC message to lower layers for transmission in ascending order based on the *segmentNumber*, upon which the procedure ends.

## 5.6.23 PUR Configuration Request

### 5.6.23.1 General



**Figure 5.6.23.1-1: PUR Configuration Request**

The purpose of this procedure is to indicate to the E-UTRAN that the UE is interested to be configured with PUR and provide PUR related information to E-UTRAN, or that the UE is no longer interested to be configured with PUR.

The procedure is applicable only for BL UEs, UEs in CE or NB-IoT UEs.

### 5.6.23.2 Initiation

A UE in RRC\_CONNECTED may initiate the procedure when all of the following conditions are fulfilled:

- 1> if the UE is connected to EPC:
  - 2> for CP transmission using PUR, *SystemInformationBlockType2* (*SystemInformationBlockType2-NB* in NB-IoT) includes *cp-PUR-EPC*; or
  - 2> for UP transmission using PUR, *SystemInformationBlockType2* (*SystemInformationBlockType2-NB* in NB-IoT) includes *up-PUR-EPC*;
- 1> else if the UE is connected to 5GC:
  - 2> for CP transmission using PUR, *SystemInformationBlockType2* (*SystemInformationBlockType2-NB* in NB-IoT) includes *cp-PUR-5GC*; or
  - 2> for UP transmission using PUR, *SystemInformationBlockType2* (*SystemInformationBlockType2-NB* in NB-IoT) includes *up-PUR-5GC*;
- 1> the size of the resulting MAC PDU including the total UL data size of the traffic is smaller than or equal to the maximum supported TBS based on the UE category.

NOTE 1: It is up to UE implementation how the UE determines whether the size of UL data is suitable for transmission using PUR.

Upon initiating the procedure, the UE shall:

- 1> initiate transmission of the *PURConfigurationRequest* message in accordance with 5.6.23.3;

### 5.6.23.3 Actions related to transmission of *PURConfigurationRequest* message

When initiating the procedure according to 5.6.23.2, the UE shall set the contents of the *PURConfigurationRequest* message as follows:

- 1> if the UE is interested to be configured with PUR, include *pur-SetupRequest* and set the contents of *pur-SetupRequest* as follows:

- 2> set *requestedNumOccasions* to the requested number of PUR occasions requested;
- 2> set *requestedPeriodicityAndOffset* according to the requested periodicity between consecutive PUR occasions and the requested time offset with respect to current time until the first PUR occasion;
- 2> set *requestedTBS* to the requested TBS for the PUR occasion(s);
- 2> if RRC response message is preferred by the UE for acknowledging the reception of a transmission using PUR, include *rrc-ACK*;
- 1> if the UE is no longer interested to be configured with PUR:
  - 2> include *pur-ReleaseRequest*;

The UE shall submit the *PURConfigurationRequest* message to lower layers for transmission.

## 5.6.24 Neighbour Relation Reporting for SON ANR in NB-IoT

### 5.6.24.0 General

This procedure specifies the neighbour measurements and CGI reading performed when the UE is in RRC\_IDLE when it has an ANR measurement configuration and the storage of the associated information by a UE in RRC\_IDLE and RRC\_CONNECTED.

NOTE: E-UTRAN may retrieve the stored ANR measurements information by means of the UE information procedure.

### 5.6.24.1 Initiation

While the UE is in RRC\_IDLE, the UE shall:

- 1> store the measurement results for the serving cell in *measResultServCell* in *VarANR-MeasReport-NB*;
- 1> while the serving cell global cell identity is the same as stored in *servCellIdentity* in *VarANR-MeasReport-NB*:
  - 2> perform the measurements once in accordance with the following:
    - 3> for each carrier frequency indicated by an entry in *anr-CarrierList*, if present, within *VarANR-MeasConfig-NB*:
      - 4> add a new entry in *measResultList* in *VarANR-MeasReport-NB*;
      - 4> set the *carrierFreq* to the carrier frequency;
      - 4> perform measurements on the corresponding carrier frequency and determines the strongest cell, if any, on the carrier frequency;

NOTE: How the UE performs ANR measurement in RRC\_IDLE is up to UE implementation as long as the measurement requirements (see TS 36.133 [16], clause 4.6) are met. While performing an ANR measurement, the UE performs inter-frequency measurements on the configured frequency regardless of the measurement rules for cell re-selection and the relaxed monitoring measurement rules as specified in TS 36.304 [4].

- 4> if the strongest cell is not identified by an entry within the *excludedCellList*, if present, for the corresponding entry in *anr-CarrierList*:
  - 5> set the *physCellId* to the physical cell identity of the cell;
  - 5> set the *measResultLastServCell* to the last measurement results of the PCell;
  - 5> set the *measResult* to the measurement results of the cell;
  - 5> if the NRSRP measurement result is above the value provided in *anr-qualityThreshold*:

6> set the *cgi-Info* with the information obtained from the *systemInformationBlockType1-NB* of the cell;

2> set the *relativeTimeStamp* to the elapsed time since the measurements configuration was received;

1> release the *VarANR-MeasConfig-NB*.

The UE may discard the ANR measurements information, i.e. release the UE variables *VarANR-MeasConfig-NB* and *VarANR-MeasReport-NB*, 96 hours after the configuration was received, upon power off or upon detach and upon entering another RAT.

## 5.6.25 DL message segment transfer

### 5.6.25.1 General



**Figure 5.6.25.1-1: DL message segment transfer**

The purpose of this procedure is to transfer segments of DL DCCH messages from E-UTRAN to the UE.

NOTE: The segmentation of DL DCCH message is only applicable to *RRCConnectionReconfiguration* and *RRCConnectionResume* messages in this release.

### 5.6.25.2 Initiation

E-UTRAN initiates the DL Dedicated Message Segment transfer procedure whenever the encoded RRC message PDU exceeds the maximum PDCP SDU size. E-UTRAN initiates the DL Dedicated Message Segment transfer procedure by sending the *DL Dedicated Message Segment* message.

### 5.6.25.3 Reception of *DL Dedicated Message Segment* by the UE

Upon receiving *DL Dedicated Message Segment* message, the UE shall:

1> store the segment;

1> if all segments of the message have been received:

2> assemble the message from the received segments and process the message according to 5.3.5 for the *RRCConnectionReconfiguration* message or 5.3.3.4a for the *RRCConnectionResume* message;

2> discard all segments.



## 5.6.26 MCG failure information

### 5.6.26.1 General

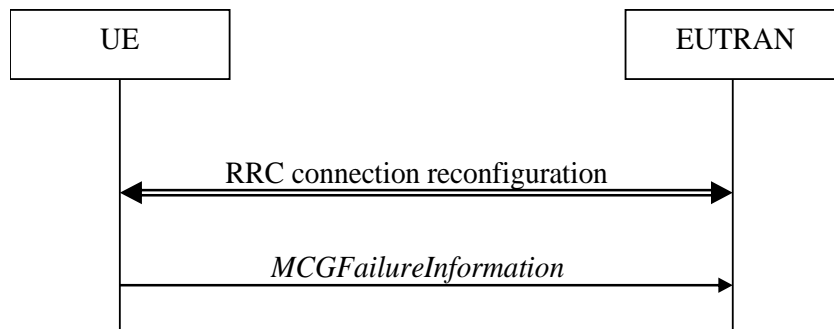

**Figure 5.6.26.1-1: MCG failure information**

The purpose of this procedure is to inform the network about an MCG failure the UE has experienced i.e. MCG radio link failure. A UE in RRC\_CONNECTED, for which AS security has been activated with SRB2 and at least one DRB setup, may initiate the fast MCG link recovery procedure in order to continue the RRC connection without re-establishment.

### 5.6.26.2 Initiation

A UE configured with split SRB1 or SRB3 initiates the procedure to report MCG failures when neither MCG nor SCG transmission is suspended, the SCG is not deactivated, *t316* is configured, and when the following condition is met:

- 1> upon detecting radio link failure of the MCG, in accordance with 5.3.11, while T316 is not running.

Upon initiating the procedure, the UE shall:

- 1> stop timer T310, if running;
- 1> stop timer T312, if running;
- 1> suspend MCG transmission for all SRBs and DRBs, except SRB0;
- 1> reset MCG MAC;
- 1> stop conditional reconfiguration evaluation for CHO, if configured;
- 1> stop conditional reconfiguration evaluation for CPC, if configured;
- 1> initiate transmission of the *MCGFailureInformation* message in accordance with 5.6.26.4.

NOTE: The handling of any outstanding UL RRC messages during the initiation of the fast MCG link recovery is left to UE implementation.

### 5.6.26.3 Failure type determination

The UE shall set the MCG failure type as follows:

- 1> if the UE initiates transmission of the *MCGFailureInformation* message due to T310 expiry:
  - 2> set the *failureType* as *t310-Expiry*;
- 1> else if the UE initiates transmission of the *MCGFailureInformation* message due to T312 expiry:
  - 2> set the *failureType* as *t312-Expiry*;
- 1> else if the UE initiates transmission of the *MCGFailureInformation* message to provide random access problem indication from MCG MAC:
  - 2> set the *failureType* as *randomAccessProblem*;

- 1> else if the UE initiates transmission of the *MCGFailureInformation* message to provide indication from MCG RLC that the maximum number of retransmissions has been reached:
  - 2> set the *failureType* as *rlc-MaxNumRetx*.

#### 5.6.26.4 Actions related to transmission of *MCGFailureInformation* message

The UE shall set the contents of the *MCGFailureInformation* message as follows:

- 1> include and set *failureType* in accordance with 5.6.26.3;
- 1> for each *measObjectEUTRA* for which a *measId* is configured and for which measurement results are available:
  - 2> include an entry in *measResultsFreqListEUTRA*;
  - 2> if a serving cell is associated with the *MeasObjectEUTRA*:
    - 3> set *measResultServingCell* to include the available quantities of the concerned cell and in accordance with the performance requirements in TS 36.133 [16];
  - 2> set the *measResultNeighCellList* to include the best measured cells, ordered such that the best cell is listed first, and based on measurements collected up to the moment the UE detected the failure, and set its fields as follows:
    - 3> ordering the cells with sorting as follows:
      - 4> using RSRP if RSRP measurement results are available, otherwise using RSRQ if RSRQ measurement results are available, otherwise using SINR;
    - 3> for each neighbour cell included:
      - 4> include the optional fields for which measurement results are available;

NOTE 1: The measured quantities are filtered by the L3 filter as configured in the mobility measurement configuration. The measurements are based on the time domain measurement resource restriction, if configured. Exclude-listed cells are not required to be reported.

- 1> for each NR frequency the UE is configured to measure by *measConfig* for which measurement results are available:
  - 2> set the *measResultFreqListNR* to include the best measured cells, ordered such that the best cell is listed first using RSRP to order the cells if RSRP measurement results are available for cells on this frequency, otherwise using RSRQ to order the cells if RSRQ measurement results are available for cells on this frequency, otherwise using SINR to order the cells, based on measurements collected up to the moment the UE detected the failure, and for each cell that is included, include the optional fields that are available;
- 1> for each UTRA frequency the UE is configured to measure by *measConfig* for which measurement results are available:
  - 2> set the *measResultFreqListUTRA* to include the best measured cells, ordered such that the best cell is listed first using RSCP to order the cells if RSCP measurement results are available for cells on this frequency, otherwise using EcN0 to order the cells, based on measurements collected up to the moment the UE detected the failure, and for each cell that is included, include the optional fields that are available;
- 1> for each GERAN frequency the UE is configured to measure by *measConfig* for which measurement results are available:
  - 2> set the *measResultFreqListGERAN* to include the best measured cells based on measurements collected up to the moment the UE detected the failure, and for each cell that is included, include the optional fields that are available;
- 1> if the UE is in (NG)EN-DC:
  - 2> include and set *measResultSCG* in accordance with TS 38.331 [82], clause 5.7.3.4:

NOTE 2: Field *measResultSCG* is used to report available results for NR frequencies the UE is configured to measure by NR RRC signalling.

- 1> if SRB1 is configured as split SRB and *pdcp-Duplication* is not configured in accordance with TS 38.331 [82, 6.3.2]:
  - 2> if the *primaryPath* for the PDCP entity of SRB1 refers to to the MCG:
    - 3> set the *primaryPath* to refer to the SCG.

The UE shall:

- 1> start timer T316;
- 1> if SRB1 is configured as split SRB:
  - 2> submit the *MCGFailureInformation* message to lower layers for transmission via SRB1, upon which the procedure ends;
- 1> else (i.e. SRB3 is configured):
  - 2> submit the *MCGFailureInformation* message to lower layers for transmission, embedded in NR RRC message *ULInformationTransferMRDC* via SRB3 as specified in TS 38.331 [82], clause 5.7.2a.3.

### 5.6.26.5 T316 expiry

The UE shall:

- 1> if T316 expires:
  - 2> initiate the connection re-establishment procedure as specified in 5.3.7.

### 5.6.27 Void

### 5.6.28 UL transfer of IRAT information

#### 5.6.28.1 General

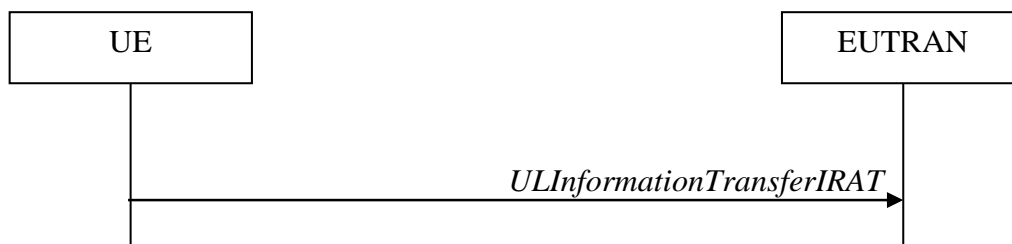

**Figure 5.6.28.1-1: UL transfer of IRAT information**

The purpose of this procedure is to transfer from the UE to E-UTRAN dedicated information terminated by E-UTRAN but specified by another RAT e.g. the NR RRC *MeasurementReport* message, the NR RRC *SidelinkUEInformationNR* message or the NR RRC *UEAssistanceInformation* message. The specific information transferred in this message is set in accordance with:

- the procedure specified in 5.7.4 of TS 38.331 [82] for NR *UEAssistanceInformation* message;
- the procedure specified in 5.8.3 of TS 38.331 [82] for NR *SidelinkUEInformationNR* message;
- the procedure specified in 5.5.5 of TS 38.331 [82] for NR *MeasurementReport* Message.

## 5.6.28.2 Initiation

A UE in RRC\_CONNECTED initiates the UL information transfer procedure whenever there is a need to transfer dedicated IRAT information as specified in TS 38.331 [82].

## 5.6.28.3 Actions related to transmission of *ULInformationTransferIRAT* message

The UE shall set the contents of the *ULInformationTransferIRAT* message as follows:

- 1> if there is a need to transfer dedicated NR information:
  - 2> set the *ul-DCCH-MessageNR* to include the IRAT dedicated information to be transferred;
- 1> submit the *ULInformationTransferIRAT* message to lower layers for transmission, upon which the procedure ends.

# 5.7 Generic error handling

## 5.7.1 General

The generic error handling defined in the subsequent clauses applies unless explicitly specified otherwise e.g. within the procedure specific error handling.

The UE shall consider a value as not comprehended when it is set:

- to an extended value that is not defined in the version of the transfer syntax supported by the UE.
- to a spare or reserved value unless the specification defines specific behaviour that the UE shall apply upon receiving the concerned spare/ reserved value.

The UE shall consider a field as not comprehended when it is defined:

- as spare or reserved unless the specification defines specific behaviour that the UE shall apply upon receiving the concerned spare/ reserved field.

## 5.7.2 ASN.1 violation or encoding error

The UE shall:

- 1> when receiving an RRC message on the BCCH, BR-BCCH, PCCH, CCCH, MCCH, SC-MCCH or SBCCH for which the abstract syntax is invalid, as specified in ITU-T X.680 (07/2002) [13]:
  - 2> ignore the message;

NOTE: This clause applies in case one or more fields is set to a value, other than a spare, reserved or extended value, not defined in this version of the transfer syntax. E.g. in the case the UE receives value 12 for a field defined as INTEGER (1..11). In cases like this, it may not be possible to reliably detect which field is in the error hence the error handling is at the message level.

## 5.7.3 Field set to a not comprehended value

The UE shall, when receiving an RRC message on any logical channel:

- 1> if the message includes a field that has a value that the UE does not comprehend:
  - 2> if a default value is defined for this field:
    - 3> treat the message while using the default value defined for this field;
  - 2> else if the concerned field is optional:

3> treat the message as if the field were absent and in accordance with the need code for absence of the concerned field;

2> else:

3> treat the message as if the field were absent and in accordance with clause 5.7.4;

## 5.7.4 Mandatory field missing

The UE shall:

1> if the message includes a field that is mandatory to include in the message (e.g. because conditions for mandatory presence are fulfilled) and that field is absent or treated as absent:

2> if the RRC message was received on DCCH or CCCH:

3> ignore the message;

2> else:

3> if the field concerns a (sub-field of) an entry of a list (i.e. a SEQUENCE OF):

4> treat the list as if the entry including the missing or not comprehended field was not present;

3> else if the field concerns a sub-field of another field, referred to as the 'parent' field i.e. the field that is one nesting level up compared to the erroneous field:

4> consider the 'parent' field to be set to a not comprehended value;

4> apply the generic error handling to the subsequent 'parent' field(s), until reaching the top nesting level i.e. the message level;

3> else (field at message level):

4> ignore the message;

NOTE 1: The error handling defined in these clauses implies that the UE ignores a message with the message type or version set to a not comprehended value.

NOTE 2: The nested error handling for messages received on logical channels other than DCCH and CCCH applies for errors in extensions also, even for errors that can be regarded as invalid E-UTRAN operation e.g. E-UTRAN not observing conditional presence.

The following ASN.1 further clarifies the levels applicable in case of nested error handling for errors in extension fields.

```
-- /example/ ASN1START
-- Example with extension addition group
ItemInfoList ::=
    SEQUENCE (SIZE (1..max)) OF ItemInfo
ItemInfo ::=
    SEQUENCE {
        itemIdentity      INTEGER (1..max),
        field1            Field1,
        field2            Field2                OPTIONAL,          -- Need ON
        ...
        [[ field3-r9      Field3-r9            OPTIONAL,          -- Cond Cond1
           field4-r9      Field4-r9            OPTIONAL          -- Need ON
        ]]
    }
-- Example with traditional non-critical extension (empty sequence)
BroadcastInfoBlock1 ::=
    SEQUENCE {
        itemIdentity      INTEGER (1..max),
        field1            Field1,
        field2            Field2                OPTIONAL,          -- Need ON
        nonCriticalExtension
            BroadcastInfoBlock1-v940-IES     OPTIONAL
    }
```

```

BroadcastInfoBlock1-v940-IEs ::= SEQUENCE {
    field3-r9                Field3-r9                OPTIONAL,      -- Cond Cond1
    field4-r9                Field4-r9                OPTIONAL,      -- Need ON
    nonCriticalExtension     SEQUENCE {}              OPTIONAL      -- Need OP
}
-- ASN1STOP

```

The UE shall, apply the following principles regarding the levels applicable in case of nested error handling:

- an extension addition group is not regarded as a level on its own. E.g. in the ASN.1 extract in the previous, a error regarding the conditionality of *field3* would result in the entire itemInfo entry to be ignored (rather than just the extension addition group containing *field3* and *field4*)
- a traditional *nonCriticalExtension* is not regarded as a level on its own. E.g. in the ASN.1 extract in the previous, a error regarding the conditionality of *field3* would result in the entire *BroadcastInfoBlock1* to be ignored (rather than just the non critical extension containing *field3* and *field4*).

## 5.7.5 Not comprehended field

The UE shall, when receiving an RRC message on any logical channel:

- 1> if the message includes a field that the UE does not comprehend:
  - 2> treat the rest of the message as if the field was absent;

NOTE: This clause does not apply to the case of an extension to the value range of a field. Such cases are addressed instead by the requirements in clause 5.7.3.

## 5.8 MBMS

### 5.8.1 Introduction

#### 5.8.1.1 General

In general the control information relevant only for UEs supporting MBMS is separated as much as possible from unicast control information. Most of the MBMS control information is provided on a logical channel specific for MBMS common control information: the MCCH. E-UTRA employs one MCCH logical channel per MBSFN area. In case the network configures multiple MBSFN areas, the UE acquires the MBMS control information from the MCCHs that are configured to identify if services it is interested to receive are ongoing. The action applicable when the UE is unable to simultaneously receive MBMS and unicast services is up to UE implementation. In this release of the specification, an MBMS capable UE is only required to support reception of a single MBMS service at a time, and reception of more than one MBMS service (also possibly on more than one MBSFN area) in parallel is left for UE implementation. The MCCH carries the *MBSFNAreaConfiguration* message, which indicates the MBMS sessions that are ongoing as well as the (corresponding) radio resource configuration. The MCCH may also carry the *MBMSCountingRequest* message, when E-UTRAN wishes to count the number of UEs in RRC\_CONNECTED that are receiving or interested to receive one or more specific MBMS services.

A limited amount of MBMS control information is provided on the BCCH. This primarily concerns the information needed to acquire the MCCH(s). This information is carried by means of a single MBMS specific *SystemInformationBlock: SystemInformationBlockType13*. An MBSFN area is identified solely by the *mbsfn-AreaId* in *SystemInformationBlockType13*. At mobility, the UE considers that the MBSFN area is continuous when the source cell and the target cell broadcast the same value in the *mbsfn-AreaId*.

#### 5.8.1.2 Scheduling

The MCCH information is transmitted periodically, using a configurable repetition period. Scheduling information is not provided for MCCH i.e. both the time domain scheduling as well as the lower layer configuration are semi-statically configured, as defined within *SystemInformationBlockType13*.

For MBMS user data, which is carried by the MTCH logical channel, E-UTRAN periodically provides MCH scheduling information (MSI) at lower layers (MAC). This MCH information only concerns the time domain scheduling i.e. the frequency domain scheduling and the lower layer configuration are semi-statically configured. The periodicity of the MSI is configurable and defined by the MCH scheduling period.

### 5.8.1.3 MCCH information validity and notification of changes

Change of MCCH information only occurs at specific radio frames, i.e. the concept of a modification period is used. Within a modification period, the same MCCH information may be transmitted a number of times, as defined by its scheduling (which is based on a repetition period). The modification period boundaries are defined by SFN values for which  $\text{SFN} \bmod m = 0$ , where  $m$  is the number of radio frames comprising the modification period. The modification period is configured by means of *SystemInformationBlockType13*.

When the network changes (some of) the MCCH information, it notifies the UEs about the change during a first modification period. In the next modification period, the network transmits the updated MCCH information. These general principles are illustrated in figure 5.8.1.3-1, in which different colours indicate different MCCH information. Upon receiving a change notification, a UE interested to receive MBMS services acquires the new MCCH information immediately from the start of the next modification period. The UE applies the previously acquired MCCH information until the UE acquires the new MCCH information.

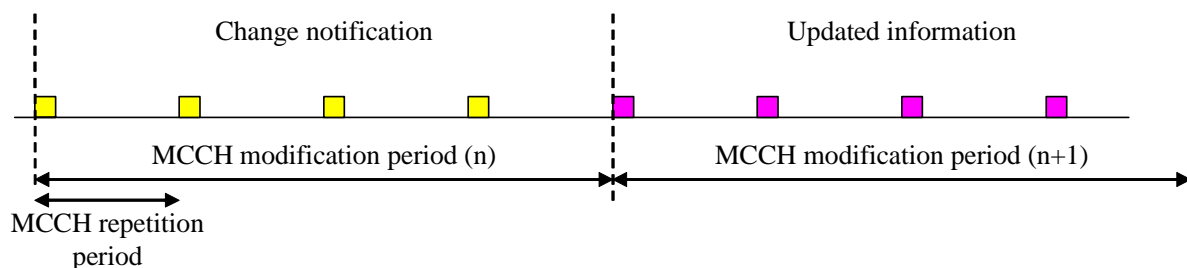

Figure 5.8.1.3-1: Change of MCCH Information

Indication of an MBMS specific RNTI, the M-RNTI (see TS 36.321 [6]), on PDCCH is used to inform UEs in RRC\_IDLE and UEs in RRC\_CONNECTED about an MCCH information change. When receiving an MCCH information change notification, the UE knows that the MCCH information will change at the next modification period boundary. The notification on PDCCH indicates which of the MCCHs will change, which is done by means of an 8-bit bitmap. Within this bitmap, the bit at the position indicated by the field *notificationIndicator* is used to indicate changes for that MBSFN area: if the bit is set to "1", the corresponding MCCH will change. No further details are provided e.g. regarding which MCCH information will change. The MCCH information change notification is used to inform the UE about a change of MCCH information upon session start or about the start of MBMS counting.

The MCCH information change notifications on PDCCH are transmitted periodically and are carried on MBSFN subframes only except on MBMS-dedicated cell or FeMBMS/Unicast-mixed cell where the MCCH information change is provided on non-MBSFN subframes. These MCCH information change notification occasions are common for all MCCHs that are configured, and configurable by parameters included in *SystemInformationBlockType13*: a repetition coefficient, a radio frame offset and a subframe index. These common notification occasions are based on the MCCH with the shortest modification period.

NOTE 1: E-UTRAN may modify the MBMS configuration information provided on MCCH at the same time as updating the MBMS configuration information carried on BCCH i.e. at a coinciding BCCH and MCCH modification period. Upon detecting that a new MCCH is configured on BCCH, a UE interested to receive one or more MBMS services should acquire the MCCH, unless it knows that the services it is interested in are not provided by the corresponding MBSFN area.

A UE that is receiving an MBMS service via MRB shall acquire the MCCH information from the start of each modification period. A UE interested to receive MBMS from a carrier on which *dl-Bandwidth* included in *MasterInformationBlock* is set to  $n_6$  shall acquire the MCCH information at least once every MCCH modification period. A UE that is not receiving an MBMS service via MRB, as well as UEs that are receiving an MBMS service via MRB but potentially interested to receive other services not started yet in another MBSFN area from a carrier on which *dl-Bandwidth* included in *MasterInformationBlock* is other than  $n_6$ , shall verify that the stored MCCH information remains valid by attempting to find the MCCH information change notification at least *notificationRepetitionCoeff* times during the modification period of the applicable MCCH(s), if no MCCH information change notification is received.

NOTE 2: In case the UE is aware which MCCH(s) E-UTRAN uses for the service(s) it is interested to receive, the UE may only need to monitor change notifications for a subset of the MCCHs that are configured, referred to as the 'applicable MCCH(s)' in the above.

## 5.8.2 MCCH information acquisition

### 5.8.2.1 General

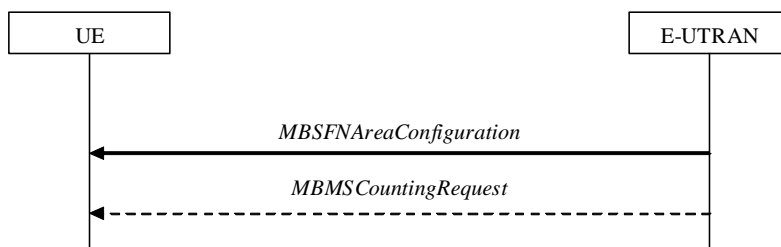

Figure 5.8.2.1-1: MCCH information acquisition

The UE applies the MCCH information acquisition procedure to acquire the MBMS control information that is broadcasted by the E-UTRAN. The procedure applies to MBMS capable UEs that are in RRC\_IDLE or in RRC\_CONNECTED.

### 5.8.2.2 Initiation

A UE interested to receive MBMS services shall apply the MCCH information acquisition procedure upon entering the corresponding MBSFN area (e.g. upon power on, following UE mobility) and upon receiving a notification that the MCCH information has changed. A UE that is receiving an MBMS service shall apply the MCCH information acquisition procedure to acquire the MCCH, that corresponds with the service that is being received, at the start of each modification period.

Unless explicitly stated otherwise in the procedural specification, the MCCH information acquisition procedure overwrites any stored MCCH information, i.e. delta configuration is not applicable for MCCH information and the UE discontinues using a field if it is absent in MCCH information unless explicitly specified otherwise.

### 5.8.2.3 MCCH information acquisition by the UE

An MBMS capable UE shall:

- 1> if the procedure is triggered by an MCCH information change notification:
  - 2> start acquiring the *MBSFNAreaConfiguration* message and the *MBMSCountingRequest* message if present, from the beginning of the modification period following the one in which the change notification was received;

NOTE 1: The UE continues using the previously received MCCH information until the new MCCH information has been acquired.

- 1> if the UE enters an MBSFN area:
  - 2> acquire the *MBSFNAreaConfiguration* message and the *MBMSCountingRequest* message if present, at the next repetition period;
- 1> if the UE is receiving an MBMS service:
  - 2> start acquiring the *MBSFNAreaConfiguration* message and the *MBMSCountingRequest* message if present, that both concern the MBSFN area of the service that is being received, from the beginning of each modification period;



#### 5.8.2.4 Actions upon reception of the *MBSFNAreaConfiguration* message

No UE requirements related to the contents of this *MBSFNAreaConfiguration* apply other than those specified elsewhere e.g. within procedures using the concerned system information, the corresponding field descriptions.

#### 5.8.2.5 Actions upon reception of the *MBMSCountingRequest* message

Upon receiving *MBMSCountingRequest* message, the UE shall perform the MBMS Counting procedure as specified in 5.8.4.

### 5.8.3 MBMS PTM radio bearer configuration

#### 5.8.3.1 General

The MBMS PTM radio bearer configuration procedure is used by the UE to configure RLC, MAC and the physical layer upon starting and/or stopping to receive an MRB. The procedure applies to UEs interested to receive one or more MBMS services.

NOTE: In case the UE is unable to receive an MBMS service due to capability limitations, upper layers may take appropriate action e.g. terminate a lower priority unicast service.

#### 5.8.3.2 Initiation

The UE applies the MRB establishment procedure to start receiving a session of a service it has an interest in. The procedure may be initiated e.g. upon start of the MBMS session, upon (re-)entry of the corresponding MBSFN service area, upon becoming interested in the MBMS service, upon removal of UE capability limitations inhibiting reception of the concerned service.

The UE applies the MRB release procedure to stop receiving a session. The procedure may be initiated e.g. upon stop of the MBMS session, upon leaving the corresponding MBSFN service area, upon losing interest in the MBMS service, when capability limitations start inhibiting reception of the concerned service.

#### 5.8.3.3 MRB establishment

Upon MRB establishment, the UE shall:

- 1> establish an RLC entity in accordance with the configuration specified in 9.1.1.4;
- 1> configure an MTCH logical channel in accordance with the received *logicalChannelIdentity*, applicable for the MRB, as included in the *MBSFNAreaConfiguration* message;
- 1> configure the physical layer in accordance with the *pmch-Config*, applicable for the MRB, as included in the *MBSFNAreaConfiguration* message;
- 1> inform upper layers about the establishment of the MRB by indicating the corresponding *tmgi* and *sessionId*;

#### 5.8.3.4 MRB release

Upon MRB release, the UE shall:

- 1> release the RLC entity as well as the related MAC and physical layer configuration;
- 1> inform upper layers about the release of the MRB by indicating the corresponding *tmgi* and *sessionId*;

### 5.8.4 MBMS Counting Procedure

#### 5.8.4.1 General

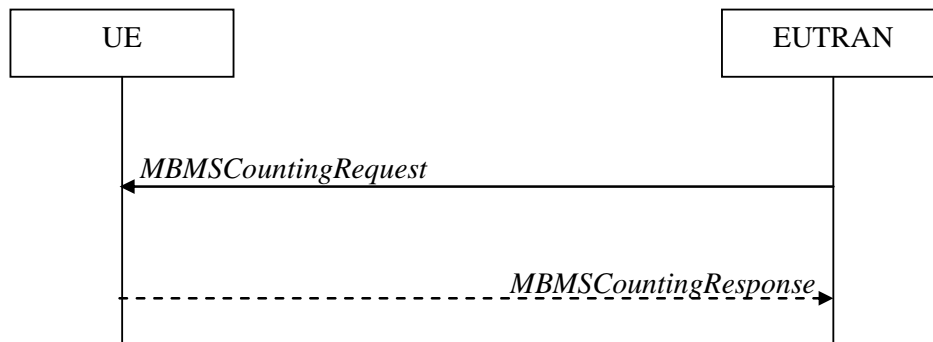

**Figure 5.8.4.1-1: MBMS Counting procedure**

The MBMS Counting procedure is used by the E-UTRAN to count the number of RRC\_CONNECTED mode UEs which are receiving via an MRB or interested to receive via an MRB the specified MBMS services.

The UE determines interest in an MBMS service, that is identified by the TMGI, by interaction with upper layers.

#### 5.8.4.2 Initiation

E-UTRAN initiates the procedure by sending an *MBMSCountingRequest* message.

#### 5.8.4.3 Reception of the *MBMSCountingRequest* message by the UE

Upon receiving the *MBMSCountingRequest* message, the UE in RRC\_CONNECTED mode shall:

- 1> if the *SystemInformationBlockType1*, that provided the scheduling information for the *systemInformationBlockType13* that included the configuration of the MCCH via which the *MBMSCountingRequest* message was received, contained the identity of the Registered PLMN; and
- 1> if the UE is receiving via an MRB or interested to receive via an MRB at least one of the services in the received *countingRequestList*:
  - 2> if more than one entry is included in the *mbsfn-AreaInfoList* received in the *SystemInformationBlockType13* that included the configuration of the MCCH via which the *MBMSCountingRequest* message was received:
    - 3> include the *mbsfn-AreaIndex* in the *MBMSCountingResponse* message and set it to the index of the entry in the *mbsfn-AreaInfoList* within the received *SystemInformationBlockType13* that corresponds with the MBSFN area used to transfer the received *MBMSCountingRequest* message;
  - 2> for each MBMS service included in the received *countingRequestList*:
    - 3> if the UE is receiving via an MRB or interested to receive via an MRB this MBMS service:
      - 4> include an entry in the *countingResponseList* within the *MBMSCountingResponse* message with *countingResponseService* set it to the index of the entry in the *countingRequestList* within the received *MBMSCountingRequest* that corresponds with the MBMS service the UE is receiving or interested to receive;
  - 2> submit the *MBMSCountingResponse* message to lower layers for transmission upon which the procedure ends;

NOTE 1: UEs that are receiving an MBMS User Service, as specified in TS 23.246 [56], by means of a Unicast Bearer Service, as specified in TS 26.346 [57], (i.e. via a DRB), but are interested to receive the concerned MBMS User Service, as specified in TS 23.246 [56], via an MBMS Bearer Service (i.e. via an MRB), respond to the counting request.

NOTE 2: If ciphering is used at upper layers, the UE does not respond to the counting request if it can not decipher the MBMS service for which counting is performed (see TS 22.146 [62], clause 5.3).

NOTE 3: The UE treats the *MBMSCountingRequest* messages received in each modification period independently. In the unlikely case E-UTRAN would repeat an *MBMSCountingRequest* (i.e. including the same services) in a subsequent modification period, the UE responds again. The UE provides at most one *MBMSCountingResponse* message to multiple transmission attempts of an *MBMSCountingRequest* messages in a given modification period.

## 5.8.5 MBMS interest indication

### 5.8.5.1 General

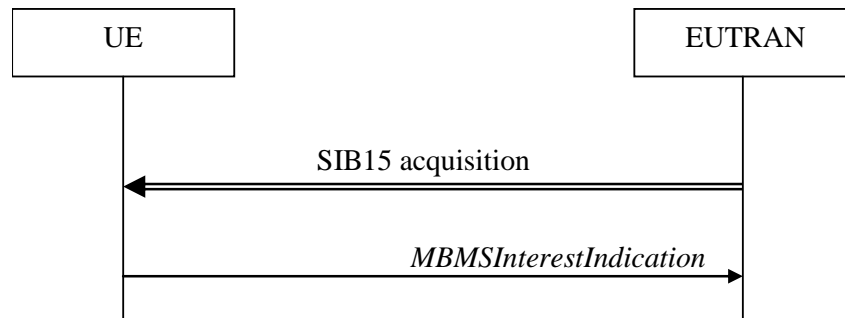

**Figure 5.8.5.1-1: MBMS interest indication**

The purpose of this procedure is to inform E-UTRAN that the UE is receiving or is interested to receive MBMS service(s) via an MRB or SC-MRB, and if so, to inform E-UTRAN about the priority of MBMS versus unicast reception or MBMS service(s) reception in receive only mode.

### 5.8.5.2 Initiation

An MBMS or SC-PTM capable UE in RRC\_CONNECTED may initiate the procedure in several cases including upon successful connection establishment, upon entering or leaving the service area, upon session start or stop, upon change of interest, upon change of priority between MBMS reception and unicast reception, upon change to a PCell broadcasting *SystemInformationBlockType15*, upon starting and stopping of MBMS service(s) in receive only mode, upon change of receive only mode frequency, bandwidth or subcarrier spacing of MBMS service(s) in receive only mode.

Upon initiating the procedure, the UE shall:

- 1> if *SystemInformationBlockType15* is broadcast by the PCell; or
- 1> if *mbms-ROM-ServiceIndication* is received in *SystemInformationBlockType2* from PCell:
  - 2> ensure having a valid version of *SystemInformationBlockType15* for the PCell, if present;
  - 2> if the UE did not transmit an *MBMSInterestIndication* message since last entering RRC\_CONNECTED state; or
  - 2> if since the last time the UE transmitted an *MBMSInterestIndication* message, the UE connected to a PCell neither broadcasting *SystemInformationBlockType15* nor including *mbms-ROM-ServiceIndication* in *SystemInformationBlockType2*:
    - 3> if the set of MBMS frequencies of interest, determined in accordance with 5.8.5.3, is not empty:
      - 4> initiate transmission of the *MBMSInterestIndication* message in accordance with 5.8.5.4;
  - 2> else:
    - 3> if the set of MBMS frequencies of interest, determined in accordance with 5.8.5.3, has changed since the last transmission of the *MBMSInterestIndication* message; or

- 3> if at least one of the subcarrier spacing or bandwidth parameter of receive only mode MBMS frequency of interest, determined in accordance with 5.8.5.3, has changed since the last transmission of the *MBMSInterestIndication* message; or
- 3> if the prioritisation of reception of all indicated MBMS frequencies compared to reception of any of the established unicast bearers has changed since the last transmission of the *MBMSInterestIndication* message:
  - 4> initiate transmission of the *MBMSInterestIndication* message in accordance with 5.8.5.4;

NOTE: The UE may send an *MBMSInterestIndication* even when it is able to receive the MBMS services it is interested in i.e. to avoid that the network allocates a configuration inhibiting MBMS reception.

- 3> else if *SystemInformationBlockType20* is broadcast by the PCell:
  - 4> if since the last time the UE transmitted an *MBMSInterestIndication* message, the UE connected to a PCell not broadcasting *SystemInformationBlockType20*; or
  - 4> if the set of MBMS services of interest determined in accordance with 5.8.5.3a is different from *mbms-Services* included in the last transmission of the *MBMSInterestIndication* message;
    - 5> initiate the transmission of the *MBMSInterestIndication* message in accordance with 5.8.5.4.

### 5.8.5.3 Determine MBMS frequencies of interest

The UE shall:

- 1> consider a frequency to be part of the MBMS frequencies of interest if the following conditions are met:
  - 2> at least one MBMS session the UE is receiving or interested to receive via an MRB or SC-MRB is ongoing or about to start; and

NOTE 1: The UE may determine whether the session is ongoing from the start and stop time indicated in the User Service Description (USD), see TS 36.300 [9] or TS 26.346 [57].

- 2> for at least one of these MBMS sessions either *SystemInformationBlockType15* acquired from the PCell includes for the concerned frequency one or more MBMS SAIs as indicated in the USD for this session or this session is in receive only mode; and

NOTE 2: The UE considers a frequency to be part of the MBMS frequencies of interest even though E-UTRAN may (temporarily) not employ an MRB or SC-MRB for the concerned session. I.e. the UE does not verify if the session is indicated on (SC-)MCCH

NOTE 3: The UE considers the frequencies of interest independently of any synchronization state, e.g. TS 36.300 [9], Annex J.1.

- 2> the UE is capable of simultaneously receiving MRBs and/or is capable of simultaneously receiving SC-MRBs on the set of MBMS frequencies of interest, regardless of whether a serving cell is configured on each of these frequencies or not; and
- 2> the *supportedBandCombination* the UE included in *UE-EUTRA-Capability* contains at least one band combination including the set of MBMS frequencies of interest;

NOTE 4: Indicating a frequency implies that the UE supports *SystemInformationBlockType13* or *SystemInformationBlockType20* acquisition for the concerned frequency i.e. the indication should be independent of whether a serving cell is configured on that frequency.

NOTE 5: When evaluating which frequencies it can receive simultaneously, the UE does not take into account the serving frequencies that are currently configured i.e. it only considers MBMS frequencies it is interested to receive.

NOTE 6: The set of MBMS frequencies of interest includes at most one frequency for a given physical frequency. The UE only considers a physical frequency to be part of the MBMS frequencies of interest if it supports at least one of the bands indicated for this physical frequency in *SystemInformationBlockType1* (for serving frequency) or *SystemInformationBlockType15* (for neighbouring frequencies). In this case, E-UTRAN may assume the UE supports MBMS reception on any of the bands supported by the UE (i.e. according to *supportedBandCombination*).

### 5.8.5.3a Determine MBMS services of interest

The UE shall:

- 1> consider a MBMS service to be part of the MBMS services of interest if the following conditions are met:
  - 2> the UE is SC-PTM capable; and
  - 2> the UE is receiving or interested to receive this service via an SC-MRB; and
  - 2> one session of this service is ongoing or about to start; and
  - 2> one or more MBMS SAIs in the USD for this service is included in *SystemInformationBlockType15* acquired from the PCell for a frequency belonging to the set of MBMS frequencies of interest, determined according to 5.8.5.3.

### 5.8.5.4 Actions related to transmission of *MBMSInterestIndication* message

The UE shall set the contents of the *MBMSInterestIndication* message as follows:

- 1> if the set of MBMS frequencies of interest, determined in accordance with 5.8.5.3, is not empty:
  - 2> include *mbms-FreqList* and set it to include the MBMS frequencies of interest sorted by decreasing order of interest, using the EARFCN corresponding with *freqBandIndicator* included in *SystemInformationBlockType1* (for serving frequency), if applicable, and the EARFCN(s) as included in *SystemInformationBlockType15* (for neighbouring frequencies);

NOTE 1: The EARFCN included in *mbms-FreqList* is merely used to indicate a physical frequency the UE is interested to receive i.e. the UE may not support the band corresponding to the included EARFCN (but it does support at least one of the bands indicated in system information for the concerned physical frequency).

- 2> include *mbms-Priority* if the UE prioritises reception of all indicated MBMS frequencies above reception of any of the unicast bearers;
- 2> if *SystemInformationBlockType20* is broadcast by the PCell:
  - 3> include *mbms-Services* and set it to indicate the set of MBMS services of interest determined in accordance with 5.8.5.3a;

NOTE 2: If the UE prioritises MBMS reception and unicast data cannot be supported because of congestion on the MBMS carrier(s), E-UTRAN may initiate release of unicast bearers. It is up to E-UTRAN implementation whether all bearers or only GBR bearers are released. E-UTRAN does not initiate re-establishment of the released unicast bearers upon alleviation of the congestion.

- 1> if the UE is receiving MBMS service(s) in receive only mode:
  - 2> if the *supportedBandCombination* the UE included in *UE-EUTRA-Capability* contains at least one band combination including the *mbms-ROM-Freq*:
    - 3> include *mbms-ROM-Freq*, *mbms-ROM-SubcarrierSpacing* and *mbms-Bandwidth*;

NOTE 3: The EARFCN included in *mbms-ROM-Freq* is used to indicate a physical frequency the UE is interested to receive MBMS service(s) in receive only mode and is determined based on UE implementation.

The UE shall submit the *MBMSInterestIndication* message to lower layers for transmission.

## 5.8a SC-PTM

### 5.8a.1 Introduction

#### 5.8a.1.1 General

SC-PTM control information is provided on a specific logical channel: the SC-MCCH. The SC-MCCH carries the *SCPTMConfiguration* message which indicates the MBMS sessions that are ongoing as well as the (corresponding) information on when each session may be scheduled, i.e. scheduling period, scheduling window and start offset. The *SCPTMConfiguration* message also provides information about the neighbour cells transmitting the MBMS sessions which are ongoing on the current cell. In this release of the specification, an SC-PTM capable UE is only required to support reception of a single MBMS service at a time, and reception of more than one MBMS service in parallel is left for UE implementation.

A limited amount of SC-PTM control information is provided on the BCCH or BR-BCCH. This primarily concerns the information needed to acquire the SC-MCCH.

NOTE: For BL UEs and UEs in CE, SC-MCCH transmission uses a 1.4 MHz channel bandwidth and a maximum TBS of 936 bits, see TS 36.213 [23]. For NB-IoT UEs, the maximum TBS for SC-MCCH transmission is 680 bits, see TS 36.213 [23].

#### 5.8a.1.2 SC-MCCH scheduling

The SC-MCCH information (i.e. information transmitted in messages sent over SC-MCCH) is transmitted periodically, using a configurable repetition period. SC-MCCH transmissions (and the associated radio resources and MCS) are indicated on PDCCH.

#### 5.8a.1.3 SC-MCCH information validity and notification of changes

Change of SC-MCCH information only occurs at specific radio frames, i.e. the concept of a modification period is used. Within a modification period, the same SC-MCCH information may be transmitted a number of times, as defined by its scheduling (which is based on a repetition period). The modification period boundaries are defined by SFN values for which  $\text{SFN} \bmod m = 0$ , where  $m$  is the number of radio frames comprising the modification period. The modification period is configured by means of *SystemInformationBlockType20* (*SystemInformationBlockType20-NB* in NB-IoT). If H-SFN is provided in *SystemInformationBlockType1-BR*, modification period boundaries for BL UEs or UEs in CE are defined by SFN values for which  $(\text{H-SFN} * 1024 + \text{SFN}) \bmod m = 0$ . The modification period boundaries for NB-IoT UEs are defined by SFN values for which  $(\text{H-SFN} * 1024 + \text{SFN}) \bmod m = 0$ .

When the network changes (some of) the SC-MCCH information, it notifies the UEs, other than BL UEs, UEs in CE or NB-IoT UEs, about the change in the first subframe which can be used for SC-MCCH transmission in a repetition period. LSB bit in 8-bit bitmap when set to '1' indicates the change in SC-MCCH. Upon receiving a change notification, a UE interested to receive MBMS services transmitted using SC-PTM acquires the new SC-MCCH information starting from the same subframe. The UE applies the previously acquired SC-MCCH information until the UE acquires the new SC-MCCH information.

When the network changes (some of) the SC-MCCH information for start of new MBMS service(s) transmitted using SC-PTM, it notifies BL UEs, UEs in CE or NB-IoT UEs about the change in every PDCCH which schedules the first SC-MCCH in a repetition period in the current modification period. The notification is transmitted with 1 bit. The bit, when set to '1', indicates the start of new MBMS service(s), see TS 36.212 [22], clauses 5.3.3.1.14 and 6.4.3.3. Upon receiving a change notification, a BL UE, UE in CE or NB-IoT UE interested to receive MBMS services transmitted using SC-PTM acquires the new SC-MCCH information scheduled by the PDCCH. The BL UE, UE in CE or NB-IoT UE applies the previously acquired SC-MCCH information until the BL UE, UE in CE or NB-IoT UE acquires the new SC-MCCH information.

When the network changes SC-MTCH specific information e.g. start of new MBMS service(s) transmitted using SC-PTM or change of ongoing MBMS service(s) transmitted using SC-PTM, it notifies the BL UEs, UEs in CE or NB-IoT UEs in the PDCCH which schedules the SC-MTCH in the current modification period. The notification is transmitted with a 2 bit bitmap. The LSB in the 2-bit bitmap, when set to '1', indicates the change of the on-going MBMS service and the MSB in the 2-bit bitmap, when set to '1', indicates the start of new MBMS service(s), see TS 36.212 [22], clauses 5.3.3.1.12, 5.3.3.1.13 and 6.4.3.2. In the case the network changes an on-going SC-MTCH transmission in the next modification period, it notifies the BL UEs, UEs in CE or NB-IoT UEs in the PDCCH which schedules this SC-

MTCH in the current modification period. In the case the network starts new MBMS service(s) transmitted using SC-PTM, the network notifies the UEs which have on-going SC-MTCH in the PDCCH scheduling each of the SC-MTCH. Upon receiving such notification, a BL UE, UE in CE or NB-IoT UE acquires the new SC-MCCH information at the start of the next modification period. The BL UE, UE in CE or NB-IoT UE applies the previously acquired SC-MCCH information until the BL UE, UE in CE or NB-IoT UE acquires the new SC-MCCH information.

#### 5.8a.1.4 Procedures

The SC-PTM capable UE receiving or interested to receive MBMS service(s) via SC-MRB applies SC-PTM procedures described in 5.8a and, except for NB-IoT UE, the MBMS interest indication procedure as specified in 5.8.5.

### 5.8a.2 SC-MCCH information acquisition

#### 5.8a.2.1 General

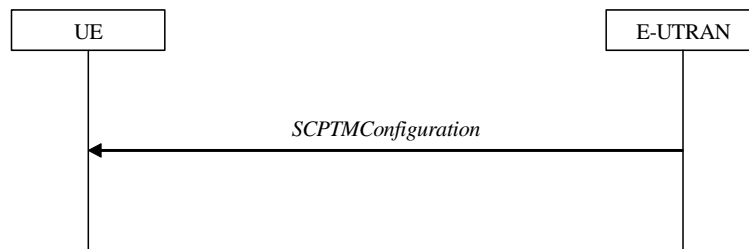

**Figure 5.8a.2.1-1: SC-MCCH information acquisition**

The UE applies the SC-MCCH information acquisition procedure to acquire the SC-PTM control information that is broadcast by the E-UTRAN. The procedure applies to SC-PTM capable UEs that are in RRC\_IDLE except for BL UEs, UEs in CE and NB-IoT UEs, performing EDT procedure. This procedure also applies to SC-PTM capable UEs that are in RRC\_CONNECTED except for BL UEs, UEs in CE or NB-IoT UEs.

#### 5.8a.2.2 Initiation

A UE interested to receive MBMS services via SC-MRB shall apply the SC-MCCH information acquisition procedure upon entering the cell broadcasting *SystemInformationBlockType20* (*SystemInformationBlockType20-NB* in NB-IoT) (e.g. upon power on, following UE mobility) and upon receiving a notification that the SC-MCCH information has changed. A UE, except for BL UE, UE in CE or NB-IoT UE, that is receiving an MBMS service via SC-MRB shall apply the SC-MCCH information acquisition procedure to acquire the SC-MCCH information that corresponds with the service that is being received, at the start of each modification period. The BL UE, UE in CE or NB-IoT UE that is receiving an MBMS service via SC-MRB shall apply the SC-MCCH information acquisition procedure upon receiving a notification that the SC-MCCH information that corresponds with the service that is being received is about to be changed. The BL UE, UE in CE or NB-IoT UE that is receiving an MBMS service via SC-MRB may apply the SC-MCCH information acquisition procedure upon receiving a notification that the SC-MCCH information is about to be changed due to start of a new service.

Unless explicitly stated otherwise in the procedural specification, the SC-MCCH information acquisition procedure overwrites any stored SC-MCCH information, i.e. delta configuration is not applicable for SC-MCCH information and the UE discontinues using a field if it is absent in SC-MCCH information unless explicitly specified otherwise.

#### 5.8a.2.3 SC-MCCH information acquisition by the UE

A SC-PTM capable UE shall:

- 1> if the procedure is triggered by an SC-MCCH information change notification and the UE has no ongoing MBMS service:
- 2> except for a BL UE, UE in CE or NB-IoT UE, start acquiring the *SCPTMConfiguration* message from the subframe in which the change notification was received;

- 2> for a BL UE, UE in CE or NB-IoT UE, acquire the *SCPTMConfiguration* message scheduled by the PDCCH in which the change notification was received;

NOTE 1: The UE continues using the previously received SC-MCCH information until the new SC-MCCH information has been acquired.

- 1> if the UE enters a cell broadcasting *SystemInformationBlockType20* (*SystemInformationBlockType20-NB* in NB-IoT):
  - 2> acquire the *SCPTMConfiguration* message at the next repetition period;
- 1> if the UE is receiving an MBMS service via an SC-MRB:
  - 2> except for BL UE, UE in CE or NB-IoT UE, start acquiring the *SCPTMConfiguration* message from the beginning of each modification period;
  - 2> a BL UE, UE in CE or NB-IoT UE shall start acquiring the *SCPTMConfiguration* message at the start of the next modification period upon receiving a notification that the SC-MCCH information that corresponds with the service that is being received is about to be changed;
  - 2> a BL UE, UE in CE or NB-IoT UE may start acquiring the *SCPTMConfiguration* message at the start of the next modification period upon receiving a notification that the SC-MCCH information is about to be changed due to start of a new service;

#### 5.8a.2.4 Actions upon reception of the *SCPTMConfiguration* message

No UE requirements related to the contents of this *SCPTMConfiguration* apply other than those specified elsewhere e.g. within procedures using the concerned system information, the corresponding field descriptions.

### 5.8a.3 SC-PTM radio bearer configuration

#### 5.8a.3.1 General

The SC-PTM radio bearer configuration procedure is used by the UE to configure RLC, MAC and the physical layer upon starting and/or stopping to receive an SC-MRB transmitted on SC-MTCH. The procedure applies to SC-PTM capable UEs that are in RRC\_IDLE and to SC-PTM capable UEs that are not BL UEs, UEs in CE or NB-IoT UEs in RRC\_CONNECTED, and are interested to receive one or more MBMS services via SC-MRB.

NOTE: In case the UE is unable to receive an MBMS service via an SC-MRB due to capability limitations, upper layers may take appropriate action e.g. terminate a lower priority unicast service.

#### 5.8a.3.2 Initiation

The UE applies the SC-MRB establishment procedure to start receiving a session of a MBMS service it has an interest in. The procedure may be initiated e.g. upon start of the MBMS session, upon entering a cell providing via SC-MRB a MBMS service in which the UE has interest, upon becoming interested in the MBMS service, upon removal of UE capability limitations inhibiting reception of the concerned service.

The UE applies the SC-MRB release procedure to stop receiving a session. The procedure may be initiated e.g. upon stop of the MBMS session, upon leaving the cell where a SC-MRB is established, upon losing interest in the MBMS service, when capability limitations start inhibiting reception of the concerned service.

#### 5.8a.3.3 SC-MRB establishment

Upon SC-MRB establishment, the UE shall:

- 1> establish an RLC entity in accordance with the configuration specified in 9.1.1.7;
- 1> configure a SC-MTCH logical channel applicable for the SC-MRB and instruct MAC to receive DL-SCH on the cell where the *SCPTMConfiguration* message was received for the MBMS service for which the SC-MRB is established and using *g-RNTI* and *sc-mtch-SchedulingInfo* (if included) in this message for this MBMS service;



- 1> configure the physical layer in accordance with the *sc-mtch-InfoList*, applicable for the SC-MRB, as included in the *SCPTMConfiguration* message;
- 1> inform upper layers about the establishment of the SC-MRB by indicating the corresponding *tmgi* and *sessionId*;

### 5.8a.3.4 SC-MRB release

Upon SC-MRB release, the UE shall:

- 1> release the RLC entity as well as the related MAC and physical layer configuration;
- 1> inform upper layers about the release of the SC-MRB by indicating the corresponding *tmgi* and *sessionId*;

## 5.9 RN procedures

### 5.9.1 RN reconfiguration

#### 5.9.1.1 General

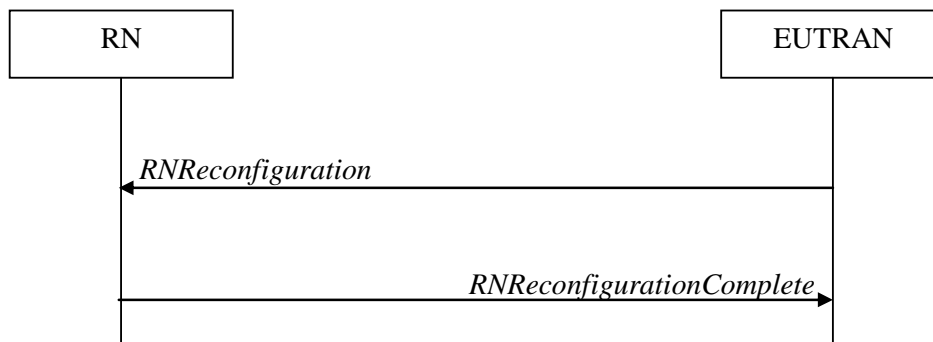

**Figure 5.9.1.1-1: RN reconfiguration**

The purpose of this procedure is to configure/reconfigure the RN subframe configuration and/or to update the system information relevant for the RN in RRC\_CONNECTED.

#### 5.9.1.2 Initiation

E-UTRAN may initiate the RN reconfiguration procedure to an RN in RRC\_CONNECTED when AS security has been activated.

#### 5.9.1.3 Reception of the *RNReconfiguration* by the RN

The RN shall:

- 1> if the *rn-SystemInfo* is included:
  - 2> if the *systemInformationBlockType1* is included:
    - 3> act upon the received *SystemInformationBlockType1* as specified in 5.2.2.7;
  - 2> if the *SystemInformationBlockType2* is included:
    - 3> act upon the received *SystemInformationBlockType2* as specified in 5.2.2.9;
- 1> if the *rn-SubframeConfig* is included:
  - 2> reconfigure lower layers in accordance with the received *subframeConfigPatternFDD* or *subframeConfigPatternTDD*;
  - 2> if the *rpdcch-Config* is included:

- 3> reconfigure lower layers in accordance with the received *rpdcch-Config*;
- 1> submit the *RNRreconfigurationComplete* message to lower layers for transmission, upon which the procedure ends;

## 5.10 Sidelink

### 5.10.1 Introduction

The sidelink communication and associated synchronisation resource configuration applies for the frequency at which it was received/ acquired. Moreover, for a UE configured with one or more SCells, the sidelink communication and associated synchronisation resource configuration provided by dedicated signalling applies for the PCell/ the primary frequency. The sidelink discovery and associated synchronisation resource configuration applies for the frequency at which it was received/ acquired or the indicated frequency in the configuration. For a UE configured with one or more SCells, the sidelink discovery and associated synchronisation resource configuration provided by dedicated signalling applies for the PCell/ the primary frequency / any other indicated frequency.

NOTE 1: Upper layers configure the UE to receive or transmit sidelink communication on a specific frequency, to monitor or transmit non-PS related sidelink discovery announcements on one or more frequencies or to monitor or transmit PS related sidelink discovery announcements on a specific frequency, but only if the UE is authorised to perform these particular ProSe related sidelink activities.

NOTE 2: It is up to UE implementation which actions to take (e.g. termination of unicast services, detach) when it is unable to perform the desired sidelink activities, e.g. due to UE capability limitations.

Sidelink communication consists of one-to-many and one-to-one sidelink communication. One-to-many sidelink communication consists of relay related and non-relay related one-to-many sidelink communication. One-to-one sidelink communication consists of relay related and non-relay related one-to-one sidelink communication. In relay related one-to-one sidelink communication the communicating parties consist of one sidelink relay UE and one sidelink remote UE.

Sidelink discovery consists of public safety related (PS related) and non-PS related sidelink discovery. PS related sidelink discovery consists of relay related and non-relay related PS related sidelink discovery. Upper layers indicate to RRC whether a particular sidelink announcement is PS related or non-PS related.

Upper layers indicate to RRC whether a particular sidelink procedure is V2X related or not.

The specification covers the use of UE to network sidelink relays by specifying the additional requirements that apply for a sidelink relay UE and a sidelink remote UE, i.e. for such UEs the regular sidelink UE requirements equally apply unless explicitly stated otherwise.

NOTE 3: In case the configurations for V2X sidelink communication are acquired from NR, the configurations for V2X sidelink communication in *SystemInformationBlockType21*, *SystemInformationBlockType26*, *SL-V2X-ConfigDedicated* within *RRCConnectionReconfiguration* used in this clause can be provided by *SIB13*, *SIB14*, *sl-ConfigDedicatedEUTRA* within *RRCReconfiguration* as specified in TS 38.331 [82], respectively.

#### 5.10.1a Conditions for sidelink communication operation

The UE shall perform sidelink communication operation only if the conditions defined in this clause are met:

- 1> if the UE's serving cell is suitable (RRC\_IDLE or RRC\_CONNECTED); and if either the selected cell on the frequency used for sidelink communication operation belongs to the registered or equivalent PLMN as specified in TS 24.334 [69] or the UE is out of coverage on the frequency used for sidelink communication operation as defined in TS 36.304 [4], clause 11.4; or
- 1> if the UE is camped on a serving cell (RRC\_IDLE) on which it fulfils the conditions to support sidelink communication in limited service state as specified in TS 23.303 [68], clause 4.5.6; and if either the serving cell is on the frequency used for sidelink communication operation or the UE is out of coverage on the frequency used for sidelink communication operation as defined in TS 36.304 [4], clause 11.4; or
- 1> if the UE has no serving cell (RRC\_IDLE);

### 5.10.1b Conditions for PS related sidelink discovery operation

The UE shall perform PS related sidelink discovery operation only if the conditions defined in this clause are met:

- 1> if the UE's serving cell is suitable (RRC\_IDLE or RRC\_CONNECTED); and if either the selected cell on the frequency used for PS related sidelink discovery operation belongs to the registered or other PLMN as specified in TS 24.334 [69] or the UE is out of coverage on the frequency used for PS related sidelink discovery operation as defined in TS 36.304 [4], clause 11.4; or
- 1> if the UE is camped on a serving cell (RRC\_IDLE) on which it fulfils the conditions to support sidelink discovery in limited service state as specified in TS 23.303 [68], clause 4.5.6; and if either the serving cell is on the frequency used for PS related sidelink discovery operation or the UE is out of coverage on the frequency used for PS related sidelink discovery operation as defined in TS 36.304 [4], clause 11.4; or
- 1> if the UE has no serving cell (RRC\_IDLE);

### 5.10.1c Conditions for non-PS related sidelink discovery operation

The UE shall perform non-PS related sidelink discovery operation only if the conditions defined in this clause are met:

- 1> if the UE's serving cell (RRC\_IDLE) or PCell (RRC\_CONNECTED) is suitable; and if the selected cell on the frequency used for non-PS related sidelink discovery operation belongs to the registered or other PLMN as specified in TS 24.334 [69].

### 5.10.1d Conditions for V2X sidelink communication operation

The UE shall perform V2X sidelink communication operation only if the conditions defined in this clause are met:

- 1> if the UE's serving cell is suitable; and if either the selected cell on the frequency used for V2X sidelink communication operation belongs to the registered or equivalent PLMN as specified in TS 24.334 [69] or the UE is out of coverage on the frequency used for V2X sidelink communication operation as defined in TS 36.304 [4], clause 11.4 and TS 38.304 [92], clause 8.1; or
- 1> if the UE's serving cell fulfils the conditions to support V2X sidelink communication in limited service state as specified in TS 23.285 [78], clause 4.4.8; and if either the serving cell is on the frequency used for V2X sidelink communication operation or the UE is out of coverage on the frequency used for V2X sidelink communication operation as defined in TS 36.304 [4], clause 11.4 and TS 38.304 [92], clause 8.1; or
- 1> if the UE has no serving cell (RRC\_IDLE);

## 5.10.2 Sidelink UE information

### 5.10.2.1 General

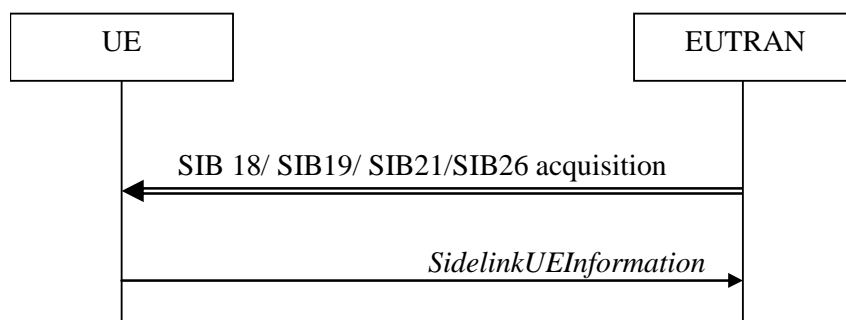

**Figure 5.10.2-1: Sidelink UE information**

The purpose of this procedure is to inform E-UTRAN that the UE is interested or no longer interested to receive sidelink communication or discovery, to receive V2X sidelink communication, as well as to request assignment or release of transmission resources for sidelink communication or discovery announcements or V2X sidelink communication or sidelink discovery gaps, to report parameters related to sidelink discovery from system information

of inter-frequency/PLMN cells and to report the synchronization reference used by the UE for V2X sidelink communication.

### 5.10.2.2 Initiation

A UE capable of sidelink communication or V2X sidelink communication or sidelink discovery that is in RRC\_CONNECTED may initiate the procedure to indicate it is (interested in) receiving sidelink communication or V2X sidelink communication or sidelink discovery in several cases including upon successful connection establishment, upon change of interest, upon change to a PCell broadcasting *SystemInformationBlockType18* or *SystemInformationBlockType19* or *SystemInformationBlockType21* including *sl-V2X-ConfigCommon*. A UE capable of sidelink communication or V2X sidelink communication or sidelink discovery may initiate the procedure to request assignment of dedicated resources for the concerned sidelink communication transmission or discovery announcements or V2X sidelink communication transmission or to request sidelink discovery gaps for sidelink discovery transmission or sidelink discovery reception and a UE capable of inter-frequency/PLMN sidelink discovery parameter reporting may initiate the procedure to report parameters related to sidelink discovery from system information of inter-frequency/PLMN cells.

NOTE 1: A UE in RRC\_IDLE that is configured to transmit sidelink communication / V2X sidelink communication / sidelink discovery announcements, while *SystemInformationBlockType18*/*SystemInformationBlockType19*/*SystemInformationBlockType21* including *sl-V2X-ConfigCommon* or *SystemInformationBlockType26* does not include the resources for transmission (in normal conditions), initiates connection establishment in accordance with 5.3.3.1a.

Upon initiating the procedure, the UE shall:

- 1> if *SystemInformationBlockType18* is broadcast by the PCell:
  - 2> ensure having a valid version of *SystemInformationBlockType18* for the PCell;
  - 2> if configured by upper layers to receive sidelink communication:
    - 3> if the UE did not transmit a *SidelinkUEInformation* message since last entering RRC\_CONNECTED state; or
    - 3> if since the last time the UE transmitted a *SidelinkUEInformation* message the UE connected to a PCell not broadcasting *SystemInformationBlockType18*; or

NOTE 2: After handover/ re-establishment from a source PCell not broadcasting *SystemInformationBlockType18* the UE repeats the same interest information that it provided previously as such a source PCell may not forward the interest information.

- 3> if the last transmission of the *SidelinkUEInformation* message did not include *commRxInterestedFreq*; or if the frequency configured by upper layers to receive sidelink communication on has changed since the last transmission of the *SidelinkUEInformation* message:
  - 4> initiate transmission of the *SidelinkUEInformation* message to indicate the sidelink communication reception frequency of interest in accordance with 5.10.2.3;
- 2> else:
  - 3> if the last transmission of the *SidelinkUEInformation* message included *commRxInterestedFreq*:
    - 4> initiate transmission of the *SidelinkUEInformation* message to indicate it is no longer interested in sidelink communication reception in accordance with 5.10.2.3;
  - 2> if configured by upper layers to transmit non-relay related one-to-many sidelink communication:
    - 3> if the UE did not transmit a *SidelinkUEInformation* message since last entering RRC\_CONNECTED state; or
    - 3> if since the last time the UE transmitted a *SidelinkUEInformation* message the UE connected to a PCell not broadcasting *SystemInformationBlockType18*; or

- 3> if the last transmission of the *SidelinkUEInformation* message did not include *commTxResourceReq*; or if the information carried by the *commTxResourceReq* has changed since the last transmission of the *SidelinkUEInformation* message:
  - 4> initiate transmission of the *SidelinkUEInformation* message to indicate the non-relay related one-to-many sidelink communication transmission resources required by the UE in accordance with 5.10.2.3;
- 2> else:
  - 3> if the last transmission of the *SidelinkUEInformation* message included *commTxResourceReq*:
    - 4> initiate transmission of the *SidelinkUEInformation* message to indicate it no longer requires non-relay related one-to-many sidelink communication transmission resources in accordance with 5.10.2.3;
  - 2> if configured by upper layer to transmit relay related one-to-many sidelink communication:
    - 3> if the UE did not transmit a *SidelinkUEInformation* message since entering RRC\_CONNECTED state; or
    - 3> if since the last time the UE transmitted a *SidelinkUEInformation* message the UE connected to a PCell not broadcasting *SystemInformationBlockType18*, connected to a PCell not broadcasting *SystemInformationBlockType19* or broadcasting *SystemInformationBlockType19* not including *discConfigRelay*; or
    - 3> if the last transmission of *SidelinkUEInformation* message did not include *commTxResourceReqRelay*; or if the information carried by the *commTxResourceReqRelay* has changed since the last transmission of the *SidelinkUEInformation* message:
      - 4> if the UE is acting as sidelink relay UE:
        - 5> initiate transmission of the *SidelinkUEInformation* message to indicate the relay related one-to-many sidelink communication transmission resources required by the UE in accordance with 5.10.2.3;
  - 2> else:
    - 3> if the last transmission of the *SidelinkUEInformation* message included *commTxResourceReqRelay*:
      - 4> initiate transmission of the *SidelinkUEInformation* message to indicate it no longer requires relay related one-to-many sidelink communication transmission resources in accordance with 5.10.2.3;
    - 2> if configured by upper layers to transmit non-relay related one-to-one sidelink communication:
      - 3> if the UE did not transmit a *SidelinkUEInformation* message since last entering RRC\_CONNECTED state; or
      - 3> if since the last time the UE transmitted a *SidelinkUEInformation* message the UE connected to a PCell not broadcasting *SystemInformationBlockType18* or connected to a PCell broadcasting *SystemInformationBlockType18* not including *commTxResourceUC-ReqAllowed*; or
      - 3> if the last transmission of the *SidelinkUEInformation* message did not include *commTxResourceReqUC*; or if the information carried by the *commTxResourceReqUC* has changed since the last transmission of the *SidelinkUEInformation* message:
        - 4> if *commTxResourceUC-ReqAllowed* is included in *SystemInformationBlockType18*:
          - 5> initiate transmission of the *SidelinkUEInformation* message to indicate the non-relay related one-to-one sidelink communication transmission resources required by the UE in accordance with 5.10.2.3;
    - 2> else:
      - 3> if the last transmission of the *SidelinkUEInformation* message included *commTxResourceReqUC*:
        - 4> initiate transmission of the *SidelinkUEInformation* message to indicate it no longer requires non-relay related one-to-one sidelink communication transmission resources in accordance with 5.10.2.3;
      - 2> if configured by upper layers to transmit relay related one-to-one sidelink communication:

- 3> if the UE did not transmit a *SidelinkUEInformation* message since last entering RRC\_CONNECTED state; or
- 3> if since the last time the UE transmitted a *SidelinkUEInformation* message the UE connected to a PCell not broadcasting *SystemInformationBlockType18*, connected to a PCell not broadcasting *SystemInformationBlockType19* or broadcasting *SystemInformationBlockType19* not including *discConfigRelay*; or
- 3> if the last transmission of the *SidelinkUEInformation* message did not include *commTxResourceReqRelayUC*; or if the information carried by the *commTxResourceReqRelayUC* has changed since the last transmission of the *SidelinkUEInformation* message:
  - 4> if the UE is acting as sidelink relay UE; or
  - 4> if the UE has a selected sidelink relay UE; and if *SystemInformationBlockType19* is broadcast by the PCell and includes *discConfigRelay*; and if the sidelink remote UE threshold conditions as specified in 5.10.11.5 are met;
    - 5> initiate transmission of the *SidelinkUEInformation* message to indicate the relay related one-to-one sidelink communication transmission resources required by the UE in accordance with 5.10.2.3;
- 2> else:
  - 3> if the last transmission of the *SidelinkUEInformation* message included *commTxResourceReqRelayUC*:
    - 4> initiate transmission of the *SidelinkUEInformation* message to indicate it no longer requires relay related one-to-one sidelink communication transmission resources in accordance with 5.10.2.3;
- 1> if *SystemInformationBlockType19* is broadcast by the PCell:
  - 2> ensure having a valid version of *SystemInformationBlockType19* for the PCell;
  - 2> if configured by upper layers to receive sidelink discovery announcements on a serving frequency or on one or more frequencies included in *discInterFreqList*, if included in *SystemInformationBlockType19* of the PCell:
    - 3> if the UE did not transmit a *SidelinkUEInformation* message since last entering RRC\_CONNECTED state; or
    - 3> if since the last time the UE transmitted a *SidelinkUEInformation* message the UE connected to a PCell not broadcasting *SystemInformationBlockType19*; or
    - 3> if the last transmission of the *SidelinkUEInformation* message did not include *discRxInterest*:
      - 4> initiate transmission of the *SidelinkUEInformation* message to indicate it is interested in sidelink discovery reception in accordance with 5.10.2.3;
  - 2> else:
    - 3> if the last transmission of the *SidelinkUEInformation* message included *discRxInterest*:
      - 4> initiate transmission of the *SidelinkUEInformation* message to indicate it is no longer interested in sidelink discovery reception in accordance with 5.10.2.3;
  - 2> if the UE is configured by upper layers to transmit non-PS related sidelink discovery announcements on the primary frequency or on one or more frequencies included in *discInterFreqList*, if included in *SystemInformationBlockType19* of the PCell, with *discTxResourcesInterFreq* included within *discResourcesNonPS* and not set to *noTxOnCarrier*:
    - 3> if the UE did not transmit a *SidelinkUEInformation* message since last entering RRC\_CONNECTED state; or
    - 3> if since the last time the UE transmitted a *SidelinkUEInformation* message the UE connected to a PCell not broadcasting *SystemInformationBlockType19* or connected to a PCell broadcasting *SystemInformationBlockType19* not including *discTxResourcesInterFreq* within *discResourcesNonPS* or *discTxResourcesInterFreq* did not include all frequencies for which the UE will request resources; or

- 3> if the last transmission of the *SidelinkUEInformation* message did not include *discTxResourceReq*; or if the non-PS related sidelink discovery announcement resources required by the UE have changed (i.e. resulting in a change of *discTxResourceReq*) since the last transmission of the *SidelinkUEInformation* message:
  - 4> initiate transmission of the *SidelinkUEInformation* message to indicate the non-PS related sidelink discovery announcement resources required by the UE in accordance with 5.10.2.3;
- 2> else:
  - 3> if the last transmission of the *SidelinkUEInformation* message included *discTxResourceReq*:
    - 4> initiate transmission of the *SidelinkUEInformation* message to indicate it no longer requires non-PS related sidelink discovery announcement resources in accordance with 5.10.2.3;
  - 2> if configured by upper layers to transmit PS related sidelink discovery announcements on the primary frequency or, in case of non-relay PS related sidelink discovery announcements, on a frequency included in *discInterFreqList*, if included in *SystemInformationBlockType19*, with *discTxResourcesInterFreq* included within *discResourcesPS* and not set to *noTxOnCarrier*:
    - 3> if the UE did not transmit a *SidelinkUEInformation* message since last entering RRC\_CONNECTED state; or
      - 3> if since the last time the UE transmitted a *SidelinkUEInformation* message the UE connected to a PCell not broadcasting *SystemInformationBlockType19*, connected to a PCell broadcasting *SystemInformationBlockType19* not including *discConfigPS*, or in case of non-relay PS related transmission: (connected to a PCell broadcasting *SystemInformationBlockType19* not including *discTxResourcesInterFreq* within *discResourcesPS* or for which *discTxResourcesInterFreq* did not include all frequencies for which the UE will request resources), or in case of relay related PS sidelink discovery announcements: (connected to a PCell broadcasting *SystemInformationBlockType19* not including *discConfigRelay*) sidelink; or
      - 3> if the last transmission of the *SidelinkUEInformation* message did not include *discTxResourceReqPS*; or if the PS related sidelink discovery announcement resources required by the UE have changed (i.e. resulting in a change of *discTxResourceReqPS*) since the last transmission of the *SidelinkUEInformation* message:
        - 4> if configured by upper layers to transmit non-relay PS related sidelink discovery announcements; or
        - 4> if the UE is acting as sidelink relay UE; and if *SystemInformationBlockType19* includes *discConfigRelay*; and if the sidelink relay UE threshold conditions as specified in 5.10.10.4 are met; or
        - 4> if the UE is selecting a sidelink relay UE / has a selected sidelink relay UE; and if *SystemInformationBlockType19* includes *discConfigRelay*; and if the sidelink remote UE threshold conditions as specified in 5.10.11.5 are met:
          - 5> initiate transmission of the *SidelinkUEInformation* message to indicate the PS related sidelink discovery announcement resources required by the UE in accordance with 5.10.2.3;
  - 2> else:
    - 3> if the last transmission of the *SidelinkUEInformation* message included *discTxResourceReqPS*:
      - 4> initiate transmission of the *SidelinkUEInformation* message to indicate it no longer requires PS related sidelink discovery announcement resources in accordance with 5.10.2.3;
    - 2> if configured by upper layers to monitor or transmit sidelink discovery announcements; and if the UE requires sidelink discovery gaps, to perform such actions:
      - 3> if the UE did not transmit a *SidelinkUEInformation* message since last entering RRC\_CONNECTED state; or
        - 3> if since the last time the UE transmitted a *SidelinkUEInformation* message the UE connected to a PCell not broadcasting *SystemInformationBlockType19* or connected to a PCell broadcasting *SystemInformationBlockType19* not including *gapRequestsAllowedCommon* while at the same time the UE was not configured with *gapRequestsAllowedDedicated*; or

- 3> if the last transmission of the *SidelinkUEInformation* message did not include the gaps required to monitor or transmit the sidelink discovery announcements (i.e. UE requiring gaps to monitor discovery announcements while *discRxGapReq* was not included or UE requiring gaps to transmit discovery announcements while *discTxGapReq* was not included); or if the sidelink discovery gaps required by the UE have changed (i.e. resulting in a change of *discRxGapReq* or *discTxGapReq*) since the last transmission of the *SidelinkUEInformation* message:
  - 4> if the UE is configured with *gapRequestsAllowedDedicated* set to *true*; or
  - 4> if the UE is not configured with *gapRequestsAllowedDedicated* and *gapRequestsAllowedCommon* is included in *SystemInformationBlockType19*:
    - 5> initiate transmission of the *SidelinkUEInformation* message to indicate the sidelink discovery gaps required by the UE in accordance with 5.10.2.3;
- 2> else:
  - 3> if the last transmission of the *SidelinkUEInformation* message included *discTxGapReq* or *discRxGapReq*:
    - 4> initiate transmission of the *SidelinkUEInformation* message to indicate it no longer requires sidelink discovery gaps in accordance with 5.10.2.3;
  - 2> if the UE acquired the relevant parameters from the system information of one or more cells on a carrier included in the *discSysInfoToReportConfig* and T370 is running:
    - 3> if the UE has configured lower layers to transmit or monitor the sidelink discovery announcements on those cells:
      - 4> initiate transmission of the *SidelinkUEInformation* message to report the acquired system information parameters and stop T370;
- 1> if *SystemInformationBlockType21* including *sl-V2X-ConfigCommon* is broadcast by the PCell:
  - 2> ensure having a valid version of *SystemInformationBlockType21* and *SystemInformationBlockType26*, if broadcast, for the PCell;
  - 2> if configured by upper layers to receive V2X sidelink communication on a primary frequency or on one or more frequencies included in *v2x-InterFreqInfoList*, if included in *SystemInformationBlockType21* or *SystemInformationBlockType26* of the PCell:
    - 3> if the UE did not transmit a *SidelinkUEInformation* message since last entering RRC\_CONNECTED state; or
    - 3> if since the last time the UE transmitted a *SidelinkUEInformation* message the UE connected to a PCell not broadcasting *SystemInformationBlockType21* including *sl-V2X-ConfigCommon*; or
    - 3> if the last transmission of the *SidelinkUEInformation* message did not include *v2x-CommRxInterestedFreqList*; or if the frequency(ies) configured by upper layers to receive V2X sidelink communication on has changed since the last transmission of the *SidelinkUEInformation* message:
      - 4> initiate transmission of the *SidelinkUEInformation* message to indicate the V2X sidelink communication reception frequency(ies) of interest in accordance with 5.10.2.3;
  - 2> else:
    - 3> if the last transmission of the *SidelinkUEInformation* message included *v2x-CommRxInterestedFreqList*:
      - 4> initiate transmission of the *SidelinkUEInformation* message to indicate it is no longer interested in V2X sidelink communication reception in accordance with 5.10.2.3;
  - 2> if configured by upper layers to transmit V2X sidelink communication on a primary frequency or on one or more frequencies included in *v2x-InterFreqInfoList*, if included in *SystemInformationBlockType21* or *SystemInformationBlockType26* of the PCell:
    - 3> if the UE did not transmit a *SidelinkUEInformation* message since last entering RRC\_CONNECTED state; or



- 3> if since the last time the UE transmitted a *SidelinkUEInformation* message the UE connected to a PCell not broadcasting *SystemInformationBlockType21* including *sl-V2X-ConfigCommon*; or
- 3> if the last transmission of the *SidelinkUEInformation* message did not include *v2x-CommTxResourceReq*; or if the information carried by the *v2x-CommTxResourceReq* has changed since the last transmission of the *SidelinkUEInformation* message:
  - 4> initiate transmission of the *SidelinkUEInformation* message to indicate the V2X sidelink communication transmission resources required by the UE in accordance with 5.10.2.3;
- 2> else:
  - 3> if the last transmission of the *SidelinkUEInformation* message included *v2x-CommTxResourceReq*:
    - 4> initiate transmission of the *SidelinkUEInformation* message to indicate it no longer requires V2X sidelink communication transmission resources in accordance with 5.10.2.3;

### 5.10.2.3 Actions related to transmission of *SidelinkUEInformation* message

The UE shall set the contents of the *SidelinkUEInformation* message as follows:

- 1> if the UE initiates the procedure to indicate it is (no more) interested to receive sidelink communication or discovery or receive V2X sidelink communication or to request (configuration/ release) of sidelink communication or V2X sidelink communication or sidelink discovery transmission resources (i.e. UE includes all concerned information, irrespective of what triggered the procedure):
  - 2> if *SystemInformationBlockType18* is broadcast by the PCell:
    - 3> if configured by upper layers to receive sidelink communication:
      - 4> include *commRxInterestedFreq* and set it to the sidelink communication frequency;
    - 3> if configured by upper layers to transmit non-relay related one-to-many sidelink communication:
      - 4> include *commTxResourceReq* and set its fields as follows:
        - 5> set *carrierFreq* to indicate the sidelink communication frequency i.e. the same value as indicated in *commRxInterestedFreq* if included;
        - 5> set *destinationInfoList* to include the non-relay related one-to-many sidelink communication transmission destination(s) for which it requests E-UTRAN to assign dedicated resources;
    - 3> if configured by upper layers to transmit non-relay related one-to-one sidelink communication; and
    - 3> if *commTxResourceUC-ReqAllowed* is included in *SystemInformationBlockType18*:
      - 4> include *commTxResourceReqUC* and set its fields as follows:
        - 5> set *carrierFreq* to indicate the one-to-one sidelink communication frequency i.e. the same value as indicated in *commRxInterestedFreq* if included;
        - 5> set *destinationInfoList* to include the non-relay related one-to-one sidelink communication transmission destination(s) for which it requests E-UTRAN to assign dedicated resources;
    - 3> if configured by upper layers to transmit relay related one-to-one sidelink communication; and
    - 3> if *SystemInformationBlockType19* is broadcast by the PCell including *discConfigRelay*; and
    - 3> if the UE is acting as sidelink relay UE; or if the UE has a selected sidelink relay UE; and if the sidelink remote UE threshold conditions as specified in 5.10.11.5 are met:
      - 4> include *commTxResourceReqRelayUC* and set its fields as follows:
        - 5> set *destinationInfoList* to include the one-to-one sidelink communication transmission destination(s) for which it requests E-UTRAN to assign dedicated resources;

- 4> include *ue-Type* and set it to *relayUE* if the UE is acting as sidelink relay UE and to *remoteUE* otherwise;
- 3> if configured by upper layers to transmit relay related one-to-many sidelink communication; and
- 3> if *SystemInformationBlockType19* is broadcast by the PCell including *discConfigRelay*; and
- 3> if the UE is acting as sidelink relay UE:
  - 4> include *commTxResourceReqRelay* and set its fields as follows:
    - 5> set *destinationInfoList* to include the one-to-many sidelink communication transmission destination(s) for which it requests E-UTRAN to assign dedicated resources;
  - 4> include *ue-Type* and set it to *relayUE*;
- 2> if *SystemInformationBlockType19* is broadcast by the PCell:
  - 3> if configured by upper layers to receive sidelink discovery announcements on a serving frequency or one or more frequencies included in *discInterFreqList*, if included in *SystemInformationBlockType19*:
    - 4> include *discRxInterest*;
  - 3> if the UE is configured by upper layers to transmit non-PS related sidelink discovery announcements:
    - 4> for each frequency on which the UE is configured to transmit non-PS related sidelink discovery announcements that concerns the primary frequency or that is included in *discInterFreqList* with *discTxResourcesInterFreq* included within *discResourcesNonPS* and not set to *noTxOnCarrier*:
      - 5> for the first frequency, include *discTxResourceReq* and set it to indicate the number of discovery messages for sidelink discovery announcement(s) for which it requests E-UTRAN to assign dedicated resources as well as the concerned frequency, if different from the primary;
      - 5> for any additional frequency, include *discTxResourceReqAddFreq* and set it to indicate the number of discovery messages for sidelink discovery announcement(s) for which it requests E-UTRAN to assign dedicated resources as well as the concerned frequency;
  - 3> if configured by upper layers to transmit PS related sidelink discovery announcements; and
  - 3> if the frequency on which the UE is configured to transmit PS related sidelink discovery announcements either concerns the primary frequency or, in case of non-relay PS related sidelink discovery announcements, is included in *discInterFreqList* with *discTxResources InterFreq* included within *discResourcesPS* and not set to *noTxOnCarrier*:
    - 4> if configured by upper layers to transmit non-relay PS related sidelink discovery announcements and *SystemInformationBlockType19* includes *discConfigPS*; or
    - 4> if the UE is acting as sidelink relay UE; and if *SystemInformationBlockType19* includes *discConfigRelay*; and if the sidelink relay UE threshold conditions as specified in 5.10.10.4 are met; or
    - 4> if the UE is selecting a sidelink relay UE / has a selected sidelink relay UE; and if *SystemInformationBlockType19* includes *discConfigRelay*; and if the sidelink remote UE threshold conditions as specified in 5.10.11.5 are met:
      - 5> include *discTxResourceReqPS* and set it to indicate the number of discovery messages for PS related sidelink discovery announcement(s) for which it requests E-UTRAN to assign dedicated resources as well as the concerned frequency, if different from the primary;
- 2> if *SystemInformationBlockType21* is broadcast by the PCell and *SystemInformationBlockType21* includes *sl-V2X-ConfigCommon*:
  - 3> if configured by upper layers to receive V2X sidelink communication:
    - 4> include *v2x-CommRxInterestedFreqList* and set it to the frequency(ies) for V2X sidelink communication reception;
  - 3> if configured by upper layers to transmit V2X sidelink communication:

- 4> if configured by upper layers to transmit P2X related V2X sidelink communication:
  - 5> include *p2x-CommTxType* set to *true*;
- 4> include *v2x-CommTxResourceReq* and set its fields as follows for each frequency on which the UE is configured for V2X sidelink communication transmission:
  - 5> set *carrierFreqCommTx* to indicate the frequency for V2X sidelink communication transmission;
  - 5> set *v2x-TypeTxSync* to the current synchronization reference type used on the associated *carrierFreqCommTx* for V2X sidelink communication transmission;
  - 5> set *v2x-DestinationInfoList* to include the V2X sidelink communication transmission destination(s) for which it requests E-UTRAN to assign dedicated resources;
- 1> else if the UE initiates the procedure to request sidelink discovery transmission and/ or reception gaps:
  - 2> if the UE is configured with *gapRequestsAllowedDedicated* set to *true*; or
  - 2> if the UE is not configured with *gapRequestsAllowedDedicated* and *gapRequestsAllowedCommon* is included in *SystemInformationBlockType19*:
  - 3> if the UE requires sidelink discovery gaps to monitor the sidelink discovery announcements the UE is configured to monitor by upper layers:
    - 4> include *discRxGapReq* and set it to indicate, for each frequency that either concerns the primary frequency or is included in *discInterFreqList* on which the UE is configured to monitor sidelink discovery announcements and for which it requires sidelink discovery gaps to do so, the gap pattern(s) as well as the concerned frequency, if different from the primary;
  - 3> if the UE requires sidelink discovery gaps to transmit the sidelink discovery announcements the UE is configured to transmit by upper layers:
    - 4> include *discTxGapReq* and set it to indicate, for each frequency that either concerns the primary or is included in *discInterFreqList* on which the UE is configured to transmit sidelink discovery announcements and for which it requires sidelink discovery gaps to do so, the gap pattern(s) as well as the concerned frequency, if different from the primary;
- 1> else if the UE initiates the procedure to report the system information parameters related to sidelink discovery of carriers other than the primary:
  - 2> include *discSysInfoReportFreqList* and set it to report the system information parameter acquired from the cells on those carriers;

The UE shall:

- 1> if the UE initiates the sidelink UE information procedure while connected to an NR PCell:
  - 2> submit the *SidelinkUEInformation* message via SRB1 embedded in NR RRC message *ULInformationTransferIRAT* as specified in TS 38.331 [82];
- 1> else:
  - 2> submit the *SidelinkUEInformation* message to lower layers for transmission.

### 5.10.3 Sidelink communication monitoring

A UE capable of sidelink communication that is configured by upper layers to receive sidelink communication shall:

- 1> if the conditions for sidelink communication operation as defined in 5.10.1a are met:
  - 2> if in coverage on the frequency used for sidelink communication, as defined in TS 36.304 [4], clause 11.4:
    - 3> if the cell chosen for sidelink communication reception broadcasts *SystemInformationBlockType18* including *commRxPool*:

4> configure lower layers to monitor sidelink control information and the corresponding data using the pool of resources indicated by *commRxPool*;

NOTE 1: If *commRxPool* includes one or more entries including *rxParametersNCell*, the UE may only monitor such entries if the associated PSS/SSS or SLSSIDs is detected. When monitoring such pool(s), the UE applies the timing of the concerned PSS/SSS or SLSS.

2> else (i.e. out of coverage on the sidelink carrier):

3> configure lower layers to monitor sidelink control information and the corresponding data using the pool of resources that were preconfigured (i.e. *preconfigComm* in *SL-Preconfiguration* defined in 9.3);

NOTE 2: The UE may monitor in accordance with the timing of the selected SyncRef UE, or if the UE does not have a selected SyncRef UE, based on the UE's own timing.

## 5.10.4 Sidelink communication transmission

A UE capable of sidelink communication that is configured by upper layers to transmit non-relay related sidelink communication and has related data to be transmitted or a UE capable of relay related sidelink communication that is configured by upper layers to transmit relay related sidelink communications and satisfies the conditions for relay related sidelink communication specified in this clause shall:

- 1> if the conditions for sidelink communication operation as defined in 5.10.1a are met:
  - 2> if in coverage on the frequency used for sidelink communication, as defined in TS 36.304 [4], clause 11.4:
    - 3> if the UE is in RRC\_CONNECTED and uses the PCell for sidelink communication:
      - 4> if the UE is configured, by the current PCell/ the PCell in which physical layer problems or radio link failure was detected, with *commTxResources* set to *scheduled*:
        - 5> if T310 or T311 is running; and if the PCell at which the UE detected physical layer problems or radio link failure broadcasts *SystemInformationBlockType18* including *commTxPoolExceptional*; or
        - 5> if T301 is running and the cell on which the UE initiated connection re-establishment broadcasts *SystemInformationBlockType18* including *commTxPoolExceptional*:
          - 6> configure lower layers to transmit the sidelink control information and the corresponding data using the pool of resources indicated by the first entry in *commTxPoolExceptional*;
        - 5> else:
          - 6> configure lower layers to request E-UTRAN to assign transmission resources for sidelink communication;
      - 4> else if the UE is configured with *commTxPoolNormalDedicated* or *commTxPoolNormalDedicatedExt*:
        - 5> if *priorityList* is included for the entries of *commTxPoolNormalDedicated* or *commTxPoolNormalDedicatedExt*:
          - 6> configure lower layers to transmit the sidelink control information and the corresponding data using the one or more pools of resources indicated by *commTxPoolNormalDedicated* or *commTxPoolNormalDedicatedExt* i.e. indicate all entries of this field to lower layers;
        - 5> else:
          - 6> configure lower layers to transmit the sidelink control information and the corresponding data using the pool of resources indicated by the first entry in *commTxPoolNormalDedicated*;
    - 3> else (i.e. sidelink communication in RRC\_IDLE or on cell other than PCell in RRC\_CONNECTED):
      - 4> if the cell chosen for sidelink communication transmission broadcasts *SystemInformationBlockType18*:
        - 5> if *SystemInformationBlockType18* includes *commTxPoolNormalCommon*:
          - 6> if *priorityList* is included for the entries of *commTxPoolNormalCommon* or *commTxPoolNormalCommonExt*:
            - 7> configure lower layers to transmit the sidelink control information and the corresponding data using the one or more pools of resources indicated by *commTxPoolNormalCommon* and/or *commTxPoolNormalCommonExt* i.e. indicate all entries of these fields to lower layers;
          - 6> else:
            - 7> configure lower layers to transmit the sidelink control information and the corresponding data using the pool of resources indicated by the first entry in *commTxPoolNormalCommon*;

- 5> else if *SystemInformationBlockType18* includes *commTxPoolExceptional*:
  - 6> from the moment the UE initiates connection establishment until receiving an *RRCCONNECTIONRECONFIGURATION* including *sl-CommConfig* or until receiving an *RRCCONNECTIONRELEASE* or an *RRCCONNECTIONREJECT*;
  - 7> configure lower layers to transmit the sidelink control information and the corresponding data using the pool of resources indicated by the first entry in *commTxPoolExceptional*;
- 2> else (i.e. out of coverage on sidelink carrier):
  - 3> if *priorityList* is included for the entries of *preconfigComm* in *SL-Preconfiguration* defined in 9.3:
    - 4> configure lower layers to transmit the sidelink control information and the corresponding data using the one or more pools of resources indicated *preconfigComm* i.e. indicate all entries of this field to lower layers and in accordance with the timing of the selected SyncRef UE, or if the UE does not have a selected SyncRef UE, based on the UEs own timing;
  - 3> else:
    - 4> configure lower layers to transmit the sidelink control information and the corresponding data using the pool of resources that were preconfigured i.e. indicated by the first entry in *preconfigComm* in *SL-Preconfiguration* defined in 9.3 and in accordance with the timing of the selected SyncRef UE, or if the UE does not have a selected SyncRef UE, based on the UEs own timing;

The conditions for relay related sidelink communication are as follows:

- 1> if the transmission concerns sidelink relay communication; and the UE is capable of sidelink relay or sidelink remote operation:
- 2> if the UE is in RRC\_IDLE; and if the UE has a selected sidelink relay UE: configure lower layers to transmit the sidelink control information and the corresponding data using the resources, as specified previously in this clause, only if the following condition is met:
  - 3> if the sidelink remote UE threshold conditions as specified in 5.10.11.5 are met; and if the UE configured lower layers with a pool of resources included in *SystemInformationBlockType18* (i.e. *commTxPoolNormalCommon*, *commTxPoolNormalCommonExt* or *commTxPoolExceptional*); and *commTxAllowRelayCommon* is included in *SystemInformationBlockType18*;
- 2> if the UE is in RRC\_CONNECTED: configure lower layers to transmit the sidelink control information and the corresponding data using the resources, as specified previously in this clause, only if the following condition is met:
  - 3> if the UE configured lower layers with resources provided by dedicated signalling (i.e. *commTxResources*); and the UE is configured with *commTxAllowRelayDedicated* set to *true*;

## 5.10.5 Sidelink discovery monitoring

A UE capable of non-PS related sidelink discovery that is configured by upper layers to monitor non-PS related sidelink discovery announcements shall:

- 1> for each frequency the UE is configured to monitor non-PS related sidelink discovery announcements on, prioritising the frequencies included in *discInterFreqList*, if included in *SystemInformationBlockType19*:
- 2> if the PCell or the cell the UE is camping on indicates the pool of resources to monitor sidelink discovery announcements on by *discRxResourcesInterFreq* in *discResourcesNonPS* within *discInterFreqList* in *SystemInformationBlockType19*:
  - 3> configure lower layers to monitor sidelink discovery announcements using the pool of resources indicated by *discRxResourcesInterFreq* in *discResourcesNonPS* within *SystemInformationBlockType19*;
- 2> else if the cell used for sidelink discovery monitoring broadcasts *SystemInformationBlockType19*:

- 3> configure lower layers to monitor sidelink discovery announcements using the pool of resources indicated by *discRxPool* in *SystemInformationBlockType19*;
- 2> if the UE is configured with *discRxGapConfig* and requires sidelink discovery gaps to monitor sidelink discovery announcements on the concerned frequency;
  - 3> configure lower layers to monitor the concerned frequency using the sidelink discovery gaps indicated by *discRxGapConfig*;
- 2> else:
  - 3> configure lower layers to monitor the concerned frequency without affecting normal operation;

A UE capable of PS related sidelink discovery that is configured by upper layers to monitor PS related sidelink discovery announcements shall:

- 1> if out of coverage on the frequency, as defined in TS 36.304 [4], clause 11.4:
  - 2> configure lower layers to monitor sidelink discovery announcements using the pool of resources that were preconfigured (i.e. indicated by *discRxPoolList* within *preconfigDisc* in *SL-Preconfiguration* defined in 9.3);
- 1> else if configured by upper layers to monitor non-relay PS related discovery announcements; and if the PCell or the cell the UE is camping on indicates a pool of resources to monitor sidelink discovery announcements on by *discRxResourcesInterFreq* in *discResourcesPS* within *discInterFreqList* in *SystemInformationBlockType19*:
  - 2> configure lower layers to monitor sidelink discovery announcements using the pool of resources indicated by *discRxResourcesInterFreq* in *discResourcesPS* in *SystemInformationBlockType19*;
- 1> else if configured by upper layers to monitor PS related sidelink discovery announcements; and if the cell used for sidelink discovery monitoring broadcasts *SystemInformationBlockType19*:
  - 2> configure lower layers to monitor sidelink discovery announcements using the pool of resources indicated by *discRxPoolPS* in *SystemInformationBlockType19*;
- 1> if the UE is configured with *discRxGapConfig* and requires sidelink discovery gaps to monitor sidelink discovery announcements on the concerned frequency;
  - 2> configure lower layers to monitor the concerned frequency using the sidelink discovery gaps indicated by *discRxGapConfig*;
- 1> else:
  - 2> configure lower layers to monitor the concerned frequency without affecting normal operation;

NOTE 1: The requirement not to affect normal UE operation also applies for the acquisition of sidelink discovery related system and synchronisation information from inter-frequency cells.

NOTE 2: The UE is not required to monitor all pools simultaneously.

NOTE 3: It is up to UE implementation to decide whether a cell is sufficiently good to be used to monitor sidelink discovery announcements.

NOTE 4: If *discRxPool*, *discRxPoolPS* or *discRxResourcesInterFreq* includes one or more entries including *rxParameters*, the UE may only monitor such entries if the associated SLSSIDs are detected. When monitoring such pool(s) the UE applies the timing of the corresponding SLSS.

## 5.10.6 Sidelink discovery announcement

A UE capable of non-PS related sidelink discovery that is configured by upper layers to transmit non-PS related sidelink discovery announcements shall, for each frequency the UE is configured to transmit such announcements on:

NOTE: In case the configured resources are insufficient it is up to UE implementation to decide which sidelink discovery announcements to transmit.

- 1> if the frequency used to transmit sidelink discovery announcements concerns the serving frequency (RRC\_IDLE) or primary frequency (RRC\_CONNECTED):

- 2> if the UE's serving cell (RRC\_IDLE) or PCell (RRC\_CONNECTED) is suitable as defined in TS 36.304 [4]:
  - 3> if the UE is in RRC\_CONNECTED (i.e. PCell is used for sidelink discovery announcement):
    - 4> if the UE is configured with *discTxResources* set to *scheduled*:
      - 5> configure lower layers to transmit the sidelink discovery announcement using the assigned resources indicated by *scheduled* in *discTxResources*;
    - 4> else if the UE is configured with *discTxPoolDedicated* (i.e. *discTxResources* set to *ue-Selected*):
      - 5> select an entry of the list of resource pool entries in *discTxPoolDedicated* and configure lower layers to use it to transmit the sidelink discovery announcements as specified in 5.10.6a;
  - 3> else if T300 is not running (i.e. UE in RRC\_IDLE, announcing via serving cell):
    - 4> if *SystemInformationBlockType19* of the serving cell includes *discTxPoolCommon*:
      - 5> select an entry of the list of resource pool entries in *discTxPoolCommon* and configure lower layers to use it to transmit the sidelink discovery announcements as specified in 5.10.6a;
- 1> else if, for the frequency used to transmit sidelink discovery announcements on, the UE is configured with dedicated resources (i.e. with *discTxResources-r12*, if *discTxCarrierFreq* is included in *discTxInterFreqInfo*, or with *discTxResources* within *discTxInfoInterFreqListAdd* in *discTxInterFreqInfo*); and the conditions for non-PS related sidelink discovery operation as defined in 5.10.1c are met:
  - 2> if the UE is configured with *discTxResources* set to *scheduled*:
    - 3> configure lower layers to transmit the sidelink discovery announcement using the assigned resources indicated by *scheduled* in *discTxResources*;
  - 2> else if the UE is configured with *discTxResources* set to *ue-Selected*:
    - 3> select an entry of the list of resource pool entries in *ue-Selected* and configure lower layers to use it to transmit the sidelink discovery announcements as specified in 5.10.6a;
- 1> else if the frequency used to transmit sidelink discovery announcements on is included in *discInterFreqList* within *SystemInformationBlockType19* of the serving cell/ PCell, and *discTxResourcesInterFreq* within *discResourcesNonPS* in the corresponding entry of *discInterFreqList* is set to *discTxPoolCommon* (i.e. serving cell/ PCell broadcasts pool of resources) and the conditions for non-PS related sidelink discovery operation as defined in 5.10.1c are met; or
  - 1> else if *discTxPoolCommon* is included in *SystemInformationBlockType19* acquired from cell selected on the sidelink discovery announcement frequency; and the conditions for non-PS related sidelink discovery operation as defined in 5.10.1c are met:
    - 2> select an entry of the list of resource pool entries in *discTxPoolCommon* and configure lower layers to use it to transmit the sidelink discovery announcements as specified in 5.10.6a;
- 1> if the UE is configured with *discTxGapConfig* and requires sidelink discovery gaps to transmit sidelink discovery announcements on the concerned frequency;
  - 2> configure lower layers to transmit on the concerned frequency using the sidelink discovery gaps indicated by *discTxGapConfig*,
- 1> else:
  - 2> configure lower layers to transmit on the concerned frequency without affecting normal operation;

A UE capable of PS related sidelink discovery that is configured by upper layers to transmit PS related sidelink discovery announcements shall:

- 1> if out of coverage on the frequency used to transmit PS related sidelink discovery announcements as defined in TS 36.304 [4], clause 11.4, and the conditions for PS-related sidelink discovery operation as defined in 5.10.1b are met:
  - 2> if configured by upper layers to transmit non-relay PS related sidelink discovery announcements; or



- 2> if the UE is selecting a sidelink relay UE/ has a selected sidelink relay UE:
  - 3> configure lower layers to transmit sidelink discovery announcements using the pool of resources that were preconfigured and in accordance with the following:
    - 4> randomly select, using a uniform distribution, an entry of *preconfigDisc* in *SL-Preconfiguration* defined in 9.3;
    - 4> using the timing of the selected SyncRef UE, or if the UE does not have a selected SyncRef UE, based on the UEs own timing;
- 1> else if the frequency used to transmit sidelink discovery announcements concerns the serving frequency (RRC\_IDLE) or primary frequency (RRC\_CONNECTED) and the conditions for PS related sidelink discovery operation as defined in 5.10.1b are met:
  - 2> if configured by upper layers to transmit non-relay PS related sidelink discovery announcements; or
  - 2> if the UE is acting as sidelink relay UE; and if the UE is in RRC\_IDLE; and if the sidelink relay UE threshold conditions as specified in 5.10.10.4 are met; or
  - 2> if the UE is acting as sidelink relay UE; and if the UE is in RRC\_CONNECTED; or
  - 2> if the UE is selecting a sidelink relay UE / has a selected sidelink relay UE; and if the sidelink remote UE threshold conditions as specified in 5.10.11.5 are met:
    - 3> if the UE is configured with *discTxPoolPS-Dedicated*; or
    - 3> if the UE is in RRC\_IDLE; and if *discTxPoolPS-Common* is included in *SystemInformationBlockType19*:
      - 4> select an entry of the list of resource pool entries and configure lower layers to use it to transmit the sidelink discovery announcements as specified in 5.10.6a;
    - 3> else if the UE is configured with *discTxResourcesPS* set to *scheduled*:
      - 4> configure lower layers to transmit the sidelink discovery announcement using the assigned resources indicated by *scheduled* in *discTxResourcesPS*;
- 1> else if, for the frequency used to transmit sidelink discovery announcements on, the UE is configured with dedicated resources (i.e. with *discTxResourcesPS* in *discTxInterFreqInfo* within *sl-DiscConfig*); and the conditions for PS related sidelink discovery operation as defined in 5.10.1b are met:
  - 2> if configured by upper layers to transmit non-relay PS related sidelink discovery announcements:
    - 3> if the UE is configured with *discTxResourcesPS* set to *scheduled*:
      - 4> configure lower layers to transmit the sidelink discovery announcement using the assigned resources indicated by *scheduled* in *discTxResourcesPS*;
    - 3> else if the UE is configured with *discTxResourcesPS* set to *ue-Selected*:
      - 4> select an entry of the list of resource pool entries in *ue-Selected* and configure lower layers to use it to transmit the sidelink discovery announcements as specified in 5.10.6a;
  - 1> else if the frequency used to transmit sidelink discovery announcements on is included in *discInterFreqList* within *SystemInformationBlockType19* of the serving cell/ PCell, while *discTxResourcesInterFreq* within *discResourcesPS* in the corresponding entry of *discInterFreqList* is set to *discTxPoolCommon* (i.e. serving cell/ PCell broadcasts pool of resources) and the conditions for PS related sidelink discovery operation as defined in 5.10.1b are met:
    - 2> if configured by upper layers to transmit non-relay PS related sidelink discovery announcements:
      - 3> select an entry of the list of resource pool entries in *discTxPoolCommon* and configure lower layers to use it to transmit the sidelink discovery announcements as specified in 5.10.6a;
  - 1> else if *discTxPoolPS-Common* is included in *SystemInformationBlockType19* acquired from cell selected on the sidelink discovery announcement frequency; and the conditions for PS related sidelink discovery operation as defined in 5.10.1b are met:

- 2> if configured by upper layers to transmit non-relay PS related sidelink discovery announcements:
  - 3> select an entry of the list of resource pool entries in *discTxPoolPS-Common* and configure lower layers to use it to transmit the sidelink discovery announcements as specified in 5.10.6a;
- 1> if the UE is configured with *discTxGapConfig* and requires gaps to transmit sidelink discovery announcements on the concerned frequency;
  - 2> configure lower layers to transmit on the concerned frequency using the gaps indicated by *discTxGapConfig*,
- 1> else:
  - 2> configure lower layers to transmit on the concerned frequency without affecting normal operation;

### 5.10.6a Sidelink discovery announcement pool selection

A UE that is configured with a list of resource pool entries for sidelink discovery announcement transmission (i.e. by *SL-DiscTxPoolList*) shall:

- 1> if *poolSelection* is set to *rsrpBased*:
  - 2> select a pool from the list of pools the UE is configured with for which the RSRP measurement of the reference cell selected as defined in 5.10.6b, after applying the layer 3 filter defined by *quantityConfig* as specified in 5.5.3.2, is in-between *threshLow* and *threshHigh*;
- 1> else:
  - 2> randomly select, using a uniform distribution, a pool from the list of pools the UE is configured with;
- 1> configure lower layers to transmit the sidelink discovery announcement using the selected pool of resources;

NOTE 1: When performing resource pool selection based on RSRP, the UE uses the latest results of the available measurements used for cell reselection evaluation in RRC\_IDLE/ for measurement report triggering evaluation in RRC\_CONNECTED, which are performed in accordance with the performance requirements specified in TS 36.133 [16].

### 5.10.6b Sidelink discovery announcement reference carrier selection

A UE capable of sidelink discovery that is configured by upper layers to transmit sidelink discovery announcements shall:

- 1> for each frequency the UE is transmitting sidelink discovery announcements on, select a cell to be used as reference for synchronisation and DL measurements in accordance with the following:
  - 2> if the frequency concerns the primary frequency:
    - 3> use the PCell as reference;
  - 2> else if the frequency concerns a secondary frequency:
    - 3> use the concerned SCell as reference;
  - 2> else if the UE is configured with *discTxRefCarrierDedicated* for the frequency:
    - 3> use the cell indicated by this field as reference;
  - 2> else if the UE is configured with *refCarrierCommon* for the frequency:
    - 3> use the serving cell (RRC\_IDLE)/ PCell (RRC\_CONNECTED) as reference;
  - 2> else:
    - 3> use the DL frequency paired with the one used to transmit sidelink discovery announcements on as reference;

### 5.10.7 Sidelink synchronisation information transmission

#### 5.10.7.1 General

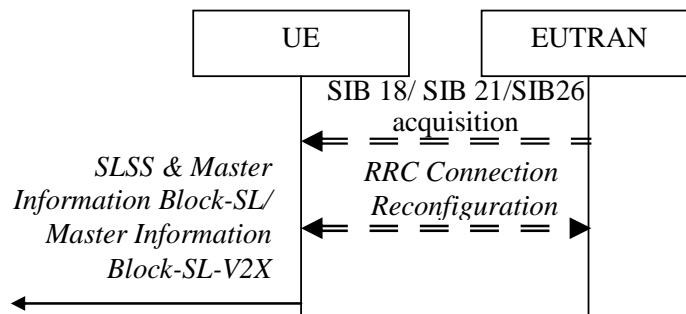

**Figure 5.10.7.1-1: Synchronisation information transmission for sidelink communication or V2X sidelink communication, in (partial) coverage**

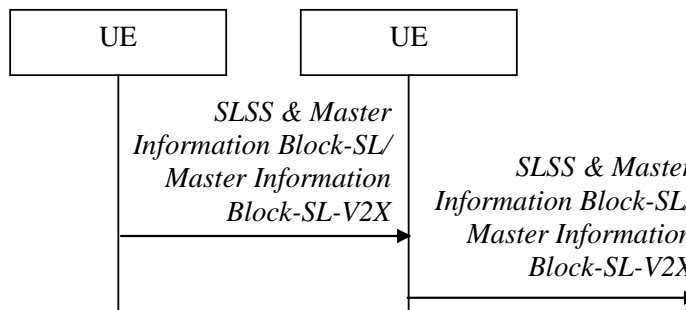

**Figure 5.10.7.1-2: Synchronisation information transmission for sidelink communication or V2X sidelink communication / sidelink discovery, out of coverage**

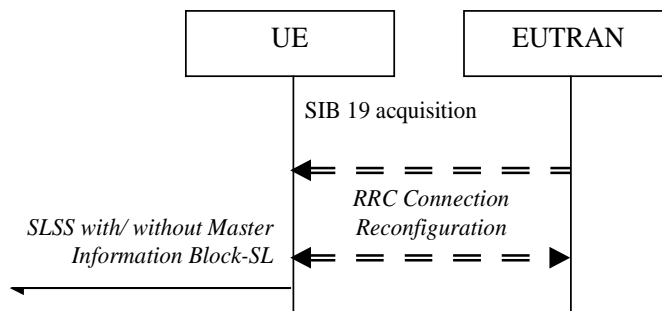

**Figure 5.10.7.1-3: Synchronisation information transmission for sidelink discovery, in (partial) coverage**

The purpose of this procedure is to provide synchronisation information to a UE. For sidelink discovery, the synchronisation information concerns a Sidelink Synchronisation Signal (SLSS) and, in case of PS related discovery, also timing information and some additional configuration parameters (i.e. the *MasterInformationBlock-SL* message), while for sidelink communication or V2X sidelink communication it concerns an SLSS and the *MasterInformationBlock-SL* or *MasterInformationBlock-SL-V2X* message. A UE transmits synchronisation information either when E-UTRAN configures it to do so by dedicated signalling (i.e. network based), or when not configured by dedicated signalling (i.e. UE based) and E-UTRAN broadcasts (in coverage) or pre-configures a threshold (out of coverage).

The synchronisation information transmitted by the UE may be derived from information/ signals received from E-UTRAN (in coverage) or received from a UE acting as synchronisation reference for the transmitting UE or received from GNSS. In the remainder, the UE acting as synchronisation reference is referred to as SyncRef UE.

### 5.10.7.2 Initiation

A UE capable of SLSS transmission shall, when transmitting sidelink discovery announcements in accordance with 5.10.6 and when the following conditions are met:

- 1> if in coverage on the frequency used for sidelink discovery, as defined in TS 36.304 [4], clause 11.4:
  - 2> if in RRC\_CONNECTED; and if *networkControlledSyncTx* is configured and set to *on*; or
  - 2> if *networkControlledSyncTx* is not configured; and *syncTxThreshIC* is included in *SystemInformationBlockType19*; and the RSRP measurement of the reference cell, selected as defined in 5.10.6b, is below the value of *syncTxThreshIC*;
  - 3> if the sidelink discovery announcements are not PS related; or if *syncTxPeriodic* is not included:
    - 4> transmit SLSS on the frequency used for sidelink discovery in accordance with 5.10.7.3 and TS 36.211 [21];
  - 3> else:
    - 4> transmit SLSS on the frequency used for sidelink discovery in accordance with 5.10.7.3 and TS 36.211 [21];
    - 4> transmit the *MasterInformationBlock-SL* message on the frequency used for sidelink discovery, in the same subframe as SLSS, and in accordance with 5.10.7.4;
- 1> else (i.e. out of coverage, PS):
  - 2> if *syncTxThreshOoC* is included in the preconfigured sidelink parameters (i.e. *SL-Preconfiguration* defined in 9.3); and the UE has not selected SyncRef UE or the S-RSRP measurement result of the selected SyncRef UE is below the value of *syncTxThreshOoC*;
  - 3> transmit SLSS on the frequency used for sidelink discovery in accordance with 5.10.7.3 and TS 36.211 [21];
  - 3> transmit the *MasterInformationBlock-SL* message on the frequency used for sidelink discovery, in the same subframe as SLSS, and in accordance with 5.10.7.4;

A UE capable of sidelink communication that is configured by upper layers to transmit sidelink communication shall, irrespective of whether or not it has data to transmit:

- 1> if the conditions for sidelink communication operation as defined in 5.10.1a are met:
  - 2> if in RRC\_CONNECTED; and if *networkControlledSyncTx* is configured and set to *on*:
    - 3> transmit SLSS in accordance with 5.10.7.3 and TS 36.211 [21];
    - 3> transmit the *MasterInformationBlock-SL* message, in the same subframe as SLSS, and in accordance with 5.10.7.4;

A UE shall, when transmitting sidelink communication in accordance with 5.10.4 and when the following conditions are met:

- 1> if in coverage on the frequency used for sidelink communication, as defined in TS 36.304 [4], clause 11.4:
  - 2> if the UE is in RRC\_CONNECTED; and *networkControlledSyncTx* is not configured; and *syncTxThreshIC* is included in *SystemInformationBlockType18*; and the RSRP measurement of the cell chosen for sidelink communication transmission is below the value of *syncTxThreshIC*; or
  - 2> if the UE is in RRC\_IDLE; and *syncTxThreshIC* is included in *SystemInformationBlockType18*; and the RSRP measurement of the cell chosen for sidelink communication transmission is below the value of *syncTxThreshIC*;
  - 3> transmit SLSS in accordance with 5.10.7.3 and TS 36.211 [21];
  - 3> transmit the *MasterInformationBlock-SL* message, in the same subframe as SLSS, and in accordance with 5.10.7.4;

1> else (i.e. out of coverage):

- 2> if *syncTxThreshOoC* is included in the preconfigured sidelink parameters (i.e. *SL-Preconfiguration* defined in 9.3); and the UE has no selected SyncRef UE or the S-RSRP measurement result of the selected SyncRef UE is below the value of *syncTxThreshOoC*:
  - 3> transmit SLSS in accordance with 5.10.7.3 and TS 36.211 [21];
  - 3> transmit the *MasterInformationBlock-SL* message, in the same subframe as SLSS, and in accordance with 5.10.7.4;

A UE capable of V2X sidelink communication and SLSS/PSBCH transmission shall, when transmitting non-P2X related V2X sidelink communication in accordance with 5.10.13, and if the conditions for V2X sidelink communication operation as defined in 5.10.1d are met and when the following conditions are met:

- 1> if in coverage on the frequency used for V2X sidelink communication, as defined in TS 36.304 [4], clause 11.4; and has selected GNSS or the cell as synchronization reference as defined in 5.10.13.3; or
- 1> if out of coverage on the frequency used for V2X sidelink communication, as defined in TS 36.304 [4], clause 11.4, and the frequency used to transmit V2X sidelink communication is included in *v2x-InterFreqInfoList* in *RRCConnectionReconfiguration* or in *v2x-InterFreqInfoList* within *SystemInformationBlockType21* or *SystemInformationBlockType26* of the serving cell/ PCell; and has selected GNSS or the cell as synchronization reference as defined in 5.10.13.3:
  - 2> if *syncFreqList* is not included in *RRCConnectionReconfiguration* nor in *SystemInformationBlockType26*; or
  - 2> if *syncFreqList* is included in *RRCConnectionReconfiguration* or in *SystemInformationBlockType26*; and if none of the frequency(ies) selected as specified in TS 36.321 [6] is included in the *syncFreqList* or the concerned frequency is selected as the synchronisation carrier frequency in accordance with 5.10.8a; or
  - 2> if *syncFreqList* and *slss-TxMultiFreq* are included in *RRCConnectionReconfiguration* or in *SystemInformationBlockType26*; and if the UE has selected a frequency other than the concerned frequency as the synchronisation carrier frequency; and if *slss-TxDisabled* corresponding to the concerned frequency is not configured in *RRCConnectionReconfiguration*; and if the concerned frequency has been selected for V2X sidelink communication transmission as specified in TS 36.321 [6] and is included in *syncFreqList*; and if UE is capable of SLSS/PSBCH transmission on the concerned frequency:
    - 3> if in RRC\_CONNECTED; and if *networkControlledSyncTx* is configured and set to *on*; or
    - 3> if *networkControlledSyncTx* is not configured; and for the concerned frequency *syncTxThreshIC* is configured; and the RSRP measurement of the reference cell, selected as defined in 5.10.13.3, for V2X sidelink communication transmission is below the value of *syncTxThreshIC*:
      - 4> transmit SLSS on the frequency used for V2X sidelink communication in accordance with 5.10.7.3 and TS 36.211 [21];
      - 4> transmit the *MasterInformationBlock-SL-V2X* message on the frequency used for V2X sidelink communication, in the same subframe as SLSS, and in accordance with 5.10.7.4;

1> else:

- 2> for the frequency used for V2X sidelink communication, if *syncOffsetIndicators* is included in *SL-V2X-Preconfiguration*:
  - 3> If *syncFreqList* is not included in *SL-V2X-Preconfiguration*; or
  - 3> if *syncFreqList* is included in *SL-V2X-Preconfiguration*, and if none of the frequency(ies) selected as specified in TS 36.321 [6] is included in the *syncFreqList* or the concerned frequency is selected as the synchronisation carrier frequency in accordance with 5.10.8a; or
  - 3> if *syncFreqList* and *slss-TxMultiFreq* are included in *SL-V2X-Preconfiguration*, and if the UE has selected a frequency other than the concerned frequency as the synchronisation carrier frequency; and if *slss-TxDisabled* corresponding to the concerned frequency is not configured in *SL-V2X-Preconfiguration*; and if the concerned frequency has been selected for V2X sidelink communication transmission as specified in TS 36.321 [6] and included in *syncFreqList*; and if the UE is capable of SLSS/PSBCH transmission on the frequency:

- 4> if *syncTxThreshOoC* is included in *SL-V2X-Preconfiguration*; and the UE is not directly synchronized to GNSS, and the UE has no selected SyncRef UE or the S-RSRP measurement result of the selected SyncRef UE is below the value of *syncTxThreshOoC*; or
- 4> if the UE selects GNSS as the synchronization reference source:
  - 5> transmit SLSS in accordance with 5.10.7.3 and TS 36.211 [21];
  - 5> transmit the *MasterInformationBlock-SL-V2X* message, in the same subframe as SLSS, and in accordance with 5.10.7.4;

NOTE 1: In the case of limited transmission capabilities on multiple carrier frequencies, when the UE is configured with *syncFreqList*, whether to transmit SLSS/PSBCH on a frequency, which is selected for V2X sidelink communication transmission as specified in TS 36.321 [6] and is other than the synchronisation carrier frequency, is up to UE implementation.

### 5.10.7.3 Transmission of SLSS

The UE shall select the SLSSID and the subframe in which to transmit SLSS as follows:

- 1> if triggered by sidelink discovery announcement and in coverage on the frequency used for sidelink discovery, as defined in TS 36.304 [4], clause 11.4:
  - 2> select the SLSSID included in the entry of *discSyncConfig* included in the received *SystemInformationBlockType19*, that includes *txParameters*;
  - 2> use *syncOffsetIndicator* corresponding to the selected SLSSID;
  - 2> for each pool used for the transmission of discovery announcements (each corresponding to the selected SLSSID):
    - 3> if a subframe indicated by *syncOffsetIndicator* corresponds to the first subframe of the discovery transmission pool;
      - 4> if *discTxGapConfig* is configured and includes the concerned subframe; or the subframe is not used for regular uplink transmission:
        - 5> select the concerned subframe;
      - 3> else:
        - 4> if *discTxGapConfig* is configured and includes the concerned subframe; or the subframe is not used for regular uplink transmission:
          - 5> select the subframe indicated by *syncOffsetIndicator* that precedes and which, in time domain, is nearest to the first subframe of the discovery transmission pool;
      - 3> if the sidelink discovery announcements concern PS; and if *syncTxPeriodic* is included:
        - 4> additionally select each subframe that periodically occurs 40 subframes after the selected subframe;
  - 1> if triggered by sidelink communication and in coverage on the frequency used for sidelink communication, as defined in TS 36.304 [4], clause 11.4:
    - 2> select the SLSSID included in the entry of *commSyncConfig* that is included in the received *SystemInformationBlockType18* and includes *txParameters*;
    - 2> use *syncOffsetIndicator* corresponding to the selected SLSSID;
    - 2> if in RRC\_CONNECTED; and if *networkControlledSyncTx* is configured and set to *on*:
      - 3> select the subframe(s) indicated by *syncOffsetIndicator*;
    - 2> else (when transmitting communication):

- 3> select the subframe(s) indicated by *syncOffsetIndicator* within the SC period in which the UE intends to transmit sidelink control information or data;
- 1> if triggered by V2X sidelink communication and in coverage on the frequency used for V2X sidelink communication, as defined in TS 36.304 [4], clause 11.4; or
  - 1> if triggered by V2X sidelink communication, and out of coverage on the frequency used for V2X sidelink communication, and the concerned frequency is included in *v2x-InterFreqInfoList* in *RRCCONNECTIONRECONFIGURATION* or in *v2x-InterFreqInfoList* within *SystemInformationBlockType21* of the serving cell/ PCell;
    - 2> if the UE has selected GNSS as synchronization reference in accordance with 5.10.8.2:
      - 3> select SLSSID 0;
      - 3> use *syncOffsetIndicator* included in the entry of *v2x-SyncConfig* corresponding to the concerned frequency in *v2x-InterFreqInfoList* or within *SystemInformationBlockType21*, that includes *txParameters* and *gnss-Sync*;
      - 3> select the subframe(s) indicated by *syncOffsetIndicator*;
    - 2> if the UE has selected a cell as synchronization reference in accordance with 5.10.8.2:
      - 3> select the SLSSID included in the entry of *v2x-SyncConfig* configured for the concerned frequency in *v2x-InterFreqInfoList* or within *SystemInformationBlockType21*, that includes *txParameters* and does not include *gnss-Sync*;
      - 3> use *syncOffsetIndicator* corresponding to the selected SLSSID;
      - 3> select the subframe(s) indicated by *syncOffsetIndicator*;
  - 1> else if triggered by V2X sidelink communication and the UE has GNSS as the synchronization reference:
    - 2> select SLSSID 0;
    - 2> if *syncOffsetIndicator3* is configured for the frequency used for V2X sidelink communication in *SL-V2X-Preconfiguration*:
      - 3> select the subframe(s) indicated by *syncOffsetIndicator3*;
    - 2> else:
      - 3> select the subframe(s) indicated by *syncOffsetIndicator1*;
  - 1> else:
    - 2> select the synchronisation reference UE (i.e. SyncRef UE) as defined in 5.10.8;
    - 2> if the UE has a selected SyncRef UE and *inCoverage* in the *MasterInformationBlock-SL* or *MasterInformationBlock-SL-V2X* message received from this UE is set to *TRUE*; or
    - 2> if the UE has a selected SyncRef UE and *inCoverage* in the *MasterInformationBlock-SL* or *MasterInformationBlock-SL-V2X* message received from this UE is set to *FALSE* while the SLSS from this UE is part of the set defined for out of coverage, see TS 36.211 [21]:
      - 3> select the same SLSSID as the SLSSID of the selected SyncRef UE;
      - 3> select the subframe in which to transmit the SLSS according to the *syncOffsetIndicator1* or *syncOffsetIndicator2* included in the preconfigured sidelink parameters (i.e. *preconfigSync* in *SL-Preconfiguration* or *v2x-CommPreconfigSync* in *SL-V2X-Preconfiguration* defined in 9.3) corresponding to the concerned frequency, such that the subframe timing is different from the SLSS of the selected SyncRef UE;
    - 2> else if the UE has a selected SyncRef UE and the SLSS from this UE was transmitted on the subframe indicated by *syncOffsetIndicator3* that is included in the *syncOffsetIndicators* in *SL-V2X-Preconfiguration*, and is corresponding to the frequency used for V2X sidelink communication:

- 3> select SLSSID 169;
- 3> select the subframe(s) indicated by *syncOffsetIndicator2*;
- 2> else if the UE has a selected SyncRef UE:
  - 3> select the SLSSID from the set defined for out of coverage having an index that is 168 more than the index of the SLSSID of the selected SyncRef UE, see TS 36.211 [21];
  - 3> select the subframe in which to transmit the SLSS according to *syncOffsetIndicator1* or *syncOffsetIndicator2* included in the preconfigured sidelink parameters (i.e. *preconfigSync* in *SL-Preconfiguration* or *v2x-CommPreconfigSync* in *SL-V2X-Preconfiguration* defined in 9.3), such that the subframe timing is different from the SLSS of the selected SyncRef UE;
- 2> else (i.e. no SyncRef UE selected):
  - 3> if the UE has not randomly selected an SLSSID:
    - 4> if triggered by V2X sidelink communication, randomly select, using a uniform distribution, an SLSSID from the set of sequences defined for out of coverage except SLSSID 168 and 169, see TS 36.211 [21];
    - 4> else, randomly select, using a uniform distribution, an SLSSID from the set of sequences defined for out of coverage, see TS 36.211 [21];
    - 4> select the subframe in which to transmit the SLSS according to the *syncOffsetIndicator1* or *syncOffsetIndicator2* (arbitrary selection between these) included in the preconfigured sidelink parameters (i.e. *preconfigSync* in *SL-Preconfiguration* or *v2x-CommPreconfigSync* in *SL-V2X-Preconfiguration* defined in 9.3);

#### 5.10.7.4 Transmission of *MasterInformationBlock-SL* or *MasterInformationBlock-SL-V2X* message

The UE shall set the contents of the *MasterInformationBlock-SL* or *MasterInformationBlock-SL-V2X* message as follows:

- 1> if in coverage on the frequency used for the sidelink operation that triggered this procedure as defined in TS 36.304 [4], clause 11.4:
  - 2> set *inCoverage* to *TRUE*;
  - 2> set *sl-Bandwidth* to the value of *ul-Bandwidth* as included in the received *SystemInformationBlockType2* of the cell chosen for the concerned sidelink operation;
  - 2> if *tdd-Config* is included in the received *SystemInformationBlockType1*:
    - 3> set *subframeAssignmentSL* to the value representing the same meaning as of *subframeAssignment* that is included in *tdd-Config* in the received *SystemInformationBlockType1*;
  - 2> else:
    - 3> set *subframeAssignmentSL* to *none*;
  - 2> if triggered by sidelink communication; and if *syncInfoReserved* is included in an entry of *commSyncConfig* from the received *SystemInformationBlockType18*:
    - 3> set *reserved* to the value of *syncInfoReserved* in the received *SystemInformationBlockType18*;
  - 2> if triggered by sidelink discovery; and if *syncInfoReserved* is included in an entry of *discSyncConfig* from the received *SystemInformationBlockType19*:
    - 3> set *reserved* to the value of *syncInfoReserved* in the received *SystemInformationBlockType19*;
  - 2> if triggered by V2X sidelink communication; and if *syncInfoReserved* is included in an entry of *v2x-SyncConfig* from the received *SystemInformationBlockType21* or *SystemInformationBlockType26*:



- 3> set *reserved* to the value of *syncInfoReserved* in the received *SystemInformationBlockType21* or *SystemInformationBlockType26*;
- 2> else:
  - 3> set all bits in *reserved* to 0;
- 1> else if out of coverage on the frequency used for V2X sidelink communication as defined in TS 36.304 [4], clause 11.4; and the concerned frequency is included in *v2x-InterFreqInfoList* in *RRCConnectionReconfiguration* or in *v2x-InterFreqInfoList* within *SystemInformationBlockType21* or *SystemInformationBlockType26* of the serving cell/ PCell:
  - 2> set *inCoverage* to *TRUE*;
  - 2> set *sl-Bandwidth* to the value of the corresponding field included in *v2x-InterFreqInfoList*;
  - 2> set *subframeAssignmentSL* and *reserved* to the value of the corresponding field included in the preconfigured sidelink parameters (i.e. *v2x-CommPreconfigGeneral* in *SL-V2X-Preconfiguration* defined in 9.3);
- 1> else if out of coverage on the frequency used for V2X sidelink communication as defined in TS 36.304 [4], clause 11.4; and the UE selects GNSS timing as the synchronization reference source and *syncOffsetIndicator3* is not included in *SL-V2X-Preconfiguration*:
  - 2> set *inCoverage* to *TRUE*;
  - 2> set *sl-Bandwidth*, *subframeAssignmentSL* and *reserved* to the value of the corresponding field included in the preconfigured sidelink parameters (i.e. *v2x-CommPreconfigGeneral* in *SL-V2X-Preconfiguration* defined in 9.3);
- 1> else if the UE has a selected SyncRef UE (as defined in 5.10.8) and if the SyncRef UE is selected on the concern frequency:
  - 2> set *inCoverage* to *FALSE*;
  - 2> set *sl-Bandwidth*, *subframeAssignmentSL* and *reserved* to the value of the corresponding field included in the received *MasterInformationBlock-SL* or *MasterInformationBlock-SL-V2X*;
- 1> else:
  - 2> set *inCoverage* to *FALSE*;
  - 2> set *sl-Bandwidth*, *subframeAssignmentSL* and *reserved* to the value of the corresponding field included in the preconfigured sidelink parameters (i.e. *preconfigGeneral* in *SL-Preconfiguration* or *v2x-CommPreconfigGeneral* in *SL-V2X-Preconfiguration* defined in 9.3);
- 1> set *directFrameNumber* and *directSubframeNumber* according to the subframe used to transmit the SLSS, as specified in 5.10.7.3;
- 1> submit the *MasterInformationBlock-SL* or *MasterInformationBlock-SL-V2X* message to lower layers for transmission upon which the procedure ends;

### 5.10.7.5 Void

## 5.10.8 Sidelink synchronisation reference

### 5.10.8.1 General

The purpose of this procedure is to select a synchronisation reference and used a.o. when transmitting sidelink communication, V2X sidelink communication, sidelink discovery or synchronisation information.

### 5.10.8.2 Selection and reselection of synchronisation reference

The UE shall:

- 1> if triggered by V2X sidelink communication, and in coverage on the frequency for V2X sidelink communication; or
- 1> if triggered by V2X sidelink communication, and out of coverage on the frequency for V2X sidelink communication, and the frequency used to transmit V2X sidelink communication is included in *v2x-InterFreqInfoList* in *RRCCONNECTIONRECONFIGURATION* or in *v2x-InterFreqInfoList* within *SystemInformationBlockType21* or *SystemInformationBlockType26* of the serving cell/ PCell:
  - 2> if *syncFreqList* is not included in *RRCCONNECTIONRECONFIGURATION* nor in *SystemInformationBlockType26*; or
  - 2> if *syncFreqList* is included in *RRCCONNECTIONRECONFIGURATION* or in *SystemInformationBlockType26*, and none of the frequency(ies) selected as specified in TS 36.321 [6] is included in the *syncFreqList*; or
  - 2> if *syncFreqList* is included in *RRCCONNECTIONRECONFIGURATION* or in *SystemInformationBlockType26*, and no synchronisation carrier frequency is selected as specified in 5.10.8a:
    - 3> if *typeTxSync* is configured for the concerned frequency and set to *enb*:
      - 4> select a cell as the synchronization reference source as defined in 5.10.13.3;
    - 3> else if *typeTxSync* for the concerned frequency is not configured or is set to *gnss*, and GNSS is reliable in accordance with TS 36.101 [42] and TS 36.133 [16]:
      - 4> select GNSS as the synchronization reference source;
    - 3> else (i.e., there is no GNSS which is reliable in accordance with TS 36.101 [42] and TS 36.133 [16]):
      - 4> search SLSSID=0 on the concerned frequency to detect candidate SLSS, in accordance with TS 36.133 [16];
      - 4> when evaluating the detected SLSS, apply layer 3 filtering as specified in 5.5.3.2 using the preconfigured *filterCoefficient* as defined in 9.3, before using the S-RSRP measurement results;
      - 4> if the S-RSRP of the SyncRef UE identified by the detected SLSS exceeds the minimum requirement defined in TS 36.133 [16]:
        - 5> select the SyncRef UE;
      - 4> else (i.e., no SLSSID=0 detected):
        - 5> select a cell as the synchronization reference source as defined in 5.10.13.3;
  - 2> if *syncFreqList* is included in *RRCCONNECTIONRECONFIGURATION* or in *SystemInformationBlockType26*, and the UE has selected a synchronisation carrier frequency as specified in 5.10.8a:
    - 3> consider the synchronisation reference source (i.e. eNB, GNSS or SyncRef UE) that is selected on the synchronisation carrier frequency as the synchronization reference;
- 1> else, if triggered by V2X sidelink communication, and out of coverage on the frequency for V2X sidelink communication, and for the frequency used for V2X sidelink communication, if *syncPriority* in *SL-V2X-Preconfiguration* is set to *gnss* and GNSS is reliable in accordance with TS 36.101 [42] and TS 36.133 [16]:
  - 2> select GNSS as the synchronization reference source;
- 1> else, for the frequency used for sidelink communication, V2X sidelink communication or sidelink discovery, if out of coverage on that frequency as defined in TS 36.304 [4], clause 11.4:
  - 2> if triggered by sidelink communication or sidelink discovery; or
  - 2> if triggered by V2X sidelink communication, and *syncFreqList* is not included in *SL-V2X-Preconfiguration*; or
  - 2> if triggered by V2X sidelink communication, and *syncFreqList* is included in *SL-V2X-Preconfiguration*, and none of the frequency(ies) selected as specified in TS 36.321 [6] is included in the *syncFreqList*; or
  - 2> if triggered by V2X sidelink communication, and *syncFreqList* is included in *SL-V2X-Preconfiguration*, and no synchronisation carrier frequency is selected as specified in 5.10.8a:

- 3> perform a full search (i.e. covering all subframes and all possible SLSSIDs) to detect candidate SLSS, in accordance with TS 36.133 [16]
- 3> when evaluating the one or more detected SLSSIDs, apply layer 3 filtering as specified in 5.5.3.2 using the preconfigured *filterCoefficient* as defined in 9.3, before using the S-RSRP measurement results;
- 3> if the UE has selected a SyncRef UE:
  - 4> if the S-RSRP of the strongest candidate SyncRef UE exceeds the minimum requirement TS 36.133 [16] by *syncRefMinHyst* and the strongest candidate SyncRef UE belongs to the same priority group as the current SyncRef UE and the S-RSRP of the strongest candidate SyncRef UE exceeds the S-RSRP of the current SyncRef UE by *syncRefDiffHyst*; or
  - 4> if the S-RSRP of the candidate SyncRef UE exceeds the minimum requirement TS 36.133 [16] by *syncRefMinHyst* and the candidate SyncRef UE belongs to a higher priority group than the current SyncRef UE; or
  - 4> if GNSS becomes reliable in accordance with TS 36.101 [42] and TS 36.133 [16], and GNSS belongs to a higher priority group than the current SyncRef UE; or
  - 4> if the S-RSRP of the current SyncRef UE is less than the minimum requirement defined in TS 36.133 [16]:
    - 5> consider no SyncRef UE to be selected;
- 3> if the UE has selected GNSS as the synchronization reference for V2X sidelink communication:
  - 4> if the S-RSRP of the candidate SyncRef UE exceeds the minimum requirement defined in TS 36.133 [16] by *syncRefMinHyst* and the candidate SyncRef UE belongs to a higher priority group than GNSS; or
  - 4> if GNSS becomes not reliable in accordance with TS 36.101 [42] and TS 36.133 [16]:
    - 5> consider GNSS not to be selected;
- 3> if the UE has not selected a SyncRef UE and has not selected GNSS as synchronization reference source:
  - 4> if not concerning V2X sidelink communication, and if the UE detects one or more SLSSIDs for which the S-RSRP exceeds the minimum requirement defined in TS 36.133 [16] by *syncRefMinHyst* and for which the UE received the corresponding *MasterInformationBlock-SL* message (candidate SyncRef UEs), select a SyncRef UE according to the following priority group order:
    - 5> UEs of which *inCoverage*, included in the *MasterInformationBlock-SL* message received from this UE, is set to *TRUE*, starting with the UE with the highest S-RSRP result (priority group 1);
    - 5> UEs of which SLSSID is part of the set defined for in coverage, starting with the UE with the highest S-RSRP result (priority group 2);
    - 5> Other UEs, starting with the UE with the highest S-RSRP result (priority group 3);
  - 4> for V2X sidelink communication, if the UE detects one or more SLSSIDs for which the S-RSRP exceeds the minimum requirement defined in TS 36.133 [16] by *syncRefMinHyst* and for which the UE received the corresponding *MasterInformationBlock-SL-V2X* message (candidate SyncRef UEs), or if the UE detects GNSS that is reliable in accordance with TS 36.101 [42] and TS 36.133 [16], select a synchronization reference according to the following priority group order:
    - 5> if *syncPriority* corresponding to the concerned frequency in *SL-V2X-Preconfiguration* is set to *enb*:
      - 6> UEs of which SLSSID is part of the set defined for in coverage, and *inCoverage*, included in the *MasterInformationBlock-SL-V2X* message received from this UE, is set to *TRUE*, starting with the UE with the highest S-RSRP result (priority group 1);
      - 6> UE of which SLSSID is part of the set defined for in coverage, and *inCoverage*, included in the *MasterInformationBlock-SL-V2X* message received from this UE, is set to *FALSE*, starting with the UE with the highest S-RSRP result (priority group 2);

- 6> GNSS that is reliable in accordance with TS 36.101 [42] and TS 36.133 [16] (priority group 3);
- 6> UEs of which SLSSID is 0, and *inCoverage*, included in the *MasterInformationBlock-SL-V2X* message received from this UE, is set to *TRUE*, or of which SLSSID is 0 and SLSS is transmitted on subframes indicated by *syncOffsetIndicator3*, starting with the UE with the highest S-RSRP result (priority group 4);
- 6> UEs of which SLSSID is 0 and is not transmitted on subframes indicated by *syncOffsetIndicator3*, and *inCoverage*, included in the *MasterInformationBlock-SL-V2X* message received from this UE, is set to *FALSE*, starting with the UE with the highest S-RSRP result (priority group 5);
- 6> UEs of which SLSSID is 169, and *inCoverage*, included in the *MasterInformationBlock-SL-V2X* message received from this UE, is set to *FALSE*, starting with the UE with the highest S-RSRP result (priority group 5);
- 6> Other UEs, starting with the UE with the highest S-RSRP result (priority group 6);
- 5> if *syncPriority* corresponding to the concerned frequency in *SL-V2X-Preconfiguration* is set to *gnss*:
  - 6> GNSS that is reliable in accordance with TS 36.101 [42] and TS 36.133 [16] (priority group 1);
  - 6> UEs of which SLSSID is part of the set defined for in coverage, and *inCoverage*, included in the *MasterInformationBlock-SL-V2X* message received from this UE, is set to *TRUE*, starting with the UE with the highest S-RSRP result (priority group 2);
  - 6> UEs of which SLSSID is 0, and *inCoverage*, included in the *MasterInformationBlock-SL-V2X* message received from this UE, is set to *TRUE*, or of which SLSSID is 0 and SLSS is transmitted on subframes indicated by *syncOffsetIndicator3*, starting with the UE with the highest S-RSRP result (priority group 2);
  - 6> UE of which SLSSID is part of the set defined for in coverage, and *inCoverage*, included in the *MasterInformationBlock-SL-V2X* message received from this UE, is set to *FALSE*, starting with the UE with the highest S-RSRP result (priority group 3);
  - 6> UEs of which SLSSID is 0 and is not transmitted on subframes indicated by *syncOffsetIndicator3*, and *inCoverage*, included in the *MasterInformationBlock-SL-V2X* message received from this UE, is set to *FALSE*, starting with the UE with the highest S-RSRP result (priority group 3);
  - 6> UEs of which SLSSID is 169, and *inCoverage*, included in the *MasterInformationBlock-SL-V2X* message received from this UE, is set to *FALSE*, starting with the UE with the highest S-RSRP result (priority group 3);
  - 6> Other UEs, starting with the UE with the highest S-RSRP result (priority group 4);
- 2> if triggered by V2X sidelink communication, and *syncFreqList* is included in *SL-V2X-Preconfiguration*, and the UE has selected a synchronisation carrier frequency as specified in 5.10.8a;
  - 3> consider the synchronisation reference source (i.e. eNB, GNSS or SyncRef UE) that selected on the synchronisation carrier frequency as the synchronization reference;

### 5.10.8a Selection and reselection of synchronisation carrier frequency

For the frequency(ies) which are in coverage for the UE as defined in TS 36.304 [4], clause 11.4 and which have been selected for V2X sidelink communication as specified in TS 36.321 [6], and/or for the frequency(ies) which are out of coverage for the UE and included in *v2x-InterFreqInfoList* within *RRCCONNECTIONRECONFIGURATION* or *SystemInformationBlockType21* or *SystemInformationBlockType26* of the serving cell/ PCell and which have been selected for V2X sidelink communication as specified in TS 36.321 [6], the UE capable of V2X sidelink communication and synchronisation carrier frequency selection shall:

- 1> if *syncFreqList* is included in *RRCCONNECTIONRECONFIGURATION* or in *SystemInformationBlockType26*, and includes at least one of the concerned frequency(ies):

- 2> if no synchronisation carrier frequency is selected:
  - 3> if *typeTxSync* is configured for the concerned frequency(ies) and set to *enb*; or
  - 3> if *typeTxSync* for the concerned frequency(ies) is not configured or is set to *gnss*, and GNSS is reliable in accordance with TS 36.101 [42] and TS 36.133 [16]:
    - 4> select one frequency from the concerned frequency(ies) which are included in *syncFreqList* as the synchronisation carrier frequency.
  - 3> else (i.e., there is no GNSS which is reliable in accordance with TS 36.101 [42] and TS 36.133 [16]):
    - 4> select the synchronisation reference source(s) on the concerned frequency(ies) which are included in *syncFreqList* according to 5.10.8.2:
    - 4> if SyncRef UE(s) with SLSSID=0 is detected on at least one frequency from the concerned frequency(ies):
      - 5> select one frequency from the concerned frequency(ies) with the SyncRef UE(s) with SLSSID=0 detected as the synchronisation carrier frequency;
    - 4> else (i.e., no SLSSID=0 detected and UE selects a cell as the synchronisation reference source):
      - 5> select one frequency from the concerned frequencies which are included in *syncFreqList* as the synchronisation carrier frequency;
- 2> else (i.e. the synchronisation carrier frequency is selected):
  - 3> if the UE selects GNSS as the synchronisation reference source, and GNSS is unreliable in accordance with TS 36.101 [42] and TS 36.133 [16]; or
  - 3> if the UE selects a cell as the synchronisation reference source, and the cell cannot fulfil the S criterion in accordance with TS 36.304 [4]; or
  - 3> if the UE selects a SyncRef UE and the S-RSRP of the current SyncRef UE is less than the minimum requirement defined in TS 36.133 [16]; or
  - 3> if the synchronisation carrier frequency is not selected for V2X sidelink communication as specified in TS 36.321 [6]:
    - 4> consider no synchronisation carrier frequency is selected;

For the frequency(ies) which are out of coverage for the UE and not included in *v2x-InterFreqInfoList* within *RRCCONNECTIONRECONFIGURATION* nor *SystemInformationBlockType21* nor *SystemInformationBlockType26* of the serving cell/ PCell and which have been selected for V2X sidelink carrier communication as specified in TS 36.321 [6], the UE capable of V2X sidelink communication and selection of synchronisation carrier frequency selection shall:

- 1> if *syncFreqList* is included in *SL-V2X-Preconfiguration*, and at least one of the concerned frequency(ies) is included in *syncFreqList*:
  - 2> if no synchronisation carrier frequency is selected:
    - 3> if *syncPriority* in *SL-V2X-Preconfiguration* is set to *gnss* and GNSS is reliable in accordance with TS 36.101 [42] and TS 36.133 [16]:
      - 4> select one frequency from the concerned frequency(ies) which are included in *syncFreqList* as the synchronisation carrier frequency.
    - 3> else:
      - 4> select the synchronisation reference source(s) on the concerned frequency(ies) which are included in *syncFreqList* according to 5.10.8.2;
      - 4> select the frequency with the highest synchronisation reference source priority as the synchronisation carrier frequency, according to the following priority group order:

- 5> if *syncPriority* corresponding to the concerned frequency(ies) in *SL-V2X-Preconfiguration* is set to *enb*:
  - 6> the frequency(ies) with SyncRef UE of which SLSSID is part of the set defined for in coverage, and *inCoverage*, included in the *MasterInformationBlock-SL-V2X* message received from this UE, is set to *TRUE* (priority group 1);
  - 6> the frequency(ies) with SyncRef UE of which SLSSID is part of the set defined for in coverage, and *inCoverage*, included in the *MasterInformationBlock-SL-V2X* message received from this UE, is set to *FALSE* (priority group 2);
  - 6> the frequency(ies) using GNSS as synchronisation reference source (priority group 3);
  - 6> the frequency(ies) with SyncRef UE of which SLSSID is 0, and *inCoverage*, included in the *MasterInformationBlock-SL-V2X* message received from this UE, is set to *TRUE*, or of which SLSSID is 0 and SLSS is transmitted on subframes indicated by *syncOffsetIndicator3* (priority group 4);
  - 6> the frequency(ies) with SyncRef UE of which SLSSID is 0 and is not transmitted on subframes indicated by *syncOffsetIndicator3*, and *inCoverage*, included in the *MasterInformationBlock-SL-V2X* message received from this UE, is set to *FALSE* (priority group 5);
  - 6> the frequency(ies) with SyncRef UE of which SLSSID is 169, and *inCoverage*, included in the *MasterInformationBlock-SL-V2X* message received from this UE, is set to *FALSE* (priority group 5);
  - 6> the frequency(ies) with other SyncRef UE (priority group 6);
- 5> if *syncPriority* corresponding to the concerned frequency(ies) in *SL-V2X-Preconfiguration* is set to *gnss*:
  - 6> the frequency(ies) with SyncRef UE of which SLSSID is part of the set defined for in coverage, and *inCoverage*, included in the *MasterInformationBlock-SL-V2X* message received from this UE, is set to *TRUE* (priority group 1);
  - 6> the frequency(ies) with SyncRef UE of which SLSSID is 0, and *inCoverage*, included in the *MasterInformationBlock-SL-V2X* message received from this UE, is set to *TRUE*, or of which SLSSID is 0 and SLSS is transmitted on subframes indicated by *syncOffsetIndicator3* (priority group 1);
  - 6> the frequency(ies) with SyncRef UE of which SLSSID is part of the set defined for in coverage, and *inCoverage*, included in the *MasterInformationBlock-SL-V2X* message received from this UE, is set to *FALSE* (priority group 2);
  - 6> the frequency(ies) with SyncRef UE of which SLSSID is 0 and is not transmitted on subframes indicated by *syncOffsetIndicator3*, and *inCoverage*, included in the *MasterInformationBlock-SL-V2X* message received from this UE, is set to *FALSE* (priority group 2);
  - 6> the frequency(ies) with SyncRef UE of which SLSSID is 169, and *inCoverage*, included in the *MasterInformationBlock-SL-V2X* message received from this UE, is set to *FALSE* (priority group 2);
  - 6> the frequency(ies) with other SyncRef UE (priority group 3);
- 2> else (i.e. the synchronisation carrier frequency is selected):
  - 3> if the UE selects GNSS as the synchronisation reference source, and GNSS is unreliable in accordance with TS 36.101 [42] and TS 36.133 [16]; or
  - 3> if the UE selects a SyncRef UE and the S-RSRP of the current SyncRef UE is less than the minimum requirement defined in TS 36.133 [16]; or
  - 3> if the synchronisation carrier frequency is not selected for V2X sidelink communication as specified in TS 36.321 [6]:
    - 4> consider no synchronisation carrier frequency is selected;

NOTE 1: If more than one selected carrier frequencies satisfy the condition as the synchronisation carrier frequency for V2X sidelink communication, how to select one synchronisation carrier frequency is up to UE implementation.

NOTE 2: All concerned carrier frequency(ies) have the same *typeTxSync* and *syncPriority* configured.

## 5.10.9 Sidelink common control information

### 5.10.9.1 General

The sidelink common control information is carried by a single message, the *MasterInformationBlock-SL* (MIB-SL) message for sidelink discovery and sidelink communication or the *MasterInformationBlock-SL-V2X* (MIB-SL-V2X) message for V2X sidelink communication. The MIB-SL or MIB-SL-V2X includes timing information as well as some configuration parameters and is transmitted via SL-BCH.

The MIB-SL for sidelink discovery and sidelink communication uses a fixed schedule with a periodicity of 40 ms without repetitions. In particular, the MIB-SL is scheduled in subframes indicated by *syncOffsetIndicator-r12* i.e. for which  $(10 \cdot \text{DFN} + \text{subframe number}) \bmod 40 = \text{syncOffsetIndicator-r12}$ .

The MIB-SL-V2X for V2X sidelink communication uses a fixed schedule with a periodicity of 160 ms without repetitions. In particular, the MIB-SL-V2X is scheduled in subframes indicated by *SL-OffsetIndicatorSync* i.e. for which  $(10 \cdot \text{DFN} + \text{subframe number}) \bmod 160 = \text{SL-OffsetIndicatorSync}$ .

The sidelink common control information may change at any transmission i.e. neither a modification period nor a change notification mechanism is used.

A UE configured to receive or transmit sidelink communication or PS related sidelink discovery shall:

- 1> if the UE has a selected SyncRef UE, as specified in 5.10.8.2:
  - 2> ensure having a valid version of the *MasterInformationBlock-SL* message of that SyncRefUE;

A UE configured to receive or transmit V2X sidelink communication shall:

- 1> if the UE has a selected SyncRef UE, as specified in 5.10.8.2:
  - 2> ensure having a valid version of the *MasterInformationBlock-SL-V2X* message of that SyncRefUE;

### 5.10.9.2 Actions related to reception of *MasterInformationBlock-SL/ MasterInformationBlock-SL-V2X* message

Upon receiving *MasterInformationBlock-SL* or *MasterInformationBlock-SL-V2X*, the UE shall:

- 1> apply the values of *sl-Bandwidth*, *subframeAssignmentSL*, *directFrameNumber* and *directSubframeNumber* included in the received *MasterInformationBlock-SL* or *MasterInformationBlock-SL-V2X* message;

## 5.10.10 Sidelink relay UE operation

### 5.10.10.1 General

This procedure is used by a UE supporting sidelink relay UE operation and involves evaluation of the AS-layer conditions that need to be met in order for upper layers to configure a sidelink relay UE to receive/ transmit relay related PS sidelink discovery/ relay related sidelink communication. The AS-layer conditions merely comprise of being configured with radio resources that can be used for transmission.

A UE that fulfils the criteria specified in 5.10.10.2 and 5.10.10.3 and that is configured by higher layers accordingly is acting as a sidelink relay UE.

### 5.10.10.2 AS-conditions for relay related sidelink communication transmission by sidelink relay UE

A UE capable of sidelink relay UE operation shall inform upper layers that it is configured with radio resources that can be used for relay related sidelink communication transmission if the following conditions are met:

- 1> if in RRC\_CONNECTED; and if the UE is configured with *commTxResources*; and the UE is configured with *commTxAllowRelayDedicated* set to *true*;

### 5.10.10.3 AS-conditions for relay PS related sidelink discovery transmission by sidelink relay UE

A UE capable of sidelink relay UE operation shall inform upper layers that it is configured with radio resources that can be used for relay PS related sidelink discovery transmission if the following conditions are met:

- 1> if in RRC\_IDLE; and if the UE's serving cell is suitable as defined in TS 36.304 [4]; and if *SystemInformationBlockType19* includes *discConfigPS* including *discTxPoolPS-Common* and *discConfigRelay*; and if the sidelink relay UE threshold conditions as specified in 5.10.10.4 are met;
- 1> else if in RRC\_CONNECTED; and if *discTxResourcesPS* is configured;

### 5.10.10.4 Sidelink relay UE threshold conditions

A UE capable of sidelink relay UE operation shall:

- 1> if the threshold conditions specified in this clause were not met:
  - 2> if neither *threshHigh* nor *threshLow* is included in *relayUE-Config* within *SystemInformationBlockType19*:
    - 3> consider the threshold conditions to be met (entry);
  - 2> else if *threshHigh* is not included in *relayUE-Config* within *SystemInformationBlockType19*; or the RSRP measurement of the PCell, or the cell on which the UE camps, is below *threshHigh* by *hystMax* (also included within *relayUE-Config*); and
  - 2> if *threshLow* is not included in *relayUE-Config* within *SystemInformationBlockType19*; or the RSRP measurement of the PCell, or the cell on which the UE camps, is above *threshLow* by *hystMin* (also included within *relayUE-Config*):
    - 3> consider the threshold conditions to be met (entry);
- 1> else:
  - 2> if *threshHigh* is included in *relayUE-Config* within *SystemInformationBlockType19*; and the RSRP measurement of the PCell, or the cell on which the UE camps, is above *threshHigh* (also included within *relayUE-Config*); or
  - 2> if *threshLow* is included in *relayUE-Config* within *SystemInformationBlockType19*; and the RSRP measurement of the PCell, or the cell on which the UE camps, is below *threshLow* (also included within *relayUE-Config*);
    - 3> consider the threshold conditions not to be met (leave);

## 5.10.11 Sidelink remote UE operation

### 5.10.11.1 General

This procedure is used by a UE supporting sidelink remote UE operation and involves evaluation of the AS-layer conditions that need to be met in order for upper layers to configure a sidelink remote UE to receive/ transmit relay related sidelink PS discovery/ relay related sidelink communication. The AS-layer conditions merely comprise of being configured with radio resources that can be used for transmission, as well as whether or not having a selected sidelink relay UE.



### 5.10.11.2 AS-conditions for relay related sidelink communication transmission by sidelink remote UE

A UE capable of sidelink remote UE operation shall inform upper layers whether it is configured with radio resources that can be used for relay related sidelink communication transmission if the following conditions are met:

- 1> if the UE is out of coverage; and is preconfigured with *SL-Preconfiguration* including *discTxPoolList* and *preconfigRelay*;
- 1> else if in RRC\_IDLE; and if the UE's serving cell is suitable as defined in TS 36.304 [4]; and if *SystemInformationBlockType18* includes *commTxPoolNormalCommon* and *commTxAllowRelayCommon*; and if *SystemInformationBlockType19* includes *discConfigRelay*; and if the sidelink remote UE threshold conditions as specified in 5.10.11.5 are met;
- 1> else if in RRC\_CONNECTED; and if the UE is configured with *commTxResources*; and the UE is configured with *commTxAllowRelayDedicated* set to *true*;

### 5.10.11.3 AS-conditions for relay PS related sidelink discovery transmission by sidelink remote UE

A UE capable of sidelink remote UE operation shall inform upper layers whether it is configured with radio resources that can be used for relay PS related sidelink discovery transmission if the following conditions are met:

- 1> if the UE is out of coverage; and is preconfigured with *SL-Preconfiguration* including *discTxPoolList* and *preconfigRelay*;
- 1> else if in RRC\_IDLE; and if the UE's serving cell is suitable as defined in TS 36.304 [4]; and if *SystemInformationBlockType19* includes *discConfigPS* including *discTxPoolPS-Common* and *discConfigRelay*; and if the sidelink remote UE threshold conditions as specified in 5.10.11.5 are met;
- 1> else if in RRC\_CONNECTED; and if *discTxResourcesPS* is configured;

### 5.10.11.4 Selection and reselection of sidelink relay UE

A UE capable of sidelink remote UE operation that is configured by upper layers to search for a sidelink relay UE shall:

- 1> if out of coverage on the frequency used for sidelink communication, as defined in TS 36.304 [4], clause 11.4; or
- 1> if the serving frequency is used for sidelink communication and the RSRP measurement of the cell on which the UE camps (RRC\_IDLE)/ the PCell (RRC\_CONNECTED) is below *threshHigh* within *remoteUE-Config* :
  - 2> search for candidate sidelink relay UEs, in accordance with TS 36.133 [16]
  - 2> when evaluating the one or more detected sidelink relay UEs, apply layer 3 filtering as specified in 5.5.3.2 across measurements that concern the same ProSe Relay UE ID and using the *filterCoefficient* in *SystemInformationBlockType19* (in coverage) or the preconfigured *filterCoefficient* as defined in 9.3(out of coverage), before using the SD-RSRP measurement results;

NOTE 1: The details of the interaction with upper layers are up to UE implementation.

- 2> if the UE does not have a selected sidelink relay UE:
  - 3> select a candidate sidelink relay UE which SD-RSRP exceeds *q-RxLevMin* included in either *reselectionInfoIC* (in coverage) or *reselectionInfoOoC* (out of coverage) by *minHyst*;
  - 2> else if SD-RSRP of the currently selected sidelink relay UE is below *q-RxLevMin* included in either *reselectionInfoIC* (in coverage) or *reselectionInfoOoC* (out of coverage); or if upper layers indicate not to use the currently selected sidelink relay: (i.e. sidelink relay UE reselection):
    - 3> select a candidate sidelink relay UE which SD-RSRP exceeds *q-RxLevMin* included in either *reselectionInfoIC* (in coverage) or *reselectionInfoOoC* (out of coverage) by *minHyst*;
  - 2> else if the UE did not detect any candidate sidelink relay UE which SD-RSRP exceeds *q-RxLevMin* included in either *reselectionInfoIC* (in coverage) or *reselectionInfoOoC* (out of coverage) by *minHyst*:

3> consider no sidelink relay UE to be selected;

NOTE 2: The UE may perform sidelink relay UE reselection in a manner resulting in selection of the sidelink relay UE, amongst all candidate sidelink relay UEs meeting higher layer criteria, that has the best radio link quality. Further details, including interaction with upper layers, are up to UE implementation.

### 5.10.11.5 Sidelink remote UE threshold conditions

A UE capable of sidelink remote UE operation shall:

1> if the threshold conditions specified in this clause were not met:

2> if *threshHigh* is not included in *remoteUE-Config* within *SystemInformationBlockType19*; or

2> if *threshHigh* is included in *remoteUE-Config* within *SystemInformationBlockType19*; and the RSRP measurement of the PCell, or the cell on which the UE camps, is below *threshHigh* by *hystMax* (also included within *remoteUE-Config*):

3> consider the threshold conditions to be met (entry);

1> else:

2> if *threshHigh* is included in *remoteUE-Config* within *SystemInformationBlockType19*; and the RSRP measurement of the PCell, or the cell on which the UE camps, is above *threshHigh* (also included within *remoteUE-Config*):

3> consider the threshold conditions not to be met (leave);

### 5.10.12 V2X sidelink communication monitoring

A UE capable of V2X sidelink communication that is configured by upper layers to receive V2X sidelink communication shall:

1> if the conditions for sidelink operation as defined in 5.10.1d are met:

2> if in coverage on the frequency used for V2X sidelink communication, as defined in TS 36.304 [4], clause 11.4, or TS 38.304 [92], clause 8.1:

3> if the frequency used to receive V2X sidelink communication is included in *v2x-InterFreqInfoList* within *RRCCONNECTIONRECONFIGURATION* or in *v2x-InterFreqInfoList* within *SystemInformationBlockType21* or *SystemInformationBlockType26* of the serving cell/Pcell, and *v2x-CommRxPool* is included in *SL-V2X-InterFreqUE-Config* within *v2x-UE-ConfigList* in the entry of *v2x-InterFreqInfoList* for the concerned frequency:

4> configure lower layers to monitor sidelink control information and the corresponding data using the pool of resources indicated in *v2x-CommRxPool*;

3> else:

4> if the cell chosen for V2X sidelink communication reception broadcasts *SystemInformationBlockType21* including *v2x-CommRxPool* in *sl-V2X-ConfigCommon* or,

4> if the UE is configured with *v2x-CommRxPool* included in *mobilityControlInfoV2X* in *RRCCONNECTIONRECONFIGURATION*:

5> configure lower layers to monitor sidelink control information and the corresponding data using the pool of resources indicated in *v2x-CommRxPool*;

2> else (i.e. out of coverage on the frequency used for V2X sidelink communication, as defined in TS 36.304 [4], clause 11.4 and TS 38.304 [92], clause 8.1):

3> if the frequency used to receive V2X sidelink communication is included in *v2x-InterFreqInfoList* within *RRCCONNECTIONRECONFIGURATION* or in *v2x-InterFreqInfoList* within *SystemInformationBlockType21* or *SystemInformationBlockType26* of the serving cell/PCell, and *v2x-CommRxPool* is included in *SL-V2X-*

*InterFreqUE-Config* within *v2x-UE-ConfigList* in the entry of *v2x-InterFreqInfoList* for the concerned frequency:

- 4> configure lower layers to monitor sidelink control information and the corresponding data using the pool of resources indicated in *v2x-CommRxPool*;
- 3> else:
  - 4> configure lower layers to monitor sidelink control information and the corresponding data using the pool of resources that were preconfigured (i.e. *v2x-CommRxPoolList* in *SL-V2X-Preconfiguration* defined in 9.3);

## 5.10.13 V2X sidelink communication transmission

### 5.10.13.1 Transmission of V2X sidelink communication

A UE capable of V2X sidelink communication that is configured by upper layers to transmit V2X sidelink communication and has related data to be transmitted shall:

- 1> if the conditions for sidelink operation as defined in 5.10.1d are met:
  - 2> if in coverage on the frequency used for V2X sidelink communication as defined in TS 36.304 [4], clause 11.4, or TS 38.304 [92], clause 8.1; or
  - 2> if the frequency used to transmit V2X sidelink communication is included in *v2x-InterFreqInfoList* in *RRCCONNECTIONRECONFIGURATION* or in *v2x-InterFreqInfoList* within *SystemInformationBlockType21* or *SystemInformationBlockType26*:
  - 3> if the UE is in *RRC\_CONNECTED* and uses the PCell or the frequency included in *v2x-InterFreqInfoList* in *RRCCONNECTIONRECONFIGURATION* for V2X sidelink communication:
    - 4> if the UE is configured, by the current PCell with *commTxResources* set to *scheduled*:
      - 5> if T310 or T311 is running; and if the PCell at which the UE detected physical layer problems or radio link failure broadcasts *SystemInformationBlockType21* including *v2x-CommTxPoolExceptional* in *sl-V2X-ConfigCommon*, or *v2x-CommTxPoolExceptional* is included in *v2x-InterFreqInfoList* for the concerned frequency in *SystemInformationBlockType21* or *SystemInformationBlockType26* or *RRCCONNECTIONRECONFIGURATION*; or
      - 5> if T301 is running and the cell on which the UE initiated connection re-establishment broadcasts *SystemInformationBlockType21* including *v2x-CommTxPoolExceptional* in *sl-V2X-ConfigCommon*, or *v2x-CommTxPoolExceptional* is included in *v2x-InterFreqInfoList* for the concerned frequency in *SystemInformationBlockType21* or *SystemInformationBlockType26*; or
      - 5> if T304 is running and the UE is configured with *v2x-CommTxPoolExceptional* included in *mobilityControlInfoV2X* in *RRCCONNECTIONRECONFIGURATION* or in *v2x-InterFreqInfoList* for the concerned frequency in *RRCCONNECTIONRECONFIGURATION*:
        - 6> configure lower layers to transmit the sidelink control information and the corresponding data based on random selection using the pool of resources indicated by *v2x-CommTxPoolExceptional* as defined in TS 36.321 [6];
    - 5> else:
      - 6> configure lower layers to request E-UTRAN to assign transmission resources for V2X sidelink communication;
  - 4> else if the UE is configured with *v2x-CommTxPoolNormalDedicated* or *v2x-CommTxPoolNormal* or *p2x-CommTxPoolNormal* in the entry of *v2x-InterFreqInfoList* for the concerned frequency in *sl-V2X-ConfigDedicated* in *RRCCONNECTIONRECONFIGURATION*:
    - 5> if the UE is configured to transmit non-P2X related V2X sidelink communication and a result of sensing on the resources configured in *v2x-CommTxPoolNormalDedicated* or *v2x-*

*CommTxPoolNormal* in the entry of *v2x-InterFreqInfoList* for the concerned frequency in *RRCCONNECTIONRECONFIGURATION* is not available in accordance with TS 36.213 [23]; or

- 5> if the UE is configured to transmit P2X related V2X sidelink communication and selects to use partial sensing according to 5.10.13.1a, and a result of partial sensing on the resources configured in *v2x-CommTxPoolNormalDedicated* or *p2x-CommTxPoolNormal* in the entry of *v2x-InterFreqInfoList* for the concerned frequency in *RRCCONNECTIONRECONFIGURATION* is not available in accordance with TS 36.213 [23]:
    - 6> if *v2x-CommTxPoolExceptional* is included in *mobilityControlInfoV2X* in *RRCCONNECTIONRECONFIGURATION* (i.e., handover case); or
    - 6> if *v2x-CommTxPoolExceptional* is included in the entry of *v2x-InterFreqInfoList* for the concerned frequency in *RRCCONNECTIONRECONFIGURATION*; or
    - 6> if the PCell broadcasts *SystemInformationBlockType21* including *v2x-CommTxPoolExceptional* in *sl-V2X-ConfigCommon* or *v2x-CommTxPoolExceptional* in *v2x-InterFreqInfoList* for the concerned frequency or broadcasts *SystemInformationBlockType26* including *v2x-CommTxPoolExceptional* in *v2x-InterFreqInfoList* for the concerned frequency:
      - 7> configure lower layers to transmit the sidelink control information and the corresponding data based on random selection using the pool of resources indicated by *v2x-CommTxPoolExceptional* as defined in TS 36.321 [6];
  - 5> else if the UE is configured to transmit P2X related V2X sidelink communication:
    - 6> select a resource pool according to 5.10.13.2;
    - 6> perform P2X related V2X sidelink communication according to 5.10.13.1a;
  - 5> else if the UE is configured to transmit non-P2X related V2X sidelink communication:
    - 6> configure lower layers to transmit the sidelink control information and the corresponding data based on sensing (as defined in TS 36.321 [6] and TS 36.213 [23]) using one of the resource pools indicated by *v2x-commTxPoolNormalDedicated* or *v2x-CommTxPoolNormal* in the entry of *v2x-InterFreqInfoList* for the concerned frequency, which is selected according to 5.10.13.2;
- 3> else:
- 4> if the cell chosen for V2X sidelink communication transmission broadcasts *SystemInformationBlockType21* or *SystemInformationBlockType26*:
    - 5> if the UE is configured to transmit non-P2X related V2X sidelink communication, and if *SystemInformationBlockType21* includes *v2x-CommTxPoolNormalCommon* or *v2x-CommTxPoolNormal* in *v2x-InterFreqInfoList* for the concerned frequency, or *SystemInformationBlockType26* includes *v2x-CommTxPoolNormal* in *v2x-InterFreqInfoList* for the concerned frequency, and if a result of sensing on the resources configured in *v2x-CommTxPoolNormalCommon* or *v2x-CommTxPoolNormal* in *v2x-InterFreqInfoList* for the concerned frequency is available in accordance with TS 36.213 [23]:
      - 6> configure lower layers to transmit the sidelink control information and the corresponding data based on sensing (as defined in TS 36.321 [6] and TS 36.213 [23]) using one of the resource pools indicated by *v2x-CommTxPoolNormalCommon* or *v2x-CommTxPoolNormal* in *v2x-InterFreqInfoList* for the concerned frequency, which is selected according to 5.10.13.2;
    - 5> else if the UE is configured to transmit P2X related V2X sidelink communication, and if *SystemInformationBlockType21* includes *p2x-CommTxPoolNormalCommon* or *p2x-CommTxPoolNormal* in *v2x-InterFreqInfoList* for the concerned frequency, or *SystemInformationBlockType26* includes *p2x-CommTxPoolNormal* in *v2x-InterFreqInfoList* for the concerned frequency, and if the UE selects to use random selection according to 5.10.13.1a, or selects to use partial sensing according to 5.10.13.1a and a result of partial sensing on the resources configured in *p2x-CommTxPoolNormalCommon* or *p2x-CommTxPoolNormal* in *v2x-InterFreqInfoList* for the concerned frequency is available in accordance with TS 36.213 [23]:

- 6> select a resource pool from *p2x-CommTxPoolNormalCommon* or *p2x-CommTxPoolNormal* in *v2x-InterFreqInfoList* for the concerned frequency according to 5.10.13.2, but ignoring *zoneConfig* in *SystemInformationBlockType21* or *SystemInformationBlockType26*;
- 6> perform P2X related V2X sidelink communication according to 5.10.13.1a;
- 5> else if *SystemInformationBlockType21* includes *v2x-CommTxPoolExceptional* in *sl-V2X-ConfigCommon* or *v2x-CommTxPoolExceptional* in *v2x-InterFreqInfoList* for the concerned frequency, or *SystemInformationBlockType26* includes *v2x-CommTxPoolExceptional* in *v2x-InterFreqInfoList* for the concerned frequency:
  - 6> from the moment the UE initiates connection establishment until receiving an *RRCCONNECTIONRECONFIGURATION* including *sl-V2X-ConfigDedicated*, or until receiving an *RRCCONNECTIONRELEASE* or an *RRCCONNECTIONREJECT*; or
  - 6> if the UE is in RRC\_IDLE and a result of sensing on the resources configured in *v2x-CommTxPoolNormalCommon* or *v2x-CommTxPoolNormal* in *v2x-InterFreqInfoList* for the concerned frequency in *SystemInformationBlockType21* or *v2x-CommTxPoolNormal* in *v2x-InterFreqInfoList* for the concerned frequency in *SystemInformationBlockType26* is not available in accordance with TS 36.213 [23]; or
  - 6> if the UE is in RRC\_IDLE and UE selects to use partial sensing according to 5.10.13.1a and a result of partial sensing on the resources configured in *p2x-CommTxPoolNormalCommon* or *p2x-CommTxPoolNormal* in *v2x-InterFreqInfoList* for the concerned frequency in *SystemInformationBlockType21* or *v2x-CommTxPoolNormal* in *v2x-InterFreqInfoList* for the concerned frequency in *SystemInformationBlockType26* is not available in accordance with TS 36.213 [23]:
    - 7> configure lower layers to transmit the sidelink control information and the corresponding data based on random selection (as defined in TS 36.321 [6]) using the pool of resources indicated in *v2x-CommTxPoolExceptional*;
- 2> else:
  - 3> configure lower layers to transmit the sidelink control information and the corresponding data based on sensing (as defined in TS 36.321 [6] and TS 36.213 [23]) using one of the resource pools indicated by *v2x-CommTxPoolList* in *SL-V2X-Preconfiguration* in case of non-P2X related V2X sidelink communication, which is selected according to 5.10.13.2, or using one of the resource pools indicated by *p2x-CommTxPoolList* in *SL-V2X-Preconfiguration* in case of P2X related V2X sidelink communication, which is selected according to 5.10.13.2, and in accordance with the timing of the selected reference as defined in 5.10.8;

The UE capable of non-P2X related V2X sidelink communication that is configured by upper layers to transmit V2X sidelink communication shall perform sensing on all pools of resources which may be used for transmission of the sidelink control information and the corresponding data. The pools of resources are indicated by *SL-V2X-Preconfiguration*, *v2x-CommTxPoolNormalCommon*, *v2x-CommTxPoolNormalDedicated* in *sl-V2X-ConfigDedicated*, or *v2x-CommTxPoolNormal* in *v2x-InterFreqInfoList* for the concerned frequency, as configured above.

### 5.10.13.1a Transmission of P2X related V2X sidelink communication

A UE configured to transmit P2X related V2X sidelink communication shall:

- 1> if *partialSensing* is included and *randomSelection* is not included in *resourceSelectionConfigP2X* of the pool selected; or
- 1> if both *partialSensing* and *randomSelection* are included in *resourceSelectionConfigP2X* of the pool selected, and the UE selects to use partial sensing:
  - 2> configure lower layers to transmit the sidelink control information and the corresponding data based on partial sensing (as defined in TS 36.321 [6] and TS 36.213 [23]) using the selected resource pool, if the UE supports partial sensing;
- 1> if *partialSensing* is not included and *randomSelection* is included in *resourceSelectionConfigP2X* of the pool selected.

- 2> configure lower layers to transmit the sidelink control information and the corresponding data based on random selection (as defined in TS 36.321 [6] and TS 36.213 [23]) using the selected resource pool;
- 1> if both *partialSensing* and *randomSelection* is included in *resourceSelectionConfigP2X* of the pool selected, and the UE selects to use random selection:
  - 2> configure lower layers to transmit the sidelink control information and the corresponding data based on random selection using the selected resource pool and indicates to lower layers that transmissions of multiple MAC PDUs are allowed (as defined in TS 36.321 [6] and TS 36.213 [23]).

NOTE: If both *partialSensing* and *randomSelection* is included in *resourceSelectionConfigP2X* of the pool selected, the selection between partial sensing and random selection is left to UE implementation.

### 5.10.13.2 V2X sidelink communication transmission pool selection

For a frequency used for V2X sidelink communication, if *zoneConfig* is not ignored as specified in 5.10.13.1, the UE configured by upper layers for V2X sidelink communication shall only use the pool which corresponds to geographical coordinates of the UE, if *zoneConfig* is included in *SystemInformationBlockType21* or *SystemInformationBlockType26* of the serving cell (RRC\_IDLE)/ PCell (RRC\_CONNECTED) or in *RRCConnectionReconfiguration* for the concerned frequency, and the UE is configured to use resource pools provided by RRC signalling for the concerned frequency; or if *zoneConfig* is included in *SL-V2X-Preconfiguration* for the concerned frequency, and the UE is configured to use resource pools in *SL-V2X-Preconfiguration* for the frequency, according to 5.10.13.1. The UE shall only use the pool which is associated with the synchronization reference source selected in accordance with 5.10.8.2.

- 1> if the UE is configured to transmit on *p2x-CommTxPoolNormalCommon* or on *p2x-CommTxPoolNormal* in *v2x-InterFreqInfoList* in *SystemInformationBlockType21* or on *p2x-CommTxPoolNormal* in *v2x-InterFreqInfoList* in *SystemInformationBlockType26* according to 5.10.13.1; or
- 1> if the UE is configured to transmit on *p2x-CommTxPoolList-r14* in *SL-V2X-Preconfiguration* according to 5.10.13.1; or
- 1> if *zoneConfig* is not included in *SystemInformationBlockType21* and the UE is configured to transmit on *v2x-CommTxPoolNormalCommon* or *v2x-CommTxPoolNormalDedicated*; or
- 1> if *zoneConfig* is included in *SystemInformationBlockType21* and the UE is configured to transmit on *v2x-CommTxPoolNormalDedicated* for P2X related V2X sidelink communication and *zoneID* is not included in *v2x-CommTxPoolNormalDedicated*; or
- 1> if *zoneConfig* is not included in the entry of *v2x-InterFreqInfoList* for the concerned frequency and the UE is configured to transmit on *v2x-CommTxPoolNormal* in *v2x-InterFreqInfoList* or *p2x-CommTxPoolNormal* in *v2x-InterFreqInfoList* in *RRCConnectionReconfiguration*; or
- 1> if *zoneConfig* is included in the entry of *v2x-InterFreqInfoList* for the concerned frequency and the UE is configured to transmit on *p2x-CommTxPoolNormal* in *v2x-InterFreqInfoList* in *RRCConnectionReconfiguration* and *zoneID* is not included in *p2x-CommTxPoolNormal*; or
- 1> if *zoneConfig* is not included in *SL-V2X-Preconfiguration* for the concerned frequency and the UE is configured to transmit on *v2x-CommTxPoolList* in *SL-V2X-Preconfiguration* for the concerned frequency:
  - 2> select a pool associated with the synchronization reference source selected in accordance with 5.10.8.2;

NOTE 0: If multiple pools are associated with the selected synchronization reference source, it is up to UE implementation which resource pool is selected for V2X sidelink communication transmission.

- 1> if *zoneConfig* is included in *SystemInformationBlockType21* and the UE is configured to transmit on *v2x-CommTxPoolNormalCommon* or *v2x-CommTxPoolNormalDedicated* for non-P2X related V2X sidelink communication; or
- 1> if *zoneConfig* is included in *SystemInformationBlockType21* and the UE is configured to transmit on *v2x-CommTxPoolNormalDedicated* for P2X related V2X sidelink communication and *zoneID* is included in *v2x-CommTxPoolNormalDedicated*; or
- 1> if *zoneConfig* is included in the entry of *v2x-InterFreqInfoList* for the concerned frequency and if the UE is configured to transmit on *v2x-CommTxPoolNormal* in *v2x-InterFreqInfoList* or is configured to transmit on *p2x-*

*CommTxPoolNormal* in *v2x-InterFreqInfoList* in *RRCConnectionReconfiguration* and *zoneID* is included in *p2x-CommTxPoolNormal*; or

- 1> if *zoneConfig* is included in *SL-V2X-Preconfiguration* for the concerned frequency and the UE is configured to transmit on *v2x-CommTxPoolList* in *SL-V2X-Preconfiguration* for the concerned frequency:
- 2> select the pool configured with *zoneID* equal to the zone identity determined below and associated with the synchronization reference source selected in accordance with 5.10.8.2;

The UE shall determine an identity of the zone (i.e. *Zone\_id*) in which it is located using the following formulae, if *zoneConfig* is included in *SystemInformationBlockType21* or *SystemInformationBlockType26* or in *SL-V2X-Preconfiguration*:

$$x_1 = \text{FLOOR} (x / L) \text{ Mod } N_x;$$

$$y_1 = \text{FLOOR} (y / W) \text{ Mod } N_y;$$

$$\text{Zone\_id} = y_1 * N_x + x_1.$$

The parameters in the formulae are defined as follows:

*L* is the value of *zoneLength* included in *zoneConfig* in *SystemInformationBlockType21* or *SystemInformationBlockType26* or in *SL-V2X-Preconfiguration*;

*W* is the value of *zoneWidth* included in *zoneConfig* in *SystemInformationBlockType21* or *SystemInformationBlockType26* or in *SL-V2X-Preconfiguration*;

*N<sub>x</sub>* is the value of *zoneIdLongiMod* included in *zoneConfig* in *SystemInformationBlockType21* or *SystemInformationBlockType26* or in *SL-V2X-Preconfiguration*;

*N<sub>y</sub>* is the value of *zoneIdLatiMod* included in *zoneConfig* in *SystemInformationBlockType21* or *SystemInformationBlockType26* or in *SL-V2X-Preconfiguration*;

*x* is the geodesic distance in longitude between UE's current location and geographical coordinates (0, 0) according to WGS84 model [80] and it is expressed in meters;

*y* is the geodesic distance in latitude between UE's current location and geographical coordinates (0, 0) according to WGS84 model [80] and it is expressed in meters.

The UE shall select a pool of resources which includes a *zoneID* equals to the *Zone\_id* calculated according to above mentioned formulae and indicated by *v2x-CommTxPoolNormalDedicated*, *v2x-CommTxPoolNormalCommon*, *v2x-CommTxPoolNormal* in *v2x-InterFreqInfoList* or *p2x-CommTxPoolNormal* in *v2x-InterFreqInfoList* in *RRCConnectionReconfiguration*, or *v2x-CommTxPoolList* according to 5.10.13.1.

NOTE 1: The UE uses its latest geographical coordinates to perform resource pool selection.

NOTE 2: If geographical coordinates are not available and zone specific TX resource pools are configured for the concerned frequency, it is up to UE implementation which resource pool is selected for V2X sidelink communication transmission.

### 5.10.13.3 V2X sidelink communication transmission reference cell selection

A UE capable of V2X sidelink communication that is configured by upper layers to transmit V2X sidelink communication shall:

- 1> for each frequency used to transmit V2X sidelink communication, select a cell to be used as reference for synchronisation and DL measurements in accordance with the following:
  - 2> if the frequency concerns the primary frequency:
    - 3> use the PCell (RRC\_CONNECTED) or the serving cell (RRC\_IDLE) as reference;
  - 2> else if the frequency concerns a secondary frequency:
    - 3> use the concerned SCell as reference;

- 2> else if the UE is in coverage of the concerned frequency:
  - 3> use the DL frequency paired with the one used to transmit V2X sidelink communication as reference;
- 2> else (i.e., out of coverage on the concerned frequency):
  - 3> use the PCell (RRC\_CONNECTED) or the serving cell (RRC\_IDLE) as reference, if needed;

### 5.10.14 DFN derivation from GNSS

When the UE selects GNSS as the synchronization reference source, the DFN used for V2X sidelink communication is derived from the current UTC time, by the following formulae:

$$DFN = \text{FLOOR}(0.1 * (T_{\text{current}} - T_{\text{ref}} - \text{offsetDFN})) \bmod 1024$$

$$\text{SubframeNumber} = \text{FLOOR}(T_{\text{current}} - T_{\text{ref}} - \text{offsetDFN}) \bmod 10$$

Where:

***T<sub>current</sub>*** is the current UTC time that obtained from GNSS. This value is expressed in milliseconds;

***T<sub>ref</sub>*** is the reference UTC time 00:00:00 on Gregorian calendar date 1 January, 1900 (midnight between Thursday, December 31, 1899 and Friday, January 1, 1900). This value is expressed in milliseconds;

***OffsetDFN*** is the value *offsetDFN* if configured, otherwise it is zero. This value is expressed in milliseconds.

NOTE: In case of leap second change event, how V2X UE obtains the scheduled time of leap second change to adjust *T<sub>current</sub>* correspondingly is left to UE implementation. How V2X UE handles the sudden discontinuity of DFN is left to UE implementation.

### 5.10.15 Void

### 5.10.16 Sidelink synchronisation information transmission for NR sidelink communication

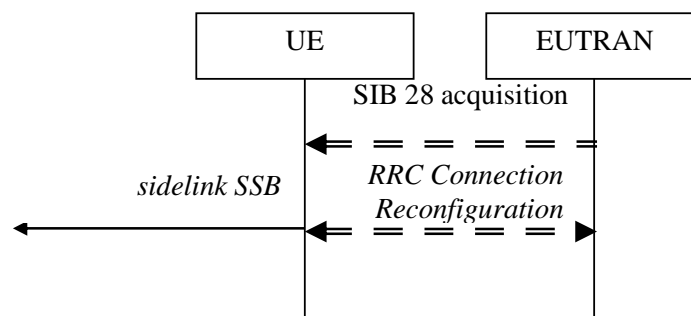
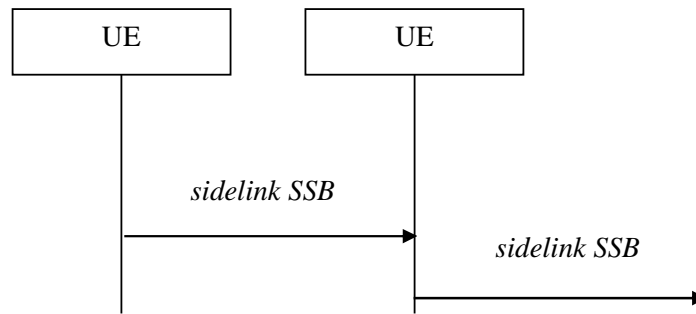

Figure 5.10.16-1: Synchronisation information transmission for NR sidelink communication, in (partial) coverage





**Figure 5.10.16-2: Synchronisation information transmission for NR sidelink communication, out of coverage**

The purpose of this procedure is to provide synchronisation information to a UE.

The initiation and the procedure for the transmission of sidelink SSB follow the procedure specified for NR sidelink communication in clause 5.8.5 of TS 38.331 [82].

NOTE: When applying the procedure in this clause, *SystemInformationBlockType28* in Figure 5.10.16-1 corresponds to *SIB12* specified in TS 38.331 [82].

## 6 Protocol data units, formats and parameters (tabular & ASN.1)

### 6.1 General

The contents of each RRC message is specified in clause 6.2 using ASN.1 to specify the message syntax and using tables when needed to provide further detailed information about the fields specified in the message syntax. The syntax of the information elements that are defined as stand-alone abstract types is further specified in a similar manner in clause 6.3.

The need for fields to be present in a message or an abstract type, i.e., the ASN.1 fields that are specified as OPTIONAL in the abstract notation (ASN.1), is specified by means of comment text tags attached to the OPTIONAL statement in the abstract syntax. All comment text tags are available for use in the downlink direction only. The meaning of each tag is specified in table 6.1-1.

**Table 6.1-1: Meaning of abbreviations used to specify the need for fields to be present**

Abbreviation	Meaning
Cond <i>conditionTag</i> (Used in downlink only)	<i>Conditionally present</i> A field for which the need is specified by means of conditions. For each <i>conditionTag</i> , the need is specified in a tabular form following the ASN.1 segment. In case, according to the conditions, a field is not present, the UE takes no action and where applicable shall continue to use the existing value (and/ or the associated functionality) unless explicitly stated otherwise (e.g. in the conditional presence table or in the description of the field itself).
Need OP (Used in downlink only)	<i>Optionally present</i> A field that is optional to signal. For downlink messages, the UE is not required to take any special action on absence of the field beyond what is specified in the procedural text or the field description table following the ASN.1 segment. The UE behaviour on absence should be captured either in the procedural text or in the field description.
Need ON (Used in downlink only)	<i>Optionally present, No action</i> A field that is optional to signal. If the message is received by the UE, and in case the field is absent, the UE takes no action and where applicable shall continue to use the existing value (and/ or the associated functionality).

Abbreviation	Meaning
Need OR (Used in downlink only)	<i>Optionally present, Release</i> A field that is optional to signal. If the message is received by the UE, and in case the field is absent, the UE shall discontinue/ stop using/ delete any existing value (and/ or the associated functionality).

Any field with Need ON in system information shall be interpreted as Need OR.

Need codes may not be specified for a parent extension field/ extension group, used in downlink, which includes one or more child extension fields. Upon absence of such a parent extension field/ extension group, the UE shall:

- For each individual child extension field, including extensions that are mandatory to include in the optional group, act in accordance with the need code that is defined for the extension;
- Apply this behaviour not only for child extension fields included directly within the optional parent extension field/ extension group, but also for extension fields defined at further nesting levels as long as for none of the fields in-between the concerned extension field and the parent extension field a need code is specified;

NOTE 1: The above applies for groups of non critical extensions using double brackets (referred to as extension groups), as well as non-critical extensions at the end of a message or at the end of a structure contained in a BIT STRING or OCTET STRING (referred to as parent extension fields).

Need codes, conditions and ASN.1 defaults specified for a particular (child) field only apply in case the (parent) field including the particular field is present. This rule does not apply for optional parent extension fields/ extension groups without need codes,

NOTE 2: The previous rule implies that E-UTRAN has to include such a parent extension field to release a child field that is either:

- Optional with need OR, or
- Conditional while the UE releases the child field when absent.

The handling of need codes as specified in the previous is illustrated by means of an example, as shown in the following ASN.1.

```
-- /example/ ASN1START
RRCMessage-r8-IEs ::= SEQUENCE {
    field1 InformationElement1,
    field2 InformationElement2 OPTIONAL, -- Need ON
    nonCriticalExtension RRCMessage-v8a0-IEs OPTIONAL
}
RRCMessage-v8a0-IEs ::= SEQUENCE {
    field3 InformationElement3 OPTIONAL, -- Need ON
    nonCriticalExtension RRCMessage-v940-IEs OPTIONAL
}
RRCMessage-v940-IEs ::= SEQUENCE {
    field4 InformationElement4 OPTIONAL, -- Need OR
    nonCriticalExtension SEQUENCE {} OPTIONAL
}
InformationElement1 ::= SEQUENCE {
    field11 InformationElement11 OPTIONAL, -- Need ON
    field12 InformationElement12 OPTIONAL, -- Need OR
    ...
    [[ field13 InformationElement13 OPTIONAL, -- Need OR
    field14 InformationElement14 OPTIONAL, -- Need ON
    ]]
}
InformationElement2 ::= SEQUENCE {
    field21 InformationElement11 OPTIONAL, -- Need OR
    ...
}
-- ASN1STOP
```

The handling of need codes as specified in the previous implies that:

- if *field2* in *RRCMessage-r8-IEs* is absent, the UE does not modify *field21*;
- if *field2* in *RRCMessage-r8-IEs* is present but does not include *field21*, the UE releases *field21*;
- if the extension group containing *field13* is absent, the UE releases *field13* and does not modify *field14*;
- if *nonCriticalExtension* defined by IE *RRCMessage-v8a0-IEs* is absent, the UE does not modify *field3* and releases *field4*;

In the ASN.1 of this specification, the first bit of a bit string refers to the leftmost bit, unless stated otherwise.

## 6.2 RRC messages

NOTE: The messages included in this clause reflect the current status of the discussions. Additional messages may be included at a later stage.

### 6.2.1 General message structure

#### – *EUTRA-RRC-Definitions*

This ASN.1 segment is the start of the E-UTRA RRC PDU definitions.

```
-- ASN1START
EUTRA-RRC-Definitions DEFINITIONS AUTOMATIC TAGS ::=
BEGIN
-- ASN1STOP
```

#### – *BCCH-BCH-Message*

The *BCCH-BCH-Message* class is the set of RRC messages that may be sent from the E-UTRAN to the UE via BCH on the BCCH logical channel.

```
-- ASN1START
BCCH-BCH-Message ::= SEQUENCE {
    message                BCCH-BCH-MessageType
}
BCCH-BCH-MessageType ::=
    MasterInformationBlock
-- ASN1STOP
```

#### – *BCCH-BCH-Message-MBMS*

The *BCCH-BCH-Message-MBMS* class is the set of RRC messages that may be sent from the E-UTRAN to the UE via BCH on the BCCH logical channel in an MBMS-dedicated cell.

```
-- ASN1START
BCCH-BCH-Message-MBMS ::= SEQUENCE {
    message                BCCH-BCH-MessageType-MBMS-r14
}
BCCH-BCH-MessageType-MBMS-r14 ::=
    MasterInformationBlock-MBMS-r14
-- ASN1STOP
```

## – *BCCH-DL-SCH-Message*

The *BCCH-DL-SCH-Message* class is the set of RRC messages that may be sent from the E-UTRAN to the UE via DL-SCH on the BCCH logical channel.

```
-- ASN1START
BCCH-DL-SCH-Message ::= SEQUENCE {
    message          BCCH-DL-SCH-MessageType
}
BCCH-DL-SCH-MessageType ::= CHOICE {
    c1              CHOICE {
        systemInformation          SystemInformation,
        systemInformationBlockType1 SystemInformationBlockType1
    },
    messageClassExtension SEQUENCE {}
}
-- ASN1STOP
```

## – *BCCH-DL-SCH-Message-BR*

The *BCCH-DL-SCH-Message-BR* class is the set of RRC messages that may be sent from the E-UTRAN to the UE via DL-SCH on the BR-BCCH logical channel.

```
-- ASN1START
BCCH-DL-SCH-Message-BR ::= SEQUENCE {
    message          BCCH-DL-SCH-MessageType-BR-r13
}
BCCH-DL-SCH-MessageType-BR-r13 ::= CHOICE {
    c1              CHOICE {
        systemInformation-BR-r13          SystemInformation-BR-r13,
        systemInformationBlockType1-BR-r13 SystemInformationBlockType1-BR-r13
    },
    messageClassExtension SEQUENCE {}
}
-- ASN1STOP
```

## – *BCCH-DL-SCH-Message-MBMS*

The *BCCH-DL-SCH-Message-MBMS* class is the set of RRC messages that may be sent from the E-UTRAN to the UE via DL-SCH on the BCCH logical channel in an MBMS-dedicated cell.

```
-- ASN1START
BCCH-DL-SCH-Message-MBMS ::= SEQUENCE {
    message          BCCH-DL-SCH-MessageType-MBMS-r14
}
BCCH-DL-SCH-MessageType-MBMS-r14 ::= CHOICE {
    c1              CHOICE {
        systemInformation-MBMS-r14          SystemInformation-MBMS-r14,
        systemInformationBlockType1-MBMS-r14 SystemInformationBlockType1-MBMS-r14
    },
    messageClassExtension SEQUENCE {}
}
-- ASN1STOP
```

## – *MCCH-Message*

The *MCCH-Message* class is the set of RRC messages that may be sent from the E-UTRAN to the UE on the MCCH logical channel.

```

-- ASN1START
MCCH-Message ::= SEQUENCE {
  message          MCCH-MessageType
}
MCCH-MessageType ::= CHOICE {
  c1               CHOICE {
    mbsfnAreaConfiguration-r9      MBSFNAreaConfiguration-r9
  },
  later
  c2               CHOICE {
    mbmsCountingRequest-r10       MBMSCountingRequest-r10
  },
  messageClassExtension SEQUENCE {}
}
-- ASN1STOP

```

### – *PCCH-Message*

The *PCCH-Message* class is the set of RRC messages that may be sent from the E-UTRAN to the UE on the PCCH logical channel.

```

-- ASN1START
PCCH-Message ::= SEQUENCE {
  message          PCCH-MessageType
}
PCCH-MessageType ::= CHOICE {
  c1               CHOICE {
    paging          Paging
  },
  messageClassExtension SEQUENCE {}
}
-- ASN1STOP

```

### – *DL-CCCH-Message*

The *DL-CCCH-Message* class is the set of RRC messages that may be sent from the E-UTRAN to the UE on the downlink CCCH logical channel.

```

-- ASN1START
DL-CCCH-Message ::= SEQUENCE {
  message          DL-CCCH-MessageType
}
DL-CCCH-MessageType ::= CHOICE {
  c1               CHOICE {
    rrcConnectionReestablishment      RRCConnectionReestablishment,
    rrcConnectionReestablishmentReject RRCConnectionReestablishmentReject,
    rrcConnectionReject                RRCConnectionReject,
    rrcConnectionSetup                 RRCConnectionSetup
  },
  messageClassExtension CHOICE {
    c2               CHOICE {
      rrcEarlyDataComplete-r15        RRCEarlyDataComplete-r15,
      spare3 NULL, spare2 NULL, spare1 NULL
    },
    messageClassExtensionFuture-r15    SEQUENCE {}
  }
}
-- ASN1STOP

```

## – DL-DCCH-Message

The *DL-DCCH-Message* class is the set of RRC messages that may be sent from the E-UTRAN to the UE or from the E-UTRAN to the RN on the downlink DCCH logical channel.

```
-- ASN1START
DL-DCCH-Message ::= SEQUENCE {
    message                DL-DCCH-MessageType
}

DL-DCCH-MessageType ::= CHOICE {
    c1                    CHOICE {
        csfbParametersResponseCDMA2000    CSFBParametersResponseCDMA2000,
        dlInformationTransfer              DLInformationTransfer,
        handoverFromEUTRAPreparationRequest HandoverFromEUTRAPreparationRequest,
        mobilityFromEUTRACCommand         MobilityFromEUTRACCommand,
        rrcConnectionReconfiguration      RRCConnectionReconfiguration,
        rrcConnectionRelease              RRCConnectionRelease,
        securityModeCommand                SecurityModeCommand,
        ueCapabilityEnquiry                UECapabilityEnquiry,
        counterCheck                       CounterCheck,
        ueInformationRequest-r9            UEInformationRequest-r9,
        loggedMeasurementConfiguration-r10 LoggedMeasurementConfiguration-r10,
        rnReconfiguration-r10              RNReconfiguration-r10,
        rrcConnectionResume-r13           RRCConnectionResume-r13,
        dlDedicatedMessageSegment-r16     DLDedicatedMessageSegment-r16,
        spare2 NULL, spare1 NULL
    },
    messageClassExtension SEQUENCE {}
}

-- ASN1STOP
```

## – UL-CCCH-Message

The *UL-CCCH-Message* class is the set of RRC messages that may be sent from the UE to the E-UTRAN on the uplink CCCH logical channel.

```
-- ASN1START
UL-CCCH-Message ::= SEQUENCE {
    message                UL-CCCH-MessageType
}

UL-CCCH-MessageType ::= CHOICE {
    c1                    CHOICE {
        rrcConnectionReestablishmentRequest RRCConnectionReestablishmentRequest,
        rrcConnectionRequest                RRCConnectionRequest
    },
    messageClassExtension CHOICE {
        c2                    CHOICE {
            rrcConnectionResumeRequest-r13 RRCConnectionResumeRequest-r13
        },
        messageClassExtensionFuture-r13 CHOICE {
            c3                    CHOICE {
                rrcEarlyDataRequest-r15 RRCEarlyDataRequest-r15,
                spare3 NULL, spare2 NULL, spare1 NULL
            },
            messageClassExtensionFuture-r15 SEQUENCE {}
        }
    }
}

-- ASN1STOP
```

## – UL-DCCH-Message

The *UL-DCCH-Message* class is the set of RRC messages that may be sent from the UE to the E-UTRAN or from the RN to the E-UTRAN on the uplink DCCH logical channel.

```

-- ASN1START
UL-DCCH-Message ::= SEQUENCE {
    message          UL-DCCH-MessageType
}

UL-DCCH-MessageType ::= CHOICE {
    c1                CHOICE {
        csfbParametersRequestCDMA2000          CSFBParametersRequestCDMA2000,
        measurementReport                      MeasurementReport,
        rrcConnectionReconfigurationComplete   RRCConnectionReconfigurationComplete,
        rrcConnectionReestablishmentComplete  RRCConnectionReestablishmentComplete,
        rrcConnectionSetupComplete           RRCConnectionSetupComplete,
        securityModeComplete                  SecurityModeComplete,
        securityModeFailure                   SecurityModeFailure,
        ueCapabilityInformation                UECapabilityInformation,
        ulHandoverPreparationTransfer          ULHandoverPreparationTransfer,
        ulInformationTransfer                  ULInformationTransfer,
        counterCheckResponse                   CounterCheckResponse,
        ueInformationResponse-r9               UEInformationResponse-r9,
        proximityIndication-r9                 ProximityIndication-r9,
        rnReconfigurationComplete-r10         RNReconfigurationComplete-r10,
        mbmsCountingResponse-r10              MBMSCountingResponse-r10,
        interFreqRSTDMeasurementIndication-r10 InterFreqRSTDMeasurementIndication-r10
    },
    messageClassExtension CHOICE {
        c2                CHOICE {
            ueAssistanceInformation-r11          UEAssistanceInformation-r11,
            inDeviceCoexIndication-r11           InDeviceCoexIndication-r11,
            mbmsInterestIndication-r11           MBMSInterestIndication-r11,
            scgFailureInformation-r12            SCGFailureInformation-r12,
            sidelinkUEInformation-r12           SidelinkUEInformation-r12,
            wlanConnectionStatusReport-r13       WLANConnectionStatusReport-r13,
            rrcConnectionResumeComplete-r13     RRCConnectionResumeComplete-r13,
            ulInformationTransferMRDC-r15        ULInformationTransferMRDC-r15,
            scgFailureInformationNR-r15         SCGFailureInformationNR-r15,
            measReportAppLayer-r15              MeasReportAppLayer-r15,
            failureInformation-r15              FailureInformation-r15,
            ulDedicatedMessageSegment-r16       ULDedicatedMessageSegment-r16,
            purConfigurationRequest-r16         PURConfigurationRequest-r16,
            failureInformation-r16              FailureInformation-r16,
            mcgFailureInformation-r16           MCGFailureInformation-r16,
            ulInformationTransferIRAT-r16        ULInformationTransferIRAT-r16
        },
        messageClassExtensionFuture-r11
    }
    SEQUENCE {}
}
-- ASN1STOP

```

## – SC-MCCH-Message

The *SC-MCCH-Message* class is the set of RRC messages that may be sent from the E-UTRAN to the UE on the SC-MCCH logical channel.

```

-- ASN1START
SC-MCCH-Message-r13 ::= SEQUENCE {
    message          SC-MCCH-MessageType-r13
}

SC-MCCH-MessageType-r13 ::= CHOICE {
    c1                CHOICE {
        scptmConfiguration-r13          SCPTMConfiguration-r13
    },
    messageClassExtension CHOICE {
        c2                CHOICE {
            scptmConfiguration-BR-r14    SCPTMConfiguration-BR-r14,
            spare                    NULL
        },
        messageClassExtensionFuture-r14 SEQUENCE {}
    }
}

```

```
-- ASN1STOP
```

## 6.2.2 Message definitions

### – CounterCheck

The *CounterCheck* message is used by the E-UTRAN to indicate the current COUNT MSB values associated to each DRB and to request the UE to compare these to its COUNT MSB values and to report the comparison results to E-UTRAN.

Signalling radio bearer: SRB1

RLC-SAP: AM

Logical channel: DCCH

Direction: E-UTRAN to UE

#### CounterCheck message

```
-- ASN1START
CounterCheck ::= SEQUENCE {
  rrc-TransactionIdentifier RRC-TransactionIdentifier,
  criticalExtensions CHOICE {
    cl CHOICE {
      counterCheck-r8 CounterCheck-r8-IEs,
      spare3 NULL, spare2 NULL, spare1 NULL
    },
    criticalExtensionsFuture SEQUENCE {}
  }
}

CounterCheck-r8-IEs ::= SEQUENCE {
  drb-CountMSB-InfoList DRB-CountMSB-InfoList,
  nonCriticalExtension CounterCheck-v8a0-IEs OPTIONAL
}

CounterCheck-v8a0-IEs ::= SEQUENCE {
  lateNonCriticalExtension OCTET STRING OPTIONAL,
  nonCriticalExtension CounterCheck-v1530-IEs OPTIONAL
}

CounterCheck-v1530-IEs ::= SEQUENCE {
  drb-CountMSB-InfoListExt-r15 DRB-CountMSB-InfoListExt-r15 OPTIONAL, -- Need ON
  nonCriticalExtension SEQUENCE {} OPTIONAL
}

DRB-CountMSB-InfoList ::= SEQUENCE (SIZE (1..maxDRB)) OF DRB-CountMSB-Info

DRB-CountMSB-InfoListExt-r15 ::= SEQUENCE (SIZE (1..maxDRBExt-r15)) OF DRB-CountMSB-Info

DRB-CountMSB-Info ::= SEQUENCE {
  drb-Identity DRB-Identity,
  countMSB-Uplink INTEGER(0..33554431),
  countMSB-Downlink INTEGER(0..33554431)
}
-- ASN1STOP
```



<b>CounterCheck field descriptions</b>
<p><b>count-MSB-Downlink</b> If configured with E-UTRA PDCP, it indicates the value of 25 MSBs from downlink COUNT associated to this DRB. If configured with NR PDCP, it indicates the value of 25 MSBs from RX_NEXT – 1 (specified in TS 38.323 [83]) associated to this DRB.</p>
<p><b>count-MSB-Uplink</b> If configured with E-UTRA PDCP, it indicates the value of 25 MSBs from uplink COUNT associated to this DRB. If configured with NR PDCP, it indicates the value of 25 MSBs from TX_NEXT – 1 (specified in TS 38.323 [83]) associated to this DRB.</p>
<p><b>drb-CountMSB-InfoList</b> Indicates the MSBs of the COUNT values of the DRBs.</p>

## – CounterCheckResponse

The *CounterCheckResponse* message is used by the UE to respond to a *CounterCheck* message.

Signalling radio bearer: SRB1

RLC-SAP: AM

Logical channel: DCCH

Direction: UE to E-UTRAN

### **CounterCheckResponse message**

```

-- ASN1START
CounterCheckResponse ::= SEQUENCE {
    rrc-TransactionIdentifier RRC-TransactionIdentifier,
    criticalExtensions CHOICE {
        counterCheckResponse-r8 CounterCheckResponse-r8-IEs,
        criticalExtensionsFuture SEQUENCE {}
    }
}

CounterCheckResponse-r8-IEs ::= SEQUENCE {
    drb-CountInfoList DRB-CountInfoList,
    nonCriticalExtension CounterCheckResponse-v8a0-IEs OPTIONAL
}

CounterCheckResponse-v8a0-IEs ::= SEQUENCE {
    lateNonCriticalExtension OCTET STRING OPTIONAL,
    nonCriticalExtension CounterCheckResponse-v1530-IEs OPTIONAL
}

CounterCheckResponse-v1530-IEs ::= SEQUENCE {
    drb-CountInfoListExt-r15 DRB-CountInfoListExt-r15 OPTIONAL,
    nonCriticalExtension SEQUENCE {} OPTIONAL
}

DRB-CountInfoList ::= SEQUENCE (SIZE (0..maxDRB)) OF DRB-CountInfo

DRB-CountInfoListExt-r15 ::= SEQUENCE (SIZE (1..maxDRBExt-r15)) OF DRB-CountInfo

DRB-CountInfo ::= SEQUENCE {
    drb-Identity DRB-Identity,
    count-Uplink INTEGER(0..4294967295),
    count-Downlink INTEGER(0..4294967295)
}
-- ASN1STOP

```

<b>CounterCheckResponse field descriptions</b>
<b>count-Downlink</b> If configured with E-UTRA PDCP, it indicates the value of downlink COUNT associated to this DRB. If configured with NR PDCP, it indicates the value of RX_NEXT – 1 (specified in TS 38.323 [83]) associated to this DRB.
<b>count-Uplink</b> If configured with E-UTRA PDCP, it indicates the value of uplink COUNT associated to this DRB. If configured with NR PDCP, it indicates the value of TX_NEXT – 1 (specified in TS 38.323 [83]) associated to this DRB.
<b>drb-CountInfoList</b> Indicates the COUNT values of the DRBs.

## – CSFBParametersRequestCDMA2000

The *CSFBParametersRequestCDMA2000* message is used by the UE to obtain the CDMA2000 1xRTT Parameters from the network. The UE needs these parameters to generate the CDMA2000 1xRTT Registration message used to register with the CDMA2000 1xRTT Network which is required to support CSFB to CDMA2000 1xRTT.

Signalling radio bearer: SRB1

RLC-SAP: AM

Logical channel: DCCH

Direction: UE to E-UTRAN

### **CSFBParametersRequestCDMA2000 message**

```
-- ASN1START
CSFBParametersRequestCDMA2000 ::= SEQUENCE {
    criticalExtensions          CHOICE {
        csfbParametersRequestCDMA2000-r8    CSFBParametersRequestCDMA2000-r8-IEs,
        criticalExtensionsFuture             SEQUENCE {}
    }
}
CSFBParametersRequestCDMA2000-r8-IEs ::= SEQUENCE {
    nonCriticalExtension        CSFBParametersRequestCDMA2000-v8a0-IEs OPTIONAL
}
CSFBParametersRequestCDMA2000-v8a0-IEs ::= SEQUENCE {
    lateNonCriticalExtension    OCTET STRING                               OPTIONAL,
    nonCriticalExtension        SEQUENCE {}                               OPTIONAL
}
-- ASN1STOP
```

## – CSFBParametersResponseCDMA2000

The *CSFBParametersResponseCDMA2000* message is used to provide the CDMA2000 1xRTT Parameters to the UE so the UE can register with the CDMA2000 1xRTT Network to support CSFB to CDMA2000 1xRTT.

Signalling radio bearer: SRB1

RLC-SAP: AM

Logical channel: DCCH

Direction: E-UTRAN to UE

### **CSFBParametersResponseCDMA2000 message**

```
-- ASN1START
CSFBParametersResponseCDMA2000 ::= SEQUENCE {
    rrc-TransactionIdentifier    RRC-TransactionIdentifier,
    criticalExtensions           CHOICE {
        csfbParametersResponseCDMA2000-r8    CSFBParametersResponseCDMA2000-r8-IEs,
    }
}
```

```

        criticalExtensionsFuture          SEQUENCE {}
    }
}
CSFBParametersResponseCDMA2000-r8-IEs ::= SEQUENCE {
    rand                                RAND-CDMA2000,
    mobilityParameters                  MobilityParametersCDMA2000,
    nonCriticalExtension                  CSFBParametersResponseCDMA2000-v8a0-IEs OPTIONAL
}
CSFBParametersResponseCDMA2000-v8a0-IEs ::= SEQUENCE {
    lateNonCriticalExtension             OCTET STRING                               OPTIONAL,
    nonCriticalExtension                  SEQUENCE {}                               OPTIONAL
}
-- ASN1STOP

```

### – *DLDedicatedMessageSegment*

The *DLDedicatedMessageSegment* message is used to transfer one segment of the *RRCConnectionResume* or *RRCConnectionReconfiguration* messages.

Signalling radio bearer: SRB1

RLC-SAP: AM

Logical channel: DCCH

Direction: E-UTRAN to UE

### *DLDedicatedMessageSegment* message

```

-- ASN1START
DLDedicatedMessageSegment-r16 ::= SEQUENCE {
    criticalExtensions                CHOICE {
        dlDedicatedMessageSegment-r16 DLDedicatedMessageSegment-r16-IEs,
        criticalExtensionsFuture        SEQUENCE {}
    }
}
DLDedicatedMessageSegment-r16-IEs ::= SEQUENCE {
    segmentNumber-r16                 INTEGER (0..4),
    rrc-MessageSegmentContainer-r16   OCTET STRING,
    rrc-MessageSegmentType-r16        ENUMERATED {notLastSegment, lastSegment},
    lateNonCriticalExtension           OCTET STRING                               OPTIONAL,
    nonCriticalExtension                SEQUENCE {}                               OPTIONAL
}
-- ASN1STOP

```

#### *DLDedicatedMessageSegment* field descriptions

##### ***segmentNumber***

Identifies the sequence number of a segment within the encoded DL DCCH message. The network transmits the segments with continuously increasing *segmentNumber* order so that the UE's RRC layer may expect to obtain them from lower layers in the correct order. Hence, the UE is not required to perform segment re-ordering on RRC level.

##### ***rrc-MessageSegmentContainer***

Includes a segment of the encoded DL DCCH message. The size of the included segment in this container should be small enough so the resulting encoded RRC message PDU is less than or equal to the PDCP SDU size limit.

##### ***rrc-MessageSegmentType***

Indicates whether the included DL DCCH message segment is the last segment of the message or not.

### – *DLInformationTransfer*

The *DLInformationTransfer* message is used for the downlink transfer of NAS, non-3GPP dedicated information, IAB-DU specific F1-C related information, or time reference information.

NOTE: The UE may use the time reference information provided in the *timeReferenceInfo* IE for numerous purposes, possibly involving upper layers e.g. to synchronise the UE clock.

Signalling radio bearer: SRB2 or SRB1. If only *timeReferenceInfo* is included in the message, SRB1 is used.

Otherwise, SRB1 is used only if SRB2 not established yet, and if SRB2 is suspended, E-UTRAN does not send this message until SRB2 is resumed. If only *dedicatedInfoFlc* is included, SRB2 is used.

RLC-SAP: AM

Logical channel: DCCH

Direction: E-UTRAN to UE

### ***DLInformationTransfer* message**

```

-- ASN1START
DLInformationTransfer ::= SEQUENCE {
    rrc-TransactionIdentifier RRC-TransactionIdentifier,
    criticalExtensions CHOICE {
        c1 CHOICE {
            dlInformationTransfer-r8 DLInformationTransfer-r8-IEs,
            dlInformationTransfer-r15 DLInformationTransfer-r15-IEs,
            spare2 NULL, spare1 NULL
        },
        criticalExtensionsFuture SEQUENCE {}
    }
}

DLInformationTransfer-r8-IEs ::= SEQUENCE {
    dedicatedInfoType CHOICE {
        dedicatedInfoNAS DedicatedInfoNAS,
        dedicatedInfoCDMA2000-1XRTT DedicatedInfoCDMA2000,
        dedicatedInfoCDMA2000-HRPD DedicatedInfoCDMA2000
    },
    nonCriticalExtension DLInformationTransfer-v8a0-IEs OPTIONAL
}

DLInformationTransfer-v8a0-IEs ::= SEQUENCE {
    lateNonCriticalExtension OCTET STRING OPTIONAL,
    nonCriticalExtension DLInformationTransfer-v1610-IEs OPTIONAL
}

DLInformationTransfer-r15-IEs ::= SEQUENCE {
    dedicatedInfoType-r15 CHOICE {
        dedicatedInfoNAS DedicatedInfoNAS,
        dedicatedInfoCDMA2000-1XRTT DedicatedInfoCDMA2000,
        dedicatedInfoCDMA2000-HRPD DedicatedInfoCDMA2000
    } OPTIONAL, -- Need ON
    timeReferenceInfo-r15 TimeReferenceInfo-r15 OPTIONAL, -- Need ON
    nonCriticalExtension DLInformationTransfer-v8a0-IEs OPTIONAL
}

DLInformationTransfer-v1610-IEs ::= SEQUENCE {
    dedicatedInfoFlc-r16 DedicatedInfoFlc-r16 OPTIONAL, -- Need ON
    nonCriticalExtension SEQUENCE {} OPTIONAL
}
-- ASN1STOP

```

### ***FailureInformation***

The *FailureInformation* message is used to provide information regarding failures detected by the UE, e.g. radio link failure for one of the RLC entities configured with PDCP duplication or failure of a DAPS HO.

Signalling radio bearer: SRB1

RLC-SAP: AM

Logical channel: DCCH

Direction: UE to E-UTRAN

### FailureInformation message

```
-- ASN1START
FailureInformation-r15 ::= SEQUENCE {
    failedLogicalChannelInfo-r15 FailedLogicalChannelInfo-r15 OPTIONAL
    -- nonCriticalExtension is removed in this version as OPTIONAL was missing
}

FailureInformation-r16 ::= SEQUENCE {
    criticalExtensions CHOICE {
        failureInformation-r16 FailureInformation-r16-IEs,
        criticalExtensionsFuture SEQUENCE {}
    }
}

FailedLogicalChannelInfo-r15 ::= SEQUENCE {
    failedLogicalChannelIdentity-r15 SEQUENCE {
        cellGroupIndication-r15 ENUMERATED {mn, sn},
        logicalChannelIdentity-r15 INTEGER (1..10) OPTIONAL,
        logicalChannelIdentityExt-r15 INTEGER (32..38) OPTIONAL
    },
    failureType ENUMERATED {duplication, spare3, spare2, spare1}
}

FailureInformation-r16-IEs ::= SEQUENCE {
    failedLogicalChannelIdentity-r16 FailedLogicalChannelIdentity-r16 OPTIONAL,
    failureType-r16 ENUMERATED {duplication, dapsHO-failure, spare2, spare1} OPTIONAL,
    nonCriticalExtension SEQUENCE {} OPTIONAL
}

FailedLogicalChannelIdentity-r16 ::= SEQUENCE {
    cellGroupIndication-r16 ENUMERATED {mn, sn},
    logicalChannelIdentity-r16 INTEGER (1..10) OPTIONAL,
    logicalChannelIdentityExt-r16 INTEGER (32..38) OPTIONAL
}
-- ASN1STOP
```

#### FailureInformation field descriptions

##### **cellGroupIndication**

This field indicates the cell group (MCG, SCG) of the RLC entity for which the PDCP duplication failure occurred.

##### **failureType**

This field indicates the type of failure reported. Value *duplication* indicates that a radio link failure for one of the RLC entities configured with PDCP duplication has been detected. Value *dapsHO-failure* indicates that timer T304 expired during a DAPS HO.

##### **logicalChannelIdentity, logicalChannelIdentityExt**

This field indicates the logical channel identity of the RLC entity for which the PDCP duplication failure occurred.

NOTE: The UE may apply the *FailureInformation-r16* message to report a failure defined in REL-15, but only if it is configured with a feature incorporating a failure that can only be reported by the *FailureInformation-r16* message.

### HandoverFromEUTRAPreparationRequest (CDMA2000)

The *HandoverFromEUTRAPreparationRequest* message is used to trigger the handover preparation procedure with a CDMA2000 RAT. This message is also used to trigger a tunneled preparation procedure with a CDMA2000 1xRTT RAT to obtain traffic channel resources for the enhanced CS fallback to CDMA2000 1xRTT, which may also involve a

concurrent preparation for handover to CDMA2000 HRPD. Also, this message is used to trigger the dual Rx/Tx redirection procedure with a CDMA2000 1xRTT RAT.

Signalling radio bearer: SRB1

RLC-SAP: AM

Logical channel: DCCH

Direction: E-UTRAN to UE

**HandoverFromEUTRAPreparationRequest message**

```
-- ASN1START
HandoverFromEUTRAPreparationRequest ::= SEQUENCE {
    rrc-TransactionIdentifier      RRC-TransactionIdentifier,
    criticalExtensions             CHOICE {
        c1                        CHOICE {
            handoverFromEUTRAPreparationRequest-r8      HandoverFromEUTRAPreparationRequest-r8-IEs,
            spare3 NULL, spare2 NULL, spare1 NULL
        },
        criticalExtensionsFuture      SEQUENCE {}
    }
}

HandoverFromEUTRAPreparationRequest-r8-IEs ::= SEQUENCE {
    cdma2000-Type                  CDMA2000-Type,
    rand                           RAND-CDMA2000                OPTIONAL, -- Cond cdma2000-Type
    mobilityParameters             MobilityParametersCDMA2000  OPTIONAL, -- Cond cdma2000-Type
    nonCriticalExtension            HandoverFromEUTRAPreparationRequest-v890-IEs  OPTIONAL
}

HandoverFromEUTRAPreparationRequest-v890-IEs ::= SEQUENCE {
    lateNonCriticalExtension        OCTET STRING                OPTIONAL,
    nonCriticalExtension            HandoverFromEUTRAPreparationRequest-v920-IEs  OPTIONAL
}

HandoverFromEUTRAPreparationRequest-v920-IEs ::= SEQUENCE {
    concurrPrepCDMA2000-HRPD-r9    BOOLEAN                    OPTIONAL, -- Cond cdma2000-Type
    nonCriticalExtension            HandoverFromEUTRAPreparationRequest-v1020-IEs  OPTIONAL
}

HandoverFromEUTRAPreparationRequest-v1020-IEs ::= SEQUENCE {
    dualRxTxRedirectIndicator-r10   ENUMERATED {true}         OPTIONAL, -- Cond cdma2000-1XRTT
    redirectCarrierCDMA2000-1XRTT-r10  CarrierFreqCDMA2000    OPTIONAL, -- Cond dualRxTxRedirect
    nonCriticalExtension            SEQUENCE {}                    OPTIONAL
}
-- ASN1STOP
```

<b>HandoverFromEUTRAPreparationRequest field descriptions</b>	
<b>concurrPrepCDMA2000-HRPD</b>	Value TRUE indicates that upper layers should initiate concurrent preparation for handover to CDMA2000 HRPD in addition to preparation for enhanced CS fallback to CDMA2000 1xRTT.
<b>dualRxTxRedirectIndicator</b>	Value TRUE indicates that the second radio of the dual Rx/Tx UE is being redirected to CDMA2000 1xRTT, as specified in TS 23.272 [51].
<b>redirectCarrierCDMA2000-1XRTT</b>	Used to indicate the CDMA2000 1xRTT carrier frequency where the UE is being redirected to.

<b>Conditional presence</b>	<b>Explanation</b>
<i>cdma2000-1XRTT</i>	The field is optionally present, need ON, if the <i>cdma2000-Type = type1XRTT</i> ; otherwise it is not present.
<i>cdma2000-Type</i>	The field is mandatory present if the <i>cdma2000-Type = type1XRTT</i> ; otherwise it is not present.
<i>dualRxTxRedirect</i>	The field is optionally present, need ON, if <i>dualRxTxRedirectIndicator</i> is present; otherwise it is not present.

– *InDeviceCoexIndication*

The *InDeviceCoexIndication* message is used to inform E-UTRAN about IDC problems which can not be solved by the UE itself, as well as to provide information that may assist E-UTRAN when resolving these problems.

Signalling radio bearer: SRB1

RLC-SAP: AM

Logical channel: DCCH

Direction: UE to E-UTRAN

***InDeviceCoexIndication message***

```
-- ASN1START

InDeviceCoexIndication-r11 ::= SEQUENCE {
    criticalExtensions          CHOICE {
        cl                     CHOICE {
            inDeviceCoexIndication-r11          InDeviceCoexIndication-r11-IEs,
            spare3 NULL, spare2 NULL, spare1 NULL
        },
        criticalExtensionsFuture          SEQUENCE {}
    }
}

InDeviceCoexIndication-r11-IEs ::= SEQUENCE {
    affectedCarrierFreqList-r11          AffectedCarrierFreqList-r11          OPTIONAL,
    tdm-AssistanceInfo-r11              TDM-AssistanceInfo-r11              OPTIONAL,
    lateNonCriticalExtension            OCTET STRING                      OPTIONAL,
    nonCriticalExtension                InDeviceCoexIndication-v11d0-IEs          OPTIONAL
}

InDeviceCoexIndication-v11d0-IEs ::= SEQUENCE {
    ul-CA-AssistanceInfo-r11            SEQUENCE {
        affectedCarrierFreqCombList-r11          AffectedCarrierFreqCombList-r11          OPTIONAL,
        victimSystemType-r11                    VictimSystemType-r11
    }
    nonCriticalExtension                InDeviceCoexIndication-v1310-IEs          OPTIONAL
}

InDeviceCoexIndication-v1310-IEs ::= SEQUENCE {
    affectedCarrierFreqList-v1310          AffectedCarrierFreqList-v1310          OPTIONAL,
    affectedCarrierFreqCombList-r13       AffectedCarrierFreqCombList-r13       OPTIONAL,
    nonCriticalExtension                InDeviceCoexIndication-v1360-IEs          OPTIONAL
}

InDeviceCoexIndication-v1360-IEs ::= SEQUENCE {
    hardwareSharingProblem-r13            ENUMERATED {true}                      OPTIONAL,
    nonCriticalExtension                InDeviceCoexIndication-v1530-IEs          OPTIONAL
}

InDeviceCoexIndication-v1530-IEs ::= SEQUENCE {
    mrdc-AssistanceInfo-r15              MRDC-AssistanceInfo-r15              OPTIONAL,
    nonCriticalExtension                InDeviceCoexIndication-v1610-IEs          OPTIONAL
}

InDeviceCoexIndication-v1610-IEs ::= SEQUENCE {
    victimSystemType-v1610              VictimSystemType-v1610              OPTIONAL,
    nonCriticalExtension                SEQUENCE {}                            OPTIONAL
}

AffectedCarrierFreqList-r11 ::= SEQUENCE (SIZE (1..maxFreqIDC-r11)) OF AffectedCarrierFreq-r11
AffectedCarrierFreqList-v1310 ::= SEQUENCE (SIZE (1..maxFreqIDC-r11)) OF AffectedCarrierFreq-v1310
AffectedCarrierFreq-r11 ::= SEQUENCE {
    carrierFreq-r11                      MeasObjectId,
    interferenceDirection-r11            ENUMERATED {eutra, other, both, spare}
}

AffectedCarrierFreq-v1310 ::= SEQUENCE {
    carrierFreq-v1310                    MeasObjectId-v1310                    OPTIONAL
}

-- ASN1END
```

```

AffectedCarrierFreqCombList-r11 ::= SEQUENCE (SIZE (1..maxCombIDC-r11)) OF AffectedCarrierFreqComb-
r11

AffectedCarrierFreqCombList-r13 ::= SEQUENCE (SIZE (1..maxCombIDC-r11)) OF AffectedCarrierFreqComb-
r13

AffectedCarrierFreqComb-r11 ::= SEQUENCE (SIZE (2..maxServCell-r10)) OF MeasObjectId
AffectedCarrierFreqComb-r13 ::= SEQUENCE (SIZE (2..maxServCell-r13)) OF MeasObjectId-r13

TDM-AssistanceInfo-r11 ::= CHOICE {
    drx-AssistanceInfo-r11          SEQUENCE {
        drx-CycleLength-r11        ENUMERATED {sf40, sf64, sf80, sf128, sf160,
                                         sf256, spare2, spare1},
        drx-Offset-r11             INTEGER (0..255) OPTIONAL,
        drx-ActiveTime-r11        ENUMERATED {sf20, sf30, sf40, sf60, sf80,
                                         sf100, spare2, spare1}
    },
    idc-SubframePatternList-r11    IDC-SubframePatternList-r11,
    ...
}

IDC-SubframePatternList-r11 ::= SEQUENCE (SIZE (1..maxSubframePatternIDC-r11)) OF IDC-
SubframePattern-r11

IDC-SubframePattern-r11 ::= CHOICE {
    subframePatternFDD-r11         BIT STRING (SIZE (4)),
    subframePatternTDD-r11        CHOICE {
        subframeConfig0-r11       BIT STRING (SIZE (70)),
        subframeConfig1-5-r11    BIT STRING (SIZE (10)),
        subframeConfig6-r11      BIT STRING (SIZE (60))
    },
    ...
}

VictimSystemType-r11 ::= SEQUENCE {
    gps-r11                        ENUMERATED {true} OPTIONAL,
    glonass-r11                   ENUMERATED {true} OPTIONAL,
    bds-r11                       ENUMERATED {true} OPTIONAL,
    galileo-r11                   ENUMERATED {true} OPTIONAL,
    wlan-r11                      ENUMERATED {true} OPTIONAL,
    bluetooth-r11                 ENUMERATED {true} OPTIONAL
}

VictimSystemType-v1610 ::= SEQUENCE {
    navic-r16                      ENUMERATED {true} OPTIONAL
}

MRDC-AssistanceInfo-r15 ::= SEQUENCE {
    affectedCarrierFreqCombInfoListMRDC-r15 SEQUENCE (SIZE (1..maxCombIDC-r11)) OF
AffectedCarrierFreqCombInfoMRDC-r15,
    ...
    [[ affectedCarrierFreqCombInfoListMRDC-v1610 SEQUENCE (SIZE (1..maxCombIDC-r11)) OF
VictimSystemType-v1610
    OPTIONAL
    ]]
}

AffectedCarrierFreqCombInfoMRDC-r15 ::= SEQUENCE {
    victimSystemType-r15           VictimSystemType-r11,
    interferenceDirectionMRDC-r15 ENUMERATED {eutra-nr, nr, other, eutra-nr-other,
nr-other, spare3, spare2, spare1},
    affectedCarrierFreqCombMRDC-r15 SEQUENCE {
        affectedCarrierFreqCombEUTRA-r15 AffectedCarrierFreqComb-r15 OPTIONAL,
        affectedCarrierFreqCombNR-r15    AffectedCarrierFreqCombNR-r15
    }
    OPTIONAL
}

AffectedCarrierFreqComb-r15 ::= SEQUENCE (SIZE (1..maxServCell-r13)) OF MeasObjectId-r13

AffectedCarrierFreqCombNR-r15 ::= SEQUENCE (SIZE (1..maxServCellNR-r15)) OF ARFCN-ValueNR-r15

-- ASN1STOP

```



<b>InDeviceCoexIndication field descriptions</b>
<p><b>AffectedCarrierFreq</b> If <i>carrierFreq-v1310</i> is included, <i>carrierFreq-r11</i> is ignored by eNB.</p>
<p><b>affectedCarrierFreqCombList</b> Indicates a list of E-UTRA carrier frequencies that are affected by IDC problems due to Inter-Modulation Distortion and harmonics from E-UTRA when configured with UL CA. <i>affectedCarrierFreqCombList-r13</i> is used when more than 5 serving cells are configured or affected combinations contain <i>MeasObjectId</i> larger than 32. If <i>affectedCarrierFreqCombList-r13</i> is included, <i>affectedCarrierFreqCombList-r11</i> shall not be included.</p>
<p><b>affectedCarrierFreqCombMRDC</b> Indicates a set of at least one NR carrier frequency and optionally one or more E-UTRA carrier frequency that is affected by IDC problems due to Inter-Modulation Distortion and harmonics when configured with MR-DC.</p>
<p><b>affectedCarrierFreqList</b> List of E-UTRA carrier frequencies affected by IDC problems. If E-UTRAN includes <i>affectedCarrierFreqList-v1310</i> it includes the same number of entries, and listed in the same order, as in <i>affectedCarrierFreqList-r11</i>.</p>
<p><b>drx-ActiveTime</b> Indicates the desired active time that the E-UTRAN is recommended to configure. Value in number of subframes. Value <i>sf20</i> corresponds to 20 subframes, <i>sf30</i> corresponds to 30 subframes and so on.</p>
<p><b>drx-CycleLength</b> Indicates the desired DRX cycle length that the E-UTRAN is recommended to configure. Value in number of subframes. Value <i>sf40</i> corresponds to 40 subframes, <i>sf64</i> corresponds to 64 subframes and so on.</p>
<p><b>drx-Offset</b> Indicates the desired DRX starting offset that the E-UTRAN is recommended to configure. The UE shall set the value of <i>drx-Offset</i> smaller than the value of <i>drx-CycleLength</i>. The starting frame and subframe satisfy the relation: <math>[(SFN * 10) + \text{subframe number}] \text{ modulo } (\text{drx-CycleLength}) = \text{drx-Offset}</math>.</p>
<p><b>hardwareSharingProblem</b> Indicates whether the UE has hardware sharing problems that the UE cannot solve by itself. The field is present (i.e. value <i>true</i>), if the UE has such hardware sharing problems. Otherwise the field is absent.</p>
<p><b>idc-SubframePatternList</b> A list of one or more subframe patterns indicating which HARQ process E-UTRAN is requested to abstain from using. Value 0 indicates that E-UTRAN is requested to abstain from using the subframe. For FDD, the radio frame in which the pattern starts (i.e. the radio frame in which the first/leftmost bit of the <i>subframePatternFDD</i> corresponds to subframe #0) occurs when <math>SFN \bmod 2 = 0</math>. For TDD, the first/leftmost bit corresponds to the subframe #0 of the radio frame satisfying <math>SFN \bmod x = 0</math>, where <i>x</i> is the size of the bit string divided by 10. The UE shall indicate a subframe pattern that follows HARQ time line, as specified in TS 36.213 [23], i.e. if a subframe is set to 1 in the subframe pattern, also the corresponding subframes carrying the potential UL grant, as specified in TS 36.213 [23], clause 8.0, the UL HARQ retransmission, as specified in TS 36.213 [23], clause 8.0, and the DL/UL HARQ feedback, as specified in TS 36.213 [23], clauses 7.3, 8.3 and 9.1.2, shall be set to 1.</p>
<p><b>interferenceDirection</b> Indicates the direction of IDC interference. Value <i>eutra</i> indicates that only E-UTRA is victim of IDC interference, value <i>other</i> indicates that only another radio is victim of IDC interference and value <i>both</i> indicates that both E-UTRA and another radio are victims of IDC interference. The other radio refers to either the ISM radio or GNSS (see TR 36.816 [63]).</p>
<p><b>interferenceDirectionMRDC</b> Indicates the direction of IDC interference. Value <i>eutra-nr</i> indicates E-UTRA and NR is victim, value <i>nr</i> indicates NR, value <i>other</i> indicates other radio system and so on. The other radio refers to either the ISM radio or GNSS (see TR 36.816 [63]).</p>
<p><b>victimSystemType</b> Indicate the list of victim system types to which IDC interference is caused from E-UTRA when configured with UL CA or from E-UTRA and NR when configured with MR-DC. <i>gps</i>, <i>glonass</i>, <i>bds</i>, <i>galileo</i>, and <i>navic</i> indicate the type of GNSS. Value <i>wlan</i> indicates WLAN and value <i>bluetooth</i> indicates Bluetooth.</p>

### – InterFreqRSTDMeasurementIndication

The *InterFreqRSTDMeasurementIndication* message is used to indicate that the UE is going to either start or stop OTDOA inter-frequency RSTD measurement which requires measurement gaps as specified in TS 36.133 [16], clause 8.1.2.6. The *InterFreqRSTDMeasurementIndication* message is also used to indicate to the network that the UE is going to start/stop OTDOA intra-frequency RSTD measurements which require measurement gaps. The *InterFreqRSTDMeasurementIndication* message is also used to indicate to the network the measurement gap that the category M1 or M2 UE prefers to perform RSTD measurements with dense PRS configuration, as specified in TS 36.133 [16], Table 8.1.2.1-3.

Signalling radio bearer: SRB1

RLC-SAP: AM

Logical channel: DCCH

Direction: UE to E-UTRAN

### ***InterFreqRSTDMeasurementIndication message***

```

-- ASN1START
InterFreqRSTDMeasurementIndication-r10 ::= SEQUENCE {
    criticalExtensions          CHOICE {
        c1                     CHOICE {
            interFreqRSTDMeasurementIndication-r10 InterFreqRSTDMeasurementIndication-r10-IEs,
            spare3 NULL, spare2 NULL, spare1 NULL
        },
        criticalExtensionsFuture SEQUENCE {}
    }
}

InterFreqRSTDMeasurementIndication-r10-IEs ::= SEQUENCE {
    rstd-InterFreqIndication-r10 CHOICE {
        start SEQUENCE {
            rstd-InterFreqInfoList-r10 RSTD-InterFreqInfoList-r10
        },
        stop NULL
    },
    lateNonCriticalExtension OCTET STRING OPTIONAL,
    nonCriticalExtension SEQUENCE {} OPTIONAL
}

RSTD-InterFreqInfoList-r10 ::= SEQUENCE (SIZE(1..maxRSTD-Freq-r10)) OF RSTD-InterFreqInfo-r10

RSTD-InterFreqInfo-r10 ::= SEQUENCE {
    carrierFreq-r10 ARFCN-ValueEUTRA,
    measPRS-Offset-r10 INTEGER (0..39),
    ...
    [[ carrierFreq-v1090 ARFCN-ValueEUTRA-v9e0 OPTIONAL
    ]],
    [[ measPRS-Offset-r15 CHOICE {
        rstd0-r15 INTEGER (0..79),
        rstd1-r15 INTEGER (0..159),
        rstd2-r15 INTEGER (0..319),
        rstd3-r15 INTEGER (0..639),
        rstd4-r15 INTEGER (0..1279),
        rstd5-r15 INTEGER (0..159),
        rstd6-r15 INTEGER (0..319),
        rstd7-r15 INTEGER (0..639),
        rstd8-r15 INTEGER (0..1279),
        rstd9-r15 INTEGER (0..319),
        rstd10-r15 INTEGER (0..639),
        rstd11-r15 INTEGER (0..1279),
        rstd12-r15 INTEGER (0..319),
        rstd13-r15 INTEGER (0..639),
        rstd14-r15 INTEGER (0..1279),
        rstd15-r15 INTEGER (0..639),
        rstd16-r15 INTEGER (0..1279),
        rstd17-r15 INTEGER (0..639),
        rstd18-r15 INTEGER (0..1279),
        rstd19-r15 INTEGER (0..639),
        rstd20-r15 INTEGER (0..1279)
    }
    ]],
}
-- ASN1STOP

```

<i>InterFreqRSTDMeasurementIndication</i> field descriptions
<p><b>carrierFreq</b> The EARFCN value of the carrier received from upper layers for which the UE needs to perform the inter-frequency RSTD measurements. If the UE includes <i>carrierFreq-v1090</i>, it shall set <i>carrierFreq-r10</i> to <i>maxEARFCN</i>. In case the UE starts intra-frequency RSTD measurements the <i>carrierFreq</i> indicates the carrier frequency of the serving cell.</p>
<p><b>measPRS-Offset</b> Indicates the requested gap offset for performing inter-frequency or intra-frequency RSTD measurements. It is the smallest subframe offset from the beginning of subframe 0 of SFN=0 of the serving cell of the requested gap for measuring PRS positioning occasions in the carrier frequency <i>carrierFreq</i> for which the UE needs to perform the inter-frequency or intra-frequency RSTD measurements. The PRS positioning occasion information is received from upper layers. The value of <i>measPRS-Offset-r10</i> is obtained by mapping the starting subframe of the PRS positioning occasion in the measured cell onto the corresponding subframe in the serving cell and is calculated as the serving cell's number of subframes from SFN=0 mod 40. If <i>measPRS-Offset-r15</i> is included, the field further indicates the requested gap pattern that the category M1 or M2 UE prefers to perform RSTD measurements with dense PRS configuration, as specified in TS 36.133 [16], Table 8.1.2.1-3, where value <i>rstd0</i> corresponds to Gap Pattern Id <i>rstd0</i>, value <i>rstd1</i> corresponds to Gap Pattern Id <i>rstd1</i> and so on. The value of <i>measPRS-Offset-r15</i> is obtained by mapping the starting subframe of the PRS positioning occasion in the measured cell onto the corresponding subframe in the serving cell and is calculated as the serving cell's number of subframes from SFN=0 mod MGRP corresponding to the requested Gap pattern Id. If <i>measPRS-Offset-r15</i> is included, <i>measPRS-Offset-r10</i> is ignored. The UE shall take into account any additional time required by the UE to start PRS measurements on the other carrier when it does this mapping for determining the <i>measPRS-Offset</i>. NOTE: Figure 6.2.2-1 illustrates the <i>measPRS-Offset</i> field.</p>
<p><b>rstd-InterFreqIndication</b> Indicates the inter-frequency or intra-frequency RSTD measurement action, i.e. the UE is going to start or stop inter-frequency or intra-frequency RSTD measurement.</p>

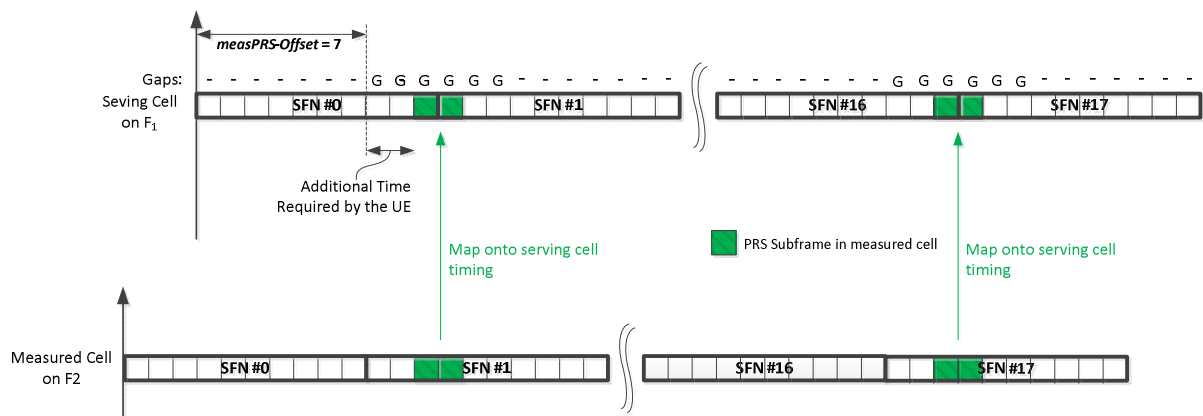

Figure 6.2.2-1 (informative): Exemplary calculation of *measPRS-Offset* field.

– *LoggedMeasurementConfiguration*

The *LoggedMeasurementConfiguration* message is used by E-UTRAN to configure the UE to perform logging of measurement results while in RRC\_IDLE or to perform logging of measurement results for MBSFN while in both RRC\_IDLE and RRC\_CONNECTED. It is used to transfer the logged measurement configuration for network performance optimisation, see TS 37.320 [60].

Signalling radio bearer: SRB1

RLC-SAP: AM

Logical channel: DCCH

Direction: E-UTRAN to UE

**LoggedMeasurementConfiguration message**

```

-- ASN1START
LoggedMeasurementConfiguration-r10 ::= SEQUENCE {
    criticalExtensions          CHOICE {
        c1                     CHOICE {
            loggedMeasurementConfiguration-r10    LoggedMeasurementConfiguration-r10-IEs,
            spare3 NULL, spare2 NULL, spare1 NULL
        },
        criticalExtensionsFuture          SEQUENCE {}
    }
}

LoggedMeasurementConfiguration-r10-IEs ::= SEQUENCE {
    traceReference-r10          TraceReference-r10,
    traceRecordingSessionRef-r10 OCTET STRING (SIZE (2)),
    tce-Id-r10                  OCTET STRING (SIZE (1)),
    absoluteTimeInfo-r10       AbsoluteTimeInfo-r10,
    areaConfiguration-r10      AreaConfiguration-r10          OPTIONAL, -- Need OR
    loggingDuration-r10        LoggingDuration-r10,
    loggingInterval-r10        LoggingInterval-r10,
    nonCriticalExtension        LoggedMeasurementConfiguration-v1080-IEs    OPTIONAL
}

LoggedMeasurementConfiguration-v1080-IEs ::= SEQUENCE {
    lateNonCriticalExtension-r10 OCTET STRING          OPTIONAL,
    nonCriticalExtension          LoggedMeasurementConfiguration-v1130-IEs    OPTIONAL
}

LoggedMeasurementConfiguration-v1130-IEs ::= SEQUENCE {
    plmn-IdentityList-r11       PLMN-IdentityList3-r11    OPTIONAL, -- Need OR
    areaConfiguration-v1130     AreaConfiguration-v1130    OPTIONAL, -- Need OR
    nonCriticalExtension         LoggedMeasurementConfiguration-v1250-IEs    OPTIONAL
}

LoggedMeasurementConfiguration-v1250-IEs ::= SEQUENCE {
    targetMBSFN-AreaList-r12    TargetMBSFN-AreaList-r12    OPTIONAL, -- Need OP
    nonCriticalExtension         LoggedMeasurementConfiguration-v1530-IEs    OPTIONAL
}

LoggedMeasurementConfiguration-v1530-IEs ::= SEQUENCE {
    bt-NameList-r15             BT-NameList-r15          OPTIONAL, --Need OR
    wlan-NameList-r15           WLAN-NameList-r15         OPTIONAL, --Need OR
    nonCriticalExtension         LoggedMeasurementConfiguration-v1700-IEs    OPTIONAL
}

LoggedMeasurementConfiguration-v1700-IEs ::= SEQUENCE {
    loggedEventTriggerConfig-r17 LoggedEventTriggerConfig-r17    OPTIONAL, --Need OR
    measUncomBarPre-r17         ENUMERATED {true}           OPTIONAL, --Need OR
    nonCriticalExtension         LoggedMeasurementConfiguration-v1800-IEs    OPTIONAL
}

LoggedMeasurementConfiguration-v1800-IEs ::= SEQUENCE {
    sigLoggedMeasType-r18       ENUMERATED {true}           OPTIONAL, --Need OR
    nonCriticalExtension         SEQUENCE {}                 OPTIONAL
}

TargetMBSFN-AreaList-r12 ::= SEQUENCE (SIZE (0..maxMBSFN-Area)) OF TargetMBSFN-Area-r12

TargetMBSFN-Area-r12 ::= SEQUENCE {
    mbsfn-AreaId-r12           MBSFN-AreaId-r12          OPTIONAL, -- Need OR
    carrierFreq-r12            ARFCN-ValueEUTRA-r9,
    ...
}

LoggedEventTriggerConfig-r17 ::= SEQUENCE {
    eventType-r17              EventType-r17
}

EventType-r17 ::= CHOICE {
    outOfCoverage              NULL,
    eventL1                    SEQUENCE {
        l1-Threshold-r17       ThresholdEUTRA,
        hysteresis-r17         Hysteresis,
        timeToTrigger-r17      TimeToTrigger
    }
}

```

```

    },
    ...
}
-- ASN1STOP

```

### LoggedMeasurementConfiguration field descriptions

<b>absoluteTimeInfo</b>	Indicates the absolute time in the current cell.
<b>areaConfiguration</b>	Used to restrict the area in which the UE performs measurement logging to cells broadcasting either one of the included cell identities or one of the included tracking area codes/ identities.
<b>eventType</b>	The value <i>outOfCoverage</i> indicates the UE to perform logging of measurements when the UE enters <i>any cell selection</i> state, and the value <i>eventL1</i> indicates the UE to perform logging of measurements when the triggering condition (similar as event A2 as specified in 5.5.4.3) as configured in the event is met for the camping cell in <i>camped normally</i> state.
<b>measUncomBarPre</b>	If configured, the UE attempts to perform the uncompensated Barometric pressure measurement in RRC_IDLE as defined in TS 37.355 [109].
<b>plmn-IdentityList</b>	Indicates a set of PLMNs defining when the UE performs measurement logging as well as the associated status indication and information retrieval i.e. the UE performs these actions when the RPLMN is part of this set of PLMNs.
<b>sigLoggedMeasType</b>	If included, the field indicates a signalling based logged measurement configuration (See TS 37.320 [60]).
<b>targetMBSFN-AreaList</b>	Used to indicate logging of MBSFN measurements and further restrict the area and frequencies for which the UE performs measurement logging for MBSFN. If both MBSFN area id and carrier frequency are present, a specific MBSFN area is indicated. If only carrier frequency is present, all MBSFN areas on that carrier frequency are indicated. If there is no entry in the list, any MBSFN area is indicated.
<b>tce-Id</b>	Parameter Trace Collection Entity Id: See TS 32.422 [58].
<b>traceRecordingSessionRef</b>	Parameter Trace Recording Session Reference: See TS 32.422 [58].

### MasterInformationBlock

The *MasterInformationBlock* includes the system information transmitted on BCH.

Signalling radio bearer: N/A

RLC-SAP: TM

Logical channel: BCCH

Direction: E-UTRAN to UE

### MasterInformationBlock

```

-- ASN1START
MasterInformationBlock ::=
    dl-Bandwidth
    phich-Config
    systemFrameNumber
    schedulingInfoSIB1-BR-r13
    systemInfoUnchanged-BR-r15
    partEARFCN-r17
        spare
        earfcn-LSB
    },
    spare
}
-- ASN1STOP
SEQUENCE {
    ENUMERATED {
        n6, n15, n25, n50, n75, n100},
    PHICH-Config,
    BIT STRING (SIZE (8)),
    INTEGER (0..31),
    BOOLEAN,
    CHOICE {
        BIT STRING (SIZE (2)),
        BIT STRING (SIZE (2))
    },
    BIT STRING (SIZE (1))
}

```

<b>MasterInformationBlock field descriptions</b>
<p><b>dl-Bandwidth</b> Parameter: transmission bandwidth configuration, <math>N_{RB}</math> in downlink, see TS 36.101 [42], table 5.6-1 and TS 36.102 [113], table 5.3A-1. n6 corresponds to 6 resource blocks, n15 to 15 resource blocks and so on.</p>
<p><b>earfcn-LSB</b> Indicates the 2 least significant bits of the EARFCN for NTN bands where 100 kHz raster is used, see TS 36.102 [113].</p>
<p><b>phich-Config</b> Specifies the PHICH configuration. If the UE is a BL UE or UE in CE, it shall ignore this field.</p>
<p><b>schedulingInfoSIB1-BR</b> Indicates the index to the tables that define <i>SystemInformationBlockType1-BR</i> scheduling information. The tables are specified in TS 36.213 [23], Table 7.1.6-1 and Table 7.1.7.2.7-1. Value 0 means that <i>SystemInformationBlockType1-BR</i> is not scheduled.</p>
<p><b>systemFrameNumber</b> Defines the 8 most significant bits of the SFN. As indicated in TS 36.211 [21], 6.6.1, the 2 least significant bits of the SFN are acquired implicitly in the P-BCH decoding, i.e. timing of 40ms P-BCH TTI indicates 2 least significant bits (within 40ms P-BCH TTI, the first radio frame: 00, the second radio frame: 01, the third radio frame: 10, the last radio frame: 11). One value applies for all serving cells of a Cell Group (i.e. MCG or SCG). The associated functionality is common (i.e. not performed independently for each cell).</p>
<p><b>systemInfoUnchanged-BR</b> Value TRUE indicates that no change has occurred in the SIB1-BR and SI messages at least over the SI validity time. NOTE: Value of <i>systemInfoUnchanged-BR</i> is also carried in RSS (if transmitted), see TS 36.211 [21].</p>

## – MasterInformationBlock-MBMS

The *MasterInformationBlock-MBMS* includes the system information transmitted on BCH.

Signalling radio bearer: N/A

RLC-SAP: TM

Logical channel: BCCH

Direction: E-UTRAN to UE

### **MasterInformationBlock-MBMS**

```

-- ASN1START
MasterInformationBlock-MBMS-r14 ::= SEQUENCE {
    dl-Bandwidth-MBMS-r14          ENUMERATED {
                                   n6, n15, n25, n50, n75, n100},
    systemFrameNumber-r14         BIT STRING (SIZE (6)),
    additionalNonMBSFNSubframes-r14 INTEGER (0..3),
    semiStaticCFI-MBMS-r16       INTEGER (0..3),
    spare                          BIT STRING (SIZE (11))
}
-- ASN1STOP

```

<i>MasterInformationBlock-MBMS</i> field descriptions
<p><b><i>additionalNonMBSFNSubframes</i></b> Configures additional non-MBSFN subframes where <i>SystemInformationBlockType1-MBMS</i> and <i>SystemInformation-MBMS</i> may be transmitted. Value 0, 1, 2, 3 mean zero, one, two, three additional non-MBSFN subframes are configured after each subframe which has PBCH.</p>
<p><b><i>dl-Bandwidth-MBMS</i></b> Parameter: transmission bandwidth configuration, <math>N_{RB}</math> in downlink, see TS 36.101 [42], table 5.6-1. <math>n_6</math> corresponds to 6 resource blocks, <math>n_{15}</math> to 15 resource blocks and so on.</p>
<p><b><i>semiStaticCFI-MBMS</i></b> Indicates semi-static value of CFI as specified in TS 36.213 [23], clause 9.1.3. If value 0 is indicated, CFI is obtained from PCFICH, otherwise the UE may assume the CFI in CAS is given by this field.</p>
<p><b><i>systemFrameNumber</i></b> Defines the 6 most significant bits of the SFN of the MBMS-dedicated cell. As indicated in TS 36.211 [21], clause 6.6.1, the 4 least significant bits of the SFN are acquired implicitly in the P-BCH decoding, i.e. timing of 160ms P-BCH TTI indicates 4 least significant bits (within 160ms P-BCH TTI, the first radio frame: 0000, the fifth radio frame: 0100, the ninth radio frame: 1000, the thirteenth radio frame: 1100).</p>

## – *MBMSCountingRequest*

The *MBMSCountingRequest* message is used by E-UTRAN to count the UEs that are receiving or interested to receive specific MBMS services.

Signalling radio bearer: N/A

RLC-SAP: UM

Logical channel: MCCH

Direction: E-UTRAN to UE

### *MBMSCountingRequest* message

```
-- ASN1START
MBMSCountingRequest-r10 ::= SEQUENCE {
    countingRequestList-r10      CountingRequestList-r10,
    lateNonCriticalExtension     OCTET STRING                OPTIONAL,
    nonCriticalExtension         SEQUENCE {}                        OPTIONAL
}
CountingRequestList-r10 ::= SEQUENCE (SIZE (1..maxServiceCount)) OF CountingRequestInfo-r10
CountingRequestInfo-r10 ::= SEQUENCE {
    tmgi-r10                     TMGI-r9,
    ...
}
-- ASN1STOP
```

## – *MBMSCountingResponse*

The *MBMSCountingResponse* message is used by the UE to respond to an *MBMSCountingRequest* message.

Signalling radio bearer: SRB1

RLC-SAP: AM

Logical channel: DCCH

Direction: UE to E-UTRAN

### *MBMSCountingResponse* message

```
-- ASN1START
MBMSCountingResponse-r10 ::= SEQUENCE {
    criticalExtensions          CHOICE {
```

```

        c1
        countingResponse-r10
        spare3 NULL, spare2 NULL, spare1 NULL
    },
    criticalExtensionsFuture
        SEQUENCE {}
}

MBMSCountingResponse-r10-IEs ::= SEQUENCE {
    mbsfn-AreaIndex-r10
        INTEGER (0..maxMBSFN-Area-1)
        OPTIONAL,
    countingResponseList-r10
        CountingResponseList-r10
        OPTIONAL,
    lateNonCriticalExtension
        OCTET STRING
        OPTIONAL,
    nonCriticalExtension
        SEQUENCE {}
        OPTIONAL
}

CountingResponseList-r10 ::= SEQUENCE (SIZE (1..maxServiceCount)) OF CountingResponseInfo-r10

CountingResponseInfo-r10 ::= SEQUENCE {
    countingResponseService-r10
        INTEGER (0..maxServiceCount-1),
    ...
}

-- ASN1STOP

```

#### **MBMSCountingResponse field descriptions**

##### **countingResponseList**

List of MBMS services which the UE is receiving or interested to receive. Value 0 for field *countingResponseService* corresponds to the first entry in *countingRequestList* within *MBMSCountingRequest*, value 1 corresponds to the second entry in this list and so on.

##### **mbsfn-AreaIndex**

Index of the entry in field *mbsfn-AreaInfoList* within *SystemInformationBlockType13*. Value 0 corresponds to the first entry in 1st *mbsfn-AreaInfoList* within *SystemInformationBlockType13*, value 1 corresponds to the second entry in the same list, or when no more entry are present within the same *mbsfn-AreaInfoList*, then the first entry in the subsequent *mbsfn-AreaInfoList* within the same *SystemInformationBlockType13* and so on.

## – **MBMSInterestIndication**

The *MBMSInterestIndication* message is used to inform E-UTRAN that the UE is receiving/ interested to receive or no longer receiving/ interested to receive MBMS via an MRB or SC-MRB including MBMS service(s) in receive only mode.

Signalling radio bearer: SRB1

RLC-SAP: AM

Logical channel: DCCH

Direction: UE to E-UTRAN

#### **MBMSInterestIndication message**

```

-- ASN1START

MBMSInterestIndication-r11 ::= SEQUENCE {
    criticalExtensions
        CHOICE {
            c1
                CHOICE {
                    interestIndication-r11
                        MBMSInterestIndication-r11-IEs,
                    spare3 NULL, spare2 NULL, spare1 NULL
                },
            criticalExtensionsFuture
                SEQUENCE {}
        }
}

MBMSInterestIndication-r11-IEs ::= SEQUENCE {
    mbms-FreqList-r11
        CarrierFreqListMBMS-r11
        OPTIONAL,
    mbms-Priority-r11
        ENUMERATED {true}
        OPTIONAL,
    lateNonCriticalExtension
        OCTET STRING
        OPTIONAL,
    nonCriticalExtension
        MBMSInterestIndication-v1310-IEs
        OPTIONAL
}

MBMSInterestIndication-v1310-IEs ::= SEQUENCE {

```



```

    mbms-Services-r13                MBMS-ServiceList-r13                OPTIONAL,
    nonCriticalExtension              MBMSInterestIndication-v1540-IEs    OPTIONAL
}
MBMSInterestIndication-v1540-IEs ::= SEQUENCE {
    mbms-ROM-InfoList-r15            SEQUENCE (SIZE(1..maxMBMS-ServiceListPerUE-r13)) OF MBMS-ROM-
Info-r15                            OPTIONAL,
    nonCriticalExtension              MBMSInterestIndication-v1610-IEs    OPTIONAL
}
MBMSInterestIndication-v1610-IEs ::= SEQUENCE {
    mbms-ROM-InfoList-r16            SEQUENCE (SIZE(1..maxMBMS-ServiceListPerUE-r13)) OF MBMS-
ROM-Info-r16                        OPTIONAL,
    nonCriticalExtension              SEQUENCE {}                            OPTIONAL
}
MBMS-ROM-Info-r15 ::= SEQUENCE {
    mbms-ROM-Freq-r15                ARFCN-ValueEUTRA-r9,
    mbms-ROM-SubcarrierSpacing-r15   ENUMERATED {kHz15, kHz7dot5, kHz1dot25},
    mbms-Bandwidth-r15               ENUMERATED {n6, n15, n25, n50, n75, n100}
}
MBMS-ROM-Info-r16 ::= SEQUENCE {
    mbms-ROM-Freq-r16                ARFCN-ValueEUTRA-r9,
    mbms-ROM-SubcarrierSpacing-r16   ENUMERATED {kHz2dot5, kHz0dot37},
    mbms-Bandwidth-r16               ENUMERATED {n6, n15, n25, n50, n75, n100}
}
-- ASN1STOP

```

#### **MBMSInterestIndication field descriptions**

##### **mbms-Bandwidth**

Indicates the UE received MBMS service frequency bandwidth configuration,  $N_{RB}$  in downlink, see TS 36.101 [42], table 5.6-1. n6 corresponds to 6 resource blocks, n15 to 15 resource blocks and so on.

##### **mbms-FreqList**

List of MBMS frequencies on which the UE is receiving or interested to receive MBMS via an MRB or SC-MRB.

##### **mbms-Priority**

Indicates whether the UE prioritises MBMS reception above unicast reception. The field is present (i.e. value *true*), if the UE prioritises reception of all listed MBMS frequencies above reception of any of the unicast bearers. Otherwise the field is absent.

##### **mbms-ROM-Freq**

The value indicates the carrier frequency used by the UE to receive MBMS service(s) in receive only mode.

##### **mbms-ROM-InfoList**

List of receive only mode MBMS service(s) related parameters which the UE is receiving or interested to receive.

##### **mbms-ROM-SubcarrierSpacing**

The value indicates subcarrier spacing for MBSFN subframes received by UE in receive only mode and kHz15 refers to 15kHz, kHz7dot5 refers to 7.5kHz subcarrier spacing and so on as defined in TS 36.211 [21], clause 6.12.

## **MBSFNAreaConfiguration**

The *MBSFNAreaConfiguration* message contains the MBMS control information applicable for an MBSFN area. For each MBSFN area included in *SystemInformationBlockType13* E-UTRAN configures an MCCH (i.e. the MCCH identifies the MBSFN area) and signals the *MBSFNAreaConfiguration* message.

Signalling radio bearer: N/A

RLC-SAP: UM

Logical channel: MCCH

Direction: E-UTRAN to UE

#### **MBSFNAreaConfiguration message**

```

-- ASN1START
MBSFNAreaConfiguration-r9 ::= SEQUENCE {
    commonSF-Alloc-r9                CommonSF-AllocPatternList-r9,
    commonSF-AllocPeriod-r9          ENUMERATED {

```

```

        pmch-InfoList-r9          rf4, rf8, rf16, rf32, rf64, rf128, rf256},
        nonCriticalExtension      PMCH-InfoList-r9,
                                  MBSFNAreaConfiguration-v930-IEs OPTIONAL
    }
MBSFNAreaConfiguration-v930-IEs ::= SEQUENCE {
    lateNonCriticalExtension      OCTET STRING                OPTIONAL,
    nonCriticalExtension          MBSFNAreaConfiguration-v1250-IEs OPTIONAL
}
MBSFNAreaConfiguration-v1250-IEs ::= SEQUENCE {
    pmch-InfoListExt-r12         PMCH-InfoListExt-r12        OPTIONAL, -- Need OR
    nonCriticalExtension          MBSFNAreaConfiguration-v1430-IEs OPTIONAL
}
MBSFNAreaConfiguration-v1430-IEs ::= SEQUENCE {
    commonSF-Alloc-v1430         CommonSF-AllocPatternList-v1430,
    nonCriticalExtension          MBSFNAreaConfiguration-v1610-IEs
    OPTIONAL
}
MBSFNAreaConfiguration-v1610-IEs ::= SEQUENCE {
    commonSF-Alloc-v1610         CommonSF-AllocPatternList-v1610    OPTIONAL, -- Need
OR
    nonCriticalExtension          SEQUENCE { }                        OPTIONAL
}
CommonSF-AllocPatternList-r9 ::= SEQUENCE (SIZE (1..maxMBSFN-Allocations)) OF MBSFN-
SubframeConfig
CommonSF-AllocPatternList-v1430 ::= SEQUENCE (SIZE (1..maxMBSFN-Allocations)) OF MBSFN-
SubframeConfig-v1430
CommonSF-AllocPatternList-v1610 ::= SEQUENCE (SIZE (1..maxMBSFN-Allocations)) OF MBSFN-
SubframeConfig-v1610
-- ASN1STOP

```

#### **MBSFNAreaConfiguration field descriptions**

##### **commonSF-Alloc**

Indicates the subframes allocated to the MBSFN area. E-UTRAN always sets this field to cover at least the subframes configured by *SystemInformationBlockType13* for this MCCH, regardless of whether any MBMS sessions are ongoing. E-UTRAN includes *commonSF-Alloc-v1610* only when the cell is a MBMS-dedicated cell. If E-UTRAN includes *commonSF-Alloc-v1430* and/or *commonSF-Alloc-v1610*, it includes the same number of entries, and listed in the same order, as in *commonSF-Alloc-r9*.

##### **commonSF-AllocPeriod**

Indicates the period during which resources corresponding with field *commonSF-Alloc* are divided between the (P)MCH that are configured for this MBSFN area. The subframe allocation patterns, as defined by *commonSF-Alloc*, repeat continuously during this period. Value *rf4* corresponds to 4 radio frames, *rf8* corresponds to 8 radio frames and so on. The *commonSF-AllocPeriod* starts in the radio frames for which:  $\text{SFN mod } \text{commonSF-AllocPeriod} = 0$ .

##### **pmch-InfoList**

EUTRAN may include *pmch-InfoListExt* even if *pmch-InfoList* does not include *maxPMCH-PerMBSFN* entries. EUTRAN configures at most *maxPMCH-PerMBSFN* entries i.e. across *pmch-InfoList* and *pmch-InfoListExt*.

### — *MCGFailureInformation*

The *MCGFailureInformation* message is used to provide information regarding E-UTRA MCG failures detected by the UE.

Signalling radio bearer: SRB1

RLC-SAP: AM

Logical channel: DCCH

Direction: UE to E-UTRAN

#### **MCGFailureInformation message**

```
-- ASN1START
```

```

MCGFailureInformation-r16 ::=
    criticalExtensions
        mcgFailureInformation
        criticalExtensionsFuture
    }
}

MCGFailureInformation-r16-IEs ::=
    failureReportMCG-r16
    lateNonCriticalExtension
    nonCriticalExtension
}

FailureReportMCG-r16 ::=
    failureType-r16

    measResultFreqListEUTRA-r16
    measResultFreqListNR-r16
    measResultFreqListGERAN-r16
    measResultFreqListUTRA-r16
    measResultSCG-r16
    ...
}
-- ASN1STOP

```

#### **MCGFailureInformation field descriptions**

<b><i>measResultFreqListEUTRA</i></b>	The field contains available results of measurements on EUTRA frequencies the UE is configured to measure by <i>measConfig</i> .
<b><i>measResultFreqListGERAN</i></b>	The field contains available results of measurements on GERAN frequencies the UE is configured to measure by <i>measConfig</i> .
<b><i>measResultFreqListNR</i></b>	The field contains available results of measurements on NR frequencies the UE is configured to measure by <i>measConfig</i> .
<b><i>measResultFreqListUTRA</i></b>	The field contains available results of measurements on UTRA frequencies the UE is configured to measure by <i>measConfig</i> .
<b><i>measResultSCG</i></b>	Includes the NR <i>MeasResultSCG-Failure</i> IE as specified in TS 38.331 [82]. The field contains available results of measurements on NR frequencies the UE is configured to measure by the NR RRCConfiguration message.

#### – ***MeasReportAppLayer***

The *MeasReportAppLayer* message is used for sending application layer measurement report.

Signalling radio bearer: SRB4

RLC-SAP: AM

Logical channel: DCCH

Direction: UE to E-UTRAN

#### ***MeasReportAppLayer* message**

```

-- ASN1START
MeasReportAppLayer-r15 ::=
    criticalExtensions
        measReportAppLayer-r15
        criticalExtensionsFuture
    }
}

MeasReportAppLayer-r15-IEs ::=
    measReportAppLayerContainer-r15
}

```

```

    serviceType-r15                ENUMERATED {qoe, qoemtsi, spare6, spare5, spare4, spare3,
spare2, spare1} OPTIONAL,
    nonCriticalExtension            MeasReportAppLayer-v1590-IEs                OPTIONAL
}

MeasReportAppLayer-v1590-IEs ::= SEQUENCE {
    lateNonCriticalExtension        OCTET STRING                            OPTIONAL,
    nonCriticalExtension            SEQUENCE {}                            OPTIONAL
}

-- ASN1STOP

```

### ***MeasReportAppLayer* field descriptions**

#### ***measReportAppLayerContainer***

The field contains container of application layer measurements, see Annex L (normative) in TS 26.247 [90] and clause 16.5 in TS 26.114 [99].

#### ***serviceType***

Indicates the type of application layer measurement. Value qoe indicates Quality of Experience Measurement Collection for streaming services, value qoemtsi indicates Quality of Experience Measurement Collection for MTSI.

## ***MeasurementReport***

The *MeasurementReport* message is used for the indication of measurement results.

Signalling radio bearer: SRB1

RLC-SAP: AM

Logical channel: DCCH

Direction: UE to E-UTRAN

### ***MeasurementReport* message**

```

-- ASN1START

MeasurementReport ::=
    criticalExtensions
        c1
            measurementReport-r8
                spare7 NULL,
                spare6 NULL, spare5 NULL, spare4 NULL,
                spare3 NULL, spare2 NULL, spare1 NULL
            },
        criticalExtensionsFuture SEQUENCE {}
    }

MeasurementReport-r8-IEs ::= SEQUENCE {
    measResults MeasResults,
    nonCriticalExtension MeasurementReport-v8a0-IEs OPTIONAL
}

MeasurementReport-v8a0-IEs ::= SEQUENCE {
    lateNonCriticalExtension OCTET STRING OPTIONAL,
    nonCriticalExtension SEQUENCE {} OPTIONAL
}

-- ASN1STOP

```

## ***MobilityFromEUTRACommand***

The *MobilityFromEUTRACommand* message is used to command handover or a cell change from E-UTRA to another RAT (3GPP or non-3GPP), or enhanced CS fallback to CDMA2000 1xRTT.

Signalling radio bearer: SRB1

RLC-SAP: AM

Logical channel: DCCH

Direction: E-UTRAN to UE

### **MobilityFromEUTRACommand message**

```

-- ASN1START
MobilityFromEUTRACommand ::= SEQUENCE {
    rrc-TransactionIdentifier      RRC-TransactionIdentifier,
    criticalExtensions             CHOICE {
        c1                        CHOICE {
            mobilityFromEUTRACommand-r8      MobilityFromEUTRACommand-r8-IEs,
            mobilityFromEUTRACommand-r9      MobilityFromEUTRACommand-r9-IEs,
            spare2 NULL, spare1              NULL
        },
        criticalExtensionsFuture             SEQUENCE {}
    }
}

MobilityFromEUTRACommand-r8-IEs ::= SEQUENCE {
    cs-FallbackIndicator          BOOLEAN,
    purpose                       CHOICE {
        handover                  Handover,
        cellChangeOrder           CellChangeOrder
    },
    nonCriticalExtension          MobilityFromEUTRACommand-v8a0-IEs OPTIONAL
}

MobilityFromEUTRACommand-v8a0-IEs ::= SEQUENCE {
    lateNonCriticalExtension      OCTET STRING OPTIONAL,
    nonCriticalExtension          MobilityFromEUTRACommand-v8d0-IEs OPTIONAL
}

MobilityFromEUTRACommand-v8d0-IEs ::= SEQUENCE {
    bandIndicator                 BandIndicatorGERAN          OPTIONAL, -- Cond GERAN
    nonCriticalExtension          SEQUENCE {}                OPTIONAL
}

MobilityFromEUTRACommand-r9-IEs ::= SEQUENCE {
    cs-FallbackIndicator          BOOLEAN,
    purpose                       CHOICE {
        handover                  Handover,
        cellChangeOrder           CellChangeOrder,
        e-CSFB-r9                 E-CSFB-r9,
        ...
    },
    nonCriticalExtension          MobilityFromEUTRACommand-v930-IEs OPTIONAL
}

MobilityFromEUTRACommand-v930-IEs ::= SEQUENCE {
    lateNonCriticalExtension      OCTET STRING OPTIONAL,
    nonCriticalExtension          MobilityFromEUTRACommand-v960-IEs OPTIONAL
}

MobilityFromEUTRACommand-v960-IEs ::= SEQUENCE {
    bandIndicator                 BandIndicatorGERAN          OPTIONAL, -- Cond GERAN
    nonCriticalExtension          MobilityFromEUTRACommand-v1530-IEs OPTIONAL
}

MobilityFromEUTRACommand-v1530-IEs ::= SEQUENCE {
    smtc-r15                      MTC-SSB-NR-r15          OPTIONAL, -- Need OP
    nonCriticalExtension          SEQUENCE {}                OPTIONAL
}

Handover ::= SEQUENCE {
    targetRAT-Type                ENUMERATED {
        utra, geran, cdma2000-1XRTT, cdma2000-HRPD,
        nr, eutra, spare2, spare1, ...},
    targetRAT-MessageContainer    OCTET STRING,
    nas-SecurityParamFromEUTRA   OCTET STRING (SIZE (1)) OPTIONAL, -- Cond UTRAGERANEP
    systemInformation             SI-OrPSI-GERAN          OPTIONAL -- Cond PSHO
}

```

```

CellChangeOrder ::=
  t304
  targetRAT-Type
    geran
      physCellId
      carrierFreq
      networkControlOrder
      systemInformation
    },
    ...
  }
}

SI-OrPSI-GERAN ::=
  si
  psi
}

E-CSFB-r9 ::=
  messageContCDMA2000-1XRTT-r9
  mobilityCDMA2000-HRPD-r9
  messageContCDMA2000-HRPD-r9
  redirectCarrierCDMA2000-HRPD-r9
}

-- ASN1STOP

```

SEQUENCE {

ENUMERATED {

ms100, ms200, ms500, ms1000,

ms2000, ms4000, ms8000, ms10000-v1310},

CHOICE {

SEQUENCE {

PhysCellIdGERAN,

CarrierFreqGERAN,

BIT STRING (SIZE (2)) OPTIONAL, -- Need OP

SI-OrPSI-GERAN OPTIONAL -- Need OP

}

}

CHOICE {

SystemInfoListGERAN,

SystemInfoListGERAN

}

SEQUENCE {

OCTET STRING OPTIONAL, -- Need ON

ENUMERATED {

handover, redirection

} OPTIONAL, -- Need OP

OCTET STRING OPTIONAL, -- Cond concHO

CarrierFreqCDMA2000 OPTIONAL -- Cond concRedir

}

<b>MobilityFromEUTRACommand field descriptions</b>	
<b>bandIndicator</b>	Indicates how to interpret the ARFCN of the BCCH carrier.
<b>carrierFreq</b>	contains the carrier frequency of the target GERAN cell.
<b>cs-FallbackIndicator</b>	Value <i>true</i> indicates that the CS fallback procedure to UTRAN or GERAN is triggered.
<b>messageContCDMA2000-1XRTT</b>	This field contains a message specified in CDMA2000 1xRTT standard that either tells the UE to move to specific 1xRTT target cell(s) or indicates a failure to allocate resources for the enhanced CS fallback to CDMA2000 1xRTT.
<b>messageContCDMA2000-HRPD</b>	This field contains a message specified in CDMA2000 HRPD standard that either tells the UE to move to specific HRPD target cell(s) or indicates a failure to allocate resources for the handover to CDMA2000 HRPD.
<b>mobilityCDMA2000-HRPD</b>	This field indicates whether or not mobility to CDMA2000 HRPD is to be performed by the UE and it also indicates the type of mobility to CDMA2000 HRPD that is to be performed; If this field is not present the UE shall perform only the enhanced CS fallback to CDMA2000 1xRTT.
<b>nas-SecurityParamFromEUTRA</b>	If the <i>targetRAT-Type</i> is set to "eutra" and the source CN is 5GC, this field is used to deliver the key synchronisation and key freshness for the Key freshness for the 5GS to EPS handovers as specified in TS 33.501 [86] and the content of the parameter is defined in TS 24.501 [95]. Otherwise, this field is used to deliver the key synchronisation and Key freshness for the E-UTRAN to UTRAN handovers as specified in TS 33.401 [32] and the content of the parameter is defined in TS24.301 [35].
<b>networkControlOrder</b>	Parameter NETWORK_CONTROL_ORDER in TS 44.060 [36].
<b>purpose</b>	Indicates which type of mobility procedure the UE is requested to perform. EUTRAN always applies value <i>e-CSFB</i> in case of enhanced CS fallback to CDMA2000 (e.g. also when that procedure results in handover to CDMA2000 1XRTT only, in handover to CDMA2000 HRPD only or in redirection to CDMA2000 HRPD only),
<b>redirectCarrierCDMA2000-HRPD</b>	The <i>redirectCarrierCDMA2000-HRPD</i> indicates a CDMA2000 carrier frequency and is used to redirect the UE to a HRPD carrier frequency.
<b>smtc</b>	The SSB periodicity/offset/duration configuration of target cell for inter-RAT handover to NR. It is based on timing reference of EUTRA PCell. If the field is absent, the UE uses the SMTC in the <i>measObjectNR</i> having the same SSB frequency and subcarrier spacing, as configured before the reception of the RRC message.
<b>SystemInfoListGERAN</b>	If <i>purpose = CellChangeOrder</i> and if the field is not present, the UE has to acquire SI/PSI from the GERAN cell.
<b>t304</b>	Timer T304 as described in clause 7.3. Value <i>ms100</i> corresponds with 100 ms, <i>ms200</i> corresponds with 200 ms and so on. EUTRAN includes extended value <i>ms10000-v1310</i> only when UE supports CE.
<b>targetRAT-Type</b>	Indicates the target RAT type.
<b>targetRAT-MessageContainer</b>	The field contains a message specified in another standard, as indicated by the <i>targetRAT-Type</i> , and carries information about the target cell identifier(s) and radio parameters relevant for the target radio access technology. NOTE 1.  A complete message is included, as specified in the other standard.

Conditional presence	Explanation
<i>conchO</i>	The field is mandatory present if the <i>mobilityCDMA2000-HRPD</i> is set to "handover"; otherwise the field is optional present, need ON.
<i>concRedir</i>	The field is mandatory present if the <i>mobilityCDMA2000-HRPD</i> is set to "redirection"; otherwise the field is not present.
GERAN	The field should be present if the <i>purpose</i> is set to "handover" and the <i>targetRAT-Type</i> is set to "geran"; otherwise the field is not present
PSHO	The field is mandatory present in case of PS handover toward GERAN; otherwise the field is optionally present, but not used by the UE
UTRAGERANEPCC	The field is mandatory present if the <i>targetRAT-Type</i> is set to "utra" or "geran" or if the <i>targetRAT-Type</i> is set to "eutra" and the source CN is 5GC; otherwise the field is not present

NOTE 1: The correspondence between the value of the *targetRAT-Type*, the standard to apply and the message contained within the *targetRAT-MessageContainer* is shown in the table below:

targetRAT-Type	Standard to apply	targetRAT-MessageContainer
<i>cdma2000-1XRTT</i>	C.S0001 or later, C.S0007 or later, C.S0008 or later	
<i>cdma2000-HRPD</i>	C.S0024 or later	
<i>eutra</i>	TS 36.331 (clause 5.4.2)	<i>RRCConnectionReconfiguration</i>
<i>geran</i>	GSM TS 04.18, version 8.5.0 or later, or TS 44.018 (clause 9.1.15)	HANDOVER COMMAND
	TS 44.060, version 6.13.0 or later (clause 11.2.43)	PS HANDOVER COMMAND
	TS 44.060, version 7.6.0 or later (clause 11.2.46)	DTM HANDOVER COMMAND
<i>nr</i>	TS 38.331 (clause 6.2.2)	<i>RRCReconfiguration</i>
<i>utra</i>	TS 25.331 (clause 10.2.16a)	HANDOVER TO UTRAN COMMAND

## Paging

The *Paging* message is used for the notification of one or more UEs.

Signalling radio bearer: N/A

RLC-SAP: TM

Logical channel: PCCH

Direction: E-UTRAN to UE

### Paging message

```
-- ASN1START
Paging ::= SEQUENCE {
    pagingRecordList          PagingRecordList          OPTIONAL, -- Need ON
    systemInfoModification    ENUMERATED {true}          OPTIONAL, -- Need ON
    etws-Indication           ENUMERATED {true}          OPTIONAL, -- Need ON
    nonCriticalExtension       Paging-v890-IEs              OPTIONAL
}

Paging-v890-IEs ::= SEQUENCE {
    lateNonCriticalExtension   OCTET STRING          OPTIONAL,
    nonCriticalExtension       Paging-v920-IEs       OPTIONAL
}

Paging-v920-IEs ::= SEQUENCE {
    cmas-Indication-r9        ENUMERATED {true}     OPTIONAL, -- Need ON
    nonCriticalExtension       Paging-v1130-IEs     OPTIONAL
}

Paging-v1130-IEs ::= SEQUENCE {
    eab-ParamModification-r11 ENUMERATED {true}     OPTIONAL, -- Need ON
    nonCriticalExtension       Paging-v1310-IEs     OPTIONAL
}

Paging-v1310-IEs ::= SEQUENCE {
    redistributionIndication-r13 ENUMERATED {true}     OPTIONAL, -- Need ON
    systemInfoModification-eDRX-r13 ENUMERATED {true}     OPTIONAL, -- Need ON
    nonCriticalExtension       Paging-v1530-IEs     OPTIONAL
}

Paging-v1530-IEs ::= SEQUENCE {
    accessType                 ENUMERATED {non3GPP}   OPTIONAL, -- Need ON
    nonCriticalExtension       Paging-v1610-IEs     OPTIONAL
}

Paging-v1610-IEs ::= SEQUENCE {
    pagingRecordList-v1610     PagingRecordList-v1610 OPTIONAL, -- Need ON
    uac-ParamModification-r16  ENUMERATED {true}     OPTIONAL, -- Need ON
    nonCriticalExtension       Paging-v1700-IEs     OPTIONAL
}

Paging-v1700-IEs ::= SEQUENCE {
    pagingRecordList-v1700     PagingRecordList-v1700 OPTIONAL, -- Need ON
}
```



```

    nonCriticalExtension          SEQUENCE {}                                OPTIONAL
  }
PagingRecordList ::=           SEQUENCE (SIZE (1..maxPageRec)) OF PagingRecord
PagingRecordList-v1610 ::=     SEQUENCE (SIZE (1..maxPageRec)) OF PagingRecord-v1610
PagingRecordList-v1700 ::=     SEQUENCE (SIZE (1..maxPageRec)) OF PagingRecord-v1700
PagingRecord ::=               SEQUENCE {
    ue-Identity                  PagingUE-Identity,
    cn-Domain                    ENUMERATED {ps, cs},
    ...
  }
PagingRecord-v1610 ::=         SEQUENCE {
    accessType-r16              ENUMERATED {non3GPP}                OPTIONAL,      -- Need ON
    mt-EDT-r16                  ENUMERATED {true}                OPTIONAL       -- Need ON
  }
PagingRecord-v1700 ::=         SEQUENCE {
    pagingCause-r17             ENUMERATED {voice}                OPTIONAL       -- Need ON
  }
PagingUE-Identity ::=         CHOICE {
    s-TMSI                      S-TMSI,
    imsi                        IMSI,
    ...,
    ng-5G-S-TMSI-r15           NG-5G-S-TMSI-r15,
    fullI-RNTI-r15             I-RNTI-r15
  }
IMSI ::=                       SEQUENCE (SIZE (6..21)) OF IMSI-Digit
IMSI-Digit ::=                 INTEGER (0..9)
-- ASN1STOP

```

<b>Paging field descriptions</b>
<p><b>accessType</b> It indicates whether Paging is originated due to the PDU sessions from the non-3GPP access when E-UTRA is connected to 5GC. E-UTRAN does not include both <i>accessType</i> (i.e., without suffix) and <i>accessType-r16</i> in a single paging message.</p>
<p><b>cmas-Indication</b> If present: indication of a CMAS notification.</p>
<p><b>cn-Domain</b> Indicates the origin of paging.</p>
<p><b>eab-ParamModification</b> If present: indication of an EAB parameters (SIB14) modification.</p>
<p><b>etws-Indication</b> If present: indication of an ETWS primary notification and/ or ETWS secondary notification.</p>
<p><b>imsi</b> The International Mobile Subscriber Identity, a globally unique permanent subscriber identity, see TS 23.003 [27]. The first element contains the first IMSI digit, the second element contains the second IMSI digit and so on.</p>
<p><b>mt-EDT</b> Indication of mobile terminating EDT.</p>
<p><b>pagingCause</b> Indicates whether the <i>Paging</i> message is originated due to IMS voice. If the field is present, it implies that the corresponding paging entry is for IMS voice. If upper layers indicate the support of paging cause and if this field is not present but <i>pagingRecordList-v1700</i> is present, it implies that the corresponding paging entry is for a service other than IMS voice. Otherwise, paging cause is undetermined.</p>
<p><b>pagingRecordList</b> If E-UTRAN includes <i>pagingRecordList-v1610</i> and/or <i>pagingRecordList-v1700</i>, it includes the same number of entries, and listed in the same order, as in <i>pagingRecordList</i> (i.e. without suffix).</p>
<p><b>redistributionIndication</b> If present: indication to trigger E-UTRAN inter-frequency redistribution procedure as specified in TS 36.304 [4], clause 5.2.4.10.</p>
<p><b>systemInfoModification</b> If present: indication of a BCCH modification other than SIB10, SIB11, SIB12, SIB14 and SIB31. This indication does not apply to UEs using eDRX cycle longer than the BCCH modification period.</p>
<p><b>systemInfoModification-eDRX</b> If present: indication of a BCCH modification other than SIB10, SIB11, SIB12, SIB14 and SIB31. This indication applies only to UEs using eDRX cycle longer than the BCCH modification period.</p>
<p><b>uac-ParamModification</b> If present: indication of UAC parameters (SIB25) modification.</p>
<p><b>ue-Identity</b> Provides the NAS identity of the UE that is being paged. The IMSI is not applicable for E-UTRA/5GC.</p>

### – ProximityIndication

The *ProximityIndication* message is used to indicate that the UE is entering or leaving the proximity of one or more CSG member cell(s).

Signalling radio bearer: SRB1

RLC-SAP: AM

Logical channel: DCCH

Direction: UE to E-UTRAN

### ProximityIndication message

```
-- ASN1START
ProximityIndication-r9 ::= SEQUENCE {
    criticalExtensions          CHOICE {
        c1                     CHOICE {
            proximityIndication-r9
            spare3 NULL, spare2 NULL, spare1 NULL
        },
        criticalExtensionsFuture SEQUENCE {}
    }
}
```

```

ProximityIndication-r9-IEs ::= SEQUENCE {
  type-r9                               ENUMERATED {entering, leaving},
  carrierFreq-r9                         CHOICE {
    eutra-r9                             ARFCN-ValueEUTRA,
    utra-r9                              ARFCN-ValueUTRA,
    ... ,
    eutra2-v9e0                          ARFCN-ValueEUTRA-v9e0
  },
  nonCriticalExtension                   ProximityIndication-v930-IEs
  OPTIONAL
}

ProximityIndication-v930-IEs ::= SEQUENCE {
  lateNonCriticalExtension               OCTET STRING                               OPTIONAL,
  nonCriticalExtension                   SEQUENCE {}                               OPTIONAL
}

-- ASN1STOP

```

#### **ProximityIndication field descriptions**

##### **carrierFreq**

Indicates the RAT and frequency of the CSG member cell(s), for which the proximity indication is sent. For E-UTRA and UTRA frequencies, the UE shall set the ARFCN according to a band it previously considered suitable for accessing (one of) the CSG member cell(s), for which the proximity indication is sent.

##### **type**

Used to indicate whether the UE is entering or leaving the proximity of CSG member cell(s).

### **PURConfigurationRequest**

The *PURConfigurationRequest* message is used by BL UE or UE in CE to indicate to the E-UTRAN that the UE is interested to be configured with PUR and provide PUR related information to E-UTRAN.

Signalling radio bearer: SRB1

RLC-SAP: AM

Logical channel: DCCH

Direction: UE to E-UTRAN

#### **PURConfigurationRequest message**

```

-- ASN1START

PURConfigurationRequest-r16 ::= SEQUENCE {
  criticalExtensions                     CHOICE {
    purConfigurationRequest             PURConfigurationRequest-r16-IEs,
    criticalExtensionsFuture            SEQUENCE {}
  }
}

PURConfigurationRequest-r16-IEs ::= SEQUENCE {
  pur-ConfigRequest-r16                 CHOICE {
    pur-ReleaseRequest                  NULL,
    pur-SetupRequest                    SEQUENCE {
      requestedNumOccasions-r16         ENUMERATED {one, infinite},
      requestedPeriodicityAndOffset-r16 PUR-PeriodicityAndOffset-r16 OPTIONAL,
      requestedTBS-r16                  ENUMERATED {b328, b344, b376, b392, b408,
        b424, b440, b456, b472, b488, b504, b536,
        b568, b584, b616, b648, b680, b712, b744,
        b776, b808, b840, b872, b904, b936, b968,
        b1000, b1032, b1064, b1096, b1128, b1160,
        b1192, b1224, b1256, b1288, b1320, b1352,
        b1384, b1416, b1480, b1544, b1608, b1672,
        b1736, b1800, b1864, b1928, b1992, b2024,
        b2088, b2152, b2216, b2280, b2344, b2408,
        b2472, b2536, b2600, b2664, b2728, b2792,
        b2856, b2984},
      rrc-ACK-r16                        ENUMERATED {true}                               OPTIONAL
    }
  }
  OPTIONAL
}
-- ASN1STOP

```

```

    lateNonCriticalExtension    OCTET STRING                OPTIONAL,
    nonCriticalExtension        SEQUENCE {}                        OPTIONAL
}
-- ASN1STOP

```

#### **PURConfigurationRequest field descriptions**

##### **requestedNumOccasions**

Indicates the requested number of PUR grant occasions. Value *one* corresponds to one occasion and value *infinite* corresponds to infinite occasions.

##### **requestedPeriodicityAndOffset**

Indicates the requested periodicity for the PUR occasions and time offset until the first PUR occasion.

##### **requestedTBS**

Indicates the requested TBS for the PUR. *b328* corresponds to 328 bits, *b344* corresponds to 344 bits and so on. The maximum requested TBS is limited to the UL TBS size supported by the UE.

##### **rrc-ACK**

Indicates RRC response message is preferred by the UE for acknowledging the reception of a transmission using PUR.

## – **RNReconfiguration**

The *RNReconfiguration* is a command to modify the RN subframe configuration and/or to convey changed system information.

Signalling radio bearer: SRB1

RLC-SAP: AM

Logical channel: DCCH

Direction: E-UTRAN to RN

### **RNReconfiguration message**

```

-- ASN1START
RNReconfiguration-r10 ::= SEQUENCE {
    rrc-TransactionIdentifier    RRC-TransactionIdentifier,
    criticalExtensions            CHOICE {
        c1                       CHOICE {
            rnReconfiguration-r10    RNReconfiguration-r10-IEs,
            spare3 NULL, spare2 NULL, spare1 NULL
        },
        criticalExtensionsFuture    SEQUENCE {}
    }
}

RNReconfiguration-r10-IEs ::= SEQUENCE {
    rn-SystemInfo-r10            RN-SystemInfo-r10                OPTIONAL, -- Need ON
    rn-SubframeConfig-r10        RN-SubframeConfig-r10           OPTIONAL, -- Need ON
    lateNonCriticalExtension      OCTET STRING                    OPTIONAL,
    nonCriticalExtension          SEQUENCE {}                      OPTIONAL
}

RN-SystemInfo-r10 ::= SEQUENCE {
    systemInformationBlockType1-r10    OCTET STRING (CONTAINING SystemInformationBlockType1)
    OPTIONAL, -- Need ON
    systemInformationBlockType2-r10    SystemInformationBlockType2    OPTIONAL, -- Need ON
    ...
}
-- ASN1STOP

```

## – **RNReconfigurationComplete**

The *RNReconfigurationComplete* message is used to confirm the successful completion of an RN reconfiguration.

Signalling radio bearer: SRB1

RLC-SAP: AM

Logical channel: DCCH

Direction: RN to E-UTRAN

### ***RNReconfigurationComplete message***

```
-- ASN1START
RNReconfigurationComplete-r10 ::= SEQUENCE {
  rrc-TransactionIdentifier      RRC-TransactionIdentifier,
  criticalExtensions              CHOICE {
    c1                            CHOICE {
      rnReconfigurationComplete-r10  RNReconfigurationComplete-r10-IEs,
      spare3 NULL, spare2 NULL, spare1 NULL
    },
    criticalExtensionsFuture        SEQUENCE {}
  }
}

RNReconfigurationComplete-r10-IEs ::= SEQUENCE {
  lateNonCriticalExtension        OCTET STRING          OPTIONAL,
  nonCriticalExtension            SEQUENCE {}           OPTIONAL
}
-- ASN1STOP
```

### ***RRCCConnectionReconfiguration***

The *RRCCConnectionReconfiguration* message is the command to modify an RRC connection. It may convey information for measurement configuration, mobility control, conditional reconfigurations (conditional handover, conditional PSCell addition or inter-SN conditional PSCell change), radio resource configuration (including RBs, MAC main configuration and physical channel configuration) including any associated dedicated NAS information and security configuration.

Signalling radio bearer: SRB1

RLC-SAP: AM

Logical channel: DCCH

Direction: E-UTRAN to UE

### ***RRCCConnectionReconfiguration message***

```
-- ASN1START
RRCCConnectionReconfiguration ::= SEQUENCE {
  rrc-TransactionIdentifier      RRC-TransactionIdentifier,
  criticalExtensions              CHOICE {
    c1                            CHOICE {
      rrcConnectionReconfiguration-r8  RRCCConnectionReconfiguration-r8-IEs,
      spare7 NULL,
      spare6 NULL, spare5 NULL, spare4 NULL,
      spare3 NULL, spare2 NULL, spare1 NULL
    },
    criticalExtensionsFuture        SEQUENCE {}
  }
}

RRCCConnectionReconfiguration-r8-IEs ::= SEQUENCE {
  measConfig                    MeasConfig              OPTIONAL, -- Need ON
  mobilityControlInfo           MobilityControlInfo      OPTIONAL, -- Cond HO
  dedicatedInfoNASList          SEQUENCE (SIZE(1..maxDRB)) OF
    DedicatedInfoNAS              OPTIONAL, -- Cond nonHO
  radioResourceConfigDedicated  RadioResourceConfigDedicated  OPTIONAL, -- Cond HO-toEUTRA
  securityConfigHO              SecurityConfigHO        OPTIONAL, -- Cond HO-toEPC
  nonCriticalExtension           RRCCConnectionReconfiguration-v890-IEs  OPTIONAL
}
```

```

}
RRCCONNECTIONRECONFIGURATION-V890-IES ::= SEQUENCE {
    lateNonCriticalExtension    OCTET STRING (CONTAINING RRCCONNECTIONRECONFIGURATION-V8M0-
    IEs)    OPTIONAL,
    nonCriticalExtension        RRCCONNECTIONRECONFIGURATION-V920-IES    OPTIONAL
}

-- Late non-critical extensions:
RRCCONNECTIONRECONFIGURATION-V8M0-IES ::= SEQUENCE {
    -- Following field is only for pre REL-10 late non-critical extensions
    lateNonCriticalExtension    OCTET STRING    OPTIONAL,
    nonCriticalExtension        RRCCONNECTIONRECONFIGURATION-V10I0-IES    OPTIONAL
}

RRCCONNECTIONRECONFIGURATION-V10I0-IES ::= SEQUENCE {
    antennaInfoDedicatedPCell-v10i0    AntennaInfoDedicated-v10i0    OPTIONAL,    -- Need ON
    nonCriticalExtension                RRCCONNECTIONRECONFIGURATION-V10I0-IES    OPTIONAL
}

RRCCONNECTIONRECONFIGURATION-V10I0-IES ::= SEQUENCE {
    mobilityControlInfo-v10i0          MobilityControlInfo-v10i0    OPTIONAL,
    sCellToAddModList-v10i0            SCellToAddModList-v10i0    OPTIONAL,    -- Need ON
    -- Following field is only for late non-critical extensions from REL-10 to REL-11
    lateNonCriticalExtension            OCTET STRING    OPTIONAL,
    nonCriticalExtension                RRCCONNECTIONRECONFIGURATION-V12F0-IES    OPTIONAL
}

RRCCONNECTIONRECONFIGURATION-V12F0-IES ::= SEQUENCE {
    scg-Configuration-v12f0            SCG-Configuration-v12f0    OPTIONAL,    -- Cond nonFullConfig
    -- Following field is only for late non-critical extensions from REL-12
    lateNonCriticalExtension            OCTET STRING    OPTIONAL,
    nonCriticalExtension                RRCCONNECTIONRECONFIGURATION-V1370-IES    OPTIONAL
}

RRCCONNECTIONRECONFIGURATION-V1370-IES ::= SEQUENCE {
    radioResourceConfigDedicated-v1370    RadioResourceConfigDedicated-v1370    OPTIONAL,    -- Need ON
    sCellToAddModListExt-v1370          SCellToAddModListExt-v1370    OPTIONAL,    -- Need ON
    nonCriticalExtension                RRCCONNECTIONRECONFIGURATION-V13C0-IES    OPTIONAL
}

RRCCONNECTIONRECONFIGURATION-V13C0-IES ::= SEQUENCE {
    radioResourceConfigDedicated-v13c0    RadioResourceConfigDedicated-v13c0    OPTIONAL,    -- Need ON
    sCellToAddModList-v13c0              SCellToAddModList-v13c0    OPTIONAL,    -- Need ON
    sCellToAddModListExt-v13c0          SCellToAddModListExt-v13c0    OPTIONAL,    -- Need ON
    scg-Configuration-v13c0              SCG-Configuration-v13c0    OPTIONAL,    -- Need ON
    -- Following field is only for late non-critical extensions from REL-13 onwards
    nonCriticalExtension                SEQUENCE {}    OPTIONAL
}

-- Regular non-critical extensions:
RRCCONNECTIONRECONFIGURATION-V920-IES ::= SEQUENCE {
    otherConfig-r9                      OtherConfig-r9    OPTIONAL,    -- Need ON
    fullConfig-r9                        ENUMERATED {true}    OPTIONAL,    -- Cond HO-Reestab
    nonCriticalExtension                RRCCONNECTIONRECONFIGURATION-V1020-IES    OPTIONAL
}

RRCCONNECTIONRECONFIGURATION-V1020-IES ::= SEQUENCE {
    sCellToReleaseList-r10              SCellToReleaseList-r10    OPTIONAL,    -- Need ON
    sCellToAddModList-r10                SCellToAddModList-r10    OPTIONAL,    -- Need ON
    nonCriticalExtension                RRCCONNECTIONRECONFIGURATION-V1130-IES    OPTIONAL
}

RRCCONNECTIONRECONFIGURATION-V1130-IES ::= SEQUENCE {
    systemInformationBlockType1Dedicated-r11    OCTET STRING (CONTAINING
    SystemInformationBlockType1)
    OPTIONAL,    -- Need ON
    nonCriticalExtension                RRCCONNECTIONRECONFIGURATION-V1250-IES    OPTIONAL
}

RRCCONNECTIONRECONFIGURATION-V1250-IES ::= SEQUENCE {
    wlan-OffloadInfo-r12                CHOICE {
        release    NULL,
        setup      SEQUENCE {
            wlan-OffloadConfigDedicated-r12    WLAN-OffloadConfig-r12,
            t350-r12    ENUMERATED {min5, min10, min20, min30, min60,
            min120, min180, spare1}    OPTIONAL    -- Need OR
        }
    }
}

```

```

    }
    scg-Configuration-r12          SCG-Configuration-r12          OPTIONAL,    -- Need ON
nonFullConfig                    OPTIONAL,    -- Cond
    sl-SyncTxControl-r12         SL-SyncTxControl-r12         OPTIONAL,    -- Need ON
    sl-DiscConfig-r12           SL-DiscConfig-r12           OPTIONAL,    -- Need ON
    sl-CommConfig-r12           SL-CommConfig-r12           OPTIONAL,    -- Need ON
    nonCriticalExtension         RRCConnectionReconfiguration-v1310-IEs OPTIONAL
}

RRCConnectionReconfiguration-v1310-IEs ::= SEQUENCE {
    sCellToReleaseListExt-r13     SCellToReleaseListExt-r13     OPTIONAL,    -- Need ON
    sCellToAddModListExt-r13     SCellToAddModListExt-r13     OPTIONAL,    -- Need ON
    lwa-Configuration-r13        LWA-Configuration-r13        OPTIONAL,    -- Need ON
    lwip-Configuration-r13       LWIP-Configuration-r13       OPTIONAL,    -- Need ON
    rclwi-Configuration-r13      RCLWI-Configuration-r13      OPTIONAL,    -- Need ON
    nonCriticalExtension         RRCConnectionReconfiguration-v1430-IEs
    OPTIONAL
}

RRCConnectionReconfiguration-v1430-IEs ::= SEQUENCE {
    sl-V2X-ConfigDedicated-r14    SL-V2X-ConfigDedicated-r14    OPTIONAL,    -- Need ON
    sCellToAddModListExt-v1430    SCellToAddModListExt-v1430    OPTIONAL,    -- Need ON
    perCC-GapIndicationRequest-r14 ENUMERATED{true}              OPTIONAL,    -- Need ON
    systemInformationBlockType2Dedicated-r14 OCTET STRING (CONTAINING
SystemInformationBlockType2)      OPTIONAL,    -- Cond nonHO
    nonCriticalExtension         RRCConnectionReconfiguration-v1510-IEs OPTIONAL
}

RRCConnectionReconfiguration-v1510-IEs ::= SEQUENCE {
    nr-Config-r15                 CHOICE {
        release                    NULL,
        setup                       SEQUENCE {
            endc-ReleaseAndAdd-r15  BOOLEAN,
            nr-SecondaryCellGroupConfig-r15 OCTET STRING          OPTIONAL,    -- Need ON
            p-MaxEUTRA-r15          P-Max                    OPTIONAL,    -- Need ON
        }
    }
    sk-Counter-r15                INTEGER (0.. 65535)          OPTIONAL,    -- Need ON
    nr-RadioBearerConfig1-r15     OCTET STRING                OPTIONAL,    -- Need ON
    nr-RadioBearerConfig2-r15     OCTET STRING                OPTIONAL,    -- Need ON
    tdm-PatternConfig-r15         TDM-PatternConfig-r15      OPTIONAL,    -- Cond FDD-PCell
    nonCriticalExtension         RRCConnectionReconfiguration-v1530-IEs OPTIONAL
}

RRCConnectionReconfiguration-v1530-IEs ::= SEQUENCE {
    securityConfigHO-v1530        SecurityConfigHO-v1530      OPTIONAL,    -- Cond HO-5GC
    sCellGroupToReleaseList-r15   SCellGroupToReleaseList-r15 OPTIONAL,    -- Need ON
    sCellGroupToAddModList-r15   SCellGroupToAddModList-r15  OPTIONAL,    -- Need ON
    dedicatedInfoNASList-r15     SEQUENCE (SIZE(1..maxDRB-r15)) OF
DedicatedInfoNAS                OPTIONAL,    -- Cond nonHO
    p-MaxUE-FR1-r15              P-Max                    OPTIONAL,    -- Need OR
    smtc-r15                     MTC-SSB-NR-r15           OPTIONAL,    -- Need OP
    nonCriticalExtension         RRCConnectionReconfiguration-v1610-IEs OPTIONAL
}

RRCConnectionReconfiguration-v1610-IEs ::= SEQUENCE {
    conditionalReconfiguration-r16 ConditionalReconfiguration-r16 OPTIONAL,    -- Need ON
    daps-SourceRelease-r16        ENUMERATED{true}          OPTIONAL,    -- Need ON
    tdm-PatternConfig2-r16        TDM-PatternConfig-r15     OPTIONAL,    -- Need ON
    sl-ConfigDedicatedForNR-r16   OCTET STRING              OPTIONAL,    -- Need OR
    sl-SSB-PriorityEUTRA-r16     INTEGER (1..8)           OPTIONAL,    -- Need OR
    nonCriticalExtension         RRCConnectionReconfiguration-v1700-IEs OPTIONAL
}

RRCConnectionReconfiguration-v1700-IEs ::= SEQUENCE {
    systemInformationBlockType31Dedicated-r17 OCTET STRING (CONTAINING
SystemInformationBlockType31-r17)
    OPTIONAL,    -- Cond NTN
    scg-State-r17                 ENUMERATED{deactivated}    OPTIONAL,    -- Need OP
    nonCriticalExtension         SEQUENCE {}                  OPTIONAL
}

SL-SyncTxControl-r12 ::= SEQUENCE {
    networkControlledSyncTx-r12  ENUMERATED {on, off}      OPTIONAL,    -- Need OP
}

PSCellToAddMod-r12 ::= SEQUENCE {
    sCellIndex-r12                SCellIndex-r10,

```

```

    cellIdentification-r12          SEQUENCE {
      physCellId-r12              PhysCellId,
      dl-CarrierFreq-r12         ARFCN-ValueEUTRA-r9
    }
    radioResourceConfigCommonPSCell-r12  RadioResourceConfigCommonPSCell-r12 OPTIONAL, -- Cond SCellAdd
SCellAdd
    radioResourceConfigDedicatedPSCell-r12  RadioResourceConfigDedicatedPSCell-r12 OPTIONAL, --
Cond SCellAdd2
    . . .
    [[ antennaInfoDedicatedPSCell-v1280      AntennaInfoDedicated-v10i0  OPTIONAL  -- Need ON
    ]],
    [[ sCellIndex-r13                        SCellIndex-r13  OPTIONAL      -- Need ON
    ]],
    [[ radioResourceConfigDedicatedPSCell-v1370  RadioResourceConfigDedicatedPSCell-v1370
OPTIONAL  -- Need ON
    ]],
    [[ radioResourceConfigDedicatedPSCell-v13c0  RadioResourceConfigDedicatedPSCell-v13c0
OPTIONAL  -- Need ON
    ]]
  }

PSCellToAddMod-v12f0 ::=          SEQUENCE {
  radioResourceConfigCommonPSCell-r12      RadioResourceConfigCommonPSCell-v12f0  OPTIONAL
}

PSCellToAddMod-v1440 ::=          SEQUENCE {
  radioResourceConfigCommonPSCell-r14      RadioResourceConfigCommonPSCell-v1440  OPTIONAL
}

PowerCoordinationInfo-r12 ::= SEQUENCE {
  p-MeNB-r12                               INTEGER (1..16),
  p-SeNB-r12                               INTEGER (1..16),
  powerControlMode-r12                     INTEGER (1..2)
}

SCellToAddModList-r10 ::=          SEQUENCE (SIZE (1..maxSCell-r10)) OF SCellToAddMod-r10
SCellToAddModList-v10i0 ::=          SEQUENCE (SIZE (1..maxSCell-r10)) OF SCellToAddMod-v10i0
SCellToAddModList-v13c0 ::=          SEQUENCE (SIZE (1..maxSCell-r10)) OF SCellToAddMod-v13c0
SCellToAddModList-r16 ::=          SEQUENCE (SIZE (1..maxSCell-r13)) OF SCellToAddMod-r16
SCellToAddModListExt-r13 ::=          SEQUENCE (SIZE (1..maxSCell-r13)) OF SCellToAddModExt-r13
SCellToAddModListExt-v1370 ::=          SEQUENCE (SIZE (1..maxSCell-r13)) OF SCellToAddModExt-v1370
SCellToAddModListExt-v13c0 ::=          SEQUENCE (SIZE (1..maxSCell-r13)) OF SCellToAddMod-v13c0
SCellToAddModListExt-v1430 ::=          SEQUENCE (SIZE (1..maxSCell-r13)) OF SCellToAddModExt-v1430
SCellGroupToAddModList-r15 ::=          SEQUENCE (SIZE (1..maxSCellGroups-r15)) OF SCellGroupToAddMod-r15

SCellToAddMod-r10 ::=          SEQUENCE {
  sCellIndex-r10                          SCellIndex-r10,
  cellIdentification-r10                  SEQUENCE {
    physCellId-r10                      PhysCellId,
    dl-CarrierFreq-r10                  ARFCN-ValueEUTRA
  }
  radioResourceConfigCommonSCell-r10      RadioResourceConfigCommonSCell-r10 OPTIONAL, -- Cond
SCellAdd
  radioResourceConfigDedicatedSCell-r10  RadioResourceConfigDedicatedSCell-r10 OPTIONAL, --
Cond SCellAdd2
  . . .
  [[ dl-CarrierFreq-v1090                  ARFCN-ValueEUTRA-v9e0  OPTIONAL  -- Cond EARFCN-max
  ]],
  [[ antennaInfoDedicatedSCell-v10i0      AntennaInfoDedicated-v10i0  OPTIONAL  -- Need ON
  ]],
  [[ srs-SwitchFromServCellIndex-r14      INTEGER (0.. 31) OPTIONAL  -- Need ON
  ]],
  [[ sCellState-r15                       ENUMERATED {activated, dormant} OPTIONAL  -- Need ON
  ]]
}

SCellToAddMod-v10i0 ::=          SEQUENCE {
  radioResourceConfigCommonSCell-v10i0    RadioResourceConfigCommonSCell-v10i0  OPTIONAL
}

```



```

SCellToAddMod-v13c0 ::= SEQUENCE {
    radioResourceConfigDedicatedSCell-v13c0 RadioResourceConfigDedicatedSCell-v13c0 OPTIONAL
}

SCellToAddMod-r16 ::= SEQUENCE {
    sCellIndex-r16 SCellIndex-r13,
    cellIdentification-r16 SEQUENCE {
        physCellId-r16 PhysCellId,
        dl-CarrierFreq-r16 ARFCN-ValueEUTRA-r9
    } OPTIONAL, -- Cond SCellAdd
    radioResourceConfigCommonSCell-r16 RadioResourceConfigCommonSCell-r10 OPTIONAL, -- Cond
SCellAdd
    radioResourceConfigDedicatedSCell-r16 RadioResourceConfigDedicatedSCell-r10 OPTIONAL, --
Cond SCellAdd2
    antennaInfoDedicatedSCell-r16 AntennaInfoDedicated-v10i0 OPTIONAL, -- Need ON
    srs-SwitchFromServCellIndex-r16 INTEGER (0.. 31) OPTIONAL, -- Need ON
    sCellState-r16 ENUMERATED {activated, dormant} OPTIONAL, -- Need ON
    ...
}

SCellToAddModExt-r13 ::= SEQUENCE {
    sCellIndex-r13 SCellIndex-r13,
    cellIdentification-r13 SEQUENCE {
        physCellId-r13 PhysCellId,
        dl-CarrierFreq-r13 ARFCN-ValueEUTRA-r9
    } OPTIONAL, -- Cond SCellAdd
    radioResourceConfigCommonSCell-r13 RadioResourceConfigCommonSCell-r10 OPTIONAL, -- Cond
SCellAdd
    radioResourceConfigDedicatedSCell-r13 RadioResourceConfigDedicatedSCell-r10 OPTIONAL, --
Cond SCellAdd2
    antennaInfoDedicatedSCell-r13 AntennaInfoDedicated-v10i0 OPTIONAL -- Need ON
}

SCellToAddModExt-v1370 ::= SEQUENCE {
    radioResourceConfigCommonSCell-v1370 RadioResourceConfigCommonSCell-v10i0 OPTIONAL
}

SCellToAddModExt-v1430 ::= SEQUENCE {
    srs-SwitchFromServCellIndex-r14 INTEGER (0.. 31) OPTIONAL, -- Need ON
    ...
    [[ sCellState-r15 ENUMERATED {activated, dormant} OPTIONAL -- Need ON
    ]]
}

SCellGroupToAddMod-r15 ::= SEQUENCE {
    sCellGroupIndex-r15 SCellGroupIndex-r15,
    sCellConfigCommon-r15 SCellConfigCommon-r15 OPTIONAL, -- Need ON
    sCellToReleaseList-r15 SCellToReleaseListExt-r13 OPTIONAL, -- Need ON
    sCellToAddModList-r15 SCellToAddModListExt-r13 OPTIONAL -- Need ON
}

SCellToReleaseList-r10 ::= SEQUENCE (SIZE (1..maxSCell-r10)) OF SCellIndex-r10

SCellToReleaseListExt-r13 ::= SEQUENCE (SIZE (1..maxSCell-r13)) OF SCellIndex-r13

SCellGroupToReleaseList-r15 ::= SEQUENCE (SIZE (1..maxSCellGroups-r15)) OF SCellGroupIndex-
r15

SCellGroupIndex-r15 ::= INTEGER (1..maxSCellGroups-r15)

SCellConfigCommon-r15 ::= SEQUENCE {
    radioResourceConfigCommonSCell-r15 RadioResourceConfigCommonSCell-r10 OPTIONAL, -- Need
ON
    radioResourceConfigDedicatedSCell-r15 RadioResourceConfigDedicatedSCell-r10 OPTIONAL, -- Need
ON
    antennaInfoDedicatedSCell-r15 AntennaInfoDedicated-v10i0 OPTIONAL -- Need ON
}

SCG-Configuration-r12 ::= CHOICE {
    release NULL,
    setup SEQUENCE {
        scg-ConfigPartMCG-r12 SEQUENCE {
            scg-Counter-r12 INTEGER (0.. 65535) OPTIONAL, -- Need ON
            powerCoordinationInfo-r12 PowerCoordinationInfo-r12 OPTIONAL, -- Need ON
            ...
        } OPTIONAL, -- Need ON
        scg-ConfigPartSCG-r12 SCG-ConfigPartSCG-r12 OPTIONAL -- Need ON
    }
}

```

```

}
SCG-Configuration-v12f0 ::= CHOICE {
  release
  setup
    scg-ConfigPartSCG-v12f0
  }
}
SCG-Configuration-v13c0 ::= CHOICE {
  release
  setup
    scg-ConfigPartSCG-v13c0
  }
}
SCG-ConfigPartSCG-r12 ::= SEQUENCE {
  radioResourceConfigDedicatedSCG-r12 RadioResourceConfigDedicatedSCG-r12 OPTIONAL, -- Need ON
  sCellToReleaseListSCG-r12 SCellToReleaseList-r10 OPTIONAL, -- Need ON
  pSCellToAddMod-r12 PSCellToAddMod-r12 OPTIONAL, -- Need ON
  sCellToAddModListSCG-r12 SCellToAddModList-r10 OPTIONAL, -- Need ON
  mobilityControlInfoSCG-r12 MobilityControlInfoSCG-r12 OPTIONAL, -- Need ON
  ...,
  [[
  sCellToReleaseListSCG-Ext-r13 SCellToReleaseListExt-r13 OPTIONAL, -- Need ON
  sCellToAddModListSCG-Ext-r13 SCellToAddModListExt-r13 OPTIONAL, -- Need ON
  ]],
  [[
  sCellToAddModListSCG-Ext-v1370 SCellToAddModListExt-v1370 OPTIONAL, -- Need ON
  ]],
  [[
  pSCellToAddMod-v1440 PSCellToAddMod-v1440 OPTIONAL, -- Need ON
  ]],
  [[
  sCellGroupToReleaseListSCG-r15 SCellGroupToReleaseList-r15 OPTIONAL, -- Need ON
  sCellGroupToAddModListSCG-r15 SCellGroupToAddModList-r15 OPTIONAL, -- Need ON
  ]],
  [[
  -- NE-DC addition for setup/ modification and release SN configured measurements
  measConfigSN-r15 MeasConfig OPTIONAL, -- Need ON
  -- NE-DC additions concerning DRBs/ SRBs are within RadioResourceConfigDedicatedSCG
  tdm-PatternConfigNE-DC-r15 TDM-PatternConfig-r15 OPTIONAL, -- Cond FDD-
]]
PSCell
]]
[[
  p-MaxEUTRA-r15 P-Max OPTIONAL, -- Need ON
]]
}
SCG-ConfigPartSCG-v12f0 ::= SEQUENCE {
  pSCellToAddMod-v12f0 PSCellToAddMod-v12f0 OPTIONAL, -- Need ON
  sCellToAddModListSCG-v12f0 SCellToAddModList-v1010 OPTIONAL, -- Need ON
}
SCG-ConfigPartSCG-v13c0 ::= SEQUENCE {
  sCellToAddModListSCG-v13c0 SCellToAddModList-v13c0 OPTIONAL, -- Need ON
  sCellToAddModListSCG-Ext-v13c0 SCellToAddModListExt-v13c0 OPTIONAL, -- Need ON
}
SecurityConfigHO ::= SEQUENCE {
  handoverType CHOICE {
    intraLTE SEQUENCE {
      securityAlgorithmConfig SecurityAlgorithmConfig OPTIONAL, -- Cond
fullConfig
      keyChangeIndicator BOOLEAN,
      nextHopChainingCount NextHopChainingCount
    },
    interRAT SEQUENCE {
      securityAlgorithmConfig SecurityAlgorithmConfig,
      nas-SecurityParamToEUTRA OCTET STRING (SIZE(6))
    }
  },
  ...
}
SecurityConfigHO-v1530 ::= SEQUENCE {
  handoverType-v1530 CHOICE {
    intra5GC SEQUENCE {
toEUTRA
      securityAlgorithmConfig-r15 SecurityAlgorithmConfig OPTIONAL, -- Cond HO-
      keyChangeIndicator-r15 BOOLEAN,

```

```
        nextHopChainingCount-r15          NextHopChainingCount,
        nas-Container-r15                 OCTET STRING    OPTIONAL    -- Need ON
    },
    fivegc-ToEPC                          SEQUENCE {
        securityAlgorithmConfig-r15      SecurityAlgorithmConfig,
        nextHopChainingCount-r15        NextHopChainingCount
    },
    epc-To5GC                             SEQUENCE {
        securityAlgorithmConfig-r15      SecurityAlgorithmConfig,
        nas-Container-r15                OCTET STRING
    }
},
...
}
-- ASN1STOP
```

<b>RRCConnectionReconfiguration field descriptions</b>
<p><b>conditionalReconfiguration</b> This field is used to configure the UE with a conditional reconfiguration. The reconfiguration is applied when the execution condition(s) is fulfilled. The field is absent if <i>daps-HO</i> is configured for any DRB or if <i>MobilityControlInfo</i> is included in the <i>RRCConnectionReconfiguration</i> message. The <i>conditionalReconfiguration</i> is not configured in the <i>RRCConnectionReconfiguration</i> message included in a <i>conditionalReconfiguration</i>.</p>
<p><b>daps-SourceRelease</b> A one-shot field that indicates that the UE shall release the resources associated with source PCell at a DAPS HO, including reconfiguration of the PDCP entity to release DAPS.</p>
<p><b>dedicatedInfoNASList</b> This field is used to transfer UE specific NAS layer information between the network and the UE. The RRC layer is transparent for each PDU in the list. If <i>dedicatedInfoNASList-r15</i> is present, UE shall ignore the <i>dedicatedInfoNASList</i> (without suffix).</p>
<p><b>endc-ReleaseAndAdd</b> A one-shot field indicating whether the UE simultaneously releases and adds all the NR SCG related configuration within <i>nr-Config</i>, i.e. the configuration set by the NR <i>RRCReconfiguration</i> message (e.g. <i>secondaryCellGroup</i>, <i>SRB3</i> and <i>measConfig</i>).</p>
<p><b>fullConfig</b> Indicates the full configuration option is applicable for the RRC Connection Reconfiguration message for intra-system intra-RAT handover. For inter-RAT handover from NR to E-UTRA, <i>fullConfig</i> indicates whether or not delta signalling of SDAP/PDCP from source RAT is applicable. This field is absent when the <i>RRCConnectionReconfiguration</i> message is generated by the E-UTRA SCG.</p>
<p><b>keyChangeIndicator</b> If UE is connected to EPC, true is used only in an intra-cell handover when a <math>K_{eNB}</math> key is derived from a <math>K_{ASME}</math> key taken into use through the latest successful NAS SMC procedure, as described in TS 33.401 [32] for <math>K_{eNB}</math> re-keying. false is used in an intra-LTE handover when the new <math>K_{eNB}</math> key is obtained from the current <math>K_{eNB}</math> key or from the NH as described in TS 33.401 [32]. If UE is connected to 5GC, with <i>keyChangeIndicator-r15</i>, true is used in an intra-cell handover when a <math>K_{eNB}</math> key is derived from a <math>K_{AMF}</math> key taken into use through the latest successful NAS SMC procedure, as described in TS 33.501 [86] for <math>K_{eNB}</math> re-keying. False is used for intra-system handover when the new <math>K_{eNB}</math> key is obtained from the current <math>K_{eNB}</math> key or from the NH as described in TS 33.501 [86]. True is also used in NG based handover procedure with <math>K_{AMF}</math> change, when a <math>K_{eNB}</math> key is derived from the new <math>K_{AMF}</math> key as described in TS 33.501 [86].</p>
<p><b>lwa-Configuration</b> This field is used to provide parameters for LWA configuration. E-UTRAN does not simultaneously configure LWA with DC, LWIP or RCLWI for a UE.</p>
<p><b>lwip-Configuration</b> This field is used to provide parameters for LWIP configuration. E-UTRAN does not simultaneously configure LWIP with DC, LWA or RCLWI for a UE.</p>
<p><b>measConfig</b> Measurements that E-UTRAN may configure when the UE is not configured with NE-DC.</p>
<p><b>measConfigSN</b> Measurements that E-UTRAN may configure when the UE is configured with NE-DC and for which reports are carried within an NR RRC message.</p>
<p><b>nas-Container</b> This field is used to transfer UE specific NAS layer information between the network and the UE. The RRC layer is transparent for this field, although, if included, it affects activation of AS- security after handover within E-UTRA/5GC. The content is defined in TS 24.501 [95]. In case of NG based handover, the content of <i>nas-Container</i> is. the Intra N1 mode NAS transparent container IE. In case of inter-system handover to from 5GS to EPS, the content of <i>NAS-Container</i> is. the S1 mode to N1 mode NAS transparent container IE.</p>
<p><b>nas-securityParamToEUTRA</b> This field is used to transfer UE specific NAS layer information between the network and the UE. The RRC layer is transparent for this field, although, if included, it affects activation of AS- security after inter-RAT handover to E-UTRA/EPC or inter-system handover to E-UTRA/EPC. The content is defined in TS 24.301 [35]. This field is not used for handover from 5GC.</p>
<p><b>networkControlledSyncTx</b> This field indicates whether the UE shall transmit synchronisation information (i.e. become synchronisation source). Value <i>On</i> indicates the UE to transmit synchronisation information while value <i>Off</i> indicates the UE to not transmit such information.</p>
<p><b>nextHopChainingCount</b> Parameter NCC: See TS 33.401 [32] if UE is connected to EPC, else see 33.501 [86] if UE is connected to 5GC.</p>
<p><b>nr-Config</b> Includes the NR related configurations. This field is used to configure (NG)EN-DC configuration, possibly in conjunction with fields <i>sk-Counter</i> and <i>nr-RadioBearerConfig1/2</i>. NOTE 1.</p>
<p><b>nr-RadioBearerConfig1, nr-RadioBearerConfig2</b> Includes the NR <i>RadioBearerConfig</i> IE as specified in TS 38.331 [82]. The field includes the configuration of RBs configured with NR PDCP.</p>

<b>RRCConnectionReconfiguration field descriptions</b>
<p><b>nr-SecondaryCellGroupConfig</b> Includes the NR <i>RRCReconfiguration</i> message as specified in TS 38.331 [82]. In this version of the specification, the NR RRC message only includes fields <i>secondaryCellGroup</i>, <i>conditionalReconfiguration</i>, <i>otherConfig</i>, <i>bap-Config</i>, <i>iab-IP-AddressConfigurationList</i> and/ or <i>measConfig</i>. If <i>nr-SecondaryCellGroupConfig</i> is configured, the network always includes this field upon MN handover to initiate an NR SCG reconfiguration with sync and key change.</p>
<p><b>perCC-GapIndicationRequest</b> Indicates that UE shall include <i>perCC-GapIndicationList</i> and <i>numFreqEffective</i> in the <i>RRCConnectionReconfigurationComplete</i> message. <i>numFreqEffectiveReduced</i> may also be included if frequencies are configured for reduced measurement performance.</p>
<p><b>p-MaxEUTRA</b> Indicates the maximum power available for LTE.</p>
<p><b>p-MaxUE-FR1</b> The maximum total transmit power to be used by the UE across all serving cells in frequency range 1 (FR1) across all cell groups. The maximum transmit power that the UE may use may be additionally limited on cell- or cell-group level. The field is optionally present, if (NG)EN-DC (nr-Config-r15) has been configured. It is absent otherwise.</p>
<p><b>p-MeNB</b> Indicates the guaranteed power for the MeNB, as specified in TS 36.213 [23]. The value N corresponds to N-1 in TS 36.213 [23].</p>
<p><b>powerControlMode</b> Indicates the power control mode used in DC. Value 1 corresponds to DC power control mode 1 and value 2 indicates DC power control mode 2, as specified in TS 36.213 [23].</p>
<p><b>p-SeNB</b> Indicates the guaranteed power for the SeNB as specified in TS 36.213 [23], Table 5.1.4.2-1. The value N corresponds to N-1 in TS 36.213 [23].</p>
<p><b>rclwi-Configuration</b> WLAN traffic steering command as specified in 5.6.16.2. E-UTRAN does not simultaneously configure RCLWI with DC, LWA or LWIP for a UE.</p>
<p><b>sCellConfigCommon</b> Indicates the common configuration for the SCell group.</p>
<p><b>sCellGroupIndex</b> Indicates the identity of SCell groups for which a common configuration is provided.</p>
<p><b>sCellIndex</b> The <i>sCellIndex</i> is unique within the scope of the UE. In case of DC, an SCG cell can not use the same value as used for an MCG cell. For <i>pSCellToAddMod</i>, if <i>sCellIndex-r13</i> is present the UE shall ignore <i>sCellIndex-r12</i>.</p>
<p><b>sCellGroupToAddModList, sCellGroupToAddModListSCG</b> Indicates the SCell group to be added or modified. E-UTRAN only configures at most 4 SCell groups per UE over all cell groups. SCell groups can only be configured for LTE SCells, and all SCells in an SCell group must belong to the same cell group.</p>
<p><b>sCellGroupToReleaseList</b> Indicates the SCell group to be released.</p>
<p><b>sCellState</b> A one-shot field that indicates whether the SCell shall be considered to be in activated or dormant state upon SCell configuration.</p>
<p><b>sCellToAddModList, sCellToAddModListExt</b> Indicates the SCell to be added or modified. E-UTRAN uses field <i>sCellToAddModList-r10</i> to add or modify SCells (with <i>sCellIndex-r10</i>) for a UE that does not support carrier aggregation with more than 5 component carriers. If E-UTRAN includes <i>sCellToAddModListExt-v1430</i> it includes the same number of entries, and listed in the same order, as in <i>sCellToAddModListExt-r13</i>. If E-UTRAN includes <i>sCellToAddModList-v1010</i> it includes the same number of entries, and listed in the same order, as in <i>sCellToAddModList-r10</i>. If E-UTRAN includes <i>sCellToAddModListExt-v1370</i> it includes the same number of entries, and listed in the same order, as in <i>sCellToAddModListExt-r13</i>. If E-UTRAN includes <i>sCellToAddModListExt-v13c0</i> it includes the same number of entries, and listed in the same order, as in <i>sCellToAddModListExt-r13</i>.</p>
<p><b>sCellToAddModListSCG, sCellToAddModListSCG-Ext</b> Indicates the SCG cell to be added or modified. The field is used for SCG cells other than the PSCell (which is added/ modified by field <i>pSCellToAddMod</i>). E-UTRAN uses field <i>sCellToAddModListSCG-r12</i> to add or modify SCells (with <i>sCellIndex-r10</i>) for a UE that does not support carrier aggregation with more than 5 component carriers. If E-UTRAN includes <i>sCellToAddModListSCG-v1010</i> it includes the same number of entries, and listed in the same order, as in <i>sCellToAddModListSCG-r12</i>. If E-UTRAN includes <i>sCellToAddModListSCG-Ext-v1370</i> it includes the same number of entries, and listed in the same order, as in <i>sCellToAddModListSCG-Ext-r13</i>. If E-UTRAN includes <i>sCellToAddModListSCG-Ext-v13c0</i> it includes the same number of entries, and listed in the same order, as in <i>sCellToAddModListSCG-Ext-r13</i>.</p>
<p><b>sCellToReleaseList, sCellToReleaseListExt</b> Indicates the SCell to be released. E-UTRAN uses field <i>sCellToReleaseList-r10</i> to release SCells for a UE that does not support carrier aggregation with more than 5 component carriers.</p>

<b><i>RRCConnectionReconfiguration</i> field descriptions</b>
<p><b><i>sCellToReleaseListSCG, sCellToReleaseListSCG-Ext</i></b> Indicates the SCG cell to be released. The field is also used to release the PSCell e.g. upon change of PSCell, upon system information change for the PSCell. E-UTRAN uses field <i>sCellToReleaseListSCG-r12</i> to release SCells for a UE that does not support carrier aggregation with more than 5 component carriers.</p>
<p><b><i>scg-Configuration</i></b> Covers the SCG configuration as used in case of DC and NE-DC. When the UE is configured with NE-DC, E-UTRAN neither applies value release nor configures <i>scg-ConfigPartMCG</i>. When resuming a connection with NE-DC, this field is included, containing at least the <i>mobilityControlInfoSCG</i>.</p>
<p><b><i>scg-Counter</i></b> A counter used upon initial configuration of SCG security as well as upon refresh of S-K<sub>gNB</sub>. E-UTRAN includes the field upon SCG change when one or more SCG DRBs are configured. Otherwise E-UTRAN does not include the field.</p>
<p><b><i>scg-State</i></b> Indicates that the NR SCG is deactivated. The field is absent if CPA or CPC is configured for the UE, or if the <i>RRCConnectionReconfiguration</i> message is contained in <i>condReconfigurationToApply</i>.</p>
<p><b><i>securityConfigHO</i></b> This field contains the parameters required to update the security keys at handover. If E-UTRAN includes the <i>securityConfigHO</i> (i.e., without suffix), the choice <i>intraLTE</i> is used for handover within E-UTRA/EPC while the choice <i>interRAT</i> is used for handover from GERAN or UTRAN to E-UTRA/EPC. If E-UTRAN includes the <i>securityConfigHO-v1530</i> (i.e., with suffix), the choice <i>intra5GC</i> is used for handover from NR or E-UTRA/5GC to E-UTRA/5GC while the choice <i>fivegc-ToEPC</i> is used for inter-system handover from NR or E-UTRA/5GC to E-UTRA/EPC and the choice <i>epc-To5GC</i> is used for inter-system handover from E-UTRA/EPC to E-UTRA/5GC.</p>
<p><b><i>sk-Counter</i></b> A one-shot counter used upon initial configuration of S-K<sub>gNB</sub> as well as upon refresh of S-K<sub>gNB</sub>. E-UTRAN always provides this field either upon initial configuration of an NR SCG, or upon configuration of the first (SN terminated) RB using S-K<sub>gNB</sub>, whichever happens first.</p>
<p><b><i>sl-ConfigDedicatedForNR</i></b> Container for providing the dedicated configurations for NR sidelink communication, the octet string contains the NR <i>RRCReconfiguration</i> message as specified in TS 38.331 [82]. In this version of the specification, the NR RRC message only includes fields related to NR sidelink communication, i.e. <i>sl-ConfigDedicatedNR</i>, <i>measConfig</i> and/or <i>otherConfig</i>. If the UE is configured by the current Pcell with <i>sl-ScheduledConfig</i> set to setup (i.e., NR sidelink communication mode 1), the network only includes <i>sl-PrioritizationThres</i> and <i>sl-ConfiguredGrantConfig</i> that only includes the configurations of configured sidelink grant Type 1 in the field <i>sl-ScheduledConfig</i>. This field is not applicable to 5GS Proximity based Services (ProSe) as defined in TS 23.304 [112] in this release.</p>
<p><b><i>sl-SSB-PriorityEUTRA</i></b> Indicates the priority of LTE PSSS/SSSS/PSBCH transmission and reception. NOTE 3.</p>
<p><b><i>sl-V2X-ConfigDedicated</i></b> Indicates sidelink configuration for non-P2X related V2X sidelink communication as well as P2X related V2X sidelink communication.</p>
<p><b><i>smtc</i></b> The SSB periodicity/offset/duration configuration of target cell for NR PSCell addition and SN change. It is based on timing reference of EUTRA PCell. NOTE 2. If the field is absent, the UE uses the SMTC in the <i>measObjectNR</i> having the same SSB frequency and subcarrier spacing, as configured before the reception of the RRC message.</p>
<p><b><i>srs-SwitchFromServCellIndex</i></b> Indicates the serving cell whose UL transmission may be interrupted during SRS transmission on a PUSCH-less cell. During SRS transmission on a PUSCH-less cell, the UE may temporarily suspend the UL transmission on a serving cell with PUSCH in the same CG to allow the PUSCH-less cell to transmit SRS. The PUSCH-less cell is always a TDD cell but the serving cell with PUSCH may be either a FDD or TDD cell.</p>
<p><b><i>systemInformationBlockType1Dedicated</i></b> This field is used to transfer <i>SystemInformationBlockType1</i> or <i>SystemInformationBlockType1-BR</i> to the UE.</p>
<p><b><i>systemInformationBlockType2Dedicated</i></b> This field is used to transfer BR version of <i>SystemInformationBlockType2</i> to BL UEs or UEs in CE or <i>SystemInformationBlockType2</i> to non-BL UEs.</p>
<p><b><i>systemInformationBlockType31Dedicated</i></b> This field is used to transfer <i>SystemInformationBlockType31</i> to BL UEs or UEs in CE for an NTN cell.</p>
<p><b><i>t350</i></b> Timer T350 as described in clause 7.3. Value <i>minN</i> corresponds to N minutes.</p>
<p><b><i>tdm-PatternConfig</i></b> This field is used when power control or IMD issues require single UL transmission in (NG)EN-DC as specified in TS 38.101-3 [101] and TS 38.213 [88].</p>
<p><b><i>tdm-PatternConfig2</i></b> This field is used for dual UL transmission in EN-DC with LTE FDD PCell and for single UL transmission in EN-DC with LTE FDD/TDD PCell, as specified in TS 38.101-3 [101] and TS 38.213 [88]. The network sets at most one of <i>tdm-PatternConfig</i> and <i>tdm-PatternConfig2</i> to setup. When this field is configured in EN-DC with LTE TDD PCell, it is not applicable if TDD configuration is sa0 or sa6 in SIB1.</p>

<b><i>RRCConnectionReconfiguration</i> field descriptions</b>	
<b><i>tdm-PatternConfigNE-DC</i></b>	
This field is used when power control or IMD issues require single UL transmission in NE-DC as specified in TS 38.101-3 [101] and TS 38.213 [88].	

<b>Conditional presence</b>	<b>Explanation</b>
<i>EARFCN-max</i>	The field is mandatory present if <i>dl-CarrierFreq-r10</i> is included and set to <i>maxEARFCN</i> . Otherwise the field is not present.
<i>FDD-PCell</i>	This field is optionally present, need ON, for a FDD PCell if there is no SCell with configured uplink. Otherwise, the field is not present.
<i>FDD-PSCell</i>	This field is optionally present, need ON, for a FDD PSCell if there is no SCell with configured uplink. Otherwise, the field is not present.
<i>fullConfig</i>	This field is mandatory present for handover within E-UTRA when the <i>fullConfig</i> is included; otherwise it is optionally present, Need OP.
<i>HO</i>	The field is mandatory present in case of handover within E-UTRA or to E-UTRA and in a message contained in a NR <i>DLInformationTransferMRDC</i> message; otherwise the field is not present. The field is not present if source PCell resources after a DAPS handover have not been released.
<i>HO-Reestab</i>	The field is mandatory present in case of inter-system handover within E-UTRA or handover from NR to E-UTRA/EPC; it is optionally present, need ON, in case of intra-system handover within E-UTRA or upon the first reconfiguration after RRC connection re-establishment; or for intra-system handover from NR to E-UTRA, otherwise the field is not present.
<i>HO-5GC</i>	The field is mandatory present in case of handover within E-UTRA/5GC, handover to E-UTRA/5GC, handover from NR to E-UTRA/EPC, or handover from E-UTRA/5GC to E-UTRA/EPC, otherwise the field is not present.
<i>HO-toEPC</i>	The field is mandatory present in case of handover within E-UTRA/EPC or to E-UTRA/EPC, except handover from NR or E-UTRA/5GC, otherwise the field is not present.
<i>HO-toEUTRA</i>	The field is mandatory present in case of handover to E-UTRA or for reconfigurations when <i>fullConfig</i> is included; otherwise the field is optionally present, need ON.
<i>nonFullConfig</i>	The field is not present when the <i>fullConfig</i> is included or in case of handover to E-UTRA; otherwise it is optional present, need ON.
<i>nonHO</i>	The field is not present in case of handover within E-UTRA or to E-UTRA; otherwise it is optional present, need ON.
<i>NTN</i>	The field is mandatory present in case of handover to a NTN cell. Otherwise the field is optionally present, Need ON, in a NTN cell.
<i>SCellAdd</i>	The field is mandatory present upon SCell addition; otherwise it is not present.
<i>SCellAdd2</i>	The field is mandatory present upon SCell addition; otherwise it is optionally present, need ON.

NOTE 1: Fields *sk-Counter* and *nr-RadioBearerConfig1/2* are placed outside *nr-Config*, as these may be configured while the UE is not configured with (NG)EN-DC.

NOTE 2: It is not specified whether the timing reference for the SMTC configuration is the source EUTRA PCell or the target EUTRA PCell in case the NR PSCell addition or SN change takes place simultaneously with handover. As a consequence, explicit SMTC configuration is only supported when the source EUTRA PCell and the target EUTRA PCell of the handover are SFN/subframe-synchronized.

NOTE 3: For UEs in RRC\_IDLE, RRC\_INACTIVE or out-of coverage, and for the case that *sl-SSB-PriorityEUTRA* is absent, it is up to UE implementation to decide the priority of LTE PSSS/SSSS/PSBCH transmission and reception.

### – *RRCConnectionReconfigurationComplete*

The *RRCConnectionReconfigurationComplete* message is used to confirm the successful completion of an RRC connection reconfiguration.

Signalling radio bearer: SRB1

RLC-SAP: AM

Logical channel: DCCH

Direction: UE to E-UTRAN

### ***RRCConnectionReconfigurationComplete message***

```
-- ASN1START
RRCConnectionReconfigurationComplete ::= SEQUENCE {
    rrc-TransactionIdentifier      RRC-TransactionIdentifier,
    criticalExtensions             CHOICE {
        rrcConnectionReconfigurationComplete-r8
        rrcConnectionReconfigurationComplete-r8-IEs,
        criticalExtensionsFuture  SEQUENCE {}
    }
}

RRCConnectionReconfigurationComplete-r8-IEs ::= SEQUENCE {
    nonCriticalExtension          RRCConnectionReconfigurationComplete-v8a0-IEs  OPTIONAL
}

RRCConnectionReconfigurationComplete-v8a0-IEs ::= SEQUENCE {
    lateNonCriticalExtension      OCTET STRING                               OPTIONAL,
    nonCriticalExtension          RRCConnectionReconfigurationComplete-v1020-IEs  OPTIONAL
}

RRCConnectionReconfigurationComplete-v1020-IEs ::= SEQUENCE {
    rlf-InfoAvailable-r10        ENUMERATED {true}                       OPTIONAL,
    logMeasAvailable-r10         ENUMERATED {true}                       OPTIONAL,
    nonCriticalExtension          RRCConnectionReconfigurationComplete-v1130-IEs  OPTIONAL
}

RRCConnectionReconfigurationComplete-v1130-IEs ::= SEQUENCE {
    connEstFailInfoAvailable-r11 ENUMERATED {true}                       OPTIONAL,
    nonCriticalExtension          RRCConnectionReconfigurationComplete-v1250-IEs  OPTIONAL
}

RRCConnectionReconfigurationComplete-v1250-IEs ::= SEQUENCE {
    logMeasAvailableMBSFN-r12    ENUMERATED {true}                       OPTIONAL,
    nonCriticalExtension          RRCConnectionReconfigurationComplete-v1430-IEs  OPTIONAL
}

RRCConnectionReconfigurationComplete-v1430-IEs ::= SEQUENCE {
    perCC-GapIndicationList-r14  PerCC-GapIndicationList-r14           OPTIONAL,
    numFreqEffective-r14          INTEGER (1..12)                          OPTIONAL,
    numFreqEffectiveReduced-r14   INTEGER (1..12)                          OPTIONAL,
    nonCriticalExtension          RRCConnectionReconfigurationComplete-v1510-IEs  OPTIONAL
}

RRCConnectionReconfigurationComplete-v1510-IEs ::= SEQUENCE {
    scg-ConfigResponseNR-r15     OCTET STRING                               OPTIONAL,
    nonCriticalExtension          RRCConnectionReconfigurationComplete-v1530-IEs  OPTIONAL
}

RRCConnectionReconfigurationComplete-v1530-IEs ::= SEQUENCE {
    logMeasAvailableBT-r15        ENUMERATED {true}                       OPTIONAL,
    logMeasAvailableWLAN-r15      ENUMERATED {true}                       OPTIONAL,
    flightPathInfoAvailable-r15   ENUMERATED {true}                       OPTIONAL,
    nonCriticalExtension          RRCConnectionReconfigurationComplete-v1700-IEs  OPTIONAL
}

RRCConnectionReconfigurationComplete-v1700-IEs ::= SEQUENCE {
    selectedCondReconfigurationToApply-r17 CondReconfigurationId-r16  OPTIONAL,
    nonCriticalExtension          RRCConnectionReconfigurationComplete-v1710-IEs  OPTIONAL
}

RRCConnectionReconfigurationComplete-v1710-IEs ::= SEQUENCE {
    gnss-ValidityDuration-r17     GNSS-ValidityDuration-r17              OPTIONAL,

```



```

    nonCriticalExtension          RRCConnectionReconfigurationComplete-v1800-IEs    OPTIONAL
  }
RRCConnectionReconfigurationComplete-v1800-IEs ::= SEQUENCE {
    gnss-PositionFixDuration-r18    GNSS-PositionFixDuration-r18    OPTIONAL,
    nonCriticalExtension              SEQUENCE {}                          OPTIONAL
}
-- ASN1STOP

```

#### ***RRCConnectionReconfigurationComplete* field descriptions**

##### ***numFreqEffective***

This field is used to indicate the number of effective frequencies that a UE measures in series according to TS 36.133 [16]. Simultaneous measurement in parallel on multiple frequencies can be equivalent to a single effective frequency. The frequencies configured for reduced measurement performance should not be included.

##### ***numFreqEffectiveReduced***

This field is used to indicate the number of effective frequencies that a UE measures in series according to TS 36.133 [16] for frequencies configured for reduced measurement performance. Simultaneous measurement in parallel on multiple frequencies can be equivalent to a single effective frequency.

##### ***perCC-GapIndicationList***

This field is used to indicate per CC measurement gap preference by the UE.

##### ***scg-ConfigResponseNR***

Includes the NR *RRCReconfigurationComplete* message as defined in TS 38.331 [82].

##### ***selectedCondReconfigurationToApply***

This field indicates the selected conditional RRC connection reconfiguration the UE applied upon the execution of CPA or inter-SN CPC.

### ***RRCConnectionReestablishment***

The *RRCConnectionReestablishment* message is used to re-establish SRB1.

Signalling radio bearer: SRB0

RLC-SAP: TM

Logical channel: CCCH

Direction: E-UTRAN to UE

#### ***RRCConnectionReestablishment* message**

```

-- ASN1START
RRCConnectionReestablishment ::= SEQUENCE {
    rrc-TransactionIdentifier      RRC-TransactionIdentifier,
    criticalExtensions              CHOICE {
        c1                          CHOICE {
            rrcConnectionReestablishment-r8    RRCConnectionReestablishment-r8-IEs,
            spare7 NULL,
            spare6 NULL, spare5 NULL, spare4    NULL,
            spare3 NULL, spare2 NULL, spare1    NULL
        },
        criticalExtensionsFuture          SEQUENCE {}
    }
}
RRCConnectionReestablishment-r8-IEs ::= SEQUENCE {
    radioResourceConfigDedicated      RadioResourceConfigDedicated,
    nextHopChainingCount              NextHopChainingCount,
    nonCriticalExtension                RRCConnectionReestablishment-v8a0-IEs    OPTIONAL
}
RRCConnectionReestablishment-v8a0-IEs ::= SEQUENCE {
    lateNonCriticalExtension            OCTET STRING                          OPTIONAL,
    nonCriticalExtension                SEQUENCE {}                          OPTIONAL
}
-- ASN1STOP

```

– *RRCCONNECTIONREESTABLISHMENTCOMPLETE*

The *RRCCONNECTIONREESTABLISHMENTCOMPLETE* message is used to confirm the successful completion of an RRC connection re-establishment.

Signalling radio bearer: SRB1

RLC-SAP: AM

Logical channel: DCCH

Direction: UE to E-UTRAN

***RRCCONNECTIONREESTABLISHMENTCOMPLETE message***

```
-- ASN1START
RRCCONNECTIONREESTABLISHMENTCOMPLETE ::= SEQUENCE {
  rrc-TransactionIdentifier      RRC-TransactionIdentifier,
  criticalExtensions              CHOICE {
    rrcConnectionReestablishmentComplete-r8
    RRCConnectionReestablishmentComplete-r8-IEs,
    criticalExtensionsFuture      SEQUENCE {}
  }
}

RRCCONNECTIONREESTABLISHMENTCOMPLETE-r8-IEs ::= SEQUENCE {
  nonCriticalExtension            RRCConnectionReestablishmentComplete-v920-IEs  OPTIONAL
}

RRCCONNECTIONREESTABLISHMENTCOMPLETE-v920-IEs ::= SEQUENCE {
  rlf-InfoAvailable-r9           ENUMERATED {true}  OPTIONAL,
  nonCriticalExtension            RRCConnectionReestablishmentComplete-v8a0-IEs  OPTIONAL
}

RRCCONNECTIONREESTABLISHMENTCOMPLETE-v8a0-IEs ::= SEQUENCE {
  lateNonCriticalExtension        OCTET STRING  OPTIONAL,
  nonCriticalExtension            RRCConnectionReestablishmentComplete-v1020-IEs  OPTIONAL
}

RRCCONNECTIONREESTABLISHMENTCOMPLETE-v1020-IEs ::= SEQUENCE {
  logMeasAvailable-r10           ENUMERATED {true}  OPTIONAL,
  nonCriticalExtension            RRCConnectionReestablishmentComplete-v1130-IEs  OPTIONAL
}

RRCCONNECTIONREESTABLISHMENTCOMPLETE-v1130-IEs ::= SEQUENCE {
  connEstFailInfoAvailable-r11   ENUMERATED {true}  OPTIONAL,
  nonCriticalExtension            RRCConnectionReestablishmentComplete-v1250-IEs  OPTIONAL
}

RRCCONNECTIONREESTABLISHMENTCOMPLETE-v1250-IEs ::= SEQUENCE {
  logMeasAvailableMBSFN-r12      ENUMERATED {true}  OPTIONAL,
  nonCriticalExtension            RRCConnectionReestablishmentComplete-v1530-IEs  OPTIONAL
}

RRCCONNECTIONREESTABLISHMENTCOMPLETE-v1530-IEs ::= SEQUENCE {
  logMeasAvailableBT-r15         ENUMERATED {true}  OPTIONAL,
  logMeasAvailableWLAN-r15       ENUMERATED {true}  OPTIONAL,
  flightPathInfoAvailable-r15    ENUMERATED {true}  OPTIONAL,
  nonCriticalExtension            RRCConnectionReestablishmentComplete-v1710-IEs  OPTIONAL
}

RRCCONNECTIONREESTABLISHMENTCOMPLETE-v1710-IEs ::= SEQUENCE {
  gnss-ValidityDuration-r17      GNSS-ValidityDuration-r17  OPTIONAL,
  nonCriticalExtension            RRCConnectionReestablishmentComplete-v1800-IEs  OPTIONAL
}

RRCCONNECTIONREESTABLISHMENTCOMPLETE-v1800-IEs ::= SEQUENCE {
  gnss-PositionFixDuration-r18   GNSS-PositionFixDuration-r18  OPTIONAL,
  nonCriticalExtension            SEQUENCE {}  OPTIONAL
}
-- ASN1STOP
```

***RRConnectionReestablishmentComplete* field descriptions*****rlf-InfoAvailable***

This field is used to indicate the availability of radio link failure or handover failure related measurements

***RRConnectionReestablishmentReject***

The *RRConnectionReestablishmentReject* message is used to indicate the rejection of an RRC connection re-establishment request.

Signalling radio bearer: SRB0

RLC-SAP: TM

Logical channel: CCCH

Direction: E-UTRAN to UE

***RRConnectionReestablishmentReject* message**

```
-- ASN1START
RRConnectionReestablishmentReject ::= SEQUENCE {
    criticalExtensions          CHOICE {
        rrcConnectionReestablishmentReject-r8
                                RRConnectionReestablishmentReject-r8-IEs,
        criticalExtensionsFuture SEQUENCE {}
    }
}
RRConnectionReestablishmentReject-r8-IEs ::= SEQUENCE {
    nonCriticalExtension          RRConnectionReestablishmentReject-v8a0-IEs OPTIONAL
}
RRConnectionReestablishmentReject-v8a0-IEs ::= SEQUENCE {
    lateNonCriticalExtension      OCTET STRING                                OPTIONAL,
    nonCriticalExtension          SEQUENCE {}                                OPTIONAL
}
-- ASN1STOP
```

***RRConnectionReestablishmentRequest***

The *RRConnectionReestablishmentRequest* message is used to request the reestablishment of an RRC connection.

Signalling radio bearer: SRB0

RLC-SAP: TM

Logical channel: CCCH

Direction: UE to E-UTRAN

***RRConnectionReestablishmentRequest* message**

```
-- ASN1START
RRConnectionReestablishmentRequest ::= SEQUENCE {
    criticalExtensions          CHOICE {
        rrcConnectionReestablishmentRequest-r8
                                RRConnectionReestablishmentRequest-r8-IEs,
        criticalExtensionsFuture SEQUENCE {}
    }
}
RRConnectionReestablishmentRequest-r8-IEs ::= SEQUENCE {
    ue-Identity                 ReestabUE-Identity,
    reestablishmentCause        ReestablishmentCause,
    spare                       BIT STRING (SIZE (2))
}
-- ASN1STOP
```

```

ReestabUE-Identity ::=
    c-RNTI
    physCellId
    shortMAC-I
}
SEQUENCE {
    C-RNTI,
    PhysCellId,
    ShortMAC-I
}

ReestablishmentCause ::=
}
ENUMERATED {
    reconfigurationFailure, handoverFailure,
    otherFailure, spare1
}

-- ASN1STOP

```

### ***RRCCConnectionReestablishmentRequest*** field descriptions

#### ***physCellId***

The Physical Cell Identity of the PCell the UE was connected to prior to the failure.

#### ***reestablishmentCause***

Indicates the failure cause that triggered the re-establishment procedure. eNB is not expected to reject a *RRCCConnectionReestablishmentRequest* due to unknown cause value being used by the UE.

#### ***ue-Identity***

UE identity included to retrieve UE context and to facilitate contention resolution by lower layers.

## – ***RRCCConnectionReject***

The *RRCCConnectionReject* message is used to reject the RRC connection establishment or to reject the EDT procedure.

Signalling radio bearer: SRB0

RLC-SAP: TM

Logical channel: CCCH

Direction: E-UTRAN to UE

### ***RRCCConnectionReject*** message

```

-- ASN1START

RRCCConnectionReject ::=
    criticalExtensions
    c1
    rrcConnectionReject-r8
    spare3 NULL, spare2 NULL, spare1 NULL
    },
    criticalExtensionsFuture
}
SEQUENCE {
    CHOICE {
        CHOICE {
            RRCCConnectionReject-r8-IEs,
            spare1 NULL
        }
    }
}

RRCCConnectionReject-r8-IEs ::=
    waitTime
    nonCriticalExtension
}
SEQUENCE {
    INTEGER (1..16),
    RRCCConnectionReject-v8a0-IEs
}

RRCCConnectionReject-v8a0-IEs ::= SEQUENCE {
    lateNonCriticalExtension
    nonCriticalExtension
}
OCTET STRING
RRCCConnectionReject-v1020-IEs
OPTIONAL,
OPTIONAL

RRCCConnectionReject-v1020-IEs ::= SEQUENCE {
    extendedWaitTime-r10
    nonCriticalExtension
}
INTEGER (1..1800)
RRCCConnectionReject-v1130-IEs
OPTIONAL, -- Need ON
OPTIONAL

RRCCConnectionReject-v1130-IEs ::= SEQUENCE {
    deprioritisationReq-r11
    deprioritisationType-r11
    deprioritisationTimer-r11
}
SEQUENCE {
    SEQUENCE {
        ENUMERATED {frequency, e-utra},
        ENUMERATED {min5, min10, min15, min30}
    }
    RRCCConnectionReject-v1320-IEs
}
OPTIONAL, -- Need ON
OPTIONAL

```

```

}
RRCConnectionReject-v1320-IEs ::= SEQUENCE {
    rrc-SuspendIndication-r13      ENUMERATED {true}          OPTIONAL,  -- Need ON
    nonCriticalExtension            SEQUENCE {}                  OPTIONAL
}
-- ASN1STOP

```

#### **RRCConnectionReject field descriptions**

<b>deprioritisationReq</b>	Indicates whether the current frequency or RAT is to be de-prioritised. The UE shall be able to store a de-prioritisation request for up to 8 frequencies (applicable when receiving another frequency specific de-prioritisation request before T325 expiry).
<b>deprioritisationTimer</b>	Indicates the period for which either the current carrier frequency or E-UTRA is de-prioritised. Value <i>minN</i> corresponds to N minutes.
<b>extendedWaitTime</b>	Value in seconds for the wait time for Delay Tolerant access requests.
<b>rrc-SuspendIndication</b>	If present, this field indicates that the UE should remain suspended and not release its stored context.
<b>waitTime</b>	Wait time value in seconds.

### – RRCConnectionRelease

The *RRCConnectionRelease* message is used to command the release of an RRC connection, or to complete an UP-EDT procedure.

Signalling radio bearer: SRB1

RLC-SAP: AM

Logical channel: DCCH

Direction: E-UTRAN to UE

#### **RRCConnectionRelease message**

```

-- ASN1START
RRCConnectionRelease ::= SEQUENCE {
    rrc-TransactionIdentifier      RRC-TransactionIdentifier,
    criticalExtensions             CHOICE {
        c1                         CHOICE {
            rrcConnectionRelease-r8      RRCConnectionRelease-r8-IEs,
            spare3 NULL, spare2 NULL, spare1 NULL
        },
        criticalExtensionsFuture        SEQUENCE {}
    }
}

RRCConnectionRelease-r8-IEs ::= SEQUENCE {
    releaseCause                  ReleaseCause,
    redirectedCarrierInfo         RedirectedCarrierInfo          OPTIONAL,  -- Need ON
    idleModeMobilityControlInfo   IdleModeMobilityControlInfo   OPTIONAL,  -- Need OP
    nonCriticalExtension          RRCConnectionRelease-v890-IEs   OPTIONAL
}

RRCConnectionRelease-v890-IEs ::= SEQUENCE {
    lateNonCriticalExtension      OCTET STRING (CONTAINING RRCConnectionRelease-v9e0-IEs)
    OPTIONAL,
    nonCriticalExtension          RRCConnectionRelease-v920-IEs   OPTIONAL
}

-- Late non critical extensions
RRCConnectionRelease-v9e0-IEs ::= SEQUENCE {
    redirectedCarrierInfo-v9e0    RedirectedCarrierInfo-v9e0    OPTIONAL,  -- Cond
    NoRedirect-r8
}

```

```

    idleModeMobilityControlInfo-v9e0      IdleModeMobilityControlInfo-v9e0      OPTIONAL,  -- Cond
IdleInfoEUTRA
    nonCriticalExtension                    SEQUENCE {}                                OPTIONAL
}

-- Regular non critical extensions
RRCConnectionRelease-v920-IEs ::= SEQUENCE {
    cellInfoList-r9                        CHOICE {
        geran-r9                            CellInfoListGERAN-r9,
        utra-FDD-r9                         CellInfoListUTRA-FDD-r9,
        utra-TDD-r9                         CellInfoListUTRA-TDD-r9,
        . . . ,
        utra-TDD-r10                        CellInfoListUTRA-TDD-r10
    }
    nonCriticalExtension                    RRCConnectionRelease-v1020-IEs          OPTIONAL,  -- Cond Redirection
}

RRCConnectionRelease-v1020-IEs ::= SEQUENCE {
    extendedWaitTime-r10                   INTEGER (1..1800)                         OPTIONAL,  -- Need ON
    nonCriticalExtension                    RRCConnectionRelease-v1320-IEs          OPTIONAL
}

RRCConnectionRelease-v1320-IEs ::= SEQUENCE {
    resumeIdentity-r13                     ResumeIdentity-r13                        OPTIONAL,  -- Need OR
    nonCriticalExtension                    RRCConnectionRelease-v1530-IEs          OPTIONAL
}

RRCConnectionRelease-v1530-IEs ::= SEQUENCE {
    drb-ContinueROHC-r15                   ENUMERATED {true}                        OPTIONAL,  -- Cond UP-EDTorPUR
    nextHopChainingCount-r15               NextHopChainingCount                     OPTIONAL,  -- Cond EarlySec
    measIdleConfig-r15                     MeasIdleConfigDedicated-r15              OPTIONAL,  -- Need ON
    rrc-InactiveConfig-r15                 RRC-InactiveConfig-r15                  OPTIONAL,  -- Need OR
    cn-Type-r15                             ENUMERATED {epc,fivegc}                  OPTIONAL,  -- Need OR
    nonCriticalExtension                    RRCConnectionRelease-v1540-IEs          OPTIONAL
}

RRCConnectionRelease-v1540-IEs ::= SEQUENCE {
    waitTime                                INTEGER (1..16)                           OPTIONAL,  -- Cond 5GC
    nonCriticalExtension                    RRCConnectionRelease-v15b0-IEs          OPTIONAL
}

RRCConnectionRelease-v15b0-IEs ::= SEQUENCE {
    noLastCellUpdate-r15                   ENUMERATED {true}                         OPTIONAL,  -- Need OP
    nonCriticalExtension                    RRCConnectionRelease-v1610-IEs          OPTIONAL
}

RRCConnectionRelease-v1610-IEs ::= SEQUENCE {
    fullI-RNTI-r16                          I-RNTI-r15                               OPTIONAL,  -- Need OR
    shortI-RNTI-r16                         ShortI-RNTI-r15                           OPTIONAL,  -- Need OR
    pur-Config-r16                          SetupRelease {PUR-Config-r16}             OPTIONAL,  -- Need ON
    rrc-InactiveConfig-v1610                RRC-InactiveConfig-v1610                 OPTIONAL,  -- Cond BLCE-IDLEeDRX
    releaseIdleMeasConfig-r16               ENUMERATED {true}                         OPTIONAL,  -- Need ON
    altFreqPriorities-r16                   ENUMERATED {true}                         OPTIONAL,  -- Need ON
    t323-r16                                ENUMERATED {
        min5, min10, min20, min30, min60, min120, min180,
        min720
    }
    nonCriticalExtension                    RRCConnectionRelease-v1650-IEs          OPTIONAL
}

RRCConnectionRelease-v1650-IEs ::= SEQUENCE {
    mpsPriorityIndication-r16                ENUMERATED {true}                         OPTIONAL,  -- Cond Redirection2
    nonCriticalExtension                    SEQUENCE {}                                OPTIONAL
}

ReleaseCause ::= ENUMERATED {loadBalancingTAUrequired,
    other, cs-FallbackHighPriority-v1020, rrc-Suspend-v1320}

RedirectedCarrierInfo ::= CHOICE {
    eutra                                    ARFCN-ValueEUTRA,
    geran                                    CarrierFreqsGERAN,
    utra-FDD                                 ARFCN-ValueUTRA,
    utra-TDD                                 ARFCN-ValueUTRA,
    cdma2000-HRPD                            CarrierFreqCDMA2000,
    cdma2000-1xRTT                           CarrierFreqCDMA2000,
    . . . ,
    utra-TDD-r10                             CarrierFreqListUTRA-TDD-r10,
    nr-r15                                    CarrierInfoNR-r15,
    nr-r17                                    CarrierInfoNR-r17
}

```

```

}
RedirectedCarrierInfo-v9e0 ::= SEQUENCE {
    eutra-v9e0 ARFCN-ValueEUTRA-v9e0
}
RRC-InactiveConfig-r15 ::= SEQUENCE {
    fullI-RNTI-r15 I-RNTI-r15,
    shortI-RNTI-r15 ShortI-RNTI-r15,
    ran-PagingCycle-r15 ENUMERATED { rf32, rf64, rf128, rf256 } OPTIONAL, --Need
OR
    ran-NotificationAreaInfo-r15 RAN-NotificationAreaInfo-r15 OPTIONAL, --Need ON
    periodic-RNAU-timer-r15 ENUMERATED {min5, min10, min20, min30, min60,
        min120, min360, min720} OPTIONAL, --Need OR
    nextHopChainingCount-r15 NextHopChainingCount OPTIONAL, --Cond INACTIVE
    dummy SEQUENCE{} OPTIONAL
}
RRC-InactiveConfig-v1610 ::= SEQUENCE {
    ran-PagingCycle-v1610 ENUMERATED {rf512, rf1024}
}
RAN-NotificationAreaInfo-r15 ::= CHOICE {
    cellList PLMN-RAN-AreaCellList-r15,
    ran-AreaConfigList PLMN-RAN-AreaConfigList-r15
}
PLMN-RAN-AreaCellList-r15 ::= SEQUENCE (SIZE (1..maxPLMN-r15)) OF PLMN-RAN-AreaCell-r15
PLMN-RAN-AreaCell-r15 ::= SEQUENCE {
    plmn-Identity-r15 PLMN-Identity OPTIONAL,
    ran-AreaCells-r15 SEQUENCE (SIZE (1..32)) OF CellIdentity
}
PLMN-RAN-AreaConfigList-r15 ::= SEQUENCE (SIZE (1..maxPLMN-r15)) OF PLMN-RAN-AreaConfig-r15
PLMN-RAN-AreaConfig-r15 ::= SEQUENCE {
    plmn-Identity-r15 PLMN-Identity OPTIONAL,
    ran-Area-r15 SEQUENCE (SIZE (1..16)) OF RAN-AreaConfig-r15
}
RAN-AreaConfig-r15 ::= SEQUENCE {
    trackingAreaCode-5GC-r15 TrackingAreaCode-5GC-r15,
    ran-AreaCodeList-r15 SEQUENCE (SIZE (1..32)) OF RAN-AreaCode-r15 OPTIONAL --Need OR
}
CarrierFreqListUTRA-TDD-r10 ::= SEQUENCE (SIZE (1..maxFreqUTRA-TDD-r10)) OF ARFCN-ValueUTRA
IdleModeMobilityControlInfo ::= SEQUENCE {
    freqPriorityListEUTRA FreqPriorityListEUTRA OPTIONAL, -- Need ON
    freqPriorityListGERAN FreqPriorityListGERAN OPTIONAL, -- Need ON
    freqPriorityListUTRA-FDD FreqPriorityListUTRA-FDD OPTIONAL, -- Need ON
    freqPriorityListUTRA-TDD FreqPriorityListUTRA-TDD OPTIONAL, -- Need ON
    bandClassPriorityListHRPD BandClassPriorityListHRPD OPTIONAL, -- Need ON
    bandClassPriorityList1XRTT BandClassPriorityList1XRTT OPTIONAL, -- Need ON
    t320 ENUMERATED {
        min5, min10, min20, min30, min60, min120, min180,
        spare1} OPTIONAL, -- Need OR
    ...,
    [[ freqPriorityListExtEUTRA-r12 FreqPriorityListExtEUTRA-r12 OPTIONAL --
Need ON
]],
    [[ freqPriorityListEUTRA-v1310 FreqPriorityListEUTRA-v1310 OPTIONAL, --
Need ON
freqPriorityListExtEUTRA-v1310 FreqPriorityListExtEUTRA-v1310 OPTIONAL --
Need ON
]],
    [[ freqPriorityListNR-r15 FreqPriorityListNR-r15 OPTIONAL -- Need ON
]]
}
IdleModeMobilityControlInfo-v9e0 ::= SEQUENCE {
    freqPriorityListEUTRA-v9e0 SEQUENCE (SIZE (1..maxFreq)) OF FreqPriorityEUTRA-v9e0
}
FreqPriorityListEUTRA ::= SEQUENCE (SIZE (1..maxFreq)) OF FreqPriorityEUTRA
FreqPriorityListExtEUTRA-r12 ::= SEQUENCE (SIZE (1..maxFreq)) OF FreqPriorityEUTRA-r12

```

```

FreqPriorityListEUTRA-v1310 ::= SEQUENCE (SIZE (1..maxFreq)) OF FreqPriorityEUTRA-v1310
FreqPriorityListExtEUTRA-v1310 ::= SEQUENCE (SIZE (1..maxFreq)) OF FreqPriorityEUTRA-v1310
FreqPriorityEUTRA ::= SEQUENCE {
    carrierFreq ARFCN-ValueEUTRA,
    cellReselectionPriority CellReselectionPriority
}
FreqPriorityEUTRA-v9e0 ::= SEQUENCE {
    carrierFreq-v9e0 ARFCN-ValueEUTRA-v9e0 OPTIONAL -- Cond EARFCN-max
}
FreqPriorityEUTRA-r12 ::= SEQUENCE {
    carrierFreq-r12 ARFCN-ValueEUTRA-r9,
    cellReselectionPriority-r12 CellReselectionPriority
}
FreqPriorityEUTRA-v1310 ::= SEQUENCE {
    cellReselectionSubPriority-r13 CellReselectionSubPriority-r13 OPTIONAL --
Need ON
}
FreqPriorityListNR-r15 ::= SEQUENCE (SIZE (1..maxFreq)) OF FreqPriorityNR-r15
FreqPriorityNR-r15 ::= SEQUENCE {
    carrierFreq-r15 ARFCN-ValueNR-r15,
    cellReselectionPriority-r15 CellReselectionPriority,
    cellReselectionSubPriority-r15 CellReselectionSubPriority-r13 OPTIONAL -- Need
OR
}
FreqsPriorityListGERAN ::= SEQUENCE (SIZE (1..maxGNFG)) OF FreqsPriorityGERAN
FreqsPriorityGERAN ::= SEQUENCE {
    carrierFreqs CarrierFreqsGERAN,
    cellReselectionPriority CellReselectionPriority
}
FreqPriorityListUTRA-FDD ::= SEQUENCE (SIZE (1..maxUTRA-FDD-Carrier)) OF FreqPriorityUTRA-FDD
FreqPriorityUTRA-FDD ::= SEQUENCE {
    carrierFreq ARFCN-ValueUTRA,
    cellReselectionPriority CellReselectionPriority
}
FreqPriorityListUTRA-TDD ::= SEQUENCE (SIZE (1..maxUTRA-TDD-Carrier)) OF FreqPriorityUTRA-TDD
FreqPriorityUTRA-TDD ::= SEQUENCE {
    carrierFreq ARFCN-ValueUTRA,
    cellReselectionPriority CellReselectionPriority
}
BandClassPriorityListHRPD ::= SEQUENCE (SIZE (1..maxCDMA-BandClass)) OF BandClassPriorityHRPD
BandClassPriorityHRPD ::= SEQUENCE {
    bandClass BandclassCDMA2000,
    cellReselectionPriority CellReselectionPriority
}
BandClassPriorityList1XRTT ::= SEQUENCE (SIZE (1..maxCDMA-BandClass)) OF BandClassPriority1XRTT
BandClassPriority1XRTT ::= SEQUENCE {
    bandClass BandclassCDMA2000,
    cellReselectionPriority CellReselectionPriority
}
CellInfoListGERAN-r9 ::= SEQUENCE (SIZE (1..maxCellInfoGERAN-r9)) OF CellInfoGERAN-r9
CellInfoGERAN-r9 ::= SEQUENCE {
    physCellId-r9 PhysCellIdGERAN,
    carrierFreq-r9 CarrierFreqGERAN,
    systemInformation-r9 SystemInfoListGERAN
}
CarrierInfoNR-r15 ::= SEQUENCE {
    carrierFreq-r15 ARFCN-ValueNR-r15,

```



```

    subcarrierSpacingSSB-r15          ENUMERATED {kHz15, kHz30, kHz120, kHz240},
    smtc-r15                          MTC-SSB-NR-r15          OPTIONAL          -- Need OP
}

CarrierInfoNR-r17 ::= SEQUENCE {
    carrierFreq-r17                  ARFCN-ValueNR-r15,
    subcarrierSpacingSSB-r17        ENUMERATED {kHz15, kHz30, kHz120, kHz240, kHz480, spare1},
    smtc-r17                        MTC-SSB-NR-r15          OPTIONAL          -- Need OP
}

CellInfoListUTRA-FDD-r9 ::= SEQUENCE (SIZE (1..maxCellInfoUTRA-r9)) OF CellInfoUTRA-FDD-r9

CellInfoUTRA-FDD-r9 ::= SEQUENCE {
    physCellId-r9                   PhysCellIdUTRA-FDD,
    utra-BCCH-Container-r9          OCTET STRING
}

CellInfoListUTRA-TDD-r9 ::= SEQUENCE (SIZE (1..maxCellInfoUTRA-r9)) OF CellInfoUTRA-TDD-r9

CellInfoUTRA-TDD-r9 ::= SEQUENCE {
    physCellId-r9                   PhysCellIdUTRA-TDD,
    utra-BCCH-Container-r9          OCTET STRING
}

CellInfoListUTRA-TDD-r10 ::= SEQUENCE (SIZE (1..maxCellInfoUTRA-r9)) OF CellInfoUTRA-TDD-r10

CellInfoUTRA-TDD-r10 ::= SEQUENCE {
    physCellId-r10                  PhysCellIdUTRA-TDD,
    carrierFreq-r10                 ARFCN-ValueUTRA,
    utra-BCCH-Container-r10        OCTET STRING
}

-- ASN1STOP

```

<b><i>RRCConnectionRelease</i> field descriptions</b>
<p><b><i>altFreqPriorities</i></b> Indicates that the UE shall apply the alternative cell reselection priorities, when available. This field is not configured together with <i>idleModeMobilityControllInfo</i>.</p>
<p><b><i>carrierFreq or bandClass</i></b> The carrier frequency (UTRA, E-UTRA, and NR) and band class (HRPD and 1xRTT) for which the associated <i>cellReselectionPriority</i> is applied. For NR, the <i>ARFCN-ValueNR</i> corresponds to a GSCN value as specified in TS 38.101 [85].</p>
<p><b><i>carrierFreqs</i></b> The list of GERAN carrier frequencies organised into one group of GERAN carrier frequencies.</p>
<p><b><i>cellInfoList</i></b> Used to provide system information of one or more cells on the redirected inter-RAT carrier frequency. The system information can be used if, upon redirection, the UE selects an inter-RAT cell indicated by the <i>physCellId</i> and <i>carrierFreq</i> (GERAN and UTRA TDD) or by the <i>physCellId</i> (other RATs). The choice shall match the <i>redirectedCarrierInfo</i>. In particular, E-UTRAN only applies value <i>utra-TDD-r10</i> in case <i>redirectedCarrierInfo</i> is set to <i>utra-TDD-r10</i>.</p>
<p><b><i>cellList</i></b> Indicates a list of cells configured as RAN area. For each element, in the absence of <i>plmn-Identity</i> the UE considers the registered PLMN. Total number of cells across all PLMNs does not exceed 32.</p>
<p><b><i>cn-Type</i></b> The <i>cn-Type</i> is used to indicate that the UE is redirected from 5GC to EPC or 5GC when <i>redirectedCarrierInfo</i> indicates E-UTRA frequency.</p>
<p><b><i>drb-ContinueROHC</i></b> This field indicates whether to continue or reset the header compression protocol context for the DRBs configured with the header compression protocol. Presence of the field indicates that the header compression protocol context continues when UE initiates UP-EDT in the same cell, while absence indicates that the header compression protocol context is reset.</p>
<p><b><i>dummy</i></b> This field is not used in the specification. If received it shall be ignored by the UE.</p>
<p><b><i>extendedWaitTime</i></b> Value in seconds for the wait time for Delay Tolerant access requests.</p>
<p><b><i>freqPriorityListX</i></b> Provides a cell reselection priority for each frequency, by means of separate lists for each RAT (including E-UTRA). The UE shall be able to store at least 3 occurrences of <i>FreqsPriorityGERAN</i>. If E-UTRAN includes <i>freqPriorityListEUTRA-v9e0</i> and/or <i>freqPriorityListEUTRA-v1310</i> it includes the same number of entries, and listed in the same order, as in <i>freqPriorityListEUTRA</i> (i.e. without suffix). Field <i>freqPriorityListExt</i> includes additional neighbouring inter-frequencies, i.e. extending the size of the inter-frequency carrier list using the general principles specified in 5.1.2. EUTRAN only includes <i>freqPriorityListExtEUTRA</i> if <i>freqPriorityListEUTRA</i> (i.e. without suffix) includes <i>maxFreq</i> entries. If E-UTRAN includes <i>freqPriorityListExtEUTRA-v1310</i> it includes the same number of entries, and listed in the same order, as in <i>freqPriorityListExtEUTRA-r12</i>.</p>
<p><b><i>idleModeMobilityControllInfo</i></b> Provides dedicated cell reselection priorities. Used for cell reselection as specified in TS 36.304 [4]. For E-UTRA and UTRA frequencies, a UE that supports multi-band cells for the concerned RAT considers the dedicated priorities to be common for all overlapping bands (i.e. regardless of the ARFCN that is used).</p>
<p><b><i>measIdleConfig</i></b> Indicates a one-shot measurement configuration to be stored and used by the UE while in RRC_IDLE or RRC_INACTIVE.</p>
<p><b><i>mpsPriorityIndication</i></b> Indicates the UE can set the establishment cause to <i>highPriorityAccess</i> for a new connection following a redirect to E-UTRA or set the resume cause to <i>highPriorityAccess</i> for a resume following a redirect to E-UTRA. If the target RAT is NR, see TS 38.331 [82]. The eNB/ng-eNB sets the indication only for UEs authorized to receive MPS treatment as indicated by ARP and/or QoS characteristics at the eNB/ng-eNB, and it is applicable only for this instance of release with redirection to carrier/RAT included in the <i>redirectedCarrierInfo</i> field in the <i>RRCConnectionRelease</i> message.</p>
<p><b><i>noLastCellUpdate</i></b> Presence of the field indicates that the last used cell for (G)WUS shall not be updated.</p>
<p><b><i>periodic-RNAU-timer</i></b> Refers to the timer that triggers the periodic RNAU procedure in UE. Value <i>min5</i> corresponds to 5 minutes, value <i>min10</i> corresponds to 10 minutes and so on.</p>
<p><b><i>ran-Area</i></b> Indicates whether TA code(s) or RAN area code(s) are used for the RAN notification area. The network uses only TA code(s) or RAN area code(s) to configure a UE. Total number of TACs across all PLMNs does not exceed 16. Total number of RAN-AreaCode across all PLMNs does not exceed 32.</p>
<p><b><i>ran-NotificationAreaInfo</i></b> Network ensures that the UE in RRC_INACTIVE always has a valid <i>ran-NotificationAreaInfo</i>.</p>
<p><b><i>ranAreaConfigList</i></b> Indicates a list of RAN area codes or RA code(s) as RAN area. For each element, in the absence of <i>plmn-Identity</i> the UE considers the registered PLMN.</p>

<b>RRCConnectionRelease field descriptions</b>
<p><b>altFreqPriorities</b> Indicates that the UE shall apply the alternative cell reselection priorities, when available. This field is not configured together with <i>idleModeMobilityControlInfo</i>.</p>
<p><b>ran-pagingCycle</b> Refers to the UE specific cycle for RAN-initiated paging. Value rf32 corresponds to 32 radio frames, rf64 corresponds to 64 radio frames and so on.</p>
<p><b>redirectedCarrierInfo</b> The <i>redirectedCarrierInfo</i> indicates a carrier frequency (downlink for FDD) and is used to redirect the UE to an E-UTRA or an inter-RAT carrier frequency, by means of the cell selection upon leaving RRC_CONNECTED as specified in TS 36.304 [4]. The value <i>geran</i> can only be included after successful security activation when UE is connected to 5GC.</p>
<p><b>releaseCause</b> The <i>releaseCause</i> is used to indicate the reason for releasing the RRC Connection. The cause value <i>cs-FallbackHighPriority</i> is only applicable when <i>redirectedCarrierInfo</i> is present with the value set to <i>utra-FDD</i>, <i>utra-TDD</i> or <i>utra-TDD-r10</i>. E-UTRAN should not set the <i>releaseCause</i> to <i>loadBalancingTAURequired</i> or to <i>cs-FallbackHighPriority</i> if the <i>extendedWaitTime</i> is present. The network should not set the <i>releaseCause</i> to <i>loadBalancingTAURequired</i> if the UE is connected to 5GC. The network does not set the <i>releaseCause</i> to <i>rrc-Suspend</i> if the UE is configured with a DAPS bearer, i.e. if source PCell resources after a DAPS handover have not been released.</p>
<p><b>releaseIdleMeasConfig</b> Indicates that the UE shall release the idle/inactive measurement configurations, if configured.</p>
<p><b>rrc-InactiveConfig</b> Indicates configuration for the RRC_INACTIVE state. The network does not configure this field when the UE is redirected to an inter-RAT carrier frequency or if the UE is configured with a DAPS bearer.</p>
<p><b>smtc</b> The SSB periodicity/offset/duration configuration of the redirected target NR frequency. It is based on the timing reference of EUTRAN PCell. If the field is absent, the UE uses the SMTC configured in the <i>measObjectNR</i> having the same SSB frequency and subcarrier spacing</p>
<p><b>subcarrierSpacingSSB</b> Indicate subcarrier spacing of SSB of redirected target NR frequency. Only the values 15 kHz or 30 kHz (FR1), 120 kHz or 240 kHz (FR2-1), 120kHz or 480kHz (FR2-2) are applicable.</p>
<p><b>systemInformation</b> Container for system information of the GERAN cell i.e. one or more System Information (SI) messages as defined in TS 44.018 [45], table 9.1.1.</p>
<p><b>t320</b> Timer T320 as described in clause 7.3. Value minN corresponds to N minutes.</p>
<p><b>t323</b> Timer T323 as described in clause 7.3. Value minN corresponds to N minutes.</p>
<p><b>utra-BCCH-Container</b> Contains System Information Container message as defined in TS 25.331 [19].</p>
<p><b>waitTime</b> Wait time value in seconds.</p>

Conditional presence	Explanation
5GC	The field is optionally present, Need ON, if the UE is connected to 5GC; otherwise the field is not present.
BLCE-IDLEeDRX	The field is optionally present, Need OR, if the UE is a BL UE or UE in CE and the UE is connected to 5GC and IDLE mode eDRX is configured and <i>ran-PagingCycle-r15</i> is absent; otherwise the field is not present.
EARFCN-max	The field is mandatory present if the corresponding <i>carrierFreq</i> (i.e. without suffix) is set to <i>maxEARFCN</i> . Otherwise the field is not present.
EarlySec	When the UE is connected to 5GC, the field is mandatory present. When the UE is connected to EPC, the field is optionally present, Need ON, if the UE supports UP-EDT or UP transmission using PUR or early security reactivation and <i>releaseCause</i> is set to <i>rrc-Suspend</i> ; otherwise the field is not present.
IdleInfoEUTRA	The field is optionally present, Need OP, if the <i>IdleModeMobilityControlInfo</i> (i.e. without suffix) is included and includes <i>freqPriorityListEUTRA</i> ; otherwise the field is not present.
INACTIVE	The field is mandatory present in this release.
NoRedirect-r8	The field is optionally present, Need OP, if the <i>redirectedCarrierInfo</i> (i.e. without suffix) is not included; otherwise the field is not present.
Redirection	The field is optionally present, Need ON, if the <i>redirectedCarrierInfo</i> is included and set to <i>geran</i> , <i>utra-FDD</i> , <i>utra-TDD</i> or <i>utra-TDD-r10</i> ; otherwise the field is not present.
Redirection2	The field is optionally present, Need OR, if <i>redirectedCarrierInfo</i> is included; otherwise the field is not present.
UP-EDT or PUR	The field is optionally present, Need ON, if the UE supports UP-EDT or UP transmission using PUR and <i>releaseCause</i> is set to <i>rrc-Suspend</i> ; otherwise the field is not present.

## – RRCConnectionRequest

The *RRCConnectionRequest* message is used to request the establishment of an RRC connection.

Signalling radio bearer: SRB0

RLC-SAP: TM

Logical channel: CCCH

Direction: UE to E-UTRAN

### RRCConnectionRequest message

```
-- ASN1START
RRCConnectionRequest ::= SEQUENCE {
    criticalExtensions      CHOICE {
        rrcConnectionRequest-r8
        rrcConnectionRequest-r15
    }
}

RRCConnectionRequest-r8-IEs ::= SEQUENCE {
    ue-Identity             InitialUE-Identity,
    establishmentCause      EstablishmentCause,
    spare                   BIT STRING (SIZE (1))
}

RRCConnectionRequest-5GC-r15-IEs ::= SEQUENCE {
    ue-Identity-r15        InitialUE-Identity-5GC-r15,
    establishmentCause-r15 EstablishmentCause-5GC-r15,
    spare                   BIT STRING (SIZE (1))
}

InitialUE-Identity ::= CHOICE {
    s-TMSI                  S-TMSI,
    randomValue             BIT STRING (SIZE (40))
}

InitialUE-Identity-5GC-r15 ::= CHOICE {
    ng-5G-S-TMSI-Part1     BIT STRING (SIZE (40)),
    randomValue             BIT STRING (SIZE (40))
}
```

```

EstablishmentCause ::=
    ENUMERATED {
        emergency, highPriorityAccess, mt-Access, mo-Signalling,
        mo-Data, delayTolerantAccess-v1020, mo-VoiceCall-v1280,
        spare1}

EstablishmentCause-5GC-r15 ::=
    ENUMERATED {
        emergency, highPriorityAccess, mt-Access, mo-Signalling,
        mo-Data, mo-VoiceCall, spare2, spare1}

-- ASN1STOP

```

#### ***RRCCONNECTIONREQUEST* field descriptions**

##### ***establishmentCause***

Provides the establishment cause for the RRC connection request as provided by the upper layers. W.r.t. the cause value names: highPriorityAccess concerns AC11..AC15, 'mt' stands for 'Mobile Terminating' and 'mo' for 'Mobile Originating'. eNB is not expected to reject a *RRCCONNECTIONREQUEST* due to unknown cause value being used by the UE. The cause value of *delayTolerantAccess* is not used for E-UTRA/5GC in this release.

##### ***randomValue***

Integer value in the range 0 to  $2^{40} - 1$ .

##### ***ng-5G-S-TMSI-Part1***

The rightmost 40 bits of 5G-S-TMSI.

##### ***ue-Identity***

UE identity included to facilitate contention resolution by lower layers.

### ***RRCCONNECTIONRESUME***

The *RRCCONNECTIONRESUME* message is used to resume the suspended RRC connection.

Signalling radio bearer: SRB1

RLC-SAP: AM

Logical channel: DCCH

Direction: E-UTRAN to UE

#### ***RRCCONNECTIONRESUME* message**

```

-- ASN1START

RRCCONNECTIONRESUME-r13 ::= SEQUENCE {
    rrc-TransactionIdentifier    RRC-TransactionIdentifier,
    criticalExtensions           CHOICE {
        c1                       CHOICE {
            rrcConnectionResume-r13    RRCCONNECTIONRESUME-r13-IEs,
            spare3                      NULL,
            spare2                      NULL,
            spare1                      NULL
        },
        criticalExtensionsFuture        SEQUENCE {}
    }
}

RRCCONNECTIONRESUME-r13-IEs ::= SEQUENCE {
    radioResourceConfigDedicated-r13    RadioResourceConfigDedicated    OPTIONAL,    -- Need ON
    nextHopChainingCount-r13            NextHopChainingCount,
    measConfig-r13                      MeasConfig                        OPTIONAL,    -- Need ON
    antennaInfoDedicatedPCell-r13       AntennaInfoDedicated-v10i0        OPTIONAL,    -- Need ON
    drb-ContinueROHC-r13                ENUMERATED {true}                 OPTIONAL,    -- Need OP
    lateNonCriticalExtension             OCTET STRING                       OPTIONAL,
    nonCriticalExtension                 RRCCONNECTIONRESUME-v1430-IEs     OPTIONAL
}

RRCCONNECTIONRESUME-v1430-IEs ::= SEQUENCE {
    otherConfig-r14                    OtherConfig-r9                    OPTIONAL,    -- Need ON
    nonCriticalExtension                 RRCCONNECTIONRESUME-v1510-IEs     OPTIONAL
}

RRCCONNECTIONRESUME-v1510-IEs ::= SEQUENCE {
    sk-Counter-r15                      INTEGER (0.. 65535)                OPTIONAL,    -- Need ON
    nr-RadioBearerConfig1-r15           OCTET STRING                       OPTIONAL,    -- Need ON
}

```

```

    nr-RadioBearerConfig2-r15          OCTET STRING          OPTIONAL,  -- Need ON
    nonCriticalExtension                RRCCConnectionResume-v1530-IEs  OPTIONAL
}
RRCCConnectionResume-v1530-IEs ::= SEQUENCE {
    fullConfig-r15                     ENUMERATED {true}     OPTIONAL,  -- Need ON
    nonCriticalExtension                RRCCConnectionResume-v1610-IEs  OPTIONAL
}
RRCCConnectionResume-v1610-IEs ::= SEQUENCE {
    idleModeMeasurementReq-r16         ENUMERATED {true}     OPTIONAL,  -- Need ON
    restoreMCG-SCells-r16              ENUMERATED {true}     OPTIONAL,  -- Need ON
    restoreSCG-r16                     ENUMERATED {true}     OPTIONAL,  -- Cond EarlySec
    sCellToAddModList-r16              SCellToAddModList-r16  OPTIONAL,  -- Cond EarlySec
    sCellToReleaseList-r16             SCellToReleaseListExt-r13  OPTIONAL,  -- Need ON
    sCellGroupToReleaseList-r16        SCellGroupToReleaseList-r15  OPTIONAL,  -- Need ON
    sCellGroupToAddModList-r16         SCellGroupToAddModList-r15  OPTIONAL,  -- Cond EarlySec
    nr-SecondaryCellGroupConfig-r16    OCTET STRING          OPTIONAL,  -- Cond
RestoreSCG
    p-MaxEUTRA-r16                     P-Max                 OPTIONAL,  -- Cond SCG
    p-MaxUE-FR1-r16                    P-Max                 OPTIONAL,  -- Cond SCG
    tdm-PatternConfig-r16              TDM-PatternConfig-r15  OPTIONAL,  -- Cond FDD-
PCell
    tdm-PatternConfig2-r16              TDM-PatternConfig-r15  OPTIONAL,  -- Need OR
    nonCriticalExtension                RRCCConnectionResume-v1700-IEs  OPTIONAL
}
RRCCConnectionResume-v1700-IEs ::= SEQUENCE {
    scg-State-r17                      ENUMERATED {deactivated}  OPTIONAL,  -- Need OP
    nonCriticalExtension                SEQUENCE {}             OPTIONAL
}
-- ASN1STOP

```

<b><i>RRCCONNECTIONRESUME</i> field descriptions</b>	
<b><i>drb-ContinueROHC</i></b>	This field indicates whether to continue or reset the header compression protocol context for the DRBs configured with EUTRA PDCP and the header compression protocol. Presence of the field indicates that the header compression protocol context continues while absence indicates that the header compression protocol context is reset.
<b><i>fullConfig</i></b>	Indicates that the full configuration option is applicable for the <i>RRCCONNECTIONRESUME</i> message.
<b><i>idleModeMeasurementReq</i></b>	This field indicates that the UE shall report the idle/inactive measurements to the network in the <i>RRCCONNECTIONRESUMECOMPLETE</i> message
<b><i>p-MaxEUTRA</i></b>	Indicates the maximum power available for E-UTRA.
<b><i>p-MaxUE-FR1</i></b>	The maximum total transmit power to be used by the UE across all serving cells in frequency range 1 (FR1) across all cell groups. The maximum transmit power that the UE may use may be additionally limited on cell- or cell-group level.
<b><i>nr-RadioBearerConfig1, nr-RadioBearerConfig2</i></b>	Includes the NR <i>RadioBearerConfig</i> IE as specified in TS 38.331 [82]. The field includes the configuration of RBs configured with NR PDCP.
<b><i>nr-SecondaryCellGroupConfig</i></b>	Includes the NR <i>RRCCONNECTIONRESUME</i> message as specified in TS 38.331 [82]. In this version of the specification, the NR RRC message only includes fields <i>secondaryCellGroup</i> , with at least <i>reconfigurationWithSync</i> , <i>otherConfig</i> and/or <i>measConfig</i> .
<b><i>restoreMCG-SCells</i></b>	Indicates that the UE shall restore the MCG SCell configurations from the UE AS Context or UE Inactive AS Context, if configured.
<b><i>restoreSCG</i></b>	If included, the UE shall restore the SCG configurations from the UE AS Context or UE Inactive AS Context.
<b><i>sCellGroupToAddModList</i></b>	Indicates the SCell group to be added or modified.
<b><i>sCellGroupToReleaseList</i></b>	Indicates the SCell group to be released.
<b><i>sCellToAddModList</i></b>	List of SCells to be added or modified.
<b><i>sCellToReleaseList</i></b>	List of SCells to be released.
<b><i>scg-State</i></b>	Indicates that the SCG is deactivated. If the field is absent, the UE behavior is specified in TS 38.331 [82], clause 5.3.5.3.
<b><i>sk-Counter</i></b>	A one-shot counter used upon initial configuration of S-K <sub>gNB</sub> as well as upon refresh of S-K <sub>gNB</sub> . E-UTRAN provides this field when the UE is configured with an (SN-terminated) RB using S-K <sub>gNB</sub> or NR SCG is configured.
<b><i>tdm-PatternConfig</i></b>	This field is used when power control or IMD issues require single UL transmission in (NG)EN-DC as specified in TS 38.101-3 [101] and TS 38.213 [88].
<b><i>tdm-PatternConfig2</i></b>	This field is used for dual UL transmission in EN-DC with LTE FDD PCell and for single UL transmission in EN-DC with LTE FDD/TDD PCell, as specified in TS 38.101-3 [101] and TS 38.213 [88]. The network sets at most one of <i>tdm-PatternConfig</i> and <i>tdm-PatternConfig2</i> to setup. When this field is configured in EN-DC with LTE TDD PCell, it is not applicable if TDD configuration is sa0 or sa6 in SIB1.

<b>Conditional presence</b>	<b>Explanation</b>
<i>EarlySec</i>	For EPC, the field is optionally present, Need ON, if the UE supports early security reactivation; otherwise the field is not present. For 5GC, the field is optionally present, Need ON.
<i>RestoreSCG</i>	The field is mandatory present if <i>restoreSCG</i> is configured. It is optionally present, Need ON, otherwise. For EPC, this field can be present only if the UE supports early security reactivation.
<i>FDD-PCell</i>	This field is optionally present, need ON, for an FDD PCell if there is no SCell with configured uplink. Otherwise, the field is not present, need OR.
<i>SCG</i>	This field is optionally present, need OR, if <i>nr-SecondaryCellGroupConfig</i> is present, otherwise it is absent, need OR.

– *RRCCConnectionResumeComplete*

The *RRCCConnectionResumeComplete* message is used to confirm the successful completion of an RRC connection resumption.

Signalling radio bearer: SRB1

RLC-SAP: AM

Logical channel: DCCH

Direction: UE to E-UTRAN

***RRCCConnectionResumeComplete* message**

```
-- ASN1START

RRCCConnectionResumeComplete-r13 ::= SEQUENCE {
    rrc-TransactionIdentifier          RRC-TransactionIdentifier,
    criticalExtensions                 CHOICE {
        rrcConnectionResumeComplete-r13          RRCCConnectionResumeComplete-r13-IEs,
        criticalExtensionsFuture                 SEQUENCE {}
    }
}

RRCCConnectionResumeComplete-r13-IEs ::= SEQUENCE {
    selectedPLMN-Identity-r13          INTEGER (1..maxPLMN-r11)          OPTIONAL,
    dedicatedInfoNAS-r13               DedicatedInfoNAS              OPTIONAL,
    rlf-InfoAvailable-r13              ENUMERATED {true}              OPTIONAL,
    logMeasAvailable-r13               ENUMERATED {true}              OPTIONAL,
    connEstFailInfoAvailable-r13       ENUMERATED {true}              OPTIONAL,
    mobilityState-r13                  ENUMERATED {normal, medium, high, spare} OPTIONAL,
    mobilityHistoryAvail-r13            ENUMERATED {true}              OPTIONAL,
    logMeasAvailableMBSFN-r13          ENUMERATED {true}              OPTIONAL,
    lateNonCriticalExtension            OCTET STRING                  OPTIONAL,
    nonCriticalExtension                RRCCConnectionResumeComplete-v1530-IEs OPTIONAL
}

RRCCConnectionResumeComplete-v1530-IEs ::= SEQUENCE {
    logMeasAvailableBT-r15              ENUMERATED {true}              OPTIONAL,
    logMeasAvailableWLAN-r15            ENUMERATED {true}              OPTIONAL,
    idleMeasAvailable-r15               ENUMERATED {true}              OPTIONAL,
    flightPathInfoAvailable-r15         ENUMERATED {true}              OPTIONAL,
    nonCriticalExtension                 RRCCConnectionResumeComplete-v1610-IEs OPTIONAL
}

RRCCConnectionResumeComplete-v1610-IEs ::= SEQUENCE {
    measResultListIdle-r16              MeasResultListIdle-r15          OPTIONAL,
    measResultListExtIdle-r16           MeasResultListExtIdle-r16       OPTIONAL,
    measResultListIdleNR-r16            MeasResultListIdleNR-r16        OPTIONAL,
    scg-ConfigResponseNR-r16           OCTET STRING                    OPTIONAL,
    nonCriticalExtension                 RRCCConnectionResumeComplete-v1710-IEs OPTIONAL
}

RRCCConnectionResumeComplete-v1710-IEs ::= SEQUENCE {
    gnss-ValidityDuration-r17           GNSS-ValidityDuration-r17       OPTIONAL,
    nonCriticalExtension                 RRCCConnectionResumeComplete-v1800-IEs OPTIONAL
}

RRCCConnectionResumeComplete-v1800-IEs ::= SEQUENCE {
    gnss-PositionFixDuration-r18        GNSS-PositionFixDuration-r18    OPTIONAL,
    nonCriticalExtension                 SEQUENCE {}                      OPTIONAL
}

-- ASN1STOP
```



**RRCConnectionResumeComplete field descriptions****idleMeasAvailable**

Indication that the UE has idle/inactive measurement report available.

**selectedPLMN-Identity**

Index of the PLMN selected by the UE from the *plmn-IdentityList* fields included in SIB1. 1 if the 1st PLMN is selected from the 1st *plmn-IdentityList* included in SIB1, 2 if the 2nd PLMN is selected from the same *plmn-IdentityList*, or when no more PLMN are present within the same *plmn-IdentityList*, then the PLMN listed 1st in the subsequent *plmn-IdentityList* within the same SIB1 and so on. The *selectedPLMN-Identity* is referred to the PLMN list for 5GC if the UE is in RRC\_INACTIVE state.

**RRCConnectionResumeRequest**

The *RRCConnectionResumeRequest* message is used to request the resumption of a suspended RRC connection or to perform UP-EDT.

Signalling radio bearer: SRB0

RLC-SAP: TM

Logical channel: CCCH

Direction: UE to E-UTRAN

**RRCConnectionResumeRequest message**

```
-- ASN1START
RRCConnectionResumeRequest-r13 ::= SEQUENCE {
    criticalExtensions          CHOICE {
        rrcConnectionResumeRequest-r13  RRCConnectionResumeRequest-r13-IEs,
        rrcConnectionResumeRequest-r15  RRCConnectionResumeRequest-5GC-r15-IEs
    }
}

RRCConnectionResumeRequest-r13-IEs ::= SEQUENCE {
    resumeIdentity-r13          CHOICE {
        resumeID-r13            ResumeIdentity-r13,
        truncatedResumeID-r13   BIT STRING (SIZE (24))
    },
    shortResumeMAC-I-r13       BIT STRING (SIZE (16)),
    resumeCause-r13           ResumeCause,
    spare                       BIT STRING (SIZE (1))
}

RRCConnectionResumeRequest-5GC-r15-IEs ::= SEQUENCE {
    resumeIdentity-r15          CHOICE {
        fullI-RNTI-r15          I-RNTI-r15,
        shortI-RNTI-r15         ShortI-RNTI-r15
    },
    shortResumeMAC-I-r15       BIT STRING (SIZE (16)),
    resumeCause-r15           ResumeCause-r15,
    spare                       BIT STRING (SIZE (1))
}

ResumeCause ::= ENUMERATED {
    emergency, highPriorityAccess, mt-Access, mo-Signalling,
    mo-Data, delayTolerantAccess-v1020, mo-VoiceCall-v1280,
    mt-EDT-v1610
}

ResumeCause-r15 ::= ENUMERATED {
    emergency, highPriorityAccess, mt-Access, mo-Signalling,
    mo-Data, rna-Update, mo-VoiceCall, spare1
}
-- ASN1STOP
```

<b><i>RRCCConnectionResumeRequest</i> field descriptions</b>
<b><i>resumeCause</i></b> Provides the resume cause for the RRC connection resume request as provided by the upper layers. The network is not expected to reject a <i>RRCCConnectionResumeRequest</i> due to unknown cause value being used by the UE.
<b><i>resumeldentity</i></b> UE identity to facilitate UE context retrieval at eNB
<b><i>shortResumeMAC-I</i></b> Authentication token to facilitate UE authentication at eNB

## – *RRCCConnectionSetup*

The *RRCCConnectionSetup* message is used to establish SRB1.

Signalling radio bearer: SRB0

RLC-SAP: TM

Logical channel: CCCH

Direction: E-UTRAN to UE

### ***RRCCConnectionSetup* message**

```

-- ASN1START
RRCCConnectionSetup ::= SEQUENCE {
  rrc-TransactionIdentifier RRC-TransactionIdentifier,
  criticalExtensions CHOICE {
    c1 CHOICE {
      rrcConnectionSetup-r8 RRCConnectionSetup-r8-IEs,
      spare7 NULL,
      spare6 NULL, spare5 NULL, spare4 NULL,
      spare3 NULL, spare2 NULL, spare1 NULL
    },
    criticalExtensionsFuture SEQUENCE {}
  }
}

RRCCConnectionSetup-r8-IEs ::= SEQUENCE {
  radioResourceConfigDedicated RadioResourceConfigDedicated,
  nonCriticalExtension RRCConnectionSetup-v8a0-IEs OPTIONAL
}

RRCCConnectionSetup-v8a0-IEs ::= SEQUENCE {
  lateNonCriticalExtension OCTET STRING OPTIONAL,
  nonCriticalExtension RRCConnectionSetup-v1610-IEs OPTIONAL
}

RRCCConnectionSetup-v1610-IEs ::= SEQUENCE {
  dedicatedInfoNAS-r16 DedicatedInfoNAS OPTIONAL, -- Need ON
  nonCriticalExtension SEQUENCE {} OPTIONAL
}
-- ASN1STOP

```

<b><i>RRCCConnectionSetup</i> field descriptions</b>
<b><i>dedicatedInfoNAS</i></b> Downlink NAS PDU in case of mobile terminated CP-EDT. E-UTRAN may include this field only if the <i>RRCCConnectionSetup</i> is in response to <i>RRCEarlyDataRequest</i> with establishment cause <i>mt-Access</i> .

## – *RRCCConnectionSetupComplete*

The *RRCCConnectionSetupComplete* message is used to confirm the successful completion of an RRC connection establishment.

Signalling radio bearer: SRB1

RLC-SAP: AM

Logical channel: DCCH

Direction: UE to E-UTRAN

### ***RRConnectionSetupComplete message***

```

-- ASN1START
RRConnectionSetupComplete ::= SEQUENCE {
    rrc-TransactionIdentifier      RRC-TransactionIdentifier,
    criticalExtensions             CHOICE {
        c1                        CHOICE {
            rrcConnectionSetupComplete-r8      RRCConnectionSetupComplete-r8-IEs,
            spare3 NULL, spare2 NULL, spare1 NULL
        },
        criticalExtensionsFuture             SEQUENCE {}
    }
}

RRConnectionSetupComplete-r8-IEs ::= SEQUENCE {
    selectedPLMN-Identity          INTEGER (1..maxPLMN-r11),
    registeredMME                  RegisteredMME                      OPTIONAL,
    dedicatedInfoNAS               DedicatedInfoNAS,
    nonCriticalExtension           RRConnectionSetupComplete-v8a0-IEs OPTIONAL
}

RRConnectionSetupComplete-v8a0-IEs ::= SEQUENCE {
    lateNonCriticalExtension       OCTET STRING                      OPTIONAL,
    nonCriticalExtension           RRConnectionSetupComplete-v1020-IEs OPTIONAL
}

RRConnectionSetupComplete-v1020-IEs ::= SEQUENCE {
    gummei-Type-r10               ENUMERATED {native, mapped}          OPTIONAL,
    rlf-InfoAvailable-r10         ENUMERATED {true}                    OPTIONAL,
    logMeasAvailable-r10         ENUMERATED {true}                    OPTIONAL,
    rn-SubframeConfigReq-r10     ENUMERATED {required, notRequired}    OPTIONAL,
    nonCriticalExtension           RRConnectionSetupComplete-v1130-IEs OPTIONAL
}

RRConnectionSetupComplete-v1130-IEs ::= SEQUENCE {
    connEstFailInfoAvailable-r11  ENUMERATED {true}                    OPTIONAL,
    nonCriticalExtension           RRConnectionSetupComplete-v1250-IEs OPTIONAL
}

RRConnectionSetupComplete-v1250-IEs ::= SEQUENCE {
    mobilityState-r12             ENUMERATED {normal, medium, high, spare}    OPTIONAL,
    mobilityHistoryAvail-r12      ENUMERATED {true}                    OPTIONAL,
    logMeasAvailableMBSFN-r12    ENUMERATED {true}                    OPTIONAL,
    nonCriticalExtension           RRConnectionSetupComplete-v1320-IEs OPTIONAL
}

RRConnectionSetupComplete-v1320-IEs ::= SEQUENCE {
    ce-ModeB-r13                 ENUMERATED {supported}                OPTIONAL,
    s-TMSI-r13                   S-TMSI                                OPTIONAL,
    attachWithoutPDN-Connectivity-r13  ENUMERATED {true}                    OPTIONAL,
    up-CIoT-EPS-Optimisation-r13  ENUMERATED {true}                    OPTIONAL,
    cp-CIoT-EPS-Optimisation-r13  ENUMERATED {true}                    OPTIONAL,
    nonCriticalExtension           RRConnectionSetupComplete-v1330-IEs OPTIONAL
}

RRConnectionSetupComplete-v1330-IEs ::= SEQUENCE {
    ue-CE-NeedULGaps-r13         ENUMERATED {true}                    OPTIONAL,
    nonCriticalExtension           RRConnectionSetupComplete-v1430-IEs OPTIONAL
}

RRConnectionSetupComplete-v1430-IEs ::= SEQUENCE {
    dcn-ID-r14                   INTEGER (0..65535)                    OPTIONAL,
    nonCriticalExtension           RRConnectionSetupComplete-v1530-IEs OPTIONAL
}

RRConnectionSetupComplete-v1530-IEs ::= SEQUENCE {
    logMeasAvailableBT-r15       ENUMERATED {true}                    OPTIONAL,
    logMeasAvailableWLAN-r15     ENUMERATED {true}                    OPTIONAL,
}

```

```

idleMeasAvailable-r15          ENUMERATED {true}          OPTIONAL,
flightPathInfoAvailable-r15   ENUMERATED {true}          OPTIONAL,
connectTo5GC-r15              ENUMERATED {true}          OPTIONAL,
registeredAMF-r15              RegisteredAMF-r15         OPTIONAL,
s-NSSAI-list-r15              SEQUENCE(SIZE (1..maxNrofS-NSSAI-r15)) OF S-NSSAI-r15
OPTIONAL,
ng-5G-S-TMSI-Bits-r15         CHOICE {
  ng-5G-S-TMSI-r15            NG-5G-S-TMSI-r15,
  ng-5G-S-TMSI-Part2-r15     BIT STRING (SIZE (8))
}
nonCriticalExtension           RRCCConnectionSetupComplete-v1540-IEs OPTIONAL,
}
RRCCConnectionSetupComplete-v1540-IEs ::= SEQUENCE {
  gummei-Type-v1540           ENUMERATED {mappedFrom5G-v1540} OPTIONAL,
  guami-Type-r15              ENUMERATED {native, mapped}   OPTIONAL,
  nonCriticalExtension         RRCCConnectionSetupComplete-v1610-IEs OPTIONAL
}
RRCCConnectionSetupComplete-v1610-IEs ::= SEQUENCE {
  rlos-Request-r16            ENUMERATED {true}            OPTIONAL,
  cp-CIoT-5GS-Optimisation-r16 ENUMERATED {true}            OPTIONAL,
  up-CIoT-5GS-Optimisation-r16 ENUMERATED {true}            OPTIONAL,
  pur-ConfigID-r16           PUR-ConfigID-r16            OPTIONAL,
  lte-M-r16                  ENUMERATED {true}            OPTIONAL,
  iab-NodeIndication-r16     ENUMERATED {true}            OPTIONAL,
  nonCriticalExtension        RRCCConnectionSetupComplete-v1690-IEs OPTIONAL
}
RRCCConnectionSetupComplete-v1690-IEs ::= SEQUENCE {
  ul-RRC-Segmentation-r16     ENUMERATED {true}            OPTIONAL,
  nonCriticalExtension         RRCCConnectionSetupComplete-v1710-IEs OPTIONAL
}
RRCCConnectionSetupComplete-v1710-IEs ::= SEQUENCE {
  gnss-ValidityDuration-r17   GNSS-ValidityDuration-r17    OPTIONAL,
  nonCriticalExtension         RRCCConnectionSetupComplete-v1800-IEs OPTIONAL
}
RRCCConnectionSetupComplete-v1800-IEs ::= SEQUENCE {
  gnss-PositionFixDuration-r18 GNSS-PositionFixDuration-r18 OPTIONAL,
  nonCriticalExtension         SEQUENCE {}                          OPTIONAL
}
RegisteredMME ::= SEQUENCE {
  plmn-Identity               PLMN-Identity                OPTIONAL,
  mmegi                       BIT STRING (SIZE (16)),
  mmec                        MMEC
}
RegisteredAMF-r15 ::= SEQUENCE {
  plmn-Identity-r15           PLMN-Identity                OPTIONAL,
  amf-Identifler-r15         AMF-Identifler-r15
}
-- ASN1STOP

```

<b><i>RRCConnectionSetupComplete</i> field descriptions</b>
<p><b><i>attachWithoutPDN-Connectivity</i></b> This field is used to indicate that the UE performs an Attach without PDN connectivity procedure, as indicated by the upper layers and specified in TS 24.301 [35].</p>
<p><b><i>cp-CIoT-5GS-Optimisation</i></b> This field is included when the UE supports the Control plane ClIoT 5GS optimisation, as indicated by the upper layers, see TS 24.501 [95].</p>
<p><b><i>cp-CIoT-EPS-Optimisation</i></b> This field is included when the UE supports the Control plane ClIoT EPS Optimisation, as indicated by the upper layers, see TS 24.301 [35].</p>
<p><b><i>ce-ModeB</i></b> Indicates whether the UE supports operation in CE mode B, as specified in TS 36.306 [5].</p>
<p><b><i>connectTo5GC</i></b> This field is not used in the specification. It shall not be sent by the UE.</p>
<p><b><i>dcn-ID</i></b> The Dedicated Core Network Identity, see TS 23.401 [41].</p>
<p><b><i>guami-Type</i></b> This field is used to indicate whether the GUAMI included is native (derived from native 5G-GUTI) or mapped (from EPS, derived from EPS GUTI) as specified in TS 24.501 [95].</p>
<p><b><i>gummei-Type</i></b> This field is used to indicate whether the GUMMEI included is native (assigned by EPC) or mapped. The value native indicates the GUMMEI is native, mapped indicates the GUMMEI is mapped from 2G/3G identifiers, and mappedFrom5G indicates the GUMMEI is mapped from 5G identifiers. A UE that sets <i>gummei-Type-v1540</i> to mappedFrom5G shall also include <i>gummei-Type-r10</i> and set it to native.</p>
<p><b><i>iab-NodeIndication</i></b> This field is used to indicate that the connection is being established by an IAB-node as specified in TS 38.300 [106].</p>
<p><b><i>idleMeasAvailable</i></b> Indication that the UE has idle/inactive measurement report available.</p>
<p><b><i>lte-M</i></b> Indicates the UE is category M.</p>
<p><b><i>mmegi</i></b> Provides the Group Identity of the registered MME within the PLMN, as provided by upper layers, see TS 23.003 [27].</p>
<p><b><i>mobilityState</i></b> This field indicates the UE mobility state (as defined in TS 36.304 [4], clause 5.2.4.3) just prior to UE going into RRC_CONNECTED state. The UE indicates the value of <i>medium</i> and <i>high</i> when being in Medium-mobility and High-mobility states respectively. Otherwise the UE indicates the value <i>normal</i>.</p>
<p><b><i>ng-5G-S-TMSI-Part2</i></b> The leftmost 8 bits of 5G-S-TMSI.</p>
<p><b><i>registeredAMF</i></b> This field is used to transfer the GUAMI of the AMF where the UE is registered, as provided by upper layers, see TS 23.003 [27].</p>
<p><b><i>registeredMME</i></b> This field is used to transfer the GUMMEI of the MME where the UE is registered, as provided by upper layers.</p>
<p><b><i>rlos-Request</i></b> Indicates whether the UE is initiating RLOS as specified in TS 23.401 [41].</p>
<p><b><i>rn-SubframeConfigReq</i></b> If present, this field indicates that the connection establishment is for an RN and whether a subframe configuration is requested or not.</p>
<p><b><i>selectedPLMN-Identity</i></b> Index of the PLMN selected by the UE from the <i>plmn-IdentityList</i> fields included in SIB1. 1 if the 1st PLMN is selected from the 1st <i>plmn-IdentityList</i> included in SIB1, 2 if the 2nd PLMN is selected from the same <i>plmn-IdentityList</i>, or when no more PLMN are present within the same <i>plmn-IdentityList</i>, then the PLMN listed 1st in the subsequent <i>plmn-IdentityList</i> within the same SIB1 and so on.</p>
<p><b><i>s-NSSAI-List</i></b> This field is a list of S-NSSAI as indicated by the upper layers. The UE can report up to eight S-NSSAI per NSSAI, see TS 23.003 [27].</p>
<p><b><i>ue-CE-NeedULGaps</i></b> Indicates whether the UE needs uplink gaps during continuous uplink transmission in FDD as specified in TS 36.211 [21] and TS 36.306 [5].</p>
<p><b><i>ul-RRC-Segmentation</i></b> This field indicates the UE supports uplink RRC segmentation of <i>UECapabilityInformation</i>.</p>
<p><b><i>up-CIoT-5GS-Optimisation</i></b> This field is included when the UE supports the User plane ClIoT 5GS optimisation, as indicated by the upper layers, see TS 24.501 [95].</p>
<p><b><i>up-CIoT-EPS-Optimisation</i></b> This field is included when the UE supports the User plane ClIoT EPS Optimisation, as indicated by the upper layers, see TS 24.301 [35].</p>

## – *RRCEarlyDataComplete*

The *RRCEarlyDataComplete* message is used to confirm the successful completion of the CP-EDT procedure.

Signalling radio bearer: SRB0

RLC-SAP: TM

Logical channel: CCCH

Direction: E-UTRAN to UE

### *RRCEarlyDataComplete* message

```
-- ASN1START
RRCEarlyDataComplete-r15 ::= SEQUENCE {
    criticalExtensions          CHOICE {
        rrcEarlyDataComplete-r15  RRCEarlyDataComplete-r15-IEs,
        criticalExtensionsFuture    SEQUENCE {}
    }
}

RRCEarlyDataComplete-r15-IEs ::= SEQUENCE {
    dedicatedInfoNAS-r15        DedicatedInfoNAS                OPTIONAL, -- Need ON
    extendedWaitTime-r15        INTEGER (1..1800)                OPTIONAL, -- Need ON
    idleModeMobilityControlInfo-r15 IdleModeMobilityControlInfo  OPTIONAL, -- Need OP
    idleModeMobilityControlInfoExt-r15 IdleModeMobilityControlInfo-v9e0  OPTIONAL, -- Cond
IdleInfoEUTRA
    redirectedCarrierInfo-r15    RedirectedCarrierInfo-r15-IEs  OPTIONAL, -- Need ON
    nonCriticalExtension         RRCEarlyDataComplete-v1590-IEs  OPTIONAL
}

RRCEarlyDataComplete-v1590-IEs ::= SEQUENCE {
    lateNonCriticalExtension     OCTET STRING                OPTIONAL,
    nonCriticalExtension         SEQUENCE {}                        OPTIONAL
}

RedirectedCarrierInfo-r15-IEs ::= CHOICE {
    eutra                        ARFCN-ValueEUTRA-r9,
    geran                        CarrierFreqsGERAN,
    utra-FDD                     ARFCN-ValueUTRA,
    cdma2000-HRPD                CarrierFreqCDMA2000,
    cdma2000-1xRTT              CarrierFreqCDMA2000,
    utra-TDD                     CarrierFreqListUTRA-TDD-r10
}
-- ASN1STOP
```

#### *RRCEarlyDataComplete* field descriptions

##### ***extendedWaitTime***

Value in seconds for the wait time for Delay Tolerant access requests.

Conditional presence	Explanation
<i>IdleInfoEUTRA</i>	The field is optionally present, Need OP, if the <i>IdleModeMobilityControlInfo-r15</i> is included and includes <i>freqPriorityListEUTRA</i> ; otherwise the field is not present.

## – *RRCEarlyDataRequest*

The *RRCEarlyDataRequest* message is used to initiate CP-EDT.

Signalling radio bearer: SRB0

RLC-SAP: TM

Logical channel: CCCH

Direction: UE to E-UTRAN

### **RRCEarlyDataRequest message**

```
-- ASN1START
RRCEarlyDataRequest-r15 ::= SEQUENCE {
    criticalExtensions          CHOICE {
        rrcEarlyDataRequest-r15      RRCEarlyDataRequest-r15-IEs,
        criticalExtensionsFuture      CHOICE {
            rrcEarlyDataRequest-5GC-r16  RRCEarlyDataRequest-5GC-r16-IEs,
            criticalExtensionsFuture-r16  SEQUENCE {}
        }
    }
}

RRCEarlyDataRequest-r15-IEs ::= SEQUENCE {
    s-TMSI-r15          S-TMSI,
    establishmentCause-r15  ENUMERATED {mo-Data, delayTolerantAccess},
    dedicatedInfoNAS-r15    DedicatedInfoNAS,
    nonCriticalExtension    RRCEarlyDataRequest-v1590-IEs          OPTIONAL
}

RRCEarlyDataRequest-v1590-IEs ::= SEQUENCE {
    lateNonCriticalExtension    OCTET STRING          OPTIONAL,
    nonCriticalExtension        RRCEarlyDataRequest-v1610-IEs  OPTIONAL
}

RRCEarlyDataRequest-v1610-IEs ::= SEQUENCE {
    establishmentCause-v1610    ENUMERATED {mt-Access, spare3, spare2, spare1},
    nonCriticalExtension        SEQUENCE {}          OPTIONAL
}

RRCEarlyDataRequest-5GC-r16-IEs ::= SEQUENCE {
    ng-5G-S-TMSI-r16          NG-5G-S-TMSI-r15,
    establishmentCause-r16    ENUMERATED {mo-Data, spare3, spare2, spare1},
    dedicatedInfoNAS-r16      DedicatedInfoNAS,
    lateNonCriticalExtension    OCTET STRING          OPTIONAL,
    nonCriticalExtension        SEQUENCE {}          OPTIONAL
}
-- ASN1STOP
```

#### **RRCEarlyDataRequest field descriptions**

##### **establishmentCause**

Provides the establishment cause for the RRC Early Data Request as provided by the upper layers. W.r.t. the cause value names: 'mo' stands for 'Mobile Originating'. eNB is not expected to reject a *RRCEarlyDataRequest* due to unknown cause value being used by the UE. If *establishmentCause-v1610* is included, E-UTRAN ignores *establishmentCause-r15*.

#### **SCGFailureInformation**

The *SCGFailureInformation* message is used to provide information regarding E-UTRA SCG failures detected by the UE.

Signalling radio bearer: SRB1

RLC-SAP: AM

Logical channel: DCCH

Direction: UE to E-UTRAN

### ***SCGFailureInformation message***

```

-- ASN1START
SCGFailureInformation-r12 ::= SEQUENCE {
    criticalExtensions          CHOICE {
        c1                     CHOICE {
            scgFailureInformation-r12 SCGFailureInformation-r12-IEs,
            spare3 NULL, spare2 NULL, spare1 NULL
        },
        criticalExtensionsFuture SEQUENCE {}
    }
}

SCGFailureInformation-r12-IEs ::= SEQUENCE {
    failureReportSCG-r12 FailureReportSCG-r12 OPTIONAL,
    nonCriticalExtension SCGFailureInformation-v12d0a-IEs OPTIONAL
}

SCGFailureInformation-v12d0a-IEs ::= SEQUENCE {
    lateNonCriticalExtension OCTET STRING (CONTAINING SCGFailureInformation-v12d0b-IEs)
        OPTIONAL,
    nonCriticalExtension SEQUENCE {} OPTIONAL
}

-- Late non-critical extensions:
SCGFailureInformation-v12d0b-IEs ::= SEQUENCE {
    failureReportSCG-v12d0 FailureReportSCG-v12d0 OPTIONAL,
    nonCriticalExtension SEQUENCE {} OPTIONAL
}

-- Regular non-critical extensions:
FailureReportSCG-r12 ::= SEQUENCE {
    failureType-r12 ENUMERATED {t313-Expiry, randomAccessProblem,
        rlc-MaxNumRetx, scg-ChangeFailure },
    measResultServFreqList-r12 MeasResultServFreqList-r10 OPTIONAL,
    measResultNeighCells-r12 MeasResultList2EUTRA-r9 OPTIONAL,
    ...,
    [[ failureType-v1290 ENUMERATED {maxUL-TimingDiff-v1290} OPTIONAL
    ]],
    [[ measResultServFreqListExt-r13 MeasResultServFreqListExt-r13 OPTIONAL
    ]]
}

FailureReportSCG-v12d0 ::= SEQUENCE {
    measResultNeighCells-v12d0 MeasResultList2EUTRA-v9e0 OPTIONAL
}

-- ASN1STOP

```

### ***SCGFailureInformationNR***

The *SCGFailureInformationNR* message is used to provide information regarding NR SCG failures detected by the UE.



Signalling radio bearer: SRB1

RLC-SAP: AM

Logical channel: DCCH

Direction: UE to E-UTRAN

### SCGFailureInformationNR message

```

-- ASN1START
SCGFailureInformationNR-r15 ::= SEQUENCE {
    criticalExtensions          CHOICE {
        c1                     CHOICE {
            scgFailureInformationNR-r15          SCGFailureInformationNR-r15-IEs,
            spare3 NULL, spare2 NULL, spare1 NULL
        },
        criticalExtensionsFuture          SEQUENCE {}
    }
}

SCGFailureInformationNR-r15-IEs ::= SEQUENCE {
    failureReportSCG-NR-r15          FailureReportSCG-NR-r15          OPTIONAL,
    nonCriticalExtension              SCGFailureInformationNR-v1590-IEs  OPTIONAL
}

SCGFailureInformationNR-v1590-IEs ::= SEQUENCE {
    lateNonCriticalExtension          OCTET STRING          OPTIONAL,
    nonCriticalExtension              SEQUENCE {}          OPTIONAL
}

FailureReportSCG-NR-r15 ::= SEQUENCE {
    failureType-r15                  ENUMERATED {
        t310-Expiry, randomAccessProblem,
        rlc-MaxNumRetx,
        synchReconfigFailureSCG, scg-reconfigFailure,
        srb3-IntegrityFailure, dummy},
    measResultFreqListNR-r15          MeasResultFreqListFailNR-r15          OPTIONAL,
    measResultSCG-r15                OCTET STRING          OPTIONAL,
    ...,
    [[ locationInfo-r16                LocationInfo-r10          OPTIONAL,
    logMeasResultListBT-r16          LogMeasResultListBT-r15          OPTIONAL,
    logMeasResultListWLAN-r16        LogMeasResultListWLAN-r15          OPTIONAL,
    failureType-v1610                ENUMERATED {t312-Expiry, scg-lbtFailure,
        beamFailureRecoveryFailure, bh-RLF-r16,
        beamFailure-r17,
        spare3, spare2, spare1} OPTIONAL
    ]]
}

MeasResultFreqListFailNR-r15 ::= SEQUENCE (SIZE (1..maxFreqNR-r15)) OF MeasResultFreqFailNR-r15

MeasResultFreqFailNR-r15 ::= SEQUENCE {
    carrierFreq-r15                  ARFCN-ValueNR-r15,
    measResultCellList-r15           MeasResultCellListNR-r15          OPTIONAL,
    ...
}
-- ASN1STOP

```

#### SCGFailureInformationNR field descriptions

##### **failureType**

Indicates the cause of the SCG failure. When the field *failureType-v1610* is included, the network ignores the field *failureType-r15*.

##### **measResultFreqListNR**

The field contains available results of measurements on NR frequencies the UE is configured to measure by *measConfig*.

##### **measResultSCG**

Includes the NR *MeasResultSCG-Failure* IE as specified in TS 38.331 [82]. The field contains available results of measurements on NR frequencies the UE is configured to measure by the NR RRCConfiguration message.

## – SCPTMConfiguration

The *SCPTMConfiguration* message contains the control information applicable for MBMS services transmitted via SC-MRB.

Signalling radio bearer: N/A

RLC-SAP: UM

Logical channel: SC-MCCH

Direction: E-UTRAN to UE

### SCPTMConfiguration message

```
-- ASN1START
SCPTMConfiguration-r13 ::= SEQUENCE {
    sc-mtch-InfoList-r13          SC-MTCH-InfoList-r13,
    scptm-NeighbourCellList-r13 SCPTM-NeighbourCellList-r13    OPTIONAL,  -- Need OP
    lateNonCriticalExtension     OCTET STRING                OPTIONAL,
    nonCriticalExtension         SCPTMConfiguration-v1340    OPTIONAL
}

SCPTMConfiguration-v1340 ::= SEQUENCE {
    p-b-r13                      INTEGER (0..3)            OPTIONAL,  -- Need ON
    nonCriticalExtension         SEQUENCE {}                OPTIONAL
}
-- ASN1STOP
```

#### SCPTMConfiguration field descriptions

##### **sc-mtch-InfoList**

Provides the configuration of each SC-MTCH in the current cell.

##### **scptm-NeighbourCellList**

List of neighbour cells providing MBMS services via SC-MRB. When absent, the UE shall assume that MBMS services listed in the *SCPTMConfiguration* message are not provided via SC-MRB in any neighbour cell.

##### **p-b**

Parameter:  $P_B$  for the PDSCH scrambled by G-RNTI, see TS 36.213 [23], Table 5.2-1.

## – SCPTMConfiguration-BR

The *SCPTMConfiguration-BR* message contains the control information applicable for MBMS services transmitted via SC-MRB for BL UEs or UEs in CE.

Signalling radio bearer: N/A

RLC-SAP: UM

Logical channel: SC-MCCH

Direction: E-UTRAN to UE

### SCPTMConfiguration-BR message

```
-- ASN1START
SCPTMConfiguration-BR-r14 ::= SEQUENCE {
    sc-mtch-InfoList-r14          SC-MTCH-InfoList-BR-r14,
    scptm-NeighbourCellList-r14 SCPTM-NeighbourCellList-r13    OPTIONAL,  -- Need OP
    p-b-r14                      INTEGER (0..3)                OPTIONAL,  -- Need OR
    lateNonCriticalExtension     OCTET STRING                OPTIONAL,
    nonCriticalExtension         SCPTMConfiguration-BR-v1610    OPTIONAL
}

SCPTMConfiguration-BR-v1610 ::= SEQUENCE {
    sc-MTCH-InfoList-MultiTB-r16 SC-MTCH-InfoList-BR-r14,
    multiTB-Gap-r16             ENUMERATED {sf2, sf4, sf8, sf16, sf32, sf64, sf128, spare}
}
-- ASN1STOP
```

```

    nonCriticalExtension          SEQUENCE {}
  }
  OPTIONAL, -- Need OR
  OPTIONAL
-- ASN1STOP

```

### SCPTMConfiguration-BR field descriptions

#### p-b

Parameter:  $P_b$  for the PDSCH scrambled by G-RNTI, see TS 36.213 [23], Table 5.2-1.

#### multiTB-Gap

Indicates scheduling gaps in sub-frames for SC-MTCH using multi-TB scheduling. Value sf2 corresponds to 2 sub-frames, value sf4 corresponds to 4 sub-frames and so on. If the field is absent, there is no scheduling gap.

#### sc-mtch-InfoList

Provides the configuration of each SC-MTCH not using multi-TB scheduling in the current cell for BL UEs or UEs in CE.

#### sc-MTCH-InfoList-MultiTB

Provides the configuration of each SC-MTCH using multi-TB scheduling in the current cell for BL UEs or UEs in CE. When this field is included, the total number of SC-MTCH configurations in *sc-mtch-InfoList* and *sc-MTCH-InfoList-MultiTB* cannot be more than *maxSC-MTCH-BR-r14*.

#### sctpm-NeighbourCellList

List of neighbour cells providing MBMS services via SC-MRB. When absent, the BL UE or UE in CE shall assume that MBMS services listed in the *SCPTMConfiguration-BR* message are not provided via SC-MRB in any neighbour cell.

## SecurityModeCommand

The *SecurityModeCommand* message is used to command the activation of AS security.

Signalling radio bearer: SRB1

RLC-SAP: AM

Logical channel: DCCH

Direction: E-UTRAN to UE

### SecurityModeCommand message

```

-- ASN1START
SecurityModeCommand ::=
  rrc-TransactionIdentifier          RRC-TransactionIdentifier,
  criticalExtensions                 CHOICE {
    c1                               CHOICE {
      securityModeCommand-r8        SecurityModeCommand-r8-IEs,
      spare3 NULL, spare2 NULL, spare1 NULL
    },
    criticalExtensionsFuture         SEQUENCE {}
  }
}

SecurityModeCommand-r8-IEs ::= SEQUENCE {
  securityConfigSMC                 SecurityConfigSMC,
  nonCriticalExtension               SecurityModeCommand-v8a0-IEs      OPTIONAL
}

SecurityModeCommand-v8a0-IEs ::= SEQUENCE {
  lateNonCriticalExtension           OCTET STRING                    OPTIONAL,
  nonCriticalExtension               SEQUENCE {}                      OPTIONAL
}

SecurityConfigSMC ::= SEQUENCE {
  securityAlgorithmConfig            SecurityAlgorithmConfig,
  ...
}
-- ASN1STOP

```

## – *SecurityModeComplete*

The *SecurityModeComplete* message is used to confirm the successful completion of a security mode command.

Signalling radio bearer: SRB1

RLC-SAP: AM

Logical channel: DCCH

Direction: UE to E-UTRAN

### ***SecurityModeComplete message***

```
-- ASN1START
SecurityModeComplete ::= SEQUENCE {
    rrc-TransactionIdentifier RRC-TransactionIdentifier,
    criticalExtensions CHOICE {
        securityModeComplete-r8 SecurityModeComplete-r8-IEs,
        criticalExtensionsFuture SEQUENCE {}
    }
}
SecurityModeComplete-r8-IEs ::= SEQUENCE {
    nonCriticalExtension SecurityModeComplete-v8a0-IEs OPTIONAL
}
SecurityModeComplete-v8a0-IEs ::= SEQUENCE {
    lateNonCriticalExtension OCTET STRING OPTIONAL,
    nonCriticalExtension SEQUENCE {} OPTIONAL
}
-- ASN1STOP
```

## – *SecurityModeFailure*

The *SecurityModeFailure* message is used to indicate an unsuccessful completion of a security mode command.

Signalling radio bearer: SRB1

RLC-SAP: AM

Logical channel: DCCH

Direction: UE to E-UTRAN

### ***SecurityModeFailure message***

```
-- ASN1START
SecurityModeFailure ::= SEQUENCE {
    rrc-TransactionIdentifier RRC-TransactionIdentifier,
    criticalExtensions CHOICE {
        securityModeFailure-r8 SecurityModeFailure-r8-IEs,
        criticalExtensionsFuture SEQUENCE {}
    }
}
SecurityModeFailure-r8-IEs ::= SEQUENCE {
    nonCriticalExtension SecurityModeFailure-v8a0-IEs OPTIONAL
}
SecurityModeFailure-v8a0-IEs ::= SEQUENCE {
    lateNonCriticalExtension OCTET STRING OPTIONAL,
    nonCriticalExtension SEQUENCE {} OPTIONAL
}
-- ASN1STOP
```

## SidelinkUEInformation

The *SidelinkUEInformation* message is used for the indication of sidelink information to the eNB.

Signalling radio bearer: SRB1

RLC-SAP: AM

Logical channel: DCCH

Direction: UE to E-UTRAN

### SidelinkUEInformation message

```

-- ASN1START
SidelinkUEInformation-r12 ::= SEQUENCE {
    criticalExtensions          CHOICE {
        c1                      CHOICE {
            sidelinkUEInformation-r12    SidelinkUEInformation-r12-IEs,
            spare3 NULL, spare2 NULL, spare1 NULL
        },
        criticalExtensionsFuture          SEQUENCE {}
    }
}

SidelinkUEInformation-r12-IEs ::= SEQUENCE {
    commRxInterestedFreq-r12          ARFCN-ValueEUTRA-r9          OPTIONAL,
    commTxResourceReq-r12             SL-CommTxResourceReq-r12    OPTIONAL,
    discRxInterest-r12                ENUMERATED {true}          OPTIONAL,
    discTxResourceReq-r12             INTEGER (1..63)           OPTIONAL,
    lateNonCriticalExtension          OCTET STRING              OPTIONAL,
    nonCriticalExtension               SidelinkUEInformation-v1310-IEs OPTIONAL
}

SidelinkUEInformation-v1310-IEs ::= SEQUENCE {
    commTxResourceReqUC-r13           SL-CommTxResourceReq-r12    OPTIONAL,
    commTxResourceInfoReqRelay-r13   SEQUENCE {
        commTxResourceReqRelay-r13    SL-CommTxResourceReq-r12    OPTIONAL,
        commTxResourceReqRelayUC-r13  SL-CommTxResourceReq-r12    OPTIONAL,
        ue-Type-r13                   ENUMERATED {relayUE, remoteUE}
    } OPTIONAL,
    discTxResourceReq-v1310          SEQUENCE {
        carrierFreqDiscTx-r13         INTEGER (1..maxFreq)        OPTIONAL,
        discTxResourceReqAddFreq-r13  SL-DiscTxResourceReqPerFreqList-r13
    } OPTIONAL,
    discTxResourceReqPS-r13          SL-DiscTxResourceReq-r13    OPTIONAL,
    discRxGapReq-r13                 SL-GapRequest-r13          OPTIONAL,
    discTxGapReq-r13                 SL-GapRequest-r13          OPTIONAL,
    discSysInfoReportFreqList-r13    SL-DiscSysInfoReportFreqList-r13
    nonCriticalExtension              SidelinkUEInformation-v1430-IEs
}

SidelinkUEInformation-v1430-IEs ::= SEQUENCE {
    v2x-CommRxInterestedFreqList-r14 SL-V2X-CommFreqList-r14    OPTIONAL,
    p2x-CommTxType-r14                ENUMERATED {true}          OPTIONAL,
    v2x-CommTxResourceReq-r14         SL-V2X-CommTxFreqList-r14  OPTIONAL,
    nonCriticalExtension               SidelinkUEInformation-v1530-IEs
}

SidelinkUEInformation-v1530-IEs ::= SEQUENCE {
    reliabilityInfoListSL-r15         SL-ReliabilityList-r15     OPTIONAL,
    nonCriticalExtension               SEQUENCE {}                OPTIONAL
}

SL-CommTxResourceReq-r12 ::= SEQUENCE {
    carrierFreq-r12                   ARFCN-ValueEUTRA-r9          OPTIONAL,
    destinationInfoList-r12          SL-DestinationInfoList-r12
}

SL-DiscTxResourceReqPerFreqList-r13 ::= SEQUENCE (SIZE (1..maxFreq)) OF SL-DiscTxResourceReq-r13

SL-DiscTxResourceReq-r13 ::= SEQUENCE {
    carrierFreqDiscTx-r13             INTEGER (1..maxFreq)        OPTIONAL,
    discTxResourceReq-r13             INTEGER (1..63)
}

```

```
SL-DestinationInfoList-r12 ::= SEQUENCE (SIZE (1..maxSL-Dest-r12)) OF SL-DestinationIdentity-r12
SL-DestinationIdentity-r12 ::= BIT STRING (SIZE (24))

SL-DiscSysInfoReportFreqList-r13 ::= SEQUENCE (SIZE (1.. maxSL-DiscSysInfoReportFreq-r13)) OF SL-
DiscSysInfoReport-r13

SL-V2X-CommFreqList-r14 ::= SEQUENCE (SIZE (1..maxFreqV2X-r14)) OF INTEGER (0..maxFreqV2X-1-r14)

SL-V2X-CommTxFreqList-r14 ::= SEQUENCE (SIZE (1..maxFreqV2X-r14)) OF SL-V2X-CommTxResourceReq-r14

SL-V2X-CommTxResourceReq-r14 ::= SEQUENCE {
    carrierFreqCommTx-r14          INTEGER (0.. maxFreqV2X-1-r14)          OPTIONAL,
    v2x-TypeTxSync-r14            SL-TypeTxSync-r14                    OPTIONAL,
    v2x-DestinationInfoList-r14  SL-DestinationInfoList-r12          OPTIONAL
}

-- ASN1STOP
```

<b>SidelinkUEInformation field descriptions</b>
<p><b>carrierFreqCommTx</b> Indicates the index of the frequency on which the UE is interested to transmit V2X sidelink communication. The value 1 corresponds to the frequency of first entry in <i>v2x-InterFreqInfoList</i> broadcast in SIB21, the value 2 corresponds to the frequency of second entry in <i>v2x-InterFreqInfoList</i> broadcast in SIB21 and so on. If SIB26 is broadcast and the number of entries included in <i>v2x-InterFreqInfoList</i> of SIB21 is N, the value N+1 corresponds to the frequency of the first entry which is included in <i>v2x-InterFreqInfoList</i> broadcast in SIB26 and has a frequency not included in SIB21, the value N+2 corresponds to the frequency of the second entry which is included in <i>v2x-InterFreqInfoList</i> broadcast in SIB26 and has a frequency not included in SIB21, and so on. The value 0 corresponds the PCell's frequency.</p>
<p><b>carrierFreqDiscTx</b> Indicates the frequency by the index of the entry in field <i>discInterFreqList</i> within <i>SystemInformationBlockType19</i>. Value 1 corresponds to the first entry in <i>discInterFreqList</i> within <i>SystemInformationBlockType19</i>, value 2 corresponds to the second entry in this list and so on.</p>
<p><b>commRxInterestedFreq</b> Indicates the frequency on which the UE is interested to receive sidelink communication.</p>
<p><b>commTxResourceReq</b> Indicates the frequency on which the UE is interested to transmit non-relay related sidelink communication as well as the one-to-many sidelink communication transmission destination(s) for which the UE requests E-UTRAN to assign dedicated resources. NOTE 1.</p>
<p><b>commTxResourceReqRelay</b> Indicates the relay related one-to-many sidelink communication transmission destination(s) for which the sidelink relay UE requests E-UTRAN to assign dedicated resources.</p>
<p><b>commTxResourceReqRelayUC</b> Indicates the relay related one-to-one sidelink communication transmission destination(s) for which the sidelink relay UE or sidelink remote UE requests E-UTRAN to assign dedicated resources i.e. either contains the unicast destination identity of the sidelink relay UE or of the sidelink remote UE.</p>
<p><b>commTxResourceReqUC</b> Indicates the frequency on which the UE is interested to transmit non-relay related one-to-one sidelink communication as well as the sidelink communication transmission destination(s) for which the UE requests E-UTRAN to assign dedicated resources. NOTE 1.</p>
<p><b>destinationInfoList</b> Indicates the destination(s) for relay or non-relay related one-to-one or one-to-many sidelink communication. For one-to-one sidelink communication the destination is identified by the ProSe UE ID for unicast communication, while for one-to-many the destination it is identified by the ProSe Layer-2 Group ID as specified in TS 23.303 [68].</p>
<p><b>discRxInterest</b> Indicates that the UE is interested to monitor sidelink discovery announcements.</p>
<p><b>discSysInfoReportFreqList</b> Indicates, for one or more frequencies, a list of sidelink discovery related parameters acquired from system information of cells on configured inter-frequency carriers.</p>
<p><b>discTxResourceReq</b> Indicates the number of separate discovery message(s) the UE wants to transmit every discovery period. This field concerns the resources the UE requires every discovery period for transmitting sidelink discovery announcement(s).</p>
<p><b>discTxResourceReqAddFreq</b> Indicates, for any frequencies in addition to the one covered by <i>discTxResourceReq</i>, the number of separate discovery message(s) the UE wants to transmit every discovery period. This field concerns the resources the UE requires every discovery period for transmitting sidelink discovery announcement(s).</p>
<p><b>discTxResourceReqPS</b> Indicates the number of separate PS related discovery message(s) the UE wants to transmit every discovery period. This field concerns the resources the UE requires every discovery period for transmitting PS related sidelink discovery announcement(s).</p>
<p><b>p2x-CommTxType</b> Indicates that the requested transmission resource pool is for P2X related V2X sidelink communication.</p>
<p><b>reliabilityInfoListSL</b> Indicates the reliability(ies) (i.e., PPPRs as specified in TS 36.300 [9]), associated with the reported traffic to be transmitted for V2X sidelink communication.</p>
<p><b>v2x-CommRxInterestedFreqList</b> Indicates the index(es) of the frequency(ies) on which the UE is interested to receive V2X sidelink communication. The value 1 corresponds to the frequency of first entry in <i>v2x-InterFreqInfoList</i> broadcast in SIB21, the value 2 corresponds to the frequency of second entry in <i>v2x-InterFreqInfoList</i> broadcast in SIB21 and so on. If SIB26 is broadcast and the number of entries included in <i>v2x-InterFreqInfoList</i> of SIB21 is N, the value N+1 corresponds to the frequency of the first entry which is included in <i>v2x-InterFreqInfoList</i> broadcast in SIB26 and has a frequency not included in SIB21, the value N+2 corresponds to the frequency of the second entry which is included in <i>v2x-InterFreqInfoList</i> broadcast in SIB26 and has a frequency not included in SIB21, and so on. The value 0 corresponds the PCell's frequency.</p>
<p><b>v2x-DestinationInfoList</b> Indicates the destination(s) for V2X sidelink communication.</p>
<p><b>v2x-TypeTxSync</b> Indicates the synchronization reference used by the UE.</p>

NOTE 1: When configuring *commTxResourceReq*, *commTxResourceReqUC*, *commTxResourceReqRelay* and *commTxResourceReqRelayUC*, E-UTRAN configures at most *maxSL-Dest-r12* destinations in total (i.e. as included in the four fields together).

## – SystemInformation

The *SystemInformation* message is used to convey one or more System Information Blocks or Positioning System Information Blocks. All the SIBs or posSIBs included are transmitted with the same periodicity. *SystemInformation-BR* and *SystemInformation-MBMS* use the same structure as *SystemInformation*.

Signalling radio bearer: N/A

RLC-SAP: TM

Logical channels: BCCH and BR-BCCH

Direction: E-UTRAN to UE

### SystemInformation message

```
-- ASN1START
SystemInformation-BR-r13 ::= SystemInformation
SystemInformation-MBMS-r14 ::= SystemInformation

SystemInformation ::=
    SEQUENCE {
        criticalExtensions          CHOICE {
            systemInformation-r8      SystemInformation-r8-IEs,
            criticalExtensionsFuture-r15 CHOICE {
                posSystemInformation-r15 PosSystemInformation-r15-IEs,
                criticalExtensionsFuture SEQUENCE {}
            }
        }
    }
}
SystemInformation-r8-IEs ::= SEQUENCE {
    sib-TypeAndInfo SEQUENCE (SIZE (1..maxSIB)) OF CHOICE {
        sib2      SystemInformationBlockType2,
        sib3      SystemInformationBlockType3,
        sib4      SystemInformationBlockType4,
        sib5      SystemInformationBlockType5,
        sib6      SystemInformationBlockType6,
        sib7      SystemInformationBlockType7,
        sib8      SystemInformationBlockType8,
        sib9      SystemInformationBlockType9,
        sib10     SystemInformationBlockType10,
        sib11     SystemInformationBlockType11,
        ...,
        sib12-v920 SystemInformationBlockType12-r9,
        sib13-v920 SystemInformationBlockType13-r9,
        sib14-v1130 SystemInformationBlockType14-r11,
        sib15-v1130 SystemInformationBlockType15-r11,
        sib16-v1130 SystemInformationBlockType16-r11,
        sib17-v1250 SystemInformationBlockType17-r12,
        sib18-v1250 SystemInformationBlockType18-r12,
        sib19-v1250 SystemInformationBlockType19-r12,
        sib20-v1310 SystemInformationBlockType20-r13,
        sib21-v1430 SystemInformationBlockType21-r14,
        sib24-v1530 SystemInformationBlockType24-r15,
        sib25-v1530 SystemInformationBlockType25-r15,
        sib26-v1530 SystemInformationBlockType26-r15,
        sib26a-v1610 SystemInformationBlockType26a-r16,
        sib27-v1610 SystemInformationBlockType27-r16,
        sib28-v1610 SystemInformationBlockType28-r16,
        sib29-v1610 SystemInformationBlockType29-r16,
        sib30-v1700 SystemInformationBlockType30-r17,
        sib31-v1700 SystemInformationBlockType31-r17,
        sib32-v1700 SystemInformationBlockType32-r17,
        sib33-v1800 SystemInformationBlockType33-r18
    }
}
```



```

    },
    nonCriticalExtension          SystemInformation-v8a0-IEs          OPTIONAL
  }
SystemInformation-v8a0-IEs ::= SEQUENCE {
    lateNonCriticalExtension      OCTET STRING                  OPTIONAL,
    nonCriticalExtension          SEQUENCE {}                  OPTIONAL
}

PosSystemInformation-r15-IEs ::= SEQUENCE {
    posSIB-TypeAndInfo-r15       SEQUENCE (SIZE (1..maxSIB)) OF CHOICE {
        posSib1-1-r15            SystemInformationBlockPos-r15,
        posSib1-2-r15            SystemInformationBlockPos-r15,
        posSib1-3-r15            SystemInformationBlockPos-r15,
        posSib1-4-r15            SystemInformationBlockPos-r15,
        posSib1-5-r15            SystemInformationBlockPos-r15,
        posSib1-6-r15            SystemInformationBlockPos-r15,
        posSib1-7-r15            SystemInformationBlockPos-r15,
        posSib2-1-r15            SystemInformationBlockPos-r15,
        posSib2-2-r15            SystemInformationBlockPos-r15,
        posSib2-3-r15            SystemInformationBlockPos-r15,
        posSib2-4-r15            SystemInformationBlockPos-r15,
        posSib2-5-r15            SystemInformationBlockPos-r15,
        posSib2-6-r15            SystemInformationBlockPos-r15,
        posSib2-7-r15            SystemInformationBlockPos-r15,
        posSib2-8-r15            SystemInformationBlockPos-r15,
        posSib2-9-r15            SystemInformationBlockPos-r15,
        posSib2-10-r15           SystemInformationBlockPos-r15,
        posSib2-11-r15           SystemInformationBlockPos-r15,
        posSib2-12-r15           SystemInformationBlockPos-r15,
        posSib2-13-r15           SystemInformationBlockPos-r15,
        posSib2-14-r15           SystemInformationBlockPos-r15,
        posSib2-15-r15           SystemInformationBlockPos-r15,
        posSib2-16-r15           SystemInformationBlockPos-r15,
        posSib2-17-r15           SystemInformationBlockPos-r15,
        posSib2-18-r15           SystemInformationBlockPos-r15,
        posSib2-19-r15           SystemInformationBlockPos-r15,
        posSib3-1-r15            SystemInformationBlockPos-r15,
        ...,
        [[
        posSib1-8-v1610           SystemInformationBlockPos-r15,
        posSib2-20-v1610          SystemInformationBlockPos-r15,
        posSib2-21-v1610          SystemInformationBlockPos-r15,
        posSib2-22-v1610          SystemInformationBlockPos-r15,
        posSib2-23-v1610          SystemInformationBlockPos-r15,
        posSib2-24-v1610          SystemInformationBlockPos-r15,
        posSib2-25-v1610          SystemInformationBlockPos-r15,
        posSib4-1-v1610           SystemInformationBlockPos-r15,
        posSib5-1-v1610           SystemInformationBlockPos-r15
        ]],
        [[
        posSib1-9-v1700           SystemInformationBlockPos-r15,
        posSib1-10-v1700          SystemInformationBlockPos-r15
        ]],
        [[
        posSib2-17a-v1770         SystemInformationBlockPos-r15,
        posSib2-18a-v1770         SystemInformationBlockPos-r15,
        posSib2-20a-v1770         SystemInformationBlockPos-r15
        ]],
        [[
        posSib1-11-v1800          SystemInformationBlockPos-r15,
        posSib1-12-v1800          SystemInformationBlockPos-r15,
        posSib2-26-v1800          SystemInformationBlockPos-r15,
        posSib2-27-v1800          SystemInformationBlockPos-r15
        ]],
    ],
    lateNonCriticalExtension      OCTET STRING                  OPTIONAL,
    nonCriticalExtension          SEQUENCE {}                  OPTIONAL
}
-- ASN1STOP

```

## – SystemInformationBlockType1

*SystemInformationBlockType1* contains information relevant when evaluating if a UE is allowed to access a cell and defines the scheduling of other system information. *SystemInformationBlockType1-BR* uses the same structure as *SystemInformationBlockType1*.

Signalling radio bearer: N/A

RLC-SAP: TM

Logical channels: BCCH and BR-BCCH

Direction: E-UTRAN to UE

### SystemInformationBlockType1 message

```
-- ASN1START

SystemInformationBlockType1-BR-r13 ::= SystemInformationBlockType1

SystemInformationBlockType1 ::= SEQUENCE {
    cellAccessRelatedInfo SEQUENCE {
        plmn-IdentityList PLMN-IdentityList,
        trackingAreaCode TrackingAreaCode,
        cellIdentity CellIdentity,
        cellBarred ENUMERATED {barred, notBarred},
        intraFreqReselection ENUMERATED {allowed, notAllowed},
        csg-Indication BOOLEAN,
        csg-Identity CSG-Identity OPTIONAL -- Need OR
    },
    cellSelectionInfo SEQUENCE {
        q-RxLevMin Q-RxLevMin,
        q-RxLevMinOffset INTEGER (1..8) OPTIONAL -- Need OP
    },
    p-Max P-Max OPTIONAL, -- Need OP
    freqBandIndicator FreqBandIndicator,
    schedulingInfoList SchedulingInfoList,
    tdd-Config TDD-Config OPTIONAL, -- Cond TDD
    si-WindowLength ENUMERATED {
        ms1, ms2, ms5, ms10, ms15, ms20,
        ms40},
    systemInfoValueTag INTEGER (0..31),
    nonCriticalExtension SystemInformationBlockType1-v890-IEs OPTIONAL
}

SystemInformationBlockType1-v890-IEs ::= SEQUENCE {
    IEs) lateNonCriticalExtension OCTET STRING (CONTAINING SystemInformationBlockType1-v8h0-
        OPTIONAL,
    nonCriticalExtension SystemInformationBlockType1-v920-IEs OPTIONAL
}

-- Late non critical extensions
SystemInformationBlockType1-v8h0-IEs ::= SEQUENCE {
    multiBandInfoList MultiBandInfoList OPTIONAL, -- Need OR
    nonCriticalExtension SystemInformationBlockType1-v9e0-IEs OPTIONAL
}

SystemInformationBlockType1-v9e0-IEs ::= SEQUENCE {
    freqBandIndicator-v9e0 FreqBandIndicator-v9e0 OPTIONAL, -- Cond FBI-max
    multiBandInfoList-v9e0 MultiBandInfoList-v9e0 OPTIONAL, -- Cond mFBI-max
    nonCriticalExtension SystemInformationBlockType1-v10j0-IEs OPTIONAL
}

SystemInformationBlockType1-v10j0-IEs ::= SEQUENCE {
    freqBandInfo-r10 NS-PmaxList-r10 OPTIONAL, -- Need OR
    multiBandInfoList-v10j0 MultiBandInfoList-v10j0 OPTIONAL, -- Need OR
    nonCriticalExtension SystemInformationBlockType1-v10l0-IEs
    OPTIONAL
}

SystemInformationBlockType1-v10l0-IEs ::= SEQUENCE {
    freqBandInfo-v10l0 NS-PmaxList-v10l0 OPTIONAL, -- Need OR
    multiBandInfoList-v10l0 MultiBandInfoList-v10l0 OPTIONAL, -- Need OR
    nonCriticalExtension SystemInformationBlockType1-v10x0-IEs
    OPTIONAL
}
-- ASN1END
```

```

SystemInformationBlockType1-v10x0-IEs ::= SEQUENCE {
  -- This field is only for late non-critical extensions from Rel-10 or Rel-11 onwards
  lateNonCriticalExtension      OCTET STRING      OPTIONAL,
  nonCriticalExtension          SystemInformationBlockType1-v12j0-IEs  OPTIONAL
}

SystemInformationBlockType1-v12j0-IEs ::= SEQUENCE {
  schedulingInfoList-v12j0      SchedulingInfoList-v12j0      OPTIONAL,  -- Need OR
  schedulingInfoListExt-r12     SchedulingInfoListExt-r12  OPTIONAL,  -- Need OR
  nonCriticalExtension          SystemInformationBlockType1-v15g0-IEs  OPTIONAL
}

SystemInformationBlockType1-v15g0-IEs ::= SEQUENCE {
  bandwidthReducedAccessRelatedInfo-v15g0 SEQUENCE {
    posSchedulingInfoList-BR-r15  SchedulingInfoList-BR-r13
  }
  nonCriticalExtension          SEQUENCE {}      OPTIONAL,  -- Need OR
}

-- Regular non critical extensions
SystemInformationBlockType1-v920-IEs ::= SEQUENCE {
  ims-EmergencySupport-r9      ENUMERATED {true}      OPTIONAL,  -- Need OR
  cellSelectionInfo-v920       CellSelectionInfo-v920    OPTIONAL,  -- Cond RSRQ
  nonCriticalExtension          SystemInformationBlockType1-v1130-IEs  OPTIONAL
}

SystemInformationBlockType1-v1130-IEs ::= SEQUENCE {
  tdd-Config-v1130             TDD-Config-v1130          OPTIONAL,  -- Cond TDD-OR
  cellSelectionInfo-v1130      CellSelectionInfo-v1130  OPTIONAL,  -- Cond WB-RSRQ
  nonCriticalExtension          SystemInformationBlockType1-v1250-IEs  OPTIONAL
}

SystemInformationBlockType1-v1250-IEs ::= SEQUENCE {
  cellAccessRelatedInfo-v1250  SEQUENCE {
    category0Allowed-r12        ENUMERATED {true}      OPTIONAL  -- Need OP
  },
  cellSelectionInfo-v1250       CellSelectionInfo-v1250  OPTIONAL,  -- Cond RSRQ2
  freqBandIndicatorPriority-r12 ENUMERATED {true}      OPTIONAL,  -- Cond mFBI
  nonCriticalExtension          SystemInformationBlockType1-v1310-IEs  OPTIONAL
}

SystemInformationBlockType1-v1310-IEs ::= SEQUENCE {
  hyperSFN-r13                 BIT STRING (SIZE (10))  OPTIONAL,  -- Need OR
  eDRX-Allowed-r13             ENUMERATED {true}      OPTIONAL,  -- Need OR
  cellSelectionInfoCE-r13      CellSelectionInfoCE-r13  OPTIONAL,  -- Need OP
  bandwidthReducedAccessRelatedInfo-r13 SEQUENCE {
    si-WindowLength-BR-r13     ENUMERATED {
      ms20, ms40, ms60, ms80, ms120,
      ms160, ms200, spare},
    si-RepetitionPattern-r13   ENUMERATED {everyRF, every2ndRF, every4thRF,
      every8thRF},
    schedulingInfoList-BR-r13  SchedulingInfoList-BR-r13  OPTIONAL,  -- Cond SI-
BR
    fdd-DownlinkOrTddSubframeBitmapBR-r13 CHOICE {
      subframePattern10-r13    BIT STRING (SIZE (10)),
      subframePattern40-r13    BIT STRING (SIZE (40))
    }
    fdd-UplinkSubframeBitmapBR-r13 BIT STRING (SIZE (10))  OPTIONAL,  -- Need OP
    startSymbolBR-r13          INTEGER (1..4),
    si-HoppingConfigCommon-r13 ENUMERATED {on,off},
    si-ValidityTime-r13        ENUMERATED {true}      OPTIONAL,  -- Need OP
    systemInfoValueTagList-r13 SystemInfoValueTagList-r13  OPTIONAL,  -- Need OR
    nonCriticalExtension          SEQUENCE {}      OPTIONAL,  -- Cond BW-reduced
}

SystemInformationBlockType1-v1320-IEs ::= SEQUENCE {
  freqHoppingParametersDL-r13  SEQUENCE {
    mpdcch-pdsch-HoppingNB-r13 ENUMERATED {nb2, nb4}      OPTIONAL,  -- Need OR
    interval-DLHoppingConfigCommonModeA-r13 CHOICE {
      interval-FDD-r13        ENUMERATED {int1, int2, int4, int8},
      interval-TDD-r13        ENUMERATED {int1, int5, int10, int20}
    }
    interval-DLHoppingConfigCommonModeB-r13 CHOICE {
      interval-FDD-r13        ENUMERATED {int2, int4, int8, int16},
      interval-TDD-r13        ENUMERATED {int5, int10, int20, int40}
    }
  }
  nonCriticalExtension          SEQUENCE {}      OPTIONAL,  -- Need OR
}

```

```

        mpdcch-pdsch-HoppingOffset-r13                INTEGER (1..maxAvailNarrowBands-r13)    OPTIONAL --
Need OR
    }
    nonCriticalExtension                             SystemInformationBlockType1-v1350-IEs
    OPTIONAL
}

SystemInformationBlockType1-v1350-IEs ::= SEQUENCE {
    cellSelectionInfoCE1-r13                        CellSelectionInfoCE1-r13    OPTIONAL, -- Need OP
    nonCriticalExtension                             SystemInformationBlockType1-v1360-IEs
    OPTIONAL
}

SystemInformationBlockType1-v1360-IEs ::= SEQUENCE {
    cellSelectionInfoCE1-v1360                      CellSelectionInfoCE1-v1360  OPTIONAL, -- Cond
QrxlevminCE1
    nonCriticalExtension                             SystemInformationBlockType1-v1430-IEs    OPTIONAL
}

SystemInformationBlockType1-v1430-IEs ::= SEQUENCE {
    eCallOverIMS-Support-r14                        ENUMERATED {true}           OPTIONAL, -- Need OR
    tdd-Config-v1430                                TDD-Config-v1430           OPTIONAL, -- Cond TDD-OR
    cellAccessRelatedInfoList-r14                  SEQUENCE (SIZE (1..maxPLMN-1-r14)) OF
    CellAccessRelatedInfo-r14                       OPTIONAL, -- Need OR
    nonCriticalExtension                             SystemInformationBlockType1-v1450-IEs
    OPTIONAL
}

SystemInformationBlockType1-v1450-IEs ::= SEQUENCE {
    tdd-Config-v1450                                TDD-Config-v1450           OPTIONAL, -- Cond TDD-OR
    nonCriticalExtension                             SystemInformationBlockType1-v1530-IEs
    OPTIONAL
}

SystemInformationBlockType1-v1530-IEs ::= SEQUENCE {
    hsdn-Cell-r15                                  ENUMERATED {true}           OPTIONAL, -- Need OR
    cellSelectionInfoCE-v1530                       CellSelectionInfoCE-v1530   OPTIONAL, -- Need OP
    crs-IntfMitigConfig-r15                         CHOICE {
        crs-IntfMitigEnabled                        NULL,
        crs-IntfMitigNumPRBs                       ENUMERATED {n6, n24}
    } OPTIONAL, -- Need OR
    cellBarred-CRS-r15                              ENUMERATED {barred, notBarred},
    plmn-IdentityList-v1530                         PLMN-IdentityList-v1530    OPTIONAL, -- Need OR
    posSchedulingInfoList-r15                       PosSchedulingInfoList-r15   OPTIONAL, -- Need OR
    cellAccessRelatedInfo-5GC-r15                   SEQUENCE {
        cellBarred-5GC-r15                         ENUMERATED {barred, notBarred},
        cellBarred-5GC-CRS-r15                     ENUMERATED {barred, notBarred},
        cellAccessRelatedInfoList-5GC-r15          SEQUENCE (SIZE (1..maxPLMN-r11)) OF
        CellAccessRelatedInfo-5GC-r15
    } OPTIONAL, -- Need OP
    ims-EmergencySupport5GC-r15                     ENUMERATED {true}           OPTIONAL, -- Need OR
    eCallOverIMS-Support5GC-r15                     ENUMERATED {true}           OPTIONAL, -- Need OR
    nonCriticalExtension                             SystemInformationBlockType1-v1540-IEs    OPTIONAL
}

SystemInformationBlockType1-v1540-IEs ::= SEQUENCE {
    si-posOffset-r15                                ENUMERATED {true}           OPTIONAL, -- Need ON
    nonCriticalExtension                             SystemInformationBlockType1-v1610-IEs    OPTIONAL
}

SystemInformationBlockType1-v1610-IEs ::= SEQUENCE {
    eDRX-Allowed-5GC-r16                            ENUMERATED {true}           OPTIONAL, -- Need OR
    transmissionInControlChRegion-r16              ENUMERATED {true}           OPTIONAL, -- Cond BW-reduced
    campingAllowedInCE-r16                          ENUMERATED {true}           OPTIONAL, -- Need OR
    plmn-IdentityList-v1610                         PLMN-IdentityList-v1610    OPTIONAL, -- Need OR
    nonCriticalExtension                             SystemInformationBlockType1-v1700-IEs    OPTIONAL
}

SystemInformationBlockType1-v1700-IEs ::= SEQUENCE {
    cellAccessRelatedInfo-NTN-r17                   SEQUENCE {
        cellBarred-NTN-r17                         ENUMERATED {barred, notBarred},
        plmn-IdentityList-v1700                     PLMN-IdentityList-v1700    OPTIONAL -- Need OR
    } OPTIONAL, -- Need OR
    nonCriticalExtension                             SystemInformationBlockType1-v1800-IEs    OPTIONAL
}

SystemInformationBlockType1-v1800-IEs ::= SEQUENCE {
    freqBandIndicatorAerial-r18                     FreqBandIndicator-r11       OPTIONAL, -- Need OR

```

```

    freqBandInfoAerial-r18                NS-PmaxListAerial-r18                OPTIONAL, -- Need OR
    multiBandInfoListAerial-r18          MultiBandInfoListAerial-r18          OPTIONAL, -- Need OR
    nonCriticalExtension                   SEQUENCE {}                          OPTIONAL
}

PLMN-IdentityList ::= SEQUENCE (SIZE (1..maxPLMN-r11)) OF PLMN-IdentityInfo

PLMN-IdentityInfo ::= SEQUENCE {
    plmn-Identity                PLMN-Identity,
    cellReservedForOperatorUse    ENUMERATED {reserved, notReserved}
}

PLMN-IdentityList-v1530 ::= SEQUENCE (SIZE (1..maxPLMN-r11)) OF PLMN-IdentityInfo-v1530

PLMN-IdentityInfo-v1530 ::= SEQUENCE {
    cellReservedForOperatorUse-CRS-r15    ENUMERATED {reserved, notReserved}
}

PLMN-IdentityList-r15 ::= SEQUENCE (SIZE (1..maxPLMN-r11)) OF PLMN-IdentityInfo-r15

PLMN-IdentityList-v1610 ::= SEQUENCE (SIZE (1..maxPLMN-r11)) OF PLMN-IdentityInfo-v1610

PLMN-IdentityList-v1700 ::= SEQUENCE (SIZE (1..maxPLMN-r11)) OF PLMN-IdentityInfo-v1700

PLMN-IdentityInfo-r15 ::= SEQUENCE {
    plmn-Identity-5GC-r15                CHOICE {
        plmn-Identity-r15                PLMN-Identity,
        plmn-Index-r15                   INTEGER (1..maxPLMN-r11)
    },
    cellReservedForOperatorUse-r15        ENUMERATED {reserved, notReserved},
    cellReservedForOperatorUse-CRS-r15    ENUMERATED {reserved, notReserved}
}

PLMN-IdentityInfo-v1610 ::= SEQUENCE {
    cp-CIoT-5GS-Optimisation-r16          ENUMERATED {true}                OPTIONAL, -- Need OR
    up-CIoT-5GS-Optimisation-r16          ENUMERATED {true}                OPTIONAL, -- Need OR
    iab-Support-r16                       ENUMERATED {true}                OPTIONAL  -- Need OR
}

PLMN-IdentityInfo-v1700 ::= SEQUENCE {
    trackingAreaList-r17                  TrackingAreaList-r17              OPTIONAL  -- Need OP
}

SchedulingInfoList ::= SEQUENCE (SIZE (1..maxSI-Message)) OF SchedulingInfo

SchedulingInfoList-v12j0 ::= SEQUENCE (SIZE (1..maxSI-Message)) OF SchedulingInfo-v12j0

SchedulingInfoListExt-r12 ::= SEQUENCE (SIZE (1..maxSI-Message)) OF SchedulingInfoExt-r12

SchedulingInfo ::= SEQUENCE {
    si-Periodicity                SI-Periodicity-r12,
    sib-MappingInfo                SIB-MappingInfo
}

SchedulingInfo-v12j0 ::= SEQUENCE {
    sib-MappingInfo-v12j0          SIB-MappingInfo-v12j0              OPTIONAL  -- Need OR
}

SchedulingInfoExt-r12 ::= SEQUENCE {
    si-Periodicity-r12            SI-Periodicity-r12,
    sib-MappingInfo-r12           SIB-MappingInfo-v12j0
}

SchedulingInfoList-BR-r13 ::= SEQUENCE (SIZE (1..maxSI-Message)) OF SchedulingInfo-BR-r13

SchedulingInfo-BR-r13 ::= SEQUENCE {
    si-Narrowband-r13             INTEGER (1..maxAvailNarrowBands-r13),
    si-TBS-r13                    ENUMERATED {b152, b208, b256, b328, b408, b504, b600, b712, b808, b936}
}

SIB-MappingInfo ::= SEQUENCE (SIZE (0..maxSIB-1)) OF SIB-Type

SIB-MappingInfo-v12j0 ::= SEQUENCE (SIZE (1..maxSIB-1)) OF SIB-Type-v12j0

-- Note: The IE SIB-Type (without suffix) will not be extended any further in this release of the
specification. If needed, the IE SIB-Type-v12j0 will be used for new SIB(s).

SIB-Type ::= ENUMERATED {

```

```

        sibType3, sibType4, sibType5, sibType6,
        sibType7, sibType8, sibType9, sibType10,
        sibType11, sibType12-v920, sibType13-v920,
        sibType14-v1130, sibType15-v1130,
        sibType16-v1130, sibType17-v1250, sibType18-v1250,
        ..., sibType19-v1250, sibType20-v1310, sibType21-v1430,
        sibType24-v1530, sibType25-v1530, sibType26-v1530,
        sibType27-v1610, sibType28-v1610,
        sibType29-v1610
    }
}
SIB-Type-v12j0 ::= ENUMERATED {
    sibType19-v1250, sibType20-v1310, sibType21-v1430,
    sibType24-v1530, sibType25-v1530, sibType26-v1530,
    sibType27-v1610, sibType28-v1610, sibType29-v1610,
    sibType30-v1700, sibType31-v1700, sibType32-v1700,
    sibType33-v1800, spare2, spare1, ...}
SI-Periodicity-r12 ::= ENUMERATED {rf8, rf16, rf32, rf64, rf128, rf256, rf512}
SystemInfoValueTagList-r13 ::= SEQUENCE (SIZE (1..maxSI-Message)) OF SystemInfoValueTagSI-r13
SystemInfoValueTagSI-r13 ::= INTEGER (0..3)
CellSelectionInfo-v920 ::= SEQUENCE {
    q-QualMin-r9 Q-QualMin-r9,
    q-QualMinOffset-r9 INTEGER (1..8) OPTIONAL -- Need OP
}
CellSelectionInfo-v1130 ::= SEQUENCE {
    q-QualMinWB-r11 Q-QualMin-r9
}
CellSelectionInfo-v1250 ::= SEQUENCE {
    q-QualMinRSRQ-OnAllSymbols-r12 Q-QualMin-r9
}
CellAccessRelatedInfo-r14 ::= SEQUENCE {
    plmn-IdentityList-r14 PLMN-IdentityList,
    trackingAreaCode-r14 TrackingAreaCode,
    cellIdentity-r14 CellIdentity
}
CellAccessRelatedInfo-5GC-r15 ::= SEQUENCE {
    plmn-IdentityList-r15 PLMN-IdentityList-r15,
    ran-AreaCode-r15 RAN-AreaCode-r15 OPTIONAL, -- Need OR
    trackingAreaCode-5GC-r15 TrackingAreaCode-5GC-r15,
    cellIdentity-5GC-r15 CellIdentity-5GC-r15
}
CellIdentity-5GC-r15 ::= CHOICE{
    cellIdentity-r15 CellIdentity,
    cellId-Index-r15 INTEGER (1..maxPLMN-r11)
}
TrackingAreaList-r17 ::= SEQUENCE (SIZE (1..maxTAC-r17)) OF TrackingAreaCode
PosSchedulingInfoList-r15 ::= SEQUENCE (SIZE (1..maxSI-Message)) OF PosSchedulingInfo-r15
PosSchedulingInfo-r15 ::= SEQUENCE {
    posSI-Periodicity-r15 ENUMERATED {rf8, rf16, rf32, rf64, rf128, rf256, rf512},
    posSIB-MappingInfo-r15 PosSIB-MappingInfo-r15
}
PosSIB-MappingInfo-r15 ::= SEQUENCE (SIZE (1..maxSIB)) OF PosSIB-Type-r15
PosSIB-Type-r15 ::= SEQUENCE {
    encrypted-r15 ENUMERATED { true } OPTIONAL, -- Need OP
    gnss-id-r15 GNSS-ID-r15 OPTIONAL, -- Need OP
    sbas-id-r15 SBAS-ID-r15 OPTIONAL, -- Need OP
    posSibType-r15 ENUMERATED { posSibType1-1,
        posSibType1-2,
        posSibType1-3,
        posSibType1-4,
        posSibType1-5,
        posSibType1-6,
        posSibType1-7,
        posSibType2-1,

```

```
posSibType2-2,  
posSibType2-3,  
posSibType2-4,  
posSibType2-5,  
posSibType2-6,  
posSibType2-7,  
posSibType2-8,  
posSibType2-9,  
posSibType2-10,  
posSibType2-11,  
posSibType2-12,  
posSibType2-13,  
posSibType2-14,  
posSibType2-15,  
posSibType2-16,  
posSibType2-17,  
posSibType2-18,  
posSibType2-19,  
posSibType3-1,  
...,  
posSibType1-8-v1610,  
posSibType2-20-v1610,  
posSibType2-21-v1610,  
posSibType2-22-v1610,  
posSibType2-23-v1610,  
posSibType2-24-v1610,  
posSibType2-25-v1610,  
posSibType4-1-v1610,  
posSibType5-1-v1610,  
posSibType1-9-v1700,  
posSibType1-10-v1700,  
posSibType2-17a-v1770,  
posSibType2-18a-v1770,  
posSibType2-20a-v1770,  
posSibType1-11-v1800,  
posSibType1-12-v1800,  
posSibType2-26-v1800,  
  
posSibType2-27-v1800  
},  
...  
}  
  
-- ASN1STOP
```

<b>SystemInformationBlockType1 field descriptions</b>
<b>bandwidthReducedAccessRelatedInfo</b> Access related information for BL UEs and UEs in CE. NOTE 3.
<b>campingAllowedInCE</b> Indicates whether non-BL UE is allowed to camp in the non-standalone BL cell in enhanced coverage mode when S-criterion for normal coverage is fulfilled. The field is not applicable for standalone BL cell.
<b>category0Allowed</b> The presence of this field indicates category 0 UEs are allowed to access the cell.
<b>cellAccessRelatedInfoList</b> This field contains a list allowing signalling of access related information per PLMN. One PLMN can be included in only one entry of this list. NOTE 4.
<b>cellAccessRelatedInfoList-5GC</b> This field contains a PLMN list and a list allowing signalling of access related information per PLMN for PLMNs that provides connectivity to 5GC. One PLMN can be included in only one entry of this list. NOTE4
<b>cellBarred, cellBarred-CRS</b> barred means the cell is barred, as defined in TS 36.304 [4].
<b>cellBarred-5GC, cellBarred-5GC-CRS</b> barred means the cell is barred for connectivity to 5GC, as defined in TS 36.304 [4].
<b>cellBarred-NTN</b> barred means the cell is barred for connectivity to NTN, as defined in TS 36.304 [4]. E-UTRAN always includes <i>cellBarred-NTN</i> and sets <i>cellBarred</i> to 'barred' in an NTN cell.
<b>cellIdentity</b> Indicates the cell identity. NOTE 2.
<b>cellId-Index</b> The index of the cell ID in the PLMN lists for EPC, indicates UE the corresponding cell ID is used for 5GC. Value 1 indicates the cell ID of the 1st PLMN list for EPC in the SIB1. Value 2 indicates the cell ID of the 2nd PLMN list for EPC, and so on.
<b>cellReservedForOperatorUse, cellReservedForOperatorUse-CRS</b> As defined in TS 36.304 [4].
<b>cellSelectionInfoCE</b> Cell selection information for BL UEs and UEs in CE. If absent, coverage enhancement S criteria is not applicable. NOTE 3.
<b>cellSelectionInfoCE1</b> Cell selection information for BL UEs and UEs in CE supporting CE Mode B. E-UTRAN includes this IE only if <i>cellSelectionInfoCE</i> is present in <i>SystemInformationBlockType1-BR</i> . NOTE 3.
<b>cp-CIoT-5GS-Optimisation</b> Indicates whether the UE is allowed to establish the connection with Control plane CiOT 5GS optimisation, see TS 24.501 [95].
<b>crs-IntfMitigConfig</b> <i>crs-IntfMitigEnabled</i> indicates CRS interference mitigation is enabled for the cell, as specified in TS 36.133 [16], clause 3.6.1.1. For BL UEs supporting <i>ce-CRS-IntfMitig</i> , presence of <i>crs-IntfMitigNumPRBs</i> indicates CRS interference mitigation is enabled in the cell, as specified in TS 36.133 [16], clauses 3.6.1.2 and 3.6.1.3, and the value of <i>crs-IntfMitigNumPRBs</i> indicates number of PRBs, i.e. 6 or 24 PRBs, for CRS transmission in the central cell BW when CRS interference mitigation is enabled. For UEs not supporting this feature, the behaviour is undefined if this field is configured and the field <i>cellBarred</i> in <i>SystemInformationBlockType1</i> ( <i>SystemInformationBlockType1-BR</i> for BL UEs or UEs in CE) is set to <i>notbarred</i> .
<b>csg-Identity</b> Identity of the Closed Subscriber Group the cell belongs to.
<b>csg-Indication</b> If set to TRUE the UE is only allowed to access the cell if it is a CSG member cell, if selected during manual CSG selection or to obtain limited service, see TS 36.304 [4].
<b>eCallOverIMS-Support</b> Indicates whether the cell supports eCall over IMS services via EPC for UEs as defined in TS 23.401 [41]. If absent, eCall over IMS via EPC is not supported by the network in the cell. NOTE 2.
<b>eCallOverIMS-Support5GC</b> Indicates whether the cell supports eCall over IMS services via 5GC as defined in TS 23.401 [41]. If absent, eCall over IMS via 5GC is not supported by the network in the cell. NOTE 2.
<b>eDRX-Allowed</b> The presence of this field indicates if idle mode extended DRX is allowed in the cell for the UE connected to EPC. The UE shall stop using extended DRX in idle mode if <i>eDRX-Allowed</i> is not present when connected to EPC.
<b>eDRX-Allowed-5GC</b> The presence of this field indicates if idle mode extended DRX is allowed in the cell for the UE connected to 5GC. The UE shall stop using extended DRX in idle mode if <i>eDRX-Allowed-5GC</i> is not present when connected to 5GC.
<b>encrypted</b> The presence of this field indicates that the <i>posSibType</i> is encrypted as specified in TS 36.355 [54].



<b>SystemInformationBlockType1 field descriptions</b>
<p><b><i>fdd-DownlinkOrTddSubframeBitmapBR</i></b>  The set of valid subframes for FDD downlink or TDD transmissions, see TS 36.213 [23].  If this field is present, <i>SystemInformationBlockType1-BR-r13</i> is transmitted in <i>RRCCONNECTIONRECONFIGURATION</i>, and if <i>RRCCONNECTIONRECONFIGURATION</i> does not include <i>systemInformationBlockType2Dedicated</i>, UE may assume the valid subframes in <i>fdd-DownlinkOrTddSubframeBitmapBR</i> are not indicated as MBSFN subframes. If this field is not present, the set of valid subframes is the set of non-MBSFN subframes as indicated by <i>mbsfn-SubframeConfigList</i>. If neither this field nor <i>mbsfn-SubframeConfigList</i> is present, all subframes are considered as valid subframes for FDD downlink transmission, all DL subframes according to the uplink-downlink configuration (see TS 36.211 [21]) are considered as valid subframes for TDD DL transmission, and all UL subframes according to the uplink-downlink configuration (see TS 36.211 [21]) are considered as valid subframes for TDD UL transmission.  The first/leftmost bit corresponds to the subframe #0 of the radio frame satisfying <math>SFN \bmod x = 0</math>, where x is the size of the bit string divided by 10. Value 0 in the bitmap indicates that the corresponding subframe is invalid for transmission. Value 1 in the bitmap indicates that the corresponding subframe is valid for transmission.</p>
<p><b><i>fdd-UplinkSubframeBitmapBR</i></b>  The set of valid subframes for FDD uplink transmissions for BL UEs, see TS 36.213 [23].  If the field is not present, then UE considers all uplink subframes as valid subframes for FDD uplink transmissions.  The first/leftmost bit corresponds to the subframe #0 of the radio frame satisfying <math>SFN \bmod x = 0</math>, where x is the size of the bit string divided by 10. Value 0 in the bitmap indicates that the corresponding subframe is invalid for transmission. Value 1 in the bitmap indicates that the corresponding subframe is valid for transmission.</p>
<p><b><i>freqBandIndicatorPriority</i></b>  If the field is present and supported by the UE, the UE shall prioritize the frequency bands in the <i>multiBandInfoList</i> field in decreasing priority order. Only if the UE does not support any of the frequency band in <i>multiBandInfoList</i>, the UE shall use the value in <i>freqBandIndicator</i> field. Otherwise, the UE applies frequency band according to the rules defined in <i>multiBandInfoList</i>. NOTE 2.</p>
<p><b><i>freqBandInfo</i></b>  A list of additional <i>P<sub>max</sub></i> and <i>additionalSpectrumEmission</i> values, as defined in TS 36.101 [42], table 6.2.4-1, for UEs neither in CE nor BL UEs, TS 36.101 [42], table 6.2.4E-1, for UEs in CE or BL UEs and TS 36.102 [113], table 6.2A.3-1, for NTN capable UE, for the frequency band in <i>freqBandIndicator</i>. If E-UTRAN includes <i>freqBandInfo-v1010</i> it includes the same number of entries, and listed in the same order, as in <i>freqBandInfo-r10</i>.</p>
<p><b><i>freqHoppingParametersDL</i></b>  Downlink frequency hopping parameters for BR versions of SI messages, MPDCCH/PDSCH of paging, MPDCCH/PDSCH of RAR/Msg4 and unicast MPDCCH/PDSCH. If not present, the UE is not configured downlink frequency hopping.</p>
<p><b><i>gnss-ID</i></b>  The presence of this field indicates that the <i>posSibType</i> is for a specific GNSS.</p>
<p><b><i>hsdn-Cell</i></b>  This field indicates this is a HSDN cell as specified in TS 36.304 [4].</p>
<p><b><i>hyperSFN</i></b>  Indicates hyper SFN which increments by one when the SFN wraps around.</p>
<p><b><i>iab-Support</i></b>  This field combines both the support of IAB-node and the cell status for IAB-node. If the field is present, the cell supports IAB-nodes and the cell is also considered as a candidate for cell (re)selection for IAB-nodes; if the field is absent, the cell does not support IAB and/or the cell is barred for IAB-node.</p>
<p><b><i>ims-EmergencySupport</i></b>  Indicates whether the cell supports IMS emergency bearer services via EPC for UEs in limited service mode. If absent, IMS emergency call via EPC is not supported by the network in the cell for UEs in limited service mode. NOTE 2.</p>
<p><b><i>ims-EmergencySupport5GC</i></b>  Indicates whether the cell supports IMS emergency bearer services for UEs in limited service mode via 5GC. If absent, IMS emergency call via 5GC is not supported by the network in the cell for UEs in limited service mode. NOTE 2.</p>
<p><b><i>intraFreqReselection</i></b>  Used to control cell reselection to intra-frequency cells when the highest ranked cell is barred, or treated as barred by the UE, as specified in TS 36.304 [4]. NOTE 2.</p>
<p><b><i>multiBandInfoList</i></b>  A list of additional frequency band indicators, as defined in TS 36.101 [42], table 5.5-1 and TS 36.102 [113], table 5.2-1, for NTN capable UE that the cell belongs to. If the UE supports the frequency band in the <i>freqBandIndicator</i> field it shall apply that frequency band. Otherwise, the UE shall apply the first listed band which it supports in the <i>multiBandInfoList</i> field. If E-UTRAN includes <i>multiBandInfoList-v9e0</i> it includes the same number of entries, and listed in the same order, as in <i>multiBandInfoList</i> (i.e. without suffix). See Annex D for more descriptions. The UE shall ignore the rule defined in this field description if <i>freqBandIndicatorPriority</i> is present and supported by the UE.</p>

<b>SystemInformationBlockType1 field descriptions</b>
<p><b>multiBandInfoList-v10j0</b> A list of <i>additionalPmax</i> and <i>additionalSpectrumEmission</i> values, as defined in TS 36.101 [42], table 6.2.4-1, for UEs neither in CE nor BL UEs, TS 36.101 [42], table 6.2.4E-1, for UEs in CE or BL UEs and TS 36.102 [113], table 6.2A.3-1, for NTN capable UE, for the frequency bands in <i>multiBandInfoList</i> (i.e. without suffix) and <i>multiBandInfoList-v9e0</i>. If E-UTRAN includes <i>multiBandInfoList-v10j0</i>, it includes the same number of entries, and listed in the same order, as in <i>multiBandInfoList</i> (i.e. without suffix). If E-UTRAN includes <i>multiBandInfoList-v10i0</i> it includes the same number of entries, and listed in the same order, as in <i>multiBandInfoList-v10j0</i>.</p>
<p><b>plmn-IdentityList</b> List of PLMN identities. The first listed <i>PLMN-Identity</i> is the primary PLMN. If <i>plmn-IdentityList-v1530</i> is included, E-UTRAN includes the same number of entries, and listed in the same order, as in <i>plmn-IdentityList</i> (without suffix). If <i>plmn-IdentityList-v1610</i> is included, E-UTRAN includes the same number of entries, and listed in the same order, as in <i>plmn-IdentityList-r15</i>. If <i>plmn-IdentityList-v1700</i> is included, E-UTRAN includes the same number of entries, and listed in the same order, as in <i>plmn-IdentityList</i> (without suffix). NOTE 2.</p>
<p><b>plmn-Index</b> Index of the PLMN in the <i>plmn-IdentityList</i> fields included in SIB1 for EPC, indicating the same PLMN ID is connected to 5GC. Value 1 indicates the 1st PLMN in the 1st <i>plmn-IdentityList</i> included in SIB1, value 2 indicates the 2nd PLMN in the same <i>plmn-IdentityList</i>, or when no more PLMNs are present within the same <i>plmn-IdentityList</i>, then the PLMN listed 1st in the subsequent <i>plmn-IdentityList</i> within the same SIB1 and so on. NOTE 6.</p>
<p><b>p-Max</b> Value applicable for the cell. If absent the UE applies the maximum power according to its capability as specified in TS 36.101 [42], clause 6.2.2. NOTE 2. This field is ignored by IAB-MT. The IAB-MT applies output power and emissions requirements, as specified in TS 38.174 [107].</p>
<p><b>posSchedulingInfoList-BR</b> Indicates additional scheduling information of positioning SI messages for BL UEs and UEs in CE. E-UTRAN always includes this field if <i>posSchedulingInfoList-r15</i> is included in <i>SystemInformationBlockType1-BR</i>, and includes the same number of entries, and listed in the same order, as in <i>posSchedulingInfoList-r15</i>.</p>
<p><b>posSIB-MappingInfo</b> List of the posSIBs mapped to this <i>SystemInformation</i> message.</p>
<p><b>posSibType</b> The positioning SIB type is defined in TS 36.355 [54].</p>
<p><b>q-QualMin</b> Parameter "Q<sub>qualmin</sub>" in TS 36.304 [4]. If <i>cellSelectionInfo-v920</i> is not present, the UE applies the (default) value of negative infinity for Q<sub>qualmin</sub>. NOTE 1.</p>
<p><b>q-QualMinRSRQ-OnAllSymbols</b> If this field is present and supported by the UE, the UE shall, when performing RSRQ measurements, perform RSRQ measurement on all OFDM symbols in accordance with TS 36.214 [48]. NOTE 1.</p>
<p><b>q-QualMinOffset</b> Parameter "Q<sub>qualminoffset</sub>" in TS 36.304 [4]. Actual value Q<sub>qualminoffset</sub> = field value [dB]. If <i>cellSelectionInfo-v920</i> is not present or the field is not present, the UE applies the (default) value of 0 dB for Q<sub>qualminoffset</sub>. Affects the minimum required quality level in the cell.</p>
<p><b>q-QualMinWB</b> If this field is present and supported by the UE, the UE shall, when performing RSRQ measurements, use a wider bandwidth in accordance with TS 36.133 [16]. NOTE 1.</p>
<p><b>q-RxLevMinOffset</b> Parameter Q<sub>rxlevminoffset</sub> in TS 36.304 [4]. Actual value Q<sub>rxlevminoffset</sub> = field value * 2 [dB]. If absent, the UE applies the (default) value of 0 dB for Q<sub>rxlevminoffset</sub>. Affects the minimum required Rx level in the cell.</p>
<p><b>sbas-ID</b> The presence of this field indicates that the <i>posSibType</i> is for a specific SBAS.</p>
<p><b>schedulingInfoList</b> Indicates scheduling information of SI messages. The <i>schedulingInfoList-v12j0</i> (if present) provides additional SIBs mapped into the SI message scheduled via <i>schedulingInfoList</i> (without suffix). If E-UTRAN includes <i>schedulingInfoList-v12j0</i>, it includes the same number of entries, and listed in the same order, as in <i>schedulingInfoList</i> (without suffix).</p>
<p><b>schedulingInfoListExt</b> Indicates scheduling information of additional SI messages. The UE concatenates the entries of <i>schedulingInfoListExt</i> to the entries in <i>schedulingInfoList</i>, according to the general concatenation principles for list extension as defined in 5.1.2. If the <i>schedulingInfoListExt</i> is present, E-UTRAN ensures that the total number of entries of this field plus <i>schedulingInfoList</i> (without suffix) shall not exceed the value of <i>maxSI-Message</i>.</p>
<p><b>sib-MappingInfo</b> List of the SIBs mapped to this <i>SystemInformation</i> message. There is no mapping information of SIB2; it is always present in the first <i>SystemInformation</i> message listed in the <i>schedulingInfoList</i> (without suffix) list. If present, <i>sib-MappingInfo-v12j0</i> indicates one or more additional SIBs mapped to the concerned SI message listed in the <i>schedulingInfoList</i> (without suffix) list. If <i>schedulingInfoList-v12j0</i> or <i>schedulingInfoListExt-r12</i> is present, E-UTRAN does not include any value indicating SIB of type 19 or higher in <i>sib-MappingInfo</i> (without suffix). If <i>schedulingInfoList-v12j0</i> is present, E-UTRAN ensures that the total number of entries of this field plus <i>sib-MappingInfo</i> (without suffix) shall not exceed the value of <i>maxSIB-1</i>.</p>

<b>SystemInformationBlockType1 field descriptions</b>
<p><b>si-HoppingConfigCommon</b> Frequency hopping activation/deactivation for BR versions of SI messages and MPDCCH/PDSCH of paging.</p>
<p><b>si-Narrowband</b> This field indicates the index of a narrowband used to broadcast the SI message towards BL UEs and UEs in CE, see TS 36.211 [21], clause 6.4.1 and TS 36.213 [23], clause 7.1.6. Field values (1..<i>maxAvailNarrowBands-r13</i>) correspond to narrowband indices (0..<i>maxAvailNarrowBands-r13-1</i>) as specified in TS 36.211 [21].</p>
<p><b>si-RepetitionPattern</b> Indicates the radio frames within the SI window used for SI message transmission. Value everyRF corresponds to every radio frame, value every2ndRF corresponds to every 2 radio frames, and so on. The first transmission of the SI message is transmitted from the first radio frame of the SI window.</p>
<p><b>si-Periodicity, posSI-Periodicity</b> Periodicity of the SI-message in radio frames, such that rf8 denotes 8 radio frames, rf16 denotes 16 radio frames, and so on. If the <i>si-posOffset</i> is configured, the <i>posSI-Periodicity</i> of rf8 cannot be used.</p>
<p><b>si-posOffset</b> This field, if present and set to <i>true</i> indicates that the SI messages in <i>PosSchedulingInfoList</i> are scheduled with an offset of 8 radio frames compared to SI messages in <i>SchedulingInfoList</i>. <i>si-posOffset</i> may be present only if the shortest configured SI message periodicity for SI messages in <i>SchedulingInfoList</i> is 80ms.</p>
<p><b>si-TBS</b> This field indicates the transport block size information used to broadcast the SI message towards BL UEs and UEs in CE, see TS 36.213 [23], Table 7.1.7.2.1-1, for a 6 PRB bandwidth and a QPSK modulation.</p>
<p><b>schedulingInfoList-BR</b> Indicates additional scheduling information of SI messages for BL UEs and UEs in CE. It includes the same number of entries, and listed in the same order, as in <i>schedulingInfoList</i> (without suffix).</p>
<p><b>si-ValidityTime</b> Indicates system information validity timer. If set to TRUE, the timer is set to 3h, otherwise the timer is set to 24h.</p>
<p><b>si-WindowLength, si-WindowLength-BR</b> Common SI scheduling window for all SIs. Unit in milliseconds, where ms1 denotes 1 millisecond, ms2 denotes 2 milliseconds and so on. In case <i>si-WindowLength-BR-r13</i> is present and the UE is a BL UE or a UE in CE, the UE shall use <i>si-WindowLength-BR-r13</i> and ignore the original field <i>si-WindowLength</i> (without suffix). UEs other than BL UEs or UEs in CE shall ignore the extension field <i>si-WindowLength-BR-r13</i>.</p>
<p><b>startSymbolBR</b> For BL UEs and UEs in CE, indicates the OFDM starting symbol for any MPDCCH, PDSCH scheduled on the same cell except the PDSCH carrying <i>SystemInformationBlockType1-BR</i>, see TS 36.213 [23]. Values 1, 2, and 3 are applicable for <i>dl-Bandwidth</i> greater than 10 resource blocks. Values 2, 3, and 4 are applicable otherwise.</p>
<p><b>systemInfoValueTagList</b> Indicates SI message specific value tags for BL UEs and UEs in CE. It includes the same number of entries, and listed in the same order, as in <i>schedulingInfoList</i> (without suffix).</p>
<p><b>systemInfoValueTagSI</b> SI message specific value tag as specified in clause 5.2.1.3. Common for all SIBs within the SI message other than MIB, SIB1, SIB10, SIB11, SIB12, SIB14, SIB31 and SIB33.</p>
<p><b>systemInfoValueTag</b> Common for all SIBs other than MIB, MIB-MBMS, SIB1, SIB1-MBMS, SIB10, SIB11, SIB12, SIB14, SIB31 and SIB33. Change of MIB, MIB-MBMS, SIB1 and SIB1-MBMS is detected by acquisition of the corresponding message.</p>
<p><b>tdd-Config</b> Specifies the TDD specific physical channel configurations. NOTE 2.</p>
<p><b>trackingAreaCode/trackingAreaCode-5GC</b> A <i>trackingAreaCode</i> that is common for all the PLMNs listed. NOTE2. NOTE 5.</p>
<p><b>trackingAreaList</b> A list of tracking area codes for the PLMN listed. For the first entry in <i>plmn-IdentityList-v1700</i>: If this field is present, the list of tracking area codes include the tracking area code in <i>trackingAreaCode</i> (without suffix) and the tracking area codes in <i>trackingAreaList</i>. If this field is absent, <i>trackingAreaCode</i> (without suffix) applies. For other entries in <i>plmn-IdentityList-v1700</i>: If this field is present, the list of tracking area codes include the tracking area codes in <i>trackingAreaList</i>. If this field is absent, the list of tracking area codes of the preceding entry in <i>plmn-IdentityList-v1700</i> applies. The total number of signalled tracking area codes across all PLMNs cannot be more than <i>maxTAC-r17</i>.</p>
<p><b>transmissionInControlChRegion</b> Indicates, for BL UEs and UEs in CE, LTE control channel region may be used for DL broadcast transmission. NOTE 3.</p>
<p><b>up-CIoT-5GS-Optimisation</b> Indicates whether the UE is allowed to resume the connection with User plane CiIoT 5GS optimisation, see TS 24.501 [95].</p>

NOTE 1: The value the UE applies for parameter " $Q_{\text{qualmin}}$ " in TS 36.304 [4] depends on the  $q\text{-QualMin}$  fields signalled by E-UTRAN and supported by the UE. In case multiple candidate options are available, the UE shall select the highest priority candidate option according to the priority order indicated by the following table (top row is highest priority).

<b>q-QualMinRSRQ-OnAllSymbols</b>	<b>q-QualMinWB</b>	<b>Value of parameter "<math>Q_{\text{qualmin}}</math>" in TS 36.304 [4]</b>
Included	Included	$q\text{-QualMinRSRQ-OnAllSymbols} - (q\text{-QualMin} - q\text{-QualMinWB})$
Included	Not included	$q\text{-QualMinRSRQ-OnAllSymbols}$
Not included	Included	$q\text{-QualMinWB}$
Not included	Not included	$q\text{-QualMin}$

NOTE 2: E-UTRAN sets this field to the same value for all instances of SIB1 message that are broadcasted within the same cell.

NOTE 3: E-UTRAN configures this field only in the BR version of SIB1 message.

NOTE 4: E-UTRAN configures at most 6 EPC PLMNs in total (i.e. across all the PLMN lists except for PLMN lists in *cellAccessRelatedInfoList-5GC* in SIB1). E-UTRAN configures at most 6 5GC PLMNs in total (i.e. across all the PLMN lists in *cellAccessRelatedInfoList-5GC* in SIB1).

NOTE 5: E-UTRAN configures only one value for this parameter per PLMN.

NOTE 6: E-UTRAN configures *plmn-Index* only if the *cellBarred* is set to *notBarred*.

<b>Conditional presence</b>	<b>Explanation</b>
<i>BW-reduced</i>	The field is optional present, Need OR, if <i>schedulingInfoSIB1-BR</i> in MIB is set to a value greater than 0. Otherwise the field is not present.
<i>FBI-max</i>	The field is mandatory present if <i>freqBandIndicator</i> (i.e. without suffix) is set to <i>maxFBI</i> . Otherwise the field is not present.
<i>mFBI</i>	The field is optional present, Need OR, if <i>multiBandInfoList</i> is present. Otherwise the field is not present.
<i>mFBI-max</i>	The field is mandatory present if one or more entries in <i>multiBandInfoList</i> (i.e. without suffix, introduced in -v8h0) is set to <i>maxFBI</i> . Otherwise the field is not present.
<i>RSRQ</i>	The field is mandatory present if SIB3 is being broadcast and <i>threshServingLowQ</i> is present in SIB3; otherwise optionally present, Need OP.
<i>RSRQ2</i>	The field is mandatory present if <i>q-QualMinRSRQ-OnAllSymbols</i> is present in SIB3; otherwise it is not present and the UE shall delete any existing value for this field.
<i>Hopping</i>	The field is mandatory present if <i>si-HoppingConfigCommon</i> field is broadcasted and set to <i>on</i> . Otherwise the field is optionally present, need OP.
<i>QrxlevminCE1</i>	The field is optionally present, Need OR, if <i>q-RxLevMinCE1-r13</i> is set below -140 dBm. Otherwise the field is not present.
<i>TDD</i>	This field is mandatory present for TDD; it is not present for FDD and the UE shall delete any existing value for this field.
<i>TDD-OR</i>	The field is optional present for TDD, need OR; it is not present for FDD.
<i>WB-RSRQ</i>	The field is optionally present, need OP if the measurement bandwidth indicated by <i>allowedMeasBandwidth</i> in <i>systemInformationBlockType3</i> is 50 resource blocks or larger; otherwise it is not present.
<i>SI-BR</i>	The field is mandatory present if <i>schedulingInfoSIB1-BR</i> is included in MIB with a value greater than 0. Otherwise the field is not present.

## – SystemInformationBlockType1-MBMS

*SystemInformationBlockType1-MBMS* contains information relevant for receiving service from MBMS-dedicated cell and defines the scheduling of other system information.

Signalling radio bearer: N/A

RLC-SAP: TM

Logical channels: BCCH

Direction: E-UTRAN to UE

### SystemInformationBlockType1-MBMS message

```
-- ASN1START
SystemInformationBlockType1-MBMS-r14 ::= SEQUENCE {
  cellAccessRelatedInfo-r14 SEQUENCE {
    plmn-IdentityList-r14 PLMN-IdentityList-MBMS-r14,
    trackingAreaCode-r14 TrackingAreaCode,
    cellIdentity-r14 CellIdentity
  },
  freqBandIndicator-r14 FreqBandIndicator-r11,
  multiBandInfoList-r14 MultiBandInfoList-r11 OPTIONAL, -- Need OR
  schedulingInfoList-MBMS-r14 SchedulingInfoList-MBMS-r14,
  si-WindowLength-r14 ENUMERATED {
    ms1, ms2, ms5, ms10, ms15, ms20, ms40, ms80},
  systemInfoValueTag-r14 INTEGER (0..31),
  nonMBSFN-SubframeConfig-r14 NonMBSFN-SubframeConfig-r14 OPTIONAL, --Need OR
  pdsch-ConfigCommon-r14 PDSCH-ConfigCommon,
  systemInformationBlockType13-r14 SystemInformationBlockType13-r9 OPTIONAL, --Need OR
  cellAccessRelatedInfoList-r14 SEQUENCE (SIZE (1..maxPLMN-1-r14)) OF
    CellAccessRelatedInfo-r14 OPTIONAL, -- Need OR
  nonCriticalExtension SEQUENCE {} OPTIONAL
}

PLMN-IdentityList-MBMS-r14 ::= SEQUENCE (SIZE (1..maxPLMN-r11)) OF PLMN-Identity

SchedulingInfoList-MBMS-r14 ::= SEQUENCE (SIZE (1..maxSI-Message)) OF SchedulingInfo-MBMS-r14

SchedulingInfo-MBMS-r14 ::= SEQUENCE {
  si-Periodicity-r14 ENUMERATED {
    rf16, rf32, rf64, rf128, rf256, rf512},
  sib-MappingInfo-r14 SIB-MappingInfo-MBMS-r14
}

SIB-MappingInfo-MBMS-r14 ::= SEQUENCE (SIZE (0..maxSIB-1)) OF SIB-Type-MBMS-r14

SIB-Type-MBMS-r14 ::= ENUMERATED {
  sibType10, sibType11, sibType12-v920, sibType13-v920,
  sibType15-v1130, sibType16-v1130, ...}

NonMBSFN-SubframeConfig-r14 ::= SEQUENCE {
  radioFrameAllocationPeriod-r14 ENUMERATED {rf4, rf8, rf16, rf32, rf64, rf128, rf512},
  radioFrameAllocationOffset-r14 INTEGER (0..7),
  subframeAllocation-r14 BIT STRING (SIZE(9))
}
-- ASN1STOP
```

<b>SystemInformationBlockType1-MBMS field descriptions</b>
<p><b>cellAccessRelatedInfoList</b> This field contains a list allowing signalling of access related information per PLMN. One PLMN can be included in only one entry of this list. NOTE 2.</p>
<p><b>cellIdentity</b> Indicates the cell identity. NOTE 1.</p>
<p><b>freqBandIndicator</b> A list of as defined in TS 36.101 [42], table 6.2.4-1, for the frequency band in <i>freqBandIndicator</i>.</p>
<p><b>multiBandInfoList</b> A list of additional frequency band indicators, as defined in TS 36.101 [42], table 5.5-1, that the cell belongs to. If the UE supports the frequency band in the <i>freqBandIndicator</i> field it shall apply that frequency band. Otherwise, the UE shall apply the first listed band which it supports in the <i>multiBandInfoList</i> field.</p>
<p><b>nonMBSFN-SubframeConfig</b> Defines the non-MBSFN subframes within the radio frame allocation period defined by the <i>radioFrameAllocationPeriod</i> and the <i>radioFrameAllocationOffset</i>.</p>
<p><b>plmn-IdentityList</b> List of PLMN identities. The first listed <i>PLMN-Identity</i> is the primary PLMN. NOTE 1.</p>
<p><b>radioFrameAllocationPeriod, radioFrameAllocationOffset</b> Radio-frames that contain non-MBSFN subframes occur when equation <math>SFN \bmod radioFrameAllocationPeriod = radioFrameAllocationOffset</math> is satisfied. Value rf4 for <i>radioFrameAllocationPeriod</i> denotes 4 radio frames, rf8 denotes 8 radio frames, and so on.</p>
<p><b>schedulingInfoList-MBMS</b> Indicates additional scheduling information of SI messages on MBMS-dedicated cell.</p>
<p><b>sib-MappingInfo</b> List of the SIBs mapped to this <i>SystemInformation</i> message.</p>
<p><b>si-Periodicity</b> Periodicity of the SI-message in radio frames, such that rf16 denotes 16 radio frames, rf32 denotes 32 radio frames, and so on.</p>
<p><b>si-WindowLength</b> Common SI scheduling window for all SIs. Unit in milliseconds, where ms1 denotes 1 millisecond, ms2 denotes 2 milliseconds and so on.</p>
<p><b>subframeAllocation</b> Defines the subframes that are allocated for non-MBSFN within the radio frame allocation period defined by the <i>radioFrameAllocationPeriod</i> and the <i>radioFrameAllocationOffset</i>. "0" denotes that the corresponding subframe is a MBSFN subframe. "1" denotes that the corresponding subframe is a non-MBSFN subframe. If E-UTRAN configures a value other than "0" for <i>additionalNonMBSFNSubframes</i> within <i>MasterInformationBlock-MBMS</i>, <i>subframeAllocation</i> configuration should also indicate subframes pointed out by <i>additionalNonMBSFNSubframes</i> as non-MBSFN subframes.</p>
<p><b>systemInformationBlockType13</b> E-UTRAN does not configure this field if <i>schedulingInfoList-MBMS</i> indicates that <i>SystemInformationBlockType13</i> is present.</p>
<p><b>systemInfoValueTag</b> Common for all SIBs other than MIB, SIB1, SIB10, SIB11, SIB12 and SIB14. Change of MIB and SIB1 is detected by acquisition of the corresponding message.</p>
<p><b>trackingAreaCode</b> A <i>trackingAreaCode</i> that is common for all the PLMNs listed. NOTE1.</p>

NOTE 1: E-UTRAN sets this field to the same value for all instances of SIB1-MBMS message that are broadcasted within the same cell.

## – UEAssistanceInformation

The *UEAssistanceInformation* message is used for the indication of UE assistance information to the eNB.

Signalling radio bearer: SRB1

RLC-SAP: AM

Logical channel: DCCH

Direction: UE to E-UTRAN

### **UEAssistanceInformation message**

-- ASN1START

```

UEAssistanceInformation-r11 ::= SEQUENCE {
    criticalExtensions CHOICE {
        c1 CHOICE {
            ueAssistanceInformation-r11 UEAssistanceInformation-r11-IEs,
            spare3 NULL, spare2 NULL, spare1 NULL
        },
        criticalExtensionsFuture SEQUENCE {}
    }
}

UEAssistanceInformation-r11-IEs ::= SEQUENCE {
    powerPrefIndication-r11 ENUMERATED {normal, lowPowerConsumption} OPTIONAL,
    lateNonCriticalExtension OCTET STRING OPTIONAL,
    nonCriticalExtension UEAssistanceInformation-v1430-IEs OPTIONAL
}

UEAssistanceInformation-v1430-IEs ::= SEQUENCE {
    bw-Preference-r14 BW-Preference-r14 OPTIONAL,
    sps-AssistanceInformation-r14 SEQUENCE {
        trafficPatternInfoListSL-r14 TrafficPatternInfoList-r14 OPTIONAL,
        trafficPatternInfoListUL-r14 TrafficPatternInfoList-r14 OPTIONAL
    } OPTIONAL,
    rlm-Report-r14 SEQUENCE {
        rlm-Event-r14 ENUMERATED {earlyOutOfSync, earlyInSync},
        excessRep-MPDCCH-r14 ENUMERATED {excessRep1, excessRep2} OPTIONAL
    } OPTIONAL,
    delayBudgetReport-r14 DelayBudgetReport-r14 OPTIONAL,
    nonCriticalExtension UEAssistanceInformation-v1450-IEs OPTIONAL
}

UEAssistanceInformation-v1450-IEs ::= SEQUENCE {
    overheatingAssistance-r14 OverheatingAssistance-r14 OPTIONAL,
    nonCriticalExtension UEAssistanceInformation-v1530-IEs OPTIONAL
}

UEAssistanceInformation-v1530-IEs ::= SEQUENCE {
    sps-AssistanceInformation-v1530 SEQUENCE {
        trafficPatternInfoListSL-v1530 TrafficPatternInfoList-v1530
    } OPTIONAL,
    nonCriticalExtension UEAssistanceInformation-v1610-IEs OPTIONAL
}

UEAssistanceInformation-v1610-IEs ::= SEQUENCE {
    overheatingAssistance-v1610 OverheatingAssistance-v1610 OPTIONAL,
    nonCriticalExtension UEAssistanceInformation-v1700-IEs OPTIONAL
}

UEAssistanceInformation-v1700-IEs ::= SEQUENCE {
    uplinkData-r17 ENUMERATED { true } OPTIONAL,
    scg-DeactivationPreference-r17 ENUMERATED { scgDeactivationPreferred,
        noPreference } OPTIONAL,
    nonCriticalExtension UEAssistanceInformation-v1710-IEs OPTIONAL
}

UEAssistanceInformation-v1710-IEs ::= SEQUENCE {
    overheatingAssistance-v1710 OverheatingAssistance-v1710 OPTIONAL,
    nonCriticalExtension SEQUENCE {} OPTIONAL
}

BW-Preference-r14 ::= SEQUENCE {
    dl-Preference-r14 ENUMERATED {mhz1dot4, mhz5, mhz20 } OPTIONAL,
    ul-Preference-r14 ENUMERATED {mhz1dot4, mhz5} OPTIONAL
}

TrafficPatternInfoList-r14 ::= SEQUENCE (SIZE (1..maxTrafficPattern-r14)) OF TrafficPatternInfo-r14

TrafficPatternInfo-r14 ::= SEQUENCE {
    trafficPeriodicity-r14 ENUMERATED {
        sf20, sf50, sf100, sf200, sf300, sf400, sf500,
        sf600, sf700, sf800, sf900, sf1000},
    timingOffset-r14 INTEGER (0..10239),
    priorityInfoSL-r14 SL-Priority-r13 OPTIONAL,
    logicalChannelIdentityUL-r14 INTEGER (3..10) OPTIONAL,
    messageSize-r14 BIT STRING (SIZE (6))
}

```

```
TrafficPatternInfoList-v1530 ::= SEQUENCE (SIZE (1..maxTrafficPattern-r14)) OF TrafficPatternInfo-
v1530

TrafficPatternInfo-v1530 ::= SEQUENCE {
    trafficDestination-r15          SL-DestinationIdentity-r12          OPTIONAL,
    reliabilityInfoSL-r15          SL-Reliability-r15                  OPTIONAL
}

DelayBudgetReport-r14 ::= CHOICE {
    type1                          ENUMERATED {
                                    msMinus1280, msMinus640, msMinus320, msMinus160,
                                    msMinus80, msMinus60, msMinus40, msMinus20, ms0, ms20,
                                    ms40, ms60, ms80, ms160, ms320, ms640, ms1280},
    type2                          ENUMERATED {
                                    msMinus192, msMinus168, msMinus144, msMinus120,
                                    msMinus96, msMinus72, msMinus48, msMinus24, ms0, ms24,
                                    ms48, ms72, ms96, ms120, ms144, ms168, ms192}
}

OverheatingAssistance-r14 ::= SEQUENCE {
    reducedUE-Category             SEQUENCE {
        reducedUE-CategoryDL      INTEGER (0..19),
        reducedUE-CategoryUL      INTEGER (0..21)
    } OPTIONAL,
    reducedMaxCCs                 SEQUENCE {
        reducedCCsDL              INTEGER (0..31),
        reducedCCsUL              INTEGER (0..31)
    } OPTIONAL
}

OverheatingAssistance-v1610 ::= SEQUENCE {
    overheatingAssistanceForSCG-r16 OCTET STRING
}

OverheatingAssistance-v1710 ::= SEQUENCE {
    overheatingAssistanceForSCG-FR2-2-r17 OCTET STRING
}

-- ASN1STOP
```



<b>UEAssistanceInformation field descriptions</b>
<p><b>delayBudgetReport</b> Indicates the UE-preferred adjustment to connected mode DRX or coverage enhancement configuration.</p>
<p><b>dl-Preference</b> Indicates UE's preference on configuration of maximum PDSCH bandwidth. The value mhz1dot4 corresponds to CE mode usage in 1.4MHz bandwidth, mhz5 corresponds to CE mode usage in 5MHz bandwidth, and mhz20 corresponds to CE mode usage in 20MHz bandwidth or normal coverage.</p>
<p><b>excessRep-MPDCCH</b> Indicates the excess number of repetitions on MPDCCH. Value excessRep1 and excessRep2 indicate the excess number of repetitions defined in TS 36.133 [16].</p>
<p><b>logicalChannelIdentityUL</b> Indicates the logical channel identity associated with the reported traffic pattern in the uplink logical channel.</p>
<p><b>messageSize</b> Indicates the maximum TB size based on the observed traffic pattern. The value refers to the index of TS 36.321 [6], table 6.1.3.1-1.</p>
<p><b>overheatingAssistanceForSCG</b> Includes the NR <i>OverheatingAssistance</i> IE as specified in TS 38.331 [82]. The field indicates UE's preference on reduced configuration for NR SCG to address overheating in FR1 and/or FR2-1.</p>
<p><b>overheatingAssistanceForSCG-FR2-2</b> Includes the NR <i>OverheatingAssistance-r17</i> IE for FR2-2 as specified in TS 38.331 [82]. The field indicates UE's preference on reduced configuration for NR SCG to address overheating in FR2-2.</p>
<p><b>powerPrefIndication</b> Value <i>lowPowerConsumption</i> indicates the UE prefers a configuration that is primarily optimised for power saving. Otherwise the value is set to <i>normal</i>.</p>
<p><b>priorityInfoSL</b> Indicates the traffic priority (i.e., PPPP) associated with the reported traffic pattern for V2X sidelink communication.</p>
<p><b>reducedCCsDL</b> Indicates the UE's preference on reduced configuration corresponding to the maximum number of downlink SCells indicated by the field, to address overheating. This maximum number includes both SCells of E-UTRA and PSCell/SCells of NR in (NG)EN-DC.</p>
<p><b>reducedCCsUL</b> Indicates the UE's preference on reduced configuration corresponding to the maximum number of uplink SCells indicated by the field, to address overheating. This maximum number includes both SCells of E-UTRA and PSCell/SCells of NR in (NG)EN-DC.</p>
<p><b>reducedUE-CategoryDL, reducedUE-CategoryUL</b> Indicates that UE prefers a configuration corresponding to the reduced UE category, to address overheating. The reduced UE DL category and reduced UE UL category should be indicated according to supported combinations for UE UL and DL Categories, see TS 36.306 [5], Table 4.1A-6.</p>
<p><b>reliabilityInfoSL</b> Indicates the traffic reliability (i.e., PPPR) associated with the reported traffic pattern for V2X sidelink communication.</p>
<p><b>rlm-Event</b> This field provides the RLM event ("early-out-of-sync" or "early-in-sync").</p>
<p><b>rlm-Report</b> This field provides the RLM report for BL UEs and UEs in CE.</p>
<p><b>sps-AssistanceInformation</b> Indicates the UE assistance information to assist E-UTRAN to configure SPS.</p>
<p><b>timingOffset</b> This field indicates the estimated timing for a packet arrival in a SL/UL logical channel. Specifically, the value indicates the timing offset with respect to subframe#0 of SFN#0 in milliseconds.</p>
<p><b>trafficDestination</b> Indicates the destination associated with the reported traffic pattern for V2X sidelink communication.</p>
<p><b>trafficPatternInfoListSL</b> This field provides the traffic characteristics of sidelink logical channel(s) that are setup for V2X sidelink communication. If <i>trafficPatternInfoListSL-v1530</i> is included, it includes the same number of entries, and listed in the same order, as in <i>trafficPatternInfoListSL-r14</i>.</p>
<p><b>trafficPatternInfoListUL</b> This field provides the traffic characteristics of uplink logical channel(s).</p>
<p><b>trafficPeriodicity</b> This field indicates the estimated data arrival periodicity in a SL/UL logical channel. Value sf20 corresponds to 20 ms, sf50 corresponds to 50 ms and so on.</p>
<p><b>type1</b> Indicates the preferred amount of increment/decrement to the connected mode DRX cycle length with respect to the current configuration. Value in number of milliseconds. Value ms40 corresponds to 40 milliseconds, msMinus40 corresponds to -40 milliseconds and so on.</p>

<b>UEAssistanceInformation field descriptions</b>
<p><b>type2</b> Indicates the preferred amount of increment/decrement to the coverage enhancement configuration with respect to the current configuration so that the Uu air interface delay changes by the indicated amount. Value in number of milliseconds. Value ms24 corresponds to 24 milliseconds, msMinus24 corresponds to -24 milliseconds and so on.</p>
<p><b>ul-Preference</b> Indicates UE's preference on configuration of maximum PUSCH bandwidth. The value mhz1dot4 corresponds to CE mode usage in 1.4MHz bandwidth, and mhz5 corresponds to CE mode usage in 5MHz bandwidth.</p>

## – UECapabilityEnquiry

The *UECapabilityEnquiry* message is used to request the transfer of UE radio access capabilities for E-UTRA as well as for other RATs.

Signalling radio bearer: SRB1

RLC-SAP: AM

Logical channel: DCCH

Direction: E-UTRAN to UE

### UECapabilityEnquiry message

```
-- ASN1START
UECapabilityEnquiry ::= SEQUENCE {
    rrc-TransactionIdentifier RRC-TransactionIdentifier,
    criticalExtensions CHOICE {
        cl CHOICE {
            ueCapabilityEnquiry-r8 UECapabilityEnquiry-r8-IEs,
            spare3 NULL, spare2 NULL, spare1 NULL
        },
        criticalExtensionsFuture SEQUENCE {}
    }
}

UECapabilityEnquiry-r8-IEs ::= SEQUENCE {
    ue-CapabilityRequest UE-CapabilityRequest,
    nonCriticalExtension UECapabilityEnquiry-v8a0-IEs OPTIONAL
}

UECapabilityEnquiry-v8a0-IEs ::= SEQUENCE {
    lateNonCriticalExtension OCTET STRING OPTIONAL,
    nonCriticalExtension UECapabilityEnquiry-v1180-IEs OPTIONAL
}

UECapabilityEnquiry-v1180-IEs ::= SEQUENCE {
    requestedFrequencyBands-r11 SEQUENCE (SIZE (1..16)) OF FreqBandIndicator-r11
    OPTIONAL,
    nonCriticalExtension UECapabilityEnquiry-v1310-IEs OPTIONAL
}

UECapabilityEnquiry-v1310-IEs ::= SEQUENCE {
    requestReducedFormat-r13 ENUMERATED {true} OPTIONAL, -- Need ON
    requestSkipFallbackComb-r13 ENUMERATED {true} OPTIONAL, -- Need ON
    requestedMaxCCsDL-r13 INTEGER (2..32) OPTIONAL, -- Need ON
    requestedMaxCCsUL-r13 INTEGER (2..32) OPTIONAL, -- Need ON
    requestReducedIntNonContComb-r13 ENUMERATED {true} OPTIONAL, -- Need ON
    nonCriticalExtension UECapabilityEnquiry-v1430-IEs OPTIONAL
}

UECapabilityEnquiry-v1430-IEs ::= SEQUENCE {
    requestDiffFallbackCombList-r14 BandCombinationList-r14 OPTIONAL, -- Need ON
    nonCriticalExtension UECapabilityEnquiry-v1510-IEs OPTIONAL
}

UECapabilityEnquiry-v1510-IEs ::= SEQUENCE {
    requestedFreqBandsNR-MRDC-r15 OCTET STRING OPTIONAL,
    nonCriticalExtension UECapabilityEnquiry-v1530-IEs OPTIONAL
}
-- ASN1END
```

```

UECapabilityEnquiry-v1530-IEs ::= SEQUENCE {
    requestSTTI-SPT-Capability-r15      ENUMERATED {true}           OPTIONAL,
    extra-nr-only-r15                   ENUMERATED {true}           OPTIONAL,
    nonCriticalExtension                 UECapabilityEnquiry-v1550-IEs OPTIONAL
}

UECapabilityEnquiry-v1550-IEs ::= SEQUENCE {
    requestedCapabilityNR-r15            OCTET STRING                OPTIONAL,
    nonCriticalExtension                 UECapabilityEnquiry-v1560-IEs OPTIONAL
}

UECapabilityEnquiry-v1560-IEs ::= SEQUENCE {
    requestedCapabilityCommon-r15        OCTET STRING                OPTIONAL,
    nonCriticalExtension                 UECapabilityEnquiry-v1610-IEs OPTIONAL
}

UECapabilityEnquiry-v1610-IEs ::= SEQUENCE {
    rrc-SegAllowed-r16                  ENUMERATED {enabled}        OPTIONAL, -- Need ON
    nonCriticalExtension                 UECapabilityEnquiry-v1710-IEs OPTIONAL
}

UECapabilityEnquiry-v1710-IEs ::= SEQUENCE {
    sidelinkRequest-r17                 ENUMERATED {true}           OPTIONAL, -- Need ON
    nonCriticalExtension                 SEQUENCE {}                 OPTIONAL
}

UE-CapabilityRequest ::= SEQUENCE (SIZE (1..maxRAT-Capabilities)) OF RAT-Type

-- ASN1STOP

```

<b><i>UECapabilityEnquiry</i> field descriptions</b>
<b><i>utra-nr-only</i></b> Indicates that the UE is requested to provide UE capabilities related to (NG)EN-DC only as specified in TS38.331 [82].
<b><i>requestDiffFallbackCombList</i></b> List of CA band combinations for which the UE is requested to provide different capabilities for their fallback band combinations in conjunction with the capabilities supported for the CA band combinations in this list. The UE shall exclude fallback band combinations for which their supported UE capabilities are the same as the CA band combination indicated in this list.
<b><i>requestReducedFormat</i></b> Indicates that the UE is requested to provide supported CA band combinations in the <i>supportedBandCombinationReduced-r13</i> instead of the <i>supportedBandCombination-r10</i> . The E-UTRAN includes this field if <i>requestSkipFallbackComb</i> or <i>requestDiffFallbackCombList</i> is included in the message.
<b><i>requestSkipFallbackComb</i></b> Indicates that the UE shall explicitly exclude fallback CA band combinations in capability signalling.
<b><i>ue-CapabilityRequest</i></b> List of the RATs for which the UE is requested to transfer the UE radio access capabilities i.e. E-UTRA, UTRA, GERAN-CS, GERAN-PS, CDMA2000. A separate <i>RAT-Type</i> value applies for some EUTRA-NR capabilities that are transferred by a separate UE capability container, used in case of MRDC.
<b><i>requestedFrequencyBands</i></b> List of frequency bands for which the UE is requested to provide supported CA band combinations and non CA bands.
<b><i>requestedFreqBandsNR-MRDC</i></b> Interpreted as <i>FreqBandList</i> IE as specified in TS 38.331 [82]. It concerns a list of NR and/ or E-UTRA frequency bands for which the UE is requested to provide its supported NR CA and/or MR-DC band combinations (i.e. within the UE capability containers for NR and MR-DC, as requested by E-UTRAN) and feature sets corresponding to the MR-DC band combinations (i.e. within the UE capability containers for LTE and NR, as requested by E-UTRAN).
<b><i>requestedCapabilityCommon</i></b> Contains the filter common for all requested MR-DC related capability containers as defined by <i>UE-CapabilityRequestFilterCommon</i> IE in TS 38.331 [82].
<b><i>requestedCapabilityNR</i></b> Interpreted as <i>UE-CapabilityRequestFilterNR</i> IE as specified in TS 38.331 [82], in which the field <i>frequencyBandListFilter</i> is omitted.
<b><i>requestedMaxCCsDL, requestedMaxCCsUL</i></b> Indicates the maximum number of CCs for which the UE is requested to provide supported CA band combinations and non-CA bands.
<b><i>requestReducedIntNonContComb</i></b> Indicates that the UE shall explicitly exclude supported intra-band non-contiguous CA band combinations other than included in capability signalling as specified in TS 36.306 [5], clause 4.3.5.21.
<b><i>requestSTTI-SPT-Capability</i></b> Indicates that the UE is requested to provide its supported short TTI and SPT capabilities in capability signalling.
<b><i>rrc-SegAllowed</i></b> A one-shot field that indicates that the UE is enabled to segment the response message into a series of <i>ULDedicatedMessageSegment</i> messages.

## – *UECapabilityInformation*

The *UECapabilityInformation* message is used to transfer of UE radio access capabilities requested by the E-UTRAN.

Signalling radio bearer: SRB1

RLC-SAP: AM

Logical channel: DCCH

Direction: UE to E-UTRAN

### ***UECapabilityInformation* message**

```
-- ASN1START
UECapabilityInformation ::= SEQUENCE {
    rrc-TransactionIdentifier RRC-TransactionIdentifier,
    criticalExtensions      CHOICE {
        c1 CHOICE {
            ueCapabilityInformation-r8 UECapabilityInformation-r8-IEs,
            spare7 NULL,
            spare6 NULL, spare5 NULL, spare4 NULL,
            spare3 NULL, spare2 NULL, spare1 NULL
        }
    }
}
```

```

    },
    criticalExtensionsFuture          SEQUENCE {}
  }
}
UECapabilityInformation-r8-IEs ::= SEQUENCE {
  ue-CapabilityRAT-ContainerList    UE-CapabilityRAT-ContainerList,
  nonCriticalExtension              UECapabilityInformation-v8a0-IEs    OPTIONAL
}
UECapabilityInformation-v8a0-IEs ::= SEQUENCE {
  lateNonCriticalExtension          OCTET STRING                    OPTIONAL,
  nonCriticalExtension              UECapabilityInformation-v1250-IEs  OPTIONAL
}
UECapabilityInformation-v1250-IEs ::= SEQUENCE {
  ue-RadioPagingInfo-r12           UE-RadioPagingInfo-r12        OPTIONAL,
  nonCriticalExtension              SEQUENCE {}                       OPTIONAL
}
-- ASN1STOP

```

#### ***UECapabilityInformation* field descriptions**

##### ***ue-RadioPagingInfo***

This field contains UE capability information used for paging.

#### – ***ULDedicatedMessageSegment***

The *ULDedicatedMessageSegment* message is used to transfer segments of the *UECapabilityInformation* message.

Signalling radio bearer: SRB1

RLC-SAP: AM

Logical channel: DCCH

Direction: UE to E-UTRAN

#### ***ULDedicatedMessageSegment* message**

```

-- ASN1START
ULDedicatedMessageSegment-r16 ::= SEQUENCE {
  criticalExtensions              CHOICE {
    ulDedicatedMessageSegment-r16 ULDedicatedMessageSegment-r16-IEs,
    criticalExtensionsFuture        SEQUENCE {}
  }
}
ULDedicatedMessageSegment-r16-IEs ::= SEQUENCE {
  segmentNumber-r16              INTEGER (0..15),
  rrc-MessageSegmentContainer-r16 OCTET STRING,
  rrc-MessageSegmentType-r16     ENUMERATED {notLastSegment, lastSegment},
  lateNonCriticalExtension        OCTET STRING                    OPTIONAL,
  nonCriticalExtension            SEQUENCE {}                       OPTIONAL
}
-- ASN1STOP

```

#### ***ULDedicatedMessageSegment* field descriptions**

##### ***segmentNumber***

Identifies the sequence number of a segment within the encoded UL DCCH message.

##### ***rrc-MessageSegmentContainer***

Includes a segment of the encoded UL DCCH message. The size of the included segment in this container should be small enough that the resulting encoded RRC message PDU is less than or equal to the PDCP SDU size limit.

##### ***rrc-MessageSegmentType***

Indicates whether the included UL DCCH message segment is the last segment or not.

– *UEInformationRequest*

The *UEInformationRequest* is the command used by E-UTRAN to retrieve information from the UE.

Signalling radio bearer: SRB1

RLC-SAP: AM

Logical channel: DCCH

Direction: E-UTRAN to UE

***UEInformationRequest message***

```

-- ASN1START
UEInformationRequest-r9 ::= SEQUENCE {
    rrc-TransactionIdentifier RRC-TransactionIdentifier,
    criticalExtensions CHOICE {
        c1 CHOICE {
            ueInformationRequest-r9 UEInformationRequest-r9-IEs,
            spare3 NULL, spare2 NULL, spare1 NULL
        },
        criticalExtensionsFuture SEQUENCE {}
    }
}

UEInformationRequest-r9-IEs ::= SEQUENCE {
    rach-ReportReq-r9 BOOLEAN,
    rlf-ReportReq-r9 BOOLEAN,
    nonCriticalExtension UEInformationRequest-v930-IEs OPTIONAL
}

UEInformationRequest-v930-IEs ::= SEQUENCE {
    lateNonCriticalExtension OCTET STRING OPTIONAL,
    nonCriticalExtension UEInformationRequest-v1020-IEs OPTIONAL
}

UEInformationRequest-v1020-IEs ::= SEQUENCE {
    logMeasReportReq-r10 ENUMERATED {true} OPTIONAL, -- Need ON
    nonCriticalExtension UEInformationRequest-v1130-IEs OPTIONAL
}

UEInformationRequest-v1130-IEs ::= SEQUENCE {
    connEstFailReportReq-r11 ENUMERATED {true} OPTIONAL, -- Need ON
    nonCriticalExtension UEInformationRequest-v1250-IEs OPTIONAL
}

UEInformationRequest-v1250-IEs ::= SEQUENCE {
    mobilityHistoryReportReq-r12 ENUMERATED {true} OPTIONAL, -- Need ON
    nonCriticalExtension UEInformationRequest-v1530-IEs OPTIONAL
}

UEInformationRequest-v1530-IEs ::= SEQUENCE {
    idleModeMeasurementReq-r15 ENUMERATED {true} OPTIONAL, -- Need ON
    flightPathInfoReq-r15 FlightPathInfoReportConfig-r15 OPTIONAL, -- Need ON
    nonCriticalExtension UEInformationRequest-v1710-IEs OPTIONAL
}

UEInformationRequest-v1710-IEs ::= SEQUENCE {
    coarseLocationReq-r17 ENUMERATED {true} OPTIONAL, -- Need ON
    nonCriticalExtension UEInformationRequest-v1800-IEs OPTIONAL
}

UEInformationRequest-v1800-IEs ::= SEQUENCE {
    rach-ReportReqNR-r18 ENUMERATED {true} OPTIONAL, -- Need ON
    nonCriticalExtension SEQUENCE {} OPTIONAL
}
-- ASN1STOP

```

<b><i>UEInformationRequest</i> field descriptions</b>
<b><i>coarseLocationReq</i></b> This field is used to request UE to report coarse location information.
<b><i>rach-ReportReq</i></b> This field is used to indicate whether the UE shall report information about the random access procedure.
<b><i>rach-ReportReqNR</i></b> This field is used to indicate whether the UE shall report information about the NR RACH information.

## – *UEInformationResponse*

The *UEInformationResponse* message is used by the UE to transfer the information requested by the E-UTRAN.

Signalling radio bearer: SRB1 or SRB2 (when logged measurement information is included)

RLC-SAP: AM

Logical channel: DCCH

Direction: UE to E-UTRAN

### ***UEInformationResponse* message**

```

-- ASN1START
UEInformationResponse-r9 ::= SEQUENCE {
    rrc-TransactionIdentifier    RRC-TransactionIdentifier,
    criticalExtensions           CHOICE {
        c1                      CHOICE {
            ueInformationResponse-r9    UEInformationResponse-r9-IEs,
            spare3 NULL, spare2 NULL, spare1 NULL
        },
        criticalExtensionsFuture       SEQUENCE {}
    }
}

UEInformationResponse-r9-IEs ::= SEQUENCE {
    rach-Report-r9              RACH-Report-r16    OPTIONAL,
    rlf-Report-r9               RLF-Report-r9      OPTIONAL,
    nonCriticalExtension         UEInformationResponse-v930-IEs    OPTIONAL
}

-- Late non critical extensions
UEInformationResponse-v9e0-IEs ::= SEQUENCE {
    rlf-Report-v9e0            RLF-Report-v9e0      OPTIONAL,
    nonCriticalExtension       SEQUENCE {}           OPTIONAL
}

-- Regular non critical extensions
UEInformationResponse-v930-IEs ::= SEQUENCE {
    lateNonCriticalExtension    OCTET STRING (CONTAINING UEInformationResponse-v9e0-IEs)
    OPTIONAL,
    nonCriticalExtension        UEInformationResponse-v1020-IEs    OPTIONAL
}

UEInformationResponse-v1020-IEs ::= SEQUENCE {
    logMeasReport-r10          LogMeasReport-r10    OPTIONAL,
    nonCriticalExtension       UEInformationResponse-v1130-IEs    OPTIONAL
}

UEInformationResponse-v1130-IEs ::= SEQUENCE {
    connEstFailReport-r11      ConnEstFailReport-r11    OPTIONAL,
    nonCriticalExtension       UEInformationResponse-v1250-IEs    OPTIONAL
}

UEInformationResponse-v1250-IEs ::= SEQUENCE {
    mobilityHistoryReport-r12   MobilityHistoryReport-r12    OPTIONAL,
    nonCriticalExtension       UEInformationResponse-v1530-IEs    OPTIONAL
}

UEInformationResponse-v1530-IEs ::= SEQUENCE {
    measResultListIdle-r15      MeasResultListIdle-r15    OPTIONAL,
    flightPathInfoReport-r15     FlightPathInfoReport-r15   OPTIONAL,
    nonCriticalExtension       UEInformationResponse-v1610-IEs    OPTIONAL
}

```

```

}
UEInformationResponse-v1610-IEs ::= SEQUENCE {
    rach-Report-v1610                RACH-Report-v1610                OPTIONAL,
    measResultListExtIdle-r16        MeasResultListExtIdle-r16        OPTIONAL,
    measResultListIdleNR-r16         MeasResultListIdleNR-r16         OPTIONAL,
    nonCriticalExtension              UEInformationResponse-v1710-IEs OPTIONAL
}

UEInformationResponse-v1710-IEs ::= SEQUENCE {
    coarseLocationInfo-r17           OCTET STRING                      OPTIONAL,
    nonCriticalExtension              UEInformationResponse-v1800-IEs OPTIONAL
}

UEInformationResponse-v1800-IEs ::= SEQUENCE {
    rach-ReportNR-r18                RACH-ReportNR-r18                OPTIONAL,
    nonCriticalExtension              SEQUENCE {}                      OPTIONAL
}

RACH-Report-r16 ::= SEQUENCE {
    numberOfPreamblesSent-r16        NumberOfPreamblesSent-r11,
    contentionDetected-r16           BOOLEAN
}

RACH-Report-v1610 ::= SEQUENCE {
    initialCEL-r16                   INTEGER (0..3),
    edt-Fallback-r16                 BOOLEAN
}

RACH-ReportNR-r18 ::= SEQUENCE {
    rach-ReportListNR-r18            OCTET STRING,
    cellIdListNR-r18                CellIdListNR-r18
}

CellIdListNR-r18 ::= SEQUENCE (SIZE (1..maxCellRAREportNR-r18)) OF CellIdNR-r18

CellIdNR-r18 ::= CHOICE {
    cellGlobalId-r18                 CellGlobalIdNR-r16,
    pci-arfcn-r18                    SEQUENCE {
        physCellId-r18               PhysCellIdNR-r15,
        carrierFreq-r18              ARFCN-ValueNR-r15
    }
}

RLF-Report-r9 ::= SEQUENCE {
    measResultLastServCell-r9        SEQUENCE {
        rsrpResult-r9                RSRP-Range,
        rsrqResult-r9                RSRQ-Range
    },
    measResultNeighCells-r9          SEQUENCE {
        measResultListEUTRA-r9       MeasResultList2EUTRA-r9        OPTIONAL,
        measResultListUTRA-r9        MeasResultList2UTRA-r9        OPTIONAL,
        measResultListGERAN-r9       MeasResultListGERAN           OPTIONAL,
        measResultsCDMA2000-r9       MeasResultList2CDMA2000-r9    OPTIONAL
    },
    ...,
    [[ locationInfo-r10              LocationInfo-r10                OPTIONAL,
        failedPCellId-r10             CHOICE {
            cellGlobalId-r10          CellGlobalIdEUTRA,
            pci-arfcn-r10             SEQUENCE {
                physCellId-r10        PhysCellId,
                carrierFreq-r10       ARFCN-ValueEUTRA
            }
        }
        ],
        reestablishmentCellId-r10     CellGlobalIdEUTRA              OPTIONAL,
        timeConnFailure-r10           INTEGER (0..1023)              OPTIONAL,
        connectionFailureType-r10     ENUMERATED {rlf, hof}         OPTIONAL,
        previousPCellId-r10           CellGlobalIdEUTRA              OPTIONAL
    ]],
    [[ failedPCellId-v1090            SEQUENCE {
        carrierFreq-v1090             ARFCN-ValueEUTRA-v9e0
    }
    ],
    ],
    [[ basicFields-r11               SEQUENCE {
        c-RNTI-r11                   C-RNTI,
        rlf-Cause-r11                ENUMERATED {
            t310-Expiry, randomAccessProblem,
            rlc-MaxNumRetx, t312-Expiry-r12},
    ]],

```



timeSinceFailure-r11	TimeSinceFailure-r11	OPTIONAL,
} previousUTRA-CellId-r11 carrierFreq-r11 physCellId-r11 fdd-r11 tdd-r11 }, cellGlobalId-r11	SEQUENCE { ARFCN-ValueUTRA, CHOICE { PhysCellIdUTRA-FDD, PhysCellIdUTRA-TDD }, CellGlobalIdUTRA	OPTIONAL, OPTIONAL,
} selectedUTRA-CellId-r11 carrierFreq-r11 physCellId-r11 fdd-r11 tdd-r11 }	SEQUENCE { ARFCN-ValueUTRA, CHOICE { PhysCellIdUTRA-FDD, PhysCellIdUTRA-TDD }	OPTIONAL
]], [[ failedPCellId-v1250 tac-FailedPCell-r12 } measResultLastServCell-v1250 lastServCellRSRQ-Type-r12 measResultListEUTRA-v1250	SEQUENCE { TrackingAreaCode RSRQ-Range-v1250 RSRQ-Type-r12 MeasResultList2EUTRA-v1250	OPTIONAL, OPTIONAL, OPTIONAL, OPTIONAL
]], [[ drb-EstablishedWithQCI-1-r13 ]], [[ measResultLastServCell-v1360 ]],	ENUMERATED {qcil} RSRP-Range-v1360	OPTIONAL OPTIONAL
[[ logMeasResultListBT-r15 logMeasResultListWLAN-r15 ]], [[ measResultListNR-r16 previousNR-PCellId-r16 failedNR-PCellId-r16 cellGlobalId pci-arfcn physCellId-r16 carrierFreq-r16 } reconnectCellId-r16 nrReconnectCellId eutraReconnectCellId cellGlobalId-r16 trackingAreaCode-EPC-r16 trackingAreaCode-5GC-r16 }	LogMeasResultListBT-r15 LogMeasResultListWLAN-r15 MeasResultCellListNR-r15 CellGlobalIdNR-r16 CHOICE { CellGlobalIdNR-r16, SEQUENCE { PhysCellIdNR-r15, ARFCN-ValueNR-r15 }, CHOICE { CellGlobalIdNR-r16, SEQUENCE { CellGlobalIdEUTRA, TrackingAreaCode TrackingAreaCode-5GC-r15	OPTIONAL, OPTIONAL, OPTIONAL, OPTIONAL, OPTIONAL, OPTIONAL, OPTIONAL, OPTIONAL, OPTIONAL
timeUntilReconnection-r16 ]], [[ measResultListNR-v1640 carrierFreqNR-r16 } measResultListExtNR-r16 ]], [[ voiceFallbackHO-r18 ]]	TimeUntilReconnection-r16 SEQUENCE { ARFCN-ValueNR-r15 MeasResultFreqListNR-r16 ENUMERATED {true}	OPTIONAL, OPTIONAL OPTIONAL, OPTIONAL OPTIONAL
} RLF-Report-v9e0 ::=	SEQUENCE { measResultListEUTRA-v9e0 MeasResultList2EUTRA-v9e0	
}		
MeasResultList2EUTRA-r9 ::=	SEQUENCE (SIZE (1..maxFreq)) OF MeasResult2EUTRA-r9	
MeasResultList2EUTRA-v9e0 ::=	SEQUENCE (SIZE (1..maxFreq)) OF MeasResult2EUTRA-v9e0	
MeasResultList2EUTRA-v1250 ::=	SEQUENCE (SIZE (1..maxFreq)) OF MeasResult2EUTRA-v1250	
MeasResult2EUTRA-r9 ::=	SEQUENCE { carrierFreq-r9 measResultList-r9 ARFCN-ValueEUTRA, MeasResultListEUTRA	
}		
MeasResult2EUTRA-v9e0 ::=	SEQUENCE { carrierFreq-v9e0 ARFCN-ValueEUTRA-v9e0	OPTIONAL

```

}
MeasResult2EUTRA-v1250 ::= SEQUENCE {
    rsrq-Type-r12          RSRQ-Type-r12          OPTIONAL
}
MeasResultList2UTRA-r9 ::= SEQUENCE (SIZE (1..maxFreq)) OF MeasResult2UTRA-r9
MeasResult2UTRA-r9 ::= SEQUENCE {
    carrierFreq-r9        ARFCN-ValueUTRA,
    measResultList-r9     MeasResultListUTRA
}
MeasResultList2CDMA2000-r9 ::= SEQUENCE (SIZE (1..maxFreq)) OF MeasResult2CDMA2000-r9
MeasResult2CDMA2000-r9 ::= SEQUENCE {
    carrierFreq-r9        CarrierFreqCDMA2000,
    measResultList-r9     MeasResultsCDMA2000
}
LogMeasReport-r10 ::= SEQUENCE {
    absoluteTimeStamp-r10 AbsoluteTimeInfo-r10,
    traceReference-r10    TraceReference-r10,
    traceRecordingSessionRef-r10 OCTET STRING (SIZE (2)),
    tce-Id-r10            OCTET STRING (SIZE (1)),
    logMeasInfoList-r10  LogMeasInfoList-r10,
    logMeasAvailable-r10 ENUMERATED {true}          OPTIONAL,
    ...,
    [[ logMeasAvailableBT-r15    ENUMERATED {true}          OPTIONAL,
       logMeasAvailableWLAN-r15 ENUMERATED {true}          OPTIONAL
    ]]
}
LogMeasInfoList-r10 ::= SEQUENCE (SIZE (1..maxLogMeasReport-r10)) OF LogMeasInfo-r10
LogMeasInfo-r10 ::= SEQUENCE {
    locationInfo-r10      LocationInfo-r10          OPTIONAL,
    relativeTimeStamp-r10 INTEGER (0..7200),
    servCellIdentity-r10  CellGlobalIdEUTRA,
    measResultServCell-r10 SEQUENCE {
        rsrpResult-r10    RSRP-Range,
        rsrqResult-r10    RSRQ-Range
    },
    measResultNeighCells-r10 SEQUENCE {
        measResultListEUTRA-r10 MeasResultList2EUTRA-r9  OPTIONAL,
        measResultListUTRA-r10  MeasResultList2UTRA-r9    OPTIONAL,
        measResultListGERAN-r10 MeasResultList2GERAN-r10  OPTIONAL,
        measResultListCDMA2000-r10 MeasResultList2CDMA2000-r9  OPTIONAL
    } OPTIONAL,
    ...,
    [[ measResultListEUTRA-v1090 MeasResultList2EUTRA-v9e0  OPTIONAL
    ]],
    [[ measResultListMBSFN-r12    MeasResultListMBSFN-r12  OPTIONAL,
       measResultServCell-v1250   RSRQ-Range-v1250     OPTIONAL,
       servCellRSRQ-Type-r12      RSRQ-Type-r12       OPTIONAL,
       measResultListEUTRA-v1250  MeasResultList2EUTRA-v1250  OPTIONAL
    ]],
    [[ inDeviceCoexDetected-r13   ENUMERATED {true}          OPTIONAL
    ]],
    [[ measResultServCell-v1360    RSRP-Range-v1360     OPTIONAL
    ]],
    [[ logMeasResultListBT-r15     LogMeasResultListBT-r15  OPTIONAL,
       logMeasResultListWLAN-r15  LogMeasResultListWLAN-r15  OPTIONAL
    ]],
    [[ anyCellSelectionDetected-r15 ENUMERATED {true}          OPTIONAL
    ]],
    [[ measResultListNR-r16        MeasResultCellListNR-r15  OPTIONAL
    ]],
    [[ measResultListNR-v1640      SEQUENCE {
        carrierFreqNR-r16        ARFCN-ValueNR-r15
    } OPTIONAL,
       measResultListExtNR-r16    MeasResultFreqListNR-r16  OPTIONAL
    ]],
    [[ uncomBarPreMeasResult-r17   OCTET STRING          OPTIONAL
    ]]
}
MeasResultListMBSFN-r12 ::= SEQUENCE (SIZE (1..maxMBSFN-Area)) OF MeasResultMBSFN-r12

```

```

MeasResultMBSFN-r12 ::= SEQUENCE {
    mbsfn-Area-r12 SEQUENCE {
        mbsfn-AreaId-r12 MBSFN-AreaId-r12,
        carrierFreq-r12 ARFCN-ValueEUTRA-r9
    },
    rsrpResultMBSFN-r12 RSRP-Range,
    rsrqResultMBSFN-r12 MBSFN-RSRQ-Range-r12,
    signallingBLER-Result-r12 BLER-Result-r12 OPTIONAL,
    dataBLER-MCH-ResultList-r12 DataBLER-MCH-ResultList-r12 OPTIONAL,
    ...
}

DataBLER-MCH-ResultList-r12 ::= SEQUENCE (SIZE (1..maxPMCH-PerMBSFN)) OF DataBLER-MCH-Result-
r12

DataBLER-MCH-Result-r12 ::= SEQUENCE {
    mch-Index-r12 INTEGER (1..maxPMCH-PerMBSFN),
    dataBLER-Result-r12 BLER-Result-r12
}

BLER-Result-r12 ::= SEQUENCE {
    bler-r12 BLER-Range-r12,
    blocksReceived-r12 SEQUENCE {
        n-r12 BIT STRING (SIZE (3)),
        m-r12 BIT STRING (SIZE (8))
    }
}

BLER-Range-r12 ::= INTEGER(0..31)

MeasResultList2GERAN-r10 ::= SEQUENCE (SIZE (1..maxCellListGERAN)) OF MeasResultListGERAN

MeasResultFreqListNR-r16 ::= SEQUENCE (SIZE (1..maxFreq-1-r16)) OF MeasResultFreqFailNR-r15

ConnEstFailReport-r11 ::= SEQUENCE {
    failedCellId-r11 CellGlobalIdEUTRA,
    locationInfo-r11 LocationInfo-r10 OPTIONAL,
    measResultFailedCell-r11 SEQUENCE {
        rsrpResult-r11 RSRP-Range,
        rsrqResult-r11 RSRQ-Range OPTIONAL
    },
    measResultNeighCells-r11 SEQUENCE {
        measResultListEUTRA-r11 MeasResultList2EUTRA-r9 OPTIONAL,
        measResultListUTRA-r11 MeasResultList2UTRA-r9 OPTIONAL,
        measResultListGERAN-r11 MeasResultListGERAN OPTIONAL,
        measResultsCDMA2000-r11 MeasResultList2CDMA2000-r9 OPTIONAL
    } OPTIONAL,
    numberOfPreamblesSent-r11 NumberOfPreamblesSent-r11,
    contentionDetected-r11 BOOLEAN,
    maxTxPowerReached-r11 BOOLEAN,
    timeSinceFailure-r11 TimeSinceFailure-r11,
    measResultListEUTRA-v1130 MeasResultList2EUTRA-v9e0 OPTIONAL,
    ...
    [[ measResultFailedCell-v1250 RSRQ-Range-v1250 OPTIONAL,
        failedCellRSRQ-Type-r12 RSRQ-Type-r12 OPTIONAL,
        measResultListEUTRA-v1250 MeasResultList2EUTRA-v1250 OPTIONAL
    ]],
    [[ measResultFailedCell-v1360 RSRP-Range-v1360 OPTIONAL
    ]],
    [[ logMeasResultListBT-r15 LogMeasResultListBT-r15 OPTIONAL,
        logMeasResultListWLAN-r15 LogMeasResultListWLAN-r15 OPTIONAL
    ]],
    [[ measResultListNR-r16 MeasResultCellListNR-r15 OPTIONAL
    ]],
    [[ measResultListNR-v1640 SEQUENCE {
        carrierFreqNR-r16 ARFCN-ValueNR-r15
    } OPTIONAL,
        measResultListExtNR-r16 MeasResultFreqListNR-r16 OPTIONAL
    ]],
}

NumberOfPreamblesSent-r11 ::= INTEGER (1..200)

TimeSinceFailure-r11 ::= INTEGER (0..172800)

TimeUntilReconnection-r16 ::= INTEGER (0..172800)

```

```
MobilityHistoryReport-r12 ::= VisitedCellInfoList-r12

FlightPathInfoReport-r15 ::= SEQUENCE {
    flightPath-r15 SEQUENCE (SIZE (1..maxWayPoint-r15)) OF WayPointLocation-r15 OPTIONAL,
    dummy SEQUENCE {} OPTIONAL
}

WayPointLocation-r15 ::= SEQUENCE {
    wayPointLocation-r15 LocationInfo-r10,
    timeStamp-r15 AbsoluteTimeInfo-r10 OPTIONAL
}

-- ASN1STOP
```

<b>UEInformationResponse field descriptions</b>
<p><b>absoluteTimeStamp</b> Indicates the absolute time when the logged measurement configuration logging is provided, as indicated by E-UTRAN within <i>absoluteTimeInfo</i>.</p>
<p><b>anyCellSelectionDetected</b> This field is used to indicate the detection of <i>any cell selection</i> state, as defined in TS 36.304 [4]. The UE sets this field when performing the logging of measurement results in RRC_IDLE and there is no suitable cell or no acceptable cell.</p>
<p><b>bler</b> Indicates the measured BLER value. The coding of BLER value is defined in TS 36.133 [16].</p>
<p><b>blocksReceived</b> Indicates total number of MCH blocks, which were received by the UE and used for the corresponding BLER calculation, within the measurement period as defined in TS 36.133 [16].</p>
<p><b>carrierFreq</b> In case the UE includes <i>carrierFreq-v9e0</i> and/ or <i>carrierFreq-v1090</i>, the UE shall set the corresponding entry of <i>carrierFreq-r9</i> and/ or <i>carrierFreq-r10</i> respectively to <i>maxEARFCN</i>. For E-UTRA and UTRA frequencies, the UE sets the ARFCN according to the band used when obtaining the concerned measurement results.</p>
<p><b>carrierFreqNR</b> In case the UE includes <i>measResultListNR</i>, the UE uses this field to indicate the ARFCN value according to the band used when obtaining the concerned measurement results</p>
<p><b>cellIdListNR</b> This field is used to indicate the unique NR cell identities of the RA procedure information stored in <i>RA-ReportList</i> IE, which is specified in TS 38.331 [82].</p>
<p><b>connectionFailureType</b> This field is used to indicate whether the connection failure is due to radio link failure or handover failure.</p>
<p><b>contentionDetected</b> This field is used to indicate that contention was detected for at least one of the transmitted preambles, see TS 36.321 [6].</p>
<p><b>coarseLocationInfo</b> This field indicates the coarse location information reported by the UE. This field is coded as the <i>Ellipsoid-Point</i> IE defined in TS 37.355 [109]. The first/leftmost bit of the first octet contains the most significant bit. The least significant bits of <i>degreesLatitude</i> and <i>degreesLongitude</i> are set to 0 to meet the accuracy requirement which corresponds to a granularity of approximately 2 km. It is up to UE implementation as to how many LSBs are set to 0 to meet the accuracy requirement.</p>
<p><b>c-RNTI</b> This field indicates the C-RNTI used in the PCell upon detecting radio link failure or the C-RNTI used in the source PCell upon handover failure.</p>
<p><b>dataBLER-MCH-ResultList</b> Includes a BLER result per MCH on subframes using <i>dataMCS</i>, with the applicable MCH(s) listed in the same order as in <i>pmch-InfoList</i> within <i>MBSFNAreaConfiguration</i>.</p>
<p><b>drb-EstablishedWithQCI-1</b> This field is used to indicate the radio link failure occurred while a bearer with QCI value equal to 1 was configured, see TS 24.301 [35].</p>
<p><b>dummy</b> This field is not used in the specification. It shall not be sent by the UE.</p>
<p><b>edt-Fallback</b> Value TRUE indicates the last successfully completed random access procedure was initiated with EDT PRACH resource and succeeded after receiving EDT fallback indication from lower layers.</p>
<p><b>failedCellId</b> This field is used to indicate the cell in which connection establishment failed.</p>
<p><b>failedPCellId</b> This field is used to indicate the PCell in which RLF is detected or the target PCell of the failed handover. The UE sets the EARFCN according to the band used for transmission/ reception when the failure occurred.</p>
<p><b>inDeviceCoexDetected</b> Indicates that measurement logging is suspended due to IDC problem detection.</p>
<p><b>initialCEL</b> Indicates the initial CE level used for the last successfully completed random access procedure for BL UEs and UEs in CE.</p>
<p><b>logMeasResultListBT</b> This field refers to the Bluetooth measurement results.</p>
<p><b>logMeasResultListWLAN</b> This field refers to the WLAN measurement results.</p>
<p><b>maxTxPowerReached</b> This field is used to indicate whether or not the maximum power level was used for the last transmitted preamble, see TS 36.321 [6].</p>
<p><b>mch-Index</b> Indicates the MCH by referring to the entry as listed in <i>pmch-InfoList</i> within <i>MBSFNAreaConfiguration</i>.</p>

<b>UEInformationResponse field descriptions</b>
<p><b>measResultFailedCell</b> This field refers to the last measurement results taken in the cell, where connection establishment failure happened. For UE supporting CE Mode B, when CE mode B is not restricted by upper layers, <i>measResultFailedCell-v1360</i> is reported if the measured RSRP is less than -140 dBm.</p>
<p><b>measResultLastServCell</b> This field refers to the last measurement results taken in the PCell, where radio link failure or handover failure happened. For BL UEs or UEs in CE, when operating in CE Mode B, <i>measResultLastServCell-v1360</i> is reported if the measured RSRP is less than -140 dBm.</p>
<p><b>measResultListEUTRA</b> If <i>measResultListEUTRA-v9e0</i>, <i>measResultListEUTRA-v1090</i> or <i>measResultListEUTRA-v1130</i> is included, the UE shall include the same number of entries, and listed in the same order, as in <i>measResultListEUTRA-r9</i>, <i>measResultListEUTRA-r10</i> and/ or <i>measResultListEUTRA-r11</i> respectively.</p>
<p><b>measResultListEUTRA-v1250</b> If included in <i>RLF-Report-r9</i> the UE shall include the same number of entries, and listed in the same order, as in <i>measResultListEUTRA-r9</i>. If included in <i>LogMeasInfo-r10</i> the UE shall include the same number of entries, and listed in the same order, as in <i>measResultListEUTRA-r10</i>. If included in <i>ConnEstFailReport-r11</i> the UE shall include the same number of entries, and listed in the same order, as in <i>measResultListEUTRA-r11</i>.</p>
<p><b>measResultListIdle</b> This field indicates the E-UTRA measurement results done during RRC_IDLE and RRC_INACTIVE at network request.</p>
<p><b>measResultListIdleNR</b> This field indicates the NR measurement results done during RRC_IDLE and RRC_INACTIVE at network request.</p>
<p><b>measResultListNR, measResultListExtNR</b> Includes NR measurement results, with <i>measResultListNR</i> including results of a first NR frequency and <i>measResultListExtNR</i> including results of additional NR frequencies, if available.</p>
<p><b>measResultServCell</b> This field refers to the log measurement results taken in the Serving cell. For UE supporting CE Mode B, when CE mode B is not restricted by upper layers, <i>measResultServCell-v1360</i> is reported if the measured RSRP is less than -140 dBm.</p>
<p><b>mobilityHistoryReport</b> This field is used to indicate the time of stay in 16 most recently visited E-UTRA cells or of stay out of E-UTRA.</p>
<p><b>numberOfPreamblesSent</b> This field is used to indicate the number of RACH preambles that were transmitted. Corresponds to parameter PREAMBLE_TRANSMISSION_COUNTER in TS 36.321 [6].</p>
<p><b>previousPCellId</b> This field is used to indicate the source PCell of the last handover (source PCell when the last <i>RRCConnectionReconfiguration</i> message including <i>mobilityControlInfo</i> was received).</p>
<p><b>previousUTRA-CellId</b> This field is used to indicate the source UTRA cell of the last successful handover to E-UTRAN, when RLF occurred at the target PCell. The UE sets the ARFCN according to the band used for transmission/ reception on the concerned cell.</p>
<p><b>rach-ReportListNR</b> This field is used to indicate the list of NR RACH report information, including the <i>NR RA-ReportList</i> IE, which is specified in TS 38.331 [82].</p>
<p><b>reconnectCellId</b> This field is used to indicate the cell in which the UE comes back to connected after connection failure and after failing to perform reestablishment. This field is absent if the selected cell after <i>MobilityFromNRCommand</i> execution failure is an acceptable cell. If the UE comes back to RRC CONNECTED in an NR cell then <i>nrReconnectCellID</i> is included and if the UE comes back to RRC CONNECTED in an LTE cell then <i>utraReconnectCellID</i> is included.</p>
<p><b>reestablishmentCellId</b> This field is used to indicate the cell in which the re-establishment attempt was made after connection failure.</p>
<p><b>relativeTimeStamp</b> Indicates the time of logging measurement results, measured relative to the <i>absoluteTimeStamp</i>. Value in seconds.</p>
<p><b>rlf-Cause</b> This field is used to indicate the cause of the last radio link failure that was detected. In case of handover failure information reporting (i.e., the <i>connectionFailureType</i> is set to 'hof'), the UE is allowed to set this field to any value.</p>
<p><b>selectedUTRA-CellId</b> This field is used to indicate the UTRA cell that the UE selects after RLF is detected, while T311 is running. The UE sets the ARFCN according to the band selected for transmission/ reception on the concerned cell.</p>
<p><b>signallingBLER-Result</b> Includes a BLER result of MBSFN subframes using <i>signallingMCS</i>.</p>
<p><b>tac-FailedPCell</b> This field is used to indicate the Tracking Area Code of the PCell in which RLF is detected.</p>

<b>UEInformationResponse field descriptions</b>
<b>tce-Id</b> Parameter Trace Collection Entity Id: See TS 32.422 [58].
<b>timeConnFailure</b> This field is used to indicate the time elapsed since the last HO initialization until connection failure. Actual value = field value * 100ms. The maximum value 1023 means 102.3s or longer.
<b>timeSinceFailure</b> This field is used to indicate the time that elapsed since the connection (establishment) failure. Value in seconds. The maximum value 172800 means 172800s or longer.
<b>timeStamp</b> Includes time stamps for the waypoints that describe planned locations for the UE.
<b>timeUntilReconnection</b> This field is used to indicate the time that elapsed between the connection (radio link or handover) failure and the next time the UE comes to RRC CONNECTED in an NR or EUTRA cell, after failing to perform reestablishment or after cell selection to an acceptable cell after <i>MobilityFromNRCommand</i> execution failure including fallback indication. Value in seconds. The maximum value 172800 means 172800s or longer.
<b>traceRecordingSessionRef</b> Parameter Trace Recording Session Reference: See TS 32.422 [58].
<b>uncomBarPreMeasResult</b> This field provides barometric pressure measurements as <i>Sensor-MeasurementInformation</i> defined in TS 37.355 [109]. The first/leftmost bit of the first octet contains the most significant bit.
<b>voiceFallbackHO</b> This field is set if the radio link failure occurred after a successful mobility from NR, and the <i>voiceFallbackIndication</i> was included in the <i>MobilityFromNRCommand</i> message in TS 38.331 [82].
<b>wayPointLocation</b> Includes location coordinates for a UE for Aerial UE operation. The waypoints describe planned locations for the UE.

### – *ULHandoverPreparationTransfer (CDMA2000)*

The *ULHandoverPreparationTransfer* message is used for the uplink transfer of handover related CDMA2000 information when requested by the higher layers.

Signalling radio bearer: SRB1

RLC-SAP: AM

Logical channel: DCCH

Direction: UE to E-UTRAN

### ***ULHandoverPreparationTransfer message***

```

-- ASN1START
ULHandoverPreparationTransfer ::= SEQUENCE {
    criticalExtensions          CHOICE {
        c1                     CHOICE {
            ulHandoverPreparationTransfer-r8          ULHandoverPreparationTransfer-r8-IEs,
            spare3 NULL, spare2 NULL, spare1 NULL
        },
        criticalExtensionsFuture          SEQUENCE {}
    }
}

ULHandoverPreparationTransfer-r8-IEs ::= SEQUENCE {
    cdma2000-Type          CDMA2000-Type,
    meid                   BIT STRING (SIZE (56))          OPTIONAL,
    dedicatedInfo          DedicatedInfoCDMA2000,
    nonCriticalExtension    ULHandoverPreparationTransfer-v8a0-IEs  OPTIONAL
}

ULHandoverPreparationTransfer-v8a0-IEs ::= SEQUENCE {
    lateNonCriticalExtension    OCTET STRING          OPTIONAL,
    nonCriticalExtension        SEQUENCE {}          OPTIONAL
}
-- ASN1STOP

```

**ULHandoverPreparationTransfer field descriptions****meid**

The 56 bit mobile identification number provided by the CDMA2000 Upper layers.

**ULInformationTransfer**

The *ULInformationTransfer* message is used for the uplink transfer of NAS, non-3GPP dedicated information, or IAB-DU specific F1-C related information.

Signalling radio bearer: SRB2 or SRB1 (only if SRB2 not established yet). If SRB2 is suspended, the UE does not send this message until SRB2 is resumed. If only *dedicatedInfoF1c* is included, SRB2 is used.

RLC-SAP: AM

Logical channel: DCCH

Direction: UE to E-UTRAN

**ULInformationTransfer message**

```
-- ASN1START
ULInformationTransfer ::= SEQUENCE {
    criticalExtensions      CHOICE {
        c1                  CHOICE {
            ulInformationTransfer-r8      ULInformationTransfer-r8-IEs,
            ulInformationTransfer-r16     ULInformationTransfer-r16-IEs,
            spare2 NULL, spare1 NULL
        },
        criticalExtensionsFuture          SEQUENCE {}
    }
}

ULInformationTransfer-r8-IEs ::= SEQUENCE {
    dedicatedInfoType      CHOICE {
        dedicatedInfoNAS      DedicatedInfoNAS,
        dedicatedInfoCDMA2000-1XRTT      DedicatedInfoCDMA2000,
        dedicatedInfoCDMA2000-HRPD      DedicatedInfoCDMA2000
    },
    nonCriticalExtension      ULInformationTransfer-v8a0-IEs      OPTIONAL
}

ULInformationTransfer-v8a0-IEs ::= SEQUENCE {
    lateNonCriticalExtension      OCTET STRING      OPTIONAL,
    nonCriticalExtension          SEQUENCE {}      OPTIONAL
}

ULInformationTransfer-r16-IEs ::= SEQUENCE {
    dedicatedInfoType-r16      CHOICE {
        dedicatedInfoNAS-r16      DedicatedInfoNAS,
        dedicatedInfoCDMA2000-1XRTT-r16      DedicatedInfoCDMA2000,
        dedicatedInfoCDMA2000-HRPD-r16      DedicatedInfoCDMA2000
    },
    dedicatedInfoF1c-r16      DedicatedInfoF1c-r16      OPTIONAL,
    nonCriticalExtension      ULInformationTransfer-v8a0-IEs      OPTIONAL
}
-- ASN1STOP
```

**ULInformationTransferIRAT**

The *ULInformationTransferIRAT* message is used for the uplink transfer of information terminated by E-UTRAN but specified by another RAT. In this release of the specification, the message is used for sidelink information specified by TS 38.331.

Signalling radio bearer: SRB1

RLC-SAP: AM



Logical channel: DCCH

Direction: UE to E-UTRAN

### ***ULInformationTransferIRAT*** message

```
-- ASN1START
ULInformationTransferIRAT-r16 ::= SEQUENCE {
    criticalExtensions          CHOICE {
        c1                     CHOICE {
            ulInformationTransferIRAT-r16          ULInformationTransferIRAT-r16-IEs,
            spare3 NULL, spare2 NULL, spare1 NULL
        },
        criticalExtensionsFuture          SEQUENCE {}
    }
}
ULInformationTransferIRAT-r16-IEs ::= SEQUENCE {
    ul-DCCH-MessageNR-r16          OCTET STRING          OPTIONAL,
    lateNonCriticalExtension          OCTET STRING          OPTIONAL,
    nonCriticalExtension          SEQUENCE {}          OPTIONAL
}
-- ASN1STOP
```

### ***ULInformationTransferIRAT*** field descriptions

#### ***ul-DCCH-MessageNR***

Includes the *UL-DCCH-Message* as defined in TS 38.331 [82]. In this version of the specification, the field is only used to transfer the NR RRC *MeasurementReport*, NR RRC *SidelinkUEInformationNR* and the NR RRC *UEAssistanceInformation* messages.

This field is not applicable to 5GS Proximity based Services (ProSe) as defined in TS 23.304 [112] in this release.

### ***ULInformationTransferMRDC***

The *ULInformationTransferMRDC* message is used for the uplink transfer of MR DC information (i.e. for the case the SCG employs another RAT e.g. for transferring the NR RRC Measurement Report message).

Signalling radio bearer: SRB1

RLC-SAP: AM

Logical channel: DCCH

Direction: UE to E-UTRAN

### ***ULInformationTransferMRDC*** message

```
-- ASN1START
ULInformationTransferMRDC-r15 ::= SEQUENCE {
    criticalExtensions          CHOICE {
        c1                     CHOICE {
            ulInformationTransferMRDC-r15          ULInformationTransferMRDC-r15-IEs,
            spare3 NULL, spare2 NULL, spare1 NULL
        },
        criticalExtensionsFuture          SEQUENCE {}
    }
}
ULInformationTransferMRDC-r15-IEs ::= SEQUENCE {
    ul-DCCH-MessageNR-r15          OCTET STRING          OPTIONAL,
    lateNonCriticalExtension          OCTET STRING          OPTIONAL,
    nonCriticalExtension          SEQUENCE {}          OPTIONAL
}
-- ASN1STOP
```

**ULInformationTransferMRDC field descriptions****ul-DCCH-MessageNR**

Includes the *ul-DCCH-Message* as defined in TS 38.331 [82]. In this version of the specification, the field is only used to transfer the NR RRC *MeasurementReport*, NR RRC *UEAssistanceInformation*, NR RRC *IABOtherInformation*, NR RRC *FailureInformation*, and the NR RRC *RRCReconfigurationComplete* messages.

**WLANConnectionStatusReport**

The *WLANConnectionStatusReport* message is used to inform the successful connection to WLAN or failure of the WLAN connection or connection attempt(s).

Signalling radio bearer: SRB1

RLC-SAP: AM

Logical channel: DCCH

Direction: UE to E-UTRAN

**WLANConnectionStatusReport message**

```
-- ASN1START
WLANConnectionStatusReport-r13 ::= SEQUENCE {
    criticalExtensions          CHOICE {
        c1                     CHOICE {
            wlanConnectionStatusReport-r13          WLANConnectionStatusReport-r13-IEs,
            spare3 NULL, spare2 NULL, spare1 NULL
        },
        criticalExtensionsFuture          SEQUENCE {}
    }
}

WLANConnectionStatusReport-r13-IEs ::= SEQUENCE {
    wlan-Status-r13              WLAN-Status-r13,
    lateNonCriticalExtension      OCTET STRING          OPTIONAL,
    nonCriticalExtension          WLANConnectionStatusReport-v1430-IEs  OPTIONAL
}

WLANConnectionStatusReport-v1430-IEs ::= SEQUENCE {
    wlan-Status-v1430            WLAN-Status-v1430,
    nonCriticalExtension          SEQUENCE {}          OPTIONAL
}
-- ASN1STOP
```

**WLANConnectionStatusReport field descriptions****wlan-Status**

Indicates the connection status to WLAN and the cause of failures. If the *wlan-Status-v1430* is included, E-UTRAN ignores the *wlan-Status-r13*.

## 6.3 RRC information elements

### 6.3.0 Parameterized types

**SetupRelease**

*SetupRelease* allows the *ElementTypeParam* to be used as the referenced data type for the setup and release entries. See A.3.8 for guidelines.

```
-- ASN1START
SetupRelease { ElementTypeParam } ::= CHOICE {
    release          NULL,
```

```

    setup          ElementTypeParam
  }
-- ASN1STOP

```

### 6.3.1 System information blocks

#### – *SystemInformationBlockPos*

The IE *SystemInformationBlockPos* contains positioning assistance data as defined in TS 36.355 [54].

#### **SystemInformationBlockPos information element**

```

-- ASN1START
SystemInformationBlockPos-r15 ::= SEQUENCE {
  assistanceDataSIB-Element-r15      OCTET STRING,
  lateNonCriticalExtension            OCTET STRING                      OPTIONAL,
  ...
}
-- ASN1STOP

```

#### **SystemInformationBlockPos field descriptions**

##### **assistanceDataSIB-Element**

Parameter *AssistanceDataSIBElement* defined in TS 36.355 [54]. The first/leftmost bit of the first octet contains the most significant bit.

#### – *SystemInformationBlockType2*

The IE *SystemInformationBlockType2* contains radio resource configuration information that is common for all UEs.

NOTE: UE timers and constants related to functionality for which parameters are provided in another SIB are included in the corresponding SIB.

#### **SystemInformationBlockType2 information element**

```

-- ASN1START
SystemInformationBlockType2 ::= SEQUENCE {
  ac-BarringInfo                SEQUENCE {
    ac-BarringForEmergency      BOOLEAN,
    ac-BarringForMO-Signalling  AC-BarringConfig          OPTIONAL, -- Need OP
    ac-BarringForMO-Data       AC-BarringConfig          OPTIONAL, -- Need OP
  }
  radioResourceConfigCommon     RadioResourceConfigCommonSIB,
  ue-TimersAndConstants         UE-TimersAndConstants,
  freqInfo                      SEQUENCE {
    ul-CarrierFreq              ARFCN-ValueEUTRA          OPTIONAL, -- Need OP
    ul-Bandwidth                ENUMERATED {n6, n15, n25, n50, n75, n100}
                                OPTIONAL, -- Need OP
  }
  additionalSpectrumEmission    AdditionalSpectrumEmission
},
mbsfn-SubframeConfigList       MBSFN-SubframeConfigList  OPTIONAL, -- Need OR
timeAlignmentTimerCommon       TimeAlignmentTimer,
...,
lateNonCriticalExtension        OCTET STRING (CONTAINING SystemInformationBlockType2-v8h0-IEs)
                                OPTIONAL,
[[ ssac-BarringForMMTEL-Voice-r9 AC-BarringConfig          OPTIONAL, -- Need OP
  ssac-BarringForMMTEL-Video-r9 AC-BarringConfig          OPTIONAL, -- Need OP
]],
[[ ac-BarringForCSFB-r10         AC-BarringConfig          OPTIONAL, -- Need OP
]],
[[ ac-BarringSkipForMMTELVoice-r12 ENUMERATED {true}        OPTIONAL, -- Need OP
  ac-BarringSkipForMMTELVideo-r12 ENUMERATED {true}        OPTIONAL, -- Need OP
  ac-BarringSkipForSMS-r12       ENUMERATED {true}        OPTIONAL, -- Need OP
  ac-BarringPerPLMN-List-r12     AC-BarringPerPLMN-List-r12 OPTIONAL, -- Need OP
]],

```

```

[[ voiceServiceCauseIndication-r12      ENUMERATED {true}                OPTIONAL  -- Need OP
]],
[[ acdc-BarringForCommon-r13             ACDC-BarringForCommon-r13       OPTIONAL, -- Need OP
   acdc-BarringPerPLMN-List-r13         ACDC-BarringPerPLMN-List-r13    OPTIONAL  -- Need OP
]],
[[
   udt-RestrictingForCommon-r13         UDT-Restricting-r13             OPTIONAL, -- Need OR
   udt-RestrictingPerPLMN-List-r13     UDT-RestrictingPerPLMN-List-r13 OPTIONAL, -- Need OR
   cIoT-EPS-OptimisationInfo-r13      CIOT-EPS-OptimisationInfo-r13  OPTIONAL, -- Need OP
   useFullResumeID-r13                 ENUMERATED {true}              OPTIONAL  -- Need OP
]],
[[ unicastFreqHoppingInd-r13            ENUMERATED {true}              OPTIONAL  -- Need OP
]],
[[ mbsfn-SubframeConfigList-v1430       MBSFN-SubframeConfigList-v1430  OPTIONAL, -- Need OP
   videoServiceCauseIndication-r14     ENUMERATED {true}              OPTIONAL  -- Need OP
]],
[[ plmn-InfoList-r15                    PLMN-InfoList-r15              OPTIONAL  -- Need OP
]],
[[ cp-EDT-r15                            ENUMERATED {true}              OPTIONAL, -- Need OR
   up-EDT-r15                            ENUMERATED {true}              OPTIONAL, -- Need OR
   idleModeMeasurements-r15             ENUMERATED {true}              OPTIONAL, -- Need OR
   reducedCP-LatencyEnabled-r15         ENUMERATED {true}              OPTIONAL  -- Need OR
]],
[[ mbms-ROM-ServiceIndication-r15       ENUMERATED {true}              OPTIONAL  -- Need OR
]],
[[ rlos-Enabled-r16                      ENUMERATED {true}              OPTIONAL, -- Need OR
   earlySecurityReactivation-r16        ENUMERATED {true}              OPTIONAL, -- Need OR
   cp-EDT-5GC-r16                       ENUMERATED {true}              OPTIONAL, -- Need OR
   up-EDT-5GC-r16                       ENUMERATED {true}              OPTIONAL, -- Need OR
   cp-PUR-EPC-r16                       ENUMERATED {true}              OPTIONAL, -- Need OR
   up-PUR-EPC-r16                       ENUMERATED {true}              OPTIONAL, -- Need OR
   cp-PUR-5GC-r16                       ENUMERATED {true}              OPTIONAL, -- Need OR
   up-PUR-5GC-r16                       ENUMERATED {true}              OPTIONAL, -- Need OR
   mpdcch-CQI-Reporting-r16             ENUMERATED {fourBits, both}    OPTIONAL, -- Need OR
   rai-ActivationEnh-r16                 ENUMERATED {true}              OPTIONAL, -- Need OR
   idleModeMeasurementsNR-r16           ENUMERATED {true}              OPTIONAL  -- Need OR
]],
[[ gnss-PositionFixDurationReporting-r18 ENUMERATED {true}              OPTIONAL, -- Need OR
   freqBandIndicatorAerial-r18          FreqBandIndicator-r11          OPTIONAL, -- Need OR
   freqInfoAerial-r18                   AdditionalSpectrumEmission-r18  OPTIONAL, -- Need OR
   multiBandInfoListAerial-r18          SEQUENCE (SIZE (1..maxMultiBands)) OF
   AdditionalSpectrumEmission-r18      OPTIONAL  -- Need OR
]]
}

SystemInformationBlockType2-v8h0-IEs ::= SEQUENCE {
  multiBandInfoList          SEQUENCE (SIZE (1..maxMultiBands)) OF AdditionalSpectrumEmission
  OPTIONAL, -- Need OR
  nonCriticalExtension        SystemInformationBlockType2-v9e0-IEs  OPTIONAL
}

SystemInformationBlockType2-v9e0-IEs ::= SEQUENCE {
  ul-CarrierFreq-v9e0        ARFCN-ValueEUTRA-v9e0      OPTIONAL, -- Cond ul-FreqMax
  nonCriticalExtension        SystemInformationBlockType2-v9i0-IEs
  OPTIONAL
}

SystemInformationBlockType2-v9i0-IEs ::= SEQUENCE {
  -- Following field is for any non-critical extensions from REL-9
  nonCriticalExtension        OCTET STRING (CONTAINING SystemInformationBlockType2-v10m0-IEs)
  OPTIONAL,
  dummy                       SEQUENCE {}  OPTIONAL
}

SystemInformationBlockType2-v10m0-IEs ::= SEQUENCE {
  freqInfo-v1010              SEQUENCE {
    additionalSpectrumEmission-v1010  AdditionalSpectrumEmission-v1010
  }
  OPTIONAL,
  multiBandInfoList-v1010     SEQUENCE (SIZE (1..maxMultiBands)) OF
  AdditionalSpectrumEmission-v1010  OPTIONAL,
  nonCriticalExtension        SystemInformationBlockType2-v10n0-IEs  OPTIONAL
}

SystemInformationBlockType2-v10n0-IEs ::= SEQUENCE {
  -- Following field is for non-critical extensions up-to REL-12
  lateNonCriticalExtension     OCTET STRING  OPTIONAL,
  nonCriticalExtension         SystemInformationBlockType2-v13c0-IEs  OPTIONAL
}

```

```

SystemInformationBlockType2-v13c0-IEs ::= SEQUENCE {
    uplinkPowerControlCommon-v13c0 UplinkPowerControlCommon-v1310          OPTIONAL,  -- Need OR
    -- Following field is for non-critical extensions from REL-13
    nonCriticalExtension              SEQUENCE {} OPTIONAL
}

AC-BarringConfig ::= SEQUENCE {
    ac-BarringFactor                  ENUMERATED {
        p00, p05, p10, p15, p20, p25, p30, p40,
        p50, p60, p70, p75, p80, p85, p90, p95},
    ac-BarringTime                    ENUMERATED {s4, s8, s16, s32, s64, s128, s256, s512},
    ac-BarringForSpecialAC            BIT STRING (SIZE(5))
}

MBSFN-SubframeConfigList ::= SEQUENCE (SIZE (1..maxMBSFN-Allocations)) OF MBSFN-SubframeConfig

MBSFN-SubframeConfigList-v1430 ::= SEQUENCE (SIZE (1..maxMBSFN-Allocations)) OF MBSFN-SubframeConfig-v1430

AC-BarringPerPLMN-List-r12 ::= SEQUENCE (SIZE (1.. maxPLMN-r11)) OF AC-BarringPerPLMN-r12

AC-BarringPerPLMN-r12 ::= SEQUENCE {
    plmn-IdentityIndex-r12            INTEGER (1..maxPLMN-r11),
    ac-BarringInfo-r12                SEQUENCE {
        ac-BarringForEmergency-r12    BOOLEAN,
        ac-BarringForMO-Signalling-r12 AC-BarringConfig  OPTIONAL,  -- Need OP
        ac-BarringForMO-Data-r12      AC-BarringConfig  OPTIONAL,  -- Need OP
    }
    ac-BarringSkipForMMTELVoice-r12   ENUMERATED {true}          OPTIONAL,  -- Need OP
    ac-BarringSkipForMMTELVideo-r12   ENUMERATED {true}          OPTIONAL,  -- Need OP
    ac-BarringSkipForSMS-r12          ENUMERATED {true}          OPTIONAL,  -- Need OP
    ac-BarringForCSFB-r12             AC-BarringConfig          OPTIONAL,  -- Need OP
    ssac-BarringForMMTEL-Voice-r12    AC-BarringConfig          OPTIONAL,  -- Need OP
    ssac-BarringForMMTEL-Video-r12    AC-BarringConfig          OPTIONAL,  -- Need OP
}

ACDC-BarringForCommon-r13 ::= SEQUENCE {
    acdc-HPLMNOnly-r13                BOOLEAN,
    barringPerACDC-CategoryList-r13    BarringPerACDC-CategoryList-r13
}

ACDC-BarringPerPLMN-List-r13 ::= SEQUENCE (SIZE (1.. maxPLMN-r11)) OF ACDC-BarringPerPLMN-r13

ACDC-BarringPerPLMN-r13 ::= SEQUENCE {
    plmn-IdentityIndex-r13            INTEGER (1..maxPLMN-r11),
    acdc-OnlyForHPLMN-r13            BOOLEAN,
    barringPerACDC-CategoryList-r13    BarringPerACDC-CategoryList-r13
}

BarringPerACDC-CategoryList-r13 ::= SEQUENCE (SIZE (1..maxACDC-Cat-r13)) OF BarringPerACDC-Category-r13

BarringPerACDC-Category-r13 ::= SEQUENCE {
    acdc-Category-r13                INTEGER (1..maxACDC-Cat-r13),
    acdc-BarringConfig-r13            SEQUENCE {
        ac-BarringFactor-r13          ENUMERATED {
            p00, p05, p10, p15, p20, p25, p30, p40,
            p50, p60, p70, p75, p80, p85, p90, p95},
        ac-BarringTime-r13            ENUMERATED {s4, s8, s16, s32, s64, s128, s256, s512}
    }
    ac-BarringTime-r13                OPTIONAL  -- Need OP
}

UDT-Restricting-r13 ::= SEQUENCE {
    udt-Restricting-r13                ENUMERATED {true}          OPTIONAL,  --Need OR
    udt-RestrictingTime-r13            ENUMERATED {s4, s8, s16, s32, s64, s128, s256, s512}
    OPTIONAL  --Need OR
}

UDT-RestrictingPerPLMN-List-r13 ::= SEQUENCE (SIZE (1..maxPLMN-r11)) OF UDT-RestrictingPerPLMN-r13

UDT-RestrictingPerPLMN-r13 ::= SEQUENCE {
    plmn-IdentityIndex-r13            INTEGER (1..maxPLMN-r11),
    udt-Restricting-r13                UDT-Restricting-r13          OPTIONAL  --Need OR
}

CIOT-EPS-OptimisationInfo-r13 ::= SEQUENCE (SIZE (1.. maxPLMN-r11)) OF CIOT-OptimisationPLMN-r13

```

```
CIoT-OptimisationPLMN-r13 ::= SEQUENCE {
    up-CIoT-EPS-Optimisation-r13      ENUMERATED {true}          OPTIONAL,  -- Need OP
    cp-CIoT-EPS-Optimisation-r13      ENUMERATED {true}          OPTIONAL,  -- Need OP
    attachWithoutPDN-Connectivity-r13 ENUMERATED {true}          OPTIONAL  -- Need OP
}

PLMN-InfoList-r15 ::= SEQUENCE (SIZE (1..maxPLMN-r11)) OF PLMN-Info-r15

PLMN-Info-r15 ::= SEQUENCE {
    upperLayerIndication-r15          ENUMERATED {true}          OPTIONAL  -- Need OR
}

-- ASN1STOP
```

<b>SystemInformationBlockType2 field descriptions</b>
<p><b>ac-BarringFactor</b> If the random number drawn by the UE is lower than this value, access is allowed. Otherwise the access is barred. The values are interpreted in the range [0,1): p00 = 0, p05 = 0.05, p10 = 0.10, ..., p95 = 0.95. Values other than p00 can only be set if all bits of the corresponding <i>ac-BarringForSpecialAC</i> are set to 0.</p>
<p><b>ac-BarringForCSFB</b> Access class barring for mobile originating CS fallback.</p>
<p><b>ac-BarringForEmergency</b> Access class barring for AC 10.</p>
<p><b>ac-BarringForMO-Data</b> Access class barring for mobile originating calls.</p>
<p><b>ac-BarringForMO-Signalling</b> Access class barring for mobile originating signalling.</p>
<p><b>ac-BarringForSpecialAC</b> Access class barring for AC 11-15. The first/ leftmost bit is for AC 11, the second bit is for AC 12, and so on.</p>
<p><b>ac-BarringTime</b> Mean access barring time value in seconds.</p>
<p><b>acdc-BarringConfig</b> Barring configuration for an ACDC category. If the field is absent, access to the cell is considered as not barred for the ACDC category in accordance with clause 5.3.3.13.</p>
<p><b>acdc-Category</b> Indicates the ACDC category as defined in TS 24.105 [72].</p>
<p><b>acdc-OnlyForHPLMN</b> Indicates whether ACDC is applicable for UEs not in their HPLMN for the corresponding PLMN. <i>TRUE</i> indicates that ACDC is applicable only for UEs in their HPLMN for the corresponding PLMN. <i>FALSE</i> indicates that ACDC is applicable for both UEs in their HPLMN and UEs not in their HPLMN for the corresponding PLMN.</p>
<p><b>additionalSpectrumEmission</b> The UE requirements related to IE <i>AdditionalSpectrumEmission</i> are defined in TS 36.101 [42], table 6.2.4-1, for UEs neither in CE nor BL UEs and TS 36.101 [42], table 6.2.4E-1, for UEs in CE or BL UEs. NOTE 1.</p>
<p><b>attachWithoutPDN-Connectivity</b> If present, the field indicates that attach without PDN connectivity as specified in TS 24.301 [35] is supported for this PLMN.</p>
<p><b>barringPerACDC-CategoryList</b> A list of barring information per ACDC category according to the order defined in TS 22.011 [10]. The first entry in the list corresponds to the highest ACDC category of which applications are the least restricted in access attempts at a cell, the second entry in the list corresponds to the ACDC category of which applications are restricted more than applications of the highest ACDC category in access attempts at a cell, and so on. The last entry in the list corresponds to the lowest ACDC category of which applications are the most restricted in access attempts at a cell.</p>
<p><b>clot-EPS-OptimisationInfo</b> A list of Clot EPS related parameters. Value 1 indicates parameters for the PLMN listed 1st in the 1st <i>plmn-IdentityList</i> included in SIB1. Value 2 indicates parameters for the PLMN listed 2nd in the same <i>plmn-IdentityList</i>, or when no more PLMN are present within the same <i>plmn-IdentityList</i>, then the value indicates parameters for PLMN listed 1st in the subsequent <i>plmn-IdentityList</i> within the same SIB1 and so on. NOTE 1.</p>
<p><b>cp-Clot-EPS-Optimisation</b> This field indicates if the UE is allowed to establish the connection with Control plane Clot EPS Optimisation, see TS 24.301 [35].</p>
<p><b>cp-EDT</b> This field indicates whether the UE is allowed to initiate CP-EDT when connected to EPC, see 5.3.3.1b.</p>
<p><b>cp-EDT-5GC</b> This field indicates whether the UE is allowed to initiate CP-EDT when connected to 5GC, see 5.3.3.1b.</p>
<p><b>cp-PUR-5GC</b> This field indicates whether CP transmission using PUR is supported in the cell when connected to 5GC, see 5.3.3.1c.</p>
<p><b>cp-PUR-EPC</b> This field indicates whether CP transmission using PUR is supported in the cell when connected to EPC, see 5.3.3.1c.</p>
<p><b>dummy</b> This field is not used in the specification. If received it shall be ignored by the UE.</p>
<p><b>earlySecurityReactivation</b> If present, this field indicates that early security reactivation when resuming a suspended RRC connection as specified in 5.3.3.18 is supported.</p>
<p><b>gnss-PositionFixDurationReporting</b> If present, this field indicates that UEs capable of performing GNSS position fix in RRC_CONNECTED are configured to include the time duration required to acquire a GNSS position in <i>RRCCConnectionSetupComplete</i>, <i>RRCCConnectionResumeComplete</i>, and <i>RRCCConnectionReestablishmentComplete</i>.</p>
<p><b>idleModeMeasurements</b> This field indicates that a UE that is configured for EUTRA idle/inactive measurements shall perform the measurements while camping in this cell and report availability of these measurements when establishing or resuming a connection in this cell. If absent, a UE is not required to perform EUTRA idle/inactive measurements.</p>

<b>SystemInformationBlockType2 field descriptions</b>
<p><b>idleModeMeasurementsNR</b> This field indicates that a UE that is configured for NR idle/inactive measurements shall perform the measurements while camping in this cell and report availability of these measurements when establishing or resuming a connection in this cell. If absent, a UE is not required to perform NR idle/inactive measurements.</p>
<p><b>mbms-ROM-ServiceIndication</b> This field indicates whether the UE is allowed to send <i>MBMSInterestIndication</i> message for the purpose of indicating receive only mode MBMS service parameters.</p>
<p><b>mbsfn-SubframeConfigList</b> Defines the subframes that are reserved for MBSFN in downlink. NOTE 1. If the cell is a FeMBMS/Unicast mixed cell, EUTRAN includes <i>mbsfn-SubframeConfigList-v1430</i>. If a FeMBMS/Unicast mixed cell does not use sub-frames #4 or #9 as MBSFN sub-frames, <i>mbsfn-SubframeConfigList-v1430</i> is still included and indicates all sub-frames as non-MBSFN sub-frames.</p>
<p><b>mpdcch-CQI-Reporting</b> This field indicates if downlink channel quality reporting during random access procedure is allowed, see TS 36.321 [6]. Value 'fourBits' indicates 4-bit CQI reporting is allowed and value 'both' indicates both 2-bit and 4-bit reporting are allowed.</p>
<p><b>multiBandInfoList</b> A list of <i>AdditionalSpectrumEmission</i> i.e. one for each additional frequency band included in <i>multiBandInfoList</i> in <i>SystemInformationBlockType1</i>, listed in the same order. If E-UTRAN includes <i>multiBandInfoList-v1010</i> it includes the same number of entries, and listed in the same order, as in <i>multiBandInfoList</i>.</p>
<p><b>plmn-IdentityIndex</b> Index of the PLMN across the <i>plmn-IdentityList</i> fields included in SIB1. Value 1 indicates the PLMN listed 1st in the 1st <i>plmn-IdentityList</i> included in SIB1. Value 2 indicates the PLMN listed 2nd in the same <i>plmn-IdentityList</i>, or when no more PLMN are present within the same <i>plmn-IdentityList</i>, then the PLMN listed 1st in the subsequent <i>plmn-IdentityList</i> within the same SIB1 and so on. NOTE 1.</p>
<p><b>plmn-InfoList</b> If E-UTRAN includes this field, it includes the same number of entries, and listed in the same order as PLMNs across the <i>plmn-IdentityList</i> fields included in SIB1. I.e. the first entry corresponds to the first entry of the combined list that results from concatenating the entries included in the second to the original <i>plmn-IdentityList</i> field.</p>
<p><b>rai-ActivationEnh</b> Indicates whether UE connected to EPC is allowed to report the AS release assistance indication using the DCQR and AS RAI MAC CE in the cell as specified in TS 36.321 [6].</p>
<p><b>reducedCP-LatencyEnabled</b> If present, reduced control plane latency is enabled. UEs supporting reduced CP latency transmit Msg3 according to <math>k_1 \geq 5</math> timing as specified in TS 36.213 [23] when transmitting <i>RRCCConnectionResumeRequest</i> in Msg3.</p>
<p><b>rlos-Enabled</b> Indicates whether access to RLOS is allowed as specified in TS 23.401 [41].</p>
<p><b>ssac-BarringForMMTEL-Video</b> Service specific access class barring for MMTEL video originating calls.</p>
<p><b>ssac-BarringForMMTEL-Voice</b> Service specific access class barring for MMTEL voice originating calls.</p>
<p><b>udt-Restricting</b> Value TRUE indicates that the UE should indicate to the higher layers to restrict unattended data traffic TS 22.101 [77] irrespective of the UE being in RRC_IDLE or RRC_CONNECTED. The UE shall not indicate to the higher layers if the UE has one or more Access Classes, as stored on the USIM, with a value in the range 11..15, which is valid for the UE to use according to TS 22.011 [10] and TS 23.122 [11].</p>
<p><b>udt-RestrictingTime</b> If present and when the <i>udt-Restricting</i> changes from TRUE, the UE runs a timer for a period equal to <math>\text{rand} * \text{udt-RestrictingTime}</math>, where <i>rand</i> is a random number drawn that is uniformly distributed in the range <math>0 \leq \text{rand} &lt; 1</math> value in seconds. The timer stops if <i>udt-Restricting</i> changes to TRUE. Upon timer expiry, the UE indicates to the higher layers that the restriction is alleviated.</p>
<p><b>unicastFreqHoppingInd</b> This field indicates if the UE is allowed to indicate support of frequency hopping for unicast MPDCCH/PDSCH/PUSCH as described in TS 36.321 [6]. This field is included only in the BR version of SI message carrying <i>SystemInformationBlockType2</i>.</p>
<p><b>ul-Bandwidth</b> Parameter: transmission bandwidth configuration, <math>N_{RB}</math>, in uplink, see TS 36.101 [42], table 5.6-1 and TS 36.108 [114], table 5.3A-1. Value <i>n6</i> corresponds to 6 resource blocks, <i>n15</i> to 15 resource blocks and so on. If for FDD this parameter is absent, the uplink bandwidth is equal to the downlink bandwidth. For TDD this parameter is absent and it is equal to the downlink bandwidth. NOTE 1.</p>
<p><b>ul-CarrierFreq</b> For FDD: If absent, the (default) value determined from the default TX-RX frequency separation defined in TS 36.101 [42], table 5.7.3-1 and 36.108 [114], table 5.4A.2-1, applies. For TDD: This parameter is absent and it is equal to the downlink frequency. NOTE 1.</p>



<b>SystemInformationBlockType2 field descriptions</b>	
<b>up-CIoT-EPS-Optimisation</b>	This field indicates if the UE is allowed to resume the connection with User plane ClIoT EPS Optimisation, see TS 24.301 [35].
<b>up-EDT</b>	This field indicates whether the UE is allowed to initiate UP-EDT when connected to EPC, see 5.3.3.1b.
<b>up-EDT-5GC</b>	This field indicates whether the UE is allowed to initiate UP-EDT when connected to 5GC, see 5.3.3.1b.
<b>up-PUR-5GC</b>	This field indicates whether UP transmission using PUR is supported in the cell when connected to 5GC, see 5.3.3.1c.
<b>up-PUR-EPC</b>	This field indicates whether UP transmission using PUR is supported in the cell when connected to EPC, see 5.3.3.1c.
<b>upperLayerIndication</b>	Indication to be provided to upper layers.
<b>useFullResumeID</b>	This field indicates if the UE indicates full resume ID of 40 bits in <i>RRCCConnectionResumeRequest</i> .
<b>videoServiceCauseIndication</b>	Indicates whether the UE is requested to use the establishment cause <i>mo-VoiceCall</i> for mobile originating MMTEL video calls.
<b>voiceServiceCauseIndication</b>	Indicates whether UE is requested to use the establishment cause <i>mo-VoiceCall</i> for mobile originating MMTEL voice calls.

<b>Conditional presence</b>	<b>Explanation</b>
<i>ul-FreqMax</i>	The field is mandatory present if <i>ul-CarrierFreq</i> (i.e. without suffix) is present and set to <i>maxEARFCN</i> . Otherwise the field is not present.

NOTE 1: E-UTRAN sets this field to the same value for all instances of SI message that are broadcasted within the same cell.

### – SystemInformationBlockType3

The IE *SystemInformationBlockType3* contains cell re-selection information common for intra-frequency, inter-frequency and/ or inter-RAT cell re-selection (i.e. applicable for more than one type of cell re-selection but not necessarily all) as well as intra-frequency cell re-selection information other than neighbouring cell related.

#### SystemInformationBlockType3 information element

```
-- ASN1START
SystemInformationBlockType3 ::= SEQUENCE {
  cellReselectionInfoCommon SEQUENCE {
    q-Hyst ENUMERATED {
      dB0, dB1, dB2, dB3, dB4, dB5, dB6, dB8, dB10,
      dB12, dB14, dB16, dB18, dB20, dB22, dB24},
    speedStateReselectionPars SEQUENCE {
      mobilityStateParameters MobilityStateParameters,
      q-HystSF SEQUENCE {
        sf-Medium ENUMERATED {
          dB-6, dB-4, dB-2, dB0},
        sf-High ENUMERATED {
          dB-6, dB-4, dB-2, dB0}
      }
    }
  } OPTIONAL -- Need OP
},
cellReselectionServingFreqInfo SEQUENCE {
  s-NonIntraSearch ReselectionThreshold OPTIONAL, -- Need OP
  threshServingLow ReselectionThreshold,
  cellReselectionPriority CellReselectionPriority
},
intraFreqCellReselectionInfo SEQUENCE {
  q-RxLevMin Q-RxLevMin,
  p-Max P-Max OPTIONAL, -- Need OP
  s-IntraSearch ReselectionThreshold OPTIONAL, -- Need OP
  allowedMeasBandwidth AllowedMeasBandwidth OPTIONAL, -- Need OP
  presenceAntennaPort1 PresenceAntennaPort1,
```

```

    neighCellConfig
    t-ReselectionEUTRA
    t-ReselectionEUTRA-SF
  },
  ...,
  lateNonCriticalExtension
v10j0-IEs) OPTIONAL,
  [[ s-IntraSearch-v920
    s-IntraSearchP-r9
    s-IntraSearchQ-r9
  ]
  s-NonIntraSearch-v920
    s-NonIntraSearchP-r9
    s-NonIntraSearchQ-r9
  ]
  q-QualMin-r9
  threshServingLowQ-r9
  ]],
  [[ q-QualMinWB-r11
  ]],
  [[ q-QualMinRSRQ-OnAllSymbols-r12
Cond RSRQ
  ]],
  [[ cellReselectionServingFreqInfo-v1310 CellReselectionServingFreqInfo-v1310 OPTIONAL, --
Need OP
  redistributionServingInfo-r13
  cellSelectionInfoCE-r13
  t-ReselectionEUTRA-CE-r13
  ]],
  [[ cellSelectionInfoCE1-r13
  ]],
  [[ cellSelectionInfoCE1-v1360
OrxlevminCE1
  ]],
  [[ cellReselectionInfoCommon-v1460
  ]],
  [[ cellReselectionInfoHSDN-r15
  cellSelectionInfoCE-v1530
  ]],
  [[ crs-IntfMitigNeighCellsCE-r15
  ]],
  [[ cellReselectionServingFreqInfo-v1610
Need OR
  ]],
  [[ t-Service-r17
  ]],
  [[ satelliteAssistanceInfoList-r18
    SEQUENCE (SIZE(1..maxSat-r17)) OF SatelliteId-r18
  ]],
  freqBandInfoAerial-r18
  multiBandInfoListAerial-r18
  ]],
  }

RedistributionServingInfo-r13 ::= SEQUENCE {
  redistributionFactorServing-r13 INTEGER(0..10),
  redistributionFactorCell-r13 ENUMERATED{true} OPTIONAL, --Need OP
  t360-r13 ENUMERATED {min4, min8, min16, min32,infinity,
    spare3,spare2,spare1},
  redistrOnPagingOnly-r13 ENUMERATED {true} OPTIONAL --Need OP
}

CellReselectionServingFreqInfo-v1310 ::= SEQUENCE {
  cellReselectionSubPriority-r13 CellReselectionSubPriority-r13
}

CellReselectionServingFreqInfo-v1610 ::= SEQUENCE {
  altCellReselectionPriority-r16 CellReselectionPriority OPTIONAL, -- Need OR
  altCellReselectionSubPriority-r16 CellReselectionSubPriority-r13 OPTIONAL -- Need OR
}

-- Late non critical extensions
SystemInformationBlockType3-v10j0-IEs ::= SEQUENCE {
  freqBandInfo-r10 NS-PmaxList-r10 OPTIONAL, -- Need OR
  multiBandInfoList-v10j0 MultiBandInfoList-v10j0 OPTIONAL, -- Need OR
  nonCriticalExtension SystemInformationBlockType3-v10j0-IEs
OPTIONAL
}

```

```
}  
SystemInformationBlockType3-v1010-IEs ::= SEQUENCE {  
    freqBandInfo-v1010          NS-PmaxList-v1010          OPTIONAL,  -- Need OR  
    multiBandInfoList-v1010    MultiBandInfoList-v1010  OPTIONAL,  -- Need OR  
    nonCriticalExtension        SEQUENCE {}                OPTIONAL  
}  
  
CellReselectionInfoCommon-v1460 ::= SEQUENCE {  
    s-SearchDeltaP-r14          ENUMERATED {dB6, dB9, dB12, dB15}  
}  
  
CellReselectionInfoHSDN-r15 ::= SEQUENCE {  
    cellEquivalentSize-r15      INTEGER(2..16)  
}  
  
-- ASN1STOP
```

<b>SystemInformationBlockType3 field descriptions</b>
<p><b>allowedMeasBandwidth</b> If absent, the value corresponding to the downlink bandwidth indicated by the <i>dl-Bandwidth</i> included in <i>MasterInformationBlock</i> applies.</p>
<p><b>altCellReselectionPriority</b> Alternative cell reselection priorities to be used by the UEs for which the <i>altFreqPriorities</i> is set to <i>true</i> in the <i>RRCCConnectionRelease</i> message.</p>
<p><b>altCellReselectionSubPriority</b> Alternative cell reselection sub-priorities to be used by the UEs for which the <i>altFreqPriorities</i> is set to <i>true</i> in the <i>RRCCConnectionRelease</i> message.</p>
<p><b>cellEquivalentSize</b> The number of cell count used for mobility state estimation for this cell as specified in TS 36.304 [4].</p>
<p><b>cellSelectionInfoCE</b> Parameters included in coverage enhancement S criteria for BL UEs and UEs in CE, applicable for intra-frequency neighbour cells. If absent, coverage enhancement S criteria is not applicable.</p>
<p><b>cellSelectionInfoCE1</b> Parameters included in coverage enhancement S criteria for BL UEs and UEs in CE supporting CE Mode B, applicable for intra-frequency neighbour cells. E-UTRAN includes this IE only if <i>cellSelectionInfoCE</i> in SIB3 is present.</p>
<p><b>cellReselectionInfoCommon</b> Cell re-selection information common for cells.</p>
<p><b>cellReselectionServingFreqInfo</b> Information common for Cell re-selection to inter-frequency and inter-RAT cells.</p>
<p><b>crs-IntfMitigNeighCellsCE</b> For BL UEs supporting <i>ce-CRS-IntfMitig</i>, this field indicates CRS interference mitigation, as specified in TS 36.133 [16], clause 3.6.1.2 and 3.6.1.3, is enabled in any of the intra-frequency neighbour cells, and the UE shall perform intra-frequency neighbour cell RRM measurements in the center 6 PRBs.</p>
<p><b>freqBandInfo</b> A list of <i>additionalPmax</i> and <i>additionalSpectrumEmission</i> values, as defined in TS 36.101 [42], table 6.2.4-1, for UEs neither in CE nor BL UEs, TS 36.101 [42], table 6.2.4E-1, for UEs in CE or BL UEs and TS 36.102 [113], table 6.2A.3-1, for NTN capable UE, applicable for the intra-frequency neighbouring E-UTRA cells if the UE selects the frequency band from <i>freqBandIndicator</i> in <i>SystemInformationBlockType1</i>. If E-UTRAN includes <i>freqBandInfo-v1010</i> it includes the same number of entries, and listed in the same order, as in <i>freqBandInfo-r10</i>.</p>
<p><b>intraFreqcellReselectionInfo</b> Cell re-selection information common for intra-frequency cells.</p>
<p><b>multiBandInfoList-v10j0</b> A list of <i>additionalPmax</i> and <i>additionalSpectrumEmission</i> values, as defined in TS 36.101 [42], table 6.2.4-1, for UEs neither in CE nor BL UEs, TS 36.101 [42], table 6.2.4E-1, for UEs in CE or BL UEs and TS 36.102 [113], table 6.2A.3-1, for NTN capable UE, applicable for the intra-frequency neighbouring E-UTRA cells if the UE selects the frequency bands in <i>multiBandInfoList</i> (i.e. without suffix) or <i>multiBandInfoList-v9e0</i> in <i>SystemInformationBlockType1</i>. If E-UTRAN includes <i>multiBandInfoList-v10j0</i>, it includes the same number of entries, and listed in the same order, as in <i>multiBandInfoList</i> (i.e. without suffix) in <i>SystemInformationBlockType1</i>. If E-UTRAN includes <i>multiBandInfoList-v1010</i> it includes the same number of entries, and listed in the same order, as in <i>multiBandInfoList-v10j0</i>.</p>
<p><b>p-Max</b> Value applicable for the intra-frequency neighbouring E-UTRA cells. If absent the UE applies the maximum power according to its capability as specified in TS 36.101 [42], clause 6.2.2. This field is ignored by IAB-MT. The IAB-MT applies output power and emissions requirements, as specified in TS 38.174 [107].</p>
<p><b>redistrOnPagingOnly</b> If this field is present and the UE is redistribution capable, the UE shall only wait for the paging message to trigger E-UTRAN inter-frequency redistribution procedure as specified in clause 5.2.4.10 of TS 36.304 [4].</p>
<p><b>q-Hyst</b> Parameter <math>Q_{hyst}</math> in TS 36.304 [4], Value in dB. Value dB1 corresponds to 1 dB, dB2 corresponds to 2 dB and so on.</p>
<p><b>q-HystSF</b> Parameter "Speed dependent ScalingFactor for <math>Q_{hyst}</math>" in TS 36.304 [4]. The sf-Medium and sf-High concern the additional hysteresis to be applied, in Medium and High Mobility state respectively, to <math>Q_{hyst}</math> as defined in TS 36.304 [4]. In dB. Value dB-6 corresponds to -6dB, dB-4 corresponds to -4dB and so on.</p>
<p><b>q-QualMin</b> Parameter "<math>Q_{qualmin}</math>" in TS 36.304 [4], applicable for intra-frequency neighbour cells. If the field is not present, the UE applies the (default) value of negative infinity for <math>Q_{qualmin}</math>. NOTE 1.</p>
<p><b>q-QualMinRSRQ-OnAllSymbols</b> If this field is present and supported by the UE, the UE shall, when performing RSRQ measurements, perform RSRQ measurement on all OFDM symbols in accordance with TS 36.214 [48]. NOTE 1.</p>
<p><b>q-QualMinWB</b> If this field is present and supported by the UE, the UE shall, when performing RSRQ measurements, use a wider bandwidth in accordance with TS 36.133 [16]. NOTE 1.</p>
<p><b>q-RxLevMin</b> Parameter "<math>Q_{rxlevmin}</math>" in TS 36.304 [4], applicable for intra-frequency neighbour cells.</p>

<b>SystemInformationBlockType3 field descriptions</b>
<b>redistributionFactorCell</b> If <i>redistributionFactorCell</i> is present, <i>redistributionFactorServing</i> is only applicable for the serving cell otherwise it is applicable for serving frequency
<b>redistributionFactorServing</b> Parameter <i>redistributionFactorServing</i> in TS 36.304 [4].
<b>s-IntraSearch</b> Parameter "S <sub>IntraSearchP</sub> " in TS 36.304 [4]. If the field <i>s-IntraSearchP</i> is present, the UE applies the value of <i>s-IntraSearchP</i> instead. Otherwise if neither <i>s-IntraSearch</i> nor <i>s-IntraSearchP</i> is present, the UE applies the (default) value of infinity for S <sub>IntraSearchP</sub> .
<b>s-IntraSearchP</b> Parameter "S <sub>IntraSearchP</sub> " in TS 36.304 [4]. See descriptions under <i>s-IntraSearch</i> .
<b>s-IntraSearchQ</b> Parameter "S <sub>IntraSearchQ</sub> " in TS 36.304 [4]. If the field is not present, the UE applies the (default) value of 0 dB for S <sub>IntraSearchQ</sub> .
<b>s-NonIntraSearch</b> Parameter "S <sub>nonIntraSearchP</sub> " in TS 36.304 [4]. If the field <i>s-NonIntraSearchP</i> is present, the UE applies the value of <i>s-NonIntraSearchP</i> instead. Otherwise if neither <i>s-NonIntraSearch</i> nor <i>s-NonIntraSearchP</i> is present, the UE applies the (default) value of infinity for S <sub>nonIntraSearchP</sub> .
<b>s-NonIntraSearchP</b> Parameter "S <sub>nonIntraSearchP</sub> " in TS 36.304 [4]. See descriptions under <i>s-NonIntraSearch</i> .
<b>s-NonIntraSearchQ</b> Parameter "S <sub>nonIntraSearchQ</sub> " in TS 36.304 [4]. If the field is not present, the UE applies the (default) value of 0 dB for S <sub>nonIntraSearchQ</sub> .
<b>s-SearchDeltaP</b> Parameter "S <sub>SearchDeltaP</sub> " in TS 36.304 [4]. This parameter is only applicable for UEs supporting relaxed monitoring as specified in TS 36.306 [5]. Value dB6 corresponds to 6 dB, dB9 corresponds to 9 dB and so on.
<b>satelliteAssistanceInfoList</b> List of satellite ID(s), used to associate with the satellite assistance information for intra-frequency neighbour cell measurements.
<b>speedStateReselectionPars</b> Speed dependent reselection parameters, see TS 36.304 [4]. If this field is absent, i.e. <i>mobilityStateParameters</i> is also not present, UE behaviour is specified in TS 36.304 [4].
<b>t-Service</b> Time information on when an NTN cell is going to stop serving the area it is currently covering, as specified in TS 36.304 [4]. This field applies for service link switches in NTN quasi-Earth fixed cells and feeder link switches for both NTN quasi-Earth fixed and earth-moving cells.
<b>t360</b> Parameter "T360" in TS 36.304 [4]. Value <i>min4</i> corresponds to 4 minutes, value <i>min8</i> corresponds to 8 minutes, and so on.
<b>threshServingLow</b> Parameter "Thresh <sub>Serving, LowP</sub> " in TS 36.304 [4].
<b>threshServingLowQ</b> Parameter "Thresh <sub>Serving, LowQ</sub> " in TS 36.304 [4].
<b>t-ReselectionEUTRA</b> Parameter "Treselction <sub>EUTRA</sub> " in TS 36.304 [4].
<b>t-ReselectionEUTRA-SF</b> Parameter "Speed dependent ScalingFactor for Treselction <sub>EUTRA</sub> " in TS 36.304 [4]. If the field is not present, the UE behaviour is specified in TS 36.304 [4].

NOTE 1: The value the UE applies for parameter "Q<sub>qualmin</sub>" in TS 36.304 [4] depends on the *q-QualMin* fields signalled by E-UTRAN and supported by the UE. In case multiple candidate options are available, the UE shall select the highest priority candidate option according to the priority order indicated by the following table (top row is highest priority).

q-QualMinRSRQ-OnAllSymbols	q-QualMinWB	Value of parameter "Q <sub>qualmin</sub> " in TS 36.304 [4]
Included	Included	$q\text{-QualMinRSRQ-OnAllSymbols} - (q\text{-QualMin} - q\text{-QualMinWB})$
Included	Not included	$q\text{-QualMinRSRQ-OnAllSymbols}$
Not included	Included	$q\text{-QualMinWB}$
Not included	Not included	$q\text{-QualMin}$

Conditional presence	Explanation
<i>QrxlevminCE1</i>	The field is optionally present, Need OR, if <i>q-RxLevMinCE1-r13</i> is set below -140 dBm. Otherwise the field is not present.
<i>RSRQ</i>	The field is optionally present, Need OR, if <i>threshServingLowQ</i> is present in SIB3; otherwise it is not present.
<i>WB-RSRQ</i>	The field is optionally present, need OP if the measurement bandwidth indicated by <i>allowedMeasBandwidth</i> is 50 resource blocks or larger; otherwise it is not present.

## – SystemInformationBlockType4

The IE *SystemInformationBlockType4* contains neighbouring cell related information relevant only for intra-frequency cell re-selection. The IE includes cells with specific re-selection parameters as well as exclude-listed cells.

### SystemInformationBlockType4 information element

```
-- ASN1START
SystemInformationBlockType4 ::= SEQUENCE {
    intraFreqNeighCellList      IntraFreqNeighCellList      OPTIONAL,  -- Need OR
    intraFreqExcludedCellList  IntraFreqExcludedCellList  OPTIONAL,  --
Need OR
    csg-PhysCellIdRange       PhysCellIdRange          OPTIONAL,  -- Cond CSG
    ...,
    lateNonCriticalExtension   OCTET STRING              OPTIONAL,
    [[ intraFreqNeighHSDN-CellList-r15  IntraFreqNeighHSDN-CellList-r15  OPTIONAL  -- Need OR
    ]],
    [[ rss-ConfigCarrierInfo-r16        RSS-ConfigCarrierInfo-r16        OPTIONAL,  -- Cond RSS
    intraFreqNeighCellList-v1610      IntraFreqNeighCellList-v1610    OPTIONAL  -- Cond RSS
    ]]
}

IntraFreqNeighCellList ::= SEQUENCE (SIZE (1..maxCellIntra)) OF IntraFreqNeighCellInfo

IntraFreqNeighCellList-v1610 ::= SEQUENCE (SIZE (1..maxCellIntra)) OF IntraFreqNeighCellInfo-v1610

IntraFreqNeighHSDN-CellList-r15 ::= SEQUENCE (SIZE (1..maxCellIntra)) OF PhysCellIdRange

IntraFreqNeighCellInfo ::= SEQUENCE {
    physCellId                PhysCellId,
    q-OffsetCell              Q-OffsetRange,
    ...
}

IntraFreqNeighCellInfo-v1610 ::= SEQUENCE {
    rss-MeasPowerBias-r16     RSS-MeasPowerBias-r16
}

IntraFreqExcludedCellList ::= SEQUENCE (SIZE (1..maxExcludedCell)) OF PhysCellIdRange
-- ASN1STOP
```

<b>SystemInformationBlockType4 field descriptions</b>
<p><b>csg-PhysCellIdRange</b> Set of physical cell identities reserved for CSG cells on the frequency on which this field was received. The received <i>csg-PhysCellIdRange</i> applies if less than 24 hours has elapsed since it was received and the UE is camped on a cell of the same primary PLMN where this field was received. The 3 hour validity restriction (clause 5.2.1.3) does not apply to this field. The UE shall not apply any stored <i>csg-PhysCellIdRange</i> when it is in <i>any cell selection</i> state defined in TS 36.304 [4].</p>
<p><b>intraFreqExcludedCellList</b> List of exclude-listed intra-frequency neighbouring cells.</p>
<p><b>intraFreqNeighCellList</b> List of intra-frequency neighbouring cells with specific cell re-selection parameters. <i>intraFreqNeighCellList-v1610</i> indicates list of RSS assistance information which is used for the corresponding <i>physCellId</i>. If E-UTRAN includes <i>intraFreqNeighCellList-v1610</i>, it includes the same number of entries, and listed in the same order, as in <i>intraFreqNeighCellList</i> (i.e. without suffix). If <i>intraFreqNeighCellList-v1610</i> is absent, measurement based on RSS is not applicable for all the neighbour cells in <i>intraFreqNeighCellList</i> (i.e. without suffix).</p>
<p><b>intraFreqNeighHSDN-CellList</b> List of intra-frequency neighbouring HSDN cells as specified in TS 36.304 [4].</p>
<p><b>q-OffsetCell</b> Parameter "Qoffset<sub>s,n</sub>" in TS 36.304 [4].</p>
<p><b>rss-ConfigCarrierInfo</b> RSS configurations for this carrier frequency. If absent and <i>rss-MeasConfig</i> is included in SIB2, RSS is collocated (time and frequency domain) in all cells.</p>

<b>Conditional presence</b>	<b>Explanation</b>
CSG	This field is optional, need OP, for non-CSG cells, and mandatory for CSG cells.
RSS	This field is optional, need OP, if <i>rss-MeasConfig</i> is included in SIB2. Otherwise the field is not present, and the UE shall delete any existing value for this field.

## SystemInformationBlockType5

The IE *SystemInformationBlockType5* contains information relevant for inter-frequency cell re-selection (i.e. information about other E-UTRA frequencies and inter-frequency neighbouring cells relevant for cell re-selection) and information relevant for E-UTRA and NR idle/inactive measurements. The IE includes cell re-selection parameters common for a frequency as well as cell specific re-selection parameters.

### SystemInformationBlockType5 information element

```

-- ASN1START
SystemInformationBlockType5 ::= SEQUENCE {
    interFreqCarrierFreqList      InterFreqCarrierFreqList,
    . . . ,
    lateNonCriticalExtension      OCTET STRING      (CONTAINING SystemInformationBlockType5-
v8h0-IEs)                        OPTIONAL,
    [[ interFreqCarrierFreqList-v1250 InterFreqCarrierFreqList-v1250      OPTIONAL, -- Need OR
    interFreqCarrierFreqListExt-r12 InterFreqCarrierFreqListExt-r12 OPTIONAL -- Need OR
    ]],
OR
    [[ interFreqCarrierFreqListExt-v1280 InterFreqCarrierFreqListExt-v1280 OPTIONAL -- Need
OR
    ]],
OR
    [[ interFreqCarrierFreqList-v1310 InterFreqCarrierFreqList-v1310      OPTIONAL, -- Need
OR
    interFreqCarrierFreqListExt-v1310 InterFreqCarrierFreqListExt-v1310 OPTIONAL -- Need
OR
    ]],
    [[ interFreqCarrierFreqList-v1350 InterFreqCarrierFreqList-v1350 OPTIONAL, -- Need OR
    interFreqCarrierFreqListExt-v1350 InterFreqCarrierFreqListExt-v1350 OPTIONAL -- Need OR
    ]],
OR
    [[ interFreqCarrierFreqListExt-v1360 InterFreqCarrierFreqListExt-v1360 OPTIONAL -- Need
OR
    ]],
    [[ scptm-FreqOffset-r14        INTEGER (1..8)                        OPTIONAL -- Need OP
    ]],
OR
    [[ interFreqCarrierFreqList-v1530 InterFreqCarrierFreqList-v1530      OPTIONAL, -- Need
OR
    interFreqCarrierFreqListExt-v1530 InterFreqCarrierFreqListExt-v1530 OPTIONAL, -- Need
OR
    measIdleConfigSIB-r15         MeasIdleConfigSIB-r15                OPTIONAL -- Need OR
    ]],

```

```

[[ interFreqCarrierFreqList-v1610      InterFreqCarrierFreqList-v1610      OPTIONAL,  -- Need
OR
   interFreqCarrierFreqListExt-v1610    InterFreqCarrierFreqListExt-v1610    OPTIONAL,  -- Need
OR
   measIdleConfigSIB-NR-r16             MeasIdleConfigSIB-NR-r16             OPTIONAL   -- Need
OR
]],
[[ interFreqCarrierFreqList-v1800      InterFreqCarrierFreqList-v1800      OPTIONAL,  -- Need OR
   interFreqCarrierFreqListExt-v1800    InterFreqCarrierFreqListExt-v1800    OPTIONAL   -- Need
OR
]]
}

-- Late non critical extensions
SystemInformationBlockType5-v8h0-IEs ::= SEQUENCE {
    interFreqCarrierFreqList-v8h0 SEQUENCE (SIZE (1..maxFreq)) OF InterFreqCarrierFreqInfo-v8h0
        OPTIONAL,  -- Need OP
    nonCriticalExtension             SystemInformationBlockType5-v9e0-IEs
        OPTIONAL
}

SystemInformationBlockType5-v9e0-IEs ::= SEQUENCE {
    interFreqCarrierFreqList-v9e0 SEQUENCE (SIZE (1..maxFreq)) OF InterFreqCarrierFreqInfo-v9e0
        OPTIONAL,  -- Need OR
    nonCriticalExtension             SystemInformationBlockType5-v10j0-IEs   OPTIONAL
}

SystemInformationBlockType5-v10j0-IEs ::= SEQUENCE {
    interFreqCarrierFreqList-v10j0 SEQUENCE (SIZE (1..maxFreq)) OF InterFreqCarrierFreqInfo-v10j0
        OPTIONAL,  -- Need OR
    nonCriticalExtension             SystemInformationBlockType5-v10l0-IEs   OPTIONAL
}

SystemInformationBlockType5-v10l0-IEs ::= SEQUENCE {
    interFreqCarrierFreqList-v10l0 SEQUENCE (SIZE (1..maxFreq)) OF InterFreqCarrierFreqInfo-v10l0
        OPTIONAL,  -- Need OR
    nonCriticalExtension             SystemInformationBlockType5-v13a0-IEs   OPTIONAL
}

SystemInformationBlockType5-v13a0-IEs ::= SEQUENCE {
    -- Late non critical extensions from REL-10 upto REL-12
    lateNonCriticalExtension         OCTET STRING                        OPTIONAL,  -- Need OR
    interFreqCarrierFreqList-v13a0  InterFreqCarrierFreqList-v13a0  OPTIONAL,  -- Need OR
    -- Late non critical extensions from REL-13
    nonCriticalExtension             SEQUENCE { }                        OPTIONAL
}

InterFreqCarrierFreqList ::= SEQUENCE (SIZE (1..maxFreq)) OF InterFreqCarrierFreqInfo
InterFreqCarrierFreqList-v1250 ::= SEQUENCE (SIZE (1..maxFreq)) OF InterFreqCarrierFreqInfo-v1250
InterFreqCarrierFreqList-v1310 ::= SEQUENCE (SIZE (1..maxFreq)) OF InterFreqCarrierFreqInfo-v1310
InterFreqCarrierFreqList-v1350 ::= SEQUENCE (SIZE (1..maxFreq)) OF InterFreqCarrierFreqInfo-v1350
InterFreqCarrierFreqList-v13a0 ::= SEQUENCE (SIZE (1..maxFreq)) OF InterFreqCarrierFreqInfo-v1360
InterFreqCarrierFreqList-v1530 ::= SEQUENCE (SIZE (1..maxFreq)) OF InterFreqCarrierFreqInfo-v1530
InterFreqCarrierFreqList-v1610 ::= SEQUENCE (SIZE (1..maxFreq)) OF InterFreqCarrierFreqInfo-v1610
InterFreqCarrierFreqList-v1800 ::= SEQUENCE (SIZE (1..maxFreq)) OF InterFreqCarrierFreqInfo-v1800
InterFreqCarrierFreqListExt-r12 ::= SEQUENCE (SIZE (1..maxFreq)) OF InterFreqCarrierFreqInfo-r12
InterFreqCarrierFreqListExt-v1280 ::= SEQUENCE (SIZE (1..maxFreq)) OF InterFreqCarrierFreqInfo-
v10j0
InterFreqCarrierFreqListExt-v1310 ::= SEQUENCE (SIZE (1..maxFreq)) OF InterFreqCarrierFreqInfo-
v1310
InterFreqCarrierFreqListExt-v1350 ::= SEQUENCE (SIZE (1..maxFreq)) OF InterFreqCarrierFreqInfo-
v1350
InterFreqCarrierFreqListExt-v1360 ::= SEQUENCE (SIZE (1..maxFreq)) OF InterFreqCarrierFreqInfo-
v1360

```



```

InterFreqCarrierFreqListExt-v1530 ::= SEQUENCE (SIZE (1..maxFreq)) OF InterFreqCarrierFreqInfo-
v1530

InterFreqCarrierFreqListExt-v1610 ::= SEQUENCE (SIZE (1..maxFreq)) OF InterFreqCarrierFreqInfo-
v1610

InterFreqCarrierFreqListExt-v1800 ::= SEQUENCE (SIZE (1..maxFreq)) OF InterFreqCarrierFreqInfo-
v1800

InterFreqCarrierFreqInfo ::= SEQUENCE {
    dl-CarrierFreq ARFCN-ValueEUTRA,
    q-RxLevMin Q-RxLevMin,
    p-Max P-Max OPTIONAL, -- Need OP
    t-ReselectionEUTRA T-Reselection,
    t-ReselectionEUTRA-SF SpeedStateScaleFactors OPTIONAL, -- Need OP
    threshX-High ReselectionThreshold,
    threshX-Low ReselectionThreshold,
    allowedMeasBandwidth AllowedMeasBandwidth,
    presenceAntennaPort1 PresenceAntennaPort1,
    cellReselectionPriority CellReselectionPriority OPTIONAL, -- Need OP
    neighCellConfig NeighCellConfig,
    q-OffsetFreq Q-OffsetRange DEFAULT dB0,
    interFreqNeighCellList InterFreqNeighCellList OPTIONAL, -- Need OR
    interFreqExcludedCellList InterFreqExcludedCellList OPTIONAL, --
Need OR
    ...
    [[ q-QualMin-r9 Q-QualMin-r9 OPTIONAL, -- Need OP
        threshX-Q-r9 SEQUENCE {
            threshX-HighQ-r9 ReselectionThresholdQ-r9,
            threshX-LowQ-r9 ReselectionThresholdQ-r9
        } OPTIONAL -- Cond RSRQ
    ]],
    [[ q-QualMinWB-r11 Q-QualMin-r9 OPTIONAL -- Cond WB-RSRQ
    ]]
}

InterFreqCarrierFreqInfo-v8h0 ::= SEQUENCE {
    multiBandInfoList MultiBandInfoList OPTIONAL -- Need OR
}

InterFreqCarrierFreqInfo-v9e0 ::= SEQUENCE {
    dl-CarrierFreq-v9e0 ARFCN-ValueEUTRA-v9e0 OPTIONAL, -- Cond dl-FreqMax
    multiBandInfoList-v9e0 MultiBandInfoList-v9e0 OPTIONAL -- Need OR
}

InterFreqCarrierFreqInfo-v10j0 ::= SEQUENCE {
    freqBandInfo-r10 NS-PmaxList-r10 OPTIONAL, -- Need OR
    multiBandInfoList-v10j0 MultiBandInfoList-v10j0 OPTIONAL -- Need OR
}

InterFreqCarrierFreqInfo-v10l0 ::= SEQUENCE {
    freqBandInfo-v10l0 NS-PmaxList-v10l0 OPTIONAL, -- Need OR
    multiBandInfoList-v10l0 MultiBandInfoList-v10l0 OPTIONAL -- Need OR
}

InterFreqCarrierFreqInfo-v1250 ::= SEQUENCE {
    reducedMeasPerformance-r12 ENUMERATED {true} OPTIONAL, -- Need OP
    q-QualMinRSRQ-OnAllSymbols-r12 Q-QualMin-r9 OPTIONAL -- Cond RSRQ2
}

InterFreqCarrierFreqInfo-r12 ::= SEQUENCE {
    dl-CarrierFreq-r12 ARFCN-ValueEUTRA-r9,
    q-RxLevMin-r12 Q-RxLevMin,
    p-Max-r12 P-Max OPTIONAL, -- Need OP
    t-ReselectionEUTRA-r12 T-Reselection,
    t-ReselectionEUTRA-SF-r12 SpeedStateScaleFactors OPTIONAL, -- Need OP
    threshX-High-r12 ReselectionThreshold,
    threshX-Low-r12 ReselectionThreshold,
    allowedMeasBandwidth-r12 AllowedMeasBandwidth,
    presenceAntennaPort1-r12 PresenceAntennaPort1,
    cellReselectionPriority-r12 CellReselectionPriority OPTIONAL, -- Need OP
    neighCellConfig-r12 NeighCellConfig,
    q-OffsetFreq-r12 Q-OffsetRange DEFAULT dB0,
    interFreqNeighCellList-r12 InterFreqNeighCellList OPTIONAL, -- Need OR
    interFreqExcludedCellList-r12 InterFreqExcludedCellList OPTIONAL, --
Need OR
    q-QualMin-r12 Q-QualMin-r9 OPTIONAL, -- Need OP
    threshX-Q-r12 SEQUENCE {

```

```

        threshX-HighQ-r12                ReselectionThresholdQ-r9,
        threshX-LowQ-r12                 ReselectionThresholdQ-r9
    }
    q-QualMinWB-r12                      Q-QualMin-r9                OPTIONAL, -- Cond RSRQ
    multiBandInfoList-r12                MultiBandInfoList-r11     OPTIONAL, -- Need OR
    reducedMeasPerformance-r12           ENUMERATED {true}         OPTIONAL, -- Need OP
    q-QualMinRSRQ-OnAllSymbols-r12       Q-QualMin-r9                OPTIONAL, -- Cond RSRQ2
    ...
}

InterFreqCarrierFreqInfo-v1310 ::= SEQUENCE {
    cellReselectionSubPriority-r13        CellReselectionSubPriority-r13  OPTIONAL, -- Need
OP
    redistributionInterFreqInfo-r13      RedistributionInterFreqInfo-r13  OPTIONAL, --Need OP
    cellSelectionInfoCE-r13              CellSelectionInfoCE-r13         OPTIONAL, -- Need OP
    t-ReselectionEUTRA-CE-r13           T-ReselectionEUTRA-CE-r13      OPTIONAL, -- Need OP
}

InterFreqCarrierFreqInfo-v1350 ::= SEQUENCE {
    cellSelectionInfoCE1-r13             CellSelectionInfoCE1-r13        OPTIONAL, -- Need OP
}

InterFreqCarrierFreqInfo-v1360 ::= SEQUENCE {
    cellSelectionInfoCE1-v1360           CellSelectionInfoCE1-v1360      OPTIONAL, -- Cond QrxlevminCE1
}

InterFreqCarrierFreqInfo-v1530 ::= SEQUENCE {
    hsdn-Indication-r15                  BOOLEAN,
    interFreqNeighHSDN-CellList-r15      InterFreqNeighHSDN-CellList-r15  OPTIONAL, -- Need OR
    cellSelectionInfoCE-v1530            CellSelectionInfoCE-v1530        OPTIONAL, -- Need OP
}

InterFreqCarrierFreqInfo-v1610 ::= SEQUENCE {
    altCellReselectionPriority-r16        CellReselectionPriority          OPTIONAL, -- Need OR
    altCellReselectionSubPriority-r16     CellReselectionSubPriority-r13   OPTIONAL, -- Need OR
    rss-ConfigCarrierInfo-r16            RSS-ConfigCarrierInfo-r16       OPTIONAL, -- Cond RSS
    interFreqNeighCellList-v1610         InterFreqNeighCellList-v1610    OPTIONAL, -- Cond RSS
}

InterFreqCarrierFreqInfo-v1800 ::= SEQUENCE {
    satelliteAssistanceInfoList-r18       SEQUENCE (SIZE(1..maxSat-r17)) OF SatelliteId-r18
                                        OPTIONAL, -- Need OR
    freqBandIndicatorAerial-r18           FreqBandIndicator-r11           OPTIONAL, -- Need OR
    freqBandInfoAerial-r18               NS-PmaxListAerial-r18           OPTIONAL, -- Need OR
    multiBandInfoListAerial-r18          MultiBandInfoListAerial-r18     OPTIONAL, -- Need OR
}

InterFreqNeighCellList ::= SEQUENCE (SIZE (1..maxCellInter)) OF InterFreqNeighCellInfo

InterFreqNeighCellList-v1610 ::= SEQUENCE (SIZE (1..maxCellInter)) OF InterFreqNeighCellInfo-v1610

InterFreqNeighHSDN-CellList-r15 ::= SEQUENCE (SIZE (1..maxCellInter)) OF PhysCellIdRange

InterFreqNeighCellInfo ::= SEQUENCE {
    physCellId                            PhysCellId,
    q-OffsetCell                           Q-OffsetRange
}

InterFreqNeighCellInfo-v1610 ::= SEQUENCE {
    rss-MeasPowerBias-r16                 RSS-MeasPowerBias-r16
}

InterFreqExcludedCellList ::= SEQUENCE (SIZE (1..maxExcludedCell)) OF PhysCellIdRange

RedistributionInterFreqInfo-r13 ::= SEQUENCE {
    redistributionFactorFreq-r13           RedistributionFactor-r13         OPTIONAL, --Need OP
    redistributionNeighCellList-r13       RedistributionNeighCellList-r13  OPTIONAL, --Need
OP
}

RedistributionNeighCellList-r13 ::= SEQUENCE (SIZE (1..maxCellInter)) OF RedistributionNeighCell-r13

RedistributionNeighCell-r13 ::= SEQUENCE {
    physCellId-r13                        PhysCellId,
    redistributionFactorCell-r13          RedistributionFactor-r13
}

```

```
RedistributionFactor-r13 ::= INTEGER(1..10)
-- ASN1STOP
```

<b>SystemInformationBlockType5 field descriptions</b>
<p><b>altCellReselectionPriority</b> Alternative cell reselection priorities to be used by the UEs for which the <i>altFreqPriorities</i> is set to <i>true</i> in the <i>RRCCONNECTIONRELEASE</i> message.</p>
<p><b>altCellReselectionSubPriority</b> Alternative cell reselection sub-priorities to be used by the UEs for which the <i>altFreqPriorities</i> is set to <i>true</i> in the <i>RRCCONNECTIONRELEASE</i> message.</p>
<p><b>cellSelectionInfoCE</b> Parameters included in coverage enhancement S criteria for BL UEs and UEs in CE, applicable for inter-frequency neighbour cells. If absent, coverage enhancement S criteria is not applicable.</p>
<p><b>cellSelectionInfoCE1</b> Parameters included in coverage enhancement S criteria for BL UEs and UEs in CE supporting CE Mode B. E-UTRAN includes this IE only in an entry of <i>InterFreqCarrierFreqList-v1350</i> or <i>InterFreqCarrierFreqListExt-v1350</i> if <i>cellSelectionInfoCE</i> is present in the corresponding entry of <i>InterFreqCarrierFreqList-v1310</i> or <i>InterFreqCarrierFreqListExt-v1310</i> is present.</p>
<p><b>freqBandInfo</b> A list of <i>additionalPmax</i> and <i>additionalSpectrumEmission</i> values, as defined in TS 36.101 [42], table 6.2.4-1, for UEs neither in CE nor BL UEs, TS 36.101 [42], table 6.2.4E-1, for UEs in CE or BL UEs and TS 36.102 [113], table 6.2A.3-1, for NTN capable UE, for the frequency band represented by <i>dl-CarrierFreq</i> for which cell reselection parameters are common. If E-UTRAN includes <i>freqBandInfo-v1010</i> it includes the same number of entries, and listed in the same order, as in <i>freqBandInfo-r10</i>.</p>
<p><b>hsdn-Indication</b> Indicates whether there are deployed HSDN cells or not on the the DL carrier frequency indicated by <i>dl-CarrierFreq-r12</i>.</p>
<p><b>interFreqCarrierFreqList</b> List of neighbouring inter-frequencies. E-UTRAN does not configure more than one entry for the same physical frequency regardless of the E-ARFCN used to indicate this. If E-UTRAN includes <i>interFreqCarrierFreqList-v8h0</i>, <i>interFreqCarrierFreqList-v9e0</i>, <i>InterFreqCarrierFreqList-v1250</i>, <i>InterFreqCarrierFreqList-v1310</i>, <i>InterFreqCarrierFreqList-v1350</i>, <i>InterFreqCarrierFreqList-v13a0</i>, <i>InterFreqCarrierFreqList-v1530</i>, <i>InterFreqCarrierFreqList-v1610</i>, and/or <i>InterFreqCarrierFreqList-v1800</i>, it includes the same number of entries, and listed in the same order, as in <i>interFreqCarrierFreqList</i> (i.e. without suffix). See Annex D for more descriptions.</p>
<p><b>interFreqCarrierFreqListExt</b> List of additional neighbouring inter-frequencies, i.e. extending the size of the inter-frequency carrier list using the general principles specified in 5.1.2. E-UTRAN does not configure more than one entry for the same physical frequency regardless of the E-ARFCN used to indicate this. EUTRAN may include <i>interFreqCarrierFreqListExt</i> even if <i>interFreqCarrierFreqList</i> (i.e. without suffix) does not include <i>maxFreq</i> entries. If E-UTRAN includes <i>InterFreqCarrierFreqListExt-v1310</i>, <i>InterFreqCarrierFreqListExt-v1350</i>, <i>InterFreqCarrierFreqListExt-v1360</i>, <i>InterFreqCarrierFreqListExt-v1530</i>, <i>InterFreqCarrierFreqListExt-v1610</i>, and/or <i>InterFreqCarrierFreqListExt-v1800</i>, it includes the same number of entries, and listed in the same order, as in <i>interFreqCarrierFreqListExt-r12</i>.</p>
<p><b>interFreqExcludedCellList</b> List of exclude-listed inter-frequency neighbouring cells.</p>
<p><b>interFreqNeighCellList</b> List of inter-frequency neighbouring cells with specific cell re-selection parameters. <i>interFreqNeighCellList-v1610</i> indicates list of RSS assistance information which is used for the corresponding <i>physCellId</i>. If E-UTRAN includes <i>interFreqNeighCellList-v1610</i> in <i>interFreqCarrierFreqList-v1610</i> / <i>interFreqCarrierFreqListExt-v1610</i>, it includes the same number of entries, and listed in the same order, as in <i>interFreqNeighCellList</i> (i.e. without suffix) / <i>interFreqNeighCellList-r12</i>. If <i>interFreqNeighCellList-v1610</i> is absent in <i>interFreqCarrierFreqList-v1610</i> / <i>interFreqCarrierFreqListExt-v1610</i>, measurement based on RSS is not applicable for all the neighbour cells in <i>interFreqNeighCellList</i> (i.e. without suffix) / <i>interFreqNeighCellList-r12</i>.</p>
<p><b>interFreqNeighHSDN-CellList</b> List of inter-frequency neighbouring HSDN cells as specified in TS 36.304 [4].</p>
<p><b>measIdleConfigSIB</b> Indicates E-UTRA measurement configuration to be stored and used by the UE while in RRC_IDLE or RRC_INACTIVE.</p>
<p><b>measIdleConfigSIB-NR</b> Indicates the NR measurement configuration to be stored and used by the UE while in RRC_IDLE or RRC_INACTIVE.</p>
<p><b>multiBandInfoList</b> Indicates the list of frequency bands in addition to the band represented by <i>dl-CarrierFreq</i> for which cell reselection parameters are common. E-UTRAN indicates at most <i>maxMultiBands</i> frequency bands (i.e. the total number of entries across both <i>multiBandInfoList</i> and <i>multiBandInfoList-v9e0</i> is below this limit).</p>
<p><b>multiBandInfoList-v10j0</b> A list of <i>additionalPmax</i> and <i>additionalSpectrumEmission</i> values, as defined in TS 36.101 [42], table 6.2.4-1, for UEs neither in CE nor BL UEs, TS 36.101 [42], table 6.2.4E-1, for UEs in CE or BL UEs and TS 36.102 [113], table 6.2A.3-1, for NTN capable UE, for the frequency bands in <i>multiBandInfoList</i> (i.e. without suffix) and <i>multiBandInfoList-v9e0</i>. If E-UTRAN includes <i>multiBandInfoList-v10j0</i>, it includes the same number of entries, and listed in the same order, as in <i>multiBandInfoList</i> (i.e. without suffix). If E-UTRAN includes <i>multiBandInfoList-v1010</i> it includes the same number of entries, and listed in the same order, as in <i>multiBandInfoList-v10j0</i>.</p>

<b>SystemInformationBlockType5 field descriptions</b>
<p><b>altCellReselectionPriority</b> Alternative cell reselection priorities to be used by the UEs for which the <i>altFreqPriorities</i> is set to <i>true</i> in the <i>RRCCConnectionRelease</i> message.</p>
<p><b>altCellReselectionSubPriority</b> Alternative cell reselection sub-priorities to be used by the UEs for which the <i>altFreqPriorities</i> is set to <i>true</i> in the <i>RRCCConnectionRelease</i> message.</p>
<p><b>p-Max</b> Value applicable for the neighbouring E-UTRA cells on this carrier frequency. If absent the UE applies the maximum power according to its capability as specified in TS 36.101 [42], clause 6.2.2. This field is ignored by IAB-MT. The IAB-MT applies output power and emissions requirements, as specified in TS 38.174 [107].</p>
<p><b>q-OffsetCell</b> Parameter "Qoffset<sub>s,n</sub>" in TS 36.304 [4].</p>
<p><b>q-OffsetFreq</b> Parameter "Qoffset<sub>frequency</sub>" in TS 36.304 [4].</p>
<p><b>q-QualMin</b> Parameter "Q<sub>qualmin</sub>" in TS 36.304 [4]. If the field is not present, the UE applies the (default) value of negative infinity for Q<sub>qualmin</sub>. NOTE 1.</p>
<p><b>q-QualMinRSRQ-OnAllSymbols</b> If this field is present and supported by the UE, the UE shall, when performing RSRQ measurements, perform RSRQ measurement on all OFDM symbols in accordance with TS 36.214 [48]. NOTE 1.</p>
<p><b>q-QualMinWB</b> If this field is present and supported by the UE, the UE shall, when performing RSRQ measurements, use a wider bandwidth in accordance with TS 36.133 [16]. NOTE 1.</p>
<p><b>redistributionFactorFreq</b> Parameter <i>redistributionFactorFreq</i> in TS 36.304 [4].</p>
<p><b>redistributionFactorCell</b> Parameter <i>redistributionFactorCell</i> in TS 36.304 [4].</p>
<p><b>reducedMeasPerformance</b> Value <i>TRUE</i> indicates that the neighbouring inter-frequency is configured for reduced measurement performance, see TS 36.133 [16]. If the field is not included, the neighbouring inter-frequency is configured for normal measurement performance, see TS 36.133 [16].</p>
<p><b>rss-ConfigCarrierInfo</b> RSS configuration for this carrier frequency. If absent and <i>rss-MeasConfig</i> is included in <i>SIB2</i>, RSS is collocated (time and frequency domain) in all cells on this carrier.</p>
<p><b>satelliteAssistanceInfoList</b> List of satellite ID(s), used to associate with the satellite assistance information for neighbour cell measurements on this frequency. If the field is not present for a frequency and <i>SystemInformationBlockType33</i> is broadcast, the UE considers the cells on the frequency to be terrestrial cells.</p>
<p><b>scptm-FreqOffset</b> Parameter Qoffset<sub>SCPTM</sub> in TS 36.304 [4]. Actual value Qoffset<sub>SCPTM</sub> = field value * 2 [dB]. If the field is not present, the UE uses infinite dBs for the SC-PTM frequency offset with cell ranking as specified in TS 36.304 [4].</p>
<p><b>threshX-High</b> Parameter "Thresh<sub>X, HighP</sub>" in TS 36.304 [4].</p>
<p><b>threshX-HighQ</b> Parameter "Thresh<sub>X, HighQ</sub>" in TS 36.304 [4].</p>
<p><b>threshX-Low</b> Parameter "Thresh<sub>X, LowP</sub>" in TS 36.304 [4].</p>
<p><b>threshX-LowQ</b> Parameter "Thresh<sub>X, LowQ</sub>" in TS 36.304 [4].</p>
<p><b>t-ReselectionEUTRA</b> Parameter "T<sub>reselectionEUTRA</sub>" in TS 36.304 [4].</p>
<p><b>t-ReselectionEUTRA-SF</b> Parameter "Speed dependent ScalingFactor for T<sub>reselectionEUTRA</sub>" in TS 36.304 [4]. If the field is not present, the UE behaviour is specified in TS 36.304 [4].</p>

NOTE 1: The value the UE applies for parameter "Q<sub>qualmin</sub>" in TS 36.304 [4] depends on the *q-QualMin* fields signalled by E-UTRAN and supported by the UE. In case multiple candidate options are available, the UE shall select the highest priority candidate option according to the priority order indicated by the following table (top row is highest priority).

q-QualMinRSRQ-OnAllSymbols	q-QualMinWB	Value of parameter "Q <sub>qualmin</sub> " in TS 36.304 [4]
Included	Included	$q\text{-QualMinRSRQ-OnAllSymbols} - (q\text{-QualMin} - q\text{-QualMinWB})$
Included	Not included	$q\text{-QualMinRSRQ-OnAllSymbols}$
Not included	Included	$q\text{-QualMinWB}$
Not included	Not included	$q\text{-QualMin}$

Conditional presence	Explanation
<i>dl-FreqMax</i>	The field is mandatory present if, for the corresponding entry in <i>InterFreqCarrierFreqList</i> (i.e. without suffix), <i>dl-CarrierFreq</i> (i.e. without suffix) is set to <i>maxEARFCN</i> . Otherwise the field is not present.
<i>QrxlevminCE1</i>	The field is optionally present, Need OR, if <i>q-RxLevMinCE1-r13</i> is set below -140 dBm. Otherwise the field is not present.
<i>RSRQ</i>	The field is mandatory present if <i>threshServingLowQ</i> is present in <i>systemInformationBlockType3</i> ; otherwise it is not present.
<i>RSRQ2</i>	The field is mandatory present for all EUTRA carriers listed in SIB5 if <i>q-QualMinRSRQ-OnAllSymbols</i> is present in SIB3; otherwise it is not present and the UE shall delete any existing value for this field.
<i>RSS</i>	This field is optional, need OP, if <i>rss-MeasConfig</i> is included in SIB2. Otherwise the field is not present, and the UE shall delete any existing value for this field.
<i>WB-RSRQ</i>	The field is optionally present, need OP if the measurement bandwidth indicated by <i>allowedMeasBandwidth</i> is 50 resource blocks or larger; otherwise it is not present.

## SystemInformationBlockType6

The IE *SystemInformationBlockType6* contains information relevant only for inter-RAT cell re-selection i.e. information about UTRA frequencies and UTRA neighbouring cells relevant for cell re-selection. The IE includes cell re-selection parameters common for a frequency.

### SystemInformationBlockType6 information element

```
-- ASN1START
SystemInformationBlockType6 ::= SEQUENCE {
    carrierFreqListUTRA-FDD CarrierFreqListUTRA-FDD OPTIONAL, -- Need OR
    carrierFreqListUTRA-TDD CarrierFreqListUTRA-TDD OPTIONAL, -- Need OR
    t-ReselectionUTRA T-Reselection,
    t-ReselectionUTRA-SF SpeedStateScaleFactors OPTIONAL, -- Need OP
    . . . ,
    lateNonCriticalExtension OCTET STRING (CONTAINING SystemInformationBlockType6-
v8h0-IEs) OPTIONAL,
    [[ carrierFreqListUTRA-FDD-v1250 SEQUENCE (SIZE (1..maxUTRA-FDD-Carrier)) OF
        CarrierFreqInfoUTRA-v1250 OPTIONAL, -- Cond UTRA-FDD
        carrierFreqListUTRA-TDD-v1250 SEQUENCE (SIZE (1..maxUTRA-TDD-Carrier)) OF
        CarrierFreqInfoUTRA-v1250 OPTIONAL, -- Cond UTRA-TDD
        carrierFreqListUTRA-FDD-Ext-r12 CarrierFreqListUTRA-FDD-Ext-r12 OPTIONAL, -- Cond UTRA-FDD
        carrierFreqListUTRA-TDD-Ext-r12 CarrierFreqListUTRA-TDD-Ext-r12 OPTIONAL -- Cond
UTRA-TDD
    ]]
}

SystemInformationBlockType6-v8h0-IEs ::= SEQUENCE {
    carrierFreqListUTRA-FDD-v8h0 SEQUENCE (SIZE (1..maxUTRA-FDD-Carrier)) OF CarrierFreqInfoUTRA-
FDD-v8h0 OPTIONAL, -- Cond UTRA-FDD
    nonCriticalExtension SEQUENCE {} OPTIONAL
}

CarrierFreqInfoUTRA-v1250 ::= SEQUENCE {
    reducedMeasPerformance-r12 ENUMERATED {true} OPTIONAL -- Need OP
}

CarrierFreqListUTRA-FDD ::= SEQUENCE (SIZE (1..maxUTRA-FDD-Carrier)) OF CarrierFreqUTRA-FDD

CarrierFreqUTRA-FDD ::= SEQUENCE {
    carrierFreq ARFCN-ValueUTRA,
    cellReselectionPriority CellReselectionPriority OPTIONAL, -- Need OP
    threshX-High ReselectionThreshold,
    threshX-Low ReselectionThreshold,
    q-RxLevMin INTEGER (-60..-13),

```

```

p-MaxUTRA                INTEGER (-50..33),
q-QualMin                 INTEGER (-24..0),
...
[[ threshX-Q-r9           SEQUENCE {
    threshX-HighQ-r9      ReselectionThresholdQ-r9,
    threshX-LowQ-r9       ReselectionThresholdQ-r9
  }
]]
                                                                    OPTIONAL      -- Cond RSRQ
}

CarrierFreqInfoUTRA-FDD-v8h0 ::= SEQUENCE {
  multiBandInfoList      SEQUENCE (SIZE (1..maxMultiBands)) OF FreqBandIndicator-
UTRA-FDD                 OPTIONAL      -- Need OR
}

CarrierFreqListUTRA-FDD-Ext-r12 ::= SEQUENCE (SIZE (1..maxUTRA-FDD-Carrier)) OF
CarrierFreqUTRA-FDD-Ext-r12

CarrierFreqUTRA-FDD-Ext-r12 ::= SEQUENCE {
  carrierFreq-r12         ARFCN-ValueUTRA,
  cellReselectionPriority-r12 CellReselectionPriority      OPTIONAL,      -- Need OP
  threshX-High-r12        ReselectionThreshold,
  threshX-Low-r12         ReselectionThreshold,
  q-RxLevMin-r12          INTEGER (-60..-13),
  p-MaxUTRA-r12           INTEGER (-50..33),
  q-QualMin-r12           INTEGER (-24..0),
  threshX-Q-r12           SEQUENCE {
    threshX-HighQ-r12     ReselectionThresholdQ-r9,
    threshX-LowQ-r12      ReselectionThresholdQ-r9
  }
                                                                    OPTIONAL,      -- Cond RSRQ
  multiBandInfoList-r12  SEQUENCE (SIZE (1..maxMultiBands)) OF FreqBandIndicator-
UTRA-FDD                 OPTIONAL,      -- Need OR
  reducedMeasPerformance-r12 ENUMERATED {true}              OPTIONAL,      -- Need OP
  ...
}

CarrierFreqListUTRA-TDD ::= SEQUENCE (SIZE (1..maxUTRA-TDD-Carrier)) OF CarrierFreqUTRA-TDD

CarrierFreqUTRA-TDD ::= SEQUENCE {
  carrierFreq             ARFCN-ValueUTRA,
  cellReselectionPriority CellReselectionPriority      OPTIONAL,      -- Need OP
  threshX-High            ReselectionThreshold,
  threshX-Low             ReselectionThreshold,
  q-RxLevMin              INTEGER (-60..-13),
  p-MaxUTRA               INTEGER (-50..33),
  ...
}

CarrierFreqListUTRA-TDD-Ext-r12 ::= SEQUENCE (SIZE (1..maxUTRA-TDD-Carrier)) OF
CarrierFreqUTRA-TDD-r12

CarrierFreqUTRA-TDD-r12 ::= SEQUENCE {
  carrierFreq-r12         ARFCN-ValueUTRA,
  cellReselectionPriority-r12 CellReselectionPriority      OPTIONAL,      -- Need OP
  threshX-High-r12        ReselectionThreshold,
  threshX-Low-r12         ReselectionThreshold,
  q-RxLevMin-r12          INTEGER (-60..-13),
  p-MaxUTRA-r12           INTEGER (-50..33),
  reducedMeasPerformance-r12 ENUMERATED {true}              OPTIONAL,      -- Need OP
  ...
}

FreqBandIndicator-UTRA-FDD ::= INTEGER (1..86)

-- ASN1STOP

```

<b>SystemInformationBlockType6 field descriptions</b>	
<b>carrierFreqListUTRA-FDD</b>	List of carrier frequencies of UTRA FDD. E-UTRAN does not configure more than one entry for the same physical frequency regardless of the ARFCN used to indicate this. If E-UTRAN includes <i>carrierFreqListUTRA-FDD-v8h0</i> and/or <i>carrierFreqListUTRA-FDD-v1250</i> , it includes the same number of entries, and listed in the same order, as in <i>carrierFreqListUTRA-FDD</i> (i.e. without suffix). See Annex D for more descriptions.
<b>carrierFreqListUTRA-FDD-Ext</b>	List of additional carrier frequencies of UTRA FDD. E-UTRAN does not configure more than one entry for the same physical frequency regardless of the ARFCN used to indicate this. EUTRAN may include <i>carrierFreqListUTRA-FDD-Ext</i> even if <i>carrierFreqListUTRA-FDD</i> (i.e without suffix) does not include <i>maxUTRA-FDD-Carrier</i> entries.
<b>carrierFreqListUTRA-TDD</b>	List of carrier frequencies of UTRA TDD. E-UTRAN does not configure more than one entry for the same physical frequency regardless of the ARFCN used to indicate this. If E-UTRAN includes <i>carrierFreqListUTRA-TDD-v1250</i> , it includes the same number of entries, and listed in the same order, as in <i>carrierFreqListUTRA-TDD</i> (i.e. without suffix).
<b>carrierFreqListUTRA-TDD-Ext</b>	List of additional carrier frequencies of UTRA TDD. E-UTRAN does not configure more than one entry for the same physical frequency regardless of the ARFCN used to indicate this. EUTRAN may include <i>carrierFreqListUTRA-TDD-Ext</i> even if <i>carrierFreqListUTRA-TDD</i> (i.e without suffix) does not include <i>maxUTRA-TDD-Carrier</i> entries.
<b>multiBandInfoList</b>	Indicates the list of frequency bands in addition to the band represented by <i>carrierFreq</i> in the <i>CarrierFreqUTRA-FDD</i> for which UTRA cell reselection parameters are common.
<b>p-MaxUTRA</b>	The maximum allowed transmission power on the (uplink) carrier frequency, see TS 25.304 [40]. In dBm
<b>q-QualMin</b>	Parameter "Q <sub>qualmin</sub> " in TS 25.304 [40]. Actual value = field value [dB].
<b>q-RxLevMin</b>	Parameter "Q <sub>rxlevmin</sub> " in TS 25.304 [40]. Actual value = field value * 2+1 [dBm].
<b>reducedMeasPerformance</b>	Value <i>TRUE</i> indicates that the UTRA carrier frequency is configured for reduced measurement performance, see TS 36.133 [16]. If the field is not included, the UTRA carrier frequency is configured for normal measurement performance, see TS 36.133 [16].
<b>t-ReselectionUTRA</b>	Parameter "T <sub>reselectionUTRAN</sub> " in TS 36.304 [4].
<b>t-ReselectionUTRA-SF</b>	Parameter "Speed dependent ScalingFactor for T <sub>reselectionUTRA</sub> " in TS 36.304 [4]. If the field is not present, the UE behaviour is specified in TS 36.304 [4].
<b>threshX-High</b>	Parameter "Thresh <sub>X, HighP</sub> " in TS 36.304 [4].
<b>threshX-HighQ</b>	Parameter "Thresh <sub>X, HighQ</sub> " in TS 36.304 [4].
<b>threshX-Low</b>	Parameter "Thresh <sub>X, LowP</sub> " in TS 36.304 [4].
<b>threshX-LowQ</b>	Parameter "Thresh <sub>X, LowQ</sub> " in TS 36.304 [4].

Conditional presence	Explanation
RSRQ	The field is mandatory present if the <i>threshServingLowQ</i> is present in <i>systemInformationBlockType3</i> ; otherwise it is not present.
UTRA-FDD	The field is optionally present, need OR, if the <i>carrierFreqListUTRA-FDD</i> is present. Otherwise it is not present.
UTRA-TDD	The field is optionally present, need OR, if the <i>carrierFreqListUTRA-TDD</i> is present. Otherwise it is not present.

## SystemInformationBlockType7

The IE *SystemInformationBlockType7* contains information relevant only for inter-RAT cell re-selection i.e. information about GERAN frequencies relevant for cell re-selection. The IE includes cell re-selection parameters for each frequency.

### SystemInformationBlockType7 information element

```
-- ASN1START
```

```
SystemInformationBlockType7 ::= SEQUENCE {
    t-ReselectionGERAN          T-Reselection,
```



```

t-ReselectionGERAN-SF          SpeedStateScaleFactors          OPTIONAL,  -- Need OR
carrierFreqsInfoList          CarrierFreqsInfoListGERAN        OPTIONAL,  -- Need OR
...
lateNonCriticalExtension      OCTET STRING                      OPTIONAL
}

CarrierFreqsInfoListGERAN ::= SEQUENCE (SIZE (1..maxGNFG)) OF CarrierFreqsInfoGERAN

CarrierFreqsInfoGERAN ::= SEQUENCE {
  carrierFreqs                  CarrierFreqsGERAN,
  commonInfo                    SEQUENCE {
    cellReselectionPriority      CellReselectionPriority          OPTIONAL,  -- Need OP
    ncc-Permitted                BIT STRING (SIZE (8)),
    q-RxLevMin                   INTEGER (0..45),
    p-MaxGERAN                   INTEGER (0..39)                  OPTIONAL,  -- Need OP
    threshX-High                 ReselectionThreshold,
    threshX-Low                 ReselectionThreshold
  },
  ...
}

-- ASN1STOP

```

### SystemInformationBlockType7 field descriptions

<b>carrierFreqs</b>	The list of GERAN carrier frequencies organised into one group of GERAN carrier frequencies.
<b>carrierFreqsInfoList</b>	Provides a list of neighbouring GERAN carrier frequencies, which may be monitored for neighbouring GERAN cells. The GERAN carrier frequencies are organised in groups and the cell reselection parameters are provided per group of GERAN carrier frequencies.
<b>commonInfo</b>	Defines the set of cell reselection parameters for the group of GERAN carrier frequencies.
<b>ncc-Permitted</b>	Field encoded as a bit map, where bit N is set to "0" if a BCCH carrier with NCC = N-1 is not permitted for monitoring and set to "1" if the BCCH carrier with NCC = N-1 is permitted for monitoring; N = 1 to 8; bit 1 of the bitmap is the leading bit of the bit string.
<b>p-MaxGERAN</b>	Maximum allowed transmission power for GERAN on an uplink carrier frequency, see TS 45.008 [28]. Value in dBm. Applicable for the neighbouring GERAN cells on this carrier frequency. If <i>pmaxGERAN</i> is absent, the maximum power according to the UE capability is used.
<b>q-RxLevMin</b>	Parameter "Q <sub>rxlevmin</sub> " in TS 36.304 [4], minimum required RX level in the GSM cell. The actual value of Q <sub>rxlevmin</sub> in dBm = (field value * 2) – 115.
<b>threshX-High</b>	Parameter "Thresh <sub>X, HighP</sub> " in TS 36.304 [4].
<b>threshX-Low</b>	Parameter "Thresh <sub>X, LowP</sub> " in TS 36.304 [4].
<b>t-ReselectionGERAN</b>	Parameter "T <sub>reselectionGERAN</sub> " in TS 36.304 [4].
<b>t-ReselectionGERAN-SF</b>	Parameter "Speed dependent ScalingFactor for T <sub>reselectionGERAN</sub> " in TS 36.304 [4]. If the field is not present, the UE behaviour is specified in TS 36.304 [4].

### SystemInformationBlockType8

The IE *SystemInformationBlockType8* contains information relevant only for inter-RAT cell re-selection i.e. information about CDMA2000 frequencies and CDMA2000 neighbouring cells relevant for cell re-selection. The IE includes cell re-selection parameters common for a frequency as well as cell specific re-selection parameters.

### SystemInformationBlockType8 information element

```

-- ASN1START

SystemInformationBlockType8 ::= SEQUENCE {
  systemTimeInfo                SystemTimeInfoCDMA2000          OPTIONAL,  -- Need OR
  searchWindowSize              INTEGER (0..15)                    OPTIONAL,  -- Need OR
  parametersHRPD                SEQUENCE {
    preRegistrationInfoHRPD      PreRegistrationInfoHRPD,

```

```

        cellReselectionParametersHRPD          CellReselectionParametersCDMA2000  OPTIONAL -- Need OR
    }
    parameters1XRTT                            SEQUENCE {
        csfb-RegistrationParam1XRTT            CSFB-RegistrationParam1XRTT      OPTIONAL, -- Need OP
        longCodeState1XRTT                    BIT STRING (SIZE (42))           OPTIONAL, -- Need OR
        cellReselectionParameters1XRTT        CellReselectionParametersCDMA2000  OPTIONAL -- Need OR
    }
    ...,
    lateNonCriticalExtension                   OCTET STRING                      OPTIONAL,
    [[ csfb-SupportForDualRxUEs-r9            BOOLEAN                          OPTIONAL, -- Need OR
    cellReselectionParametersHRPD-v920       CellReselectionParametersCDMA2000-v920  OPTIONAL, --
Cond NCL-HRPD
    cellReselectionParameters1XRTT-v920     CellReselectionParametersCDMA2000-v920  OPTIONAL, --
Cond NCL-1XRTT
    csfb-RegistrationParam1XRTT-v920        CSFB-RegistrationParam1XRTT-v920      OPTIONAL, --
Cond REG-1XRTT
    ac-BarringConfig1XRTT-r9                 AC-BarringConfig1XRTT-r9           OPTIONAL -- Cond REG-
1XRTT
    ]],
    [[ csfb-DualRxTxSupport-r10              ENUMERATED {true}                 OPTIONAL -- Cond REG-
1XRTT
    ]],
    [[ sib8-PerPLMN-List-r11                 SIB8-PerPLMN-List-r11            OPTIONAL -- Need OR
    ]]
}

CellReselectionParametersCDMA2000 ::= SEQUENCE {
    bandClassList                            BandClassListCDMA2000,
    neighCellList                            NeighCellListCDMA2000,
    t-ReselectionCDMA2000                    T-Reselection,
    t-ReselectionCDMA2000-SF                 SpeedStateScaleFactors            OPTIONAL -- Need OP
}

CellReselectionParametersCDMA2000-r11 ::= SEQUENCE {
    bandClassList                            BandClassListCDMA2000,
    neighCellList-r11                        SEQUENCE (SIZE (1..16)) OF NeighCellCDMA2000-r11,
    t-ReselectionCDMA2000                    T-Reselection,
    t-ReselectionCDMA2000-SF                 SpeedStateScaleFactors            OPTIONAL -- Need OP
}

CellReselectionParametersCDMA2000-v920 ::= SEQUENCE {
    neighCellList-v920                        NeighCellListCDMA2000-v920
}

NeighCellListCDMA2000 ::= SEQUENCE (SIZE (1..16)) OF NeighCellCDMA2000

NeighCellCDMA2000 ::= SEQUENCE {
    bandClass                                BandclassCDMA2000,
    neighCellsPerFreqList                    NeighCellsPerBandclassListCDMA2000
}

NeighCellCDMA2000-r11 ::= SEQUENCE {
    bandClass                                BandclassCDMA2000,
    neighFreqInfoList-r11                    SEQUENCE (SIZE (1..16)) OF NeighCellsPerBandclassCDMA2000-
r11
}

NeighCellsPerBandclassListCDMA2000 ::= SEQUENCE (SIZE (1..16)) OF NeighCellsPerBandclassCDMA2000

NeighCellsPerBandclassCDMA2000 ::= SEQUENCE {
    arfcn                                    ARFCN-ValueCDMA2000,
    physCellIdList                            PhysCellIdListCDMA2000
}

NeighCellsPerBandclassCDMA2000-r11 ::= SEQUENCE {
    arfcn                                    ARFCN-ValueCDMA2000,
    physCellIdList-r11                        SEQUENCE (SIZE (1..40)) OF PhysCellIdCDMA2000
}

NeighCellListCDMA2000-v920 ::= SEQUENCE (SIZE (1..16)) OF NeighCellCDMA2000-v920

NeighCellCDMA2000-v920 ::= SEQUENCE {
    neighCellsPerFreqList-v920                NeighCellsPerBandclassListCDMA2000-v920
}

NeighCellsPerBandclassListCDMA2000-v920 ::= SEQUENCE (SIZE (1..16)) OF
NeighCellsPerBandclassCDMA2000-v920

```

```

NeighCellsPerBandclassCDMA2000-v920 ::= SEQUENCE {
    physCellIdList-v920          PhysCellIdListCDMA2000-v920
}

PhysCellIdListCDMA2000 ::= SEQUENCE (SIZE (1..16)) OF PhysCellIdCDMA2000

PhysCellIdListCDMA2000-v920 ::= SEQUENCE (SIZE (0..24)) OF PhysCellIdCDMA2000

BandClassListCDMA2000 ::= SEQUENCE (SIZE (1..maxCDMA-BandClass)) OF BandClassInfoCDMA2000

BandClassInfoCDMA2000 ::= SEQUENCE {
    bandClass                    BandclassCDMA2000,
    cellReselectionPriority      CellReselectionPriority          OPTIONAL, -- Need OP
    threshX-High                INTEGER (0..63),
    threshX-Low                 INTEGER (0..63),
    ...
}

AC-BarringConfig1XRTT-r9 ::= SEQUENCE {
    ac-Barring0to9-r9           INTEGER (0..63),
    ac-Barring10-r9            INTEGER (0..7),
    ac-Barring11-r9            INTEGER (0..7),
    ac-Barring12-r9            INTEGER (0..7),
    ac-Barring13-r9            INTEGER (0..7),
    ac-Barring14-r9            INTEGER (0..7),
    ac-Barring15-r9            INTEGER (0..7),
    ac-BarringMsg-r9           INTEGER (0..7),
    ac-BarringReg-r9           INTEGER (0..7),
    ac-BarringEmg-r9           INTEGER (0..7)
}

SIB8-PerPLMN-List-r11 ::= SEQUENCE (SIZE (1..maxPLMN-r11)) OF SIB8-PerPLMN-r11

SIB8-PerPLMN-r11 ::= SEQUENCE {
    plmn-Identity-r11          INTEGER (1..maxPLMN-r11),
    parametersCDMA2000-r11    CHOICE {
        explicitValue          ParametersCDMA2000-r11,
        defaultValue          NULL
    }
}

ParametersCDMA2000-r11 ::= SEQUENCE {
    systemTimeInfo-r11        CHOICE {
        explicitValue          SystemTimeInfoCDMA2000,
        defaultValue          NULL
    }
    searchWindowSize-r11      INTEGER (0..15),
    parametersHRPD-r11        SEQUENCE {
        preRegistrationInfoHRPD-r11 PreRegistrationInfoHRPD,
        cellReselectionParametersHRPD-r11 CellReselectionParametersCDMA2000-r11 OPTIONAL -- Need
OR
    }
    parameters1XRTT-r11       SEQUENCE {
        csfb-RegistrationParam1XRTT-r11 CSFB-RegistrationParam1XRTT          OPTIONAL, -- Need OP
        csfb-RegistrationParam1XRTT-Ext-r11 CSFB-RegistrationParam1XRTT-v920    OPTIONAL, -- Cond
REG-1XRTT-PerPLMN
        longCodeState1XRTT-r11          BIT STRING (SIZE (42)) OPTIONAL, -- Cond PerPLMN-LC
        cellReselectionParameters1XRTT-r11 CellReselectionParametersCDMA2000-r11 OPTIONAL, --
Need OR
        ac-BarringConfig1XRTT-r11       AC-BarringConfig1XRTT-r9          OPTIONAL, -- Cond
REG-1XRTT-PerPLMN
        csfb-SupportForDualRxUEs-r11    BOOLEAN                          OPTIONAL, -- Need OR
        csfb-DualRxTxSupport-r11        ENUMERATED {true}                OPTIONAL -- Cond REG-1XRTT-
PerPLMN
    }
    ...
}
-- ASN1STOP

```

<b>SystemInformationBlockType8 field descriptions</b>
<p><b>ac-BarringConfig1XRTT</b> Contains the access class barring parameters the UE uses to calculate the access class barring factor, see C.S0097 [53].</p>
<p><b>ac-Barring0to9</b> Parameter used for calculating the access class barring factor for access overload classes 0 through 9. It is the parameter "PSIST" in C.S0004 [34] for access overload classes 0 through 9.</p>
<p><b>ac-BarringEmg</b> Parameter used for calculating the access class barring factor for emergency calls and emergency message transmissions for access overload classes 0 through 9. It is the parameter "PSIST_EMG" in C.S0004 [34].</p>
<p><b>ac-BarringMsg</b> Parameter used for modifying the access class barring factor for message transmissions. It is the parameter "MSG_PSIST" in C.S0004 [34].</p>
<p><b>ac-BarringN</b> Parameter used for calculating the access class barring factor for access overload class N (N = 10 to 15). It is the parameter "PSIST" in C.S0004 [34] for access overload class N.</p>
<p><b>ac-BarringReg</b> Parameter used for modifying the access class barring factor for autonomous registrations. It is the parameter "REG_PSIST" in C.S0004 [34].</p>
<p><b>bandClass</b> Identifies the Frequency Band in which the Carrier can be found. Details can be found in C.S0057 [24, Table 1.5].</p>
<p><b>bandClassList</b> List of CDMA2000 frequency bands.</p>
<p><b>cellReselectionParameters1XRTT</b> Cell reselection parameters applicable only to CDMA2000 1xRTT system.</p>
<p><b>cellReselectionParameters1XRTT-Ext</b> Cell reselection parameters applicable for cell reselection to CDMA2000 1XRTT system.</p>
<p><b>cellReselectionParameters1XRTT-v920</b> Cell reselection parameters applicable for cell reselection to CDMA2000 1XRTT system. The field is not present if <i>cellReselectionParameters1XRTT</i> is not present; otherwise it is optionally present.</p>
<p><b>cellReselectionParametersHRPD</b> Cell reselection parameters applicable for cell reselection to CDMA2000 HRPD system</p>
<p><b>cellReselectionParametersHRPD-Ext</b> Cell reselection parameters applicable for cell reselection to CDMA2000 HRPD system.</p>
<p><b>cellReselectionParametersHRPD-v920</b> Cell reselection parameters applicable for cell reselection to CDMA2000 HRPD system. The field is not present if <i>cellReselectionParametersHRPD</i> is not present; otherwise it is optionally present.</p>
<p><b>csfb-DualRxTxSupport</b> Value TRUE indicates that the network supports dual Rx/Tx enhanced 1xCSFB, which enables UEs capable of dual Rx/Tx enhanced 1xCSFB to switch off their 1xRTT receiver/transmitter while camped in E-UTRAN [51].</p>
<p><b>csfb-RegistrationParam1XRTT</b> Contains the parameters the UE will use to determine if it should perform a CDMA2000 1xRTT Registration/Re-Registration. This field is included if either CSFB or enhanced CS fallback to CDMA2000 1xRTT is supported.</p>
<p><b>csfb-SupportForDualRxUEs</b> Value TRUE indicates that the network supports dual Rx CSFB [51].</p>
<p><b>longCodeState1XRTT</b> The state of long code generation registers in CDMA2000 1XRTT system as defined in C.S0002 [12], clause 1.3, at <math>\lceil t/10 \rceil \times 10 + 320</math> ms, where <math>t</math> equals to the <i>cdma-SystemTime</i>. This field is required for reporting CGI for 1xRTT, SRVCC handover and enhanced CS fallback to CDMA2000 1xRTT operation. Otherwise this IE is not needed. This field is excluded when estimating changes in system information, i.e. changes of <i>longCodeState1XRTT</i> should neither result in system information change notifications nor in a modification of <i>systemInfoValueTag</i> in SIB1.</p>
<p><b>neighCellList</b> List of CDMA2000 neighbouring cells. The total number of neighbouring cells in <i>neighCellList</i> for each RAT (1XRTT or HRPD) is limited to 32.</p>
<p><b>neighCellList-v920</b> Extended List of CDMA2000 neighbouring cells. The combined total number of CDMA2000 neighbouring cells in both <i>neighCellList</i> and <i>neighCellList-v920</i> is limited to 32 for HRPD and 40 for 1xRTT.</p>

<b>SystemInformationBlockType8 field descriptions</b>
<p><b>neighCellsPerFreqList</b> List of carrier frequencies and neighbour cell ids in each frequency within a CDMA2000 Band, see C.S0002 [12] or C.S0024 [26].</p>
<p><b>neighCellsPerFreqList-v920</b> Extended list of neighbour cell ids, in the same CDMA2000 Frequency Band as the corresponding instance in "NeighCellListCDMA2000".</p>
<p><b>parameters1XRTT</b> Parameters applicable for interworking with CDMA2000 1XRTT system.</p>
<p><b>parametersCDMA2000</b> Provides the corresponding SIB8 parameters for the CDMA2000 network associated with the PLMN indicated in <i>plmn-Identity</i>. A choice is used to indicate whether for this PLMN the parameters are signalled explicitly or set to the (default) values common for all PLMNs i.e. the values not included in <i>sib8-PerPLMN-List</i>.</p>
<p><b>parametersHRPD</b> Parameters applicable only for interworking with CDMA2000 HRPD systems.</p>
<p><b>physCellIdList</b> Identifies the list of CDMA2000 cell ids, see C.S0002 [12] or C.S0024 [26].</p>
<p><b>physCellIdList-v920</b> Extended list of CDMA2000 cell ids, in the same CDMA2000 ARFCN as the corresponding instance in "NeighCellsPerBandclassCDMA2000".</p>
<p><b>plmn-Identity</b> Indicates the PLMN associated with this CDMA2000 network. Value 1 indicates the PLMN listed 1st in the 1st <i>plmn-IdentityList</i> included in SIB1, value 2 indicates the PLMN listed 2nd in the same <i>plmn-IdentityList</i>, or when no more PLMN are present within the same <i>plmn_identityList</i>, then the PLMN listed 1st in the subsequent <i>plmn-IdentityList</i> within the same SIB1 and so on. A PLMN which identity is not indicated in the <i>sib8-PerPLMN-List</i>, does not support inter-working with CDMA2000.</p>
<p><b>preRegistrationInfoHRPD</b> The CDMA2000 HRPD Pre-Registration Information tells the UE if it should pre-register with the CDMA2000 HRPD network and identifies the Pre-registration zone to the UE.</p>
<p><b>searchWindowSize</b> The search window size is a CDMA2000 parameter to be used to assist in searching for the neighbouring pilots. For values see C.S0005 [25], Table 2.6.6.2.1-1, and C.S0024 [26], Table 8.7.6.2-4. This field is required for a UE with <i>rx-ConfigHRPD= single</i> and/ or <i>rx-Config1XRTT= single</i> to perform handover, cell re-selection, UE measurement based redirection and enhanced 1xRTT CS fallback from E-UTRAN to CDMA2000 according to this specification and TS 36.304 [4].</p>
<p><b>sib8-PerPLMN-List</b> This field provides the values for the interworking CDMA2000 networks corresponding, if any, to the UE's RPLMN.</p>
<p><b>systemTimeInfo</b> Information on CDMA2000 system time. This field is required for a UE with <i>rx-ConfigHRPD= single</i> and/ or <i>rx-Config1XRTT= single</i> to perform handover, cell re-selection, UE measurement based redirection and enhanced 1xRTT CS fallback from E-UTRAN to CDMA2000 according to this specification and TS 36.304 [4]. This field is excluded when estimating changes in system information, i.e. changes of <i>systemTimeInfo</i> should neither result in system information change notifications nor in a modification of <i>systemInfoValueTag</i> in SIB1. For the field included in <i>ParametersCDMA2000</i>, a choice is used to indicate whether for this PLMN the parameters are signalled explicitly or set to the (default) value common for all PLMNs i.e. the value not included in <i>sib8-PerPLMN-List</i>.</p>
<p><b>threshX-High</b> Parameter "Thresh<sub>X, HighP</sub>" in TS 36.304 [4]. This specifies the high threshold used in reselection towards this CDMA2000 band class expressed as an unsigned binary number equal to FLOOR (-2 x 10 x log<sub>10</sub> E<sub>c</sub>/I<sub>0</sub>) in units of 0.5 dB, as defined in C.S0005 [25].</p>
<p><b>threshX-Low</b> Parameter "Thresh<sub>X, LowP</sub>" in TS 36.304 [4]. This specifies the low threshold used in reselection towards this CDMA2000 band class expressed as an unsigned binary number equal to FLOOR (-2 x 10 x log<sub>10</sub> E<sub>c</sub>/I<sub>0</sub>) in units of 0.5 dB, as defined in C.S0005 [25].</p>
<p><b>t-ReselectionCDMA2000</b> Parameter "Treselction<sub>CDMA_HRPD</sub>" or "Treselction<sub>CDMA_1XRTT</sub>" in TS 36.304 [4].</p>
<p><b>t-ReselectionCDMA2000-SF</b> Parameter "Speed dependent ScalingFactor for Treselction<sub>CDMA-HRPD</sub>" or Treselction<sub>CDMA-1XRTT</sub>" in TS 36.304 [4]. If the field is not present, the UE behaviour is specified in TS 36.304 [4].</p>

Conditional presence	Explanation
<i>NCL-1XRTT</i>	The field is optional present, need OR, if <i>cellReselectionParameters1xRTT</i> is present; otherwise it is not present.
<i>NCL-HRPD</i>	The field is optional present, need OR, if <i>cellReselectionParametersHRPD</i> is present; otherwise it is not present.
<i>PerPLMN-LC</i>	The field is optional present, need OR, when <i>systemTimeInfo</i> is included in <i>SIB8PerPLMN</i> for this CDMA2000 network; otherwise it is not present.
<i>REG-1XRTT</i>	The field is optional present, need OR, if <i>csfb-RegistrationParam1XRTT</i> is present; otherwise it is not present.
<i>REG-1XRTT-PerPLMN</i>	The field is optional present, need OR, if <i>csfb-RegistrationParam1XRTT</i> is included in <i>SIB8PerPLMN</i> for this CDMA2000 network; otherwise it is not present.

## – *SystemInformationBlockType9*

The IE *SystemInformationBlockType9* contains a home eNB name (HNB Name).

### *SystemInformationBlockType9* information element

```
-- ASN1START
SystemInformationBlockType9 ::= SEQUENCE {
    hnb-Name                OCTET STRING (SIZE(1..48))    OPTIONAL,    -- Need OR
    ...,
    lateNonCriticalExtension OCTET STRING                OPTIONAL
}
-- ASN1STOP
```

### *SystemInformationBlockType9* field descriptions

#### ***hnb-Name***

Carries the name of the home eNB, coded in UTF-8 with variable number of bytes per character, see TS 22.011 [10].

## – *SystemInformationBlockType10*

The IE *SystemInformationBlockType10* contains an ETWS primary notification.

### *SystemInformationBlockType10* information element

```
-- ASN1START
SystemInformationBlockType10 ::= SEQUENCE {
    messageIdentifier        BIT STRING (SIZE (16)),
    serialNumber             BIT STRING (SIZE (16)),
    warningType              OCTET STRING (SIZE (2)),
    dummy                   OCTET STRING (SIZE (50))    OPTIONAL,    -- Need OP
    ...,
    lateNonCriticalExtension OCTET STRING                OPTIONAL
}
-- ASN1STOP
```

<b>SystemInformationBlockType10 field descriptions</b>
<p><b>messageIdentifier</b></p> <p>Identifies the source and type of ETWS notification. The leading bit (which is equivalent to the leading bit of the equivalent IE defined in TS 36.413 [39], clause 9.2.1.44) contains bit 7 of the first octet of the equivalent IE, defined in and encoded according to TS 23.041 [37], clause 9.4.3.2.1, while the trailing bit contains bit 0 of the second octet of the same equivalent IE.</p>
<p><b>serialNumber</b></p> <p>Identifies variations of an ETWS notification. The leading bit (which is equivalent to the leading bit of the equivalent IE defined in TS 36.413 [39], clause 9.2.1.45), contains bit 7 of the first octet of the equivalent IE, defined in and encoded according to TS 23.041 [37], clause 9.4.3.2.2, while the trailing bit contains bit 0 of the second octet of the same equivalent IE.</p>
<p><b>dummy</b></p> <p>This field is not used in the specification. If received it shall be ignored by the UE.</p>
<p><b>warningType</b></p> <p>Identifies the warning type of the ETWS primary notification and provides information on emergency user alert and UE popup. The first octet (which is equivalent to the first octet of the equivalent IE defined in TS 36.413 [39], clause 9.2.1.50) contains the first octet of the equivalent IE defined in and encoded according to TS 23.041 [37], clause 9.3.24, and so on.</p>

## – SystemInformationBlockType11

The IE *SystemInformationBlockType11* contains an ETWS secondary notification.

### SystemInformationBlockType11 information element

```

-- ASN1START
SystemInformationBlockType11 ::= SEQUENCE {
    messageIdentifier          BIT STRING (SIZE (16)),
    serialNumber              BIT STRING (SIZE (16)),
    warningMessageSegmentType ENUMERATED {notLastSegment, lastSegment},
    warningMessageSegmentNumber INTEGER (0..63),
    warningMessageSegment     OCTET STRING,
    dataCodingScheme          OCTET STRING (SIZE (1))    OPTIONAL,    -- Cond Segment1
    . . . ,
    lateNonCriticalExtension  OCTET STRING              OPTIONAL
}
-- ASN1STOP

```

<b>SystemInformationBlockType11 field descriptions</b>
<p><b>dataCodingScheme</b></p> <p>Identifies the alphabet/coding and the language applied variations of an ETWS notification. The octet (which is equivalent to the octet of the equivalent IE defined in TS 36.413 [39], clause 9.2.1.52), contains the octet of the equivalent IE defined in TS 23.041 [37], clause 9.4.3.2.3, and encoded according to TS 23.038 [38].</p>
<p><b>messageIdentifier</b></p> <p>Identifies the source and type of ETWS notification. The leading bit (which is equivalent to the leading bit of the equivalent IE defined in TS 36.413 [39], clause 9.2.1.44), contains bit 7 of the first octet of the equivalent IE, defined in and encoded according to TS 23.041 [37], clause 9.4.3.2.1, while the trailing bit contains bit 0 of second octet of the same equivalent IE.</p>
<p><b>serialNumber</b></p> <p>Identifies variations of an ETWS notification. The leading bit (which is equivalent to the leading bit of the equivalent IE defined in TS 36.413 [39], clause 9.2.1.45) contains bit 7 of the first octet of the equivalent IE, defined in and encoded according to TS 23.041 [37], clause 9.4.3.2.2, while the trailing bit contains bit 0 of second octet of the same equivalent IE.</p>
<p><b>warningMessageSegment</b></p> <p>Carries a segment of the <i>Warning Message Contents</i> IE defined in TS 36.413 [39], clause 9.2.1.53. The first octet of the <i>Warning Message Contents</i> IE is equivalent to the first octet of the <i>CB data</i> IE defined in and encoded according to TS 23.041 [37], clause 9.4.2.2.5, and so on.</p>
<p><b>warningMessageSegmentNumber</b></p> <p>Segment number of the ETWS warning message segment contained in the SIB. A segment number of zero corresponds to the first segment, one corresponds to the second segment, and so on.</p>

<b>SystemInformationBlockType11 field descriptions</b>	
<b>warningMessageSegmentType</b>	
Indicates whether the included ETWS warning message segment is the last segment or not.	

<b>Conditional presence</b>	<b>Explanation</b>
<i>Segment1</i>	The field is mandatory present in the first segment of SIB11, otherwise it is not present.

## – SystemInformationBlockType12

The IE *SystemInformationBlockType12* contains a CMAS notification.

### SystemInformationBlockType12 information element

```
-- ASN1START
SystemInformationBlockType12-r9 ::= SEQUENCE {
    messageIdentifier-r9          BIT STRING (SIZE (16)),
    serialNumber-r9              BIT STRING (SIZE (16)),
    warningMessageSegmentType-r9 ENUMERATED {notLastSegment, lastSegment},
    warningMessageSegmentNumber-r9 INTEGER (0..63),
    warningMessageSegment-r9    OCTET STRING,
    dataCodingScheme-r9         OCTET STRING (SIZE (1))    OPTIONAL,    -- Cond Segment1
    lateNonCriticalExtension     OCTET STRING                OPTIONAL,
    . . . ,
    [[ warningAreaCoordinatesSegment-r15    OCTET STRING    OPTIONAL    -- Need OR
    ]]
}
-- ASN1STOP
```

<b>SystemInformationBlockType12 field descriptions</b>	
<b>dataCodingScheme</b>	
Identifies the alphabet/coding and the language applied variations of a CMAS notification. The octet (which is equivalent to the octet of the equivalent IE defined in TS 36.413 [39], clause 9.2.1.52), contains the octet of the equivalent IE defined in TS 23.041 [37], clause 9.4.3.2.3, and encoded according to TS 23.038 [38].	
<b>messageIdentifier</b>	
Identifies the source and type of CMAS notification. The leading bit (which is equivalent to the leading bit of the equivalent IE defined in TS 36.413 [39], clause 9.2.1.44) contains bit 7 of the first octet of the equivalent IE, defined in and encoded according to TS 23.041 [37], clause 9.4.3.2.1, while the trailing bit contains bit 0 of second octet of the same equivalent IE.	
<b>serialNumber</b>	
Identifies variations of a CMAS notification. The leading bit (which is equivalent to the leading bit of the equivalent IE defined in TS 36.413 [39], clause 9.2.1.45), contains bit 7 of the first octet of the equivalent IE, defined in and encoded according to TS 23.041 [37], clause 9.4.3.2.2, while the trailing bit contains bit 0 of second octet of the same equivalent IE.	
<b>warningAreaCoordinatesSegment</b>	
If present, carries a segment, with one or more octets, of the geographical area where the CMAS warning message is valid as defined in [98]. The first octet of the first <i>warningAreaCoordinatesSegment</i> is equivalent to the first octet of Warning Area Coordinates IE defined in and encoded according to TS 23.041 [37] and so on.	
<b>warningMessageSegment</b>	
Carries a segment, with one or more octets, of the <i>Warning Message Contents</i> IE defined in TS 36.413 [39]. The first octet of the <i>Warning Message Contents</i> IE is equivalent to the first octet of the <i>CB data</i> IE defined in and encoded according to TS 23.041 [37], clause 9.4.2.2.5, and so on.	
<b>warningMessageSegmentNumber</b>	
Segment number of the CMAS warning message segment contained in the SIB. A segment number of zero corresponds to the first segment, one corresponds to the second segment, and so on. If warning area coordinates are provided for the warning message, then this field applies to both warning message segment and warning area coordinates segment.	
<b>warningMessageSegmentType</b>	
Indicates whether the included CMAS warning message segment is the last segment or not. If warning area coordinates are provided for the warning message, then this field applies to both warning message segment and warning area coordinates segment.	



Conditional presence	Explanation
<i>Segment1</i>	The field is mandatory present in the first segment of SIB12, otherwise it is not present.

## – SystemInformationBlockType13

The IE *SystemInformationBlockType13* contains the information required to acquire the MBMS control information associated with one or more MBSFN areas.

### SystemInformationBlockType13 information element

```
-- ASN1START
SystemInformationBlockType13-r9 ::= SEQUENCE {
  mbsfn-AreaInfoList-r9          MBSFN-AreaInfoList-r9,
  notificationConfig-r9         MBMS-NotificationConfig-r9,
  lateNonCriticalExtension       OCTET STRING                OPTIONAL,
  ...,
  [[
  notificationConfig-v1430       MBMS-NotificationConfig-v1430    OPTIONAL
  ]],
  [[
  mbsfn-AreaInfoList-r16        MBSFN-AreaInfoList-r16    OPTIONAL    -- Need OR
  ]],
  [[
  mbsfn-AreaInfoList-r17        MBSFN-AreaInfoList-r17    OPTIONAL    -- Cond Ded15or25PRB
  ]]
}
-- ASN1STOP
```

### SystemInformationBlockType13 field descriptions

#### **notificationConfig**

Indicates the MBMS notification related configuration parameters. The UE shall ignore this field when *dl-Bandwidth* included in *MasterInformationBlock* is set to n6.

Conditional presence	Explanation
<i>Ded15or25PRB</i>	The field is optionally present, need OR, for an MBMS-dedicated cell when <i>dl-Bandwidth-MBMS</i> is set to n15 or n25. Otherwise the field is not present.

## – SystemInformationBlockType14

The IE *SystemInformationBlockType14* contains the EAB parameters.

### SystemInformationBlockType14 information element

```
-- ASN1START
SystemInformationBlockType14-r11 ::= SEQUENCE {
  eab-Param-r11                  CHOICE {
    eab-Common-r11              EAB-Config-r11,
    eab-PerPLMN-List-r11       SEQUENCE (SIZE (1..maxPLMN-r11)) OF EAB-ConfigPLMN-
r11
  }
  lateNonCriticalExtension       OCTET STRING                OPTIONAL, -- Need OR
  ...,
  [[ eab-PerRSRP-r15             ENUMERATED {thresh0, thresh1, thresh2, thresh3} OPTIONAL --
Need OR
  ]]
}

EAB-ConfigPLMN-r11 ::= SEQUENCE {
  eab-Config-r11                EAB-Config-r11                OPTIONAL -- Need OR
}

EAB-Config-r11 ::= SEQUENCE {
  eab-Category-r11             ENUMERATED {a, b, c},
  eab-BarringBitmap-r11        BIT STRING (SIZE (10))
}
-- ASN1STOP
```

```
-- ASN1STOP
```

<b>SystemInformationBlockType14 field descriptions</b>
<p><b>eab-BarringBitmap</b> Extended access class barring for AC 0-9. The first/ leftmost bit is for AC 0, the second bit is for AC 1, and so on.</p>
<p><b>eab-Category</b> Indicates the category of UEs for which EAB applies. Value <i>a</i> corresponds to all UEs, value <i>b</i> corresponds to the UEs that are neither in their HPLMN nor in a PLMN that is equivalent to it, and value <i>c</i> corresponds to the UEs that are neither in the PLMN listed as most preferred PLMN of the country where the UEs are roaming in the operator-defined PLMN selector list on the USIM, nor in their HPLMN nor in a PLMN that is equivalent to their HPLMN, see TS 22.011 [10].</p>
<p><b>eab-Common</b> The EAB parameters applicable for all PLMN(s).</p>
<p><b>eab-PerPLMN-List</b> The EAB parameters per PLMN, listed in the same order as the PLMN(s) listed across the <i>plmn-IdentityList</i> fields in <i>SystemInformationBlockType1</i>.</p>
<p><b>eab-PerRSRP</b> Access barring per RSRP. Value <i>thresh0</i> means access to the cell is barred when in enhanced coverage as specified in TS 36.304 [4] and does not apply to UEs satisfying S criteria for normal coverage. Value <i>thresh1</i> is compared to the first entry configured in <i>rsrp-ThresholdsPrachInfoList</i>, value <i>thresh2</i> is compared to the second entry configured in <i>rsrp-ThresholdsPrachInfoList</i> and so on.</p>

## SystemInformationBlockType15

The IE *SystemInformationBlockType15* contains the MBMS Service Area Identities (SAI) of the current and/ or neighbouring carrier frequencies.

### SystemInformationBlockType15 information element

```
-- ASN1START

SystemInformationBlockType15-r11 ::= SEQUENCE {
    mbms-SAI-IntraFreq-r11          MBMS-SAI-List-r11          OPTIONAL,  -- Need OR
    mbms-SAI-InterFreqList-r11     MBMS-SAI-InterFreqList-r11 OPTIONAL,  -- Need OR
    lateNonCriticalExtension        OCTET STRING              OPTIONAL,
    ...
    [[ mbms-SAI-InterFreqList-v1140 MBMS-SAI-InterFreqList-v1140 OPTIONAL -- Cond
InterFreq
    ]],
    [[ mbms-IntraFreqCarrierType-r14 MBMS-CarrierType-r14          OPTIONAL,  -- Need OR
    mbms-InterFreqCarrierTypeList-r14 MBMS-InterFreqCarrierTypeList-r14 OPTIONAL -- Need
OR
    ]]
}

MBMS-SAI-List-r11 ::= SEQUENCE (SIZE (1..maxSAI-MBMS-r11)) OF MBMS-SAI-r11
MBMS-SAI-r11 ::= INTEGER (0..65535)
MBMS-SAI-InterFreqList-r11 ::= SEQUENCE (SIZE (1..maxFreq)) OF MBMS-SAI-InterFreq-r11
MBMS-SAI-InterFreqList-v1140 ::= SEQUENCE (SIZE (1..maxFreq)) OF MBMS-SAI-InterFreq-v1140
MBMS-SAI-InterFreq-r11 ::= SEQUENCE {
    dl-CarrierFreq-r11          ARFCN-ValueEUTRA-r9,
    mbms-SAI-List-r11          MBMS-SAI-List-r11
}

MBMS-SAI-InterFreq-v1140 ::= SEQUENCE {
    multiBandInfoList-r11      MultiBandInfoList-r11          OPTIONAL  -- Need OR
}

MBMS-InterFreqCarrierTypeList-r14 ::= SEQUENCE (SIZE (1..maxFreq)) OF MBMS-CarrierType-r14
MBMS-CarrierType-r14 ::= SEQUENCE {
    carrierType-r14            ENUMERATED {mbms, fembmsMixed, fembmsDedicated},
    frameOffset-r14           INTEGER (0..3)                OPTIONAL  -- Need OR
}

-- ASN1STOP
```

-- ASN1STOP

<b>SystemInformationBlockType15 field descriptions</b>	
<b>carrierType</b>	Indicates whether the carrier is pre-Rel-14 MBMS carrier ( <i>mbms</i> ) or FeMBMS/Unicast mixed carrier ( <i>fembmsMixed</i> ) or MBMS-dedicated carrier ( <i>fembmsDedicated</i> ).
<b>frameOffset</b>	For MBMS-dedicated carrier, the <i>frameOffset</i> gives the radio frame which contains PBCH by SFN mod 4 = <i>frameOffset</i> .
<b>mbms-InterFreqCarrierTypeList</b>	Indicates whether this is an FeMBMS carrier. The field is included only if <i>mbms-SAI-InterFreqList-r11</i> is included. The number of entries is the same in both fields and carrier type relates to the frequency indicated in <i>mbms-SAI-InterFreqList-r11</i> in the corresponding entry index.
<b>mbms-IntraFreqCarrierType</b>	Contains indication whether the carrier is pre-Rel-14 MBMS carrier, FeMBMS/Unicast mixed carrier or MBMS-dedicated carrier.
<b>mbms-SAI-InterFreqList</b>	Contains a list of neighboring frequencies including additional bands, if any, that provide MBMS services and the corresponding MBMS SAIs.
<b>mbms-SAI-IntraFreq</b>	Contains the list of MBMS SAIs for the current frequency. A duplicate MBMS SAI indicates that this and all following SAIs are not offered by this cell but only by neighbour cells on the current frequency. For MBMS service continuity, the UE shall use all MBMS SAIs listed in <i>mbms-SAI-IntraFreq</i> to derive the MBMS frequencies of interest.
<b>mbms-SAI-List</b>	Contains a list of MBMS SAIs for a specific frequency.
<b>multiBandInfoList</b>	A list of additional frequency bands applicable for the cells participating in the MBSFN transmission.

<b>Conditional presence</b>	<b>Explanation</b>
<i>InterFreq</i>	The field is optionally present, need OR, if the <i>mbms-SAI-InterFreqList-r11</i> is present. Otherwise it is not present.

## – SystemInformationBlockType16

The IE *SystemInformationBlockType16* contains information related to GPS time and Coordinated Universal Time (UTC). The UE may use the parameters provided in this system information block to obtain the UTC, the GPS and the local time.

NOTE: The UE may use the time information for numerous purposes, possibly involving upper layers e.g. to assist GPS initialisation, to synchronise the UE clock (a.o. to determine MBMS session start/ stop).

### SystemInformationBlockType16 information element

```
-- ASN1START
SystemInformationBlockType16-r11 ::=
    SEQUENCE {
        timeInfo-r11
            SEQUENCE {
                timeInfoUTC-r11
                    INTEGER (0..549755813887),
                dayLightSavingTime-r11
                    BIT STRING (SIZE (2))
                    OPTIONAL, -- Need OR
                leapSeconds-r11
                    INTEGER (-127..128)
                    OPTIONAL, -- Need OR
                localTimeOffset-r11
                    INTEGER (-63..64)
                    OPTIONAL, -- Need OR
            }
        lateNonCriticalExtension
            OCTET STRING
            OPTIONAL,
        ...
        [[ timeReferenceInfo-r15
            TimeReferenceInfo-r15
            OPTIONAL -- Need OR
        ]]
    }
-- ASN1STOP
```

<b>SystemInformationBlockType16 field descriptions</b>
<p><b>dayLightSavingTime</b> It indicates if and how daylight saving time (DST) is applied to obtain the local time. The semantics is the same as the semantics of the <i>Daylight Saving Time</i> IE in TS 24.301 [35] and TS 24.008 [49]. The first/leftmost bit of the bit string contains the b2 of octet 3, i.e. the value part of the <i>Daylight Saving Time</i> IE, and the second bit of the bit string contains b1 of octet 3.</p>
<p><b>leapSeconds</b> Number of leap seconds offset between GPS Time and UTC. UTC and GPS time are related i.e. GPS time - <i>leapSeconds</i> = UTC time.</p>
<p><b>localTimeOffset</b> Offset between UTC and local time in units of 15 minutes. Actual value = field value * 15 minutes. Local time of the day is calculated as UTC time + <i>localTimeOffset</i>.</p>
<p><b>timeInfoUTC</b> Coordinated Universal Time corresponding to the SFN boundary at or immediately after the ending boundary of the SI-window in which <i>SystemInformationBlockType16</i> is transmitted. In an NTN cell, the indicated time is referenced at the uplink time synchronization reference point (RP), i.e., UE should take into account the propagation delay between UE and RP when determining the UTC time at the UE. The field counts the number of UTC seconds in 10 ms units since 00:00:00 on Gregorian calendar date 1 January, 1900 (midnight between Sunday, December 31, 1899 and Monday, January 1, 1900). NOTE 1. This field is excluded when estimating changes in system information, i.e. changes of <i>timeInfoUTC</i> should neither result in system information change notifications nor in a modification of <i>systemInfoValueTag</i> in SIB1.</p>

NOTE 1: The UE may use this field together with the leapSeconds field to obtain GPS time as follows: GPS Time (in seconds) = timeInfoUTC (in seconds) - 2,524,953,600 (seconds) + leapSeconds, where 2,524,953,600 is the number of seconds between 00:00:00 on Gregorian calendar date 1 January, 1900 and 00:00:00 on Gregorian calendar date 6 January, 1980 (start of GPS time).

## – SystemInformationBlockType17

The IE *SystemInformationBlockType17* contains information relevant for traffic steering between E-UTRAN and WLAN.

### SystemInformationBlockType17 information element

```
-- ASN1START
SystemInformationBlockType17-r12 ::= SEQUENCE {
    wlan-OffloadInfoPerPLMN-List-r12 SEQUENCE (SIZE (1..maxPLMN-r11)) OF
        wlan-OffloadInfoPerPLMN-r12 OPTIONAL, -- Need OR
    lateNonCriticalExtension OCTET STRING OPTIONAL,
    ...
}
wlan-OffloadInfoPerPLMN-r12 ::= SEQUENCE {
    wlan-OffloadConfigCommon-r12 wlan-OffloadConfig-r12 OPTIONAL, -- Need OR
    wlan-Id-List-r12 wlan-Id-List-r12 OPTIONAL, -- Need OR
    ...
}
wlan-Id-List-r12 ::= SEQUENCE (SIZE (1..maxWLAN-Id-r12)) OF wlan-Identifiers-r12
wlan-Identifiers-r12 ::= SEQUENCE {
    ssid-r12 OCTET STRING (SIZE (1..32)) OPTIONAL, -- Need OR
    bssid-r12 OCTET STRING (SIZE (6)) OPTIONAL, -- Need OR
    hessid-r12 OCTET STRING (SIZE (6)) OPTIONAL, -- Need OR
    ...
}
-- ASN1STOP
```

<b>SystemInformationBlockType17 field descriptions</b>
<p><b>bssid</b> Basic Service Set Identifier (BSSID) defined in IEEE 802.11-2012 [67].</p>
<p><b>hessid</b> Homogenous Extended Service Set Identifier (HESSID) defined in IEEE 802.11-2012 [67].</p>
<p><b>ssid</b> Service Set Identifier (SSID) defined in IEEE 802.11-2012 [67].</p>

**SystemInformationBlockType17 field descriptions****wlan-OffloadInfoPerPLMN-List**

The WLAN offload configuration per PLMN includes the same number of entries, listed in the same order as the PLMN(s) listed across the *plmn-IdentityList* fields in *SystemInformationBlockType1*.

**SystemInformationBlockType18**

The IE *SystemInformationBlockType18* indicates E-UTRAN supports the sidelink UE information procedure and may contain sidelink communication related resource configuration information.

**SystemInformationBlockType18 information element**

```
-- ASN1START
SystemInformationBlockType18-r12 ::= SEQUENCE {
  commConfig-r12          SEQUENCE {
    commRxPool-r12          SL-CommRxPoolList-r12,
    commTxPoolNormalCommon-r12  SL-CommTxPoolList-r12          OPTIONAL, -- Need OR
    commTxPoolExceptional-r12  SL-CommTxPoolList-r12          OPTIONAL, -- Need OR
    commSyncConfig-r12        SL-SyncConfigList-r12           OPTIONAL, -- Need OR
  }
  lateNonCriticalExtension OCTET STRING          OPTIONAL,
  ...,
  [ [ commTxPoolNormalCommonExt-r13  SL-CommTxPoolListExt-r13  OPTIONAL, -- Need OR
    commTxResourceUC-ReqAllowed-r13  ENUMERATED {true}        OPTIONAL, -- Need OR
    commTxAllowRelayCommon-r13       ENUMERATED {true}        OPTIONAL, -- Need OR
  ] ]
}
-- ASN1STOP
```

**SystemInformationBlockType18 field descriptions****commRxPool**

Indicates the resources by which the UE is allowed to receive sidelink communication while in RRC\_IDLE and while in RRC\_CONNECTED.

**commSyncConfig**

Indicates the configuration by which the UE is allowed to receive and transmit synchronisation information. E-UTRAN configures *commSyncConfig* including *txParameters* when configuring UEs by dedicated signalling to transmit synchronisation information.

**commTxAllowRelayCommon**

Indicates whether the UE is allowed to transmit relay related sidelink communication data using the transmission pools included in *SystemInformationBlockType18* i.e. either via *commTxPoolNormalCommon*, *commTxPoolNormalCommonExt* or via *commTxPoolExceptional*.

**commTxPoolExceptional**

Indicates the resources by which the UE is allowed to transmit sidelink communication in exceptional conditions, as specified in 5.10.4.

**commTxPoolNormalCommon**

Indicates the resources by which the UE is allowed to transmit sidelink communication while in RRC\_IDLE or when in RRC\_CONNECTED while transmitting sidelink via a frequency other than the primary.

**commTxPoolNormalCommonExt**

Indicates transmission resource pool(s) in addition to the pool(s) indicated by field *commTxPoolNormalCommon*, by which the UE is allowed to transmit sidelink communication while in RRC\_IDLE or when in RRC\_CONNECTED while transmitting sidelink via a frequency other than the primary. E-UTRAN configures *commTxPoolNormalCommonExt* only when it configures *commTxPoolNormalCommon*.

**commTxResourceUC-ReqAllowed**

Indicates whether the UE is allowed to request transmission pools for non-relay related one-to-one sidelink communication.

**SystemInformationBlockType19**

The IE *SystemInformationBlockType19* indicates E-UTRAN supports the sidelink UE information procedure and may contain sidelink discovery related resource configuration information.

**SystemInformationBlockType19 information element**

```

-- ASN1START
SystemInformationBlockType19-r12 ::= SEQUENCE {
  discConfig-r12          SEQUENCE {
    discRxPool-r12          SL-DiscRxPoolList-r12,
    discTxPoolCommon-r12   SL-DiscTxPoolList-r12          OPTIONAL, -- Need OR
    discTxPowerInfo-r12    SL-DiscTxPowerInfoList-r12  OPTIONAL, -- Cond Tx
    discSyncConfig-r12     SL-SyncConfigList-r12        OPTIONAL, -- Need OR
  }
  discInterFreqList-r12   SL-CarrierFreqInfoList-r12  OPTIONAL, -- Need OR
  lateNonCriticalExtension OCTET STRING                OPTIONAL,
  ...
  [[ discConfig-v1310     SEQUENCE {
    discInterFreqList-v1310 SL-CarrierFreqInfoList-v1310  OPTIONAL, -- Need OR
    gapRequestsAllowedCommon ENUMERATED {true}              OPTIONAL, -- Need OR
  }
  discConfigRelay-r13     SEQUENCE {
    relayUE-Config-r13     SL-DiscConfigRelayUE-r13,
    remoteUE-Config-r13    SL-DiscConfigRemoteUE-r13
  }
  discConfigPS-r13       SEQUENCE {
    discRxPoolPS-r13       SL-DiscRxPoolList-r12,
    discTxPoolPS-Common-r13 SL-DiscTxPoolList-r12          OPTIONAL, -- Need OR
  }
  ]]
}

SL-CarrierFreqInfoList-r12 ::= SEQUENCE (SIZE (1..maxFreq)) OF SL-CarrierFreqInfo-r12

SL-CarrierFreqInfoList-v1310 ::= SEQUENCE (SIZE (1..maxFreq)) OF SL-CarrierFreqInfo-v1310

SL-CarrierFreqInfo-r12 ::= SEQUENCE {
  carrierFreq-r12          ARFCN-ValueEUTRA-r9,
  plmn-IdentityList-r12    PLMN-IdentityList4-r12          OPTIONAL -- Need OP
}

SL-DiscConfigRelayUE-r13 ::= SEQUENCE {
  threshHigh-r13           RSRP-RangeSL4-r13          OPTIONAL, -- Need OR
  threshLow-r13            RSRP-RangeSL4-r13          OPTIONAL, -- Need OR
  hystMax-r13              ENUMERATED {dB0, dB3, dB6, dB9, dB12, dBinf}  OPTIONAL, -- Cond
  ThreshHigh
  hystMin-r13              ENUMERATED {dB0, dB3, dB6, dB9, dB12}  OPTIONAL -- Cond ThreshLow
}

SL-DiscConfigRemoteUE-r13 ::= SEQUENCE {
  threshHigh-r13           RSRP-RangeSL4-r13          OPTIONAL, -- Need OR
  hystMax-r13              ENUMERATED {dB0, dB3, dB6, dB9, dB12}  OPTIONAL, -- Cond ThreshHigh
  reselectionInfoIC-r13    ReselectionInfoRelay-r13
}

ReselectionInfoRelay-r13 ::= SEQUENCE {
  q-RxLevMin-r13           Q-RxLevMin,
  -- Note that the mapping of individual values may be different for PC5, but the granularity/
  -- number of values is same as for Uu
  filterCoefficient-r13    FilterCoefficient,
  minHyst-r13              ENUMERATED {dB0, dB3,
                                     dB6, dB9, dB12, dBinf}  OPTIONAL -- Need OR
}

SL-CarrierFreqInfo-v1310 ::= SEQUENCE {
  discResourcesNonPS-r13   SL-ResourcesInterFreq-r13          OPTIONAL, -- Need OR
  discResourcesPS-r13     SL-ResourcesInterFreq-r13          OPTIONAL, -- Need OR
  discConfigOther-r13     SL-DiscConfigOtherInterFreq-r13   OPTIONAL, -- Need OR
  ...
}

PLMN-IdentityList4-r12 ::= SEQUENCE (SIZE (1..maxPLMN-r11)) OF PLMN-IdentityInfo2-r12

PLMN-IdentityInfo2-r12 ::= CHOICE {
  plmn-Index-r12          INTEGER (1..maxPLMN-r11),
  plmnIdentity-r12        PLMN-Identity
}

SL-DiscTxResourcesInterFreq-r13 ::= CHOICE {
  acquireSI-FromCarrier-r13 NULL,
  discTxPoolCommon-r13     SL-DiscTxPoolList-r12,
}

```

```

    requestDedicated-r13          NULL,
    noTxOnCarrier-r13            NULL
}

SL-DiscConfigOtherInterFreq-r13 ::= SEQUENCE {
    txPowerInfo-r13              SL-DiscTxPowerInfoList-r12          OPTIONAL, -- Cond Tx
    refCarrierCommon-r13        ENUMERATED {pCell}                 OPTIONAL, -- Need OR
    discSyncConfig-r13          SL-SyncConfigListNFFreq-r13         OPTIONAL, -- Need OR
    discCellSelectionInfo-r13    CellSelectionInfoNFFreq-r13        OPTIONAL, -- Need OR
}

SL-ResourcesInterFreq-r13 ::= SEQUENCE {
    discRxResourcesInterFreq-r13 SL-DiscRxPoolList-r12             OPTIONAL, -- Need OR
    discTxResourcesInterFreq-r13 SL-DiscTxResourcesInterFreq-r13  OPTIONAL, -- Need OR
}

-- ASN1STOP

```

### SystemInformationBlockType19 field descriptions

#### **discCellSelectionInfo**

Parameters that may be used by the UE to select/ reselect a cell on the concerned non serving frequency. If absent, the UE acquires the information from the target cell on the concerned frequency. See TS 36.304 [4], clause 11.4.

#### **discInterFreqList**

Indicates the neighbouring frequencies on which sidelink discovery announcement is supported. May also provide further information i.e. reception resource pool and/ or transmission resource pool, or an indication how resources could be obtained.

#### **discRxPool**

Indicates the resources by which the UE is allowed to receive non-PS related sidelink discovery announcements while in RRC\_IDLE and while in RRC\_CONNECTED.

#### **discRxPoolPS**

Indicates the resources by which the UE is allowed to receive PS related sidelink discovery announcements while in RRC\_IDLE and while in RRC\_CONNECTED.

#### **discRxResourcesInterFreq**

Indicates the resource pool configuration for receiving discovery announcements on a carrier frequency.

#### **discSyncConfig**

Indicates the configuration by which the UE is allowed to receive and transmit synchronisation information. E-UTRAN configures *discSyncConfig* including *txParameters* when configuring UEs by dedicated signalling to transmit synchronisation information.

#### **discTxPoolCommon**

Indicates the resources by which the UE is allowed to transmit non-PS related sidelink discovery announcements while in RRC\_IDLE.

#### **discTxPoolPS-Common**

Indicates the resources by which the UE is allowed to transmit PS related sidelink discovery announcements while in RRC\_IDLE.

#### **discTxResourcesInterFreq**

For the concerned frequency, either provides the UE with a pool of sidelink discovery announcement transmission resources the UE is allowed to use while in RRC\_IDLE, or indicates whether such transmission is allowed, and if so how the UE may obtain the required resources. Value *noTxOnCarrier* indicates that the UE is not allowed to transmit sidelink discovery announcements on the concerned frequency. Value *acquireSI-FromCarrier* indicates that the required resources are to be obtained by autonomously acquiring SIB19 and other relevant SIBs from the concerned frequency. Value *requestDedicated* indicates, that for the concerned carrier, the required sidelink discovery resources are to be obtained by means of a dedicated resource request using the *SidelinkUEInformation* message.

#### **plmn-IdentityList**

List of PLMN identities for the neighbouring frequency indicated by *carrierFreq*. Absence of the field indicates the same PLMN identities as listed across the *plmn-IdentityList* fields (without suffix) in *SystemInformationBlockType1*.

#### **plmn-Index**

Index of the corresponding entry across the *plmn-IdentityList* fields (without suffix) within *SystemInformationBlockType1*.

#### **refCarrierCommon**

Indicates if the PCell (RRC\_CONNECTED)/ serving cell (RRC\_IDLE) is to be used as reference for DL measurements and synchronization, instead of the DL frequency paired with the one used to transmit sidelink discovery announcements on, see TS 36.213 [23], clause 14.3.1.

#### **reselectionInfoC**

Includes the parameters used by the UE when selecting/ reselecting a sidelink relay UE.

#### **SL-CarrierFreqInfoList-v1310**

If included, the UE shall include the same number of entries, and listed in the same order, as in *SL-CarrierFreqInfoList-r12*.

**SystemInformationBlockType19 field descriptions****threshHigh, threshLow (relayUE)**

Indicates when a sidelink remote UE or sidelink relay UE that is in network coverage may use the broadcast PS related sidelink discovery Tx resource pool, if broadcast, or request Tx resources by dedicated signalling otherwise. For remote UEs, this parameter is used similarly for relay related sidelink communication.

Conditional presence	Explanation
ThreshHigh	The field is mandatory present if <i>threshHigh</i> is included in the corresponding IE. Otherwise the field is not present and UE shall delete any existing value for this field.
ThreshLow	The field is mandatory present if <i>threshLow</i> is included. Otherwise the field is not present UE shall delete any existing value for this field.
Tx	The field is mandatory present if <i>discTxPoolCommon</i> is included. Otherwise the field is optional present, need OR.

**SystemInformationBlockType20**

The IE *SystemInformationBlockType20* contains the information required to acquire the control information associated transmission of MBMS using SC-PTM.

**SystemInformationBlockType20 information element**

```
-- ASN1START
SystemInformationBlockType20-r13 ::= SEQUENCE {
  sc-mcch-RepetitionPeriod-r13      ENUMERATED {rf2, rf4, rf8, rf16, rf32, rf64, rf128, rf256},
  sc-mcch-Offset-r13                INTEGER (0..10),
  sc-mcch-FirstSubframe-r13         INTEGER (0..9),
  sc-mcch-duration-r13              INTEGER (2..9) OPTIONAL,
  sc-mcch-ModificationPeriod-r13    ENUMERATED {rf2, rf4, rf8, rf16, rf32, rf64, rf128, rf256,
                                                rf512, rf1024, r2048, rf4096, rf8192, rf16384, rf32768,
                                                rf65536},
  lateNonCriticalExtension           OCTET STRING                               OPTIONAL,
  . . .
  [[ br-BCCH-Config-r14              SEQUENCE {
    dummy                            ENUMERATED {rf1},
    dummy2                           ENUMERATED {rf1},
    mpdcch-Narrowband-SC-MCCH-r14    INTEGER (1..maxAvailNarrowBands-r13),
    mpdcch-NumRepetition-SC-MCCH-r14 ENUMERATED {r1, r2, r4, r8, r16,
                                                r32, r64, r128, r256},

    mpdcch-StartSF-SC-MCCH-r14       CHOICE {
      fdd-r14                         ENUMERATED {v1, v1dot5, v2, v2dot5, v4,
                                                v5, v8, v10},
      tdd-r14                         ENUMERATED {v1, v2, v4, v5, v8, v10, v20}
    },
    mpdcch-PDSCH-HoppingConfig-SC-MCCH-r14 ENUMERATED {off, ce-ModeA, ce-ModeB},
    sc-mcch-CarrierFreq-r14          ARFCN-ValueEUTRA-r9,
    sc-mcch-Offset-BR-r14            INTEGER (0..10),
    sc-mcch-RepetitionPeriod-BR-r14  ENUMERATED {rf32, rf128, rf512, rf1024,
                                                rf2048, rf4096, rf8192, rf16384},
    sc-mcch-ModificationPeriod-BR-r14 ENUMERATED { rf32, rf128, rf256, rf512, rf1024,
                                                rf2048, rf4096, rf8192, rf16384, rf32768,
                                                rf65536, rf131072, rf262144, rf524288,
                                                rf1048576}
  }
  sc-mcch-SchedulingInfo-r14         SC-MCCH-SchedulingInfo-r14           OPTIONAL, -- Need OR
  pdsch-maxNumRepetitionCEmodeA-SC-MTCH-r14
    ENUMERATED { r16, r32 }          OPTIONAL, -- Need OR
  pdsch-maxNumRepetitionCEmodeB-SC-MTCH-r14
    ENUMERATED {
      r192, r256, r384, r512, r768, r1024,
      r1536, r2048}                  OPTIONAL -- Need OR
  ]],
  [[ sc-mcch-RepetitionPeriod-v1470  ENUMERATED {rf1}                    OPTIONAL, -- Need OR
    sc-mcch-ModificationPeriod-v1470  ENUMERATED {rf1}                    OPTIONAL, -- Need OR
  ]]
}

SC-MCCH-SchedulingInfo-r14 ::= SEQUENCE {
  onDurationTimerSCPTM-r14          ENUMERATED {psf10, psf20, psf100, psf300,
                                                psf500, psf1000, psf1200, psf1600},
  drx-InactivityTimerSCPTM-r14     ENUMERATED {psf0, psf1, psf2, psf4, psf8, psf16,
```



```
schedulingPeriodStartOffsetSCPTM-r14 CHOICE {
  sf10 INTEGER(0..9),
  sf20 INTEGER(0..19),
  sf32 INTEGER(0..31),
  sf40 INTEGER(0..39),
  sf64 INTEGER(0..63),
  sf80 INTEGER(0..79),
  sf128 INTEGER(0..127),
  sf160 INTEGER(0..159),
  sf256 INTEGER(0..255),
  sf320 INTEGER(0..319),
  sf512 INTEGER(0..511),
  sf640 INTEGER(0..639),
  sf1024 INTEGER(0..1023),
  sf2048 INTEGER(0..2047),
  sf4096 INTEGER(0..4095),
  sf8192 INTEGER(0..8191)
},
...
}
-- ASN1STOP
```

<b>SystemInformationBlockType20 field descriptions</b>
<p><b>br-BCCH-Config-r14</b> The field is present if <i>SystemInformationBlockType20</i> is sent on BR-BCCH. Otherwise the field is absent.</p>
<p><b>dummy</b> This field is not used in the specification. If received it shall be ignored by the UE.</p>
<p><b>drx-InactivityTimerSCPTM</b> Timer for listening to SC-MCCH scheduling in TS 36.321 [6]. Value in number of MPDCCH sub-frames. Value psf0 corresponds to 0 MPDCCH sub-frame, psf1 corresponds to 1 MPDCCH sub-frame and so on.</p>
<p><b>mpdcch-Narrowband-SC-MCCH</b> Narrowband for MPDCCH for SC-MCCH, see TS 36.213 [23].</p>
<p><b>mpdcch-NumRepetitions-SC-MCCH</b> The maximum number of MPDCCH repetitions the UE needs to monitor for SC-MCCH, see TS 36.213 [23].</p>
<p><b>mpdcch-StartSF-SC-MCCH</b> Configuration of the starting subframes of the MPDCCH search space for SC-MCCH, see TS 36.213 [23].</p>
<p><b>mpdcch-PDSCH-HoppingConfig-SC-MCCH</b> Frequency hopping configuration for MPDCCH/PDSCH for SC-MCCH, see TS 36.213 [23].</p>
<p><b>onDurationTimerSCPTM</b> Indicates the duration in subframes during which SC-MCCH may be scheduled in MPDCCH sub-frames, see TS 36.321 [6].</p>
<p><b>pdsch-maxNumRepetitionCEmodeA-SC-MTCH</b> Maximum value to indicate the set of PDSCH repetition numbers for SC-MTCH to UEs in CE mode A, see TS 36.213 [23].</p>
<p><b>pdsch-maxNumRepetitionCEmodeB-SC-MTCH</b> Maximum value to indicate the set of PDSCH repetition numbers for SC-MTCH CE to UEs in mode B, see TS 36.213 [23].</p>
<p><b>schedulingPeriodStartOffsetSCPTM</b> <i>SCPTM-SchedulingCycle</i> and <i>SCPTM-SchedulingOffset</i> in TS 36.321 [6]. The value of <i>SCPTM-SchedulingCycle</i> is in number of sub-frames. Value sf10 corresponds to 10 sub-frames, sf20 corresponds to 20 sub-frames and so on. The value of <i>SCPTM-SchedulingOffset</i> is in number of sub-frames.</p>
<p><b>sc-mcch-CarrierFreq</b> Downlink carrier used for all multicast SC-MCCH transmissions.</p>
<p><b>sc-mcch-duration</b> Indicates, starting from the subframe indicated by <i>sc-mcch-FirstSubframe</i>, the duration in subframes during which SC-MCCH may be scheduled in PDCCH sub-frames, see TS 36.321 [6]. Absence of this IE means that SC-MCCH is only scheduled in the subframe indicated by <i>sc-mcch-FirstSubframe</i>.</p>
<p><b>sc-mcch-ModificationPeriod</b> Defines periodically appearing boundaries, i.e. radio frames for which <math>\text{SFN mod } sc\text{-}mcch\text{-}ModificationPeriod = 0</math>. The contents of different transmissions of SC-MCCH information can only be different if there is at least one such boundary in-between them. Value rf2 corresponds to 2 radio frames, value rf4 corresponds to 4 radio frames and so on. In case <i>sc-mcch-ModificationPeriod-v1470</i> is configured, the UE shall ignore the configuration of <i>sc-mcch-ModificationPeriod-r13</i>.</p>
<p><b>sc-mcch-ModificationPeriod-BR</b> Defines periodically appearing boundaries for BL UE or UE in CE, i.e. radio frames for which <math>(\text{H-SFN} \cdot 1024 + \text{SFN}) \text{ mod } sc\text{-}mcch\text{-}ModificationPeriod\text{-}BR = 0</math> if hyperSFN is present in <i>SystemInformationBlockType1-BR</i> or radio frames for which <math>\text{SFN mod } sc\text{-}mcch\text{-}ModificationPeriod\text{-}BR = 0</math> otherwise. The contents of different transmissions of SC-MCCH information can only be different if there is at least one such boundary in-between them. Value rf32 corresponds to 32 radio frames, value rf128 corresponds to 128 radio frames and so on.</p>
<p><b>sc-mcch-FirstSubframe</b> Indicates the first subframe in which SC-MCCH is scheduled</p>
<p><b>sc-mcch-Offset</b> Indicates, together with the <i>sc-mcch-RepetitionPeriod</i>, the radio frames in which SC-MCCH is scheduled i.e. SC-MCCH is scheduled in radio frames for which: <math>\text{SFN mod } sc\text{-}mcch\text{-}RepetitionPeriod = sc\text{-}mcch\text{-}Offset</math>.</p>
<p><b>sc-mcch-Offset-BR</b> Indicates, together with the <i>sc-mcch-RepetitionPeriod-BR</i>, the boundary of the SC-MCCH repetition period for BL UE or UE in CE: <math>(\text{H-SFN} \cdot 1024 + \text{SFN}) \text{ mod } sc\text{-}mcch\text{-}RepetitionPeriod\text{-}BR = sc\text{-}mcch\text{-}Offset\text{-}BR</math> if hyperSFN is present in <i>SystemInformationBlockType1-BR</i> or radio frames for which <math>(\text{SFN mod } sc\text{-}mcch\text{-}RepetitionPeriod\text{-}BR) = sc\text{-}mcch\text{-}Offset\text{-}BR</math> otherwise.</p>
<p><b>sc-mcch-RepetitionPeriod</b> Defines the interval between transmissions of SC-MCCH information, in radio frames. Value rf2 corresponds to 2 radio frames, rf4 corresponds to 4 radio frames and so on. In case <i>sc-mcch-RepetitionPeriod-v1470</i> is configured, the UE shall ignore the configuration of <i>sc-mcch-RepetitionPeriod-r13</i>.</p>
<p><b>sc-mcch-RepetitionPeriod-BR</b> Defines the interval between transmissions of SC-MCCH information for BL UE or UE in CE, in radio frames. Value rf32 corresponds to 32 radio frames, rf128 corresponds to 128 radio frames and so on.</p>
<p><b>sc-mcch-SchedulingInfo</b> DRX information for the SC-MCCH. If this field is absent, DRX is not used for SC-MCCH reception.</p>

– **SystemInformationBlockType21**

The IE *SystemInformationBlockType21* contains V2X sidelink communication configuration.

**SystemInformationBlockType21 information element**

```
-- ASN1START
SystemInformationBlockType21-r14 ::= SEQUENCE {
  sl-V2X-ConfigCommon-r14          SL-V2X-ConfigCommon-r14          OPTIONAL,  -- Need OR
  lateNonCriticalExtension         OCTET STRING                    OPTIONAL,
  . . . ,
  [[ anchorCarrierFreqListNR-r16  SL-NR-AnchorCarrierFreqList-r16  OPTIONAL  -- Need OR
  ]],
  [[ sl-A2X-ConfigCommon-r18      SL-A2X-ConfigCommon-r18          OPTIONAL  -- Need OR
  ]]
}

SL-V2X-ConfigCommon-r14 ::= SEQUENCE {
  v2x-CommRxPool-r14              SL-CommRxPoolListV2X-r14          OPTIONAL,  -- Need OR
  v2x-CommTxPoolNormalCommon-r14  SL-CommTxPoolListV2X-r14          OPTIONAL,  -- Need OR
  p2x-CommTxPoolNormalCommon-r14  SL-CommTxPoolListV2X-r14          OPTIONAL,  -- Need OR
  v2x-CommTxPoolExceptional-r14    SL-CommResourcePoolV2X-r14        OPTIONAL,  -- Need OR
  v2x-SyncConfig-r14              SL-SyncConfigListV2X-r14          OPTIONAL,  -- Need OR
  v2x-InterFreqInfoList-r14        SL-InterFreqInfoListV2X-r14       OPTIONAL,  -- Need OR
  v2x-ResourceSelectionConfig-r14   SL-CommTxPoolSensingConfig-r14    OPTIONAL,  -- Need OR
  zoneConfig-r14                   SL-ZoneConfig-r14                 OPTIONAL,  -- Need OR
  typeTxSync-r14                   SL-TypeTxSync-r14                 OPTIONAL,  -- Need OR
  thresSL-TxPrioritization-r14      SL-Priority-r13                   OPTIONAL,  -- Need OR
  anchorCarrierFreqList-r14         SL-AnchorCarrierFreqList-V2X-r14  OPTIONAL,  -- Need OR
  offsetDFN-r14                     INTEGER (0..1000)                  OPTIONAL,  -- Need OR
  cbr-CommonTxConfigList-r14        SL-CBR-CommonTxConfigList-r14     OPTIONAL,  -- Need OR
}

SL-A2X-ConfigCommon-r18 ::= SEQUENCE {
  a2x-CommRxPool-r18              SL-CommRxPoolListV2X-r14          OPTIONAL,  -- Need OR
  a2x-commTxPool-r18              SL-CommTxPoolListV2X-r14          OPTIONAL,  -- Need OR
}
-- ASN1STOP
```

<b>SystemInformationBlockType21 field descriptions</b>	
<b>a2x-CommRxPool</b>	Indicates the resources by which the UE is allowed to receive sidelink communication for A2X services.
<b>a2x-CommTxPool</b>	Indicates the resources by which the UE is allowed to transmit sidelink communication for A2X services.
<b>anchorCarrierFreqList</b>	Indicates EUTRA carrier frequencies which may include inter-carrier resource configuration for V2X sidelink communication.
<b>anchorCarrierFreqListNR</b>	Indicates NR carrier frequencies which may include inter-carrier resource configuration for V2X sidelink communication.
<b>cbr-CommonTxConfigList</b>	Indicates the common list of CBR ranges and the list of PSSCH transmissions parameter configurations available to configure congestion control to the UE for V2X sidelink communication.
<b>offsetDFN</b>	Indicates the timing offset for the UE to determine DFN timing when GNSS is used for timing reference for the PCell. Value 0 corresponds to 0 milliseconds, value 1 corresponds to 0.001 milliseconds, value 2 corresponds to 0.002 milliseconds, and so on.
<b>p2x-CommTxPoolNormalCommon</b>	Indicates the resources by which the UE is allowed to transmit P2X related V2X sidelink communication. <i>zoneID</i> is not configured in the pools in this field.
<b>thresSL-TxPrioritization</b>	Indicates the threshold used to determine whether SL V2X transmission is prioritized over uplink transmission if they overlap in time (see TS 36.321 [6]). This value shall overwrite <i>thresSL-TxPrioritization</i> configured in <i>SL-V2X-Preconfiguration</i> if any.
<b>typeTxSync</b>	Indicates the prioritized synchronization type (i.e. eNB or GNSS) for performing V2X sidelink communication on the carrier frequency on which this field is broadcast.
<b>v2x-CommRxPool</b>	Indicates the resources by which the UE is allowed to receive V2X sidelink communication while in RRC_IDLE and RRC_CONNECTED.
<b>v2x-CommTxPoolExceptional</b>	Indicates the resources by which the UE is allowed to transmit V2X sidelink communication in exceptional conditions, as specified in 5.10.13.
<b>v2x-CommTxPoolNormalCommon</b>	Indicates the resources by which the UE is allowed to transmit non-P2X related V2X sidelink communication when in RRC_IDLE or when in RRC_CONNECTED while transmitting V2X sidelink communication via a frequency other than the primary. E-UTRAN configures one resource pool per zone.
<b>v2x-InterFreqInfoList</b>	Indicates synchronization and resource allocation configurations of neighboring frequencies for V2X sidelink communication.
<b>v2x-ResourceSelectionConfig</b>	Indicates V2X sidelink communication configurations used for UE autonomous resource selection.
<b>v2x-SyncConfig</b>	Indicates the configuration by which the UE is allowed to receive and transmit synchronisation information for V2X sidelink communication. E-UTRAN configures <i>v2x-SyncConfig</i> including <i>txParameters</i> when configuring UEs to transmit synchronisation information.
<b>zoneConfig</b>	Indicates zone configurations used for V2X sidelink communication in 5.10.13.2.

## – SystemInformationBlockType24

The IE *SystemInformationBlockType24* contains information relevant for inter-RAT cell re-selection (i.e. information about NR frequencies and NR neighbouring cells relevant for cell re-selection), which can also be used for NR idle/inactive measurements. The IE includes cell re-selection parameters common for a frequency.

### SystemInformationBlockType24 information element

```
-- ASN1START
SystemInformationBlockType24-r15 ::= SEQUENCE {
  carrierFreqListNR-r15          CarrierFreqListNR-r15          OPTIONAL,      -- Need
OR
  t-ReselectionNR-r15           T-Reselection,
  t-ReselectionNR-SF-r15       SpeedStateScaleFactors        OPTIONAL,      -- Need OR
  lateNonCriticalExtension      OCTET STRING                   OPTIONAL,
  ...
-- ASN1END
```

```

[[ carrierFreqListNR-v1610      CarrierFreqListNR-v1610      OPTIONAL      -- Need OR
]],
[[ carrierFreqListNR-v1700      CarrierFreqListNR-v1700      OPTIONAL      -- Need OR
]],
[[ carrierFreqListNR-v1720      CarrierFreqListNR-v1720      OPTIONAL      -- Need OR
]],
[[ carrierFreqListNR-v1810      CarrierFreqListNR-v1810      OPTIONAL      -- Need OR
]]
}

CarrierFreqListNR-r15 ::=      SEQUENCE (SIZE (1..maxFreq)) OF CarrierFreqNR-r15

CarrierFreqListNR-v1610 ::=      SEQUENCE (SIZE (1..maxFreq)) OF CarrierFreqNR-v1610

CarrierFreqListNR-v1700 ::=      SEQUENCE (SIZE (1..maxFreq)) OF CarrierFreqNR-v1700

CarrierFreqListNR-v1720 ::=      SEQUENCE (SIZE (1..maxFreq)) OF CarrierFreqNR-v1720

CarrierFreqListNR-v1810 ::=      SEQUENCE (SIZE (1..maxFreq)) OF CarrierFreqNR-v1810

CarrierFreqNR-r15 ::=          SEQUENCE {
    carrierFreq-r15              ARFCN-ValueNR-r15,
    multiBandInfoList-r15        MultiFrequencyBandListNR-r15      OPTIONAL,      -- Need OR
    multiBandInfoListSUL-r15     MultiFrequencyBandListNR-r15      OPTIONAL,      -- Need OR
    measTimingConfig-r15         MTC-SSB-NR-r15                    OPTIONAL,      -- Need OR
    subcarrierSpacingSSB-r15     ENUMERATED {kHz15, kHz30, kHz120, kHz240},
    ss-RSSI-Measurement-r15      SS-RSSI-Measurement-r15           OPTIONAL,      -- Cond RSRQ2
    cellReselectionPriority-r15   CellReselectionPriority            OPTIONAL,      -- Need OP
    cellReselectionSubPriority-r15 CellReselectionSubPriority-r13     OPTIONAL,      -- Need OR
    threshX-High-r15             ReselectionThreshold,
    threshX-Low-r15              ReselectionThreshold,
    threshX-Q-r15                SEQUENCE {
        threshX-HighQ-r15         ReselectionThresholdQ-r9,
        threshX-LowQ-r15         ReselectionThresholdQ-r9
    }
    }
    OPTIONAL,      -- Cond RSRQ
    q-RxLevMin-r15               INTEGER (-70..-22),
    q-RxLevMinSUL-r15            INTEGER (-70..-22)                OPTIONAL,      -- Need OR
    p-MaxNR-r15                  P-MaxNR-r15,
    ns-PmaxListNR-r15            NS-PmaxListNR-r15                OPTIONAL,      -- Need OR
    q-QualMin-r15                INTEGER (-43..-12)                OPTIONAL,      -- Need OP
    deriveSSB-IndexFromCell-r15  BOOLEAN,
    maxRS-IndexCellQual-r15      MaxRS-IndexCellQualNR-r15        OPTIONAL,      -- Need OR
    threshRS-Index-r15           ThresholdListNR-r15              OPTIONAL,      -- Need OR
    . . .
    [[ multiBandNsPmaxListNR-v1550 MultiBandNsPmaxListNR-1-v1550  OPTIONAL,      -- Need OR
      multiBandNsPmaxListNR-SUL-v1550 MultiBandNsPmaxListNR-v1550  OPTIONAL,      -- Need OR
      ssb-ToMeasure-r15            SSB-ToMeasure-r15              OPTIONAL,      -- Need OR
    ]],
    [[ ns-PmaxListNR-v1760          NS-PmaxListNR-v1760            OPTIONAL,      -- Need OR
      multiBandNsPmaxListNR-v1760 MultiBandNsPmaxListNR-1-v1760  OPTIONAL,      -- Need OR
      multiBandNsPmaxListNR-SUL-v1760 MultiBandNsPmaxListNR-v1760  OPTIONAL,      -- Need OR
    ]]
}

CarrierFreqNR-v1610 ::=      SEQUENCE {
    smtc2-LP-r16                 MTC-SSB2-LP-NR-r16              OPTIONAL,      -- Need OR
    ssb-PositionQCL-CommonNR-r16 SSB-PositionQCL-RelationNR-r16  OPTIONAL,      -- Cond
SharedSpectrum2
    allowedCellListNR-r16        AllowedCellListNR-r16            OPTIONAL,      -- Cond
SharedSpectrum
    highSpeedCarrierNR-r16        ENUMERATED {true}                OPTIONAL,      -- Need OR
}

CarrierFreqNR-v1700 ::=      SEQUENCE {
    nr-FreqNeighHSDN-CellList-r17 NR-FreqNeighHSDN-CellList-r17  OPTIONAL,      -- Need OR
}

CarrierFreqNR-v1720 ::=      SEQUENCE {
    subcarrierSpacingSSB-r17      ENUMERATED {kHz480, spare1}      OPTIONAL,      -- Need OR
    ssb-PositionQCL-CommonNR-r17 SSB-PositionQCL-RelationNR-r17  OPTIONAL,      -- Cond
SharedSpectrum2
}

CarrierFreqNR-v1810 ::=      SEQUENCE {
    carrierFreq-r18               ARFCN-ValueNR-r15                OPTIONAL,      -- Cond LessThan5MHz
    multiBandInfoList-r18         MultiFrequencyBandListNR-r15     OPTIONAL,      -- Cond LessThan5MHz
    multiBandInfoListAerial-r18   MultiFrequencyBandListNR-r15     OPTIONAL,      -- Need OR
    ns-PmaxListNR-Aerial-r18      NS-PmaxListNR-Aerial-r18         OPTIONAL,      -- Need OR
}

```

```
multiBandNsPmaxListNR-Aerial-r18 MultiBandNsPmaxListNR-Aerial-1-r18 OPTIONAL, -- Need OR
mobileIAB-CellList-r18 PhysCellIdRangeNR-r16 OPTIONAL, -- Need OR
mobileIAB-Freq-r18 ENUMERATED {true} OPTIONAL -- Need OR
}
MultiBandNsPmaxListNR-1-v1550 ::= SEQUENCE (SIZE (1.. maxMultiBandsNR-1-r15)) OF NS-PmaxListNR-r15
MultiBandNsPmaxListNR-v1550 ::= SEQUENCE (SIZE (1.. maxMultiBandsNR-r15)) OF NS-PmaxListNR-r15
MultiBandNsPmaxListNR-1-v1760 ::= SEQUENCE (SIZE (1.. maxMultiBandsNR-1-r15)) OF NS-PmaxListNR-
v1760
MultiBandNsPmaxListNR-v1760 ::= SEQUENCE (SIZE (1.. maxMultiBandsNR-r15)) OF NS-PmaxListNR-v1760
MultiBandNsPmaxListNR-Aerial-1-r18 ::= SEQUENCE (SIZE (1.. maxMultiBandsNR-1-r15)) OF NS-
PmaxListNR-Aerial-r18
AllowedCellListNR-r16 ::= SEQUENCE (SIZE (1..maxCellAllowedNR-r16)) OF PhysCellIdNR-r15
NR-FreqNeighHSDN-CellList-r17 ::= SEQUENCE (SIZE (1..maxCellNR-r17)) OF PhysCellIdRangeNR-r16
-- ASN1STOP
```

<b>SystemInformationBlockType24 field descriptions</b>
<p><b>allowedCellListNR</b> List of allow-listed neighbouring NR cells.</p>
<p><b>carrierFreqListNR</b> List of carrier frequencies of NR carriers. These frequencies correspond to GSCN values as specified in TS 38.101 [85]. If the <i>carrierFreqListNR-v1610</i>, <i>carrierFreqListNR-v1700</i>, <i>carrierFreqListNR-v1720</i> or <i>carrierFreqListNR-v1810</i> is present, it contains the same number of entries, listed in the same order as in the <i>carrierFreqListNR</i> (without suffix). For a neighbouring carrier frequency when <i>carrierFreq-r18</i> is included, the network sets the corresponding value of <i>carrierFreq-r15</i> to 250, and the UE applies <i>carrierFreq-r18</i> instead of <i>carrierFreq-r15</i>. In such case, if the UE does not support the GSCN value corresponding to the <i>carrierFreq-r18</i>, it ignores the corresponding neighbour cell.</p>
<p><b>cellReselectionPriority</b> The field concerns the absolute priority of the concerned carrier frequency as used by the cell reselection procedure. Corresponds with parameter "priority" in TS 36.304 [4].</p>
<p><b>deriveSSB-IndexFromCell</b> The field indicates whether the UE may use, to derive the SSB index of a cell on the indicated SSB frequency and subcarrier spacing, the timing of any detected cell with the same SSB frequency and subcarrier spacing. If this field is set to TRUE, the UE assumes SFN and frame boundary alignment across cells on the same NR carrier frequency as specified in TS 36.133 [16].</p>
<p><b>highSpeedCarrierNR</b> If the field is present, the UE shall apply the enhanced inter-RAT NR measurement requirements to support high speed up to 500 km/h as specified in TS 36.133 [16] to the NR carrier.</p>
<p><b>maxRS-IndexCellQual</b> Number of SS blocks to average for cell measurement derivation. Corresponds to the parameter <i>nrofSS-BlocksToAverage</i> in TS 38.304 [92].</p>
<p><b>measTimingConfig</b> Used to configure measurement timing configurations, i.e., timing occasions at which the UE measures SSBs. If the field is absent, the UE assumes that SSB periodicity is 5ms in this frequency.</p>
<p><b>mobileIAB-CellList</b> List of neighbouring mobile IAB cells as specified in TS 36.304 [4].</p>
<p><b>mobileIAB-Freq</b> If present, it indicates that a mobile IAB node may be deployed on the NR frequency.</p>
<p><b>multiBandInfoList</b> Indicates the list of frequency bands for which the NR cell reselection parameters apply. The UE shall select the first listed band which it supports in the <i>multiBandInfoList</i> field to represent the NR neighbour carrier frequency. The network always includes <i>multiBandInfoList-r15</i>. For a neighbouring carrier frequency when <i>multiBandInfoList-r18</i> is included, the network sets the corresponding value of <i>FreqBandIndicatorNR-r15</i> in <i>multiBandInfoList-r15</i> to 200, and the UE applies <i>multiBandInfoList-r18</i> instead of <i>multiBandInfoList-r15</i>.</p>
<p><b>multiBandInfoListAerial</b> Indicates the list of frequency bands for which the NR cell reselection parameters apply. The aerial UE shall select the first listed band which it supports in the <i>multiBandInfoListAerial</i> field to represent the NR neighbour carrier frequency.</p>
<p><b>multiBandInfoListSUL</b> Indicates the list of frequency bands for which the NR cell reselection parameters apply. The UE shall select the first listed band which it supports in the <i>multiBandInfoListSUL</i> field to represent the NR neighbour carrier frequency.</p>
<p><b>multiBandNsPmaxListNR</b> Indicates the <i>NS-PmaxListNR</i> configuration for the NR frequency band(s) listed in <i>multiBandInfoList</i>. The first entry corresponds to the second listed band in <i>multiBandInfoList</i>, and second entry corresponds to the third listed band in <i>multiBandInfoList</i>, and so on.</p>
<p><b>multiBandNsPmaxListNR-Aerial</b> Indicates the <i>NS-PmaxListNR-Aerial</i> configuration for the NR frequency band(s) listed in <i>multiBandInfoListAerial</i>. The first entry corresponds to the second listed band in <i>multiBandInfoListAerial</i>, and second entry corresponds to the third listed band in <i>multiBandInfoListAerial</i>, and so on.</p>
<p><b>multiBandNsPmaxListNR-SUL</b> Indicates the <i>NS-PmaxListNR</i> configuration for the NR SUL frequency band(s) listed in <i>multiBandInfoListSUL</i>. The first entry corresponds to the first listed band in <i>multiBandInfoListSUL</i>, and second entry corresponds to the second listed band in <i>multiBandInfoListSUL</i>, and so on.</p>
<p><b>nr-FreqNeighHSDN-CellList</b> List of neighbouring NR HSDN cells as specified in TS 38.304 [92].</p>
<p><b>ns-PmaxListNR</b> Indicates a list of <i>additionalPmax</i> and <i>additionalSpectrumEmission</i>, corresponds to the first listed band in the <i>multiBandInfoList</i>.</p>
<p><b>ns-PmaxListNR-Aerial</b> Indicates a list of <i>additionalPmax</i> and <i>additionalSpectrumEmission</i> for aerial UE, corresponds to the first listed band in the <i>multiBandInfoListAerial</i>.</p>
<p><b>p-MaxNR</b> Indicates the maximum power for NR (see TS 38.104 [91]).</p>

<b>q-QualMin</b>	Parameter "Q <sub>qualmin</sub> " in TS 36.304 [4], applicable for NR neighbour cells. If the field is not present, the UE applies the (default) value of negative infinity for Q <sub>qualmin</sub> . The actual value Q <sub>qualmin</sub> = field value [dB].
<b>q-RxLevMin</b>	Parameter "Q <sub>rxlevmin</sub> " in TS 38.304 [92], applicable for NR neighbour cells. The actual value Q <sub>rxlevmin</sub> = field value * 2 [dBm].
<b>q-RxLevMinSUL</b>	Parameter "Q <sub>rxlevmin</sub> " in TS 38.304 [92], applicable for NR neighbouring cells. The actual value Q <sub>rxlevmin</sub> = field value * 2 [dBm].
<b>smtc2-LP</b>	Measurement timing configuration for inter-RAT neighbour cells in NR with a Long Periodicity (LP) indicated by periodicity in <i>smtc2-LP</i> . The timing offset and duration are equal to the offset and duration indicated in <i>measTimingConfig</i> in <i>CarrierFreqNR</i> . The periodicity in <i>smtc2-LP</i> can only be set to a value strictly larger than the periodicity in <i>measTimingConfig</i> in <i>CarrierFreqNR</i> (e.g. if <i>measTimingConfig</i> indicates sf20 the Long Periodicity can only be set to sf40, sf80 or sf160, if <i>measTimingConfig</i> indicates sf160, <i>smtc2-LP</i> cannot be configured). The <i>pci-List</i> , if present, includes the physical cell identities of the inter-RAT neighbour cells with Long Periodicity. If <i>smtc2-LP</i> is absent, the UE assumes that there are no inter-RAT neighbour cells with a Long Periodicity.
<b>ssb-PositionQCL-CommonNR</b>	Indicates the QCL relationship between SS/PBCH blocks for NR neighbor cells on the indicated frequency as specified in TS 38.213 [88], clause 4.1. If <i>ssb-PositionQCL-CommonNR-r17</i> is present, the UE ignores <i>ssb-PositionQCL-CommonNR-r16</i> .
<b>ssb-ToMeasure</b>	The set of SS blocks to be measured within the SMTC measurement duration (see TS 38.215 [89]). When the field is absent the UE measures on all SS-blocks.
<b>ss-RSSI-Measurements</b>	Indicates the SSB-based RSSI measurement configuration. If the field is absent, the UE behaviour is defined in TS 38.215 [89], clause 5.1.3.
<b>subcarrierSpacingSSB</b>	Indicates the subcarrier spacing of SSB of NR frequency. Only the values 15 kHz or 30 kHz (FR1), 120 kHz or 240 kHz (FR2-1), 120 kHz or 480 kHz (FR2-2) are applicable. If <i>subcarrierSpacingSSB-r17</i> is present, the UE ignores <i>subcarrierSpacingSSB-r15</i> .
<b>threshRS-Index</b>	List of thresholds for consolidation of L1 measurements per RS index. Corresponds to the parameter <i>absThreshSS-BlocksConsolidation</i> in TS 38.304 [92].
<b>threshX-High</b>	Parameter "Thresh <sub>X, HighP</sub> " in TS 36.304 [4].
<b>threshX-HighQ</b>	Parameter "Thresh <sub>X, HighQ</sub> " in TS 36.304 [4].
<b>threshX-Low</b>	Parameter "Thresh <sub>X, LowP</sub> " in TS 36.304 [4].
<b>threshX-LowQ</b>	Parameter "Thresh <sub>X, LowQ</sub> " in TS 36.304 [4].
<b>t-ReselectionNR</b>	Parameter "Treselction <sub>NR</sub> " in TS 36.304 [4].
<b>t-ReselectionNR-SF</b>	Parameter "Speed dependent ScalingFactor for Treselction <sub>NR</sub> " in TS 36.304 [4]. If the field is not present, the UE behaviour is specified in TS 36.304 [4].

Conditional presence	Explanation
<i>LessThan5MHz</i>	The field is mandatory present if the NR neighbor cell supports 12 PRB, 15 PRB or 20 PRB transmission bandwidth configuration as defined in TS 38.101-1 [85], TS 38.211 [117] and TS 38.213 [88]. Otherwise, the field is not present and the corresponding Rel-15 field applies.
<i>RSRQ</i>	The field is mandatory present if the <i>threshServingLowQ</i> is present in <i>systemInformationBlockType3</i> ; otherwise it is not present.
<i>RSRQ2</i>	The field is optional Need OP if the <i>threshServingLowQ</i> is present in <i>systemInformationBlockType3</i> ; otherwise it is not present.
<i>SharedSpectrum</i>	The field is optional Need OP if NR operates with shared spectrum channel access; otherwise, it is not present.
<i>SharedSpectrum2</i>	The field is mandatory present if NR operates with shared spectrum channel access; otherwise, it is not present.

## – SystemInformationBlockType25

The IE *SystemInformationBlockType25* contains the UAC parameters.



**SystemInformationBlockType25 information element**

```

-- ASN1START
SystemInformationBlockType25-r15 ::= SEQUENCE {
  uac-BarringForCommon-r15          UAC-BarringPerCatList-r15          OPTIONAL, --
Need OP
  uac-BarringPerPLMN-List-r15      UAC-BarringPerPLMN-List-r15      OPTIONAL, -- Need
OP
  uac-BarringInfoSetList-r15      UAC-BarringInfoSetList-r15,
  uac-AC1-SelectAssistInfo-r15    CHOICE {
    plmnCommon-r15                UAC-AC1-SelectAssistInfo-r15,
    individualPLMNList-r15        SEQUENCE (SIZE (2..maxPLMN-r11)) OF UAC-AC1-SelectAssistInfo-r15
  } OPTIONAL, -- Need OR
  lateNonCriticalExtension         OCTET STRING                      OPTIONAL,
  ...,
  [[ ab-PerRSRP-r16                ENUMERATED {thresh0, thresh1, thresh2, thresh3} OPTIONAL --
Need OR
]],
  [[
    uac-AC1-SelectAssistInfo-r16    SEQUENCE (SIZE (2..maxPLMN-r11)) OF UAC-AC1-SelectAssistInfo-
r16 OPTIONAL -- Need OR
  ]],
  [[
    uac-BarringInfoSetList-v1700    UAC-BarringInfoSetList-v1700    OPTIONAL -- Cond MINT
  ]]
}

UAC-BarringPerPLMN-List-r15 ::= SEQUENCE (SIZE (1.. maxPLMN-r11)) OF UAC-BarringPerPLMN-r15

UAC-BarringPerPLMN-r15 ::= SEQUENCE {
  plmn-IdentityIndex-r15          INTEGER (1.. maxPLMN-r11),
  uac-AC-BarringListType-r15      CHOICE{
    uac-ImplicitAC-BarringList-r15 SEQUENCE (SIZE(maxAccessCat-1-r15)) OF UAC-
BarringInfoSetIndex-r15,
    uac-ExplicitAC-BarringList-r15 UAC-BarringPerCatList-r15
  } OPTIONAL -- Need OR
}

UAC-BarringPerCatList-r15 ::= SEQUENCE (SIZE (1..maxAccessCat-1-r15)) OF UAC-BarringPerCat-r15

UAC-BarringPerCat-r15 ::= SEQUENCE {
  accessCategory-r15              INTEGER (1..maxAccessCat-1-r15),
  uac-barringInfoSetIndex-r15     UAC-BarringInfoSetIndex-r15
}

UAC-BarringInfoSetIndex-r15 ::= INTEGER (1..maxBarringInfoSet-r15)
UAC-BarringInfoSetList-r15 ::= SEQUENCE (SIZE (1..maxBarringInfoSet-r15)) OF UAC-BarringInfoSet-
r15

UAC-BarringInfoSetList-v1700 ::= SEQUENCE (SIZE(1..maxBarringInfoSet-r15)) OF UAC-BarringInfoSet-
v1700

UAC-BarringInfoSet-r15 ::= SEQUENCE {
  uac-BarringFactor-r15           ENUMERATED {
    p00, p05, p10, p15, p20, p25, p30, p40,
    p50, p60, p70, p75, p80, p85, p90, p95},
  uac-BarringTime-r15            ENUMERATED {s4, s8, s16, s32, s64, s128, s256, s512},
  uac-BarringForAccessIdentity-r15 BIT STRING (SIZE(7))
}

UAC-BarringInfoSet-v1700 ::= SEQUENCE {
  uac-BarringFactorForAI3-r17     ENUMERATED {p00, p05, p10, p15, p20, p25, p30, p40,
    p50, p60, p70, p75, p80, p85, p90, p95} OPTIONAL -- Need OP
}

UAC-AC1-SelectAssistInfo-r15 ::= ENUMERATED {a, b, c}

UAC-AC1-SelectAssistInfo-r16 ::= ENUMERATED {a, b, c, notConfigured}

-- ASN1STOP

```

<b>SystemInformationBlockType25 field descriptions</b>	
<b>accessCategory</b>	The Access Category according to TS 22.261 [96].
<b>ab-PerRSRP</b>	Access barring per RSRP. Value <i>thresh0</i> means access to the cell is barred when UE is in enhanced coverage as specified in TS 36.304 [4] and does not apply to UEs satisfying S criteria for normal coverage. Value <i>thresh1</i> is compared to the first entry configured in <i>rsrp-ThresholdsPrachInfoList</i> , value <i>thresh2</i> is compared to the second entry configured in <i>rsrp-ThresholdsPrachInfoList</i> and so on. E-UTRA/5GC includes this field only in the BR version of <i>SystemInformationBlockType25</i> .
<b>uac-AC-BarringListType</b>	Access control parameters for each access category valid only for a specific PLMN. UE behaviour upon absence of this field is specified in clause 5.3.16.2.
<b>uac-AC1-SelectAssistInfo</b>	Information used to determine whether Access Category 1 applies to the UE, as defined in TS 22.261 [96]. If <i>plmnCommon</i> is chosen, the <i>UAC-AC1-SelectAssistInfo</i> is applicable to all the PLMNs in <i>cellAccessRelatedInfoList-5GC</i> . If <i>individualPLMNList</i> is chosen, the 1 <sup>st</sup> entry in the list corresponds to the first PLMN in <i>cellAccessRelatedInfoList-5GC</i> , the 2 <sup>nd</sup> entry in the list corresponds to the second PLMN in <i>cellAccessRelatedInfoList-5GC</i> and so on. If <i>uac-AC1-SelectAssistInfo-r16</i> is present, the UE shall ignore the <i>uac-AC1-SelectAssistInfo-r15</i> . Value <i>notConfigured</i> indicates that Access Category1 is not configured for the corresponding PLMN. The corresponding <i>UAC-AC1-SelectAssistInfo</i> for the selected PLMN is forwarded to upper layers, if present and set to a, b or c.
<b>uac-BarringFactor</b>	Represents the probability that access attempt would be allowed during access barring check.
<b>uac-BarringFactorForAI3</b>	Barring factor applicable for Access Identity 3. Represents the probability that access attempt would be allowed during access barring check. If absent, the UE considers the access attempt as allowed.
<b>uac-BarringForAccessIdentity</b>	Indicates whether access attempt is allowed for each Access Identity. The leftmost bit, bit 0 in the bit string corresponds to Access Identity 1, bit 1 in the bit string corresponds to Access Identity 2, bit 2 in the bit string corresponds to Access Identity 11, bit 3 in the bit string corresponds to Access Identity 12 and so on. Value 0 means that access attempt is allowed for the corresponding access identity.
<b>uac-BarringForCommon</b>	Common access control parameters for each access category. Common values are used for all PLMNs, unless overwritten by the PLMN specific configuration provided in <i>uac-BarringPerPLMN-List</i> . The parameters are specified by providing an index to the set of configurations ( <i>uac-BarringInfoSetList</i> ). UE behaviour upon absence of this field is specified in clause 5.3.16.2.
<b>uac-barringInfoSetIndex</b>	Index of the entry in field <i>uac-BarringInfoSetList</i> . Value 1 corresponds to the first entry in <i>uac-BarringInfoSetList</i> , value 2 corresponds to the second entry in this list and so on. An index value referring to an entry not included in <i>uac-BarringInfoSetList</i> indicates no barring.
<b>uac-BarringInfoSetList</b>	List of access control parameter sets. Each access category can be configured with access parameters corresponding to a particular set by <i>uac-barringInfoSetIndex</i> . Association of an access category with an index that has no corresponding entry in the <i>uac-BarringInfoSetList</i> is valid configuration and indicates no barring.
<b>uac-BarringPerPLMN-List</b>	Access control parameters for each access category valid only for a specific PLMN.
<b>uac-BarringTime</b>	The average time in seconds before a new access attempt is to be performed after an access attempt was barred at access barring check for the same access category, see 5.3.16.5.

Conditional presence	Explanation
<i>MINT</i>	The field is optionally present, Need OR, in a cell that provides a configuration for disaster roaming, otherwise it is absent.

## SystemInformationBlockType26

The IE *SystemInformationBlockType26* contains V2X sidelink communication configurations which can be used jointly with those included in *SystemInformationBlockType21*.

### SystemInformationBlockType26 information element

```
-- ASN1START
SystemInformationBlockType26-r15 ::= SEQUENCE {
    v2x-InterFreqInfoList-r15          SL-InterFreqInfoListV2X-r14          OPTIONAL,  -- Need OR
```

```

cbr-pssch-TxConfigList-r15      SL-CBR-PPPP-TxConfigList-r15      OPTIONAL,  -- Need OR
v2x-PacketDuplicationConfig-r15  SL-V2X-PacketDuplicationConfig-r15  OPTIONAL,  -- Need OR
syncFreqList-r15                SL-V2X-SyncFreqList-r15            OPTIONAL,  -- Need OR
slss-TxMultiFreq-r15            ENUMERATED{true}                   OPTIONAL,  -- Need OR
v2x-FreqSelectionConfigList-r15  SL-V2X-FreqSelectionConfigList-r15  OPTIONAL,  -- Need OR
threshS-RSSI-CBR-r15            INTEGER (0..45)                     OPTIONAL,  -- Need OR
...
lateNonCriticalExtension         OCTET STRING                         OPTIONAL
}
-- ASN1STOP

```

### SystemInformationBlockType26 field descriptions

#### **cbr-pssch-TxConfigList**

Indicates the mapping between PPPPs, CBR ranges by using indexes of the entry in *cbr-RangeCommonConfigList* included in SIB21, and PSSCH transmission parameters and CR limit by using indexes of the entry in *sl-CBR-PSSCH-TxConfigList* included in SIB21. The configurations in this field apply to all the resource pools on all the carrier frequencies included in SIB26 for V2X sidelink communication transmission. The *mcs-PSSCH-RangeList-r15* included in this field also applies to all the resource pools on all the carrier frequencies included in SIB21 for V2X sidelink communication transmission.

#### **slss-TxMultiFreq**

Value TRUE indicates the UE transmits SLSS on multiple carrier frequencies for V2X sidelink communication. If this field is absent, the UE transmits SLSS only on the synchronisation carrier frequency.

#### **syncFreqList**

Indicates a list of candidate carrier frequencies that can be used for the synchronisation of V2X sidelink communication.

#### **threshS-RSSI-CBR**

Indicates the S-RSSI threshold for determining the contribution of a sub-channel to the CBR measurement, as specified in TS 36.214 [48]. Value 0 corresponds to -112 dBm, value 1 to -110 dBm, value n to  $(-112 + n*2)$  dBm, and so on. If included, the *threshS-RSSI-CBR* in *SL-CommResourcePoolV2X* in SIB26 is absent.

#### **v2x-FreqSelectionConfigList**

Indicates the configuration information for the carrier selection for V2X sidelink communication transmission on the carrier frequency where the field is broadcast.

#### **v2x-PacketDuplicationConfig**

Indicates the configuration information for sidelink packet duplication for V2X sidelink communication.

#### **v2x-InterFreqInfoList**

If this field includes a carrier frequency which is included in SIB21 and some configuration(s) for that carrier are already included in SIB21, the corresponding configuration(s) for that carrier frequency are not included in this field.

## SystemInformationBlockType26a

The IE *SystemInformationBlockType26a* contains NR bands list which can be used for EN-DC operation with the serving cell.

### SystemInformationBlockType26a information element

```

-- ASN1START
SystemInformationBlockType26a-r16 ::= SEQUENCE {
    plmn-InfoList-r16          PLMN-InfoList-r16,
    bandListENDC-r16          BandListENDC-r16,
    lateNonCriticalExtension   OCTET STRING                OPTIONAL,
    ...
}
BandListENDC-r16 ::= SEQUENCE (SIZE (1.. maxBandsENDC-r16)) OF FreqBandIndicatorNR-r15
PLMN-InfoList-r16 ::= SEQUENCE (SIZE (0..maxPLMN-r11)) OF PLMN-Info-r16
PLMN-Info-r16 ::= SEQUENCE {
    nr-BandList-r16          BIT STRING (SIZE(maxBandsENDC-r16)) OPTIONAL  -- Need OR
}
-- ASN1STOP

```

<b>SystemInformationBlockType26a field descriptions</b>
<p><b>bandListENDC</b> A list of NR bands which can be configured as SCG in EN-DC operation with serving cell for the forwarding of <i>upperLayerIndication</i> to upper layers.</p>
<p><b>plmn-InfoList</b> This field includes the same number of entries, and listed in the same order as PLMNs across the <i>plmn-IdentityList</i> fields <i>plmn-IdentityList</i> and <i>plmn-IdentityList-r14</i> included in SIB1. I.e. the first entry corresponds to the first entry of the combined list that results from concatenating the entries included in the second to the original <i>plmn-IdentityList</i> field in SIB1. If the size of the field is set to 0, all bands in <i>bandListENDC</i> apply for all PLMNs listed in SIB1.</p>
<p><b>nr-BandList</b> This field indicates a list of bands and is encoded as a bitmap, where the bit N is set to "1" if the current serving cell supports EN-DC operation with the N-th NR band in <i>bandListENDC</i>. The bits which have no corresponding bands in <i>bandListENDC</i> shall be set to 0; bit 1 of the bitmap is the leading bit of the bit string.</p>

## – SystemInformationBlockType27

The IE *SystemInformationBlockType27* contains information relevant only for inter-RAT cell selection i.e. assistance information about NB-IoT frequencies for cell selection.

### SystemInformationBlockType27 information element

```
-- ASN1START
SystemInformationBlockType27-r16 ::= SEQUENCE {
    carrierFreqListNBIOT-r16      CarrierFreqListNBIOT-r16      OPTIONAL,  -- Need OR
    lateNonCriticalExtension      OCTET STRING                OPTIONAL,
    ...
}

CarrierFreqListNBIOT-r16 ::= SEQUENCE (SIZE (1.. maxFreqNBIOT-r16)) OF
    CarrierFreqNBIOT-r16

CarrierFreqNBIOT-r16 ::= SEQUENCE {
    carrierFreq-r16              ARFCN-ValueEUTRA-r9,
    carrierFreqOffset-r16        ENUMERATED {v-10, v-9, v-8dot5, v-8, v-7, v-6, v-5, v-4dot5,
                                             v-4, v-3, v-2, v-1, v-0dot5, v0, v1, v2, v3, v3dot5,
                                             v4, v5, v6, v7, v7dot5, v8, v9}
}
-- ASN1STOP
```

<b>SystemInformationBlockType27 field descriptions</b>
<p><b>carrierFreqListNBIOT</b> Provides a list of neighbouring NB-IoT carrier frequencies, which may be searched for neighbouring NB-IoT cells.</p>
<p><b>carrierFreq</b> Provides the ARFCN applicable for the NB-IoT carrier frequency as defined in TS 36.101 [42], Table 5.7.3-1.</p>
<p><b>carrierFreqOffset</b> Offset of the NB-IoT channel number to EARFCN as defined in TS 36.101 [42], clause 5.7.3F. Value <i>v-10</i> means -10, <i>v-9</i> means -9, and so on. The values <i>v-8dot5</i>, <i>v-4dot5</i>, <i>v3dot5</i> and <i>v7dot5</i> are only applicable for a carrier in a TDD band.</p>

## – SystemInformationBlockType28

The IE *SystemInformationBlockType28* contains NR sidelink communication configuration.

### SystemInformationBlockType28 information element

```
-- ASN1START
SystemInformationBlockType28-r16 ::= SEQUENCE {
    segmentNumber-r16            INTEGER (0..63),
    segmentType-r16              ENUMERATED {notLastSegment, lastSegment},
    segmentContainer-r16         OCTET STRING,
    lateNonCriticalExtension      OCTET STRING                OPTIONAL,
    ...
}
-- ASN1STOP
```

```
-- ASN1STOP
```

#### **SystemInformationBlockType28 field descriptions**

##### **segmentContainer**

Container for the configuration for NR sidelink communication, this field includes a segment of *SIB12-IEs* as specified in TS 38.331 [82]. The size of the included segment in this container should be small enough that the SIB message size is less than or equal to the maximum size of a LTE SI i.e. 2216 bits.

This field is not applicable to 5GS Proximity based Services (ProSe) as defined in TS 23.304 [112] in this release.

##### **segmentNumber**

This field identifies the sequence number of a segment of *SIB12-IEs* IE as specified in TS 38.331 [82]. A segment number of zero corresponds to the first segment, a segment number of one corresponds to the second segment, and so on.

##### **segmentType**

This field indicates whether the included segment is the last segment or not.

### – **SystemInformationBlockType29**

The IE *SystemInformationBlockType29* contains common resource reservation, e.g. for coexistence with NR.

#### **SystemInformationBlockType29 information element**

```
-- ASN1START
SystemInformationBlockType29-r16 ::= SEQUENCE {
    resourceReservationConfigCommonDL-r16 ResourceReservationConfigDL-r16 OPTIONAL, -- Need OR
    resourceReservationConfigCommonUL-r16 ResourceReservationConfigUL-r16 OPTIONAL, -- Need OR
    lateNonCriticalExtension OCTET STRING OPTIONAL,
    ...
}
-- ASN1STOP
```

### – **SystemInformationBlockType30**

The IE *SystemInformationBlockType30* contains configurations of disaster roaming information.

#### **SystemInformationBlockType30 information element**

```
-- ASN1START
SystemInformationBlockType30-r17 ::= SEQUENCE {
    commonPLMNsWithDisasterCondition-r17 SEQUENCE (SIZE (1..maxPLMN-r11)) OF PLMN-Identity
        OPTIONAL, -- Need OR
    applicableDisasterInfoList-r17 SEQUENCE (SIZE (1..maxPLMN-r11)) OF
ApplicableDisasterInfo-r17 OPTIONAL, -- Need OR
    lateNonCriticalExtension OCTET STRING OPTIONAL,
    ...
}
ApplicableDisasterInfo-r17 ::= CHOICE {
    noDisasterRoaming-r17 NULL,
    disasterRelatedIndication-r17 NULL,
    commonPLMNs-r17 NULL,
    dedicatedPLMNs-r17 SEQUENCE (SIZE (1..maxPLMN-r11)) OF PLMN-Identity
}
-- ASN1STOP
```

<b>SystemInformationBlockType30 field descriptions</b>
<p><b>commonPLMNsWithDisasterCondition</b> A list of PLMN(s) for which disaster condition applies and that disaster inbound roaming is accepted, which can be commonly applicable to the PLMNs sharing the cell.</p>
<p><b>applicableDisasterInfoList</b> A list indicating the applicable disaster roaming information for the networks indicated by <i>plmn-IdentityList-r15</i> in <i>CellAccessRelatedInfo-5GC-r15</i>. The first entry in this list indicates the disaster roaming information applicable for the network(s) in the first entry of <i>plmn-IdentityList</i>, the second entry in this list indicates the disaster roaming information applicable for the network(s) in the second entry on <i>plmn-IdentityList</i>, and so on. Each entry in this list can either be having the value <i>noDisasterRoaming</i>, <i>disasterRelatedIndication</i>, <i>commonPLMNs</i>, or <i>dedicatedPLMNs</i>. If an entry in this list takes the value <i>noDisasterRoaming</i>, disaster inbound roaming is not allowed in this network(s). If an entry in this list takes the value <i>disasterRelatedIndication</i>, the meaning of this field for this network(s) is as specified for "disaster related indication" in TS 23.122 [11], clause 4.4.3.1.1. If an entry in this list takes the value <i>commonPLMNs</i>, the PLMN(s) with disaster conditions indicated in the field <i>commonPLMNsWithDisasterCondition</i> apply for this network(s). If an entry in this list contains the value <i>dedicatedPLMNs</i>, the listed PLMN(s) are the PLMN(s) with disaster conditions that the network(s) corresponding to this entry accepts disaster inbound roamers from.</p>

## – SystemInformationBlockType31

The IE *SystemInformationBlockType31* contains satellite assistance information for the serving cell. *SystemInformationBlockType31* is only signalled for an NTN cell.

### SystemInformationBlockType31 information element

```

-- ASN1START
SystemInformationBlockType31-r17 ::= SEQUENCE {
    servingSatelliteInfo-r17      ServingSatelliteInfo-r17,
    lateNonCriticalExtension      OCTET STRING                OPTIONAL,
    ...,
    [[ servingSatelliteInfo-v1820 ServingSatelliteInfo-v1820  OPTIONAL  -- Need OR
    ]]
}

ServingSatelliteInfo-r17 ::= SEQUENCE {
    ephemerisInfo-r17            CHOICE {
        stateVectors              EphemerisStateVectors-r17,
        orbitalParameters         EphemerisOrbitalParameters-r17
    },
    nta-CommonParameters-r17     SEQUENCE {
        nta-Common-r17            INTEGER (0..8316827)        OPTIONAL,  -- Need OP
        nta-CommonDrift-r17       INTEGER (-261935..261935)    OPTIONAL,  -- Need OP
        nta-CommonDriftVariation-r17 INTEGER (0..29479)        OPTIONAL,  -- Need OP
    },
    ul-SyncValidityDuration-r17  ENUMERATED {s5, s10, s15, s20, s25, s30, s35, s40,
        s45, s50, s55, s60, s120, s180, s240, s900},
    epochTime-r17               SEQUENCE {
        startSFN-r17              INTEGER (0..1023),
        startSubFrame-r17         INTEGER (0..9)
    }
    OPTIONAL,  -- Need OP
    k-Offset-r17                INTEGER (0..1023),
    k-Mac-r17                   INTEGER (1..512)                OPTIONAL,  -- Need OP
    ...
}

ServingSatelliteInfo-v1820 ::= SEQUENCE {
    satelliteId-r18              SatelliteId-r18                OPTIONAL,  -- Need OR
    referenceLocation-r18        CHOICE {
        fixedReferenceLocation-r18 ReferenceLocation-r18,
        movingReferenceLocation-r18 ReferenceLocation-r18
    }
    OPTIONAL,  -- Need OR
    distanceThresh-r18          INTEGER(0..65535)                OPTIONAL,  -- Need OR
}
-- ASN1STOP

```

<b>SystemInformationBlockType31 field descriptions</b>
<p><b>distanceThresh</b> Distance from the serving cell reference location and is used in location-based measurement initiation in RRC_IDLE (as specified in TS 36.304 [4]) and RRC_CONNECTED. Each step represents 50m.</p>
<p><b>epochTime</b> Epoch time of the satellite ephemeris data and common TA parameters, see TS 36.213 [23]. This field also indicates the epoch time for the reference location of earth moving cells if present. The reference point for epoch time of the serving satellite ephemeris and Common TA parameters is the uplink time synchronization reference point. <i>epochTime</i> is the starting time of a DL subframe indicated by <i>startSFN</i> and <i>startSubframe</i>. For serving cell, the <i>startSFN</i> indicates the current SFN or the next upcoming SFN after the frame where the message indicating the <i>epochTime</i> is received. If the field is absent, the epoch time is the starting time of the DL subframe corresponding to the end of the SI window during which the SI message carrying SIB31(-NB) is transmitted. E-UTRAN always includes <i>epochTime</i> when SIB31(-NB) is provided through dedicated signalling. In case of handover or conditional handover, this field is based on the timing of the target cell, i.e. the <i>startSFN</i> and <i>startSubFrame</i> number indicated in this field refers to the SFN and sub-frame of the target cell, and UE considers the target cell epoch time (indicated by the <i>startSFN</i> and <i>startSubFrame</i> in this field) to be the frame nearest to the frame where <i>RRCConnectionReconfiguration</i> message is received.</p>
<p><b>k-Mac</b> Scheduling offset used when downlink and uplink frame timing are not aligned at the eNB, see TS 36.213 [23]. Unit in ms. If the field is absent, the UE uses the (default) value of 0.</p>
<p><b>k-Offset</b> Scheduling offset used in the timing relationships in NTN, see TS 36.213 [23]. Unit in ms.</p>
<p><b>nta-Common</b> Network-controlled common TA, see TS 36.213 [23]. Unit of <math>\mu\text{s}</math>. Step of <math>32.55208 \times 10^{-3} \mu\text{s}</math>. Actual value = field value * <math>32.55208 \times 10^{-3}</math>. If the field is absent, the UE uses the (default) value of 0.</p>
<p><b>nta-CommonDrift</b> Drift rate of the common TA, see TS 36.213 [23]. Unit of <math>\mu\text{s/s}</math>. Step of <math>0.2 \times 10^{-3} \mu\text{s/s}</math>. Actual value = field value * <math>0.2 \times 10^{-3}</math>. If the field is absent, the UE uses the (default) value of 0.</p>
<p><b>nta-CommonDriftVariation</b> Drift rate variation of the common TA, see TS 36.213 [23]. Unit of <math>\mu\text{s/s}^2</math>. Step of <math>0.2 \times 10^{-4} \mu\text{s/s}^2</math>. Actual value = field value * <math>0.2 \times 10^{-4}</math>. If the field is absent, the UE uses the (default) value of 0.</p>
<p><b>orbitalParameters</b> Instantaneous values of the satellite orbital parameters. The signalled values are valid at least for the duration as defined by <i>ul-SyncValidityDuration</i> and <i>epochTime</i>.</p>
<p><b>referenceLocation</b> Reference location of the NTN (quasi-)earth fixed cell or earth moving cell, used in location-based measurement initiation in RRC_IDLE (as specified in TS 36.304 [4]) and RRC_CONNECTED if <i>distanceThresh</i> is also configured. If configured by an earth moving cell, the broadcast reference location corresponds to the epoch time and is also used in the evaluation of Event D2 and CondEvent D2, and the UE derives the real-time reference location based on the serving satellite ephemeris, see TS 36.304 [4].</p>
<p><b>stateVectors</b> Instantaneous values of the satellite state vectors. The signalled values are valid at least for the duration as defined by <i>ul-SyncValidityDuration</i> and <i>epochTime</i>.</p>
<p><b>ul-SyncValidityDuration</b> Validity duration of the satellite ephemeris data and common TA parameters, i.e. maximum time duration (from <i>epochTime</i>) during which the UE can apply the satellite ephemeris without acquiring new satellite ephemeris, see TS 36.213 [23]. Unit in second. Value <i>s5</i> corresponds to 5 seconds, value <i>s10</i> corresponds to 10 seconds and so on. The <i>ul-SyncValidityDuration</i> is only updated when at least one of <i>epochTime</i>, <i>nta-CommonParameters</i>, <i>ephemerisInfo</i> is updated.</p>

## SystemInformationBlockType32

The IE *SystemInformationBlockType32* contains satellite assistance information for prediction of discontinuous coverage. *SystemInformationBlockType32* is only signalled in a NTN cell.

### SystemInformationBlockType32 information element

```
-- ASN1START
SystemInformationBlockType32-r17 ::= SEQUENCE {
```

```

    satelliteInfoList-r17          SatelliteInfoList-r17  OPTIONAL,  -- Need OR
    lateNonCriticalExtension      OCTET STRING          OPTIONAL,
    ...,
    [[ satelliteInfoList-v1800    SatelliteInfoList-v1800 OPTIONAL  -- Need OR
    ]],
    [[ satelliteInfoList-v1830    SatelliteInfoList-v1830 OPTIONAL  -- Need OR
    ]]
}

SatelliteInfoList-r17 ::= SEQUENCE (SIZE (1..maxSat-r17)) OF SatelliteInfo-r17

SatelliteInfoList-v1800 ::= SEQUENCE (SIZE (1..maxSat-r17)) OF CarrierFreqList-v1800

SatelliteInfoList-v1830 ::= SEQUENCE (SIZE (1..maxSat-r17)) OF CarrierFreqList-v1830

SatelliteInfo-r17 ::=
    SEQUENCE {
        satelliteId-r17          INTEGER (0..255),
        serviceInfo-r17         SEQUENCE {
            tle-EphemerisParameters-r17 TLE-EphemerisParameters-r17 OPTIONAL,  -- Need OR
            t-ServiceStart-r17         TimeOffsetUTC-r17          OPTIONAL  -- Need OR
        },
        footprintInfo-r17       SEQUENCE {
            referencePoint-r17       SEQUENCE {
                longitude-r17        INTEGER (-131072..131071),
                latitude-r17         INTEGER (-131072..131071)
            } OPTIONAL, -- Need OR
            elevationAngles-r17     SEQUENCE {
                elevationAngleRight-r17 INTEGER (-14..14),
                elevationAngleLeft-r17  INTEGER (-14..14)          OPTIONAL  -- Need OP
            } OPTIONAL, -- Need OR
            radius-r17             INTEGER (1..256)                OPTIONAL  -- Need OR
        }
    }

CarrierFreqList-v1800 ::= SEQUENCE (SIZE (1..maxFreq)) OF ARFCN-ValueEUTRA

CarrierFreqList-v1830 ::= SEQUENCE {
    carrierFreqList-r18         SEQUENCE (SIZE (1..maxFreq)) OF ARFCN-ValueEUTRA-r9
}

-- ASN1STOP

```



<b>SystemInformationBlockType32 field descriptions</b>
<p><b>carrierFreqList</b> Includes a list of E-UTRA frequencies, see TS 36.304 [4].</p>
<p><b>elevationAngleLeft, elevationAngleRight</b> Leftmost and rightmost (with reference to the satellite direction) elevation angle. Unit in degree. Step of 5 degree. Actual value = field value * 5. If the field <i>elevationAngleLeft</i> is absent, the leftmost elevation angle is equal to the value of field <i>elevationAngleRight</i>.</p>
<p><b>footprintInfo</b> Satellite footprint. E-UTRAN may configure <i>elevationAngles</i> and/or <i>radius</i> for earth moving cell. E-UTRAN may configure <i>referencePoint</i> and <i>radius</i> for quasi-earth fixed cell.</p>
<p><b>latitude</b> Latitude of the reference point. Unit in degree. Step of 360 / 262144 degree. Actual value = field value * (360 / 262144).</p>
<p><b>longitude</b> Longitude of the reference point. Unit in degree. Step of 360 / 262144 degree. Actual value = field value * (360 / 262144).</p>
<p><b>radius</b> Distance between the reference point and the edge of the satellite or beam coverage. Unit in km. Step of 10 km. Actual value = field value * 10.</p>
<p><b>satelliteInfoList</b> List of satellite information. If E-UTRAN includes <i>satelliteInfoList-v1830</i>, it includes the same number of entries, and listed in the same order, as in <i>satelliteInfoList-r17</i>. In this version of the specification, E-UTRAN does not include <i>satelliteInfoList-v1800</i>.</p>
<p><b>serviceInfo</b> Information on when the satellite will provide coverage. E-UTRAN always configures <i>tle-EphemerisParameters</i> for a satellite with earth moving cell(s) and always configures <i>t-ServiceStart</i> for a quasi-earth fixed cell.</p>
<p><b>tle-EphemerisParameters</b> Mean values of the satellite orbital parameters based on the TLE set format for estimating in-coverage and out-of-coverage periods for a satellite with earth moving cell(s), see TS 36.304 [4].</p>
<p><b>t-ServiceStart</b> Time information on when the incoming satellite is going to start serving the area for quasi-earth fixed cell.</p>

## SystemInformationBlockType33

The IE *SystemInformationBlockType33* contains satellite assistance information for neighbour cells.

### SystemInformationBlockType33 information element

```

-- ASN1START
SystemInformationBlockType33-r18 ::= SEQUENCE {
    neighSatelliteInfoList-r18 NeighSatelliteInfoList-r18 OPTIONAL, -- Need OR
    neighValidityDuration-r18 ENUMERATED {s5, s10, s15, s20, s25, s30, s35, s40,
                                           s45, s50, s55, s60, s120, s180, s240, s900}
                                           OPTIONAL, -- Need OP
    lateNonCriticalExtension OCTET STRING OPTIONAL,
    ...
}

NeighSatelliteInfoList-r18 ::= SEQUENCE (SIZE(1..maxSat-r17)) OF NeighSatelliteInfo-r18

NeighSatelliteInfo-r18 ::= SEQUENCE {
    satelliteId-r18 SatelliteId-r18,
    ephemerisInfo-r18 CHOICE {
        stateVectors-r18 EphemerisStateVectors-r17,
        orbitalParameters-r18 EphemerisOrbitalParameters-r17
    },
    nta-CommonParameters-r18 SEQUENCE {
        nta-Common-r18 INTEGER (0..8316827) OPTIONAL, -- Need OP
        nta-CommonDrift-r18 INTEGER (-261935..261935) OPTIONAL, -- Need OP
        nta-CommonDriftVariation-r18 INTEGER (0..29479) OPTIONAL -- Need OP
    },
    epochTime-r18 SEQUENCE {
        startSFN-r18 INTEGER (0..1023),
        startSubFrame-r18 INTEGER (0..9)
    }
    OPTIONAL, -- Need OP
    k-Mac-r18 INTEGER (1..512) OPTIONAL, -- Need OP
    t-ServiceStartNeigh-r18 TimeOffsetUTC-r17 OPTIONAL -- Need OR
}

```

```
}
-- ASN1STOP
```

<b>SystemInformationBlockType33 field descriptions</b>
<p><b>epochTime</b> Epoch time of the neighbour satellite ephemeris data and common TA parameters, see TS 36.213 [23]. The reference point for epoch time of the neighbour satellite ephemeris and Common TA parameters is the uplink time synchronization reference point when this field is provided in an NTN cell and the eNB when this field is provided in a TN cell. <i>epochTime</i> is the starting time of a DL subframe indicated by <i>startSFN</i> and <i>startSubframe</i>. If this field is absent in an NTN cell, the UE uses epoch time of the serving cell, otherwise the field is based on the timing of the serving cell, i.e. the SFN and sub-frame number indicated in this field refers to the SFN and sub-frame of the serving cell. <i>The startSFN</i> indicates the SFN nearest to the frame where the message indicating the <i>epochTime</i> is received. If this field is absent in a TN cell, the epoch time is the starting time of the DL subframe corresponding to the end of the SI window during which the SI message carrying SIB33(-NB) is transmitted.</p>
<p><b>k-Mac</b> Scheduling offset used when downlink and uplink frame timing are not aligned at the eNB, see TS 36.213 [23]. Unit in ms. If the field is absent, the UE uses the (default) value of 0.</p>
<p><b>neighValidityDuration</b> Validity duration of the neighbour satellite ephemeris data and common TA parameters, i.e. maximum time duration (from <i>epochTime</i>) during which the UE can apply the satellite ephemeris without acquiring new satellite ephemeris, see TS 36.213 [23]. Unit in second. Value <i>s5</i> corresponds to 5 seconds, value <i>s10</i> corresponds to 10 seconds and so on. If this field is absent in an NTN cell, the UE uses validity duration from the serving cell assistance information. If this field is absent in a TN cell, how the UE sets validity duration is left to UE implementation.</p>
<p><b>nta-Common</b> Network-controlled common TA, see TS 36.213 [23]. Unit of <math>\mu\text{s}</math>. Step of <math>32.55208 \times 10^{-3} \mu\text{s}</math>. Actual value = field value * <math>32.55208 \times 10^{-3}</math>. If the field is absent, the UE uses the (default) value of 0.</p>
<p><b>nta-CommonDrift</b> Drift rate of the common TA, see TS 36.213 [23]. Unit of <math>\mu\text{s/s}</math>. Step of <math>0.2 \times 10^{-3} \mu\text{s/s}</math>. Actual value = field value * <math>0.2 \times 10^{-3}</math>. If the field is absent, the UE uses the (default) value of 0.</p>
<p><b>nta-CommonDriftVariation</b> Drift rate variation of the common TA, see TS 36.213 [23]. Unit of <math>\mu\text{s/s}^2</math>. Step of <math>0.2 \times 10^{-4} \mu\text{s/s}^2</math>. Actual value = field value * <math>0.2 \times 10^{-4}</math>. If the field is absent, the UE uses the (default) value of 0.</p>
<p><b>t-ServiceStartNeigh</b> Indicates the earliest time when the area covered by the current serving cell is going to be covered by the neighbour cell(s) served by the satellite indicated by <i>satelliteId</i>, see 5.5.3.1, 5.5.8 and 36.304 [4]. This field is only present for the NTN quasi-Earth fixed neighbour cell(s).</p>

## 6.3.2 Radio resource control information elements

### – *Alpha*

The IE *Alpha* is used to indicate parameter  $\alpha$ , see TS 36.213 [23], clause 5.1.1.1 and 5.1.3.1. Value *al0* corresponds to 0, *al04* corresponds to value 0.4, *al05* to 0.5, *al06* to 0.6, *al07* to 0.7, *al08* to 0.8, *al09* to 0.9 and *al1* corresponds to 1.

#### **Alpha information element**

```
-- ASN1START
Alpha-r12 ::= ENUMERATED {al0, al04, al05, al06, al07, al08, al09, al1}
-- ASN1STOP
```

### – *AntennaInfo*

The IE *AntennaInfoCommon* and the *AntennaInfoDedicated* are used to specify the common and the UE specific antenna configuration respectively.

**AntennaInfo information elements**

```

-- ASN1START
AntennaInfoCommon ::=
SEQUENCE {
  antennaPortsCount
    ENUMERATED {an1, an2, an4, spare1}
}

AntennaInfoDedicated ::=
SEQUENCE {
  transmissionMode
    ENUMERATED {
      tm1, tm2, tm3, tm4, tm5, tm6,
      tm7, tm8-v920},
  codebookSubsetRestriction
    CHOICE {
      n2TxAntenna-tm3
        BIT STRING (SIZE (2)),
      n4TxAntenna-tm3
        BIT STRING (SIZE (4)),
      n2TxAntenna-tm4
        BIT STRING (SIZE (6)),
      n4TxAntenna-tm4
        BIT STRING (SIZE (64)),
      n2TxAntenna-tm5
        BIT STRING (SIZE (4)),
      n4TxAntenna-tm5
        BIT STRING (SIZE (16)),
      n2TxAntenna-tm6
        BIT STRING (SIZE (4)),
      n4TxAntenna-tm6
        BIT STRING (SIZE (16))
    }
    OPTIONAL,
  ue-TransmitAntennaSelection
    CHOICE{
      release
        NULL,
      setup
        ENUMERATED {closedLoop, openLoop}
    }
}
-- Cond TM

AntennaInfoDedicated-v920 ::=
SEQUENCE {
  codebookSubsetRestriction-v920
    CHOICE {
      n2TxAntenna-tm8-r9
        BIT STRING (SIZE (6)),
      n4TxAntenna-tm8-r9
        BIT STRING (SIZE (32))
    }
    OPTIONAL
}
-- Cond TM8

AntennaInfoDedicated-r10 ::=
SEQUENCE {
  transmissionMode-r10
    ENUMERATED {
      tm1, tm2, tm3, tm4, tm5, tm6, tm7, tm8-v920,
      tm9-v1020, tm10-v1130, spare6, spare5, spare4,
      spare3, spare2, spare1},
  codebookSubsetRestriction-r10
    BIT STRING
    OPTIONAL,
  ue-TransmitAntennaSelection
    CHOICE{
      release
        NULL,
      setup
        ENUMERATED {closedLoop, openLoop}
    }
}
-- Cond TMX

AntennaInfoDedicated-v10i0 ::=
SEQUENCE {
  maxLayersMIMO-r10
    ENUMERATED {twoLayers, fourLayers, eightLayers}
}
OPTIONAL
Need OR

AntennaInfoDedicated-v1250 ::=
SEQUENCE {
  alternativeCodebookEnabledFor4TX-r12
    BOOLEAN
}

AntennaInfoDedicated-v1430 ::=
SEQUENCE {
  ce-UE-TxAntennaSelection-config-r14
    ENUMERATED {on}
}
OPTIONAL
-- Need OR

AntennaInfoDedicatedSTTI-r15 ::=
CHOICE {
  release
    NULL,
  setup
    SEQUENCE {
      transmissionModeDL-MBSFN-r15
        ENUMERATED {tm9, tm10}
        OPTIONAL,
      transmissionModeDL-nonMBSFN-r15
        ENUMERATED {tm1, tm2, tm3, tm4, tm6, tm8, tm9,
          tm10}
        OPTIONAL,
      codebookSubsetRestriction
        CHOICE {
          n2TxAntenna-tm3-r15
            BIT STRING (SIZE (2)),
          n4TxAntenna-tm3-r15
            BIT STRING (SIZE (4)),
          n2TxAntenna-tm4-r15
            BIT STRING (SIZE (6)),
          n4TxAntenna-tm4-r15
            BIT STRING (SIZE (64)),
          n2TxAntenna-tm5-r15
            BIT STRING (SIZE (4)),
          n4TxAntenna-tm5-r15
            BIT STRING (SIZE (16)),
          n2TxAntenna-tm6-r15
            BIT STRING (SIZE (4)),
          n4TxAntenna-tm6-r15
            BIT STRING (SIZE (16)),
          n2TxAntenna-tm8-r15
            BIT STRING (SIZE (6)),
          n4TxAntenna-tm8-r15
            BIT STRING (SIZE (64)),
          n2TxAntenna-tm9and10-r15
            BIT STRING (SIZE (6)),
        }
    }
}
-- Need OR

```

```
        n4TxAntenna-tm9and10-r15          BIT STRING (SIZE (96)),
        n8TxAntenna-tm9and10-r15          BIT STRING (SIZE (109))
    }
    OPTIONAL,
    maxLayersMIMO-STTI-r15                  ENUMERATED {twoLayers, fourLayers} OPTIONAL, -- Cond TM
    slotSubslotPDSCH-TxDiv-2Layer-r15      BOOLEAN,
    slotSubslotPDSCH-TxDiv-4Layer-r15      BOOLEAN
}
}

AntennaInfoDedicated-v1530 ::=          CHOICE {
    release                                NULL,
    setup                                  CHOICE {
        ue-TxAntennaSelection-SRS-1T4R-Config-r15    NULL,
        ue-TxAntennaSelection-SRS-2T4R-NrOfPairs-r15  ENUMERATED {two, three}
    }
}

-- ASN1STOP
```

<b>AntennaInfo field descriptions</b>
<p><b>alternativeCodebookEnabledFor4TX</b> Indicates whether code book in TS 36.213 [23] Table 7.2.4-0A to Table 7.2.4-0D is being used for deriving CSI feedback and reporting. E-UTRAN only configures the field if the UE is configured with a) <i>tm8</i> with 4 CRS ports, <i>tm9</i> or <i>tm10</i> with 4 CSI-RS ports and b) PMI/RI reporting.</p>
<p><b>antennaPortsCount</b> Parameter represents the number of cell specific antenna ports where an1 corresponds to 1, an2 to 2 antenna ports etc. see TS 36.211 [21], clause 6.2.1.</p>
<p><b>ce-ue-TxAntennaSelection-config</b> Configuration of UL closed-loop transmit antenna selection for non-BL UE in CE Mode A, see TS 36.212 [22].</p>
<p><b>codebookSubsetRestriction</b> Parameter: <i>codebookSubsetRestriction</i>, see TS 36.213 [23], clause 7.2 and TS 36.211 [21], clause 6.3.4.2.3. The number of bits in the <i>codebookSubsetRestriction</i> for applicable transmission modes is defined in TS 36.213 [23], Table 7.2-1b. If the UE is configured with <i>transmissionMode</i> <i>tm8</i>, E-UTRAN configures the field <i>codebookSubsetRestriction</i> if PMI/RI reporting is configured. If the UE is configured with <i>transmissionMode</i> <i>tm9</i>, E-UTRAN configures the field <i>codebookSubsetRestriction</i> if PMI/RI reporting is configured and if the number of CSI-RS ports is greater than 1. E-UTRAN does not configure the field <i>codebookSubsetRestriction</i> in other cases where the UE is configured with <i>transmissionMode</i> <i>tm8</i> or <i>tm9</i>. Furthermore, E-UTRAN does not configure the field <i>codebookSubsetRestriction</i> if the UE is configured with <i>eMIMO-Type</i> unless it is set to <i>beamformed</i>, <i>alternativeCodebookEnabledBeamformed</i> is set to <i>FALSE</i> and <i>csi-RS-ConfigNZPIdListExt</i> is not configured.</p>
<p><b>maxLayersMIMO</b> Indicates the maximum number of layers for spatial multiplexing used to determine the rank indication bit width and Kc determination of the soft buffer size for the corresponding serving cell according to TS 36.212 [22]. EUTRAN configures this field only when <i>transmissionMode</i> is set to <i>tm3</i>, <i>tm4</i>, <i>tm9</i> or <i>tm10</i> for the corresponding serving cell. When configuring the field for a serving cell which <i>transmissionMode</i> is set to <i>tm3</i> or <i>tm4</i>, EUTRAN only configures value <i>fourLayers</i>: For a serving cell which <i>transmissionMode</i> is set to <i>tm9</i> or <i>tm10</i>, EUTRAN only configures the field only if <i>intraBandContiguousCC-InfoList</i> or <i>FeatureSetDL-PerCC</i> is indicated for the band and the band combination of the corresponding serving cell or the UE supports <i>maxLayersMIMO-Indication</i>.</p>
<p><b>maxLayersMIMO-STTI</b> Indicates the maximum number of layers, for each serving cell, to be used when determining if the shifted DMRS pattern is applicable TS 36.211 [21], clause 6.10.3.2.</p>
<p><b>slotSubslotPDSCH-TxDiv-2Layer, slotSubslotPDSCH-TxDiv-4Layer</b> Indicates the table to be used in case of dynamic TX diversity fallback for TM9 and 10 for up to 2-layer/4-layer slot or subslot PDSCH operation, see TS 36.212 [22], clause 5.3.3.1.22.</p>
<p><b>transmissionMode</b> Points to one of Transmission modes defined in TS 36.213 [23], clause 7.1, where <i>tm1</i> refers to transmission mode 1, <i>tm2</i> to transmission mode 2 etc.</p>
<p><b>transmissionModeDL-MBSFN</b> Indicates, for MBSFN, the transmission mode as defined in TS 36.213 [23], clause 7.1, where <i>tm1</i> refers to transmission mode 1, <i>tm2</i> to transmission mode 2 etc for slot or subslot operation. In case of FDD, TM8 is not applicable.</p>
<p><b>transmissionModeDL-nonMBSFN</b> Indicates, for non-MBSFN, the transmission mode as defined in TS 36.213 [23], clause 7.1, where <i>tm1</i> refers to transmission mode 1, <i>tm2</i> to transmission mode 2 etc. for slot or subslot operation. In case of FDD, TM8 is not applicable.</p>
<p><b>ue-TransmitAntennaSelection</b> For value <i>setup</i>, the field indicates whether UE transmit antenna selection control is closed-loop or open-loop as described in TS 36.213 [23], clause 8.7.</p>
<p><b>ue-TxAntennaSelection-SRS-1T4R-Config</b> Configuration of UL closed-loop transmit antenna selection for UE to select one antenna among four antennas to transmit SRS for the corresponding serving cell as described in TS 36.213 [23]. When <i>ue-TxAntennaSelection-SRS-1T4R-Config</i> and <i>ue-TransmitAntennaSelection</i> are configured simultaneously for a given serving cell, the UE selects one of the first two antennas for PUSCH transmission and selects one antenna among four antennas at each SRS instance for SRS transmission for the corresponding serving cell as described in TS 36.213 [23].</p>
<p><b>ue-TxAntennaSelection-SRS-2T4R-NrOfPairs</b> Presence of the field indicates configuration of UL closed-loop transmit antenna selection for UE to select two antennas among four antennas to transmit SRS simultaneously for the corresponding serving cell as described in TS 36.213 [23]. Further, the field indicates the number of antenna pairs to select from for SRS transmission for a given serving cell as described in TS 36.213 [23]. Value two indicates the UE to select one antenna pair between two antenna pairs to transmit SRS simultaneously at each SRS instance for the corresponding serving cell. Value three indicates the UE to select one antenna pair among three antenna pairs to transmit SRS simultaneously at each SRS instance for the corresponding serving cell. EUTRAN does not simultaneously configure <i>ue-TransmitAntennaSelection</i> and <i>ue-TxAntennaSelection-SRS-2T4R-NrOfPairs</i> for a given serving cell.</p>

Conditional presence	Explanation
<i>TM</i>	The field is mandatory present if the <i>transmissionMode</i> is set to <i>tm3</i> , <i>tm4</i> , <i>tm5</i> or <i>tm6</i> . Otherwise the field is not present and the UE shall delete any existing value for this field.
<i>TM8</i>	The field is optional present, need OR, if <i>AntennaInfoDedicated</i> is included and <i>transmissionMode</i> is set to <i>tm8</i> . If <i>AntennaInfoDedicated</i> is included and <i>transmissionMode</i> is set to a value other than <i>tm8</i> , the field is not present and the UE shall delete any existing value for this field. Otherwise the field is not present.
<i>TMX</i>	The field is mandatory present if the <i>transmissionMode-r10</i> is set to <i>tm3</i> , <i>tm4</i> , <i>tm5</i> or <i>tm6</i> . The field is optionally present, need OR, if the <i>transmissionMode-r10</i> is set to <i>tm8</i> or <i>tm9</i> . Otherwise the field is not present and the UE shall delete any existing value for this field.

## – *AntennaInfoUL*

The IE *AntennaInfoUL* is used to specify the UL antenna configuration.

### *AntennaInfoUL* information elements

```
-- ASN1START
AntennaInfoUL-r10 ::= SEQUENCE {
    transmissionModeUL-r10      ENUMERATED {tm1, tm2, spare6, spare5,
                                             spare4, spare3, spare2, spare1} OPTIONAL, --
Need OR
    fourAntennaPortActivated-r10  ENUMERATED {setup}          OPTIONAL          -- Need OR
}
AntennaInfoUL-STTI-r15 ::= SEQUENCE {
    transmissionModeUL-STTI-r15  ENUMERATED {tm1, tm2}          OPTIONAL          -- Need OR
}
-- ASN1STOP
```

### *AntennaInfoUL* field descriptions

#### ***fourAntennaPortActivated***

Parameter indicates if four antenna ports are used. See TS 36.213 [23], clause 8.2. E-UTRAN optionally configures *fourAntennaPortActivated* only if *transmissionModeUL* is set to *tm2*.

#### ***transmissionModeUL***

Points to one of UL Transmission modes defined in TS 36.213 [23], clause 8.0, where *tm1* refers to transmission mode 1, *tm2* to transmission mode 2 etc.

#### ***transmissionModeUL-STTI***

Indicates the UL transmission mode as defined in TS 36.213 [23], clause 8.0, where *tm1* refers to transmission mode 1 and *tm2* to transmission mode 2 for slot or subslot operation.

## – *AUL-Config*

The IE *AUL-Config* is used to specify the autonomous uplink configuration.

### *AUL-Config* information element

```
-- ASN1START
AUL-Config-r15 ::= CHOICE {
    release      NULL,
    setup       SEQUENCE {
        aul-CRNTI-r15          C-RNTI,
        aul-Subframes-r15     BIT STRING (SIZE (40)),
        aul-HARQ-Processes-r15 INTEGER (1..16),
        transmissionModeUL-AUL-r15  ENUMERATED {tm1,tm2},
        aul-StartingFullBW-InsideMCOT-r15  BIT STRING (SIZE (5)),
        aul-StartingFullBW-OutsideMCOT-r15  BIT STRING (SIZE (7)),
        aul-StartingPartialBW-InsideMCOT-r15  ENUMERATED {o34, o43, o52, o61, oOS1},
        aul-StartingPartialBW-OutsideMCOT-r15  ENUMERATED {o16, o25, o34, o43, o52, o61, oOS1},
        aul-RetransmissionTimer-r15  ENUMERATED {psf4, psf5, psf6, psf8, psf10, psf12,
        psf20, psf28, psf37, psf44, psf68, psf84, psf100,
        psf116, psf132, psf164, psf324},
        endingSymbolAUL-r15  INTEGER(12..13),
        subframeOffsetCOT-Sharing-r15  INTEGER(2..4),
    }
}
-- ASN1STOP
```

```

    contentionWindowSizeTimer-r15      ENUMERATED {n0, n5, n10}
  }
}
-- ASN1STOP

```

### AUL-Config field descriptions

<p><b>aul-CRNTI</b> AUL C-RNTI, see TS 36.321 [6].</p>
<p><b>aul-HARQ-Processes</b> This field indicates which HARQ process IDs are configured for AUL operation as described in TS 36.321 [6]. In case tm1 is configured for the <i>transmissionModeUL-AUL</i> the number of configured HARQ processes equals to field value. In case tm2 is configured for the <i>transmissionModeUL-AUL</i> the number of configured HARQ processes equals to double of the field value. The largest value of the HARQ process ID is equal to the number of configured HARQ processes - 1.</p>
<p><b>aul-RetransmissionTimer</b> This timer is used to restrict both new transmission and retransmission for the same HARQ process for AUL operation as described in TS 36.321 [6]. Value psf4 corresponds to 4 PDCCH subframes etc.</p>
<p><b>aul-StartingFullBW-InsideMCOT</b> This field indicates the AUL-specific set of PUSCH starting offset values for the AUL transmission inside of eNB obtained MCOT when a UE configured with AUL configuration is allocated to occupy the full channel bandwidth as described in TS 36.213 [23], clause 8.0. The first/leftmost bit corresponds to value 34, second bit corresponds to value 43, third bit corresponds to value 52, fourth bit corresponds to value 61 and last bit corresponds to value OS#1.</p>
<p><b>aul-StartingFullBW-OutsideMCOT</b> This field indicates the AUL-specific set of PUSCH starting offset values for the AUL transmission outside of eNB obtained MCOT when a UE configured with AUL configuration is allocated to occupy the full channel bandwidth as described in TS 36.213 [23], clause 8.0. The first/leftmost bit corresponds to value 16, second bit corresponds to value 25, third bit corresponds to value 34, fourth bit corresponds to value 43, fifth bit corresponds to value 52, sixth bit corresponds to value 61 and last bit corresponds to value OS#1.</p>
<p><b>aul-StartingPartialBW-InsideMCOT</b> This field indicates the exact AUL-specific PUSCH starting offset value for the AUL transmission inside of eNB obtained MCOT when a UE configured with AUL configuration is allocated to occupy partial channel bandwidth as described in TS 36.213 [23], clause 8.0. The value o34 corresponds to 34, and the value o43 corresponds to 43 and so on.</p>
<p><b>aul-StartingPartialBW-OutsideMCOT</b> This field indicates the exact AUL-specific PUSCH starting offset value for the AUL transmission outside of eNB obtained MCOT when a UE configured with AUL configuration is allocated to occupy partial channel bandwidth as described in TS 36.213 [23], clause 8.0. The value o16 corresponds to 16, the value o25 corresponds to 25 and so on.</p>
<p><b>aul-Subframes</b> This field indicates which subframes are allowed for AUL operation as described in TS 36.321 [6]. The first/leftmost bit corresponds to the subframe #0 of the radio frame satisfying SFN mod 4 = 0. Value 0 in the bitmap indicates that the corresponding subframe is not allowed for AUL. Value 1 in the bitmap indicates that the corresponding subframe is allowed for AUL.</p>
<p><b>contentionWindowSizeTimer</b> This field indicates contention window size adjustment timer as described in TS 37.213 [94], clause 4.2.2. The value n0 corresponds to 0ms, value n5 corresponds to 5ms, value n10 corresponds to 10ms. The value is set to n0 or n5 if the absence of other technologies on the same carrier cannot be guaranteed. The value is set to n0 or n10 if the absence of other technologies on the same carrier can be guaranteed.</p>
<p><b>endingSymbolAUL</b> This field indicates PUSCH ending symbol of the last AUL subframe in an AUL burst as described in TS 36.211 [21], clause 4.1.3.</p>
<p><b>subframeOffsetCOT-Sharing</b> This field is COT sharing indication parameter X indicating if subframe n+X is an applicable subframe for UL to DL sharing as described in TS 37.213 [94], clause 4.1.3.</p>
<p><b>transmissionModeUL-AUL</b> This field indicates which UL transmission mode is used for AUL as described in TS 36.213 [23], clause 8.0, where tm1 refers to transmission mode 1, tm2 to transmission mode 2.</p>

### CQI-ReportAperiodic

The IE *CQI-ReportAperiodic* is used to specify the aperiodic CQI reporting configuration.

### CQI-ReportAperiodic information elements

```
-- ASN1START
```

```

CQI-ReportAperiodic-r10 ::= CHOICE {
  release          NULL,
  setup           SEQUENCE {
    cqi-ReportModeAperiodic-r10  CQI-ReportModeAperiodic,
    aperiodicCSI-Trigger-r10     SEQUENCE {
      trigger1-r10                BIT STRING (SIZE (8)),
      trigger2-r10                BIT STRING (SIZE (8))
    }
  }
}
OPTIONAL -- Need OR

CQI-ReportAperiodic-v1250 ::= CHOICE {
  release          NULL,
  setup           SEQUENCE {
    aperiodicCSI-Trigger-v1250   SEQUENCE {
      trigger-SubframeSetIndicator-r12  ENUMERATED {s1, s2},
      trigger1-SubframeSetIndicator-r12  BIT STRING (SIZE (8)),
      trigger2-SubframeSetIndicator-r12  BIT STRING (SIZE (8))
    }
  }
}

CQI-ReportAperiodic-v1310 ::= CHOICE {
  release          NULL,
  setup           SEQUENCE {
    aperiodicCSI-Trigger-v1310   SEQUENCE {
      trigger1-r13                BIT STRING (SIZE (32)),
      trigger2-r13                BIT STRING (SIZE (32)),
      trigger3-r13                BIT STRING (SIZE (32)),
      trigger4-r13                BIT STRING (SIZE (32)),
      trigger5-r13                BIT STRING (SIZE (32)),
      trigger6-r13                BIT STRING (SIZE (32))
    }
    aperiodicCSI-Trigger2-r13    CHOICE {
      release          NULL,
      setup           SEQUENCE {
        trigger1-SubframeSetIndicator-r13  BIT STRING (SIZE (32)),
        trigger2-SubframeSetIndicator-r13  BIT STRING (SIZE (32)),
        trigger3-SubframeSetIndicator-r13  BIT STRING (SIZE (32)),
        trigger4-SubframeSetIndicator-r13  BIT STRING (SIZE (32)),
        trigger5-SubframeSetIndicator-r13  BIT STRING (SIZE (32)),
        trigger6-SubframeSetIndicator-r13  BIT STRING (SIZE (32))
      }
    }
  }
}
OPTIONAL -- Need ON

CQI-ReportAperiodicProc-r11 ::= SEQUENCE {
  cqi-ReportModeAperiodic-r11  CQI-ReportModeAperiodic,
  trigger01-r11                BOOLEAN,
  trigger10-r11                BOOLEAN,
  trigger11-r11                BOOLEAN
}

CQI-ReportAperiodicProc-v1310 ::= SEQUENCE {
  trigger001-r13               BOOLEAN,
  trigger010-r13               BOOLEAN,
  trigger011-r13               BOOLEAN,
  trigger100-r13               BOOLEAN,
  trigger101-r13               BOOLEAN,
  trigger110-r13               BOOLEAN,
  trigger111-r13               BOOLEAN
}

CQI-ReportAperiodicHybrid-r14 ::= SEQUENCE {
  triggers-r14                 CHOICE {
    oneBit-r14                  SEQUENCE {
      trigger1-Indicator-r14     BIT STRING (SIZE (8))
    },
    twoBit-r14                  SEQUENCE {
      trigger01-Indicator-r14    BIT STRING (SIZE (8)),
      trigger10-Indicator-r14    BIT STRING (SIZE (8)),
      trigger11-Indicator-r14    BIT STRING (SIZE (8))
    },
    threeBit-r14                SEQUENCE {
      trigger001-Indicator-r14   BIT STRING (SIZE (32)),
      trigger010-Indicator-r14   BIT STRING (SIZE (32)),
      trigger011-Indicator-r14   BIT STRING (SIZE (32))
    }
  }
}

```



```
        trigger100-Indicator-r14      BIT STRING (SIZE (32)) ,
        trigger101-Indicator-r14      BIT STRING (SIZE (32)),
        trigger110-Indicator-r14      BIT STRING (SIZE (32)),
        trigger111-Indicator-r14      BIT STRING (SIZE (32))
    }
}
OPTIONAL -- Need OR
}
CQI-ReportModeAperiodic ::=          ENUMERATED {
    rm12, rm20, rm22, rm30, rm31,
    rm32-v1250, rm10-v1310, rm11-v1310
}
-- ASN1STOP
```

<b>CQI-ReportAperiodic field descriptions</b>
<p><b>aperiodicCSI-Trigger</b> Indicates for which serving cell(s) the aperiodic CSI report is triggered when one or more SCells are configured. <i>trigger1-r10</i> corresponds to the CSI request field 10 while <i>trigger1-r13</i> corresponds to the CSI request field 010, <i>trigger2-r10</i> corresponds to the CSI request field 11 while <i>trigger2-r13</i> corresponds to the CSI request field 011, <i>trigger3-r13</i> corresponds to the CSI request field 100, see TS 36.213 [23], table 7.2.1-1A and table 7.2.1-1D, and so on. The leftmost bit, bit 0 in the bit string corresponds to the cell with <i>ServCellIndex</i>=0 and bit 1 in the bit string corresponds to the cell with <i>ServCellIndex</i>=1 etc. Each bit has either value 0 (means no aperiodic CSI report is triggered) or value 1 (means the aperiodic CSI report is triggered). At most 5 bits can be set to value 1 in the bit string in <i>aperiodicCSI-Trigger-r10</i> and in <i>aperiodicCSI-Trigger-v1250</i> and at most 32 bits can be set to value 1 in the bit string in <i>aperiodicCSI-Trigger-v1310</i>. E-UTRAN configures value 1 only for cells configured with <i>transmissionMode</i> set in range <i>tm1</i> to <i>tm9</i>. One value applies for all serving cells configured with <i>transmissionMode</i> set in range <i>tm1</i> to <i>tm9</i> and belonging to the same PUCCH group (the associated functionality is common i.e. not performed independently for each cell).</p>
<p><b>trigger-SubframeSetIndicator</b> For a serving cell configured with <i>csi-MeasSubframeSets-r12</i>, indicates for which CSI subframe set the aperiodic CSI report is triggered for the serving cell if the aperiodic CSI is triggered by the CSI request field 01 or 001, see TS 36.213 [23], table 7.2.1-1C or table 7.2.1-1E. Value <i>s1</i> corresponds to CSI subframe set 1 and value <i>s2</i> corresponds to CSI subframe set 2.</p>
<p><b>trigger001</b> Indicates whether or not reporting for this CSI-process or reporting for this CSI-process corresponding to a CSI subframe set is triggered by CSI request field set to 001, for a CSI request applicable for the serving cell on the same frequency as the CSI process, see TS 36.213 [23], table 7.2.1-1D and 7.2.1-E.</p>
<p><b>trigger001-IndicatorN.. trigger111-IndicatorN</b> Indicates for which eMIMO-Type the aperiodic CSI report is triggered (the corresponding CSI process, CSI subframe set)-pair(s) and/or a serving cell) as applicable, See TS 36.213 [23], table 7.2.1-1A, 7.2.1-1B, and 7.2.1-1C.</p>
<p><b>trigger01</b> Indicates whether or not reporting for this CSI-process or reporting for this CSI-process corresponding to a CSI subframe set is triggered by CSI request field set to 01, for a CSI request applicable for the serving cell on the same frequency as the CSI process, see TS 36.213 [23], table 7.2.1-1D and 7.2.1-1E.</p>
<p><b>trigger010, trigger011, trigger100, trigger101, Trigger110, Trigger111</b> Indicates whether or not reporting for this CSI-process or reporting for this CSI-process corresponding to a CSI subframe set is triggered by CSI request field set to 010, 011, 100, 101, 110 or 111, see TS 36.213 [23], table 7.2.1-1D and 7.2.1-1E.</p>
<p><b>trigger10, trigger11</b> Indicates whether or not reporting for this CSI-process or reporting for this CSI-process corresponding to a CSI subframe set is triggered by CSI request field set to 10 or 11, see TS 36.213 [23], table 7.2.1-1B. EUTRAN configures at most 5 CSI processes, across all serving frequencies within each CG, to be triggered by a CSI request field set to value 10. The same restriction applies for value 11. In case E-UTRAN simultaneously triggers CSI requests for more than 5 CSI processes some limitations apply, see TS 36.213 [23].</p>
<p><b>trigger1-SubframeSetIndicator</b> If signalled in the <i>aperiodicCSI-Trigger-v1250</i>, indicates for which CSI subframe set the aperiodic CSI report is triggered when aperiodic CSI is triggered by the CSI request field 10, see TS 36.213 [23], table 7.2.1-1C, or by the CSI request field 010, see TS 36.213 [23], table 7.2.1-1E. The leftmost bit, bit 0 in the bit string corresponds to the cell with <i>ServCellIndex</i>=0 and bit 1 in the bit string corresponds to the cell with <i>ServCellIndex</i>=1 etc. Each bit has either value 0 (means that aperiodic CSI report is triggered for CSI subframe set 1) or value 1 (means that aperiodic CSI report is triggered for CSI subframe set 2).</p>
<p><b>trigger2-SubframeSetIndicator</b> If signalled in the <i>aperiodicCSI-Trigger-v1250</i>, indicates for which CSI subframe set the aperiodic CSI report is triggered when aperiodic CSI is triggered by the CSI request field 11, see TS 36.213 [23], table 7.2.1-1C, or by the CSI request field 011, see TS 36.213 [23], table 7.2.1-1E. The leftmost bit, bit 0 in the bit string corresponds to the cell with <i>ServCellIndex</i>=0 and bit 1 in the bit string corresponds to the cell with <i>ServCellIndex</i>=1 etc. Each bit has either value 0 (means that aperiodic CSI report is triggered for CSI subframe set 1) or value 1 (means that aperiodic CSI report is triggered for CSI subframe set 2).</p>
<p><b>trigger3-SubframeSetIndicator</b> Indicates for which CSI subframe set the aperiodic CSI report is triggered when aperiodic CSI is triggered by the CSI request field 100, see TS 36.213 [23], table 7.2.1-1E. The leftmost bit, bit 0 in the bit string corresponds to the cell with <i>ServCellIndex</i>=0 and bit 1 in the bit string corresponds to the cell with <i>ServCellIndex</i>=1 etc. Each bit has either value 0 (means that aperiodic CSI report is triggered for CSI subframe set 1) or value 1 (means that aperiodic CSI report is triggered for CSI subframe set 2).</p>
<p><b>trigger4-SubframeSetIndicator</b> Indicates for which CSI subframe set the aperiodic CSI report is triggered when aperiodic CSI is triggered by the CSI request field 101, see TS 36.213 [23], table 7.2.1-1E. The leftmost bit, bit 0 in the bit string corresponds to the cell with <i>ServCellIndex</i>=0 and bit 1 in the bit string corresponds to the cell with <i>ServCellIndex</i>=1 etc. Each bit has either value 0 (means that aperiodic CSI report is triggered for CSI subframe set 1) or value 1 (means that aperiodic CSI report is triggered for CSI subframe set 2).</p>

**CQI-ReportAperiodic field descriptions****trigger5-SubframeSetIndicator**

Indicates for which CSI subframe set the aperiodic CSI report is triggered when aperiodic CSI is triggered by the CSI request field 110, see TS 36.213 [23], table 7.2.1-1E. The leftmost bit, bit 0 in the bit string corresponds to the cell with *ServCellIndex*=0 and bit 1 in the bit string corresponds to the cell with *ServCellIndex* =1 etc. Each bit has either value 0 (means that aperiodic CSI report is triggered for CSI subframe set 1) or value 1 (means that aperiodic CSI report is triggered for CSI subframe set 2).

**trigger6-SubframeSetIndicator**

Indicates for which CSI subframe set the aperiodic CSI report is triggered when aperiodic CSI is triggered by the CSI request field 111, see TS 36.213 [23], table 7.2.1-1E. The leftmost bit, bit 0 in the bit string corresponds to the cell with *ServCellIndex*=0 and bit 1 in the bit string corresponds to the cell with *ServCellIndex* =1 etc. Each bit has either value 0 (means that aperiodic CSI report is triggered for CSI subframe set 1) or value 1 (means that aperiodic CSI report is triggered for CSI subframe set 2).

**CQI-ReportBoth**

The IE *CQI-ReportBoth* is used to specify the CQI reporting configuration common to both periodic and aperiodic configurations.

**CQI-ReportBoth information elements**

```
-- ASN1START
CQI-ReportBoth-r11 ::=          SEQUENCE {
  csi-IM-ConfigToReleaseList-r11  CSI-IM-ConfigToReleaseList-r11  OPTIONAL,  -- Need ON
  csi-IM-ConfigToAddModList-r11   CSI-IM-ConfigToAddModList-r11   OPTIONAL,  -- Need ON
  csi-ProcessToReleaseList-r11     CSI-ProcessToReleaseList-r11     OPTIONAL,  -- Need ON
  csi-ProcessToAddModList-r11      CSI-ProcessToAddModList-r11      OPTIONAL,  -- Need ON
}

CQI-ReportBoth-v1250 ::=       SEQUENCE {
  csi-IM-ConfigToReleaseListExt-r12 CSI-IM-ConfigId-v1250  OPTIONAL,  -- Need ON
  csi-IM-ConfigToAddModListExt-r12  CSI-IM-ConfigExt-r12   OPTIONAL,  -- Need ON
}

CQI-ReportBoth-v1310 ::=       SEQUENCE {
  csi-IM-ConfigToReleaseListExt-r13 CSI-IM-ConfigToReleaseListExt-r13  OPTIONAL,  -- Need ON
  csi-IM-ConfigToAddModListExt-r13  CSI-IM-ConfigToReleaseListExt-r13  OPTIONAL,  -- Need ON
}

CSI-IM-ConfigToAddModList-r11 ::= SEQUENCE (SIZE (1..maxCSI-IM-r11)) OF CSI-IM-Config-r11
CSI-IM-ConfigToAddModListExt-r13 ::= SEQUENCE (SIZE (1..maxCSI-IM-v1310)) OF CSI-IM-ConfigExt-r12
CSI-IM-ConfigToReleaseList-r11 ::= SEQUENCE (SIZE (1..maxCSI-IM-r11)) OF CSI-IM-ConfigId-r11
CSI-IM-ConfigToReleaseListExt-r13 ::= SEQUENCE (SIZE (1..maxCSI-IM-v1310)) OF CSI-IM-ConfigId-
v1310
CSI-ProcessToAddModList-r11 ::= SEQUENCE (SIZE (1..maxCSI-Proc-r11)) OF CSI-Process-r11
CSI-ProcessToReleaseList-r11 ::= SEQUENCE (SIZE (1..maxCSI-Proc-r11)) OF CSI-ProcessId-r11
CQI-ReportBothProc-r11 ::= SEQUENCE {
  ri-Ref-CSI-ProcessId-r11          CSI-ProcessId-r11          OPTIONAL,  -- Need OR
  pmi-RI-Report-r11                 ENUMERATED {setup}         OPTIONAL,  -- Need OR
}
-- ASN1STOP
```

<b>CQI-ReportBoth field descriptions</b>
<p><b>csi-IM-ConfigToAddModList</b> For a serving frequency E-UTRAN configures one or more <i>CSI-IM-Config</i> only when transmission mode 10 is configured for the serving cell on this carrier frequency.</p>
<p><b>csi-ProcessToAddModList</b> For a serving frequency E-UTRAN configures one or more <i>CSI-Process</i> only when transmission mode 10 is configured for the serving cell on this carrier frequency.</p>
<p><b>cqi-ReportModeAperiodic</b> Parameter: <i>reporting mode</i>. Value <i>rm12</i> corresponds to Mode 1-2, <i>rm20</i> corresponds to Mode 2-0, <i>rm22</i> corresponds to Mode 2-2 etc. PUSCH reporting modes are described in TS 36.213 [23], clause 7.2.1. The UE shall ignore <i>cqi-ReportModeAperiodic-r10</i> when transmission mode 10 is configured for the serving cell on this carrier frequency. The UE shall ignore <i>cqi-ReportModeAperiodic-r10</i> configured for the PCell/ PSCell when the transmission bandwidth of the PCell/PSCell in downlink is 6 resource blocks.</p>
<p><b>pmi-RI-Report</b> See TS 36.213 [23], clause 7.2. The presence of this field means PMI/RI reporting is configured; otherwise the PMI/RI reporting is not configured. EUTRAN configures this field only when <i>transmissionMode</i> is set to <i>tm8</i>, <i>tm9</i> or <i>tm10</i>. The UE shall ignore <i>pmi-RI-Report-r9</i>/<i>pmi-RI-Report-r10</i> when transmission mode 10 is configured for the serving cell on this carrier frequency.</p>
<p><b>ri-Ref-CSI-ProcessId</b> CSI process whose RI value the UE inherits when reporting RI, in the same subframe, for CSI reporting. E-UTRAN ensures that the CSI process that inherits the RI value is configured in accordance with the conditions specified in TS 36.213 [23], clauses 7.2.1 and 7.2.2.</p>

## CQI-ReportConfig

The IE *CQI-ReportConfig* is used to specify the CQI reporting configuration.

### CQI-ReportConfig information elements

```

-- ASN1START
CQI-ReportConfig ::=
    SEQUENCE {
        cqi-ReportModeAperiodic    CQI-ReportModeAperiodic OPTIONAL,      -- Need OR
        nomPDSCH-RS-EPRE-Offset    INTEGER (-1..6),
        cqi-ReportPeriodic         CQI-ReportPeriodic   OPTIONAL      -- Need ON
    }

CQI-ReportConfig-v920 ::=
    SEQUENCE {
        cqi-Mask-r9                 ENUMERATED {setup}          OPTIONAL,      -- Cond cqi-Setup
        pmi-RI-Report-r9            ENUMERATED {setup}          OPTIONAL      -- Cond PMIRI
    }

CQI-ReportConfig-r10 ::=
    SEQUENCE {
        cqi-ReportAperiodic-r10    CQI-ReportAperiodic-r10    OPTIONAL,      -- Need ON
        nomPDSCH-RS-EPRE-Offset    INTEGER (-1..6),
        cqi-ReportPeriodic-r10     CQI-ReportPeriodic-r10     OPTIONAL,      -- Need ON
        pmi-RI-Report-r9           ENUMERATED {setup}          OPTIONAL,      -- Cond
    }
PMIRIPCell
    csi-SubframePatternConfig-r10 CHOICE {
        release                      NULL,
        setup                        SEQUENCE {
            csi-MeasSubframeSet1-r10 MeasSubframePattern-r10,
            csi-MeasSubframeSet2-r10 MeasSubframePattern-r10
        }
    }
    } OPTIONAL      -- Need ON

CQI-ReportConfig-v1130 ::=
    SEQUENCE {
        cqi-ReportPeriodic-v1130    CQI-ReportPeriodic-v1130,
        cqi-ReportBoth-r11          CQI-ReportBoth-r11
    }

CQI-ReportConfig-v1250 ::=
    SEQUENCE {
        csi-SubframePatternConfig-r12 CHOICE {
            release                      NULL,
            setup                        SEQUENCE {
                csi-MeasSubframeSets-r12 BIT STRING (SIZE (10))
            }
        }
        cqi-ReportBoth-v1250         CQI-ReportBoth-v1250     OPTIONAL,      -- Need ON
        cqi-ReportAperiodic-v1250    CQI-ReportAperiodic-v1250 OPTIONAL,      -- Need ON
        altCQI-Table-r12             ENUMERATED {

```

```

    allSubframes, csi-SubframeSet1,
    csi-SubframeSet2, spare1} OPTIONAL -- Need OP
}
CQI-ReportConfig-v1310 ::= SEQUENCE {
    cqi-ReportBoth-v1310 CQI-ReportBoth-v1310 OPTIONAL, -- Need ON
    cqi-ReportAperiodic-v1310 CQI-ReportAperiodic-v1310 OPTIONAL, -- Need ON
    cqi-ReportPeriodic-v1310 CQI-ReportPeriodic-v1310 OPTIONAL -- Need ON
}
CQI-ReportConfig-v1320 ::= SEQUENCE {
    cqi-ReportPeriodic-v1320 CQI-ReportPeriodic-v1320 OPTIONAL -- Need ON
}
CQI-ReportConfig-v1430 ::= SEQUENCE {
    cqi-ReportAperiodicHybrid-r14 CQI-ReportAperiodicHybrid-r14 OPTIONAL -- Need ON
}
CQI-ReportConfig-v1530 ::= SEQUENCE {
    altCQI-Table-1024QAM-r15 ENUMERATED {
        allSubframes, csi-SubframeSet1,
        csi-SubframeSet2, spare1} OPTIONAL -- Need OP
}
CQI-ReportConfig-r15 ::= CHOICE {
    release NULL,
    setup SEQUENCE {
        cqi-ReportConfig-r10 CQI-ReportConfig-r10 OPTIONAL, -- Need ON
        cqi-ReportConfig-v1130 CQI-ReportConfig-v1130 OPTIONAL, -- Need ON
        cqi-ReportConfigPCell-v1250 CQI-ReportConfig-v1250 OPTIONAL, -- Need ON
        cqi-ReportConfig-v1310 CQI-ReportConfig-v1310 OPTIONAL, -- Need ON
        cqi-ReportConfig-v1320 CQI-ReportConfig-v1320 OPTIONAL, -- Need ON
        cqi-ReportConfig-v1430 CQI-ReportConfig-v1430 OPTIONAL, -- Need ON
        altCQI-Table-1024QAM-r15 ENUMERATED {allSubframes, csi-SubframeSet1,
        csi-SubframeSet2, spare1} OPTIONAL -- Need OP
    }
}
CQI-ReportConfigSCell-r10 ::= SEQUENCE {
    cqi-ReportModeAperiodic-r10 CQI-ReportModeAperiodic OPTIONAL, -- Need OR
    nomPDSCH-RS-EPRE-Offset-r10 INTEGER (-1..6),
    cqi-ReportPeriodicSCell-r10 CQI-ReportPeriodic-r10 OPTIONAL, -- Need ON
    pmi-RI-Report-r10 ENUMERATED {setup} OPTIONAL -- Cond
}
PMIRISCell
}
CQI-ReportConfigSCell-r15 ::= SEQUENCE {
    cqi-ReportPeriodicSCell-r15 CQI-ReportPeriodicSCell-r15 OPTIONAL, -- Need ON
    altCQI-Table-1024QAM-r15 ENUMERATED {allSubframes, csi-SubframeSet1,
    csi-SubframeSet2, spare1} OPTIONAL -- Need
}
OP
}
-- ASN1STOP

```

<b>CQI-ReportConfig field descriptions</b>
<p><b>altCQI-Table, altCQI-Table-1024QAM</b> Indicates the applicability of the alternative CQI table (i.e. Table 7.2.3-2 and Table 7.2.3-4 in TS 36.213 [23]) for both aperiodic and periodic CSI reporting for the concerned serving cell. Value <i>allSubframes</i> means the alternative CQI table applies to all the subframes and CSI processes, if configured, and value <i>csi-SubframeSet1</i> means the alternative CQI table applies to CSI subframe set1, and value <i>csi-SubframeSet2</i> means the alternative CQI table applies to CSI subframe set2. EUTRAN sets the value to <i>csi-SubframeSet1</i> or <i>csi-SubframeSet2</i> only if <i>transmissionMode</i> is set in range <i>tm1</i> to <i>tm9</i> and <i>csi-SubframePatternConfig-r10</i> is configured for the concerned serving cell and different CQI tables apply to the two CSI subframe sets; otherwise EUTRAN sets the value to <i>allSubframes</i>. EUTRAN does not configure <i>altCQI-Table-r12</i> in <i>CQI-ReportConfig-v1250</i> and <i>altCQI-Table-1024QAM-r15</i> in <i>CQI-ReportConfig-v1530</i> or in <i>CQI-ReportConfigSCell-r15</i> in the same serving cell simultaneously. If <i>altCQI-Table-r12</i> and <i>altCQI-Table-1024QAM-r15</i> are absent, the UE shall use Table 7.2.3-1 in TS 36.213 [23] for all subframes and CSI processes, if configured.</p>
<p><b>cqi-Mask</b> Limits CQI/PMI/PTI/RI reports to the on-duration period of the DRX cycle, see TS 36.321 [6]. One value applies for all CSI processes and all serving cells (the associated functionality is common i.e. not performed independently for each cell).</p>
<p><b>cqi-ReportAperiodic</b> E-UTRAN does not configure <i>CQI-ReportAperiodic</i> when transmission mode 10 is configured for all serving cells. E-UTRAN configures <i>cqi-ReportAperiodic-v1250</i> only if <i>cqi-ReportAperiodic-r10</i> and <i>csi-MeasSubframeSets-r12</i> are configured. E-UTRAN configures <i>cqi-ReportAperiodic-v1310</i> only if <i>cqi-ReportAperiodic-r10</i> is configured.</p>
<p><b>cqi-ReportModeAperiodic</b> Parameter: <i>reporting mode</i>. Value <i>rm12</i> corresponds to Mode 1-2, <i>rm20</i> corresponds to Mode 2-0, <i>rm22</i> corresponds to Mode 2-2 etc. PUSCH reporting modes are described in TS 36.213 [23], clause 7.2.1. The UE shall ignore <i>cqi-ReportModeAperiodic-r10</i> when transmission mode 10 is configured for the serving cell on this carrier frequency. The UE shall ignore <i>cqi-ReportModeAperiodic-r10</i> configured for the PCell/ PSCell when the transmission bandwidth of the PCell/PSCell in downlink is 6 resource blocks.</p>
<p><b>cqi-ReportPeriodic</b> E-UTRAN does not configure <i>CQI-ReportPeriodic</i> for sTTI within <i>CQI-ReportConfig</i>.</p>
<p><b>csi-MeasSubframeSets</b> Indicates the two CSI subframe sets. Value 0 means the subframe belongs to CSI subframe set 1 and value 1 means the subframe belongs to CSI subframe set 2. CSI subframe set 1 refers to <math>C_{CSI,0}</math> in TS 36.213 [23], clause 7.2, and CSI subframe set 2 refers to <math>C_{CSI,1}</math> in TS 36.213 [23], clause 7.2. EUTRAN does not configure <i>csi-MeasSubframeSet1-r10</i> and <i>csi-MeasSubframeSet2-r10</i> if either <i>csi-MeasSubframeSets-r12</i> for PCell or <i>eimta-MainConfigPCell-r12</i> is configured.</p>
<p><b>csi-MeasSubframeSet1, csi-MeasSubframeSet2</b> Indicates the CSI measurement subframe sets. <i>csi-MeasSubframeSet1</i> refers to <math>C_{CSI,0}</math> in TS 36.213 [23], clause 7.2 and <i>csi-MeasSubframeSet2</i> refers to <math>C_{CSI,1}</math> in TS 36.213 [23], clause 7.2. E-UTRAN only configures the two CSI measurement subframe sets for the PCell.</p>
<p><b>nomPDSCH-RS-EPRE-Offset</b> Parameter: <math>\Delta_{offset}</math> see TS 36.213 [23], clause 7.2.3. Actual value = field value * 2 [dB].</p>
<p><b>pmi-RI-Report</b> See TS 36.213 [23], clause 7.2. The presence of this field means PMI/RI reporting is configured; otherwise the PMI/RI reporting is not configured. EUTRAN configures this field only when <i>transmissionMode</i> is set to <i>tm8</i>, <i>tm9</i> or <i>tm10</i>. The UE shall ignore <i>pmi-RI-Report-r9</i>/ <i>pmi-RI-Report-r10</i> when transmission mode 10 is configured for the serving cell on this carrier frequency.</p>

Conditional presence	Explanation
<i>cqi-Setup</i>	This field is not present for an Scell except for the PSCell, while it is conditionally present for the PCell and the PSCell according to the following. The field is optional present, need OR, if the <i>cqi-ReportPeriodic</i> in the <i>cqi-ReportConfig</i> is set to <i>setup</i> . If the field <i>cqi-ReportPeriodic</i> is present and set to <i>release</i> , the field is not present and the UE shall delete any existing value for this field. Otherwise the field is not present.
<i>PMIRI</i>	The field is optional present, need OR, if <i>cqi-ReportPeriodic</i> is included and set to <i>setup</i> , or <i>cqi-ReportModeAperiodic</i> is included. If the field <i>cqi-ReportPeriodic</i> is present and set to <i>release</i> and <i>cqi-ReportModeAperiodic</i> is absent, the field is not present and the UE shall delete any existing value for this field. Otherwise the field is not present.
<i>PMIRIPCell</i>	The field is optional present, need OR, if <i>cqi-ReportPeriodic</i> is included in the <i>CQI-ReportConfig-r10</i> and set to <i>setup</i> , or <i>cqi-ReportAperiodic</i> is included in the <i>CQI-ReportConfig-r10</i> and set to <i>setup</i> . If the field <i>cqi-ReportPeriodic</i> is present in the <i>CQI-ReportConfig-r10</i> and set to <i>release</i> and <i>cqi-ReportAperiodic</i> is included in the <i>CQI-ReportConfig-r10</i> and set to <i>release</i> , the field is not present and the UE shall delete any existing value for this field. Otherwise the field is not present.
<i>PMIRISCell</i>	The field is optional present, need OR, if <i>cqi-ReportPeriodicSCell</i> is included and set to <i>setup</i> , or <i>cqi-ReportModeAperiodic-r10</i> is included in the <i>CQI-ReportConfigSCell</i> . If the field <i>cqi-ReportPeriodicSCell</i> is present and set to <i>release</i> and <i>cqi-ReportModeAperiodic-r10</i> is absent in the <i>CQI-ReportConfigSCell</i> , the field is not present and the UE shall delete any existing value for this field. Otherwise the field is not present.

## – CQI-ReportPeriodic

The IE *CQI-ReportPeriodic* is used to specify the periodic CQI reporting configuration elements.

### CQI-ReportPeriodic information elements

```
-- ASN1START
CQI-ReportPeriodic ::= CHOICE {
  release          NULL,
  setup            SEQUENCE {
    cqi-PUCCH-ResourceIndex    INTEGER (0..1185),
    cqi-pmi-ConfigIndex        INTEGER (0..1023),
    cqi-FormatIndicatorPeriodic CHOICE {
      widebandCQI              NULL,
      subbandCQI               SEQUENCE {
        k                       INTEGER (1..4)
      }
    },
    ri-ConfigIndex            INTEGER (0..1023)    OPTIONAL,      -- Need OR
    simultaneousAckNackAndCQI BOOLEAN
  }
}

CQI-ReportPeriodic-r10 ::= CHOICE {
  release          NULL,
  setup            SEQUENCE {
    cqi-PUCCH-ResourceIndex-r10    INTEGER (0..1184),
    cqi-PUCCH-ResourceIndexP1-r10  INTEGER (0..1184)    OPTIONAL,      -- Need OR
    cqi-pmi-ConfigIndex            INTEGER (0..1023),
    cqi-FormatIndicatorPeriodic-r10 CHOICE {
      widebandCQI-r10              SEQUENCE {
        csi-ReportMode-r10         ENUMERATED {submode1, submode2}    OPTIONAL  -- Need OR
      },
      subbandCQI-r10              SEQUENCE {
        k                           INTEGER (1..4),
        periodicityFactor-r10      ENUMERATED {n2, n4}
      }
    },
    ri-ConfigIndex            INTEGER (0..1023)    OPTIONAL,      -- Need OR
    simultaneousAckNackAndCQI BOOLEAN,
    cqi-Mask-r9               ENUMERATED {setup}    OPTIONAL,      -- Need OR
    csi-ConfigIndex-r10       CHOICE {
      release                    NULL,
      setup                      SEQUENCE {
        cqi-pmi-ConfigIndex2-r10  INTEGER (0..1023),
        ri-ConfigIndex2-r10      INTEGER (0..1023)    OPTIONAL  -- Need OR
      }
    }
  }
}
-- ASN1END
```

```

}

CQI-ReportPeriodic-v1130 ::= SEQUENCE {
    simultaneousAckNackAndCQI-Format3-r11    ENUMERATED {setup}    OPTIONAL,    -- Need OR
    cqi-ReportPeriodicProcExtToReleaseList-r11    CQI-ReportPeriodicProcExtToReleaseList-r11
    OPTIONAL,    -- Need ON
    cqi-ReportPeriodicProcExtToAddModList-r11    CQI-ReportPeriodicProcExtToAddModList-r11    OPTIONAL
    -- Need ON
}

CQI-ReportPeriodic-v1310 ::= SEQUENCE {
    cri-ReportConfig-r13    CRI-ReportConfig-r13    OPTIONAL,    -- Need OR
    simultaneousAckNackAndCQI-Format4-Format5-r13    ENUMERATED {setup}    OPTIONAL-- Need OR
}

CQI-ReportPeriodic-v1320 ::= SEQUENCE {
    periodicityFactorWB-r13    ENUMERATED {n2, n4}    OPTIONAL    -- Need OR
}

CQI-ReportPeriodicSCell-r15 ::= CHOICE {
    release    NULL,
    setup    SEQUENCE {
        cqi-pmi-ConfigIndexDormant-r15    INTEGER (0..1023),
        ri-ConfigIndexDormant-r15    INTEGER (0..1023)    OPTIONAL,    -- Need OR
        csi-SubframePatternDormant-r15    CHOICE {
            release    NULL,
            setup    SEQUENCE {
                csi-MeasSubframeSet1-r15    MeasSubframePattern-r10,
                csi-MeasSubframeSet2-r15    MeasSubframePattern-r10
            }
        }
    }
    OPTIONAL,    -- Need ON
    cqi-FormatIndicatorDormant-r15    CHOICE {
        widebandCQI-r15    SEQUENCE {
            csi-ReportMode-r15    ENUMERATED {submode1, submode2}    OPTIONAL    -- Need OR
        },
        subbandCQI-r15    SEQUENCE {
            k-r15    INTEGER (1..4),
            periodicityFactor-r15    ENUMERATED {n2, n4}
        }
    }
}
OPTIONAL    -- Need OR
}

CQI-ReportPeriodicProcExtToAddModList-r11 ::= SEQUENCE (SIZE (1..maxCQI-ProcExt-r11)) OF CQI-ReportPeriodicProcExt-r11

CQI-ReportPeriodicProcExtToReleaseList-r11 ::= SEQUENCE (SIZE (1..maxCQI-ProcExt-r11)) OF CQI-ReportPeriodicProcExtId-r11

CQI-ReportPeriodicProcExt-r11 ::= SEQUENCE {
    cqi-ReportPeriodicProcExtId-r11    CQI-ReportPeriodicProcExtId-r11,
    cqi-pmi-ConfigIndex-r11    INTEGER (0..1023),
    cqi-FormatIndicatorPeriodic-r11    CHOICE {
        widebandCQI-r11    SEQUENCE {
            csi-ReportMode-r11    ENUMERATED {submode1, submode2}    OPTIONAL    -- Need OR
        },
        subbandCQI-r11    SEQUENCE {
            k    INTEGER (1..4),
            periodicityFactor-r11    ENUMERATED {n2, n4}
        }
    },
    ri-ConfigIndex-r11    INTEGER (0..1023)    OPTIONAL,    -- Need OR
    csi-ConfigIndex-r11    CHOICE {
        release    NULL,
        setup    SEQUENCE {
            cqi-pmi-ConfigIndex2-r11    INTEGER (0..1023),
            ri-ConfigIndex2-r11    INTEGER (0..1023)    OPTIONAL    -- Need OR
        }
    }
}
OPTIONAL,    -- Need ON
...,
[[ cri-ReportConfig-r13    CRI-ReportConfig-r13    OPTIONAL    -- Need ON
]],
[[ periodicityFactorWB-r13    ENUMERATED {n2, n4}    OPTIONAL    -- Need ON
]]
}

CQI-ShortConfigSCell-r15 ::= CHOICE {

```





<b>CQI-ReportPeriodic field descriptions</b>
<p><b><i>cqi-FormatIndicatorPeriodic</i></b> Parameter: <i>PUCCH CQI Feedback Type</i>, see TS 36.213 [23], table 7.2.2-1. Depending on transmissionMode, reporting mode is implicitly given from the table.</p>
<p><b><i>cqi-Mask</i></b> Limits CQI/PMI/PTI/RI reports to the on-duration period of the DRX cycle, see TS 36.321 [6]. One value applies for all CSI processes and all serving cells (the associated functionality is common i.e. not performed independently for each cell).</p>
<p><b><i>cqi-pmi-ConfigIndex</i></b> Parameter: <i>CQI/PMI Periodicity and Offset Configuration Index I<sub>CQI/PMI</sub></i>, see TS 36.213 [23], tables 7.2.2-1A and 7.2.2-1C. If subframe patterns for CSI (CQI/PMI/PTI/RI) reporting are configured (i.e. <i>csi-SubframePatternConfig</i> is configured), the parameter applies to the subframe pattern corresponding to <i>csi-MeasSubframeSet1</i> or corresponding to the CSI subframe set 1 indicated by <i>csi-MeasSubframeSets-r12</i>.</p>
<p><b><i>cqi-pmi-ConfigIndexDormant</i></b> If subframe patterns for CSI (CQI/PMI/PTI/RI) reporting for dormant SCell are configured (i.e. <i>csi-SubframePatternDormant</i> is configured), the parameter applies to the subframe pattern corresponding to <i>csi-MeasSubframeSet1-r15</i>.</p>
<p><b><i>cqi-pmi-ConfigIndex2</i></b> Parameter: <i>CQI/PMI Periodicity and Offset Configuration Index I<sub>CQI/PMI</sub></i>, see TS 36.213 [23], tables 7.2.2-1A and 7.2.2-1C. The parameter applies to the subframe pattern corresponding to <i>csi-MeasSubframeSet2</i> or corresponding to the CSI subframe set 2 indicated by <i>csi-MeasSubframeSets-r12</i>.</p>
<p><b><i>cqi-pmi-ConfigIndex2Dormant</i></b> If subframe patterns for CSI (CQI/PMI/PTI/RI) reporting for dormant SCell are configured (i.e. <i>csi-SubframePatternDormant</i> is configured), the parameter applies to the subframe pattern corresponding to <i>csi-MeasSubframeSet2-r15</i>.</p>
<p><b><i>cqi-PUCCH-ResourceIndex, cqi-PUCCH-ResourceIndexP1</i></b> Parameter <math>n_{\text{PUCCH}}^{(2,p)}</math> for antenna port P0 and for antenna port P1 respectively, see TS 36.213 [23], clause 7.2. E-UTRAN does not apply value 1185. One value applies for all CSI processes.</p>
<p><b><i>cqi-ReportAperiodic</i></b> E-UTRAN does not configure <i>CQI-ReportAperiodic</i> when transmission mode 10 is configured for all serving cells. E-UTRAN configures <i>cqi-ReportAperiodic-v1250</i> only if <i>cqi-ReportAperiodic-r10</i> and <i>csi-MeasSubframeSets-r12</i> are configured. E-UTRAN configures <i>cqi-ReportAperiodic-v1310</i> only if <i>cqi-ReportAperiodic-r10</i> is configured.</p>
<p><b><i>cqi-ReportModeAperiodic</i></b> Parameter: <i>reporting mode</i>. Value rm12 corresponds to Mode 1-2, rm20 corresponds to Mode 2-0, rm22 corresponds to Mode 2-2 etc. PUSCH reporting modes are described in TS 36.213 [23], clause 7.2.1. The UE shall ignore <i>cqi-ReportModeAperiodic-r10</i> when transmission mode 10 is configured for the serving cell on this carrier frequency. The UE shall ignore <i>cqi-ReportModeAperiodic-r10</i> configured for the PCell/ PSCell when the transmission bandwidth of the PCell/PSCell in downlink is 6 resource blocks.</p>
<p><b><i>CQI-ReportPeriodicProcExt</i></b> A set of periodic CQI related parameters for which E-UTRAN may configure different values for each CSI process. For a serving frequency E-UTRAN configures one or more <i>CQI-ReportPeriodicProcExt</i> only when transmission mode 10 is configured for the serving cell on this carrier frequency.</p>
<p><b><i>cri-ConfigIndex</i></b> Parameter: <i>cri-ConfigIndex I<sub>CR</sub></i> see TS 36.213 [23]. The parameter applies to the subframe pattern corresponding to <i>csi-MeasSubframeSet1</i>. EUTRAN configures the field if subframe patterns for CSI (CQI/PMI/PTI/RI/CRI) reporting are configured (i.e. <i>csi-SubframePatternConfig</i> is configured).</p>
<p><b><i>cri-ConfigIndex2</i></b> Parameter: <i>cri-ConfigIndex I<sub>CR</sub></i> see TS 36.213 [23]. The parameter applies to the subframe pattern corresponding to <i>csi-MeasSubframeSet2</i> or corresponding to the CSI subframe set 2 indicated by <i>csi-MeasSubframeSets</i>. E-UTRAN configures <i>cri-ConfigIndex2</i> only if <i>cri-ConfigIndex</i> is configured.</p>
<p><b><i>cri-ReportConfig</i></b> E-UTRAN configures the field only if the UE is configured with <i>eMIMO-Type</i> set to "beamformed" and if multiple references to RS configuration using non-zero power transmission are configured (i.e. if <i>csi-RS-ConfigNZPIdListExt</i> is configured).</p>
<p><b><i>csi-ConfigIndex</i></b> E-UTRAN configures <i>csi-ConfigIndex</i> only for PCell and only if <i>csi-SubframePatternConfig</i> is configured. The UE shall release <i>csi-ConfigIndex</i> if <i>csi-SubframePatternConfig</i> is released.</p>
<p><b><i>csi-ProcessToAddModList</i></b> For a serving frequency E-UTRAN configures one or more <i>CSI-Process</i> only when transmission mode 10 is configured for the serving cell on this carrier frequency.</p>
<p><b><i>csi-ReportMode</i></b> Parameter: <i>PUCCH_format1-1_CSI_reporting_mode</i>, see TS 36.213 [23], clause 7.2.2.</p>
<p><b>K</b> Parameter: K, see TS 36.213 [23], clause 7.2.2.</p>
<p><b><i>nomPDSCH-RS-EPRE-Offset</i></b> Parameter: <math>\Delta_{\text{offset}}</math> see TS 36.213 [23], clause 7.2.3. Actual value = field value * 2 [dB].</p>

<b>CQI-ReportPeriodic field descriptions</b>
<p><b>periodicityFactor, periodicityFactorWB</b> Parameter: <math>H'</math>, see TS 36.213 [23], clause 7.2.2. E-UTRAN configures field <i>periodicityFactorWB</i> only when the UE is configured with <i>eMIMO-Type</i> set to <i>nonPrecoded</i> and with <i>cqi-FormatIndicatorPeriodic</i> set to <i>widebandCQI</i>.</p>
<p><b>ri-ConfigIndex</b> Parameter: <i>RI Config Index</i> <math>I_{RI}</math>, see TS 36.213 [23], clause 7.2.2-1B. If subframe patterns for CSI (CQI/PMI/PTI/RI/CR1) reporting are configured (i.e. <i>csi-SubframePatternConfig</i> is configured), the parameter applies to the subframe pattern corresponding to <i>csi-MeasSubframeSet1</i>.</p>
<p><b>ri-ConfigIndexDormant</b> If subframe patterns for CSI (CQI/PMI/PTI/RI) reporting for dormant SCell are configured (i.e. <i>csi-SubframePatternDormant</i> is configured), the parameter applies to the subframe pattern corresponding to <i>csi-MeasSubframeSet1-r15</i>.</p>
<p><b>ri-ConfigIndex2</b> Parameter: <i>RI Config Index</i> <math>I_{RI}</math>, see TS 36.213 [23], clause 7.2.2-1B. The parameter applies to the subframe pattern corresponding to <i>csi-MeasSubframeSet2</i> or corresponding to the CSI subframe set 2 indicated by <i>csi-MeasSubframeSets-r12</i>. E-UTRAN configures <i>ri-ConfigIndex2</i> only if <i>ri-ConfigIndex</i> is configured.</p>
<p><b>ri-ConfigIndex2Dormant</b> If subframe patterns for CSI (CQI/PMI/PTI/RI) reporting for dormant SCell are configured (i.e. <i>csi-SubframePatternDormant</i> is configured), the parameter applies to the subframe pattern corresponding to <i>csi-MeasSubframeSet2-r15</i>.</p>
<p><b>simultaneousAckNackAndCQI</b> Parameter: <i>Simultaneous-AN-and-CQI</i>, see TS 36.213 [23], clause 10.1. TRUE indicates that simultaneous transmission of ACK/NACK and CQI is allowed. One value applies for all CSI processes. For SCells except for the PSCell and PUCCH SCell this field is not applicable and the UE shall ignore the value.</p>
<p><b>simultaneousAckNackAndCQI-Format3</b> Indicates that the UE shall perform simultaneous transmission of HARQ A/N and periodic CQI report multiplexing on PUCCH format 3, see TS 36.213 [23], clauses 7.2 and 10.1.1. E-UTRAN configures this information only when <i>pucch-Format</i> is set to <i>format3</i>. One value applies for all CSI processes. For SCells except for the PSCell and PUCCH SCell this field is not applicable and the UE shall ignore the value.</p>
<p><b>simultaneousAckNackAndCQI-Format4-Format5</b> Indicates that the UE shall perform simultaneous transmission of HARQ A/N and periodic CSI report multiplexing on PUCCH format 4 and format 5, see TS 36.213 [23], clause 10.1.1. E-UTRAN configures this information only when <i>pucch-Format</i> is set to <i>format4</i> or <i>format5</i>. One value applies for all CSI processes. For SCells except for the PSCell and PUCCH SCell this field is not applicable and the UE shall ignore the value.</p>

### – CQI-ReportPeriodicProcExtId

The IE *CQI-ReportPeriodicProcExtId* is used to identify a periodic CQI reporting configuration that E-UTRAN may configure in addition to the configuration specified by the IE *CQI-ReportPeriodic-r10*. These additional configurations are specified by the IE *CQI-ReportPeriodicProcExt-r11*. The identity is unique within the scope of a carrier frequency.

#### **CQI-ReportPeriodicProcExtId information elements**

```
-- ASN1START
CQI-ReportPeriodicProcExtId-r11 ::= INTEGER (1..maxCQI-ProcExt-r11)
-- ASN1STOP
```

### – CrossCarrierSchedulingConfig

The IE *CrossCarrierSchedulingConfig* is used to specify the configuration when the cross carrier scheduling is used in a cell.

#### **CrossCarrierSchedulingConfig information elements**

```
-- ASN1START
CrossCarrierSchedulingConfig-r10 ::= SEQUENCE {
  schedulingCellInfo-r10 CHOICE {
    own-r10 SEQUENCE { -- No cross carrier
      scheduling cif-Presence-r10 BOOLEAN
    }
  }
},
```

```

        other-r10                               SEQUENCE {                -- Cross carrier
scheduling
    schedulingCellId-r10                        ServCellIndex-r10,
        pdsch-Start-r10                        INTEGER (1..4)
    }
}
}
CrossCarrierSchedulingConfig-r13 ::=          SEQUENCE {
    schedulingCellInfo-r13                     CHOICE {
        own-r13                               SEQUENCE {                -- No cross carrier
scheduling
            cif-Presence-r13                   BOOLEAN
        },
        other-r13                             SEQUENCE {                -- Cross carrier scheduling
            schedulingCellId-r13                ServCellIndex-r13,
            pdsch-Start-r13                    INTEGER (1..4),
            cif-InSchedulingCell-r13           INTEGER (1..7)
        }
    }
}
CrossCarrierSchedulingConfigLAA-UL-r14 ::=    SEQUENCE {
    schedulingCellId-r14                        ServCellIndex-r13,
    cif-InSchedulingCell-r14                   INTEGER (1..7)
}
-- ASN1STOP

```

#### **CrossCarrierSchedulingConfig field descriptions**

##### **cif-Presence**

The field is used to indicate whether carrier indicator field is present (value TRUE) or not (value FALSE) in PDCCH/EPDCCH DCI formats, see TS 36.212 [22], clause 5.3.3.1.

##### **cif-InSchedulingCell**

The field indicates the CIF value used in the scheduling cell to indicate this cell, see TS 36.212 [22], clause 5.3.3.1. In case of carrier indicator field is present, the CIF value is 0.

##### **pdsch-Start**

The starting OFDM symbol of PDSCH for the concerned SCell, see TS 36.213 [23]. clause 7.1.6.4. Values 1, 2, 3 are applicable when *dl-Bandwidth* for the concerned SCell is greater than 10 resource blocks, values 2, 3, 4 are applicable when *dl-Bandwidth* for the concerned SCell is less than or equal to 10 resource blocks, see TS 36.211 [21], Tables 6 and 7-1.

##### **schedulingCellId**

Indicates which cell signals the downlink allocations and uplink grants, if applicable, for the concerned SCell. In case the UE is configured with DC, the scheduling cell is part of the same cell group (i.e. MCG or SCG) as the scheduled cell. In case the UE is configured with *crossCarrierSchedulingConfigLAA-UL*, *schedulingCellId* indicated in *crossCarrierSchedulingConfigLAA-UL* only indicates which cell signals the uplink grants.

## – CRS-ChEstMPDCCH-Config

The IE *CRS-ChEstMPDCCH-Config* is used to configure and enable use of CRS for MPDCCH performance improvement, see TS 36.211 [21], clause 6.8B.5 and TS 36.213 [23], clause 9.1.5.

#### **CRS-ChEstMPDCCH-Config information elements**

```

-- ASN1START
CRS-ChEstMPDCCH-ConfigCommon-r16 ::=          SEQUENCE {
    powerRatio-r16                             ENUMERATED {dB-4dot77, dB-3, dB-1dot77, dB0, dB1, dB2, dB3, dB4dot77}
}
CRS-ChEstMPDCCH-ConfigDedicated-r16 ::=      SEQUENCE {
    powerRatio-r16                             ENUMERATED {dB-4dot77, dB-3, dB-1dot77, dB0, dB1, dB2, dB3,
    localizedMappingType-r16                   ENUMERATED {predefined, csi-Based, reciprocityBased}
    DEFAULT predefined
}
-- ASN1STOP

```

<b>CRS-ChEstMPDCCH-Config field descriptions</b>	
<b>powerRatio</b>	Power ratio in dB between DMRS and CRS antenna ports of MPDCCH, see TS 36.213 [23], clause 5.2. Value dB-4dot77 corresponds to -4.77 dB, value dB-3 corresponds to -3 dB and so on.
<b>localizedMappingType</b>	DMRS mapping type for MPDCCH performance improvement with localized MPDCCH allocation for CE mode A or B in RRC_CONNECTED, see TS 36.213 [23], clause 9.1.5. Value <i>predefined</i> corresponds to predefined mapping, value <i>csi-Based</i> corresponds to CSI-based mapping, and value <i>reciprocityBased</i> corresponds to reciprocity based mapping. Reciprocity based mapping is only applicable for TDD.

<b>Conditional presence</b>	<b>Explanation</b>
<i>setup</i>	The field is mandatory present if <i>CRS-ChEstMPDCCH-ConfigDedicated</i> is set to <i>setup</i> and this field has not been configured in <i>CRS-ChEstMPDCCH-ConfigCommon</i> ; otherwise the field is optional, need ON.

## – CSI-IM-Config

The IE *CSI-IM-Config* is the CSI Interference Measurement (IM) configuration that E-UTRAN may configure on a serving frequency, see TS 36.213 [23], clause 7.2.6.

### CSI-IM-Config information elements

```
-- ASN1START
CSI-IM-Config-r11 ::= SEQUENCE {
    csi-IM-ConfigId-r11      CSI-IM-ConfigId-r11,
    resourceConfig-r11      INTEGER (0..31),
    subframeConfig-r11      INTEGER (0..154),
    ...,
    [[ interferenceMeasRestriction-r13  BOOLEAN  OPTIONAL  -- Need ON
    ]]
}

CSI-IM-ConfigExt-r12 ::= SEQUENCE {
    csi-IM-ConfigId-v1250    CSI-IM-ConfigId-v1250,
    resourceConfig-r12      INTEGER (0..31),
    subframeConfig-r12      INTEGER (0..154),
    ...,
    [[ interferenceMeasRestriction-r13  BOOLEAN  OPTIONAL,  -- Need ON
    csi-IM-ConfigId-v1310    CSI-IM-ConfigId-v1310  OPTIONAL  -- Need ON
    ]]
}
-- ASN1STOP
```

<b>CSI-IM-Config field descriptions</b>	
<b>resourceConfig</b>	Parameter: CSI reference signal configuration, see TS 36.213 [23], clause 7.2.6 and TS 36.211 [21], tables 6.10.5.2-1 and 6.10.5.2-2 for 4 REs.
<b>subframeConfig</b>	Parameter: $I_{\text{CSI-RS}}$ , see TS 36.213 [23], clause 7.2.6 and TS 36.211 [21], table 6.10.5.3-1.

## – CSI-IM-ConfigId

The IE *CSI-IM-ConfigId* is used to identify a CSI-IM configuration that is configured by the IE *CSI-IM-Config*. The identity is unique within the scope of a carrier frequency.

### CSI-IM-ConfigId information elements

```
-- ASN1START
CSI-IM-ConfigId-r11 ::= INTEGER (1..maxCSI-IM-r11)
CSI-IM-ConfigId-r12 ::= INTEGER (1..maxCSI-IM-r12)
CSI-IM-ConfigId-v1250 ::= INTEGER (maxCSI-IM-r12)
CSI-IM-ConfigId-v1310 ::= INTEGER (minCSI-IM-r13..maxCSI-IM-r13)
-- ASN1STOP
```

```
CSI-IM-ConfigId-r13 ::= INTEGER (1..maxCSI-IM-r13)
-- ASN1STOP
```

## – CSI-Process

The IE *CSI-Process* is the CSI process configuration that E-UTRAN may configure on a serving frequency.

### CSI-Process information elements

```
-- ASN1START
CSI-Process-r11 ::= SEQUENCE {
  csi-ProcessId-r11          CSI-ProcessId-r11,
  csi-RS-ConfigNZPId-r11    CSI-RS-ConfigNZPId-r11,
  csi-IM-ConfigId-r11       CSI-IM-ConfigId-r11,
  p-C-AndCBSRList-r11      P-C-AndCBSR-Pair-r13a,
  cqi-ReportBothProc-r11    CQI-ReportBothProc-r11          OPTIONAL,      -- Need OR
  cqi-ReportPeriodicProcId-r11  INTEGER (0..maxCQI-ProcExt-r11)  OPTIONAL,      -- Need OR
  cqi-ReportAperiodicProc-r11 CQI-ReportAperiodicProc-r11          OPTIONAL,      -- Need OR
  ...,
  [[ alternativeCodebookEnabledFor4TXProc-r12  ENUMERATED {true}  OPTIONAL,      -- Need ON
    csi-IM-ConfigIdList-r12  CHOICE {
      release                NULL,
      setup                  SEQUENCE (SIZE (1..2)) OF CSI-IM-ConfigId-r12
    }
    OPTIONAL,      -- Need ON
  cqi-ReportAperiodicProc2-r12  CHOICE {
    release                NULL,
    setup                  CQI-ReportAperiodicProc-r11
  }
  OPTIONAL,      -- Need ON
  ]],
  [[ cqi-ReportAperiodicProc-v1310  CHOICE {
    release                NULL,
    setup                  CQI-ReportAperiodicProc-v1310
  }
  OPTIONAL,      -- Need ON
  cqi-ReportAperiodicProc2-v1310  CHOICE {
    release                NULL,
    setup                  CQI-ReportAperiodicProc-v1310
  }
  OPTIONAL,      -- Need ON
  eMIMO-Type-r13              CSI-RS-ConfigEMIMO-r13          OPTIONAL,      -- Need ON
  ]],
  [[ dummy                    CSI-RS-ConfigEMIMO-v1430          OPTIONAL,      -- Need ON
  eMIMO-Hybrid-r14            CSI-RS-ConfigEMIMO-Hybrid-r14          OPTIONAL,      -- Need ON
  advancedCodebookEnabled-r14  BOOLEAN                    OPTIONAL,      -- Need ON
  ]],
  [[ eMIMO-Type-v1480          CSI-RS-ConfigEMIMO-v1480          OPTIONAL,      -- Need ON
  ]],
  [[ feCOMP-CSI-Enabled-v1530  BOOLEAN                    OPTIONAL,      -- Need ON
  eMIMO-Type-v1530            CSI-RS-ConfigEMIMO-v1530          OPTIONAL,      -- Need ON
  ]],
  ]],
-- ASN1STOP
```

<b>CSI-Process field descriptions</b>
<p><b>advancedCodebookEnabled</b> Value TRUE indicates that the UE should use the advanced code book defined in TS 36.213 [23]. EUTRAN does not configure the field when the UE is configured with <i>eMIMO-Type</i> is set to <i>beamformed</i>, when the UE is configured with <i>eMIMO-Hybrid</i> or when the UE is configured with <i>semiOpenLoop</i>.</p>
<p><b>alternativeCodebookEnabledFor4TXProc</b> Indicates whether code book in TS 36.213 [23] Table 7.2.4-0A to Table 7.2.4-0D is being used for deriving CSI feedback and reporting for a CSI process. EUTRAN may configure the field only if the number of CSI-RS ports for non-zero power transmission CSI-RS configuration is 4.</p>
<p><b>cqi-ReportAperiodicProc</b> If <i>csi-MeasSubframeSets-r12</i> is configured for the same frequency as the CSI process, <i>cqi-ReportAperiodicProc</i> applies for CSI subframe set 1. If <i>csi-MeasSubframeSet1-r10</i> or <i>csi-MeasSubframeSet2-r10</i> are configured for the same frequency as the CSI process, <i>cqi-ReportAperiodicProc</i> applies for CSI subframe set 1 or CSI subframe set 2. Otherwise, <i>cqi-ReportAperiodicProc</i> applies for all subframes. E-UTRAN configures <i>cqi-ReportAperiodicProc-v1310</i> only if <i>cqi-ReportAperiodicProc-r11</i> is configured</p>
<p><b>cqi-ReportAperiodicProc2</b> <i>cqi-ReportAperiodicProc2</i> is configured only if <i>csi-MeasSubframeSets-r12</i> is configured for the same frequency as the CSI process. <i>cqi-ReportAperiodicProc2</i> is for CSI subframe set 2. E-UTRAN shall set <i>cqi-ReportModeAperiodic-r11</i> in <i>cqi-ReportAperiodicProc2</i> the same as in <i>cqi-ReportAperiodicProc</i>. E-UTRAN configures <i>cqi-ReportAperiodicProc2-v1310</i> only if <i>cqi-ReportAperiodicProc2-r12</i> is configured.</p>
<p><b>cqi-ReportBothProc</b> Includes CQI configuration parameters applicable for both aperiodic and periodic CSI reporting, for which CSI process specific values may be configured. E-UTRAN configures the field if and only if <i>cqi-ReportPeriodicProcId</i> is included and/ or if <i>cqi-ReportAperiodicProc</i> is included.</p>
<p><b>cqi-ReportPeriodicProcId</b> Refers to a periodic CQI reporting configuration that is configured for the same frequency as the CSI process. Value 0 refers to the set of parameters defined by the REL-10 CQI reporting configuration fields, while the other values refer to the additional configurations E-UTRAN assigns by <i>CQI-ReportPeriodicProcExt-r11</i> (and as covered by <i>CQI-ReportPeriodicProcExtId</i>).</p>
<p><b>csi-IM-ConfigId</b> Refers to a CSI-IM configuration that is configured for the same frequency as the CSI process. If <i>csi-IM-ConfigId-v1250</i> or <i>csi-IM-ConfigId-v1310</i> is configured, the UE only considers this extension (i.e., UE ignores <i>csi-IM-ConfigId-r11</i> and <i>csi-IM-ConfigId-r12</i>).</p>
<p><b>csi-IM-ConfigIdList</b> Refers to one or two CSI-IM configurations that are configured for the same frequency as the CSI process. <i>csi-IM-ConfigIdList</i> can include 2 entries only if <i>csi-MeasSubframeSets-r12</i> is configured for the same frequency as the CSI process.</p>
<p><b>csi-RS-ConfigNZPId</b> Refers to a CSI RS configuration using non-zero power transmission that is configured for the same frequency as the CSI process.</p>
<p><b>dummy</b> This field is not used in the specification. If received it shall be ignored by the UE.</p>
<p><b>eMIMO-Type</b> Parameter: <i>eMIMO-Type</i>, see TS 36.213 [23], TS 36.211 [21]. If <i>eMIMO-Type</i> is set to <i>nonPrecoded</i>, the codebooks used for deriving CSI feedback are in TS 36.213 [23], Table 7.2.4-10 to Table 7.2.4-17. Choice values <i>nonPrecoded</i> and <i>beamformed</i> correspond to 'CLASS A' and 'CLASS B' respectively, see TS 36.212 [22] and TS 36.213 [23].</p>
<p><b>feCOMP-CSI-Enabled</b> Parameter: <i>FeCoMPCSIEnabled</i>, see TS 36.213 [23], clause 7.1.10. Refers to CSI feedback based on FeCoMP. E-UTRAN only configures the field when the UE is configured with <i>eMIMO-Type-r13</i> set to <i>beamformed</i> with two NZP CSI-RS resources using the IE <i>CSI-RS-ConfigBeamformed-r13</i> which contains the two NZP CSI-RS resources configured with <i>csi-RS-ConfigNZPIdListExt-r13</i>.</p>
<p><b>p-C-AndCBSRList</b> The UE shall ignore <i>p-C-AndCBSRList-r11</i> if configured with <i>eMIMO-Type</i> unless it is set to <i>beamformed</i>, <i>alternativeCodebookEnabledBeamformed</i> (in <i>CSI-RS-ConfigBeamformed</i>) is set to <i>FALSE</i> and <i>csi-RS-ConfigNZPIdListExt</i> is not configured,</p>

## – CSI-ProcessId

The IE *CSI-ProcessId* is used to identify a CSI process that is configured by the IE *CSI-Process*. The identity is unique within the scope of a carrier frequency.

### CSI-ProcessId information elements

```
-- ASN1START
```

```
CSI-ProcessId-r11 ::= INTEGER (1..maxCSI-Proc-r11)
```

```
-- ASN1STOP
```

## CSI-RS-Config

The IE *CSI-RS-Config* is used to specify the CSI (Channel-State Information) reference signal configuration.

### CSI-RS-Config information elements

```
-- ASN1START
CSI-RS-Config-r10 ::= SEQUENCE {
  csi-RS-r10 CHOICE {
    release NULL,
    setup SEQUENCE {
      antennaPortsCount-r10 ENUMERATED {an1, an2, an4, an8},
      resourceConfig-r10 INTEGER (0..31),
      subframeConfig-r10 INTEGER (0..154),
      p-C-r10 INTEGER (-8..15)
    }
  }
  zeroTxPowerCSI-RS-r10 ZeroTxPowerCSI-RS-Conf-r12 OPTIONAL, -- Need ON
}

CSI-RS-Config-v1250 ::= SEQUENCE {
  zeroTxPowerCSI-RS2-r12 ZeroTxPowerCSI-RS-Conf-r12 OPTIONAL, -- Need ON
  ds-ZeroTxPowerCSI-RS-r12 CHOICE {
    release NULL,
    setup SEQUENCE {
      zeroTxPowerCSI-RS-List-r12 SEQUENCE (SIZE (1..maxDS-ZTP-CSI-RS-r12)) OF ZeroTxPowerCSI-
RS-r12
    }
  }
} OPTIONAL -- Need ON

CSI-RS-Config-v1310 ::= SEQUENCE {
  eMIMO-Type-r13 CSI-RS-ConfigEMIMO-r13 OPTIONAL -- Need ON
}

CSI-RS-Config-v1430 ::= SEQUENCE {
  dummy CSI-RS-ConfigEMIMO-v1430 OPTIONAL, -- Need ON
  eMIMO-Hybrid-r14 CSI-RS-ConfigEMIMO-Hybrid-r14 OPTIONAL, -- Need ON
  advancedCodebookEnabled-r14 BOOLEAN OPTIONAL -- Need ON
}

CSI-RS-Config-v1480 ::= SEQUENCE {
  eMIMO-Type-v1480 CSI-RS-ConfigEMIMO-v1480 OPTIONAL -- Need ON
}

CSI-RS-Config-v1530 ::= SEQUENCE {
  eMIMO-Type-v1530 CSI-RS-ConfigEMIMO-v1530 OPTIONAL -- Need ON
}

CSI-RS-Config-r15 ::= CHOICE {
  release NULL,
  setup SEQUENCE {
    csi-RS-Config-r10 CSI-RS-Config-r10 OPTIONAL, -- Need ON
    csi-RS-Config-v1250 CSI-RS-Config-v1250 OPTIONAL, -- Need ON
    csi-RS-Config-v1310 CSI-RS-Config-v1310 OPTIONAL, -- Need ON
    csi-RS-Config-v1430 CSI-RS-Config-v1430 OPTIONAL -- Need ON
  }
}

ZeroTxPowerCSI-RS-Conf-r12 ::= CHOICE {
  release NULL,
  setup ZeroTxPowerCSI-RS-r12
}

ZeroTxPowerCSI-RS-r12 ::= SEQUENCE {
  zeroTxPowerResourceConfigList-r12 BIT STRING (SIZE (16)),
  zeroTxPowerSubframeConfig-r12 INTEGER (0..154)
}
-- ASN1STOP
```



<b>CSI-RS-Config field descriptions</b>
<p><b>advancedCodebookEnabled</b> Value TRUE indicates that the UE should use the advanced code book defined in TS 36.213 [23]. EUTRAN does not configure the field when the UE is configured with <i>eMIMO-Type</i> is set to <i>beamformed</i>, when the UE is configured with <i>eMIMO-Hybrid</i> or when the UE is configured with <i>semiOpenLoop</i>.</p>
<p><b>antennaPortsCount</b> Parameter represents the number of antenna ports used for transmission of CSI reference signals where value an1 corresponds to 1 antenna port, an2 to 2 antenna ports and so on, see TS 36.211 [21], clause 6.10.5.</p>
<p><b>ds-ZeroTxPowerCSI-RS</b> Parameter for additional <i>zeroTxPowerCSI-RS</i> for a serving cell, concerning the CSI-RS included in discovery signals.</p>
<p><b>dummy</b> This field is not used in the specification. If received it shall be ignored by the UE.</p>
<p><b>eMIMO-Type</b> Parameter: <i>eMIMO-Type</i>, see TS 36.213 [23], TS 36.211 [21]. If <i>eMIMO-Type</i> is set to <i>nonPrecoded</i>, the codebooks used for deriving CSI feedback are in TS 36.213 [23], Table 7.2.4-10 to Table 7.2.4-17. Choice values <i>nonPrecoded</i> and <i>beamformed</i> correspond to 'CLASS A' and 'CLASS B' respectively, see TS 36.212 [22] and TS 36.213 [23].</p>
<p><b>p-C</b> Parameter: <math>P_c</math>, see TS 36.213 [23], clause 7.2.5. The UE shall ignore <i>p-C-r10</i> if configured with <i>eMIMO-Type</i> unless it is set to <i>beamformed</i>, <i>alternativeCodebookEnabledBeamformed</i> (in <i>CSI-RS-ConfigBeamformed</i>) is set to <i>FALSE</i> and <i>csi-RS-ConfigNZPIdListExt</i> is not configured.</p>
<p><b>resourceConfig</b> Parameter: CSI reference signal configuration, see TS 36.211 [21], tables 6.10.5.2-1 and 6.10.5.2-2.</p>
<p><b>subframeConfig</b> Parameter: <math>I_{\text{CSI-RS}}</math>, see TS 36.211 [21], table 6.10.5.3-1.</p>
<p><b>zeroTxPowerCSI-RS2</b> Parameter for additional <i>zeroTxPowerCSI-RS</i> for a serving cell. E-UTRAN configures the field only if <i>csi-MeasSubframeSets-r12</i> and <i>TM 1 – 9</i> are configured for the serving cell.</p>
<p><b>zeroTxPowerResourceConfigList</b> Parameter: <i>ZeroPowerCSI-RS</i>, see TS 36.213 [23], clause 7.2.7.</p>
<p><b>zeroTxPowerSubframeConfig</b> Parameter: <math>I_{\text{CSI-RS}}</math>, see TS 36.211 [21], table 6.10.5.3-1.</p>

## CSI-RS-ConfigBeamformed

The IE *CSI-RS-ConfigBeamformed* is used to specify the beamforming configuration of EBF/ FD-MIMO.

### CSI-RS-ConfigBeamformed information elements

```
-- ASN1START
CSI-RS-ConfigBeamformed-r13 ::= SEQUENCE {
    csi-RS-ConfigNZPIdListExt-r13 SEQUENCE (SIZE (1..7)) OF CSI-RS-ConfigNZPId-r13
    OPTIONAL, -- Need OR
    csi-IM-ConfigIdList-r13 SEQUENCE (SIZE (1..8)) OF CSI-IM-ConfigId-r13
    OPTIONAL, -- Need OR
    p-C-AndCBSR-PerResourceConfigList-r13 SEQUENCE (SIZE (1..8)) OF P-C-AndCBSR-Pair-r13
    OPTIONAL, -- Need OR
    ace-For4Tx-PerResourceConfigList-r13 SEQUENCE (SIZE (1..7)) OF BOOLEAN OPTIONAL, -- Need
OR
    alternativeCodebookEnabledBeamformed-r13 ENUMERATED {true} OPTIONAL, -- Need OR
    channelMeasRestriction-r13 ENUMERATED {on} OPTIONAL -- Need OR
}
CSI-RS-ConfigBeamformed-r14 ::= SEQUENCE {
    csi-RS-ConfigNZPIdListExt-r14 SEQUENCE (SIZE (1..7)) OF CSI-RS-ConfigNZPId-r13
    OPTIONAL, -- Need OR
    csi-IM-ConfigIdList-r14 SEQUENCE (SIZE (1..8)) OF CSI-IM-ConfigId-r13
    OPTIONAL, -- Need OR
    p-C-AndCBSR-PerResourceConfigList-r14 SEQUENCE (SIZE (1..8)) OF P-C-AndCBSR-Pair-r13
    OPTIONAL, -- Need OR
    ace-For4Tx-PerResourceConfigList-r14 SEQUENCE (SIZE (1..7)) OF BOOLEAN OPTIONAL, -- Need
OR
    alternativeCodebookEnabledBeamformed-r14 ENUMERATED {true} OPTIONAL, -- Need OR
    channelMeasRestriction-r14 ENUMERATED {on} OPTIONAL, -- Need OR
    csi-RS-ConfigNZP-ApList-r14 SEQUENCE (SIZE (1..8)) OF CSI-RS-ConfigNZP-r11
    OPTIONAL, -- Need OR
    nzp-ResourceConfigOriginal-v1430 CSI-RS-Config-NZP-v1430 OPTIONAL, -- Need OR
}
```

```

csi-RS-NZP-Activation-r14          CSI-RS-ConfigNZP-Activation-r14 OPTIONAL    -- Need
OR
}
CSI-RS-ConfigBeamformed-v1430 ::= SEQUENCE {
  csi-RS-ConfigNZP-ApList-r14      SEQUENCE (SIZE (1..8)) OF CSI-RS-ConfigNZP-r11
                                     OPTIONAL,    -- Need OR
  nzp-ResourceConfigOriginal-v1430 CSI-RS-Config-NZP-v1430      OPTIONAL,    -- Need OR
  csi-RS-NZP-Activation-r14        CSI-RS-ConfigNZP-Activation-r14 OPTIONAL    -- Need
OR
}
CSI-RS-Config-NZP-v1430 ::= SEQUENCE {
  transmissionComb-r14             NZP-TransmissionComb-r14  OPTIONAL,    -- Need OR
  frequencyDensity-r14            NZP-FrequencyDensity-r14    OPTIONAL,    -- Need OR
}
CSI-RS-ConfigNZP-Activation-r14 ::= SEQUENCE {
  csi-RS-NZP-mode-r14             ENUMERATED {semiPersistent, aperiodic},
  activatedResources-r14          INTEGER (0..4)
}
-- ASN1STOP

```

<b>CSI-RS-ConfigBeamformed field descriptions</b>
<p><b>ace-For4Tx-PerResourceConfigList</b> The field indicates the <i>alternativeCodeBookEnabledFor4TX-r12</i> per CSI-RS resource. E-UTRAN configures the field only if <i>csi-RS-ConfigNZPIdListExt</i> is configured.</p>
<p><b>activatedResources</b> The number of activated CSI-RS resources, which concerns a subset of the aperiodic CSI-RS resources (for both semi-persistent and aperiodic mode). E-UTRAN configures at most the minimum between <i>nMaxResource</i> as configured by <i>MIMO-UE-ParametersPerTM-r1430</i> and the number of resources as configured by <i>csi-RS-ConfigNZP-ApList-r14</i>.</p>
<p><b>alternativeCodebookEnabledBeamformed</b> The field indicates whether code book in TS 36.213 [23], Table 7.2.4-18 to Table 7.2.4-20, is being used for deriving CSI feedback and reporting for a CSI process. E-UTRAN configures the field only for a process referring to a single RS configuration using non-zero power transmission (i.e a process for which <i>csi-RS-ConfigNZPIdListExt</i> is not configured). Field <i>alternativeCodebookEnabledBeamformed</i> corresponds to parameter <i>alternativeCodebookEnabledCLASSB_K1</i> in TS 36.212 [22] and TS 36.213 [23].</p>
<p><b>csi-IM-ConfigIdList</b> E-UTRAN configures the field <i>csi-IM-ConfigIdList</i> only if the IE is included in CSI-Process is configured (i.e. when TM10 is configured for the serving cell).</p>
<p><b>CSI-RS-ConfigBeamformed</b> If <i>csi-RS-ConfigNZPIdListExt-r13</i> is configured, E-UTRAN configures the same total number of entries for NZP, <i>csi-IM-ConfigIdList-r13</i> and <i>p-C-AndCBSR-PerResourceConfigList-r13</i>.</p>
<p><b>csi-RS-ConfigNZP-ApList</b> The field is used to configure NZP configurations for aperiodic or semi-persistent CSI RS reporting for which MAC controls activation. EUTRAN configures this field only when the UE is configured to use 2, 4 or and 8 ports CSI-RS, in which case EUTRAN configures the number of entries to be the same as the number of NZP resource configurations. For all these entries the UE shall ignore field <i>subframeConfig</i>. EUTRAN always configures this field together with <i>csi-RS-NZP-Activation</i>. Furthermore, for a given process, E-UTRAN does not simultaneously configure the periodic NZP configuration(s) and NZP CSI RS configurations for aperiodic or semi-persistent reporting.</p>
<p><b>csi-RS-ConfigNZP-EMIMO</b> The field is used to configure NZP configurations additional to the one defined by the original NZP configuration as included in <i>CSI-RS-Config/CSI-Process</i> when using 12 and 16 ports CSI-RS.</p>
<p><b>csi-RS-ConfigNZPIdListExt (in CSI-RS-ConfigBeamformed)</b> Indicates the NZP configuration(s) in addition to the original NZP configuration, as defined by <i>csi-RS-Config-r10</i> (TM9) or <i>csi-RS-ConfigNZPId-r11</i> (TM10). I.e. extends the size of the NZP configuration list (originally a single entry i.e. list of size 1) using the general principles specified in 5.1.2.</p>
<p><b>p-C-AndCBSR-PerResourceConfigList</b> E-UTRAN does not configure the field <i>p-C-AndCBSR-PerResourceConfigList</i> if the UE is configured with <i>eMIMO-Type</i> set to <i>beamformed</i>, <i>alternativeCodebookEnabledBeamformed</i> is set to <i>FALSE</i> and <i>csi-RS-ConfigNZPIdListExt</i> is not configured.</p>

### – CSI-RS-ConfigEMIMO

The IE *CSI-RS-ConfigEMIMO* is used to specify the CSI (Channel-State Information) reference signal configuration for EBF/ FD-MIMO.

**CSI-RS-ConfigEMIMO information elements**

```

-- ASN1START
CSI-RS-ConfigEMIMO-r13 ::= CHOICE {
  release          NULL,
  setup           CHOICE {
    nonPrecoded-r13  CSI-RS-ConfigNonPrecoded-r13,
    beamformed-r13  CSI-RS-ConfigBeamformed-r13
  }
}

CSI-RS-ConfigEMIMO-v1430 ::= CHOICE {
  release          NULL,
  setup           CHOICE {
    nonPrecoded-v1430 CSI-RS-ConfigNonPrecoded-v1430,
    beamformed-v1430  CSI-RS-ConfigBeamformed-v1430
  }
}

CSI-RS-ConfigEMIMO-v1480 ::= CHOICE {
  release          NULL,
  setup           CHOICE {
    nonPrecoded-v1480 CSI-RS-ConfigNonPrecoded-v1480,
    beamformed-v1480  CSI-RS-ConfigBeamformed-v1430
  }
}

CSI-RS-ConfigEMIMO-v1530 ::= CHOICE {
  release          NULL,
  setup           CHOICE {
    nonPrecoded-v1530 CSI-RS-ConfigNonPrecoded-v1530
  }
}

CSI-RS-ConfigEMIMO2-r14 ::= CHOICE {
  release          NULL,
  setup           CSI-RS-ConfigBeamformed-r14
}

CSI-RS-ConfigEMIMO-Hybrid-r14 ::= CHOICE {
  release          NULL,
  setup           SEQUENCE {
    periodicityOffsetIndex-r14  INTEGER (0..1023)          OPTIONAL,  -- Need OR
    eMIMO-Type2-r14             CSI-RS-ConfigEMIMO2-r14  OPTIONAL  -- Need ON
  }
}

-- ASN1STOP

```

**CSI-RS-ConfigEMIMO field descriptions*****periodicityOffsetIndex***

This parameter is associated with the first EMIMO configuration of the hybrid eMIMO configuration.

***CSI-RS-ConfigNonPrecoded***

The IE *CSI-RS-ConfigNonPrecoded* is used to specify the non-coded EBF/ FD-MIMO configuration.

```

-- ASN1START
CSI-RS-ConfigNonPrecoded-r13 ::= SEQUENCE {
  p-C-AndCBSRList-r13          P-C-AndCBSR-Pair-r13          OPTIONAL,  -- Need OR
  codebookConfigN1-r13        ENUMERATED {n1, n2, n3, n4, n8},
  codebookConfigN2-r13        ENUMERATED {n1, n2, n3, n4, n8},
  codebookOverSamplingRateConfig-01-r13  ENUMERATED {n4, n8}          OPTIONAL,  -- Need OR
  codebookOverSamplingRateConfig-02-r13  ENUMERATED {n4, n8}          OPTIONAL,  -- Need OR
  codebookConfig-r13          INTEGER (1..4),
  csi-IM-ConfigIdList-r13     SEQUENCE (SIZE (1..2)) OF CSI-IM-ConfigId-r13
  OPTIONAL,  -- Need OR
  csi-RS-ConfigNZP-EMIMO-r13  CSI-RS-ConfigNZP-EMIMO-r13  OPTIONAL  -- Need ON
}

```

```

}
CSI-RS-ConfigNonPrecoded-v1430 ::= SEQUENCE {
  csi-RS-ConfigNZIP-EMIMO-v1430      CSI-RS-ConfigNZIP-EMIMO-v1430  OPTIONAL,  -- Need ON
  codebookConfigN1-v1430             ENUMERATED {n5, n6, n7, n10, n12, n14, n16},
  codebookConfigN2-v1430             ENUMERATED {n5, n6, n7},
  nzip-ResourceConfigTM9-Original-v1430  CSI-RS-Config-NZIP-v1430
}

CSI-RS-ConfigNonPrecoded-v1480 ::= SEQUENCE {
  csi-RS-ConfigNZIP-EMIMO-v1480      CSI-RS-ConfigNZIP-EMIMO-v1430  OPTIONAL,  -- Need ON
  codebookConfigN1-v1480             ENUMERATED {n5, n6, n7, n10, n12, n14, n16}
  OPTIONAL,  -- Need OR
  codebookConfigN2-r1480             ENUMERATED {n5, n6, n7}          OPTIONAL,  -- Need OR
  nzip-ResourceConfigTM9-Original-v1480  CSI-RS-Config-NZIP-v1430
}

CSI-RS-ConfigNonPrecoded-v1530 ::= SEQUENCE {
  p-C-AndCBSRList-r15                P-C-AndCBSR-Pair-r15          OPTIONAL  -- Need OR
}

-- ASN1STOP

```

### CSI-RS-ConfigNonPrecoded field descriptions

#### **codebookConfig**

Indicates a sub-set of the codebook entry, see TS 36.213 [23].

#### **codebookConfigNx**

Indicates the number of antenna ports per polarization in dimension x as used for transmission of CSI reference signals. Value n1 corresponds to 1, value n2 corresponds to 2 and so on, see TS 36.213 [23]. E-UTRAN configures the field in accordance with the restrictions as specified in TS 36.213 [23]. If *codebookConfigNx* in *CSI-RS-ConfigNonPrecoded-v1480* is configured, the UE shall ignore the field *codebookConfigNx* in *CSI-RS-ConfigNonPrecoded-r13*.

#### **codebookOverSamplingRateConfig-Ox**

Indicates the spatial over-sampling rate in dimension x as used for transmission of CSI reference signals. Value n4 corresponds to 4 and value n8 corresponds to 8, see TS 36.213 [23].

#### **csi-IM-ConfigId(List)**

E-UTRAN configures the field *csi-IM-ConfigIdList* only if the IE is included in CSI-Process is configured (i.e. when TM10 is configured for the serving cell).

#### **csi-RS-ConfigNZIP-EMIMO**

The field is used to configure NZP configurations additional to the one defined by the original NZP configuration as included in *CSI-RS-Config/CSI-Process* when using more than 8 ports CSI-RS as defined in TS 36.211 [21], table 6.10.5-1.

## CSI-RS-ConfigNZIP

The IE *CSI-RS-ConfigNZIP* is the CSI-RS resource configuration using non-zero power transmission that E-UTRAN may configure on a serving frequency.

### CSI-RS-ConfigNZIP information elements

```

-- ASN1START
CSI-RS-ConfigNZIP-r11 ::= SEQUENCE {
  csi-RS-ConfigNZIPId-r11          CSI-RS-ConfigNZIPId-r11,
  antennaPortsCount-r11            ENUMERATED {an1, an2, an4, an8},
  resourceConfig-r11              INTEGER (0..31),
  subframeConfig-r11              INTEGER (0..154),
  scramblingIdentity-r11          INTEGER (0..503),
  qcl-CRS-Info-r11                SEQUENCE {
    qcl-ScramblingIdentity-r11    INTEGER (0..503),
    crs-PortsCount-r11            ENUMERATED {n1, n2, n4, spare1},
    mbsfn-SubframeConfigList-r11 CHOICE {
      release                      NULL,
      setup                       SEQUENCE {
        subframeConfigList        MBSFN-SubframeConfigList
      }
    }
  }
}
OPTIONAL -- Need ON
OPTIONAL -- Need OR
...
[[ csi-RS-ConfigNZIPId-v1310      CSI-RS-ConfigNZIPId-v1310          OPTIONAL -- Need ON

```

```

]],
[[ transmissionComb-r14          NZP-TransmissionComb-r14          OPTIONAL, -- Need OR
   frequencyDensity-r14         NZP-FrequencyDensity-r14         OPTIONAL, -- Need OR
]],
[[ mbsfn-SubframeConfigList-v1430 CHOICE {
      release                    NULL,
      setup                      SEQUENCE {
        subframeConfigList-v1430 MBSFN-SubframeConfigList-v1430
      }
    }
]]
}

CSI-RS-ConfigNZP-EMIMO-r13 ::= CHOICE {
  release  NULL,
  setup    SEQUENCE {
    nzp-resourceConfigList-r13 SEQUENCE (SIZE (1..2)) OF NZP-ResourceConfig-r13,
    cdmType-r13                ENUMERATED {cdm2, cdm4} OPTIONAL -- Need OR
  }
}

CSI-RS-ConfigNZP-EMIMO-v1430 ::= SEQUENCE {
  -- All extensions are for Non-Precoded so could be grouped by setup/ release choice
  nzp-resourceConfigListExt-r14 SEQUENCE (SIZE (0..4)) OF NZP-ResourceConfig-r13,
  cdmType-v1430                ENUMERATED {cdm8 }          OPTIONAL -- Need OR
}

NZP-ResourceConfig-r13 ::= SEQUENCE {
  resourceConfig-r13          ResourceConfig-r13,
  ...,
  [[ transmissionComb-r14     NZP-TransmissionComb-r14     OPTIONAL, -- Need OR
   frequencyDensity-r14     NZP-FrequencyDensity-r14     OPTIONAL, -- Need OR
  ]]
}

ResourceConfig-r13 ::=
  INTEGER (0..31)

NZP-TransmissionComb-r14 ::=
  INTEGER (0..2)
NZP-FrequencyDensity-r14 ::=
  ENUMERATED {d1, d2, d3}

-- ASN1STOP

```

### CSI-RS-ConfigNZP field descriptions

<b>antennaPortsCount</b>	Parameter represents the number of antenna ports used for transmission of CSI reference signals where an1 corresponds to 1, an2 to 2 antenna ports etc. see TS 36.211 [21], clause 6.10.5.
<b>cdmType</b>	Parameter: <i>CDMType</i> , see TS 36.211 [21], clause 6.10.5.2.
<b>csi-RS-ConfigNZPId</b>	Refers to a CSI RS configuration using non-zero power transmission that is configured for the same frequency as the CSI process. UE shall ignore <i>CSI-RS-ConfigNZPId-r11</i> if <i>CSI-RS-ConfigNZPId-v1310</i> is signalled.
<b>frequencyDensity</b>	Indicates the frequency-domain density reduction. E-UTRAN configures the values in accordance with the restrictions specified in TS 36.213 [23].
<b>mbsfn-SubframeConfigList</b>	Indicates the MBSFN configuration for the CSI-RS resources. If <i>qcl-CRS-Info-r11</i> is absent, the field is released.
<b>nzp-resourceConfigList</b>	Indicate a list of non-zero power transmission CSI-RS resources using parameter <i>resourceConfig</i> .
<b>qcl-CRS-Info</b>	Indicates CRS antenna ports that is quasi co-located with the CSI-RS antenna ports, see TS 36.213 [23], clause 7.2.5. EUTRAN configures this field if and only if the UE is configured with <i>qcl-Operation</i> set to <i>typeB</i> .
<b>resourceConfig</b>	Parameter: CSI reference signal configuration, see TS 36.211 [21], table 6.10.5.2-1 and 6.10.5.2-2.
<b>subframeConfig</b>	Parameter: $I_{\text{CSI-RS}}$ , see TS 36.211 [21], table 6.10.5.3-1.
<b>scramblingIdentity</b>	Parameter: Pseudo-random sequence generator parameter, $n_{\text{ID}}$ , see TS 36.213 [23], clause 7.2.5.
<b>transmissionComb</b>	Indicates the transmission combining offset. E-UTRAN configures the values in accordance with the restrictions specified in TS 36.213 [23].

## – *CSI-RS-ConfigNZPId*

The IE *CSI-RS-ConfigNZPId* is used to identify a CSI-RS resource configuration using non-zero transmission power, as configured by the IE *CSI-RS-ConfigNZP*. The identity is unique within the scope of a carrier frequency.

### **CSI-RS-ConfigNZPId information elements**

```
-- ASN1START
CSI-RS-ConfigNZPId-r11 ::=          INTEGER (1..maxCSI-RS-NZP-r11)
CSI-RS-ConfigNZPId-v1310 ::=      INTEGER (minCSI-RS-NZP-r13..maxCSI-RS-NZP-r13)
CSI-RS-ConfigNZPId-r13 ::=          INTEGER (1..maxCSI-RS-NZP-r13)
-- ASN1STOP
```

## – *CSI-RS-ConfigZP*

The IE *CSI-RS-ConfigZP* is the CSI-RS resource configuration, for which UE assumes zero transmission power, that E-UTRAN may configure on a serving frequency.

### **CSI-RS-ConfigZP information elements**

```
-- ASN1START
CSI-RS-ConfigZP-r11 ::=          SEQUENCE {
    csi-RS-ConfigZPId-r11          CSI-RS-ConfigZPId-r11,
    resourceConfigList-r11        BIT STRING (SIZE (16)),
    subframeConfig-r11           INTEGER (0..154),
    ...
}
CSI-RS-ConfigZP-ApList-r14 ::=   CHOICE {
    release                        NULL,
    setup                         SEQUENCE (SIZE (1.. maxCSI-RS-ZP-r11)) OF CSI-RS-ConfigZP-r11
}
-- ASN1STOP
```

### **CSI-RS-ConfigZP field descriptions**

#### **CSI-RS-ConfigZP-ApList**

Indicates the aperiodic zero power CSI-RS present in a given subframe. See 36.213 [23], Table 7.1.9-2. First entry in the list corresponds to aperiodic trigger 00, second entry in the list corresponds to aperiodic trigger 01 and so on.

#### **resourceConfigList**

Parameter: *ZeroPowerCSI-RS*, see TS 36.213 [23], clause 7.2.7.

#### **subframeConfig**

Parameter:  $I_{\text{CSI-RS}}$ , see TS 36.211 [21], table 6.10.5.3-1.

## – *CSI-RS-ConfigZPId*

The IE *CSI-RS-ConfigZPId* is used to identify a CSI-RS resource configuration for which UE assumes zero transmission power, as configured by the IE *CSI-RS-ConfigZP*. The identity is unique within the scope of a carrier frequency.

### **CSI-RS-ConfigZPId information elements**

```
-- ASN1START
CSI-RS-ConfigZPId-r11 ::=          INTEGER (1..maxCSI-RS-ZP-r11)
-- ASN1STOP
```

## – *DataInactivityTimer*

The IE *DataInactivityTimer* is used to control Data inactivity operation. Corresponds to the timer for data inactivity monitoring in TS 36.321 [6]. Value s1 corresponds to 1 second, s2 corresponds to 2 seconds and so on.

### **DataInactivityTimer information element**

```
-- ASN1START
DataInactivityTimer-r14 ::=          ENUMERATED {
                                     s1, s2, s3, s5, s7, s10, s15, s20, s40, s50, s60,
                                     s80, s100, s120, s150, s180}
-- ASN1STOP
```

## – *DMRS-Config*

The IE *DMRS-Config* is the DMRS configuration that E-UTRAN may configure on a serving frequency.

### **DMRS-Config information elements**

```
-- ASN1START
DMRS-Config-r11 ::=          CHOICE {
  release          NULL,
  setup           SEQUENCE {
    scramblingIdentity-r11    INTEGER (0..503),
    scramblingIdentity2-r11   INTEGER (0..503)
  }
}
DMRS-Config-v1310 ::=       SEQUENCE {
  dmrs-tableAlt-r13          ENUMERATED {true}          OPTIONAL  -- Need OR
}
-- ASN1STOP
```

### **DMRS-Config field descriptions**

#### ***scramblingIdentity*, *scramblingIdentity2***

Parameter:  $n_{ID}^{DMRS,j}$ , see TS 36.211 [21], clause 6.10.3.1.

#### ***dmrs-tableAlt***

The field indicates whether to use an alternative table for DMRS upon PDSCH transmission, see TS 36.213 [23].

## – *DRB-Identity*

The IE *DRB-Identity* is used to identify a DRB used by a UE.

### **DRB-Identity information elements**

```
-- ASN1START
DRB-Identity ::=          INTEGER (1..32)
-- ASN1STOP
```

## – *EPDCCH-Config*

The IE *EPDCCH-Config* specifies the subframes and resource blocks for EPDCCH monitoring that E-UTRAN may configure for a serving cell.

### **EPDCCH-Config information element**

```
-- ASN1START
```

```

EPDCCH-Config-r11 ::= SEQUENCE{
  config-r11 CHOICE {
    release NULL,
    setup SEQUENCE {
      subframePatternConfig-r11 CHOICE {
        release NULL,
        setup SEQUENCE {
          subframePattern-r11 MeasSubframePattern-r10
        }
      }
      startSymbol-r11 INTEGER (1..4) OPTIONAL, -- Need ON
      setConfigToReleaseList-r11 EPDCCH-SetConfigToReleaseList-r11 OPTIONAL, -- Need ON
      setConfigToAddModList-r11 EPDCCH-SetConfigToAddModList-r11 OPTIONAL -- Need ON
    }
  }
}

EPDCCH-SetConfigToAddModList-r11 ::= SEQUENCE (SIZE(1..maxEPDCCH-Set-r11)) OF EPDCCH-SetConfig-r11

EPDCCH-SetConfigToReleaseList-r11 ::= SEQUENCE (SIZE(1..maxEPDCCH-Set-r11)) OF EPDCCH-SetConfigId-
r11

EPDCCH-SetConfig-r11 ::= SEQUENCE {
  setConfigId-r11 EPDCCH-SetConfigId-r11,
  transmissionType-r11 ENUMERATED {localised, distributed},
  resourceBlockAssignment-r11 SEQUENCE{
    numberPRB-Pairs-r11 ENUMERATED {n2, n4, n8},
    resourceBlockAssignment-r11 BIT STRING (SIZE(4..38))
  },
  dmrs-ScramblingSequenceInt-r11 INTEGER (0..503),
  pucch-ResourceStartOffset-r11 INTEGER (0..2047),
  re-MappingQCL-ConfigId-r11 PDSCH-RE-MappingQCL-ConfigId-r11 OPTIONAL, -- Need OR
  ...
  [[ csi-RS-ConfigZPID2-r12 CHOICE {
    release NULL,
    setup CSI-RS-ConfigZPID-r11
  } OPTIONAL -- Need ON
  ]],
  [[ numberPRB-Pairs-v1310 CHOICE {
    release NULL,
    setup ENUMERATED {n6}
  } OPTIONAL, -- Need ON
  ]],
  mpdcch-config-r13 CHOICE {
    release NULL,
    setup SEQUENCE {
      csi-NumRepetitionCE-r13 ENUMERATED {sf1, sf2, sf4, sf8, sf16, sf32},
      mpdcch-pdsch-HoppingConfig-r13 ENUMERATED {on,off},
      mpdcch-StartSF-UeSS-r13 CHOICE {
        fdd-r13 ENUMERATED {v1, v1dot5, v2, v2dot5, v4,
          v5, v8, v10},
        tdd-r13 ENUMERATED {v1, v2, v4, v5, v8, v10,
          v20, spare1}
      },
      mpdcch-NumRepetition-r13 ENUMERATED {r1, r2, r4, r8, r16,
        r32, r64, r128, r256},
      mpdcch-Narrowband-r13 INTEGER (1.. maxAvailNarrowBands-r13)
    }
  } OPTIONAL -- Need ON
  ]],
}

EPDCCH-SetConfigId-r11 ::= INTEGER (0..1)

-- ASN1STOP

```



<b>EPDCCH-Config field descriptions</b>
<p><b>csi-NumRepetitionCE</b> Number of subframes for CSI reference resource, see TS 36.213 [23]. Value sf1 corresponds to 1 subframe, sf2 corresponds to 2 subframes and so on.</p>
<p><b>csi-RS-ConfigZPId2</b> Indicates the rate matching parameters in addition to those indicated by <i>re-MappingQCL-ConfigId</i>. E-UTRAN configures this field only when tm10 is configured.</p>
<p><b>dmrs-ScramblingSequenceInt</b> The DMRS scrambling sequence initialization parameter <math>n_{ID,i}^{EPDCCH}</math> or <math>n_{ID,i}^{MPDCCH}</math> defined in TS 36.211 [21], clause 6.10.3A.1.</p>
<p><b>EPDCCH-SetConfig</b> Provides EPDCCH configuration set. See TS 36.213 [23], clause 9.1.4. E-UTRAN configures at least one <i>EPDCCH-SetConfig</i> when <i>EPDCCH-Config</i> is configured. For BL UEs or UEs in CE, EUTRAN does not configure more than one EPDCCH-SetConfig.</p>
<p><b>mpdcch-Narrowband</b> Parameter: <math>n_{NB}</math>, see TS 36.211 [21], clause 6.8B.5. Field values (1..<i>maxAvailNarrowBands-r13</i>) correspond to narrowband indices (0..<i>maxAvailNarrowBands-r13-1</i>) as specified in TS 36.211 [21].</p>
<p><b>mpdcch-NumRepetition</b> Maximum numbers of repetitions for UE-SS for MPDCCH, see TS 36.213 [23].</p>
<p><b>mpdcch-pdsch-HoppingConfig</b> Frequency hopping activation/deactivation for unicast MPDCCH/PDSCH, see TS 36.211 [21]. E-UTRAN does not configure the value <i>on</i> if <i>freqHoppingParametersDL</i> is not present in <i>SystemInformationBlockType1</i>.</p>
<p><b>mpdcch-StartSF-U ESS</b> Starting subframe configuration for an MPDCCH UE-specific search space, see TS 36.213 [23]. Value v1 corresponds to 1, value v1dot5 corresponds to 1.5, and so on.</p>
<p><b>numberPRB-Pairs</b> Indicates the number of physical resource-block pairs used for the EPDCCH set. Value n2 corresponds to 2 physical resource-block pairs; n4 corresponds to 4 physical resource-block pairs and so on. Value n8 is not supported if <i>dl-Bandwidth</i> is set to 6 resource blocks. EUTRAN only configures values up to n6 for BL UEs or UEs in CE. Value n6 is only applicable to BL UEs or UEs in CE.</p>
<p><b>pucch-ResourceStartOffset</b> PUCCH format 1a, 1b and 3 resource starting offset for the EPDCCH set. See TS 36.213 [23], clause 10.1.</p>
<p><b>re-MappingQCL-ConfigId</b> Indicates the starting OFDM symbol, the related rate matching parameters and quasi co-location assumption for EPDCCH when the UE is configured with tm10. This field provides the identity of a configured <i>PDSCH-RE-MappingQCL-Config</i>. E-UTRAN configures this field only when tm10 is configured.</p>
<p><b>resourceBlockAssignment</b> Indicates the index to a specific combination of physical resource-block pair for EPDCCH set. See TS 36.213 [23], clause 9.1.4.4. The size of <i>resourceBlockAssignment</i> is specified in TS 36.213 [23], clause 9.1.4.4, and based on <i>numberPRB-Pairs</i> and the signalled value of <i>dl-Bandwidth</i>. If <i>numberPRB-Pairs-v1310</i> field is present, the total number of physical resource-block pairs is 6 and it is composed of one subset of 2 physical resource-block pairs and another subset of 4 physical resource-block pairs, and the <i>resourceBlockAssignment</i> field defines the subset of 2 physical resource-block pairs.</p>
<p><b>setConfigId</b> Indicates the identity of the EPDCCH configuration set.</p>
<p><b>startSymbol</b> Indicates the OFDM starting symbol for any EPDCCH and PDSCH scheduled by EPDCCH on the same cell, see TS 36.213 [23], clause 9.1.4.1. If not present, the UE shall release the configuration and shall derive the starting OFDM symbol of EPDCCH and PDSCH scheduled by EPDCCH from PCFICH. Values 1, 2, and 3 are applicable for <i>dl-Bandwidth</i> greater than 10 resource blocks. Values 2, 3, and 4 are applicable otherwise. E-UTRAN does not configure the field for UEs configured with tm10.</p>
<p><b>subframePatternConfig</b> Configures the subframes which the UE shall monitor the UE-specific search space on EPDCCH, except for pre-defined rules in TS 36.213 [23], clause 9.1.4. If the field is not configured when EPDCCH is configured, the UE shall monitor the UE-specific search space on EPDCCH in all subframes except for pre-defined rules in TS 36.213 [23], clause 9.1.4.</p>
<p><b>transmissionType</b> Indicates whether distributed or localized EPDCCH transmission mode is used as defined in TS 36.211 [21], clause 6.8A.1.</p>

## – *EIMTA-MainConfig*

The IE *EIMTA-MainConfig* is used to specify the eIMTA-RNTI used for eIMTA and the subframes used for monitoring PDCCH with eIMTA-RNTI. The IE *EIMTA-MainConfigServCell* is used to specify the eIMTA related parameters applicable for the concerned serving cell.

### ***EIMTA-MainConfig* information element**

```
-- ASN1START
EIMTA-MainConfig-r12 ::= CHOICE {
  release      NULL,
  setup        SEQUENCE {
    eimta-RNTI-r12      C-RNTI,
    eimta-CommandPeriodicity-r12  ENUMERATED {sf10, sf20, sf40, sf80},
    eimta-CommandSubframeSet-r12  BIT STRING (SIZE(10))
  }
}

EIMTA-MainConfigServCell-r12 ::= CHOICE {
  release      NULL,
  setup        SEQUENCE {
    eimta-UL-DL-ConfigIndex-r12  INTEGER (1..5),
    eimta-HARQ-ReferenceConfig-r12  ENUMERATED {sa2, sa4, sa5},
    mbsfn-SubframeConfigList-v1250  CHOICE {
      release      NULL,
      setup        SEQUENCE {
        subframeConfigList-r12  MBSFN-SubframeConfigList
      }
    }
  }
}
-- ASN1STOP
```

### ***EIMTA-MainConfig* field descriptions**

#### ***eimta-CommandPeriodicity***

Configures the periodicity to monitor PDCCH with eIMTA-RNTI, see TS 36.213 [23], clause 13.1. Value sf10 corresponds to 10 subframes, sf20 corresponds to 20 subframes and so on.

#### ***eimta-CommandSubframeSet***

Configures the subframe(s) to monitor PDCCH with eIMTA-RNTI within the periodicity configured by *eimta-CommandPeriodicity*. The 10 bits correspond to all subframes in the last radio frame within each periodicity. The left most bit is for subframe 0 and so on. Each bit can be of value 0 or 1. The value of 1 means that the corresponding subframe is configured for monitoring PDCCH with eIMTA-RNTI, and the value of 0 means otherwise. In case of TDD as PCell, only the downlink and the special subframes indicated by the UL/ DL configuration in SIB1 can be configured for monitoring PDCCH with eIMTA-RNTI. In case of FDD as PCell, any of the ten subframes can be configured for monitoring PDCCH with eIMTA-RNTI.

#### ***eimta-HARQ-ReferenceConfig***

Indicates UL/ DL configuration used as the DL HARQ reference configuration for this serving cell. Value sa2 corresponds to Configuration2, sa4 to Configuration4 etc, as specified in TS 36.211 [21], table 4.2-2. E-UTRAN configures the same value for all serving cells residing on same frequency band.

#### ***eimta-UL-DL-ConfigIndex***

Index of *l*, see TS 36.212 [22], clause 5.3.3.1.4. E-UTRAN configures the same value for all serving cells residing on same frequency band.

#### ***mbsfn-SubframeConfigList***

Configure the MBSFN subframes for the UE on this serving cell. An uplink subframe indicated by the DL/UL subframe configuration in SIB1 can be configured as MBSFN subframe.

## – *GWUS-Config*

The IE *GWUS-Config* is used to specify the Group WUS configuration. For the UEs supporting GWUS, E-UTRAN uses GWUS to indicate that the UE shall attempt to receive paging in that cell, see TS 36.304 [4].

### ***GWUS-Config* information element**

```
-- ASN1START
GWUS-Config-r16 ::= SEQUENCE {
```

```

groupAlternation-r16          ENUMERATED {true}          OPTIONAL, -- Need OR
commonSequence-r16           ENUMERATED {g0, g126}      OPTIONAL, -- Need OR
timeParameters-r16           GWUS-TimeParameters-r16   OPTIONAL, -- Cond NoWUSr15
resourceConfigDRX-r16        GWUS-ResourceConfig-r16,
resourceConfig-eDRX-Short-r16 GWUS-ResourceConfig-r16   OPTIONAL, -- Need OP
resourceConfig-eDRX-Long-r16 GWUS-ResourceConfig-r16   OPTIONAL, -- Cond TimeOffset
probThreshList-r16           GWUS-ProbThreshList-r16  OPTIONAL, -- Cond ProbabilityBased
groupNarrowBandList-r16      GWUS-GroupNarrowBandList-r16 OPTIONAL -- Need OR
}

GWUS-TimeParameters-r16 ::= SEQUENCE {
    maxDurationFactor-r16     ENUMERATED {one32th, one16th, one8th, one4th},
    numPOs-r16                ENUMERATED {n1, n2, n4, spare1}          DEFAULT n1,
    timeOffsetDRX-r16         ENUMERATED {ms40, ms80, ms160, ms240},
    timeOffset-eDRX-Short-r16 ENUMERATED {ms40, ms80, ms160, ms240},
    timeOffset-eDRX-Long-r16 ENUMERATED {ms1000, ms2000}          OPTIONAL, -- Need OP
    numDRX-CyclesRelaxed-r16  ENUMERATED {n1, n2, n4, n8}          OPTIONAL, -- Need OR
    powerBoost-r16            ENUMERATED {dB0, dB1dot8, dB3, dB4dot8} OPTIONAL, -- Need OR
    ...
}

GWUS-ResourceConfig-r16 ::= SEQUENCE {
    resourceMappingPattern-r16 CHOICE {
        resourceLocationWithWUS    ENUMERATED {primary, secondary, primary3FDM},
        resourceLocationWithoutWUS ENUMERATED {n0, n2}
    },
    numGroupsList-r16             GWUS-NumGroupsList-r16          OPTIONAL, -- Need OP
    groupsForServiceList-r16      GWUS-GroupsForServiceList-r16  OPTIONAL -- Cond
ProbabilityBased
}

GWUS-GroupsForServiceList-r16 ::= SEQUENCE (SIZE (1..maxGWUS-ProbThresholds-r16)) OF INTEGER
(1..maxGWUS-Groups-1-r16)

GWUS-GroupNarrowBandList-r16 ::= SEQUENCE (SIZE (1..maxAvailNarrowBands-r13)) OF BOOLEAN

GWUS-NumGroupsList-r16 ::= SEQUENCE (SIZE (1..maxGWUS-Resources-r16)) OF GWUS-NumGroups-r16

GWUS-ProbThreshList-r16 ::= SEQUENCE (SIZE (1..maxGWUS-ProbThresholds-r16)) OF GWUS-
PagingProbThresh-r16

GWUS-NumGroups-r16 ::= ENUMERATED {n1, n2, n4, n8}

GWUS-PagingProbThresh-r16 ::= ENUMERATED {p20, p30, p40, p50, p60, p70, p80, p90}

-- ASN1STOP

```

<b>GWUS-Config field descriptions</b>	
<b>commonSequence</b>	Presence of the field indicates common WUS sequence is configured. Value <i>g0</i> indicates common WUS sequence for the shared WUS resource corresponds to $g = 0$ , and value <i>g126</i> indicates common WUS sequence for the shared WUS resource corresponds to $g = 126$ , see TS 36.211 [21].
<b>groupAlternation</b>	Presence of the field enables WUS group alternation between the two or more WUS resources for the gap type, see TS 36.304 [4].
<b>groupNarrowBandList</b>	List indicating which paging narrowbands support group WUS see TS 36.304 [4]. First entry in the list indicates WUS support for first paging narrowband, second entry in the list indicates WUS support for second paging narrowband, and so on. If E-UTRAN includes <i>groupNarrowBandList</i> , the number of entries is equal to the value of <i>paging-narrowBands</i> . If this list is absent, group WUS is supported on all paging narrowbands. E-UTRAN does not configure this field when RRC_INACTIVE is used in the cell.
<b>groupsForServiceList</b>	Number of WUS groups for each paging probability group see TS 36.304 [4]. The first entry corresponds to the first probability group, the second entry corresponds to the second paging probability group, and so on. Total number of WUS groups in this list cannot be more than the total number of WUS groups in <i>numGroupsList</i> . If E-UTRAN includes <i>groupsForServiceList</i> , it includes the same number of entries and listed in the same order as in <i>probThreshList</i> .
<b>numGroupsList</b>	List of WUS groups for each WUS resource see TS 36.304 [4]. First entry corresponds to the first resource, second entry corresponds to the second resource, and so on. <i>numGroupsList</i> is mandatory present in <i>resourceConfigDRX</i> . If <i>numGroupsList</i> is not present in <i>resourceConfig-eDRX-Short</i> , parameter for DRX WUS resource applies for short eDRX WUS resource. If <i>numGroupsList</i> is not present in <i>resourceConfig-eDRX-Long</i> , parameter for short eDRX WUS resource applies for long eDRX WUS resource.
<b>probThreshList</b>	Paging probability thresholds corresponding to the paging probability groups, see TS 36.304 [4]. Value <i>p20</i> corresponds to 20%, value <i>p30</i> corresponds to 30%, and so on.
<b>resourceConfigDRX, resourceConfig-eDRX-Short, resourceConfig-eDRX-Long</b>	WUS resource configured for each gap type see TS 36.304 [4]. If <i>resourceConfig-eDRX-Short</i> is not present, DRX WUS parameters apply for short eDRX WUS resource. If <i>resourceConfig-eDRX-Long</i> is not present, short eDRX WUS parameters apply for long eDRX WUS resource.
<b>resourceMappingPattern</b>	Identifies the WUS resource mapping to time/frequency as defined in TS 36.304 [4]. If <i>wus-Config-r15</i> is present in <i>SystemInformationBlockType2</i> , the field is set to value <i>resourceLocationWithWUS</i> ; otherwise the field is set to value <i>resourceLocationWithoutWUS</i> .
<b>timeParameters</b>	Time domain WUS configuration information. For individual field descriptions, see <i>WUS-Config</i> . If the field is absent, the parameters in <i>wus-Config</i> apply.

Conditional presence	Explanation
<i>NoWUSr15</i>	The field is mandatory present if <i>wus-Config-r15</i> is not present in <i>SystemInformationBlockType2</i> ; otherwise the field is not present.
<i>ProbabilityBased</i>	The field is mandatory present if paging probability based WUS group selection is configured; otherwise the field is not present and the UE shall delete any existing value for this field.
<i>TimeOffset</i>	The field is optionally present, Need OP, if <i>timeOffset-eDRX-Long</i> is present in <i>timeParameters</i> ; otherwise the field is not present, and the UE shall delete any existing value for this field.

## – LogicalChannelConfig

The IE *LogicalChannelConfig* is used to configure the logical channel parameters.

### LogicalChannelConfig information element

```
-- ASN1START
LogicalChannelConfig ::=
    SEQUENCE {
        ul-SpecificParameters
            SEQUENCE {
                priority
                    INTEGER (1..16),
                prioritisedBitRate
                    ENUMERATED {
                        kbps0, kbps8, kbps16, kbps32, kbps64, kbps128,
                        kbps256, infinity, kbps512-v1020, kbps1024-v1020,
                        kbps2048-v1020, spare5, spare4, spare3, spare2,
                        spare1},
            }
    }
-- ASN1END
```

```

        bucketSizeDuration          ENUMERATED {
            ms50, ms100, ms150, ms300, ms500, ms1000, spare2,
            spare1},
        logicalChannelGroup          INTEGER (0..3)          OPTIONAL          -- Need OR
    }
    OPTIONAL,
    -- Cond UL
    ...,
    [[ logicalChannelSR-Mask-r9      ENUMERATED {setup}    OPTIONAL          -- Cond SRmask
    ]],
    [[ logicalChannelSR-Prohibit-r12  BOOLEAN              OPTIONAL          -- Need ON
    ]],
    [[ laa-UL-Allowed-r14             BOOLEAN              OPTIONAL,        -- Need ON
    bitRateQueryProhibitTimer-r14    ENUMERATED {
        s0, s0dot4, s0dot8, s1dot6, s3, s6, s12,
        s30}          OPTIONAL          --Need OR
    ]],
    [[ allowedTTI-Lengths-r15        CHOICE {
        release          NULL,
        setup            SEQUENCE {
            shortTTI-r15  BOOLEAN,
            subframeTTI-r15  BOOLEAN
        }
    }          OPTIONAL,
    logicalChannelSR-Restriction-r15 CHOICE {
        release          NULL,
        setup            ENUMERATED {spucch, pucch}
    }          OPTIONAL,
    channelAccessPriority-r15        CHOICE {
        release          NULL,
        setup            INTEGER (1..4)
    }          OPTIONAL,
    lch-CellRestriction-r15          BIT STRING (SIZE (maxServCell-r13)) OPTIONAL -- Need ON
    ]],
    [[
    bitRateMultiplier-r16          ENUMERATED {x40, x70, x100, x200}  OPTIONAL          -- Need OR
    ]],
    [[
    allowedHARQ-Mode-r18           ENUMERATED {harqModeA, harqModeB}  OPTIONAL          -- Need OR
    ]],
    ]],
}
-- ASN1STOP

```

<b>LogicalChannelConfig field descriptions</b>	
<b>allowedHARQ-Mode</b>	Indicates the allowed HARQ mode of a HARQ process mapped to this logical channel. If the parameter is absent, there is no restriction for HARQ mode for the mapping. This field applies to SRB1, SRB2 and DRBs.
<b>allowedTTI-Lengths</b>	Indicates the allowed TTI lengths for the logical channel. If not configured, the UE is allowed to transmit the logical channel using any TTI length.
<b>bitRateMultiplier</b>	Bit rate multiplier for recommended bit rate MAC CE as specified in TS 36.321 [6]. Value <i>x40</i> indicates bit rate multiplier 40, value <i>x70</i> indicates bit rate multiplier 70 and so on.
<b>bitRateQueryProhibitTimer</b>	The timer is used for bit rate recommendation query in TS 36.321 [6], clause 5.18, in seconds. Value <i>s0</i> means 0s, <i>s0dot4</i> means 0.4s and so on.
<b>bucketSizeDuration</b>	Bucket Size Duration for logical channel prioritization in TS 36.321 [6]. Value in milliseconds. Value <i>ms50</i> corresponds to 50 ms, <i>ms100</i> corresponds to 100 ms and so on.
<b>channelAccessPriority</b>	Indicates the channel access priority class for the logical channel. UE shall select the lowest channel access priority class (i.e. highest signalled value) of the logical channel with MAC SDU multiplexed into the MAC PDU. MAC CEs except padding BSR apply the highest channel access priority class (i.e. lowest signalled value) , as defined in TS 36.300 [9].
<b>laa-UL-Allowed</b>	Indicates whether the data of a logical channel is allowed to be transmitted via UL of LAA SCells. Value <i>TRUE</i> indicates that the logical channel is allowed to be sent via UL of LAA SCells. Value <i>FALSE</i> indicates that the logical channel is not allowed to be sent via UL of LAA SCells.
<b>lch-CellRestriction</b>	Indicates cells which are restricted for the logical channel, The bit is set to 1 if the cell is restricted and to 0 if the cell is not restricted, for each cell. The least significant bit corresponds to the serving cell with index 0, the next bit corresponds to the serving cell with index 1, and so on. If the cell is restricted for the logical channel, then data for the logical channel is not allowed to be sent using that cell. If the field is not included, no cells are restricted. See also TS 36.321 [6], clause 5.4.3.1. The restriction is only active when PDCP duplication using CA is activated.
<b>logicalChannelGroup</b>	Mapping of logical channel to logical channel group for BSR reporting in TS 36.321 [6].
<b>logicalChannelSR-Mask</b>	Controlling SR triggering on a logical channel basis when an uplink grant is configured. See TS 36.321 [6].
<b>logicalChannelSR-Prohibit</b>	Value <i>TRUE</i> indicates that the <i>logicalChannelSR-ProhibitTimer</i> is enabled for the logical channel. E-UTRAN only (optionally) configures the field (i.e. indicates value <i>TRUE</i> ) if <i>logicalChannelSR-ProhibitTimer</i> is configured. See TS 36.321 [6].
<b>logicalChannelSR-Restriction</b>	Defines the restricted SR configuration for the logical channel. Value <i>spucch</i> indicates that the SR cannot be sent on SPUCCH and value <i>pucch</i> indicates that the SR cannot be sent on PUCCH. If not configured, the UE is allowed to transmit the SR on any SR resource.
<b>prioritisedBitRate</b>	Prioritized Bit Rate for logical channel prioritization in TS 36.321 [6]. Value in kilobytes/second. Value <i>kBps0</i> corresponds to 0 kB/second, <i>kBps8</i> corresponds to 8 kB/second, <i>kBps16</i> corresponds to 16 kB/second and so on. Infinity is the only applicable value for SRB1 and SRB2
<b>priority</b>	Logical channel priority in TS 36.321 [6]. Value is an integer.
<b>shortTTI, subframeTTI</b>	For short TTIs and subframe TTIs respectively: Value <i>TRUE</i> indicates that the UE is allowed to transmit using this TTI length for the logical channel and the value <i>FALSE</i> indicates that the UE is not allowed to transmit using this TTI length for the logical channel. If not configured for a TTI length, then the UE is allowed to transmit this logical channel using this TTI length.

Conditional presence	Explanation
<i>SRmask</i>	The field is optionally present if <i>ul-SpecificParameters</i> is present, need OR; otherwise it is not present.
<i>UL</i>	The field is mandatory present for UL logical channels; otherwise it is not present.

## – LWA-Configuration

The IE *LWA-Configuration* is used to setup/modify/release LTE-WLAN Aggregation.

-- ASN1START

```

LWA-Configuration-r13 ::= CHOICE {
  release          NULL,
  setup           SEQUENCE {
    lwa-Config-r13
  }
}

LWA-Config-r13 ::= SEQUENCE {
  lwa-MobilityConfig-r13 WLAN-MobilityConfig-r13 OPTIONAL, -- Need ON
  lwa-WT-Counter-r13     INTEGER (0..65535)           OPTIONAL, -- Need ON
  ...
  [[ wt-MAC-Address-r14  OCTET STRING (SIZE (6)) OPTIONAL -- Need ON
  ]]
}

-- ASN1STOP

```

#### **LWA-Configuration field descriptions**

##### ***lwa-MobilityConfig***

Indicates the parameters used for WLAN mobility.

##### ***lwa-WT-Counter***

Indicates the parameter used by UE for WLAN authentication.

##### ***wt-MAC-Address***

Indicates the WT MAC address of the WT handling the LWA operation for the UE. The UE uses this MAC address in uplink transmissions to enable routing of LWA uplink data from the AP to the WT. E-UTRAN configures the field only if *ul-LWA-Config-r14* is configured for at least one LWA bearer.

## – *LWIP-Configuration*

The IE *LWIP-Configuration* is used to add, modify or release DRBs that are using LWIP Tunnel.

```

-- ASN1START

LWIP-Configuration-r13 ::= CHOICE {
  release          NULL,
  setup           SEQUENCE {
    lwip-Config-r13
  }
}

LWIP-Config-r13 ::= SEQUENCE {
  lwip-MobilityConfig-r13 WLAN-MobilityConfig-r13 OPTIONAL, -- Need ON
  tunnelConfigLWIP-r13   TunnelConfigLWIP-r13           OPTIONAL, -- Need ON
  ...
}

-- ASN1STOP

```

#### **LWIP-Configuration field descriptions**

##### ***lwip-MobilityConfig***

Indicates the WLAN mobility set for LWIP.

##### ***tunnelConfigLWIP***

Indicates the parameters used for establishing the LWIP tunnel.

## – *MAC-MainConfig*

The IE *MAC-MainConfig* is used to specify the MAC main configuration for signalling and data radio bearers. All MAC main configuration parameters can be configured independently per Cell Group (i.e. MCG or SCG), unless explicitly specified otherwise.

#### **MAC-MainConfig information element**

```

-- ASN1START

MAC-MainConfig ::= SEQUENCE {
  ul-SCH-Config SEQUENCE {

```

```

maxHARQ-Tx          ENUMERATED {
                    n1, n2, n3, n4, n5, n6, n7, n8,
                    n10, n12, n16, n20, n24, n28,
                    spare2, spare1} OPTIONAL, -- Need ON
periodicBSR-Timer   PeriodicBSR-Timer-r12 OPTIONAL, -- Need ON
retxBSR-Timer       RetxBSR-Timer-r12,
ttiBundling         BOOLEAN
                    OPTIONAL, -- Need ON
}
drx-Config          DRX-Config          OPTIONAL, -- Need ON
timeAlignmentTimerDedicated TimeAlignmentTimer,
phr-Config          CHOICE {
  release           NULL,
  setup            SEQUENCE {
    periodicPHR-Timer      ENUMERATED {sf10, sf20, sf50, sf100, sf200,
                                       sf500, sf1000, infinity},
    prohibitPHR-Timer     ENUMERATED {sf0, sf10, sf20, sf50, sf100,
                                       sf200, sf500, sf1000},
    dl-PathlossChange     ENUMERATED {dB1, dB3, dB6, infinity}
  }
}
                    OPTIONAL, -- Need ON
...
[[ sr-ProhibitTimer-r9          INTEGER (0..7)          OPTIONAL -- Need ON
]],
[[ mac-MainConfig-v1020        SEQUENCE {
  sCellDeactivationTimer-r10   ENUMERATED {
    rf2, rf4, rf8, rf16, rf32, rf64, rf128,
    spare} OPTIONAL, -- Need OP
  extendedBSR-Sizes-r10       ENUMERATED {setup}    OPTIONAL, -- Need OR
  extendedPHR-r10             ENUMERATED {setup}    OPTIONAL, -- Need OR
}
]],
[[ stag-ToReleaseList-r11      STAG-ToReleaseList-r11 OPTIONAL, -- Need ON
  stag-ToAddModList-r11       STAG-ToAddModList-r11 OPTIONAL, -- Need ON
  drx-Config-v1130            DRX-Config-v1130     OPTIONAL, -- Need ON
]],
[[ e-HARQ-Pattern-r12         BOOLEAN                OPTIONAL, -- Need ON
  dualConnectivityPHR        CHOICE {
    release                 NULL,
    setup                  SEQUENCE {
      phr-ModeOtherCG-r12  ENUMERATED {real, virtual}
    }
  }
                    OPTIONAL, -- Need ON
  logicalChannelSR-Config-r12 CHOICE {
    release                 NULL,
    setup                  SEQUENCE {
      logicalChannelSR-ProhibitTimer-r12 ENUMERATED {sf20, sf40, sf64, sf128, sf512,
sf1024, sf2560, spare1}
    }
  }
                    OPTIONAL -- Need ON
]],
[[ drx-Config-v1310           DRX-Config-v1310     OPTIONAL, -- Need ON
  extendedPHR2-r13            BOOLEAN OPTIONAL, -- Need ON
  eDRX-Config-CycleStartOffset-r13 CHOICE {
    release                 NULL,
    setup                  CHOICE {
      sf5120                INTEGER(0..1),
      sf10240               INTEGER(0..3)
    }
  }
                    OPTIONAL -- Need ON
]],
[[ drx-Config-r13            CHOICE {
  release                 NULL,
  setup                  DRX-Config-r13
}
                    OPTIONAL -- Need ON
]],
[[ skipUplinkTx-r14          CHOICE {
  release                 NULL,
  setup                  SEQUENCE {
    skipUplinkTxSPS-r14    ENUMERATED {true}    OPTIONAL, -- Need OR
    skipUplinkTxDynamic-r14 ENUMERATED {true}    OPTIONAL, -- Need OR
  }
}
                    OPTIONAL, -- Need ON
  dataInactivityTimerConfig-r14 CHOICE {
    release                 NULL,
    setup                  SEQUENCE {
      dataInactivityTimer-r14 DataInactivityTimer-r14
    }
  }

```



```

    }
    OPTIONAL -- Need ON
  ]],
  [[ rai-Activation-r14
    ENUMERATED {true}
    OPTIONAL -- Need OR
  ]],
  [[ shortTTI-AndSPT-r15
    CHOICE {
      release
        NULL,
      setup
        SEQUENCE {
          drx-Config-r15
            DRX-Config-r15
            OPTIONAL, -- Need ON
          periodicBSR-Timer-r15
            ENUMERATED {
              sf1, sf5, sf10, sf16, sf20, sf32, sf40,
              sf64, sf80, sf128, sf160, sf320, sf640,
              sf1280, sf2560, infinity}
            OPTIONAL, -- Need ON
          proc-Timeline-r15
            ENUMERATED {nplus4set1, nplus6set1,
              nplus6set2, nplus8set2 }
            OPTIONAL, -- Need ON
          sss-ProhibitTimer-r15
            INTEGER (0..7)
            OPTIONAL -- Need ON
        }
      }
    }
    OPTIONAL, -- Need ON
  mpdcch-UL-HARQ-ACK-FeedbackConfig-r15
    BOOLEAN
    OPTIONAL, -- Need ON
  dormantStateTimers-r15
    CHOICE {
      release
        NULL,
      setup
        SEQUENCE {
          sCellHibernationTimer-r15
            ENUMERATED {
              rf2, rf4, rf8, rf16, rf32, rf64, rf128, spare}
            OPTIONAL, -- Need OR
          dormantSCellDeactivationTimer-r15
            ENUMERATED {
              rf2, rf4, rf8, rf16, rf32, rf64,
              rf128, rf320, rf640, rf1280, rf2560,
              rf5120, rf10240, spare3, spare2, spare1}
            OPTIONAL -- Need OR
        }
      }
    }
    OPTIONAL -- Need ON
  ]],
  [[ ce-ETWS-CMAS-RxInConn-r16
    ENUMERATED {true}
    OPTIONAL -- Need OR
  ]],
  [[ offsetThresholdTA-r17
    SetupRelease {OffsetThresholdTA-r17}
    OPTIONAL, -- Need ON
  sr-ProhibitTimerOffset-r17
    SetupRelease {SR-ProhibitTimerOffset-r17}
    OPTIONAL -- Need ON
  ]],
}

MAC-MainConfigSCell-r11 ::=
SEQUENCE {
  stag-Id-r11
    STAG-Id-r11
    OPTIONAL, -- Need OP
  ...
}

DRX-Config ::=
CHOICE {
  release
    NULL,
  setup
    SEQUENCE {
      onDurationTimer
        ENUMERATED {
          psf1, psf2, psf3, psf4, psf5, psf6,
          psf8, psf10, psf20, psf30, psf40,
          psf50, psf60, psf80, psf100,
          psf200},
      drx-InactivityTimer
        ENUMERATED {
          psf1, psf2, psf3, psf4, psf5, psf6,
          psf8, psf10, psf20, psf30, psf40,
          psf50, psf60, psf80, psf100,
          psf200, psf300, psf500, psf750,
          psf1280, psf1920, psf2560, psf0-v1020,
          spare9, spare8, spare7, spare6,
          spare5, spare4, spare3, spare2,
          spare1},
      drx-RetransmissionTimer
        ENUMERATED {
          psf1, psf2, psf4, psf6, psf8, psf16,
          psf24, psf33},
      longDRX-CycleStartOffset
        CHOICE {
          sf10
            INTEGER(0..9),
          sf20
            INTEGER(0..19),
          sf32
            INTEGER(0..31),
          sf40
            INTEGER(0..39),
          sf64
            INTEGER(0..63),
          sf80
            INTEGER(0..79),
          sf128
            INTEGER(0..127),
          sf160
            INTEGER(0..159),
          sf256
            INTEGER(0..255),
          sf320
            INTEGER(0..319),
          sf512
            INTEGER(0..511),
          sf640
            INTEGER(0..639),

```

```

        sf1024                INTEGER(0..1023),
        sf1280                INTEGER(0..1279),
        sf2048                INTEGER(0..2047),
        sf2560                INTEGER(0..2559)
    },
    shortDRX                  SEQUENCE {
        shortDRX-Cycle        ENUMERATED {
            sf2, sf5, sf8, sf10, sf16, sf20,
            sf32, sf40, sf64, sf80, sf128, sf160,
            sf256, sf320, sf512, sf640},
        drxShortCycleTimer    INTEGER (1..16)
    }
}
-- Need OR

DRX-Config-v1130 ::= SEQUENCE {
    drx-RetransmissionTimer-v1130    ENUMERATED {psf0-v1130} OPTIONAL, --Need OR
    longDRX-CycleStartOffset-v1130   CHOICE {
        sf60-v1130                    INTEGER(0..59),
        sf70-v1130                    INTEGER(0..69)
    } OPTIONAL, --Need OR
    shortDRX-Cycle-v1130             ENUMERATED {sf4-v1130} OPTIONAL --Need OR
}

DRX-Config-v1310 ::= SEQUENCE {
    longDRX-CycleStartOffset-v1310   SEQUENCE {
        sf60-v1310                    INTEGER(0..59)
    } OPTIONAL --Need OR
}

DRX-Config-r13 ::= SEQUENCE {
    onDurationTimer-v1310            ENUMERATED {psf300, psf400, psf500, psf600,
        psf800, psf1000, psf1200, psf1600}
        OPTIONAL, --Need OR
    drx-RetransmissionTimer-v1310    ENUMERATED {psf40, psf64, psf80, psf96, psf112,
        psf128, psf160, psf320}
        OPTIONAL, --Need OR
    drx-ULRetransmissionTimer-r13    ENUMERATED {psf0, psf1, psf2, psf4, psf6, psf8, psf16,
        psf24, psf33, psf40, psf64, psf80, psf96,
        psf112, psf128, psf160, psf320}
        OPTIONAL --Need OR
}

DRX-Config-r15 ::= SEQUENCE {
    drx-RetransmissionTimerShortTTI-r15    ENUMERATED {
        tti10, tti20, tti40, tti64, tti80, tti96,
        tti112, tti128, tti160, tti320} OPTIONAL, --Need
OR
    drx-UL-RetransmissionTimerShortTTI-r15    ENUMERATED {
        tti0, tti1, tti2, tti4, tti6, tti8, tti16,
        tti24, tti33, tti40, tti64, tti80, tti96, tti112,
        tti128, tti160, tti320} OPTIONAL --Need OR
}

PeriodicBSR-Timer-r12 ::= ENUMERATED {
    sf5, sf10, sf16, sf20, sf32, sf40, sf64, sf80,
    sf128, sf160, sf320, sf640, sf1280, sf2560,
    infinity, spare1}

RetxBSR-Timer-r12 ::= ENUMERATED {
    sf320, sf640, sf1280, sf2560, sf5120,
    sf10240, spare2, spare1}

OffsetThresholdTA-r17 ::= ENUMERATED {
    ms0dot5, ms1, ms2, ms3, ms4, ms5, ms6 ,ms7,
    ms8, ms9, ms10, ms11, ms12, ms13, ms14, ms15
}

SR-ProhibitTimerOffset-r17 ::= ENUMERATED {
    ms90, ms180, ms270, ms360,
    ms450, ms540, ms1080, spare
}

STAG-ToReleaseList-r11 ::= SEQUENCE (SIZE (1..maxSTAG-r11)) OF STAG-Id-r11
STAG-ToAddModList-r11 ::= SEQUENCE (SIZE (1..maxSTAG-r11)) OF STAG-ToAddMod-r11
STAG-ToAddMod-r11 ::= SEQUENCE {
    stag-Id-r11                STAG-Id-r11,

```

```
    timeAlignmentTimerSTAG-r11 TimeAlignmentTimer,  
    ...  
}  
STAG-Id-r11 ::= INTEGER (1..maxSTAG-r11)  
-- ASN1STOP
```

<b>MAC-MainConfig field descriptions</b>
<p><b>ce-ETWS-CMAS-RxInConn</b> Indicates UE shall monitor for ETWS/CMAS notification on control channels associated with the shared data channel in RRC_CONNECTED as specified in TS 36.213 [23], clause 7.1.</p>
<p><b>dl-PathlossChange</b> DL Pathloss Change and the change of the required power backoff due to power management (as allowed by P-MPRc, see TS 36.101 [42]) for PHR reporting in TS 36.321 [6]. Value in dB. Value dB1 corresponds to 1 dB, dB3 corresponds to 3 dB and so on. The same value applies for each serving cell (although the associated functionality is performed independently for each cell).</p>
<p><b>dormantSCellDeactivationTimer</b> SCell deactivation timer for UEs supporting dormant state as specified in TS 36.321 [6]. Value in number of radio frames. Value rf4 corresponds to 4 radio frames, value rf8 corresponds to 8 radio frames and so on. E-UTRAN only configures the field if the UE is configured with one or more SCells other than the PSCell and PUCCH SCell. The same value applies for each SCell of a Cell Group (i.e. MCG or SCG) (although the associated functionality is performed independently for each SCell). Field <i>dormantSCellDeactivationTimer</i> does not apply for the PUCCH SCell.</p>
<p><b>drx-Config</b> Used to configure DRX as specified in TS 36.321 [6]. E-UTRAN configures the values in <i>DRX-Config-v1130</i> only if the UE indicates support for IDC indication. E-UTRAN configures <i>drx-Config-v1130</i>, <i>drx-Config-v1310</i> and <i>drx-Config-r13</i> only if <i>drx-Config</i> (without suffix) is configured. E-UTRAN configures <i>drx-Config-r13</i> only if UE supports CE or if the UE is configured with uplink of an LAA SCell.</p>
<p><b>drx-InactivityTimer</b> Timer for DRX in TS 36.321 [6]. Value in number of PDCCH sub-frames. Value psf0 corresponds to 0 PDCCH sub-frame and behaviour as specified in 7.3.2 applies, value psf1 corresponds to 1 PDCCH sub-frame, psf2 corresponds to 2 PDCCH sub-frames and so on.</p>
<p><b>drx-RetransmissionTimer</b> Timer for DRX in TS 36.321 [6]. Value in number of PDCCH sub-frames. Value psf0 corresponds to 0 PDCCH sub-frame and behaviour as specified in 7.3.2 applies, value psf1 corresponds to 1 PDCCH sub-frame, psf2 corresponds to 2 PDCCH sub-frames and so on. In case <i>drx-RetransmissionTimer-v1130</i> or <i>drx-RetransmissionTimer-v1310</i> is signalled, the UE shall ignore <i>drx-RetransmissionTimer</i> (i.e. without suffix).</p>
<p><b>drx-RetransmissionTimerShortTTI</b> Timer for DRX in TS 36.321 [6]. Value in number of short TTIs when short TTI is configured. Value <i>tii0</i> corresponds to 10 TTIs, value <i>tii20</i> corresponds to 20 TTIs and so on.</p>
<p><b>drx-ULRetransmissionTimer</b> Timer for DRX in TS 36.321 [6]. Value in number of PDCCH sub-frames. Value psf0 corresponds to 0 PDCCH sub-frame and behaviour as specified in 7.3.2 applies, value psf1 corresponds to 1 PDCCH sub-frame, psf2 corresponds to 2 PDCCH sub-frames and so on.</p>
<p><b>drx-UL-RetransmissionTimerShortTTI</b> Timer for DRX in TS 36.321 [6]. Value in number of short TTIs when short TTI is configured. Value <i>tii0</i> corresponds to 0 TTIs and behaviour as specified in 7.3.2 applies, value <i>tii1</i> corresponds to 1 TTI and so on.</p>
<p><b>drxShortCycleTimer</b> Timer for DRX in TS 36.321 [6]. Value in multiples of shortDRX-Cycle. A value of 1 corresponds to shortDRX-Cycle, a value of 2 corresponds to 2 * shortDRX-Cycle and so on.</p>
<p><b>dualConnectivityPHR</b> Indicates if power headroom shall be reported using Dual Connectivity Power Headroom Report MAC Control Element defined in TS 36.321 [6] (value <i>setup</i>). For both LTE DC and (NG)EN-DC, if PHR functionality is configured, E-UTRAN always configures the value <i>setup</i> for this field and configures <i>phr-Config</i> and <i>dualConnectivityPHR</i>. For LTE DC, E-UTRAN configures the field for both CGs while for (NG)EN-DC, E-UTRAN configures the field only for MCG. E-UTRAN does not configure this field when a DAPS bearer is configured.</p>
<p><b>e-HARQ-Pattern</b> TRUE indicates that enhanced HARQ pattern for TTI bundling is enabled for FDD. E-UTRAN enables this field only when <i>tiiBundling</i> is set to <i>TRUE</i>.</p>
<p><b>eDRX-Config-CycleStartOffset</b> Indicates <i>longDRX-Cycle</i> and <i>drxStartOffset</i> in TS 36.321 [6]. The value of <i>longDRX-Cycle</i> is in number of sub-frames. The value of <i>drxStartOffset</i>, in number of subframes, is indicated by the value of <i>eDRX-Config-CycleStartOffset</i> multiplied by 2560 plus the offset value configured in <i>longDRX-CycleStartOffset</i>. E-UTRAN only configures value <i>setup</i> when the value in <i>longDRX-CycleStartOffset</i> is sf2560.</p>
<p><b>extendedBSR-Sizes</b> If value <i>setup</i> is configured, the BSR index indicates extended BSR size levels as defined in TS 36.321 [6], Table 6.1.3.1-2.</p>
<p><b>extendedPHR</b> Indicates if power headroom shall be reported using the Extended Power Headroom Report MAC control element defined in TS 36.321 [6] (value <i>setup</i>). E-UTRAN always configures the value <i>setup</i> if more than one and up to eight Serving Cell(s) with uplink is configured and none of the serving cells with uplink configured has a <i>servingCellIndex</i> higher than seven and if PUCCH on SCell is not configured and if dual connectivity is not configured. E-UTRAN configures <i>extendedPHR</i> only if <i>phr-Config</i> is configured. E-UTRAN does not configure this field when a DAPS bearer is configured. The UE shall release <i>extendedPHR</i> if <i>phr-Config</i> is released.</p>

<p><b>extendedPHR2</b> Indicates if power headroom shall be reported using the Extended Power Header Report MAC Control Element defined in TS 36.321 [6] (value <i>setup</i>). E-UTRAN always configures the value <i>setup</i> if any of the serving cells with uplink configured has a <i>servingCellIndex</i> higher than seven in case dual connectivity is not configured or if PUCCH SCell (with any number of serving cells with uplink configured) is configured. E-UTRAN configures <i>extendedPHR2</i> only if <i>phr-Config</i> is configured. E-UTRAN does not configure this field when a DAPS bearer is configured. The UE shall release <i>extendedPHR2</i> if <i>phr-Config</i> is released.</p>
<p><b>logicalChannelSR-ProhibitTimer</b> Timer used to delay the transmission of an SR for logical channels enabled by <i>logicalChannelSR-Prohibit</i>. Value <i>sf20</i> corresponds to 20 subframes, <i>sf40</i> corresponds to 40 subframes, and so on. See TS 36.321 [6].</p>
<p><b>longDRX-CycleStartOffset</b> <i>longDRX-Cycle</i> and <i>drxStartOffset</i> in TS 36.321 [6] unless <i>eDRX-Config-CycleStartOffset</i> is configured. The value of <i>longDRX-Cycle</i> is in number of sub-frames. Value <i>sf10</i> corresponds to 10 sub-frames, <i>sf20</i> corresponds to 20 sub-frames and so on. If <i>shortDRX-Cycle</i> is configured, the value of <i>longDRX-Cycle</i> shall be a multiple of the <i>shortDRX-Cycle</i> value. The value of <i>drxStartOffset</i> value is in number of sub-frames. In case <i>longDRX-CycleStartOffset-v1130</i> is signalled, the UE shall ignore <i>longDRX-CycleStartOffset</i> (i.e. without suffix). In case <i>longDRX-CycleStartOffset-v1310</i> is signalled, the UE shall ignore <i>longDRX-CycleStartOffset</i> (i.e. without suffix).</p>
<p><b>maxHARQ-Tx</b> Maximum number of transmissions for UL HARQ in TS 36.321 [6].</p>
<p><b>mpdcch-UL-HARQ-ACK-FeedbackConfig</b> TRUE indicates E-UTRAN may send UL HARQ-ACK feedback or UL grant corresponding to a new transmission for early termination of PUSCH transmission, or positive acknowledgement of completed PUSCH transmissions as specified in TS 36.321 [6] and TS 36.212 [22]. In case of acknowledgement of RRC Connection Release, MPDCCH monitoring is terminated.</p>
<p><b>offsetThresholdTA</b> Offset for TA reporting as specified in TS 36.321 [6]. Value <i>ms0dot5</i> corresponds to 0.5 millisecond, value <i>ms1</i> corresponds to 1 millisecond and so on.</p>
<p><b>onDurationTimer</b> Timer for DRX in TS 36.321 [6]. Value in number of PDCCH sub-frames. Value <i>psf1</i> corresponds to 1 PDCCH sub-frame, <i>psf2</i> corresponds to 2 PDCCH sub-frames and so on. In case <i>onDurationTimer-v1310</i> is signalled, the UE shall ignore <i>onDurationTimer</i> (i.e. without suffix).</p>
<p><b>periodicBSR-Timer</b> Timer for BSR reporting in TS 36.321 [6]. Value in number of sub-frames. Value <i>sf10</i> corresponds to 10 sub-frames, <i>sf20</i> corresponds to 20 sub-frames and so on.</p>
<p><b>periodicPHR-Timer</b> Timer for PHR reporting in TS 36.321 [6]. Value in number of sub-frames. Value <i>sf10</i> corresponds to 10 subframes, <i>sf20</i> corresponds to 20 subframes and so on.</p>
<p><b>phr-ModeOtherCG</b> Indicates the mode (i.e. <i>real</i> or <i>virtual</i>) used for the PHR of the activated cells that are part of the other Cell Group (i.e. MCG or SCG), when DC is configured.</p>
<p><b>proc-Timeline</b> Minimum processing timeline for short TTI with subslot operation. Value <i>nplus4set1</i> indicates processing time <i>n+4</i> for set 1, value <i>nplus6set1</i> indicates processing time <i>n+6</i> for set 1, value <i>nplus6set2</i> indicates processing time <i>n+6</i> for set 2 and value <i>nplus8set2</i> indicates processing time <i>n+8</i> for set 2. See also UE capability <i>min-Proc-TimelineSubslot</i> for sTTI.</p>
<p><b>prohibitPHR-Timer</b> Timer for PHR reporting in TS 36.321 [6]. Value in number of sub-frames. Value <i>sf0</i> corresponds to 0 subframes and behaviour as specified in 7.3.2 applies, <i>sf100</i> corresponds to 100 subframes and so on.</p>
<p><b>rai-Activation</b> Activation of release assistance indication (RAI) in TS 36.321 [6] for BL UEs.</p>
<p><b>retxBSR-Timer</b> Timer for BSR reporting in TS 36.321 [6]. Value in number of sub-frames. Value <i>sf640</i> corresponds to 640 sub-frames, <i>sf1280</i> corresponds to 1280 sub-frames and so on.</p>
<p><b>sCellDeactivationTimer</b> SCell deactivation timer in TS 36.321 [6]. Value in number of radio frames. Value <i>rf4</i> corresponds to 4 radio frames, value <i>rf8</i> corresponds to 8 radio frames and so on. E-UTRAN only configures the field if the UE is configured with one or more SCells other than the PSCell and PUCCH SCell. If the field is absent, the UE shall delete any existing value for this field and assume the value to be set to <i>infinity</i>. The same value applies for each SCell of a Cell Group (i.e. MCG or SCG) (although the associated functionality is performed independently for each SCell). Field <i>sCellDeactivationTimer</i> does not apply for the PUCCH SCell.</p>
<p><b>sCellHibernationTimer</b> SCell hibernation timer for UEs supporting dormant SCell state as specified in TS 36.321 [6]. Value in number of radio frames. Value <i>rf4</i> corresponds to 4 radio frames, value <i>rf8</i> corresponds to 8 radio frames and so on. E-UTRAN only configures the field if the UE is configured with one or more SCells other than the PSCell and PUCCH SCell. The same value applies for each SCell of a Cell Group (i.e. MCG or SCG) (although the associated functionality is performed independently for each SCell). Field <i>sCellHibernationTimer</i> does not apply for the PUCCH SCell.</p>

<p><b>shortDRX-Cycle</b> Short DRX cycle in TS 36.321 [6]. Value in number of sub-frames. Value sf2 corresponds to 2 sub-frames, sf5 corresponds to 5 subframes and so on. In case <i>shortDRX-Cycle-v1130</i> is signalled, the UE shall ignore <i>shortDRX-Cycle</i> (i.e. without suffix). Short DRX cycle is not configured for UEs in CE.</p>
<p><b>skipUplinkTxDynamic</b> If configured, the UE skips UL transmissions for an uplink grant other than a configured uplink grant if no data is available for transmission in the UE buffer as described in TS 36.321 [6].</p>
<p><b>skipUplinkTxSPS</b> If configured, the UE skips UL transmissions for a configured uplink grant if no data is available for transmission in the UE buffer as described in TS 36.321 [6]. E-UTRAN always configures <i>skipUplinkTxSPS</i> when there is at least one SPS configuration with <i>semiPersistSchedIntervalUL</i> shorter than sf10 or when at least one SPS-ConfigUL-STTI is configured for the cell group.</p>
<p><b>sr-ProhibitTimer</b> Timer for SR transmission on PUCCH in TS 36.321 [6]. Value in number of SR period(s) of shortest SR period of any serving cell with PUCCH. Value 0 means that behaviour as specified in 7.3.2 applies. Value 1 corresponds to one SR period, Value 2 corresponds to 2*SR periods and so on. SR period is defined in TS 36.213 [23], table 10.1.5-1. If <i>sr-ProhibitTimerOffset</i> is present, actual value of <i>sr-ProhibitTimer</i> = CEIL (<i>sr-ProhibitTimerOffset</i>/ SR period) + signalled value of <i>sr-ProhibitTimer</i>.</p>
<p><b>sr-ProhibitTimerOffset</b> Time offset for SR transmission on PUCCH. Value in milliseconds. Value <i>ms90</i> corresponds to 90 ms, value <i>ms180</i> corresponds to 180 ms and so on.</p>
<p><b>ssr-ProhibitTimer</b> Timer for prohibiting SR transmission on SPUCCH in TS 36.321 [6]. Value in number of SR period(s) of shortest SR period of any serving cell with SPUCCH. Value 0 means that behaviour as specified in 7.3.2 applies. Value 1 corresponds to one SR period, value 2 corresponds to 2 SR periods and so on. SR period is defined in TS 36.213 [23], table 10.1.5-1.</p>
<p><b>stag-Id</b> Indicates the TAG of an SCell, see TS 36.321 [6]. Uniquely identifies the TAG within the scope of a Cell Group (i.e. MCG or SCG). If the field is not configured for an SCell (e.g. absent in <i>MAC-MainConfigSCell</i>), the SCell is part of the PTAG.</p>
<p><b>stag-ToAddModList, stag-ToReleaseList</b> Used to configure one or more STAGs. E-UTRAN ensures that a STAG contains at least one SCell with configured uplink. If, due to SCell release a reconfiguration would result in an 'empty' TAG, E-UTRAN includes release of the concerned TAG.</p>
<p><b>timeAlignmentTimerSTAG</b> Indicates the value of the time alignment timer for an STAG, see TS 36.321 [6].</p>
<p><b>ttiBundling</b> TRUE indicates that TTI bundling TS 36.321 [6] is enabled while FALSE indicates that TTI bundling is disabled. TTI bundling can be enabled for FDD and for TDD for configurations 0, 1 and 6 and additionally for configurations 2 and 3 when <i>symPUSCH-UpPTS-r14</i> is configured. The functionality is performed independently per Cell Group (i.e. MCG or SCG), but E-UTRAN does not configure TTI bundling for the SCG. For a TDD PCell, E-UTRAN does not simultaneously enable TTI bundling and semi-persistent scheduling in this release of specification. Furthermore, for a Cell Group, E-UTRAN does not simultaneously configure TTI bundling and SCells with configured uplink, and E-UTRAN does not simultaneously configure TTI bundling and eIMTA.</p>

## *P-C-AndCBSR*

The IE *P-C-AndCBSR* is used to specify the power control and codebook subset restriction configuration.

### *P-C-AndCBSR* information elements

```
-- ASN1START
P-C-AndCBSR-r11 ::= SEQUENCE {
    p-C-r11                INTEGER (-8..15),
    codebookSubsetRestriction-r11  BIT STRING
}

P-C-AndCBSR-r13 ::= SEQUENCE {
    p-C-r13                INTEGER (-8..15),
    cbsr-Selection-r13     CHOICE {
        nonPrecoded-r13    SEQUENCE {
            codebookSubsetRestriction1-r13  BIT STRING,
            codebookSubsetRestriction2-r13  BIT STRING
        },
        beamformedK1a-r13  SEQUENCE {
            codebookSubsetRestriction3-r13  BIT STRING
        }
    }
},
```

```

        beamformedKN-r13          SEQUENCE {
            codebookSubsetRestriction-r13  BIT STRING
        },
        ...
    }

P-C-AndCBSR-r15 ::= SEQUENCE {
    p-C-r15          INTEGER (-8..15),
    codebookSubsetRestriction4-r15  BIT STRING
}

P-C-AndCBSR-Pair-r13a ::= SEQUENCE (SIZE (1..2)) OF P-C-AndCBSR-r11
P-C-AndCBSR-Pair-r13 ::= SEQUENCE (SIZE (1..2)) OF P-C-AndCBSR-r13
P-C-AndCBSR-Pair-r15 ::= SEQUENCE (SIZE (1..2)) OF P-C-AndCBSR-r15

-- ASN1STOP

```

### P-C-AndCBSR field descriptions

#### **cbsr-Selection**

Indicates which codebook subset restriction parameter(s) are to be used. E-UTRAN applies values *nonPrecoded* when *eMIMO-Type* is set to *nonPrecoded*. E-UTRAN applies value *beamformedK1a* when *eMIMO-Type* is set to *beamformed*, *alternativeCodebookEnabledBeamformed* is set to *TRUE* and *csi-RS-ConfigNZPIdListExt* is not configured. E-UTRAN applies value *beamformedKN* when *csi-RS-ConfigNZPIdListExt* is configured. E-UTRAN applies value *beamformedKN* when *eMIMO-Type* is set to *beamformed*, *csi-RS-ConfigNZPIdListExt* is not configured and *alternativeCodebookEnabledBeamformed* is set to *FALSE*.

#### **codebookSubsetRestriction**

Parameter: *codebookSubsetRestriction*, see TS 36.213 [23] and TS 36.211 [21]. The number of bits in the *codebookSubsetRestriction* for applicable transmission modes is defined in TS 36.213 [23].

#### **codebookSubsetRestriction1**

Parameter: *codebookSubsetRestriction1*, see TS 36.213 [23], Table 7.2-1d. The number of bits in the *codebookSubsetRestriction1* for applicable transmission modes is defined in TS 36.213 [23].

#### **codebookSubsetRestriction2**

Parameter: *codebookSubsetRestriction2*, see TS 36.213 [23], Table 7.2-1e. The number of bits in the *codebookSubsetRestriction2* for applicable transmission modes is defined in TS 36.213 [23].

#### **codebookSubsetRestriction3**

Parameter: *codebookSubsetRestriction3*, see TS 36.213 [23], Table 7.2-1f. The UE shall ignore *codebookSubsetRestriction-r11* or *codebookSubsetRestriction-r10* if *codebookSubsetRestriction3-r13* is configured. The number of bits in the *codebookSubsetRestriction3* for applicable transmission modes is defined in TS 36.213 [23].

#### **codebookSubsetRestriction4**

Parameter: *codebookSubsetRestriction4*, see TS 36.213 [23], Table 7.2. The number of bits in the *codebookSubsetRestriction4* for applicable transmission modes is defined in TS 36.213 [23].

#### **p-C**

Parameter:  $P_c$ , see TS 36.213 [23], clause 7.2.5.

#### **P-C-AndCBSR-Pair**

E-UTRAN includes a single entry if the UE is configured with TM9. If the UE is configured with TM10 and E-UTRAN includes 2 entries, this indicates that the subframe patterns configured for CSI (CQI/PMI/PTI/RI/CRI) reporting (i.e. as defined by field *csi-MeasSubframeSet1* and *csi-MeasSubframeSet2*, or as defined by *csi-MeasSubframeSets-r12*) are to be used for this CSI process, while including a single entry indicates that the subframe patterns are not to be used for this CSI process. For a UE configured with TM10, E-UTRAN does not include 2 entries with *csi-MeasSubframeSet1* and *csi-MeasSubframeSet2* for CSI processes concerning a secondary frequency. Furthermore, E-UTRAN includes 2 entries when configuring both *cqi-pmi-ConfigIndex* and *cqi-pmi-ConfigIndex2*.

## PDCCH-ConfigSCell

The IE *PDCCH-ConfigSCell* specifies PDCCH monitoring parameters that E-UTRAN may configure for a serving cell.

### PDCCH-ConfigSCell information element

```

-- ASN1START

PDCCH-ConfigSCell-r13 ::= SEQUENCE {
    skipMonitoringDCI-format0-1A-r13  ENUMERATED {true}          OPTIONAL  -- Need OR
}

PDCCH-ConfigLAA-r14 ::= SEQUENCE {

```

```

maxNumberOfSchedSubframes-Format0B-r14  ENUMERATED {sf2, sf3, sf4}  OPTIONAL,      -- Need OR
maxNumberOfSchedSubframes-Format4B-r14  ENUMERATED {sf2, sf3, sf4}  OPTIONAL,      -- Need OR
skipMonitoringDCI-Format0A-r14           ENUMERATED {true}         OPTIONAL,      -- Need OR
skipMonitoringDCI-Format4A-r14           ENUMERATED {true}         OPTIONAL,      -- Need OR
pdccch-CandidateReductions-Format0A-r14
      PDCCH-CandidateReductions-r13      OPTIONAL,      -- Need ON
pdccch-CandidateReductions-Format4A-r14
      PDCCH-CandidateReductionsLAA-UL-r14  OPTIONAL,      -- Need ON
pdccch-CandidateReductions-Format0B-r14
      PDCCH-CandidateReductionsLAA-UL-r14  OPTIONAL,      -- Need ON
pdccch-CandidateReductions-Format4B-r14
      PDCCH-CandidateReductionsLAA-UL-r14  OPTIONAL      -- Need ON
}

PDCCH-CandidateReductionValue-r13 ::= ENUMERATED {n0, n33, n66, n100}

PDCCH-CandidateReductionValue-r14 ::= ENUMERATED {n0, n50, n100, n150}

PDCCH-CandidateReductions-r13 ::= CHOICE {
  release          NULL,
  setup           SEQUENCE {
    pdccch-candidateReductionAL1-r13  PDCCH-CandidateReductionValue-r13,
    pdccch-candidateReductionAL2-r13  PDCCH-CandidateReductionValue-r13,
    pdccch-candidateReductionAL3-r13  PDCCH-CandidateReductionValue-r13,
    pdccch-candidateReductionAL4-r13  PDCCH-CandidateReductionValue-r13,
    pdccch-candidateReductionAL5-r13  PDCCH-CandidateReductionValue-r13
  }
}

PDCCH-CandidateReductionsLAA-UL-r14 ::= CHOICE {
  release          NULL,
  setup           SEQUENCE {
    pdccch-candidateReductionAL1-r14  PDCCH-CandidateReductionValue-r13,
    pdccch-candidateReductionAL2-r14  PDCCH-CandidateReductionValue-r13,
    pdccch-candidateReductionAL3-r14  PDCCH-CandidateReductionValue-r14,
    pdccch-candidateReductionAL4-r14  PDCCH-CandidateReductionValue-r14,
    pdccch-candidateReductionAL5-r14  PDCCH-CandidateReductionValue-r14
  }
}

-- ASN1STOP

```

#### **PDCCH-ConfigSCell field descriptions**

<b>maxNumberOfSchedSubframes-Format0B</b>	Indicates maximum number of schedulable subframes for DCI format 0B as specified in TS 36.213 [23]. Value sf2 corresponds to 2 subframes, value sf3 corresponds to 3 subframes and so on.
<b>maxNumberOfSchedSubframes-Format4B</b>	Indicates maximum number of schedulable subframes for DCI format 4B as specified in TS 36.213 [23]. Value sf2 corresponds to 2 subframes, value sf3 corresponds to 3 subframes and so on.
<b>skipMonitoringDCI-format0-1A</b>	Indicates whether the UE is configured to omit monitoring DCI format 0/1A, see TS 36.213 [23], clause 9.1.1.
<b>skipMonitoringDCI-Format0A</b>	Indicates whether the UE is configured to omit monitoring DCI format 0A as specified in TS 36.213 [23].
<b>skipMonitoringDCI-Format4A</b>	Indicates whether the UE is configured to omit monitoring DCI format 4A as specified in TS 36.213 [23].
<b>pdccch-candidateReductionALx</b>	Indicates reduced (E)PDCCH monitoring requirements on UE specific search space of the x-th aggregation level, see TS 36.213 [23], clause 9.1.1. Value n0 corresponds to 0%, value n33 corresponds to 33% and so on.
<b>pdccch-CandidateReductions-Formatx</b>	Indicates number of blind detections on UE specific search space for each aggregation layer as specified in TS 36.213 [23]. The field can only be present when the UE is configured with uplink of an LAA SCell. If <i>pdccch-CandidateReductions-Formatx</i> is not configured, <i>pdccch-CandidateReductions-r13</i> applies to the corresponding DCIs (if configured).

#### – PDCP-Config

The IE *PDCP-Config* is used to set the configurable PDCP parameters for data radio bearers.



**PDCP-Config information element**

```

-- ASN1START
PDCP-Config ::= SEQUENCE {
  discardTimer      ENUMERATED {
    ms50, ms100, ms150, ms300, ms500,
    ms750, ms1500, infinity
  } OPTIONAL, -- Cond Setup
  rlc-AM            SEQUENCE {
    statusReportRequired BOOLEAN
  } OPTIONAL, -- Cond Rlc-AM-
UM
  rlc-UM           SEQUENCE {
    pdcp-SN-Size    ENUMERATED {len7bits, len12bits}
  } OPTIONAL, -- Cond Rlc-UM
  headerCompression CHOICE {
    notUsed        NULL,
    rohc           SEQUENCE {
      maxCID      INTEGER (1..16383)          DEFAULT 15,
      profiles    SEQUENCE {
        profile0x0001  BOOLEAN,
        profile0x0002  BOOLEAN,
        profile0x0003  BOOLEAN,
        profile0x0004  BOOLEAN,
        profile0x0006  BOOLEAN,
        profile0x0101  BOOLEAN,
        profile0x0102  BOOLEAN,
        profile0x0103  BOOLEAN,
        profile0x0104  BOOLEAN
      }
    }
  },
  ...
},
...,
[[ rn-IntegrityProtection-r10  ENUMERATED {enabled}  OPTIONAL  -- Cond RN
]],
[[ pdcp-SN-Size-v1130          ENUMERATED {len15bits}  OPTIONAL  -- Cond Rlc-AM2
]],
[[ ul-DataSplitDRB-ViaSCG-r12  BOOLEAN          OPTIONAL,  -- Need ON
   t-Reordering-r12            ENUMERATED {
     ms0, ms20, ms40, ms60, ms80, ms100, ms120, ms140,
     ms160, ms180, ms200, ms220, ms240, ms260, ms280, ms300,
     ms500, ms750, spare14, spare13, spare12, spare11, spare10,
     spare9, spare8, spare7, spare6, spare5, spare4, spare3,
     spare2, spare1}
   } OPTIONAL  -- Cond SetupS
]],
[[ ul-DataSplitThreshold-r13   CHOICE {
   release                     NULL,
   setup                       ENUMERATED {
     b0, b100, b200, b400, b800, b1600, b3200, b6400, b12800,
     b25600, b51200, b102400, b204800, b409600, b819200,
     spare1}
   } OPTIONAL,  -- Need ON
   pdcp-SN-Size-v1310          ENUMERATED {len18bits}  OPTIONAL,  -- Cond Rlc-AM3
   statusFeedback-r13         CHOICE {
     release                     NULL,
     setup                       SEQUENCE {
       statusPDU-TypeForPolling-r13  ENUMERATED {type1, type2}  OPTIONAL,  --
Need ON
       statusPDU-Periodicity-Type1-r13  ENUMERATED {
         ms5, ms10, ms20, ms30, ms40, ms50, ms60, ms70, ms80, ms90,
         ms100, ms150, ms200, ms300, ms500, ms1000, ms2000, ms5000,
         ms10000, ms20000, ms50000}
         OPTIONAL,  -- Need ON
       statusPDU-Periodicity-Type2-r13  ENUMERATED {
         ms5, ms10, ms20, ms30, ms40, ms50, ms60, ms70, ms80, ms90,
         ms100, ms150, ms200, ms300, ms500, ms1000, ms2000, ms5000,
         ms10000, ms20000, ms50000}
         OPTIONAL,  -- Need ON
       statusPDU-Periodicity-Offset-r13  ENUMERATED {
         ms1, ms2, ms5, ms10, ms25, ms50, ms100, ms250, ms500,
         ms2500, ms5000, ms25000}
         OPTIONAL  -- Need ON
       }
     }
   }
   } OPTIONAL  -- Need ON
]],
[[ ul-LWA-Config-r14          CHOICE {
   release                     NULL,
   setup                       SEQUENCE {
     ul-LWA-DRB-ViaWLAN-r14      BOOLEAN,

```

```

        ul-LWA-DataSplitThreshold-r14    ENUMERATED {
            b0, b100, b200, b400, b800, b1600, b3200, b6400,
            b12800, b25600, b51200, b102400, b204800, b409600,
            b819200 }                    OPTIONAL -- Need OR
    }
}
uplinkOnlyHeaderCompression-r14        CHOICE {
    notUsed-r14                          NULL,
    rohc-r14                              SEQUENCE {
        maxCID-r14                       INTEGER (1..16383)    DEFAULT 15,
        profiles-r14                     SEQUENCE {
            profile0x0006-r14             BOOLEAN
        },
        ...
    }
}
OPTIONAL -- Need ON
]],
[[ uplinkDataCompression-r15           SEQUENCE {
    bufferSize-r15                       ENUMERATED {kbyte2, kbyte4, kbyte8, spare1},
    dictionary-r15                       ENUMERATED {sip-SDP, operator}  OPTIONAL, -- Need OR
    ...
}
OPTIONAL, -- Cond Rlc-AM4
pdcp-DuplicationConfig-r15            CHOICE {
    release                              NULL,
    setup                               SEQUENCE {
        pdcp-Duplication-r15             ENUMERATED {configured, activated}
    }
}
OPTIONAL -- Need ON
]],
[[ ethernetHeaderCompression-r16      SetupRelease {EthernetHeaderCompression-r16}  OPTIONAL -- Need
ON
]],
[[ discardTimerExt-r17                SetupRelease {DiscardTimerExt-r17}  OPTIONAL -- Need ON
]]
}

EthernetHeaderCompression-r16 ::= SEQUENCE {
    ehc-Common-r16                SEQUENCE {
        ehc-CID-Length-r16        ENUMERATED {bits7, bits15}
    },
    ehc-Downlink-r16              SEQUENCE {
        drb-ContinueEHC-DL-r16    ENUMERATED {true}                OPTIONAL -- Need OR
    }
    OPTIONAL, -- Need ON
    ehc-Uplink-r16                SEQUENCE {
        maxCID-EHC-UL-r16         INTEGER (1..32767),
        drb-ContinueEHC-UL-r16    ENUMERATED {true}                OPTIONAL -- Need OR
    }
    OPTIONAL, -- Need ON
    ...
}

DiscardTimerExt-r17 ::= ENUMERATED {ms2000, spare}

-- ASN1STOP

```

<b>PDCP-Config field descriptions</b>
<p><b>bufferSize</b> Indicates the buffer size applied for UDC specified in TS 36.323 [8]. Value <i>kbyte2</i> means 2048 bytes, <i>kbyte4</i> means 4096 bytes and so on.</p>
<p><b>dictionary</b> Indicates which pre-defined dictionary is used for UDC as specified in TS 36.323 [8]. The value <i>sip-SDP</i> means that UE shall prefill the buffer with standard dictionary for SIP and SDP defined in TS 36.323 [8], and the value <i>operator</i> means that UE shall prefill the buffer with operator-defined dictionary.</p>
<p><b>discardTimer</b> Indicates the discard timer value specified in TS 36.323 [8]. Value in milliseconds. Value <i>ms50</i> means 50 ms, <i>ms100</i> means 100 ms and so on.</p>
<p><b>discardTimerExt</b> Indicates the discard timer value specified in TS 36.323 [8]. Value in milliseconds. Value <i>ms2000</i> means 2000 ms. The UE shall use the extended value <i>discardTimerExt</i>, if present, and ignore the value signaled by <i>discardTimer</i>.</p>
<p><b>drb-ContinueEHC-DL</b> Indicates whether the PDCP entity continues or resets the downlink EHC header compression protocol during PDCP re-establishment, as specified in TS 36.323 [8]. The field is configured only in case of resuming an RRC connection or reconfiguration with sync, where the PDCP termination point is not changed and the <i>fullConfig</i> is not indicated.</p>
<p><b>drb-ContinueEHC-UL</b> Indicates whether the PDCP entity continues or resets the uplink EHC header compression protocol during PDCP re-establishment, as specified in TS 36.323 [8]. The field is configured only in case of resuming an RRC connection or reconfiguration with sync, where the PDCP termination point is not changed and the <i>fullConfig</i> is not indicated.</p>
<p><b>ehc-CID-Length</b> Indicates the length of the CID field for EHC packet. Once the field <i>ethernetHeaderCompression-r16</i> is configured for a DRB, the value of the field <i>ehc-CID-Length</i> for this DRB is not reconfigured to a different value.</p>
<p><b>ehc-Common</b> Indicates the configurations that apply for both downlink and uplink.</p>
<p><b>ehc-Downlink</b> Indicates the configurations that apply for only downlink. If the field is configured, then Ethernet header compression is configured for downlink. Otherwise, it is not configured for downlink.</p>
<p><b>ehc-Uplink</b> Indicates the configurations that apply for only uplink. If the field is configured, then Ethernet header compression is configured for uplink. Otherwise, it is not configured for uplink.</p>
<p><b>ethernetHeaderCompression</b> This field configures Ethernet Header Compression. This field can only be configured for DRB. E-UTRAN does not reconfigure <i>ethernetHeaderCompression</i> for an MCG DRB except for upon handover and upon the first reconfiguration after RRC connection re-establishment. E-UTRAN does not reconfigure <i>ethernetHeaderCompression</i> for a SCG DRB except for upon SCG change involving PDCP re-establishment. E-UTRAN does not configure this field if <i>uplinkDataCompression</i> is configured. E-UTRAN does not configure this field for split and LWA DRBs.</p>
<p><b>headerCompression</b> E-UTRAN does not reconfigure header compression for an MCG DRB except for upon handover and upon the first reconfiguration after RRC connection re-establishment, and without any <i>drb-ContinueROHC</i>. E-UTRAN does not reconfigure header compression for a SCG DRB except for upon SCG change involving PDCP re-establishment. E-UTRAN does not configure header compression while <i>t-Reordering</i> is configured except for DAPS bearers. E-UTRAN only configures this field when neither <i>uplinkOnlyHeaderCompression</i> nor <i>uplinkDataCompression</i> is configured. If <i>headerCompression</i> is configured, the UE shall apply the configured ROHC profile(s) in both uplink and downlink. ROHC and EHC can be both configured simultaneously for a DRB.</p>
<p><b>maxCID</b> Indicates the value of the MAX_CID parameter as specified in TS 36.323 [8]. The total value of MAX_CIDs across all bearers for the UE should be less than or equal to the value of <i>maxNumberROHC-ContextSessions</i> parameter as indicated by the UE.</p>
<p><b>maxCID-EHC-UL</b> Indicates the value of the MAX_CID_EHC_UL parameter as specified in TS 36.323 [8]. The total value of MAX_CID_EHC_UL across all bearers for the UE should be less than or equal to the value of <i>maxNumberEHC-Contexts</i> parameter as indicated by the UE.</p>
<p><b>pdcp-Duplication</b> Parameter for configuring PDCP duplication as specified in TS 36.323 [8]. Value <i>configured</i> indicates that PDCP duplication is configured but initially deactivated and value <i>activated</i> indicates that PDCP duplication is configured and activated upon configuration. For EN-DC, E-UTRAN configures PDCP duplication for MCG DRB only if PDCP duplication is not configured for any split DRB. PDCP duplication is not supported during a DAPS handover.</p>
<p><b>pdcp-SN-Size</b> Indicates the PDCP Sequence Number length in bits. For RLC UM: value <i>len7bits</i> means that the 7-bit PDCP SN format is used and <i>len12bits</i> means that the 12-bit PDCP SN format is used. For RLC AM: value <i>len15bits</i> means that the 15-bit PDCP SN format is used, value <i>len18bits</i> means that the 18-bit PDCP SN format is used, otherwise if the field is not included upon setup of the PDCP entity 12-bit PDCP SN format is used, as specified in TS 36.323 [8].</p>

<b>PDCP-Config field descriptions</b>
<p><b>profiles</b> The profiles used by both compressor and decompressor in both UE and E-UTRAN. The field indicates which of the ROHC profiles specified in TS 36.323 [8] are supported, i.e. value <i>true</i> indicates that the profile is supported. Profile 0x0000 shall always be supported when the use of ROHC is configured. If support of two ROHC profile identifiers with the same 8 LSB's is signalled, only the profile corresponding to the highest value shall be applied.</p>
<p><b>statusFeedback</b> Indicates whether the UE shall send PDCP Status Report periodically or by E-UTRAN polling as specified in TS 36.323 [8]. E-UTRAN configures this field only for LWA DRB.</p>
<p><b>statusPDU-TypeForPolling</b> Indicates the PDCP Control PDU option when it is triggered by E-UTRAN polling. Value <i>type1</i> indicates using the legacy PDCP Control PDU for PDCP status reporting and value <i>type2</i> indicates using the LWA specific PDCP Control PDU for LWA status reporting as specified in TS 36.323 [8].</p>
<p><b>statusPDU-Periodicity-Type1</b> Indicates the value of the PDCP Status reporting periodicity for <i>type1</i> Status PDU, as specified in TS 36.323 [8]. Value in milliseconds. Value ms5 means 5 ms, ms10 means 10 ms and so on.</p>
<p><b>statusPDU-Periodicity-Type2</b> Indicates the value of the PDCP Status reporting periodicity for <i>type2</i> Status PDU, as specified in TS 36.323 [8]. Value in milliseconds. Value ms5 means 5 ms, ms10 means 10 ms and so on.</p>
<p><b>statusPDU-Periodicity-Offset</b> Indicates the value of the offset for <i>type2</i> Status PDU periodicity, as specified in TS 36.323 [8]. Value in milliseconds. Value ms1 means 1 ms, ms2 means 2 ms and so on.</p>
<p><b>t-Reordering</b> Indicates the value of the reordering timer, as specified in TS 36.323 [8]. Value in milliseconds. Value ms0 means 0 ms and behaviour as specified in 7.3.2 applies, ms20 means 20 ms and so on.</p>
<p><b>rn-IntegrityProtection</b> Indicates that integrity protection or verification shall be applied for all subsequent packets received and sent by the RN on the DRB.</p>
<p><b>statusReportRequired</b> Indicates whether or not the UE shall send a PDCP Status Report upon re-establishment of the PDCP entity, upon PDCP data recovery, upon uplink data switching during DAPS handover and upon release of the source cell after DAPS handover as specified in TS 36.323 [8]. If the UE supports DAPS handover, for RLC UM radio bearers, the field has the value FALSE if it has not been configured.</p>
<p><b>ul-DataSplitDRB-ViaSCG</b> Indicates whether the UE shall send PDCP PDUs via SCG as specified in TS 36.323 [8]. E-UTRAN only configures the field (i.e. indicates value <i>TRUE</i>) for split DRBs. For PDCP duplication, if this field is set to <i>TRUE</i>, the primary RLC entity is SCG RLC entity and the secondary RLC entity is MCG RLC entity. If this field is not configured or set to <i>FALSE</i>, the primary RLC entity is MCG RLC entity and the secondary RLC entity is SCG RLC entity.</p>
<p><b>ul-DataSplitThreshold</b> Indicates the threshold value for uplink data split operation specified in TS 36.323 [8]. Value b100 means 100 Bytes, b200 means 200 Bytes and so on. E-UTRAN only configures this field for split DRBs.</p>
<p><b>ul-LWA-DRB-ViaWLAN</b> Indicates whether the UE shall send PDCP PDUs via the LWAAP entity as specified in TS 36.323 [8]. E-UTRAN only configures this field (i.e. indicates value <i>TRUE</i>) for LWA DRBs.</p>
<p><b>ul-LWA-DataSplitThreshold</b> Indicates the threshold value for uplink data split operation as specified in TS 36.323 [8]. Value b0 means 0 Bytes, b100 means 100 Bytes and so on. E-UTRAN only configures this field for LWA DRBs.</p>
<p><b>uplinkDataCompression</b> Indicates the UDC configuration that the UE shall apply. E-UTRAN does not configure <i>uplinkDataCompression</i> for a DRB, if <i>ethernetHeaderCompression</i>, <i>headerCompression</i> or <i>uplinkOnlyHeaderCompression</i> is already configured for the DRB. E-UTRAN does not configure <i>uplinkDataCompression</i> for the split and LWA DRBs. The maximum number of DRBs where <i>uplinkDataCompression</i> can be applied is two. In this version of the specification, for existing DRBs, E-UTRAN can only (re)configure <i>uplinkDataCompression</i> via handover procedure or the first <i>RRCConnectionReconfiguration</i> message after RRC connection re-establishment.</p>
<p><b>uplinkOnlyHeaderCompression</b> Indicates the ROHC configuration that the UE shall apply uplink-only ROHC operations, see TS 36.323 [8]. E-UTRAN only configures this field when <i>headerCompression</i> is not configured. E-UTRAN does not reconfigure header compression for an MCG DRB except for upon handover and upon the first reconfiguration after RRC connection re-establishment. E-UTRAN does not reconfigure header compression for a SCG DRB except for upon SCG change involving PDCP re-establishment. For split and LWA DRBs E-UTRAN configures only <i>notUsed</i>.</p>

Conditional presence	Explanation
<i>Rlc-AM-UM</i>	The field is mandatory present upon setup of a PDCP entity for a radio bearer configured with RLC AM. The field is optional, need ON, in case of reconfiguration of a PDCP entity at handover, at the first reconfiguration after RRC re-establishment or at SCG change involving PDCP re-establishment or PDCP data recovery for a radio bearer configured with RLC AM. If the UE supports DAPS handover, this field is optional, need ON, for a radio bearer configured with RLC UM. Otherwise the field is not present.
<i>Rlc-AM2</i>	The field is optionally present, need OP, upon setup of a PDCP entity for a radio bearer configured with RLC AM. Otherwise the field is not present.
<i>Rlc-AM3</i>	The field is optionally present, need OP, upon setup of a PDCP entity for a radio bearer configured with RLC AM, if <i>pdcp-SN-Size-v1130</i> is absent. Otherwise the field is not present.
<i>Rlc-AM4</i>	The field is optionally present, need ON, upon setup of a PDCP entity for a radio bearer configured with RLC AM. The field is optional, need OP, in case of reconfiguration of a PDCP entity at handover, or at the first reconfiguration after RRC re-establishment. Otherwise the field is not present and the UE shall continue to use the existing value.
<i>Rlc-UM</i>	The field is mandatory present upon setup of a PDCP entity for a radio bearer configured with RLC UM. It is optionally present, Need ON, upon handover within E-UTRA, upon the first reconfiguration after re-establishment and upon SCG change involving PDCP re-establishment. Otherwise the field is not present.
<i>RN</i>	The field is optionally present when signalled to the RN, need OR. Otherwise the field is not present.
<i>Setup</i>	The field is mandatory present in case of radio bearer setup. Otherwise the field is optionally present, need ON.
<i>SetupS</i>	The field is mandatory present in case of setup of or reconfiguration to a split DRB or LWA DRB as well as in case of setup of or reconfiguration to a DRB associated with at least one RLC entity configured with <i>rlc-OutOfOrderDelivery</i> . The field is optionally present upon reconfiguration of a split DRB or LWA DRB or upon DRB type change from split to MCG DRB or from LWA to LTE only as well as upon reconfiguration of a DRB associated with at least one RLC entity configured with <i>rlc-OutOfOrderDelivery</i> , need ON. Otherwise the field is not present.

## – PDSCH-Config

The IE *PDSCH-ConfigCommon* and the IE *PDSCH-ConfigDedicated* are used to specify the common and the UE specific PDSCH configuration respectively.

### PDSCH-Config information element

```
-- ASN1START
PDSCH-ConfigCommon ::= SEQUENCE {
    referenceSignalPower    INTEGER (-60..50),
    p-b                     INTEGER (0..3)
}

PDSCH-ConfigCommon-v1310 ::= SEQUENCE {
    pdsch-maxNumRepetitionCEmodeA-r13    ENUMERATED {
        r16, r32 }                                OPTIONAL,    -- Need OR
    pdsch-maxNumRepetitionCEmodeB-r13    ENUMERATED {
        r192, r256, r384, r512, r768, r1024,
        r1536, r2048 }                            OPTIONAL    -- Need OR
}

PDSCH-ConfigDedicated ::= SEQUENCE {
    p-a                     ENUMERATED {
        dB-6, dB-4dot77, dB-3, dB-1dot77,
        dB0, dB1, dB2, dB3}
}

PDSCH-ConfigDedicated-v1130 ::= SEQUENCE {
    dmrs-ConfigPDSCH-r11    DMRS-Config-r11                OPTIONAL,    -- Need ON
    qcl-Operation            ENUMERATED {typeA, typeB}        OPTIONAL,    -- Need OR
    re-MappingQCLConfigToReleaseList-r11    RE-MappingQCLConfigToReleaseList-r11    OPTIONAL,    --
Need ON
    re-MappingQCLConfigToAddModList-r11     RE-MappingQCLConfigToAddModList-r11     OPTIONAL    --
Need ON
}

PDSCH-ConfigDedicated-v1280 ::= SEQUENCE {
```

```

    tbsIndexAlt-r12                ENUMERATED {a26, a33}                OPTIONAL    -- Need OR
  }
PDSCH-ConfigDedicated-v1310 ::= SEQUENCE {
    dmrs-ConfigPDSCH-v1310          DMRS-Config-v1310          OPTIONAL    -- Need ON
}
PDSCH-ConfigDedicated-v1430 ::= SEQUENCE {
    ce-PDSCH-MaxBandwidth-r14       ENUMERATED {bw5, bw20}       OPTIONAL,   -- Need OP
    ce-PDSCH-TenProcesses-r14       ENUMERATED {on}              OPTIONAL,   -- Need OR
    ce-HARQ-AckBundling-r14         ENUMERATED {on}              OPTIONAL,   -- Need OR
    ce-SchedulingEnhancement-r14    ENUMERATED {range1, range2}  OPTIONAL,   -- Need OR
    tbsIndexAlt2-r14                ENUMERATED {b33}             OPTIONAL    -- Need OR
}
PDSCH-ConfigDedicated-v1530 ::= SEQUENCE {
    qcl-Operation-v1530              ENUMERATED {typeC}           OPTIONAL,   -- Need OR
    tbs-IndexAlt3-r15                ENUMERATED {a37}             OPTIONAL,   -- Need OR
    ce-CQI-AlternativeTableConfig-r15 ENUMERATED {on}              OPTIONAL,   -- Need OR
    ce-PDSCH-64QAM-Config-r15        ENUMERATED {on}              OPTIONAL,   -- Need OR
    ce-PDSCH-FlexibleStartPRB-AllocConfig-r15 ENUMERATED {on}             OPTIONAL,   -- Need OR
    altMCS-TableScalingConfig-r15    ENUMERATED {oDot5, oDot625, oDot75, oDot875} OPTIONAL,   --
Need OR
}
PDSCH-ConfigDedicated-v1610 ::= SEQUENCE {
    ce-PDSCH-MultiTB-Config-r16      SetupRelease {CE-PDSCH-MultiTB-Config-r16}
}
PDSCH-ConfigDedicated-v1700 ::= SEQUENCE {
    ce-PDSCH-14HARQ-Config-r17       SetupRelease {CE-PDSCH-14HARQ-Config-r17}  OPTIONAL,   -- Need
ON
    ce-PDSCH-maxTBS-r17              ENUMERATED {enabled}         OPTIONAL    -- Need OR
}
PDSCH-ConfigDedicated-v1800 ::= SEQUENCE {
    downlinkHARQ-FeedbackDisabledBitmap-r18
        SetupRelease {DownlinkHARQ-FeedbackDisabledBitmap-r18}  OPTIONAL,   -- Need ON
    downlinkHARQ-FeedbackDisabledDCI-r18    ENUMERATED {true}           OPTIONAL    -- Need OR
}
PDSCH-ConfigDedicatedSCell-v1430 ::= SEQUENCE {
    tbsIndexAlt2-r14                ENUMERATED {b33}             OPTIONAL    -- Need OR
}
CE-PDSCH-MultiTB-Config-r16 ::= SEQUENCE {
    interleaving-r16                 ENUMERATED {on}              OPTIONAL,   -- Need OR
    harq-AckBundling-r16             ENUMERATED {on}              OPTIONAL    -- Need OR
}
CE-PDSCH-14HARQ-Config-r17 ::= SEQUENCE {
    ce-HARQ-AckDelay-r17             ENUMERATED {alt-1, alt-2e}
}
RE-MappingQCLConfigToAddModList-r11 ::= SEQUENCE (SIZE (1..maxRE-MapQCL-r11)) OF PDSCH-RE-
MappingQCL-Config-r11
RE-MappingQCLConfigToReleaseList-r11 ::= SEQUENCE (SIZE (1..maxRE-MapQCL-r11)) OF PDSCH-RE-
MappingQCL-ConfigId-r11
PDSCH-RE-MappingQCL-Config-r11 ::= SEQUENCE {
    pdsch-RE-MappingQCL-ConfigId-r11 PDSCH-RE-MappingQCL-ConfigId-r11,
    optionalSetOfFields-r11          SEQUENCE {
        crs-PortsCount-r11           ENUMERATED {n1, n2, n4, spare1},
        crs-FreqShift-r11            INTEGER (0..5),
        mbsfn-SubframeConfigList-r11 CHOICE {
            release                    NULL,
            setup                      SEQUENCE {
                subframeConfigList    MBSFN-SubframeConfigList
            }
        }
    }
    pdsch-Start-r11                  ENUMERATED {reserved, n1, n2, n3, n4, assigned}
}
csi-RS-ConfigZPID-r11               CSI-RS-ConfigZPID-r11,
qcl-CSI-RS-ConfigNZPID-r11          CSI-RS-ConfigNZPID-r11      OPTIONAL,   -- Need OR
...
[[ mbsfn-SubframeConfigList-v1430 CHOICE {
    release                          NULL,

```

```

        setup          SEQUENCE {
            subframeConfigList-v1430  MBSFN-SubframeConfigList-v1430
        }
    },
    OPTIONAL          -- Need OP
[[
    codewordOneConfig-v1530          CHOICE {
        release          NULL,
        setup            SEQUENCE {
            crs-PortsCount-v1530      ENUMERATED {n1, n2, n4, spare1},
            crs-FreqShift-v1530       INTEGER (0..5),
            mbsfn-SubframeConfigList-v1530  MBSFN-SubframeConfigList OPTIONAL,
            mbsfn-SubframeConfigListExt-v1530 MBSFN-SubframeConfigList-v1430 OPTIONAL,
            pdsch-Start-v1530         ENUMERATED {reserved, n1, n2, n3, n4,
assigned},
            csi-RS-ConfigZPID-v1530    CSI-RS-ConfigZPID-r11,
            qcl-CSI-RS-ConfigNZPID-v1530 CSI-RS-ConfigNZPID-r11 OPTIONAL
        }
    }
    OPTIONAL          -- Cond TypeC
]]
}

DownlinkHARQ-FeedbackDisabledBitmap-r18 ::= BIT STRING (SIZE(14))

-- ASN1STOP

```

<b>PDSCH-Config field descriptions</b>
<p><b>altMCS-TableScalingConfig</b> Presence of the field indicates activation of 6-bit MCS table (i.e., <i>altMCS-Table</i>) for UE indicating support for <i>altMCS-Table</i>, see TS 36.212 [22] and TS 36.213 [23]. The indicated value configures the parameter <i>altMCS-Table-Scaling</i> where value <i>oDot5</i> corresponds to scaling factor 0.5, value <i>oDot625</i> corresponds to scaling factor 0.625 and so on, see TS 36.213 [23].</p>
<p><b>ce-CQI-AlternativeTableConfig</b> Configures the UE supporting alternative CQI table to use the alternative CQI table in CE mode A. See TS 36.213 [23].</p>
<p><b>ce-HARQ-AckBundling</b> Activation of PDSCH HARQ-ACK bundling in half duplex FDD in CE mode A, see TS 36.212 [22] and TS 36.213 [23].</p>
<p><b>ce-HARQ-AckDelay</b> Configures the HARQ ACK delay between different subframe types and absolute subframes when UE is configured with 14 HARQ, see TS 36.212 [22] and TS 36.213 [23]. Value <i>alt-1</i> corresponds to Alt-1 and value <i>alt-2e</i> corresponds to Alt-2e.</p>
<p><b>ce-PDSCH-14HARQ-Config</b> Indicates whether 14-HARQ is enabled for HD-FDD Cat M1 UE, see TS 36.211 [21], TS 36.212 [22] and TS 36.213 [23]. E-UTRAN may set this field to setup only when DL multi-TB scheduling is not enabled and PUCCH repetition with HARQ-ACK bundling is not configured.</p>
<p><b>ce-PDSCH-64QAM-Config</b> Activation of 64 QAM for non-repeated unicast PDSCH in CE mode A.</p>
<p><b>ce-PDSCH-FlexibleStartPRB-AllocConfig</b> Activation of flexible starting PRB for PDSCH resource allocation in CE mode A or B. E-UTRAN does not configure this field when E-UTRA system bandwidth is 1.4 MHz.</p>
<p><b>ce-PDSCH-MaxBandwidth</b> Maximum PDSCH channel bandwidth in CE mode A and B, see TS 36.212 [22] and TS 36.213 [23]. Value <i>bw5</i> corresponds to 5 MHz, and value <i>bw20</i> corresponds to 20 MHz. If this field is absent, the UE shall release any existing value and set the maximum PDSCH channel bandwidth in CE mode A and B to 1.4 MHz. Parameter: transmission bandwidth configuration, see TS 36.101 [42], table 5.6-1. The max bandwidth can be configured to 5MHz for BL UEs and 5MHz or 20MHz for UEs in CE.</p>
<p><b>ce-PDSCH-maxTBS</b> Indicates whether DL TBS of 1736 bits is enabled for HD-FDD Cat M1 UE in CE mode A, see TS 36.213 [23], clause 7.1.7.2.</p>
<p><b>ce-PDSCH-MultiTB-Config</b> Indicates whether DL multi-TB scheduling is enabled, i.e., a single DCI can schedule up to 8 PDSCH transport blocks in CE mode A and up to 4 PDSCH transport blocks in CE mode B. See TS 36.213 [23], clause 7.1.11.</p>
<p><b>ce-PDSCH-TenProcesses</b> Configuration of 10 (instead of 8) DL HARQ processes in FDD in CE mode A, see TS 36.212 [22] and TS 36.213 [23].</p>
<p><b>ce-SchedulingEnhancement</b> Activation of dynamic HARQ-ACK delay for HD-FDD for PDSCH in CE mode A controlled by the DCI, see TS 36.212 [22] and TS 36.213 [23]. Value <i>range1</i> corresponds to the first range of HARQ-ACK delays, and value <i>range2</i> corresponds to second range of HARQ-ACK delays.</p>
<p><b>codewordOneConfig</b> The field corresponds to codeword 1, see TS 36.213 [23], clause 7.1.10. If absent, the UE applies the values from the serving cell configured on the same frequency.</p>
<p><b>downlinkHARQ-FeedbackDisabledBitmap</b> Used to disable the DL HARQ feedback, sent in the uplink, per HARQ process ID, see TS 36.321 [6]. The first/leftmost bit corresponds to HARQ process ID 0, the next bit to HARQ process ID 1 and so on. Bits corresponding to HARQ process IDs that are not configured shall be ignored. A bit set to one identifies a HARQ process with disabled DL HARQ feedback and a bit set to zero identifies a HARQ process with enabled DL HARQ feedback.</p>
<p><b>downlinkHARQ-FeedbackDisabledDCI</b> Presence of this field indicates that DCI indication is used to directly indicate or override RRC configuration for disabling HARQ feedback.</p>
<p><b>harq-AckBundling</b> Indicates whether HARQ-ACK bundling for DL multi-TB scheduling is enabled, see TS 36.213 [23], clause 7.3.</p>
<p><b>interleaving</b> Indicates whether interleaving for DL multi-TB scheduling is enabled, see TS 36.213 [23], clause 7.1.11.</p>
<p><b>mbsfn-SubframeConfigList</b> Indicates the MBSFN configuration for the CSI-RS resources. If <i>optionalSetOfFields</i> is absent, the fields <i>mbsfn-SubframeConfigList-r11</i> and <i>mbsfn-SubframeConfigList-v1430</i> are released.</p>
<p><b>optionalSetOfFields</b> If absent, the UE releases the configuration provided previously, if any, and applies the values from the serving cell configured on the same frequency. If the UE is configured with <i>qcl-Operation-v1530</i>, this field corresponds to codeword 0, see TS 36.213 [23], clause 7.1.10.</p>
<p><b>p-a</b> Parameter: <math>P_A</math>, see TS 36.213 [23], clause 5.2. Value <i>dB-6</i> corresponds to -6 dB, <i>dB-4dot77</i> corresponds to -4.77 dB etc.</p>



<b>p-b</b>
Parameter: $P_B$ , see TS 36.213 [23], clause Table 5.2-1.
<b>pdsch-maxNumRepetitionCEmodeA</b>
Maximum value to indicate the set of PDSCH repetition numbers for CE mode A, see TS 36.211 [21] and TS 36.213 [23].
<b>pdsch-maxNumRepetitionCEmodeB</b>
Maximum value to indicate the set of PDSCH repetition numbers for CE mode B, see TS 36.211 [21] and TS 36.213 [23].
<b>pdsch-Start</b>
The starting OFDM symbol of PDSCH for the concerned serving cell, see TS 36.213 [23], clause 7.1.6.4. Values 1, 2, 3 are applicable when <i>dl-Bandwidth</i> for the concerned serving cell is greater than 10 resource blocks, values 2, 3, 4 are applicable when <i>dl-Bandwidth</i> for the concerned serving cell is less than or equal to 10 resource blocks, see TS 36.211 [21], Table 6.7-1. Value <i>n1</i> corresponds to 1, value <i>n2</i> corresponds to 2 and so on. If the field <i>pdsch-Start-v1530</i> is also configured, E-UTRAN ensures that this value is the same as <i>pdsch-Start</i> (i.e., without suffix).
<b>qcl-CSI-RS-ConfigNZPId</b>
Indicates the CSI-RS resource that is quasi co-located with the PDSCH antenna ports, see TS 36.213 [23], clause 7.1.9. E-UTRAN configures this field if and only if the UE is configured with <i>qcl-Operation</i> set to <i>typeB</i> or <i>qcl-Operation-v1530</i> set to <i>typeC</i> . If the UE is configured with <i>qcl-Operation-v1530</i> set to <i>typeC</i> , the field <i>qcl-CSI-RS-ConfigNZPId-r11</i> corresponds to codeword 0, and the field <i>qcl-CSI-RS-ConfigNZPId-v1530</i> corresponds to codeword 1, see TS 36.213 [23], clause 7.1.10..
<b>qcl-Operation</b>
Indicates the quasi co-location behaviour to be used by the UE, type A, type B, or type C, as described in TS 36.213 [23], clause 7.1.10. In case <i>qcl-Operation-v1530</i> is present, the UE shall ignore the field <i>qcl-Operation</i> (without suffix). E-UTRAN configures <i>qcl-Operation-v1530</i> only when transmission mode 10 is configured for the serving cell on this carrier frequency and QCL type C is configured.
<b>referenceSignalPower</b>
Parameter: <i>Reference-signal power</i> , which provides the downlink reference-signal EPRE, see TS 36.213 [23], clause 5.2. The actual value in dBm.
<b>re-MappingQCLConfigToAddModList, re-MappingQCLConfigToReleaseList</b>
For a serving frequency E-UTRAN configures at least one <i>PDSCH-RE-MappingQCL-Config</i> when transmission mode 10 is configured for the serving cell on this carrier frequency. Otherwise it does not configure this field.
<b>tbsIndexAlt</b>
Indicates the applicability of the alternative TBS index for the $I_{TBS}$ 26 and 33 (see TS 36.213 [23], Table 7.1.7.2.1-1), to all subframes scheduled by DCI format 2C or 2D. Value <i>a26</i> refers to the alternative TBS index $I_{TBS}$ 26A, and value <i>a33</i> refers to the alternative TBS index $I_{TBS}$ 33A. If this field is not configured, the UE shall use $I_{TBS}$ 26 specified in Table 7.1.7.2.1-1 in TS 36.213 [23] for all subframes instead. If neither this field nor <i>tbsIndexAlt2</i> configures an alternative TBS index for $I_{TBS}$ 33, the UE shall use $I_{TBS}$ 33 specified in Table 7.1.7.2.1-1 in TS 36.213 [23] for all subframes instead.
<b>tbsIndexAlt2</b>
Indicates the applicability of the alternative TBS index for the $I_{TBS}$ 33 (see TS 36.213 [23], Table 7.1.7.2.1-1) to all subframes. Value <i>b33</i> refers to the alternative TBS index $I_{TBS}$ 33B. If neither this field nor <i>tbsIndexAlt</i> configures an alternative TBS index for $I_{TBS}$ 33, the UE shall use $I_{TBS}$ 33 specified in Table 7.1.7.2.1-1 in TS 36.213 [23] for all subframes instead.
<b>tbs-IndexAlt3</b>
Indicates the applicability of the alternative TBS index for the $I_{TBS}$ 37 (see TS 36.213 [23], Table 7.1.7.2.1-1) to all subframes. Value <i>a37</i> refers to the alternative TBS index $I_{TBS}$ 37A.

Conditional presence	Explanation
<i>TypeC</i>	The field is optional, need ON when <i>qcl-Operation</i> is configured with <i>typeC</i> . Otherwise the field is not present and the UE shall delete any existing value for this field.

### – PDSCH-RE-MappingQCL-ConfigId

The IE *PDSCH-RE-MappingQCL-ConfigId* is used to identify a set of PDSCH parameters related to resource element mapping and quasi co-location, as configured by the IE *PDSCH-RE-MappingQCL-Config*. The identity is unique within the scope of a carrier frequency.

#### PDSCH-RE-MappingQCL-ConfigId information elements

```
-- ASN1START
PDSCH-RE-MappingQCL-ConfigId-r11 ::=
    INTEGER (1..maxRE-MapQCL-r11)
-- ASN1STOP
```

## – *PerCC-GapIndicationList*

The IE *PerCC-GapIndicationList* is used to specify the UE measurement gap preference.

### ***PerCC-GapIndication* information elements**

```
-- ASN1START
PerCC-GapIndicationList-r14 ::= SEQUENCE (SIZE (1..maxServCell-r13)) OF PerCC-GapIndication-r14

PerCC-GapIndication-r14 ::=          SEQUENCE {
    servCellId-r14                    ServCellIndex-r13,
    gapIndication-r14                 ENUMERATED {gap, ncsg, nogap-noNcsg}
}

-- ASN1STOP
```

#### ***PerCC-GapIndication* field descriptions**

##### ***servCellId***

This field identifies the serving cell for which the measurement gap preference is provided.

##### ***gapIndication***

This field is used to indicate the measurement gap preference per component carrier (serving cell) by the UE both in non-CA and CA configurations. Value *gap* indicates that a measurement gap is needed for the associated *servCellId*, value *nogap-noNcsg* indicates that neither a measurement gap nor a ncsg is needed for the associated *servCellId*, value *ncsg* indicates that ncsg is needed for the associated *servCellId*. The UE shall indicate the per CC measurement gap preference consistently for the same non-CA or CA configuration and measurement configuration during the same RRC connection.

## – *PHICH-Config*

The IE *PHICH-Config* is used to specify the PHICH configuration.

### ***PHICH-Config* information element**

```
-- ASN1START

PHICH-Config ::=          SEQUENCE {
    phich-Duration          ENUMERATED {normal, extended},
    phich-Resource          ENUMERATED {oneSixth, half, one, two}
}

-- ASN1STOP
```

#### ***PHICH-Config* field descriptions**

##### ***phich-Duration***

Parameter: *PHICH-Duration*, see TS 36.211 [21], Table 6.9.3-1.

##### ***phich-Resource***

Parameter: *Ng*, see TS 36.211 [21], clause 6.9. Value *oneSixth* corresponds to 1/6, *half* corresponds to 1/2 and so on.

## – *PhysicalConfigDedicated*

The IE *PhysicalConfigDedicated* is used to specify the UE specific physical channel configuration.

### ***PhysicalConfigDedicated* information element**

```
-- ASN1START

PhysicalConfigDedicated ::=          SEQUENCE {
    pdsch-ConfigDedicated              PDSCH-ConfigDedicated          OPTIONAL,      -- Need ON
    pucch-ConfigDedicated              PUCCH-ConfigDedicated          OPTIONAL,      -- Need ON
    pusch-ConfigDedicated              PUSCH-ConfigDedicated          OPTIONAL,      -- Need ON
    uplinkPowerControlDedicated        UplinkPowerControlDedicated  OPTIONAL,      -- Need ON
    tpc-PDCCH-ConfigPUCCH              TPC-PDCCH-Config            OPTIONAL,      -- Need ON
    tpc-PDCCH-ConfigPUSCH              TPC-PDCCH-Config            OPTIONAL,      -- Need ON
    cqi-ReportConfig                   CQI-ReportConfig             OPTIONAL,      -- Cond CQI-
}

r8
```

	soundingRS-UL-ConfigDedicated	SoundingRS-UL-ConfigDedicated	OPTIONAL,	-- Need ON
	antennaInfo	CHOICE {		
	explicitValue	AntennaInfoDedicated,		
	defaultValue	NULL		
	}		OPTIONAL,	-- Cond AI-r8
	schedulingRequestConfig	SchedulingRequestConfig	OPTIONAL,	-- Need ON
	...			
r8	[[ cqi-ReportConfig-v920	CQI-ReportConfig-v920	OPTIONAL,	-- Cond CQI-
r8	antennaInfo-v920	AntennaInfoDedicated-v920	OPTIONAL	-- Cond AI-
	]],			
	[[ antennaInfo-r10	CHOICE {		
	explicitValue-r10	AntennaInfoDedicated-r10,		
	defaultValue	NULL		
	}		OPTIONAL,	-- Cond AI-r10
	antennaInfoUL-r10	AntennaInfoUL-r10	OPTIONAL,	-- Need ON
	cif-Presence-r10	BOOLEAN	OPTIONAL,	-- Need ON
	cqi-ReportConfig-r10	CQI-ReportConfig-r10	OPTIONAL,	-- Cond CQI-r10
	csi-RS-Config-r10	CSI-RS-Config-r10	OPTIONAL,	-- Need ON
	pucch-ConfigDedicated-v1020	PUCCH-ConfigDedicated-v1020	OPTIONAL,	-- Need ON
	pusch-ConfigDedicated-v1020	PUSCH-ConfigDedicated-v1020	OPTIONAL,	-- Need ON
	schedulingRequestConfig-v1020	SchedulingRequestConfig-v1020	OPTIONAL,	-- Need ON
	soundingRS-UL-ConfigDedicated-v1020	SoundingRS-UL-ConfigDedicated-v1020	OPTIONAL,	-- Need ON
	soundingRS-UL-ConfigDedicatedAperiodic-r10	SoundingRS-UL-ConfigDedicatedAperiodic-r10	OPTIONAL,	-- Need ON
	uplinkPowerControlDedicated-v1020	UplinkPowerControlDedicated-v1020	OPTIONAL,	-- Need ON
	]],			
	[[ additionalSpectrumEmissionCA-r10	CHOICE {		
	release	NULL,		
	setup	SEQUENCE {		
	additionalSpectrumEmissionPCell-r10	AdditionalSpectrumEmission		
	}			
	}]		OPTIONAL	-- Need ON
	]],			
	[[ -- DL configuration as well as configuration applicable for DL and UL			
	csi-RS-ConfigNZPTToReleaseList-r11	CSI-RS-ConfigNZPTToReleaseList-r11	OPTIONAL,	-- Need ON
	csi-RS-ConfigNZPTToAddModList-r11	CSI-RS-ConfigNZPTToAddModList-r11	OPTIONAL,	-- Need ON
	csi-RS-ConfigZPTToReleaseList-r11	CSI-RS-ConfigZPTToReleaseList-r11	OPTIONAL,	-- Need ON
	csi-RS-ConfigZPTToAddModList-r11	CSI-RS-ConfigZPTToAddModList-r11	OPTIONAL,	-- Need ON
	epdccb-Config-r11	EPDCC-Config-r11	OPTIONAL,	-- Need ON
	pdsch-ConfigDedicated-v1130	PDSCH-ConfigDedicated-v1130	OPTIONAL,	-- Need ON
-- UL configuration	cqi-ReportConfig-v1130	CQI-ReportConfig-v1130	OPTIONAL,	-- Need ON
	pucch-ConfigDedicated-v1130	PUCCH-ConfigDedicated-v1130	OPTIONAL,	-- Need ON
	pusch-ConfigDedicated-v1130	PUSCH-ConfigDedicated-v1130	OPTIONAL,	-- Need ON
	uplinkPowerControlDedicated-v1130	UplinkPowerControlDedicated-v1130	OPTIONAL	-- Need ON
	]],			
	[[ antennaInfo-v1250	AntennaInfoDedicated-v1250	OPTIONAL,	-- Cond AI-r10
	eimta-MainConfig-r12	EIMTA-MainConfig-r12	OPTIONAL,	-- Need ON
	eimta-MainConfigPCell-r12	EIMTA-MainConfigServCell-r12	OPTIONAL,	-- Need ON
	pucch-ConfigDedicated-v1250	PUCCH-ConfigDedicated-v1250	OPTIONAL,	-- Need ON
	cqi-ReportConfigPCell-v1250	CQI-ReportConfig-v1250	OPTIONAL,	-- Need ON
	uplinkPowerControlDedicated-v1250	UplinkPowerControlDedicated-v1250	OPTIONAL,	-- Need ON
	pusch-ConfigDedicated-v1250	PUSCH-ConfigDedicated-v1250	OPTIONAL,	-- Need ON
	csi-RS-Config-v1250	CSI-RS-Config-v1250	OPTIONAL	-- Need ON
	]],			
	[[ pdsch-ConfigDedicated-v1280	PDSCH-ConfigDedicated-v1280	OPTIONAL	-- Need ON
	]],			
	[[ pdsch-ConfigDedicated-v1310	PDSCH-ConfigDedicated-v1310	OPTIONAL,	-- Need ON
	pucch-ConfigDedicated-r13	PUCCH-ConfigDedicated-r13	OPTIONAL,	-- Need ON
	pusch-ConfigDedicated-r13	PUSCH-ConfigDedicated-r13	OPTIONAL,	-- Need ON
	pdccb-CandidateReductions-r13	PDCCH-CandidateReductions-r13	OPTIONAL,	-- Need ON
	cqi-ReportConfig-v1310	CQI-ReportConfig-v1310	OPTIONAL,	-- Need ON
	soundingRS-UL-ConfigDedicated-v1310	SoundingRS-UL-ConfigDedicated-v1310	OPTIONAL,	-- Need ON
	soundingRS-UL-ConfigDedicatedUpPTsExt-r13	SoundingRS-UL-ConfigDedicatedUpPTsExt-r13	OPTIONAL,	-- Need ON
	soundingRS-UL-ConfigDedicatedAperiodic-v1310	SoundingRS-UL-ConfigDedicatedAperiodic-v1310	OPTIONAL,	-- Need ON

```

soundingRS-UL-ConfigDedicatedAperiodicUpPTsExt-r13
  SoundingRS-UL-ConfigDedicatedAperiodicUpPTsExt-r13 OPTIONAL, -- Need ON
csi-RS-Config-v1310 CSI-RS-Config-v1310 OPTIONAL, -- Need ON
ce-Mode-r13 CHOICE {
  release NULL,
  setup ENUMERATED {ce-ModeA,ce-ModeB}
}
csi-RS-ConfigNZPTToAddModListExt-r13 CSI-RS-ConfigNZPTToAddModListExt-r13 OPTIONAL, -- Need
ON
csi-RS-ConfigNZPTToReleaseListExt-r13 CSI-RS-ConfigNZPTToReleaseListExt-r13 OPTIONAL --
Need ON
}],
[[ cqi-ReportConfig-v1320 CQI-ReportConfig-v1320 OPTIONAL -- Need ON
]],
[[ typeA-SRS-TPC-PDCCH-Group-r14 CHOICE {
  release NULL,
  setup SEQUENCE (SIZE (1..32)) OF SRS-TPC-PDCCH-Config-r14
}
must-Config-r14 CHOICE{
  release NULL,
  setup SEQUENCE {
    k-max-r14 ENUMERATED {11, 13},
    p-a-must-r14 ENUMERATED {
      dB-6, dB-4dot77, dB-3, dB-1dot77,
      dB0, dB1, dB2, dB3} OPTIONAL -- Need ON
    }
}
pusch-EnhancementsConfig-r14 PUSCH-EnhancementsConfig-r14 OPTIONAL, -- Need
ON
ce-pdsch-pusch-EnhancementConfig-r14 ENUMERATED {on} OPTIONAL, -- Need OR
antennaInfo-v1430 AntennaInfoDedicated-v1430 OPTIONAL, -- Need ON
pucch-ConfigDedicated-v1430 PUCCH-ConfigDedicated-v1430 OPTIONAL, -- Need ON
pdsch-ConfigDedicated-v1430 PDSCH-ConfigDedicated-v1430 OPTIONAL, -- Need ON
pusch-ConfigDedicated-v1430 PUSCH-ConfigDedicated-v1430 OPTIONAL, -- Need ON
soundingRS-UL-PeriodicConfigDedicatedList-r14 SEQUENCE (SIZE (1..2)) OF
SoundingRS-UL-ConfigDedicated OPTIONAL, -- Cond PeriodicSRSPCell
soundingRS-UL-PeriodicConfigDedicatedUpPTsExtList-r14 SEQUENCE (SIZE (1..4)) OF
SoundingRS-UL-ConfigDedicatedUpPTsExt-r13 OPTIONAL, -- Cond PeriodicSRSExt
soundingRS-UL-AperiodicConfigDedicatedList-r14 SEQUENCE (SIZE (1..2)) OF
SoundingRS-UL-ConfigDedicatedAperiodic-r10 OPTIONAL, -- Cond AperiodicSRS
soundingRS-UL-ConfigDedicatedApUpPTsExtList-r14 SEQUENCE (SIZE (1..4)) OF SoundingRS-UL-
ConfigDedicatedAperiodicUpPTsExt-r13 OPTIONAL, -- Cond AperiodicSRSExt
csi-RS-Config-v1430 CSI-RS-Config-v1430 OPTIONAL, -- Need ON
csi-RS-ConfigZP-ApList-r14 CSI-RS-ConfigZP-ApList-r14 OPTIONAL, -- Need ON
cqi-ReportConfig-v1430 CQI-ReportConfig-v1430 OPTIONAL, -- Need ON
semiOpenLoop-r14 BOOLEAN OPTIONAL, -- Need ON
]],
[[ csi-RS-Config-v1480 CSI-RS-Config-v1480 OPTIONAL -- Need ON
]],
[[ physicalConfigDedicatedSTTI-r15 PhysicalConfigDedicatedSTTI-r15 OPTIONAL,-- Need ON
pdsch-ConfigDedicated-v1530 PDSCH-ConfigDedicated-v1530 OPTIONAL,-- Need ON
pusch-ConfigDedicated-v1530 PUSCH-ConfigDedicated-v1530 OPTIONAL,-- Need ON
cqi-ReportConfig-v1530 CQI-ReportConfig-v1530 OPTIONAL,-- Need ON
antennaInfo-v1530 AntennaInfoDedicated-v1530 OPTIONAL,-- Need ON
csi-RS-Config-v1530 CSI-RS-Config-v1530 OPTIONAL,-- Need ON
uplinkPowerControlDedicated-v1530 UplinkPowerControlDedicated-v1530 OPTIONAL, -- Need ON
semiStaticCFI-Config-r15 CHOICE{
  release NULL,
  setup CHOICE{
    cfi-Config-r15 CFI-Config-r15,
    cfi-PatternConfig-r15 CFI-PatternConfig-r15
  }
}
blindPDSCH-Repetition-Config-r15 CHOICE{
  release NULL,
  setup SEQUENCE {
    blindSubframePDSCH-Repetitions-r15 BOOLEAN,
    blindSlotSubslotPDSCH-Repetitions-r15 BOOLEAN,
    maxNumber-SubframePDSCH-Repetitions-r15 ENUMERATED {n4,n6} OPTIONAL, -- Need ON
    maxNumber-SlotSubslotPDSCH-Repetitions-r15 ENUMERATED {n4,n6} OPTIONAL, --
Need ON
  }
  rv-SubframePDSCH-Repetitions-r15 ENUMERATED {dlrvseq1, dlrvseq2} OPTIONAL, --
Need ON
  rv-SlotsublotPDSCH-Repetitions-r15 ENUMERATED {dlrvseq1, dlrvseq2} OPTIONAL, --
Need ON
  numberOfProcesses-SubframePDSCH-Repetitions-r15 INTEGER(1..16) OPTIONAL, -- Need ON

```

```

        numberOfProcessesSlotSubslotPDSCH-Repetitions-r15 INTEGER(1..16) OPTIONAL, --
Need ON
        mcs-restrictionSubframePDSCH-Repetitions-r15 ENUMERATED {n0, n1} OPTIONAL, --
Need ON
        mcs-restrictionSlotSubslotPDSCH-Repetitions-r15 ENUMERATED {n0, n1} OPTIONAL -- Need
ON
    }
}
OPTIONAL -- Need ON
]],
[[ spucch-Config-v1550 SPUCCH-Config-v1550 OPTIONAL -- Need ON
]],
[[ pdsch-ConfigDedicated-v1610 PDSCH-ConfigDedicated-v1610 OPTIONAL, -- Need ON
pusch-ConfigDedicated-v1610 PUSCH-ConfigDedicated-v1610 OPTIONAL, -- Need ON
ce-CSI-RS-Feedback-r16 ENUMERATED {enabled} OPTIONAL, -- Need OR
resourceReservationConfigDedicatedDL-r16 SetupRelease
{ResourceReservationConfigDedicatedDL-r16} OPTIONAL, -- Need ON
resourceReservationConfigDedicatedUL-r16 SetupRelease
{ResourceReservationConfigDedicatedUL-r16} OPTIONAL, -- Need ON
r16} soundingRS-UL-ConfigDedicatedAdd-r16 SetupRelease {SoundingRS-UL-ConfigDedicatedAdd-
OPTIONAL, -- Need ON
Need ON uplinkPowerControlAddSRS-r16 SetupRelease {UplinkPowerControlAddSRS-r16} OPTIONAL, --
Need ON soundingRS-VirtualCellID-r16 SetupRelease {SoundingRS-VirtualCellID-r16} OPTIONAL, --
Need ON widebandPRG-r16 SetupRelease {WidebandPRG-r16} OPTIONAL --
Need ON
]],
[[ pdsch-ConfigDedicated-v1700 PDSCH-ConfigDedicated-v1700 OPTIONAL, -- Need ON
ntn-ConfigDedicated-r17 SEQUENCE {
    pucch-TxDuration-r17 SetupRelease {PUCCH-TxDuration-r17} OPTIONAL, -- Need ON
    pusch-TxDuration-r17 SetupRelease {PUSCH-TxDuration-r17} OPTIONAL -- Need ON
} OPTIONAL --Cond NTN
]],
[[ uplinkSegmentedPrecompensationGap-r17 ENUMERATED {sym1,s11,sf1} OPTIONAL -- Need OR
]],
[[ pdsch-ConfigDedicated-v1800 PDSCH-ConfigDedicated-v1800 OPTIONAL, -- Need ON
pusch-ConfigDedicated-v1800 PUSCH-ConfigDedicated-v1800 OPTIONAL -- Need ON
]]
}

PhysicalConfigDedicated-v1370 ::= SEQUENCE {
    pucch-ConfigDedicated-v1370 PUCCH-ConfigDedicated-v1370 OPTIONAL -- Cond
PUCCH-Format4or5
}

PhysicalConfigDedicated-v13c0 ::= SEQUENCE {
    pucch-ConfigDedicated-v13c0 PUCCH-ConfigDedicated-v13c0
}

PhysicalConfigDedicatedSCell-r10 ::= SEQUENCE {
    -- DL configuration as well as configuration applicable for DL and UL
    nonUL-Configuration-r10 SEQUENCE {
        antennaInfo-r10 AntennaInfoDedicated-r10 OPTIONAL, -- Need ON
        crossCarrierSchedulingConfig-r10 CrossCarrierSchedulingConfig-r10 OPTIONAL, -- Need ON
        csi-RS-Config-r10 CSI-RS-Config-r10 OPTIONAL, -- Need ON
        pdsch-ConfigDedicated-r10 PDSCH-ConfigDedicated OPTIONAL, -- Need ON
    }
    -- UL configuration
    ul-Configuration-r10 SEQUENCE {
        antennaInfoUL-r10 AntennaInfoUL-r10 OPTIONAL, -- Need ON
        pusch-ConfigDedicatedSCell-r10 PUSCH-ConfigDedicatedSCell-r10 OPTIONAL, -- Cond PUSCH-SCell1
        uplinkPowerControlDedicatedSCell-r10 UplinkPowerControlDedicatedSCell-r10 OPTIONAL, -- Need ON
        cqi-ReportConfigSCell-r10 CQI-ReportConfigSCell-r10 OPTIONAL, -- Need ON
        soundingRS-UL-ConfigDedicated-r10 SoundingRS-UL-ConfigDedicated OPTIONAL, -- Need ON
        soundingRS-UL-ConfigDedicated-v1020 SoundingRS-UL-ConfigDedicated-v1020 OPTIONAL, -- Need ON
        soundingRS-UL-ConfigDedicatedAperiodic-r10 SoundingRS-UL-ConfigDedicatedAperiodic-r10 OPTIONAL, -- Need ON
    }
}
...
[[ -- DL configuration as well as configuration applicable for DL and UL

```

```

csi-RS-ConfigNZPTToReleaseList-r11
    CSI-RS-ConfigNZPTToReleaseList-r11 OPTIONAL, -- Need ON
csi-RS-ConfigNZPTToAddModList-r11
    CSI-RS-ConfigNZPTToAddModList-r11 OPTIONAL, -- Need ON
csi-RS-ConfigZPTToReleaseList-r11
    CSI-RS-ConfigZPTToReleaseList-r11 OPTIONAL, -- Need ON
csi-RS-ConfigZPTToAddModList-r11
    CSI-RS-ConfigZPTToAddModList-r11 OPTIONAL, -- Need ON
epdcch-Config-r11
    EPDCCH-Config-r11 OPTIONAL, -- Need ON
-- UL configuration
pdsch-ConfigDedicated-v1130
    PDSCH-ConfigDedicated-v1130 OPTIONAL, -- Need ON
cqi-ReportConfig-v1130
    CQI-ReportConfig-v1130 OPTIONAL, -- Need ON
pusch-ConfigDedicated-v1130
    PUSCH-ConfigDedicated-v1130 OPTIONAL, -- Cond PUSCH-SCell1
uplinkPowerControlDedicatedSCell-v1130
    UplinkPowerControlDedicated-v1130 OPTIONAL, -- Need ON
]],
[[ antennaInfo-v1250
    AntennaInfoDedicated-v1250 OPTIONAL, -- Need ON
eimta-MainConfigSCell-r12
    EIMTA-MainConfigServCell-r12 OPTIONAL, -- Need ON
cqi-ReportConfigSCell-v1250
    CQI-ReportConfig-v1250 OPTIONAL, -- Need ON
uplinkPowerControlDedicatedSCell-v1250
    UplinkPowerControlDedicated-v1250 OPTIONAL, -- Need ON
csi-RS-Config-v1250
    CSI-RS-Config-v1250 OPTIONAL, -- Need ON
]],
[[ pdsch-ConfigDedicated-v1280
    PDSCH-ConfigDedicated-v1280 OPTIONAL, -- Need ON
]],
[[ pucch-Cell-r13
    ENUMERATED {true} OPTIONAL, -- Cond PUCCH-SCell1
pucch-SCell
    CHOICE {
    release
        NULL,
    setup
        SEQUENCE {
        pucch-ConfigDedicated-r13
            PUCCH-ConfigDedicated-r13 OPTIONAL, -- Need ON
        schedulingRequestConfig-r13
            SchedulingRequestConfigSCell-r13 OPTIONAL, -- Need ON
        tpc-PDCCH-ConfigPUCCH-SCell-r13
            TPC-PDCCH-ConfigSCell-r13 OPTIONAL, -- Need ON
        pusch-ConfigDedicated-r13
            PUSCH-ConfigDedicated-r13 OPTIONAL, -- Cond PUSCH-SCell
        uplinkPowerControlDedicated-r13
            UplinkPowerControlDedicatedSCell-v1310 OPTIONAL, -- Need ON
        }
    }
crossCarrierSchedulingConfig-r13
    CrossCarrierSchedulingConfig-r13 OPTIONAL, -- Cond Cross-Carrier-Config
pdccch-ConfigSCell-r13
    PDCCCH-ConfigSCell-r13 OPTIONAL, -- Need ON
cqi-ReportConfig-v1310
    CQI-ReportConfig-v1310 OPTIONAL, -- Need ON
pdsch-ConfigDedicated-v1310
    PDSCH-ConfigDedicated-v1310 OPTIONAL, -- Need ON
soundingRS-UL-ConfigDedicated-v1310
    SoundingRS-UL-ConfigDedicated-v1310 OPTIONAL, -- Need ON
soundingRS-UL-ConfigDedicatedUpPTsExt-r13
    SoundingRS-UL-ConfigDedicatedUpPTsExt-r13 OPTIONAL, -- Need ON
soundingRS-UL-ConfigDedicatedAperiodic-v1310
    SoundingRS-UL-ConfigDedicatedAperiodic-v1310 OPTIONAL, -- Need ON
soundingRS-UL-ConfigDedicatedAperiodicUpPTsExt-r13
    SoundingRS-UL-ConfigDedicatedAperiodicUpPTsExt-r13 OPTIONAL, -- Need ON
csi-RS-Config-v1310
    CSI-RS-Config-v1310 OPTIONAL, -- Need ON
laa-SCellConfiguration-r13
    LAA-SCellConfiguration-r13 OPTIONAL, -- Need ON
csi-RS-ConfigNZPTToAddModListExt-r13
    CSI-RS-ConfigNZPTToAddModListExt-r13 OPTIONAL, -- Need
ON
csi-RS-ConfigNZPTToReleaseListExt-r13
    CSI-RS-ConfigNZPTToReleaseListExt-r13 OPTIONAL --
Need ON
]],
[[ cqi-ReportConfig-v1320
    CQI-ReportConfig-v1320 OPTIONAL, -- Need ON
]],
[[ laa-SCellConfiguration-v1430
    LAA-SCellConfiguration-v1430
        OPTIONAL, -- Need ON
typeB-SRS-TPC-PDCCH-Config-r14
    SRS-TPC-PDCCH-Config-r14 OPTIONAL, -- Need ON
uplinkPUSCH-LessPowerControlDedicated-v1430
    UplinkPUSCH-LessPowerControlDedicated-v1430
OPTIONAL, -- Need ON
soundingRS-UL-PeriodicConfigDedicatedList-r14
    SEQUENCE (SIZE (1..2)) OF
SoundingRS-UL-ConfigDedicated
    OPTIONAL, -- Cond PeriodicSRS
soundingRS-UL-PeriodicConfigDedicatedUpPTsExtList-r14
    SEQUENCE (SIZE
(1..4)) OF SoundingRS-UL-ConfigDedicatedUpPTsExt-r13
    OPTIONAL, -- Cond
PeriodicSRSExt
soundingRS-UL-AperiodicConfigDedicatedList-r14
    SEQUENCE (SIZE (1..2)) OF
SoundingRS-AperiodicSet-r14
    OPTIONAL, -- Cond AperiodicSRS

```

```

    soundingRS-UL-ConfigDedicatedApUpPtsExtList-r14 SEQUENCE (SIZE (1..4)) OF
SoundingRS-AperiodicSetUpPtsExt-r14 OPTIONAL, -- Cond AperiodicSRSExt
    must-Config-r14 CHOICE{
        release NULL,
        setup SEQUENCE {
            k-max-r14 ENUMERATED {11, 13},
            p-a-must-r14 ENUMERATED {
                dB-6, dB-4dot77, dB-3, dB-1dot77,
                dB0, dB1, dB2, dB3} OPTIONAL, -- Need ON
        }
    }
    }
pusch-ConfigDedicated-v1430 OPTIONAL, -- Need ON
PUSCH-ConfigDedicatedSCell-v1430 OPTIONAL, -- Need
ON
csi-RS-Config-v1430 CSI-RS-Config-v1430 OPTIONAL, -- Need ON
csi-RS-ConfigZP-ApList-r14 CSI-RS-ConfigZP-ApList-r14 OPTIONAL, -- Need
ON
cqi-ReportConfig-v1430 CQI-ReportConfig-v1430 OPTIONAL, -- Need ON
semiOpenLoop-r14 BOOLEAN OPTIONAL, -- Need ON
pdsch-ConfigDedicatedSCell-v1430 PDSCH-ConfigDedicatedSCell-v1430 OPTIONAL
-- Need ON
]],
[[ csi-RS-Config-v1480 CSI-RS-Config-v1480 OPTIONAL -- Need ON
]],
[[ physicalConfigDedicatedSTTI-r15 PhysicalConfigDedicatedSTTI-r15 OPTIONAL, -- Need ON
pdsch-ConfigDedicated-v1530 PDSCH-ConfigDedicated-v1530 OPTIONAL, -- Need ON
dummy CQI-ReportConfig-v1530 OPTIONAL, -- Need ON
cqi-ReportConfigSCell-r15 CQI-ReportConfigSCell-r15 OPTIONAL, -- Need ON
cqi-ShortConfigSCell-r15 CQI-ShortConfigSCell-r15 OPTIONAL, -- Need ON
csi-RS-Config-v1530 CSI-RS-Config-v1530 OPTIONAL, -- Need ON
uplinkPowerControlDedicatedSCell-v1530
UplinkPowerControlDedicated-v1530 OPTIONAL, -- Need ON
laa-SCellConfiguration-v1530 LAA-SCellConfiguration-v1530 OPTIONAL, -- Need ON
pusch-ConfigDedicated-v1530 PUSCH-ConfigDedicatedSCell-v1530 OPTIONAL, -- Cond
AUL
semiStaticCFI-Config-r15 CHOICE{
    release NULL,
    setup CHOICE{
        cfi-Config-r15 CFI-Config-r15,
        cfi-PatternConfig-r15 CFI-PatternConfig-r15
    }
}
OPTIONAL, -- Need ON
blindPDSCH-Repetition-Config-r15 CHOICE{
    release NULL,
    setup SEQUENCE {
        blindSubframePDSCH-Repetitions-r15 BOOLEAN,
        blindSlotSubslotPDSCH-Repetitions-r15 BOOLEAN,
        maxNumber-SubframePDSCH-Repetitions-r15 ENUMERATED {n4,n6} OPTIONAL, -- Need ON
        maxNumber-SlotSubslotPDSCH-Repetitions-r15 ENUMERATED {n4,n6} OPTIONAL, --
Need ON
        rv-SubframePDSCH-Repetitions-r15 ENUMERATED {dlrvseq1, dlrvseq2} OPTIONAL, --
Need ON
        rv-SlotSubslotPDSCH-Repetitions-r15 ENUMERATED {dlrvseq1, dlrvseq2} OPTIONAL, --
Need ON
        numberOfProcesses-SubframePDSCH-Repetitions-r15 INTEGER(1..16) OPTIONAL, -- Need ON
        numberOfProcesses-SlotSubslotPDSCH-Repetitions-r15 INTEGER(1..16) OPTIONAL, --
Need ON
        mcs-restrictionSubframePDSCH-Repetitions-r15 ENUMERATED {n0, n1} OPTIONAL, --
Need ON
        mcs-restrictionSlotSubslotPDSCH-Repetitions-r15 ENUMERATED {n0, n1} OPTIONAL -- Need
ON
    }
}
OPTIONAL -- Need ON
]],
[[ spucch-Config-v1550 SPUCCH-Config-v1550 OPTIONAL -- Need ON
]],
[[ soundingRS-UL-ConfigDedicatedAdd-r16 SetupRelease {SoundingRS-UL-ConfigDedicatedAdd-
r16}
OPTIONAL, -- Need ON
uplinkPowerControlAddSRS-r16 SetupRelease {UplinkPowerControlAddSRS-r16}
OPTIONAL, -- Need ON
soundingRS-VirtualCellID-r16 SetupRelease {SoundingRS-VirtualCellID-r16}
OPTIONAL, -- Need ON
widebandPRG-r16 SetupRelease {WidebandPRG-r16} OPTIONAL --
Need ON
]]
}
PhysicalConfigDedicatedSCell-v1370 ::= SEQUENCE {

```

```

    pucch-SCell-v1370          CHOICE{
      release                  NULL,
      setup                    SEQUENCE {
        pucch-ConfigDedicated-v1370 PUCCH-ConfigDedicated-v1370 OPTIONAL -- Cond
PUCCH-Format4or5
      }
    }
}

PhysicalConfigDedicatedSCell-v13c0 ::= SEQUENCE {
  pucch-SCell-v13c0          CHOICE{
    release                  NULL,
    setup                    SEQUENCE {
      pucch-ConfigDedicated-v13c0 PUCCH-ConfigDedicated-v13c0
    }
  }
}

PhysicalConfigDedicatedSCell-v1730 ::= SEQUENCE {
  cqi-ReportPeriodicSCell-v1730 SetupRelease {CQI-ReportPeriodicSCell-v1730}
}

CFI-Config-r15 ::= SEQUENCE {
  cfi-SubframeNonMBSFN-r15    INTEGER (1..4)          OPTIONAL, -- Need ON
  cfi-SlotSubslotNonMBSFN-r15 INTEGER (1..3)          OPTIONAL, -- Need ON
  cfi-SubframeMBSFN-r15      INTEGER (1..2)          OPTIONAL, -- Need ON
  cfi-SlotSubslotMBSFN-r15   INTEGER (1..2)          OPTIONAL, -- Need ON
}

CFI-PatternConfig-r15 ::= SEQUENCE {
  cfi-PatternSubframe-r15     SEQUENCE (SIZE(10)) OF INTEGER (1..4) OPTIONAL, -- Need ON
  cfi-PatternSlotSubslot-r15 SEQUENCE (SIZE(10)) OF INTEGER (1..3) OPTIONAL, -- Need ON
}

LAA-SCellConfiguration-r13 ::= SEQUENCE {
  subframeStartPosition-r13    ENUMERATED {s0, s07},
  laa-SCellSubframeConfig-r13 BIT STRING (SIZE(8))
}

LAA-SCellConfiguration-v1430 ::= SEQUENCE {
  crossCarrierSchedulingConfig-UL-r14 CHOICE {
    release                  NULL,
    setup                    SEQUENCE {
      crossCarrierSchedulingConfigLAA-UL-r14 CrossCarrierSchedulingConfigLAA-UL-r14
    }
  }
  lbt-Config-r14              LBT-Config-r14          OPTIONAL, -- Cond Cross-Carrier-ConfigUL
  pdcch-ConfigLAA-r14         PDCCH-ConfigLAA-r14    OPTIONAL, -- Need ON
  absenceOfAnyOtherTechnology-r14 ENUMERATED {true}  OPTIONAL, -- Need OR
  soundingRS-UL-ConfigDedicatedAperiodic-v1430 SoundingRS-UL-ConfigDedicatedAperiodic-v1430 OPTIONAL -- Need ON
}

LAA-SCellConfiguration-v1530 ::= SEQUENCE {
  aul-Config-r15              AUL-Config-r15          OPTIONAL, -- Need ON
  pusch-ModeConfigLAA-r15     PUSCH-ModeConfigLAA-r15 OPTIONAL, -- Need OR
}

PUSCH-ModeConfigLAA-r15 ::= SEQUENCE {
  laa-PUSCH-Mode1 BOOLEAN,
  laa-PUSCH-Mode2 BOOLEAN,
  laa-PUSCH-Mode3 BOOLEAN
}

LBT-Config-r14 ::= CHOICE{
  maxEnergyDetectionThreshold-r14 INTEGER(-85..-52),
  energyDetectionThresholdOffset-r14 INTEGER(-13..20)
}

CSI-RS-ConfigNZPToAddModList-r11 ::= SEQUENCE (SIZE (1..maxCSI-RS-NZP-r11)) OF CSI-RS-ConfigNZP-r11

CSI-RS-ConfigNZPToAddModListExt-r13 ::= SEQUENCE (SIZE (1..maxCSI-RS-NZP-v1310)) OF CSI-RS-ConfigNZP-r11

CSI-RS-ConfigNZPToAddModList-r15 ::= SEQUENCE (SIZE (1..maxCSI-RS-NZP-r13)) OF CSI-RS-ConfigNZP-r11

```



```

CSI-RS-ConfigNZPToReleaseList-r11 ::= SEQUENCE (SIZE (1..maxCSI-RS-NZP-r11)) OF CSI-RS-
ConfigNZPID-r11

CSI-RS-ConfigNZPToReleaseListExt-r13 ::= SEQUENCE (SIZE (1..maxCSI-RS-NZP-v1310)) OF CSI-RS-
ConfigNZPID-v1310

CSI-RS-ConfigNZPToReleaseList-r15 ::= SEQUENCE (SIZE (1..maxCSI-RS-NZP-r13)) OF CSI-RS-
ConfigNZPID-r13

CSI-RS-ConfigZPToAddModList-r11 ::= SEQUENCE (SIZE (1..maxCSI-RS-ZP-r11)) OF CSI-RS-ConfigZP-r11

CSI-RS-ConfigZPToReleaseList-r11 ::= SEQUENCE (SIZE (1..maxCSI-RS-ZP-r11)) OF CSI-RS-ConfigZPID-
r11

PhysicalConfigDedicatedSTTI-r15 ::= CHOICE {
  release          NULL,
  setup           SEQUENCE {
    antennaInfoDedicatedSTTI-r15      AntennaInfoDedicatedSTTI-r15      OPTIONAL, -- Need ON
    antennaInfoUL-STTI-r15            AntennaInfoUL-STTI-r15            OPTIONAL, -- Need ON
    pucch-ConfigDedicated-v1530       PUCCH-ConfigDedicated-v1530       OPTIONAL, -- Need ON
    schedulingRequestConfig-v1530     SchedulingRequestConfig-v1530     OPTIONAL, -- Need ON
    uplinkPowerControlDedicatedSTTI-r15 UplinkPowerControlDedicatedSTTI-r15 OPTIONAL, --Need
ON
    cqi-ReportConfig-r15              CQI-ReportConfig-r15              OPTIONAL, -- Need ON
    csi-RS-Config-r15                 CSI-RS-Config-r15                 OPTIONAL, -- Need ON
    csi-RS-ConfigNZPToReleaseList-r15 CSI-RS-ConfigNZPToReleaseList-r15 OPTIONAL, -- Need ON
    csi-RS-ConfigNZPToAddModList-r15  CSI-RS-ConfigNZPToAddModList-r15  OPTIONAL, -- Need ON
    csi-RS-ConfigZPToReleaseList-r15  CSI-RS-ConfigZPToReleaseList-r11  OPTIONAL, -- Need ON
    csi-RS-ConfigZPToAddModList-r11   CSI-RS-ConfigZPToAddModList-r11   OPTIONAL, -- Need ON
    csi-RS-ConfigZP-ApList-r15        CSI-RS-ConfigZP-ApList-r14        OPTIONAL, -- Need ON
    eimta-MainConfig-r12              EIMTA-MainConfig-r12              OPTIONAL, -- Need ON
    eimta-MainConfigServCell-r15      EIMTA-MainConfigServCell-r12      OPTIONAL, -- Need ON
    semiOpenLoopSTTI-r15              BOOLEAN,
    slotOrSubslotPDSCH-Config-r15     SlotOrSubslotPDSCH-Config-r15     OPTIONAL, -- Need ON
    slotOrSubslotPUSCH-Config-r15     SlotOrSubslotPUSCH-Config-r15     OPTIONAL, -- Need ON
    spdcch-Config-r15                 SPDCCH-Config-r15                 OPTIONAL, -- Need ON
    spucch-Config-r15                 SPUCCH-Config-r15                 OPTIONAL, -- Need ON
    srs-DCI7-TriggeringConfig-r15     BOOLEAN,
    shortProcessingTime-r15            BOOLEAN,
    shortTTI-r15                       ShortTTI-r15                       OPTIONAL -- Need ON
  }
}

SoundingRS-AperiodicSet-r14 ::= SEQUENCE{
  srs-CC-SetIndexList-r14
      SEQUENCE (SIZE (1..4)) OF SRS-CC-SetIndex-r14
      OPTIONAL, -- Cond SRS-Trigger-TypeA
  soundingRS-UL-ConfigDedicatedAperiodic-r14
      SoundingRS-UL-ConfigDedicatedAperiodic-r10
}

SoundingRS-AperiodicSetUpPTsExt-r14 ::= SEQUENCE{
  srs-CC-SetIndexList-r14
      SEQUENCE (SIZE (1..4)) OF SRS-CC-SetIndex-r14
      OPTIONAL, -- Cond SRS-Trigger-TypeA
  soundingRS-UL-ConfigDedicatedAperiodicUpPTsExt-r14
      SoundingRS-UL-ConfigDedicatedAperiodicUpPTsExt-r13
}

ShortTTI-r15 ::= SEQUENCE {
  dl-STTI-Length-r15      ShortTTI-Length-r15      OPTIONAL, -- Need OR
  ul-STTI-Length-r15      ShortTTI-Length-r15      OPTIONAL  -- Need OR
}

ShortTTI-Length-r15 ::= ENUMERATED {slot, subslot}

SoundingRS-VirtualCellID-r16 ::= SEQUENCE {
  srs-VirtualCellID-r16      INTEGER (0..503),
  srs-VirtualCellID-AllSRS-r16 BOOLEAN
}

WidebandPRG-r16 ::= SEQUENCE {
  widebandPRG-Subframe-r16    BOOLEAN,
  widebandPRG-SlotSubslot-r16 BOOLEAN
}

```

```
ResourceReservationConfigDedicatedDL-r16 ::= SEQUENCE {
    resourceReservationDedicatedDL-r16          ResourceReservationConfigDL-r16 OPTIONAL -- Need OP
}
ResourceReservationConfigDedicatedUL-r16 ::= SEQUENCE {
    resourceReservationDedicatedUL-r16          ResourceReservationConfigUL-r16 OPTIONAL -- Need OP
}
-- ASN1STOP
```

<b>PhysicalConfigDedicated field descriptions</b>
<p><b>absenceOfAnyOtherTechnology</b> Presence of this field indicates absence on a long term basis (e.g. by level of regulation) of any other technology sharing the carrier; absence of this field indicates the potential presence of any other technology sharing the carrier, as specified in TS 37.213 [94].</p>
<p><b>additionalSpectrumEmissionPCell</b> E-UTRAN does not configure this field in this release of the specification.</p>
<p><b>antennaInfo</b> A choice is used to indicate whether the <i>antennaInfo</i> is signalled explicitly or set to the default antenna configuration as specified in clause 9.2.4.</p>
<p><b>blindSlotSubslotPDSCH-Repetitions</b> Enables HARQ-less/blind slot or subslot PDSCH repetitions for a UE in a given cell, i.e. back to back slot/subslot PDSCH transmissions for the same transport block. The number of slot/subslot PDSCH transmissions is indicated in the DCI.</p>
<p><b>blindSubframePDSCH-Repetitions</b> Enables HARQ-less/blind subframe PDSCH repetitions for a UE in a given cell, i.e. back to back PDSCH transmissions for the same transport block. The number of PDSCH transmissions is indicated in the DCI.</p>
<p><b>ce-CSI-RS-Feedback</b> Indicates whether CSI-RS-based CSI feedback is enabled for non-BL UE in CE mode A, see TS 36.213 [23], clause 7.2.2.</p>
<p><b>ce-Mode</b> Indicates the CE mode as specified in TS 36.213 [23].</p>
<p><b>ce-pdsch-pusch-Enhancement-Config</b> Activation of new numbers of repetitions for PUSCH and modulation restrictions for PDSCH/PUSCH in CE mode A, see TS 36.212 [22] and TS 36.213 [23].</p>
<p><b>cfi-SlotSubslotNonMBSFN</b> Indicates the semi-static control format indicator for slot/subslot operation in non-MBSFN subframes.</p>
<p><b>cfi-SlotSubslotMBSFN</b> Indicates the semi-static control format indicator for slot/subslot operation in MBSFN subframes.</p>
<p><b>cfi-SubframeMBSFN</b> Indicates the semi-static control format indicator for subframe operation in MBSFN subframes.</p>
<p><b>cfi-SubframeNonMBSFN</b> Indicates the semi-static control format indicator for subframe operation in non-MBSFN subframes.</p>
<p><b>cqi-ShortConfigSCell</b> Indicates whether the CSI (CQI/PMI/RI/PTI/CRI) reporting resource configured by <i>cqi-ShortConfigSCell</i> is available upon receiving the SCell activation command for this SCell. E-UTRAN only configures this field when transmission mode 1-8 is configured for the serving cell on this carrier frequency.</p>
<p><b>csi-RS-Config</b> For a serving frequency E-UTRAN does not configure <i>csi-RS-Config</i> (includes <i>zeroTxPowerCSI-RS</i>) when transmission mode 10 is configured for the serving cell on this carrier frequency.</p>
<p><b>csi-RS-ConfigNZPTToAddModList</b> For a serving frequency E-UTRAN configures one or more <i>CSI-RS-ConfigNZP</i> only when transmission mode 9 or 10 is configured for the serving cell on this carrier frequency. For a serving frequency, EUTRAN configures a maximum number of <i>CSI-RS-ConfigNZP</i> in accordance with transmission mode (including CSI processes), eMIMO (including class) and associated UE capabilities (e.g. k-Max, n-MaxList).</p>
<p><b>csi-RS-ConfigZP-ApList</b> The aperiodic ZP CSI-RS for PDSCH rate matching. The field <i>subframeConfig</i> is applicable to semi-persistent CSI RS reporting. In other cases, the UE shall ignore field <i>subframeConfig</i>.</p>
<p><b>csi-RS-ConfigZPTToAddModList</b> For a serving frequency E-UTRAN configures one or more <i>CSI-RS-ConfigZP</i> only when transmission mode 10 is configured for the serving cell on this carrier frequency.</p>
<p><b>dl-STTI-Length, ul-STTI-Length</b> Indicates the DL and UL short TTI lengths. Value slot corresponds to 7 OFDM symbols and value subslot corresponds to 2 or 3 OFDM symbols. E-UTRAN configures the same value for all serving cells sending PUCCH feedback on the same cell. If one SCell is configured with short TTI in the group of cells configured to send PUCCH on the same cell, the cell carrying PUCCH shall be configured with short TTI. E-UTRAN can configure different value of <i>dl-STTI-Length</i> and <i>ul-STTI-Length</i> for serving cells sending PUCCH feedback on different cells. E-UTRAN does not configure the combination {slot,subslot} for {DL,UL}.</p>
<p><b>dummy</b> This field is not used in the specification. If received it shall be ignored by the UE.</p>
<p><b>eimta-MainConfigPCell, eimta-MainConfigSCell</b> If E-UTRAN configures <i>eimta-MainConfigPCell</i> or <i>eimta-MainConfigSCell</i> for one serving cell in a frequency band, E-UTRAN configures <i>eimta-MainConfigPCell</i> or <i>eimta-MainConfigSCell</i> for all serving cells residing on the frequency band. E-UTRAN configures <i>eimta-MainConfigPCell</i> or <i>eimta-MainConfigSCell</i> only if <i>eimta-MainConfig</i> is configured.</p>
<p><b>energyDetectionThresholdOffset</b> Indicates the offset to the default maximum energy detection threshold value. Unit in dB. Value -13 corresponds to -13dB, value -12 corresponds to -12dB, and so on (i.e. in steps of 1dB) as specified in TS 37.213 [94].</p>

<b>PhysicalConfigDedicated field descriptions</b>
<p><b>epdcch-Config</b> indicates the <i>EPDCCH-Config</i> for the cell. E-UTRAN does not configure <i>EPDCCH-Config</i> for an SCell that is configured with value <i>other</i> for <i>schedulingCellInfo</i> in <i>CrossCarrierSchedulingConfig</i>.</p>
<p><b>k-max</b> Indicates the maximum number of interfering spatial layers signaled in the assistance information for MUST. Value l1 corresponds to 1 layer, Value l3 corresponds to 3 layers.</p>
<p><b>laa-PUSCH-Mode1, laa-PUSCH-Mode2, laa-PUSCH-Mode3</b> Indicates whether LAA PUSCH mode 1, 2 and/or 3 is configured as specified in TS 36.212 [22], clause 5.3.3.1.</p>
<p><b>laa-SCellSubframeConfig</b> A bit-map indicating LAA SCell subframe configuration, "1" denotes that the corresponding subframe is allocated as MBSFN subframe. The bitmap is interpreted as follows: Starting from the first/leftmost bit in the bitmap, the allocation applies to subframes #1, #2, #3, #4, #6, #7, #8, and #9.</p>
<p><b>maxEnergyDetectionThreshold</b> Indicates the absolute maximum energy detection threshold value. Unit in dBm. Value -85 corresponds to -85 dBm, value -84 corresponds to -84 dBm, and so on (i.e. in steps of 1dBm) as specified in TS 36.213 [23]. If the field is not configured, the UE shall use a default maximum energy detection threshold value as specified in TS 37.213 [94].</p>
<p><b>maxNumber-SlotSubslotPDSCH-Repetitions</b> Indicates the maximum number of PDSCH transmissions for slot or subslot PDSCH repetitions.</p>
<p><b>maxNumber-SubframePDSCH-Repetitions</b> Indicates the maximum number of PDSCH transmissions for subframe PDSCH repetitions.</p>
<p><b>mcs-restrictionSlotSubslotPDSCH-Repetitions</b> Indicates the MCS restriction in terms of number of non-addressable MSB in the MCS bit-field for slot or subslot PDSCH repetition applicable when <math>k &gt; 1</math>.</p>
<p><b>mcs-restrictionSubframePDSCH-Repetitions</b> Indicates MCS restriction in terms of number of non-addressable MSB in the MCS bit-field for subframe PDSCH repetition applicable when <math>k &gt; 1</math>.</p>
<p><b>numberOfProcesses-SlotSubslotPDSCH-Repetitions</b> Indicates the number of HARQ processes for slot/subslot PDSCH repetition applicable when <math>k &gt; 1</math> configured per serving cell.</p>
<p><b>numberOfProcesses-SubframePDSCH-Repetitions</b> Indicates the number of HARQ processes for subframe PDSCH repetition applicable when <math>k &gt; 1</math> configured per serving cell.</p>
<p><b>p-a-must</b> Parameter: <math>P_A</math>, see TS 36.213 [23], clause 5.2. Value dB-6 corresponds to -6 dB, dB-4dot77 corresponds to -4.77 dB etc.</p>
<p><b>pdsch-ConfigDedicated-v1130</b> For a serving frequency, E-UTRAN configures <i>pdsch-ConfigDedicated-v1130</i> only when transmission mode 10 is configured for the serving cell on this carrier frequency.</p>
<p><b>pdsch-ConfigDedicated-v1280</b> For a serving frequency, E-UTRAN configures <i>pdsch-ConfigDedicated-v1280</i> only when transmission mode 9 or 10 is configured for the serving cell on this carrier frequency.</p>
<p><b>pucch-Cell</b> If present, PUCCH feedback of this SCell is sent on the PUCCH SCell. If absent, PUCCH feedback of this SCell is sent on PCell or PSCell, or if the cell concerns the PUCCH SCell, on the concerned cell. If this field is not modified upon change of PUCCH SCell, the UE shall always send the PUCCH feedback of the concerned SCell using the configured PUCCH SCell.</p>
<p><b>pucch-ConfigDedicated</b> E-UTRAN configures <i>pucch-ConfigDedicated-r13</i> only if <i>pucch-ConfigDedicated</i> (i.e., without suffix) is not configured. UE shall ignore <i>pucch-ConfigDedicated-v1020</i> when <i>pucch-ConfigDedicated-r13</i> is configured.</p>
<p><b>pucch-SCell</b> If present, the concerned SCell is the PUCCH SCell. E-UTRAN only configures this field upon SCell addition i.e. this field is only released when the SCell is released. The field is not applicable for an LAA SCell in this release.</p>
<p><b>pusch-ConfigDedicated-r13</b> E-UTRAN configures <i>pusch-ConfigDedicated-r13</i> only if <i>pusch-ConfigDedicated</i> is not configured.</p>
<p><b>pusch-ConfigDedicated-v1250</b> E-UTRAN configures <i>pusch-ConfigDedicated-v1250</i> only if <i>tpc-SubframeSet</i> is configured.</p>
<p><b>pusch-EnhancementsConfig</b> Indicates that the UE shall transmit in the PUSCH enhancement mode if <i>pusch-EnhancementsConfig</i> is set to <i>setup</i>, see TS 36.211 [21] and TS 36.213 [23].</p>
<p><b>resourceReservationConfigDedicatedDL</b> Indicates whether the DL resource reservation is enabled for the UE, e.g. for NR coexistence. If the field is set to <i>setup</i> and <i>resourceReservationDedicatedDL</i> is not included, then <i>resourceReservationConfigCommonDL</i> in <i>SystemInformationBlockType29</i> applies.</p>

<b>PhysicalConfigDedicated field descriptions</b>
<p><b>resourceReservationConfigDedicatedUL</b> Indicates whether the UL resource reservation is enabled for the UE, e.g. for NR coexistence. If the field is set to <i>setup</i> and <i>resourceReservationDedicatedUL</i> is not included, then <i>resourceReservationConfigCommonUL</i> in <i>SystemInformationBlockType29</i> applies.</p>
<p><b>rv-SlotsublotPDSCH-Repetitions</b> Indicates the RV cycling sequence for slot or subslot PDSCH repetition. Value <i>dlrvseq1</i> = {0, 0, 0, 0} and value <i>dlrvseq2</i> = {0, 2, 3, 1}.</p>
<p><b>rv-SubframePDSCH-Repetitions</b> Indicates the RV cycling sequence for subframe PDSCH repetition. Value <i>dlrvseq1</i> = {0, 0, 0, 0} and value <i>dlrvseq2</i> = {0, 2, 3, 1}.</p>
<p><b>semiOpenLoop, semiOpenLoopSTTI</b> Value TRUE indicates that semi-open-loop transmission is used for deriving CSI reporting and corresponding PDSCH transmission (DMRS).</p>
<p><b>shortProcessingTime</b> Indicates whether short processing time is configured as specific in TS 36.321 [6]. An SCell can only be configured with short processing if the cell carrying PUCCH for that SCell is configured with short processing time.</p>
<p><b>soundingRS-UL-PeriodicConfigDedicatedList</b> Indicates periodic soundingRS configuration except for the extension sounding symbols of the UpPTs subframe. E-UTRAN configures this field in <i>PhysicalConfigDedicated</i> only for the UE indicating support of <i>ce-SRS-Enhancement-r14</i> or <i>ce-SRS-EnhancementWithoutComb4-r14</i>. E-UTRAN configures this field in <i>PhysicalConfigDedicatedSCell-r10</i> only for the UE indicating support of <i>srs-UpPTS-6sym-r14</i>.</p>
<p><b>soundingRS-UL-PeriodicConfigDedicatedUpPTsExtList</b> Indicates periodic soundingRS configuration in extension sounding symbols of the UpPTs subframe. E-UTRAN configures this field in <i>PhysicalConfigDedicated</i> only for the UE indicating support of <i>ce-SRS-Enhancement-r14</i> or <i>ce-SRS-EnhancementWithoutComb4-r14</i>. E-UTRAN configures this field in <i>PhysicalConfigDedicatedSCell-r10</i> only for the UE indicating support of <i>srs-UpPTS-6sym-r14</i>.</p>
<p><b>soundingRS-UL-AperiodicConfigDedicatedList</b> Indicates aperiodic soundingRS configuration except for the extension sounding symbols of the UpPTs subframe. E-UTRAN configures this field in <i>PhysicalConfigDedicated</i> only for the UE indicating support of <i>ce-SRS-Enhancement-r14</i> or <i>ce-SRS-EnhancementWithoutComb4-r14</i>. E-UTRAN configures this field in <i>PhysicalConfigDedicatedSCell-r10</i> only for the UE indicating support of <i>srs-UpPTS-6sym-r14</i>.</p>
<p><b>soundingRS-UL-DedicatedApUpPTsExtList</b> Indicates aperiodic soundingRS configuration in extension sounding symbols of the UpPTs subframe. E-UTRAN configures this field in <i>PhysicalConfigDedicated</i> only for the UE indicating support of <i>ce-SRS-Enhancement-r14</i> or <i>ce-SRS-EnhancementWithoutComb4-r14</i>. E-UTRAN configures this field in <i>PhysicalConfigDedicatedSCell-r10</i> only for the UE indicating support of <i>srs-UpPTS-6sym-r14</i>.</p>
<p><b>srs-CC-SetIndexList</b> Indicates the <i>srs-CC-SetIndex</i> list which the <i>soundingRS-UL-ConfigDedicatedAperiodic</i> and <i>soundingRS-UL-ConfigDedicatedAperiodicUpPTsExt</i> belongs to.</p>
<p><b>srs-DCI7-TriggeringConfig</b> Indicates whether SRS triggering via DCI7 is configured.</p>
<p><b>srs-VirtualCellID</b> Indicates the virtual cell ID for SRS.</p>
<p><b>srs-VirtualCellID-AllSRS</b> Value TRUE indicates the configured virtual cell ID is applied to all SRS symbols. Value FALSE indicates the configured virtual cell ID is applied only to additional SRS symbols.</p>
<p><b>subframeStartPosition</b> Indicates possible starting positions of transmission in the first subframe of the DL transmission burst, see TS 36.211 [21]. Value <i>s0</i> means the starting position is subframe boundary, <i>s07</i> means the starting position is either subframe boundary or slot boundary.</p>
<p><b>tpc-PDCCH-ConfigPUCCH</b> PDCCH configuration for power control of PUCCH using format 3/3A, see TS 36.212 [22].</p>
<p><b>tpc-PDCCH-ConfigPUSCH</b> PDCCH configuration for power control of PUSCH using format 3/3A, see TS 36.212 [22].</p>
<p><b>typeA-SRS-TPC-PDCCH-Group</b> Indicates Type A trigger configuration for SRS transmission on a PUSCH-less SCell. E-UTRAN configures the UE with either <i>typeA-SRS-TPC-PDCCH-Group</i> or <i>typeB-SRS-TPC-PDCCH-Group</i>, if any.</p>
<p><b>uplinkPowerControlDedicated</b> E-UTRAN configures <i>uplinkPowerControlDedicated-v1130</i> only if <i>uplinkPowerControlDedicated</i> (without suffix) is configured.</p>
<p><b>uplinkPowerControlDedicatedSCell</b> E-UTRAN configures <i>uplinkPowerControlDedicatedSCell-v1130</i> only if <i>uplinkPowerControlDedicatedSCell-r10</i> is configured for this serving cell.</p>
<p><b>uplinkSegmentedPrecompensationGap</b> Indicates the gap value between segments for PUSCH and PUCCH for TA pre-compensation. Value <i>sym1</i> corresponds to 1 symbol, value <i>sl1</i> corresponds to 1 slot, value <i>sf1</i> corresponds to 1 subframe.</p>

<b>PhysicalConfigDedicated field descriptions</b>	
<b>widebandPRG-SlotSubslot</b>	Indicates whether the precoding resource block group size is the whole scheduled bandwidth for slot or subslot PDSCH operation as specified in TS 36.213 [23].
<b>widebandPRG-Subframe</b>	Indicates whether the precoding resource block group size is the whole scheduled bandwidth for subframe PDSCH operation as specified in TS 36.213 [23].

<b>Conditional presence</b>	<b>Explanation</b>
<i>AI-r8</i>	The field is optionally present, need ON, if <i>antennaInfoDedicated-r10</i> is absent. Otherwise the field is not present
<i>AI-r10</i>	The field is optionally present, need ON, if <i>antennaInfoDedicated</i> is absent. Otherwise the field is not present
<i>AperiodicSRS</i>	If <i>soundingRS-UL-ConfigDedicatedAperiodic-r10</i> is absent, the field is optional, Need ON. Otherwise the field is not present and the UE shall delete any existing value for this field.
<i>AperiodicSRSExt</i>	If <i>soundingRS-UL-ConfigDedicatedAperiodicUpPTsExt-r13</i> is absent, the field is optional, Need ON. Otherwise the field is not present and the UE shall delete any existing value for this field.
<i>AUL</i>	The field is optionally present, need ON, if <i>aul-config-r15</i> is present. Otherwise the field is not present.
<i>CommonUL</i>	The field is mandatory present if <i>ul-Configuration</i> of <i>RadioResourceConfigCommonSCell-r10</i> is present; otherwise it is optional, need ON.
<i>CQI-r8</i>	The field is optionally present, need ON, if <i>cqi-ReportConfig-r10</i> is absent. Otherwise the field is not present
<i>CQI-r10</i>	The field is optionally present, need ON, if <i>cqi-ReportConfig</i> is absent. Otherwise the field is not present
<i>Cross-Carrier-Config</i>	The field is optionally present, need ON, if <i>crossCarrierSchedulingConfig-r10</i> is absent. Otherwise the field is not present
<i>Cross-Carrier-ConfigUL</i>	The field is optionally present, need ON, if <i>crossCarrierSchedulingConfig-r10</i> and <i>crossCarrierSchedulingConfig-r13</i> are absent or <i>schedulingCellInfo</i> is set to 'own'. Otherwise the field is not present.
<i>NTN</i>	The field is optionally present, Need ON, for NTN. Otherwise, the field is not present and the UE shall delete any existing value for this field.
<i>PeriodicSRS</i>	If <i>soundingRS-UL-ConfigDedicated-r10</i> is absent, the field is optional, Need ON. Otherwise the field is not present and the UE shall delete any existing value for this field.
<i>PeriodicSRSPCell</i>	If <i>soundingRS-UL-ConfigDedicated</i> is absent, the field is optional, Need ON. Otherwise the field is not present and the UE shall delete any existing value for this field.
<i>PeriodicSRSExt</i>	If <i>soundingRS-UL-ConfigDedicatedUpPTsExt-r13</i> is absent, the field is optional, Need ON. Otherwise the field is not present and the UE shall delete any existing value for this field.
<i>PUCCH-Format4or5</i>	The field is mandatory present with <i>pucch-Format-v1370</i> set to <i>setup</i> if <i>pucch-ConfigDedicated-r13</i> is configured and <i>pucch-ConfigDedicated-r13</i> indicates PUCCH format 4 or PUCCH format 5; otherwise it is not present and the UE shall delete any existing value for this field.
<i>PUCCH-SCell1</i>	The field is optionally present, need OR, for SCell not configured with <i>pucch-configDedicated-r13</i> . Otherwise it is not present.
<i>PUSCH-SCell</i>	The field is optionally present, need ON, if <i>pusch-ConfigDedicatedSCell-r10</i> and <i>pusch-ConfigDedicated-v1130</i> are absent. Otherwise the field is not present
<i>PUSCH-SCell1</i>	The field is optionally present, need ON, for SCell not configured with <i>pucch-configDedicated-r13</i> . Otherwise it is not present.
<i>SCellAdd</i>	The field is mandatory present if <i>cellIdentification</i> is present; otherwise it is optional, need ON.
<i>SRS-Trigger-TypeA</i>	The field is mandatory present if <i>typeA-SRS-TPC-PDCCH-Group-r14</i> is present. Otherwise the field is not present and the UE shall delete any existing value for this field.

NOTE 1: During handover, the UE performs a MAC reset, which involves reverting to the default CQI/ SRS/ SR configuration in accordance with clause 5.3.13 and TS 36.321 [6], clauses 5.9 and 5.2. Hence, for these parts of the dedicated radio resource configuration, the default configuration (rather than the configuration used in the source PCell) is used as the basis for the delta signalling that is included in the message used to perform handover.

NOTE 2: Since delta signalling is not supported for the common SCell configuration, E-UTRAN can only add or release the uplink of an SCell by releasing and adding the concerned SCell.

## – *P-Max*

The IE *P-Max* is used to limit the UE's uplink transmission power on a carrier frequency and is used to calculate the parameter *P<sub>compensation</sub>* defined in TS 36.304 [4]. Corresponds to parameter  $P_{EMAX}$  or  $P_{EMAX,c}$  in TS 36.101 [42]. The UE transmit power on one serving cell shall not exceed the configured maximum UE output power of the serving cell determined by this value as specified in TS 36.101 [42], clauses 6.2.5 or 6.2.5A, or, when transmitting sidelink discovery announcements within the coverage of the concerned cell, as specified in TS 36.101 [42], clause 6.2.5D.

### *P-Max* information element

```
-- ASN1START
P-Max ::=
    INTEGER (-30..33)
-- ASN1STOP
```

## – *PRACH-Config*

The IE *PRACH-ConfigSIB* and IE *PRACH-Config* are used to specify the PRACH configuration in the system information and in the mobility control information, respectively.

### *PRACH-Config* information elements

```
-- ASN1START
PRACH-ConfigSIB ::=
    SEQUENCE {
        rootSequenceIndex
            INTEGER (0..837),
        prach-ConfigInfo
            PRACH-ConfigInfo
    }

PRACH-ConfigSIB-v1310 ::=
    SEQUENCE {
        rsrp-ThresholdsPrachInfoList-r13
            RSRP-ThresholdsPrachInfoList-r13,
        mpdcch-startSF-CSS-RA-r13
            CHOICE {
                fdd-r13
                    ENUMERATED {v1, v1dot5, v2, v2dot5, v4, v5, v8,
                                v10},
                tdd-r13
                    ENUMERATED {v1, v2, v4, v5, v8, v10, v20, spare}
            }
            OPTIONAL, -- Cond MP
        prach-HoppingOffset-r13
            INTEGER (0..94)
            OPTIONAL, -- Need OR
        prach-ParametersListCE-r13
            PRACH-ParametersListCE-r13
    }

PRACH-ConfigSIB-v1530 ::=
    SEQUENCE {
        edt-PRACH-ParametersListCE-r15
            SEQUENCE (SIZE(1..maxCE-Level-r13)) OF EDT-PRACH-
            ParametersCE-r15
    }

PRACH-Config ::=
    SEQUENCE {
        rootSequenceIndex
            INTEGER (0..837),
        prach-ConfigInfo
            PRACH-ConfigInfo
            OPTIONAL -- Need ON
    }

PRACH-Config-v1310 ::=
    SEQUENCE {
        rsrp-ThresholdsPrachInfoList-r13
            RSRP-ThresholdsPrachInfoList-r13
            OPTIONAL, --
        Cond MP
        mpdcch-startSF-CSS-RA-r13
            CHOICE {
                fdd-r13
                    ENUMERATED {v1, v1dot5, v2, v2dot5, v4, v5, v8,
                                v10},
                tdd-r13
                    ENUMERATED {v1, v2, v4, v5, v8, v10, v20, spare}
            }
            OPTIONAL, -- Cond MP
        prach-HoppingOffset-r13
            INTEGER (0..94)
            OPTIONAL, -- Need OR
        prach-ParametersListCE-r13
            PRACH-ParametersListCE-r13
            OPTIONAL, -- Cond MP
        initial-CE-level-r13
            INTEGER (0..3)
            OPTIONAL -- Need OR
    }

PRACH-Config-v1430 ::=
    SEQUENCE {
        rootSequenceIndexHighSpeed-r14
            INTEGER (0..837),
        zeroCorrelationZoneConfigHighSpeed-r14
            INTEGER (0..12),
        prach-ConfigIndexHighSpeed-r14
            INTEGER (0..63),
        prach-FreqOffsetHighSpeed-r14
            INTEGER (0..94)
    }

PRACH-ConfigSCell-r10 ::=
    SEQUENCE {
        prach-ConfigIndex-r10
            INTEGER (0..63)
    }
```

```

}
PRACH-ConfigInfo ::= SEQUENCE {
    prach-ConfigIndex      INTEGER (0..63),
    highSpeedFlag          BOOLEAN,
    zeroCorrelationZoneConfig  INTEGER (0..15),
    prach-FreqOffset       INTEGER (0..94)
}

PRACH-ParametersListCE-r13 ::= SEQUENCE (SIZE(1..maxCE-Level-r13)) OF PRACH-ParametersCE-r13

PRACH-ParametersCE-r13 ::= SEQUENCE {
    prach-ConfigIndex-r13      INTEGER (0..63),
    prach-FreqOffset-r13       INTEGER (0..94),
    prach-StartingSubframe-r13  ENUMERATED {sf2, sf4, sf8, sf16, sf32, sf64, sf128,
                                                sf256} OPTIONAL, -- Need OP
    maxNumPreambleAttemptCE-r13  ENUMERATED {n3, n4, n5, n6, n7, n8, n10} OPTIONAL, -- Need OP
    numRepetitionPerPreambleAttempt-r13  ENUMERATED {n1,n2,n4,n8,n16,n32,n64,n128},
    mpdcch-NarrowbandsToMonitor-r13  SEQUENCE (SIZE(1..2)) OF
                                        INTEGER (1..maxAvailNarrowBands-r13),
    mpdcch-NumRepetition-RA-r13  ENUMERATED {r1, r2, r4, r8, r16,
                                                r32, r64, r128, r256},
    prach-HoppingConfig-r13       ENUMERATED {on,off}
}

EDT-PRACH-ParametersCE-r15 ::= SEQUENCE {
    edt-PRACH-ParametersCE-r15  SEQUENCE {
        prach-ConfigIndex-r15      INTEGER (0..63),
        prach-FreqOffset-r15       INTEGER (0..94),
        prach-StartingSubframe-r15  ENUMERATED {sf2, sf4, sf8, sf16, sf32, sf64, sf128,
                                                sf256} OPTIONAL, -- Need OP
        mpdcch-NarrowbandsToMonitor-r15  SEQUENCE (SIZE(1..2)) OF INTEGER
(1..maxAvailNarrowBands-r13)
    } OPTIONAL -- Need OR
}

RSRP-ThresholdsPrachInfoList-r13 ::= SEQUENCE (SIZE(1..3)) OF RSRP-Range

PRACH-TxDuration-r17 ::= SEQUENCE {
    prach-TxDuration-r17         ENUMERATED {n1, n2, n4, n8, n16, n32, n64, n128}
}

-- ASN1STOP

```



<b>PRACH-Config field descriptions</b>
<p><b>edt-PRACH-ParametersListCE</b> Configures PRACH parameters for each CE level applicable to a UE performing EDT. If included, the number of entries is same as number of entries in <i>prach-ParametersListCE</i>. The first entry in the list is the PRACH parameters for CE level 0, the second entry in the list is the PRACH parameters for CE level 1, and so on. The parameters <i>maxNumPreambleAttemptCE</i>, <i>numRepetitionPerPreambleAttempt</i>, <i>mpdcch-NumRepetition-RA</i>, <i>prach-HoppingConfig</i> included in <i>prach-ParametersListCE</i> for CE level X are also applicable for EDT.</p>
<p><b>initial-CE-level</b> Indicates initial PRACH CE level at random access, see TS 36.321 [6]. If not configured, UE selects PRACH CE level based on measured RSRP level, see TS 36.321 [6].</p>
<p><b>highSpeedFlag</b> Parameter: High-speed-flag, see TS 36.211 [21], clause 5.7.2]. TRUE corresponds to Restricted set and FALSE to Unrestricted set.</p>
<p><b>maxNumPreambleAttemptCE</b> Maximum number of preamble transmission attempts per CE level. See TS 36.321 [6]. If the field is absent, the UE shall use the default value n3.</p>
<p><b>mpdcch-NarrowbandsToMonitor</b> Narrowbands to monitor for MPDCCH for RAR, see TS 36.213 [23], clause 6.2. Field values (1..<i>maxAvailNarrowBands-r13</i>) correspond to narrowband indices (0..<i>maxAvailNarrowBands-r13-1</i>) as specified in TS 36.211 [21].</p>
<p><b>mpdcch-NumRepetition-RA</b> Maximum number of repetitions for MPDCCH common search space (CSS) for RAR, Msg3 and Msg4, see TS 36.211 [21].</p>
<p><b>mpdcch-startSF-CSS-RA</b> Starting subframe configuration for MPDCCH common search space (CSS), including RAR, Msg3 retransmission, PDSCH with contention resolution and PDSCH with CCCH MAC SDU, see TS 36.211 [21] and TS 36.213 [23]. Value v1 corresponds to 1, value v1dot5 corresponds to 1.5, and so on.</p>
<p><b>numRepetitionPerPreambleAttempt</b> Number of PRACH repetitions per attempt for each CE level, See TS 36.211 [21].</p>
<p><b>prach-ConfigIndex</b> Parameter: <i>prach-ConfigurationIndex</i>, see TS 36.211 [21], clause 5.7.1.</p>
<p><b>prach-ConfigIndexHighSpeed</b> Parameter: <i>prach-ConfigurationIndexHighSpeed</i>, see TS 36.211 [21], clause 5.7.1. If this field is present, the UE shall ignore <i>prach-ConfigIndex</i>.</p>
<p><b>prach-FreqOffset</b> Parameter: <i>prach-FrequencyOffset</i>, see TS 36.211 [21], clause 5.7.1. For TDD the value range is dependent on the value of <i>prach-ConfigIndex</i>.</p>
<p><b>prach-FreqOffsetHighSpeed</b> Parameter: <i>prach-FrequencyOffsetHighSpeed</i>, see TS 36.211 [21], clause 5.7.1. For TDD the value range is dependent on the value of <i>prach-ConfigIndexHighSpeed</i>. If this field is present, the UE shall ignore <i>prach-FreqOffset</i>.</p>
<p><b>prach-HoppingConfig</b> Coverage level specific frequency hopping configuration for PRACH.</p>
<p><b>prach-HoppingOffset</b> Parameter: PRACH frequency hopping offset, expressed as a number of resource blocks, see TS 36.211 [21], clause 5.7.1.</p>
<p><b>prach-ParametersListCE</b> Configures PRACH parameters for each CE level. The first entry in the list is the PRACH parameters of CE level 0, the second entry in the list is the PRACH parameters of CE level 1, and so on.</p>
<p><b>prach-StartingSubframe</b> PRACH starting subframe periodicity, expressed in number of subframes available for preamble transmission (PRACH opportunities), see TS 36.211 [21]. Value sf2 corresponds to 2 subframes, sf4 corresponds to 4 subframes and so on. EUTRAN configures the PRACH starting subframe periodicity larger than or equal to the number of PRACH repetitions per attempt for each CE level (<i>numRepetitionPerPreambleAttempt</i>). If the field is absent, the value is determined implicitly in TS 36.211 [21], clause 5.7.1.</p>
<p><b>prach-TxDuration</b> Duration of PRACH segment transmission in NTN transmission, see TS 36.213 [23]. Unit in duration of one preamble transmission including guard period (TCP+TSEQ+TGP). Value n1 corresponds to the duration of 1 preamble transmission, value n2 corresponds to the duration of 2 preambles transmission and so on.</p>
<p><b>rootSequenceIndex</b> Parameter: <i>RACH_ROOT_SEQUENCE</i>, see TS 36.211 [21], clause 5.7.1.</p>
<p><b>rootSequenceIndexHighSpeed</b> The field indicates starting logical root sequence index used to derive the 64 random access preambles based on restricted set type B in high speed scenario, see TS 36.211 [21], clause 5.7.2. If this field is present, the UE shall generate random access preambles based on restricted set type B and ignore <i>rootSequenceIndex</i>.</p>

<b>PRACH-Config field descriptions</b>
<p><b><i>rsrp-ThresholdsPrachInfoList</i></b>  The criterion for BL UEs and UEs in CE to select PRACH resource set. Up to 3 RSRP threshold values are signalled to determine the CE level for PRACH, see TS 36.213 [23]. The first element corresponds to RSRP threshold 1, the second element corresponds to RSRP threshold 2 and so on, see TS 36.321 [6]. The UE shall ignore this field if only one CE level, i.e. CE level 0, is configured in <i>prach-ParametersListCE</i>. The number of RSRP thresholds present in <i>rsrp-ThresholdsPrachInfoList</i> is equal to the number of CE levels configured in <i>prach-ParametersListCE</i> minus one. A UE that supports <i>powerClass-14dBm</i> shall correct the RSRP threshold values before applying them as follows: RSRP threshold = Signalled RSRP threshold - min{0, (14-min(23, P-Max))} where P-Max is the value of <i>p-Max</i> field in <i>SystemInformationBlockType1-BR</i>.</p>
<p><b><i>zeroCorrelationZoneConfig</i></b>  Parameter: Ncs configuration, see TS 36.211 [21], clause 5.7.2: table 5.7.2-2, for preamble format 0..3 and TS 36.211 [21], clause 5.7.2: table 5.7.2-3, for preamble format 4.</p>
<p><b><i>zeroCorrelationZoneConfigHighSpeed</i></b>  The field indicates Ncs configuration for the restricted set type B in high speed scenario, see TS 36.211 [21], clause 5.7.2. If this field is present, the UE shall generate random access preambles based on restricted set type B and ignore <i>zeroCorrelationZoneConfig</i>.</p>

<b>Conditional presence</b>	<b>Explanation</b>
<i>MP</i>	The field is mandatory present.

## – *PresenceAntennaPort1*

The IE *PresenceAntennaPort1* is used to indicate whether all the neighbouring cells use Antenna Port 1. When set to *TRUE*, the UE may assume that at least two cell-specific antenna ports are used in all neighbouring cells.

### ***PresenceAntennaPort1* information element**

```
-- ASN1START
PresenceAntennaPort1 ::=          BOOLEAN
-- ASN1STOP
```

## – *PUCCH-Config*

The IE *PUCCH-ConfigCommon* and IE *PUCCH-ConfigDedicated* are used to specify the common and the UE specific PUCCH configuration respectively.

### ***PUCCH-Config* information elements**

```
-- ASN1START
PUCCH-ConfigCommon ::=          SEQUENCE {
    deltaPUCCH-Shift              ENUMERATED {ds1, ds2, ds3},
    nRB-CQI                       INTEGER (0..98),
    nCS-AN                        INTEGER (0..7),
    n1PUCCH-AN                    INTEGER (0..2047)
}

PUCCH-ConfigCommon-v1310 ::=    SEQUENCE {
    n1PUCCH-AN-InfoList-r13       N1PUCCH-AN-InfoList-r13    OPTIONAL, -- Need OR
    pucch-NumRepetitionCE-Msg4-Level0-r13  ENUMERATED {n1, n2, n4, n8}    OPTIONAL, -- Need OR
    pucch-NumRepetitionCE-Msg4-Level1-r13  ENUMERATED {n1, n2, n4, n8}    OPTIONAL, -- Need OR
    pucch-NumRepetitionCE-Msg4-Level2-r13  ENUMERATED {n4, n8, n16, n32}   OPTIONAL, -- Need OR
    pucch-NumRepetitionCE-Msg4-Level3-r13  ENUMERATED {n4, n8, n16, n32}   OPTIONAL, -- Need OR
}

PUCCH-ConfigCommon-v1430 ::=    SEQUENCE {
    pucch-NumRepetitionCE-Msg4-Level3-r14  ENUMERATED {n64, n128}         OPTIONAL, -- Need OR
}

PUCCH-ConfigDedicated ::=       SEQUENCE {
    ackNackRepetition             CHOICE {
        release                    NULL,
    }
}
```

```

        setup                                SEQUENCE {
            repetitionFactor                  ENUMERATED {n2, n4, n6, spare1},
            n1PUCCH-AN-Rep                    INTEGER (0..2047)
        },
        tdd-AckNackFeedbackMode              ENUMERATED {bundling, multiplexing} OPTIONAL -- Cond TDD
    }

PUCCH-ConfigDedicated-v1020 ::= SEQUENCE {
    pucch-Format-r10                        CHOICE {
        format3-r10                          PUCCH-Format3-Conf-r13,
        channelSelection-r10                 SEQUENCE {
            n1PUCCH-AN-CS-r10                CHOICE {
                release                       NULL,
                setup                         SEQUENCE {
                    n1PUCCH-AN-CS-List-r10   SEQUENCE (SIZE (1..2)) OF N1PUCCH-AN-CS-r10
                }
            }
        }
    }
    twoAntennaPortActivatedPUCCH-Format1alb-r10  ENUMERATED {true} OPTIONAL -- Need OR
    simultaneousPUCCH-PUSCH-r10                 ENUMERATED {true} OPTIONAL -- Need OR
    n1PUCCH-AN-RepP1-r10                        INTEGER (0..2047) OPTIONAL -- Need OR
}

PUCCH-ConfigDedicated-v1130 ::= SEQUENCE {
    n1PUCCH-AN-CS-v1130                      CHOICE {
        release                               NULL,
        setup                                 SEQUENCE {
            n1PUCCH-AN-CS-ListP1-r11         SEQUENCE (SIZE (2..4)) OF INTEGER (0..2047)
        }
    }
    nPUCCH-Param-r11                         CHOICE {
        release                               NULL,
        setup                                 SEQUENCE {
            nPUCCH-Identity-r11             INTEGER (0..503),
            n1PUCCH-AN-r11                  INTEGER (0..2047)
        }
    }
}
OPTIONAL -- Need ON

PUCCH-ConfigDedicated-v1250 ::= SEQUENCE {
    nkaPUCCH-Param-r12                      CHOICE {
        release                               NULL,
        setup                                 SEQUENCE {
            nkaPUCCH-AN-r12                 INTEGER (0..2047)
        }
    }
}

PUCCH-ConfigDedicated-r13 ::= SEQUENCE {
--Release 8
    ackNackRepetition-r13                   CHOICE{
        release                               NULL,
        setup                                 SEQUENCE {
            repetitionFactor-r13            ENUMERATED {n2, n4, n6, spare1},
            n1PUCCH-AN-Rep-r13              INTEGER (0..2047)
        }
    },
    tdd-AckNackFeedbackMode-r13             ENUMERATED {bundling, multiplexing} OPTIONAL, -- Cond TDD
--Release 10
    pucch-Format-r13                        CHOICE {
        format3-r13                          SEQUENCE {
            n3PUCCH-AN-List-r13             SEQUENCE (SIZE (1..4)) OF INTEGER (0..549) OPTIONAL, -- Need ON
            twoAntennaPortActivatedPUCCH-Format3-r13 CHOICE {
                release                       NULL,
                setup                         SEQUENCE {
                    n3PUCCH-AN-ListP1-r13   SEQUENCE (SIZE (1..4)) OF INTEGER (0..549)
                }
            }
        }
    }
    channelSelection-r13                    SEQUENCE {
        n1PUCCH-AN-CS-r13                   CHOICE {
            release                           NULL,
            setup                             SEQUENCE {
                n1PUCCH-AN-CS-List-r13     SEQUENCE (SIZE (1..2)) OF N1PUCCH-AN-CS-r10,
                dummy1                      SEQUENCE (SIZE (2..4)) OF INTEGER (0..2047)
            }
        }
    }
}

```

```

    }
    },
    format4-r13 SEQUENCE {
        format4-resourceConfiguration-r13 SEQUENCE (SIZE (4)) OF Format4-resource-r13,
        format4-MultiCSI-resourceConfiguration-r13 SEQUENCE (SIZE (1..2)) OF Format4-resource-
r13 OPTIONAL -- Need OR
    },
    format5-r13 SEQUENCE {
        format5-resourceConfiguration-r13 SEQUENCE (SIZE (4)) OF Format5-resource-r13,
        format5-MultiCSI-resourceConfiguration-r13 Format5-resource-r13 OPTIONAL -- Need OR
    }
}
twoAntennaPortActivatedPUCCH-Format1alb-r13 ENUMERATED {true} OPTIONAL, -- Need OR
simultaneousPUCCH-PUSCH-r13 ENUMERATED {true} OPTIONAL, -- Need OR
n1PUCCH-AN-RepP1-r13 INTEGER (0..2047) OPTIONAL, -- Need OR
--Release 11
nPUCCH-Param-r13 CHOICE {
    release NULL,
    setup SEQUENCE {
        nPUCCH-Identity-r13 INTEGER (0..503),
        n1PUCCH-AN-r13 INTEGER (0..2047)
    }
}
OPTIONAL, -- Need ON
--Release 12
nkaPUCCH-Param-r13 CHOICE {
    release NULL,
    setup SEQUENCE {
        nkaPUCCH-AN-r13 INTEGER (0..2047)
    }
}
OPTIONAL, -- Need ON
--Release 13
spatialBundlingPUCCH-r13 BOOLEAN,
spatialBundlingPUSCH-r13 BOOLEAN,
harq-TimingTDD-r13 BOOLEAN,
codebookSizeDetermination-r13 ENUMERATED {dai,cc} OPTIONAL, -- Need OR
maximumPayloadCoderate-r13 INTEGER (0..7) OPTIONAL, -- Need OR
pucch-NumRepetitionCE-r13 CHOICE {
    release NULL,
    setup CHOICE {
        modeA SEQUENCE {
            pucch-NumRepetitionCE-format1-r13 ENUMERATED {r1, r2, r4, r8},
            pucch-NumRepetitionCE-format2-r13 ENUMERATED {r1, r2, r4, r8}
        },
        modeB SEQUENCE {
            pucch-NumRepetitionCE-format1-r13 ENUMERATED {r4, r8, r16, r32},
            pucch-NumRepetitionCE-format2-r13 ENUMERATED {r4, r8, r16, r32}
        }
    }
}
OPTIONAL --Need ON
}
PUCCH-ConfigDedicated-v1370 ::= SEQUENCE {
    pucch-Format-v1370 CHOICE {
        release NULL,
        setup PUCCH-Format3-Conf-r13
    }
}
PUCCH-ConfigDedicated-v13c0 ::= SEQUENCE {
    channelSelection-v13c0 SEQUENCE {
        n1PUCCH-AN-CS-v13c0 CHOICE {
            release NULL,
            setup SEQUENCE {
                n1PUCCH-AN-CS-ListP1-v13c0 SEQUENCE (SIZE (2..4)) OF INTEGER (0..2047)
            }
        }
    }
}
PUCCH-Format3-Conf-r13 ::= SEQUENCE {
    n3PUCCH-AN-List-r13 SEQUENCE (SIZE (1..4)) OF INTEGER (0..549) OPTIONAL, -- Need ON
    twoAntennaPortActivatedPUCCH-Format3-r13 CHOICE {
        release NULL,
        setup SEQUENCE {
            n3PUCCH-AN-ListP1-r13 SEQUENCE (SIZE (1..4)) OF INTEGER (0..549)
        }
    }
}
OPTIONAL -- Need ON
}

```

```
PUCCH-ConfigDedicated-v1430 ::= SEQUENCE {
  pucch-NumRepetitionCE-format1-r14    ENUMERATED {r64,r128}    OPTIONAL  -- Need OR
}

PUCCH-ConfigDedicated-v1530 ::= SEQUENCE {
  n1PUCCH-AN-SPT-r15                   INTEGER (0..2047)      OPTIONAL,  -- Need OR
  codebooksizeDeterminationSTTI-r15    ENUMERATED {dai,cc}    OPTIONAL  -- Need OR
}

Format4-resource-r13 ::= SEQUENCE {
  startingPRB-format4-r13               INTEGER (0..109),
  numberOfPRB-format4-r13               INTEGER (0..7)
}

Format5-resource-r13 ::= SEQUENCE {
  startingPRB-format5-r13               INTEGER (0..109),
  cdm-index-format5-r13                 INTEGER (0..1)
}

N1PUCCH-AN-CS-r10 ::= SEQUENCE (SIZE (1..4)) OF INTEGER (0..2047)

N1PUCCH-AN-InfoList-r13 ::= SEQUENCE (SIZE(1..maxCE-Level-r13)) OF INTEGER (0..2047)

PUCCH-TxDuration-r17 ::= SEQUENCE {
  pucch-TxDuration-r17                 ENUMERATED {sf2, sf4, sf8, sf16, sf32, sf64, sf128}
}

-- ASN1STOP
```

<b>PUCCH-Config field descriptions</b>
<p><b>ackNackRepetition</b> Parameter indicates whether ACK/NACK repetition is configured, see TS 36.213 [23], clause 10.1.</p>
<p><b>cdm-index-format5</b> Parameter <math>n_{oc}</math> see TS 36.211 [21], clause 5.4.2c, for determining PUCCH resource(s) of PUCCH format 5.</p>
<p><b>codebooksizeDetermination, codebooksizeDeterminationSTTI</b> Parameter indicates whether HARQ codebook size is determined with downlink assignment indicator based solution or number of configured CCs, see TS 36.212 [22], clauses 5.2.2.6, 5.2.3.1 and 5.3.3.1.2, and TS 36.213 [23], clauses 10.1.2.2.3, 10.1.3.2.3, 10.1.3.2.3.1, 10.1.3.2.3.2 and 10.1.3.2.4.</p>
<p><b>deltaPUCCH-Shift</b> Parameter: <math>\Delta_{\text{shift}}^{\text{PUCCH}}</math>, see TS 36.211 [21], clause 5.4.1, where ds1 corresponds to value 1, ds2 corresponds to value 2 etc.</p>
<p><b>dummy1</b> This field is not used in the specification. If received it shall be ignored by the UE.</p>
<p><b>harq-TimingTDD</b> Parameter indicates for a TDD SCell when aggregated with a TDD PCell of different UL/DL configurations whether deriving the HARQ timing for such a cell is done in the same way as the DL HARQ timing of an FDD SCell with a TDD PCell, see TS 36.213 [23], clause 10.2.</p>
<p><b>maximumPayloadCoderate</b> Maximum payload or code rate for multi P-CSI on each PUCCH resource, see TS 36.213 [23], clause 10.1.1.</p>
<p><b>n1PUCCH-AN</b> Parameter: <math>N_{\text{PUCCH}}^{(1)}</math>, see TS 36.213 [23], clause 10.1. <math>n1\text{PUCCH-AN-r11}</math> indicates UE-specific PUCCH AN resource offset, see TS 36.213 [23], clause 10.1.</p>
<p><b>n1PUCCH-AN-CS-List</b> Parameter: <math>n_{\text{PUCCH},j}^{(1)}</math> for antenna port <math>p_0</math> for PUCCH format 1b with channel selection, see TS 36.213 [23], clauses 10.1.2.2.1 and 10.1.3.2.1.</p>
<p><b>n1PUCCH-AN-CS-ListP1</b> Parameter: <math>n_{\text{PUCCH},j}^{(1,\tilde{p}_1)}</math> for antenna port <math>p_1</math> for PUCCH format 1b with channel selection, see TS 36.213 [23], clause 10.1. E-UTRAN configures this field only when <i>pucch-Format</i> is set to <i>channelSelection</i>.</p>
<p><b>n1PUCCH-AN-Rep, n1PUCCH-AN-RepP1</b> Parameter: <math>n_{\text{PUCCH},\text{ANRep}}^{(1,p)}</math> for antenna port P0 and for antenna port P1 respectively, see TS 36.213 [23], clause 10.1.</p>
<p><b>n3PUCCH-AN-List, n3PUCCH-AN-ListP1</b> Parameter: <math>n_{\text{PUCCH}}^{(3,p)}</math> for antenna port P0 and for antenna port P1 respectively, see TS 36.213 [23], clause 10.1.</p>
<p><b>n1PUCCH-AN-SPT</b> Parameter: <math>N_{\text{PUCCH}}^{(1)}</math>, see TS 36.213 [23], clause 10.1. Indicates UE-specific PUCCH AN resource offset for short processing time.</p>
<p><b>nCS-An</b> Parameter: <math>N_{\text{CS}}^{(1)}</math> see TS 36.211 [21], clause 5.4.</p>
<p><b>nkaPUCCH-AN</b> Parameter: <math>N_{\text{PUCCH}}^{K_A}</math>, see TS 36.213 [23], clause 10.1.3. <math>nka\text{PUCCH-AN-r12}</math> indicates PUCCH format 1a/1b starting offset for the subframe set <math>K^A</math>, see TS 36.213 [23], clause 10.1.3. E-UTRAN configures <i>nkaPUCCH-AN</i> only if <i>eimta-MainConfig</i> is configured.</p>
<p><b>nPUCCH-Identity</b> Parameter: <math>n_{\text{ID}}^{\text{PUCCH}}</math>, see TS 36.211 [21], clause 5.5.1.5.</p>
<p><b>nRB-CQI</b> Parameter: <math>N_{\text{RB}}^{(2)}</math>, see TS 36.211 [21], clause 5.4.</p>
<p><b>numberOfPRB-format4</b> Parameter <math>n_{\text{PUCCH}}^{(4)}</math> see TS 36.213 [23], Table 10.1.1-2, for determining PUCCH resource(s) of PUCCH format 4.</p>
<p><b>n1PUCCH-AN-InfoList</b> Starting offsets of the PUCCH resource(s) indicated by SIB1-BR. The first entry in the list is the starting offset of the PUCCH resource(s) of CE level 0, the second entry in the list is the starting offset of the PUCCH resource(s) of CE level 1, and so on. If E-UTRAN includes <i>n1PUCCH-AN-InfoList</i>, it includes the same number of entries as in <i>prach-ParametersListCE</i>. See TS 36.213 [23].</p>

<b>PUCCH-Config field descriptions</b>	
<b><i>pucch-Format</i></b>	Parameter indicates one of the PUCCH formats for transmission of HARQ-ACK, see TS 36.213 [23], clause 10.1. For TDD, if the UE is configured with PCell only, the <i>channelSelection</i> indicates the transmission of HARQ-ACK multiplexing as defined in Tables 10.1.3-5, 10.1.3-6, and 10.1.3-7 in TS 36.213 [23] for PUCCH, and in 7.3 in TS 36.213 [23] for PUSCH. E-UTRAN only configures <i>pucch-Format-v1370</i> when <i>pucch-Format-r13</i> is configured and set to <i>format4</i> or <i>format5</i> .
<b><i>pucch-NumRepetitionCE</i></b>	Number of PUCCH repetitions for PUCCH format 1/1a and for PUCCH format 2/2a/2b for CE modes A and B, see TS 36.211 [21] and TS 36.213 [23]. The UE shall ignore <i>pucch-NumRepetitionCE-format2-r13</i> , if received, for CE mode B in this release of specification. For UE in CE mode B supporting extended PUCCH repetition, if <i>pucch-NumRepetitionCE-format1-r14</i> is included then the UE shall ignore <i>pucch-NumRepetitionCE-format1-r13</i> .
<b><i>pucch-NumRepetitionCE-Msg4-Level0</i>, <i>pucch-NumRepetitionCE-Msg4-Level1</i>, <i>pucch-NumRepetitionCE-Msg4-Level2</i>, <i>pucch-NumRepetitionCE-Msg4-Level3</i></b>	Number of repetitions for PUCCH carrying HARQ response to PDSCH containing Msg4 for PRACH CE levels 0, 1, 2 and 3, see TS 36.211 [21] and TS 36.213 [23]. Value <i>n1</i> corresponds to 1 repetition, value <i>n2</i> corresponds to 2 repetitions, and so on. For BL UEs or non-BL UEs in enhanced coverage supporting extended PUCCH repetition, if <i>pucch-NumRepetitionCE-Msg4-Level3-r14</i> is included then the UE shall ignore <i>pucch-NumRepetitionCE-Msg4-Level3-r13</i> .
<b><i>pucch-TxDuration</i></b>	Duration of PUCCH segment transmission in NTN transmission, see TS 36.213 [23]. Unit in subframe. Value <i>sf2</i> corresponds to 2 subframes, value <i>sf4</i> corresponds to 4 subframes and so on.
<b><i>repetitionFactor</i></b>	Parameter $N_{ANRep}$ see TS 36.213 [23], clause 10.1, where <i>n2</i> corresponds to repetition factor 2, <i>n4</i> to 4.
<b><i>simultaneousPUCCH-PUSCH</i></b>	Parameter indicates whether simultaneous PUCCH and PUSCH or simultaneous SPUCCH and SlotOrSubslotPUSCH transmissions are configured, see TS 36.213 [23], clauses 10.1 and 5.1.1. E-UTRAN configures this field for the PCell, only when the <i>nonContiguousUL-RA-WithinCC-Info</i> is set to <i>supported</i> in the band on which PCell is configured. Likewise, E-UTRAN configures this field for the PSCell, only when the <i>nonContiguousUL-RA-WithinCC-Info</i> is set to <i>supported</i> in the band on which PSCell is configured. Likewise, E-UTRAN configures this field for the PUCCH SCell, only when the <i>nonContiguousUL-RA-WithinCC-Info</i> is set to <i>supported</i> in the band on which PUCCH SCell is configured.
<b><i>spatialBundlingPUCCH</i></b>	Parameter indicates whether spatial bundling is enabled or not for PUCCH, see TS 36.212 [22], clause 5.2.3.1.
<b><i>spatialBundlingPUSCH</i></b>	Parameter indicates whether spatial bundling is enabled or not for PUSCH, see see TS 36.212 [22], clause 5.2.2.6.
<b><i>startingPRB-format4</i></b>	Parameter $n_{PUCCH}^{(4)}$ see TS 36.211 [21], clause 5.4.3 for determining PUCCH resource(s) of PUCCH format 4.
<b><i>startingPRB-format5</i></b>	Parameter $n_{PUCCH}^{(5)}$ see TS 36.211 [21], clause 5.4.3 for determining PUCCH resource(s) of PUCCH format 5.
<b><i>tdd-AckNackFeedbackMode</i></b>	Parameter indicates one of the TDD ACK/NACK feedback modes used, see TS 36.213 [23], clauses 7.3 and 10.1.3. The value <i>bundling</i> corresponds to use of ACK/NACK bundling whereas, the value <i>multiplexing</i> corresponds to ACK/NACK multiplexing as defined in Tables 10.1.3-2, 10.1.3-3, and 10.1.3-4 in TS 36.213 [23]. The same value applies to both ACK/NACK feedback modes on PUCCH as well as on PUSCH.
<b><i>twoAntennaPortActivatedPUCCH-Format1a1b</i></b>	Indicates whether two antenna ports are configured for PUCCH format 1a/1b for HARQ-ACK, see TS 36.213 [23], clause 10.1. The field also applies for PUCCH format 1a/1b transmission when <i>format3</i> is configured, see TS 36.213 [23], clauses 10.1.2.2.2 and 10.1.3.2.2.
<b><i>twoAntennaPortActivatedPUCCH-Format3</i></b>	Indicates whether two antenna ports are configured for PUCCH format 3 for HARQ-ACK, see TS 36.213 [23], clause 10.1.

Conditional presence	Explanation
<i>TDD</i>	The field is mandatory present for TDD if the <i>pucch-Format</i> is not present. If the <i>pucch-Format</i> is present, the field is not present and the UE shall delete any existing value for this field. It is not present for FDD and the UE shall delete any existing value for this field.

– **PUR-Config**

The IE *PUR-Config* is used to specify the PUR configuration.

**PUR-Config information element**

```

-- ASN1START
PUR-Config-r16 ::= SEQUENCE {
  pur-ConfigID-r16 PUR-ConfigID-r16 OPTIONAL, -- Need OR
  pur-ImplicitReleaseAfter-r16 ENUMERATED {n2, n4, n8, spare} OPTIONAL, -- Need OR
  pur-StartTimeParameters-r16 SEQUENCE {
    periodicityAndOffset-r16 PUR-PeriodicityAndOffset-r16,
    startSFN-r16 INTEGER (0..1023),
    startSubFrame-r16 INTEGER (0..9),
    hsfN-LSB-Info-r16 BIT STRING (SIZE(1))
  } OPTIONAL, --Need ON
  pur-NumOccasions-r16 ENUMERATED {one, infinite},
  pur-RNTI-r16 C-RNTI OPTIONAL, -- Need ON
  pur-TimeAlignmentTimer-r16 INTEGER (1..8) OPTIONAL, -- Need OR
  pur-RSRP-ChangeThreshold-r16 SetupRelease {PUR-RSRP-ChangeThreshold-r16} OPTIONAL, -- Need
ON
  pur-ResponseWindowTimer-r16 ENUMERATED {sf240, sf480, sf960, sf1920, sf3840, sf5760, sf7680,
sf10240} OPTIONAL, -- Need ON
  pur-MPDCCH-Config-r16 PUR-MPDCCH-Config-r16 OPTIONAL, -- Need ON
  pur-PDSCH-FreqHopping-r16 BOOLEAN,
  pur-PUCCH-Config-r16 PUR-PUCCH-Config-r16 OPTIONAL, -- Need ON
  pur-PUSCH-Config-r16 PUR-PUSCH-Config-r16 OPTIONAL, -- Need ON
  ...,
  [[ pur-PDSCH-maxTBS-r17 BOOLEAN OPTIONAL -- Need ON
  ]]
}

PUR-MPDCCH-Config-r16 ::= SEQUENCE {
  mpdcch-FreqHopping-r16 BOOLEAN,
  mpdcch-Narrowband-r16 INTEGER (1..maxAvailNarrowBands-r13),
  mpdcch-PRB-PairsConfig-r16 SEQUENCE{
    numberPRB-Pairs-r16 ENUMERATED {n2, n4, n6, spare1},
    resourceBlockAssignment-r16 BIT STRING (SIZE(4))
  },
  mpdcch-NumRepetition-r16 ENUMERATED {r1, r2, r4, r8, r16, r32, r64, r128, r256},
  mpdcch-StartSF-UESS-r16 CHOICE {
    fdd ENUMERATED {v1, v1dot5, v2, v2dot5, v4, v5, v8, v10},
    tdd ENUMERATED {v1, v2, v4, v5, v8, v10, v20, spare1}
  },
  mpdcch-Offset-PUR-SS-r16 ENUMERATED {zero, oneEighth, oneQuarter,
threeEighth, oneHalf, fiveEighth,
threeQuarter, sevenEighth}
}

PUR-PUCCH-Config-r16 ::= SEQUENCE {
  n1PUCCH-AN-r16 INTEGER (0..2047) OPTIONAL, -- Need ON
  pucch-NumRepetitionCE-Format1-r16 ENUMERATED {n1, n2, n4, n8} OPTIONAL -- Need ON
}

PUR-PUSCH-Config-r16 ::= SEQUENCE {
  pur-GrantInfo-r16 CHOICE {
    ce-ModeA SEQUENCE {
      numRUs-r16 BIT STRING (SIZE(2)),
      prb-AllocationInfo-r16 BIT STRING (SIZE(10)),
      mcs-r16 BIT STRING (SIZE(4)),
      numRepetitions-r16 BIT STRING (SIZE(3))
    },
    ce-ModeB SEQUENCE {
      subPRB-Allocation-r16 BOOLEAN,
      numRUs-r16 BOOLEAN,
      prb-AllocationInfo-r16 BIT STRING (SIZE(8)),
      mcs-r16 BIT STRING (SIZE(4)),
      numRepetitions-r16 BIT STRING (SIZE(3))
    }
  } OPTIONAL, -- Need ON
  pur-PUSCH-FreqHopping-r16 BOOLEAN,
  p0-UE-PUSCH-r16 INTEGER (-8..7),
  alpha-r16 Alpha-r12,
  pusch-CyclicShift-r16 ENUMERATED {n0, n6},
  pusch-NB-MaxTBS-r16 BOOLEAN,
  locationCE-ModeB-r16 INTEGER (0..5) OPTIONAL -- Cond SubPRB
}

PUR-RSRP-ChangeThreshold-r16 ::= SEQUENCE {
  increaseThresh-r16 RSRP-ChangeThresh-r16,
  decreaseThresh-r16 RSRP-ChangeThresh-r16 OPTIONAL --Need OP
}

```



```
}  
RSRP-ChangeThresh-r16 ::= ENUMERATED {dB4, dB6, dB8, dB10, dB14, dB18, dB22, dB26, dB30, dB34,  
spare6, spare5, spare4, spare3, spare2, spare1}  
-- ASN1STOP
```

<b>PUR-Config field descriptions</b>
<p><b>alpha</b> Parameter: <math>\alpha_c(3)</math>. See TS 36.213 [23], clause 5.1.1.1.</p>
<p><b>hsfn-LSB-Info</b> Indicates the LSB of the H-SFN corresponding to the last subframe of the first transmission of <i>RRCCConnectionRelease</i> message containing <i>pur-Config</i>.</p>
<p><b>locationCE-ModeB</b> PRB location within the narrowband when PUSCH sub-PRB resource allocation is enabled for PUR grant in CE mode B.</p>
<p><b>mpdcch-FreqHopping</b> Frequency hopping activation/deactivation for MPDCCH. See TS 36.213 [23].</p>
<p><b>mpdcch-Narrowband</b> Indicates the index of a narrowband on which the UE monitors for MPDCCH, see TS 36.213 [23], clause 9.1.5. Field values (1..<i>maxAvailNarrowBands-r13</i>) correspond to narrowband indices (0..<i>maxAvailNarrowBands-r13-1</i>) as specified in TS 36.211 [21].</p>
<p><b>mpdcch-NumRepetition</b> Maximum number of repetitions levels for UE-SS for MPDCCH, see TS 36.213 [23].</p>
<p><b>mpdcch-Offset-PUR-SS</b> Starting subframes configuration of the MPDCCH search space for PUR, see TS 36.213 [23].</p>
<p><b>mpdcch-PRB-PairsConfig</b> Indicates the configuration of physical resource-block pairs used for MPDCCH. See TS 36.213 [23]. <i>mpdcch-PRB-Pairs</i> indicates the number of PRB pairs. Value <i>n2</i> corresponds to 2 PRB pairs; <i>n4</i> corresponds to 4 PRB pairs and so on. <i>resourceBlockAssignment</i> indicates the index to a specific combination of PRB pair for MPDCCH set. See TS 36.213 [23], clause 9.1.4.4.</p>
<p><b>mpdcch-StartSF-U ESS</b> Starting subframe configuration for an MPDCCH PUR search space, see TS 36.213 [23]. Value <i>v1</i> corresponds to 1, value <i>v1dot5</i> corresponds to 1.5, and so on.</p>
<p><b>n1PUCCH-AN</b> Indicates UE-specific PUCCH AN resource offset, see TS 36.213 [23], clause 10.1.</p>
<p><b>p0-UE-PUSCH</b> Parameter: <math>P_{0,UE\_PUSCH,c}(3)</math>. See TS 36.213 [23], clause 5.1.1.1, unit dB.</p>
<p><b>pucch-NumRepetitionCE-Format1</b> Number of PUCCH repetitions for PUCCH format 1/1a, see TS 36.211 [21] and TS 36.213 [23]. When <i>pur-GrantInfo</i> is set to <i>ce-ModeA</i>, value <i>n1</i> corresponds to 1 repetition, value <i>n2</i> corresponds to 2 repetitions, and so on. When <i>pur-GrantInfo</i> is set to <i>ce-ModeB</i>, actual value corresponds to 4 * indicated value.</p>
<p><b>pusch-CyclicShift</b> Parameter: <math>n_{cs,\lambda}</math>. See TS 36.211 [21] clause 5.5.2.1.1. Value <i>n0</i> corresponds to 0 and <i>n6</i> corresponds to 6.</p>
<p><b>pusch-NB-MaxTBS</b> Activation of 2984 bits maximum PUSCH TBS in 1.4 MHz in CE mode A, see TS 36.212 [22] and TS 36.213 [23].</p>
<p><b>pur-GrantInfo</b> Indicates UL grant for transmission using PUR. Field set to <i>ce-ModeA</i> indicates the PUR grant is for CE Mode A and the field set to <i>ce-ModeB</i> indicates the PUR grant is for CE Mode B. <i>numRUs</i> indicates DCI field for PUSCH number of resource units, see TS 36.213 [23] clause 8.1.6. <i>prbAllocationInfo</i> indicates DCI field for PUSCH resource block assignment, see TS 36.212 [22], clause 5.3.3.1.10 (CE Mode A) and clause 5.3.3.1.11 (CE Mode B). <i>mcs</i> indicates DCI field for PUSCH modulation and coding scheme, see TS 36.213 [23] clause 8.6. <i>numRepetitions</i> indicates DCI field for PUSCH repetition number, see TS 36.213 [23] clause 8.0. For CE Mode A, <i>numRUs</i> set to '00' indicates use of full-PRB resource allocation, otherwise sub-PRB resource allocation as defined in TS 36.213 [23], clause 8.1.6. For CE Mode B, <i>subPRB-Allocation</i> indicates whether sub-PRB resource allocation is used.</p>
<p><b>pur-ImplicitReleaseAfter</b> Number of consecutive PUR occasions that can be skipped before implicit release, as specified in 5.3.3.20. Value <i>n2</i> corresponds to 2 PUR occasions, value <i>n4</i> corresponds to 4 PUR occasions and so on.</p>
<p><b>pur-NumOccasions</b> Number of PUR occasions. Value <i>one</i> corresponds to 1 PUR occasion, and value <i>infinite</i> corresponds to an infinite number of PUR occasions.</p>
<p><b>pur-PDSCH-FreqHopping</b> Frequency hopping activation/deactivation for PDSCH. See TS 36.213 [23].</p>
<p><b>pur-PDSCH-maxTBS</b> Activation/deactivation of DL TBS of 1736 bits for HD-FDD BL UE in CE mode A, see TS 36.213 [23], clause 7.1.7.2.</p>
<p><b>pur-PeriodicityAndOffset</b> Indicates the periodicity for the PUR occasions and time offset until the first PUR occasion.</p>
<p><b>pur-PUSCH-FreqHopping</b> Frequency hopping activation/deactivation for PUSCH. See TS 36.213 [23].</p>
<p><b>pur-ResponseWindowTimer</b> PUR MPDCCH search space window duration. See TS 36.321 [6] and TS 36.213 [23]. Value in subframes. Value <i>sf240</i> corresponds to 240 subframes, value <i>sf480</i> corresponds to 480 subframes and so on.</p>

***pur-RSRP-ChangeThreshold***

Indicates the threshold(s) of change in serving cell RSRP in dB for TA validation. Value dB4 corresponds to 4 dB, value dB6 corresponds to 6 dB and so on. When *pur-RSRP-ChangeThreshold* is set to *setup*, if *decreaseThresh* is absent the value of *increaseThresh* is also used for *decreaseThresh*.

***pur-TimeAlignmentTimer***

Indicates the idle mode TA timer in seconds for TA validation. Actual value = indicated value \* PUR periodicity.

Conditional presence	Explanation
<i>SubPRB</i>	This field is optionally present, need ON, if <i>subPRB-Allocation</i> is set to TRUE; otherwise the field is not present and UE shall delete any existing value for this field.

## – *PUR-ConfigID*

The IE *PUR-ConfigID* is used to indicate the PUR configuration identity.

### ***PUR-ConfigID* information element**

```
-- ASN1START
PUR-ConfigID-r16 ::= BIT STRING (SIZE(20))
-- ASN1STOP
```

## – *PUR-PeriodicityAndOffset*

The IE *PUR-PeriodicityAndOffset* is used to indicate H-SFN of the first PUR occasion and periodicity of the subsequent PUR occasions. The value of periodicity is in the unit of H-SFN duration (i.e., 10.24s). Value *periodicity8* corresponds to periodicity of 8 H-SFN, value *periodicity16* corresponds to periodicity of 16 H-SFN and so on. The value of offset is in the unit of H-SFN duration (i.e., 10.24s).

### ***PUR-PeriodicityAndOffset* information element**

```
-- ASN1START
PUR-PeriodicityAndOffset-r16 ::= CHOICE {
  periodicity8      INTEGER (1..7),
  periodicity16    INTEGER (1..15),
  periodicity32    INTEGER (1..31),
  periodicity64    INTEGER (1..63),
  periodicity128   INTEGER (1..127),
  periodicity256   INTEGER (1..255),
  periodicity512   INTEGER (1..511),
  periodicity1024  INTEGER (1..1023),
  periodicity2048  INTEGER (1..2047),
  periodicity4096  INTEGER (1..4095),
  periodicity8192  INTEGER (1..8191)
}
-- ASN1STOP
```

## – *PUSCH-Config*

The IE *PUSCH-ConfigCommon* is used to specify the common PUSCH configuration and the reference signal configuration for PUSCH and PUCCH. The IE *PUSCH-ConfigDedicated* is used to specify the UE specific PUSCH configuration.

### ***PUSCH-Config* information element**

```
-- ASN1START
PUSCH-ConfigCommon ::= SEQUENCE {
  pusch-ConfigBasic SEQUENCE {
    n-SB          INTEGER (1..4),
    hoppingMode   ENUMERATED {interSubFrame, intraAndInterSubFrame},

```

```

        pusch-HoppingOffset          INTEGER (0..98),
        enable64QAM                  BOOLEAN
    },
    ul-ReferenceSignalsPUSCH         UL-ReferenceSignalsPUSCH
}

PUSCH-ConfigCommon-v1270 ::=      SEQUENCE {
    enable64QAM-v1270                ENUMERATED {true}
}

PUSCH-ConfigCommon-v1310 ::=      SEQUENCE {
    pusch-maxNumRepetitionCEmodeA-r13  ENUMERATED {
        r8, r16, r32 }                OPTIONAL, -- Need OR
    pusch-maxNumRepetitionCEmodeB-r13  ENUMERATED {
        r192, r256, r384, r512, r768, r1024,
        r1536, r2048}                OPTIONAL, -- Need OR
    pusch-HoppingOffset-v1310          INTEGER (1..maxAvailNarrowBands-r13)  OPTIONAL, -- Need OR
}

PUSCH-ConfigDedicated ::=         SEQUENCE {
    betaOffset-ACK-Index              INTEGER (0..15),
    betaOffset-RI-Index               INTEGER (0..15),
    betaOffset-CQI-Index              INTEGER (0..15)
}

PUSCH-ConfigDedicated-v1020 ::=   SEQUENCE {
    betaOffsetMC-r10                  SEQUENCE {
        betaOffset-ACK-Index-MC-r10    INTEGER (0..15),
        betaOffset-RI-Index-MC-r10     INTEGER (0..15),
        betaOffset-CQI-Index-MC-r10    INTEGER (0..15)
    }                                OPTIONAL, -- Need OR
    groupHoppingDisabled-r10          ENUMERATED {true}                OPTIONAL, -- Need OR
    dmrs-WithOCC-Activated-r10        ENUMERATED {true}                OPTIONAL, -- Need OR
}

PUSCH-ConfigDedicated-v1130 ::=   SEQUENCE {
    pusch-DMRS-r11                    CHOICE {
        release                          NULL,
        setup                            SEQUENCE {
            nPUSCH-Identity-r11          INTEGER (0..509),
            nDMRS-CSH-Identity-r11      INTEGER (0..509)
        }
    }
}

PUSCH-ConfigDedicated-v1250 ::=   SEQUENCE {
    uciOnPUSCH                        CHOICE {
        release                          NULL,
        setup                            SEQUENCE {
            betaOffset-ACK-Index-SubframeSet2-r12  INTEGER (0..15),
            betaOffset-RI-Index-SubframeSet2-r12   INTEGER (0..15),
            betaOffset-CQI-Index-SubframeSet2-r12  INTEGER (0..15),
            betaOffsetMC-r12                     SEQUENCE {
                betaOffset-ACK-Index-MC-SubframeSet2-r12  INTEGER (0..15),
                betaOffset-RI-Index-MC-SubframeSet2-r12   INTEGER (0..15),
                betaOffset-CQI-Index-MC-SubframeSet2-r12  INTEGER (0..15)
            }
        }                                OPTIONAL, -- Need OR
    }
}

PUSCH-ConfigDedicated-r13 ::=     SEQUENCE {
    betaOffset-ACK-Index-r13           INTEGER (0..15),
    betaOffset2-ACK-Index-r13          INTEGER (0..15)                OPTIONAL, -- Need OR
    betaOffset-RI-Index-r13            INTEGER (0..15),
    betaOffset-CQI-Index-r13           INTEGER (0..15),
    betaOffsetMC-r13                   SEQUENCE {
        betaOffset-ACK-Index-MC-r13        INTEGER (0..15),
        betaOffset2-ACK-Index-MC-r13       INTEGER (0..15)                OPTIONAL, -- Need OR
        betaOffset-RI-Index-MC-r13         INTEGER (0..15),
        betaOffset-CQI-Index-MC-r13        INTEGER (0..15)
    }                                OPTIONAL, -- Need OR
    groupHoppingDisabled-r13           ENUMERATED {true}                OPTIONAL, -- Need OR
    dmrs-WithOCC-Activated-r13         ENUMERATED {true}                OPTIONAL, -- Need OR
    pusch-DMRS-r11                     CHOICE {
        release                          NULL,
        setup                            SEQUENCE {
            nPUSCH-Identity-r13          INTEGER (0..509),
}

```

```

        nDMRS-CSH-Identity-r13                INTEGER (0..509)
    }
}
uciOnPUSCH                                CHOICE {
  release                                  NULL,
  setup                                    SEQUENCE {
    betaOffset-ACK-Index-SubframeSet2-r13  INTEGER (0..15),
    betaOffset2-ACK-Index-SubframeSet2-r13  INTEGER (0..15) OPTIONAL, -- Need OR
    betaOffset-RI-Index-SubframeSet2-r13    INTEGER (0..15),
    betaOffset-CQI-Index-SubframeSet2-r13   INTEGER (0..15),
    betaOffsetMC-r12                        SEQUENCE {
      betaOffset-ACK-Index-MC-SubframeSet2-r13  INTEGER (0..15),
      betaOffset2-ACK-Index-MC-SubframeSet2-r13  INTEGER (0..15) OPTIONAL, -- Need OR
      betaOffset-RI-Index-MC-SubframeSet2-r13    INTEGER (0..15),
      betaOffset-CQI-Index-MC-SubframeSet2-r13   INTEGER (0..15)
    }
  }
}
pusch-HoppingConfig-r13                    ENUMERATED {on}
}
}

PUSCH-ConfigDedicated-v1430 ::= SEQUENCE {
  ce-PUSCH-NB-MaxTBS-r14                ENUMERATED {on}                OPTIONAL, -- Need OR
  ce-PUSCH-MaxBandwidth-r14              ENUMERATED {bw5}                OPTIONAL, -- Need OR
  tdd-PUSCH-UpPTS-r14                    TDD-PUSCH-UpPTS-r14            OPTIONAL, -- Need ON
  ul-DMRS-IFDMA-r14                      BOOLEAN,
  enable256QAM-r14                       Enable256QAM-r14              OPTIONAL -- Need ON
}

PUSCH-ConfigDedicated-v1530 ::= SEQUENCE {
  ce-PUSCH-FlexibleStartPRB-AllocConfig-r15 CHOICE {
    release                                NULL,
    setup                                    SEQUENCE {
      offsetCE-ModeB-r15                   INTEGER (-1..3) OPTIONAL        -- Cond CE-ModeB
    }
  },
  ce-PUSCH-SubPRB-Config-r15              CHOICE {
    release                                NULL,
    setup                                    SEQUENCE {
      locationCE-ModeB-r15                  INTEGER (0..5)                OPTIONAL, -- Cond CE-ModeB
      sixToneCyclicShift-r15                INTEGER (0..3),
      threeToneCyclicShift-r15              INTEGER (0..2)
    }
  }
} OPTIONAL -- Need ON
}

PUSCH-ConfigDedicated-v1610 ::= SEQUENCE {
  ce-PUSCH-MultiTB-Config-r16              SetupRelease {CE-PUSCH-MultiTB-Config-r16}
}

PUSCH-ConfigDedicated-v1800 ::= SEQUENCE {
  uplinkHARQ-Mode-r18                      SetupRelease {UplinkHARQ-Mode-r18}
}

PUSCH-ConfigDedicatedSCell-r10 ::= SEQUENCE {
  groupHoppingDisabled-r10                  ENUMERATED {true}                OPTIONAL, -- Need OR
  dmrs-WithOCC-Activated-r10                ENUMERATED {true}                OPTIONAL -- Need OR
}

PUSCH-ConfigDedicatedSCell-v1430 ::= SEQUENCE {
  enable256QAM-r14                          Enable256QAM-r14              OPTIONAL -- Need OR
}

PUSCH-ConfigDedicatedScell-v1530 ::= SEQUENCE {
  uci-OnPUSCH-r15                          CHOICE {
    release                                  NULL,
    setup                                    SEQUENCE {
      betaOffsetAUL-r15                     INTEGER (0..15)
    }
  }
}

TDD-PUSCH-UpPTS-r14 ::= CHOICE {
  release                                  NULL,
  setup                                    SEQUENCE {
    symPUSCH-UpPTS-r14                      ENUMERATED {sym1, sym2, sym3, sym4, sym5, sym6}
                                          OPTIONAL, -- Need ON
    dmrs-LessUpPTS-Config-r14                ENUMERATED {true}                OPTIONAL -- Need OR
  }
}

```

```

}
}
CE-PUSCH-MultitTB-Config-r16 ::= SEQUENCE {
    interleaving-r16          ENUMERATED {on}          OPTIONAL  -- Need OR
}
PUSCH-TxDuration-r17 ::= SEQUENCE {
    pusch-TxDuration-r17     ENUMERATED {n2, n4, n8, n16, n32, n64, n128, n256}
}
Enable256QAM-r14 ::= CHOICE {
    release                   NULL,
    setup                     CHOICE {
        tpc-SubframeSet-Configured-r14 SEQUENCE {
            subframeSet1-DCI-Format0-r14          BOOLEAN,
            subframeSet1-DCI-Format4-r14          BOOLEAN,
            subframeSet2-DCI-Format0-r14          BOOLEAN,
            subframeSet2-DCI-Format4-r14          BOOLEAN
        },
        tpc-SubframeSet-NotConfigured-r14 SEQUENCE {
            dci-Format0-r14          BOOLEAN,
            dci-Format4-r14          BOOLEAN
        }
    }
}
PUSCH-EnhancementsConfig-r14 ::= CHOICE {
    release                   NULL,
    setup                     SEQUENCE {
        pusch-HoppingOffsetPUSCH-Enh-r14          INTEGER (1..100)          OPTIONAL,  -- Need ON
        interval-ULHoppingPUSCH-Enh-r14          CHOICE {
            interval-FDD-PUSCH-Enh-r14          ENUMERATED {int1, int2, int4, int8},
            interval-TDD-PUSCH-Enh-r14          ENUMERATED {int1, int5, int10, int20}
        }
    }
}
UL-ReferenceSignalsPUSCH ::= SEQUENCE {
    groupHoppingEnabled      BOOLEAN,
    groupAssignmentPUSCH     INTEGER (0..29),
    sequenceHoppingEnabled   BOOLEAN,
    cyclicShift              INTEGER (0..7)
}
UplinkHARQ-Mode-r18 ::= BIT STRING (SIZE(8))
-- ASN1STOP

```

<b>PUSCH-Config field descriptions</b>
<p><b><i>betaOffset-ACK-Index, betaOffset2-ACK-Index, betaOffset-ACK-Index-MC, betaOffset2-ACK-Index-MC</i></b></p> <p>Parameter: <math>I_{offset}^{HARQ-ACK}</math>, <math>I_{offset,X}^{HARQ-ACK}</math>, <math>I_{offset,MC}^{HARQ-ACK}</math> and <math>I_{offset,MC,X}^{HARQ-ACK}</math>, for single- and multiple-codeword respectively, see TS 36.213 [23], Table 8.6.3-1. <i>betaOffset-ACK-Index</i> and <i>betaOffset2-ACK-Index</i> are used for single-codeword and <i>betaOffset-ACK-Index-MC</i> and <i>betaOffset2-ACK-Index-MC</i> are used for multiple-codeword. If <i>betaOffset2-ACK-Index</i> is configured; <i>betaOffset-ACK-Index</i> is used when up to 22 HARQ-ACK bits are transmitted otherwise <i>betaOffset2-ACK-Index</i> is used. If <i>betaOffset-ACK2-Index-MC</i> is configured; <i>betaOffset-ACK-Index-MC</i> is used when up to 22 HARQ-ACK bits are transmitted otherwise <i>betaOffset2-ACK-Index-MC</i> is used. One value applies for all serving cells with an uplink in a cell group (MCG or SCG or the group of cells configured to send PUCCH on the same cell in case PUCCH SCell is configured) and not configured with uplink power control subframe sets. The same value also applies for subframe set 1 of all serving cells with an uplink in that cell group and configured with uplink power control subframe sets (the associated functionality is common i.e. not performed independently for each cell).</p>
<p><b><i>betaOffset-ACK-Index-SubframeSet2, betaOffset2-ACK-Index-SubframeSet2, betaOffset-ACK-Index-MC-SubframeSet2, betaOffset2-ACK-Index-MC-SubframeSet2</i></b></p> <p>Parameter: <math>I_{offset,set2}^{HARQ-ACK}</math>, <math>I_{offset,set2,X}^{HARQ-ACK}</math>, <math>I_{offset,MC,set2}^{HARQ-ACK}</math> and <math>I_{offset,MC,set2,X}^{HARQ-ACK}</math> respectively, see TS 36.213 [23], Table 8.6.3-1. <i>betaOffset-ACK-Index-SubframeSet2</i> and <i>betaOffset2-ACK-Index-SubframeSet2</i> are used for single-codeword, <i>betaOffset-ACK-Index-MC-SubframeSet2</i>, <i>betaOffset2-ACK-Index-MC-SubframeSet2</i> are used for multiple-codeword. If <i>betaOffset2-ACK-Index-SubframeSet2</i> is configured; <i>betaOffset-ACK-Index-SubframeSet2</i> is used when up to 22 HARQ-ACK bits are transmitted otherwise <i>betaOffset2-ACK-Index-SubframeSet2</i> is used. If <i>betaOffset2-ACK-Index-MC-SubframeSet2</i> is configured; <i>betaOffset-ACK-Index-MC-SubframeSet2</i> is used when up to 22 HARQ-ACK bits are transmitted otherwise <i>betaOffset2-ACK-Index-MC-SubframeSet2</i> is used. One value applies for subframe set 2 of all serving cells with an uplink in a cell group (MCG or SCG or the group of cells configured to send PUCCH on the same cell in case PUCCH SCell is configured) and configured with uplink power control subframe sets (the associated functionality is common i.e. not performed independently for each cell configured with uplink power control subframe sets).</p>
<p><b><i>betaOffsetAUL</i></b></p> <p>Parameter: <math>\beta_{offset}^{AUL-UCI}</math> see TS 36.213 [23], clause 8.6.3.</p>
<p><b><i>betaOffset-CQI-Index, betaOffset-CQI-Index-MC</i></b></p> <p>Parameter: <math>I_{offset}^{CQI}</math>, for single- and multiple-codeword respectively, see TS 36.213 [23], Table 8.6.3-3. One value applies for all serving cells with an uplink in a cell group (MCG or SCG or the group of cells configured to send PUCCH on the same cell in case PUCCH SCell is configured) and not configured with uplink power control subframe sets. The same value also applies for subframe set 1 of all serving cells with an uplink in that cell group and configured with uplink power control subframe sets (the associated functionality is common i.e. not performed independently for each cell).</p>
<p><b><i>betaOffset-CQI-Index-SubframeSet2, betaOffset-CQI-Index-MC-SubframeSet2</i></b></p> <p>Parameter: <math>I_{offset}^{CQI}</math>, for single- and multiple-codeword respectively, see TS 36.213 [23], Table 8.6.3-3. One value applies for subframe set 2 of all serving cells with an uplink in a cell group (MCG or SCG or the group of cells configured to send PUCCH on the same cell in case PUCCH SCell is configured) and configured with uplink power control subframe sets (the associated functionality is common i.e. not performed independently for each cell configured with uplink power control subframe sets).</p>
<p><b><i>betaOffset-RI-Index, betaOffset-RI-Index-MC</i></b></p> <p>Parameter: <math>I_{offset}^{RI}</math>, for single- and multiple-codeword respectively, see TS 36.213 [23], Table 8.6.3-2. One value applies for all serving cells with an uplink in a cell group (MCG or SCG or the group of cells configured to send PUCCH on the same cell in case PUCCH SCell is configured) and not configured with uplink power control subframe sets. The same value also applies for subframe set 1 of all serving cells with an uplink in that cell group and configured with uplink power control subframe sets (the associated functionality is common i.e. not performed independently for each cell).</p>
<p><b><i>betaOffset-RI-Index-SubframeSet2, betaOffset-RI-Index-MC-SubframeSet2</i></b></p> <p>Parameter: <math>I_{offset}^{RI}</math>, for single- and multiple-codeword respectively, see TS 36.213 [23], Table 8.6.3-2. One value applies for subframe set 2 of all serving cells with an uplink in a cell group (MCG or SCG or the group of cells configured to send PUCCH on the same cell in case PUCCH SCell is configured) and configured with uplink power control subframe sets (the associated functionality is common i.e. not performed independently for each cell configured with uplink power control subframe sets).</p>
<p><b><i>ce-PUSCH-FlexibleStartPRB-AllocConfig</i></b></p> <p>Activation of flexible starting PRB for PUSCH resource allocation in CE mode A or B. <i>offsetCE-ModeB</i> indicates starting PRB offset when flexible starting PRB for PUSCH resource allocation in CE mode B is enabled. See TS 36.212 [22] and TS 36.213 [23]. E-UTRAN does not configure this field when E-UTRA system bandwidth is 1.4 MHz.</p>

<b>PUSCH-Config field descriptions</b>
<p><b>ce-PUSCH-MaxBandwidth</b> Maximum PUSCH channel bandwidth in CE mode A, see TS 36.212 [22] and TS 36.213 [23]. Value bw5 corresponds to 5 MHz. If this field is not configured, the maximum PUSCH channel bandwidth in CE mode A set to 1.4 MHz. The maximum PUSCH channel bandwidth in CE mode B is 1.4 MHz regardless of the setting of this parameter. Parameter: transmission bandwidth configuration, see TS 36.101 [42], table 5.6-1.</p>
<p><b>ce-PUSCH-MultiTB-Config</b> Indicates whether UL multi-TB scheduling is enabled, i.e., a single DCI can schedule up to 8 PUSCH transport blocks in CE mode A and up to 4 PUSCH transport blocks in CE mode B. See TS 36.213 [23], clause 8.0.</p>
<p><b>ce-PUSCH-NB-MaxTBS</b> Activation of 2984 bits maximum PUSCH TBS in 1.4 MHz in CE mode A, see TS 36.212 [22] and TS 36.213 [23].</p>
<p><b>ce-PUSCH-SubPRB-Config</b> Activation of PUSCH sub-PRB allocation in CE mode A or B, see TS 36.211 [21], TS 36.212 [22] and TS 36.213 [23].</p>
<p><b>cyclicShift</b> Parameters: <i>cyclicShift</i>, see TS 36.211 [21], Table 5.5.2.1.1-2.</p>
<p><b>dmrs-LessUpPTS-Config</b> Indicates the UE not to transmit DMRS for PUSCH in UpPTS, see TS36.211 [21], clause 5.5.2.1.2.</p>
<p><b>dmrs-WithOCC-Activated</b> Parameter: <i>Activate-DMRS-with OCC</i>, see TS 36.211 [21], clause 5.5.2.1.</p>
<p><b>enable256QAM</b> See TS 36.213 [23], clause 8.6.1. If <i>enable256QAM</i> is included and if uplink power control subframe sets are configured by <i>tpc-SubframeSet</i>, the field indicates (if set to TRUE) per uplink power control subframe set and DCI format 0/0A/0B and 4/4A/4B that 256QAM is allowed for UE UL categories as indicated in TS 36.306 [5], Table 4.1A-2, while FALSE indicates that 256 QAM is not allowed. If <i>enable256QAM</i> is included and if uplink power control subframe sets are not configured by <i>tpc-SubframeSet</i>, the field indicates (if set to TRUE) per DCI format 0/0A/0B and 4/4A/4B that 256QAM is allowed for UE UL categories as indicated in TS 36.306 [5], Table 4.1A-2, while FALSE indicates that 256 QAM is not allowed.</p>
<p><b>enable64QAM</b> See TS 36.213 [23], clause 8.6.1. If <i>enable64QAM</i> (without suffix) is set to TRUE, it indicates that 64QAM is allowed for UE categories 5 and 8 indicated in <i>ue-Category</i> and UL categories indicated in <i>ue-CategoryUL</i> which support UL 64QAM and can fallback to category 5 or 8, see TS 36.306 [5], Table 4.1A-2 and Table 4.1A-6, while FALSE indicates that 64QAM is not allowed. If <i>enable64QAM-v1270</i> is set to TRUE, it indicates that 64QAM is allowed for UL categories indicated in <i>ue-CategoryUL</i> which support UL 64QAM but cannot fallback category 5 or 8, see TS 36.306 [5], Table 4.1A-2 and Table 4.1A-6. E-UTRAN configures <i>enable64QAM-v1270</i> only when <i>enable64QAM</i> (without suffix) is set to TRUE.</p>
<p><b>interleaving</b> Indicates whether interleaving for UL multi-TB scheduling is enabled, see TS 36.213 [23], clause 8.0.</p>
<p><b>interval-ULHoppingPUSCH-Enh</b> Number of consecutive absolute subframes over which PUSCH stays at the same PRBs before hopping to other PRBs. For <i>interval-FDD-PUSCH-Enh</i>, int1 corresponds to 1 subframe, int2 corresponds to 2 subframes, and so on. For <i>interval-TDD-PUSCH-Enh</i>, int1 corresponds to 1 subframe, int5 corresponds to 5 subframes, and so on. See TS 36.211 [21], clause 5.3.4.</p>
<p><b>groupAssignmentPUSCH</b> Parameter: <math>\Delta SS</math> See TS 36.211 [21], clause 5.5.1.3.</p>
<p><b>groupHoppingDisabled</b> Parameter: <i>Disable-sequence-group-hopping</i>, see TS 36.211 [21], clause 5.5.1.3.</p>
<p><b>groupHoppingEnabled</b> Parameter: <i>Group-hopping-enabled</i>, see TS 36.211 [21], clause 5.5.1.3.</p>
<p><b>hoppingMode</b> Parameter: <i>Hopping-mode</i>, see TS 36.211 [21], clause 5.3.4.</p>
<p><b>locationCE-ModeB</b> PRB location within the narrowband when PUSCH sub-PRB allocation is enabled in CE mode B.</p>
<p><b>nDMRS-CSH-Identity</b> Parameter: <math>N_{ID}^{csh\_DMRS}</math>, see TS 36.211 [21], clause 5.5.2.1.1.</p>
<p><b>nPUSCH-Identity</b> Parameter: <math>n_{ID}^{PUSCH}</math>, see TS 36.211 [21], clause 5.5.1.5.</p>
<p><b>n-SB</b> Parameter: <math>N_{sb}</math> see TS 36.211 [21], clause 5.3.4.</p>
<p><b>pusch-HoppingConfig</b> For BL UEs and UEs in CE, frequency hopping activation/deactivation for unicast PUSCH, see TS 36.211 [21]</p>
<p><b>pusch-hoppingOffset</b> Except for BL UEs and UEs in CE, parameter: <math>N_{RB}^{HO}</math>, see TS 36.211 [21], clause 5.3.4. For BL UEs and UEs in CE, the <i>pusch-hoppingOffset-v1310</i> indicates the parameter <math>f_{NB,hop}^{PUSCH}</math>, see TS 36.211 [21], clause 5.3.4. . In case <i>pusch-hoppingOffset-v1310</i> is signalled, the BL UEs and UEs in CE shall ignore <i>pusch-hoppingOffset</i> (i.e. without suffix).</p>



<b>PUSCH-Config field descriptions</b>	
<b>pusch-HoppingOffsetPUSCH-Enh</b>	Indicates the frequency domain hopping offset between PRBs for PUSCH in frequency hopping, see TS 36.211 [21], clause 5.3.4. Value 1 corresponds to 1 PRB, value 2 corresponds to 2 PRBs, and so on.
<b>pusch-maxNumRepetitionCEmodeA</b>	Maximum value to indicate the set of PUSCH repetition numbers for CE mode A, see TS 36.211 [21] and TS 36.213 [23]. E-UTRAN does not configure value r8. If the field is not configured, the UE shall apply the default value as defined in TS 36.213 [23], clause 8.0.
<b>pusch-maxNumRepetitionCEmodeB</b>	Maximum value to indicate the set of PUSCH repetition numbers for CE mode B, see TS 36.211 [21] and TS 36.213 [23].
<b>pusch-TxDuration</b>	Duration of PUSCH segment transmission in NTN transmission, see TS 36.213 [23]. Value in number of resource units. Value <i>n2</i> corresponds to 2 resource units, value <i>n4</i> corresponds to 4 resource units and so on. The signalled value corresponds to full-PRB allocation (unit: subframe). If PUSCH sub-PRB is configured, the signalled value is divided by 2, 4 and 8 for sub-PRB allocation of 6, 3 and 2-out-of-3 tones allocation and corresponds to the resource unit for 6 tones, 3 and 2-out-of-3 tones, respectively. If value <i>n2</i> is signalled and PUSCH sub-PRB is configured, segment transmission is not applicable to 3 and 2-out-of-3 tones allocation. If value <i>n4</i> is signalled and PUSCH sub-PRB is configured, segment transmission is not applicable to 2-out-of-3 tones allocation.
<b>sequenceHoppingEnabled</b>	Parameter: <i>Sequence-hopping-enabled</i> , see TS 36.211 [21], clause 5.5.1.4.
<b>sixToneCyclicShift, threeToneCyclicShift</b>	Cyclic shift for PUSCH reference signal sequence of six/three subcarriers in CE mode A or B.
<b>symPUSCH-UpPTS</b>	Indicates the number of data symbols that configured for PUSCH transmission in UpPTS. Values <i>sym2</i> , <i>sym3</i> , <i>sym4</i> , <i>sym5</i> and <i>sym6</i> can be used for normal cyclic prefix, if <i>dmrsLess-UpPTS</i> is set to <i>true</i> , otherwise, values <i>sym2</i> , <i>sym3</i> , <i>sym4</i> , <i>sym5</i> can be used for normal cyclic prefix and values <i>sym1</i> , <i>sym2</i> , <i>sym3</i> and <i>sym4</i> can be used for extended cyclic prefix, see TS 36.213 [23], clause 8.6.2 and TS 36.211 [21], clause 5.3.4.
<b>ul-DMRS-IFDMA</b>	Value <i>TRUE</i> indicates that the UE is configured with enhanced UL DMRS.
<b>ul-ReferenceSignalsPUSCH</b>	Used to specify parameters needed for the transmission on PUSCH (or PUCCH).
<b>uplinkHARQ-Mode</b>	Used to set the HARQ mode per HARQ process ID, see TS 36.321 [6]. The first/leftmost bit corresponds to HARQ process ID 0, the next bit to HARQ process ID 1 and so on. Bits corresponding to HARQ process IDs that are not configured shall be ignored. A bit set to one identifies a HARQ process with HARQ mode A and a bit set to zero identifies a HARQ process with HARQ mode B.

<b>Conditional presence</b>	<b>Explanation</b>
<i>CE-ModeB</i>	The field is optionally present, need ON, for CE Mode B. Otherwise, the field is not present.

## – RACH-ConfigCommon

The IE *RACH-ConfigCommon* is used to specify the generic random access parameters.

### **RACH-ConfigCommon information element**

```

-- ASN1START
RACH-ConfigCommon ::= SEQUENCE {
    preambleInfo SEQUENCE {
        numberOfRA-Preambles ENUMERATED {
            n4, n8, n12, n16, n20, n24, n28,
            n32, n36, n40, n44, n48, n52, n56,
            n60, n64},
        preamblesGroupAConfig SEQUENCE {
            sizeOfRA-PreamblesGroupA ENUMERATED {
                n4, n8, n12, n16, n20, n24, n28,
                n32, n36, n40, n44, n48, n52, n56,
                n60},
            messageSizeGroupA ENUMERATED {b56, b144, b208, b256},
            messagePowerOffsetGroupB ENUMERATED {
                minusinfinity, dB0, dB5, dB8, dB10, dB12,
                dB15, dB18},
            ...
        }
    }
}
-- Need OP

```

```

    },
    powerRampingParameters          PowerRampingParameters,
    ra-SupervisionInfo              SEQUENCE {
        preambleTransMax            PreambleTransMax,
        ra-ResponseWindowSize       ENUMERATED {
            sf2, sf3, sf4, sf5, sf6, sf7,
            sf8, sf10},
        mac-ContentionResolutionTimer  ENUMERATED {
            sf8, sf16, sf24, sf32, sf40, sf48,
            sf56, sf64}
    },
    maxHARQ-Msg3Tx                  INTEGER (1..8),
    ...
    [[ preambleTransMax-CE-r13       PreambleTransMax            OPTIONAL, -- Need OR
      rach-CE-LevelInfoList-r13     RACH-CE-LevelInfoList-r13  OPTIONAL  -- Need OR
    ]],
    [[ edt-SmallTBS-Subset-r15      ENUMERATED {true}        OPTIONAL  -- Cond
EDT-OR
    ]]
}

RACH-ConfigCommon-v1250 ::= SEQUENCE {
    txFailParams-r12              SEQUENCE {
        connEstFailCount-r12       ENUMERATED {n1, n2, n3, n4},
        connEstFailOffsetValidity-r12  ENUMERATED {s30, s60, s120, s240,
            s300, s420, s600, s900},
        connEstFailOffset-r12      INTEGER (0..15)          OPTIONAL  -- Need OP
    }
}

RACH-ConfigCommonSCell-r11 ::= SEQUENCE {
    powerRampingParameters-r11    PowerRampingParameters,
    ra-SupervisionInfo-r11        SEQUENCE {
        preambleTransMax-r11      PreambleTransMax
    },
    ...
}

RACH-CE-LevelInfoList-r13 ::= SEQUENCE (SIZE (1..maxCE-Level-r13)) OF RACH-CE-LevelInfo-r13

RACH-CE-LevelInfo-r13 ::= SEQUENCE {
    preambleMappingInfo-r13       SEQUENCE {
        firstPreamble-r13         INTEGER(0..63),
        lastPreamble-r13          INTEGER(0..63)
    },
    ra-ResponseWindowSize-r13     ENUMERATED {sf20, sf50, sf80, sf120, sf180,
        sf240, sf320, sf400},
    mac-ContentionResolutionTimer-r13  ENUMERATED {sf80, sf100, sf120,
        sf160, sf200, sf240, sf480, sf960},
    rar-HoppingConfig-r13         ENUMERATED {on,off},
    ...
    [[ edt-Parameters-r15         SEQUENCE {
        edt-LastPreamble-r15       INTEGER(0..63),
        edt-SmallTBS-Enabled-r15   BOOLEAN,
        edt-TBS-r15                ENUMERATED {b328, b408, b504, b600, b712,
            b808, b936, b1000or456},
        mac-ContentionResolutionTimer-r15  ENUMERATED {sf240, sf480, sf960,
            sf1920, sf3840, sf5760, sf7680, sf10240}
        OPTIONAL -- Need OP
    } OPTIONAL  -- Cond EDT
    ]]
}

PowerRampingParameters ::= SEQUENCE {
    powerRampingStep              ENUMERATED {dB0, dB2,dB4, dB6},
    preambleInitialReceivedTargetPower  ENUMERATED {
        dBm-120, dBm-118, dBm-116, dBm-114, dBm-112,
        dBm-110, dBm-108, dBm-106, dBm-104, dBm-102,
        dBm-100, dBm-98, dBm-96, dBm-94,
        dBm-92, dBm-90}
}

PreambleTransMax ::= ENUMERATED {
    n3, n4, n5, n6, n7, n8, n10, n20, n50,
    n100, n200}

-- ASN1STOP

```



<b>RACH-ConfigCommon field descriptions</b>
<p><b><i>connEstFailCount</i></b> Number of times that the UE detects T300 expiry on the same cell before applying <i>connEstFailOffset</i>.</p>
<p><b><i>connEstFailOffset</i></b> Parameter "Qoffset<sub>temp</sub>" in TS 36.304 [4]. If the field is not present the value of infinity shall be used for "Qoffset<sub>temp</sub>".</p>
<p><b><i>connEstFailOffsetValidity</i></b> Amount of time that the UE applies <i>connEstFailOffset</i> before removing the offset from evaluation of the cell. Value s30 corresponds to 30 seconds, s60 corresponds to 60 seconds, and so on.</p>
<p><b><i>edt-LastPreamble</i></b> Provides the mapping of preambles to groups for each CE level for EDT, as specified in TS 36.321 [6]. For the concerned CE level, if PRACH resources configured by <i>edt-PRACH-ParametersCE-r15</i> are different from the PRACH resources configured by <i>PRACH-ParametersCE-r13</i> for all CE levels and <i>edt-PRACH-ParametersCE-r15</i> for all other CE levels, the preambles for EDT are the preambles <i>firstPreamble-r13</i> to <i>edt-LastPreamble-r15</i>, otherwise the preambles for EDT are the preambles <i>lastPreamble-r13+1</i> to <i>edt-LastPreamble-r15</i>.</p>
<p><b><i>edt-SmallTBS-Enabled</i></b> Value TRUE indicates UE performing EDT is allowed to select TBS smaller than <i>edt-TBS</i> for Msg3 in the corresponding CE level, as specified in TS 36.213 [23].</p>
<p><b><i>edt-SmallTBS-Subset</i></b> Presence indicates only two of the TBS values can be used according to <i>edt-TBS</i> corresponding to the CE level, as specified in TS 36.213 [23]. When the field is not present, any of the TBS values according to <i>edt-TBS</i> corresponding to the CE level can be used. This field is applicable for a CE level only when <i>edt-SmallTBS-Enabled</i> is included for the corresponding CE level.</p>
<p><b><i>edt-TBS</i></b> Largest TBS for Msg3 for a CE level applicable to a UE performing EDT. Value in bits. Value b328 corresponds to 328 bits, b408 corresponds to 408 bits and so on. Additionally, value b1000or456 corresponds to 1000 bits for CE levels 0 and 1, and 456 bits for CE levels 2 and 3. See TS 36.213 [23].</p>
<p><b><i>mac-ContentionResolutionTimer</i></b> Timer for contention resolution in TS 36.321 [6]. Value in subframes. Value sf8 corresponds to 8 subframes, sf16 corresponds to 16 subframes and so on. <i>mac-ContentionResolutionTimer-r15</i> is only applicable for EDT. UE performing EDT shall use <i>mac-ContentionResolutionTimer-r15</i>, if present.</p>
<p><b><i>maxHARQ-Msg3Tx</i></b> Maximum number of Msg3 HARQ transmissions in TS 36.321 [6], used for contention based random access. Value is an integer.</p>
<p><b><i>messagePowerOffsetGroupB</i></b> Threshold for preamble selection in TS 36.321 [6]. Value in dB. Value minusinfinity corresponds to -infinity. Value dB0 corresponds to 0 dB, dB5 corresponds to 5 dB and so on.</p>
<p><b><i>messageSizeGroupA</i></b> Threshold for preamble selection in TS 36.321 [6]. Value in bits. Value b56 corresponds to 56 bits, b144 corresponds to 144 bits and so on.</p>
<p><b><i>numberOfRA-Preambles</i></b> Number of non-dedicated random access preambles in TS 36.321 [6]. Value is an integer. Value n4 corresponds to 4, n8 corresponds to 8 and so on.</p>
<p><b><i>powerRampingStep</i></b> Power ramping factor in TS 36.321 [6]. Value in dB. Value dB0 corresponds to 0 dB, dB2 corresponds to 2 dB and so on.</p>
<p><b><i>preambleInitialReceivedTargetPower</i></b> Initial preamble power in TS 36.321 [6]. Value in dBm. Value dBm-120 corresponds to -120 dBm, dBm-118 corresponds to -118 dBm and so on.</p>
<p><b><i>preambleMappingInfo</i></b> Provides the mapping of preambles to groups for each CE level, except for EDT, as specified in TS 36.321 [6]. When random access preambles group B is used, <i>firstPreamble-r13</i> is set to 0 and <i>lastPreamble-r13</i> is set to <i>numberOfRA-Preambles-1</i>.</p>
<p><b><i>preamblesGroupAConfig</i></b> Provides the configuration for preamble grouping in TS 36.321 [6]. If the field is not signalled, the size of the random access preambles group A, as specified in TS 36.321 [6], is equal to <i>numberOfRA-Preambles</i>.</p>
<p><b><i>preambleTransMax, preambleTransMax-CE</i></b> Maximum number of preamble transmission in TS 36.321 [6]. Value is an integer. Value n3 corresponds to 3, n4 corresponds to 4 and so on.</p>
<p><b><i>rach-CE-LevelInfoList</i></b> Provides RACH information for each coverage level. The first entry in the list contains RACH information of CE level 0, the second entry in the list contains RACH information of CE level 1, and so on. If E-UTRAN includes <i>rach-CE-LevelInfoList</i>, it includes the same number of entries as in <i>prach-ParametersListCE</i>.</p>
<p><b><i>ra-ResponseWindowSize</i></b> Duration of the RA response window in TS 36.321 [6]. Value in subframes. Value sf2 corresponds to 2 subframes, sf3 corresponds to 3 subframes and so on. The same value applies for each serving cell (although the associated functionality is performed independently for each cell).</p>

RACH-ConfigCommon field descriptions	
<b>connEstFailCount</b>	Number of times that the UE detects T300 expiry on the same cell before applying <i>connEstFailOffset</i> .
<b>rar-HoppingConfig</b>	Frequency hopping activation/deactivation for RAR/Msg3/Msg4 for a CE level, see TS 36.211 [21].
<b>sizeOfRA-PreamblesGroupA</b>	Size of the random access preambles group A in TS 36.321 [6]. Value is an integer. Value n4 corresponds to 4, n8 corresponds to 8 and so on.

Conditional presence	Explanation
EDT	The field is mandatory present if <i>cp-EDT</i> or <i>up-EDT</i> in <i>SystemInformationBlockType2</i> is present; otherwise the field is not present and the UE shall delete any existing value for this field.
EDT-OR	The field is optionally present, Need OR, if <i>cp-EDT</i> or <i>up-EDT</i> in <i>SystemInformationBlockType2</i> is present; otherwise the field is not present and the UE shall delete any existing value for this field.

## – RACH-ConfigDedicated

The IE *RACH-ConfigDedicated* is used to specify the dedicated random access parameters.

### RACH-ConfigDedicated information element

```
-- ASN1START
RACH-ConfigDedicated ::= SEQUENCE {
    ra-PreambleIndex          INTEGER (0..63),
    ra-PRACH-MaskIndex        INTEGER (0..15)
}
-- ASN1STOP
```

RACH-ConfigDedicated field descriptions	
<b>ra-PRACH-MaskIndex</b>	Explicitly signalled PRACH Mask Index for RA Resource selection in TS 36.321 [6].
<b>ra-PreambleIndex</b>	Explicitly signalled Random Access Preamble for RA Resource selection in TS 36.321 [6].

## – RadioResourceConfigCommon

The IE *RadioResourceConfigCommonSIB* and IE *RadioResourceConfigCommon* are used to specify common radio resource configurations in the system information and in the mobility control information, respectively, e.g., the random access parameters and the static physical layer parameters.

### RadioResourceConfigCommon information element

```
-- ASN1START
RadioResourceConfigCommonSIB ::= SEQUENCE {
    rach-ConfigCommon          RACH-ConfigCommon,
    bch-Config                  BCCH-Config,
    pcc-Config                  PCCH-Config,
    prach-Config                PRACH-ConfigSIB,
    pdsch-ConfigCommon          PDSCH-ConfigCommon,
    pusch-ConfigCommon          PUSCH-ConfigCommon,
    pucch-ConfigCommon          PUCCH-ConfigCommon,
    soundingRS-UL-ConfigCommon SoundingRS-UL-ConfigCommon,
    uplinkPowerControlCommon    UplinkPowerControlCommon,
    ul-CyclicPrefixLength       UL-CyclicPrefixLength,
    . . .
    [[ uplinkPowerControlCommon-v1020 UplinkPowerControlCommon-v1020 OPTIONAL -- Need OR
    ]],
    [[ rach-ConfigCommon-v1250        RACH-ConfigCommon-v1250        OPTIONAL -- Need OR
    ]],
    [[ pusch-ConfigCommon-v1270       PUSCH-ConfigCommon-v1270       OPTIONAL -- Need OR
    ]]
```

```

]],
[[ bcch-Config-v1310 BCCH-Config-v1310 OPTIONAL, -- Need OR
   pcch-Config-v1310 PCCH-Config-v1310 OPTIONAL, -- Need OR
   freqHoppingParameters-r13 FreqHoppingParameters-r13 OPTIONAL, -- Need OR
   pdsch-ConfigCommon-v1310 PDSCH-ConfigCommon-v1310 OPTIONAL, -- Need OR
   pusch-ConfigCommon-v1310 PUSCH-ConfigCommon-v1310 OPTIONAL, -- Need OR
   prach-Config-v1310 PRACH-ConfigSIB-v1310 OPTIONAL, -- Need OR
   pucch-ConfigCommon-v1310 PUCCH-ConfigCommon-v1310 OPTIONAL, -- Need OR
]],
[[ highSpeedConfig-r14 HighSpeedConfig-r14 OPTIONAL, -- Need OR
   prach-Config-v1430 PRACH-Config-v1430 OPTIONAL, -- Need OR
   pucch-ConfigCommon-v1430 PUCCH-ConfigCommon-v1430 OPTIONAL, -- Need OR
]],
[[ prach-Config-v1530 PRACH-ConfigSIB-v1530 OPTIONAL, -- Cond EDT
   ce-RSS-Config-r15 RSS-Config-r15 OPTIONAL, -- Need OR
   wus-Config-r15 WUS-Config-r15 OPTIONAL, -- Need OR
   highSpeedConfig-v1530 HighSpeedConfig-v1530 OPTIONAL, -- Need OR
]],
[[ uplinkPowerControlCommon-v1540 UplinkPowerControlCommon-v1530 OPTIONAL, -- Need OR
]],
[[ wus-Config-v1560 WUS-Config-v1560 OPTIONAL, -- Need OR
]],
[[ wus-Config-v1610 WUS-Config-v1610 OPTIONAL, -- Need OR
   highSpeedConfig-v1610 HighSpeedConfig-v1610 OPTIONAL, -- Need OR
   crs-ChEstMPDCCH-ConfigCommon-r16 CRS-ChEstMPDCCH-ConfigCommon-r16 OPTIONAL, -- Need OR
   gwus-Config-r16 GWUS-Config-r16 OPTIONAL, -- Need OR
   uplinkPowerControlCommon-v1610 UplinkPowerControlCommon-v1610 OPTIONAL, -- Need OR
   rrs-MeasConfig-r16 ENUMERATED {enabled} OPTIONAL, -- Need OR
   rrs-MeasNonNCL-r16 ENUMERATED {enabled} OPTIONAL, -- Need OR
   puncturedSubcarriersDL-r16 BIT STRING (SIZE (2)) OPTIONAL, -- Need OR
   highSpeedInterRAT-NR-r16 BOOLEAN OPTIONAL, -- Need OR
]],
[[ pcch-Config-v1700 PCCH-Config-v1700 OPTIONAL, -- Need OR
   ntn-ConfigCommon-r17 SEQUENCE {
     ta-Report-r17 ENUMERATED {enabled} OPTIONAL, -- Need
OR
     t318-r17 ENUMERATED {
       ms0, ms50, ms100, ms200,
       ms500, ms1000, ms2000, ms4000},
     prach-TxDuration-r17 PRACH-TxDuration-r17 OPTIONAL, -- Need OR
     pucch-TxDuration-r17 PUCCH-TxDuration-r17 OPTIONAL, -- Need OR
     pusch-TxDuration-r17 PUSCH-TxDuration-r17 OPTIONAL, -- Need OR
   } OPTIONAL, -- Cond NTN
]],
}

RadioResourceConfigCommon ::= SEQUENCE {
  rach-ConfigCommon RACH-ConfigCommon OPTIONAL, -- Need ON
  prach-Config PRACH-Config,
  pdsch-ConfigCommon PDSCH-ConfigCommon OPTIONAL, -- Need ON
  pusch-ConfigCommon PUSCH-ConfigCommon,
  phich-Config PHICH-Config OPTIONAL, -- Need ON
  pucch-ConfigCommon PUCCH-ConfigCommon OPTIONAL, -- Need ON
  soundingRS-UL-ConfigCommon SoundingRS-UL-ConfigCommon OPTIONAL, -- Need ON
  uplinkPowerControlCommon UplinkPowerControlCommon OPTIONAL, -- Need ON
  antennaInfoCommon AntennaInfoCommon OPTIONAL, -- Need ON
  p-Max P-Max OPTIONAL, -- Need OP
  tdd-Config TDD-Config OPTIONAL, -- Cond TDD
  ul-CyclicPrefixLength UL-CyclicPrefixLength,
  ...,
  [[ uplinkPowerControlCommon-v1020 UplinkPowerControlCommon-v1020 OPTIONAL, -- Need ON
  ]],
  [[ tdd-Config-v1130 TDD-Config-v1130 OPTIONAL, -- Cond TDD3
  ]],
  [[ pusch-ConfigCommon-v1270 PUSCH-ConfigCommon-v1270 OPTIONAL, -- Need OR
  ]],
  [[ prach-Config-v1310 PRACH-Config-v1310 OPTIONAL, -- Need ON
     freqHoppingParameters-r13 FreqHoppingParameters-r13 OPTIONAL, -- Need ON
     pdsch-ConfigCommon-v1310 PDSCH-ConfigCommon-v1310 OPTIONAL, -- Need ON
     pucch-ConfigCommon-v1310 PUCCH-ConfigCommon-v1310 OPTIONAL, -- Need ON
     pusch-ConfigCommon-v1310 PUSCH-ConfigCommon-v1310 OPTIONAL, -- Need ON
     uplinkPowerControlCommon-v1310 UplinkPowerControlCommon-v1310 OPTIONAL, -- Need ON
  ]],
  [[ highSpeedConfig-r14 HighSpeedConfig-r14 OPTIONAL, -- Need OR
     prach-Config-v1430 PRACH-Config-v1430 OPTIONAL, -- Need OR
  ]],
}

```

```

    pucch-ConfigCommon-v1430          PUCCH-ConfigCommon-v1430          OPTIONAL,  -- Need OR
    tdd-Config-v1430                  TDD-Config-v1430                  OPTIONAL   -- Cond TDD3
  ]],
  [[
    tdd-Config-v1450                  TDD-Config-v1450                  OPTIONAL   -- Cond TDD3
  ]],
  [[
    uplinkPowerControlCommon-v1530    UplinkPowerControlCommon-v1530    OPTIONAL,  -- Need ON
    highSpeedConfig-v1530              HighSpeedConfig-v1530              OPTIONAL   -- Need OR
  ]],
  [[
    highSpeedConfig-v1610              HighSpeedConfig-v1610              OPTIONAL,  -- Need OR
    uplinkPowerControlCommon-v1610    UplinkPowerControlCommon-v1610    OPTIONAL,  -- Need OR
    highSpeedInterRAT-NR-r16          BOOLEAN                             OPTIONAL   -- Need ON
  ]],
  [[
    ntn-ConfigCommon-r17              SEQUENCE {
      ta-Report-r17                   ENUMERATED {enabled}              OPTIONAL,  -- Need OR
      t318-r17                         ENUMERATED {
        ms0, ms50, ms100, ms200, ms500,
        ms1000, ms2000, ms4000, ms6000},
      prach-TxDuration-r17            PRACH-TxDuration-r17              OPTIONAL,  -- Need OR
      pucch-TxDuration-r17            PUCCH-TxDuration-r17              OPTIONAL,  -- Need OR
      pusch-TxDuration-r17            PUSCH-TxDuration-r17              OPTIONAL,  -- Need OR
    } OPTIONAL -- Cond NTN
  ]],
}

RadioResourceConfigCommonPSCell-r12 ::= SEQUENCE {
  basicFields-r12                    RadioResourceConfigCommonSCell-r10,
  pucch-ConfigCommon-r12             PUCCH-ConfigCommon,
  rach-ConfigCommon-r12              RACH-ConfigCommon,
  uplinkPowerControlCommonPSCell-r12 UplinkPowerControlCommonPSCell-r12,
  ...,
  [[ uplinkPowerControlCommonPSCell-v1310
                                     UplinkPowerControlCommon-v1310          OPTIONAL   -- Need ON
  ]],
  [[ uplinkPowerControlCommonPSCell-v1530
                                     UplinkPowerControlCommon-v1530          OPTIONAL   -- Need ON
  ]],
}

RadioResourceConfigCommonPSCell-v12f0 ::= SEQUENCE {
  basicFields-v12f0                  RadioResourceConfigCommonSCell-v1010
}

RadioResourceConfigCommonPSCell-v1440 ::= SEQUENCE {
  basicFields-v1440                  RadioResourceConfigCommonSCell-v1440
}

RadioResourceConfigCommonSCell-r10 ::= SEQUENCE {
  -- DL configuration as well as configuration applicable for DL and UL
  nonUL-Configuration-r10            SEQUENCE {
    -- 1: Cell characteristics
    dl-Bandwidth-r10                  ENUMERATED {n6, n15, n25, n50, n75, n100},
    -- 2: Physical configuration, general
    antennaInfoCommon-r10             AntennaInfoCommon,
    mbsfn-SubframeConfigList-r10      MBSFN-SubframeConfigList          OPTIONAL,  -- Need OR
    -- 3: Physical configuration, control
    phich-Config-r10                  PHICH-Config,
    -- 4: Physical configuration, physical channels
    pdsch-ConfigCommon-r10            PDSCH-ConfigCommon,
    tdd-Config-r10                    TDD-Config                         OPTIONAL   -- Cond
  }
}

TDDSCell
},
-- UL configuration
ul-Configuration-r10                SEQUENCE {
  ul-FreqInfo-r10                    SEQUENCE {
    ul-CarrierFreq-r10                ARFCN-ValueEUTRA                  OPTIONAL,  -- Need OP
    ul-Bandwidth-r10                  ENUMERATED {n6, n15,
    n25, n50, n75, n100}              OPTIONAL,  -- Need OP
  }
  additionalSpectrumEmissionSCell-r10 AdditionalSpectrumEmission
},
p-Max-r10                           P-Max                             OPTIONAL,  -- Need OP
uplinkPowerControlCommonSCell-r10    UplinkPowerControlCommonSCell-r10,
-- A special version of IE UplinkPowerControlCommon may be introduced
-- 3: Physical configuration, control
soundingRS-UL-ConfigCommon-r10      SoundingRS-UL-ConfigCommon,
ul-CyclicPrefixLength-r10            UL-CyclicPrefixLength,
-- 4: Physical configuration, physical channels

```

```

prach-ConfigSCell-r10                PRACH-ConfigSCell-r10                OPTIONAL,  -- Cond TDD-
OR-NoR11
pusch-ConfigCommon-r10                PUSCH-ConfigCommon                    OPTIONAL,  -- Need OR
}
...
[[ ul-CarrierFreq-v1090                ARFCN-ValueEUTRA-v9e0                OPTIONAL  -- Need OP
]],
[[ rach-ConfigCommonSCell-r11          RACH-ConfigCommonSCell-r11          OPTIONAL,  -- Cond
ULSCell
prach-ConfigSCell-r11                PRACH-Config                          OPTIONAL,  -- Cond UL
tdd-Config-v1130                    TDD-Config-v1130                    OPTIONAL,  -- Cond TDD2
uplinkPowerControlCommonSCell-v1130  UplinkPowerControlCommonSCell-v1130  OPTIONAL  -- Cond UL
]],
[[ pusch-ConfigCommon-v1270            PUSCH-ConfigCommon-v1270            OPTIONAL  -- Need OR
]],
[[ pucch-ConfigCommon-r13              PUCCH-ConfigCommon                  OPTIONAL,  -- Cond UL
uplinkPowerControlCommonSCell-v1310  UplinkPowerControlCommonSCell-v1310  OPTIONAL  -- Cond UL
]],
[[ highSpeedConfigSCell-r14            HighSpeedConfigSCell-r14            OPTIONAL,  -- Need OR
prach-Config-v1430                    PRACH-Config-v1430                    OPTIONAL,  -- Cond UL
ul-Configuration-r14                  SEQUENCE {
ul-FreqInfo-r14                        SEQUENCE {
ul-CarrierFreq-r14                    ARFCN-ValueEUTRA-r9                OPTIONAL,  -- Need OP
ul-Bandwidth-r14                      ENUMERATED {n6, n15,
n25, n50, n75, n100}              OPTIONAL,  -- Need OP
additionalSpectrumEmissionSCell-r14  AdditionalSpectrumEmission
}},
p-Max-r14                              P-Max                                OPTIONAL,  -- Need OP
soundingRS-UL-ConfigCommon-r14        SoundingRS-UL-ConfigCommon,
ul-CyclicPrefixLength-r14             UL-CyclicPrefixLength,
prach-ConfigSCell-r14                PRACH-ConfigSCell-r10                OPTIONAL,  -- Cond TDD-
OR-NoR11
uplinkPowerControlCommonPUSCH-LessCell-v1430
UplinkPowerControlCommonPUSCH-LessCell-v1430  OPTIONAL  -- Need OR
}
OPTIONAL,  -- Cond ULRS
OR
harq-ReferenceConfig-r14              ENUMERATED {sa2,sa4,sa5}            OPTIONAL,  -- Need
soundingRS-FlexibleTiming-r14        ENUMERATED {true}                   OPTIONAL  -- Need OR
]],
[[ mbsfn-SubframeConfigList-v1430     MBSFN-SubframeConfigList-v1430     OPTIONAL  -- Need ON
]],
[[ uplinkPowerControlCommonSCell-v1530 UplinkPowerControlCommon-v1530     OPTIONAL  -- Need ON
]],
[[ highSpeedEnhMeasFlagSCell-r16      BOOLEAN                               OPTIONAL  -- Need ON
]]
}

RadioResourceConfigCommonSCell-v1010 ::= SEQUENCE {
-- UL configuration
ul-Configuration-v1010                SEQUENCE {
additionalSpectrumEmissionSCell-v1010  AdditionalSpectrumEmission-v1010
}
}

RadioResourceConfigCommonSCell-v1440 ::= SEQUENCE {
ul-Configuration-v1440                SEQUENCE {
ul-FreqInfo-v1440                    SEQUENCE {
additionalSpectrumEmissionSCell-v1440  AdditionalSpectrumEmission-v1010
}
}
}

BCCH-Config ::= SEQUENCE {
modificationPeriodCoeff              ENUMERATED {n2, n4, n8, n16}
}

BCCH-Config-v1310 ::= SEQUENCE {
modificationPeriodCoeff-v1310        ENUMERATED {n64}
}

FreqHoppingParameters-r13 ::= SEQUENCE {
dummy                                ENUMERATED {nb2, nb4}                OPTIONAL,
dummy2                                CHOICE {
interval-FDD-r13                      ENUMERATED {int1, int2, int4, int8},
interval-TDD-r13                      ENUMERATED {int1, int5, int10, int20}
}
OPTIONAL,
}

```



```

dummy3 CHOICE {
  interval-FDD-r13 ENUMERATED {int2, int4, int8, int16},
  interval-TDD-r13 ENUMERATED { int5, int10, int20, int40}
}
interval-ULHoppingConfigCommonModeA-r13 CHOICE {
  interval-FDD-r13 ENUMERATED {int1, int2, int4, int8},
  interval-TDD-r13 ENUMERATED {int1, int5, int10, int20}
}
interval-ULHoppingConfigCommonModeB-r13 CHOICE {
  interval-FDD-r13 ENUMERATED {int2, int4, int8, int16},
  interval-TDD-r13 ENUMERATED { int5, int10, int20, int40}
}
dummy4 INTEGER (1..maxAvailNarrowBands-r13)
}
}

PCCH-Config ::= SEQUENCE {
  defaultPagingCycle ENUMERATED {
    rf32, rf64, rf128, rf256},
  nB ENUMERATED {
    fourT, twoT, oneT, halfT, quarterT, oneEighthT,
    oneSixteenthT, oneThirtySecondT}
}

PCCH-Config-v1310 ::= SEQUENCE {
  paging-narrowBands-r13 INTEGER (1..maxAvailNarrowBands-r13),
  mpdcch-NumRepetition-Paging-r13 ENUMERATED {r1, r2, r4, r8, r16, r32, r64, r128, r256},
  nB-v1310 ENUMERATED {one64thT, one128thT, one256thT}
}
}

PCCH-Config-v1700 ::= SEQUENCE {
  ranPagingInIdlePO-r17 ENUMERATED {true}
}

UL-CyclicPrefixLength ::= ENUMERATED {len1, len2}

HighSpeedConfig-r14 ::= SEQUENCE {
  highSpeedEnhancedMeasFlag-r14 ENUMERATED {true} OPTIONAL, -- Need OR
  highSpeedEnhancedDemodulationFlag-r14 ENUMERATED {true} OPTIONAL -- Need OR
}

HighSpeedConfig-v1530 ::= SEQUENCE {
  highSpeedMeasGapCE-ModeA-r15 ENUMERATED {true}
}

HighSpeedConfigSCell-r14 ::= SEQUENCE {
  highSpeedEnhancedDemodulationFlag-r14 ENUMERATED {true} OPTIONAL -- Need OR
}

HighSpeedConfig-v1610 ::= SEQUENCE {
  highSpeedEnhMeasFlag2-r16 ENUMERATED {true} OPTIONAL, -- Need OR
  highSpeedEnhDemodFlag2-r16 ENUMERATED {true} OPTIONAL -- Need OR
}

-- ASN1STOP

```

<b>RadioResourceConfigCommon field descriptions</b>
<p><b>additionalSpectrumEmissionSCell</b> The UE requirements related to <i>additionalSpectrumEmissionSCell</i> are defined in TS 36.101 [42]. E-UTRAN configures the same value in <i>additionalSpectrumEmissionSCell</i> for all SCell(s) of the same band with UL configured. The <i>additionalSpectrumEmissionSCell</i> is applicable for all serving cells (including PCell) of the same band with UL configured.</p>
<p><b>crs-ChEstMPDCCH-ConfigCommon</b> Presence of this field indicates use of CRS for improving channel estimation on MPDCCH is enabled in RRC_IDLE and RRC_CONNECTED.</p>
<p><b>defaultPagingCycle</b> Default paging cycle, used to derive 'T' in TS 36.304 [4]. Value rf32 corresponds to 32 radio frames, rf64 corresponds to 64 radio frames and so on.</p>
<p><b>dummy</b> This field is not used in the specification. If received it shall be ignored by the UE.</p>
<p><b>harq-ReferenceConfig</b> Indicates UL/ DL configuration used as the DL HARQ reference configuration for this serving cell. Value sa2 corresponds to Configuration2, sa4 to Configuration4 etc, as specified in TS 36.211 [21], table 4.2-2. E-UTRAN configures the same value for all serving cells residing on same frequency band.</p>
<p><b>highSpeedEnhancedMeasFlag</b> If the field is present, the UE shall apply the high speed (350 km/h) measurement enhancements as specified in TS 36.133 [16]. If <i>highSpeedEnhMeasFlag2</i> is present, the UE indicating <i>measurementEnhancements2</i> shall ignore this field.</p>
<p><b>highSpeedEnhancedDemodulationFlag</b> If the field is present, the UE shall apply the advanced receiver in SFN scenario (350 km/h) as specified in TS 36.101 [42]. If this field is included in <i>HighSpeedConfig</i> and <i>highSpeedEnhDemodFlag2</i> is present, the UE indicating <i>demodulationEnhancements2</i> shall ignore this field in <i>HighSpeedConfig</i>.</p>
<p><b>highSpeedEnhDemodFlag2</b> If the field is present, the UE shall apply the further enhanced receiver in HST-SFN scenario (500 km/h) as specified in TS 36.101 [42].</p>
<p><b>highSpeedEnhMeasFlag2</b> If the field is present, the UE shall apply the high speed (500 km/h) measurement enhancements as specified in TS 36.133 [16].</p>
<p><b>highSpeedEnhMeasFlagSCell</b> If configured with value TRUE, the UE shall apply the high speed (350 km/h) SCell measurement enhancements as specified in TS 36.133 [16].</p>
<p><b>highSpeedInterRAT-NR</b> If the field is present, the UE shall apply the enhanced inter-RAT NR measurement requirements to support high speed up to 500 km/h as specified in TS 36.133 [16].</p>
<p><b>highSpeedMeasGapCE-ModeA</b> If the field is present, the UE in CE mode A shall apply the measurement gap sharing table associated with high-velocity scenario for measurements, as specified in TS 36.133 [16].</p>
<p><b>interval-DLHoppingConfigCommonModeX</b> Number of consecutive absolute subframes over which MPDCCH or PDSCH for CE mode X stays at the same narrowband before hopping to another narrowband. For interval-FDD, int1 corresponds to 1 subframe, int2 corresponds to 2 subframes, and so on. For interval-TDD, int1 corresponds to 1 subframe, int5 corresponds to 5 subframes, and so on.</p>
<p><b>interval-ULHoppingConfigCommonModeX</b> Number of consecutive absolute subframes over which PUCCH or PUSCH for CE mode X stays at the same narrowband before hopping to another narrowband. For interval-FDD, int1 corresponds to 1 subframe, int2 corresponds to 2 subframes, and so on. For interval-TDD, int1 corresponds to 1 subframe, int5 corresponds to 5 subframes, and so on.</p>
<p><b>modificationPeriodCoeff</b> Actual modification period, expressed in number of radio frames= <i>modificationPeriodCoeff</i> * <i>defaultPagingCycle</i>. n2 corresponds to value 2, n4 corresponds to value 4, n8 corresponds to value 8, n16 corresponds to value 16, and n64 corresponds to value 64.</p>
<p><b>mpdcch-NumRepetition-Paging</b> Maximum number of repetitions for MPDCCH common search space (CSS) for paging, see TS 36.211 [21].</p>
<p><b>mpdcch-pdsch-HoppingOffset</b> Parameter: <math>f_{NB, hop}^{DL}</math>, see TS 36.211 [21], clause 6.4.1.</p>
<p><b>mpdcch-pdsch-HoppingNB</b> The number of narrowbands for MPDCCH/PDSCH frequency hopping. Value nb2 corresponds to 2 narrowbands and value nb4 corresponds to 4 narrowbands.</p>
<p><b>nB</b> Parameter: nB is used as one of parameters to derive the Paging Frame and Paging Occasion according to TS 36.304 [4]. Value in multiples of 'T' as defined in TS 36.304 [4]. A value of fourT corresponds to 4 * T, a value of twoT corresponds to 2 * T and so on. In case <i>nB-v1310</i> is signalled, the UE shall ignore <i>nB</i> (i.e. without suffix). EUTRAN configures <i>nB-v1310</i> only in the BR version of SI message.</p>

<b><i>paging-narrowBands</i></b>
Number of narrowbands used for paging, see TS 36.304 [4], TS 36.212 [22] and TS 36.213 [23].
<b><i>p-Max</i></b>
Pmax to be used in the target cell. If absent, for the band used in the target cell, the UE applies the maximum power according to its capability as specified in 36.101 [42], clause 6.2.2. In case the UE is configured with uplink intra-band contiguous CA and the UE indicates <i>ue-CA-PowerClass-N</i> in that band combination, then the <i>p-Max</i> in <i>RadioResourceConfigCommonSCell</i> for that SCell, if present, also applies for that band combination whenever that SCell is activated. This field is ignored by IAB-MT. The IAB-MT applies output power and emissions requirements, as specified in TS 38.174 [107]
<b><i>prach-ConfigSCell</i></b>
Indicates a PRACH configuration for an SCell. The field is not applicable for an LAA SCell in this release.
<b><i>puncturedSubcarriersDL</i></b>
Indicates number of punctured DL subcarriers and their locations, see TS 36.211 [31].
<b><i>rach-ConfigCommonSCell</i></b>
Indicates a RACH configuration for an SCell. The field is not applicable for an LAA SCell in this release.
<b><i>ranPagingInIdlePO</i></b>
Indicates that the network supports to send RAN paging in PO that corresponds to the <i>i_s</i> determined by UE in RRC_IDLE state, see TS 36.304 [4].
<b><i>rss-MeasConfig</i></b>
Indicates whether RSS-based measurement is enabled.
<b><i>rss-MeasNonNCL</i></b>
Indicates RSS of neighbour cells not in the Neighbour Cell List may be used for measurements. When this field is included, the UE assumes for all neighbour cells not in the Neighbour Cell List the RSS power bias is same as used for the serving cell or the camped cell.
<b><i>soundingRS-FlexibleTiming</i></b>
Indicates the SRS flexible timing (if configured) for aperiodic SRS triggered by DL grant. If the SRS transmission is collided with ACK/NACK, postpone once to the next configured SRS transmission opportunity.
<b><i>ta-Report</i></b>
When this field is included in <i>SystemInformationBlockType2</i> , it indicates reporting of timing advance is enabled during Random Access due to RRC connection establishment, RRC connection resume or RRC connection reestablishment. When this field is included in <i>MobilityControlInfo</i> , it indicates TA reporting is enabled during Random Access due to handover, see TS 36.321 [6], clause 5.4.9.
<b><i>t318</i></b>
The value of timer T318. Value <i>ms0</i> corresponds with 0 ms, <i>ms50</i> corresponds with 50 ms and so on.
<b><i>ul-Bandwidth</i></b>
Parameter: transmission bandwidth configuration, $N_{RB}$ , in uplink, see TS 36.101 [42], table 5.6-1 and TS 36.108 [114], table 5.3A-1. Value <i>n6</i> corresponds to 6 resource blocks, <i>n15</i> to 15 resource blocks and so on. If for FDD this parameter is absent, the uplink bandwidth is equal to the downlink bandwidth. For TDD this parameter is absent and it is equal to the downlink bandwidth.
<b><i>ul-CarrierFreq</i></b>
For FDD: If absent, the (default) value determined from the default TX-RX frequency separation defined in TS 36.101 [42], table 5.7.3-1 and TS 36.108 [114], table 5.4A.2-1, applies. For TDD: This parameter is absent and it is equal to the downlink frequency.
<b><i>ul-CyclicPrefixLength</i></b>
Parameter: Uplink cyclic prefix length see TS 36.211 [21], clause 5.2.1, where <i>len1</i> corresponds to normal cyclic prefix and <i>len2</i> corresponds to extended cyclic prefix.

Conditional presence	Explanation
<i>EDT</i>	The field is optionally present, Need OR, if <i>edt-Parameters</i> is present; otherwise the field is not present and the UE shall delete any existing value for this field.
<i>MP-A</i>	The field is mandatory present for CE mode A. Otherwise the field is optional, Need OR.
<i>MP-B</i>	The field is mandatory present for CE mode B. Otherwise the field is optional, Need OR.
<i>NTN</i>	The field is mandatory present for NTN. Otherwise, the field is not present.
<i>TDD</i>	The field is optional for TDD, Need ON; it is not present for FDD and the UE shall delete any existing value for this field.
<i>TDD2</i>	If <i>tdd-Config-r10</i> is present, the field is optional, Need OR. Otherwise the field is not present and the UE shall delete any existing value for this field.
<i>TDD3</i>	If <i>tdd-Config</i> is present, the field is optional, Need OR. Otherwise the field is not present and the UE shall delete any existing value for this field.
<i>TDD-OR-NoR11</i>	If <i>prach-ConfigSCell-r11</i> is absent, the field is optional for TDD, Need OR. Otherwise the field is not present and the UE shall delete any existing value for this field.
<i>TDDSCell</i>	This field is mandatory present for TDD; it is not present for FDD and LAA SCell, and the UE shall delete any existing value for this field.
<i>UL</i>	If the SCell is part of the STAG or concerns the PSCell or PUCCH SCell and if <i>ul-Configuration</i> is included, the field is optional, Need OR. Otherwise the field is not present and the UE shall delete any existing value for this field.
<i>ULSCell</i>	For the PSCell (IE is included in <i>RadioResourceConfigCommonPSCell</i> ) the field is absent. Otherwise, if the SCell is part of the STAG and if <i>ul-Configuration</i> is included, the field is optional, Need OR. Otherwise the field is not present and the UE shall delete any existing value for this field.
<i>ULSRS</i>	If <i>ul-Configuration-r10</i> is absent, the field is optional, Need OR. Otherwise the field is not present and the UE shall delete any existing value for this field.

### – *RadioResourceConfigDedicated*

The IE *RadioResourceConfigDedicated* is used to setup/modify/release RBs, to modify the MAC main configuration, to modify the SPS configuration and to modify dedicated physical configuration.

#### ***RadioResourceConfigDedicated* information element**

```
-- ASN1START
RadioResourceConfigDedicated ::= SEQUENCE {
  srb-ToAddModList          SRB-ToAddModList          OPTIONAL,      -- Cond HO-Conn
  drb-ToAddModList          DRB-ToAddModList          OPTIONAL,      -- Cond HO-
toEUTRA
  drb-ToReleaseList         DRB-ToReleaseList         OPTIONAL,      -- Need ON
  mac-MainConfig            CHOICE {
    explicitValue            MAC-MainConfig,
    defaultValue            NULL
  } OPTIONAL,      -- Cond HO-
toEUTRA2
  sps-Config                SPS-Config                OPTIONAL,      -- Need ON
  physicalConfigDedicated   PhysicalConfigDedicated OPTIONAL,      -- Need ON
  ...,
  [[ rlf-TimersAndConstants-r9 RLF-TimersAndConstants-r9 OPTIONAL -- Need ON
  ]],
  [[ measSubframePatternPCell-r10 MeasSubframePatternPCell-r10 OPTIONAL -- Need ON
  ]],
  [[ neighCellsCRS-Info-r11 NeighCellsCRS-Info-r11 OPTIONAL -- Need ON
  ]],
  [[ naics-Info-r12 NAICS-AssistanceInfo-r12 OPTIONAL -- Need ON
  ]],
  [[ neighCellsCRS-Info-r13 NeighCellsCRS-Info-r13 OPTIONAL, -- Cond
CRSIM
  rlf-TimersAndConstants-r13 RLF-TimersAndConstants-r13 OPTIONAL -- Need ON
  ]],
  [[ sps-Config-v1430 SPS-Config-v1430 OPTIONAL -- Cond SPS
  ]],
  [[ srb-ToAddModListExt-r15 SRB-ToAddModListExt-r15 OPTIONAL, -- Need ON
  srb-ToReleaseListExt-r15 INTEGER (4) OPTIONAL, -- Need ON
  ]],
  sps-Config-v1530          SPS-Config-v1530          OPTIONAL,      -- Need ON
  crs-IntfMitigConfig-r15 CHOICE {
    release                  NULL,
    setup                    CHOICE {
```

```

        crs-IntfMitigEnabled          NULL,
        crs-IntfMitigNumPRBs        ENUMERATED {n6, n24}
    }
}
    OPTIONAL, -- Need ON
neighCellsCRS-Info-r15             NeighCellsCRS-Info-r15    OPTIONAL, -- Need ON
drb-ToAddModList-r15               DRB-ToAddModList-r15    OPTIONAL, -- Need ON
drb-ToReleaseList-r15              DRB-ToReleaseList-r15   OPTIONAL, -- Need ON
dummy                               SEQUENCE (SIZE (1..2)) OF INTEGER (1..2)  OPTIONAL --
Need ON
]],
[[ sps-Config-v1540                 SPS-Config-v1540        OPTIONAL -- Need ON
]],
[[
    rlf-TimersAndConstantsMCG-Failure-r16 RLF-TimersAndConstantsMCG-Failure-r16
    OPTIONAL, -- Cond Split-SRB1-SRB3
    crs-ChEstMPDCCH-ConfigDedicated-r16 SetupRelease{CRS-ChEstMPDCCH-ConfigDedicated-r16}
OPTIONAL, -- Need ON
newUE-Identity-r16                 C-RNTI                   OPTIONAL -- Need OP
]],
[[ harq-FeedbackEnablingforSPSactive-r18 ENUMERATED {enabled}    OPTIONAL, -- Need OR
gns-AutonomousEnabled-r18          ENUMERATED {true}        OPTIONAL, -- Need OR
ul-TransmissionExtensionEnabled-r18 ENUMERATED {true}        OPTIONAL, -- Need OR
ul-TransmissionExtensionValue-r18  ENUMERATED {sf500, sf750, sf1280, sf1920,
sf2560, sf5120, sf10240, spare1}
OPTIONAL -- Need OR
]]
}
RadioResourceConfigDedicated-v1370 ::= SEQUENCE {
    physicalConfigDedicated-v1370 PhysicalConfigDedicated-v1370    OPTIONAL -- Need ON
}
RadioResourceConfigDedicated-v13c0 ::= SEQUENCE {
    physicalConfigDedicated-v13c0 PhysicalConfigDedicated-v13c0
}
RadioResourceConfigDedicatedPSCell-r12 ::= SEQUENCE {
    -- UE specific configuration extensions applicable for an PSCell
    physicalConfigDedicatedPSCell-r12 PhysicalConfigDedicated    OPTIONAL, -- Need ON
    sps-Config-r12                      SPS-Config                 OPTIONAL, -- Need ON
    naics-Info-r12                       NAICS-AssistanceInfo-r12   OPTIONAL, -- Need ON
    ...,
    [[ neighCellsCRS-InfoPSCell-r13      NeighCellsCRS-Info-r13    OPTIONAL -- Need ON
    ]],
    [[ sps-Config-v1430                  SPS-Config-v1430          OPTIONAL -- Cond SPS2
    ]],
    [[ sps-Config-v1530                  SPS-Config-v1530          OPTIONAL, -- Need ON
    crs-IntfMitigEnabled-r15             BOOLEAN                    OPTIONAL, -- Need ON
    neighCellsCRS-Info-r15              NeighCellsCRS-Info-r15    OPTIONAL -- Need ON
    ]],
    [[ sps-Config-v1540                  SPS-Config-v1540          OPTIONAL -- Need ON
    ]]
}
RadioResourceConfigDedicatedPSCell-v1370 ::= SEQUENCE {
    physicalConfigDedicatedPSCell-v1370 PhysicalConfigDedicated-v1370    OPTIONAL -- Need ON
}
RadioResourceConfigDedicatedPSCell-v13c0 ::= SEQUENCE {
    physicalConfigDedicatedPSCell-v13c0 PhysicalConfigDedicated-v13c0
}
RadioResourceConfigDedicatedSCG-r12 ::= SEQUENCE {
    drb-ToAddModListSCG-r12             DRB-ToAddModListSCG-r12    OPTIONAL, -- Need ON
    mac-MainConfigSCG-r12               MAC-MainConfig             OPTIONAL, -- Need ON
    rlf-TimersAndConstantsSCG-r12       RLF-TimersAndConstantsSCG-r12 OPTIONAL, -- Need ON
    ...,
    [[ drb-ToAddModListSCG-r15           DRB-ToAddModListSCG-r15    OPTIONAL -- Need ON
    ]],
    [[ srb-ToAddModListSCG-r15           SRB-ToAddModList           OPTIONAL, -- Need ON
    srb-ToReleaseListSCG-r15           SRB-ToReleaseList-r15      OPTIONAL -- Need
ON
    ]],
    [[ -- NE-DC additions for release of RLC bearer config for DRBs
    drb-ToReleaseListSCG-r15           DRB-ToReleaseList-r15      OPTIONAL -- Need ON
    ]]
}

```

```

RadioResourceConfigDedicatedSCell-r10 ::= SEQUENCE {
  -- UE specific configuration extensions applicable for an SCell
  physicalConfigDedicatedSCell-r10 PhysicalConfigDedicatedSCell-r10 OPTIONAL, -- Need
ON
  ...,
  [[ mac-MainConfigSCell-r11 MAC-MainConfigSCell-r11 OPTIONAL -- Cond SCellAdd
  ]],
  [[ naics-Info-r12 NAICS-AssistanceInfo-r12 OPTIONAL -- Need ON
  ]],
  [[ neighCellsCRS-InfoSCell-r13 NeighCellsCRS-Info-r13 OPTIONAL -- Need ON
  ]],
  [[ physicalConfigDedicatedSCell-v1370 PhysicalConfigDedicatedSCell-v1370 OPTIONAL -- Need
ON
  ]],
  [[ crs-IntfMitigEnabled-r15 BOOLEAN OPTIONAL, -- Need ON
  neighCellsCRS-Info-r15 NeighCellsCRS-Info-r15 OPTIONAL, -- Need ON
  sps-Config-v1530 SPS-Config-v1530 OPTIONAL -- Need ON
  ]],
  [[ physicalConfigDedicatedSCell-v1730 PhysicalConfigDedicatedSCell-v1730 OPTIONAL -- Cond
CQI-ReportPeriodicSCell
  ]]
}

RadioResourceConfigDedicatedSCell-v13c0 ::= SEQUENCE {
  physicalConfigDedicatedSCell-v13c0 PhysicalConfigDedicatedSCell-v13c0
}

SRB-ToAddModList ::= SEQUENCE (SIZE (1..2)) OF SRB-ToAddMod

SRB-ToAddModListExt-r15 ::= SEQUENCE (SIZE (1)) OF SRB-ToAddMod

SRB-ToAddMod ::= SEQUENCE {
  srb-Identity INTEGER (1..2),
  rlc-Config CHOICE {
    explicitValue RLC-Config,
    defaultValue NULL
  } OPTIONAL, -- Cond Setup
  logicalChannelConfig CHOICE {
    explicitValue LogicalChannelConfig,
    defaultValue NULL
  } OPTIONAL, -- Cond Setup
  ...,
  [[ pdcp-verChange-r15 ENUMERATED {true} OPTIONAL, -- Cond NR-PDCP
  rlc-Config-v1530 RLC-Config-v1530 OPTIONAL, -- Need ON
  rlc-BearerConfigSecondary-r15 RLC-BearerConfig-r15 OPTIONAL, -- Need ON
  srb-Identity-v1530 INTEGER (4) OPTIONAL -- Need ON
  ]],
  [[ rlc-Config-v1560 RLC-Config-v1510 OPTIONAL -- Need ON
  ]],
  [[ rlc-Config-v1700 RLC-Config-v1700 OPTIONAL -- Need ON
  ]]
}

DRB-ToAddModList ::= SEQUENCE (SIZE (1..maxDRB)) OF DRB-ToAddMod
DRB-ToAddModList-r15 ::= SEQUENCE (SIZE (1..maxDRB-r15)) OF DRB-ToAddMod

DRB-ToAddModListSCG-r12 ::= SEQUENCE (SIZE (1..maxDRB)) OF DRB-ToAddModSCG-r12
DRB-ToAddModListSCG-r15 ::= SEQUENCE (SIZE (1..maxDRB-r15)) OF DRB-ToAddModSCG-r12

DRB-ToAddMod ::= SEQUENCE {
  eps-BearerIdentity INTEGER (0..15) OPTIONAL, -- Cond DRB-Setup
  drb-Identity DRB-Identity,
  pdcp-Config PDCP-Config OPTIONAL, -- Cond PDCP
  rlc-Config RLC-Config OPTIONAL, -- Cond SetupM
  logicalChannelIdentity INTEGER (3..10) OPTIONAL, -- Cond DRB-SetupM
  logicalChannelConfig LogicalChannelConfig OPTIONAL, -- Cond SetupM
  ...,
  [[ drb-TypeChange-r12 ENUMERATED {toMCG} OPTIONAL, -- Need OP
  rlc-Config-v1250 RLC-Config-v1250 OPTIONAL -- Need ON
  ]],
  [[ rlc-Config-v1310 RLC-Config-v1310 OPTIONAL, -- Need ON
  drb-TypeLWA-r13 BOOLEAN OPTIONAL, -- Need ON
  drb-TypeLWIP-r13 ENUMERATED {lwip, lwip-DL-only,
  lwip-UL-only, eutran} OPTIONAL -- Need ON
  ]],
  [[ rlc-Config-v1430 RLC-Config-v1430 OPTIONAL, -- Need ON
  lwip-UL-Aggregation-r14 BOOLEAN OPTIONAL, -- Cond LWIP
  lwip-DL-Aggregation-r14 BOOLEAN OPTIONAL, -- Cond LWIP
  ]]
}

```

```

    lwa-WLAN-AC-r14          ENUMERATED {ac-bk, ac-be, ac-vi, ac-vo} OPTIONAL  -- Cond UL-LWA
  ]],
  [[ rlc-Config-v1510          RLC-Config-v1510          OPTIONAL  -- Need ON
  ]],
  [[ rlc-Config-v1530          RLC-Config-v1530          OPTIONAL,  -- Need ON
    rlc-BearerConfigSecondary-r15  RLC-BearerConfig-r15  OPTIONAL,  -- Need ON
    logicalChannelIdentity-r15     INTEGER (32..38)      OPTIONAL  -- Need ON
  ]],
  [[ daps-HO-r16              ENUMERATED {true}      OPTIONAL  -- Cond DAPS
  ]],
  [[ rlc-Config-v1700          RLC-Config-v1700          OPTIONAL  -- Need ON
  ]]
}

DRB-ToAddModSCG-r12 ::= SEQUENCE {
  drb-Identity-r12          DRB-Identity,
  drb-Type-r12              CHOICE {
    split-r12              NULL,
    scg-r12                SEQUENCE {
      eps-BearerIdentity-r12  INTEGER (0..15) OPTIONAL,  -- Cond DRB-Setup
      pdcp-Config-r12        PDCP-Config  OPTIONAL  -- Cond PDCP-S
    }
  }
  OPTIONAL,  -- Cond SetupS2
  rlc-ConfigSCG-r12        RLC-Config  OPTIONAL,  -- Cond SetupS
  rlc-Config-v1250         RLC-Config-v1250          OPTIONAL,  -- Need ON
  logicalChannelIdentitySCG-r12  INTEGER (3..10)  OPTIONAL,  -- Cond DRB-SetupS
  logicalChannelConfigSCG-r12  LogicalChannelConfig  OPTIONAL,  -- Cond SetupS
  ...,
  [[ rlc-Config-v1430          RLC-Config-v1430          OPTIONAL  -- Need ON
  ]],
  [[ logicalChannelIdentitySCG-r15  INTEGER (32..38)  OPTIONAL,  -- Need ON
    rlc-Config-v1530          RLC-Config-v1530          OPTIONAL,  -- Need ON
    rlc-BearerConfigSecondary-r15  RLC-BearerConfig-r15  OPTIONAL  -- Need ON
  ]],
  [[ rlc-Config-v1560          RLC-Config-v1510          OPTIONAL  -- Need ON
  ]]
}

DRB-ToReleaseList ::= SEQUENCE (SIZE (1..maxDRB)) OF DRB-Identity
DRB-ToReleaseList-r15 ::= SEQUENCE (SIZE (1..maxDRB-r15)) OF DRB-Identity

SRB-ToReleaseList-r15 ::= SEQUENCE (SIZE (1..2)) OF INTEGER (1..2)

MeasSubframePatternPCell-r10 ::= CHOICE {
  release          NULL,
  setup           MeasSubframePattern-r10
}

NeighCellsCRS-Info-r11 ::= CHOICE {
  release          NULL,
  setup           CRS-AssistanceInfoList-r11
}

CRS-AssistanceInfoList-r11 ::= SEQUENCE (SIZE (1..maxCellReport)) OF CRS-AssistanceInfo-r11

CRS-AssistanceInfo-r11 ::= SEQUENCE {
  physCellId-r11          PhysCellId,
  antennaPortsCount-r11   ENUMERATED {an1, an2, an4, spare1},
  mbsfn-SubframeConfigList-r11  MBSFN-SubframeConfigList,
  ...,
  [[ mbsfn-SubframeConfigList-v1430  MBSFN-SubframeConfigList-v1430  OPTIONAL  -- Need ON
  ]]
}

NeighCellsCRS-Info-r13 ::= CHOICE {
  release          NULL,
  setup           CRS-AssistanceInfoList-r13
}

CRS-AssistanceInfoList-r13 ::= SEQUENCE (SIZE (1..maxCellReport)) OF CRS-AssistanceInfo-r13

CRS-AssistanceInfo-r13 ::= SEQUENCE {
  physCellId-r13          PhysCellId,
  antennaPortsCount-r13   ENUMERATED {an1, an2, an4, spare1},
  mbsfn-SubframeConfigList-r13  MBSFN-SubframeConfigList  OPTIONAL,  -- Need ON
  ...,
  [[ mbsfn-SubframeConfigList-v1430  MBSFN-SubframeConfigList-v1430  OPTIONAL  -- Need ON
  ]]
}

```

```

}
NeighCellsCRS-Info-r15 ::= CHOICE {
    release          NULL,
    setup           CRS-AssistanceInfoList-r15
}

CRS-AssistanceInfoList-r15 ::= SEQUENCE (SIZE (1..maxCellReport)) OF CRS-AssistanceInfo-r15

CRS-AssistanceInfo-r15 ::= SEQUENCE {
    physCellId-r15          PhysCellId,
    crs-IntfMitigEnabled-r15  ENUMERATED {enabled}          OPTIONAL  -- Need ON
}

NAICS-AssistanceInfo-r12 ::= CHOICE {
    release          NULL,
    setup           SEQUENCE {
        neighCellsToReleaseList-r12  NeighCellsToReleaseList-r12  OPTIONAL,  -- Need ON
        neighCellsToAddModList-r12   NeighCellsToAddModList-r12  OPTIONAL,  -- Need ON
        servCellp-a-r12              P-a                          OPTIONAL,  -- Need ON
    }
}

NeighCellsToReleaseList-r12 ::= SEQUENCE (SIZE (1..maxNeighCell-r12)) OF PhysCellId

NeighCellsToAddModList-r12 ::= SEQUENCE (SIZE (1..maxNeighCell-r12)) OF NeighCellsInfo-r12

NeighCellsInfo-r12 ::= SEQUENCE {
    physCellId-r12          PhysCellId,
    p-b-r12                 INTEGER (0..3),
    crs-PortsCount-r12     ENUMERATED {n1, n2, n4, spare},
    mbsfn-SubframeConfig-r12 MBSFN-SubframeConfigList          OPTIONAL,  -- Need ON
    p-aList-r12             SEQUENCE (SIZE (1..maxP-a-PerNeighCell-r12)) OF P-a,
    transmissionModeList-r12 BIT STRING (SIZE(8)),
    resAllocGranularity-r12 INTEGER (1..4),
    ...
}

P-a ::= ENUMERATED { dB-6, dB-4dot77, dB-3, dB-1dot77, dB0, dB1, dB2, dB3}

RLC-BearerConfig-r15 ::= CHOICE {
    release          NULL,
    setup           SEQUENCE {
        rlc-Config-r15          RLC-Config-r15          OPTIONAL,  -- Need ON
        logicalChannelIdentityConfig-r15 CHOICE {
            logicalChannelIdentity-r15          INTEGER (1..10),
            logicalChannelIdentityExt-r15       INTEGER (32..38)
        },
        logicalChannelConfig-r15          LogicalChannelConfig          OPTIONAL  -- Need ON
    }
}

-- ASN1STOP

```



<b>RadioResourceConfigDedicated field descriptions</b>
<p><b>crs-ChEstMPDCCH-ConfigDedicated</b> Indicates whether use of CRS for improving channel estimation on MPDCCH is enabled in RRC_CONNECTED. If this field is not configured, the field <i>crs-ChEstMPDCCH-ConfigCommon</i> in <i>SystemInformationBlockType2</i> applies, if present.</p>
<p><b>crs-IntfMitigConfig</b> <i>crs-IntfMitigEnabled-r15</i> indicates CRS interference mitigation is enabled for the cell, as specified in TS 36.133 [16], clause 3.6.1.1. For BL UEs supporting <i>ce-CRS-IntfMitig</i>, presence of this field indicates CRS interference mitigation is enabled in the cell, as specified in TS 36.133 [16], clauses 3.6.1.2 and 3.6.1.3, and the value <i>crs-IntfMitigNumPRBs</i> indicates number of PRBs, i.e. 6 or 24 PRBs, for CRS transmission in the central cell BW when CRS interference mitigation is enabled. For UEs not supporting this feature, the behaviour is undefined if this field is configured and the field <i>cellBarred</i> in <i>SystemInformationBlockType1</i> (<i>SystemInformationBlockType1-BR</i> for BL UEs or UEs in CE) is set to <i>notbarred</i>.</p>
<p><b>crs-PortsCount</b> Parameter represents the number of antenna ports for cell-specific reference signal used by the signaled neighboring cell where n1 corresponds to 1 antenna port, n2 to 2 antenna ports etc. see TS 36.211 [21], clause 6.10.1.</p>
<p><b>daps-HO</b> This field indicates that the handover, triggered in the same <i>RRCCoalitionReconfiguration</i> message, shall be performed as a DAPS HO for the DRB. <i>daps-HO</i> is not configured if sidelink is configured.</p>
<p><b>drb-Identity</b> In case of DC, the DRB identity is unique within the scope of the UE i.e. an SCG DRB can not use the same value as used for an MCG or split DRB. For a split DRB the same identity is used for the MCG- and SCG parts of the configuration.</p>
<p><b>drb-ToAddModList</b> When <i>drb-ToAddModList-r15</i> is configured, UE shall ignore the <i>drb-ToAddModList</i> (without suffix).</p>
<p><b>drb-ToAddModListSCG</b> When an SCG is configured, E-UTRAN configures at least one SCG or split DRB. When <i>drb-ToAddModListSCG-r15</i> is configured, UE shall ignore the <i>drb-ToAddModListSCG</i> (without suffix). When NE-DC is configured, this field indicates the SCG RLC bearers to be (re-)configured.</p>
<p><b>drb-ToReleaseList</b> When <i>drb-ToReleaseList-r15</i> is configured, UE shall ignore the <i>drb-ToReleaseList</i> (without suffix).</p>
<p><b>drb-ToReleaseListSCG</b> When NE-DC is configured, this field indicates the SCG RLC bearers to be released.</p>
<p><b>drb-Type</b> This field indicates whether the DRB is split or SCG DRB. E-UTRAN does not configure split and SCG DRBs simultaneously for the UE.</p>
<p><b>drb-TypeChange</b> Indicates that a split/SCG DRB is reconfigured to an MCG DRB (i.e. E-UTRAN only signals the field in case the DRB type changes).</p>
<p><b>drb-TypeLWA</b> Indicates whether a DRB is (re)configured as an LWA DRB or an LWA DRB is reconfigured not to use WLAN resources. NOTE 1</p>
<p><b>drb-TypeLWIP</b> Indicates whether a DRB is (re)configured to use LWIP Tunnel in UL and DL (value <i>lwip</i>), DL only (value <i>lwip-DL-only</i>), UL only (value <i>lwip-UL-only</i>) or not to use LWIP Tunnel (value <i>eutran</i>).</p>
<p><b>dummy</b> This field is not used in the specification. If received it shall be ignored by the UE.</p>
<p><b>gnss-AutonomousEnabled</b> Presence of this field indicates that autonomous GNSS re-acquisition using an autonomous gap is enabled by network.</p>
<p><b>harq-FeedbackEnablingforSPSActive</b> If present, UE reports ACK/NACK for the first SPS PDSCH after activation, regardless of if HARQ feedback is enabled or disabled for the HARQ process corresponding to the first SPS PDSCH after activation. Otherwise, UE follows configuration of HARQ feedback enabled/disabled for the HARQ process corresponding to the first SPS PDSCH after activation.</p>
<p><b>logicalChannelConfig</b> For SRBs a choice is used to indicate whether the logical channel configuration is signalled explicitly or set to the default logical channel configuration for SRB1 as specified in 9.2.1.1 or for SRB2 as specified in 9.2.1.2.</p>
<p><b>logicalChannelIdentity, LogicalChannelIdentityExt</b> The logical channel identity for both UL and DL. Value 4 is not configured for DRBs if SRB4 is configured. When <i>logicalChannelIdentity-r15</i> is signalled, UE shall ignore contents of <i>logicalChannelIdentity</i> (without suffix).</p>
<p><b>logicalChannelIdentitySCG</b> The logical channel identity for both UL and DL. When <i>logicalChannelIdentitySCG-r15</i> is signalled, UE shall ignore contents of <i>logicalChannelIdentitySCG</i> (without suffix).</p>

<b>RadioResourceConfigDedicated field descriptions</b>
<p><b><i>lwa-WLAN-AC</i></b> For LWA bearers, indicates the corresponding WLAN access category for uplink. AC-BK (value <i>ac-bk</i>) corresponds to Background access category, AC-BE (value <i>ac-be</i>) corresponds to Best Effort access category, AC-VI (value <i>ac-vi</i>) corresponds to Video access category and AC-VO (value <i>ac-vo</i>) corresponds to Voice access category as defined by IEEE 802.11-2012 [67]. If <i>lwa-WLAN-AC</i> is not configured, it is left up to UE to decide which IEEE 802.11 AC value to use when performing transmissions of packets for this DRB over WLAN in the uplink.</p>
<p><b><i>lwip-DL-Aggregation, lwip-UL-Aggregation</i></b> Indicates whether LWIP is configured to utilize LWIP aggregation in DL or UL.</p>
<p><b><i>mac-MainConfig</i></b> Although the ASN.1 includes a choice that is used to indicate whether the <i>mac-MainConfig</i> is signalled explicitly or set to the default MAC main configuration as specified in 9.2.2, EUTRAN does not apply "defaultValue".</p>
<p><b><i>mbsfn-SubframeConfig</i></b> Defines the MBSFN subframe configuration used by the signaled neighboring cell. If absent, UE assumes no MBSFN configuration for the neighboring cell.</p>
<p><b><i>measSubframePatternPCell</i></b> Time domain measurement resource restriction pattern for the PCell measurements (RSRP, RSRQ and the radio link monitoring).</p>
<p><b><i>neighCellsCRS-Info, neighCellsCRS-InfoSCell, neighCellsCRS-InfoPSCell</i></b> This field contains assistance information used by the UE to mitigate interference from CRS while performing RRM/RLM/CSI measurement or data demodulation or DL control channel demodulation. When the received CRS assistance information is for a cell with CRS non-colliding with that of the CRS of the cell to measure, the UE may use the CRS assistance information to mitigate CRS interference. When the received CRS assistance information is for a cell with CRS colliding with that of the CRS of the cell to measure, the UE may use the CRS assistance information to mitigate CRS interference RRM/RLM (as specified in TS 36.133 [16]) and for CSI (as specified in TS 36.101 [42]) on the subframes indicated by <i>measSubframePatternPCell</i>, <i>measSubframePatternConfigNeigh</i>, <i>csi-MeasSubframeSet1</i> if configured, and the CSI subframe set 1 if <i>csi-MeasSubframeSets-r12</i> is configured. The UE may use CRS assistance information to mitigate CRS interference from the cells in the <i>CRS-AssistanceInfoList</i> for the demodulation purpose or DL control channel demodulation as specified in TS 36.101 [42]. EUTRAN does not configure <i>neighCellsCRS-Info-r11</i> or <i>neighCellsCRS-Info-r13</i> if <i>eimta-MainConfigPCell-r12</i> is configured.</p>
<p><b><i>neighCellsToAddModList</i></b> This field contains assistance information used by the UE to cancel and suppress interference of a neighbouring cell. If this field is present for a neighbouring cell, the UE assumes that the transmission parameters listed in the sub-fields are used by the neighbouring cell. If this field is present for a neighbouring cell, the UE assumes the neighbour cell is subframe and SFN synchronized to the serving cell, has the same system bandwidth, UL/DL and special subframe configuration, and cyclic prefix length as the serving cell.</p>
<p><b><i>newUE-Identity</i></b> C-RNTI used after moving to RRC_CONNECTED in response to transmission using PUR.</p>
<p><b><i>p-aList</i></b> Indicates the restricted subset of power offset for QPSK, 16QAM, and 64QAM PDSCH transmissions for the neighbouring cell by using the parameter <math>P_A</math>, see TS 36.213 [23], clause 5.2. Value dB-6 corresponds to -6 dB, dB-4dot77 corresponds to -4.77 dB etc.</p>
<p><b><i>p-b</i></b> Parameter: <math>P_B</math>, indicates the cell-specific ratio used by the signaled neighboring cell, see TS 36.213 [23], Table 5.2-1.</p>
<p><b><i>pdcp-verChange</i></b> Indicates that the PDCP version of the SRB is changed from NR PDCP to E-UTRA PDCP. Network only configures this version change for during handover, resume and first reconfiguration after re-establishment. E-UTRAN does not include this field when <i>SRB-ToAddMod</i> is included in <i>srb-ToAddModListSCG</i>.</p>
<p><b><i>physicalConfigDedicated</i></b> The default dedicated physical configuration is specified in 9.2.4.</p>
<p><b><i>resAllocGranularity</i></b> Indicates the resource allocation and precoding granularity in PRB pair level of the signaled neighboring cell, see TS 36.213 [23], clause 7.1.6.</p>
<p><b><i>rlc-BearerConfigSecondary</i></b> The configuration of a secondary RLC bearer within the same Cell Group as may e.g. be used in case of PDCP duplication using CA. The configuration comprises a (secondary) RLC entity, a logical channel identity and a logical channel configuration. E-UTRAN may configure this for SRB1, SRB2 and DRBs. For SRBs, E-UTRAN only configures the field for MCG (i.e. if included in <i>radioResourceConfigDedicated</i>. E-UTRAN configures the same RLC mode (AM/UM) as used for the original RLC entity. The primary RLC entity is configured by <i>RLC-Config</i>.</p>
<p><b><i>rlc-Config</i></b> For SRBs a choice is used to indicate whether the RLC configuration is signalled explicitly or set to the values defined in the default RLC configuration for SRB1 in 9.2.1.1 or for SRB2 in 9.2.1.2. RLC AM is the only applicable RLC mode for SRB1 and SRB2. E-UTRAN does not reconfigure the RLC mode of DRBs except when a full configuration option is used, and may reconfigure the RLC SN field size and the AM RLC LI field size only upon handover within E-UTRA or upon the first reconfiguration after RRC connection re-establishment or upon SCG Change for SCG and split DRBs.</p>

<b>RadioResourceConfigDedicated field descriptions</b>
<p><b>servCellP-a</b> Indicates the power offset for QPSK C-RNTI based PDSCH transmissions used by the serving cell, see TS 36.213 [23], clause 5.2. Value dB-6 corresponds to -6 dB, dB-4dot77 corresponds to -4.77 dB etc.</p>
<p><b>sps-Config</b> The default SPS configuration is specified in 9.2.3. Except for handover or releasing SPS for MCG, E-UTRAN does not reconfigure <i>sps-Config</i> for MCG when there is a configured downlink assignment or a configured uplink grant for MCG (see TS 36.321 [6]). Except for SCG change or releasing SPS for SCG, E-UTRAN does not reconfigure <i>sps-Config</i> for SCG when there is a configured downlink assignment or a configured uplink grant for SCG (see TS 36.321 [6]). In one serving cell, <i>sps-Config-v1530</i> is not present simultaneously with either <i>sps-Config</i> (without suffix) or <i>sps-Config-r12</i>.</p>
<p><b>srb-Identity</b> Value 1 is applicable for SRB1 only. Value 2 is applicable for SRB2 only. Value 4 is applicable for SRB4 only, if configured. For a split SRB the same identity is used for the MCG and NR SCG RLC bearer configurations. If <i>srb-Identity-v1530</i> is received, the UE shall ignore <i>srb-Identity</i> (i.e. without suffix).</p>
<p><b>srb-Identity-v1530</b> E-UTRAN does not include this field when <i>SRB-ToAddMod</i> is included in <i>srb-ToAddModListSCG</i>.</p>
<p><b>srb-ToAddModListExt</b> The field is to configure SRB4.</p>
<p><b>srb-ToAddModList</b> E-UTRAN configures the same RAT type (i.e. EUTRA or NR) for PDCP configuration of SRB1 and SRB2.</p>
<p><b>transmissionModeList</b> Indicates a subset of transmission mode 1, 2, 3, 4, 6, 8, 9, 10, for the signaled neighboring cell for which <i>NeighCellsInfo</i> applies. When TM10 is signaled, other signaled transmission parameters in <i>NeighCellsInfo</i> are not applicable to up to 8 layer transmission scheme of TM10. E-UTRAN may indicate TM9 when TM10 with QCL type A and DMRS scrambling with <math>n_{ID}^{(i)} = N_{ID}^{cell}</math> in TS 36.211 [21], clause 6.10.3.1, is used in the signalled neighbour cell and TM9 or TM10 with QCL type A and DMRS scrambling with <math>n_{ID}^{(i)} = N_{ID}^{cell}</math> in TS 36.211 [21], clause 6.10.3.1, is used in the serving cell. UE behaviour with NAICS when TM10 is used is only defined when QCL type A and DMRS scrambling with <math>n_{ID}^{(i)} = N_{ID}^{cell}</math> in TS 36.211 [21], clause 6.10.3.1, is used for the serving cell and all signalled neighbour cells. The first/ leftmost bit is for transmission mode 1, the second bit is for transmission mode 2, and so on.</p>
<p><b>ul-TransmissionExtensionEnabled</b> Presence of this field indicates that UL transmission extension after original GNSS validity duration expires is enabled by the network.</p>
<p><b>ul-TransmissionExtensionValue</b> Indicates the duration after original GNSS validity duration expires within which UL transmission is allowed. Value in number of sub-frames, value <i>sf500</i> corresponds to 500 sub-frames, <i>sf750</i> corresponds to 750 sub-frames and so on.</p>

NOTE 1: It is up to eNB to ensure that the field indicating LWA bearer type is set to FALSE when LWA bearer is no longer used (e.g. during handover or re-establishment where LWA configuration is released).

Conditional presence	Explanation
<i>CRSIM</i>	The field is optionally present, need ON, if <i>neighCellsCRS-Info-r11</i> is not present; otherwise it is not present.
<i>CQI-ReportPeriodicSCell</i>	The field is optionally present, Need ON, if <i>cqi-ReportPeriodicSCell-r15</i> is configured. Otherwise the field is not present.
<i>DRB-Setup</i>	The field is mandatory present if the corresponding DRB is being set up and the UE is connected to EPC; otherwise it is not present.
<i>DRB-SetupM</i>	The field is: <ul style="list-style-type: none"> <li>- mandatory present: <ul style="list-style-type: none"> <li>- for the UE without SCG: upon setup of MCG DRB;</li> <li>- for E-UTRA DC, upon setup of MCG or split DRB;</li> <li>- for (NG)EN-DC: <ul style="list-style-type: none"> <li>- upon setup of MCG RLC bearer;</li> </ul> </li> </ul> </li> <li>- optionally present, Need ON: <ul style="list-style-type: none"> <li>- for E-UTRA DC, upon change from SCG to MCG DRB;</li> <li>- for (NG)EN-DC: <ul style="list-style-type: none"> <li>- upon change of <i>keyToUse</i>, as defined in TS 38.331 [82], for a DRB configured with an MCG RLC bearer;</li> <li>- when configured with MCG RLC bearer, upon change of S-K<sub>gNB</sub> without handover;</li> </ul> </li> </ul> </li> <li>- not present otherwise.</li> </ul>
<i>DRB-SetupS</i>	The field is: <ul style="list-style-type: none"> <li>- mandatory present: <ul style="list-style-type: none"> <li>- for E-UTRA DC: <ul style="list-style-type: none"> <li>- upon setup of SCG or split DRB;</li> <li>- upon change from MCG to split DRB;</li> </ul> </li> <li>- for NE-DC: <ul style="list-style-type: none"> <li>- upon setup of SCG RLC bearer;</li> </ul> </li> </ul> </li> <li>- optionally present, Need ON: <ul style="list-style-type: none"> <li>- for E-UTRA DC, upon change from MCG to SCG DRB;</li> <li>- for NE-DC, upon change of <i>keyToUse</i>, as defined in TS 38.331 [82], for a DRB configured with an SCG RLC bearer;</li> </ul> </li> <li>- not present otherwise.</li> </ul>
<i>HO-Conn</i>	The field is mandatory present in case of handover to E-UTRA or when the <i>fullConfig</i> is included in the <i>RRCCConnectionReconfiguration</i> message or in case of RRC connection establishment (excluding <i>RRCCConnectionResume</i> ); otherwise the field is optionally present, need ON. Upon connection establishment/ re-establishment only SRB1 is applicable (excluding <i>RRCCConnectionResume</i> ).
<i>HO-toEUTRA</i>	The field is mandatory present <ul style="list-style-type: none"> <li>- in case of handover to E-UTRA with the configuration for at least one MCG RLC bearer; or</li> <li>- when the <i>fullConfig</i> is included in the <i>RRCCConnectionReconfiguration</i> message with the configuration for at least one MCG bearer or split data bearer;</li> </ul> In case of RRC connection establishment (excluding <i>RRCCConnectionResume</i> ); and RRC connection re-establishment the field is not present; otherwise the field is optionally present, need ON.
<i>HO-toEUTRA2</i>	The field is mandatory present in case of handover to E-UTRA or when the <i>fullConfig</i> is included in the <i>RRCCConnectionReconfiguration</i> message; otherwise the field is optionally present, need ON.
<i>LWIP</i>	The field is optionally present, Need ON, if <i>drb-TypeLWIP-r13</i> is configured and not set to <i>eutran</i> ; otherwise it is not present and the UE shall delete any existing value for this field.
<i>DAPS</i>	This field is optionally present, Need ON, <ul style="list-style-type: none"> <li>- in case of handover within E-UTRA when the <i>fullConfig</i> and the <i>rach-Skip</i> are not included in the <i>RRCCConnectionReconfiguration</i> message; and</li> <li>- when the <i>uplinkDataCompression</i> and the <i>ethernetHeaderCompression</i> are not configured for the DRB; and</li> <li>- when SCell(s) and SCG are not configured; and</li> <li>- when the <i>conditionalReconfiguration</i> is not configured; and</li> <li>- when the <i>RRCCConnectionReconfiguration</i> message is not included in a <i>conditionalReconfiguration</i>.</li> </ul> Otherwise the field is not present.
<i>NR-PDCP</i>	The field is optional present, Need ON, when the SRB is configured with NR-PDCP prior to reception of this reconfiguration message. Otherwise it is not present.

Conditional presence	Explanation
<i>PDCP</i>	The field is mandatory present: - when connected to E-UTRA/EPC: - for the bearers configured with E-UTRA PDCP, if the corresponding DRB is being setup; the field is optionally present, need ON : - when connected to E-UTRA/EPC: - for the bearers configured with E-UTRA PDCP, upon reconfiguration of the corresponding split DRB or LWA DRB, upon the corresponding DRB type change from split to MCG bearer, upon the corresponding DRB type change from MCG to split bearer or LWA bearer, upon the corresponding DRB type change from LWA to LTE only bearer, upon handover within E-UTRA and upon the first reconfiguration after re-establishment but in all these cases only when <i>fullConfig</i> is not included in the <i>RRCCoalitionReconfiguration</i> message; otherwise it is not present.
<i>PDCP-S</i>	The field is mandatory present if the corresponding DRB is being setup; the field is optionally present, need ON, upon SCG change; otherwise it is not present.
<i>RLC-Setup</i>	This field is optionally present if the corresponding DRB is being setup, need ON; otherwise it is not present.
<i>SCellAdd</i>	The field is optionally present, need ON, upon SCell addition; otherwise it is not present.
<i>Setup</i>	The field is mandatory present if the corresponding SRB/DRB is being setup; otherwise the field is optionally present, need ON.
<i>SetupM</i>	The field is mandatory present upon setup of an MCG or split DRB, or upon setup of MCG RLC bearer; otherwise the field is optionally present, need ON.
<i>SetupS</i>	The field is mandatory present: - for E-UTRA DC: - upon setup of an SCG or split DRB, - upon change from MCG to split DRB; - for NE-DC, upon setup of SCG RLC bearer; otherwise the field is optionally present, need ON.
<i>SetupS2</i>	The field is: - mandatory present: - for E-UTRA DC: - upon setup of an SCG or split DRB, as well as upon change from MCG to split or SCG DRB. - optionally present, need ON: - for E-UTRA DC: - for an SCG DRB otherwise the field is not present.
<i>Split-SRB1-SRB3</i>	This field is optionally present, Need ON, if the UE is configured with split SRB1 or SRB3. It is absent otherwise.
<i>SPS</i>	The field is optionally present, need ON, if <i>sps-Config</i> (without suffix) is not configured; otherwise it is not present.
<i>SPS2</i>	The field is optionally present, need ON, if <i>sps-Config-r12</i> is not configured; otherwise it is not present.
<i>UL-LWA</i>	The field is optionally present, need ON if <i>ul-LWA-Config-r14</i> is present. Otherwise the field is not present.

## – RCLWI-Configuration

The IE *RCLWI-Configuration* is used to add, modify or release the RCLWI configuration.

```
-- ASN1START
RCLWI-Configuration-r13 ::=
    CHOICE {
        release
            NULL,
        setup
            SEQUENCE {
                rclwi-Config-r13
            }
    }

RCLWI-Config-r13 ::=
    SEQUENCE {
        command
            CHOICE {
                steerToWLAN-r13
                    SEQUENCE {
                        mobilityConfig-r13
                        WLAN-Id-List-r12
                    },
                steerToLTE-r13
                    NULL
            }
    },
```

```

}
...
-- ASN1STOP

```

## ResourceReservationConfig

The IE *ResourceReservationConfig* is used to specify the resource reservation, e.g. for coexistence with NR.

### ResourceReservationConfig information element

```

-- ASN1START
ResourceReservationConfigDL-r16 ::= SEQUENCE {
  periodicityStartPos-r16      PeriodicityStartPos-r16,
  resourceReservationFreq-r16 CHOICE {
    rbg-Bitmap1dot4           BIT STRING (SIZE (6)),
    rbg-Bitmap3               BIT STRING (SIZE (8)),
    rbg-Bitmap5               BIT STRING (SIZE (13)),
    rbg-Bitmap10              BIT STRING (SIZE (17)),
    rbg-Bitmap15              BIT STRING (SIZE (19)),
    rbg-Bitmap20              BIT STRING (SIZE (25))
  } OPTIONAL, -- Need OP
  slotBitmap-r16              CHOICE {
    slotPattern10ms           BIT STRING (SIZE (20)),
    slotPattern40ms           BIT STRING (SIZE (80))
  },
  symbolBitmap1-r16           BIT STRING (SIZE (7))   OPTIONAL, -- Cond Bitmap1
  symbolBitmap2-r16           BIT STRING (SIZE (7))   OPTIONAL, -- Cond Bitmap2
  ...
}

ResourceReservationConfigUL-r16 ::= SEQUENCE {
  periodicityStartPos-r16      PeriodicityStartPos-r16,
  slotBitmap-r16              CHOICE {
    slotPattern10ms           BIT STRING (SIZE (20)),
    slotPattern40ms           BIT STRING (SIZE (80))
  } OPTIONAL, -- Cond FDDandTDDnoDL
  symbolBitmap1-r16           BIT STRING (SIZE (7))   OPTIONAL, -- Cond Bitmap1
  symbolBitmap2-r16           BIT STRING (SIZE (7))   OPTIONAL, -- Cond Bitmap2
  ...
}

PeriodicityStartPos-r16 ::= CHOICE {
  periodicity10ms             NULL,
  periodicity20ms             INTEGER(0..1),
  periodicity40ms             INTEGER(0..3),
  periodicity80ms             INTEGER(0..7),
  periodicity160ms            INTEGER(0..15),
  spare3 NULL, spare2 NULL, spare1 NULL
}
-- ASN1STOP

```

<b>ResourceReservationConfig field descriptions</b>
<p><b>periodicityStartPos</b> Indicates periodicity and start offset of the reserved resources. Value set to <i>periodicity10ms</i> corresponds to periodicity 10 milliseconds and corresponding start position is 0, value set to <i>periodicity20ms</i> corresponds to periodicity 20 milliseconds and corresponding start position in milliseconds = indicated value * 10ms, and so on.</p>
<p><b>resourceReservationFreq</b> Downlink frequency domain resource reservation bitmap where each bit corresponds to a resource block group (RBG), see TS 36.213 [23]. Value <i>rbg-Bitmap1dot4</i> corresponds to 1.4 MHz system bandwidth, value <i>rbg-Bitmap3</i> corresponds to 3 MHz system bandwidth, and so on. If the field is absent, all RBGs in the system bandwidth are reserved.</p>
<p><b>slotBitmap</b> Slot-level resource reservation configuration. Value <i>slotPattern10ms</i> corresponds to 10ms slot pattern and <i>slotPattern40ms</i> corresponds to 40ms slot pattern, see TS 36.213 [23] for DL and TS 36.211 [21] for UL. The first/leftmost 2-bits corresponds to the subframe #0 of the radio frame satisfying SFN mod periodicity = start position, as indicated by <i>periodicityStartPos</i>. Two bits for each subframe coded as: 00: both slots are not reserved 01: the first slot is not reserved, the second slot is reserved 10: the first slot is reserved, the second slot is not reserved 11: both slots are reserved. For a UE that supports subframe-level resource reservation but does not support slot/symbol-level resource reservation, two bits for each subframe are interpreted as: 00: subframe is not reserved 01: subframe is reserved. E-UTRAN does not set the field to this value when included in dedicated signalling. 10: subframe is reserved. E-UTRAN does not set the field to this value when included in dedicated signalling. 11: subframe is reserved. If the field is not included in UL configuration, the value of the field from DL configuration applies.</p>
<p><b>symbolBitmap1, symbolBitmap2</b> Provides the symbol-level resource reservation for one subframe. If <i>symbolBitmap1</i> is absent, value '01' in the <i>slotBitmap</i> corresponds to the whole 2nd slot being reserved. If <i>symbolBitmap2</i> is absent, value '10' in the <i>slotBitmap</i> corresponds to the whole 1st slot being reserved. A UE that supports subframe-level resource reservation but does not support slot/symbol-level resource reservation shall ignore <i>symbolBitmap1</i> and <i>symbolBitmap2</i>, if present.</p>

<b>Conditional presence</b>	<b>Explanation</b>
<i>Bitmap1</i>	The field is optionally present, need OR, if value of <i>slotBitmap</i> corresponding to at least one subframe is '01'; otherwise the field is not present.
<i>Bitmap2</i>	The field is optionally present, need OR, if value of <i>slotBitmap</i> corresponding to at least one subframe is '10'; otherwise the field is not present.
<i>FDDandTDDnoDL</i>	The field is mandatory present for TDD when resource reservation for DL is not configured, and for FDD; otherwise the field is optionally present, need OP.

## – RLC-Config

The IE *RLC-Config* is used to specify the RLC configuration of SRBs and DRBs.

### **RLC-Config information element**

```

-- ASN1START
RLC-Config ::= CHOICE {
  am SEQUENCE {
    ul-AM-RLC UL-AM-RLC,
    dl-AM-RLC DL-AM-RLC
  },
  um-Bi-Directional SEQUENCE {
    ul-UM-RLC UL-UM-RLC,
    dl-UM-RLC DL-UM-RLC
  },
  um-Uni-Directional-UL SEQUENCE {
    ul-UM-RLC UL-UM-RLC
  },
  um-Uni-Directional-DL SEQUENCE {
    dl-UM-RLC DL-UM-RLC
  },
  ...
}
RLC-Config-v1250 ::= SEQUENCE {

```

```

    ul-extended-RLC-LI-Field-r12          BOOLEAN,
    dl-extended-RLC-LI-Field-r12          BOOLEAN
}

RLC-Config-v1310 ::=
    ul-extended-RLC-AM-SN-r13              BOOLEAN,
    dl-extended-RLC-AM-SN-r13              BOOLEAN,
    pollPDU-v1310                          PollPDU-v1310          OPTIONAL    -- Need OR
}

RLC-Config-v1430 ::=
    release                                 NULL,
    setup                                   SEQUENCE {
        pollByte-r14                        PollByte-r14
    }
}

RLC-Config-v1510 ::=
    reestablishRLC-r15                     ENUMERATED {true}
}

RLC-Config-v1530 ::=
    release                                 NULL,
    setup                                   SEQUENCE {
        rlc-OutOfOrderDelivery-r15          ENUMERATED {true}
    }
}

RLC-Config-v1700 ::=
    t-ReorderingExt-r17                    SetupRelease {T-ReorderingExt-r17}
}

RLC-Config-r15 ::=
    mode-r15                                CHOICE {
        am-r15                               SEQUENCE {
            ul-AM-RLC-r15                     UL-AM-RLC-r15,
            dl-AM-RLC-r15                     DL-AM-RLC-r15
        },
        um-Bi-Directional-r15                SEQUENCE {
            ul-UM-RLC-r15                     UL-UM-RLC,
            dl-UM-RLC-r15                     DL-UM-RLC-r15
        },
        um-Uni-Directional-UL-r15            SEQUENCE {
            ul-UM-RLC-r15                     UL-UM-RLC
        },
        um-Uni-Directional-DL-r15            SEQUENCE {
            dl-UM-RLC-r15                     DL-UM-RLC-r15
        }
    },
    reestablishRLC-r15                       ENUMERATED {true}          OPTIONAL,    -- Need ON
    rlc-OutOfOrderDelivery-r15               ENUMERATED {true}          OPTIONAL,    -- Need ON
    ...
}

UL-AM-RLC ::=
    t-PollRetransmit                        T-PollRetransmit,
    pollPDU                                  PollPDU,
    pollByte                                 PollByte,
    maxRetxThreshold                         ENUMERATED {
        t1, t2, t3, t4, t6, t8, t16, t32}
}

UL-AM-RLC-r15 ::=
    t-PollRetransmit-r15                    T-PollRetransmit,
    pollPDU-r15                              PollPDU-r15,
    pollByte-r15                             PollByte-r14,
    maxRetxThreshold-r15                     ENUMERATED {
        t1, t2, t3, t4, t6, t8, t16, t32},
    extended-RLC-LI-Field-r15                BOOLEAN
}

DL-AM-RLC ::=
    t-Reordering                             T-Reordering,
    t-StatusProhibit                         T-StatusProhibit
}

DL-AM-RLC-r15 ::=
    t-Reordering                             T-Reordering,

```



t-StatusProhibit-r15	T-StatusProhibit,
extended-RLC-LI-Field-r15	BOOLEAN
}	
UL-UM-RLC ::=	SEQUENCE {
sn-FieldLength	SN-FieldLength
}	
DL-UM-RLC ::=	SEQUENCE {
sn-FieldLength	SN-FieldLength,
t-Reordering	T-Reordering
}	
DL-UM-RLC-r15 ::=	SEQUENCE {
sn-FieldLength-r15	SN-FieldLength-r15,
t-Reordering-r15	T-Reordering
}	
SN-FieldLength ::=	ENUMERATED {size5, size10}
SN-FieldLength-r15 ::=	ENUMERATED {size5, size10, size16-r15}
T-PollRetransmit ::=	ENUMERATED {
	ms5, ms10, ms15, ms20, ms25, ms30, ms35,
	ms40, ms45, ms50, ms55, ms60, ms65, ms70,
	ms75, ms80, ms85, ms90, ms95, ms100, ms105,
	ms110, ms115, ms120, ms125, ms130, ms135,
	ms140, ms145, ms150, ms155, ms160, ms165,
	ms170, ms175, ms180, ms185, ms190, ms195,
	ms200, ms205, ms210, ms215, ms220, ms225,
	ms230, ms235, ms240, ms245, ms250, ms300,
	ms350, ms400, ms450, ms500, ms800-v1310,
	ms1000-v1310, ms2000-v1310, ms4000-v1310,
	spare5, spare4, spare3, spare2, spare1}
PollPDU ::=	ENUMERATED {
	p4, p8, p16, p32, p64, p128, p256, pInfinity}
PollPDU-v1310 ::=	ENUMERATED {
	p512, p1024, p2048, p4096, p6144, p8192, p12288, p16384}
PollPDU-r15 ::=	ENUMERATED {
	p4, p8, p16, p32, p64, p128, p256, p512, p1024,
	p2048-r15, p4096-r15, p6144-r15, p8192-r15,
	p12288-r15, p16384-r15, pInfinity}
PollByte ::=	ENUMERATED {
	kB25, kB50, kB75, kB100, kB125, kB250, kB375,
	kB500, kB750, kB1000, kB1250, kB1500, kB2000,
	kB3000, kBinfinity, spare1}
PollByte-r14 ::=	ENUMERATED {
	kB1, kB2, kB5, kB8, kB10, kB15, kB3500,
	kB4000, kB4500, kB5000, kB5500, kB6000, kB6500,
	kB7000, kB7500, kB8000, kB9000, kB10000, kB11000, kB12000,
	kB13000, kB14000, kB15000, kB16000, kB17000, kB18000,
	kB19000, kB20000, kB25000, kB30000, kB35000, kB40000}
T-Reordering ::=	ENUMERATED {
	ms0, ms5, ms10, ms15, ms20, ms25, ms30, ms35,
	ms40, ms45, ms50, ms55, ms60, ms65, ms70,
	ms75, ms80, ms85, ms90, ms95, ms100, ms110,
	ms120, ms130, ms140, ms150, ms160, ms170,
	ms180, ms190, ms200, ms1600-v1310}
T-ReorderingExt-r17 ::=	ENUMERATED {ms2200, ms3200}
T-StatusProhibit ::=	ENUMERATED {
	ms0, ms5, ms10, ms15, ms20, ms25, ms30, ms35,
	ms40, ms45, ms50, ms55, ms60, ms65, ms70,
	ms75, ms80, ms85, ms90, ms95, ms100, ms105,
	ms110, ms115, ms120, ms125, ms130, ms135,
	ms140, ms145, ms150, ms155, ms160, ms165,
	ms170, ms175, ms180, ms185, ms190, ms195,
	ms200, ms205, ms210, ms215, ms220, ms225,
	ms230, ms235, ms240, ms245, ms250, ms300,
	ms350, ms400, ms450, ms500, ms800-v1310,

```

ms2400-v1310, spare2,
ms1000-v1310, ms1200-v1310, ms1600-v1310, ms2000-v1310,
spare1}
-- ASN1STOP

```

<b>RLC-Config field descriptions</b>
<p><b>dl-extended-RLC-LI-Field, ul-extended-RLC-LI-Field</b> Indicates the RLC LI field size. Value <i>TRUE</i> means that 15 bit LI length shall be used, otherwise 11 bit LI length shall be used; see TS 36.322 [7]. E-UTRAN enables this field only when <i>RLC-Config</i> (without suffix) is set to <i>am</i>.</p>
<p><b>maxRetxThreshold</b> Parameter for RLC AM in TS 36.322 [7]. Value <i>t1</i> corresponds to 1 retransmission, <i>t2</i> to 2 retransmissions and so on.</p>
<p><b>reestablishRLC</b> Indicates that RLC shall be re-established. For a UE configured with (NG)EN-DC, E-UTRAN may include this field for the (primary) RLC entity of an MCG RLC bearer of a DRB (used upon change from SN terminated split to MN terminated MCG RLC bearer). For a UE configured with NE-DC, E-UTRAN may include this field for the (primary) RLC entity of an SCG RLC bearer of a DRB or of an SRB (used upon key refresh for MN terminated split RB).</p>
<p><b>pollByte</b> Parameter for RLC AM in TS 36.322 [7]. Value <i>kB25</i> corresponds to 25 kBytes, <i>kB50</i> to 50 kBytes and so on. <i>kBInfinity</i> corresponds to an infinite amount of kBytes. In case <i>pollByte-r14</i> is signalled, the UE shall ignore <i>pollByte</i> (i.e. without suffix).</p>
<p><b>pollPDU</b> Parameter for RLC AM in TS 36.322 [7]. Value <i>p4</i> corresponds to 4 PDUs, <i>p8</i> to 8 PDUs and so on. <i>plnfinity</i> corresponds to an infinite number of PDUs. In case <i>pollPDU-r13</i> is signalled, the UE shall ignore <i>pollPDU</i> (i.e. without suffix). E-UTRAN enables <i>pollPDU-v1310</i> field only when <i>RLC-Config</i> (without suffix) is set to <i>am</i>.</p>
<p><b>rlc-OutOfOrderDelivery</b> Indicates that out-of-order delivery from RLC to PDCP is configured for this RLC entity as specified in TS 36.322 [7].</p>
<p><b>sn-FieldLength</b> Indicates the UM RLC SN field size, see TS 36.322 [7], in bits. Value <i>size5</i> means 5 bits, <i>size10</i> means 10 bits.</p>
<p><b>t-PollRetransmit</b> Timer for RLC AM in TS 36.322 [7], in milliseconds. Value <i>ms5</i> means 5ms, <i>ms10</i> means 10ms and so on. EUTRAN configures values <i>msX-v1310</i> (with suffix) only if UE supports CE.</p>
<p><b>t-Reordering</b> Timer for reordering in TS 36.322 [7], in milliseconds. Value <i>ms0</i> means 0ms and behaviour as specified in 7.3.2 applies, <i>ms5</i> means 5ms and so on.</p>
<p><b>t-ReorderingExt</b> Timer for reordering in TS 36.322 [7], in milliseconds. Value <i>ms2200</i> corresponds to 2200 ms, value <i>ms3200</i> corresponds to 3200 ms. The UE shall use the extended value <i>t-ReorderingExt-r17</i>, if present, and ignore the value signaled by <i>t-Reordering</i> or <i>t-Reordering-r15</i>.</p>
<p><b>t-StatusProhibit</b> Timer for status reporting in TS 36.322 [7], in milliseconds. Value <i>ms0</i> means 0ms and behaviour as specified in 7.3.2 applies, <i>ms5</i> means 5ms and so on. EUTRAN configures values <i>msX-v1310</i> (with suffix) only if UE supports operation in CE.</p>
<p><b>ul-extended-RLC-AM-SN, dl-extended-RLC-AM-SN</b> Indicates whether or not the UE shall use the extended SN and SO length for AM bearer. Value <i>TRUE</i> means that 16 bit SN length and 16 bit SO length shall be used, otherwise 10 bit SN length and 15 bit SO length shall be used; see TS 36.322 [7].</p>

## RLF-TimersAndConstants

The IE *RLF-TimersAndConstants* contains UE specific timers and constants applicable for UEs in *RRC\_CONNECTED*.

### RLF-TimersAndConstants information element

```

-- ASN1START
RLF-TimersAndConstants-r9 ::=
  CHOICE {
    release
      NULL,
    setup
      SEQUENCE {
        t301-r9
          ENUMERATED {
            ms100, ms200, ms300, ms400, ms600, ms1000, ms1500,
            ms2000},
        t310-r9
          ENUMERATED {
            ms0, ms50, ms100, ms200, ms500, ms1000, ms2000},
        n310-r9
          ENUMERATED {

```

```

        t311-r9          n1, n2, n3, n4, n6, n8, n10, n20},
                        ENUMERATED {
                            ms1000, ms3000, ms5000, ms10000, ms15000,
                            ms20000, ms30000},
        n311-r9          ENUMERATED {
                            n1, n2, n3, n4, n5, n6, n8, n10},
        ...
    }
}

RLF-TimersAndConstants-r13 ::= CHOICE {
    release                NULL,
    setup                  SEQUENCE {
        t301-v1310        ENUMERATED {
                            ms2500, ms3000, ms3500, ms4000, ms5000,
                            ms6000, ms8000, ms10000},
        ...,
        [[ t310-v1330    ENUMERATED {ms4000, ms6000} OPTIONAL    -- Need ON
        ]]
    }
}

RLF-TimersAndConstantsSCG-r12 ::= CHOICE {
    release                NULL,
    setup                  SEQUENCE {
        t313-r12          ENUMERATED {
                            ms0, ms50, ms100, ms200, ms500, ms1000, ms2000},
        n313-r12          ENUMERATED {
                            n1, n2, n3, n4, n6, n8, n10, n20},
        n314-r12          ENUMERATED {
                            n1, n2, n3, n4, n5, n6, n8, n10},
        ...
    }
}

RLF-TimersAndConstantsMCG-Failure-r16 ::= CHOICE {
    release                NULL,
    setup                  SEQUENCE {
        t316-r16          ENUMERATED {ms50, ms100, ms200, ms300, ms400,
                            ms500, ms600, ms1000, ms1500, ms2000},
        ...
    }
}
-- ASN1STOP

```

#### **RLF-TimersAndConstants field descriptions**

##### **n3xy**

Constants are described in clause 7.4. n1 corresponds with 1, n2 corresponds with 2 and so on.

##### **t3xy**

Timers are described in clause 7.3. Value ms0 corresponds with 0 ms, ms50 corresponds with 50 ms and so on.

E-UTRAN configures *RLF-TimersAndConstants-r13* only if UE supports *ce-ModeB*. UE shall use the extended values *t3xy-v1310* and *t3xy-v1330*, if present, and ignore the values signaled by *t3xy-r9*.

## – *RN-SubframeConfig*

The IE *RN-SubframeConfig* is used to specify the subframe configuration for an RN.

#### **RN-SubframeConfig information element**

```

-- ASN1START
RN-SubframeConfig-r10 ::= SEQUENCE {
    subframeConfigPattern-r10 CHOICE {
        subframeConfigPatternFDD-r10 BIT STRING (SIZE(8)),
        subframeConfigPatternTDD-r10 INTEGER (0..31)
    } OPTIONAL, -- Need ON
    rpdccch-Config-r10 SEQUENCE {
        resourceAllocationType-r10 ENUMERATED {type0, type1, type2Localized, type2Distributed,
        spare4, spare3, spare2, spare1},
        resourceBlockAssignment-r10 CHOICE {
            type01-r10 CHOICE {
                nrb6-r10 BIT STRING (SIZE(6)),

```

```

        nrb15-r10          BIT STRING (SIZE(8)),
        nrb25-r10          BIT STRING (SIZE(13)),
        nrb50-r10          BIT STRING (SIZE(17)),
        nrb75-r10          BIT STRING (SIZE(19)),
        nrb100-r10         BIT STRING (SIZE(25))
    },
    type2-r10              CHOICE {
        nrb6-r10            BIT STRING (SIZE(5)),
        nrb15-r10           BIT STRING (SIZE(7)),
        nrb25-r10           BIT STRING (SIZE(9)),
        nrb50-r10           BIT STRING (SIZE(11)),
        nrb75-r10           BIT STRING (SIZE(12)),
        nrb100-r10          BIT STRING (SIZE(13))
    },
    ...
},
demodulationRS-r10       CHOICE {
    interleaving-r10       ENUMERATED {crs},
    noInterleaving-r10     ENUMERATED {crs, dmrs}
},
pdsch-Start-r10          INTEGER (1..3),
pucch-Config-r10         CHOICE {
    tdd                    CHOICE {
        channelSelectionMultiplexingBundling SEQUENCE {
            n1PUCCH-AN-List-r10 SEQUENCE (SIZE (1..4)) OF INTEGER (0..2047)
        },
        fallbackForFormat3 SEQUENCE {
            n1PUCCH-AN-P0-r10 INTEGER (0..2047),
            n1PUCCH-AN-P1-r10 INTEGER (0..2047) OPTIONAL -- Need OR
        }
    },
    fdd                    SEQUENCE {
        n1PUCCH-AN-P0-r10 INTEGER (0..2047),
        n1PUCCH-AN-P1-r10 INTEGER (0..2047) OPTIONAL -- Need OR
    }
},
...
}
...
}
OPTIONAL, -- Need ON
}
-- ASN1STOP

```

<b>RN-SubframeConfig field descriptions</b>
<p><b>demodulationRS</b> Indicates which reference signals are used for R-PDCCH demodulation according to TS 36.216 [55], clause 7.4.1. Value interleaving corresponds to cross-interleaving and value noInterleaving corresponds to no cross-interleaving according to TS 36.216 [55], clauses 7.4.2 and 7.4.3.</p>
<p><b>n1PUCCH-AN-List</b> Parameter: <math>n_{\text{PUCCH},i}^{(1)}</math>, see TS 36.216, [55], clause 7.5.1. This parameter is only applicable for TDD. Configures PUCCH HARQ-ACK resources if the RN is configured to use HARQ-ACK channel selection, HARQ-ACK multiplexing or HARQ-ACK bundling.</p>
<p><b>n1PUCCH-AN-P0, n1PUCCH-AN-P1</b> Parameter: <math>n_{\text{PUCCH}}^{(1,p)}</math>, for antenna port P0 and for antenna port P1 respectively, see TS 36.216, [55], clause 7.5.1, for FDD and [55], clause 7.5.2 for TDD.</p>
<p><b>pdsch-Start</b> Parameter: <i>DL-StartSymbol</i>, see TS 36.216 [55], Table 5.4-1.</p>
<p><b>resourceAllocationType</b> Represents the resource allocation used: type 0, type 1 or type 2 according to TS 36.213 [23], clause 7.1.6. Value type0 corresponds to type 0, value type1 corresponds to type 1, value type2Localized corresponds to type 2 with localized virtual resource blocks and type2Distributed corresponds to type 2 with distributed virtual resource blocks.</p>
<p><b>resourceBlockAssignment</b> Indicates the resource block assignment bits according to TS 36.213 [23], clause 7.1.6. Value type01 corresponds to type 0 and type 1, and the value type2 corresponds to type 2. Value nrb6 corresponds to a downlink system bandwidth of 6 resource blocks, value nrb15 corresponds to a downlink system bandwidth of 15 resource blocks, and so on.</p>
<p><b>subframeConfigPatternFDD</b> Parameter: <i>SubframeConfigurationFDD</i>, see TS 36.216 [55], Table 5.2-1. Defines the DL subframe configuration for eNB-to-RN transmission, i.e. those subframes in which the eNB may indicate downlink assignments for the RN. The radio frame in which the pattern starts (i.e. the radio frame in which the first bit of the <i>subframeConfigPatternFDD</i> corresponds to subframe #0) occurs when <math>\text{SFN mod } 4 = 0</math>.</p>
<p><b>subframeConfigPatternTDD</b> Parameter: <i>SubframeConfigurationTDD</i>, see TS 36.216 [55], Table 5.2-2. Defines the DL and UL subframe configuration for eNB-RN transmission.</p>

## – RSS-Config

The IE *RSS-Config* is used to specify the RSS configuration, see TS 36.211 [21].

### **RSS-Config information element**

```

-- ASN1START
RSS-Config-r15 ::=
    SEQUENCE {
        duration-r15          ENUMERATED {sf8, sf16, sf32, sf40},
        freqLocation-r15      INTEGER (0..98),
        periodicity-r15       ENUMERATED {ms160, ms320, ms640, ms1280},
        powerBoost-r15        ENUMERATED {dB0, dB3, dB4dot8, dB6},
        timeOffset-r15        INTEGER (0..31)
    }
-- ASN1STOP

```

<b>RSS-Config field descriptions</b>
<b>duration</b> Duration of RSS in subframes. Value sf8 corresponds to 8 subframes, value sf16 corresponds to 16 subframes and so on.
<b>freqLocation</b> Frequency location (lowest PRB number) of RSS.
<b>periodicity</b> Periodicity of RSS. Value ms160 corresponds to 160 ms, value ms320 corresponds to 320 ms and so on.
<b>powerBoost</b> Power offset of RSS relative to CRS in dB. Value dB0 corresponds to 0 dB, value dB3 corresponds to 3 dB, value dB4dot8 corresponds to 4.8 dB and so on.
<b>timeOffset</b> Time offset of RSS in frames. The actual value of time offset is based on the value of <i>periodicity</i> , as follows: For <i>periodicity</i> 160 ms, only value range 0 to 15 are applicable. Actual value = <i>timeOffset</i> * 1 frame. For <i>periodicity</i> 320 ms, actual value = <i>timeOffset</i> * 1 frame. For <i>periodicity</i> 640 ms, actual value = <i>timeOffset</i> * 2 frames. For <i>periodicity</i> 1280 ms, actual value = <i>timeOffset</i> * 4 frames.

## SchedulingRequestConfig

The IE *SchedulingRequestConfig* is used to specify the Scheduling Request related parameters

### SchedulingRequestConfig information element

```

-- ASN1START
SchedulingRequestConfig ::= CHOICE {
    release          NULL,
    setup           SEQUENCE {
        sr-PUCCH-ResourceIndex    INTEGER (0..2047),
        sr-ConfigIndex           INTEGER (0..157),
        dsr-TransMax             ENUMERATED {
                                n4, n8, n16, n32, n64, spare3, spare2, spare1}
    }
}

SchedulingRequestConfig-v1020 ::= SEQUENCE {
    sr-PUCCH-ResourceIndexP1-r10    INTEGER (0..2047)          OPTIONAL    -- Need OR
}

SchedulingRequestConfigSCell-r13 ::= CHOICE {
    release          NULL,
    setup           SEQUENCE {
        sr-PUCCH-ResourceIndex-r13    INTEGER (0..2047),
        sr-PUCCH-ResourceIndexP1-r13  INTEGER (0..2047)          OPTIONAL,    -- Need OR
        sr-ConfigIndex-r13           INTEGER (0..157),
        dsr-TransMax-r13             ENUMERATED {
                                n4, n8, n16, n32, n64, spare3, spare2, spare1}
    }
}

SchedulingRequestConfig-v1530 ::= CHOICE {
    release          NULL,
    setup           SEQUENCE {
        sr-SlotSPUCCH-IndexFH-r15     INTEGER (0..1319)          OPTIONAL, -- Need OR
        sr-SlotSPUCCH-IndexNoFH-r15   INTEGER (0..3959)          OPTIONAL, -- Need OR
        sr-SubslotSPUCCH-ResourceList-r15  SR-SubslotSPUCCH-ResourceList-r15 OPTIONAL, -- Need OR
        sr-ConfigIndexSlot-r15         INTEGER (0..36)             OPTIONAL, -- Need OR
        sr-ConfigIndexSubslot-r15       INTEGER (0..122)           OPTIONAL, -- Need OR
        dssr-TransMax-r15              ENUMERATED {
                                n4, n8, n16, n32, n64, spare3, spare2, spare1}
    }
}

SR-SubslotSPUCCH-ResourceList-r15 ::= SEQUENCE (SIZE(1..4)) OF INTEGER (0..1319)

-- ASN1STOP

```

<b>SchedulingRequestConfig field descriptions</b>
<p><b><i>dsr-TransMax</i></b> Parameter for SR transmission in TS 36.321 [6], clause 5.4.4. The value n4 corresponds to 4 transmissions, n8 corresponds to 8 transmissions and so on. EUTRAN configures the same value for all serving cells for which this field is configured.</p>
<p><b><i>dssr-TransMax</i></b> Parameter for SPUCCH SR transmission in TS 36.321 [6], clause 5.4.4. EUTRAN configures the same value for all serving cells for which this field is configured.</p>
<p><b><i>sr-ConfigIndex, sr-ConfigIndexSlot, sr-ConfigIndexSubslot</i></b> Parameter <math>I_{SR}</math>. See TS 36.213 [23], clause 10.1. The values 156 and 157 are not applicable for Release 8.</p>
<p><b><i>sr-PUCCH-ResourceIndex, sr-PUCCH-ResourceIndexP1</i></b> Parameter: <math>n_{PUCCH,SRI}^{(1,p)}</math> for antenna port P0 and for antenna port P1 respectively, see TS 36.213 [23], clause 10.1. E-UTRAN configures <i>sr-PUCCH-ResourceIndexP1</i> only if <i>sr-PUCCHResourceIndex</i> is configured.</p>
<p><b><i>sr-SlotSPUCCH-IndexFH</i></b> Resource configuration for SR using slot-SPUCCH when frequency hopping is enabled, see TS 36.213 [23], clause 10.1.5.</p>
<p><b><i>sr-SlotSPUCCH-IndexNoFH</i></b> Resource configuration for SR using slot-SPUCCH when frequency hopping is disabled, see TS 36.213 [23], clause 10.1.5.</p>
<p><b><i>sr-SubslotSPUCCH-ResourceList</i></b> Resource configuration for SR using subslot-SPUCCH, see TS 36.213 [23], clause 10.1.5.</p>

## – SlotOrSubslotPDSCH-Config

The IE *SlotOrSubslotPDSCH-Config* is used to specify the UE specific PDSCH configuration when sTTI is used.

### **SlotOrSubslotPDSCH-Config information element**

```

-- ASN1START
SlotOrSubslotPDSCH-Config-r15 ::= CHOICE {
  release      NULL,
  setup       SEQUENCE {
    altCQI-TableSTTI-r15      ENUMERATED {
      allSubframes, csi-SubframeSet1,
      csi-SubframeSet2, spare1}      OPTIONAL, -- Need OR
    altCQI-Table1024QAM-STTI-r15  ENUMERATED {
      allSubframes, csi-SubframeSet1,
      csi-SubframeSet2, spare1}      OPTIONAL, -- Need OR
    resourceAllocation-r15      ENUMERATED {
      resourceAllocationType0,resourceAllocationType2}      OPTIONAL, -- Need OR
    tbsIndexAlt-STTI-r15      ENUMERATED {a33}      OPTIONAL, -- Need OR
    tbsIndexAlt2-STTI-r15     ENUMERATED {b33}      OPTIONAL, -- Need OR
    tbsIndexAlt3-STTI-r15     ENUMERATED {a37}      OPTIONAL, -- Need OR
    ...
  }
}
-- ASN1STOP

```

<b>SlotOrSubslotPDSCH-Config field descriptions</b>
<p><b>altCQI-TableSTTI, altCQI-Table1024QAM-STTI</b></p> <p>Indicates the applicability of the alternative CQI table (i.e. Table 7.2.3-2 and Table 7.2.3-4 in TS 36.213 [23]) for aperiodic CSI reporting for slot or subslot PDSCH for the concerned serving cell. Value <i>allSubframes</i> means the alternative CQI table applies to all the subframes and CSI processes, if configured, and value <i>csi-SubframeSet1</i> means the alternative CQI table applies to CSI subframe set1, and value <i>csi-SubframeSet2</i> means the alternative CQI table applies to CSI subframe set2. EUTRAN sets the value to <i>csi-SubframeSet1</i> or <i>csi-SubframeSet2</i> only if transmissionMode is set in range <i>tm1</i> to <i>tm9</i> and <i>csi-SubframePatternConfig-r10</i> is configured for the concerned serving cell and different CQI tables apply to the two CSI subframe sets; otherwise EUTRAN sets the value to <i>allSubframes</i>. EUTRAN does not configure the same value for altCQI-TableSTTI-r15 and altCQI-Table-1024QAM-STTI-r15 in SlotOrSubslotPDSCH-Config-r15. EUTRAN does not configure altCQI-Table-1024QAM-STTI-r15 if the value of altCQI-TableSTTI-r15 is set to <i>allSubframes</i>. EUTRAN does not configure altCQI-TableSTTI-r15 if the value of altCQI-Table-1024QAM-STTI-r15 is set to <i>allSubframes</i>. If both altCQI-TableSTTI-r15 and altCQI-Table-1024QAM-STTI-r15 are absent, the UE shall use Table 7.2.3-1 in TS 36.213 [23] for all subframes and CSI processes, if configured.</p>
<p><b>resourceAllocation</b></p> <p>Parameter indicates resource allocation type for slot-PDSCH or subslot-PDSCH.</p>
<p><b>tbsIndexAlt-STTI</b></p> <p>Indicates the applicability of the alternative TBS index for the <math>h_{\text{TBS}} 33</math> (see TS 36.213 [23], Table 7.1.7.2.1-1) to all slots/subslots scheduled by DCI format 7-1F and 7-1G. Value <i>a33</i> refers to the alternative TBS index <math>h_{\text{TBS}} 33A</math>. If neither this field nor <i>tbsIndexAlt2-STTI</i> configures an alternative TBS index for <math>h_{\text{TBS}} 33</math>, the UE shall use <math>h_{\text{TBS}} 33</math> specified in Table 7.1.7.2.1-1 in TS 36.213 [23] for all slots/subslots instead.</p>
<p><b>tbsIndexAlt2-STTI</b></p> <p>Indicates the applicability of the alternative TBS index for the <math>h_{\text{TBS}} 33</math> (see TS 36.213 [23], Table 7.1.7.2.1-1) to all slots/subslots scheduled by DCI format 7-1B/7-1C/7-1D. Value <i>b33</i> refers to the alternative TBS index <math>h_{\text{TBS}} 33B</math>. If neither this field nor <i>tbsIndexAlt-STTI</i> configures an alternative TBS index for <math>h_{\text{TBS}} 33</math>, the UE shall use <math>h_{\text{TBS}} 33</math> specified in Table 7.1.7.2.1-1 in TS 36.213 [23] for all slots/subslots instead.</p>
<p><b>tbsIndexAlt3-STTI</b></p> <p>Indicates the applicability of the alternative TBS index for the <math>h_{\text{TBS}} 37</math> (see TS 36.213 [23], Table 7.1.7.2.1-1) to all slots/subslots scheduled by DCI format 7-1F/7-1G. Value <i>a37</i> refers to the alternative TBS index <math>h_{\text{TBS}} 37A</math>. If this field does not configure an alternative TBS index for <math>h_{\text{TBS}} 37</math>, the UE shall use <math>h_{\text{TBS}} 37</math> specified in TS 36.213 [23], Table 7.1.7.2.1-1 for all slots/subslots instead.</p>

### SlotOrSubslotPUSCH-Config

The IE *SlotOrSubslotPUSCH-Config* is used to specify the UE specific PUSCH configuration when sTTI is used.

#### SlotOrSubslotPUSCH-Config information element

```

-- ASN1START
SlotOrSubslotPUSCH-Config-r15 ::= CHOICE {
    release          NULL,
    setup           SEQUENCE {
        betaOffsetSlot-ACK-Index-r15      INTEGER(0..15)      OPTIONAL, -- Need OR
        betaOffset2Slot-ACK-Index-r15     INTEGER(0..15)     OPTIONAL, -- Need OR
        betaOffsetSubslot-ACK-Index-r15   SEQUENCE (SIZE(1..2)) OF INTEGER(0..15) OPTIONAL, --
Need OR
        betaOffset2Subslot-ACK-Index-r15   SEQUENCE (SIZE(1..2)) OF INTEGER(0..15) OPTIONAL, --
Need OR
        betaOffsetSlot-RI-Index-r15       INTEGER(0..15)     OPTIONAL, -- Need OR
        betaOffsetSubslot-RI-Index-r15    SEQUENCE (SIZE(1..2)) OF INTEGER(0..15) OPTIONAL, --
Need OR
        betaOffsetSlot-CQI-Index-r15      INTEGER(0..15)     OPTIONAL, -- Need OR
        betaOffsetSubslot-CQI-Index-r15   INTEGER(0..15)     OPTIONAL, -- Need OR
        enable256QAM-SlotOrSubslot-r15    Enable256QAM-r14 OPTIONAL, -- Need ON
        resourceAllocationOffset-r15      INTEGER (1..2)     OPTIONAL, -- Need OR
        ul-DMRS-IFDMA-SlotOrSubslot-r15   BOOLEAN,
        ...
    }
}
-- ASN1STOP

```



<b>SlotOrSubslotPUSCH-Config field descriptions</b>
<p><b><i>betaOffsetSlot-ACK-Index, betaOffsetSubslot-ACK-Index, betaOffset2Slot-ACK-Index, betaOffset2Subslot-ACK-Index</i></b></p> <p>Parameter: <math>I_{offset}^{HARQ-ACK}</math> and <math>I_{offset,X}^{HARQ-ACK}</math> for single-codeword, see TS 36.213 [23], Table 8.6.3-1. If <i>betaOffset2Slot-ACK-Index/betaOffset2Subslot-ACK-Index</i> is configured; <i>betaOffsetSlot-ACK-Index/betaOffsetSubslot-ACK-Index</i> is used when up to 22 HARQ-ACK bits are transmitted otherwise <i>betaOffset2Slot-ACK-Index/betaOffset2Subslot-ACK-Index</i> is used. The values apply for all serving cells with an uplink in a cell group (MCG or SCG or the group of cells configured to send SPUCCH on the same cell in case SPUCCH SCell is configured) and not configured with uplink power control subframe sets. It is indicated in DCI format 7-0A/7-0B which of the two values taken by <i>betaOffsetSubslot-ACK-Index-r15/betaOffset2Subslot-ACK-Index-r15/ betaOffsetSubslot-RI-Index-r15</i> to use. The same value also applies for subframe set 1 of all serving cells with an uplink in that cell group and configured with uplink power control subframe sets (the associated functionality is common i.e. not performed independently for each cell).</p>
<p><b><i>betaOffsetSlot-RI-Index, betaOffsetSubslot-RI-Index</i></b></p> <p>Parameter: <math>I_{offset}^{RI}</math>, for single codeword, see TS 36.213 [23], Table 8.6.3-2. One value applies for subframe set 2 of all serving cells with an uplink in a cell group (MCG or SCG or the group of cells configured to send SPUCCH on the same cell in case SPUCCH SCell is configured) and configured with uplink power control subframe sets (the associated functionality is common i.e. not performed independently for each cell configured with uplink power control subframe sets).</p>
<p><b><i>betaOffsetSlot-CQI-Index, betaOffsetSubslot-CQI-Index</i></b></p> <p>Parameter: <math>I_{offset}^{CQI}</math>, for single codeword, see TS 36.213 [23], Table 8.6.3-3. One value applies for all serving cells with an uplink in a cell group (MCG or SCG or the group of cells configured to send SPUCCH on the same cell in case SPUCCH SCell is configured) and not configured with uplink power control subframe sets. The same value also applies for subframe set 1 of all serving cells with an uplink in that cell group and configured with uplink power control subframe sets (the associated functionality is common i.e. not performed independently for each cell).</p>
<p><b><i>enable256QAM-SlotOrSubslot</i></b></p> <p>Indicates that 256QAM for slot or subslot is enabled, see TS 36.213 [23], clause 8.6.1.</p>
<p><b><i>resourceAllocationOffset</i></b></p> <p>Indicates an RB resource allocation offset of 1 or 2 PRBs for slot-PUSCH or subslot-PUSCH. When the field is absent, the UE assumes no offset is used (i.e. offset = 0).</p>
<p><b><i>ul-DMRS-IFDMA-SlotOrSubslot</i></b></p> <p>Value <i>TRUE</i> indicates that the UE is configured with enhanced UL DMRS.</p>

## – SoundingRS-UL-Config

The IE *SoundingRS-UL-Config* is used to specify the uplink Sounding RS configuration for periodic and aperiodic sounding.

### SoundingRS-UL-Config information element

```

-- ASN1START
SoundingRS-UL-ConfigCommon ::= CHOICE {
  release      NULL,
  setup       SEQUENCE {
    srs-BandwidthConfig      ENUMERATED {bw0, bw1, bw2, bw3, bw4, bw5, bw6, bw7},
    srs-SubframeConfig      ENUMERATED {
      sc0, sc1, sc2, sc3, sc4, sc5, sc6, sc7,
      sc8, sc9, sc10, sc11, sc12, sc13, sc14, sc15},
    ackNackSRS-SimultaneousTransmission BOOLEAN,
    srs-MaxUpPts            ENUMERATED {true} OPTIONAL -- Cond TDD
  }
}

SoundingRS-UL-ConfigDedicated ::= CHOICE{
  release      NULL,
  setup       SEQUENCE {
    srs-Bandwidth      ENUMERATED {bw0, bw1, bw2, bw3},
    srs-HoppingBandwidth  ENUMERATED {hbw0, hbw1, hbw2, hbw3},
    freqDomainPosition  INTEGER (0..23),
    duration            BOOLEAN,
    srs-ConfigIndex    INTEGER (0..1023),
    transmissionComb    INTEGER (0..1),
    cyclicShift        ENUMERATED {cs0, cs1, cs2, cs3, cs4, cs5, cs6, cs7}
  }
}
-- ASN1END

```

```

SoundingRS-UL-ConfigDedicated-v1020 ::= SEQUENCE {
    srs-AntennaPort-r10          SRS-AntennaPort
}

SoundingRS-UL-ConfigDedicated-v1310 ::= CHOICE{
    release                      NULL,
    setup                        SEQUENCE {
        transmissionComb-v1310  INTEGER (2..3)          OPTIONAL, -- Need OR
        cyclicShift-v1310       ENUMERATED {cs8, cs9, cs10, cs11} OPTIONAL, -- Need
OR
        transmissionCombNum-r13 ENUMERATED {n2, n4}          OPTIONAL -- Need OR
    }
}

SoundingRS-UL-ConfigDedicatedUpPTsExt-r13 ::= CHOICE{
    release                      NULL,
    setup                        SEQUENCE {
        srs-UpPtsAdd-r13        ENUMERATED {sym2, sym4},
        srs-Bandwidth-r13      ENUMERATED {bw0, bw1, bw2, bw3},
        srs-HoppingBandwidth-r13 ENUMERATED {hbw0, hbw1, hbw2, hbw3},
        freqDomainPosition-r13 INTEGER (0..23),
        duration-r13           BOOLEAN,
        srs-ConfigIndex-r13    INTEGER (0..1023),
        transmissionComb-r13   INTEGER (0..3),
        cyclicShift-r13        ENUMERATED {cs0, cs1, cs2, cs3, cs4, cs5, cs6, cs7,
                                           cs8, cs9, cs10, cs11},
        srs-AntennaPort-r13    SRS-AntennaPort,
        transmissionCombNum-r13 ENUMERATED {n2, n4}
    }
}

SoundingRS-UL-ConfigDedicatedAperiodic-r10 ::= CHOICE{
    release                      NULL,
    setup                        SEQUENCE {
        srs-ConfigIndexAp-r10   INTEGER (0..31),
        srs-ConfigApDCI-Format4-r10 SEQUENCE (SIZE (1..3)) OF SRS-ConfigAp-r10 OPTIONAL,--
Need ON
        srs-ActivateAp-r10     CHOICE {
            release            NULL,
            setup              SEQUENCE {
                srs-ConfigApDCI-Format0-r10   SRS-ConfigAp-r10,
                srs-ConfigApDCI-Format1a2b2c-r10 SRS-ConfigAp-r10,
                ...
            }
        }
    }
}
OPTIONAL -- Need ON

SoundingRS-UL-ConfigDedicatedAperiodic-v1310 ::= CHOICE{
    release                      NULL,
    setup                        SEQUENCE {
        srs-ConfigApDCI-Format4-v1310 SEQUENCE (SIZE (1..3)) OF SRS-ConfigAp-v1310
OPTIONAL,--Need ON
        srs-ActivateAp-v1310     CHOICE {
            release            NULL,
            setup              SEQUENCE {
                srs-ConfigApDCI-Format0-v1310   SRS-ConfigAp-v1310 OPTIONAL, -- Need ON
                srs-ConfigApDCI-Format1a2b2c-v1310 SRS-ConfigAp-v1310 OPTIONAL -- Need ON
            }
        }
    }
}
OPTIONAL -- Need ON

SoundingRS-UL-ConfigDedicatedAperiodicUpPTsExt-r13 ::= CHOICE{
    release                      NULL,
    setup                        SEQUENCE {
        srs-UpPtsAdd-r13        ENUMERATED {sym2, sym4},
        srs-ConfigIndexAp-r13   INTEGER (0..31),
        srs-ConfigApDCI-Format4-r13 SEQUENCE (SIZE (1..3)) OF SRS-ConfigAp-r13 OPTIONAL,--
Need ON
        srs-ActivateAp-r13     CHOICE {
            release            NULL,
            setup              SEQUENCE {
                srs-ConfigApDCI-Format0-r13   SRS-ConfigAp-r13,
                srs-ConfigApDCI-Format1a2b2c-r13 SRS-ConfigAp-r13
            }
        }
    }
}
OPTIONAL -- Need ON

```

```

}
SoundingRS-UL-ConfigDedicatedAperiodic-v1430 ::= CHOICE{
  release          NULL,
  setup           SEQUENCE {
    srs-SubframeIndication-r14  INTEGER (1..4)  OPTIONAL    -- Need ON
  }
}

SoundingRS-UL-ConfigDedicatedAdd-r16 ::= SEQUENCE {
  srs-ConfigIndexAp-r16          INTEGER (0..31),
  srs-ConfigApDCI-Format4-r16    SEQUENCE (SIZE (1..3)) OF SRS-ConfigAdd-r16
                                   OPTIONAL,    --Need ON

  srs-ActivateAp-r13            CHOICE {
    release          NULL,
    setup           SEQUENCE {
      srs-ConfigApDCI-Format0-r16  SRS-ConfigAdd-r16,
      srs-ConfigApDCI-Format1a2b2c-r16  SRS-ConfigAdd-r16
    }
  }
} OPTIONAL    --Need ON

SRS-ConfigAp-r10 ::= SEQUENCE {
  srs-AntennaPortAp-r10          SRS-AntennaPort,
  srs-BandwidthAp-r10            ENUMERATED {bw0, bw1, bw2, bw3},
  freqDomainPositionAp-r10       INTEGER (0..23),
  transmissionCombAp-r10         INTEGER (0..1),
  cyclicShiftAp-r10             ENUMERATED {cs0, cs1, cs2, cs3, cs4, cs5, cs6, cs7}
}

SRS-ConfigAp-v1310 ::= SEQUENCE {
  transmissionCombAp-v1310       INTEGER (2..3)          OPTIONAL,    -- Need OR
  cyclicShiftAp-v1310           ENUMERATED {cs8, cs9, cs10, cs11}  OPTIONAL,    -- Need OR
  transmissionCombNum-r13        ENUMERATED {n2, n4}          OPTIONAL    -- Need OR
}

SRS-ConfigAp-r13 ::= SEQUENCE {
  srs-AntennaPortAp-r13          SRS-AntennaPort,
  srs-BandwidthAp-r13            ENUMERATED {bw0, bw1, bw2, bw3},
  freqDomainPositionAp-r13       INTEGER (0..23),
  transmissionCombAp-r13         INTEGER (0..3),
  cyclicShiftAp-r13             ENUMERATED {cs0, cs1, cs2, cs3, cs4, cs5, cs6, cs7,
                                             cs8, cs9, cs10, cs11},
  transmissionCombNum-r13        ENUMERATED {n2, n4}
}

SRS-AntennaPort ::= ENUMERATED {an1, an2, an4, spare1}

SRS-ConfigAdd-r16 ::= SEQUENCE {
  srs-RepNumAdd-r16              ENUMERATED {n1, n2, n3, n4, n6, n7, n8, n9, n12, n13},
  srs-BandwidthAdd-r16           ENUMERATED {bw0, bw1, bw2, bw3},
  srs-HoppingBandwidthAdd-r16    ENUMERATED {hbw0, hbw1, hbw2, hbw3},
  srs-FreqDomainPosAdd-r16       INTEGER (0..23),
  srs-AntennaPortAdd-r16        SRS-AntennaPort,
  srs-CyclicShiftAdd-r16        ENUMERATED {cs0, cs1, cs2, cs3, cs4, cs5, cs6, cs7,
                                             cs8, cs9, cs10, cs11},
  srs-TransmissionCombNumAdd-r16  ENUMERATED {n2, n4},
  srs-TransmissionCombAdd-r16    INTEGER (0..3),
  srs-StartPosAdd-r16            INTEGER (1..13),
  srs-DurationAdd-r16            INTEGER (1..13),
  srs-GuardSymbolAS-Add-r16      ENUMERATED {enabled}          OPTIONAL,    -- Need ON
  srs-GuardSymbolFH-Add-r16     ENUMERATED {enabled}          OPTIONAL,    -- Need ON
}

-- ASN1STOP

```

<b>SoundingRS-UL-Config field descriptions</b>
<p><b>ackNackSRS-SimultaneousTransmission</b> Parameter: <i>Simultaneous-AN-and-SRS</i>, see TS 36.213 [23], clause 8.2. For SCells without PUCCH configured, this field is not applicable and the UE shall ignore the value.</p>
<p><b>cyclicShift, cyclicShiftAp, srs-CyclicShiftAdd</b> Parameter: <math>n_{\text{SRS}}</math> for periodic, aperiodic and additional sounding reference signal transmission respectively except for an LAA SCell. See TS 36.211 [21], clause 5.5.3.1, where <math>cs_0</math> corresponds to 0 etc.</p>
<p><b>duration</b> Parameter: Duration for periodic sounding reference signal transmission except for an LAA SCell. See TS 36.213 [21], clause 8.2. FALSE corresponds to "single" and value TRUE to "indefinite".</p>
<p><b>freqDomainPosition, freqDomainPositionAp, srs-FreqDomainPosAdd</b> Parameter: <math>n_{\text{RRC}}</math> for periodic, aperiodic and additional sounding reference signal transmission respectively, see TS 36.211 [21], clause 5.5.3.2.</p>
<p><b>srs-AntennaPort, srs-AntennaPortAp, srs-AntennaPortAdd</b> Indicates the number of antenna ports used for periodic, aperiodic and additional sounding reference signal transmission respectively, see TS 36.211 [21], clause 5.5.3. UE shall release <i>srs-AntennaPort</i> if <i>SoundingRS-UL-ConfigDedicated</i> is released.</p>
<p><b>srs-Bandwidth, srs-BandwidthAp, srs-BandwidthAdd</b> Parameter: <math>B_{\text{SRS}}</math> for periodic, aperiodic and additional sounding reference signal transmission respectively, see TS 36.211 [21], tables 5.5.3.2-1, 5.5.3.2-2, 5.5.3.2-3 and 5.5.3.2-4. For LAA SCell only <math>bw_0</math> is applied.</p>
<p><b>srs-BandwidthConfig</b> Parameter: SRS Bandwidth Configuration. See TS 36.211, [21], tables 5.5.3.2-1, 5.5.3.2-2, 5.5.3.2-3 and 5.5.3.2-4. Actual configuration depends on UL bandwidth. <math>bw_0</math> corresponds to value 0, <math>bw_1</math> to value 1 and so on.</p>
<p><b>srs-ConfigApDCI-Format0 / srs-ConfigApDCI-Format1a2b2c / srs-ConfigApDCI-Format4</b> Parameters indicate the resource configurations for aperiodic sounding reference signal transmissions triggered by DCI formats 0, 1A, 2B, 2C, 4. See TS 36.213 [23], clause 8.2.</p>
<p><b>srs-ConfigIndex, srs-ConfigIndexAp</b> Parameter: <math>I_{\text{SRS}}</math> for periodic and aperiodic sounding reference signal transmission respectively except for an LAA SCell. See TS 36.213 [23], tables 8.2-1 and 8.2-2, for periodic and TS 36.213 [23], tables 8.2-4 and 8.2-5, for aperiodic and additional SRS transmission. If both <i>srs-ConfigIndexAp-r10</i> and <i>srs-ConfigIndexAp-r16</i> are included, E-UTRAN configures the same value for both fields.</p>
<p><b>srs-DurationAdd</b> Indicates the duration of the additional SRS including guard symbols within a UL subframe, see TS 36.211 [21], clause 5.5.3. E-UTRAN configures <i>addSRS-StartPos</i> and this field such that all the configured additional SRS occur within the same subframe.</p>
<p><b>srs-GuardSymbolAS-Add</b> If enabled, there is a guard period of one symbol after antenna switching, see TS 36.211 [21], clause 5.5.3 and TS 36.213 [23] clause 8.2.</p>
<p><b>srs-GuardSymbolFH-Add</b> If enabled, there is a guard period of one symbol after frequency hopping, see TS 36.211 [21], clause 5.5.3 and TS 36.213 [23] clause 8.2.</p>
<p><b>srs-HoppingBandwidth, srs-HoppingBandwidthAdd</b> Parameter: SRS hopping bandwidth <math>b_{\text{hop}} \in \{0,1,2,3\}</math> for periodic and additional sounding reference signal transmission respectively except for an LAA SCell, see TS 36.211 [21], clause 5.5.3.2, where <math>hbw_0</math> corresponds to value 0, <math>hbw_1</math> to value 1 and so on.</p>
<p><b>srs-MaxUpPts</b> Parameter: <math>srsMaxUpPts</math>, see TS 36.211 [21], clause 5.5.3.2. If this field is present, reconfiguration of <math>m_{\text{SRS},0}^{\text{max}}</math> applies for UpPts, otherwise reconfiguration does not apply.</p>
<p><b>srs-RepNumAdd</b> Parameter: R which indicates the number of the additional SRS repetitions, see TS 36.211 [21], clause 5.5.3.2 and TS 36.213 [23] clause 8.3.</p>
<p><b>srs-StartPosAdd</b> Indicates the starting position of the additional SRS within a UL subframe excluding UpPTS, see TS 36.211 [21], clause 5.5.3.</p>
<p><b>srs-SubframeConfig</b> Parameter: SRS Subframe Configuration except for an LAA SCell. See TS 36.211, [21], table 5.5.3.3-1, applies for FDD whereas TS 36.211 [21], table 5.5.3.3-2, applies for TDD. <math>sc_0</math> corresponds to value 0, <math>sc_1</math> corresponds to value 1 and so on.</p>
<p><b>srs-SubframeIndication</b> Parameter: SRS subframe indication in SRS parameter set configuration for aperiodic sounding reference signal transmission on an LAA SCell configured with uplink, see TS 36.213 [23].</p>

<b>SoundingRS-UL-Config field descriptions</b>
<p><b>srs-UpPtsAdd</b> The field only applies for TDD and frame structure type 3, see TS 36.211 [21]. If E-UTRAN configures both <i>soundingRS-UL-ConfigDedicatedUpPTsExt</i> and <i>soundingRS-UL-ConfigDedicatedAperiodicUpPTsExt</i>, <i>srs-UpPtsAdd</i> in both fields is set to the same value. If E-UTRAN configures <i>soundingRS-UL-PeriodicConfigDedicatedUpPTsExtList-r14</i> with a number of <i>soundingRS-UL-ConfigDedicatedUpPTsExt</i> and/or <i>soundingRS-UL-AperiodicConfigDedicatedList-r14</i> with a number of <i>soundingRS-UL-ConfigDedicatedAperiodicUpPTsExt</i>, <i>srs-UpPtsAdd</i> in all fields are set to the same value.</p>
<p><b>transmissionComb, transmissionCombAp, srs-TransmissionCombAdd</b> Parameter: <math>\bar{k}_{TC} \in \{0..3\}</math> for periodic, aperiodic and additional sounding reference signal transmission respectively, see TS 36.211 [21], clause 5.5.3.2.</p>

<b>Conditional presence</b>	<b>Explanation</b>
<i>TDD</i>	This field is optional present for TDD, need OR; it is not present for FDD and the UE shall delete any existing value for this field.

## – SPDCCH-Config

The IE SPDCCH-Config is used to specify the UE specific SPDCCH configuration.

### SPDCCH-Config information element

```

-- ASN1START
SPDCCH-Config-r15 ::= CHOICE {
    release          NULL,
    setup           SEQUENCE {
        spdcch-L1-ReuseIndication-r15  ENUMERATED {n0,n1,n2}  OPTIONAL, -- Need OR
        spdcch-SetConfig-r15          SPDCCH-Set-r15          OPTIONAL -- Need OR
    }
}

SPDCCH-Set-r15 ::= SEQUENCE (SIZE (1..4)) OF SPDCCH-Elements-r15

SPDCCH-Elements-r15 ::= CHOICE {
    release          NULL,
    setup           SEQUENCE {
        spdcch-SetConfigId-r15          INTEGER (0..3)          OPTIONAL, -- Need OR
        spdcch-SetReferenceSig-r15      ENUMERATED {crs, dmrs}  OPTIONAL, -- Need OR
        transmissionType-r15           ENUMERATED {localised, distributed} OPTIONAL, -- Need OR
        spdcch-NoOfSymbols-r15         INTEGER (1..2)          OPTIONAL, -- Need OR
        dmrs-ScramblingSequenceInt-r15 INTEGER (0..503)       OPTIONAL, -- Need OR
        dci7-CandidatesPerAL-PDCCH-r15 SEQUENCE (SIZE(1..4)) OF
            DCI7-Candidates-r15 OPTIONAL, -- Need OR
        dci7-CandidateSetsPerAL-SPDCCH-r15 SEQUENCE (SIZE(1..2)) OF
            DCI7-CandidatesPerAL-SPDCCH-r15 OPTIONAL, -- Need OR
        resourceBlockAssignment-r15    SEQUENCE{
            numberRB-InFreq-domain-r15  INTEGER (2..100),
            resourceBlockAssignment-r15  BIT STRING (SIZE(98))
        } OPTIONAL, -- Need OR
        subslotApplicability-r15       BIT STRING (SIZE(5))  OPTIONAL, -- Need OR
        al-StartingPointSPDCCH-r15    SEQUENCE (SIZE(1..4)) OF
            INTEGER(0..49)              OPTIONAL, -- Need OR
        subframeType-r15              ENUMERATED {mbsfn, nonmbsfn, all}  OPTIONAL, -- Need OR
        rateMatchingMode-r15          ENUMERATED {m1, m2, m3, m4}    OPTIONAL, -- Need OR
        ...
    }
}

DCI7-Candidates-r15 ::= INTEGER (0..6)
DCI7-CandidatesPerAL-SPDCCH-r15 ::= SEQUENCE (SIZE(1..4)) OF DCI7-Candidates-r15
-- ASN1STOP

```

<b>SPDCCH-Config field descriptions</b>
<p><b>al-StartingPointSPDCCH</b> Indicates the starting SCCE index for an aggregation level, see TS 36.213 [23], clause 9.1.6.</p>
<p><b>dci7-Candidates</b> Number of candidates in each aggregation level for DCI format 7. The number of PDCCH/SPDCCH candidate(s) M_DCI format 7^(L) at aggregation level L for monitoring DCI format 7 in PDCCH and SPDCCH region shall conform to the following restriction:</p> <ul style="list-style-type: none"> <li>less than or equal to 2 for aggregation level 4 and 8,</li> <li>less than or equal to 6 for aggregation level 1 and 2</li> </ul>
<p><b>dci7-CandidatesPerAL-SPDCCH</b> SPDCCH candidates configured per aggregation level in SPDCCH region</p>
<p><b>dmrs-ScramblingSeqSPDCCH</b> The DMRS scrambling sequence initialization parameter <math>n_{ID,i}^{SPDCCH}</math> defined in TS 36.211 [21], clause 6.10.3A.1.</p>
<p><b>numberRB-InFreq-domain</b> Indicates the number of resource-blocks in the frequency domain used for the SPDCCH set. There is no restriction on the number of RBs in the frequency domain that can be configured to an SPDCCH resource set (up to 100), but at least two need to be configured to contain at least one SCCE. The granularity of resource block allocation in frequency domain for configuring an SPDCCH resource set is one in case spdcch-SetReferenceSig-r15 is set to crs. The granularity of resource block allocation for configuring an SPDCCH resource set is two in case sPDCCH-SetReferenceSig-r15 is set to dmrs.</p>
<p><b>rateMatchingMode</b> Indicates, per resource-set, the mode of SPDCCH rate-matching operation</p> <ul style="list-style-type: none"> <li>Mode 1: UE rate-matches only around the DCI format 7 scheduling the slot or subslot PDSCH (if transmitted in the SPDCCH resource-set), otherwise no rate-matching is performed for the RB set.</li> <li>Mode 2: UE rate-matches around the whole SPDCCH resource set</li> <li>Mode 3: UE rate-matches around the whole SPDCCH resource set if DCI format 7 scheduling the slot or subslot PDSCH is found in the resource-set, otherwise no rate-matching is performed for the RB set.</li> <li>Mode 4: UE rate-matches around the whole SPDCCH resource set if DCI format 7 scheduling the slot or subslot PDSCH is not found in the resource-set, otherwise UE rate-matches only around the DCI format 7 scheduling the slot or subslot PDSCH (if transmitted in the SPDCCH resource-set)</li> </ul> <p>If the DCI format 7 scheduling the slot or subslot PDSCH is found on a candidate belonging to two SPDCCH resource sets, the DCI format 7 is assumed to be found in both resource sets.</p>
<p><b>resourceBlockAssignment</b> Indicates the index to a specific combination of physical resource block in frequency for SPDCCH set, see TS 36.213 [23], clause 9.1.4.4. The value range is dependent on the combinatorial number defined in 36.213 [23], clause 9.1.4.4 with the assumption of no limitation in the number of RBs in frequency domain configured by the set.</p>
<p><b>spdcch-NoOfSymbols</b> Indicates the number of OFDM symbols that the CRS based SPDCCH is mapped over.</p>
<p><b>spdcch-L1-ReuseIndication</b> For the up to two resource sets configured with the same <i>subframeType</i> applicability, the <i>SPDCCH-L1-ReuseIndication</i> defines the allowed combinations for the two resource sets: {1,1}, {2,0} or {0,2} corresponding to the values n0, n1 and n2 respectively. In case one resource set is configured, the allowed combinations are {2, 0} or {0,2} corresponding to n1 or n2. EUTRAN does not configure n0 in case one resource set is configured.</p>
<p><b>spdcch-SetConfigId</b> Indicates the ID of the SPDCCH set configured in <i>SPDCCH-Elements</i>. Maximum two sets can be configured for MBSFN and two for non-MBSFN.</p>
<p><b>spdcch-SetReferenceSig</b> Indicates CRS or DMRS based SPDCCH set.</p>
<p><b>subframeType</b> Indicates applicable subframe type(s) for the SPDCCH set. CRS-based SPDCCH is only applied to non-MBSFN subframe.</p>
<p><b>subslotApplicability</b> Indicates the set of subslots within the subframe where SPDCCH candidate set per aggregation levels applies, see <i>DCI7-CandidateSetsPerAL-SPDCCH</i>. The bitmap applies to the 5 DL subslot indices in a DL subframe. The first element in the sequence <i>DCI7-CandidateSetsPerAL-SPDCCH</i> applies to the indicated <i>subslotApplicability</i>. The second element in the sequence (if present) applies to the complement of the <i>subslotApplicability</i>.</p>
<p><b>transmissionType</b> Indicates whether distributed or localized SPDCCH transmission mode is used as defined in TS 36.211 [21], clause 6.8A.1.</p>

## – SPS-Config

The IE *SPS-Config* is used to specify the semi-persistent scheduling configuration.

**SPS-Config information element**

```

-- ASN1START
SPS-Config ::= SEQUENCE {
    semiPersistSchedC-RNTI          C-RNTI          OPTIONAL,      -- Need OR
    sps-ConfigDL                    SPS-ConfigDL      OPTIONAL,      -- Need ON
    sps-ConfigUL                    SPS-ConfigUL      OPTIONAL,      -- Need ON
}

SPS-Config-v1430 ::= SEQUENCE {
    ul-SPS-V-RNTI-r14              C-RNTI          OPTIONAL,      -- Need OR
    sl-SPS-V-RNTI-r14              C-RNTI          OPTIONAL,      -- Need OR
    sps-ConfigUL-ToAddModList-r14   SPS-ConfigUL-ToAddModList-r14 OPTIONAL,      -- Need ON
    sps-ConfigUL-ToReleaseList-r14 SPS-ConfigUL-ToReleaseList-r14 OPTIONAL,      -- Need ON
    sps-ConfigSL-ToAddModList-r14   SPS-ConfigSL-ToAddModList-r14 OPTIONAL,      -- Need ON
    sps-ConfigSL-ToReleaseList-r14  SPS-ConfigSL-ToReleaseList-r14 OPTIONAL,      -- Need ON
}

SPS-ConfigUL-ToAddModList-r14 ::= SEQUENCE (SIZE (1..maxConfigSPS-r14)) OF SPS-ConfigUL
SPS-ConfigUL-ToReleaseList-r14 ::= SEQUENCE (SIZE (1..maxConfigSPS-r14)) OF SPS-ConfigIndex-r14
SPS-ConfigSL-ToAddModList-r14 ::= SEQUENCE (SIZE (1..maxConfigSPS-r14)) OF SPS-ConfigSL-r14
SPS-ConfigSL-ToReleaseList-r14 ::= SEQUENCE (SIZE (1..maxConfigSPS-r14)) OF SPS-ConfigIndex-r14

SPS-Config-v1530 ::= SEQUENCE {
    semiPersistSchedC-RNTI-r15     C-RNTI          OPTIONAL,      -- Need OR
    sps-ConfigDL-r15               SPS-ConfigDL      OPTIONAL,      -- Need ON
    sps-ConfigUL-STTI-ToAddModList-r15 SPS-ConfigUL-STTI-ToAddModList-r15 OPTIONAL,      -- Need ON
    sps-ConfigUL-STTI-ToReleaseList-r15 SPS-ConfigUL-STTI-ToReleaseList-r15 OPTIONAL,      -- Need ON
    sps-ConfigUL-ToAddModList-r15   SPS-ConfigUL-ToAddModList-r15 OPTIONAL,      -- Need ON
    sps-ConfigUL-ToReleaseList-r15  SPS-ConfigUL-ToReleaseList-r15 OPTIONAL,      -- Need ON
}

SPS-Config-v1540 ::= SEQUENCE {
    sps-ConfigDL-STTI-r15          SPS-ConfigDL-STTI-r15          OPTIONAL,      -- Need OR
}

SPS-ConfigUL-STTI-ToAddModList-r15 ::= SEQUENCE (SIZE (1..maxConfigSPS-r15)) OF SPS-ConfigUL-STTI-r15
SPS-ConfigUL-STTI-ToReleaseList-r15 ::= SEQUENCE (SIZE (1..maxConfigSPS-r15)) OF SPS-ConfigIndex-r15
SPS-ConfigUL-ToAddModList-r15 ::= SEQUENCE (SIZE (1..maxConfigSPS-r15)) OF SPS-ConfigUL
SPS-ConfigUL-ToReleaseList-r15 ::= SEQUENCE (SIZE (1..maxConfigSPS-r15)) OF SPS-ConfigIndex-r15

SPS-ConfigDL ::= CHOICE {
    release          NULL,
    setup           SEQUENCE {
        semiPersistSchedIntervalDL    ENUMERATED {
            sf10, sf20, sf32, sf40, sf64, sf80,
            sf128, sf160, sf320, sf640, spare6,
            spare5, spare4, spare3, spare2,
            spare1},
        numberOfConfSPS-Processes      INTEGER (1..8),
        n1PUCCH-AN-PersistentList     N1PUCCH-AN-PersistentList,
        ...,
        [[ twoAntennaPortActivated-r10 CHOICE {
            release          NULL,
            setup           SEQUENCE {
                n1PUCCH-AN-PersistentListP1-r10 N1PUCCH-AN-PersistentList
            }
        }
    ]]
    }
}

SPS-ConfigUL ::= CHOICE {
    release          NULL,
    setup           SEQUENCE {
        semiPersistSchedIntervalUL    ENUMERATED {
            sf10, sf20, sf32, sf40, sf64, sf80,
            sf128, sf160, sf320, sf640, sf1-v1430,
            sf2-v1430, sf3-v1430, sf4-v1430, sf5-v1430,
            spare1},
}

```

```

implicitReleaseAfter      ENUMERATED {e2, e3, e4, e8},
p0-Persistent             SEQUENCE {
  p0-NominalPUSCH-Persistent  INTEGER (-126..24),
  p0-UE-PUSCH-Persistent     INTEGER (-8..7)
}
  OPTIONAL, -- Need OP
twoIntervalsConfig       ENUMERATED {true}
  OPTIONAL, -- Cond TDD
...
[[ p0-PersistentSubframeSet2-r12 CHOICE {
  release      NULL,
  setup       SEQUENCE {
    p0-NominalPUSCH-PersistentSubframeSet2-r12  INTEGER (-126..24),
    p0-UE-PUSCH-PersistentSubframeSet2-r12     INTEGER (-8..7)
  }
}
  OPTIONAL -- Need ON
]],
[[ numberOfConfULSPS-Processes-r13  INTEGER (1..8)  OPTIONAL -- Need OR
]],
[[ fixedRV-NonAdaptive-r14          ENUMERATED {true}  OPTIONAL, -- Need OR
   sps-ConfigIndex-r14              SPS-ConfigIndex-r14  OPTIONAL, -- Need OR
   semiPersistSchedIntervalUL-v1430 ENUMERATED {
     sf50, sf100, sf200, sf300, sf400, sf500,
     sf600, sf700, sf800, sf900, sf1000, spare5,
     spare4, spare3, spare2, spare1} OPTIONAL -- Need OR
  ]],
[[ cyclicShiftSPS-r15              ENUMERATED {cs0, cs1, cs2, cs3, cs4, cs5, cs6, cs7}
  OPTIONAL, -- Need ON
   harq-ProcID-Offset-r15          INTEGER (0..7)  OPTIONAL, -- Need ON
   rv-SPS-UL-Repetitions-r15      ENUMERATED {ulrvseq1, ulrvseq2, ulrvseq3} OPTIONAL,
-- Need ON
   tpc-PDCCH-ConfigPUSCH-SPS-r15  TPC-PDCCH-Config  OPTIONAL, -- Need ON
   totalNumberPUSCH-SPS-UL-Repetitions-r15  ENUMERATED {n2,n3,n4,n6}  OPTIONAL, -- Need ON
   sps-ConfigIndex-r15            SPS-ConfigIndex-r15  OPTIONAL -- Cond SPS
  ]],
}
}

SPS-ConfigSL-r14 ::= SEQUENCE {
  sps-ConfigIndex-r14      SPS-ConfigIndex-r14,
  semiPersistSchedIntervalSL-r14  ENUMERATED {
    sf20, sf50, sf100, sf200, sf300, sf400,
    sf500, sf600, sf700, sf800, sf900, sf1000,
    spare4, spare3, spare2, spare1}
}

SPS-ConfigIndex-r14 ::= INTEGER (1..maxConfigSPS-r14)
SPS-ConfigIndex-r15 ::= INTEGER (1..maxConfigSPS-r15)
N1PUCCH-AN-PersistentList ::= SEQUENCE (SIZE (1..4)) OF INTEGER (0..2047)
N1SPUCCH-AN-PersistentList-r15 ::= SEQUENCE (SIZE (1..4)) OF INTEGER (0..2047)
SPS-ConfigDL-STTI-r15 ::= CHOICE{
  release      NULL,
  setup       SEQUENCE {
    semiPersistSchedIntervalDL-STTI-r15  ENUMERATED {
      sTTI1, sTTI2, sTTI3, sTTI4, sTTI6, sTTI8, sTTI12,
      sTTI16,
      sTTI20, sTTI40, sTTI60, sTTI80, sTTI120, sTTI240,
      spare2, spare1},
    numberOfConfSPS-Processes-STTI-r15  INTEGER (1..12),
    twoAntennaPortActivated-r15        CHOICE {
      release      NULL,
      setup       SEQUENCE {
        n1SPUCCH-AN-PersistentListP1-r15  N1SPUCCH-AN-PersistentList-r15
      }
    }
  }
  OPTIONAL, -- Need ON
  sTTI-StartTimeDL-r15                INTEGER (0..5),
  tpc-PDCCH-ConfigPUCCH-SPS-r15      TPC-PDCCH-Config  OPTIONAL, -- Need ON
  ...
}
}

SPS-ConfigUL-STTI-r15 ::= CHOICE {
  release      NULL,
  setup       SEQUENCE {
    semiPersistSchedIntervalUL-STTI-r15  ENUMERATED {

```



```

sTTI16,
    sTTI1, sTTI2, sTTI3, sTTI4, sTTI6, sTTI8, sTTI12,
    sTTI20, sTTI40, sTTI60, sTTI80, sTTI120, sTTI240,
    spare2, spare1},
    implicitReleaseAfter      ENUMERATED {e2, e3, e4, e8},
    p0-Persistent-r15         SEQUENCE {
        p0-NominalSPUSCH-Persistent-r15  INTEGER (-126..24),
        p0-UE-SPUSCH-Persistent-r15     INTEGER (-8..7)
    }
    twoIntervalsConfig-r15    ENUMERATED {true}
    p0-PersistentSubframeSet2-r15 CHOICE {
        release                NULL,
        setup                   SEQUENCE {
            p0-NominalSPUSCH-PersistentSubframeSet2-r15  INTEGER (-126..24),
            p0-UE-SPUSCH-PersistentSubframeSet2-r15     INTEGER (-8..7)
        }
    }
    numberOfConfUL-SPS-Processes-STTI-r15  INTEGER (1..12)
    sTTI-StartTimeUL-r15                   INTEGER (0..5),
    tpc-PDCCH-ConfigPUSCH-SPS-r15         TPC-PDCCH-Config
    cyclicShiftSPS-STTI-r15               ENUMERATED {cs0, cs1, cs2, cs3, cs4, cs5, cs6, cs7}
    ifdma-Config-SPS-r15                   BOOLEAN
    harq-ProcID-offset-r15                 INTEGER (0..15)
    rv-SPS-STTI-UL-Repetitions-r15        ENUMERATED {ulrvseq1, ulrvseq2, ulrvseq3}
Need ON
    sps-ConfigIndex-r15                    SPS-ConfigIndex-r15
    tbs-scalingFactorSubslotSPS-UL-Repetitions-r15  ENUMERATED {n6, n12}
Need ON
    totalNumberPUSCH-SPS-STTI-UL-Repetitions-r15  ENUMERATED {n2,n3,n4,n6}
Need ON
    ...
}
-- ASN1STOP

```

<b>SPS-Config field descriptions</b>
<p><b><i>cyclicShiftSPS, cyclicShiftSPS-sTTI,</i></b> Indicates the cyclic shift <math>n_{\text{DMRS}}^{(2)}</math> to be used for the UE-specific reference signal in case of UL SPS, see TS 36.211 [5] clause 5.2.1.1.</p>
<p><b><i>fixedRV-NonAdaptive</i></b> If this field is present and <i>skipUplinkTxSPS</i> is configured, non-adaptive retransmissions on configured uplink grant uses redundancy version 0, otherwise the redundancy version for each retransmission is updated based on the sequence of redundancy versions as described in TS 36.321 [6].</p>
<p><b><i>harq-ProclD-offset</i></b> If configured, this field indicates the offset used in deriving the HARQ process IDs, see TS 36.321 [6], clause 5.4.1.</p>
<p><b><i>lfdma-Config-SPS</i></b> Indicated <math>\varpi</math> to be used for the UE-specific reference signal in case of UL SPS see TS 36.211 [5], clause 5.2,1.1.</p>
<p><b><i>implicitReleaseAfter</i></b> Number of empty transmissions before implicit release, see TS 36.321 [6], clause 5.10.2. Value e2 corresponds to 2 transmissions, e3 corresponds to 3 transmissions and so on. If <i>skipUplinkTxSPS</i> is configured, the UE shall ignore this field.</p>
<p><b><i>n1PUCCH-AN-PersistentList, n1PUCCH-AN-PersistentListP1</i></b> List of parameter: <math>n_{\text{PUCCH}}^{(1,p)}</math> for antenna port P0 and for antenna port P1 respectively, see TS 36.213 [23], clause 10.1. Field <i>n1-PUCCH-AN-PersistentListP1</i> is applicable only if the <i>twoAntennaPortActivatedPUCCH-Format1a1b</i> in <i>PUCCH-ConfigDedicated-v1020</i> is set to <i>true</i>. Otherwise the field is not configured.</p>
<p><b><i>numberOfConfSPS-Processes</i></b> The number of configured HARQ processes for downlink Semi-Persistent Scheduling, see TS 36.321 [6].</p>
<p><b><i>numberOfConfSPS-Processes-sTTI</i></b> The number of configured HARQ processes for downlink Semi-Persistent Scheduling for sTTI in DL, see TS 36.321 [6].</p>
<p><b><i>numberOfConfUISPS-Processes</i></b> The number of configured HARQ processes for uplink Semi-Persistent Scheduling, see TS 36.321 [6]. E-UTRAN always configures this field for asynchronous UL HARQ. Otherwise it does not configure this field.</p>
<p><b><i>numberOfConfUL-SPS-Processes-sTTI</i></b> The number of configured HARQ processes for uplink Semi-Persistent Scheduling for sTTI in UL, see TS 36.321 [6]. E-UTRAN always configures this field for asynchronous UL HARQ. Otherwise it does not configure this field.</p>
<p><b><i>p0-NominalPUSCH-Persistent, p0-NominalSPUSCH-Persistent</i></b> Parameter: <math>P_{\text{O\_NOMINAL\_PUSCH}}(0)</math>. See TS 36.213 [23], clause 5.1.1.1, unit dBm step 1. This field is applicable for persistent scheduling, only. If choice setup is used and <i>p0-Persistent</i> is absent, apply the value of <i>p0-NominalPUSCH</i> for <i>p0-NominalPUSCH-Persistent</i>. If uplink power control subframe sets are configured by <i>tpc-SubframeSet</i>, this field applies for uplink power control subframe set 1.</p>
<p><b><i>p0-NominalPUSCH-PersistentSubframeSet2, p0-NominalSPUSCH-PersistentSubframeSet2</i></b> Parameter: <math>P_{\text{O\_NOMINAL\_PUSCH}}(0)</math>. See TS 36.213 [23], clause 5.1.1.1, unit dBm step 1. This field is applicable for persistent scheduling, only. If <i>p0-PersistentSubframeSet2-r12</i> is not configured, apply the value of <i>p0-NominalPUSCH-SubframeSet2-r12</i> for <i>p0-NominalPUSCH-PersistentSubframeSet2</i>. E-UTRAN configures this field only if uplink power control subframe sets are configured by <i>tpc-SubframeSet</i>, in which case this field applies for uplink power control subframe set 2.</p>
<p><b><i>p0-UE-PUSCH-Persistent</i></b> Parameter: <math>P_{\text{O\_UE\_PUSCH}}(0)</math>. See TS 36.213 [23], clause 5.1.1.1, unit dB. This field is applicable for persistent scheduling, only. If choice setup is used and <i>p0-Persistent</i> is absent, apply the value of <i>p0-UE-PUSCH</i> for <i>p0-UE-PUSCH-Persistent</i>. If uplink power control subframe sets are configured by <i>tpc-SubframeSet</i>, this field applies for uplink power control subframe set 1.</p>
<p><b><i>p0-UE-PUSCH-PersistentSubframeSet2</i></b> Parameter: <math>P_{\text{O\_UE\_PUSCH}}(0)</math>. See TS 36.213 [23], clause 5.1.1.1, unit dB. This field is applicable for persistent scheduling, only. If <i>p0-PersistentSubframeSet2-r12</i> is not configured, apply the value of <i>p0-UE-PUSCH-SubframeSet2</i> for <i>p0-UE-PUSCH-PersistentSubframeSet2</i>. E-UTRAN configures this field only if uplink power control subframe sets are configured by <i>tpc-SubframeSet</i>, in which case this field applies for uplink power control subframe set 2.</p>
<p><b><i>rv-SPS-sTTI-UL-Repetitions</i></b> Indicates the RV sequence of slot or subslot PUSCH for slot or subslot UL SPS repetitions. Value <i>ulrvseq1</i>= {0, 0, 0, 0, 0}, value <i>ulrvseq2</i>= {0, 2, 3, 1, 0, 2} and value <i>ulrvseq3</i>= {0, 3, 0, 3, 0, 3}.</p>
<p><b><i>rv-SPS-UL-Repetitions</i></b> Indicates the RV sequence of PUSCH for subframe UL SPS repetitions. Value <i>ulrvseq1</i>= {0, 0, 0, 0, 0, 0}, value <i>ulrvseq2</i>= {0, 2, 3, 1, 0, 2} and value <i>ulrvseq3</i>= {0, 3, 0, 3, 0, 3}.</p>
<p><b><i>semiPersistSchedC-RNTI</i></b> Semi-persistent Scheduling C-RNTI, see TS 36.321 [6]. If <i>sps-Config</i> is present for more than one cells in the same cell group, <i>semiPersistSchedC-RNTI</i> is present in only one <i>sps-Config</i>.</p>

<b>SPS-Config field descriptions</b>
<p><b><i>semiPersistSchedIntervalDL</i></b> Semi-persistent scheduling interval in downlink, see TS 36.321 [6]. Value in number of sub-frames. Value sf10 corresponds to 10 sub-frames, sf20 corresponds to 20 sub-frames and so on. For TDD, the UE shall round this parameter down to the nearest integer (of 10 sub-frames), e.g. sf10 corresponds to 10 sub-frames, sf32 corresponds to 30 sub-frames, sf128 corresponds to 120 sub-frames.</p>
<p><b><i>semiPersistSchedIntervalDL-STTI</i></b> Semi-persistent scheduling interval for sTTI in downlink, see TS 36.321 [6]. Value in number of sTTI. Value sTTI1 corresponds to a spacing of 1 sTTI interval, sTTI2 corresponds to 2 spacings of sTTI intervals and so on, e.g. sTTI1 equal to sub-slot of 2 symbols or 3 symbols when the type of 2OS sTTI is configured, or e.g. sTTI1 equal to slot of 7 symbols when type of 7OS sTTI is configured. SPS for sTTI is not supported for TDD.</p>
<p><b><i>semiPersistSchedIntervalSL</i></b> Semi-persistent scheduling interval in sidelink, see TS 36.321 [6]. Value in number of sub-frames. Value sf20 corresponds to 20 sub-frames, sf50 corresponds to 50 sub-frames and so on.</p>
<p><b><i>semiPersistSchedIntervalUL</i></b> Semi-persistent scheduling interval in uplink, see TS 36.321 [6]. Value in number of sub-frames. Value sf10 corresponds to 10 sub-frames, sf20 corresponds to 20 sub-frames and so on. For TDD, when the configured Semi-persistent scheduling interval is greater than or equal to 10 sub-frames, the UE shall round this parameter down to the nearest integer (of 10 sub-frames), e.g. sf10 corresponds to 10 sub-frames, sf32 corresponds to 30 sub-frames, sf128 corresponds to 120 sub-frames. If <i>semiPersistSchedIntervalUL-v1430</i> is configured, the UE only considers this extension (and ignores <i>semiPersistSchedIntervalUL</i> i.e. without suffix).</p>
<p><b><i>semiPersistSchedIntervalUL-STTI</i></b> Semi-persistent scheduling interval for sTTI in uplink, see TS 36.321 [6]. Value in number of sTTI. Value sTTI1 corresponds to a spacing of 1 sTTI interval, sTTI2 corresponds to 2 spacings of sTTI intervals and so on, e.g. sTTI1 equal to sub-slot of 2 symbols or 3 symbols when the type of 2OS sTTI is configured, or e.g. sTTI1 equal to slot of 7 symbols when type of 7OS sTTI is configured. SPS for sTTI is not supported for TDD.</p>
<p><b><i>sl-SPS-V-RNTI</i></b> SL Semi-Persistent Scheduling V-RNTI for V2X sidelink communication, see TS 36.321 [6].</p>
<p><b><i>sps-ConfigIndex</i></b> Indicates the index of one of multiple SL/UL SPS configurations.</p>
<p><b><i>sps-ConfigDL-STTI</i></b> If <i>sps-ConfigDL-sTTI-r15</i> is signalled, the UE ignores <i>sps-ConfigDL</i>.</p>
<p><b><i>sps-ConfigSL-ToAddModList</i></b> Indicates the SL SPS configurations to be added or modified, identified by <i>SPS-ConfigIndex</i>.</p>
<p><b><i>sps-ConfigSL-ToReleaseList</i></b> Indicates the SL SPS configurations to be released, identified by <i>SPS-ConfigIndex</i>.</p>
<p><b><i>sps-ConfigUL-STTI-ToAddModList</i></b> Indicates the UL sTTI SPS configurations to be added or modified, identified by <i>SPS-ConfigIndex</i>. If this list includes more than one entry, E-UTRAN includes <i>totalNumberPUSCH-SPS-STTI-UL-Repetitions</i> in each entry.</p>
<p><b><i>sps-ConfigUL-STTI-ToReleaseList</i></b> Indicates the UL sTTI SPS configurations to be released, identified by <i>SPS-ConfigIndex</i>.</p>
<p><b><i>sps-ConfigUL-ToAddModList</i></b> Indicates the UL SPS configurations to be added or modified, identified by <i>SPS-ConfigIndex</i>. If this list includes more than one entry, E-UTRAN includes <i>totalNumberPUSCH-SPS-UL-Repetitions</i> in each entry.</p>
<p><b><i>sps-ConfigUL-ToReleaseList</i></b> Indicates the UL SPS configurations to be released, identified by <i>SPS-ConfigIndex</i>.</p>
<p><b><i>sTTI-StartTimeDL</i></b> Indicates the DL sTTI index start offset for SPS (re-)initialization, see TS 36.321 [6].</p>
<p><b><i>sTTI-StartTimeUL</i></b> Indicates the UL sTTI index start offset for SPS (re-)initialization, see TS 36.321 [6].</p>
<p><b><i>tbs-scalingFactorSubslotSPS-UL-Repetitions</i></b> Indicates the TBS scaling factor of subslot PUSCH for UL SPS repetitions. Value n6 corresponds to 1/6 and value n12 corresponds to 1/12.</p>
<p><b><i>totalNumberPUSCH-SPS-STTI-UL-Repetitions</i></b> Indicates the total number of UL transmissions for slot or subslot UL SPS repetitions. If the UE is configured with UL SPS and the configured number of SPS PUSCH transmissions <math>k &gt; 1</math>, simultaneous transmission of PUSCH and PUCCH is not configured.</p>
<p><b><i>totalNumberPUSCH-SPS-UL-Repetitions</i></b> Indicates the total number of UL transmissions for subframe UL SPS repetitions. If the UE is configured with UL SPS and the configured number of SPS PUSCH transmissions <math>k &gt; 1</math>, simultaneous transmission of PUSCH and PUCCH is not configured.</p>
<p><b><i>tpc-PDCCH-ConfigPUCCH-SPS</i></b> PDCCH configuration for power control of slot/subslot-PUCCH using format 3/3A, see TS 36.212 [22], when <i>SPS-ConfigDL-STTI</i> is configured.</p>

<b>SPS-Config field descriptions</b>	
<b><i>tpc-PDCCH-ConfigPUSCH-SPS</i></b>	PDCCH configuration for power control of slot/subslot-PUSCH using format 3/3A, see TS 36.212 [22], when <i>SPS-ConfigUL-STTI</i> is configured. If a UE is configured with multiple UL SPS configurations in a serving cell, the same TPC index for DCI format 3/3A applies to all the UL SPS configurations in the serving cell.
<b><i>twoIntervalsConfig</i></b>	Trigger of two-intervals-Semi-Persistent Scheduling in uplink. See TS 36.321 [6], clause 5.10. If this field is present and the configured Semi-persistent scheduling interval greater than or equal to 10 sub-frames, two-intervals-SPS is enabled for uplink. Otherwise, two-intervals-SPS is disabled.
<b><i>ul-SPS-V-RNTI</i></b>	UL Semi-Persistent Scheduling V-RNTI for UEs capable of multiple uplink SPS configurations and which support V2X communication, see TS 36.321 [6].

<b>Conditional presence</b>	<b>Explanation</b>
<i>TDD</i>	This field is optional present for TDD, need OR; it is not present for FDD and the UE shall delete any existing value for this field.
<i>SPS</i>	This field is optional present if <i>sps-ConfigIndex-r14</i> is not configured, need OR; otherwise it is not present.

## – *SPUCCH-Config*

The IE *SPUCCH-Config* is used to specify the UE specific SPUCCH configuration.

### ***SPUCCH-Config* information element**

```
-- ASN1START

SPUCCH-Config-r15 ::= CHOICE {
    release          NULL,
    setup            SEQUENCE {
        spucch-Set-r15          SPUCCH-Set-r15          OPTIONAL, -- Need ON
        twoAntennaPortActivatedSPUCCH-Format1alb-r15  ENUMERATED {true}  OPTIONAL, -- Need OR
        dummy                  SEQUENCE {
            n3SPUCCH-AN-List-r15  SEQUENCE (SIZE (1..4)) OF INTEGER (0..549)
        }
    }
}

SPUCCH-Config-v1550 ::= CHOICE {
    release          NULL,
    setup            SEQUENCE {
        twoAntennaPortActivatedSPUCCH-Format3-v1550  SEQUENCE {
            n3SPUCCH-AN-List-v1550  SEQUENCE (SIZE (1..4)) OF INTEGER (0..549)
        }
    }
}

SPUCCH-Set-r15 ::= SEQUENCE (SIZE (1..4)) OF SPUCCH-Elements-r15

SPUCCH-Elements-r15 ::= CHOICE {
    release          NULL,
    setup            SEQUENCE {
        n1SubslotSPUCCH-AN-List-r15  SEQUENCE (SIZE(1..4)) OF INTEGER (0..1319) OPTIONAL, -- Need
OR
        n1SlotSPUCCH-FH-AN-List-r15  INTEGER (0..1319)          OPTIONAL, -- Need OR
        n1SlotSPUCCH-NoFH-AN-List-r15  INTEGER (0..3959)          OPTIONAL, -- Need OR
        n3SPUCCH-AN-List-r15          INTEGER (0..549)          OPTIONAL, -- Need OR
        n4SPUCCHslot-Resource-r15     SEQUENCE (SIZE(1..2)) OF N4SPUCCH-Resource-r15  OPTIONAL, --
Need OR
        n4SPUCCHSubslot-Resource-r15  SEQUENCE (SIZE(1..2)) OF N4SPUCCH-Resource-r15  OPTIONAL, --
Need OR
        n4maxCoderateSlotPUCCH-r15    INTEGER (0..7)          OPTIONAL, -- Need OR
        n4maxCoderateSubslotPUCCH-r15  INTEGER (0..7)          OPTIONAL, -- Need OR
        n4maxCoderateMultiResourceSlotPUCCH-r15  INTEGER (0..7)          OPTIONAL, -- Need OR
        n4maxCoderateMultiResourceSubslotPUCCH-r15  INTEGER (0..7)          OPTIONAL, -- Need OR
    }
}

N4SPUCCH-Resource-r15 ::= SEQUENCE {
    n4startingPRB-r15  INTEGER (0..109),
```

```

n4numberOfPRB-r15                INTEGER (0..7)
}
-- ASN1STOP

```

### SPUCCH-Config field descriptions

<b>dummy</b>
This field is not used in the specification. If received it shall be ignored by the UE.
<b>n1SlotSPUCCH-FH-AN-List</b>
Resource configuration for slot-SPUCCH format 1 when frequency hopping is enabled. Parameter: $n_{SPUCCH}^{(1,p)}$ for antenna port P0 and for antenna port P1 respectively, see TS 36.213 [23], clause 10.1.
<b>n1SlotSPUCCH-NoFH-AN-List</b>
Resource configuration for slot-SPUCCH format 1 when frequency hopping is disabled. Parameter: $n_{SPUCCH}^{(3,p)}$ for antenna port P0 and for antenna port P1 respectively, see TS 36.213 [23], clause 10.1.
<b>n1SubslotSPUCCH-AN-List</b>
Resource configuration for subslot-SPUCCH format 1. Parameter: $n_{SPUCCH}^{(1,p)}$ for antenna port P0 and for antenna port P1 respectively, see TS 36.213 [23], clause 10.1.
<b>n3SPUCCH-AN-List</b>
Resource index for slot-SPUCCH format 3: $n_{SPUCCH}^{(3,p)}$ , see TS 36.213 [23], clause 10.1.
<b>n4maxCoderateSlotPUCCH, n4maxCoderateSubslotPUCCH</b>
Indicates the maximum coding rate for slot-PUCCH and subslot-PUCCH format 4 transmission.
<b>n4maxCoderateMultiResourceSlotPUCCH, n4maxCoderateMultiResourceSubslotPUCCH</b>
Indicates the maximum coding rate for slot-PUCCH and subslot-PUCCH format 4 transmission in case of multiple resource configuration.
<b>n4numberOfPRB, n4numberOfPRBSubslot</b>
Parameter $n_{SPUCCH}^{(4)}$ see TS 36.213 [23], Table 10.1.1-2 for determining SPUCCH resource(s) of SPUCCH format 4.
<b>n4startingPRB</b>
Parameter $n_{SPUCCH}^{(4)}$ see TS 36.211 [21], clause 5.4A.3 for determining SPUCCH resource(s) of SPUCCH format 4.
<b>twoAntennaPortActivatedSPUCCH-Format1a1b</b>
Indicates whether two antenna ports are configured for SPUCCH format 1a/1b for HARQ-ACK, see TS 36.213 [23], clause 10.1. The field also applies for SPUCCH format 1a/1b transmission when <i>format3</i> is configured, see TS 36.213 [23], clauses 10.1.2.2.2 and 10.1.3.2.2.
<b>twoAntennaPortActivatedSPUCCH-Format3</b>
Indicates whether two antenna ports are configured for SPUCCH format 3 for HARQ-ACK, see TS 36.213 [23], clause 10.1.

### SRS-TPC-PDCCH-Config

The IE *SRS-TPC-PDCCH-Config* is used to specify the RNTIs and indexes for A-SRS trigger and TPC according to TS 36.212 [22].

### SRS-TPC-PDCCH-Config information element

```

-- ASN1START
SRS-TPC-PDCCH-Config-r14 ::= CHOICE {
  release      NULL,
  setup       SEQUENCE {
    srs-TPC-RNTI-r14          BIT STRING (SIZE (16)),
    startingBitOfFormat3B-r14 INTEGER (0..31),
    fieldTypeFormat3B-r14    INTEGER (1..4),
    srs-CC-SetIndexlist-r14  SEQUENCE (SIZE(1..4)) OF SRS-CC-SetIndex-r14
  }
  OPTIONAL   -- Cond SRS-Trigger-TypeA
}
SRS-CC-SetIndex-r14 ::= SEQUENCE {
  cc-SetIndex-r14          INTEGER (0..3),
  cc-IndexInOneCC-Set-r14 INTEGER (0..7)
}
-- ASN1STOP

```

<b>SRS-TPC-PDCCH-Config field descriptions</b>	
<b>cc-IndexInOneCC-Set</b>	Indicates the CC index in one CC set for Type A associated with the group DCI with SRS request field (optional) and TPC commands for a PUSCH-less SCell
<b>cc-SetIndex</b>	Indicates the CC set index for Type A associated with the group DCI with SRS request field (optional) and TPC commands for a PUSCH-less SCell.
<b>fieldTypeFormat3B</b>	The type of a field within the group DCI with SRS request fields (optional) and TPC commands for a PUSCH-less SCell, which indicates how many bits in the field are for SRS request (0 or 1/2) and how many bits in the field are for TPC (1 or 2). Note that for Type A, there is a common SRS request field for all SCells in the set, but each SCell has its own TPC command bits. See TS 36.212 [22], clause 5.3.3.1.7A. EUTRAN configures this field with the same value for all PUSCH-less SCells.
<b>srs-CC-SetIndexlist</b>	Indicates the index of the <i>SRS-TPC-PDCCH-Config</i> for Type A trigger by the group DCI with SRS request field (optional) and TPC commands for a PUSCH-less SCell. Each set may contain at most 8 CCs.
<b>srs-TPC-RNTI</b>	RNTI for SRS trigger and power control using DCI format 3B, see TS 36.212 [22], clause 5.1.3.1.
<b>startingBitOfFormat3B</b>	The starting bit position of a block within the group DCI with SRS request fields (optional) and TPC commands for a PUSCH-less SCell.

<b>Conditional presence</b>	<b>Explanation</b>
<i>SRS-Trigger-TypeA</i>	The field is mandatory present if <i>typeA-SRS-TPC-PDCCH-Group-r14</i> is present. Otherwise the field is not present and the UE shall delete any existing value for this field.

## *TDD-Config*

The IE *TDD-Config* is used to specify the TDD specific physical channel configuration.

### **TDD-Config information element**

```
-- ASN1START
TDD-Config ::=
    SEQUENCE {
        subframeAssignment          ENUMERATED {
            sa0, sa1, sa2, sa3, sa4, sa5, sa6},
        specialSubframePatterns    ENUMERATED {
            ssp0, ssp1, ssp2, ssp3, ssp4, ssp5, ssp6, ssp7,
            ssp8}
    }

TDD-Config-v1130 ::=
    SEQUENCE {
        specialSubframePatterns-v1130    ENUMERATED {ssp7, ssp9}
    }

TDD-Config-v1430 ::=
    SEQUENCE {
        specialSubframePatterns-v1430    ENUMERATED {ssp10}
    }

TDD-Config-v1450 ::=
    SEQUENCE {
        specialSubframePatterns-v1450    ENUMERATED {ssp10-CRS-LessDwPTS}
    }

TDD-ConfigSL-r12 ::=
    SEQUENCE {
        subframeAssignmentSL-r12         ENUMERATED {
            none, sa0, sa1, sa2, sa3, sa4, sa5, sa6}
    }
-- ASN1STOP
```

<b>TDD-Config field descriptions</b>
<p><b>specialSubframePatterns</b> Indicates Configuration as in TS 36.211 [21], table 4.2-1, where <i>ssp0</i> points to Configuration 0, <i>ssp1</i> to Configuration 1 etc. Value <i>ssp7</i> points to Configuration 7 for extended cyclic prefix, value <i>ssp9</i> points to Configuration 9 for normal cyclic prefix and value <i>ssp10</i> points to Configuration 10 for normal cyclic prefix. Value <i>ssp10-CRS-LessDwPTS</i> corresponds to <i>ssp10</i> without CRS transmission on the 5th symbol of DwPTS. E-UTRAN signals <i>ssp7</i> only when setting <i>specialSubframePatterns</i> (without suffix i.e. the version defined in REL-8) to <i>ssp4</i>. E-UTRAN signals value <i>ssp9</i> only when setting <i>specialSubframePatterns</i> (without suffix) to <i>ssp5</i>. E-UTRAN signals value <i>ssp10</i> or <i>ssp10-CRS-LessDwPTS</i> only when setting <i>specialSubframePatterns</i> (without suffix) to <i>ssp0</i> or <i>ssp5</i>. If <i>specialSubframePatterns-v1130</i>, <i>specialSubframePatterns-v1430</i>, or <i>specialSubframePatterns-v1450</i> is present, the UE shall ignore <i>specialSubframePatterns</i> (without suffix). If <i>specialSubframePatterns-v1430</i> or <i>specialSubframePatterns-v1450</i> is present, the UE shall ignore <i>specialSubframePatterns-v1130</i>. E-UTRAN does not simultaneously configure <i>TDD-Config-v1430</i> and <i>TDD-Config-v1450</i>.</p>
<p><b>subframeAssignment</b> Indicates DL/UL subframe configuration where <i>sa0</i> points to Configuration 0, <i>sa1</i> to Configuration 1 etc. as specified in TS 36.211 [21], table 4.2-2. E-UTRAN configures the same value for serving cells residing on same frequency band.</p>
<p><b>subframeAssignmentSL</b> Indicates UL/ DL subframe configuration where <i>sa0</i> points to Configuration 0, <i>sa1</i> to Configuration 1 etc. as specified in TS 36.211 [21], table 4.2-2. The value <i>none</i> means that no TDD specific physical channel configuration is applicable (i.e. the carrier on which <i>MasterInformationBlock-SL</i> is transmitted is an FDD UL carrier or the carrier on which <i>MasterInformationBlock-SL-V2X</i> is transmitted is a carrier for V2X sidelink communication).</p>

## – TDM-PatternConfig

The IE *TDM-PatternConfig* is used to specify the UL/DL reference configuration indicating the time during which a UE configured with (NG)EN-DC or NE-DC is allowed to transmit, as specified in TS 38.101-3 [101] and TS 38.213 [88].

### **TDM-PatternConfig information element**

```
-- ASN1START
TDM-PatternConfig-r15 ::= CHOICE {
    release          NULL,
    setup           SEQUENCE {
        subframeAssignment-r15  SubframeAssignment-r15,
        harq-Offset-r15        INTEGER (0..9)
    }
}
SubframeAssignment-r15 ::= ENUMERATED {sa0, sa1, sa2, sa3, sa4, sa5, sa6}
-- ASN1STOP
```

<b>TDM-PatternConfig field descriptions</b>
<p><b>subframeAssignment</b> Indicates DL/UL subframe configuration where <i>sa0</i> points to Configuration 0, <i>sa1</i> to Configuration 1 etc. as specified in TS 36.211 [21], table 4.2-2. When configured in EN-DC with LTE TDD PCell, the value range of this field is {<i>sa2</i>, <i>sa4</i>, <i>sa5</i>}.</p>
<p><b>harq-Offset</b> Indicates a HARQ subframe offset that is applied to the subframes designated as UL in the associated subframe assignment, see TS 36.213 [23]. When configured in EN-DC with LTE TDD PCell, the network ensures it does not violate the TDD configuration in SIB1, and the value range of this field is {0, 1, 2, 5, 6}.</p>

## – TimeAlignmentTimer

The IE *TimeAlignmentTimer* is used to control how long the UE considers the serving cells belonging to the associated TAG to be uplink time aligned. Corresponds to the Timer for time alignment in TS 36.321 [6]. Value in number of subframes. Value *sf500* corresponds to 500 sub-frames, *sf750* corresponds to 750 sub-frames and so on.

### **TimeAlignmentTimer information element**

```
-- ASN1START
TimeAlignmentTimer ::= ENUMERATED {
```

sf500, sf750, sf1280, sf1920, sf2560, sf5120, sf10240, infinity}

-- ASN1STOP

*TimeReferenceInfo*

**TimeReferenceInfo information elements**

```
-- ASN1START
TimeReferenceInfo-r15 ::= SEQUENCE {
    time-r15 ReferenceTime-r15,
    uncertainty-r15 INTEGER (0..12) OPTIONAL, -- Need OR
    timeInfoType-r15 ENUMERATED {localClock} OPTIONAL, -- Need OR
    referenceSFN-r15 INTEGER (0..1023) OPTIONAL -- Cond TimeRef
}

ReferenceTime-r15 ::= SEQUENCE {
    refDays-r15 INTEGER (0..72999),
    refSeconds-r15 INTEGER (0..86399),
    refMilliSeconds-r15 INTEGER (0..999),
    refQuarterMicroSeconds-r15 INTEGER (0..3999)
}
-- ASN1STOP
```

**TimeReferenceInfo field descriptions**

**referenceSFN**

This field indicates the reference SFN for time reference information. The *time* field indicates the time at the ending boundary of the SFN indicated by *referenceSFN*. The UE considers the frame indicated by the *referenceSFN* nearest to the frame where the field is received.

If the *time* field is included in *SystemInformationBlockType16* and the *referenceSFN* field is not included, the *time* field indicates the time at the SFN boundary at or immediately after the ending boundary of the SI-window in which *SystemInformationBlockType16* is transmitted.

**time, timeInfoType**

This field indicates time reference with 0.25 us granularity. The indicated time is referenced at the network, i.e., without compensating for RF propagation delay. In an NTN cell, the indicated time is referenced at the uplink time synchronization reference point (RP), i.e., UE should take into account the propagation delay between UE and RP when determining the time at the UE. The indicated time in 0.25 us unit from the origin is  $refDays * 86400 * 1000 * 4000 + refSeconds * 1000 * 4000 + refMilliSeconds * 4000 + refQuarterMicroSeconds$ . The *refDays* field specifies the sequential number of days (with day count starting at 0) from the origin of the *time* field. If *timeInfoType* is not included, the origin of the *time* field is 00:00:00 on Gregorian calendar date 6 January, 1980 (start of GPS time). If *timeInfoType* is set to *localClock*, the interpretation of the origin of the *time* is unspecified and left up to upper layers.

If *time* field is included in *SystemInformationBlockType16*, this field is excluded when estimating changes in system information, i.e. changes of *time* should neither result in system information change notifications nor in a modification of *systemInfoValueTag* in SIB1.

NOTE: The estimated time in an NTN-cell may be less accurate than the estimated time in a TN-cell.

**uncertainty**

This field indicates the number of LSBs which may be inaccurate in the *refQuarterMicroSeconds* field. If *uncertainty* is absent, the uncertainty of *refQuarterMicroSeconds* is not specified.

Conditional presence	Explanation
<i>TimeRef</i>	The field is mandatory present if <i>TimeReferenceInfo</i> is included in <i>DLInformationTransfer</i> message; otherwise the field is not present.

*TPC-PDCCH-Config*

The IE *TPC-PDCCH-Config* is used to specify the RNTIs and indexes for PUCCH and PUSCH power control according to TS 36.212 [22]. The power control function can either be setup or released with the IE.



**TPC-PDCCH-Config** information element

```

-- ASN1START
TPC-PDCCH-Config ::= CHOICE {
  release      NULL,
  setup       SEQUENCE {
    tpc-RNTI   BIT STRING (SIZE (16)),
    tpc-Index  TPC-Index
  }
}

TPC-PDCCH-ConfigSCell-r13 ::= CHOICE {
  release      NULL,
  setup       SEQUENCE {
    tpc-Index-PUCCH-SCell-r13 TPC-Index
  }
}

TPC-Index ::= CHOICE {
  indexOfFormat3      INTEGER (1..15),
  indexOfFormat3A    INTEGER (1..31)
}
-- ASN1STOP

```

**TPC-PDCCH-Config** field descriptions**indexOfFormat3**

Index of N when DCI format 3 is used. See TS 36.212 [22], clause 5.3.3.1.6.

**indexOfFormat3A**

Index of M when DCI format 3A is used. See TS 36.212 [22], clause 5.3.3.1.7.

**tpc-Index**

Index of N or M, see TS 36.212 [22], clauses 5.3.3.1.6 and 5.3.3.1.7, where N or M is dependent on the used DCI format (i.e. format 3 or 3a).

**tpc-Index-PUCCH-SCell**

Index of N or M, see TS 36.212 [22], clauses 5.3.3.1.6 and 5.3.3.1.7, where N or M is dependent on the used DCI format (i.e. format 3 or 3a).

**tpc-RNTI**

RNTI for power control using DCI format 3/3A, see TS 36.212 [22].

**TunnelConfigLWIP**

The IE *TunnelConfigLWIP* is used to setup/release LWIP Tunnel.

```

-- ASN1START
TunnelConfigLWIP-r13 ::= SEQUENCE {
  ip-Address-r13      IP-Address-r13,
  ike-Identity-r13    IKE-Identity-r13,
  ...,
  [[ lwip-Counter-r13  INTEGER (0..65535)      OPTIONAL  -- Cond LWIP-Setup
  ]]
}

IKE-Identity-r13 ::= SEQUENCE {
  idI-r13             OCTET STRING
}

IP-Address-r13 ::= CHOICE {
  ipv4-r13            BIT STRING (SIZE (32)),
  ipv6-r13            BIT STRING (SIZE (128))
}
-- ASN1STOP

```

<b>TunnelConfigLWIP field descriptions</b>	
<b>ip-Address</b>	Parameter indicates the LWIP-SeGW IP Address to be used by the UE for initiating LWIP Tunnel establishment [32].
<b>ike-Identity</b>	Parameter indicates the IKE Identity elements (IDi) to be used in IKE Authentication Procedures [32].
<b>lwip-Counter</b>	Indicates the parameter used by UE for computing the security keys used in LWIP tunnel establishment, as specified in TS 33.401 [32].

<b>Conditional presence</b>	<b>Explanation</b>
<i>LWIP-Setup</i>	The field is mandatory present upon setup of LWIP tunnel. Otherwise the field is optional, Need ON.

## – UplinkPowerControl

The IE *UplinkPowerControlCommon* and IE *UplinkPowerControlDedicated* are used to specify parameters for uplink power control in the system information and in the dedicated signalling, respectively.

### UplinkPowerControl information elements

```
-- ASN1START

UplinkPowerControlCommon ::= SEQUENCE {
    p0-NominalPUSCH          INTEGER (-126..24),
    alpha                    Alpha-r12,
    p0-NominalPUCCH          INTEGER (-127..-96),
    deltaFList-PUCCH         DeltaFList-PUCCH,
    deltaPreambleMsg3        INTEGER (-1..6)
}

UplinkPowerControlCommon-v1020 ::= SEQUENCE {
    deltaF-PUCCH-Format3-r10  ENUMERATED {deltaF-1, deltaF0, deltaF1, deltaF2,
                                                deltaF3, deltaF4, deltaF5, deltaF6},
    deltaF-PUCCH-Format1bCS-r10  ENUMERATED {deltaF1, deltaF2, spare2, spare1}
}

UplinkPowerControlCommon-v1310 ::= SEQUENCE {
    deltaF-PUCCH-Format4-r13  ENUMERATED {deltaF16, deltaF15, deltaF14, deltaF13, deltaF12,
                                                deltaF11, deltaF10, spare1} OPTIONAL, -- Need OR
    deltaF-PUCCH-Format5-13   ENUMERATED { deltaF13, deltaF12, deltaF11, deltaF10, deltaF9,
                                                deltaF8, deltaF7, spare1} OPTIONAL -- Need OR
}

UplinkPowerControlCommon-v1530 ::= SEQUENCE {
    deltaFList-SPUCCH-r15     DeltaFList-SPUCCH-r15
}

UplinkPowerControlCommon-v1610 ::= SEQUENCE {
    alphaSRS-Add-r16          Alpha-r12,
    p0-NominalSRS-Add-r16     INTEGER (-126..24)
}

UplinkPowerControlCommonPSCell-r12 ::= SEQUENCE {
-- For uplink power control the additional/ missing fields are signalled (compared to SCell)
    deltaF-PUCCH-Format3-r12  ENUMERATED {deltaF-1, deltaF0, deltaF1, deltaF2,
                                                deltaF3, deltaF4, deltaF5, deltaF6},
    deltaF-PUCCH-Format1bCS-r12  ENUMERATED {deltaF1, deltaF2, spare2, spare1},
    p0-NominalPUCCH-r12         INTEGER (-127..-96),
    deltaFList-PUCCH-r12        DeltaFList-PUCCH
}

UplinkPowerControlCommonSCell-r10 ::= SEQUENCE {
    p0-NominalPUSCH-r10       INTEGER (-126..24),
    alpha-r10                  Alpha-r12
}

UplinkPowerControlCommonSCell-v1130 ::= SEQUENCE {
    deltaPreambleMsg3-r11     INTEGER (-1..6)
}
-- ASN1END
```

```

UplinkPowerControlCommonSCell-v1310 ::= SEQUENCE {
-- For uplink power control the additional/ missing fields are signalled (compared to SCell)
  p0-NominalPUCCH                INTEGER (-127..-96),
  deltaFList-PUCCH                DeltaFList-PUCCH,
  deltaF-PUCCH-Format3-r12        ENUMERATED {deltaF-1, deltaF0, deltaF1,
  deltaF2, deltaF3, deltaF4, deltaF5,
  deltaF6}                        OPTIONAL,      -- Need OR
  deltaF-PUCCH-Format1bCS-r12     ENUMERATED {deltaF1, deltaF2,
  spare2, spare1}                 OPTIONAL,      -- Need OR
  deltaF-PUCCH-Format4-r13        ENUMERATED {deltaF16, deltaF15, deltaF14,
  deltaF13, deltaF12, deltaF11, deltaF10,
  spare1}                         OPTIONAL,      -- Need OR
  deltaF-PUCCH-Format5-13         ENUMERATED { deltaF13, deltaF12, deltaF11,
  deltaF10, deltaF9, deltaF8, deltaF7,
  spare1}                         OPTIONAL      -- Need OR
}

UplinkPowerControlCommonPUSCH-LessCell-v1430 ::= SEQUENCE {
  p0-Nominal-PeriodicSRS-r14      INTEGER (-126..24)      OPTIONAL,      -- Need OR
  p0-Nominal-AperiodicSRS-r14     INTEGER (-126..24)     OPTIONAL,      -- Need OR
  alpha-SRS-r14                   Alpha-r12                   OPTIONAL      -- Need OR
}

UplinkPowerControlDedicated ::= SEQUENCE {
  p0-UE-PUSCH                     INTEGER (-8..7),
  deltaMCS-Enabled                 ENUMERATED {en0, en1},
  accumulationEnabled             BOOLEAN,
  p0-UE-PUCCH                     INTEGER (-8..7),
  pSRS-Offset                     INTEGER (0..15),
  filterCoefficient               FilterCoefficient             DEFAULT fc4
}

UplinkPowerControlDedicated-v1020 ::= SEQUENCE {
  deltaTxD-OffsetListPUCCH-r10    DeltaTxD-OffsetListPUCCH-r10  OPTIONAL,      -- Need OR
  pSRS-OffsetAp-r10              INTEGER (0..15)              OPTIONAL      -- Need OR
}

UplinkPowerControlDedicated-v1130 ::= SEQUENCE {
  pSRS-Offset-v1130              INTEGER (16..31)          OPTIONAL,      -- Need OR
  pSRS-OffsetAp-v1130            INTEGER (16..31)          OPTIONAL,      -- Need OR
  deltaTxD-OffsetListPUCCH-v1130 DeltaTxD-OffsetListPUCCH-v1130  OPTIONAL      -- Need OR
}

UplinkPowerControlDedicated-v1250 ::= SEQUENCE {
  set2PowerControlParameter       CHOICE {
    release                        NULL,
    setup                          SEQUENCE {
      tpc-SubframeSet-r12          BIT STRING (SIZE(10)),
      p0-NominalPUSCH-SubframeSet2-r12  INTEGER (-126..24),
      alpha-SubframeSet2-r12       Alpha-r12,
      p0-UE-PUSCH-SubframeSet2-r12  INTEGER (-8..7)
    }
  }
}

UplinkPowerControlDedicated-v1530 ::= SEQUENCE {
  alpha-UE-r15                    Alpha-r12                    OPTIONAL,      -- Need OR
  p0-UE-PUSCH-r15                 INTEGER (-16..15)         OPTIONAL      -- Need OR
}

UplinkPowerControlDedicatedSTTI-r15 ::= SEQUENCE {
  accumulationEnabledSTTI-r15     BOOLEAN,
  deltaTxD-OffsetListSPUCCH-r15   DeltaTxD-OffsetListSPUCCH-r15  OPTIONAL,      -- Need OR
  uplinkPower-CSIPayload          BOOLEAN
}

UplinkPUSCH-LessPowerControlDedicated-v1430 ::= SEQUENCE {
  p0-UE-PeriodicSRS-r14           INTEGER (-8..7)          OPTIONAL,      -- Need OR
  p0-UE-AperiodicSRS-r14          INTEGER (-8..7)          OPTIONAL,      -- Need OR
  accumulationEnabled-r14          BOOLEAN
}

UplinkPowerControlAddSRS-r16 ::= SEQUENCE {
  tpc-IndexSRS-Add-r16            TPC-Index                OPTIONAL,      -- Need ON
  startingBitOfFormat3B-SRS-Add-r16  INTEGER (0..31)         OPTIONAL,      -- Need ON
  fieldTypeFormat3B-SRS-Add-r16     INTEGER (1..2)          OPTIONAL,      -- Need ON
  p0-UE-SRS-Add-r16               INTEGER (-16..15)       OPTIONAL,      -- Need ON
  accumulationEnabledSRS-Add-r16    BOOLEAN
}

```

```

}

UplinkPowerControlDedicatedSCell-r10 ::= SEQUENCE {
    p0-UE-PUSCH-r10          INTEGER (-8..7),
    deltaMCS-Enabled-r10     ENUMERATED {en0, en1},
    accumulationEnabled-r10 BOOLEAN,
    pSRS-Offset-r10          INTEGER (0..15),
    pSRS-OffsetAp-r10        INTEGER (0..15)           OPTIONAL, -- Need OR
    filterCoefficient-r10    FilterCoefficient        DEFAULT fc4,
    pathlossReferenceLinking-r10 ENUMERATED {pCell, sCell}
}

UplinkPowerControlDedicatedSCell-v1310 ::= SEQUENCE {
--Release 8
    p0-UE-PUCCH              INTEGER (-8..7),
--Release 10
    deltaTxD-OffsetListPUCCH-r10 DeltaTxD-OffsetListPUCCH-r10   OPTIONAL -- Need OR
}

DeltaFList-PUCCH ::= SEQUENCE {
    deltaF-PUCCH-Format1     ENUMERATED {deltaF-2, deltaF0, deltaF2},
    deltaF-PUCCH-Format1b    ENUMERATED {deltaF1, deltaF3, deltaF5},
    deltaF-PUCCH-Format2     ENUMERATED {deltaF-2, deltaF0, deltaF1, deltaF2},
    deltaF-PUCCH-Format2a    ENUMERATED {deltaF-2, deltaF0, deltaF2},
    deltaF-PUCCH-Format2b    ENUMERATED {deltaF-2, deltaF0, deltaF2}
}

DeltaFList-SPUCCH-r15 ::= CHOICE {
    release                  NULL,
    setup                    SEQUENCE {
        deltaF-slotSPUCCH-Format1-r15  ENUMERATED {deltaF-1, deltaF0, deltaF1, deltaF2,
            deltaF3, deltaF4, deltaF5, deltaF6} OPTIONAL, --Need OR
        deltaF-slotSPUCCH-Format1a-r15  ENUMERATED {deltaF1, deltaF2, deltaF3, deltaF4,
            deltaF5, deltaF6, deltaF7, deltaF8} OPTIONAL, --Need OR
        deltaF-slotSPUCCH-Format1b-r15  ENUMERATED {deltaF3, deltaF4, deltaF5, deltaF6,
            deltaF7, deltaF8, deltaF9, deltaF10} OPTIONAL, --Need OR
        deltaF-slotSPUCCH-Format3-r15   ENUMERATED {deltaF4, deltaF5, deltaF6, deltaF7,
            deltaF8, deltaF9, deltaF10, deltaF11} OPTIONAL, --Need OR
        deltaF-slotSPUCCH-RM-Format4-r15 ENUMERATED {deltaF13, deltaF14, deltaF15, deltaF16,
            deltaF17, deltaF18, deltaF19, deltaF20} OPTIONAL,
--Need OR
        deltaF-slotSPUCCH-TBCC-Format4-r15  ENUMERATED {deltaF10, deltaF11, deltaF12, deltaF13,
            deltaF14, deltaF15, deltaF16, deltaF17} OPTIONAL,
--Need OR
        deltaF-subslotSPUCCH-Format1and1a-r15  ENUMERATED {deltaF5, deltaF6, deltaF7, deltaF8,
            deltaF9, deltaF10, deltaF11, deltaF12} OPTIONAL,
--Need OR
        deltaF-subslotSPUCCH-Format1b-r15     ENUMERATED {deltaF6, deltaF7, deltaF8, deltaF9,
            deltaF10, deltaF11, deltaF12, deltaF13} OPTIONAL,
--Need OR
        deltaF-subslotSPUCCH-RM-Format4-r15   ENUMERATED {deltaF15, deltaF16, deltaF17, deltaF18,
            deltaF19, deltaF20, deltaF21, deltaF22} OPTIONAL,
--Need OR
        deltaF-subslotSPUCCH-TBCC-Format4-r15  ENUMERATED {deltaF10, deltaF11, deltaF12, deltaF13,
            deltaF14, deltaF15, deltaF16, deltaF17} OPTIONAL,
--Need OR
        ...
    }
}

DeltaTxD-OffsetListPUCCH-r10 ::= SEQUENCE {
    deltaTxD-OffsetPUCCH-Format1-r10     ENUMERATED {dB0, dB-2},
    deltaTxD-OffsetPUCCH-Format1a1b-r10  ENUMERATED {dB0, dB-2},
    deltaTxD-OffsetPUCCH-Format2a2b-r10  ENUMERATED {dB0, dB-2},
    deltaTxD-OffsetPUCCH-Format3-r10     ENUMERATED {dB0, dB-2},
    ...
}

DeltaTxD-OffsetListPUCCH-v1130 ::= SEQUENCE {
    deltaTxD-OffsetPUCCH-Format1bCS-r11  ENUMERATED {dB0, dB-1}
}

DeltaTxD-OffsetListSPUCCH-r15 ::= SEQUENCE {
    deltaTxD-OffsetSPUCCH-Format1-r15     ENUMERATED {dB0, dB-2},
    deltaTxD-OffsetSPUCCH-Format1a-r15    ENUMERATED {dB0, dB-2},
    deltaTxD-OffsetSPUCCH-Format1b-r15    ENUMERATED {dB0, dB-2},
    deltaTxD-OffsetSPUCCH-Format3-r15     ENUMERATED {dB0, dB-2},
}

```

```
} ...  
-- ASN1STOP
```

<b>UplinkPowerControl field descriptions</b>
<p><b>accumulationEnabled, accumulationEnabledSTTI</b> Parameter: Accumulation-enabled, see TS 36.213 [23], clauses 5.1.1.1 and 5.1.3.1. TRUE corresponds to "enabled" whereas FALSE corresponds to "disabled".</p>
<p><b>accumulationEnabledSRS-Add</b> Parameter: accumulationEnabled-additionalSRS, see TS 36.213 [23], clauses 5.1.3.1. TRUE corresponds to "enabled" whereas FALSE corresponds to "disabled".</p>
<p><b>alpha</b> Parameter: <math>\alpha</math> See TS 36.213 [23], clause 5.1.1.1. This field applies for uplink power control subframe set 1 if uplink power control subframe sets are configured by <i>tpc-SubframeSet</i>.</p>
<p><b>alpha-SRS, alphaSRS-Add</b> Parameter: <math>\alpha_{SRS}</math>. See TS 36.213 [23], clause 5.1.3.1. <i>alpha-SRS</i> applies for SRS power control on a PUSCH-less SCell, <i>alphaSRS-Add</i> applies for SRS power control on the additional SRS symbols.</p>
<p><b>alpha-SubframeSet2</b> Parameter: <math>\alpha</math>. See TS 36.213 [23], clause 5.1.1.1. This field applies for uplink power control subframe set 2 if uplink power control subframe sets are configured by <i>tpc-SubframeSet</i>.</p>
<p><b>alpha-UE</b> Parameter: <math>\alpha_{UE}</math> See TS 36.213 [23], clause 5.1.1.1.</p>
<p><b>deltaF-PUCCH-FormatX</b> Parameter: <math>\Delta_{F\_PUCCH}(F)</math> for the PUCCH formats 1, 1b, 2, 2a, 2b, 3, 4, 5 and 1b with channel selection. See TS 36.213 [23], clause 5.1.2, where deltaF-2 corresponds to -2 dB, deltaF0 corresponds to 0 dB and so on.</p>
<p><b>deltaF-PUCCH-FormatX, deltaF-slotSPUCCH-FormatX, deltaF-subslotSPUCCH-FormatX</b> Parameter: <math>\Delta_{F\_PUCCH}(F)</math> for the SPUCCH formats 1, 1a, 1b, 3 and 4. See TS 36.213 [23], clause 5.1.2 where deltaF-2 corresponds to -2 dB, deltaF0 corresponds to 0 dB and so on. In case both an A and a B configuration exist, configuration A is used in case SPUCCH carries <math>\leq 22</math> HARQ-ACK bits, and B otherwise.</p>
<p><b>deltaMCS-Enabled</b> Parameter: <math>K_s</math> See TS 36.213 [23], clause 5.1.1.1. en0 corresponds to value 0 corresponding to state "disabled". en1 corresponds to value 1.25 corresponding to "enabled".</p>
<p><b>deltaPreambleMsg3</b> Parameter: <math>\Delta_{PREMABLE\_Msg3}</math> see TS 36.213 [23], clause 5.1.1.1. Actual value = field value * 2 [dB].</p>
<p><b>deltaTxD-OffsetPUCCH-FormatX</b> Parameter: <math>\Delta_{TxD}(F')</math> for the PUCCH formats 1, 1a/1b, 1b with channel selection, 2/2a/2b and 3 when two antenna ports are configured for PUCCH transmission. See TS 36.213 [23], clause 5.1.2.1, where dB0 corresponds to 0 dB, dB-1 corresponds to -1 dB, dB-2 corresponds to -2 dB. EUTRAN configures the field <i>deltaTxD-OffsetPUCCH-Format1bCS-r11</i> for the PCell and/or the PSCell only.</p>
<p><b>deltaTxD-OffsetSPUCCH-FormatX</b> Parameter: <math>\Delta_{TxD}(F')</math> for the SPUCCH formats 1, 1a/1b, 1b with channel selection and 3 when two antenna ports are configured for SPUCCH transmission. See TS 36.213 [23], clause 5.1.2.1 where dB0 corresponds to 0 dB, dB-1 corresponds to -1 dB, dB-2 corresponds to -2 dB.</p>
<p><b>fieldTypeFormat3B-SRS-Add</b> Indicates the field width of power control field in DCI format 3B for additional SRS. See TS 36.212 [22], clause 5.3.3.1.7A.</p>
<p><b>filterCoefficient</b> Specifies the filtering coefficient for RSRP measurements used to calculate path loss, as specified in TS 36.213 [23], clause 5.1.1.1. The same filtering mechanism applies as for <i>quantityConfig</i> described in 5.5.3.2.</p>
<p><b>p0-Nominal-AperiodicSRS</b> Parameter: <math>P_{O\_NOMINAL\_SRS,c}(m)</math> where <math>m=1</math>. See TS 36.213 [23], clause 5.1.3.1, unit dBm.</p>
<p><b>p0-Nominal-PeriodicSRS</b> Parameter: <math>P_{O\_NOMINAL\_SRS,c}(m)</math> where <math>m=0</math>. See TS 36.213 [23], clause 5.1.3.1, unit dBm.</p>
<p><b>p0-NominalPUCCH</b> Parameter: <math>P_{O\_NOMINAL\_PUCCH}</math> See TS 36.213 [23], clause 5.1.2.1, unit dBm.</p>
<p><b>p0-NominalPUSCH</b> Parameter: <math>P_{O\_NOMINAL\_PUSCH}(1)</math> See TS 36.213 [23], clause 5.1.1.1, unit dBm. This field is applicable for non-persistent scheduling only. This field applies for uplink power control subframe set 1 if uplink power control subframe sets are configured by <i>tpc-SubframeSet</i>.</p>
<p><b>p0-NominalPUSCH-SubframeSet2</b> Parameter: <math>P_{O\_NOMINAL\_PUSCH}(1)</math>. See TS 36.213 [23], clause 5.1.1.1, unit dBm. This field is applicable for non-persistent scheduling only. This field applies for uplink power control subframe set 2 if uplink power control subframe sets are configured by <i>tpc-SubframeSet</i>.</p>

<b>UplinkPowerControl field descriptions</b>
<p><b>p0-NominalSRS-Add</b> Parameter: <math>P_{O\_NOMINAL\_SRS,c}(m)</math> where <math>m=2</math>. See TS 36.213 [23], clause 5.1.3.1, unit dBm.</p>
<p><b>p0-UE-SRS-Add</b> Parameter: <math>P_{O\_UE\_SRS,c}(m)</math> where <math>m=2</math>. See TS 36.213 [23], clause 5.1.3.1, unit dB.</p>
<p><b>p0-UE-AperiodicSRS</b> Parameter: <math>P_{O\_UE\_SRS,c}(m)</math> where <math>m=1</math>. See TS 36.213 [23], clause 5.1.3.1, unit dB.</p>
<p><b>p0-UE-PeriodicSRS</b> Parameter: <math>P_{O\_UE\_SRS,c}(m)</math> where <math>m=0</math>. See TS 36.213 [23], clause 5.1.3.1, unit dB.</p>
<p><b>p0-UE-PUCCH</b> Parameter: <math>P_{O\_UE\_PUCCH}</math> See TS 36.213 [23], clause 5.1.2.1. Unit dB</p>
<p><b>p0-UE-PUSCH</b> Parameter: <math>P_{O\_UE\_PUSCH}(1)</math> See TS 36.213 [23], clause 5.1.1.1, unit dB. This field is applicable for non-persistent scheduling, only. This field applies for uplink power control subframe set 1 if uplink power control subframe sets are configured by <i>tpc-SubframeSet</i>. If <i>p0-UE-PUSCH-r15</i> is included, the UE ignores <i>p0-UE-PUSCH</i> (i.e., without suffix).</p>
<p><b>p0-UE-PUSCH-SubframeSet2</b> Parameter: <math>P_{O\_UE\_PUSCH}(1)</math> See TS 36.213 [23], clause 5.1.1.1, unit dB. This field is applicable for non-persistent scheduling, only. This field applies for uplink power control subframe set 2 if uplink power control subframe sets are configured by <i>tpc-SubframeSet</i>.</p>
<p><b>pathlossReferenceLinking</b> Indicates whether the UE shall apply as pathloss reference either the downlink of the PCell or of the SCell that corresponds with this uplink (i.e. according to the <i>cellIdentification</i> within the field <i>sCellToAddMod</i>). For SCells part of an STAG E-UTRAN sets the value to sCell.</p>
<p><b>pSRS-Offset, pSRS-OffsetAp</b> Parameter: <math>P_{SRS\_OFFSET}</math> for periodic and aperiodic sounding reference signal transmission respectively. See TS 36.213 [23], clause 5.1.3.1. For <math>K_s=1.25</math>, the actual parameter value is <i>pSRS-Offset</i> value – 3. For <math>K_s=0</math>, the actual parameter value is <math>-10.5 + 1.5 * pSRS-Offset</math> value. If <i>pSRS-Offset-v1130</i> is included, the UE ignores <i>pSRS-Offset</i> (i.e., without suffix). Likewise, if <i>pSRS-OffsetAp-v1130</i> is included, the UE ignores <i>pSRS-OffsetAp-r10</i>. For <math>K_s=0</math>, E-UTRAN does not set values larger than 26.</p>
<p><b>startingBitOfFormat3B-SRS-Add</b> Indicates the starting position of a block to trigger and TPC commands for the additional SRS symbols. See TS 36.212 [22], clause 5.3.3.1.7A.</p>
<p><b>tpc-IndexSRS-Add</b> Indicates the index to the TPC command for the SRS in additional symbols. See TS 36.212 [22], clause 5.3.3.1.6 and 5.3.3.1.7.</p>
<p><b>tpc-SubframeSet</b> Indicates the uplink subframes (including UpPTS in special subframes) of the uplink power control subframe sets. Value 0 means the subframe belongs to uplink power control subframe set 1, and value 1 means the subframe belongs to uplink power control subframe set 2.</p>
<p><b>uplinkPower-CSIPayload</b> <i>TRUE</i> indicates that the UE shall derive BPRE based on the actual value of <i>O_CQI</i> for slot/subslot-PUSCH, whereas <i>FALSE</i> indicates that the largest value of <i>O_CQI</i> across all RI values shall be used for the derivation of BPRE for slot/subslot-PUSCH.</p>

## – WLAN-Id-List

The IE *WLAN-Id-List* is used to list WLAN(s) for configuration of WLAN measurements and WLAN mobility set.

```
-- ASN1START
WLAN-Id-List-r13 ::= SEQUENCE (SIZE (1..maxWLAN-Id-r13)) OF WLAN-Identifiers-r12
-- ASN1STOP
```

## – WLAN-MobilityConfig

The IE *WLAN-MobilityConfig* is used for configuration of WLAN mobility set and WLAN Status Reporting. E-UTRAN configures at least one WLAN identifier in the *WLAN-MobilityConfig*.

```

-- ASN1START
WLAN-MobilityConfig-r13 ::= SEQUENCE {
    wlan-ToReleaseList-r13          WLAN-Id-List-r13          OPTIONAL, -- Need ON
    wlan-ToAddList-r13             WLAN-Id-List-r13          OPTIONAL, -- Need ON
    associationTimer-r13            ENUMERATED {s10, s30,
    s60, s120, s240}          OPTIONAL, -- Need OR
    successReportRequested-r13     ENUMERATED {true}          OPTIONAL, -- Need OR
    . . .
    [[ wlan-SuspendConfig-r14      WLAN-SuspendConfig-r14  OPTIONAL -- Need ON
    ]]
}
-- ASN1STOP

```

#### **WLAN-MobilityConfig field descriptions**

##### **associationTimer**

Indicates the maximum time for connection to WLAN before connection failure reporting is initiated. Value s10 means 10 seconds, value s30 means 30 seconds and so on. E-UTRAN includes *associationTimer* only upon change in WLAN mobility set, *lwa-WT-Counter* or *lwip-Counter*.

##### **successReportRequested**

Indicates whether the UE shall report successful connection to WLAN. Applicable to LWA and LWIP.

##### **wlan-ToAddList**

Indicates the WLAN identifiers to be added to the WLAN mobility set.

##### **wlan-ToReleaseList**

Indicates the WLAN identifiers to be removed from the WLAN mobility set.

## – WUS-Config

The IE *WUS-Config* is used to specify the WUS configuration. For the UEs supporting WUS, E-UTRAN uses WUS to indicate that the UE shall attempt to receive paging in that cell, see TS 36.304 [4].

#### **WUS-Config information element**

```

-- ASN1START
WUS-Config-r15 ::= SEQUENCE {
    maxDurationFactor-r15          ENUMERATED {one32th, one16th, one8th, one4th},
    numPOs-r15                     ENUMERATED {n1, n2, n4, spare1}    DEFAULT n1,
    freqLocation-r15               ENUMERATED {n0, n2, n4, spare1},
    timeOffsetDRX-r15              ENUMERATED {ms40, ms80, ms160, ms240},
    timeOffset-eDRX-Short-r15      ENUMERATED {ms40, ms80, ms160, ms240},
    timeOffset-eDRX-Long-r15       ENUMERATED {ms1000, ms2000}    OPTIONAL -- Need OP
}

WUS-Config-v1560 ::= SEQUENCE {
    powerBoost-r15                 ENUMERATED {dB0, dB1dot8, dB3, dB4dot8}
}

WUS-Config-v1610 ::= SEQUENCE {
    numDRX-CyclesRelaxed-r16       ENUMERATED {n1, n2, n4, n8}
}
-- ASN1STOP

```



<b>WUS-Config field descriptions</b>
<p><b>freqLocation</b> Frequency location of WUS within paging narrowband for BL UEs and UEs in CE. Value <i>n0</i> corresponds to WUS in the 1st and 2nd PRB, value <i>n2</i> represents the 3rd and 4th PRB, and value <i>n4</i> represents the 5th and 6th PRB.</p>
<p><b>maxDurationFactor</b> Maximum WUS duration, expressed as a ratio of Rmax associated with Type 1-CSS, see TS 36.211 [21]. Value <i>one32th</i> corresponds to <math>R_{max} * 1/32</math>, value <i>one16th</i> corresponds to <math>R_{max} * 1/16</math> and so on. The value <math>L_{MWUS,max}</math> in TS 36.213 [23] considered by the UE is : <math>maxDuration = \text{Max}(\text{signalled value} * R_{max}, 1)</math> where Rmax is the value of <i>mpdcch-NumRepetitionPaging</i> for the carrier.</p>
<p><b>numDRX-CyclesRelaxed</b> Maximum number of consecutive DRX cycles during which the UE can use WUS for synchronisation and skip serving cell measurements, see TS 36.133 [16]. Value <i>n1</i> corresponds to 1 DRX cycle, value <i>n2</i> corresponds to 2 DRX cycles and so on.</p>
<p><b>numPOs</b> Number of consecutive Paging Occasions (PO) mapped to one WUS, applicable to UEs configured to use extended DRX, see TS 36.304 [4]. Value <i>n1</i> corresponds to 1 PO, value <i>n2</i> corresponds to 2 POs and so on.</p>
<p><b>powerBoost</b> Power offset of WUS relative to CRS in dB, see TS 36.213 [23] clause 5.2. Value <i>db0</i> corresponds to 0dB, value <i>db1dot8</i> corresponds to 1.8dB, and so on.</p>
<p><b>timeOffsetDRX</b> Minimum time gap in milliseconds from the end of the configured maximum WUS duration to the first associated PO, see TS 36.211 [21]. Value <i>ms40</i> corresponds to 40 ms, value <i>ms80</i> corresponds to 80 ms and so on.</p>
<p><b>timeOffset-eDRX-Short</b> When eDRX is used, the short non-zero gap in milliseconds from the end of the configured maximum WUS duration to the associated PO, see TS 36.211 [21]. Value <i>ms40</i> corresponds to 40 ms, value <i>ms80</i> corresponds to 80 ms and so on. E-UTRAN configures <i>timeOffset-eDRX-Short</i> to a value longer than or equal to <i>timeOffsetDRX</i>.</p>
<p><b>timeOffset-eDRX-Long</b> When eDRX is used, the long non-zero gap in milliseconds from the end of the configured maximum WUS duration to the associated PO, see TS 36.211 [21]. Value <i>ms1000</i> corresponds to 1000 ms and value <i>ms2000</i> corresponds to 2000 ms. If the field is absent, UE uses <i>timeOffset-eDRX-Short</i> for monitoring WUS.</p>

### 6.3.3 Security control information elements

#### – *NextHopChainingCount*

The IE *NextHopChainingCount* is used to update the  $K_{eNB}$  key and corresponds to parameter NCC: See TS 33.401 [32], clause 7.2.8.4.

#### **NextHopChainingCount information element**

```
-- ASN1START
NextHopChainingCount ::=
    INTEGER (0..7)
-- ASN1STOP
```

#### – *SecurityAlgorithmConfig*

The IE *SecurityAlgorithmConfig* is used to configure AS integrity protection algorithm and AS ciphering algorithm for SRBs and DRBs. For RNs, the IE *SecurityAlgorithmConfig* is also used to configure AS integrity protection algorithm for DRBs between the RN and the E-UTRAN.

#### **SecurityAlgorithmConfig information element**

```
-- ASN1START
SecurityAlgorithmConfig ::=
    SEQUENCE {
        cipheringAlgorithm
            CipheringAlgorithm-r12,
        integrityProtAlgorithm
            ENUMERATED {
                eia0-v920, eia1, eia2, eia3-v1130, spare4, spare3,
                spare2, spare1, ...}
    }
-- ASN1STOP
```

```
CipheringAlgorithm-r12 ::=          ENUMERATED {
                                     eea0, eea1, eea2, eea3-v1130, spare4, spare3,
                                     spare2, spare1, ...}
-- ASN1STOP
```

#### **SecurityAlgorithmConfig field descriptions**

##### ***cipheringAlgorithm***

Indicates the ciphering algorithm to be used for SRBs and DRBs, as specified in TS 33.401 [32], clause 5.1.3.2.

##### ***integrityProtAlgorithm***

Indicates the integrity protection algorithm to be used for SRBs, as specified in TS 33.401 [32], clause 5.1.4.2. For RNs, this field also indicates the integrity protection algorithm to be used for integrity protection-enabled DRB(s). For UEs capable of user plane integrity protection, this field also indicates the integrity protection algorithm to be used to derive the  $K_{UPint}$  key.

## – *ShortMAC-I*

The IE *ShortMAC-I* is used to identify and verify the UE at RRC connection re-establishment. The 16 least significant bits of the MAC-I calculated using the security configuration of the source PCell, as specified in 5.3.7.4.

#### **ShortMAC-I information element**

```
-- ASN1START
ShortMAC-I ::=          BIT STRING (SIZE (16))
-- ASN1STOP
```

## 6.3.4 Mobility control information elements

### – *AdditionalSpectrumEmission*

If an extension is signalled using the extended value range (as defined by IE *AdditionalSpectrumEmission-v1010*), the corresponding original field, using the value range as defined by IE *AdditionalSpectrumEmission* i.e. without suffix) shall be set to value 32, if signalled. UE supporting an LTE band assigned NS values larger than 32 as defined in TS 36.101 [42], clause 6.2.4 and TS 36.102 [113] clause 6.2.A.3 for NTN capable UE, needs to support extension signaling (as defined by IE *AdditionalSpectrumEmission-v1010*).

#### **AdditionalSpectrumEmission information element**

```
-- ASN1START
AdditionalSpectrumEmission ::=          INTEGER (1..32)
AdditionalSpectrumEmission-v1010 ::=    INTEGER (33..288)
AdditionalSpectrumEmission-r18 ::=      INTEGER (1..288)
-- ASN1STOP
```

### – *AdditionalSpectrumEmissionNR*

The IE *AdditionalSpectrumEmissionNR* is used to indicate NR emission requirements to be fulfilled by the UE (see TS 38.101-1 [85], clause 6.2.3, and TS 38.101-2 [100], clause 6.2.3 and TS 38.101-3 [101], clause 6.5B.2). If an extension is signalled using the extended value range (as defined by the IE *AdditionalSpectrumEmissionNR-v1760*), the corresponding original field, using the value range as defined by the IE *AdditionalSpectrumEmissionNR* (with suffix -r15) shall be set to value 7.

#### **AdditionalSpectrumEmissionNR information element**

```
-- ASN1START
```

```

AdditionalSpectrumEmissionNR-r15 ::=          INTEGER (0..7)
AdditionalSpectrumEmissionNR-v1760 ::=      INTEGER (8..39)
AdditionalSpectrumEmissionNR-r18 ::=          INTEGER (0..39)
-- ASN1STOP

```

## – *ARFCN-ValueCDMA2000*

The IE *ARFCN-ValueCDMA2000* used to indicate the CDMA2000 carrier frequency within a CDMA2000 band, see C.S0002 [12].

### ***ARFCN-ValueCDMA2000* information element**

```

-- ASN1START
ARFCN-ValueCDMA2000 ::=          INTEGER (0..2047)
-- ASN1STOP

```

## – *ARFCN-ValueEUTRA*

The IE *ARFCN-ValueEUTRA* is used to indicate the ARFCN applicable for a downlink, uplink or bi-directional (TDD) E-UTRA carrier frequency, as defined in TS 36.101 [42] and TS 36.108 [114]. If an extension is signalled using the extended value range (as defined by IE *ARFCN-ValueEUTRA-v9e0*), the UE shall only consider this extension (and hence ignore the corresponding original field, using the value range as defined by IE *ARFCN-ValueEUTRA* i.e. without suffix, if signalled). In dedicated signalling, E-UTRAN only provides an EARFCN corresponding to an E-UTRA band supported by the UE.

### ***ARFCN-ValueEUTRA* information element**

```

-- ASN1START
ARFCN-ValueEUTRA ::=          INTEGER (0..maxEARFCN)
ARFCN-ValueEUTRA-v9e0 ::=      INTEGER (maxEARFCN-Plus1..maxEARFCN2)
ARFCN-ValueEUTRA-r9 ::=        INTEGER (0..maxEARFCN2)
-- ASN1STOP

```

**NOTE:** For fields using the original value range, as defined by IE *ARFCN-ValueEUTRA* i.e. without suffix, value *maxEARFCN* indicates that the E-UTRA carrier frequency is indicated by means of an extension. In such a case, UEs not supporting the extension consider the field to be set to a not supported value.

## – *ARFCN-ValueGERAN*

The IE *ARFCN-ValueGERAN* is used to specify the ARFCN value applicable for a GERAN BCCH carrier frequency, see TS 45.005 [20].

### ***ARFCN-ValueGERAN* information element**

```

-- ASN1START
ARFCN-ValueGERAN ::=          INTEGER (0..1023)
-- ASN1STOP

```

– *ARFCN-ValueNR*

The IE *ARFCN-ValueNR* is used to indicate the ARFCN applicable for a downlink, uplink or bi-directional (TDD) NR carrier frequency, as defined in TS 38.101 [85].

***ARFCN-ValueNR* information element**

```
-- ASN1START
ARFCN-ValueNR-r15 ::=                INTEGER (0.. 3279165)
-- ASN1STOP
```

– *ARFCN-ValueUTRA*

The IE *ARFCN-ValueUTRA* is used to indicate the ARFCN applicable for a downlink (Nd, FDD) or bi-directional (Nt, TDD) UTRA carrier frequency, as defined in TS 25.331 [19].

***ARFCN-ValueUTRA* information element**

```
-- ASN1START
ARFCN-ValueUTRA ::=                INTEGER (0..16383)
-- ASN1STOP
```

– *BandclassCDMA2000*

The IE *BandclassCDMA2000* is used to define the CDMA2000 band in which the CDMA2000 carrier frequency can be found, as defined in C.S0057 [24], table 1.5-1.

***BandclassCDMA2000* information element**

```
-- ASN1START
BandclassCDMA2000 ::=                ENUMERATED {
                                        bc0, bc1, bc2, bc3, bc4, bc5, bc6, bc7, bc8,
                                        bc9, bc10, bc11, bc12, bc13, bc14, bc15, bc16,
                                        bc17, bc18-v9a0, bc19-v9a0, bc20-v9a0, bc21-v9a0,
                                        spare10, spare9, spare8, spare7, spare6, spare5, spare4,
                                        spare3, spare2, spare1, ...}
-- ASN1STOP
```

– *BandIndicatorGERAN*

The IE *BandIndicatorGERAN* indicates how to interpret an associated GERAN carrier ARFCN, see TS 45.005 [20]. More specifically, the IE indicates the GERAN frequency band in case the ARFCN value can concern either a DCS 1800 or a PCS 1900 carrier frequency. For ARFCN values not associated with one of these bands, the indicator has no meaning.

***BandIndicatorGERAN* information element**

```
-- ASN1START
BandIndicatorGERAN ::=                ENUMERATED {dcs1800, pcs1900}
-- ASN1STOP
```

– *CarrierFreqCDMA2000*

The IE *CarrierFreqCDMA2000* used to provide the CDMA2000 carrier information.

**CarrierFreqCDMA2000 information element**

```

-- ASN1START
CarrierFreqCDMA2000 ::=          SEQUENCE {
    bandClass                BandclassCDMA2000,
    arfcn                    ARFCN-ValueCDMA2000
}
-- ASN1STOP

```

**CarrierFreqGERAN**

The IE *CarrierFreqGERAN* is used to provide an unambiguous carrier frequency description of a GERAN cell.

**CarrierFreqGERAN information element**

```

-- ASN1START
CarrierFreqGERAN ::=          SEQUENCE {
    arfcn                    ARFCN-ValueGERAN,
    bandIndicator            BandIndicatorGERAN
}
-- ASN1STOP

```

**CarrierFreqGERAN field descriptions****arfcn**

GERAN ARFCN of BCCH carrier.

**bandIndicator**

Indicates how to interpret the ARFCN of the BCCH carrier.

**CarrierFreqsGERAN**

The IE *CarrierFreqListGERAN* is used to provide one or more GERAN ARFCN values, as defined in TS 45.005 [43], which represents a list of GERAN BCCH carrier frequencies.

**CarrierFreqsGERAN information element**

```

-- ASN1START
CarrierFreqsGERAN ::=          SEQUENCE {
    startingARFCN            ARFCN-ValueGERAN,
    bandIndicator            BandIndicatorGERAN,
    followingARFCNs          CHOICE {
        explicitListofARFCNs    ExplicitListofARFCNs,
        equallySpacedARFCNs     SEQUENCE {
            arfcn-Spacing        INTEGER (1..8),
            numberOfFollowingARFCNs    INTEGER (0..31)
        },
        variableBitMapOfARFCNs  OCTET STRING (SIZE (1..16))
    }
}
ExplicitListofARFCNs ::=          SEQUENCE (SIZE (0..31)) OF ARFCN-ValueGERAN
-- ASN1STOP

```

<b>CarrierFreqsGERAN field descriptions</b>
<b>arfcn-Spacing</b> Space, d, between a set of equally spaced ARFCN values.
<b>bandIndicator</b> Indicates how to interpret the ARFCN of the BCCH carrier.
<b>explicitListOfARFCNs</b> The remaining ARFCN values in the set are explicitly listed one by one.
<b>followingARFCNs</b> Field containing a representation of the remaining ARFCN values in the set.
<b>numberOfFollowingARFCNs</b> The number, n, of the remaining equally spaced ARFCN values in the set. The complete set of (n+1) ARFCN values is defined as: {s, ((s + d) mod 1024), ((s + 2*d) mod 1024) ... ((s + n*d) mod 1024)}.
<b>startingARFCN</b> The first ARFCN value, s, in the set.
<b>variableBitMapOfARFCNs</b> Bitmap field representing the remaining ARFCN values in the set. The leading bit of the first octet in the bitmap corresponds to the ARFCN = ((s + 1) mod 1024), the next bit to the ARFCN = ((s + 2) mod 1024), and so on. If the bitmap consists of N octets, the trailing bit of octet N corresponds to ARFCN = ((s + 8*N) mod 1024). The complete set of ARFCN values consists of ARFCN = s and the ARFCN values, where the corresponding bit in the bitmap is set to "1".

### – **CarrierFreqListMBMS**

The IE *CarrierFreqListMBMS* is used to indicate the E-UTRA ARFCN values of the one or more MBMS frequencies the UE is interested to receive.

#### **CarrierFreqListMBMS information element**

```
-- ASN1START
CarrierFreqListMBMS-r11 ::= SEQUENCE (SIZE (1..maxFreqMBMS-r11)) OF ARFCN-ValueEUTRA-r9
-- ASN1STOP
```

### – **CDMA2000-Type**

The IE *CDMA2000-Type* is used to describe the type of CDMA2000 network.

#### **CDMA2000-Type information element**

```
-- ASN1START
CDMA2000-Type ::= ENUMERATED {type1XRTT, typeHRPD}
-- ASN1STOP
```

### – **CellGlobalIdNR**

The IE *CellGlobalIdNR* specifies the Cell Global Identifier (CGI), the globally unique identity and the tracking area code (TAC) of a cell in NR.

#### **CellGlobalIdNR information element**

```
-- ASN1START
CellGlobalIdNR-r16 ::= SEQUENCE {
    plmn-Identity-r16          PLMN-Identity,
    cellIdentity-r16          CellIdentityNR-r15,
    trackingAreaCode-r16     TrackingAreaCodeNR-r15    OPTIONAL
}
-- ASN1STOP
```

CellGlobalIdNR field descriptions
<b>cellIdentity</b> Identity of the cell within the context of the PLMN.
<b>plmn-Identity</b> Identifies the PLMN of the cell as given by the first PLMN entry in the <i>plmn-IdentityInfoList</i> in <i>SIB1</i> .
<b>trackingAreaCode</b> Indicates Tracking Area Code to which the cell indicated by <i>cellIdentity</i> field belongs.

## – *CellIdentity*

The IE *CellIdentity* is used to unambiguously identify a cell within a PLMN.

### **CellIdentity information element**

```
-- ASN1START
CellIdentity ::=          BIT STRING (SIZE (28))
-- ASN1STOP
```

## – *CellIndexList*

The IE *CellIndexList* concerns a list of cell indices, which may be used for different purposes.

### **CellIndexList information element**

```
-- ASN1START
CellIndexList ::=        SEQUENCE (SIZE (1..maxCellMeas)) OF CellIndex
CellIndex ::=            INTEGER (1..maxCellMeas)
-- ASN1STOP
```

## – *CellReselectionPriority*

The IE *CellReselectionPriority* concerns the absolute priority of the concerned carrier frequency/ set of frequencies (GERAN)/ bandclass (CDMA2000), as used by the cell reselection procedure. Corresponds with parameter "priority" in TS 36.304 [4]. Value 0 means: lowest priority. The UE behaviour for the case the field is absent, if applicable, is specified in TS 36.304 [4].

### **CellReselectionPriority information element**

```
-- ASN1START
CellReselectionPriority ::=          INTEGER (0..7)
-- ASN1STOP
```

## – *CellSelectionInfoCE*

The IE *CellSelectionInfoCE* contains cell selection information for CE. The *q-RxLevMinCE* corresponds to parameter  $Q_{rxlevmin\_CE}$  in TS 36.304 [4]. The *q-QualMinRSRQ-CE* corresponds to parameter  $Q_{qualmin\_CE}$  in TS 36.304 [4]. If *q-QualMinRSRQ-CE* is not present, the UE applies the (default) value of negative infinity for  $Q_{qualmin}$ .

### **CellSelectionInfoCE information element**

```
-- ASN1START
CellSelectionInfoCE-r13 ::=          SEQUENCE {
  q-RxLevMinCE-r13                Q-RxLevMin,
  q-QualMinRSRQ-CE-r13             Q-QualMin-r9                OPTIONAL  -- Need OR
}
-- ASN1STOP
```

```

CellSelectionInfoCE-v1530 ::=          SEQUENCE {
    powerClass14dBm-Offset-r15          ENUMERATED {dB-6, dB-3, dB3, dB6, dB9, dB12}
}
-- ASN1STOP

```

#### **CellSelectionInfoCE field descriptions**

##### **powerClass14dBm-Offset**

Parameter "Poffset" in TS 36.304 [4], only applicable for UE supporting *powerClass-14dBm*. Value in dB. Value dB-6 corresponds to -6 dB, dB-3 corresponds to -3 dB and so on. E-UTRAN configures this field only if *cellSelectionInfoCE-r13* is configured. If the field is absent, the UE applies the (default) value of 0 dB for "Poffset" in TS 36.304 [4].

### **CellSelectionInfoCE1**

The IE *CellSelectionInfoCE1* contains cell selection information for BL UEs or UEs in CE supporting CE Mode B. The *q-RxLevMinCE1* corresponds to parameter  $Q_{rxlevmin\_CE1}$  in TS 36.304 [4]. If *delta-RxLevMinCE1* is not included, actual value  $Q_{rxlevmin\_CE1} = q-RxLevMinCE1 * 2$  [dBm]. If *delta-RxLevMinCE1* is included, the actual value  $Q_{rxlevmin\_CE1} = (q-RxLevMinCE1 + delta-RxLevMinCE1) * 2$  [dBm]. The *q-QualMinRSRQ-CE1* corresponds to parameter  $Q_{qualmin\_CE1}$  in TS 36.304 [4]. If *q-QualMinRSRQ-CE1* is not present, the UE applies the (default) value of negative infinity for  $Q_{qualmin}$ .

#### **CellSelectionInfoCE1 information element**

```

-- ASN1START
CellSelectionInfoCE1-r13 ::=          SEQUENCE {
    q-RxLevMinCE1-r13                 Q-RxLevMin,
    q-QualMinRSRQ-CE1-r13             Q-QualMin-r9          OPTIONAL    -- Need OR
}
CellSelectionInfoCE1-v1360 ::=       SEQUENCE {
    delta-RxLevMinCE1-v1360           INTEGER (-8..-1)
}
-- ASN1STOP

```

### **CellReselectionSubPriority**

The IE *CellReselectionSubPriority* indicates a fractional value to be added to the value of *cellReselectionPriority* to obtain the absolute priority of the concerned carrier frequency for E-UTRA and NR. Value *oDot2* corresponds to 0.2, *oDot4* corresponds to 0.4 and so on.

#### **CellReselectionSubPriority information element**

```

-- ASN1START
CellReselectionSubPriority-r13 ::=    ENUMERATED {oDot2, oDot4, oDot6, oDot8}
-- ASN1STOP

```

### **CSFB-RegistrationParam1XRTT**

The IE *CSFB-RegistrationParam1XRTT* is used to indicate whether or not the UE shall perform a CDMA2000 1xRTT pre-registration if the UE does not have a valid / current pre-registration.

```

-- ASN1START
CSFB-RegistrationParam1XRTT ::=      SEQUENCE {
    sid                                BIT STRING (SIZE (15)),
    nid                                BIT STRING (SIZE (16)),
    multipleSID                        BOOLEAN,
    multipleNID                        BOOLEAN,
    homeReg                            BOOLEAN,
    foreignSIDReg                      BOOLEAN,
    foreignNIDReg                      BOOLEAN,
}

```



```

parameterReg          BOOLEAN,
powerUpReg            BOOLEAN,
registrationPeriod    BIT STRING (SIZE (7)),
registrationZone      BIT STRING (SIZE (12)),
totalZone             BIT STRING (SIZE (3)),
zoneTimer            BIT STRING (SIZE (3))
}

CSFB-RegistrationParam1XRTT-v920 ::= SEQUENCE {
  powerDownReg-r9     ENUMERATED {true}
}

-- ASN1STOP

```

#### **CSFB-RegistrationParam1XRTT field descriptions**

<b>foreignNIDReg</b>	The CDMA2000 1xRTT NID roamer registration indicator.
<b>foreignSIDReg</b>	The CDMA2000 1xRTT SID roamer registration indicator.
<b>homeReg</b>	The CDMA2000 1xRTT Home registration indicator.
<b>multipleNID</b>	The CDMA2000 1xRTT Multiple NID storage indicator.
<b>multipleSID</b>	The CDMA2000 1xRTT Multiple SID storage indicator.
<b>nid</b>	Used along with the <i>sid</i> as a pair to control when the UE should Register or Re-Register with the CDMA2000 1xRTT network.
<b>parameterReg</b>	The CDMA2000 1xRTT Parameter-change registration indicator.
<b>powerDownReg</b>	The CDMA2000 1xRTT Power-down registration indicator. If set to TRUE, the UE that has a valid / current CDMA2000 1xRTT pre-registration will perform a CDMA2000 1xRTT power down registration when it is switched off.
<b>powerUpReg</b>	The CDMA2000 1xRTT Power-up registration indicator.
<b>registrationPeriod</b>	The CDMA2000 1xRTT Registration period.
<b>registrationZone</b>	The CDMA2000 1xRTT Registration zone.
<b>sid</b>	Used along with the <i>nid</i> as a pair to control when the UE should Register or Re-Register with the CDMA2000 1xRTT network.
<b>totalZone</b>	The CDMA2000 1xRTT Number of registration zones to be retained.
<b>zoneTimer</b>	The CDMA2000 1xRTT Zone timer length.

### CellGlobalIdEUTRA

The IE *CellGlobalIdEUTRA* specifies the Evolved Cell Global Identifier (ECGI), the globally unique identity of a cell in E-UTRA.

#### **CellGlobalIdEUTRA information element**

```

-- ASN1START
CellGlobalIdEUTRA ::= SEQUENCE {
  plmn-Identity      PLMN-Identity,
  cellIdentity       CellIdentity
}
-- ASN1STOP

```

CellGlobalIdEUTRA field descriptions
<b>cellIdentity</b> Identity of the cell within the context of the PLMN.
<b>plmn-Identity</b> Identifies the PLMN of the cell as given by the first PLMN entry in the <i>plmn-IdentityList</i> in <i>SystemInformationBlockType1</i> .

## – CellGlobalIdUTRA

The IE *CellGlobalIdUTRA* specifies the global UTRAN Cell Identifier, the globally unique identity of a cell in UTRA.

### CellGlobalIdUTRA information element

```
-- ASN1START
CellGlobalIdUTRA ::= SEQUENCE {
    plmn-Identity      PLMN-Identity,
    cellIdentity       BIT STRING (SIZE (28))
}
-- ASN1STOP
```

CellGlobalIdUTRA field descriptions
<b>cellIdentity</b> UTRA Cell Identifier which is unique within the context of the identified PLMN as defined in TS 25.331 [19].
<b>plmn-Identity</b> Identifies the PLMN of the cell as given by the common PLMN broadcast in the MIB, as defined in TS 25.331 [19].

## – CellGlobalIdGERAN

The IE *CellGlobalIdGERAN* specifies the Cell Global Identification (CGI), the globally unique identity of a cell in GERAN.

### CellGlobalIdGERAN information element

```
-- ASN1START
CellGlobalIdGERAN ::= SEQUENCE {
    plmn-Identity      PLMN-Identity,
    locationAreaCode   BIT STRING (SIZE (16)),
    cellIdentity       BIT STRING (SIZE (16))
}
-- ASN1STOP
```

CellGlobalIdGERAN field descriptions
<b>cellIdentity</b> Cell Identifier which is unique within the context of the GERAN location area as defined in TS 23.003 [27].
<b>locationAreaCode</b> A fixed length code identifying the location area within a PLMN as defined in TS 23.003 [27].
<b>plmn-Identity</b> Identifies the PLMN of the cell, as defined in TS 23.003 [27].

## – CellGlobalIdCDMA2000

The IE *CellGlobalIdCDMA2000* specifies the Cell Global Identification (CGI), the globally unique identity of a cell in CDMA2000.

### CellGlobalIdCDMA2000 information element

```
-- ASN1START
```

```

CellGlobalIdCDMA2000 ::= CHOICE {
    cellGlobalId1XRTT      BIT STRING (SIZE (47)),
    cellGlobalIdHRPD      BIT STRING (SIZE (128))
}
-- ASN1STOP

```

#### CellGlobalIdCDMA2000 field descriptions

##### **cellGlobalId1XRTT**

Unique identifier for a CDMA2000 1xRTT cell, corresponds to BASEID, SID and NID parameters (in that order) defined in C.S0005 [25].

##### **cellGlobalIdHRPD**

Unique identifier for a CDMA2000 HRPD cell, corresponds to SECTOR ID parameter defined in C.S0024 [26], clause 14.9.

## CellSelectionInfoNFreq

The IE *CellSelectionInfoNFreq* includes the parameters used for cell selection on a neighbouring frequency, see TS 36.304 [4].

### CellSelectionInfoNFreq information element

```

-- ASN1START
CellSelectionInfoNFreq-r13 ::= SEQUENCE {
    -- Cell selection information as in SIB1
    q-RxLevMin-r13          Q-RxLevMin,
    q-RxLevMinOffset       INTEGER (1..8)          OPTIONAL, -- Need OP
    -- Cell re-selection information as in SIB3
    q-Hyst-r13             ENUMERATED {
        dB0, dB1, dB2, dB3, dB4, dB5, dB6, dB8, dB10,
        dB12, dB14, dB16, dB18, dB20, dB22, dB24},
    q-RxLevMinReselection-r13 Q-RxLevMin,
    t-ReselectionEUTRA-r13   T-Reselection
}
-- ASN1STOP

```

## ConditionalReconfiguration

The IE *ConditionalReconfiguration* is used to add, modify or release the configuration of a conditional handover, conditional PSCell addition or inter-SN conditional PSCell change per target candidate cell.

### ConditionalReconfiguration information element

```

-- ASN1START
ConditionalReconfiguration-r16 ::= SEQUENCE {
    condReconfigurationToAddModList-r16 CondReconfigurationToAddModList-r16  OPTIONAL, -- Need ON
    condReconfigurationToRemoveList-r16 CondReconfigurationToRemoveList-r16  OPTIONAL, -- Need ON
    attemptCondReconf-r16             ENUMERATED {true}                      OPTIONAL, -- Cond
    CHO
    ...
}

CondReconfigurationToRemoveList-r16 ::= SEQUENCE (SIZE (1..maxCondConfig-r16)) OF
CondReconfigurationId-r16
-- ASN1STOP

```

<i>ConditionalReconfiguration</i> field descriptions
<b><i>attemptCondReconf</i></b> If present, the UE shall perform conditional reconfiguration if selected cell is a target candidate cell and it is the first cell selection after failure as described in 5.3.7.3.
<b><i>condReconfigurationToAddModList</i></b> List of conditional reconfigurations (i.e. conditional handover, conditional PSCell addition or inter-SN conditional PSCell change) to add and/or modify.
<b><i>condReconfigurationToRemoveList</i></b> List of conditional reconfigurations (i.e. conditional handover, conditional PSCell addition or inter-SN conditional PSCell change) to remove.

Conditional presence	Explanation
<i>CHO</i>	The field is optional present, Need OR, if the UE is configured with at least a candidate cell for CHO. Otherwise the field is not present.

### – *ConditionalReconfigurationId*

The IE *ConditionalReconfigurationId* is used to identify a conditional reconfiguration (e.g. CHO, CPA or inter-SN CPC).

#### ***ConditionalReconfigurationId* information element**

```
-- ASN1START
CondReconfigurationId-r16 ::= INTEGER (1.. maxCondConfig-r16)
-- ASN1STOP
```

### – *CondReconfigurationToAddModList*

The IE *CondReconfigurationToAddModList* concerns a list of conditional reconfigurations (i.e. conditional handover, conditional PSCell addition or inter-SN conditional PSCell change) to add or modify, for each entry the *measId* (associated to the triggering condition configuration) and the associated *RRCCConnectionReconfiguration*.

#### ***CondReconfigurationToAddModList* information element**

```
-- ASN1START
CondReconfigurationToAddModList-r16 ::= SEQUENCE (SIZE (1.. maxCondConfig-r16)) OF
CondReconfigurationAddMod-r16
CondReconfigurationAddMod-r16 ::= SEQUENCE {
  condReconfigurationId-r16      CondReconfigurationId-r16,
  triggerCondition-r16          SEQUENCE (SIZE (1..2)) OF MeasId
                                OPTIONAL, -- Need ON
  condReconfigurationToApply-r16 OCTET STRING (CONTAINING RRCCConnectionReconfiguration)
                                OPTIONAL, -- Cond CondReconfigurationAdd
  ...,
  [[
  triggerConditionSN-r17        OCTET STRING      OPTIONAL -- Need ON
  ]]
}
-- ASN1STOP
```

<b>CondReconfigurationToAddMod field descriptions</b>
<p><b>condReconfigurationToApply</b> The RRCConnectionReconfiguration message to be applied when the condition(s) are fulfilled.</p>
<p><b>triggerCondition</b> The condition that needs to be fulfilled in order to trigger the execution of a conditional reconfiguration for CHO, CPA or MN initiated inter-SN CPC. When configuring two triggering events (MeasIds) for a candidate cell, the network ensures that both refer to the same <i>measObject</i>. For each <i>condReconfigurationId</i>, the network always configures either <i>triggerCondition</i> or <i>triggerConditionSN</i> (not both). For CHO in NTN, <i>condEventD1</i> or <i>condEventD2</i> or <i>condEventT1</i> can be configured independently for a candidate cell (i.e. without a second triggering event <i>condEventA3</i>, <i>condEventA4</i> or <i>condEventA5</i> for the same candidate cell), e.g. in hard satellite switching cases where the coverage gap between previous satellite and the incoming satellite is assumed to be zero or negligible. The network configures at most one from <i>condEventD1</i>, <i>condEventD2</i> or <i>condEventT1</i> for the same candidate cell. For CHO in terrestrial networks, the network does not indicate a <i>MeasId</i> associated with <i>condEventA4</i>.</p>
<p><b>triggerConditionSN</b> Includes the NR <i>CondReconfigExecCondSCG</i> as specified in TS 38.331 [82]. For each <i>condReconfigurationId</i>, the network always configures either <i>triggerCondition</i> or <i>triggerConditionSN</i> (not both). The field is applied to the case of SN initiated inter-SN CPC.</p>

<b>Conditional presence</b>	<b>Explanation</b>
<i>CondReconfigurationAdd</i>	The field is mandatory present if a <i>condReconfigurationId</i> is being added. Otherwise it is optional, need ON.

## – *CSG-Identity*

The IE *CSG-Identity* is used to identify a Closed Subscriber Group.

### **CSG-Identity information element**

```
-- ASN1START
CSG-Identity ::= BIT STRING (SIZE (27))
-- ASN1STOP
```

## – *EphemerisOrbitalParameters*

The IE *EphemerisOrbitalParameters* provides satellite ephemeris in format of orbital parameters in ECI.

NOTE: The ECI and ECEF coincide at Epoch time (e.g. x,y,z axis in ECEF are aligned with x,y,z axis in ECI).

### **EphemerisOrbitalParameters information element**

```
-- ASN1START
EphemerisOrbitalParameters-r17 ::= SEQUENCE {
    semiMajorAxis-r17 INTEGER (0..8589934591),
    eccentricity-r17 INTEGER (0..1048575),
    periapsis-r17 INTEGER (0..268435455),
    longitude-r17 INTEGER (0..268435455),
    inclination-r17 INTEGER (-67108864..67108863),
    anomaly-r17 INTEGER (0..268435455)
}
-- ASN1STOP
```

<b><i>EphemerisOrbitalParameters</i></b> field descriptions
<p><b><i>anomaly</i></b> Mean anomaly M at epoch time, see NIMA TR 8350.2 [110]. Unit in radian. Step of <math>2.341 \times 10^{-8}</math> rad. Actual value = field value * (<math>2.341 \times 10^{-8}</math>).</p>
<p><b><i>eccentricity</i></b> Eccentricity e, see NIMA TR 8350.2 [110]. Step <math>1.431 \times 10^{-8}</math>. Actual value = field value * (<math>1.431 \times 10^{-8}</math>).</p>
<p><b><i>inclination</i></b> Inclination i, see NIMA TR 8350.2 [110]. Unit in radian. Step of <math>2.341 \times 10^{-8}</math> rad. Actual value = field value * (<math>2.341 \times 10^{-8}</math>).</p>
<p><b><i>longitude</i></b> Longitude of ascending node <math>\Omega</math>, see NIMA TR 8350.2 [110]. Unit in radian. Step of <math>2.341 \times 10^{-8}</math> rad. Actual value = field value * (<math>2.341 \times 10^{-8}</math>).</p>
<p><b><i>periapsis</i></b> Argument of periapsis <math>\omega</math>, see NIMA TR 8350.2 [110]. Unit in radian. Step of <math>2.341 \times 10^{-8}</math> rad. Actual value = field value * (<math>2.341 \times 10^{-8}</math>).</p>
<p><b><i>semiMajorAxis</i></b> Semi major axis <math>\alpha</math>, see NIMA TR 8350.2 [110]. Unit in meter. Step of <math>4.249 \times 10^{-3}</math> m. Actual value = <math>6500000 +</math> field value * (<math>4.249 \times 10^{-3}</math>).</p>

## *EphemerisStateVectors*

The IE *EphemerisStateVectors* provides satellite ephemeris in format of position and velocity state vectors in ECEF.

### ***EphemerisStateVectors*** information element

```
-- ASN1START
EphemerisStateVectors-r17 ::= SEQUENCE {
    positionX-r17          PositionStateVector-r17,
    positionY-r17          PositionStateVector-r17,
    positionZ-r17          PositionStateVector-r17,
    velocityVX-r17         VelocityStateVector-r17,
    velocityVY-r17         VelocityStateVector-r17,
    velocityVZ-r17         VelocityStateVector-r17
}
PositionStateVector-r17 ::= INTEGER (-33554432..33554431)
VelocityStateVector-r17 ::= INTEGER (-131072..131071)
-- ASN1STOP
```

<b><i>EphemerisStateVectors</i></b> field descriptions
<p><b><i>positionX, positionY, positionZ</i></b> X, Y, Z coordinate of satellite position state vector in ECEF. Unit in meter. Step of 1.3 m. Actual value = field value * 1.3.</p>
<p><b><i>velocityVX, velocityVY, velocityVZ</i></b> X, Y, Z coordinate of satellite velocity state vector in ECEF. Unit in meter/second. Step of 0.06 m/s. Actual value = field value * 0.06.</p>

## *FreqBandIndicator*

The IE *FreqBandIndicator* indicates the E-UTRA operating band as defined in TS 36.101 [42], table 5.5-1 and TS 36.102 [113], table 5.2-1 for NTN capable UE. If an extension is signalled using the extended value range (as defined by IE *FreqBandIndicator-v9e0*), the UE shall only consider this extension (and hence ignore the corresponding original field, using the value range as defined by IE *FreqBandIndicator* i.e. without suffix, if signalled).

### ***FreqBandIndicator*** information element

```
-- ASN1START
FreqBandIndicator ::= INTEGER (1..maxFBI)
FreqBandIndicator-v9e0 ::= INTEGER (maxFBI-Plus1..maxFBI2)
-- ASN1STOP
```

```
FreqBandIndicator-r11 ::= INTEGER (1..maxFBI2)
-- ASN1STOP
```

NOTE: For fields using the original value range, as defined by IE *FreqBandIndicator* i.e. without suffix, value *maxFBI* indicates that the frequency band is indicated by means of an extension. In such a case, UEs not supporting the extension consider the field to be set to a not supported value.

## – *FreqBandIndicatorNR*

The IE *FreqBandIndicatorNR* indicates the NR operating band as defined in TS 38.101 [85].

### *FreqBandIndicatorNR* information element

```
-- ASN1START
FreqBandIndicatorNR-r15 ::= INTEGER (1.. maxFBI-NR-r15)
-- ASN1STOP
```

## – *MobilityControlInfo*

The IE *MobilityControlInfo* includes parameters relevant for network controlled mobility to/within E-UTRA.

### *MobilityControlInfo* information element

```
-- ASN1START
MobilityControlInfo ::= SEQUENCE {
  targetPhysCellId PhysCellId,
  carrierFreq CarrierFreqEUTRA OPTIONAL, -- Cond HO-
toEUTRA2
  carrierBandwidth CarrierBandwidthEUTRA OPTIONAL, -- Cond HO-
toEUTRA
  additionalSpectrumEmission AdditionalSpectrumEmission OPTIONAL, -- Cond HO-
toEUTRA
  t304 ENUMERATED {
    ms50, ms100, ms150, ms200, ms500, ms1000,
    ms2000, ms10000-v1310},
  newUE-Identity C-RNTI,
  radioResourceConfigCommon RadioResourceConfigCommon,
  rach-ConfigDedicated RACH-ConfigDedicated OPTIONAL, -- Need OP
  ...,
  [[ carrierFreq-v9e0 CarrierFreqEUTRA-v9e0 OPTIONAL -- Need ON
  ]],
  [[ drb-ContinueROHC-r11 ENUMERATED {true} OPTIONAL -- Cond HO
  ]],
  [[ mobilityControlInfoV2X-r14 MobilityControlInfoV2X-r14 OPTIONAL, -- Need ON
  handoverWithoutWT-Change-r14 ENUMERATED {keepLWA-Config, sendEndMarker} OPTIONAL, --
Cond HO
  makeBeforeBreak-r14 ENUMERATED {true} OPTIONAL, -- Need OR
  rach-Skip-r14 RACH-Skip-r14 OPTIONAL, -- Need OR
  sameSFN-Indication-r14 ENUMERATED {true} OPTIONAL -- Cond HO-
SFNsyncd
  ]],
  [[
  mib-RepetitionStatus-r14 BOOLEAN OPTIONAL, -- Need OR
  schedulingInfoSIB1-BR-r14 INTEGER (0..31) OPTIONAL -- Cond HO-
SFNsyncd
  ]],
  [[ daps-Config-r16 DAPS-Config-r16 OPTIONAL -- Cond
NotFullConfigHO
  ]],
  [[ gnss-PositionFixDurationReporting-r18 ENUMERATED {true} OPTIONAL -- Need OR
  ]]
}
MobilityControlInfo-v1010 ::= SEQUENCE {
```

```

    additionalSpectrumEmission-v1010 AdditionalSpectrumEmission-v1010 OPTIONAL -- Need ON
}

MobilityControlInfoSCG-r12 ::= SEQUENCE {
    t307-r12 ENUMERATED {
        ms50, ms100, ms150, ms200, ms500, ms1000,
        ms2000, spare1},
    ue-IdentitySCG-r12 C-RNTI OPTIONAL, -- Cond SCGEst
    rach-ConfigDedicated-r12 RACH-ConfigDedicated OPTIONAL, -- Need OP
    cipheringAlgorithmSCG-r12 CipheringAlgorithm-r12 OPTIONAL, -- Need ON
    ...,
    [[ makeBeforeBreakSCG-r14 ENUMERATED {true} OPTIONAL, -- Need OR
      rach-SkipSCG-r14 RACH-Skip-r14 OPTIONAL -- Need OR
    ]]
}

MobilityControlInfoV2X-r14 ::= SEQUENCE {
    v2x-CommTxPoolExceptional-r14 SL-CommResourcePoolV2X-r14 OPTIONAL, -- Need OR
    v2x-CommRxPool-r14 SL-CommRxPoolListV2X-r14 OPTIONAL, -- Need OR
    v2x-CommSyncConfig-r14 SL-SyncConfigListV2X-r14 OPTIONAL, -- Need OR
    cbr-MobilityTxConfigList-r14 SL-CBR-CommonTxConfigList-r14 OPTIONAL -- Need OR
}

CarrierBandwidthEUTRA ::= SEQUENCE {
    dl-Bandwidth ENUMERATED {
        n6, n15, n25, n50, n75, n100, spare10,
        spare9, spare8, spare7, spare6, spare5,
        spare4, spare3, spare2, spare1},
    ul-Bandwidth ENUMERATED {
        n6, n15, n25, n50, n75, n100, spare10,
        spare9, spare8, spare7, spare6, spare5,
        spare4, spare3, spare2, spare1} OPTIONAL -- Need OP
}

CarrierFreqEUTRA ::= SEQUENCE {
    dl-CarrierFreq ARFCN-ValueEUTRA,
    ul-CarrierFreq ARFCN-ValueEUTRA OPTIONAL -- Cond FDD
}

CarrierFreqEUTRA-v9e0 ::= SEQUENCE {
    dl-CarrierFreq-v9e0 ARFCN-ValueEUTRA-r9,
    ul-CarrierFreq-v9e0 ARFCN-ValueEUTRA-r9 OPTIONAL -- Cond FDD
}

DAPS-Config-r16 ::= SEQUENCE {
    daps-PowerCoordinationInfo-r16 DAPS-PowerCoordinationInfo-r16 OPTIONAL, -- Need ON
    ...
}

DAPS-PowerCoordinationInfo-r16 ::= SEQUENCE {
    p-DAPS-Source-r16 INTEGER (1..16),
    p-DAPS-Target-r16 INTEGER (1..16),
    powerControlMode-r16 INTEGER (1..2)
}

RACH-Skip-r14 ::= SEQUENCE {
    targetTA-r14 CHOICE {
        ta0-r14 NULL,
        mcg-PTAG-r14 NULL,
        scg-PTAG-r14 NULL,
        mcg-STAG-r14 STAG-Id-r11,
        scg-STAG-r14 STAG-Id-r11
    },
    ul-ConfigInfo-r14 SEQUENCE {
        numberOfConfUL-Processes-r14 INTEGER (1..8),
        ul-SchedInterval-r14 ENUMERATED {sf2, sf5, sf10},
        ul-StartSubframe-r14 INTEGER (0..9),
        ul-Grant-r14 BIT STRING (SIZE (16))
    }
}

-- ASN1STOP

```



<b>MobilityControlInfo field descriptions</b>
<p><b>additionalSpectrumEmission</b> For a UE with no SCells configured for UL in the same band as the PCell, the UE shall apply the value for the PCell instead of the corresponding value from <i>SystemInformationBlockType2</i> or <i>SystemInformationBlockType1</i>. For a UE with SCell(s) configured for UL in the same band as the PCell, the UE shall, in case all SCells configured for UL in that band are released after handover completion, apply the value for the PCell instead of the corresponding value from <i>SystemInformationBlockType2</i> or <i>SystemInformationBlockType1</i>. The UE requirements related to IE <i>AdditionalSpectrumEmission</i> are defined in TS 36.101 [42], table 6.2.4-1, for UEs neither in CE nor BL UEs, TS 36.101 [42], table 6.2.4E-1, for UEs in CE or BL UEs and TS 36.102 [113], table 6.2A.3-1, for NTN capable UE.</p>
<p><b>carrierBandwidth</b> Provides the parameters <i>Downlink bandwidth</i>, and <i>Uplink bandwidth</i>, see TS 36.101 [42].</p>
<p><b>carrierFreq</b> Provides the EARFCN to be used by the UE in the target cell.</p>
<p><b>cbr-MobilityTxConfigList</b> Indicates the list of CBR ranges and the list of PSSCH transmission parameter configurations available to configure congestion control to the UE for V2X sidelink communication during handover.</p>
<p><b>cipheringAlgorithmSCG</b> Indicates the ciphering algorithm to be used for SCG DRBs. E-UTRAN includes the field upon SCG change when one or more SCG DRBs are configured. Otherwise E-UTRAN does not include the field.</p>
<p><b>dl-Bandwidth</b> Parameter: <i>Downlink bandwidth</i>, see TS 36.101 [42].</p>
<p><b>drb-ContinueROHC</b> This field indicates whether to continue or reset, for this handover, the header compression protocol context for the RLC UM bearers configured with the header compression protocol. Presence of the field indicates that the header compression protocol context continues while absence indicates that the header compression protocol context is reset. E-UTRAN includes the field only in case of a handover within the same eNB. This field does not apply to any configured DAPS bearers.</p>
<p><b>gnss-PositionFixDurationReporting</b> If present, this field indicates that UEs are configured to include the time duration required to acquire a GNSS position in <i>RRCConnectionReconfigurationComplete</i> to the target cell.</p>
<p><b>handoverWithoutWT-Change</b> Indicates whether UE performs handover where LWA configuration is retained with the same WT If <i>sendEndMarker</i> is configured, the LWA end-marker for PDCP key change indication is used as defined in [8]. If value <i>keepLWA-Config</i> is configured, LWA end marker is not used and UE shall only retain the LWA configuration.</p>
<p><b>makeBeforeBreak</b> Indicates that the UE shall continue uplink transmission/ downlink reception with the source cell(s) before performing the first transmission through PRACH to the target intra-frequency PCell, or performing initial PUSCH transmission to the target intra-frequency PCell while <i>rach-Skip</i> is configured.</p>
<p><b>makeBeforeBreakSCG</b> Indicates that the UE shall continue uplink transmission/ downlink reception with the source cell(s) before performing the first transmission through PRACH to the target intra-frequency PCell, or performing initial PUSCH transmission to the target intra-frequency PCell while <i>rach-SkipSCG</i> is configured.</p>
<p><b>mib-RepetitionStatus</b> Indicates whether additional MIB repetition is enabled in the target cell or not. Value TRUE indicates additional MIB repetition is enabled in the target cell. Value FALSE indicates additional MIB repetition is not enabled in the target cell. The absence of this field indicates additional MIB repetition may or may not be enabled in the target cell. See 5.2.1.2 and TS 36.211 [21], clause 6.4.1. This field is applicable to BL UE or UE in CE.</p>
<p><b>mobilityControlInfoV2X</b> Indicates the sidelink configurations of the target cell for V2X sidelink communication during handover.</p>
<p><b>numberOfConfUL-Processes</b> The number of configured HARQ processes for preallocated uplink grant, see TS 36.321 [6], clause 5.20. This field is applicable if a UE is configured with asynchronous HARQ, otherwise it shall be ignored.</p>
<p><b>p-DAPS-Source</b> Indicates the guaranteed power for the source PCell during a DAPS handover, as specified in TS 36.213 [23]. The value N corresponds to N-1 in TS 36.213 [23].</p>
<p><b>p-DAPS-Target</b> Indicates the guaranteed power for the target PCell during a DAPS handover as specified in TS 36.213 [23], Table 5.1.4.2-1. The value N corresponds to N-1 in TS 36.213 [23].</p>
<p><b>powerControlMode</b> Indicates the power control mode used in during a DAPS handover. Value 1 corresponds to DC power control mode 1 and value 2 indicates DC power control mode 2, as specified in TS 36.213 [23].</p>
<p><b>rach-ConfigDedicated</b> The dedicated random access parameters. If absent the UE applies contention based random access as specified in TS 36.321 [6].</p>
<p><b>rach-Skip</b> This field indicates whether random access procedure for the target PCell is skipped.</p>

<b>MobilityControlInfo field descriptions</b>
<p><b>additionalSpectrumEmission</b> For a UE with no SCells configured for UL in the same band as the PCell, the UE shall apply the value for the PCell instead of the corresponding value from <i>SystemInformationBlockType2</i> or <i>SystemInformationBlockType1</i>. For a UE with SCell(s) configured for UL in the same band as the PCell, the UE shall, in case all SCells configured for UL in that band are released after handover completion, apply the value for the PCell instead of the corresponding value from <i>SystemInformationBlockType2</i> or <i>SystemInformationBlockType1</i>. The UE requirements related to IE <i>AdditionalSpectrumEmission</i> are defined in TS 36.101 [42], table 6.2.4-1, for UEs neither in CE nor BL UEs, TS 36.101 [42], table 6.2.4E-1, for UEs in CE or BL UEs and TS 36.102 [113], table 6.2A.3-1, for NTN capable UE.</p>
<p><b>rach-SkipSCG</b> This field indicates whether random access procedure for the target PSCell is skipped.</p>
<p><b>sameSFN-Indication</b> This field indicates that the target cell has the same SFN as the source cell and that the BL UE or UE in CE is not required to acquire <i>MasterInformationBlock</i> in the target PCell during handover to obtain the SFN of the target cell, as specified in clause 5.3.5.4.</p>
<p><b>schedulingInfoSIB1-BR</b> Indicates the index to the tables that define <i>SystemInformationBlockType1-BR</i> scheduling information. The tables are specified in TS 36.213 [23], Table 7.1.6-1 and Table 7.1.7.2.7-1. Value 0 means <i>SystemInformationBlockType1-BR</i> is not scheduled. If absent when <i>sameSFN-Indication</i> is present, UE assumes that <i>SystemInformationBlockType1-BR</i> scheduling information in target cell may be different from source cell.</p>
<p><b>t304</b> Timer T304 as described in clause 7.3. ms50 corresponds with 50 ms, ms100 corresponds with 100 ms and so on. EUTRAN includes extended value <i>ms10000-v1310</i> only when UE supports CE.</p>
<p><b>t307</b> Timer T307 as described in clause 7.3. ms50 corresponds with 50 ms, ms100 corresponds with 100 ms and so on.</p>
<p><b>targetTA</b> This field refers to the timing adjustment indication, see TS 36.213 [23], indicating the <math>N_{TA}</math> value which the UE shall use for the target PTAG of handover or the target PSTAG of SCG change. <i>ta0</i> corresponds to <math>N_{TA}=0</math>. <i>mcg-PTAG</i> corresponds to the latest <math>N_{TA}</math> value of the PTAG associated with MCG. <i>scg-PTAG</i> corresponds to the latest <math>N_{TA}</math> value of the PTAG associated with SCG. <i>mcg-STAG</i> corresponds to the latest <math>N_{TA}</math> value of a MCG STAG indicated by the STAG-Id. <i>scg-STAG</i> corresponds to the latest <math>N_{TA}</math> value of a SCG STAG indicated by the STAG-Id.</p>
<p><b>ul-Bandwidth</b> Parameter: <i>Uplink bandwidth</i>, see TS 36.101 [42], table 5.6-1. For TDD, the parameter is absent and it is equal to downlink bandwidth. If absent for FDD, apply the same value as applies for the downlink bandwidth.</p>
<p><b>ul-Grant</b> Indicates the resources of the target PCell/PSCell to be used for the uplink transmission of PUSCH [23], clause 8.8.</p>
<p><b>ul-SchedInterval</b> Indicates the scheduling interval in uplink, see TS 36.321 [6], clause 5.20. Value in number of sub-frames. Value sf2 corresponds to 2 subframes, sf5 corresponds to 5 subframes and so on.</p>
<p><b>ul-StartSubframe</b> Indicates the subframe in which the UE may initiate the uplink transmission, see TS 36.321 [6], clause 5.20. Value 0 corresponds to subframe number 0, 1 corresponds to subframe number 1 and so on. The subframe indicating a valid uplink grant according to the calculation of UL grant configured by <i>ul-StartSubframe</i> and <i>ul-SchedInterval</i>, see TS 36.321 [6], clause 5.20, is the same across all radio frames.</p>
<p><b>v2x-CommRxPool</b> Indicates reception pools for receiving V2X sidelink communication during handover.</p>
<p><b>v2x-CommSyncConfig</b> Indicates synchronization configurations for performing V2X sidelink communication during handover.</p>
<p><b>v2x-CommTxPoolExceptional</b> Indicates the transmission resources by which the UE is allowed to transmit V2X sidelink communication during handover.</p>

Conditional presence	Explanation
<i>FDD</i>	The field is mandatory with default value (the default duplex distance defined for the concerned band, as specified in TS 36.101 [42]) in case of "FDD"; otherwise the field is not present.
<i>HO</i>	This field is optionally present, need OP, in case of handover within E-UTRA when the <i>fullConfig</i> is not included; otherwise the field is not present.
<i>HO-SFNsynced</i>	This field is optionally present, need OP, in case of source E-UTRA and target E-UTRA cells are SFN synchronised.
<i>HO-toEUTRA</i>	The field is mandatory present in case of inter-RAT handover to E-UTRA; otherwise the field is optionally present, need ON.
<i>HO-toEUTRA2</i>	The field is absent if <i>carrierFreq-v9e0</i> is present. Otherwise it is mandatory present in case of inter-RAT handover to E-UTRA and optionally present, need ON, in all other cases.
<i>NotFullConfigHO</i>	This field is optionally present, Need OR, in case of handover within E-UTRA when the <i>fullConfig</i> is not included in the <i>RRConnectionReconfiguration</i> message. Otherwise the field is not present.
<i>SCGEst</i>	This field is mandatory present in case of SCG establishment; otherwise the field is optionally present, need ON.

### – *MobilityParametersCDMA2000 (1xRTT)*

The *MobilityParametersCDMA2000* contains the parameters provided to the UE for handover and (enhanced) CSFB to 1xRTT support, as defined in C.S0097 [53].

#### ***MobilityParametersCDMA2000* information element**

```
-- ASN1START
MobilityParametersCDMA2000 ::= OCTET STRING
-- ASN1STOP
```

### – *MobilityStateParameters*

The IE *MobilityStateParameters* contains parameters to determine UE mobility state.

#### ***MobilityStateParameters* information element**

```
-- ASN1START
MobilityStateParameters ::= SEQUENCE {
    t-Evaluation      ENUMERATED {
        s30, s60, s120, s180, s240, spare3, spare2, spare1},
    t-HystNormal      ENUMERATED {
        s30, s60, s120, s180, s240, spare3, spare2, spare1},
    n-CellChangeMedium INTEGER (1..16),
    n-CellChangeHigh  INTEGER (1..16)
}
-- ASN1STOP
```

#### ***MobilityStateParameters* field descriptions**

##### ***n-CellChangeHigh***

The number of cell changes to enter high mobility state. Corresponds to  $N_{CR\_H}$  in TS 36.304 [4].

##### ***n-CellChangeMedium***

The number of cell changes to enter medium mobility state. Corresponds to  $N_{CR\_M}$  in TS 36.304 [4].

##### ***t-Evaluation***

The duration for evaluating criteria to enter mobility states. Corresponds to  $T_{CRmax}$  in TS 36.304 [4]. Value in seconds, s30 corresponds to 30 s and so on.

##### ***t-HystNormal***

The additional duration for evaluating criteria to enter normal mobility state. Corresponds to  $T_{CRmaxHyst}$  in TS 36.304 [4]. Value in seconds, s30 corresponds to 30 s and so on.

## – MultiBandInfoList

### MultiBandInfoList information element

```

-- ASN1START
MultiBandInfoList ::= SEQUENCE (SIZE (1..maxMultiBands)) OF FreqBandIndicator
MultiBandInfoList-v9e0 ::= SEQUENCE (SIZE (1..maxMultiBands)) OF MultiBandInfo-v9e0
MultiBandInfoList-v10j0 ::= SEQUENCE (SIZE (1..maxMultiBands)) OF NS-PmaxList-r10
MultiBandInfoList-v10l0 ::= SEQUENCE (SIZE (1..maxMultiBands)) OF NS-PmaxList-v10l0
MultiBandInfoList-r11 ::= SEQUENCE (SIZE (1..maxMultiBands)) OF FreqBandIndicator-r11
MultiBandInfo-v9e0 ::= SEQUENCE {
    freqBandIndicator-v9e0 FreqBandIndicator-v9e0 OPTIONAL -- Need OP
}
MultiBandInfoListAerial-r18 ::= SEQUENCE (SIZE (1..maxMultiBands)) OF MultiBandInfoAerial-r18
MultiBandInfoAerial-r18 ::= SEQUENCE {
    freqBandIndicatorAerial-r18 FreqBandIndicator-r11 OPTIONAL, -- Cond NotSIB3
    ns-PmaxListAerial-r18 NS-PmaxListAerial-r18 OPTIONAL -- Need OP
}
-- ASN1STOP

```

Conditional presence	Explanation
NotSIB3	The field is absent for SIB3. Otherwise it is optional, Need OR.

## – MultiFrequencyBandListNR

The IE MultiFrequencyBandListNR is used to configure a list of one or multiple NR frequency bands.

### MultiFrequencyBandListNR information element

```

-- ASN1START
MultiFrequencyBandListNR-r15 ::= SEQUENCE (SIZE (1..maxMultiBandsNR-r15)) OF
FreqBandIndicatorNR-r15
-- ASN1STOP

```

## – NS-PmaxList

The IE *NS-PmaxList* concerns a list of *additionalPmax* and *additionalSpectrumEmission*, as defined in TS 36.101 [42], table 6.2.4-1, for UEs neither in CE nor BL UEs, TS 36.101 [42], table 6.2.4E-1, for UEs in CE or BL UEs and TS 36.102 [113], table 6.2A.3-1, for NTN capable UE, for a given frequency band. E-UTRAN does not include the same value of *additionalSpectrumEmission* in *SystemInformationBlockType2* within this list. For a given frequency band, if *NS-PmaxListAerial* is absent, the value indicated by the *NS-PmaxList* for the same E-UTRA frequency band number applies, if present.

### NS-PmaxList information element

```

-- ASN1START
NS-PmaxList-r10 ::= SEQUENCE (SIZE (1..maxNS-Pmax-r10)) OF NS-PmaxValue-r10
NS-PmaxList-v10l0 ::= SEQUENCE (SIZE (1..maxNS-Pmax-r10)) OF NS-PmaxValue-v10l0
NS-PmaxListAerial-r18 ::= SEQUENCE (SIZE (1..maxNS-Pmax-r10)) OF NS-PmaxValueAerial-r18
NS-PmaxValue-r10 ::= SEQUENCE {
    additionalPmax-r10 P-Max OPTIONAL, -- Need OP
    additionalSpectrumEmission AdditionalSpectrumEmission
}

```

```

NS-PmaxValue-v1010 ::=          SEQUENCE {
    additionalSpectrumEmission-v1010  AdditionalSpectrumEmission-v1010  OPTIONAL  -- Need OP
}
NS-PmaxValueAerial-r18 ::=      SEQUENCE {
    additionalPmax-r18                 P-Max                            OPTIONAL,  -- Need OP
    additionalSpectrumEmission-r18     AdditionalSpectrumEmission-r18   OPTIONAL  -- Need OP
}
-- ASN1STOP

```

## – *NS-PmaxListNR*

The IE *NS-PmaxListNR* concerns a list of *additionalPmax* and *additionalSpectrumEmission*, as defined in TS 38.101-1 [85], clause 6, TS 38.101-2 [100], clause 6 and TS 38.101-5 [116], clause 6.2.3 for a given frequency band.

### ***NS-PmaxListNR* information element**

```

-- ASN1START
NS-PmaxListNR-r15 ::=          SEQUENCE (SIZE (1..8)) OF NS-PmaxValueNR-r15
NS-PmaxValueNR-r15 ::=        SEQUENCE {
    additionalPmaxNR-r15          P-MaxNR-r15                      OPTIONAL,  -- Need ON
    additionalSpectrumEmissionNR-r15  AdditionalSpectrumEmissionNR-r15
}
NS-PmaxListNR-v1760 ::=       SEQUENCE (SIZE (1..8)) OF NS-PmaxValueNR-v1760
NS-PmaxValueNR-v1760 ::=      SEQUENCE {
    additionalSpectrumEmissionNR-v1760  AdditionalSpectrumEmissionNR-v1760  OPTIONAL  -- Need OR
}
NS-PmaxListNR-Aerial-r18 ::=  SEQUENCE (SIZE (1..8)) OF NS-PmaxValueNR-Aerial-r18
NS-PmaxValueNR-Aerial-r18 ::= SEQUENCE {
    additionalPmaxNR-r18            P-MaxNR-r15                      OPTIONAL,  -- Need OP
    additionalSpectrumEmissionNR-r18  AdditionalSpectrumEmissionNR-r18  OPTIONAL  -- Need OP
}
-- ASN1STOP

```

## – *PhysCellId*

The IE *PhysCellId* is used to indicate the physical layer identity of the cell, as defined in TS 36.211 [21].

### ***PhysCellId* information element**

```

-- ASN1START
PhysCellId ::=                INTEGER (0..503)
-- ASN1STOP

```

## – *PhysCellIdCDMA2000*

The IE *PhysCellIdCDMA2000* identifies the PNOffset that represents the "Physical cell identity" in CDMA2000.

### ***PhysCellIdCDMA2000* information element**

```

-- ASN1START
PhysCellIdCDMA2000 ::=        INTEGER (0..maxPNOffset)
-- ASN1STOP

```

## – *PhysCellIdGERAN*

The IE *PhysCellIdGERAN* contains the Base Station Identity Code (BSIC).

### ***PhysCellIdGERAN* information element**

```
-- ASN1START
PhysCellIdGERAN ::=          SEQUENCE {
    networkColourCode          BIT STRING (SIZE (3)),
    baseStationColourCode      BIT STRING (SIZE (3))
}
-- ASN1STOP
```

#### ***PhysCellIdGERAN* field descriptions**

##### ***baseStationColourCode***

Base station Colour Code as defined in TS 23.003 [27].

##### ***networkColourCode***

Network Colour Code as defined in TS 23.003 [27].

## – *PhysCellIdNR*

The IE *PhysCellIdNR* indicates the physical layer identity (PCI) of an NR cell.

### ***PhysCellIdNR* information element**

```
-- ASN1START
PhysCellIdNR-r15 ::=          INTEGER (0.. 1007)
-- ASN1STOP
```

## – *PhysCellIdRange*

The IE *PhysCellIdRange* is used to encode either a single or a range of physical cell identities. The range is encoded by using a *start* value and by indicating the number of consecutive physical cell identities (including *start*) in the range. For fields comprising multiple occurrences of *PhysCellIdRange*, E-UTRAN may configure overlapping ranges of physical cell identities.

### ***PhysCellIdRange* information element**

```
-- ASN1START
PhysCellIdRange ::=          SEQUENCE {
    start                      PhysCellId,
    range                      ENUMERATED {
        n4, n8, n12, n16, n24, n32, n48, n64, n84,
        n96, n128, n168, n252, n504, spare2,
        spare1}                OPTIONAL    -- Need OP
}
-- ASN1STOP
```

#### ***PhysCellIdRange* field descriptions**

##### ***range***

Indicates the number of physical cell identities in the range (including *start*). Value n4 corresponds with 4, n8 corresponds with 8 and so on. The UE shall apply value 1 in case the field is absent, in which case only the physical cell identity value indicated by *start* applies.

##### ***start***

Indicates the lowest physical cell identity in the range.

## – *PhysCellIdRangeNR*

The IE *PhysCellIdRangeNR* is used to encode either a single or a range of physical layer identities of NR cells. The range is encoded by using a *start* value and by indicating the number of consecutive physical layer identities (including *start*) in the range. For fields comprising multiple occurrences of *PhysCellIdRangeNR*, E-UTRAN may configure overlapping ranges of physical layer identities.

### *PhysCellIdRangeNR* information element

```
-- ASN1START
PhysCellIdRangeNR-r16 ::= SEQUENCE {
    start          PhysCellIdNR-r15,
    range          ENUMERATED {
        n4, n8, n12, n16, n24, n32, n48, n64, n84,
        n96, n128, n168, n252, n504, n1008,
        spare1}          OPTIONAL -- Need OP
}
-- ASN1STOP
```

#### *PhysCellIdRangeNR* field descriptions

##### **range**

Indicates the number of physical layer identities in the range (including *start*). Value n4 corresponds with 4, n8 corresponds with 8 and so on. The UE shall apply value 1 in case the field is absent, in which case only the physical layer identity value indicated by *start* applies.

##### **start**

Indicates the lowest physical layer identity in the range.

## – *PhysCellIdRangeUTRA-FDDList*

The IE *PhysCellIdRangeUTRA-FDDList* is used to encode one or more of *PhysCellIdRangeUTRA-FDD*. While the IE *PhysCellIdRangeUTRA-FDD* is used to encode either a single physical layer identity or a range of physical layer identities, i.e. primary scrambling codes. Each range is encoded by using a *start* value and by indicating the number of consecutive physical cell identities (including *start*) in the range.

### *PhysCellIdRangeUTRA-FDDList* information element

```
-- ASN1START
PhysCellIdRangeUTRA-FDDList-r9 ::= SEQUENCE (SIZE (1..maxPhysCellIdRange-r9)) OF
PhysCellIdRangeUTRA-FDD-r9
PhysCellIdRangeUTRA-FDD-r9 ::= SEQUENCE {
    start-r9      PhysCellIdUTRA-FDD,
    range-r9      INTEGER (2..512)          OPTIONAL -- Need OP
}
-- ASN1STOP
```

#### *PhysCellIdRangeUTRA-FDDList* field descriptions

##### **range**

Indicates the number of primary scrambling codes in the range (including *start*). The UE shall apply value 1 in case the field is absent, in which case only the primary scrambling code value indicated by *start* applies.

##### **start**

Indicates the lowest primary scrambling code in the range.

## – *PhysCellIdUTRA-FDD*

The IE *PhysCellIdUTRA-FDD* is used to indicate the physical layer identity of the cell, i.e. the primary scrambling code, as defined in TS 25.331 [19].

**PhysCellIdUTRA-FDD information element**

```
-- ASN1START
PhysCellIdUTRA-FDD ::=                INTEGER (0..511)
-- ASN1STOP
```

**PhysCellIdUTRA-TDD**

The IE *PhysCellIdUTRA-TDD* is used to indicate the physical layer identity of the cell, i.e. the cell parameters ID (TDD), as specified in TS 25.331 [19]. Also corresponds to the Initial Cell Parameter Assignment in TS 25.223 [46].

**PhysCellIdUTRA-TDD information element**

```
-- ASN1START
PhysCellIdUTRA-TDD ::=                INTEGER (0..127)
-- ASN1STOP
```

**PLMN-Identity**

The IE *PLMN-Identity* identifies a Public Land Mobile Network. Further information regarding how to set the IE are specified in TS 23.003 [27].

**PLMN-Identity information element**

```
-- ASN1START
PLMN-Identity ::=                     SEQUENCE {
    mcc                                MCC                                OPTIONAL,                -- Cond MCC
    mnc                                MNC
}
MCC ::=                               SEQUENCE (SIZE (3)) OF
    MCC-MNC-Digit
MNC ::=                               SEQUENCE (SIZE (2..3)) OF
    MCC-MNC-Digit
MCC-MNC-Digit ::=                    INTEGER (0..9)
-- ASN1STOP
```

**PLMN-Identity field descriptions****mcc**

The first element contains the first MCC digit, the second element the second MCC digit and so on. If the field is absent, it takes the same value as the mcc of the immediately preceding IE *PLMN-Identity*. See TS 23.003 [27].

**mnc**

The first element contains the first MNC digit, the second element the second MNC digit and so on. See TS 23.003 [27].

Conditional presence	Explanation
MCC	This IE is mandatory when <i>PLMN-Identity</i> is included in <i>CellGlobalIdEUTRA</i> , in <i>CellGlobalIdUTRA</i> , in <i>CellGlobalIdGERAN</i> or in <i>RegisteredMME</i> . This IE is also mandatory in the first occurrence of the IE <i>PLMN-Identity</i> within the IE <i>PLMN-IdentityList</i> . Otherwise it is optional, need OP.

**PLMN-IdentityList3**

Includes a list of PLMN identities.



**PLMN-IdentityList3 information element**

```
-- ASN1START
PLMN-IdentityList3-r11 ::=          SEQUENCE (SIZE (1..16)) OF PLMN-Identity
-- ASN1STOP
```

– ***PmaxNR***

The IE *PmaxNR* concerns a list of *additionalPmax* and *additionalSpectrumEmission*, as defined in TS 38.101 [85], table 6.2.3-1 for a given frequency band.

***PmaxNR* information element**

```
-- ASN1START
P-MaxNR-r15 ::=          INTEGER (-30..33)
-- ASN1STOP
```

– ***PreRegistrationInfoHRPD***

```
-- ASN1START
PreRegistrationInfoHRPD ::=          SEQUENCE {
    preRegistrationAllowed          BOOLEAN,
    preRegistrationZoneId          PreRegistrationZoneIdHRPD    OPTIONAL, -- cond PreRegAllowed
    secondaryPreRegistrationZoneIdList SecondaryPreRegistrationZoneIdListHRPD  OPTIONAL -- Need OR
}
SecondaryPreRegistrationZoneIdListHRPD ::= SEQUENCE (SIZE (1..2)) OF PreRegistrationZoneIdHRPD
PreRegistrationZoneIdHRPD ::=          INTEGER (0..255)
-- ASN1STOP
```

***PreRegistrationInfoHRPD* field descriptions*****preRegistrationAllowed***

TRUE indicates that a UE shall perform a CDMA2000 HRPD pre-registration if the UE does not have a valid / current pre-registration. FALSE indicates that the UE is not allowed to perform CDMA2000 HRPD pre-registration in the current cell.

***preRegistrationZoneId***

ColorCode (see C.S0024 [26], C.S0087 [44]) of the CDMA2000 Reference Cell corresponding to the HRPD sector under the HRPD AN that is configured for this LTE cell. It is used to control when the UE should register or re-register.

***secondaryPreRegistrationZoneIdList***

List of SecondaryColorCodes (see C.S0024 [26], C.S0087 [44]) of the CDMA2000 Reference Cell corresponding to the HRPD sector under the HRPD AN that is configured for this LTE cell. They are used to control when the UE should re-register.

Conditional presence	Explanation
<i>PreRegAllowed</i>	The field is mandatory in case the <i>preRegistrationAllowed</i> is set to <i>true</i> . Otherwise the field is not present and the UE shall delete any existing value for this field.

– ***Q-QualMin***

The IE *Q-QualMin* is used to indicate for cell selection/ re-selection the required minimum received RSRQ level in the (E-UTRA) cell. Corresponds to parameter  $Q_{qualmin}$  in TS 36.304 [4]. Actual value  $Q_{qualmin}$  = field value [dB].

***Q-QualMin* information element**

```
-- ASN1START
```

```
Q-QualMin-r9 ::=
    INTEGER (-34..-3)
-- ASN1STOP
```

### – *Q-RxLevMin*

The IE *Q-RxLevMin* is used to indicate for cell selection/ re-selection the required minimum received RSRP level in the (E-UTRA) cell. Corresponds to parameter  $Q_{rxlevmin}$  in TS 36.304 [4]. Actual value  $Q_{rxlevmin} = \text{field value} * 2$  [dBm].

#### **Q-RxLevMin information element**

```
-- ASN1START
Q-RxLevMin ::=
    INTEGER (-70..-22)
-- ASN1STOP
```

### – *Q-OffsetRange*

The IE *Q-OffsetRange* is used to indicate a cell, CSI-RS resource or frequency specific offset to be applied when evaluating candidates for cell re-selection or when evaluating triggering conditions for measurement reporting. The value in dB. Value dB-24 corresponds to -24 dB, dB-22 corresponds to -22 dB and so on.

#### **Q-OffsetRange information element**

```
-- ASN1START
Q-OffsetRange ::=
    ENUMERATED {
        dB-24, dB-22, dB-20, dB-18, dB-16, dB-14,
        dB-12, dB-10, dB-8, dB-6, dB-5, dB-4, dB-3,
        dB-2, dB-1, dB0, dB1, dB2, dB3, dB4, dB5,
        dB6, dB8, dB10, dB12, dB14, dB16, dB18,
        dB20, dB22, dB24}
-- ASN1STOP
```

### – *Q-OffsetRangeInterRAT*

The IE *Q-OffsetRangeInterRAT* is used to indicate a frequency specific offset to be applied when evaluating triggering conditions for measurement reporting. The value in dB.

#### **Q-OffsetRangeInterRAT information element**

```
-- ASN1START
Q-OffsetRangeInterRAT ::=
    INTEGER (-15..15)
-- ASN1STOP
```

### – *ReselectionThreshold*

The IE *ReselectionThreshold* is used to indicate an Rx level threshold for cell reselection. Actual value of threshold = field value \* 2 [dB].

#### **ReselectionThreshold information element**

```
-- ASN1START
ReselectionThreshold ::=
    INTEGER (0..31)
-- ASN1STOP
```

## – *ReselectionThresholdQ*

The IE *ReselectionThresholdQ* is used to indicate a quality level threshold for cell reselection. Actual value of threshold = field value [dB].

### **ReselectionThresholdQ information element**

```
-- ASN1START
ReselectionThresholdQ-r9 ::=          INTEGER (0..31)
-- ASN1STOP
```

## – *RSS-ConfigCarrierInfo*

The IE *RSS-ConfigCarrierInfo* contains RSS configuration for a carrier.

### **RSS-ConfigCarrierInfo information element**

```
-- ASN1START
RSS-ConfigCarrierInfo-r16 ::= SEQUENCE {
    narrowbandIndex-r16          BIT STRING (SIZE (1..maxAvailNarrowBands-1-r16)),
    timeOffsetGranularity-r16  ENUMERATED {g1, g2, g4, g8, g16, g32, g64, g128}
}
-- ASN1STOP
```

### **RSS-ConfigCarrierInfo field descriptions**

#### ***narrowbandIndex***

Bitmap containing narrowbands used for RSS deployment in the carrier. Narrowbands including central 6 PRBs are excluded from the bitmap. The RSS Cell Frequency Location of a specific cell is determined according to  $I_{RSS} = PCID \text{ MOD } (3N_{NB})$  where  $I_{RSS}$  is the index of possible RSS frequency locations starting with the lowest location and  $N_{NB}$  is the number of narrowbands, determined from *narrowbandIndex*, such that there are three non-overlapping RSS locations in each narrowband.

#### ***timeOffsetGranularity***

RSS Time Offset granularity ( $G_{RSS}$ ). Value *g1* corresponds to 1 frame, value *g2* corresponds to 2 frames, and so on. Only the following values of  $G_{RSS}$  are applicable depending on the serving cell RSS periodicity ( $P_{RSS}$ ) given by parameter *periodicity* in *ce-RSS-Config-r15*:

$G_{RSS} = \{1, 2, 4, 8, 16\}$  frames for  $P_{RSS} = 160$  ms

$G_{RSS} = \{1, 2, 4, 8, 16, 32\}$  frames for  $P_{RSS} = 320$  ms

$G_{RSS} = \{2, 4, 8, 16, 32, 64\}$  frames for  $P_{RSS} = 640$  ms

$G_{RSS} = \{4, 8, 16, 32, 64, 128\}$  frames for  $P_{RSS} = 1280$  ms.

The actual RSS time offset of a specific cell ( $O_{RSS}$ , see TS 36.211 [21] clause 6.11.3.2) in SFN radio frames is given by  $(X_{RSS} \times G_{RSS}) + \Delta_{RSS}$  where:

- $X_{RSS}$  is determined based on its PCID using  $X_{RSS} = \text{FLOOR}(PCID / (3N_{NB}))$  modulo  $M_{RSS}$ , and distributed across  $M_{RSS}$  time locations per  $P_{RSS}$  such that  $M_{RSS} = P_{RSS} / (10 \times G_{RSS})$ ; and
- $\Delta_{RSS}$  is calculated by using the serving cell  $X_{RSS}$  (i.e., based on serving cell PCID and parameters given in *ce-RSS-Config-r15*) such that serving cell  $O_{RSS} = (X_{RSS} \times G_{RSS}) + \Delta_{RSS}$ .

## – *RSS-MeasPowerBias*

The IE *RSS-MeasPowerBias* indicates power bias in dB relative to Qoffset of neighbour cell CRS. Value *dB-6* corresponds to -6 dB, value *dB-3* corresponds to -3 dB and so on. Value *rssNotUsed* indicates measurement based on RSS is not applicable for the corresponding neighbour cell.

### **RSS-MeasPowerBias information element**

```
-- ASN1START
RSS-MeasPowerBias-r16 ::= ENUMERATED {dB-6, dB-3, dB0, dB3, dB6, dB9, dB12, rssNotUsed}
-- ASN1STOP
```

## – *SCellIndex*

The IE *SCellIndex* concerns a short identity, used to identify an SCell.

### **SCellIndex information element**

```
-- ASN1START
SCellIndex-r10 ::=          INTEGER (1..7)
SCellIndex-r13 ::=          INTEGER (1..31)
-- ASN1STOP
```

## – *ServCellIndex*

The IE *ServCellIndex* concerns a short identity, used to identify a serving cell (i.e. the PCell or an SCell). Value 0 applies for the PCell, while the *SCellIndex* that has previously been assigned applies for SCells.

### **ServCellIndex information element**

```
-- ASN1START
ServCellIndex-r10 ::=      INTEGER (0..7)
ServCellIndex-r13 ::=      INTEGER (0..31)
-- ASN1STOP
```

## – *SpeedStateScaleFactors*

The IE *SpeedStateScaleFactors* concerns factors, to be applied when the UE is in medium or high speed state, used for scaling a mobility control related parameter.

### **SpeedStateScaleFactors information element**

```
-- ASN1START
SpeedStateScaleFactors ::= SEQUENCE {
    sf-Medium      ENUMERATED {oDot25, oDot5, oDot75, lDot0},
    sf-High        ENUMERATED {oDot25, oDot5, oDot75, lDot0}
}
-- ASN1STOP
```

#### **SpeedStateScaleFactors field descriptions**

##### ***sf-High***

The concerned mobility control related parameter is multiplied with this factor if the UE is in High Mobility state as defined in TS 36.304 [4]. Value oDot25 corresponds to 0.25, oDot5 corresponds to 0.5, oDot75 corresponds to 0.75 and so on.

##### ***sf-Medium***

The concerned mobility control related parameter is multiplied with this factor if the UE is in Medium Mobility state as defined in TS 36.304 [4]. Value oDot25 corresponds to 0.25, oDot5 corresponds to 0.5, oDot75 corresponds to 0.75 and so on.

## – *SystemInfoListGERAN*

The IE *SystemInfoListGERAN* contains system information of a GERAN cell.

### **SystemInfoListGERAN information element**

```
-- ASN1START
SystemInfoListGERAN ::= SEQUENCE (SIZE (1..maxGERAN-SI)) OF
```

OCTET STRING (SIZE (1..23))

-- ASN1STOP

**SystemInfoListGERAN field descriptions**

**SystemInfoListGERAN**

Each OCTET STRING contains one System Information (SI) message as defined in TS 44.018 [45], table 9.1.1, excluding the L2 Pseudo Length, the RR management Protocol Discriminator and the Skip Indicator or a complete Packet System Information (PSI) message as defined in TS 44.060 [36], table 11.2.1.

**SystemTimeInfoCDMA2000**

The IE *SystemTimeInfoCDMA2000* informs the UE about the absolute time in the current cell. The UE uses this absolute time knowledge to derive the CDMA2000 Physical cell identity, expressed as PNOffset, of neighbour CDMA2000 cells.

NOTE: The UE needs the CDMA2000 system time with a certain level of accuracy for performing measurements as well as for communicating with the CDMA2000 network (HRPD or 1xRTT).

**SystemTimeInfoCDMA2000 information element**

```
-- ASN1START
SystemTimeInfoCDMA2000 ::= SEQUENCE {
    cdma-EUTRA-Synchronisation    BOOLEAN,
    cdma-SystemTime               CHOICE {
        synchronousSystemTime     BIT STRING (SIZE (39)),
        asynchronousSystemTime    BIT STRING (SIZE (49))
    }
}
-- ASN1STOP
```

**SystemTimeInfoCDMA2000 field descriptions**

**asynchronousSystemTime**

The CDMA2000 system time corresponding to the SFN boundary at or after the ending boundary of the SI-Window in which *SystemInformationBlockType8* is transmitted. E-UTRAN includes this field if the E-UTRA frame boundary is not aligned to the start of CDMA2000 system time. This field size is 49 bits and the unit is 8 CDMA chips based on 1.2288 Mcps.

**cdma-EUTRA-Synchronisation**

TRUE indicates that there is no drift in the timing between E-UTRA and CDMA2000. FALSE indicates that the timing between E-UTRA and CDMA2000 can drift. NOTE 1

**synchronousSystemTime**

CDMA2000 system time corresponding to the SFN boundary at or after the ending boundary of the SI-window in which *SystemInformationBlockType8* is transmitted. E-UTRAN includes this field if the E-UTRA frame boundary is aligned to the start of CDMA2000 system time. This field size is 39 bits and the unit is 10 ms based on a 1.2288 Mcps chip rate.

NOTE 1: The following table shows the recommended combinations of the *cdma-EUTRA-Synchronisation* field and the choice of *cdma-SystemTime* included by E-UTRAN for FDD and TDD:

FDD/TDD	<i>cdma-EUTRA-Synchronisation</i>	<i>synchronousSystemTime</i>	<i>asynchronousSystemTime</i>
FDD	FALSE	Not Recommended	Recommended
FDD	TRUE	Recommended	Recommended
TDD	FALSE	Not Recommended	Recommended
TDD	TRUE	Recommended	Recommended

## – *ThresholdNR*

The IE *ThresholdNR* and IE *ThresholdListNR* contain thresholds for NR related inter-RAT measurements.

### ***ThresholdNR* information element**

```
-- ASN1START
ThresholdNR-r15 ::= CHOICE{
  nr-RSRP-r15          RSRP-RangeNR-r15,
  nr-RSRQ-r15          RSRQ-RangeNR-r15,
  nr-SINR-r15          RS-SINR-RangeNR-r15
}
ThresholdListNR-r15 ::= SEQUENCE{
  nr-RSRP-r15          RSRP-RangeNR-r15          OPTIONAL, -- Need OR
  nr-RSRQ-r15          RSRQ-RangeNR-r15          OPTIONAL, -- Need OR
  nr-SINR-r15          RS-SINR-RangeNR-r15      OPTIONAL -- Need OR
}
-- ASN1STOP
```

## – *TLE-EphemerisParameters*

The IE *TLE-EphemerisParameters* provides satellite ephemeris parameters based on the CCSDS orbit mean-elements message (OMM) format, see [111]. The reference frame for SGP4 propagator and SGP4 parameter generation is TEME as per the NORAD Space Track standard.

### ***TLE-EphemerisParameters* information element**

```
-- ASN1START
TLE-EphemerisParameters-r17 ::= SEQUENCE {
  inclination-r17          INTEGER (0..2097151),
  argumentPerigee-r17     INTEGER (0..4194303),
  rightAscension-r17      INTEGER (0..4194303),
  meanAnomaly-r17        INTEGER (0..4194303),
  eccentricity-r17        INTEGER (0..16777215),
  meanMotion-r17         INTEGER (0..17179869183),
  bStarDecimal-r17        INTEGER (-99999..99999),
  bStarExponent-r17       INTEGER (-9..9),
  epochStar-r17          INTEGER (-1048575..1048575)
}
-- ASN1STOP
```

<i>TLE-EphemerisParameters</i> field descriptions
<p><b>argumentPerigee</b> Argument of perigee, see [111] Table 4-3: OMM Data. Unit in degree. Step of 360 / 4194303 degree. Actual value = field value * (360 / 4194303).</p>
<p><b>bStarDecimal</b> Decimal part of B*, see [111] Table 4-3: OMM Data. Unit in inverse Earth radii. Step of 0.00001 . Actual value = field value * 0.00001.</p>
<p><b>bStarExponent</b> Exponent part of B*, see [111] Table 4-3: OMM Data.</p>
<p><b>eccentricity</b> Eccentricity, see [111] Table 4-3: OMM Data. Step of 0.9999999 / 16777215. Actual value = field value * (0.9999999 / 16777215).</p>
<p><b>epochStar</b> Time offset to the beginning of the current week (Monday 00:00:00 UTC) of the Epoch. Unit in second.</p>
<p><b>inclination</b> Inclination, see [111] Table 4-3: OMM Data. Unit in degree. Step of 180 / 2097151 degree. Actual value = field value * (180 / 2097151).</p>
<p><b>meanAnomaly</b> Mean anomaly at epoch time, see [111] Table 4-3: OMM Data. Unit in degree. Step of 360 / 4194303 degree. Actual value = field value * (360 / 4194303).</p>
<p><b>meanMotion</b> Mean motion at epoch time, see [111] Table 4-3: OMM Data]. Unit in revolution/day. Step of 99.99999999 / 17179869183 rev/day. Actual value = field value * (99.99999999 / 17179869183).</p>
<p><b>rightAscension</b> Right ascension of ascending node, see [111] Table 4-3: OMM Data. Unit in degree. Step of 360 / 4194303 degree. Actual value = field value * (360 / 4194303).</p>

## – *TrackingAreaCode*

The IE *TrackingAreaCode* is used to identify a tracking area within the scope of a PLMN, see TS 24.301 [35].

### ***TrackingAreaCode* information element**

```
-- ASN1START
TrackingAreaCode ::=                BIT STRING (SIZE (16))
TrackingAreaCode-5GC-r15 ::=       BIT STRING (SIZE (24))
-- ASN1STOP
```

## – *T-Reselection*

The IE *T-Reselection* concerns the cell reselection timer  $T_{reselction_{RAT}}$  for E-UTRA, UTRA, GERAN or CDMA2000. Value in seconds. For value 0, behaviour as specified in 7.3.2 applies.

### ***T-Reselection* information element**

```
-- ASN1START
T-Reselection ::=                   INTEGER (0..7)
-- ASN1STOP
```

## – *T-ReselectionEUTRA-CE*

The IE *T-ReselectionEUTRA-CE* concerns the cell reselection timer  $T_{reselction_{EUTRA\_CE}}$  as specified in TS 36.304 [4]. Value in seconds. For value 0, behaviour as specified in 7.3.2 applies.

### ***T-ReselectionEUTRA-CE* information element**

```
-- ASN1START
T-ReselectionEUTRA-CE-r13 ::=      INTEGER (0..15)
-- ASN1STOP
```

```
-- ASN1STOP
```

## 6.3.5 Measurement information elements

### – *AllowedMeasBandwidth*

The IE *AllowedMeasBandwidth* is used to indicate the maximum allowed measurement bandwidth on a carrier frequency as defined by the parameter Transmission Bandwidth Configuration "N<sub>RB</sub>" TS 36.104 [47]. The values mbw6, mbw15, mbw25, mbw50, mbw75, mbw100 indicate 6, 15, 25, 50, 75 and 100 resource blocks respectively.

#### **AllowedMeasBandwidth information element**

```
-- ASN1START
AllowedMeasBandwidth ::=          ENUMERATED {mbw6, mbw15, mbw25, mbw50, mbw75, mbw100}
-- ASN1STOP
```

### – *BT-NameList*

The IE *BT-NameList* is used to indicate the names of the Bluetooth beacon which the UE is configured to measure.

#### **BT-NameList information element**

```
-- ASN1START
BT-NameListConfig-r15 ::=          CHOICE{
  release          NULL,
  setup            BT-NameList-r15
}
BT-NameList-r15 ::=                SEQUENCE (SIZE (1..maxBT-Name-r15)) OF BT-Name-r15
BT-Name-r15 ::=                    OCTET STRING (SIZE (1..248))
-- ASN1STOP
```

#### **BT-NameList field descriptions**

##### ***bt-Name***

If configured, the UE only performs Bluetooth measurements according to the names identified. For each name, it refers to LOCAL NAME defined in Bluetooth specification [93].

### – *CSI-RSRP-Range*

The IE *CSI-RSRP-Range* specifies the value range used in CSI-RSRP measurements and thresholds. Integer value for CSI-RSRP measurements according to mapping table in TS 36.133 [16].

#### **CSI-RSRP-Range information element**

```
-- ASN1START
CSI-RSRP-Range-r12 ::=             INTEGER(0..97)
-- ASN1STOP
```

### – *Hysteresis*

The IE *Hysteresis* is a parameter used within the entry and leave condition of an event triggered reporting condition. The actual value is field value \* 0.5 dB, except if included in *reportConfigEUTRA* and associated to *eventV1* or *eventV2*. If included in *reportConfigEUTRA* and associated to *eventV1* or *eventV2*, the actual value is field value divided by 100.



**Hysteresis information element**

```
-- ASN1START
Hysteresis ::= INTEGER (0..30)
-- ASN1STOP
```

– **HysteresisLocation**

The IE *HysteresisLocation* is a parameter used within entry and leave condition of a location-based measurement report triggering event or conditional event. The actual value is field value \* 10 meters.

**HysteresisLocation information element**

```
-- ASN1START
HysteresisLocation-r18 ::= INTEGER (0..32767)
-- ASN1STOP
```

– **LocationInfo**

The IE *LocationInfo* is used to transfer detailed location information available at the UE to correlate measurements and UE position information.

**LocationInfo information element**

```
-- ASN1START
LocationInfo-r10 ::= SEQUENCE {
  locationCoordinates-r10 CHOICE {
    ellipsoidPoint-r10 OCTET STRING,
    ellipsoidPointWithAltitude-r10 OCTET STRING,
    ...,
    ellipsoidPointWithUncertaintyCircle-r11 OCTET STRING,
    ellipsoidPointWithUncertaintyEllipse-r11 OCTET STRING,
    ellipsoidPointWithAltitudeAndUncertaintyEllipsoid-r11 OCTET STRING,
    ellipsoidArc-r11 OCTET STRING,
    polygon-r11 OCTET STRING
  },
  horizontalVelocity-r10 OCTET STRING OPTIONAL,
  gnss-TOD-msec-r10 OCTET STRING OPTIONAL,
  ...,
  [[ verticalVelocityInfo-r15 CHOICE {
    verticalVelocity-r15 OCTET STRING,
    verticalVelocityAndUncertainty-r15 OCTET STRING
  }
  ]]
}
-- ASN1STOP
```

<b>LocationInfo field descriptions</b>
<b>ellipsoidArc</b> Parameter <i>EllipsoidArc</i> defined in TS 36.355 [54]. The first/leftmost bit of the first octet contains the most significant bit.
<b>ellipsoid-Point</b> Parameter <i>Ellipsoid-Point</i> defined in TS 36.355 [54]. The first/leftmost bit of the first octet contains the most significant bit.
<b>ellipsoidPointWithAltitude</b> Parameter <i>EllipsoidPointWithAltitude</i> defined in TS 36.355 [54]. The first/leftmost bit of the first octet contains the most significant bit.
<b>ellipsoidPointWithAltitudeAndUncertaintyEllipsoid</b> Parameter <i>EllipsoidPointWithAltitudeAndUncertaintyEllipsoid</i> defined in TS 36.355 [54]. The first/leftmost bit of the first octet contains the most significant bit.
<b>ellipsoidPointWithUncertaintyCircle</b> Parameter <i>Ellipsoid-PointWithUncertaintyCircle</i> defined in TS 36.355 [54]. The first/leftmost bit of the first octet contains the most significant bit.
<b>ellipsoidPointWithUncertaintyEllipse</b> Parameter <i>EllipsoidPointWithUncertaintyEllipse</i> defined in TS 36.355 [54]. The first/leftmost bit of the first octet contains the most significant bit.
<b>gnss-TOD-msec</b> Parameter <i>Gnss-TOD-msec</i> defined in TS 36.355 [54]. The first/leftmost bit of the first octet contains the most significant bit.
<b>horizontalVelocity</b> Parameter <i>HorizontalVelocity</i> defined in TS 36.355 [54]. The first/leftmost bit of the first octet contains the most significant bit.
<b>polygon</b> Parameter <i>Polygon</i> defined in TS 36.355 [54]. The first/leftmost bit of the first octet contains the most significant bit.
<b>verticalVelocityAndUncertainty</b> Parameter <i>verticalVelocityAndUncertainty</i> corresponds to <i>horizontalWithVerticalVelocityAndUncertainty</i> defined in TS 36.355 [54]. The first/leftmost bit of the first octet contains the most significant bit.
<b>verticalVelocity</b> Parameter <i>verticalVelocity</i> corresponds to <i>horizontalWithVerticalVelocity</i> defined in TS 36.355 [54]. The first/leftmost bit of the first octet contains the most significant bit.

## – *LogMeasResultListBT*

The IE *LogMeasResultListBT* covers measured results for Bluetooth.

### **LogMeasResultListBT information element**

```

-- ASN1START
LogMeasResultListBT-r15 ::= SEQUENCE (SIZE (1..maxBT-IdReport-r15)) OF LogMeasResultBT-r15
LogMeasResultBT-r15 ::= SEQUENCE {
    bt-Addr-r15          BIT STRING (SIZE (48)),
    rssi-BT-r15         INTEGER (-128..127)          OPTIONAL,
    ...
}
-- ASN1STOP

```

<b>LogMeasResultListBT field descriptions</b>
<b>bt-Addr</b> This field indicates the Bluetooth public address of the Bluetooth beacon as defined in TS 36.355 [54].
<b>rssi-BT</b> This field provides the beacon received signal strength indicator (RSSI) in dBm as defined in TS 36.355 [54].

## – *LogMeasResultListWLAN*

The IE *LogMeasResultListWLAN* covers measured results for WLAN.

**LogMeasResultListWLAN information element**

```

-- ASN1START
LogMeasResultListWLAN-r15 ::= SEQUENCE (SIZE (1..maxWLAN-Id-Report-r14)) OF LogMeasResultWLAN-r15
LogMeasResultWLAN-r15 ::= SEQUENCE {
    wlan-Identifiers-r15          WLAN-Identifiers-r12,
    rssiWLAN-r15                 WLAN-RSSI-Range-r13          OPTIONAL,
    rtt-WLAN-r15                 WLAN-RTT-r15                 OPTIONAL,
    ...
}
-- ASN1STOP

```

**LogMeasResultListWLAN field descriptions****rssiWLAN**

Measured WLAN RSSI result in dBm.

**rtt-WLAN**

This field provides the measured round trip time between the target device and WLAN AP and optionally the accuracy expressed as the standard deviation of the delay. Units for each of these are 1000ns, 100ns, 10ns, 1ns, and 0.1ns as defined in TS 36.355 [54].

**wlan-Identifiers**

Indicates the WLAN parameters used for identification of the WLAN for which the measurement results are applicable.

– **MaxRS-IndexCellQualNR**

The IE *MaxRS-IndexCellQualNR* indicates the maximum number of RS indices to be considered/ averaged to derive the cell quality for RRM.

**MaxRS-IndexCellQualNR information element**

```

-- ASN1START
MaxRS-IndexCellQualNR-r15 ::= INTEGER (1..maxRS-IndexCellQual-r15)
-- ASN1STOP

```

– **MBSFN-RSRQ-Range**

The IE *MBSFN-RSRQ-Range* specifies the value range used in MBSFN RSRQ measurements. Integer value for MBSFN RSRQ measurements according to mapping table in TS 36.133 [16].

**MBSFN-RSRQ-Range information element**

```

-- ASN1START
MBSFN-RSRQ-Range-r12 ::= INTEGER(0..31)
-- ASN1STOP

```

– **MeasConfig**

The IE *MeasConfig* specifies measurements to be performed by the UE, and covers intra-frequency, inter-frequency and inter-RAT mobility as well as configuration of measurement gaps.

**MeasConfig information element**

```

-- ASN1START
MeasConfig ::= SEQUENCE {
    -- Measurement objects
    measObjectToRemoveList      MeasObjectToRemoveList      OPTIONAL, -- Need ON
    measObjectToAddModList     MeasObjectToAddModList     OPTIONAL, -- Need ON
    -- Reporting configurations
}

```

```

reportConfigToRemoveList      ReportConfigToRemoveList      OPTIONAL, -- Need ON
reportConfigToAddModList      ReportConfigToAddModList      OPTIONAL, -- Need ON
-- Measurement identities
measIdToRemoveList           MeasIdToRemoveList           OPTIONAL, -- Need ON
measIdToAddModList           MeasIdToAddModList           OPTIONAL, -- Need ON
-- Other parameters
quantityConfig                QuantityConfig                OPTIONAL, -- Need ON
measGapConfig                 MeasGapConfig                 OPTIONAL, -- Need ON
s-Measure                      RSRP-Range                    OPTIONAL, -- Need ON
preRegistrationInfoHRPD        PreRegistrationInfoHRPD        OPTIONAL, -- Need OP
speedStatePars                 CHOICE {
  release                       NULL,
  setup                          SEQUENCE {
    mobilityStateParameters      MobilityStateParameters,
    timeToTrigger-SF             SpeedStateScaleFactors
  }
}                               OPTIONAL, -- Need ON
...,
[[ measObjectToAddModList-v9e0 MeasObjectToAddModList-v9e0 OPTIONAL -- Need ON
]],
[[ allowInterruptions-r11      BOOLEAN                        OPTIONAL -- Need ON
]],
[[ measScaleFactor-r12         CHOICE {
  release                       NULL,
  setup                          MeasScaleFactor-r12
}                               OPTIONAL, -- Need ON
measIdToRemoveListExt-r12      MeasIdToRemoveListExt-r12    OPTIONAL -- Need ON
measIdToAddModListExt-r12      MeasIdToAddModListExt-r12    OPTIONAL -- Need ON
measRSRQ-OnAllSymbols-r12      BOOLEAN                        OPTIONAL -- Need ON
]],
[[
  measObjectToRemoveListExt-r13 MeasObjectToRemoveListExt-r13 OPTIONAL -- Need ON
  measObjectToAddModListExt-r13 MeasObjectToAddModListExt-r13 OPTIONAL -- Need ON
  measIdToAddModList-v1310      MeasIdToAddModList-v1310     OPTIONAL -- Need ON
  measIdToAddModListExt-v1310   MeasIdToAddModListExt-v1310  OPTIONAL -- Need ON
]],
[[ measGapConfigPerCC-List-r14 MeasGapConfigPerCC-List-r14 OPTIONAL -- Need ON
measGapSharingConfig-r14       MeasGapSharingConfig-r14     OPTIONAL -- Need ON
]],
[[ fr1-Gap-r15                  BOOLEAN                        OPTIONAL, -- Need ON
mgta-r15                        BOOLEAN                        OPTIONAL -- Need ON
]],
[[ measGapConfigDensePRS-r15    MeasGapConfigDensePRS-r15    OPTIONAL, -- Need ON
heightThreshRef-r15           CHOICE {
  release                       NULL,
  setup                          INTEGER (0..31)
}                               OPTIONAL --Need ON
]],
[[ timeMeasConfig-r18           ENUMERATED {true}             OPTIONAL, -- Need OR
locationMeasConfig-r18        ENUMERATED {true}             OPTIONAL -- Need OR
]]
}

MeasIdToRemoveList ::= SEQUENCE (SIZE (1..maxMeasId)) OF MeasId
MeasIdToRemoveListExt-r12 ::= SEQUENCE (SIZE (1..maxMeasId)) OF MeasId-v1250
MeasObjectToRemoveList ::= SEQUENCE (SIZE (1..maxObjectId)) OF MeasObjectId
MeasObjectToRemoveListExt-r13 ::= SEQUENCE (SIZE (1..maxObjectId)) OF MeasObjectId-v1310
ReportConfigToRemoveList ::= SEQUENCE (SIZE (1..maxReportConfigId)) OF ReportConfigId
-- ASN1STOP

```

<b>MeasConfig field descriptions</b>
<p><b>allowInterruptions</b> Value TRUE indicates that the UE is allowed to cause interruptions to serving cells when performing measurements of deactivated SCell carriers for <i>measCycleSCell</i> of less than 640ms, as specified in TS 36.133 [16]. E-UTRAN enables this field only when an SCell is configured.</p>
<p><b>fr1-Gap</b> Indicates whether the gap is only applicable for measurements on FR1. E-UTRAN sets this field to <i>TRUE</i> only when the UE is configured with (NG)EN-DC.</p>
<p><b>heightThreshRef</b> Reference height threshold for <i>eventH1</i> and <i>eventH2</i> in <i>reportConfig</i>. Value 0 refers to -420m, value 1 refers to -120m, and so on until value 30 refers to 8880m. The actual value is height in meters relative to sea level. Value 31 is reserved.</p>
<p><b>measGapConfig</b> Used to setup and release measurement gaps. E-UTRAN includes either <i>measGapConfig</i> or <i>measGapConfigPerCC-List</i>, if any.</p>
<p><b>measGapConfigDensePRS</b> Used to setup and release additional measurement gap pattern with dense PRS configuration as specified in TS 36.133 [16], Table 8.1.2.1-3. E-UTRAN configures this field only when UE indicates the preference of measurement gap configuration for dense PRS, i.e., <i>measPRS-Offset-r15</i>.</p>
<p><b>measGapConfigPerCC-List</b> Used to setup and release serving cell sepecific measurement gaps. E-UTRAN includes either <i>measGapConfig</i> or <i>measGapConfigPerCC-List</i>, if any.</p>
<p><b>measGapSharingConfig</b> Used to setup and release measurement gap sharing for intra- and inter-frequency measurement as specified in TS 36.133 [16].</p>
<p><b>measIdToAddModList</b> List of measurement identities. Field <i>measIdToAddModListExt</i> includes additional measurement identities i.e. extends the size of the measurement identity list using the general principles specified in 5.1.2. If E-UTRAN includes <i>measIdToAddModList-v1310</i> it includes the same number of entries, and listed in the same order, as in <i>measIdToAddModList</i> (i.e. without suffix). If E-UTRAN includes <i>measIdToAddModListExt-v1310</i>, it includes the same number of entries, and listed in the same order, as in <i>measIdToAddModListExt-r12</i>.</p>
<p><b>measIdToRemoveList</b> List of measurement identities to remove. Field <i>measIdToRemoveListExt</i> includes additional measurement identities i.e. extends the size of the measurement identity list using the general principles specified in 5.1.2.</p>
<p><b>measObjectToAddModList</b> If E-UTRAN includes <i>measObjectToAddModList-v9e0</i> it includes the same number of entries, and listed in the same order, as in <i>measObjectToAddModList</i> (i.e. without suffix). Field <i>measObjectToAddModListExt</i> includes additional measurement object identities i.e. extends the size of the measurement object identity list using the general principles specified in 5.1.2.</p>
<p><b>measObjectToRemoveList</b> List of measurement objects to remove. Field <i>measObjectToRemoveListExt</i> includes additional measurement object identities i.e. extends the size of the measurement object identity list using the general principles specified in 5.1.2.</p>
<p><b>measRSRQ-OnAllSymbols</b> Value <i>TRUE</i> indicates that the UE shall, when performing RSRQ measurements, perform RSRQ measurement on all OFDM symbols in accordance with TS 36.214 [48]. If <i>widebandRSRQ-Meas</i> is enabled for the frequency in <i>MeasObjectEUTRA</i>, the UE shall, when performing RSRQ measurements, perform RSRQ measurement on all OFDM symbols with wider bandwidth for concerned frequency in accordance with TS 36.214 [48].</p>
<p><b>measScaleFactor</b> Even if <i>reducedMeasPerformance</i> is not included in any <i>measObjectEUTRA</i> or <i>measObjectUTRA</i>, E-UTRAN may configure this field. The UE behavior is specified in TS 36.133 [16].</p>
<p><b>mgta</b> Indicates whether a timing advance value of 0.5 ms is applicable to the measurement gap configuration provided by E-UTRAN according to TS 38.133 [84]. E-UTRAN sets <i>mgta</i> to <i>TRUE</i> only when the UE is configured to perform NR measurements.</p>
<p><b>preRegistrationInfoHRPD</b> The CDMA2000 HRPD Pre-Registration Information tells the UE if it should pre-register with the CDMA2000 HRPD network and identifies the Pre-registration zone to the UE.</p>

<b>MeasConfig field descriptions</b>
<b>locationMeasConfig</b> Presence of this field indicates that UE shall perform location-based measurement initiation. If this field is configured, <i>s-Measure</i> is also configured.
<b>reportConfigToRemoveList</b> List of measurement reporting configurations to remove.
<b>s-Measure</b> PCell (or PSCell, if the UE is in NE-DC) quality threshold controlling whether or not the UE is required to perform measurements of intra-frequency, inter-frequency and inter-RAT neighbouring cells. Value "0" indicates to disable <i>s-Measure</i> .
<b>timeMeasConfig</b> Presence of this field indicates that UE shall perform time-based measurement initiation. If this field is configured, <i>s-Measure</i> is also configured.
<b>timeToTrigger-SF</b> The <i>timeToTrigger</i> in <i>ReportConfigEUTRA</i> and in <i>ReportConfigInterRAT</i> are multiplied with the scaling factor applicable for the UE's speed state.

## – *MeasDS-Config*

The IE *MeasDS-Config* specifies information applicable for discovery signals measurement.

### **MeasDS-Config information elements**

```

-- ASN1START
MeasDS-Config-r12 ::= CHOICE {
  release          NULL,
  setup            SEQUENCE {
    dmtc-PeriodOffset-r12 CHOICE {
      ms40-r12          INTEGER(0..39),
      ms80-r12          INTEGER(0..79),
      ms160-r12         INTEGER(0..159),
      ...
    },
    ds-OccasionDuration-r12 CHOICE {
      durationFDD-r12   INTEGER(1..maxDS-Duration-r12),
      durationTDD-r12   INTEGER(2..maxDS-Duration-r12)
    },
    measCSI-RS-ToRemoveList-r12 MeasCSI-RS-ToRemoveList-r12 OPTIONAL, -- Need ON
    measCSI-RS-ToAddModList-r12 MeasCSI-RS-ToAddModList-r12 OPTIONAL, -- Need ON
    ...
  }
}

MeasCSI-RS-ToRemoveList-r12 ::= SEQUENCE (SIZE (1..maxCSI-RS-Meas-r12)) OF MeasCSI-RS-Id-r12
MeasCSI-RS-ToAddModList-r12 ::= SEQUENCE (SIZE (1..maxCSI-RS-Meas-r12)) OF MeasCSI-RS-Config-r12
MeasCSI-RS-Id-r12 ::= INTEGER (1..maxCSI-RS-Meas-r12)
MeasCSI-RS-Config-r12 ::= SEQUENCE {
  measCSI-RS-Id-r12          MeasCSI-RS-Id-r12,
  physCellId-r12             INTEGER (0..503),
  scramblingIdentity-r12     INTEGER (0..503),
  resourceConfig-r12         INTEGER (0..31),
  subframeOffset-r12         INTEGER (0..4),
  csi-RS-IndividualOffset-r12 Q-OffsetRange,
  ...
}
-- ASN1STOP

```

<b>MeasDS-Config field descriptions</b>
<p><b>csi-RS-IndividualOffset</b> CSI-RS individual offset applicable to a specific CSI-RS resource. Value dB-24 corresponds to -24 dB, dB-22 corresponds to -22 dB and so on.</p>
<p><b>dmtc-PeriodOffset</b> Indicates the discovery signals measurement timing configuration (DMTC) periodicity (<i>dmtc-Periodicity</i>) and offset (<i>dmtc-Offset</i>) for this frequency. For DMTC periodicity, value ms40 corresponds to 40ms, ms80 corresponds to 80ms and so on. The value of DMTC offset is in number of subframe(s). The duration of a DMTC occasion is 6ms.</p>
<p><b>ds-OccasionDuration</b> Indicates the duration of discovery signal occasion for this frequency. Discovery signal occasion duration is common for all cells transmitting discovery signals on one frequency. If the <i>carrierFreq</i> in the measurement object is on an unlicensed band as specified in [42], the UE shall ignore the field <i>ds-OccasionDuration</i> for the carrier frequency and apply a value 1 instead.</p>
<p><b>measCSI-RS-ToAddModList</b> List of CSI-RS resources to add/ modify in the CSI-RS resource list for discovery signals measurement.</p>
<p><b>measCSI-RS-ToRemoveList</b> List of CSI-RS resources to remove from the CSI-RS resource list for discovery signals measurement.</p>
<p><b>physCellId</b> Indicates the physical cell identity where UE may assume that the CSI-RS and the PSS/SSS/CRS corresponding to the indicated physical cell identity are quasi co-located with respect to average delay and doppler shift.</p>
<p><b>resourceConfig</b> Parameter: CSI reference signal configuration, see TS 36.211 [21], tables 6.10.5.2-1 and 6.10.5.2-2. If the <i>carrierFreq</i> in the measurement object is on an unlicensed band as specified in TS 36.101 [42], E-UTRAN does not configure the values {0, 4, 5, 9, 10, 11, 18, 19}.</p>
<p><b>scramblingIdentity</b> Parameter: Pseudo-random sequence generator parameter, <math>n_{ID}</math>, see TS 36.213 [23], clause 7.2.5.</p>
<p><b>subframeOffset</b> Indicates the subframe offset between SSS of the cell indicated by <i>physCellId</i> and the CSI-RS resource in a discovery signal occasion. The field <i>subframeOffset</i> is set to values 0 if the <i>carrierFreq</i> in the measurement object is on an unlicensed band as specified in TS 36.101 [42].</p>

## – MeasGapConfig

The IE *MeasGapConfig* specifies the measurement gap configuration and controls setup/ release of measurement gaps.

### MeasGapConfig information element

```

-- ASN1START
MeasGapConfig ::=
    CHOICE {
        release          NULL,
        setup            SEQUENCE {
            gapOffset   CHOICE {
                gp0      INTEGER (0..39),
                gp1      INTEGER (0..79),
                ...,
                gp2-r14  INTEGER (0..39),
                gp3-r14  INTEGER (0..79),
                gp-ncsg0-r14  INTEGER (0..39),
                gp-ncsg1-r14  INTEGER (0..79),
                gp-ncsg2-r14  INTEGER (0..39),
                gp-ncsg3-r14  INTEGER (0..79),
                gp-nonUniform1-r14  INTEGER (0..1279),
                gp-nonUniform2-r14  INTEGER (0..2559),
                gp-nonUniform3-r14  INTEGER (0..5119),
                gp-nonUniform4-r14  INTEGER (0..10239),
                gp4-r15      INTEGER (0..19),
                gp5-r15      INTEGER (0..159),
                gp6-r15      INTEGER (0..19),
                gp7-r15      INTEGER (0..39),
                gp8-r15      INTEGER (0..79),
                gp9-r15      INTEGER (0..159),
                gp10-r15     INTEGER (0..19),
                gp11-r15     INTEGER (0..159)
            }
        }
    }
-- ASN1END

```

```
-- ASN1STOP
```

### **MeasGapConfig field descriptions**

#### **gapOffset**

Value *gapOffset* of *gp0* corresponds to gap offset of Gap Pattern Id "0" with MGRP = 40ms, *gapOffset* of *gp1* corresponds to gap offset of Gap Pattern Id "1" with MGRP = 80ms, *gapOffset* of *gp2* corresponds to gap offset of Gap Pattern Id "2" with MGRP = 40ms and MGL = 3ms, *gapOffset* of *gp3* Gap Pattern Id "3" with MGRP = 80ms and MGL = 3ms, *gapOffset* of *gp-ncsg0* corresponds to gap offset of NCSG Pattern Id "0" with VIRP = 40ms and ML = 4ms, *gapOffset* of *gp-ncsg1* corresponds to gap offset of NCSG Pattern Id "1" with VIRP = 80ms and ML = 4ms, *gapOffset* of *gp-ncsg2* corresponds to gap offset of NCSG Pattern Id "2" with VIRP = 40ms and ML = 3ms, *gapOffset* of *gp-ncsg3* corresponds to gap offset of NCSG Pattern Id "3" with VIRP = 80ms and ML = 3ms. *gapOffset* of *gp-nonUniform1* corresponds to gap offset of non uniform gap pattern Id "1" with LMGRP = 1280ms, *gapOffset* of *gp-nonUniform2* corresponds to gap offset of non uniform gap pattern Id "2" with LMGRP = 2560ms, *gapOffset* of *gp-nonUniform3* corresponds to gap offset of non uniform gap pattern Id "3" with LMGRP = 5120ms, *gapOffset* of *gp-nonUniform4* corresponds to gap offset of non uniform gap pattern Id "4" with LMGRP = 10240ms. Also used to specify the measurement gap pattern to be applied, as defined in TS 36.133 [16]. For Gap Patterns (including non-uniform gap patterns, but excluding NCSG patterns), E-UTRAN includes the same *gapOffset* value (gap pattern id and gap offset) for all serving cells that are configured with a Gap Pattern. For NCSG Patterns, E-UTRAN includes *gapOffset* value indicating VIRP and gap offset consistent with the Gap Pattern configuration (MGRP and gap offset). Value *gapOffset* of *gp4*, *gp5*, ..., *gp11* are corresponding to gap pattern with Gap Pattern ID 4, 5, ..11 respectively, see TS 38.133 [84], Table 9.1.2-1. Value *gp4*, *gp5*, ..., *gp11* can be applied for (NG)EN-DC, see TS 38.133 [84], Table 9.1.2-2.

#### **servCellId**

Identifies the serving cell for which measurement gap configuration is provided (setup) or deleted (release).

## **MeasGapConfigDensePRS**

The IE *MeasGapConfigDensePRS* specifies the additional measurement gap pattern configuration for RSTD measurements with dense PRS configuration, see TS 36.133 [16], Table 8.1.2.1-3. Measurement gaps are configured according to applicability rules specified in 36.133 [16], Table 8.1.2.1-3.

### **MeasGapConfigDensePRS information element**

```
-- ASN1START
MeasGapConfigDensePRS-r15 ::= CHOICE {
  release          NULL,
  setup           SEQUENCE {
    gapOffsetDensePRS-r15 CHOICE {
      rst0-r15      INTEGER (0..79),
      rst1-r15      INTEGER (0..159),
      rst2-r15      INTEGER (0..319),
      rst3-r15      INTEGER (0..639),
      rst4-r15      INTEGER (0..1279),
      rst5-r15      INTEGER (0..159),
      rst6-r15      INTEGER (0..319),
      rst7-r15      INTEGER (0..639),
      rst8-r15      INTEGER (0..1279),
      rst9-r15      INTEGER (0..319),
      rst10-r15     INTEGER (0..639),
      rst11-r15     INTEGER (0..1279),
      rst12-r15     INTEGER (0..319),
      rst13-r15     INTEGER (0..639),
      rst14-r15     INTEGER (0..1279),
      rst15-r15     INTEGER (0..639),
      rst16-r15     INTEGER (0..1279),
      rst17-r15     INTEGER (0..639),
      rst18-r15     INTEGER (0..1279),
      rst19-r15     INTEGER (0..639),
      rst20-r15     INTEGER (0..1279),
      ...
    }
  }
}
-- ASN1STOP
```



**MeasGapConfigDensePRS field descriptions****gapOffsetDensePRS**

Indicates the gap offset for performing RSTD measurements with dense PRS configurations as specified in 5.5.2.9a corresponding to measurement gap pattern ID specified in TS 36.133 [16].

**MeasGapConfigPerCC-List**

The IE *MeasGapConfigPerCC-List* specifies the measurement gap configuration and controls setup/ release of measurement gaps.

**MeasGapConfigPerCC-List information element**

```
-- ASN1START
MeasGapConfigPerCC-List-r14 ::= CHOICE {
  release          NULL,
  setup           SEQUENCE {
    measGapConfigToRemoveList-r14  MeasGapConfigToRemoveList-r14  OPTIONAL,  -- Need ON
    measGapConfigToAddModList-r14  MeasGapConfigToAddModList-r14  OPTIONAL  -- Need ON
  }
}

MeasGapConfigToRemoveList-r14 ::= SEQUENCE (SIZE (1..maxServCell-r13)) OF ServCellIndex-r13
MeasGapConfigToAddModList-r14 ::= SEQUENCE (SIZE (1..maxServCell-r13)) OF MeasGapConfigPerCC-r14

MeasGapConfigPerCC-r14 ::= SEQUENCE {
  servCellId-r14      ServCellIndex-r13,
  measGapConfig-r14  MeasGapConfig
}
-- ASN1STOP
```

**MeasGapConfigPerCC-List field descriptions****measGapConfigToAddModList**

List of serving cells and corresponding serving cell specific measurement gap configuration to add /modify.

**measGapConfigToRemoveList**

List of serving cells for which measurement gap configuration is removed.

**MeasGapSharingConfig**

The IE *MeasGapSharingConfig* specifies the measurement gap sharing scheme and controls setup/ release of measurement gap sharing.

**MeasGapSharingConfig information element**

```
-- ASN1START
MeasGapSharingConfig-r14 ::= CHOICE {
  release          NULL,
  setup           SEQUENCE {
    measGapSharingScheme-r14  ENUMERATED {scheme00, scheme01, scheme10, scheme11}
  }
}
-- ASN1STOP
```

**MeasGapSharingConfig field descriptions****measGapSharingScheme**

Indicates the measurement gaps sharing scheme for BL UEs in CE mode A and CE mode B and for (NG)EN-DC (for the measurement gap configured by E-UTRAN). For BL UEs, see TS 36.133 [16], Table 8.13.2.1.1.1-2 and Table 8.13.3.1.1.1-3. For (NG)EN-DC, see TS 36.133 [16], Table 8.17.1.1-1. Value *scheme00* corresponds to "00", value *scheme01* corresponds to "01", and so on.

## – *MeasId*

The IE *MeasId* is used to identify a measurement configuration, i.e., linking of a measurement object and a reporting configuration.

### ***MeasId* information element**

```
-- ASN1START
MeasId ::= INTEGER (1..maxMeasId)
MeasId-v1250 ::= INTEGER (maxMeasId-Plus1..maxMeasId-r12)
-- ASN1STOP
```

## – *MeasIdleConfig*

The IE *MeasIdleConfig* is used to convey information to UE about measurements requested to be done while in RRC\_IDLE or RRC\_INACTIVE.

### ***MeasIdleConfig* information element**

```
-- ASN1START
MeasIdleConfigSIB-r15 ::= SEQUENCE {
    measIdleCarrierListEUTRA-r15 EUTRA-CarrierList-r15,
    ...
}
MeasIdleConfigSIB-NR-r16 ::= SEQUENCE {
    measIdleCarrierListNR-r16 NR-CarrierList-r16,
    ...
}
MeasIdleConfigDedicated-r15 ::= SEQUENCE {
    measIdleCarrierListEUTRA-r15 EUTRA-CarrierList-r15 OPTIONAL, -- Need OR
    measIdleDuration-r15 ENUMERATED {sec10, sec30, sec60, sec120,
    sec180, sec240, sec300, spare},
    ...,
    [[
    measIdleCarrierListNR-r16 NR-CarrierList-r16 OPTIONAL, -- Need OR
    validityAreaList-r16 ValidityAreaList-r16 OPTIONAL -- Need OR
    ]]
}
EUTRA-CarrierList-r15 ::= SEQUENCE (SIZE (1..maxFreqIdle-r15)) OF MeasIdleCarrierEUTRA-r15
NR-CarrierList-r16 ::= SEQUENCE (SIZE (1..maxFreqIdle-r15)) OF MeasIdleCarrierNR-r16
MeasIdleCarrierEUTRA-r15 ::= SEQUENCE {
    carrierFreq-r15 ARFCN-ValueEUTRA-r9,
    allowedMeasBandwidth-r15 AllowedMeasBandwidth,
    validityArea-r15 CellList-r15 OPTIONAL, -- Need OR
    measCellList-r15 CellList-r15 OPTIONAL, -- Need OR
    reportQuantities ENUMERATED {rsrp, rsrq, both},
    qualityThreshold-r15 SEQUENCE {
        idlerSRP-Threshold-r15 RSRP-Range OPTIONAL, -- Need OR
        idlerSRQ-Threshold-r15 RSRQ-Range-r13 OPTIONAL, -- Need OR
    }
    ...
}
ValidityAreaList-r16 ::= SEQUENCE (SIZE (1..maxFreqIdle-r15)) OF ValidityArea-r16
ValidityArea-r16 ::= SEQUENCE {
    carrierFreq-r16 ARFCN-ValueEUTRA-r9,
    validityCellList-r16 ValidityCellList-r16 OPTIONAL -- Need ON
}
ValidityCellList-r16 ::= SEQUENCE (SIZE (1..maxCellMeasIdle-r15)) OF PhysCellIdRange
MeasIdleCarrierNR-r16 ::= SEQUENCE {
    carrierFreqNR-r16 ARFCN-ValueNR-r15,
    subcarrierSpacingSSB-r16 ENUMERATED {kHz15, kHz30, kHz120, kHz240},
```

```

frequencyBandList          MultiFrequencyBandListNR-r15      OPTIONAL, -- Need OR
measCellListNR-r16        CellListNR-r16                        OPTIONAL, -- Need OR
reportQuantitiesNR-r16    ENUMERATED {rsrp, rsrq, both},
qualityThresholdNR-r16    SEQUENCE {
  idleRSRP-ThresholdNR-r16  RSRP-RangeNR-r15                    OPTIONAL, -- Need OR
  idleRSRQ-ThresholdNR-r16  RSRQ-RangeNR-r15                    OPTIONAL, -- Need OR
}
  OPTIONAL, -- Need OR
ssb-MeasConfig-r16        SEQUENCE {
  maxRS-IndexCellQual-r16   MaxRS-IndexCellQualNR-r15           OPTIONAL, -- Need OR
  threshRS-Index-r16        ThresholdListNR-r15                 OPTIONAL, -- Need OR
  measTimingConfig-r16      MTC-SSB-NR-r15                      OPTIONAL, -- Need OR
  ssb-ToMeasure-r16         SSB-ToMeasure-r15                   OPTIONAL, -- Need OR
  deriveSSB-IndexFromCell-r16  BOOLEAN,
  ss-RSSI-Measurement-r16    SS-RSSI-Measurement-r15             OPTIONAL, -- Need OP
}
  OPTIONAL, -- Need OP
beamMeasConfigIdle-r16    BeamMeasConfigIdleNR-r16            OPTIONAL, -- Need OR
...
[[
subcarrierSpacingSSB-r17   ENUMERATED {kHz480, spare1}         OPTIONAL, -- Need OR
]]
}

CellList-r15 ::=          SEQUENCE (SIZE (1..maxCellMeasIdle-r15)) OF PhysCellIdRange
CellListNR-r16 ::=        SEQUENCE (SIZE (1..maxCellMeasIdle-r15)) OF PhysCellIdRangeNR-r16

BeamMeasConfigIdleNR-r16 ::= SEQUENCE {
  reportQuantityRS-IndexNR-r16  ENUMERATED {rsrp, rsrq, both},
  maxReportRS-Index-r16         INTEGER (0..maxRS-IndexReport-r15),
  reportRS-IndexResultsNR-r16   BOOLEAN
}

-- ASN1STOP

```

<b>MeasIdleConfig field descriptions</b>
<p><b>allowedMeasBandwidth</b> If absent, the value corresponding to the downlink bandwidth indicated by the <i>dl-Bandwidth</i> included in <i>MasterInformationBlock</i> of serving cell applies.</p>
<p><b>beamMeasConfigIdle</b> Indicates the beam level measurement configuration.</p>
<p><b>carrierFreq</b> Indicates the E-UTRA carrier frequency to be used for measurements during <i>RRC_IDLE</i> or <i>RRC_INACTIVE</i>.</p>
<p><b>carrierFreqNR</b> Indicates the NR carrier frequency to be used for measurements during <i>RRC_IDLE</i> or <i>RRC_INACTIVE</i>.</p>
<p><b>frequencyBandList</b> Indicates the list of frequency bands for which the NR idle/inactive measurement parameters apply. The UE shall select the first listed band which it supports in the <i>frequencyBandList</i> field to represent the NR neighbour carrier frequency.</p>
<p><b>deriveSSB-IndexFromCell</b> The field indicates whether the UE may use, to derive the SSB index of a cell on the indicated SSB frequency and subcarrier spacing, the timing of any detected cell with the same SSB frequency and subcarrier spacing. If this field is set to TRUE, the UE assumes SFN and frame boundary alignment across cells on the same NR carrier frequency as specified in TS 36.133 [16].</p>
<p><b>maxReportRS-Index</b> Max number of beam indices to include in the idle/inactive measurement result.</p>
<p><b>maxRS-IndexCellQual</b> Number of SS blocks to average for cell measurement derivation. Corresponds to the parameter <i>nrofSS-BlocksToAverage</i> in TS 38.304 [92].</p>
<p><b>measCellList</b> Indicates the list of E-UTRA cells which the UE is requested to measure and report for idle/inactive measurements.</p>
<p><b>measCellListNR</b> Indicates the list of NR cells which the UE is requested to measure and report for idle/inactive measurements.</p>
<p><b>measIdleCarrierListEUTRA</b> Indicates the E-UTRA carriers to be measured during <i>RRC_IDLE</i> or <i>RRC_INACTIVE</i>.</p>
<p><b>measIdleCarrierListNR</b> Indicates the NR carriers to be measured during <i>RRC_IDLE</i> or <i>RRC_INACTIVE</i>.</p>
<p><b>measIdleDuration</b> Indicates the duration for performing measurements during <i>RRC_IDLE</i> or <i>RRC_INACTIVE</i> for measurements assigned via <i>RRCConnectionRelease</i>. Value <i>sec10</i> correspond to 10 seconds, value <i>sec30</i> to 30 seconds and so on.</p>
<p><b>measTimingConfig</b> Used to configure the NR measurement timing configurations, i.e., timing occasions at which the UE measures SSBs. If the field is absent in <i>VarMeasConfig</i>, the UE assumes that SSB periodicity is 5ms in this frequency.</p>
<p><b>qualityThreshold</b> Indicates the quality thresholds for reporting the measured cells for idle/inactive E-UTRA measurements.</p>
<p><b>qualityThresholdNR</b> Indicates the quality thresholds for reporting the measured cells for idle/inactive NR measurements.</p>
<p><b>reportQuantities</b> Indicates which E-UTRA measurement quantities the UE is requested to report in the idle/inactive measurement report. In this version of the specification, E-UTRAN always configures the value '<i>both</i>'.</p>
<p><b>reportQuantitiesNR</b> Indicates which NR measurement quantities the UE is requested to report in the idle/inactive measurement report.</p>
<p><b>reportQuantityRS-IndexNR</b> Indicates which measurement information per beam index the UE shall include in the NR idle/inactive measurement results.</p>
<p><b>reportRS-IndexResultsNR</b> Indicates whether or not the UE shall include beam measurements in the NR idle/inactive measurement results.</p>
<p><b>ss-RSSI-Measurement</b> Indicates the SSB-based RSSI measurement configuration. If the field is absent in <i>VarMeasConfig</i>, the UE behaviour is defined in TS 38.215 [89], clause 5.1.3.</p>
<p><b>ssb-ToMeasure</b> The set of SS blocks to be measured within the SMTC measurement duration (see TS 38.215 [89]). When the field is absent in <i>VarMeasConfig</i>, the UE measures on all SS-blocks.</p>
<p><b>subcarrierSpacingSSB</b> Indicates subcarrier spacing of SSB of NR frequency. If <i>subcarrierSpacingSSB-r17</i> is present, the UE shall ignore <i>subcarrierSpacingSSB-r16</i>.</p>
<p><b>threshRS-Index</b> List of thresholds for consolidation of L1 measurements per RS index. Corresponds to the parameter <i>absThreshSS-BlocksConsolidation</i> in TS 38.304 [92].</p>

<b>MeasIdleConfig field descriptions</b>
<p><b>validityArea</b> Indicates the list of cells within which UE is requested to do measurements during RRC_IDLE or RRC_INACTIVE. If the UE reselects to a cell whose physical cell identity does not match any entry in <i>validityArea</i> for the corresponding carrier frequency, the measurements are no longer required. E-UTRAN configures this field only in <i>RRCConnectionRelease</i>.</p>
<p><b>validityAreaList</b> Indicates the list of frequencies and optionally, for each frequency, a list of cells within which the UE is required to perform measurements during RRC_IDLE or RRC_INACTIVE. E-UTRAN configures this field only in <i>RRCConnectionRelease</i>. A UE can be configured either with <i>validityArea</i> or <i>validityAreaList</i>, but not both.</p>

## – *MeasIdToAddModList*

The IE *MeasIdToAddModList* concerns a list of measurement identities to add or modify, with for each entry the *measId*, the associated *measObjectId* and the associated *reportConfigId*. Field *measIdToAddModListExt* includes additional measurement identities i.e. extends the size of the measurement identity list using the general principles specified in 5.1.2.

### **MeasIdToAddModList information element**

```

-- ASN1START
MeasIdToAddModList ::= SEQUENCE (SIZE (1..maxMeasId)) OF MeasIdToAddMod
MeasIdToAddModList-v1310 ::= SEQUENCE (SIZE (1..maxMeasId)) OF MeasIdToAddMod-v1310
MeasIdToAddModListExt-r12 ::= SEQUENCE (SIZE (1..maxMeasId)) OF MeasIdToAddModExt-r12
MeasIdToAddModListExt-v1310 ::= SEQUENCE (SIZE (1..maxMeasId)) OF MeasIdToAddMod-v1310

MeasIdToAddMod ::= SEQUENCE {
    measId MeasId,
    measObjectId MeasObjectId,
    reportConfigId ReportConfigId
}

MeasIdToAddModExt-r12 ::= SEQUENCE {
    measId-v1250 MeasId-v1250,
    measObjectId-r12 MeasObjectId,
    reportConfigId-r12 ReportConfigId
}

MeasIdToAddMod-v1310 ::= SEQUENCE {
    measObjectId-v1310 MeasObjectId-v1310 OPTIONAL
}
-- ASN1STOP

```

<b>MeasIdToAddModList field descriptions</b>
<p><b>measObjectId</b> If the <i>measObjectId-v1310</i> is included, the <i>measObjectId</i> or <i>measObjectId-r12</i> is ignored by the UE.</p>

## – *MeasObjectCDMA2000*

The IE *MeasObjectCDMA2000* specifies information applicable for inter-RAT CDMA2000 neighbouring cells.

### **MeasObjectCDMA2000 information element**

```

-- ASN1START
MeasObjectCDMA2000 ::= SEQUENCE {
    cdma2000-Type CDMA2000-Type,
    carrierFreq CarrierFreqCDMA2000,
    searchWindowSize INTEGER (0..15) OPTIONAL, -- Need ON
    offsetFreq Q-OffsetRangeInterRAT DEFAULT 0,
    cellsToRemoveList CellIndexList OPTIONAL, -- Need ON
    cellsToAddModList CellsToAddModListCDMA2000 OPTIONAL, -- Need ON
}
-- ASN1STOP

```

```

    cellForWhichToReportCGI          PhysCellIdCDMA2000          OPTIONAL,  -- Need ON
  }
  ...
CellsToAddModListCDMA2000 ::=      SEQUENCE (SIZE (1..maxCellMeas)) OF CellsToAddModCDMA2000
CellsToAddModCDMA2000 ::=      SEQUENCE {
    cellIndex                        INTEGER (1..maxCellMeas),
    physCellId                      PhysCellIdCDMA2000
  }
-- ASN1STOP

```

<b>MeasObjectCDMA2000 field descriptions</b>
<b>carrierInfo</b> Identifies CDMA2000 carrier frequency for which this configuration is valid.
<b>cdma2000-Type</b> The type of CDMA2000 network: CDMA2000 1xRTT or CDMA2000 HRPD.
<b>cellIndex</b> Entry index in the neighbouring cell list.
<b>cellsToAddModList</b> List of cells to add/ modify in the neighbouring cell list.
<b>cellsToRemoveList</b> List of cells to remove from the neighbouring cell list.
<b>physCellId</b> CDMA2000 Physical cell identity of a cell in neighbouring cell list expressed as PNOffset.
<b>searchWindowSize</b> Provides the search window size to be used by the UE for the neighbouring pilot, see C.S0005 [25].

## – *MeasObjectEUTRA*

The IE *MeasObjectEUTRA* specifies information applicable for intra-frequency or inter-frequency E-UTRA cells.

### **MeasObjectEUTRA information element**

```

-- ASN1START
MeasObjectEUTRA ::=
    SEQUENCE {
        carrierFreq                ARFCN-ValueEUTRA,
        allowedMeasBandwidth        AllowedMeasBandwidth,
        presenceAntennaPort1        PresenceAntennaPort1,
        neighCellConfig             NeighCellConfig,
        offsetFreq                  Q-OffsetRange                DEFAULT dB0,
        -- Cell list
        cellsToRemoveList           CellIndexList                OPTIONAL,  -- Need ON
        cellsToAddModList           CellsToAddModList            OPTIONAL,  -- Need ON
        -- Excluded list
        excludedCellsToRemoveList   CellIndexList                OPTIONAL,  -- Need ON
        excludedCellsToAddModList   ExcludedCellsToAddModList   OPTIONAL,  -- Need
ON
        cellForWhichToReportCGI     PhysCellId                OPTIONAL,  -- Need ON
        ...,
        [[measCycleSCell-r10         MeasCycleSCell-r10        OPTIONAL,  -- Need ON
           measSubframePatternConfigNeigh-r10 MeasSubframePatternConfigNeigh-r10 OPTIONAL
           -- Need ON
        ]],
        [[widebandRSRQ-Meas-r11      BOOLEAN OPTIONAL        -- Cond WB-RSRQ
        ]],
        [[ altTTT-CellsToRemoveList-r12 CellIndexList            OPTIONAL,  -- Need ON
           altTTT-CellsToAddModList-r12 AltTTT-CellsToAddModList-r12 OPTIONAL,  -- Need ON
           t312-r12                  CHOICE {
               release                NULL,
               setup                   ENUMERATED {ms0, ms50, ms100, ms200,
               ms300, ms400, ms500, ms1000}
           }
           OPTIONAL,  -- Need ON
           reducedMeasPerformance-r12 BOOLEAN                    OPTIONAL,  -- Need ON
           measDS-Config-r12         MeasDS-Config-r12        OPTIONAL    -- Need ON
        ]],
        [[
           allowedCellsToRemoveList-r13 CellIndexList            OPTIONAL,  -- Need ON

```

```

ON
    allowedCellsToAddModList-r13          AllowedCellsToAddModList-r13    OPTIONAL,      -- Need
    rmtc-Config-r13                       RMTc-Config-r13                OPTIONAL,      -- Need ON
    carrierFreq-r13                       ARFCN-ValueEUTRA-v9e0         OPTIONAL      -- Need ON
  ]],
  [[
    tx-ResourcePoolToRemoveList-r14 Tx-ResourcePoolMeasList-r14    OPTIONAL,      -- Need ON
    tx-ResourcePoolToAddList-r14   Tx-ResourcePoolMeasList-r14    OPTIONAL,      -- Need ON
    fembms-MixedCarrier-r14        BOOLEAN                          OPTIONAL      -- Need ON
  ]],
  [[
    measSensing-Config-r15          MeasSensing-Config-r15        OPTIONAL      -- Need ON
  ]],
  [[
    measRSS-DedicatedConfig-r16     SetupRelease {MeasRSS-DedicatedConfig-r16}  OPTIONAL --
Need ON
  ]],
  [[
    cellsToAddModList-v1810         CellsToAddModList-v1810       OPTIONAL      -- Need ON
  ]]
}

MeasObjectEUTRA-v9e0 ::= SEQUENCE {
    carrierFreq-v9e0                ARFCN-ValueEUTRA-v9e0
}

MeasRSS-DedicatedConfig-r16 ::= SEQUENCE {
    rss-ConfigCarrierInfo-r16       RSS-ConfigCarrierInfo-r16     OPTIONAL,      -- Need OP
    cellsToAddModList-v1610         CellsToAddModList-v1610       OPTIONAL      -- Need ON
}

CellsToAddModList ::= SEQUENCE (SIZE (1..maxCellMeas)) OF CellsToAddMod

CellsToAddModList-v1610 ::= SEQUENCE (SIZE (1..maxCellMeas)) OF CellsToAddMod-v1610
CellsToAddModList-v1810 ::= SEQUENCE (SIZE (1..maxCellMeas)) OF CellsToAddMod-v1810

CellsToAddMod ::= SEQUENCE {
    cellIndex                       INTEGER (1..maxCellMeas),
    physCellId                      PhysCellId,
    cellIndividualOffset             Q-OffsetRange
}

CellsToAddMod-v1610 ::= SEQUENCE {
    rss-MeasPowerBias-r16           RSS-MeasPowerBias-r16
}

CellsToAddMod-v1810 ::= SEQUENCE {
    satelliteId-r18                 SatelliteId-r18                OPTIONAL,      -- Need OR
    ephemerisInfo-r18              CHOICE {
        stateVectors-r18           EphemerisStateVectors-r17,
        orbitalParameters-r18      EphemerisOrbitalParameters-r17
    }
    epochTime-r18                  SEQUENCE {
        startSFN-r18               INTEGER (0..1023),
        startSubFrame-r18          INTEGER (0..9)
    }
    referenceLocation-r18           ReferenceLocation-r18          OPTIONAL,      -- Cond Moving
}

ExcludedCellsToAddModList ::= SEQUENCE (SIZE (1..maxCellMeas)) OF ExcludedCellsToAddMod

ExcludedCellsToAddMod ::= SEQUENCE {
    cellIndex                       INTEGER (1..maxCellMeas),
    physCellIdRange                 PhysCellIdRange
}

MeasCycleSCell-r10 ::= ENUMERATED {sf160, sf256, sf320, sf512,
    sf640, sf1024, sf1280, spare1}

MeasSubframePatternConfigNeigh-r10 ::= CHOICE {
    release                          NULL,
    setup                            SEQUENCE {
        measSubframePatternNeigh-r10 MeasSubframePattern-r10,
        measSubframeCellList-r10    MeasSubframeCellList-r10    OPTIONAL      -- Cond
always
    }
}

```

```

MeasSubframeCellList-r10 ::= SEQUENCE (SIZE (1..maxCellMeas)) OF PhysCellIdRange
AltTTT-CellsToAddModList-r12 ::= SEQUENCE (SIZE (1..maxCellMeas)) OF AltTTT-CellsToAddMod-r12
AltTTT-CellsToAddMod-r12 ::= SEQUENCE {
    cellIndex-r12          INTEGER (1..maxCellMeas),
    physCellIdRange-r12   PhysCellIdRange
}
AllowedCellsToAddModList-r13 ::= SEQUENCE (SIZE (1..maxCellMeas)) OF
AllowedCellsToAddMod-r13
AllowedCellsToAddMod-r13 ::= SEQUENCE {
    cellIndex-r13          INTEGER (1..maxCellMeas),
    physCellIdRange-r13   PhysCellIdRange
}
RMTC-Config-r13 ::= CHOICE {
    release                NULL,
    setup                  SEQUENCE {
        rmtc-Period-r13   ENUMERATED {ms40, ms80, ms160, ms320, ms640},
        rmtc-SubframeOffset-r13 INTEGER(0..639) OPTIONAL, -- Need ON
        measDuration-r13  ENUMERATED {sym1, sym14, sym28, sym42, sym70},
        ...
    }
}
Tx-ResourcePoolMeasList-r14 ::= SEQUENCE (SIZE (1..maxSL-PoolToMeasure-r14)) OF SL-V2X-
TxPoolReportIdentity-r14
-- ASN1STOP

```



<b>MeasObjectEUTRA field descriptions</b>
<b>allowedCellsToAddModList</b> List of cells to add/modify in the list of allow-listed cells.
<b>allowedCellsToRemoveList</b> List of cells to remove from the list of allow-listed cells.
<b>altTTT-CellsToAddModList</b> List of cells to add/ modify in the cell list for which the alternative time to trigger specified by <i>alternativeTimeToTrigger</i> in <i>reportConfigEUTRA</i> , if configured, applies.
<b>altTTT-CellsToRemoveList</b> List of cells to remove from the list of cells for alternative time to trigger.
<b>carrierFreq</b> Identifies E-UTRA carrier frequency for which this configuration is valid. E-UTRAN does not configure more than one measurement object for the same physical frequency regardless of the E-ARFCN used to indicate this. CarrierFreq-r13 is included only when the extension list <i>measObjectToAddModListExt-r13</i> is used. If <i>carrierFreq-r13</i> is present, <i>carrierFreq</i> (i.e., without suffix) shall be set to value <i>maxEARFCN</i> .
<b>cellIndex</b> Entry index in the cell list. An entry may concern a range of cells, in which case this value applies to the entire range.
<b>cellIndividualOffset</b> Cell individual offset applicable to a specific cell. Value dB-24 corresponds to -24 dB, dB-22 corresponds to -22 dB and so on.
<b>cellsToAddModList</b> List of cells to add/ modify in the cell list. <i>cellsToAddModList-v1610</i> indicates list of RSS assistance information which is used for the corresponding <i>physCellId</i> . If E-UTRAN includes <i>cellsToAddModList-v1610</i> and/or <i>cellsToAddModList-v1810</i> , it includes the same number of entries, and listed in the same order, as in <i>cellsToAddModList</i> (i.e. without suffix).
<b>cellsToRemoveList</b> List of cells to remove from the cell list.
<b>epochTime</b> Epoch time of the satellite ephemeris data and reference location for earth moving cells. This field is based on the timing of the serving cell, i.e. the <i>startSFN</i> and <i>startSubFrame</i> number indicated in this field refers to the SFN and sub-frame of the serving cell, and <i>startSFN</i> indicates the current SFN or the next upcoming SFN after the frame where the message indicating the <i>epochTime</i> is received.
<b>excludedCellsToAddModList</b> List of cells to add/ modify in the list of exclude-listed cells.
<b>excludedCellsToRemoveList</b> List of cells to remove from the list of exclude-listed cells.
<b>fembms-MixedCarrier</b> If this field is set to <i>TRUE</i> , the cells on the carrier frequency indicated by the <i>measObject</i> are FeMBMS/Unicast-mixed cells.
<b>measCycleSCell</b> The parameter is used only when an SCell is configured on the frequency indicated by the <i>measObject</i> and is in deactivated state, see TS 36.133 [16], clause 8.3.3. E-UTRAN configures the parameter whenever an SCell is configured on the frequency indicated by the <i>measObject</i> , but the field may also be signalled when an SCell is not configured. Value <i>sf160</i> corresponds to 160 sub-frames, <i>sf256</i> corresponds to 256 sub-frames and so on.
<b>measDS-Config</b> Parameters applicable to discovery signals measurement on the carrier frequency indicated by <i>carrierFreq</i> .
<b>measDuration</b> Number of consecutive symbols for which the Physical Layer reports samples of RSSI, see TS 36.214 [48]. Value <i>sym1</i> corresponds to one symbol, <i>sym14</i> corresponds to 14 symbols, and so on.
<b>measRSS-DedicatedConfig</b> The field indicates whether measurements based on RSS in RRC_CONNECTED is enabled and provides neighbour cell RSS information.
<b>measSubframeCellList</b> List of cells for which <i>measSubframePatternNeigh</i> is applied.
<b>measSubframePatternNeigh</b> Time domain measurement resource restriction pattern applicable to neighbour cell RSRP and RSRQ measurements on the carrier frequency indicated by <i>carrierFreq</i> . For cells in <i>measSubframeCellList</i> the UE shall assume that the subframes indicated by <i>measSubframePatternNeigh</i> are non-MBSFN subframes, and have the same special subframe configuration as PCell.
<b>offsetFreq</b> Offset value applicable to the carrier frequency. Value dB-24 corresponds to -24 dB, dB-22 corresponds to -22 dB and so on.
<b>physCellId</b> Physical cell identity of a cell in the cell list.
<b>physCellIdRange</b> Physical cell identity or a range of physical cell identities.

<b>MeasObjectEUTRA field descriptions</b>
<p><b>reducedMeasPerformance</b> If set to <i>TRUE</i>, the EUTRA carrier frequency is configured for reduced measurement performance, otherwise it is configured for normal measurement performance, see TS 36.133 [16].</p>
<p><b>referenceLocation</b> Reference location associated with a neighbour cell for <i>eventD2</i> or a candidate target cell for <i>condEventD2</i>.</p>
<p><b>rmtc-Config</b> Parameters applicable to RSSI and channel occupancy measurement on the carrier frequency indicated by <i>carrierFreq</i>.</p>
<p><b>rmtc-Period</b> Indicates the RSSI measurement timing configuration (RMTTC) periodicity for this frequency. Value <i>ms40</i> corresponds to 40 ms periodicity, <i>ms80</i> corresponds to 80 ms periodicity and so on, see TS 36.214 [48].</p>
<p><b>rmtc-SubframeOffset</b> Indicates the RSSI measurement timing configuration (RMTTC) subframe offset for this frequency. The value of <i>rmtc-SubframeOffset</i> should be smaller than the value of <i>rmtc-Period</i>, see TS 36.214 [48]. For inter-frequency measurements, this field is optional present and if it is not configured, the UE chooses a random value as <i>rmtc-SubframeOffset</i> for <i>measDuration</i> which shall be selected to be between 0 and the configured <i>rmtc-Period</i> with equal probability.</p>
<p><b>rss-ConfigCarrierInfo</b> RSS configurations for this carrier frequency. If absent, RSS is collocated (time and frequency domain) in all cells.</p>
<p><b>satelliteld</b> The satellite ID applicable to a specific cell, used to associate with the satellite assistance information for neighbour cell measurements.</p>
<p><b>t312</b> The value of timer T312. Value <i>ms0</i> represents 0 ms, <i>ms50</i> represents 50 ms and so on.</p>
<p><b>tx-ResourcePoolToAddList</b> List of transmission pools identities to be added to the list of pools configured for CBR measurements and for which <i>poolReportId</i> is included in <i>SL-V2X-ConfigDedicated</i>, <i>SystemInformationBlockType21</i> or <i>SystemInformationBlockType26</i>.</p>
<p><b>tx-ResourcePoolToRemoveList</b> List of transmission resource pools identities to be removed from the list of pools configured for CBR measurements and for which <i>poolReportId</i> is included in <i>SL-V2X-ConfigDedicated</i>, <i>SystemInformationBlockType21</i> or <i>SystemInformationBlockType26</i>.</p>
<p><b>widebandRSRQ-Meas</b> If this field is set to <i>TRUE</i>, the UE shall, when performing RSRQ measurements, use a wider bandwidth in accordance with TS 36.133 [16].</p>

<b>Conditional presence</b>	<b>Explanation</b>
<i>always</i>	The field is mandatory present.
<i>Moving</i>	The field is mandatory present if one of the associated <i>reportConfigEUTRA</i> contains <i>EventD2</i> or <i>condEventD2</i> . Otherwise it is optionally present, need OR.
<i>WB-RSRQ</i>	The field is optionally present, need ON, if the measurement bandwidth indicated by <i>allowedMeasBandwidth</i> is 50 resource blocks or larger; otherwise it is not present and the UE shall delete any existing value for this field, if configured.

## – *MeasObjectGERAN*

The IE *MeasObjectGERAN* specifies information applicable for inter-RAT GERAN neighbouring frequencies.

### **MeasObjectGERAN information element**

```

-- ASN1START
MeasObjectGERAN ::=
    SEQUENCE {
        carrierFreqs          CarrierFreqsGERAN,
        offsetFreq            Q-OffsetRangeInterRAT          DEFAULT 0,
        ncc-Permitted         BIT STRING(SIZE (8))           DEFAULT '11111111'B,
        cellForWhichToReportCGI PhysCellIdGERAN              OPTIONAL, -- Need ON
        ...
    }
-- ASN1STOP

```

<b>MeasObjectGERAN field descriptions</b>
<p><b>ncc-Permitted</b> Field encoded as a bit map, where bit N is set to "0" if a BCCH carrier with NCC = N-1 is not permitted for monitoring and set to "1" if a BCCH carrier with NCC = N-1 is permitted for monitoring; N = 1 to 8; bit 1 of the bitmap is the leading bit of the bit string.</p>
<p><b>carrierFreqs</b> If E-UTRAN includes <i>cellForWhichToReportCGI</i>, it includes only one GERAN ARFCN value in <i>carrierFreqs</i>.</p>

## – *MeasObjectId*

The IE *MeasObjectId* used to identify a measurement object configuration.

### **MeasObjectId information element**

```
-- ASN1START
MeasObjectId ::=
    INTEGER (1..maxObjectId)
MeasObjectId-v1310 ::=
    INTEGER (maxObjectId-Plus1-r13..maxObjectId-r13)
MeasObjectId-r13 ::=
    INTEGER (1..maxObjectId-r13)
-- ASN1STOP
```

## – *MeasObjectNR*

The IE *MeasObjectNR* specifies information applicable for inter-RAT NR neighbouring cells.

### **MeasObjectNR information element**

```
-- ASN1START
MeasObjectNR-r15 ::=
    SEQUENCE {
        carrierFreq-r15          ARFCN-ValueNR-r15,
        rs-ConfigSSB-r15        RS-ConfigSSB-NR-r15,
        threshRS-Index-r15      ThresholdListNR-r15          OPTIONAL,      -- Need OR
        maxRS-IndexCellQual-r15 MaxRS-IndexCellQualNR-r15  OPTIONAL,      -- Need OR
        offsetFreq-r15          Q-OffsetRangeInterRAT          DEFAULT 0,
        excludedCellsToRemoveList-r15 CellIndexList          OPTIONAL,      -- Need
ON
        excludedCellsToAddModList-r15 CellsToAddModListNR-r15  OPTIONAL,      -- Need
ON
        quantityConfigSet-r15   INTEGER (1.. maxQuantSetsNR-r15),
        cellsForWhichToReportSFTD-r15 SEQUENCE (SIZE (1..maxCellsSFTD)) OF PhysCellIdNR-r15
    OPTIONAL,      -- Need OR
        ...
        [[ cellForWhichToReportCGI-r15 PhysCellIdNR-r15          OPTIONAL,      -- Need ON
           derivesSSB-IndexFromCell-r15 BOOLEAN                OPTIONAL,      -- Need ON
           ss-RSSI-Measurement-r15    SS-RSSI-Measurement-r15    OPTIONAL,      -- Need ON
           bandNR-r15                 CHOICE {
               release                NULL,
               setup                   FreqBandIndicatorNR-r15
           }
           OPTIONAL      -- Need ON
        ]],
        [[
           rmtc-ConfigNR-r16           SetupRelease {RMTc-ConfigNR-r16}          OPTIONAL
           -- Cond SharedSpectrum
        ]],
        [[
           cellsToRemoveList-r16       CellIndexList          OPTIONAL,      -- Need ON
           cellsToAddModList-r16       CellsToAddModListNR-r16  OPTIONAL      -- Need ON
        ]]
    }

RS-ConfigSSB-NR-r15 ::=
    SEQUENCE {
        measTimingConfig-r15          MTC-SSB-NR-r15,
        subcarrierSpacingSSB-r15      ENUMERATED {kHz15, kHz30, kHz120, kHz240},
        ...
        [[ ssb-ToMeasure-r15          CHOICE {
           release                NULL,
           setup                   SSB-ToMeasure-r15
        ]]
```

```

    }
    OPTIONAL -- Need ON
  ]],
  [[
    ssb-PositionQCL-CommonNR-r16 SSB-PositionQCL-RelationNR-r16 OPTIONAL, -- Cond
SharedSpectrum2
    ssb-PositionQCL-CellsToAddModListNR-r16 SSB-PositionQCL-CellsToAddModListNR-r16 OPTIONAL, --
Cond SharedSpectrum
    ssb-PositionQCL-CellsToRemoveListNR-r16 SEQUENCE (SIZE (1..maxCellMeas)) OF PhysCellIdNR-r15
OPTIONAL -- Cond SharedSpectrum
  ]],
  [[
    subcarrierSpacingSSB-r17 ENUMERATED {kHz480, kHz960} OPTIONAL, -- Need OR
    ssb-PositionQCL-CommonNR-r17 SSB-PositionQCL-RelationNR-r17 OPTIONAL, -- Cond
SharedSpectrum2
    ssb-PositionQCL-CellsToAddModListNR-r17 SSB-PositionQCL-CellsToAddModListNR-r17 OPTIONAL, --
Cond SharedSpectrum
    ssb-PositionQCL-CellsToRemoveListNR-r17 SEQUENCE (SIZE (1..maxCellMeas)) OF PhysCellIdNR-r15
OPTIONAL -- Cond SharedSpectrum
  ]]
}

CellsToAddModListNR-r15 ::= SEQUENCE (SIZE (1..maxCellMeas)) OF CellsToAddModNR-r15

CellsToAddModListNR-r16 ::= SEQUENCE (SIZE (1..maxCellMeas)) OF CellsToAddModNR-r16

CellsToAddModNR-r15 ::= SEQUENCE {
  cellIndex-r15 INTEGER (1..maxCellMeas),
  physCellId-r15 PhysCellIdNR-r15
}

CellsToAddModNR-r16 ::= SEQUENCE {
  cellIndex-r16 INTEGER (1..maxCellMeas),
  physCellId-r16 PhysCellIdNR-r15,
  cellIndividualOffset-r16 Q-OffsetRange
}

SSB-PositionQCL-CellsToAddModListNR-r16 ::= SEQUENCE (SIZE (1..maxCellMeas)) OF SSB-PositionQCL-
CellsToAddNR-r16

SSB-PositionQCL-CellsToAddNR-r16 ::= SEQUENCE {
  physCellId-r16 PhysCellIdNR-r15,
  ssb-PositionQCL-NR-r16 SSB-PositionQCL-RelationNR-r16
}

RMTC-ConfigNR-r16 ::= SEQUENCE {
  rmtc-PeriodicityNR-r16 ENUMERATED {ms40, ms80, ms160, ms320, ms640},
  rmtc-SubframeOffsetNR-r16 INTEGER(0..639) OPTIONAL, -- Need ON
  measDurationNR-r16 ENUMERATED {sym1, sym14or12, sym28or24, sym42or36,
sym70or60},
  rmtc-FrequencyNR-r16 ARFCN-ValueNR-r15,
  refSCS-CP-NR-r16 ENUMERATED {kHz15, kHz30, kHz60-NCP, kHz60-ECP},
  ...,
  [[
    rmtc-BandwidthNR-r17 ENUMERATED {mhz100, mhz400, mhz800, mhz1600, mhz2000} OPTIONAL, -- Need
OR
    measDurationNR-r17 ENUMERATED {sym140, sym560, sym1120} OPTIONAL, -- Need OR
    refSCS-CP-NR-r17 ENUMERATED {kHz120, kHz480, kHz960} OPTIONAL -- Need OR
  ]]
}

SSB-PositionQCL-CellsToAddModListNR-r17 ::= SEQUENCE (SIZE (1..maxCellMeas)) OF SSB-PositionQCL-
CellsToAddNR-r17

SSB-PositionQCL-CellsToAddNR-r17 ::= SEQUENCE {
  physCellIdNR-r17 PhysCellIdNR-r15,
  ssb-PositionQCL-NR-r17 SSB-PositionQCL-RelationNR-r17
}

-- ASN1STOP

```

<b>MeasObjectNR field descriptions</b>	
<b>bandNR</b>	Indicates the frequency band of the NR carrier frequency configured in this <i>MeasObjectNR</i> . This field is always set to setup when the network configures measurements with this <i>MeasObjectNR</i> .
<b>carrierFreq</b>	Identifies the SSB frequency to be measured. E-UTRAN does not configure more than one measurement object for the same SSB frequency.
<b>cellIndividualOffset</b>	Cell individual offset applicable to a specific cell.
<b>deriveSSB-IndexFromCell</b>	The field indicates whether the UE may use, to derive the SSB index of a cell on the indicated SSB frequency and subcarrier spacing, the timing of the NR serving cell with the same SSB frequency and subcarrier spacing if configured. Otherwise, the field indicates whether the UE may use the timing of any detected cell with the same SSB frequency and subcarrier spacing.
<b>measDurationNR</b>	Number of consecutive symbols for which the Physical Layer reports samples of RSSI (see TS 38.215 [89]). Value <i>sym1</i> corresponds to one symbol, <i>sym14or12</i> corresponds to 14 symbols of the reference numerology for NCP and 12 symbols for ECP, and so on. If <i>measDurationNR-r17</i> is present, the UE shall ignore <i>measDurationNR-r16</i> .
<b>quantityConfigSet</b>	Indicates the n-th element of <i>quantityConfigNRLList</i> provided in <i>MeasConfig</i> .
<b>refSCS-CP-NR</b>	Indicates a reference subcarrier spacing and cyclic prefix to be used for RSSI measurements (see TS 38.215 [89]).
<b>rmtc-FrequencyNR</b>	Indicates the center frequency of the measured bandwidth (see TS 38.215 [89]).
<b>rmtc-PeriodicityNR</b>	Indicates the RSSI measurement timing configuration (RMTTC) periodicity (see TS 38.215 [89]). Value <i>ms40</i> corresponds to 40 ms periodicity, <i>ms80</i> corresponds to 80 ms periodicity, and so on.
<b>rmtc-SubframeOffsetNR</b>	Indicates the RSSI measurement timing configuration (RMTTC) subframe offset (see TS 38.215 [89]). If not configured, the UE chooses a random value as <i>rmtc-SubframeOffsetNR</i> for <i>measDurationNR</i> which shall be selected to be between 0 and the configured <i>rmtc-PeriodicityNR</i> with equal probability.
<b>rs-ConfigSSB</b>	Indicates the SSB configuration for measuring the set of SS blocks within the SMTC measurement duration.
<b>ssb-PositionQCL-NR</b>	Indicates the QCL relationship between SS/PBCH blocks for a specific neighbor cell as specified in TS 38.213 [88], clause 4.1. If provided, the cell specific value overwrites the common value signalled by <i>ssb-PositionQCL-CommonNR</i> in <i>MeasObjectNR</i> for the indicated cell.
<b>ssb-PositionQCL-CommonNR</b>	Indicates the QCL relationship between SS/PBCH blocks for NR neighbor cells as specified in TS 38.213 [88], clause 4.1. If <i>ssb-PositionQCL-CommonNR-r17</i> is present, the UE shall ignore <i>ssb-PositionQCL-CommonNR-r16</i> .
<b>subcarrierSpacingSSB</b>	Subcarrier spacing of SSB. Only the following values are applicable depending on the used frequency: FR1: 15 or 30 kHz FR2-1: 120 or 240 kHz FR2-2: 120, 480, or 960 kHz
<b>rmtc-BandwidthNR</b>	Indicates the bandwidth for the RSSI measurement.
<b>threshRS-Index</b>	List of thresholds for consolidation of L1 measurements per RS index.

Conditional presence	Explanation
<i>SharedSpectrum</i>	The field is optional Need ON if NR operates with shared spectrum channel access; otherwise, it is not present.
<i>SharedSpectrum2</i>	The field is mandatory present if NR operates with shared spectrum channel access; otherwise, it is not present.

### – *MeasObjectToAddModList*

The IE *MeasObjectToAddModList* concerns a list of measurement objects to add or modify

#### ***MeasObjectToAddModList* information element**

-- ASN1START

```

MeasObjectToAddModList ::= SEQUENCE (SIZE (1..maxObjectId)) OF MeasObjectToAddMod
MeasObjectToAddModListExt-r13 ::= SEQUENCE (SIZE (1..maxObjectId)) OF MeasObjectToAddModExt-r13
MeasObjectToAddModList-v9e0 ::= SEQUENCE (SIZE (1..maxObjectId)) OF MeasObjectToAddMod-v9e0
MeasObjectToAddMod ::= SEQUENCE {
    measObjectId          MeasObjectId,
    measObject            CHOICE {
        measObjectEUTRA      MeasObjectEUTRA,
        measObjectUTRA       MeasObjectUTRA,
        measObjectGERAN      MeasObjectGERAN,
        measObjectCDMA2000   MeasObjectCDMA2000,
        . . . ,
        measObjectWLAN-r13   MeasObjectWLAN-r13,
        measObjectNR-r15    MeasObjectNR-r15
    }
}

MeasObjectToAddModExt-r13 ::= SEQUENCE {
    measObjectId-r13      MeasObjectId-v1310,
    measObject-r13       CHOICE {
        measObjectEUTRA-r13  MeasObjectEUTRA,
        measObjectUTRA-r13   MeasObjectUTRA,
        measObjectGERAN-r13  MeasObjectGERAN,
        measObjectCDMA2000-r13 MeasObjectCDMA2000,
        . . . ,
        measObjectWLAN-v1320 MeasObjectWLAN-r13,
        measObjectNR-r15    MeasObjectNR-r15
    }
}

MeasObjectToAddMod-v9e0 ::= SEQUENCE {
    measObjectEUTRA-v9e0 MeasObjectEUTRA-v9e0 OPTIONAL -- Cond eutra
}
-- ASN1STOP

```

Conditional presence	Explanation
<i>eutra</i>	The field is optional present, need OR, if for the corresponding entry in <i>MeasObjectToAddModList</i> or <i>MeasObjectToAddModListExt-r13</i> field <i>measObject</i> is set to <i>measObjectEUTRA</i> and its sub-field <i>carrierFreq</i> is set to <i>maxEARFCN</i> . Otherwise the field is not present and the UE shall delete any existing value for this field.

## – *MeasObjectUTRA*

The IE *MeasObjectUTRA* specifies information applicable for inter-RAT UTRA neighbouring cells.

### *MeasObjectUTRA* information element

```

-- ASN1START
MeasObjectUTRA ::= SEQUENCE {
    carrierFreq          ARFCN-ValueUTRA,
    offsetFreq          Q-OffsetRangeInterRAT DEFAULT 0,
    cellsToRemoveList   CellIndexList OPTIONAL, -- Need ON
    cellsToAddModList  CHOICE {
        cellsToAddModListUTRA-FDD CellsToAddModListUTRA-FDD,
        cellsToAddModListUTRA-TDD CellsToAddModListUTRA-TDD
    } OPTIONAL, -- Need ON
    cellForWhichToReportCGI CHOICE {
        utra-FDD PhysCellIdUTRA-FDD,
        utra-TDD PhysCellIdUTRA-TDD
    } OPTIONAL, -- Need ON
    . . . ,
    [[ csg-allowedReportingCells-v930 CSG-AllowedReportingCells-r9 OPTIONAL --
Need ON
]],
    [[ reducedMeasPerformance-r12 BOOLEAN OPTIONAL -- Need ON
]],
}

CellsToAddModListUTRA-FDD ::= SEQUENCE (SIZE (1..maxCellMeas)) OF CellsToAddModUTRA-FDD

```

```

CellsToAddModUTRA-FDD ::= SEQUENCE {
    cellIndex          INTEGER (1..maxCellMeas),
    physCellId        PhysCellIdUTRA-FDD
}

CellsToAddModListUTRA-TDD ::= SEQUENCE (SIZE (1..maxCellMeas)) OF CellsToAddModUTRA-TDD

CellsToAddModUTRA-TDD ::= SEQUENCE {
    cellIndex          INTEGER (1..maxCellMeas),
    physCellId        PhysCellIdUTRA-TDD
}

CSG-AllowedReportingCells-r9 ::= SEQUENCE {
    physCellIdRangeUTRA-FDDList-r9  OPTIONAL  -- Need OR
}
-- ASN1STOP

```

### ***MeasObjectUTRA*** field descriptions

<b><i>carrierFreq</i></b>	Identifies UTRA carrier frequency for which this configuration is valid. E-UTRAN does not configure more than one measurement object for the same physical frequency regardless of the ARFCN used to indicate this.
<b><i>cellIndex</i></b>	Entry index in the neighbouring cell list.
<b><i>cellsToAddModListUTRA-FDD</i></b>	List of UTRA FDD cells to add/ modify in the neighbouring cell list.
<b><i>cellsToAddModListUTRA-TDD</i></b>	List of UTRA TDD cells to add/modify in the neighbouring cell list.
<b><i>cellsToRemoveList</i></b>	List of cells to remove from the neighbouring cell list.
<b><i>csg-allowedReportingCells</i></b>	One or more ranges of physical cell identities for which UTRA-FDD reporting is allowed.
<b><i>reducedMeasPerformance</i></b>	If set to <i>TRUE</i> the UTRA carrier frequency is configured for reduced measurement performance, otherwise it is configured for normal measurement performance, see TS 36.133 [16].

### ***MeasObjectWLAN***

The IE *MeasObjectWLAN* specifies information applicable for inter-RAT WLAN measurements. E-UTRAN configures at least one WLAN identifier in the *MeasObjectWLAN*.

```

-- ASN1START

MeasObjectWLAN-r13 ::= SEQUENCE {
    carrierFreq-r13          CHOICE {
        bandIndicatorListWLAN-r13  SEQUENCE (SIZE (1..maxWLAN-Bands-r13)) OF WLAN-
BandIndicator-r13,
        carrierInfoListWLAN-r13    SEQUENCE (SIZE (1..maxWLAN-CarrierInfo-r13)) OF WLAN-
CarrierInfo-r13
    } OPTIONAL,  -- Need ON
    wlan-ToAddModList-r13      WLAN-Id-List-r13          OPTIONAL,  -- Need ON
    wlan-ToRemoveList-r13     WLAN-Id-List-r13          OPTIONAL,  -- Need ON
    ...
}

WLAN-BandIndicator-r13 ::= ENUMERATED {band2dot4, band5, band60-v1430, spare5, spare4, spare3,
spare2, spare1, ...}

-- ASN1STOP

```

<b>MeasObjectWLAN field descriptions</b>
<b>bandIndicatorListWLAN</b> Includes the list of WLAN bands. Value band2dot4 indicates the 2.4GHz band, value band5 indicates the 5GHz band and value band60 indicates the 60GHz band.
<b>carrierInfoListWLAN</b> Includes the list of WLAN carrier information for the measurement object.
<b>wlan-ToAddModList</b> Includes the list of WLAN identifiers to be added to the measurement configuration.
<b>wlan-ToRemoveList</b> Includes the list of WLAN identifiers to be removed from the measurement configuration.

## – MeasResults

The IE *MeasResults* covers measured results for intra-frequency, inter-frequency and inter- RAT mobility and for idle/inactive measurements.

### MeasResults information element

```
-- ASN1START
MeasResults ::=
    SEQUENCE {
        measId                      MeasId,
        measResultPCell              SEQUENCE {
            rsrpResult              RSRP-Range,
            rsrqResult              RSRQ-Range
        },
        measResultNeighCells         CHOICE {
            measResultListEUTRA     MeasResultListEUTRA,
            measResultListUTRA      MeasResultListUTRA,
            measResultListGERAN     MeasResultListGERAN,
            measResultsCDMA2000     MeasResultsCDMA2000,
            . . . ,
            measResultNeighCellListNR-r15 MeasResultCellListNR-r15
        } OPTIONAL,
        . . . ,
        [[ measResultForECID-r9      MeasResultForECID-r9          OPTIONAL
        ]],
        [[ locationInfo-r10          LocationInfo-r10           OPTIONAL,
        measResultServFreqList-r10  MeasResultServFreqList-r10 OPTIONAL
        ]],
        [[ measId-v1250              MeasId-v1250             OPTIONAL,
        measResultPCell-v1250        RSRQ-Range-v1250        OPTIONAL,
        measResultCSI-RS-List-r12    MeasResultCSI-RS-List-r12 OPTIONAL
        ]],
        [[ measResultForRSSI-r13     MeasResultForRSSI-r13    OPTIONAL,
        measResultServFreqListExt-r13 MeasResultServFreqListExt-r13 OPTIONAL,
        measResultSSTD-r13          MeasResultSSTD-r13      OPTIONAL,
        measResultPCell-v1310       SEQUENCE {
            rs-sinr-Result-r13     RS-SINR-Range-r13
        } OPTIONAL,
        ul-PDCP-DelayResultList-r13  UL-PDCP-DelayResultList-r13 OPTIONAL,
        measResultListWLAN-r13      MeasResultListWLAN-r13  OPTIONAL
        ]],
        [[ measResultPCell-v1360     RSRP-Range-v1360        OPTIONAL
        ]],
        [[ measResultListCBR-r14      MeasResultListCBR-r14   OPTIONAL,
        measResultListWLAN-r14      MeasResultListWLAN-r14  OPTIONAL
        ]],
        [[ measResultServFreqListNR-r15 MeasResultServFreqListNR-r15 OPTIONAL,
        measResultCellListSFTD-r15   MeasResultCellListSFTD-r15 OPTIONAL
        ]],
        [[ logMeasResultListBT-r15    LogMeasResultListBT-r15  OPTIONAL,
        logMeasResultListWLAN-r15    LogMeasResultListWLAN-r15 OPTIONAL,
        measResultSensing-r15        MeasResultSensing-r15   OPTIONAL,
        heightUE-r15                 INTEGER (-400..8880)     OPTIONAL
        ]],
        [[ ul-PDCP-DelayValueResultList-r16 UL-PDCP-DelayValueResultList-r16 OPTIONAL,
        measResultForRSSI-NR-r16     MeasResultForRSSI-NR-r16 OPTIONAL
        ]],
        [[ uncomBarPreMeasResult-r17   OCTET STRING            OPTIONAL,
        coarseLocationInfo-r17       OCTET STRING            OPTIONAL
        ]],
    }
-- ASN1END
```



```

MeasResultListEUTRA ::= SEQUENCE (SIZE (1..maxCellReport)) OF MeasResultEUTRA

MeasResultEUTRA ::= SEQUENCE {
    physCellId PhysCellId,
    cgi-Info SEQUENCE {
        cellGlobalId CellGlobalIdEUTRA,
        trackingAreaCode TrackingAreaCode,
        plmn-IdentityList PLMN-IdentityList2 OPTIONAL,
    }
    measResult SEQUENCE {
        rsrpResult RSRP-Range OPTIONAL,
        rsrqResult RSRQ-Range OPTIONAL,
        ...
        [[ additionalSI-Info-r9 AdditionalSI-Info-r9 OPTIONAL
        ]],
        [[ primaryPLMN-Suitable-r12 ENUMERATED {true} OPTIONAL,
        measResult-v1250 RSRQ-Range-v1250 OPTIONAL
        ]],
        [[ rs-sinr-Result-r13 RS-SINR-Range-r13 OPTIONAL,
        cgi-Info-v1310 SEQUENCE {
            freqBandIndicator-r13 FreqBandIndicator-r11 OPTIONAL,
            multiBandInfoList-r13 MultiBandInfoList-r11 OPTIONAL,
            freqBandIndicatorPriority-r13 ENUMERATED {true} OPTIONAL
        }
        ]],
        [[
        measResult-v1360 RSRP-Range-v1360 OPTIONAL
        ]],
        [[
        cgi-Info-5GC-r15 SEQUENCE (SIZE (1..maxPLMN-r11)) OF CellAccessRelatedInfo-5GC-
r15 OPTIONAL
        ]]
    }
}

MeasResultListIdle-r15 ::= SEQUENCE (SIZE (1..maxIdleMeasCarriers-r15)) OF MeasResultIdle-r15

MeasResultIdle-r15 ::= SEQUENCE {
    measResultServingCell-r15 SEQUENCE {
        rsrpResult-r15 RSRP-Range,
        rsrqResult-r15 RSRQ-Range-r13
    },
    measResultNeighCells-r15 CHOICE {
        measResultIdleListEUTRA-r15 MeasResultIdleListEUTRA-r15,
        ...
    }
    ...
}

MeasResultIdleListEUTRA-r15 ::= SEQUENCE (SIZE (1..maxCellMeasIdle-r15)) OF MeasResultIdleEUTRA-r15

MeasResultIdleEUTRA-r15 ::= SEQUENCE {
    carrierFreq-r15 ARFCN-ValueEUTRA-r9,
    physCellId-r15 PhysCellId,
    measResult-r15 SEQUENCE {
        rsrpResult-r15 RSRP-Range,
        rsrqResult-r15 RSRQ-Range-r13
    },
    ...
}

MeasResultListExtIdle-r16 ::= SEQUENCE(SIZE (1..maxIdleMeasCarriersExt-r16)) OF
MeasResultIdleListEUTRA-r15

MeasResultListIdleNR-r16 ::= SEQUENCE(SIZE (1..maxIdleMeasCarriers-r16)) OF MeasResultIdleNR-r16

MeasResultIdleNR-r16 ::= SEQUENCE {
    carrierFreqNR-r16 ARFCN-ValueNR-r15,
    measResultsPerCellListIdleNR-r16 SEQUENCE (SIZE (1..maxCellMeasIdle-r15)) OF
MeasResultsPerCellIdleNR-r16,
    ...
}

MeasResultsPerCellIdleNR-r16 ::= SEQUENCE {
    physCellIdNR-r16 PhysCellIdNR-r15,
    measIdleResultNR-r16 SEQUENCE {
        rsrpResultNR-r16 RSRP-RangeNR-r15 OPTIONAL,

```

```

        rsrqResultNR-r16                RSRQ-RangeNR-r15                OPTIONAL,
        resultRS-IndexList-r16          ResultsPerSSB-IndexList-r16  OPTIONAL
    },
    ...
}

ResultsPerSSB-IndexList-r16 ::= SEQUENCE (SIZE (1..maxRS-IndexReport-r15)) OF ResultsPerSSB-
IndexIdle-r16

ResultsPerSSB-IndexIdle-r16 ::= SEQUENCE {
    ssb-Index-r16                RS-IndexNR-r15,
    ssb-Results-r16              SEQUENCE {
        ssb-RSRP-Result-r16      RSRP-RangeNR-r15                OPTIONAL,
        ssb-RSRQ-Result-r16      RSRQ-RangeNR-r15                OPTIONAL
    }
}

MeasResultServFreqListNR-r15 ::= SEQUENCE (SIZE (1..maxServCell-r13)) OF MeasResultServFreqNR-r15

MeasResultServFreqNR-r15 ::= SEQUENCE {
    carrierFreq-r15              ARFCN-ValueNR-r15,
    measResultSCell-r15          MeasResultCellNR-r15          OPTIONAL,
    measResultBestNeighCell-r15 MeasResultCellNR-r15          OPTIONAL,
    ...
}

MeasResultCellListNR-r15 ::= SEQUENCE (SIZE (1..maxCellReport)) OF MeasResultCellNR-r15

MeasResultCellNR-r15 ::= SEQUENCE {
    pci-r15                      PhysCellIdNR-r15,
    measResultCell-r15           MeasResultNR-r15,
    measResultRS-IndexList-r15  MeasResultSSB-IndexList-r15  OPTIONAL,
    ...
    [[ cgi-Info-r15              CGI-InfoNR-r15                OPTIONAL
    ]]
}

MeasResultNR-r15 ::= SEQUENCE {
    rsrpResult-r15              RSRP-RangeNR-r15                OPTIONAL,
    rsrqResult-r15              RSRQ-RangeNR-r15                OPTIONAL,
    rs-sinr-Result-r15          RS-SINR-RangeNR-r15           OPTIONAL,
    ...
}

MeasResultSSB-IndexList-r15 ::= SEQUENCE (SIZE (1..maxRS-IndexReport-r15)) OF MeasResultSSB-
Index-r15

MeasResultSSB-Index-r15 ::= SEQUENCE {
    ssb-Index-r15                RS-IndexNR-r15,
    measResultSSB-Index-r15      MeasResultNR-r15                OPTIONAL,
    ...
}

MeasResultServFreqList-r10 ::= SEQUENCE (SIZE (1..maxServCell-r10)) OF MeasResultServFreq-r10

MeasResultServFreqListExt-r13 ::= SEQUENCE (SIZE (1..maxServCell-r13)) OF MeasResultServFreq-r13

MeasResultServFreq-r10 ::= SEQUENCE {
    servFreqId-r10              ServCellIndex-r10,
    measResultSCell-r10          SEQUENCE {
        rsrpResultSCell-r10      RSRP-Range,
        rsrqResultSCell-r10      RSRQ-Range
    }
    measResultBestNeighCell-r10 SEQUENCE {
        physCellId-r10          PhysCellId,
        rsrpResultNCell-r10     RSRP-Range,
        rsrqResultNCell-r10     RSRQ-Range
    }
    ...
    [[ measResultSCell-v1250     RSRQ-Range-v1250  OPTIONAL,
    measResultBestNeighCell-v1250 RSRQ-Range-v1250  OPTIONAL
    ]],
    [[ measResultSCell-v1310     SEQUENCE {
        rs-sinr-Result-r13      RS-SINR-Range-r13
    }
    OPTIONAL,
    measResultBestNeighCell-v1310 SEQUENCE {
        rs-sinr-Result-r13      RS-SINR-Range-r13
    }
    OPTIONAL
    ]]
}

```

```

    ]]
  }
MeasResultServFreq-r13 ::= SEQUENCE {
  servFreqId-r13          ServCellIndex-r13,
  measResultSCell-r13    SEQUENCE {
    rsrpResultSCell-r13  RSRP-Range,
    rsrqResultSCell-r13  RSRQ-Range-r13,
    rs-sinr-Result-r13   RS-SINR-Range-r13  OPTIONAL
  } OPTIONAL,
  measResultBestNeighCell-r13 SEQUENCE {
    physCellId-r13      PhysCellId,
    rsrpResultNCell-r13 RSRP-Range,
    rsrqResultNCell-r13 RSRQ-Range-r13,
    rs-sinr-Result-r13 RS-SINR-Range-r13  OPTIONAL
  } OPTIONAL,
  ...,
  [[ measResultBestNeighCell-v1360 SEQUENCE {
    rsrpResultNCell-v1360 RSRP-Range-v1360
  } OPTIONAL
  ]]
}

MeasResultCSI-RS-List-r12 ::= SEQUENCE (SIZE (1..maxCellReport)) OF MeasResultCSI-RS-r12

MeasResultCSI-RS-r12 ::= SEQUENCE {
  measCSI-RS-Id-r12      MeasCSI-RS-Id-r12,
  csi-RSRP-Result-r12    CSI-RSRP-Range-r12,
  ...
}

MeasResultListUTRA ::= SEQUENCE (SIZE (1..maxCellReport)) OF MeasResultUTRA

MeasResultUTRA ::= SEQUENCE {
  physCellId            CHOICE {
    fdd                  PhysCellIdUTRA-FDD,
    tdd                  PhysCellIdUTRA-TDD
  },
  cgi-Info              SEQUENCE {
    cellGlobalId        CellGlobalIdUTRA,
    locationAreaCode    BIT STRING (SIZE (16))  OPTIONAL,
    routingAreaCode     BIT STRING (SIZE (8))   OPTIONAL,
    plmn-IdentityList   PLMN-IdentityList2     OPTIONAL
  } OPTIONAL,
  measResult            SEQUENCE {
    ultra-RSCP          INTEGER (-5..91)        OPTIONAL,
    ultra-EcN0          INTEGER (0..49)         OPTIONAL,
    ...,
    [[ additionalSI-Info-r9 AdditionalSI-Info-r9 OPTIONAL
    ]],
    [[ primaryPLMN-Suitable-r12 ENUMERATED {true} OPTIONAL
    ]]
  }
}

MeasResultListGERAN ::= SEQUENCE (SIZE (1..maxCellReport)) OF MeasResultGERAN

MeasResultGERAN ::= SEQUENCE {
  carrierFreq          CarrierFreqGERAN,
  physCellId          PhysCellIdGERAN,
  cgi-Info            SEQUENCE {
    cellGlobalId      CellGlobalIdGERAN,
    routingAreaCode   BIT STRING (SIZE (8))  OPTIONAL
  } OPTIONAL,
  measResult          SEQUENCE {
    rssi              INTEGER (0..63),
    ...
  }
}

MeasResultsCDMA2000 ::= SEQUENCE {
  preRegistrationStatusHRPD BOOLEAN,
  measResultListCDMA2000 MeasResultListCDMA2000
}

MeasResultListCDMA2000 ::= SEQUENCE (SIZE (1..maxCellReport)) OF MeasResultCDMA2000

MeasResultCDMA2000 ::= SEQUENCE {

```

```

    physCellId          PhysCellIdCDMA2000,
    cgi-Info            CellGlobalIdCDMA2000          OPTIONAL,
    measResult          SEQUENCE {
        pilotPnPhase    INTEGER (0..32767)          OPTIONAL,
        pilotStrength   INTEGER (0..63),
        ...
    }
}

MeasResultListWLAN-r13 ::= SEQUENCE (SIZE (1..maxCellReport)) OF MeasResultWLAN-r13

MeasResultListWLAN-r14 ::= SEQUENCE (SIZE (1..maxWLAN-Id-Report-r14)) OF MeasResultWLAN-r13

MeasResultWLAN-r13 ::= SEQUENCE {
    wlan-Identifiers-r13      WLAN-Identifiers-r12,
    carrierInfoWLAN-r13      WLAN-CarrierInfo-r13    OPTIONAL,
    bandWLAN-r13              WLAN-BandIndicator-r13  OPTIONAL,
    rssiWLAN-r13              WLAN-RSSI-Range-r13,
    availableAdmissionCapacityWLAN-r13  INTEGER (0..31250)    OPTIONAL,
    backhaulDL-BandwidthWLAN-r13  WLAN-backhaulRate-r12  OPTIONAL,
    backhaulUL-BandwidthWLAN-r13  WLAN-backhaulRate-r12  OPTIONAL,
    channelUtilizationWLAN-r13    INTEGER (0..255)        OPTIONAL,
    stationCountWLAN-r13          INTEGER (0..65535)        OPTIONAL,
    connectedWLAN-r13            ENUMERATED {true}      OPTIONAL,
    ...
}

MeasResultListCBR-r14 ::= SEQUENCE (SIZE (1..maxCBR-Report-r14)) OF MeasResultCBR-r14

MeasResultCBR-r14 ::= SEQUENCE {
    poolIdentity-r14          SL-V2X-TxPoolReportIdentity-r14,
    cbr-PSSCH-r14            SL-CBR-r14,
    cbr-PSCCH-r14            SL-CBR-r14              OPTIONAL
}

MeasResultSensing-r15 ::= SEQUENCE {
    sl-SubframeRef-r15        INTEGER (0..10239),
    sensingResult-r15         SEQUENCE (SIZE (0..400)) OF SensingResult-r15
}

SensingResult-r15 ::= SEQUENCE {
    resourceIndex-r15         INTEGER (1..2000)
}

MeasResultForECID-r9 ::= SEQUENCE {
    ue-RxTxTimeDiffResult-r9  INTEGER (0..4095),
    currentSFN-r9              BIT STRING (SIZE (10))
}

PLMN-IdentityList2 ::= SEQUENCE (SIZE (1..5)) OF PLMN-Identity

AdditionalSI-Info-r9 ::= SEQUENCE {
    csg-MemberStatus-r9       ENUMERATED {member}      OPTIONAL,
    csg-Identity-r9           CSG-Identity              OPTIONAL
}

MeasResultForRSSI-r13 ::= SEQUENCE {
    rssi-Result-r13           RSSI-Range-r13,
    channelOccupancy-r13      INTEGER (0..100),
    ...
}

MeasResultForRSSI-NR-r16 ::= SEQUENCE {
    rssi-ResultNR-r16         RSSI-Range-r13,
    channelOccupancyNR-r16    INTEGER (0..100),
    ...
}

UL-PDCP-DelayResultList-r13 ::= SEQUENCE (SIZE (1..maxQCI-r13)) OF UL-PDCP-DelayResult-r13

UL-PDCP-DelayResult-r13 ::= SEQUENCE {
    qci-Id-r13                ENUMERATED {qci1, qci2, qci3, qci4, spare4, spare3, spare2,
    spare1},
    excessDelay-r13           INTEGER (0..31),
    ...
}

```

```

UL-PDCP-DelayValueResultList-r16 ::= SEQUENCE (SIZE (1..maxDRB)) OF UL-PDCP-DelayValueResult-
r16
UL-PDCP-DelayValueResult-r16 ::= SEQUENCE {
  drb-Id-r16 DRB-Identity,
  averageDelay-r16 INTEGER (0..10000),
  ...
}
CGI-InfoNR-r15 ::= SEQUENCE {
  plmn-IdentityInfoList-r15 PLMN-IdentityInfoListNR-r15 OPTIONAL,
  frequencyBandList-r15 MultiFrequencyBandListNR-r15 OPTIONAL,
  noSIB1-r15 SEQUENCE {
    ssb-SubcarrierOffset-r15 INTEGER (0..15),
    pdcch-ConfigSIB1-r15 INTEGER (0..255)
  } OPTIONAL,
  ...
  [[
    plmn-IdentityInfoList-v1710 PLMN-IdentityInfoListNR-v1710 OPTIONAL
  ]]
}
CellIdentityNR-r15 ::= BIT STRING (SIZE (36))
PLMN-IdentityListNR-r15 ::= SEQUENCE (SIZE (1.. maxPLMN-NR-r15)) OF PLMN-Identity
PLMN-IdentityInfoListNR-r15 ::= SEQUENCE (SIZE (1..maxPLMN-NR-r15)) OF PLMN-IdentityInfoNR-r15
PLMN-IdentityInfoListNR-v1710 ::= SEQUENCE (SIZE (1..maxPLMN-NR-r15)) OF PLMN-IdentityInfoNR-v1710
PLMN-IdentityInfoNR-r15 ::= SEQUENCE {
  plmn-IdentityList-r15 PLMN-IdentityListNR-r15,
  trackingAreaCode-r15 TrackingAreaCodeNR-r15 OPTIONAL,
  ran-AreaCode-r15 RAN-AreaCode-r15 OPTIONAL,
  cellIdentity-r15 CellIdentityNR-r15
}
PLMN-IdentityInfoNR-v1710 ::= SEQUENCE {
  gNB-ID-Length-r17 INTEGER (22..32) OPTIONAL
}
TrackingAreaCodeNR-r15 ::= BIT STRING (SIZE (24))
-- ASN1STOP

```

<b>MeasResults field descriptions</b>	
<b>availableAdmissionCapacityWLAN</b>	Indicates the available admission capacity of WLAN as defined in IEEE 802.11-2012 [67].
<b>averageDelay</b>	Indicates average delay for the packets during the reporting period, as specified in TS 38.314 [103]. Value 0 corresponds to 0 millisecond, value 1 corresponds to 0.1 millisecond, value 2 corresponds to 0.2 millisecond, and so on.
<b>backhaulDL-BandwidthWLAN</b>	Indicates the backhaul available downlink bandwidth of WLAN, equal to Downlink Speed times Downlink Load defined in Wi-Fi Alliance Hotspot 2.0 [76].
<b>backhaulUL-BandwidthWLAN</b>	Indicates the backhaul available uplink bandwidth of WLAN, equal to Uplink Speed times Uplink Load defined in Wi-Fi Alliance Hotspot 2.0 [76].
<b>bandWLAN</b>	Indicates the WLAN band.
<b>carrierFreq</b>	Indicates the E-UTRA carrier frequency. Within <i>MeasResultIdleListEUTRA-r15</i> , UE only includes measurements with the same carrier frequency.
<b>carrierFreqNR</b>	Indicates the NR carrier frequency.
<b>carrierInfoWLAN</b>	Indicates the WLAN channel information.
<b>cbr-PSSCH</b>	Indicates the CBR measurement results on the PSSCH of the pool indicated by <i>poolIdentity</i> . If <i>adjacencyPSCCH-PSSCH</i> is set to <i>TRUE</i> for the pool indicated by <i>poolIdentity</i> , this field indicates the CBR measurement of both the PSSCH and PSCCH resources which are measured together.
<b>cbr-PSCCH</b>	Indicates the CBR measurement results on the PSCCH of the pool indicated by <i>poolIdentity</i> . This field is only included if <i>adjacencyPSCCH-PSSCH</i> is set to <i>FALSE</i> for the pool indicated by <i>poolIdentity</i> .
<b>channelOccupancy</b>	Indicates the percentage of samples when the RSSI was above the configured <i>channelOccupancyThreshold</i> for the associated <i>reportConfig</i> .
<b>channelUtilizationWLAN</b>	Indicates WLAN channel utilization as defined in IEEE 802.11-2012 [67].
<b>coarseLocationInfo</b>	This field indicates the coarse location information reported by the UE. This field is coded as the Ellipsoid-Point IE defined in TS 37.355 [109]. The first/leftmost bit of the first octet contains the most significant bit. The least significant bits of <i>degreesLatitude</i> and <i>degreesLongitude</i> are set to 0 to meet the accuracy requirement which corresponds to a granularity of approximately 2 km. It is up to UE implementation as to how many LSBs are set to 0 to meet the accuracy requirement.
<b>connectedWLAN</b>	Indicates whether the UE is connected to the WLAN for which the measurement results are applicable.
<b>csg-MemberStatus</b>	Indicates whether or not the UE is a member of the CSG of the neighbour cell.
<b>currentSFN</b>	Indicates the current system frame number when receiving the UE Rx-Tx time difference measurement results from lower layer.
<b>drb-Id</b>	Indicates the identity of DRB for which UL PDCP Packet Delay value is provided, according to TS 38.314 [103].
<b>excessDelay</b>	Indicates excess queueing delay ratio in UL, according to excess delay ratio measurement report mapping table, as defined in TS 36.314 [71], Table 4.2.1.1.1-1.
<b>gNB-ID-Length</b>	Indicates the length of the gNB ID corresponding to the associated entry in the <i>PLMN-IdentityInfoNR</i> .
<b>heightUE</b>	Indicates height of the UE in meters relative to the sea level. Value 0 corresponds to sea level (i.e., negative value indicates depth of the UE below sea level). Value -400 corresponds to -400 m, value -399 corresponds to -399 m and so on.
<b>locationAreaCode</b>	A fixed length code identifying the location area within a PLMN, as defined in TS 23.003 [27].
<b>measId</b>	Identifies the measurement identity for which the reporting is being performed. If the <i>measId-v1250</i> is included, the <i>measId</i> (i.e. without a suffix) is ignored by eNB.
<b>measIdleResultNR</b>	Idle/inactive measurement results for an NR cell (optionally including beam level measurements).

<b>MeasResults field descriptions</b>
<p><b>measResult</b>  Measured result of an E-UTRA cell;  Measured result of a UTRA cell;  Measured result of a GERAN cell or frequency;  Measured result of a CDMA2000 cell;  Measured result of a WLAN;  Measured result of UE Rx–Tx time difference;  Measured result of UE SFN, radio frame and subframe timing difference; or  Measured result of RSSI and channel occupancy.</p>
<p><b>measResultCSI-RS-List</b>  Measured results of the CSI-RS resources in discovery signals measurement.</p>
<p><b>measResultListCDMA2000</b>  List of measured results for the maximum number of reported best cells for a CDMA2000 measurement identity.</p>
<p><b>measResultListEUTRA</b>  List of measured results for the maximum number of reported best cells for an E-UTRA measurement identity. For UE supporting CE Mode B, when CE mode B is not restricted by upper layers, <i>measResult-v1360</i> is reported if the measured RSRP is less than -140 dBm.</p>
<p><b>measResultListGERAN</b>  List of measured results for the maximum number of reported best cells or frequencies for a GERAN measurement identity.</p>
<p><b>measResultListIdle</b>  List of measured results for E-UTRA idle/inactive measurements.</p>
<p><b>measResultListIdleNR</b>  List of measured results for NR idle/inactive measurements.</p>
<p><b>measResultListSFTD</b>  List of measured SFTD results for the reported cells for a NR measurement identity.</p>
<p><b>measResultListUTRA</b>  List of measured results for the maximum number of reported best cells for a UTRA measurement identity.</p>
<p><b>measResultListWLAN</b>  List of measured results for the maximum number of reported best WLAN outside the WLAN mobility set and connected WLAN, if any, for a WLAN measurement identity.</p>
<p><b>measResultPCell</b>  Measured result of the PCell. For BL UEs or UEs in CE, when operating in CE Mode B, <i>measResultPCell-v1360</i> is reported if the measured RSRP is less than -140 dBm. If sending of the MeasurementReport message is triggered by a measurement configured by the field <i>sl-ConfigDedicatedEUTRA</i> that was received within an NR RRCReconfiguration message (i.e. CBR measurements), <i>measResultPCell</i> is not applicable, its contents is invalid and ignored by the network.</p>
<p><b>measResultsCDMA2000</b>  Contains the CDMA2000 HRPD pre-registration status and the list of CDMA2000 measurements.</p>
<p><b>measResultServFreqList</b>  Measured results of the serving frequencies: the measurement result of each SCell, if any, and of the best neighbouring cell on each serving frequency. For UE supporting CE Mode B, when CE mode B is not restricted by upper layers, <i>measResultBestNeighCell-v1360</i> is reported if the measured RSRP is less than -140 dBm.</p>
<p><b>measResultServingCell</b>  Measured results of the serving cell (i.e., PCell) from idle/inactive measurements.</p>
<p><b>measResultsPerCellListIdleNR</b>  List of idle/inactive measured results for the maximum number of reported best cells for a given NR carrier.</p>
<p><b>noSIB1</b>  Contains <i>ssb-SubcarrierOffset</i> and <i>pdccch-ConfigSIB1</i> fields acquired by the UE from MIB of the cell for which report CGI procedure was requested by the network in case SIB1 was not broadcast by the cell.</p>
<p><b>pilotPnPhase</b>  Indicates the arrival time of a CDMA2000 pilot, measured relative to the UE's time reference in units of PN chips, see C.S0005 [25]. This information is used in either SRVCC handover or enhanced 1xRTT CS fallback procedure to CDMA2000 1xRTT.</p>
<p><b>pilotStrength</b>  CDMA2000 Pilot Strength, the ratio of pilot power to total power in the signal bandwidth of a CDMA2000 Forward Channel. See C.S0005 [25] for CDMA2000 1xRTT and C.S0024 [26] for CDMA2000 HRPD.</p>
<p><b>poolIdentity</b>  The identity of the transmission resource pool which is corresponding to the <i>poolReportId</i> configured in a resource pool for V2X sidelink communication.</p>
<p><b>plmn-IdentityList</b>  The list of PLMN Identity read from broadcast information when the multiple PLMN Identities are broadcast.</p>
<p><b>preRegistrationStatusHRPD</b>  Set to TRUE if the UE is currently pre-registered with CDMA2000 HRPD. Otherwise set to FALSE. This can be ignored by the eNB for CDMA2000 1xRTT.</p>

<b>MeasResults field descriptions</b>
<p><b>qci-Id</b> Indicates QCI value for which <i>excessDelay</i> is provided, according to TS 36.314 [71].</p>
<p><b>resourceIndex</b> Indicates the available resource candidates within the [T1, T2] window as specified in TS 36.213 [23]. clause 14.1.1.6. Value 1 indicates the resource candidate on the subframe indicated by <i>sl-SubframeRef</i>, from subchannel 0 to <i>sensingSubchannelNumber-1</i>. Value 2 indicates the resource candidate on the first subframe following the subframe indicated by <i>sl-SubframeRef</i>, from subchannel 0 to <i>sensingSubchannelNumber-1</i> (Value 101 indicates the resource candidate on the subframe indicated by <i>sl-SubframeRef</i>, from subchannel 1 to <i>sensingSubchannelNumber</i>, if the <i>numSubchannel</i> of the resource pool is larger than <i>sensingSubchannelNumber</i>) and so on.</p>
<p><b>resultRS-IndexList</b> Beam level measurement results (indexes and optionally, beam measurements).</p>
<p><b>routingAreaCode</b> The RAC identity read from broadcast information, as defined in TS 23.003 [27].</p>
<p><b>rsrpResult</b> Measured RSRP result of an E-UTRA cell. The <i>rsrpResult</i> is only reported if configured by the eNB.</p>
<p><b>rsrpResultNR</b> Measured RSRP result of an NR cell. The <i>rsrpResultNR</i> is only reported if configured by the eNB.</p>
<p><b>rsrqResult</b> Measured RSRQ result of an E-UTRA cell. The <i>rsrqResult</i> is only reported if configured by the eNB. If the measurement is performed in RRC_CONNECTED and measurements based on RSS is enabled in the cell in <i>measRSS-DedicatedConfig-r16</i>, E-UTRAN ignores <i>rsrqResult</i>.</p>
<p><b>rsrqResultNR</b> Measured RSRQ result of an NR cell. The <i>rsrqResultNR</i> is only reported if configured by the eNB.</p>
<p><b>rssi</b> GERAN Carrier RSSI. RXLEV is mapped to a value between 0 and 63, TS 45.008 [28]. When mapping the RXLEV value to the RSSI bit string, the first/leftmost bit of the bit string contains the most significant bit.</p>
<p><b>rssi-Result</b> Measured RSSI result in dBm.</p>
<p><b>rs-sinr-Result</b> Measured RS-SINR result of an E-UTRA or NR cell. The <i>rs-sinr-Result</i> is only reported if configured by the eNB.</p>
<p><b>rssiWLAN</b> Measured WLAN RSSI result in dBm.</p>
<p><b>sl-SubframeRef</b> Indicates the subframe corresponding to n+T1 used to obtain the sensing measurement results (see TS 36.213 [23]). Specifically, the value indicates the timing offset with respect to subframe#0 of DFN#0 in milliseconds.</p>
<p><b>stationCountWLAN</b> Indicates the total number stations currently associated with this WLAN as defined in IEEE 802.11-2012 [67].</p>
<p><b>ue-RxTxTimeDiffResult</b> UE Rx-Tx time difference measurement result of the PCell, provided by lower layers. If <i>ue-RxTxTimeDiffPeriodicalTDD-r13</i> is set to <i>TRUE</i>, the measurement mapping is according to EUTRAN TDD UE Rx-Tx time difference report mapping in TS 36.133 [16] and measurement result includes <i>N<sub>TAoffset</sub></i>, else the measurement mapping is according to EUTRAN FDD UE Rx-Tx time difference report mapping in TS 36.133 [16].</p>
<p><b>uncomBarPreMeasResult</b> This field provides barometric pressure measurements as <i>Sensor-MeasurementInformation</i> defined in TS 37.355 [109]. The first/leftmost bit of the first octet contains the most significant bit.</p>
<p><b>utra-EcNO</b> According to CPICH_Ec/No in TS 25.133 [29] for FDD. Fourteen spare values. The field is not present for TDD.</p>
<p><b>utra-RSCP</b> According to CPICH_RSCP in TS 25.133 [29] for FDD and P-CCPCH_RSCP in TS 25.123 [30] for TDD. Thirty-one spare values.</p>
<p><b>wlan-Identifiers</b> Indicates the WLAN parameters used for identification of the WLAN for which the measurement results are applicable.</p>

– **MeasResultCellSFTD**

The IE *MeasResultCellSFTD* consists of SFN and radio frame boundary difference between the PCell and an NR cell as specified in TS 38.215 [89] and TS 38.133 [84].

**MeasResultCellSFTD information element**

-- ASN1START



```

MeasResultCellListSFTD-r15 ::= SEQUENCE (SIZE (1..maxCellsFTD)) OF MeasResultCellSFTD-r15
MeasResultCellSFTD-r15 ::= SEQUENCE {
    physCellId-r15 PhysCellIdNR-r15,
    sfn-OffsetResult-r15 INTEGER (0..1023),
    frameBoundaryOffsetResult-r15 INTEGER (-30720..30719),
    rsrpResult-r15 RSRP-RangeNR-r15 OPTIONAL
}
-- ASN1STOP

```

#### **MeasResultCellSFTD field descriptions**

**physCellId**

Indicates the physical layer identity (PCI) of an NR cell.

**sfn-OffsetResult**

Indicates the SFN difference between the PCell and the NR cell as an integer value according to TS 38.215 [89].

**frameBoundaryOffsetResult**

Indicates the frame boundary difference between the PCell and the NR cell as an integer value according to TS 38.215 [89].

**rsrpResult**

Measured RSRP result of an NR cell.

### – **MeasResultSCG-FailureMRDC**

The IE *MeasResultSCG-FailureMRDC* is used to provide measurement information concerning E-UTRA measurements upon SCG failure detected by a UE configured with NE-DC.

#### **MeasResultSCG-FailureMRDC information element**

```

-- ASN1START
MeasResultSCG-FailureMRDC-r15 ::= SEQUENCE {
    measResultFreqListEUTRA-r15 MeasResultList3EUTRA-r15,
    . . . ,
    [[ locationInfo-r16 LocationInfo-r16 OPTIONAL,
      logMeasResultListBT-r16 LogMeasResultListBT-r15 OPTIONAL,
      logMeasResultListWLAN-r16 LogMeasResultListWLAN-r15 OPTIONAL
    ]]
}
MeasResultList3EUTRA-r15 ::= SEQUENCE (SIZE (1..maxFreq)) OF MeasResult3EUTRA-r15
MeasResult3EUTRA-r15 ::= SEQUENCE {
    carrierFreq-r15 ARFCN-ValueEUTRA-r9,
    measResultServingCell-r15 MeasResultEUTRA OPTIONAL,
    measResultNeighCellList-r15 MeasResultListEUTRA OPTIONAL,
    . . .
}
-- ASN1STOP

```

### – **MeasResultSSTD**

The IE *MeasResultSSTD* consists of SFN, radio frame and subframe boundary difference between the PCell and the PSCell as specified in TS 36.214 [48] and TS 36.133 [16].

#### **MeasResultSSTD information element**

```

-- ASN1START
MeasResultSSTD-r13 ::= SEQUENCE {
    sfn-OffsetResult-r13 INTEGER (0..1023),
    frameBoundaryOffsetResult-r13 INTEGER (-5..4),
    subframeBoundaryOffsetResult-r13 INTEGER (0..127)
}
-- ASN1STOP

```

<b>MeasResultSSTD field descriptions</b>
<p><b><i>sfn-OffsetResult</i></b> Indicates the SFN difference between the PCell and the PSCell as an integer value according to TS 36.214 [48].</p>
<p><b><i>frameBoundaryOffsetResult</i></b> Indicates the frame boundary difference between the PCell and the PSCell as an integer value according to TS 36.214 [48].</p>
<p><b><i>subframeBoundaryOffsetResult</i></b> Indicates the subframe boundary difference between the PCell and the PSCell as an integer value according to the mapping table in TS 36.133 [16].</p>

## – *MeasScaleFactor*

The IE *MeasScaleFactor* specifies the factor for scaling the measurement performance requirements in TS 36.133 [16].

### **MeasScaleFactor information element**

```
-- ASN1START
MeasScaleFactor-r12 ::=          ENUMERATED {sf-EUTRA-cf1, sf-EUTRA-cf2}
-- ASN1STOP
```

NOTE: If the *reducedMeasPerformance* is not included in any *measObjectEUTRA* or *measObjectUTRA* and the *measScaleFactor* is included in the *measConfig*, E-UTRAN can configure any of the values for the *measScaleFactor* as specified in TS 36.133 [16].

## – *MeasSensing-Config*

The IE *MeasSensing-Config* specifies the input factors for sensing measurement as specified in TS 36.213 [23].

### **MeasSensing-Config information element**

```
-- ASN1START
MeasSensing-Config-r15 ::=          SEQUENCE {
    sensingSubchannelNumber-r15      INTEGER (1..20),
    sensingPeriodicity-r15           ENUMERATED {ms20, ms50, ms100, ms200,
                                                ms300, ms400, ms500, ms600,
                                                ms700, ms800, ms900, ms1000},
    sensingReselectionCounter-r15    INTEGER (5..75),
    sensingPriority-r15               INTEGER (1..8)
}
-- ASN1STOP
```

<b>MeasSensing-Config field descriptions</b>
<p><b><i>sensingReselectionCounter</i></b> Indicate the value of SL_RESOURCE_RESELECTION_COUNTER, which is used to derive <math>C_{resel}</math>, as specified in TS 36.213 [23], clause 14.1.1.6.</p>
<p><b><i>sensingSubchannelNumber</i></b> Indicate the number of sub-channels, i.e., parameter <math>L_{subCH}</math>, as specified in TS 36.213 [23], clause 14.1.1.6.</p>
<p><b><i>sensingPeriodicity</i></b> Indicate the resource reservation interval, i.e., parameter <math>P_{rsvp\_TX}</math>, as specified in TS 36.213 [23], clause 14.1.1.6.</p>
<p><b><i>sensingPriority</i></b> Indicate the priority, i.e., parameter <math>prio_{TX}</math> as specified in TS 36.213 [23], clause 14.1.1.6.</p>

## – MTC-SSB-NR

The IE *MTC-SSB-NR* specifies the SS/PBCH block measurement timing configuration (SMTC) applicable for SSB based NR measurements i.e. the time occasions for performing these measurements, see 5.5.2.13.

### MTC-SSB-NR information elements

```

-- ASN1START
MTC-SSB-NR-r15 ::= SEQUENCE {
    periodicityAndOffset-r15 CHOICE {
        sf5-r15 INTEGER (0..4),
        sf10-r15 INTEGER (0..9),
        sf20-r15 INTEGER (0..19),
        sf40-r15 INTEGER (0..39),
        sf80-r15 INTEGER (0..79),
        sf160-r15 INTEGER (0..159)
    },
    ssb-Duration-r15 ENUMERATED {sf1, sf2, sf3, sf4, sf5 }
}

MTC-SSB2-LP-NR-r16 ::= SEQUENCE {
    pci-List-r16 SEQUENCE (SIZE (1..maxNrofPCI-PerSMTC-r16)) OF PhysCellIdNR-r15
    OPTIONAL, -- Need OR
    periodicity-r16 ENUMERATED {sf10, sf20, sf40, sf80, sf160, spare3, spare2, spare1}
}
-- ASN1STOP

```

### MTC-SSB-NR field descriptions

#### **pci-List**

PCIs that are known to follow this SMTC.

## – QuantityConfig

The IE *QuantityConfig* specifies the measurement quantities and layer 3 filtering coefficients for E-UTRA and inter-RAT measurements.

### QuantityConfig information element

```

-- ASN1START
QuantityConfig ::= SEQUENCE {
    quantityConfigEUTRA QuantityConfigEUTRA OPTIONAL, -- Need ON
    quantityConfigUTRA QuantityConfigUTRA OPTIONAL, -- Need ON
    quantityConfigGERAN QuantityConfigGERAN OPTIONAL, -- Need ON
    quantityConfigCDMA2000 QuantityConfigCDMA2000 OPTIONAL, -- Need ON
    ...,
    [[ quantityConfigUTRA-v1020 QuantityConfigUTRA-v1020 OPTIONAL -- Need ON
    ]],
    [[ quantityConfigEUTRA-v1250 QuantityConfigEUTRA-v1250 OPTIONAL -- Need ON
    ]],
    [[ quantityConfigEUTRA-v1310 QuantityConfigEUTRA-v1310 OPTIONAL, -- Need ON
    quantityConfigWLAN-r13 QuantityConfigWLAN-r13 OPTIONAL -- Need ON
    ]],
    [[ quantityConfigNRLList-r15 QuantityConfigNRLList-r15 OPTIONAL -- Need ON
    ]]
}

QuantityConfigEUTRA ::= SEQUENCE {
    filterCoefficientRSRP FilterCoefficient DEFAULT fc4,
    filterCoefficientRSRQ FilterCoefficient DEFAULT fc4
}

QuantityConfigEUTRA-v1250 ::= SEQUENCE {
    filterCoefficientCSI-RSRP-r12 FilterCoefficient OPTIONAL -- Need
OR
}

QuantityConfigEUTRA-v1310 ::= SEQUENCE {
    filterCoefficientRS-SINR-r13 FilterCoefficient DEFAULT fc4
}

```

```

}
QuantityConfigUTRA ::=
    measQuantityUTRA-FDD          SEQUENCE {
    measQuantityUTRA-TDD          ENUMERATED {cpich-RSCP, cpich-EcN0},
    filterCoefficient            ENUMERATED {pccpch-RSCP},
                                FilterCoefficient            DEFAULT fc4
    }
QuantityConfigUTRA-v1020 ::=
    filterCoefficient2-FDD-r10    SEQUENCE {
                                FilterCoefficient            DEFAULT fc4
    }
QuantityConfigGERAN ::=
    measQuantityGERAN            SEQUENCE {
    filterCoefficient            ENUMERATED {rssi},
                                FilterCoefficient            DEFAULT fc2
    }
QuantityConfigCDMA2000 ::=
    measQuantityCDMA2000         SEQUENCE {
                                ENUMERATED {pilotStrength, pilotPnPhaseAndPilotStrength}
    }
QuantityConfigNRList-r15 ::=
    SEQUENCE (SIZE (1..maxQuantSetsNR-r15)) OF QuantityConfigNR-r15
QuantityConfigNR-r15 ::=
    measQuantityCellNR-r15        SEQUENCE {
    measQuantityRS-IndexNR-r15    QuantityConfigRS-NR-r15,
                                QuantityConfigRS-NR-r15        OPTIONAL
    }
QuantityConfigRS-NR-r15 ::=
    filterCoeff-RSRP-r15          SEQUENCE {
    filterCoeff-RSRQ-r15          FilterCoefficient            DEFAULT fc4,
    filterCoefficient-SINR-r13    FilterCoefficient            DEFAULT fc4,
                                FilterCoefficient            DEFAULT fc4
    }
QuantityConfigWLAN-r13 ::=
    measQuantityWLAN-r13          SEQUENCE {
    filterCoefficient-r13         ENUMERATED {rssiWLAN},
                                FilterCoefficient            DEFAULT fc4
    }
-- ASN1STOP

```

<b>QuantityConfig field descriptions</b>
<b>filterCoefficient2-FDD</b> Specifies the filtering coefficient used for the UTRAN FDD measurement quantity, which is not included in <i>measQuantityUTRA-FDD</i> , when <i>reportQuantityUTRA-FDD</i> is present in <i>ReportConfigInterRAT</i> .
<b>filterCoefficientCSI-RSRP</b> Specifies the filtering coefficient used for CSI-RSRP.
<b>filterCoefficientRSRP</b> Specifies the filtering coefficient used for RSRP.
<b>filterCoefficientRSRQ</b> Specifies the filtering coefficient used for RSRQ.
<b>filterCoefficientRS-SINR</b> Specifies the filtering coefficient used for RS-SINR.
<b>measQuantityCDMA2000</b> Measurement quantity used for CDMA2000 measurements. <i>pilotPnPhaseAndPilotStrength</i> is only applicable for <i>MeasObjectCDMA2000</i> of <i>cdma2000-Type = type1XRTT</i> .
<b>measQuantityRS-IndexNR</b> Specifies L3 filter configurations for measurement results of an NR RS index for a particular RS Type (e.g. SS/PBCH block) and the configurable measurement quantities (e.g. RSRP, RSRQ and SINR).
<b>measQuantityGERAN</b> Measurement quantity used for GERAN measurements.
<b>measQuantityCellINR</b> Specifies L3 filter configurations for measurement results of an NR cell for a particular RS Type (e.g. SS/PBCH block) and the configurable measurement quantities (e.g. RSRP, RSRQ and SINR).
<b>measQuantityUTRA</b> Measurement quantity used for UTRA measurements.
<b>measQuantityWLAN</b> Measurement quantity used for WLAN measurements.
<b>quantityConfigCDMA2000</b> Specifies quantity configurations for CDMA2000 measurements.
<b>quantityConfigEUTRA</b> Specifies filter configurations for E-UTRA measurements.
<b>quantityConfigGERAN</b> Specifies quantity and filter configurations for GERAN measurements.
<b>quantityConfigUTRA</b> Specifies quantity and filter configurations for UTRA measurements. Field <i>quantityConfigUTRA-v1020</i> is applicable only when <i>reportQuantityUTRA-FDD</i> is configured.
<b>quantityConfigWLAN</b> Specifies quantity and filter configurations for WLAN measurements.

### – *ReferenceLocation*

The IE *ReferenceLocation* contains location information used as a reference location. The value of the field is same as *Ellipsoid-Point* defined in TS 37.355 [109]. The first/leftmost bit of the first octet contains the most significant bit.

#### **ReferenceLocation information element**

```
-- ASN1START
ReferenceLocation-r18 ::=          OCTET STRING
-- ASN1STOP
```

### – *ReportConfigEUTRA*

The IE *ReportConfigEUTRA* specifies criteria for triggering of an E-UTRA measurement reporting or conditional reconfiguration (i.e. conditional handover) event. The E-UTRA measurement reporting events concerning CRS are labelled AN with N equal to 1, 2 and so on. The E-UTRA measurement reporting events concerning distance(s) between UE and reference location(s) are labelled DN with N equal to 1, 2.

- Event A1: Serving becomes better than absolute threshold;
- Event A2: Serving becomes worse than absolute threshold;
- Event A3: Neighbour becomes amount of offset better than PCell/ PSCell;
- Event A4: Neighbour becomes better than absolute threshold;
- Event A5: PCell/ PSCell becomes worse than absolute threshold1 AND Neighbour becomes better than another absolute threshold2;
- Event A6: Neighbour becomes amount of offset better than SCell;
- Event D1: Distance between UE and a reference location *referenceLocation1* becomes larger than configured threshold *distanceThreshFromReference1* and distance between UE and a reference location *referenceLocation2* becomes shorter than configured threshold *distanceThreshFromReference2*;
- Event D2: Distance between UE and a moving reference location based on *movingReferenceLocation* becomes larger than configured threshold *distanceThreshFromReference1* and distance between UE and a moving reference location based on *referenceLocation* and its corresponding satellite ephemeris (provided in *ephemerisInfo* or indicated by *satelliteId*) and epoch time provided in the associated *measObjectEUTRA* becomes shorter than configured threshold *distanceThreshFromReference2*.

The E-UTRA measurement reporting events concerning CRS for conditional reconfigurations are labelled AN with N equal to 3, 4 or 5. The E-UTRA measurement reporting event concerning distance(s) between UE and reference location(s) for conditional reconfiguration is labelled CondEvent D1 or CondEvent D2. The E-UTRA measurement reporting event concerning measured time for conditional reconfiguration is labelled with CondEvent T1.

- CondEvent A3: Conditional reconfiguration candidate becomes amount of offset better than PCell;
- CondEvent A4: Conditional reconfiguration candidate becomes better than absolute threshold;
- CondEvent A5: PCell becomes worse than absolute threshold1 AND conditional reconfiguration candidate becomes better than another absolute threshold2;
- CondEvent D1: Distance between UE and a reference location *referenceLocation1* becomes larger than configured threshold *distanceThreshFromReference1* and distance between UE and a reference location *referenceLocation2* of conditional reconfiguration candidate becomes shorter than configured threshold *distanceThreshFromReference2*;
- CondEvent D2: Distance between UE and a moving reference location based on *movingReferenceLocation* becomes larger than configured threshold *distanceThreshFromReference1* and distance between UE and a moving reference location based on *referenceLocation* and its corresponding satellite ephemeris (provided in *ephemerisInfo* or indicated by *satelliteId*) and epoch time provided in the associated *measObjectEUTRA* for the conditional reconfiguration candidate becomes shorter than configured threshold *distanceThreshFromReference2*;
- CondEvent T1: Time measured at UE becomes more than configured threshold *t1-Threshold* but is less than *t1-Threshold + duration*;

The E-UTRA measurement reporting events concerning CSI-RS are labelled CN with N equal to 1 and 2.

- Event C1: CSI-RS resource becomes better than absolute threshold;
- Event C2: CSI-RS resource becomes amount of offset better than reference CSI-RS resource.

The E-UTRA measurement reporting events concerning CBR are labelled VN with N equal to 1 and 2.

- Event V1: CBR becomes larger than absolute threshold;
- Event V2: CBR becomes smaller than absolute threshold.

The E-UTRA reporting events concerning Aerial UE height are labelled HN with N equal to 1 and 2.

Event H1: Aerial UE height becomes higher than absolute threshold;

Event H2: Aerial UE height becomes lower than absolute threshold.

### ReportConfigEUTRA information element

```

-- ASN1START
ReportConfigEUTRA ::=
  triggerType
  event
  eventId
    eventA1
      a1-Threshold
    },
    eventA2
      a2-Threshold
    },
    eventA3
      a3-Offset
      reportOnLeave
    },
    eventA4
      a4-Threshold
    },
    eventA5
      a5-Threshold1
      a5-Threshold2
    },
    ...,
    eventA6-r10
      a6-Offset-r10
      a6-ReportOnLeave-r10
    },
    eventC1-r12
      c1-Threshold-r12
      c1-ReportOnLeave-r12
    },
    eventC2-r12
      c2-RefCSI-RS-r12
      c2-Offset-r12
      c2-ReportOnLeave-r12
    },
    eventV1-r14
      v1-Threshold-r14
    },
    eventV2-r14
      v2-Threshold-r14
    },
    eventH1-r15
      h1-ThresholdOffset-r15
      h1-Hysteresis-r15
    },
    eventH2-r15
      h2-ThresholdOffset-r15
      h2-Hysteresis-r15
    },
    eventD1-r18
      distanceThreshFromReference1-r18
      distanceThreshFromReference2-r18
      referenceLocation1-r18
      referenceLocation2-r18
      hysteresisLocation-r18
      reportOnLeave-r18
    },
    eventD2-r18
      distanceThreshFromReference1-r18
      distanceThreshFromReference2-r18
      hysteresisLocation-r18
      reportOnLeave-r18
  },
  hysteresis
  timeToTrigger
},
periodical
purpose
SEQUENCE {
  CHOICE {
    SEQUENCE {
      CHOICE {
        SEQUENCE {
          ThresholdEUTRA
        }
        SEQUENCE {
          ThresholdEUTRA
        }
        SEQUENCE {
          INTEGER (-30..30),
          BOOLEAN
        }
        SEQUENCE {
          ThresholdEUTRA
        }
        SEQUENCE {
          ThresholdEUTRA,
          ThresholdEUTRA
        }
        SEQUENCE {
          INTEGER (-30..30),
          BOOLEAN
        }
        SEQUENCE {
          ThresholdEUTRA-v1250,
          BOOLEAN
        }
        SEQUENCE {
          MeasCSI-RS-Id-r12,
          INTEGER (-30..30),
          BOOLEAN
        }
        SEQUENCE {
          SL-CBR-r14
        }
        SEQUENCE {
          SL-CBR-r14
        }
        SEQUENCE {
          INTEGER (0..300),
          INTEGER (1..16)
        }
        SEQUENCE {
          INTEGER (0..300),
          INTEGER (1..16)
        }
        SEQUENCE {
          INTEGER(0.. 65535),
          INTEGER(0.. 65535),
          ReferenceLocation-r18,
          ReferenceLocation-r18,
          HysteresisLocation-r18,
          BOOLEAN
        }
        SEQUENCE {
          INTEGER(0.. 65535),
          INTEGER(0.. 65535),
          HysteresisLocation-r18,
          BOOLEAN
        }
      }
      Hysteresis,
      TimeToTrigger
    }
    SEQUENCE {
      ENUMERATED {

```

```

        reportStrongestCells, reportCGI}
    },
    triggerQuantity          ENUMERATED {rsrp, rsrq},
    reportQuantity           ENUMERATED {sameAsTriggerQuantity, both},
    maxReportCells           INTEGER (1..maxCellReport),
    reportInterval           ReportInterval,
    reportAmount             ENUMERATED {r1, r2, r4, r8, r16, r32, r64, infinity},
    ...,
    [[ si-RequestForHO-r9    ENUMERATED {setup}          OPTIONAL, -- Cond reportCGI
       ue-RxTxTimeDiffPeriodical-r9  ENUMERATED {setup}          OPTIONAL, -- Need OR
    ]],
    [[ includeLocationInfo-r10      ENUMERATED {true}          OPTIONAL, -- Need OR
       reportAddNeighMeas-r10      ENUMERATED {setup}          OPTIONAL, -- Need OR
    ]],
    [[ alternativeTimeToTrigger-r12 CHOICE {
       release                      NULL,
       setup                        TimeToTrigger
     }
     useT312-r12                    BOOLEAN                OPTIONAL, -- Need ON
     usePSCell-r12                  BOOLEAN                OPTIONAL, -- Need ON
     aN-Threshold1-v1250            RSRQ-RangeConfig-r12  OPTIONAL, -- Need ON
     a5-Threshold2-v1250            RSRQ-RangeConfig-r12  OPTIONAL, -- Need ON
     reportStrongestCSI-RSs-r12     BOOLEAN                OPTIONAL, -- Need ON
     reportCRS-Meas-r12             BOOLEAN                OPTIONAL, -- Need ON
     triggerQuantityCSI-RS-r12      BOOLEAN                OPTIONAL, -- Need ON
    ]],
    [[ reportSSTD-Meas-r13          BOOLEAN                OPTIONAL, -- Need ON
       rs-sinr-Config-r13          CHOICE {
         release                    NULL,
         setup                      SEQUENCE {
           triggerQuantity-v1310    ENUMERATED {sinr}          OPTIONAL, -- Need ON
           aN-Threshold1-r13        RS-SINR-Range-r13      OPTIONAL, -- Need ON
           a5-Threshold2-r13        RS-SINR-Range-r13      OPTIONAL, -- Need ON
           reportQuantity-v1310    ENUMERATED {rsrpANDsinr, rsrqANDsinr, all}
         }
       }
     useAllowedCellList-r13        BOOLEAN                OPTIONAL, -- Need ON
     measRSSI-ReportConfig-r13     MeasRSSI-ReportConfig-r13  OPTIONAL, -- Need ON
     includeMultiBandInfo-r13      ENUMERATED {true}          OPTIONAL, -- Cond
reportCGI
    ul-DelayConfig-r13            UL-DelayConfig-r13      OPTIONAL, -- Need ON
    ]],
    [[ ue-RxTxTimeDiffPeriodicalTDD-r13  BOOLEAN                OPTIONAL, -- Need ON
    ]],
    [[ purpose-v1430                ENUMERATED {reportLocation, sidelink, spare2, spare1}
                                     OPTIONAL, -- Need ON
    ]],
    [[ maxReportRS-Index-r15        INTEGER (0..maxRS-IndexReport-r15)  OPTIONAL, -- Need ON
    ]],
    [[ includeBT-Meas-r15           BT-NameListConfig-r15    OPTIONAL, -- Need ON
       includeWLAN-Meas-r15        WLAN-NameListConfig-r15    OPTIONAL, -- Need
ON
       purpose-r15                 ENUMERATED {sensing}          OPTIONAL, -- Need ON
       numberOfTriggeringCells-r15 INTEGER (2..maxCellReport)  OPTIONAL, -- Cond a3a4a5
       a4-a5-ReportOnLeave-r15      BOOLEAN                OPTIONAL, -- Cond a4a5
    ]],
    [[ condReconfigurationTriggerEUTRA-r16 CondReconfigurationTriggerEUTRA-r16  OPTIONAL,
-- Need ON
       ul-DelayValueConfig-r16     UL-DelayValueConfig-r16    OPTIONAL, -- Need ON
    ]],
    [[ includeUncomBarPreMeas-r17    BOOLEAN                OPTIONAL, -- Need ON
       coarseLocationReq-r17       ENUMERATED {true}          OPTIONAL, -- Need OR
    ]]
}

CondReconfigurationTriggerEUTRA-r16 ::= SEQUENCE {
  condEventId-r16          CHOICE {
    condEventA3-r16        SEQUENCE {
      a3-Offset-r16        INTEGER (-30..30),
      hysteresis-r16       Hysteresis,
      timeToTrigger-r16    TimeToTrigger
    },
    condEventA5-r16        SEQUENCE {
      a5-Threshold1-r16    ThresholdEUTRA,
      a5-Threshold2-r16    ThresholdEUTRA,

```



```

        hysteresis-r16                Hysteresis,
        timeToTrigger-r16            TimeToTrigger
    },
    ...,
    [[
    condEventA4-r18                    SEQUENCE {
        a4-Threshold-r18              ThresholdEUTRA,
        hysteresis-r18                Hysteresis,
        timeToTrigger-r18            TimeToTrigger
    },
    condEventD1-r18                    SEQUENCE {
        distanceThreshFromReference1-r18  INTEGER(0.. 65535),
        distanceThreshFromReference2-r18  INTEGER(0.. 65535),
        referenceLocation1-r18           ReferenceLocation-r18,
        referenceLocation2-r18           ReferenceLocation-r18,
        hysteresisLocation-r18           HysteresisLocation-r18,
        timeToTrigger-r18                TimeToTrigger
    },
    condEventD2-r18                    SEQUENCE {
        distanceThreshFromReference1-r18  INTEGER(0.. 65535),
        distanceThreshFromReference2-r18  INTEGER(0.. 65535),
        hysteresisLocation-r18           HysteresisLocation-r18,
        timeToTrigger-r18                TimeToTrigger
    },
    condEventT1-r18                    SEQUENCE {
        t1-Threshold-r18                TimeOffsetUTC-r17,
        duration-r18                     INTEGER (1..6000)
    }
    ]]
}

RSRQ-RangeConfig-r12 ::= CHOICE {
    release
    setup
}

ThresholdEUTRA ::= CHOICE {
    threshold-RSRP
    threshold-RSRQ
}

ThresholdEUTRA-v1250 ::= CSI-RSRP-Range-r12

MeasRSSI-ReportConfig-r13 ::= SEQUENCE {
    channelOccupancyThreshold-r13
    RSSI-Range-r13
}
OPTIONAL -- Need OR

-- ASN1STOP

```

<b>ReportConfigEUTRA field descriptions</b>
<p><b>a3-Offset/ a6-Offset/ c2-Offset</b> Offset value to be used in EUTRA measurement report triggering condition for event a3/ a6/ c2, or to be used in conditional reconfiguration trigger condition for cond event a3. The actual value is field value * 0.5 dB.</p>
<p><b>a5-Threshold1/ a5-Threshold2</b> Threshold value associated to the selected trigger quantity (e.g. RSRP, RSRQ, SINR) to be used in conditional reconfiguration trigger condition for cond event a5. In the same <i>condeventA5</i>, the network configures the same quantity for the <i>TriggerQuantity</i> of the <i>a5-Threshold1</i> and for the <i>MeasTriggerQuantity</i> of the <i>a5-Threshold2</i>.</p>
<p><b>alternativeTimeToTrigger</b> Indicates the time to trigger applicable for cells specified in <i>altTTT-CellsToAddModList</i> of the associated measurement object, if configured</p>
<p><b>aN-ThresholdM/ cN-ThresholdM</b> Threshold to be used in EUTRA measurement report triggering condition for event number aN/ cN. If multiple thresholds are defined for event number aN/ cN, the thresholds are differentiated by M. E-UTRAN configures <i>aN-Threshold1</i> only for events A1, A2, A4, A5 and <i>a5-Threshold2</i> only for event A5.</p>
<p><b>c1-ReportOnLeave/ c2-ReportOnLeave</b> Indicates whether or not the UE shall initiate the measurement reporting procedure when the leaving condition is met for a CSI-RS resource in <i>csi-RS-TriggeredList</i>, as specified in 5.5.4.1.</p>
<p><b>c2-RefCSI-RS</b> Identity of the CSI-RS resource from the <i>measCSI-RS-ToAddModList</i> of the associated <i>measObject</i>, to be used as the reference CSI-RS resource in EUTRA measurement report triggering condition for event c2.</p>
<p><b>channelOccupancyThreshold</b> RSSI threshold which is used for channel occupancy evaluation.</p>
<p><b>coarseLocationReq</b> If this field is set to <i>true</i>, the UE shall report coarse location information if available.</p>
<p><b>condEventId</b> Choice of conditional reconfiguration event triggered criteria.</p>
<p><b>condReconfigurationTriggerEUTRA</b> Event configured for conditional reconfiguration. If this field is configured, the UE shall ignore the configuration of <i>triggerType</i>, <i>reportQuantity</i>, <i>maxReportCells</i>, <i>reportInterval</i>, and <i>reportAmount</i>.</p>
<p><b>distanceThreshFromReference1, distanceThreshFromReference2</b> Threshold value associated to the distance from a reference location. Each step represents 50m.</p>
<p><b>duration</b> This field is used for defining the leaving condition T1-2 for conditional HO event <i>condEventT1</i>. Each step represents 100ms.</p>
<p><b>eventId</b> Choice of E-UTRA event triggered reporting criteria. EUTRAN may set this field to <i>eventC1</i> or <i>eventC2</i> only if <i>measDS-Config</i> is configured in the associated <i>measObject</i> with one or more CSI-RS resources. The <i>eventC1</i> and <i>eventC2</i> are not applicable for the <i>eventId</i> if RS-SINR is configured as <i>triggerQuantity</i> or <i>reportQuantity</i>.</p>
<p><b>h1-Hysteresis, h2-Hysteresis</b> This parameter is used within the entry and leave condition of an event triggered reporting condition for event H1 and event H2. The actual value is field value. If this field is configured UE shall ignore parameter <i>hysteresis</i>.</p>
<p><b>h1-ThresholdOffset, h2-ThresholdOffset</b> An offset value to <i>heightThreshRef</i> to obtain the threshold to be used in EUTRA height report triggering condition for event H1 and event H2. The value for h1-ThresholdOffset and h2-ThresholdOffset is expressed in meters such that granularity is 2meters. Value 0 corresponds to offset value 0m, value 1 corresponds to offset value 2m, value 2 correspond to offset value 4m, and so on.</p>
<p><b>includeMultiBandInfo</b> If this field is present, the UE shall acquire and include multi band information in the measurement report.</p>
<p><b>maxReportCells</b> Max number of cells, excluding the serving cell, to include in the measurement report concerning CRS, and max number of CSI-RS resources to include in the measurement report concerning CSI-RS.</p>
<p><b>measRSSI-ReportConfig</b> If this field is present, the UE shall perform measurement reporting for RSSI and channel occupancy and ignore the <i>triggerQuantity</i>, <i>reportQuantity</i> and <i>maxReportCells</i> fields. E-UTRAN sets this field to <i>true</i> only when setting <i>triggerType</i> to <i>periodical</i> and <i>purpose</i> to <i>reportStrongestCells</i>.</p>
<p><b>numberOfTriggeringCells</b> Indicates the number of cells detected that are required to fulfill an event for a measurement report to be triggered. This field is set only for the events concerning neighbor cells, i.e. <i>eventA3</i>, <i>eventA4</i>, <i>eventA5</i>.</p>
<p><b>referenceLocation1, referenceLocation2</b> For <i>eventD1</i> or <i>condEventD1</i>, the <i>referenceLocation1</i> is associated to serving cell. For <i>eventD1</i>, the <i>referenceLocation2</i> is associated to neighbour cell. For <i>condEventD1</i>, the <i>referenceLocation2</i> is associated to candidate target cell.</p>
<p><b>reportAmount</b> Number of measurement reports applicable for <i>triggerType event</i> as well as for <i>triggerType periodical</i>. In case <i>purpose</i> is set to <i>reportCGI</i> or <i>reportSSTD-Meas</i> is set to <i>true</i>, only value 1 applies.</p>

<b>ReportConfigEUTRA field descriptions</b>
<p><b>reportCRS-Meas</b> If this field is set to <i>TRUE</i> the UE shall include <i>rsrp</i>, <i>rsrq</i> together with <i>csi-rsrp</i> in the measurement report, if possible.</p>
<p><b>reportOnLeave/ a6-ReportOnLeave/ a4-a5-ReportOnLeave</b> Indicates whether or not the UE shall initiate the measurement reporting procedure when the leaving condition is met for a cell in <i>cellsTriggeredList</i>, or when the leaving condition is met for <i>eventD1</i> or <i>eventD2</i>, as specified in 5.5.4.1.</p>
<p><b>reportQuantity</b> The quantities to be included in the measurement report. The value <i>both</i> means that both the <i>rsrp</i> and <i>rsrq</i> quantities are to be included in the measurement report. The value <i>rsrpANDsinr</i> and <i>rsrqANDsinr</i> mean that both <i>rsrp</i> and <i>rs-sinr</i> quantities, and both <i>rsrq</i> and <i>rs-sinr</i> quantities are to be included respectively in the measurement report. The value <i>all</i> means that <i>rsrp</i>, <i>rsrq</i> and <i>rs-sinr</i> are to be included in the measurement report. In case <i>triggerQuantityCSI-RS</i> is set to <i>TRUE</i>, only value <i>sameAsTriggerQuantity</i> applies. If <i>reportQuantity-v1310</i> is configured, the UE only considers this extension (and ignores <i>reportQuantity</i> i.e. without suffix).</p>
<p><b>reportSSTD-Meas</b> If this field is set to <i>true</i>, the UE shall measure SSTD between the PCell and the PSCell as specified in TS 36.214 [48] and ignore the <i>triggerQuantity</i>, <i>reportQuantity</i> and <i>maxReportCells</i> fields. E-UTRAN sets this field to <i>true</i> only when setting <i>triggerType</i> to <i>periodical</i> and <i>purpose</i> to <i>reportStrongestCells</i>.</p>
<p><b>reportStrongestCSI-RSs</b> Indicates that periodical CSI-RS measurement report is performed. EUTRAN configures value <i>TRUE</i> only if <i>measDS-Config</i> is configured in the associated <i>measObject</i> with one or more CSI-RS resources.</p>
<p><b>si-RequestForHO</b> The field applies to the <i>reportCGI</i> functionality, and when the field is included, the UE is allowed to use autonomous gaps in acquiring system information from the neighbour cell, applies a different value for T321, and includes different fields in the measurement report.</p>
<p><b>ThresholdEUTRA</b> For RSRP: RSRP based threshold for event evaluation. The actual value is field value – 140 dBm. For RSRQ: RSRQ based threshold for event evaluation. The actual value is (field value – 40)/2 dB. For RS-SINR: RS-SINR based threshold for event evaluation. The actual value is (field value -46)/2 dB. For CSI-RSRP: CSI-RSRP based threshold for event evaluation. The actual value is field value – 140 dBm. EUTRAN configures the same threshold quantity for all the thresholds of an event.</p>
<p><b>timeToTrigger</b> Time during which specific criteria for the event needs to be met in order to trigger a measurement report, or to execute the conditional reconfiguration evaluation.</p>
<p><b>triggerQuantity</b> The quantity used to evaluate the triggering condition for the event concerning CRS. EUTRAN sets the value according to the quantity of the <i>ThresholdEUTRA</i> for this event. The values <i>rsrp</i>, <i>rsrq</i> and <i>sinr</i> correspond to Reference Signal Received Power (RSRP), Reference Signal Received Quality (RSRQ) and Reference Signal Signal to Noise and Interference Ratio (RS-SINR), see TS 36.214 [48]. If <i>triggerQuantity-v1310</i> is configured, the UE only considers this extension (and ignores <i>triggerQuantity</i> i.e. without suffix).</p>
<p><b>triggerQuantityCSI-RS</b> The quantity used to evaluate the triggering condition for the event concerning CSI-RS. The value <i>TRUE</i> corresponds to CSI Reference Signal Received Power (CSI-RSRP), see TS 36.214 [48]. E-UTRAN configures value <i>TRUE</i> if and only if the measurement reporting event concerns CSI-RS.</p>
<p><b>ue-RxTxTimeDiffPeriodical</b> If this field is present, the UE shall perform UE Rx-Tx time difference measurement reporting and ignore the fields <i>triggerQuantity</i>, <i>reportQuantity</i> and <i>maxReportCells</i>. If the field is present, the only applicable values for the corresponding <i>triggerType</i> and <i>purpose</i> are <i>periodical</i> and <i>reportStrongestCells</i> respectively.</p>
<p><b>ue-RxTxTimeDiffPeriodicalTDD</b> If this field is set to <i>TRUE</i>, the UE shall perform UE Rx-Tx time difference measurement reporting according to EUTRAN TDD UE Rx-Tx time difference report mapping in TS 36.133 [16]. If the field is configured, the <i>ue-RxTxTimeDiffPeriodical</i> shall be configured. The field is applicable for TDD only.</p>
<p><b>useAllowedCellList</b> Indicates whether only the cells included in the list of allow-listed cells of the associated <i>measObject</i> are applicable as specified in 5.5.4.1. E-UTRAN does not configure the field for events A1, A2, C1, C2, D1 and D2.</p>
<p><b>usePSCell</b> If this field is set to <i>TRUE</i> the UE shall use the PSCell instead of the PCell. E-UTRAN configures value <i>TRUE</i> only for events A3 and A5, see 5.5.4.4 and 5.5.4.6.</p>
<p><b>useT312</b> If value <i>TRUE</i> is configured, the UE shall use the timer T312 with the value <i>t312</i> as specified in the corresponding <i>measObject</i>. If the corresponding <i>measObject</i> does not include the timer T312 then the timer T312 is considered as not configured. E-UTRAN configures value <i>TRUE</i> only if <i>triggerType</i> is set to <i>event</i>.</p>
<p><b>ul-DelayConfig</b> If the field is present, E-UTRAN configures UL PDCP Packet Delay per QCI measurement and the UE shall ignore the fields <i>triggerQuantity</i> and <i>maxReportCells</i>. The applicable values for the corresponding <i>triggerType</i> and <i>reportInterval</i> are <i>periodical</i> and (one of the) <i>ms1024</i>, <i>ms2048</i>, <i>ms5120</i> or <i>ms10240</i> respectively. The <i>reportInterval</i> indicates the periodicity for performing and reporting of UL PDCP Delay per QCI measurement as specified in TS 36.314 [71].</p>

<b>ReportConfigEUTRA field descriptions</b>
<p><b>ul-DelayValueConfig</b></p> <p>If the field is present, the UE shall perform the UL PDCP Packet Delay measurement per DRB as specified in TS 38.314 [103] and the UE shall ignore the fields <i>reportQuantityCell</i> and <i>maxReportCells</i>. The applicable values for the corresponding <i>reportInterval</i> are (one of the) { ms120, ms240, ms480, ms640, ms1024, ms2048, ms5120, ms10240, min1, min6, min12, min30, min60}. The <i>reportInterval</i> indicates the periodicity for performing and reporting of UL PDCP Packet Delay per DRB measurement as specified in TS 38.314 [103].</p>

<b>Conditional presence</b>	<b>Explanation</b>
<i>reportCGI</i>	The field is optional, need OR, in case <i>purpose</i> is included and set to <i>reportCGI</i> ; otherwise the field is not present and the UE shall delete any existing value for this field.
<i>a3a4a5</i>	This field is optional, need OR, in case <i>eventId</i> is set to eventA3 or eventA4 or eventA5; otherwise, this field is not present and the UE shall delete any existing value of this field.
<i>a4a5</i>	This field is optional, need OR, in case <i>eventId</i> is set to eventA4 or eventA5; otherwise, this field is not present and the UE shall delete any existing value of this field.

### – *ReportConfigId*

The IE *ReportConfigId* is used to identify a measurement reporting configuration.

#### **ReportConfigId information element**

```
-- ASN1START
ReportConfigId ::=
    INTEGER (1..maxReportConfigId)
-- ASN1STOP
```

### – *ReportConfigInterRAT*

The IE *ReportConfigInterRAT* specifies criteria for triggering of an inter-RAT measurement reporting event or of a CPA or MN initiated inter-SN CPC event. The inter-RAT measurement reporting events for NR, UTRAN, GERAN and CDMA2000 are labelled *BN* with *N* equal to 1, 2 and so on. The inter-RAT measurement reporting events for WLAN are labelled *WN* with *N* equal to 1, 2 and so on.

Event B1: Neighbour becomes better than absolute threshold;

Event B2: PCell becomes worse than absolute threshold1 AND Neighbour becomes better than another absolute threshold2.

Event W1: WLAN becomes better than a threshold;

Event W2: All WLAN inside WLAN mobility set become worse than a threshold1 and a WLAN outside WLAN mobility set becomes better than a threshold2;

Event W3: All WLAN inside WLAN mobility set become worse than a threshold.

CondEvent B1: Conditional reconfiguration candidate becomes better than absolute threshold.

The b1 and b2 event thresholds for CDMA2000 are the CDMA2000 pilot detection thresholds are expressed as an unsigned binary number equal to  $[-2 \times 10 \log_{10} E_c/I_0]$  in units of 0.5dB, see C.S0005 [25] for details.

#### **ReportConfigInterRAT information element**

```
-- ASN1START
ReportConfigInterRAT ::=
    SEQUENCE {
        triggerType
        event
        eventId
        eventB1
            b1-Threshold
                b1-ThresholdUTRA
                b1-ThresholdGERAN
                b1-ThresholdCDMA2000
        CHOICE {
            SEQUENCE {
                CHOICE {
                    SEQUENCE {
                        CHOICE {
                            ThresholdUTRA,
                            ThresholdGERAN,
                            ThresholdCDMA2000
                        }
                    }
                }
            }
        }
    }
-- ASN1STOP
```

```

    },
    eventB2
        b2-Threshold1
        b2-Threshold2
        b2-Threshold2UTRA
        b2-Threshold2GERAN
        b2-Threshold2CDMA2000
    },
    ...,
    eventW1-r13
        w1-Threshold-r13
    },
    eventW2-r13
        w2-Threshold1-r13
        w2-Threshold2-r13
    },
    eventW3-r13
        w3-Threshold-r13
    },
    eventB1-NR-r15
        b1-ThresholdNR-r15
        reportOnLeave-r15
    },
    eventB2-NR-r15
        b2-Threshold1-r15
        b2-Threshold2NR-r15
        reportOnLeave-r15
    },
    hysteresis
        timeToTrigger
    },
    periodical
        purpose
    },
    maxReportCells
    reportInterval
    reportAmount
    ...,
    [[ si-RequestForHO-r9
        ]],
    [[ reportQuantityUTRA-FDD-r10
        ]],
    [[ includeLocationInfo-r11
        ]],
    [[ b2-Threshold1-v1250
        release
        setup
        ]],
    [[ reportQuantityWLAN-r13
    ]],
    [[ reportAnyWLAN-r14
    ]],
    [[ reportQuantityCellNR-r15
    maxReportRS-Index-r15
    reportQuantityRS-IndexNR-r15
    reportRS-IndexResultsNR
    reportsFTD-Meas-r15
    ]],
    [[ useAutonomousGapsNR-r16
    measRSSI-ReportConfigNR-r16
    ]],
    [[ condReconfigurationTriggerNR-r17
    ]],
    CondReconfigurationTriggerNR-r17 ::= SEQUENCE {
        condEventId-r17
        condEventB1-NR-r17
        b1-ThresholdNR-r17
    CHOICE {
        SEQUENCE {
            ThresholdEUTRA,
            ThresholdUTRA,
            ThresholdGERAN,
            ThresholdCDMA2000
        }
        SEQUENCE {
            ThresholdNR-r15,
            BOOLEAN
        }
        SEQUENCE {
            ThresholdEUTRA,
            ThresholdNR-r15,
            BOOLEAN
        }
        Hysteresis,
        TimeToTrigger
    },
    SEQUENCE {
        WLAN-RSSI-Range-r13
    },
    SEQUENCE {
        WLAN-RSSI-Range-r13,
        WLAN-RSSI-Range-r13
    },
    SEQUENCE {
        WLAN-RSSI-Range-r13
    },
    SEQUENCE {
        reportStrongestCells,
        reportStrongestCellsForSON,
        reportCGI
    }
    INTEGER (1..maxCellReport),
    ReportInterval,
    ENUMERATED {r1, r2, r4, r8, r16, r32, r64, infinity},
    ENUMERATED {setup} OPTIONAL -- Cond reportCGI
    ENUMERATED {both} OPTIONAL -- Need OR
    BOOLEAN OPTIONAL -- Need ON
    CHOICE {
        NULL,
        RSRQ-Range-v1250
    } OPTIONAL -- Need ON
    ReportQuantityWLAN-r13 OPTIONAL -- Need ON
    BOOLEAN OPTIONAL -- Need ON
    ReportQuantityNR-r15 OPTIONAL, -- Need ON
    INTEGER (0..maxRS-IndexReport-r15) OPTIONAL, -- Need ON
    ReportQuantityNR-r15 OPTIONAL, -- Need ON
    BOOLEAN OPTIONAL, -- Need ON
    ENUMERATED {pSCell, neighborCells} OPTIONAL -- Need ON
    ENUMERATED {setup} OPTIONAL, -- Cond reportCGI-NR
    MeasRSSI-ReportConfig-r13 OPTIONAL -- Need ON
    CondReconfigurationTriggerNR-r17 OPTIONAL-- Need ON
}

```

```

        hysteresis-r17                Hysteresis,
        timeToTrigger-r17            TimeToTrigger
    },
    ...
}

ThresholdUTRA ::= CHOICE{
    ultra-RSCP                INTEGER (-5..91),
    ultra-EcN0                INTEGER (0..49)
}

ThresholdGERAN ::= INTEGER (0..63)

ThresholdCDMA2000 ::= INTEGER (0..63)

ReportQuantityNR-r15 ::= SEQUENCE {
    ss-rsrp                    BOOLEAN,
    ss-rsrq                    BOOLEAN,
    ss-sinr                    BOOLEAN
}

ReportQuantityWLAN-r13 ::= SEQUENCE {
    bandRequestWLAN-r13        ENUMERATED {true}    OPTIONAL, -- Need OR
    carrierInfoRequestWLAN-r13 ENUMERATED {true}    OPTIONAL, -- Need OR
    availableAdmissionCapacityRequestWLAN-r13    ENUMERATED {true}    OPTIONAL, -- Need OR
    backhaulDL-BandwidthRequestWLAN-r13          ENUMERATED {true}    OPTIONAL, -- Need OR
    backhaulUL-BandwidthRequestWLAN-r13          ENUMERATED {true}    OPTIONAL, -- Need OR
    channelUtilizationRequestWLAN-r13            ENUMERATED {true}    OPTIONAL, -- Need OR
    stationCountRequestWLAN-r13                  ENUMERATED {true}    OPTIONAL, -- Need OR
    ...
}

-- ASN1STOP

```

<b>ReportConfigInterRAT field descriptions</b>
<p><b>availableAdmissionCapacityRequestWLAN</b> The value true indicates that the UE shall include, if available, WLAN Available Admission Capacity in measurement reports.</p>
<p><b>backhaulDL-BandwidthRequestWLAN</b> The value true indicates that the UE shall include, if available, WLAN Backhaul Downlink Bandwidth in measurement reports.</p>
<p><b>backhaulUL-BandwidthRequestWLAN</b> The value true indicates that the UE shall include, if available, WLAN Backhaul Uplink Bandwidth in measurement reports.</p>
<p><b>bandRequestWLAN</b> The value true indicates that the UE shall include WLAN band in measurement reports.</p>
<p><b>bN-ThresholdM</b> Threshold to be used in inter RAT measurement report triggering condition for event number bN. If multiple thresholds are defined for event number bN, the thresholds are differentiated by M.</p>
<p><b>carrierInfoRequestWLAN</b> The value true indicates that the UE shall include, if available, WLAN Carrier Information in measurement reports.</p>
<p><b>channelUtilizationRequest-WLAN</b> The value true indicates that the UE shall include, if available, WLAN Channel Utilization in measurement reports.</p>
<p><b>condReconfigurationTriggerNR</b> The conditional reconfiguration trigger event that is used for CPA or MN initiated inter-SN CPC. If this field is configured, the UE shall ignore the configuration of <i>triggerType</i>, <i>maxReportCells</i>, <i>reportInterval</i>, and <i>reportAmount</i>.</p>
<p><b>condEventId</b> Choice of conditional reconfiguration event triggered criteria.</p>
<p><b>eventId</b> Choice of inter-RAT event triggered reporting criteria.</p>
<p><b>maxReportCells</b> Max number of cells, excluding the serving cell, to include in the measurement report. In case <i>purpose</i> is set to <i>reportStrongestCellsForSON</i> only value 1 applies. For inter-RAT WLAN, it is the maximum number of WLANs to include in the measurement report.</p>
<p><b>maxReportRS-Index</b> Max number of RS indices to include in the measurement report. E-UTRAN configures value 0 only if it sets <i>reportRS-IndexResultsNR</i> to <i>FALSE</i>.</p>
<p><b>measRSSI-ReportConfigNR</b> If this field is present, the UE shall perform measurement reporting for RSSI and channel occupancy and ignore the <i>triggerQuantity</i>, <i>reportQuantity</i> and <i>maxReportCells</i> fields. E-UTRAN sets this field to <i>true</i> only when setting <i>triggerType</i> to <i>periodical</i> and <i>purpose</i> to <i>reportStrongestCells</i>.</p>
<p><b>Purpose</b> <i>reportStrongestCellsForSON</i> applies only in case <i>reportConfig</i> is linked to a <i>measObject</i> set to <i>measObjectUTRA</i> or <i>measObjectCDMA2000</i>.</p>
<p><b>reportAmount</b> Number of measurement reports applicable for <i>triggerType event</i> as well as for <i>triggerType periodical</i>. In case <i>purpose</i> is set to <i>reportCGI</i> or <i>reportStrongestCellsForSON</i> only value 1 applies. In case <i>reportSFTD-Meas</i> is configured, only value 1 applies.</p>
<p><b>reportAnyWLAN</b> Indicates UE to report any WLAN AP meeting the triggering requirements, even if it is not included in the corresponding <i>MeasObjectWLAN</i>.</p>
<p><b>reportOnLeave</b> Indicates whether or not the UE shall initiate the measurement reporting procedure when the leaving condition is met for a cell in <i>cellsTriggeredList</i>, as specified in 5.5.4.1.</p>
<p><b>reportQuantityUTRA-FDD</b> The quantities to be included in the UTRA measurement report. The value <i>both</i> means that both the cpich RSCP and cpich EcN0 quantities are to be included in the measurement report.</p>
<p><b>reportRS-IndexResultsNR</b> Indicates whether or not the UE shall report beam measurement result of NR in the measurement report.</p>
<p><b>reportSFTD-Meas</b> If this field is set to <i>pSCell</i>, the UE shall measure SFTD between the PCell and the PSCell as specified in TS 38.215 [89], in this case, the frequency of PSCell is configured in the corresponding <i>measObjectNR</i>. If the field is set to <i>neighborCells</i>, the UE shall measure SFTD between the PCell and the NR cells included in <i>cellsForWhichToReportSFTD</i> (if configured in the corresponding <i>measObjectNR</i>) or between the PCell and up to 3 strongest detected NR cells (if <i>cellsForWhichToReportSFTD</i> is not configured in the corresponding <i>measObjectNR</i>), as specified in TS 38.215 [89]. E-UTRAN only includes this field when setting <i>triggerType</i> to <i>periodical</i> and <i>purpose</i> to <i>reportStrongestCells</i>. If included, the UE shall ignore the <i>maxReportCells</i> field.</p>

<b>ReportConfigInterRAT field descriptions</b>	
<b>availableAdmissionCapacityRequestWLAN</b>	The value true indicates that the UE shall include, if available, WLAN Available Admission Capacity in measurement reports.
<b>backhaulDL-BandwidthRequestWLAN</b>	The value true indicates that the UE shall include, if available, WLAN Backhaul Downlink Bandwidth in measurement reports.
<b>backhaulUL-BandwidthRequestWLAN</b>	The value true indicates that the UE shall include, if available, WLAN Backhaul Uplink Bandwidth in measurement reports.
<b>bandRequestWLAN</b>	The value true indicates that the UE shall include WLAN band in measurement reports.
<b>si-RequestForHO</b>	The field applies to the <i>reportCGI</i> functionality, and when the field is included, the UE is allowed to use autonomous gaps in acquiring system information from the neighbour cell, applies a different value for T321, and includes different fields in the measurement report. EUTRAN does not configure the field if <i>reportConfig</i> is linked to a <i>measObject</i> set to <i>measObjectNR</i> .
<b>ss-rsrp</b>	Indicates whether or not the UE shall report SS-RSRP quantity of NR.
<b>ss-rsrq</b>	Indicates whether or not the UE shall report SS-RSRQ quantity of NR.
<b>ss-sinr</b>	Indicates whether or not the UE shall report SS-SINR quantity of NR.
<b>stationCountRequestWLAN</b>	The value true indicates that the UE shall include, if available, WLAN Station Count in measurement reports.
<b>b1-ThresholdGERAN, b2-Threshold2GERAN</b>	The actual value is field value – 110 dBm.
<b>b1-ThresholdUTRA, b2-Threshold2UTRA</b>	<i>utra-RSCP</i> corresponds to CPICH_RSCP in TS 25.133 [29] for FDD and P-CCPCH_RSCP in TS 25.123 [30] for TDD. <i>utra-EcN0</i> corresponds to CPICH_Ec/No in TS 25.133 [29] for FDD, and is not applicable for TDD. For <i>utra-RSCP</i> : The actual value is field value – 115 dBm. For <i>utra-EcN0</i> : The actual value is (field value – 49)/2 dB.
<b>timeToTrigger</b>	Time during which specific criteria for the event needs to be met in order to trigger a measurement report or to execute the conditional reconfiguration evaluation.
<b>triggerType</b>	E-UTRAN does not configure the value <i>periodical</i> in case <i>reportConfig</i> is linked to a <i>measObject</i> set to <i>measObjectWLAN</i> .
<b>useAutonomousGapsNR</b>	The field applies to the <i>reportCGI</i> functionality, and when the field is included, the UE is allowed to use autonomous gaps in acquiring system information from the NR neighbour cell, applies the corresponding value for T321, EUTRAN can configure the field only if <i>reportConfig</i> is linked to a <i>measObject</i> set to <i>measObjectNR</i> .

<b>Conditional presence</b>	<b>Explanation</b>
<i>reportCGI</i>	The field is optional, need OR, in case <i>purpose</i> is included and set to <i>reportCGI</i> ; otherwise the field is not present and the UE shall delete any existing value for this field.
<i>reportCGI-NR</i>	The field is optional, need OR, in case <i>purpose</i> is included and set to <i>reportCGI</i> , and <i>reportConfig</i> is linked to a <i>measObject</i> set to <i>measObjectNR</i> , otherwise the field is not present and the UE shall delete any existing value for this field.

## – ReportConfigToAddModList

The IE *ReportConfigToAddModList* concerns a list of reporting configurations to add or modify

### ReportConfigToAddModList information element

```
-- ASN1START
ReportConfigToAddModList ::= SEQUENCE (SIZE (1..maxReportConfigId)) OF ReportConfigToAddMod
ReportConfigToAddMod ::= SEQUENCE {
    reportConfigId      ReportConfigId,
    reportConfig        CHOICE {
        reportConfigEUTRA      ReportConfigEUTRA,
        reportConfigInterRAT   ReportConfigInterRAT
    }
}
```



```
}
-- ASN1STOP
```

## – *ReportInterval*

The *ReportInterval* indicates the interval between periodical reports. The *ReportInterval* is applicable if the UE performs periodical reporting (i.e. when *reportAmount* exceeds 1), for *triggerType event* as well as for *triggerType periodical*. Value *ms120* corresponds with 120 ms, *ms240* corresponds with 240 ms and so on, while value *min1* corresponds with 1 min, *min6* corresponds with 6 min and so on.

### **ReportInterval information element**

```
-- ASN1START
ReportInterval ::=
    ENUMERATED {
        ms120, ms240, ms480, ms640, ms1024, ms2048, ms5120, ms10240,
        min1, min6, min12, min30, min60, spare3, spare2, spare1}
-- ASN1STOP
```

## – *RS-IndexNR*

The IE *RS-IndexNR* is used to identify an NR Reference Signal.

### **RS-IndexNR information element**

```
-- ASN1START
RS-IndexNR-r15 ::=
    INTEGER (0.. maxRS-Index-1-r15)
-- ASN1STOP
```

## – *RSRP-Range*

The IE *RSRP-Range* specifies the value range used in RSRP measurements and thresholds. Integer value for RSRP measurements according to mapping table in TS 36.133 [16]. A given field using *RSRP-Range-v1360* shall only be signalled if the corresponding original field (using *RSRP-Range* i.e. without suffix) is set to value 0.

### **RSRP-Range information element**

```
-- ASN1START
RSRP-Range ::=
    INTEGER(0..97)
RSRP-Range-v1360 ::=
    INTEGER(-17..-1)
RSRP-RangeSL-r12 ::=
    INTEGER(0..13)
RSRP-RangeSL2-r12 ::=
    INTEGER(0..7)
RSRP-RangeSL3-r12 ::=
    INTEGER(0..11)
RSRP-RangeSL4-r13 ::=
    INTEGER(0..49)
-- ASN1STOP
```

<b>RSRP-Range field descriptions</b>
<p><b>RSRP-Range</b> For UE supporting CE Mode B, when CE mode B is not restricted by upper layers, <i>RSRP-Range-v1360</i> (i.e., with suffix) is reported if the measured RSRP is less than -140 dBm.</p>
<p><b>RSRP-RangeSL</b> Value 0 corresponds to -infinity, value 1 to -115dBm, value 2 to -110dBm, and so on (i.e. in steps of 5dBm) until value 12, which corresponds to -60dBm, while value 13 corresponds to +infinity.</p>
<p><b>RSRP-RangeSL2</b> Value 0 corresponds to -infinity, value 1 to -110dBm, value 2 to -100dBm, and so on (i.e. in steps of 10dBm) until value 6, which corresponds to -60dBm, while value 7 corresponds to +infinity.</p>
<p><b>RSRP-RangeSL3</b> Value 0 corresponds to -110dBm, value 1 to -105dBm, value 2 to -100dBm, and so on (i.e. in steps of 5dBm) until value 10, which corresponds to -60dBm, while value 11 corresponds to +infinity.</p>
<p><b>RSRP-RangeSL4</b> Indicates the range for SD-RSRP. Value 0 corresponds to -130dBm, value 1 to -128dBm, value 2 to -126dBm, and so on (i.e. in steps of 2dBm) until value 48, which corresponds to -34dBm, while value 49 corresponds to +infinity.</p>

### – *RSRP-RangeNR*

The IE *RSRP-RangeNR* specifies the value range used in RSRP measurements and thresholds. For RSRP measurements, integer value is according to mapping table in TS 38.133 [84]. For thresholds, the actual value is (field value – 156) dBm, except for field value 127, in which case the actual value is infinity.

#### **RSRP-RangeNR information element**

```
-- ASN1START
RSRP-RangeNR-r15 ::=                INTEGER (0..127)
-- ASN1STOP
```

### – *RSRQ-Range*

The IE *RSRQ-Range* specifies the value range used in RSRQ measurements and thresholds. Integer value for RSRQ measurements is according to mapping table in TS 36.133 [16]. A given field using *RSRQ-Range-v1250* shall only be signalled if the corresponding original field (using *RSRQ-Range* i.e. without suffix) is set to value 0 or 34. Only a UE indicating support of *extendedRSRQ-LowerRange-r12* or *rsrq-OnAllSymbols-r12* may report *RSRQ-Range-v1250*, and this may be done without explicit configuration from the E-UTRAN. If received, the UE shall use the value indicated by the *RSRQ-Range-v1250* and ignore the value signalled by *RSRQ-Range* (without the suffix). *RSRQ-Range-r13* covers the original range and extended *RSRQ-Range-v1250*. *RSRQ-Range-r13* may be signalled without the corresponding original field and without any requirements for indicated support of *extendedRSRQ-LowerRange-r12* or *rsrq-OnAllSymbols-r12*.

#### **RSRQ-Range information element**

```
-- ASN1START
RSRQ-Range ::=                INTEGER(0..34)
RSRQ-Range-v1250 ::=          INTEGER(-30..46)
RSRQ-Range-r13 ::=            INTEGER(-30..46)
-- ASN1STOP
```

### – *RSRQ-RangeNR*

The IE *RSRQ-RangeNR* specifies the value range used in RSRQ measurements and thresholds. For RSRQ measurements, integer value is according to mapping table in TS 38.133 [84]. For thresholds, the actual value is (field value – 87) / 2 dB.

**RSRQ-RangeNR information element**

```
-- ASN1START
RSRQ-RangeNR-r15 ::=          INTEGER (0..127)
-- ASN1STOP
```

**RSRQ-Type**

The IE *RSRQ-Type* specifies the RSRQ value type used in RSRQ measurements, see TS 36.214 [48].

**RSRQ-Type information element**

```
-- ASN1START
RSRQ-Type-r12 ::=          SEQUENCE {
    allSymbols-r12          BOOLEAN,
    wideBand-r12           BOOLEAN
}
-- ASN1STOP
```

**RSRQ-Type field descriptions*****allSymbols***

Value TRUE indicates use of all OFDM symbols when performing RSRQ measurements.

***wideBand***

Value TRUE indicates use of a wider bandwidth when performing RSRQ measurements.

**RS-SINR-Range**

The IE *RS-SINR-Range* specifies the value range used in RS-SINR measurements and thresholds. Integer value for RS-SINR measurements is according to mapping table in TS 36.133 [16].

**RS-SINR-Range information element**

```
-- ASN1START
RS-SINR-Range-r13 ::=          INTEGER(0..127)
-- ASN1STOP
```

**RS-SINR-RangeNR**

The IE *RS-SINR-RangeNR* specifies the value range used in RS-SINR measurements and thresholds. For RS-SINR measurements, integer value is according to mapping table in TS 38.133 [84]. For thresholds, the actual value is (field value – 46) / 2 dB.

**RS-SINR-RangeNR information element**

```
-- ASN1START
RS-SINR-RangeNR-r15 ::=          INTEGER (0..127)
-- ASN1STOP
```

**RSSI-Range-r13**

The IE *RSSI-Range* specifies the value range used in RSSI measurements and thresholds. Integer value for RSSI measurements is according to mapping table in TS 36.133 [16].

**RSSI-Range information element**

```
-- ASN1START
RSSI-Range-r13 ::=                INTEGER(0..76)
-- ASN1STOP
```

**SS-RSSI-Measurement**

The IE *SS-RSSI-Measurement* specifies the configuration of NR SSB based RSSI measurements.

**SS-RSSI-Measurement information element**

```
-- ASN1START
SS-RSSI-Measurement-r15 ::=      SEQUENCE {
  measurementSlots-r15          BIT STRING (SIZE(1..80)),
  endSymbol-r15                 INTEGER(0..3)
}
-- ASN1STOP
```

**SS-RSSI-Measurement field descriptions****endSymbol**

Within a slot that is configured for RSSI measurements (see *measurementSlots*) the UE measures the RSSI from symbol 0 to symbol *endSymbol*. This field identifies the entry in Table 5.1.33-1 in TS 36.214 which determines the actual end symbol.

**measurementSlots**

Indicates the slots in which the UE can perform NR RSSI measurements. The length of the BIT STRING is equal to the number of slots in the configured SMTC window (determined by the *ssb-duration* and by the *subcarrierSpacingSSB*). The first (left-most / most significant) bit in the bitmap corresponds to the first slot in the SMTC window, the second bit in the bitmap corresponds to the second slot in the SMTC window, and so on. The UE measures in slots for which the corresponding bit in the bitmap is set to 1.

**SSB-PositionQCL-RelationNR**

The IE *SSB-PositionQCL-RelationNR* is used to indicate the QCL relationship between SSB positions on the indicated frequency or cell (see TS 38.213 [88], clause 4.1) for NR operation with shared spectrum channel access. Value *n1* corresponds to 1, value *n2* corresponds to 2 and so on.

**SSB-PositionQCL-RelationNR information element**

```
-- ASN1START
SSB-PositionQCL-RelationNR-r16 ::=  ENUMERATED {n1, n2, n4, n8}
SSB-PositionQCL-RelationNR-r17 ::=  ENUMERATED {n32, n64}
-- ASN1STOP
```

**SSB-ToMeasure**

The IE *SSB-ToMeasure* is used to configure a pattern of SSBs. For operation with shared spectrum channel access, only *mediumBitmap* is used.

**SSB-ToMeasure information element**

```
-- ASN1START
```

```

SSB-ToMeasure-r15 ::= CHOICE {
    shortBitmap-r15      BIT STRING (SIZE (4)),
    mediumBitmap-r15    BIT STRING (SIZE (8)),
    longBitmap-r15      BIT STRING (SIZE (64))
}
-- ASN1STOP

```

#### **SSB-ToMeasure field descriptions**

##### **longBitmap**

Bitmap when maximum number of SS/PBCH blocks per half frame equals to 64 as defined in TS 38.213 [88], clause 4.1.

##### **mediumBitmap**

Bitmap when maximum number of SS/PBCH blocks per half frame equals to 8 as defined in TS 38.213 [88], clause 4.1. For operation with shared spectrum channel access, if the k-th bit is set to 1, the UE assumes that one or more SS/PBCH blocks within the SMTC measurement duration with candidate SS/PBCH block indexes corresponding to SS/PBCH block index equal to k - 1 may be transmitted; if the k-th bit is set to 0, the UE assumes that the corresponding SS/PBCH block(s) are not transmitted. The k-th bit is set to 0, where  $k > \text{ssb-PositionQCL-CommonNR}$  and the number of actually transmitted SS/PBCH blocks is not larger than the number of 1's in the bitmap. If *ssb-PositionQCL-NR* is configured with a value smaller than *ssb-PositionQCL-CommonNR*, only the leftmost K bits ( $K = \text{ssb-PositionQCL-NR}$ ) are applicable for the corresponding cell.

##### **shortBitmap**

Bitmap when maximum number of SS/PBCH blocks per half frame equals to 4 as defined in TS 38.213 [88], clause 4.1.

## – *TimeToTrigger*

The IE *TimeToTrigger* specifies the value range used for time to trigger parameter, which concerns the time during which specific criteria for the event needs to be met in order to trigger a measurement report. Value ms0 corresponds to 0 ms and behaviour as specified in 7.3.2 applies, ms40 corresponds to 40 ms, and so on.

#### **TimeToTrigger information element**

```

-- ASN1START
TimeToTrigger ::= ENUMERATED {
    ms0, ms40, ms64, ms80, ms100, ms128, ms160, ms256,
    ms320, ms480, ms512, ms640, ms1024, ms1280, ms2560,
    ms5120}
-- ASN1STOP

```

## – *UL-DelayConfig*

The IE *UL-DelayConfig* IE specifies the configuration of the UL PDCP Packet Delay per QCI measurement specified in TS 36.314 [71].

#### **UL-DelayConfig information element**

```

-- ASN1START
UL-DelayConfig-r13 ::= CHOICE {
    release      NULL,
    setup        SEQUENCE {
        delayThreshold-r13  ENUMERATED {
            ms30, ms40, ms50, ms60, ms70, ms80,
            ms90, ms100, ms150, ms300, ms500, ms750, spare4,
            spare3, spare2, spare1}
        }
    }
-- ASN1STOP

```

**UL-DelayConfig field descriptions****delayThreshold**

Indicates the delay threshold value used by UE to provide results of UL PDCP Packet Delay per QCI measurement as specified in TS 36.314 [71]. Value in milliseconds. Value ms30 means 30 ms and so on.

**UL-DelayValueConfig**

The IE *UL-DelayValueConfig* specifies the configuration of the UL PDCP Packet Delay value per DRB measurements specified in TS 38.314 [103].

**UL-DelayValueConfig information element**

```
-- ASN1START
UL-DelayValueConfig-r16 ::= CHOICE {
    release          NULL,
    setup            SEQUENCE {
        delay-DRBlist-r16 SEQUENCE (SIZE(1..maxDRB)) OF DRB-Identity
    }
}
-- ASN1STOP
```

**UL-DelayValueConfig field descriptions****delay-DRBlist**

Indicates the DRB IDs used by UE to provide results of UL PDCP Packet Delay value per DRB measurement as specified in TS 38.314 [103].

**WLAN-CarrierInfo**

The IE *WLAN-CarrierInfo* is used to identify the WLAN frequency band information, as specified in Annex E in [67].

**WLAN-CarrierInfo information element**

```
-- ASN1START
WLAN-CarrierInfo-r13 ::= SEQUENCE {
    operatingClass-r13 INTEGER (0..255) OPTIONAL, -- Need ON
    countryCode-r13   ENUMERATED {unitedStates, europe, japan, global, ...} OPTIONAL, -- Need ON
    channelNumbers-r13 WLAN-ChannelList-r13 OPTIONAL, -- Need ON
    ...
}
WLAN-ChannelList-r13 ::= SEQUENCE (SIZE (1..maxWLAN-Channels-r13)) OF WLAN-Channel-r13
WLAN-Channel-r13 ::= INTEGER(0..255)
-- ASN1STOP
```

**WLAN-CarrierInfo field descriptions****channelNumbers**

Indicates the WLAN channels as defined in IEEE 802.11-2012 [67]. Value 0 is not used.

**countryCode**

Indicates the country code of WLAN as defined in IEEE 802.11-2012 [67].

**operatingClass**

Indicates the Operating Class of WLAN as defined in IEEE 802.11-2012 [67].

**WLAN-NameList**

The IE *WLAN-NameList* is used to indicate the names of the WLAN AP for which the UE is configured to measure.

**WLAN-NameList information element**

```

-- ASN1START
WLAN-NameListConfig-r15 ::= CHOICE{
    release          NULL,
    setup           WLAN-NameList-r15
}
WLAN-NameList-r15 ::= SEQUENCE (SIZE (1..maxWLAN-Name-r15)) OF WLAN-Name-r15
WLAN-Name-r15 ::= OCTET STRING (SIZE (1..32))
-- ASN1STOP

```

**WLAN-NameList field descriptions****WLAN-Name**

If configured, the UE only performs WLAN measurements according to the names identified. For each name, it refers to Service Set Identifier (SSID) defined in IEEE 802.11-2012 [67].

**WLAN-RSSI-Range**

The IE *WLAN-RSSI-Range* specifies the value range used in WLAN RSSI measurements and thresholds. Integer value for WLAN RSSI measurements is according to mapping table in TS 36.133 [16]. Value 0 corresponds to -infinity, value 1 to -100dBm, value 2 to -99dBm, and so on (i.e. in steps of 1dBm) until value 140, which corresponds to 39dBm, while value 141 corresponds to +infinity.

**WLAN-RSSI-Range information element**

```

-- ASN1START
WLAN-RSSI-Range-r13 ::= INTEGER(0..141)
-- ASN1STOP

```

**WLAN-RTT**

The IE *WLAN-RTT* covers the measured round trip time between the target device and WLAN AP and optionally the accuracy expressed as the standard deviation of the delay.

**WLAN-RTT information element**

```

-- ASN1START
WLAN-RTT-r15 ::= SEQUENCE {
    rttValue-r15          INTEGER (0..16777215),
    rttUnits-r15         ENUMERATED { microseconds,
    hundredsofnanoseconds,
    tensofnanoseconds,
    nanoseconds,
    tenthssofnanoseconds,
    ... },
    rttAccuracy-r15     INTEGER (0..255) OPTIONAL,
    ...
}
-- ASN1STOP

```

<b>WLAN-RTT field descriptions</b>
<p><b>rttValue</b> This field specifies the Round Trip Time (RTT) measurement between the target device and WLAN AP in units given by the field rttUnits as defined in TS 36.355 [54].</p>
<p><b>rttUnits</b> This field specifies the Units for the fields rttValue and rttAccuracy. The available Units are 1000ns, 100ns, 10ns, 1ns, and 0.1ns as defined in TS 36.355 [54].</p>
<p><b>rttAccuracy</b> This field provides the estimated accuracy of the provided rttValue expressed as the standard deviation in units given by the field rttUnits as defined in TS 36.355 [54].</p>

## – WLAN-Status

The IE *WLAN-Status* indicates the current status of WLAN connection. The values are set as described in clause 5.6.15.2 and 5.6.15.4.

### **WLAN-Status information element**

```
-- ASN1START
WLAN-Status-r13 ::=      ENUMERATED {successfulAssociation, failureWlanRadioLink,
failureWlanUnavailable, failureTimeout}
WLAN-Status-v1430 ::=  ENUMERATED {suspended, resumed}
-- ASN1STOP
```

## – WLAN-SuspendConfig

The IE *WLAN-SuspendConfig* is used for configuration of WLAN suspend/resume functionality.

```
-- ASN1START
WLAN-SuspendConfig-r14 ::= SEQUENCE {
    wlan-SuspendResumeAllowed-r14          BOOLEAN          OPTIONAL,    -- Need ON
    wlan-SuspendTriggersStatusReport-r14  BOOLEAN          OPTIONAL,    -- Need ON
}
-- ASN1STOP
```

<b>WLAN-SuspendConfig field descriptions</b>
<p><b>wlan-SuspendResumeAllowed</b> Indicates whether the UE is allowed to use suspend-resume mechanism, i.e., to indicate WLAN being temporarily unavailable and WLAN being available again after temporary unavailability.</p>
<p><b>wlan-SuspendTriggersStatusReport</b> Indicates whether the UE shall trigger PDCP status report as defined in TS 36.323 [8] when WLAN is temporarily unavailable and UE reports this status.</p>

## 6.3.6 Other information elements

### – AbsoluteTimeInfo

The IE *AbsoluteTimeInfo* indicates an absolute time in a format YY-MM-DD HH:MM:SS and using BCD encoding. The first/ leftmost bit of the bit string contains the most significant bit of the most significant digit of the year and so on.

### **AbsoluteTimeInfo information element**

```
-- ASN1START
AbsoluteTimeInfo-r10 ::=      BIT STRING (SIZE (48))
-- ASN1STOP
```



## – *AMF-Identifier*

The IE *AMF-Identifier* (AMFI) comprises of an AMF Region ID, an AMF Set ID and an AMF Pointer as specified in 23.003 [27], clause 2.10.1.

### **AMF-Identifier information element**

```
-- ASN1START
AMF-Identifier-r15 ::= BIT STRING (SIZE (24))
-- ASN1STOP
```

## – *AreaConfiguration*

The *AreaConfiguration* indicates area for which UE is requested to perform measurement logging. If not configured, measurement logging is not restricted to specific cells or tracking areas but applies as long as the RPLMN is contained in *plmn-IdentityList* stored in *VarLogMeasReport*.

### **AreaConfiguration information element**

```
-- ASN1START
AreaConfiguration-r10 ::= CHOICE {
  cellGlobalIdList-r10      CellGlobalIdList-r10,
  trackingAreaCodeList-r10  TrackingAreaCodeList-r10
}
AreaConfiguration-v1130 ::= SEQUENCE {
  trackingAreaCodeList-v1130 TrackingAreaCodeList-v1130
}
CellGlobalIdList-r10 ::= SEQUENCE (SIZE (1..32)) OF CellGlobalIdEUTRA
TrackingAreaCodeList-r10 ::= SEQUENCE (SIZE (1..8)) OF TrackingAreaCode
TrackingAreaCodeList-v1130 ::= SEQUENCE {
  plmn-Identity-perTAC-List-r11 SEQUENCE (SIZE (1..8)) OF PLMN-Identity
}
-- ASN1STOP
```

#### **AreaConfiguration field descriptions**

##### ***plmn-Identity-perTAC-List***

Includes the PLMN identity for each of the TA codes included in *trackingAreaCodeList*. The PLMN identity listed first in *plmn-Identity-perTAC-List* corresponds with the TA code listed first in *trackingAreaCodeList* and so on.

## – *BandCombinationList*

The IE *BandCombinationList* contains a list of CA band combinations.

### **BandCombinationList information element**

```
-- ASN1START
BandCombinationList-r14 ::= SEQUENCE (SIZE (1..maxBandComb-r13)) OF BandCombination-r14
BandCombination-r14 ::= SEQUENCE (SIZE (1..maxSimultaneousBands-r10)) OF BandIndication-r14
BandIndication-r14 ::= SEQUENCE {
  bandEUTRA-r14          FreqBandIndicator-r11,
  ca-BandwidthClassDL-r14 CA-BandwidthClass-r10,
  ca-BandwidthClassUL-r14 CA-BandwidthClass-r10          OPTIONAL
}
-- ASN1STOP
```

## – *C-RNTI*

The IE *C-RNTI* identifies a UE having a RRC connection within a cell.

### **C-RNTI information element**

```
-- ASN1START
C-RNTI ::= BIT STRING (SIZE (16))
-- ASN1STOP
```

## – *DedicatedInfoCDMA2000*

The *DedicatedInfoCDMA2000* is used to transfer UE specific CDMA2000 information between the network and the UE. The RRC layer is transparent for this information.

### **DedicatedInfoCDMA2000 information element**

```
-- ASN1START
DedicatedInfoCDMA2000 ::= OCTET STRING
-- ASN1STOP
```

## – *DedicatedInfoF1c*

The IE *DedicatedInfoF1c* is used to transfer IAB-DU specific F1-C related information between the network and the IAB-node. The carried information consists of F1AP message encapsulated in SCTP/IP or F1-C related IP packet with or without SCTP encapsulation, see TS 38.472 [105] and TS 36.423 [108]. The RRC layer is transparent for this information.

### **DedicatedInfoF1c information element**

```
-- ASN1START
DedicatedInfoF1c-r16 ::= OCTET STRING
-- ASN1STOP
```

## – *DedicatedInfoNAS*

The IE *DedicatedInfoNAS* is used to transfer UE specific NAS layer information between the network and the UE. The RRC layer is transparent for this information.

### **DedicatedInfoNAS information element**

```
-- ASN1START
DedicatedInfoNAS ::= OCTET STRING
-- ASN1STOP
```

## – *FilterCoefficient*

The IE *FilterCoefficient* specifies the measurement filtering coefficient. Value *fc0* corresponds to  $k = 0$ , *fc1* corresponds to  $k = 1$ , and so on.

### **FilterCoefficient information element**

```
-- ASN1START
FilterCoefficient ::= ENUMERATED {
    fc0, fc1, fc2, fc3, fc4, fc5,

```

```
fc6, fc7, fc8, fc9, fc11, fc13,
fc15, fc17, fc19, spare1, ...}
```

```
-- ASN1STOP
```

## – *FlightPathInfoReportConfig*

The IE *FlightPathInfoReportConfig* specifies flight path information report configuration.

### *FlightPathInfoReportConfig* information element

```
-- ASN1START
FlightPathInfoReportConfig-r15 ::= SEQUENCE {
    maxWayPointNumber-r15          INTEGER (1..maxWayPoint-r15),
    includeTimeStamp-r15           ENUMERATED {true}                OPTIONAL
}
-- ASN1STOP
```

#### *FlightPathInfoReportConfig* field descriptions

##### ***maxWayPointNumber***

Indicates the maximum number of way points UE can include in the flight path information report if this information is available at the UE.

##### ***includeTimeStamp***

Indicates whether time stamp of each way point can be reported in the flight path information report if time stamp information is available at the UE.

## – *GNSS-ID*

The IE *GNSS-ID* is used to indicate a specific GNSS (see also TS 36.355 [54]).

### *GNSS-ID* information element

```
-- ASN1START
GNSS-ID-r15 ::= SEQUENCE {
    gnss-id-r15          ENUMERATED{gps, sbas, qzss, galileo, glonass, bds, ..., navic-v1610},
    ...
}
-- ASN1STOP
```

## – *GNSS-PositionFixDuration*

The IE *GNSS-PositionFixDuration* indicates the time duration required for the UE to acquire a GNSS position. Value s1 corresponds to 1 second, s2 corresponds to 2 seconds and so on.

### *GNSS-PositionFixDuration* information element

```
-- ASN1START
GNSS-PositionFixDuration-r18 ::= ENUMERATED{
    s1, s2, s3, s4, s5, s6, s7, s13, s19, s25, s31}
-- ASN1STOP
```

## – *GNSS-ValidityDuration*

The IE *GNSS-ValidityDuration* indicates the remaining GNSS validity duration in the UE. Value s10 corresponds to 10 seconds, s20 corresponds to 20 seconds and so on. Value min5 corresponds to 5 minutes, value min10 corresponds to 10 minutes and so on.

**GNSS-ValidityDuration information element**

```

-- ASN1START
GNSS-ValidityDuration-r17 ::= ENUMERATED{
    s10, s20, s30, s40, s50, s60, min5, min10,
    min15, min20, min25, min30, min50, min90, min120, infinity}
-- ASN1STOP

```

– ***I-RNTI***

The *I-RNTI* IE is used to identify the suspended UE context of a UE in RRC\_INACTIVE and for User plane CIoT 5GS optimisation.

***I-RNTI* information element**

```

-- ASN1START
I-RNTI-r15 ::= BIT STRING (SIZE(40))
-- ASN1STOP

```

– ***LoggingDuration***

The *LoggingDuration* indicates the duration for which UE is requested to perform measurement logging. Value min10 corresponds to 10 minutes, value min20 corresponds to 20 minutes and so on.

***LoggingDuration* information element**

```

-- ASN1START
LoggingDuration-r10 ::= ENUMERATED {
    min10, min20, min40, min60, min90, min120, spare2, spare1}
-- ASN1STOP

```

– ***LoggingInterval***

The *LoggingInterval* indicates the periodicity for logging measurement results. Value ms1280 corresponds to 1.28s, value ms2560 corresponds to 2.56s and so on.

***LoggingInterval* information element**

```

-- ASN1START
LoggingInterval-r10 ::= ENUMERATED {
    ms1280, ms2560, ms5120, ms10240, ms20480,
    ms30720, ms40960, ms61440}
-- ASN1STOP

```

– ***MeasSubframePattern***

The IE *MeasSubframePattern* is used to specify a subframe pattern. The first/leftmost bit corresponds to the subframe #0 of the radio frame satisfying SFN mod x = 0, where SFN is that of PCell and x is the size of the bit string divided by 10. "1" denotes that the corresponding subframe is used.

***MeasSubframePattern* information element**

```

-- ASN1START
MeasSubframePattern-r10 ::= CHOICE {
    subframePatternFDD-r10 BIT STRING (SIZE (40)),

```

```

subframePatternTDD-r10          CHOICE {
  subframeConfig1-5-r10         BIT STRING (SIZE (20)),
  subframeConfig0-r10          BIT STRING (SIZE (70)),
  subframeConfig6-r10          BIT STRING (SIZE (60)),
  ...
},
...
}
-- ASN1STOP

```

## – MMEC

The IE *MMEC* identifies an MME within the scope of an MME Group within a PLMN, see TS 23.003 [27].

### **MMEC information element**

```

-- ASN1START
MMEC ::= BIT STRING (SIZE (8))
-- ASN1STOP

```

## – NeighCellConfig

The IE *NeighCellConfig* is used to provide the information related to MBSFN and TDD UL/DL configuration of neighbour cells.

### **NeighCellConfig information element**

```

-- ASN1START
NeighCellConfig ::= BIT STRING (SIZE (2))
-- ASN1STOP

```

#### **NeighCellConfig field descriptions**

##### **neighCellConfig**

Provides information related to MBSFN and TDD UL/DL configuration of neighbour cells of this frequency

00: Not all neighbour cells have the same MBSFN subframe allocation as the serving cell on this frequency, if configured, and as the PCell otherwise

10: The MBSFN subframe allocations of all neighbour cells are identical to or subsets of that in the serving cell on this frequency, if configured, and of that in the PCell otherwise

01: No MBSFN subframes are present in all neighbour cells

11: Different UL/DL allocation in neighbouring cells for TDD compared to the serving cell on this frequency, if configured, and compared to the PCell otherwise

For TDD, 00, 10 and 01 are only used for same UL/DL allocation in neighbouring cells compared to the serving cell on this frequency, if configured, and compared to the PCell otherwise.

## – NG-5G-S-TMSI

The IE *NG-5G-S-TMSI* contains a 5G S-Temporary Mobile Subscriber Identity, a temporary UE identity provided by the AMF which uniquely identifies the UE within the tracking area, see TS 23.003 [27].

### **NG-5G-S-TMSI information element**

```

-- ASN1START
NG-5G-S-TMSI-r15 ::= BIT STRING (SIZE (48))
-- ASN1STOP

```



```

    ]],
    [[ idc-HardwareSharingIndication-r13  ENUMERATED {setup}          OPTIONAL  -- Need OR
    ]],
    [[ idc-Indication-MRDC-r15           CHOICE{
        release                          NULL,
        setup                             CandidateServingFreqListNR-r15
    }                                     OPTIONAL  -- Cond idc-Ind
    ]]
}

ObtainLocationConfig-r11 ::= SEQUENCE {
    obtainLocation-r11          ENUMERATED {setup}          OPTIONAL  -- Need OR
}

PowerPrefIndicationConfig-r11 ::= CHOICE{
    release                     NULL,
    setup                       SEQUENCE{
        powerPrefIndicationTimer-r11  ENUMERATED {s0, s0dot5, s1, s2, s5, s10, s20,
                                                s30, s60, s90, s120, s300, s600, spare3,
                                                spare2, spare1}
    }
}

ReportProximityConfig-r9 ::= SEQUENCE {
    proximityIndicationEUTRA-r9  ENUMERATED {enabled}          OPTIONAL,  -- Need OR
    proximityIndicationUTRA-r9  ENUMERATED {enabled}          OPTIONAL  -- Need OR
}

CandidateServingFreqListNR-r15 ::= SEQUENCE (SIZE (1..maxFreqIDC-r11)) OF ARFCN-ValueNR-r15

SCG-DeactivationPreferenceConfig-r17 ::= SEQUENCE {
    scg-DeactivationPreferenceProhibitTimer-r17
        ENUMERATED {s0, s1, s2, s4, s8, s10, s20, s30,
                    s60, s120, s180, s240, s300, s600, s900, s1800}
}

-- ASN1STOP

```

<b>OtherConfig field descriptions</b>
<p><b><i>aile-BitConfig</i></b> Indicates whether the UE is allowed to provide assistance information bit for local cache. If configured, the UE shall only apply to a DRB configured with 12-bit PDCP SN format as specified in TS 36.323 [8].</p>
<p><b><i>autonomousDenialSubframes</i></b> Indicates the maximum number of the UL subframes for which the UE is allowed to deny any UL transmission. Value n2 corresponds to 2 subframes, n5 to 5 subframes and so on. E-UTRAN does not configure autonomous denial for frequencies on which SCG cells are configured.</p>
<p><b><i>autonomousDenialValidity</i></b> Indicates the validity period over which the UL autonomous denial subframes shall be counted. Value sf200 corresponds to 200 subframes, sf500 corresponds to 500 subframes and so on.</p>
<p><b><i>bt-NameListConfig</i></b> Configuration for the UE to report measurements from specific Bluetooth beacons. E-UTRAN configures the field only if <i>includeBT-Meas</i> is configured for one or more measurements.</p>
<p><b><i>bw-PreferenceIndicationTimer</i></b> Prohibit timer for bandwidth preference indication reporting. Value in seconds. Value s0 means prohibit timer is set to 0 second, value s0dot5 means prohibit timer is set to 0.5 second, value s1 means prohibit timer is set to 1 second and so on.</p>
<p><b><i>CandidateServingFreqListNR</i></b> Indicates for each candidate NR serving cells, the center frequency around which UE is requested to report IDC issues for MR-DC.</p>
<p><b><i>delayBudgetReportingProhibitTimer</i></b> Prohibit timer for delay budget reporting. Value in seconds. Value s0 means prohibit timer is set to 0 second, value s0dot4 means prohibit timer is set to 0.4 second, and so on.</p>
<p><b><i>idc-HardwareSharingIndication</i></b> The field is used to indicate whether the UE is allowed indicate in <i>InDeviceCoexIndication</i> that the cause of the problems are due to hardware sharing, and whether the UE is allowed to omit the TDM assistance information.</p>
<p><b><i>idc-Indication</i></b> The field is used to indicate whether the UE is configured to initiate transmission of the <i>InDeviceCoexIndication</i> message to the network.</p>
<p><b><i>idc-Indication-MRDC</i></b> The field is used to indicate whether the UE is configured to provide IDC indications for MR-DC using the <i>InDeviceCoexIndication</i> message.</p>
<p><b><i>idc-Indication-UL-CA</i></b> The field is used to indicate whether the UE is configured to provide IDC indications for UL CA using the <i>InDeviceCoexIndication</i> message.</p>
<p><b><i>measConfigAppLayerContainer</i></b> The field contains configuration of application layer measurements, see Annex L (normative) in TS 26.247 [90] and clause 16.5 in TS 26.114 [99]. The maximum number of configurations of application layer measurements that a UE supports is one regardless of <i>serviceType</i>.</p>
<p><b><i>serviceType</i></b> Indicates the type of application layer measurement. Value qoe indicates Quality of Experience Measurement Collection for streaming services, value qoemtsi indicates Enhanced Quality of Experience Measurement Collection for MTSI.</p>
<p><b><i>obtainLocation</i></b> Requests the UE to attempt to have detailed location information available using GNSS. E-UTRAN configures the field only if <i>includeLocationInfo</i> is configured for one or more measurements.</p>
<p><b><i>overheatingAssistanceConfig</i></b> Configuration for the UE to report assistance information to inform the eNB about UE detected internal overheating.</p>
<p><b><i>overheatingAssistanceConfigForSCG</i></b> The field is used to indicate whether the UE is configured to provide overheating assistance information for NR SCG. E-UTRAN configures value <i>TRUE</i> only when the UE is configured with an NR SCG.</p>
<p><b><i>overheatingIndicationProhibitTimer</i></b> Prohibit timer for overheating assistance information reporting. Value in seconds. Value s0 means prohibit timer is set to 0 seconds, value s0dot5 means prohibit timer is set to 0.5 second, value s1 means prohibit timer is set to 1 second and so on.</p>
<p><b><i>powerPrefIndicationTimer</i></b> Prohibit timer for Power Preference Indication reporting. Value in seconds. Value s0 means prohibit timer is set to 0 second, value s0dot5 means prohibit timer is set to 0.5 second, value s1 means prohibit timer is set to 1 second and so on.</p>
<p><b><i>reportProximityConfig</i></b> Indicates, for each of the applicable RATs (EUTRA, UTRA), whether or not proximity indication is enabled for CSG member cell(s) of the concerned RAT. Note.</p>
<p><b><i>rlmReportTimer</i></b> Prohibit timer for RLM event reporting, i.e. "early-out-of-sync" and "early-in-sync" event reporting, as specified in clause 5.6.10. Value in seconds. Value s0 means prohibit timer is set to 0 second, value s0dot5 means prohibit timer is set to 0.5 second, value s1 means prohibit timer is set to 1 second and so on.</p>



<b>OtherConfig field descriptions</b>
<p><b><i>aile-BitConfig</i></b> Indicates whether the UE is allowed to provide assistance information bit for local cache. If configured, the UE shall only apply to a DRB configured with 12-bit PDCP SN format as specified in TS 36.323 [8].</p>
<p><b><i>autonomousDenialSubframes</i></b> Indicates the maximum number of the UL subframes for which the UE is allowed to deny any UL transmission. Value n2 corresponds to 2 subframes, n5 to 5 subframes and so on. E-UTRAN does not configure autonomous denial for frequencies on which SCG cells are configured.</p>
<p><b><i>autonomousDenialValidity</i></b> Indicates the validity period over which the UL autonomous denial subframes shall be counted. Value sf200 corresponds to 200 subframes, sf500 corresponds to 500 subframes and so on.</p>
<p><b><i>bt-NameListConfig</i></b> Configuration for the UE to report measurements from specific Bluetooth beacons. E-UTRAN configures the field only if <i>includeBT-Meas</i> is configured for one or more measurements.</p>
<p><b><i>rlmReportRep-MPDCCH</i></b> The field is used to indicate whether the UE is configured to report excess repetitions on MPDCCH.</p>
<p><b><i>sps-AssistanceInfoReport</i></b> Value TRUE indicates that the UE is allowed to report SPS-AssistanceInformation. If the <i>sl-V2X-SPS-Config</i> is provided by an E-UTRA <i>RRCConnectionReconfiguration</i> message embedded within an NR <i>RRCReconfiguration</i> for V2X sidelink communication (i.e. <i>sl-ConfigDedicatedEUTRA</i>) as in TS 38.331 [82], the network should configure the <i>otherConfig</i> and set this field to TRUE.</p>
<p><b><i>wlan-NameListConfig</i></b> Configuration for the UE to report measurements from specific WLAN APs. E-UTRAN configures the field only if <i>includeWLAN-Meas</i> is configured for one or more measurements.</p>

NOTE: Enabling/ disabling of proximity indication includes enabling/ disabling of the related functionality e.g. autonomous search in connected mode.

<b>Conditional presence</b>	<b>Explanation</b>
<i>idc-Ind</i>	The field is optionally present if <i>idc-Indication</i> is present, need OR. Otherwise the field is not present.
<i>overheating</i>	The field is optionally present, need ON, if the UE is configured with <i>overheatingAssistanceConfig</i> ; if <i>overheatingAssistanceConfig</i> is included and set to <i>release</i> , the UE shall delete any existing value for this field; otherwise, the field is not present.

## – *RAN-AreaCode*

The *RAN-AreaCode* IE indicates RAN area code of the cell.

### ***RAN-AreaCode* information element**

```
-- ASN1START
RAN-AreaCode-r15 ::= INTEGER (0..255)
-- ASN1STOP
```

## – *RAND-CDMA2000 (1xRTT)*

The *RAND-CDMA2000* concerns a random value, generated by the eNB, to be passed to the CDMA2000 upper layers.

### ***RAND-CDMA2000* information element**

```
-- ASN1START
RAND-CDMA2000 ::= BIT STRING (SIZE (32))
-- ASN1STOP
```

## – *RAT-Type*

The IE *RAT-Type* is used to indicate the radio access technology (RAT), including E-UTRA, of the requested/transferred UE capabilities. A separate value applies for some EUTRA-NR capabilities that are transferred by a separate UE capability container, used in case of MR-DC.

### **RAT-Type information element**

```
-- ASN1START
RAT-Type ::=
    ENUMERATED {
        eutra, utra, geran-cs, geran-ps, cdma2000-1XRTT,
        nr, eutra-nr, spare1, ...}
-- ASN1STOP
```

## – *ResumeIdentity*

The IE *ResumeIdentity* is used to identify the suspended UE context

### **ResumeIdentity information element**

```
-- ASN1START
ResumeIdentity-r13 ::=
    BIT STRING (SIZE(40))
-- ASN1STOP
```

## – *RRC-TransactionIdentifier*

The IE *RRC-TransactionIdentifier* is used, together with the message type, for the identification of an RRC procedure (transaction).

### **RRC-TransactionIdentifier information element**

```
-- ASN1START
RRC-TransactionIdentifier ::=
    INTEGER (0..3)
-- ASN1STOP
```

## – *SatelliteId*

The IE *SatelliteId* is used to identify the satellite assistance information of the serving or neighbour satellites.

### **SatelliteId information element**

```
-- ASN1START
SatelliteId-r18 ::= INTEGER (0..255)
-- ASN1STOP
```

## – *SBAS-ID*

The IE *SBAS-ID* is used to indicate a specific SBAS (see also TS 36.355 [54]).

### **SBAS-ID information element**

```
-- ASN1START
SBAS-ID-r15 ::= SEQUENCE {
    sbas-id-r15
        ENUMERATED {waas, egnos, msas, gagan, ...},
-- ASN1STOP
```

```

}
...
-- ASN1STOP

```

## – ShortI-RNTI

The *ShortI-RNTI* IE is used to identify the suspended UE context of a UE in RRC\_INACTIVE using fewer bits compared to *I-RNTI*.

### ShortI-RNTI information element

```

-- ASN1START
ShortI-RNTI-r15 ::=          BIT STRING (SIZE(24))
-- ASN1STOP

```

## – S-NSSAI

The IE *S-NSSAI* identifies a Network Slice end to end and comprises a slice/service type and a slice differentiator, see TS 23.003 [27].

### S-NSSAI information element

```

-- ASN1START
S-NSSAI-r15 ::=          CHOICE{
    sst                BIT STRING (SIZE (8)),
    sst-SD             BIT STRING (SIZE (32))
}
-- ASN1STOP

```

#### S-NSSAI field descriptions

##### **sst**

Indicates the *S-NSSAI* consists of Slice/Service Type, see TS 23.003 [27].

##### **sst-SD**

Indicates the *S-NSSAI* consists of Slice/Service Type and Slice Differentiator, see TS 23.003 [27].

## – S-TMSI

The IE *S-TMSI* contains an S-Temporary Mobile Subscriber Identity, a temporary UE identity provided by the EPC which uniquely identifies the UE within the tracking area, see TS 23.003 [27].

### S-TMSI information element

```

-- ASN1START
S-TMSI ::=          SEQUENCE {
    mmec            MMEC,
    m-TMSI         BIT STRING (SIZE (32))
}
-- ASN1STOP

```

#### S-TMSI field descriptions

##### **m-TMSI**

The first/leftmost bit of the bit string contains the most significant bit of the M-TMSI.

– *TimeOffsetUTC*

The IE *TimeOffsetUTC* provides the time offset to the beginning of week (Monday 00:00:00 UTC). Units in seconds.

***TimeOffsetUTC* information element**

```
-- ASN1START
TimeOffsetUTC-r17 ::=          INTEGER (0..1048575)
-- ASN1STOP
```

– *TraceReference*

The *TraceReference* contains parameter Trace Reference as defined in TS 32.422 [58].

***TraceReference* information element**

```
-- ASN1START
TraceReference-r10 ::=          SEQUENCE {
    plmn-Identity-r10          PLMN-Identity,
    traceId-r10                OCTET STRING (SIZE (3))
}
-- ASN1STOP
```

– *UE-CapabilityRAT-ContainerList*

The IE *UE-CapabilityRAT-ContainerList* contains list of containers, one for each RAT for which UE capabilities are transferred, if any.

***UE-CapabilityRAT-ContainerList* information element**

```
-- ASN1START
UE-CapabilityRAT-ContainerList ::=SEQUENCE (SIZE (0..maxRAT-Capabilities)) OF UE-CapabilityRAT-
Container
UE-CapabilityRAT-Container ::= SEQUENCE {
    rat-Type                    RAT-Type,
    ueCapabilityRAT-Container   OCTET STRING
}
-- ASN1STOP
```

**UECapabilityRAT-ContainerList field descriptions****ueCapabilityRAT-Container**

Container for the UE capabilities of the indicated RAT. The encoding is defined in the specification of each RAT:

For E-UTRA: the encoding of UE capabilities is defined in IE *UE-EUTRA-Capability*.

For UTRA: the octet string contains the INTER RAT HANDOVER INFO message defined in TS 25.331 [19].

For GERAN CS: the octet string contains the concatenated string of the Mobile Station Classmark 2 and Mobile Station Classmark 3. The first 5 octets correspond to Mobile Station Classmark 2 and the following octets correspond to Mobile Station Classmark 3. The Mobile Station Classmark 2 is formatted as 'TLV' and is coded in the same way as the *Mobile Station Classmark 2* information element in TS 24.008 [49]. The first octet is the *Mobile station classmark 2 IEI* and its value shall be set to 33H. The second octet is the *Length of mobile station classmark 2* and its value shall be set to 3. The octet 3 contains the first octet of the value part of the *Mobile Station Classmark 2* information element, the octet 4 contains the second octet of the value part of the *Mobile Station Classmark 2* information element and so on. For each of these octets, the first/ leftmost/ most significant bit of the octet contains b8 of the corresponding octet of the Mobile Station Classmark 2. The Mobile Station Classmark 3 is formatted as 'V' and is coded in the same way as the value part in the *Mobile station classmark 3* information element in TS 24.008 [49]. The sixth octet of this octet string contains octet 1 of the value part of *Mobile station classmark 3*, the seventh of octet of this octet string contains octet 2 of the value part of *Mobile station classmark 3* and so on. Note.

For GERAN PS: the encoding of UE capabilities is formatted as 'V' and is coded in the same way as the value part in the *MS Radio Access Capability* information element in TS 24.008 [49].

For CDMA2000-1XRTT: the octet string contains the A21 Mobile Subscription Information and the encoding of this is defined in A.S0008 [33]. The A21 Mobile Subscription Information contains the supported CDMA2000 1xRTT band class and band sub-class information.

For NR: The octet string contains the IE *UE-NR-Capability* as defined in TS 38.331 [82].

For EUTRA-NR: The octet string contains the IE *UE-MRDC-Capability* as defined in TS 38.331 [82]

NOTE: The value part is specified by means of CSN.1, which encoding results in a bit string, to which final padding may be appended up to the next octet boundary TS 24.008 [49]. The first/ leftmost bit of the CSN.1 bit string is placed in the first/ leftmost/ most significant bit of the first octet. This continues until the last bit of the CSN.1 bit string, which is placed in the last/ rightmost/ least significant bit of the last octet.

**UE-EUTRA-Capability**

The IE *UE-EUTRA-Capability* is used to convey the E-UTRA UE Radio Access Capability Parameters, see TS 36.306 [5], and the Feature Group Indicators for mandatory features (defined in Annexes B.1 and C.1) to the network. The IE *UE-EUTRA-Capability* is transferred in E-UTRA or in another RAT.

NOTE 0: For (UE capability specific) guidelines on the use of keyword OPTIONAL, see Annex A.3.5.

**UE-EUTRA-Capability information element**

```
-- ASN1START
UE-EUTRA-Capability ::= SEQUENCE {
    accessStratumRelease      AccessStratumRelease,
    ue-Category               INTEGER (1..5),
    pdcp-Parameters           PDCP-Parameters,
    phyLayerParameters        PhyLayerParameters,
    rf-Parameters             RF-Parameters,
    measParameters            MeasParameters,
    featureGroupIndicators    BIT STRING (SIZE (32))           OPTIONAL,
    interRAT-Parameters       SEQUENCE {
        utraFDD                IRAT-ParametersUTRA-FDD           OPTIONAL,
        utraTDD128             IRAT-ParametersUTRA-TDD128        OPTIONAL,
        utraTDD384             IRAT-ParametersUTRA-TDD384        OPTIONAL,
        utraTDD768             IRAT-ParametersUTRA-TDD768        OPTIONAL,
        geran                  IRAT-ParametersGERAN             OPTIONAL,
        cdma2000-HRPD           IRAT-ParametersCDMA2000-HRPD    OPTIONAL,
        cdma2000-1XRTT         IRAT-ParametersCDMA2000-1XRTT    OPTIONAL
    },
    nonCriticalExtension       UE-EUTRA-Capability-v920-IEs     OPTIONAL
}

-- Late non critical extensions
UE-EUTRA-Capability-v9a0-IEs ::= SEQUENCE {
    featureGroupIndRel9Add-r9 BIT STRING (SIZE (32))           OPTIONAL,
    fdd-Add-UE-EUTRA-Capabilities-r9 UE-EUTRA-CapabilityAddXDD-Mode-r9  OPTIONAL,
    tdd-Add-UE-EUTRA-Capabilities-r9 UE-EUTRA-CapabilityAddXDD-Mode-r9  OPTIONAL,
    nonCriticalExtension       UE-EUTRA-Capability-v9c0-IEs     OPTIONAL
}
```

```

}
UE-EUTRA-Capability-v9c0-IEs ::= SEQUENCE {
  interRAT-ParametersUTRA-v9c0          IRAT-ParametersUTRA-v9c0          OPTIONAL,
  nonCriticalExtension                    UE-EUTRA-Capability-v9d0-IEs     OPTIONAL
}
UE-EUTRA-Capability-v9d0-IEs ::= SEQUENCE {
  phyLayerParameters-v9d0              PhyLayerParameters-v9d0          OPTIONAL,
  nonCriticalExtension                    UE-EUTRA-Capability-v9e0-IEs     OPTIONAL
}
UE-EUTRA-Capability-v9e0-IEs ::= SEQUENCE {
  rf-Parameters-v9e0                    RF-Parameters-v9e0                OPTIONAL,
  nonCriticalExtension                    UE-EUTRA-Capability-v9h0-IEs     OPTIONAL
}
UE-EUTRA-Capability-v9h0-IEs ::= SEQUENCE {
  interRAT-ParametersUTRA-v9h0          IRAT-ParametersUTRA-v9h0          OPTIONAL,
  -- Following field is only to be used for late REL-9 extensions
  lateNonCriticalExtension                OCTET STRING                       OPTIONAL,
  nonCriticalExtension                    UE-EUTRA-Capability-v10c0-IEs     OPTIONAL
}
UE-EUTRA-Capability-v10c0-IEs ::= SEQUENCE {
  otdoa-PositioningCapabilities-r10      OTDOA-PositioningCapabilities-r10  OPTIONAL,
  nonCriticalExtension                    UE-EUTRA-Capability-v10f0-IEs     OPTIONAL
}
UE-EUTRA-Capability-v10f0-IEs ::= SEQUENCE {
  rf-Parameters-v10f0                    RF-Parameters-v10f0                OPTIONAL,
  nonCriticalExtension                    UE-EUTRA-Capability-v10i0-IEs     OPTIONAL
}
UE-EUTRA-Capability-v10i0-IEs ::= SEQUENCE {
  rf-Parameters-v10i0                    RF-Parameters-v10i0                OPTIONAL,
  -- Following field is only to be used for late REL-10 extensions
  lateNonCriticalExtension                OCTET STRING (CONTAINING UE-EUTRA-Capability-v10j0-IEs)
  OPTIONAL,
  nonCriticalExtension                    UE-EUTRA-Capability-v11d0-IEs     OPTIONAL
}
UE-EUTRA-Capability-v10j0-IEs ::= SEQUENCE {
  rf-Parameters-v10j0                    RF-Parameters-v10j0                OPTIONAL,
  nonCriticalExtension                    SEQUENCE {}                        OPTIONAL
}
UE-EUTRA-Capability-v11d0-IEs ::= SEQUENCE {
  rf-Parameters-v11d0                    RF-Parameters-v11d0                OPTIONAL,
  otherParameters-v11d0                  Other-Parameters-v11d0             OPTIONAL,
  nonCriticalExtension                    UE-EUTRA-Capability-v11x0-IEs     OPTIONAL
}
UE-EUTRA-Capability-v11x0-IEs ::= SEQUENCE {
  -- Following field is only to be used for late REL-11 extensions
  lateNonCriticalExtension                OCTET STRING                       OPTIONAL,
  nonCriticalExtension                    UE-EUTRA-Capability-v12b0-IEs     OPTIONAL
}
UE-EUTRA-Capability-v12b0-IEs ::= SEQUENCE {
  rf-Parameters-v12b0                    RF-Parameters-v12b0                OPTIONAL,
  nonCriticalExtension                    UE-EUTRA-Capability-v12x0-IEs     OPTIONAL
}
UE-EUTRA-Capability-v12x0-IEs ::= SEQUENCE {
  -- Following field is only to be used for late REL-12 extensions
  lateNonCriticalExtension                OCTET STRING                       OPTIONAL,
  nonCriticalExtension                    UE-EUTRA-Capability-v1370-IEs     OPTIONAL
}
UE-EUTRA-Capability-v1370-IEs ::= SEQUENCE {
  ce-Parameters-v1370                    CE-Parameters-v1370                OPTIONAL,
  fdd-Add-UE-EUTRA-Capabilities-v1370   UE-EUTRA-CapabilityAddXDD-Mode-v1370  OPTIONAL,
  tdd-Add-UE-EUTRA-Capabilities-v1370   UE-EUTRA-CapabilityAddXDD-Mode-v1370  OPTIONAL,
  nonCriticalExtension                    UE-EUTRA-Capability-v1380-IEs     OPTIONAL
}
UE-EUTRA-Capability-v1380-IEs ::= SEQUENCE {

```

```

rf-Parameters-v1380                RF-Parameters-v1380                OPTIONAL,
ce-Parameters-v1380                CE-Parameters-v1380,
fdd-Add-UE-EUTRA-Capabilities-v1380 UE-EUTRA-CapabilityAddXDD-Mode-v1380,
tdd-Add-UE-EUTRA-Capabilities-v1380 UE-EUTRA-CapabilityAddXDD-Mode-v1380,
nonCriticalExtension                UE-EUTRA-Capability-v1390-IEs        OPTIONAL
}

UE-EUTRA-Capability-v1390-IEs ::= SEQUENCE {
  rf-Parameters-v1390                RF-Parameters-v1390                OPTIONAL,
  nonCriticalExtension                UE-EUTRA-Capability-v13e0a-IEs    OPTIONAL
}

UE-EUTRA-Capability-v13e0a-IEs ::= SEQUENCE {
  lateNonCriticalExtension            OCTET STRING (CONTAINING UE-EUTRA-Capability-v13e0b-IEs)
  OPTIONAL,
  nonCriticalExtension                UE-EUTRA-Capability-v1470-IEs    OPTIONAL
}

UE-EUTRA-Capability-v13e0b-IEs ::= SEQUENCE {
  phyLayerParameters-v13e0            PhyLayerParameters-v13e0,
  -- Following field is only to be used for late REL-13 extensions
  nonCriticalExtension                SEQUENCE {}                       OPTIONAL
}

UE-EUTRA-Capability-v1470-IEs ::= SEQUENCE {
  mbms-Parameters-v1470              MBMS-Parameters-v1470              OPTIONAL,
  phyLayerParameters-v1470            PhyLayerParameters-v1470            OPTIONAL,
  rf-Parameters-v1470                RF-Parameters-v1470                OPTIONAL,
  nonCriticalExtension                UE-EUTRA-Capability-v14a0-IEs    OPTIONAL
}

UE-EUTRA-Capability-v14a0-IEs ::= SEQUENCE {
  phyLayerParameters-v14a0            PhyLayerParameters-v14a0,
  nonCriticalExtension                UE-EUTRA-Capability-v14b0-IEs    OPTIONAL
}

UE-EUTRA-Capability-v14b0-IEs ::= SEQUENCE {
  rf-Parameters-v14b0                RF-Parameters-v14b0                OPTIONAL,
  nonCriticalExtension                UE-EUTRA-Capability-v14x0-IEs    OPTIONAL
}

UE-EUTRA-Capability-v14x0-IEs ::= SEQUENCE {
  -- Following field is only to be used for late REL-14 extensions
  lateNonCriticalExtension            OCTET STRING                        OPTIONAL,
  nonCriticalExtension                UE-EUTRA-Capability-v15x0-IEs    OPTIONAL
}

UE-EUTRA-Capability-v15x0-IEs ::= SEQUENCE {
  -- Following field is only to be used for late REL-15 extensions
  lateNonCriticalExtension            OCTET STRING                        OPTIONAL,
  nonCriticalExtension                UE-EUTRA-Capability-v16c0-IEs    OPTIONAL
}

UE-EUTRA-Capability-v16c0-IEs ::= SEQUENCE {
  measParameters-v16c0                MeasParameters-v16c0,
  -- Following field is only to be used for late REL-16 extensions
  lateNonCriticalExtension            OCTET STRING                        OPTIONAL,
  nonCriticalExtension                SEQUENCE {}                       OPTIONAL
}

-- Regular non critical extensions
UE-EUTRA-Capability-v920-IEs ::= SEQUENCE {
  phyLayerParameters-v920            PhyLayerParameters-v920,
  interRAT-ParametersGERAN-v920      IRAT-ParametersGERAN-v920,
  interRAT-ParametersUTRA-v920       IRAT-ParametersUTRA-v920           OPTIONAL,
  interRAT-ParametersCDMA2000-v920   IRAT-ParametersCDMA2000-1XRTT-v920 OPTIONAL,
  deviceType-r9                       ENUMERATED {noBenFromBatConsumpOpt} OPTIONAL,
  csg-ProximityIndicationParameters-r9 CSG-ProximityIndicationParameters-r9,
  neighCellSI-AcquisitionParameters-r9 NeighCellSI-AcquisitionParameters-r9,
  son-Parameters-r9                   SON-Parameters-r9,
  nonCriticalExtension                UE-EUTRA-Capability-v940-IEs    OPTIONAL
}

UE-EUTRA-Capability-v940-IEs ::= SEQUENCE {
  lateNonCriticalExtension            OCTET STRING (CONTAINING UE-EUTRA-Capability-v9a0-IEs)
  OPTIONAL,
  nonCriticalExtension                UE-EUTRA-Capability-v1020-IEs    OPTIONAL
}

```

```

UE-EUTRA-Capability-v1020-IEs ::= SEQUENCE {
    ue-Category-v1020                INTEGER (6..8)                OPTIONAL,
    phyLayerParameters-v1020          PhyLayerParameters-v1020      OPTIONAL,
    rf-Parameters-v1020               RF-Parameters-v1020         OPTIONAL,
    measParameters-v1020              MeasParameters-v1020       OPTIONAL,
    featureGroupIndRel10-r10          BIT STRING (SIZE (32))     OPTIONAL,
    interRAT-ParametersCDMA2000-v1020 IRAT-ParametersCDMA2000-1XRTT-v1020 OPTIONAL,
    ue-BasedNetwPerfMeasParameters-r10 UE-BasedNetwPerfMeasParameters-r10 OPTIONAL,
    interRAT-ParametersUTRA-TDD-v1020 IRAT-ParametersUTRA-TDD-v1020 OPTIONAL,
    nonCriticalExtension               UE-EUTRA-Capability-v1060-IEs OPTIONAL
}

UE-EUTRA-Capability-v1060-IEs ::= SEQUENCE {
    fdd-Add-UE-EUTRA-Capabilities-v1060 UE-EUTRA-CapabilityAddXDD-Mode-v1060 OPTIONAL,
    tdd-Add-UE-EUTRA-Capabilities-v1060 UE-EUTRA-CapabilityAddXDD-Mode-v1060 OPTIONAL,
    rf-Parameters-v1060                RF-Parameters-v1060         OPTIONAL,
    nonCriticalExtension                UE-EUTRA-Capability-v1090-IEs OPTIONAL
}

UE-EUTRA-Capability-v1090-IEs ::= SEQUENCE {
    rf-Parameters-v1090                RF-Parameters-v1090         OPTIONAL,
    nonCriticalExtension                UE-EUTRA-Capability-v1130-IEs OPTIONAL
}

UE-EUTRA-Capability-v1130-IEs ::= SEQUENCE {
    pdcp-Parameters-v1130              PDCP-Parameters-v1130,
    phyLayerParameters-v1130            PhyLayerParameters-v1130      OPTIONAL,
    rf-Parameters-v1130                RF-Parameters-v1130,
    measParameters-v1130               MeasParameters-v1130,
    interRAT-ParametersCDMA2000-v1130 IRAT-ParametersCDMA2000-v1130,
    otherParameters-r11                Other-Parameters-r11,
    fdd-Add-UE-EUTRA-Capabilities-v1130 UE-EUTRA-CapabilityAddXDD-Mode-v1130 OPTIONAL,
    tdd-Add-UE-EUTRA-Capabilities-v1130 UE-EUTRA-CapabilityAddXDD-Mode-v1130 OPTIONAL,
    nonCriticalExtension                UE-EUTRA-Capability-v1170-IEs OPTIONAL
}

UE-EUTRA-Capability-v1170-IEs ::= SEQUENCE {
    phyLayerParameters-v1170            PhyLayerParameters-v1170      OPTIONAL,
    ue-Category-v1170                  INTEGER (9..10)              OPTIONAL,
    nonCriticalExtension                UE-EUTRA-Capability-v1180-IEs OPTIONAL
}

UE-EUTRA-Capability-v1180-IEs ::= SEQUENCE {
    rf-Parameters-v1180                RF-Parameters-v1180         OPTIONAL,
    mbms-Parameters-r11                MBMS-Parameters-r11         OPTIONAL,
    fdd-Add-UE-EUTRA-Capabilities-v1180 UE-EUTRA-CapabilityAddXDD-Mode-v1180 OPTIONAL,
    tdd-Add-UE-EUTRA-Capabilities-v1180 UE-EUTRA-CapabilityAddXDD-Mode-v1180 OPTIONAL,
    nonCriticalExtension                UE-EUTRA-Capability-v11a0-IEs OPTIONAL
}

UE-EUTRA-Capability-v11a0-IEs ::= SEQUENCE {
    ue-Category-v11a0                  INTEGER (11..12)             OPTIONAL,
    measParameters-v11a0               MeasParameters-v11a0        OPTIONAL,
    nonCriticalExtension                UE-EUTRA-Capability-v1250-IEs OPTIONAL
}

UE-EUTRA-Capability-v1250-IEs ::= SEQUENCE {
    phyLayerParameters-v1250            PhyLayerParameters-v1250      OPTIONAL,
    rf-Parameters-v1250                RF-Parameters-v1250         OPTIONAL,
    rlc-Parameters-r12                 RLC-Parameters-r12          OPTIONAL,
    ue-BasedNetwPerfMeasParameters-v1250 UE-BasedNetwPerfMeasParameters-v1250 OPTIONAL,
    ue-CategoryDL-r12                  INTEGER (0..14)              OPTIONAL,
    ue-CategoryUL-r12                  INTEGER (0..13)              OPTIONAL,
    wlan-IW-Parameters-r12             WLAN-IW-Parameters-r12       OPTIONAL,
    measParameters-v1250               MeasParameters-v1250        OPTIONAL,
    dc-Parameters-r12                  DC-Parameters-r12           OPTIONAL,
    mbms-Parameters-v1250              MBMS-Parameters-v1250       OPTIONAL,
    mac-Parameters-r12                  MAC-Parameters-r12          OPTIONAL,
    fdd-Add-UE-EUTRA-Capabilities-v1250 UE-EUTRA-CapabilityAddXDD-Mode-v1250 OPTIONAL,
    tdd-Add-UE-EUTRA-Capabilities-v1250 UE-EUTRA-CapabilityAddXDD-Mode-v1250 OPTIONAL,
    sl-Parameters-r12                   SL-Parameters-r12           OPTIONAL,
    nonCriticalExtension                UE-EUTRA-Capability-v1260-IEs OPTIONAL
}

UE-EUTRA-Capability-v1260-IEs ::= SEQUENCE {
    ue-CategoryDL-v1260                 INTEGER (15..16)             OPTIONAL,
    nonCriticalExtension                UE-EUTRA-Capability-v1270-IEs OPTIONAL
}

```



```

}
UE-EUTRA-Capability-v1270-IEs ::= SEQUENCE {
    rf-Parameters-v1270                RF-Parameters-v1270                OPTIONAL,
    nonCriticalExtension                UE-EUTRA-Capability-v1280-IEs    OPTIONAL
}
UE-EUTRA-Capability-v1280-IEs ::= SEQUENCE {
    phyLayerParameters-v1280          PhyLayerParameters-v1280          OPTIONAL,
    nonCriticalExtension                UE-EUTRA-Capability-v1310-IEs    OPTIONAL
}
UE-EUTRA-Capability-v1310-IEs ::= SEQUENCE {
    ue-CategoryDL-v1310                ENUMERATED {n17, m1}                OPTIONAL,
    ue-CategoryUL-v1310                ENUMERATED {n14, m1}                OPTIONAL,
    pdcp-Parameters-v1310              PDCP-Parameters-v1310,
    rlc-Parameters-v1310                RLC-Parameters-v1310,
    mac-Parameters-v1310                MAC-Parameters-v1310                OPTIONAL,
    phyLayerParameters-v1310            PhyLayerParameters-v1310            OPTIONAL,
    rf-Parameters-v1310                RF-Parameters-v1310                OPTIONAL,
    measParameters-v1310                MeasParameters-v1310                OPTIONAL,
    dc-Parameters-v1310                DC-Parameters-v1310                OPTIONAL,
    sl-Parameters-v1310                SL-Parameters-v1310                OPTIONAL,
    scptm-Parameters-r13                SCPTM-Parameters-r13                OPTIONAL,
    ce-Parameters-r13                  CE-Parameters-r13                  OPTIONAL,
    interRAT-ParametersWLAN-r13        IRAT-ParametersWLAN-r13,
    laa-Parameters-r13                  LAA-Parameters-r13                  OPTIONAL,
    lwa-Parameters-r13                  LWA-Parameters-r13                  OPTIONAL,
    wlan-IW-Parameters-v1310            WLAN-IW-Parameters-v1310,
    lwip-Parameters-r13                LWIP-Parameters-r13,
    fdd-Add-UE-EUTRA-Capabilities-v1310 UE-EUTRA-CapabilityAddXDD-Mode-v1310 OPTIONAL,
    tdd-Add-UE-EUTRA-Capabilities-v1310 UE-EUTRA-CapabilityAddXDD-Mode-v1310 OPTIONAL,
    nonCriticalExtension                UE-EUTRA-Capability-v1320-IEs    OPTIONAL
}
UE-EUTRA-Capability-v1320-IEs ::= SEQUENCE {
    ce-Parameters-v1320                CE-Parameters-v1320                OPTIONAL,
    phyLayerParameters-v1320            PhyLayerParameters-v1320            OPTIONAL,
    rf-Parameters-v1320                RF-Parameters-v1320                OPTIONAL,
    fdd-Add-UE-EUTRA-Capabilities-v1320 UE-EUTRA-CapabilityAddXDD-Mode-v1320 OPTIONAL,
    tdd-Add-UE-EUTRA-Capabilities-v1320 UE-EUTRA-CapabilityAddXDD-Mode-v1320 OPTIONAL,
    nonCriticalExtension                UE-EUTRA-Capability-v1330-IEs    OPTIONAL
}
UE-EUTRA-Capability-v1330-IEs ::= SEQUENCE {
    ue-CategoryDL-v1330                INTEGER (18..19)                    OPTIONAL,
    phyLayerParameters-v1330            PhyLayerParameters-v1330            OPTIONAL,
    ue-CE-NeedULGaps-r13                ENUMERATED {true}                  OPTIONAL,
    nonCriticalExtension                UE-EUTRA-Capability-v1340-IEs    OPTIONAL
}
UE-EUTRA-Capability-v1340-IEs ::= SEQUENCE {
    ue-CategoryUL-v1340                INTEGER (15)                        OPTIONAL,
    nonCriticalExtension                UE-EUTRA-Capability-v1350-IEs    OPTIONAL
}
UE-EUTRA-Capability-v1350-IEs ::= SEQUENCE {
    ue-CategoryDL-v1350                ENUMERATED {oneBis}                OPTIONAL,
    ue-CategoryUL-v1350                ENUMERATED {oneBis}                OPTIONAL,
    ce-Parameters-v1350                CE-Parameters-v1350,
    nonCriticalExtension                UE-EUTRA-Capability-v1360-IEs    OPTIONAL
}
UE-EUTRA-Capability-v1360-IEs ::= SEQUENCE {
    other-Parameters-v1360              Other-Parameters-v1360              OPTIONAL,
    nonCriticalExtension                UE-EUTRA-Capability-v1430-IEs    OPTIONAL
}
UE-EUTRA-Capability-v1430-IEs ::= SEQUENCE {
    phyLayerParameters-v1430            PhyLayerParameters-v1430,
    ue-CategoryDL-v1430                ENUMERATED {m2}                    OPTIONAL,
    ue-CategoryUL-v1430                ENUMERATED {n16, n17, n18, n19, n20, m2} OPTIONAL,
    ue-CategoryUL-v1430b                ENUMERATED {n21}                    OPTIONAL,
    mac-Parameters-v1430                MAC-Parameters-v1430                OPTIONAL,
    measParameters-v1430                MeasParameters-v1430                OPTIONAL,
    pdcp-Parameters-v1430              PDCP-Parameters-v1430              OPTIONAL,
    rlc-Parameters-v1430                RLC-Parameters-v1430,
    rf-Parameters-v1430                RF-Parameters-v1430                OPTIONAL,
}

```

```

    laa-Parameters-v1430                LAA-Parameters-v1430                OPTIONAL,
    lwa-Parameters-v1430                LWA-Parameters-v1430                OPTIONAL,
    lwip-Parameters-v1430               LWIP-Parameters-v1430               OPTIONAL,
    otherParameters-v1430               Other-Parameters-v1430,
    mmtel-Parameters-r14                MMTEL-Parameters-r14                OPTIONAL,
    mobilityParameters-r14              MobilityParameters-r14               OPTIONAL,
    ce-Parameters-v1430                 CE-Parameters-v1430,
    fdd-Add-UE-EUTRA-Capabilities-v1430 UE-EUTRA-CapabilityAddXDD-Mode-v1430 OPTIONAL,
    tdd-Add-UE-EUTRA-Capabilities-v1430 UE-EUTRA-CapabilityAddXDD-Mode-v1430 OPTIONAL,
    mbms-Parameters-v1430               MBMS-Parameters-v1430               OPTIONAL,
    sl-Parameters-v1430                 SL-Parameters-v1430                 OPTIONAL,
    ue-BasedNetwPerfMeasParameters-v1430 UE-BasedNetwPerfMeasParameters-v1430 OPTIONAL,
    highSpeedEnhParameters-r14          HighSpeedEnhParameters-r14          OPTIONAL,
    nonCriticalExtension                 UE-EUTRA-Capability-v1440-IEs      OPTIONAL
}

UE-EUTRA-Capability-v1440-IEs ::= SEQUENCE {
    lwa-Parameters-v1440                LWA-Parameters-v1440,
    mac-Parameters-v1440                MAC-Parameters-v1440,
    nonCriticalExtension                 UE-EUTRA-Capability-v1450-IEs      OPTIONAL
}

UE-EUTRA-Capability-v1450-IEs ::= SEQUENCE {
    phyLayerParameters-v1450            PhyLayerParameters-v1450            OPTIONAL,
    rf-Parameters-v1450                 RF-Parameters-v1450                 OPTIONAL,
    otherParameters-v1450               OtherParameters-v1450,
    ue-CategoryDL-v1450                 INTEGER (20)                         OPTIONAL,
    nonCriticalExtension                 UE-EUTRA-Capability-v1460-IEs      OPTIONAL
}

UE-EUTRA-Capability-v1460-IEs ::= SEQUENCE {
    ue-CategoryDL-v1460                 INTEGER (21)                         OPTIONAL,
    otherParameters-v1460               Other-Parameters-v1460,
    nonCriticalExtension                 UE-EUTRA-Capability-v1510-IEs      OPTIONAL
}

UE-EUTRA-Capability-v1510-IEs ::= SEQUENCE {
    irat-ParametersNR-r15               IRAT-ParametersNR-r15               OPTIONAL,
    featureSetsEUTRA-r15                FeatureSetsEUTRA-r15                OPTIONAL,
    pdcp-ParametersNR-r15               PDCP-ParametersNR-r15               OPTIONAL,
    fdd-Add-UE-EUTRA-Capabilities-v1510 UE-EUTRA-CapabilityAddXDD-Mode-v1510 OPTIONAL,
    tdd-Add-UE-EUTRA-Capabilities-v1510 UE-EUTRA-CapabilityAddXDD-Mode-v1510 OPTIONAL,
    nonCriticalExtension                 UE-EUTRA-Capability-v1520-IEs      OPTIONAL
}

UE-EUTRA-Capability-v1520-IEs ::= SEQUENCE {
    measParameters-v1520                 MeasParameters-v1520,
    nonCriticalExtension                 UE-EUTRA-Capability-v1530-IEs      OPTIONAL
}

UE-EUTRA-Capability-v1530-IEs ::= SEQUENCE {
    measParameters-v1530                 MeasParameters-v1530                OPTIONAL,
    otherParameters-v1530               Other-Parameters-v1530               OPTIONAL,
    neighCellSI-AcquisitionParameters-v1530 NeighCellSI-AcquisitionParameters-v1530 OPTIONAL,
    mac-Parameters-v1530                 MAC-Parameters-v1530                OPTIONAL,
    phyLayerParameters-v1530             PhyLayerParameters-v1530             OPTIONAL,
    rf-Parameters-v1530                 RF-Parameters-v1530                 OPTIONAL,
    pdcp-Parameters-v1530               PDCP-Parameters-v1530               OPTIONAL,
    ue-CategoryDL-v1530                 INTEGER (22..26)                     OPTIONAL,
    ue-BasedNetwPerfMeasParameters-v1530 UE-BasedNetwPerfMeasParameters-v1530 OPTIONAL,
    rlc-Parameters-v1530                 RLC-Parameters-v1530                OPTIONAL,
    sl-Parameters-v1530                 SL-Parameters-v1530                 OPTIONAL,
    extendedNumberOfDRBs-r15            ENUMERATED {supported}               OPTIONAL,
    reducedCP-Latency-r15                ENUMERATED {supported}               OPTIONAL,
    laa-Parameters-v1530                 LAA-Parameters-v1530                OPTIONAL,
    ue-CategoryUL-v1530                 INTEGER (22..26)                     OPTIONAL,
    fdd-Add-UE-EUTRA-Capabilities-v1530 UE-EUTRA-CapabilityAddXDD-Mode-v1530 OPTIONAL,
    tdd-Add-UE-EUTRA-Capabilities-v1530 UE-EUTRA-CapabilityAddXDD-Mode-v1530 OPTIONAL,
    nonCriticalExtension                 UE-EUTRA-Capability-v1540-IEs      OPTIONAL
}

UE-EUTRA-Capability-v1540-IEs ::= SEQUENCE {
    phyLayerParameters-v1540             PhyLayerParameters-v1540             OPTIONAL,
    otherParameters-v1540               Other-Parameters-v1540,
    fdd-Add-UE-EUTRA-Capabilities-v1540 UE-EUTRA-CapabilityAddXDD-Mode-v1540 OPTIONAL,
    tdd-Add-UE-EUTRA-Capabilities-v1540 UE-EUTRA-CapabilityAddXDD-Mode-v1540 OPTIONAL,
    sl-Parameters-v1540                 SL-Parameters-v1540                 OPTIONAL,
    irat-ParametersNR-v1540             IRAT-ParametersNR-v1540             OPTIONAL,

```

```

    nonCriticalExtension                UE-EUTRA-Capability-v1550-IEs                OPTIONAL
  }
UE-EUTRA-Capability-v1550-IEs ::= SEQUENCE {
  neighCellSI-AcquisitionParameters-v1550 NeighCellSI-AcquisitionParameters-v1550 OPTIONAL,
  phyLayerParameters-v1550                PhyLayerParameters-v1550,
  mac-Parameters-v1550                    MAC-Parameters-v1550,
  fdd-Add-UE-EUTRA-Capabilities-v1550    UE-EUTRA-CapabilityAddXDD-Mode-v1550,
  tdd-Add-UE-EUTRA-Capabilities-v1550    UE-EUTRA-CapabilityAddXDD-Mode-v1550,
  nonCriticalExtension                    UE-EUTRA-Capability-v1560-IEs                OPTIONAL
}
UE-EUTRA-Capability-v1560-IEs ::= SEQUENCE {
  pdcp-ParametersNR-v1560                PDCP-ParametersNR-v1560,
  irat-ParametersNR-v1560                IRAT-ParametersNR-v1560,
  appliedCapabilityFilterCommon-r15      OCTET STRING                                OPTIONAL,
  fdd-Add-UE-EUTRA-Capabilities-v1560  UE-EUTRA-CapabilityAddXDD-Mode-v1560,
  tdd-Add-UE-EUTRA-Capabilities-v1560  UE-EUTRA-CapabilityAddXDD-Mode-v1560,
  nonCriticalExtension                    UE-EUTRA-Capability-v1570-IEs                OPTIONAL
}
UE-EUTRA-Capability-v1570-IEs ::= SEQUENCE {
  rf-Parameters-v1570                    RF-Parameters-v1570                        OPTIONAL,
  irat-ParametersNR-v1570                IRAT-ParametersNR-v1570                    OPTIONAL,
  nonCriticalExtension                    UE-EUTRA-Capability-v15a0-IEs                OPTIONAL
}
UE-EUTRA-Capability-v15a0-IEs ::= SEQUENCE {
  neighCellSI-AcquisitionParameters-v15a0 NeighCellSI-AcquisitionParameters-v15a0,
  eutra-5GC-Parameters-r15                EUTRA-5GC-Parameters-r15                OPTIONAL,
  fdd-Add-UE-EUTRA-Capabilities-v15a0  UE-EUTRA-CapabilityAddXDD-Mode-v15a0    OPTIONAL,
  tdd-Add-UE-EUTRA-Capabilities-v15a0  UE-EUTRA-CapabilityAddXDD-Mode-v15a0    OPTIONAL,
  nonCriticalExtension                    UE-EUTRA-Capability-v1610-IEs                OPTIONAL
}
UE-EUTRA-Capability-v1610-IEs ::= SEQUENCE {
  highSpeedEnhParameters-v1610          HighSpeedEnhParameters-v1610            OPTIONAL,
  neighCellSI-AcquisitionParameters-v1610 NeighCellSI-AcquisitionParameters-v1610 OPTIONAL,
  mbms-Parameters-v1610                  MBMS-Parameters-v1610                    OPTIONAL,
  pdcp-Parameters-v1610                  PDCP-Parameters-v1610                    OPTIONAL,
  mac-Parameters-v1610                    MAC-Parameters-v1610                      OPTIONAL,
  phyLayerParameters-v1610                PhyLayerParameters-v1610                  OPTIONAL,
  measParameters-v1610                    MeasParameters-v1610                      OPTIONAL,
  pur-Parameters-r16                      PUR-Parameters-r16                        OPTIONAL,
  eutra-5GC-Parameters-v1610              EUTRA-5GC-Parameters-v1610              OPTIONAL,
  otherParameters-v1610                  Other-Parameters-v1610                    OPTIONAL,
  dl-DedicatedMessageSegmentation-r16    ENUMERATED {supported}                    OPTIONAL,
  mmtel-Parameters-v1610                  MMTTEL-Parameters-v1610                  OPTIONAL,
  irat-ParametersNR-v1610                IRAT-ParametersNR-v1610                    OPTIONAL,
  rf-Parameters-v1610                      RF-Parameters-v1610                        OPTIONAL,
  mobilityParameters-v1610                MobilityParameters-v1610                    OPTIONAL,
  ue-BasedNetwPerfMeasParameters-v1610  UE-BasedNetwPerfMeasParameters-v1610    OPTIONAL,
  sl-Parameters-v1610                      SL-Parameters-v1610                        OPTIONAL,
  fdd-Add-UE-EUTRA-Capabilities-v1610  UE-EUTRA-CapabilityAddXDD-Mode-v1610    OPTIONAL,
  tdd-Add-UE-EUTRA-Capabilities-v1610  UE-EUTRA-CapabilityAddXDD-Mode-v1610    OPTIONAL,
  nonCriticalExtension                    UE-EUTRA-Capability-v1630-IEs                OPTIONAL
}
UE-EUTRA-Capability-v1630-IEs ::= SEQUENCE {
  rf-Parameters-v1630                    RF-Parameters-v1630                        OPTIONAL,
  sl-Parameters-v1630                      SL-Parameters-v1630                        OPTIONAL,
  earlySecurityReactivation-r16            ENUMERATED {supported}                    OPTIONAL,
  mac-Parameters-v1630                    MAC-Parameters-v1630                      OPTIONAL,
  measParameters-v1630                    MeasParameters-v1630                      OPTIONAL,
  fdd-Add-UE-EUTRA-Capabilities-v1630  UE-EUTRA-CapabilityAddXDD-Mode-v1630    OPTIONAL,
  tdd-Add-UE-EUTRA-Capabilities-v1630  UE-EUTRA-CapabilityAddXDD-Mode-v1630    OPTIONAL,
  nonCriticalExtension                    UE-EUTRA-Capability-v1650-IEs                OPTIONAL
}
UE-EUTRA-Capability-v1650-IEs ::= SEQUENCE {
  otherParameters-v1650                  Other-Parameters-v1650                    OPTIONAL,
  nonCriticalExtension                    UE-EUTRA-Capability-v1660-IEs                OPTIONAL
}
UE-EUTRA-Capability-v1660-IEs ::= SEQUENCE {
  irat-ParametersNR-v1660                IRAT-ParametersNR-v1660,
  nonCriticalExtension                    UE-EUTRA-Capability-v1690-IEs                OPTIONAL
}

```

```

UE-EUTRA-Capability-v1690-IEs ::= SEQUENCE {
    other-Parameters-v1690          Other-Parameters-v1690,
    nonCriticalExtension             UE-EUTRA-Capability-v1700-IEs          OPTIONAL
}

UE-EUTRA-Capability-v1700-IEs ::= SEQUENCE {
    measParameters-v1700            MeasParameters-v1700          OPTIONAL,
    ue-BasedNetwPerfMeasParameters-v1700 UE-BasedNetwPerfMeasParameters-v1700 OPTIONAL,
    phyLayerParameters-v1700        PhyLayerParameters-v1700,
    ntn-Parameters-r17              NTN-Parameters-r17          OPTIONAL,
    irat-ParametersNR-v1700         IRAT-ParametersNR-v1700      OPTIONAL,
    mbms-Parameters-v1700           MBMS-Parameters-v1700,
    nonCriticalExtension             UE-EUTRA-Capability-v1710-IEs  OPTIONAL
}

UE-EUTRA-Capability-v1710-IEs ::= SEQUENCE {
    irat-ParametersNR-v1710         IRAT-ParametersNR-v1710,
    neighCellSI-AcquisitionParameters-v1710 NeighCellSI-AcquisitionParameters-v1710 OPTIONAL,
    sl-Parameters-v1710            SL-Parameters-v1710          OPTIONAL,
    sidelinkRequested-r17          ENUMERATED {true}          OPTIONAL,
    nonCriticalExtension            UE-EUTRA-Capability-v1720-IEs  OPTIONAL
}

UE-EUTRA-Capability-v1720-IEs ::= SEQUENCE {
    ntn-Parameters-v1720            NTN-Parameters-v1720,
    nonCriticalExtension            UE-EUTRA-Capability-v1730-IEs  OPTIONAL
}

UE-EUTRA-Capability-v1730-IEs ::= SEQUENCE {
    phyLayerParameters-v1730        PhyLayerParameters-v1730,
    nonCriticalExtension            UE-EUTRA-Capability-v1770-IEs  OPTIONAL
}

UE-EUTRA-Capability-v1770-IEs ::= SEQUENCE {
    measParameters-v1770            MeasParameters-v1770,
    nonCriticalExtension            UE-EUTRA-Capability-v1800-IEs  OPTIONAL
}

UE-EUTRA-Capability-v1800-IEs ::= SEQUENCE {
    measParameters-v1800            MeasParameters-v1800          OPTIONAL,
    rf-Parameters-v1800            RF-Parameters-v1800          OPTIONAL,
    ntn-Parameters-v1800           NTN-Parameters-v1800          OPTIONAL,
    -- A2X capabilities
    sl-Parameters-v1800            SL-Parameters-v1800          OPTIONAL,
    son-Parameters-v1800           SON-Parameters-v1800,
    ue-BasedNetwPerfMeasParameters-v1800 UE-BasedNetwPerfMeasParameters-v1800,
    nonCriticalExtension            UE-EUTRA-Capability-v1830-IEs  OPTIONAL
}

UE-EUTRA-Capability-v1830-IEs ::= SEQUENCE {
    ntn-Parameters-v1830           NTN-Parameters-v1830,
    nonCriticalExtension            SEQUENCE {}                  OPTIONAL
}

UE-EUTRA-CapabilityAddXDD-Mode-r9 ::= SEQUENCE {
    phyLayerParameters-r9          PhyLayerParameters          OPTIONAL,
    featureGroupIndicators-r9      BIT STRING (SIZE (32))      OPTIONAL,
    featureGroupIndRel9Add-r9     BIT STRING (SIZE (32))      OPTIONAL,
    interRAT-ParametersGERAN-r9   IRAT-ParametersGERAN        OPTIONAL,
    interRAT-ParametersUTRA-r9    IRAT-ParametersUTRA-v920    OPTIONAL,
    interRAT-ParametersCDMA2000-r9 IRAT-ParametersCDMA2000-1XRTT-v920 OPTIONAL,
    neighCellSI-AcquisitionParameters-r9 NeighCellSI-AcquisitionParameters-r9 OPTIONAL,
    ...
}

UE-EUTRA-CapabilityAddXDD-Mode-v1060 ::= SEQUENCE {
    phyLayerParameters-v1060       PhyLayerParameters-v1020     OPTIONAL,
    featureGroupIndRel10-v1060     BIT STRING (SIZE (32))      OPTIONAL,
    interRAT-ParametersCDMA2000-v1060 IRAT-ParametersCDMA2000-1XRTT-v1020 OPTIONAL,
    interRAT-ParametersUTRA-TDD-v1060 IRAT-ParametersUTRA-TDD-v1020 OPTIONAL,
    ...
    [[ otdoa-PositioningCapabilities-r10 OTDOA-PositioningCapabilities-r10 OPTIONAL
    ]]
}

UE-EUTRA-CapabilityAddXDD-Mode-v1130 ::= SEQUENCE {
    phyLayerParameters-v1130       PhyLayerParameters-v1130     OPTIONAL,

```

```

measParameters-v1130 MeasParameters-v1130 OPTIONAL,
otherParameters-r11 Other-Parameters-r11 OPTIONAL,
...
}
UE-EUTRA-CapabilityAddXDD-Mode-v1180 ::= SEQUENCE {
  mbms-Parameters-r11 MBMS-Parameters-r11
}
UE-EUTRA-CapabilityAddXDD-Mode-v1250 ::= SEQUENCE {
  phyLayerParameters-v1250 PhyLayerParameters-v1250 OPTIONAL,
  measParameters-v1250 MeasParameters-v1250 OPTIONAL
}
UE-EUTRA-CapabilityAddXDD-Mode-v1310 ::= SEQUENCE {
  phyLayerParameters-v1310 PhyLayerParameters-v1310 OPTIONAL
}
UE-EUTRA-CapabilityAddXDD-Mode-v1320 ::= SEQUENCE {
  phyLayerParameters-v1320 PhyLayerParameters-v1320 OPTIONAL,
  sctpm-Parameters-r13 SCPTM-Parameters-r13 OPTIONAL
}
UE-EUTRA-CapabilityAddXDD-Mode-v1370 ::= SEQUENCE {
  ce-Parameters-v1370 CE-Parameters-v1370 OPTIONAL
}
UE-EUTRA-CapabilityAddXDD-Mode-v1380 ::= SEQUENCE {
  ce-Parameters-v1380 CE-Parameters-v1380
}
UE-EUTRA-CapabilityAddXDD-Mode-v1430 ::= SEQUENCE {
  phyLayerParameters-v1430 PhyLayerParameters-v1430 OPTIONAL,
  mmTel-Parameters-r14 MMTEL-Parameters-r14 OPTIONAL
}
UE-EUTRA-CapabilityAddXDD-Mode-v1510 ::= SEQUENCE {
  pdcp-ParametersNR-r15 PDCP-ParametersNR-r15 OPTIONAL
}
UE-EUTRA-CapabilityAddXDD-Mode-v1530 ::= SEQUENCE {
  neighCellSI-AcquisitionParameters-v1530 NeighCellSI-AcquisitionParameters-v1530 OPTIONAL,
  reducedCP-Latency-r15 ENUMERATED {supported} OPTIONAL
}
UE-EUTRA-CapabilityAddXDD-Mode-v1540 ::= SEQUENCE {
  eutra-5GC-Parameters-r15 EUTRA-5GC-Parameters-r15 OPTIONAL,
  irat-ParametersNR-v1540 IRAT-ParametersNR-v1540 OPTIONAL
}
UE-EUTRA-CapabilityAddXDD-Mode-v1550 ::= SEQUENCE {
  neighCellSI-AcquisitionParameters-v1550 NeighCellSI-AcquisitionParameters-v1550 OPTIONAL
}
UE-EUTRA-CapabilityAddXDD-Mode-v1560 ::= SEQUENCE {
  pdcp-ParametersNR-v1560 PDCP-ParametersNR-v1560
}
UE-EUTRA-CapabilityAddXDD-Mode-v15a0 ::= SEQUENCE {
  phyLayerParameters-v1530 PhyLayerParameters-v1530 OPTIONAL,
  phyLayerParameters-v1540 PhyLayerParameters-v1540 OPTIONAL,
  phyLayerParameters-v1550 PhyLayerParameters-v1550 OPTIONAL,
  neighCellSI-AcquisitionParameters-v15a0 NeighCellSI-AcquisitionParameters-v15a0
}
UE-EUTRA-CapabilityAddXDD-Mode-v1610 ::= SEQUENCE {
  phyLayerParameters-v1610 PhyLayerParameters-v1610 OPTIONAL,
  pur-Parameters-r16 PUR-Parameters-r16 OPTIONAL,
  measParameters-v1610 MeasParameters-v1610 OPTIONAL,
  eutra-5GC-Parameters-v1610 EUTRA-5GC-Parameters-v1610 OPTIONAL,
  irat-ParametersNR-v1610 IRAT-ParametersNR-v1610 OPTIONAL,
  neighCellSI-AcquisitionParameters-v1610 NeighCellSI-AcquisitionParameters-v1610 OPTIONAL,
  mobilityParameters-v1610 MobilityParameters-v1610 OPTIONAL
}
UE-EUTRA-CapabilityAddXDD-Mode-v1630 ::= SEQUENCE {
  measParameters-v1630 MeasParameters-v1630
}

```

```

}
AccessStratumRelease ::=          ENUMERATED {
    rel8, rel9, rel10, rel11, rel12, rel13,
    rel14, rel15, ..., rel16, rel17, rel18}

FeatureSetsEUTRA-r15 ::=  SEQUENCE {
    featureSetsDL-r15          SEQUENCE (SIZE (1..maxFeatureSets-r15)) OF FeatureSetDL-r15
    OPTIONAL,
    featureSetsDL-PerCC-r15    SEQUENCE (SIZE (1..maxPerCC-FeatureSets-r15)) OF FeatureSetDL-PerCC-
r15    OPTIONAL,
    featureSetsUL-r15          SEQUENCE (SIZE (1..maxFeatureSets-r15)) OF FeatureSetUL-r15
    OPTIONAL,
    featureSetsUL-PerCC-r15    SEQUENCE (SIZE (1..maxPerCC-FeatureSets-r15)) OF FeatureSetUL-PerCC-
r15    OPTIONAL,
    ...,
    [[ featureSetsDL-v1550      SEQUENCE (SIZE (1..maxFeatureSets-r15)) OF FeatureSetDL-v1550
    OPTIONAL
    ]]
}

MobilityParameters-r14 ::=      SEQUENCE {
    makeBeforeBreak-r14        ENUMERATED {supported}                OPTIONAL,
    rach-Less-r14              ENUMERATED {supported}                OPTIONAL
}

MobilityParameters-v1610 ::=    SEQUENCE {
    cho-r16                    ENUMERATED {supported}                OPTIONAL,
    cho-FDD-TDD-r16           ENUMERATED {supported}                OPTIONAL,
    cho-Failure-r16           ENUMERATED {supported}                OPTIONAL,
    cho-TwoTriggerEvents-r16   ENUMERATED {supported}                OPTIONAL
}

DC-Parameters-r12 ::=          SEQUENCE {
    drb-TypeSplit-r12         ENUMERATED {supported}                OPTIONAL,
    drb-TypeSCG-r12          ENUMERATED {supported}                OPTIONAL
}

DC-Parameters-v1310 ::=        SEQUENCE {
    pdcp-TransferSplitUL-r13   ENUMERATED {supported}                OPTIONAL,
    ue-SSTD-Meas-r13          ENUMERATED {supported}                OPTIONAL
}

MAC-Parameters-r12 ::=         SEQUENCE {
    logicalChannelSR-ProhibitTimer-r12  ENUMERATED {supported}                OPTIONAL,
    longDRX-Command-r12                ENUMERATED {supported}                OPTIONAL
}

MAC-Parameters-v1310 ::=       SEQUENCE {
    extendedMAC-LengthField-r13         ENUMERATED {supported}                OPTIONAL,
    extendedLongDRX-r13                 ENUMERATED {supported}                OPTIONAL
}

MAC-Parameters-v1430 ::=       SEQUENCE {
    shortSPS-IntervalFDD-r14           ENUMERATED {supported}                OPTIONAL,
    shortSPS-IntervalTDD-r14          ENUMERATED {supported}                OPTIONAL,
    skipUplinkDynamic-r14              ENUMERATED {supported}                OPTIONAL,
    skipUplinkSPS-r14                  ENUMERATED {supported}                OPTIONAL,
    multipleUplinkSPS-r14              ENUMERATED {supported}                OPTIONAL,
    dataInactMon-r14                   ENUMERATED {supported}                OPTIONAL
}

MAC-Parameters-v1440 ::=       SEQUENCE {
    rai-Support-r14                    ENUMERATED {supported}                OPTIONAL
}

MAC-Parameters-v1530 ::=       SEQUENCE {
    min-Proc-TimelineSubslot-r15       SEQUENCE (SIZE(1..3)) OF ProcessingTimelineSet-r15  OPTIONAL,
    skipSubframeProcessing-r15         SkipSubframeProcessing-r15                OPTIONAL,
    earlyData-UP-r15                   ENUMERATED {supported}                OPTIONAL,
    dormantSCellState-r15              ENUMERATED {supported}                OPTIONAL,
    directSCellActivation-r15          ENUMERATED {supported}                OPTIONAL,
    directSCellHibernation-r15         ENUMERATED {supported}                OPTIONAL,
    extendedLCID-Duplication-r15       ENUMERATED {supported}                OPTIONAL,
    sps-ServingCell-r15                ENUMERATED {supported}                OPTIONAL
}

```

```

MAC-Parameters-v1550 ::= SEQUENCE {
    eLCID-Support-r15      ENUMERATED {supported}      OPTIONAL
}

MAC-Parameters-v1610 ::= SEQUENCE {
    directMCG-SCellActivationResume-r16  ENUMERATED {supported}      OPTIONAL,
    directSCG-SCellActivationResume-r16  ENUMERATED {supported}      OPTIONAL,
    earlyData-UP-5GC-r16                 ENUMERATED {supported}      OPTIONAL,
    rai-SupportEnh-r16                   ENUMERATED {supported}      OPTIONAL
}

MAC-Parameters-v1630 ::= SEQUENCE {
    directSCG-SCellActivationNEDC-r16    ENUMERATED {supported}      OPTIONAL
}

NTN-Parameters-r17 ::= SEQUENCE {
    ntn-Connectivity-EPC-r17             ENUMERATED {supported}      OPTIONAL,
    ntn-TA-Report-r17                   ENUMERATED {supported}      OPTIONAL,
    ntn-PUR-TimerDelay-r17               ENUMERATED {supported}      OPTIONAL,
    ntn-OffsetTimingEnh-r17              ENUMERATED {supported}      OPTIONAL,
    ntn-ScenarioSupport-r17              ENUMERATED {ngso,gso}      OPTIONAL
}

NTN-Parameters-v1720 ::= SEQUENCE {
    ntn-SegmentedPrecompensationGaps-r17  ENUMERATED {sym1,s11,sf1}  OPTIONAL
}

NTN-Parameters-v1800 ::= SEQUENCE {
    ntn-EventA4BasedCHO-r18              ENUMERATED {supported}      OPTIONAL,
    ntn-LocationBasedCHO-EFC-r18         ENUMERATED {supported}      OPTIONAL,
    ntn-LocationBasedCHO-EMC-r18         ENUMERATED {supported}      OPTIONAL,
    ntn-TimeBasedCHO-r18                 ENUMERATED {supported}      OPTIONAL,
    eventD1-MeasReportTrigger-r18        ENUMERATED {supported}      OPTIONAL,
    eventD2-MeasReportTrigger-r18        ENUMERATED {supported}      OPTIONAL,
    ntn-LocationBasedMeasTrigger-EFC-r18  ENUMERATED {supported}      OPTIONAL,
    ntn-LocationBasedMeasTrigger-EMC-r18  ENUMERATED {supported}      OPTIONAL,
    ntn-TimeBasedMeasTrigger-r18         ENUMERATED {supported}      OPTIONAL,
    ntn-RRC-HarqDisableSingleTB-CE-ModeA-r18  ENUMERATED {supported}      OPTIONAL,
    ntn-RRC-HarqDisableMultiTB-CE-ModeA-r18  ENUMERATED {supported}      OPTIONAL,
    ntn-RRC-HarqDisableSingleTB-CE-ModeB-r18  ENUMERATED {supported}      OPTIONAL,
    ntn-OverriddenHarqDisableSingleTB-CE-ModeB-r18  ENUMERATED {supported}      OPTIONAL,
    ntn-DCI-HarqDisableSingleTB-CE-ModeB-r18  ENUMERATED {supported}      OPTIONAL,
    ntn-RRC-HarqDisableMultiTB-CE-ModeB-r18  ENUMERATED {supported}      OPTIONAL,
    ntn-OverriddenHarqDisableMultiTB-CE-ModeB-r18  ENUMERATED {supported}      OPTIONAL,
    ntn-DCI-HarqDisableMultiTB-CE-ModeB-r18  ENUMERATED {supported}      OPTIONAL,
    ntn-SemiStaticHarqDisableSPS-r18      ENUMERATED {supported}      OPTIONAL,
    ntn-UplinkHarq-ModeB-SingleTB-r18     ENUMERATED {supported}      OPTIONAL,
    ntn-UplinkHarq-ModeB-MultiTB-r18     ENUMERATED {supported}      OPTIONAL,
    ntn-HarqEnhScenarioSupport-r18        ENUMERATED {ngso,gso}      OPTIONAL,
    ntn-Triggered-GNSS-Fix-r18           ENUMERATED {supported}      OPTIONAL,
    ntn-Autonomous-GNSS-Fix-r18          ENUMERATED {supported}      OPTIONAL,
    ntn-UplinkTxExtension-r18            ENUMERATED {supported}      OPTIONAL,
    ntn-GNSS-EnhScenarioSupport-r18       ENUMERATED {ngso,gso}      OPTIONAL
}

NTN-Parameters-v1830 ::= SEQUENCE {
    satelliteInfoConfigDedicated-r18      ENUMERATED {supported}      OPTIONAL
}

ProcessingTimelineSet-r15 ::= ENUMERATED {set1, set2}

RLC-Parameters-r12 ::= SEQUENCE {
    extended-RLC-LI-Field-r12             ENUMERATED {supported}
}

RLC-Parameters-v1310 ::= SEQUENCE {
    extendedRLC-SN-SO-Field-r13           ENUMERATED {supported}      OPTIONAL
}

RLC-Parameters-v1430 ::= SEQUENCE {
    extendedPollByte-r14                  ENUMERATED {supported}      OPTIONAL
}

RLC-Parameters-v1530 ::= SEQUENCE {
    flexibleUM-AM-Combinations-r15        ENUMERATED {supported}      OPTIONAL,
    rlc-AM-Ooo-Delivery-r15               ENUMERATED {supported}      OPTIONAL,
    rlc-UM-Ooo-Delivery-r15               ENUMERATED {supported}      OPTIONAL
}

```

```

PDCP-Parameters ::= SEQUENCE {
    supportedROHC-Profiles ROHC-ProfileSupportList-r15,
    maxNumberROHC-ContextSessions ENUMERATED {
        cs2, cs4, cs8, cs12, cs16, cs24, cs32,
        cs48, cs64, cs128, cs256, cs512, cs1024,
        cs16384, spare2, spare1} DEFAULT cs16,
    ...
}

PDCP-Parameters-v1130 ::= SEQUENCE {
    pdcp-SN-Extension-r11 ENUMERATED {supported} OPTIONAL,
    supportRohcContextContinue-r11 ENUMERATED {supported} OPTIONAL
}

PDCP-Parameters-v1310 ::= SEQUENCE {
    pdcp-SN-Extension-18bits-r13 ENUMERATED {supported} OPTIONAL
}

PDCP-Parameters-v1430 ::= SEQUENCE {
    supportedUplinkOnlyROHC-Profiles-r14 SEQUENCE {
        profile0x0006-r14 BOOLEAN
    },
    maxNumberROHC-ContextSessions-r14 ENUMERATED {
        cs2, cs4, cs8, cs12, cs16, cs24, cs32,
        cs48, cs64, cs128, cs256, cs512, cs1024,
        cs16384, spare2, spare1} DEFAULT cs16
}

PDCP-Parameters-v1530 ::= SEQUENCE {
    supportedUDC-r15 SupportedUDC-r15 OPTIONAL,
    pdcp-Duplication-r15 ENUMERATED {supported} OPTIONAL
}

PDCP-Parameters-v1610 ::= SEQUENCE {
    pdcp-VersionChangeWithoutHO-r16 ENUMERATED {supported} OPTIONAL,
    ehc-r16 ENUMERATED {supported} OPTIONAL,
    continueEHC-Context-r16 ENUMERATED {supported} OPTIONAL,
    maxNumberEHC-Contexts-r16 ENUMERATED {cs2, cs4, cs8, cs16, cs32, cs64, cs128, cs256,
        cs512, cs1024, cs2048, cs4096, cs8192, cs16384,
        cs32768, cs65536} OPTIONAL,
    jointEHC-ROHC-Config-r16 ENUMERATED {supported} OPTIONAL
}

SupportedUDC-r15 ::= SEQUENCE {
    supportedStandardDic-r15 ENUMERATED {supported} OPTIONAL,
    supportedOperatorDic-r15 SupportedOperatorDic-r15 OPTIONAL
}

SupportedOperatorDic-r15 ::= SEQUENCE {
    versionOfDictionary-r15 INTEGER (0..15),
    associatedPLMN-ID-r15 PLMN-Identity
}

PhyLayerParameters ::= SEQUENCE {
    ue-TxAntennaSelectionSupported BOOLEAN,
    ue-SpecificRefSigsSupported BOOLEAN
}

PhyLayerParameters-v920 ::= SEQUENCE {
    enhancedDualLayerFDD-r9 ENUMERATED {supported} OPTIONAL,
    enhancedDualLayerTDD-r9 ENUMERATED {supported} OPTIONAL
}

PhyLayerParameters-v9d0 ::= SEQUENCE {
    tm5-FDD-r9 ENUMERATED {supported} OPTIONAL,
    tm5-TDD-r9 ENUMERATED {supported} OPTIONAL
}

PhyLayerParameters-v1020 ::= SEQUENCE {
    twoAntennaPortsForPUCCH-r10 ENUMERATED {supported} OPTIONAL,
    tm9-With-8Tx-FDD-r10 ENUMERATED {supported} OPTIONAL,
    pmi-Disabling-r10 ENUMERATED {supported} OPTIONAL,
    crossCarrierScheduling-r10 ENUMERATED {supported} OPTIONAL,
    simultaneousPUCCH-PUSCH-r10 ENUMERATED {supported} OPTIONAL,
    multiClusterPUSCH-WithinCC-r10 ENUMERATED {supported} OPTIONAL,
    nonContiguousUL-RA-WithinCC-List-r10 NonContiguousUL-RA-WithinCC-List-r10 OPTIONAL
}

```



PhyLayerParameters-v1130 ::=	SEQUENCE {		
crs-InterfHandl-r11	ENUMERATED {supported}		OPTIONAL,
ePDCCH-r11	ENUMERATED {supported}		OPTIONAL,
multiACK-CSI-Reporting-r11	ENUMERATED {supported}		OPTIONAL,
ss-CCH-InterfHandl-r11	ENUMERATED {supported}		OPTIONAL,
tdd-SpecialSubframe-r11	ENUMERATED {supported}		OPTIONAL,
txDiv-PUCCH1b-ChSelect-r11	ENUMERATED {supported}		OPTIONAL,
ul-CoMP-r11	ENUMERATED {supported}		OPTIONAL
}			
PhyLayerParameters-v1170 ::=	SEQUENCE {		
interBandTDD-CA-WithDifferentConfig-r11	BIT STRING (SIZE (2))		OPTIONAL
}			
PhyLayerParameters-v1250 ::=	SEQUENCE {		
e-HARQ-Pattern-FDD-r12	ENUMERATED {supported}		OPTIONAL,
enhanced-4TxCodebook-r12	ENUMERATED {supported}		OPTIONAL,
tdd-FDD-CA-PCellDuplex-r12	BIT STRING (SIZE (2))		OPTIONAL,
phy-TDD-ReConfig-TDD-PCell-r12	ENUMERATED {supported}		OPTIONAL,
phy-TDD-ReConfig-FDD-PCell-r12	ENUMERATED {supported}		OPTIONAL,
pusch-FeedbackMode-r12	ENUMERATED {supported}		OPTIONAL,
pusch-SRS-PowerControl-SubframeSet-r12	ENUMERATED {supported}		OPTIONAL,
csi-SubframeSet-r12	ENUMERATED {supported}		OPTIONAL,
noResourceRestrictionForTTIBundling-r12	ENUMERATED {supported}		OPTIONAL,
discoverySignalsInDeactSCell-r12	ENUMERATED {supported}		OPTIONAL,
naics-Capability-List-r12	NAICS-Capability-List-r12		OPTIONAL
}			
PhyLayerParameters-v1280 ::=	SEQUENCE {		
alternativeTBS-Indices-r12	ENUMERATED {supported}		OPTIONAL
}			
PhyLayerParameters-v1310 ::=	SEQUENCE {		
aperiodicCSI-Reporting-r13	BIT STRING (SIZE (2))		OPTIONAL,
codebook-HARQ-ACK-r13	BIT STRING (SIZE (2))		OPTIONAL,
crossCarrierScheduling-B5C-r13	ENUMERATED {supported}		OPTIONAL,
fdd-HARQ-TimingTDD-r13	ENUMERATED {supported}		OPTIONAL,
maxNumberUpdatedCSI-Proc-r13	INTEGER (5..32)		OPTIONAL,
pucch-Format4-r13	ENUMERATED {supported}		OPTIONAL,
pucch-Format5-r13	ENUMERATED {supported}		OPTIONAL,
pucch-SCell-r13	ENUMERATED {supported}		OPTIONAL,
spatialBundling-HARQ-ACK-r13	ENUMERATED {supported}		OPTIONAL,
supportedBlindDecoding-r13	SEQUENCE {		
maxNumberDecoding-r13	INTEGER (1..32)		OPTIONAL,
pdccch-CandidateReductions-r13	ENUMERATED {supported}		OPTIONAL,
skipMonitoringDCI-Format0-1A-r13	ENUMERATED {supported}		OPTIONAL,
}			OPTIONAL,
uci-PUSCH-Ext-r13	ENUMERATED {supported}		OPTIONAL,
crs-InterfMitigationTM10-r13	ENUMERATED {supported}		OPTIONAL,
pdsch-CollisionHandling-r13	ENUMERATED {supported}		OPTIONAL
}			
PhyLayerParameters-v1320 ::=	SEQUENCE {		
mimo-UE-Parameters-r13	MIMO-UE-Parameters-r13		OPTIONAL
}			
PhyLayerParameters-v1330 ::=	SEQUENCE {		
cch-InterfMitigation-RefRecTypeA-r13	ENUMERATED {supported}		OPTIONAL,
cch-InterfMitigation-RefRecTypeB-r13	ENUMERATED {supported}		OPTIONAL,
cch-InterfMitigation-MaxNumCCs-r13	INTEGER (1.. maxServCell-r13)		OPTIONAL,
crs-InterfMitigationTM1toTM9-r13	INTEGER (1.. maxServCell-r13)		OPTIONAL
}			
PhyLayerParameters-v13e0 ::=	SEQUENCE {		
mimo-UE-Parameters-v13e0	MIMO-UE-Parameters-v13e0		
}			
PhyLayerParameters-v1430 ::=	SEQUENCE {		
ce-PUSCH-NB-MaxTBS-r14	ENUMERATED {supported}		OPTIONAL,
ce-PDSCH-PUSCH-MaxBandwidth-r14	ENUMERATED {bw5, bw20}		OPTIONAL,
ce-HARQ-AckBundling-r14	ENUMERATED {supported}		OPTIONAL,
ce-PDSCH-TenProcesses-r14	ENUMERATED {supported}		OPTIONAL,
ce-RetuningSymbols-r14	ENUMERATED {n0, n1}		OPTIONAL,
ce-PDSCH-PUSCH-Enhancement-r14	ENUMERATED {supported}		OPTIONAL,
ce-SchedulingEnhancement-r14	ENUMERATED {supported}		OPTIONAL,
ce-SRS-Enhancement-r14	ENUMERATED {supported}		OPTIONAL,
ce-PUCCH-Enhancement-r14	ENUMERATED {supported}		OPTIONAL,

ce-ClosedLoopTxAntennaSelection-r14	ENUMERATED {supported}	OPTIONAL,
tdd-SpecialSubframe-r14	ENUMERATED {supported}	OPTIONAL,
tdd-TTI-Bundling-r14	ENUMERATED {supported}	OPTIONAL,
dmrs-LessUpPTS-r14	ENUMERATED {supported}	OPTIONAL,
mimo-UE-Parameters-v1430	MIMO-UE-Parameters-v1430	OPTIONAL,
alternativeTBS-Index-r14	ENUMERATED {supported}	OPTIONAL,
feMBMS-Unicast-Parameters-r14	FeMBMS-Unicast-Parameters-r14	OPTIONAL
}		
PhyLayerParameters-v1450 ::=	SEQUENCE {	
ce-SRS-EnhancementWithoutComb4-r14	ENUMERATED {supported}	OPTIONAL,
crs-LessDwPTS-r14	ENUMERATED {supported}	OPTIONAL}
PhyLayerParameters-v1470 ::=	SEQUENCE {	
mimo-UE-Parameters-v1470	MIMO-UE-Parameters-v1470	OPTIONAL,
srs-UpPTS-6sym-r14	ENUMERATED {supported}	OPTIONAL
}		
PhyLayerParameters-v14a0 ::=	SEQUENCE {	
sspl0-TDD-Only-r14	ENUMERATED {supported}	OPTIONAL
}		
PhyLayerParameters-v1530 ::=	SEQUENCE {	
stti-SPT-Capabilities-r15	SEQUENCE {	
aperiodicCsi-ReportingSTTI-r15	ENUMERATED {supported}	OPTIONAL,
dmrs-BasedSPDCCH-MBSFN-r15	ENUMERATED {supported}	OPTIONAL,
dmrs-BasedSPDCCH-nonMBSFN-r15	ENUMERATED {supported}	OPTIONAL,
dmrs-PositionPattern-r15	ENUMERATED {supported}	OPTIONAL,
dmrs-SharingSubslotPDSCH-r15	ENUMERATED {supported}	OPTIONAL,
dmrs-RepetitionSubslotPDSCH-r15	ENUMERATED {supported}	OPTIONAL,
epdcch-SPT-differentCells-r15	ENUMERATED {supported}	OPTIONAL,
epdcch-STTI-differentCells-r15	ENUMERATED {supported}	OPTIONAL,
maxLayersSlotOrSubslotPUSCH-r15	ENUMERATED {oneLayer, twoLayers, fourLayers}	
OPTIONAL,		
maxNumberUpdatedCSI-Proc-SPT-r15	INTEGER(5..32)	OPTIONAL,
maxNumberUpdatedCSI-Proc-STTI-Comb77-r15	INTEGER(1..32)	OPTIONAL,
maxNumberUpdatedCSI-Proc-STTI-Comb27-r15	INTEGER(1..32)	OPTIONAL,
maxNumberUpdatedCSI-Proc-STTI-Comb22-Set1-r15	INTEGER(1..32)	OPTIONAL,
maxNumberUpdatedCSI-Proc-STTI-Comb22-Set2-r15	INTEGER(1..32)	OPTIONAL,
mimo-UE-ParametersSTTI-r15	MIMO-UE-Parameters-r13	OPTIONAL,
mimo-UE-ParametersSTTI-v1530	MIMO-UE-Parameters-v1430	OPTIONAL,
numberOfBlindDecodesUSS-r15	INTEGER(4..32)	OPTIONAL,
pdsch-SlotSubslotPDSCH-Decoding-r15	ENUMERATED {supported}	OPTIONAL,
powerUCI-SlotPUSCH	ENUMERATED {supported}	OPTIONAL,
powerUCI-SubslotPUSCH	ENUMERATED {supported}	OPTIONAL,
slotPDSCH-TxDiv-TM9and10	ENUMERATED {supported}	OPTIONAL,
subslotPDSCH-TxDiv-TM9and10	ENUMERATED {supported}	OPTIONAL,
spdcch-differentRS-types-r15	ENUMERATED {supported}	OPTIONAL,
srs-DCI7-TriggeringFS2-r15	ENUMERATED {supported}	OPTIONAL,
sps-cyclicShift-r15	ENUMERATED {supported}	OPTIONAL,
spdcch-Reuse-r15	ENUMERATED {supported}	OPTIONAL,
sps-STTI-r15	ENUMERATED {slot, subslot, slotAndSubslot}	
OPTIONAL,		
tm8-slotPDSCH-r15	ENUMERATED {supported}	OPTIONAL,
tm9-slotSubslot-r15	ENUMERATED {supported}	OPTIONAL,
tm9-slotSubslotMBSFN-r15	ENUMERATED {supported}	OPTIONAL,
tm10-slotSubslot-r15	ENUMERATED {supported}	OPTIONAL,
tm10-slotSubslotMBSFN-r15	ENUMERATED {supported}	OPTIONAL,
txDiv-SPUCCH-r15	ENUMERATED {supported}	OPTIONAL,
ul-AsyncHarqSharingDiff-TTI-Lengths-r15	ENUMERATED {supported}	OPTIONAL,
}		
ce-Capabilities-r15	SEQUENCE {	
ce-CRS-IntfMitig-r15	ENUMERATED {supported}	OPTIONAL,
ce-CQI-AlternativeTable-r15	ENUMERATED {supported}	OPTIONAL,
ce-PDSCH-FlexibleStartPRB-CE-ModeA-r15	ENUMERATED {supported}	OPTIONAL,
ce-PDSCH-FlexibleStartPRB-CE-ModeB-r15	ENUMERATED {supported}	OPTIONAL,
ce-PDSCH-64QAM-r15	ENUMERATED {supported}	OPTIONAL,
ce-PUSCH-FlexibleStartPRB-CE-ModeA-r15	ENUMERATED {supported}	OPTIONAL,
ce-PUSCH-FlexibleStartPRB-CE-ModeB-r15	ENUMERATED {supported}	OPTIONAL,
ce-PUSCH-SubPRB-Allocation-r15	ENUMERATED {supported}	OPTIONAL,
ce-UL-HARQ-ACK-Feedback-r15	ENUMERATED {supported}	OPTIONAL
OPTIONAL,		
shortCQI-ForSCellActivation-r15	ENUMERATED {supported}	OPTIONAL,
mimo-CBSR-AdvancedCSI-r15	ENUMERATED {supported}	OPTIONAL,
crs-IntfMitig-r15	ENUMERATED {supported}	OPTIONAL,
ul-PowerControlEnhancements-r15	ENUMERATED {supported}	OPTIONAL,
urllc-Capabilities-r15	SEQUENCE {	
pdsch-RepSubframe-r15	ENUMERATED {supported}	OPTIONAL,

```

    pdsch-RepSlot-r15                ENUMERATED {supported}    OPTIONAL,
    pdsch-RepSubslot-r15             ENUMERATED {supported}    OPTIONAL,
    pusch-SPS-MultiConfigSubframe-r15 INTEGER (0..6)           OPTIONAL,
    pusch-SPS-MaxConfigSubframe-r15  INTEGER (0..31)          OPTIONAL,
    pusch-SPS-MultiConfigSlot-r15    INTEGER (0..6)           OPTIONAL,
    pusch-SPS-MaxConfigSlot-r15      INTEGER (0..31)          OPTIONAL,
    pusch-SPS-MultiConfigSubslot-r15 INTEGER (0..6)           OPTIONAL,
    pusch-SPS-MaxConfigSubslot-r15   INTEGER (0..31)          OPTIONAL,
    pusch-SPS-SlotRepPCell-r15       ENUMERATED {supported}    OPTIONAL,
    pusch-SPS-SlotRepPSCell-r15      ENUMERATED {supported}    OPTIONAL,
    pusch-SPS-SlotRepSCell-r15       ENUMERATED {supported}    OPTIONAL,
    pusch-SPS-SubframeRepPCell-r15   ENUMERATED {supported}    OPTIONAL,
    pusch-SPS-SubframeRepPSCell-r15  ENUMERATED {supported}    OPTIONAL,
    pusch-SPS-SubframeRepSCell-r15   ENUMERATED {supported}    OPTIONAL,
    pusch-SPS-SubslotRepPCell-r15    ENUMERATED {supported}    OPTIONAL,
    pusch-SPS-SubslotRepPSCell-r15   ENUMERATED {supported}    OPTIONAL,
    pusch-SPS-SubslotRepSCell-r15    ENUMERATED {supported}    OPTIONAL,
    semiStaticCFI-r15                ENUMERATED {supported}    OPTIONAL,
    semiStaticCFI-Pattern-r15        ENUMERATED {supported}    OPTIONAL
  } OPTIONAL,
  altMCS-Table-r15                   ENUMERATED {supported}    OPTIONAL
}

PhyLayerParameters-v1540 ::= SEQUENCE {
  stti-SPT-Capabilities-v1540        SEQUENCE {
    slotPDSCH-TxDiv-TM8-r15          ENUMERATED {supported}    OPTIONAL,
  }
  crs-IM-TM1-toTM9-OneRX-Port-v1540  ENUMERATED {supported}    OPTIONAL,
  cch-IM-RefRecTypeA-OneRX-Port-v1540 ENUMERATED {supported}    OPTIONAL
}

PhyLayerParameters-v1550 ::= SEQUENCE {
  dmrs-OverheadReduction-r15        ENUMERATED {supported}    OPTIONAL
}

PhyLayerParameters-v1610 ::= SEQUENCE {
  ce-Capabilities-v1610             SEQUENCE {
    ce-CSI-RS-Feedback-r16           ENUMERATED {supported}    OPTIONAL,
    ce-CSI-RS-FeedbackCodebookRestriction-r16 ENUMERATED {supported}    OPTIONAL,
    crs-ChEstMPDCCH-CE-ModeA-r16     ENUMERATED {supported}    OPTIONAL,
    crs-ChEstMPDCCH-CE-ModeB-r16     ENUMERATED {supported}    OPTIONAL,
    crs-ChEstMPDCCH-CSI-r16          ENUMERATED {supported}    OPTIONAL,
    crs-ChEstMPDCCH-ReciprocityTDD-r16 ENUMERATED {supported}    OPTIONAL,
    etws-CMAS-RxInConnCE-ModeA-r16   ENUMERATED {supported}    OPTIONAL,
    etws-CMAS-RxInConnCE-ModeB-r16   ENUMERATED {supported}    OPTIONAL,
    mpdcch-InLteControlRegionCE-ModeA-r16 ENUMERATED {supported}    OPTIONAL,
    mpdcch-InLteControlRegionCE-ModeB-r16 ENUMERATED {supported}    OPTIONAL,
    pdsch-InLteControlRegionCE-ModeA-r16 ENUMERATED {supported}    OPTIONAL,
    pdsch-InLteControlRegionCE-ModeB-r16 ENUMERATED {supported}    OPTIONAL,
    multiTB-Parameters-r16           CE-MultiTB-Parameters-r16  OPTIONAL,
    resourceResvParameters-r16       CE-ResourceResvParameters-r16  OPTIONAL
  } OPTIONAL,
  widebandPRG-Slot-r16               ENUMERATED {supported}    OPTIONAL,
  widebandPRG-Subslot-r16            ENUMERATED {supported}    OPTIONAL,
  widebandPRG-Subframe-r16           ENUMERATED {supported}    OPTIONAL,
  addSRS-r16                         SEQUENCE {
    addSRS-FrequencyHopping-r16      ENUMERATED {supported}    OPTIONAL,
    addSRS-AntennaSwitching-r16     ENUMERATED {useBasic}     OPTIONAL,
    addSRS-CarrierSwitching-r16     ENUMERATED {supported}    OPTIONAL
  } OPTIONAL,
  virtualCellID-BasicSRS-r16         ENUMERATED {supported}    OPTIONAL,
  virtualCellID-AddSRS-r16          ENUMERATED {supported}    OPTIONAL
}

PhyLayerParameters-v1700 ::= SEQUENCE {
  ce-Capabilities-v1700             SEQUENCE {
    ce-PDSCH-14HARQProcesses-r17     ENUMERATED {supported}    OPTIONAL,
    ce-PDSCH-14HARQProcesses-Alt2-r17 ENUMERATED {supported}    OPTIONAL,
    ce-PDSCH-MaxTBS-r17              ENUMERATED {supported}    OPTIONAL
  } OPTIONAL
}

PhyLayerParameters-v1730 ::= SEQUENCE {
  csi-SubframeSet2ForDormantSCell-r17 ENUMERATED {supported}    OPTIONAL
}

MIMO-UE-Parameters-r13 ::= SEQUENCE {
  parametersTM9-r13                 MIMO-UE-ParametersPerTM-r13  OPTIONAL,

```

parametersTM10-r13	MIMO-UE-ParametersPerTM-r13	OPTIONAL,
srs-EnhancementsTDD-r13	ENUMERATED {supported}	OPTIONAL,
srs-Enhancements-r13	ENUMERATED {supported}	OPTIONAL,
interferenceMeasRestriction-r13	ENUMERATED {supported}	OPTIONAL
}		
MIMO-UE-Parameters-v13e0 ::=	SEQUENCE {	
mimo-WeightedLayersCapabilities-r13	MIMO-WeightedLayersCapabilities-r13	OPTIONAL
}		
MIMO-UE-Parameters-v1430 ::=	SEQUENCE {	
parametersTM9-v1430	MIMO-UE-ParametersPerTM-v1430	OPTIONAL,
parametersTM10-v1430	MIMO-UE-ParametersPerTM-v1430	OPTIONAL
}		
MIMO-UE-Parameters-v1470 ::=	SEQUENCE {	
parametersTM9-v1470	MIMO-UE-ParametersPerTM-v1470,	
parametersTM10-v1470	MIMO-UE-ParametersPerTM-v1470	
}		
MIMO-UE-ParametersPerTM-r13 ::=	SEQUENCE {	
nonPrecoded-r13	MIMO-NonPrecodedCapabilities-r13	OPTIONAL,
beamformed-r13	MIMO-UE-BeamformedCapabilities-r13	OPTIONAL,
channelMeasRestriction-r13	ENUMERATED {supported}	OPTIONAL,
dmrs-Enhancements-r13	ENUMERATED {supported}	OPTIONAL,
csi-RS-EnhancementsTDD-r13	ENUMERATED {supported}	OPTIONAL
}		
MIMO-UE-ParametersPerTM-v1430 ::=	SEQUENCE {	
nzp-CSI-RS-AperiodicInfo-r14	SEQUENCE {	
nMaxProc-r14	INTEGER(5..32),	
nMaxResource-r14	ENUMERATED {n1, n2, n4, n8}	
}		OPTIONAL,
nzp-CSI-RS-PeriodicInfo-r14	SEQUENCE {	
nMaxResource-r14	ENUMERATED {n1, n2, n4, n8}	
}		OPTIONAL,
zp-CSI-RS-AperiodicInfo-r14	ENUMERATED {supported}	OPTIONAL,
ul-dmrs-Enhancements-r14	ENUMERATED {supported}	OPTIONAL,
densityReductionNP-r14	ENUMERATED {supported}	OPTIONAL,
densityReductionBF-r14	ENUMERATED {supported}	OPTIONAL,
hybridCSI-r14	ENUMERATED {supported}	OPTIONAL,
semiOL-r14	ENUMERATED {supported}	OPTIONAL,
csi-ReportingNP-r14	ENUMERATED {supported}	OPTIONAL,
csi-ReportingAdvanced-r14	ENUMERATED {supported}	OPTIONAL
}		
MIMO-UE-ParametersPerTM-v1470 ::=	SEQUENCE {	
csi-ReportingAdvancedMaxPorts-r14	ENUMERATED {n8, n12, n16, n20, n24, n28}	OPTIONAL
}		
MIMO-CA-ParametersPerBoBC-r13 ::=	SEQUENCE {	
parametersTM9-r13	MIMO-CA-ParametersPerBoBCPerTM-r13	OPTIONAL,
parametersTM10-r13	MIMO-CA-ParametersPerBoBCPerTM-r13	OPTIONAL
}		
MIMO-CA-ParametersPerBoBC-r15 ::=	SEQUENCE {	
parametersTM9-r15	MIMO-CA-ParametersPerBoBCPerTM-r15	OPTIONAL,
parametersTM10-r15	MIMO-CA-ParametersPerBoBCPerTM-r15	OPTIONAL
}		
MIMO-CA-ParametersPerBoBC-v1430 ::=	SEQUENCE {	
parametersTM9-v1430	MIMO-CA-ParametersPerBoBCPerTM-v1430	OPTIONAL,
parametersTM10-v1430	MIMO-CA-ParametersPerBoBCPerTM-v1430	OPTIONAL
}		
MIMO-CA-ParametersPerBoBC-v1470 ::=	SEQUENCE {	
parametersTM9-v1470	MIMO-CA-ParametersPerBoBCPerTM-v1470,	
parametersTM10-v1470	MIMO-CA-ParametersPerBoBCPerTM-v1470	
}		
MIMO-CA-ParametersPerBoBCPerTM-r13 ::=	SEQUENCE {	
nonPrecoded-r13	MIMO-NonPrecodedCapabilities-r13	OPTIONAL,
beamformed-r13	MIMO-BeamformedCapabilityList-r13	OPTIONAL,
dmrs-Enhancements-r13	ENUMERATED {different}	OPTIONAL
}		
MIMO-CA-ParametersPerBoBCPerTM-v1430 ::=	SEQUENCE {	
csi-ReportingNP-r14	ENUMERATED {different}	OPTIONAL,

```

    csi-ReportingAdvanced-r14          ENUMERATED {different}          OPTIONAL
  }
MIMO-CA-ParametersPerBoBCPerTM-v1470 ::= SEQUENCE {
    csi-ReportingAdvancedMaxPorts-r14  ENUMERATED {n8, n12, n16, n20, n24, n28}  OPTIONAL
}
MIMO-CA-ParametersPerBoBCPerTM-r15 ::= SEQUENCE {
    nonPrecoded-r13                    MIMO-NonPrecodedCapabilities-r13  OPTIONAL,
    beamformed-r13                     MIMO-BeamformedCapabilityList-r13  OPTIONAL,
    dmrs-Enhancements-r13              ENUMERATED {different}            OPTIONAL,
    csi-ReportingNP-r14                 ENUMERATED {different}            OPTIONAL,
    csi-ReportingAdvanced-r14           ENUMERATED {different}            OPTIONAL
}
MIMO-NonPrecodedCapabilities-r13 ::= SEQUENCE {
    config1-r13                         ENUMERATED {supported}            OPTIONAL,
    config2-r13                         ENUMERATED {supported}            OPTIONAL,
    config3-r13                         ENUMERATED {supported}            OPTIONAL,
    config4-r13                         ENUMERATED {supported}            OPTIONAL
}
MIMO-UE-BeamformedCapabilities-r13 ::= SEQUENCE {
    altCodebook-r13                     ENUMERATED {supported}            OPTIONAL,
    mimo-BeamformedCapabilities-r13     MIMO-BeamformedCapabilityList-r13
}
MIMO-BeamformedCapabilityList-r13 ::= SEQUENCE (SIZE (1..maxCSI-Proc-r11)) OF MIMO-
BeamformedCapabilities-r13
MIMO-BeamformedCapabilities-r13 ::= SEQUENCE {
    k-Max-r13                           INTEGER (1..8),
    n-MaxList-r13                        BIT STRING (SIZE (1..7))          OPTIONAL
}
MIMO-WeightedLayersCapabilities-r13 ::= SEQUENCE {
    relWeightTwoLayers-r13  ENUMERATED {v1, v1dot25, v1dot5, v1dot75, v2, v2dot5, v3, v4},
    relWeightFourLayers-r13  ENUMERATED {v1, v1dot25, v1dot5, v1dot75, v2, v2dot5, v3, v4}
    OPTIONAL,
    relWeightEightLayers-r13  ENUMERATED {v1, v1dot25, v1dot5, v1dot75, v2, v2dot5, v3, v4}
    OPTIONAL,
    totalWeightedLayers-r13  INTEGER (2..128)
}
NonContiguousUL-RA-WithinCC-List-r10 ::= SEQUENCE (SIZE (1..maxBands)) OF NonContiguousUL-RA-
WithinCC-r10
NonContiguousUL-RA-WithinCC-r10 ::= SEQUENCE {
    nonContiguousUL-RA-WithinCC-Info-r10  ENUMERATED {supported}            OPTIONAL
}
RF-Parameters ::= SEQUENCE {
    supportedBandListEUTRA                SupportedBandListEUTRA
}
RF-Parameters-v9e0 ::= SEQUENCE {
    supportedBandListEUTRA-v9e0           SupportedBandListEUTRA-v9e0          OPTIONAL
}
RF-Parameters-v1020 ::= SEQUENCE {
    supportedBandCombination-r10           SupportedBandCombination-r10
}
RF-Parameters-v1060 ::= SEQUENCE {
    supportedBandCombinationExt-r10        SupportedBandCombinationExt-r10
}
RF-Parameters-v1090 ::= SEQUENCE {
    supportedBandCombination-v1090        SupportedBandCombination-v1090       OPTIONAL
}
RF-Parameters-v10f0 ::= SEQUENCE {
    modifiedMPR-Behavior-r10              BIT STRING (SIZE (32))              OPTIONAL
}
RF-Parameters-v10i0 ::= SEQUENCE {
    supportedBandCombination-v10i0        SupportedBandCombination-v10i0       OPTIONAL
}

```

```

RF-Parameters-v10j0 ::=          SEQUENCE {
    multiNS-Pmax-r10              ENUMERATED {supported}          OPTIONAL
}

RF-Parameters-v1130 ::=          SEQUENCE {
    supportedBandCombination-v1130 SupportedBandCombination-v1130  OPTIONAL
}

RF-Parameters-v1180 ::=          SEQUENCE {
    freqBandRetrieval-r11         ENUMERATED {supported}          OPTIONAL,
    requestedBands-r11           SEQUENCE (SIZE (1.. maxBands)) OF FreqBandIndicator-r11
    supportedBandCombinationAdd-r11 SupportedBandCombinationAdd-r11  OPTIONAL
}

RF-Parameters-v11d0 ::=          SEQUENCE {
    supportedBandCombinationAdd-v11d0 SupportedBandCombinationAdd-v11d0  OPTIONAL
}

RF-Parameters-v1250 ::=          SEQUENCE {
    supportedBandListEUTRA-v1250  SupportedBandListEUTRA-v1250    OPTIONAL,
    supportedBandCombination-v1250 SupportedBandCombination-v1250    OPTIONAL,
    supportedBandCombinationAdd-v1250 SupportedBandCombinationAdd-v1250  OPTIONAL,
    freqBandPriorityAdjustment-r12 ENUMERATED {supported}          OPTIONAL
}

RF-Parameters-v1270 ::=          SEQUENCE {
    supportedBandCombination-v1270 SupportedBandCombination-v1270    OPTIONAL,
    supportedBandCombinationAdd-v1270 SupportedBandCombinationAdd-v1270  OPTIONAL
}

RF-Parameters-v1310 ::=          SEQUENCE {
    eNB-RequestedParameters-r13   SEQUENCE {
        reducedIntNonContCombRequested-r13 ENUMERATED {true}          OPTIONAL,
        requestedCCsDL-r13                INTEGER (2..32)              OPTIONAL,
        requestedCCsUL-r13                INTEGER (2..32)              OPTIONAL,
        skipFallbackCombRequested-r13     ENUMERATED {true}          OPTIONAL
    }
    maximumCCsRetrieval-r13       ENUMERATED {supported}          OPTIONAL,
    skipFallbackCombinations-r13   ENUMERATED {supported}          OPTIONAL,
    reducedIntNonContComb-r13     ENUMERATED {supported}          OPTIONAL,
    supportedBandListEUTRA-v1310  SupportedBandListEUTRA-v1310    OPTIONAL,
    supportedBandCombinationReduced-r13 SupportedBandCombinationReduced-r13  OPTIONAL
}

RF-Parameters-v1320 ::=          SEQUENCE {
    supportedBandListEUTRA-v1320  SupportedBandListEUTRA-v1320    OPTIONAL,
    supportedBandCombination-v1320 SupportedBandCombination-v1320    OPTIONAL,
    supportedBandCombinationAdd-v1320 SupportedBandCombinationAdd-v1320  OPTIONAL,
    supportedBandCombinationReduced-v1320 SupportedBandCombinationReduced-v1320  OPTIONAL
}

RF-Parameters-v1380 ::=          SEQUENCE {
    supportedBandCombination-v1380 SupportedBandCombination-v1380    OPTIONAL,
    supportedBandCombinationAdd-v1380 SupportedBandCombinationAdd-v1380  OPTIONAL,
    supportedBandCombinationReduced-v1380 SupportedBandCombinationReduced-v1380  OPTIONAL
}

RF-Parameters-v1390 ::=          SEQUENCE {
    supportedBandCombination-v1390 SupportedBandCombination-v1390    OPTIONAL,
    supportedBandCombinationAdd-v1390 SupportedBandCombinationAdd-v1390  OPTIONAL,
    supportedBandCombinationReduced-v1390 SupportedBandCombinationReduced-v1390  OPTIONAL
}

RF-Parameters-v12b0 ::=          SEQUENCE {
    maxLayersMIMO-Indication-r12  ENUMERATED {supported}          OPTIONAL
}

RF-Parameters-v1430 ::=          SEQUENCE {
    supportedBandCombination-v1430 SupportedBandCombination-v1430    OPTIONAL,
    supportedBandCombinationAdd-v1430 SupportedBandCombinationAdd-v1430  OPTIONAL,
    supportedBandCombinationReduced-v1430 SupportedBandCombinationReduced-v1430  OPTIONAL,
    eNB-RequestedParameters-v1430 SEQUENCE {
        requestedDiffFallbackCombList-r14 BandCombinationList-r14
    }
    diffFallbackCombReport-r14    ENUMERATED {supported}          OPTIONAL
}

```

```

RF-Parameters-v1450 ::= SEQUENCE {
    supportedBandCombination-v1450 SupportedBandCombination-v1450 OPTIONAL,
    supportedBandCombinationAdd-v1450 SupportedBandCombinationAdd-v1450 OPTIONAL,
    supportedBandCombinationReduced-v1450 SupportedBandCombinationReduced-v1450 OPTIONAL
}

RF-Parameters-v1470 ::= SEQUENCE {
    supportedBandCombination-v1470 SupportedBandCombination-v1470 OPTIONAL,
    supportedBandCombinationAdd-v1470 SupportedBandCombinationAdd-v1470 OPTIONAL,
    supportedBandCombinationReduced-v1470 SupportedBandCombinationReduced-v1470 OPTIONAL
}

RF-Parameters-v14b0 ::= SEQUENCE {
    supportedBandCombination-v14b0 SupportedBandCombination-v14b0 OPTIONAL,
    supportedBandCombinationAdd-v14b0 SupportedBandCombinationAdd-v14b0 OPTIONAL,
    supportedBandCombinationReduced-v14b0 SupportedBandCombinationReduced-v14b0 OPTIONAL
}

RF-Parameters-v1530 ::= SEQUENCE {
    sTTI-SPT-Supported-r15 ENUMERATED {supported} OPTIONAL,
    supportedBandCombination-v1530 SupportedBandCombination-v1530 OPTIONAL,
    supportedBandCombinationAdd-v1530 SupportedBandCombinationAdd-v1530 OPTIONAL,
    supportedBandCombinationReduced-v1530 SupportedBandCombinationReduced-v1530 OPTIONAL,
    powerClass-14dBm-r15 ENUMERATED {supported} OPTIONAL
}

RF-Parameters-v1570 ::= SEQUENCE {
    dl-1024QAM-ScalingFactor-r15 ENUMERATED {v1, v1dot2, v1dot25},
    dl-1024QAM-TotalWeightedLayers-r15 INTEGER (0..10)
}

RF-Parameters-v1610 ::= SEQUENCE {
    supportedBandCombination-v1610 SupportedBandCombination-v1610 OPTIONAL,
    supportedBandCombinationAdd-v1610 SupportedBandCombinationAdd-v1610 OPTIONAL,
    supportedBandCombinationReduced-v1610 SupportedBandCombinationReduced-v1610 OPTIONAL
}

RF-Parameters-v1630 ::= SEQUENCE {
    supportedBandCombination-v1630 SupportedBandCombination-v1630 OPTIONAL,
    supportedBandCombinationAdd-v1630 SupportedBandCombinationAdd-v1630 OPTIONAL,
    supportedBandCombinationReduced-v1630 SupportedBandCombinationReduced-v1630 OPTIONAL
}

RF-Parameters-v1800 ::= SEQUENCE {
    -- Support handling of aerial-specific Ns and Pmax list broadcasted by the cell
    multiNS-PmaxAerial-r18 ENUMERATED {supported} OPTIONAL,
    supportedBandListEUTRA-v1800 SupportedBandListEUTRA-v1800 OPTIONAL,
    supportedBandCombination-v1800 SupportedBandCombination-v1800 OPTIONAL,
    supportedBandCombinationAdd-v1800 SupportedBandCombinationAdd-v1800 OPTIONAL,
    supportedBandCombinationReduced-v1800 SupportedBandCombinationReduced-v1800 OPTIONAL
}

SkipSubframeProcessing-r15 ::= SEQUENCE {
    skipProcessingDL-Slot-r15 INTEGER (0..3) OPTIONAL,
    skipProcessingDL-SubSlot-r15 INTEGER (0..3) OPTIONAL,
    skipProcessingUL-Slot-r15 INTEGER (0..3) OPTIONAL,
    skipProcessingUL-SubSlot-r15 INTEGER (0..3) OPTIONAL
}

SPT-Parameters-r15 ::= SEQUENCE {
    frameStructureType-SPT-r15 BIT STRING (SIZE (3)) OPTIONAL,
    maxNumberCCs-SPT-r15 INTEGER (1..32) OPTIONAL
}

STTI-SPT-BandParameters-r15 ::= SEQUENCE {
    dl-1024QAM-Slot-r15 ENUMERATED {supported} OPTIONAL,
    dl-1024QAM-SubslotTA-1-r15 ENUMERATED {supported} OPTIONAL,
    dl-1024QAM-SubslotTA-2-r15 ENUMERATED {supported} OPTIONAL,
    simultaneousTx-differentTx-duration-r15 ENUMERATED {supported} OPTIONAL,
    sTTI-CA-MIMO-ParametersDL-r15 CA-MIMO-ParametersDL-r15 OPTIONAL,
    sTTI-CA-MIMO-ParametersUL-r15 CA-MIMO-ParametersUL-r15,
    sTTI-FD-MIMO-Coexistence ENUMERATED {supported} OPTIONAL,
    sTTI-MIMO-CA-ParametersPerBoBCs-r15 MIMO-CA-ParametersPerBoBC-r13 OPTIONAL,
    sTTI-MIMO-CA-ParametersPerBoBCs-v1530 MIMO-CA-ParametersPerBoBC-v1430 OPTIONAL,
    sTTI-SupportedCombinations-r15 STTI-SupportedCombinations-r15 OPTIONAL,
    sTTI-SupportedCSI-Proc-r15 ENUMERATED {n1, n3, n4} OPTIONAL,
    ul-256QAM-Slot-r15 ENUMERATED {supported} OPTIONAL,

```

```

    ul-256QAM-Subslot-r15          ENUMERATED {supported}          OPTIONAL,
    ...
}

STTI-SupportedCombinations-r15 ::= SEQUENCE {
    combination-22-r15             DL-UL-CCs-r15                OPTIONAL,
    combination-77-r15             DL-UL-CCs-r15                OPTIONAL,
    combination-27-r15             DL-UL-CCs-r15                OPTIONAL,
    combination-22-27-r15          SEQUENCE (SIZE (1..2)) OF DL-UL-CCs-r15  OPTIONAL,
    combination-77-22-r15          SEQUENCE (SIZE (1..2)) OF DL-UL-CCs-r15  OPTIONAL,
    combination-77-27-r15          SEQUENCE (SIZE (1..2)) OF DL-UL-CCs-r15  OPTIONAL
}

DL-UL-CCs-r15 ::= SEQUENCE {
    maxNumberDL-CCs-r15           INTEGER (1..32)           OPTIONAL,
    maxNumberUL-CCs-r15           INTEGER (1..32)           OPTIONAL
}

SupportedBandCombination-r10 ::= SEQUENCE (SIZE (1..maxBandComb-r10)) OF BandCombinationParameters-r10

SupportedBandCombinationExt-r10 ::= SEQUENCE (SIZE (1..maxBandComb-r10)) OF BandCombinationParametersExt-r10

SupportedBandCombination-v1090 ::= SEQUENCE (SIZE (1..maxBandComb-r10)) OF BandCombinationParameters-v1090

SupportedBandCombination-v10i0 ::= SEQUENCE (SIZE (1..maxBandComb-r10)) OF BandCombinationParameters-v10i0

SupportedBandCombination-v1130 ::= SEQUENCE (SIZE (1..maxBandComb-r10)) OF BandCombinationParameters-v1130

SupportedBandCombination-v1250 ::= SEQUENCE (SIZE (1..maxBandComb-r10)) OF BandCombinationParameters-v1250

SupportedBandCombination-v1270 ::= SEQUENCE (SIZE (1..maxBandComb-r10)) OF BandCombinationParameters-v1270

SupportedBandCombination-v1320 ::= SEQUENCE (SIZE (1..maxBandComb-r10)) OF BandCombinationParameters-v1320

SupportedBandCombination-v1380 ::= SEQUENCE (SIZE (1..maxBandComb-r10)) OF BandCombinationParameters-v1380

SupportedBandCombination-v1390 ::= SEQUENCE (SIZE (1..maxBandComb-r10)) OF BandCombinationParameters-v1390

SupportedBandCombination-v1430 ::= SEQUENCE (SIZE (1..maxBandComb-r10)) OF BandCombinationParameters-v1430

SupportedBandCombination-v1450 ::= SEQUENCE (SIZE (1..maxBandComb-r10)) OF BandCombinationParameters-v1450

SupportedBandCombination-v1470 ::= SEQUENCE (SIZE (1..maxBandComb-r10)) OF BandCombinationParameters-v1470

SupportedBandCombination-v14b0 ::= SEQUENCE (SIZE (1..maxBandComb-r10)) OF BandCombinationParameters-v14b0

SupportedBandCombination-v1530 ::= SEQUENCE (SIZE (1..maxBandComb-r10)) OF BandCombinationParameters-v1530

SupportedBandCombination-v1610 ::= SEQUENCE (SIZE (1..maxBandComb-r10)) OF BandCombinationParameters-v1610

SupportedBandCombination-v1630 ::= SEQUENCE (SIZE (1..maxBandComb-r10)) OF BandCombinationParameters-v1630

SupportedBandCombination-v1800 ::= SEQUENCE (SIZE (1..maxBandComb-r10)) OF BandCombinationParameters-v1800

SupportedBandCombinationAdd-r11 ::= SEQUENCE (SIZE (1..maxBandComb-r11)) OF BandCombinationParameters-r11

SupportedBandCombinationAdd-v11d0 ::= SEQUENCE (SIZE (1..maxBandComb-r11)) OF BandCombinationParameters-v10i0

```



SupportedBandCombinationAdd-v1250 ::= SEQUENCE (SIZE (1..maxBandComb-r11)) OF BandCombinationParameters-v1250

SupportedBandCombinationAdd-v1270 ::= SEQUENCE (SIZE (1..maxBandComb-r11)) OF BandCombinationParameters-v1270

SupportedBandCombinationAdd-v1320 ::= SEQUENCE (SIZE (1..maxBandComb-r11)) OF BandCombinationParameters-v1320

SupportedBandCombinationAdd-v1380 ::= SEQUENCE (SIZE (1..maxBandComb-r11)) OF BandCombinationParameters-v1380

SupportedBandCombinationAdd-v1390 ::= SEQUENCE (SIZE (1..maxBandComb-r11)) OF BandCombinationParameters-v1390

SupportedBandCombinationAdd-v1430 ::= SEQUENCE (SIZE (1..maxBandComb-r11)) OF BandCombinationParameters-v1430

SupportedBandCombinationAdd-v1450 ::= SEQUENCE (SIZE (1..maxBandComb-r11)) OF BandCombinationParameters-v1450

SupportedBandCombinationAdd-v1470 ::= SEQUENCE (SIZE (1..maxBandComb-r11)) OF BandCombinationParameters-v1470

SupportedBandCombinationAdd-v14b0 ::= SEQUENCE (SIZE (1..maxBandComb-r11)) OF BandCombinationParameters-v14b0

SupportedBandCombinationAdd-v1530 ::= SEQUENCE (SIZE (1..maxBandComb-r11)) OF BandCombinationParameters-v1530

SupportedBandCombinationAdd-v1610 ::= SEQUENCE (SIZE (1..maxBandComb-r11)) OF BandCombinationParameters-v1610

SupportedBandCombinationAdd-v1630 ::= SEQUENCE (SIZE (1..maxBandComb-r11)) OF BandCombinationParameters-v1630

SupportedBandCombinationAdd-v1800 ::= SEQUENCE (SIZE (1..maxBandComb-r11)) OF BandCombinationParameters-v1800

SupportedBandCombinationReduced-r13 ::= SEQUENCE (SIZE (1..maxBandComb-r13)) OF BandCombinationParameters-r13

SupportedBandCombinationReduced-v1320 ::= SEQUENCE (SIZE (1..maxBandComb-r13)) OF BandCombinationParameters-v1320

SupportedBandCombinationReduced-v1380 ::= SEQUENCE (SIZE (1..maxBandComb-r13)) OF BandCombinationParameters-v1380

SupportedBandCombinationReduced-v1390 ::= SEQUENCE (SIZE (1..maxBandComb-r13)) OF BandCombinationParameters-v1390

SupportedBandCombinationReduced-v1430 ::= SEQUENCE (SIZE (1..maxBandComb-r13)) OF BandCombinationParameters-v1430

SupportedBandCombinationReduced-v1450 ::= SEQUENCE (SIZE (1..maxBandComb-r13)) OF BandCombinationParameters-v1450

SupportedBandCombinationReduced-v1470 ::= SEQUENCE (SIZE (1..maxBandComb-r13)) OF BandCombinationParameters-v1470

SupportedBandCombinationReduced-v14b0 ::= SEQUENCE (SIZE (1..maxBandComb-r13)) OF BandCombinationParameters-v14b0

SupportedBandCombinationReduced-v1530 ::= SEQUENCE (SIZE (1..maxBandComb-r13)) OF BandCombinationParameters-v1530

SupportedBandCombinationReduced-v1610 ::= SEQUENCE (SIZE (1..maxBandComb-r13)) OF BandCombinationParameters-v1610

SupportedBandCombinationReduced-v1630 ::= SEQUENCE (SIZE (1..maxBandComb-r13)) OF BandCombinationParameters-v1630

SupportedBandCombinationReduced-v1800 ::= SEQUENCE (SIZE (1..maxBandComb-r13)) OF BandCombinationParameters-v1800

BandCombinationParameters-r10 ::= SEQUENCE (SIZE (1..maxSimultaneousBands-r10)) OF BandParameters-r10

```

BandCombinationParametersExt-r10 ::= SEQUENCE {
    supportedBandwidthCombinationSet-r10 SupportedBandwidthCombinationSet-r10 OPTIONAL
}

BandCombinationParameters-v1090 ::= SEQUENCE (SIZE (1..maxSimultaneousBands-r10)) OF BandParameters-
v1090

BandCombinationParameters-v10i0 ::= SEQUENCE {
    bandParameterList-v10i0 SEQUENCE (SIZE (1..maxSimultaneousBands-r10)) OF
        BandParameters-v10i0 OPTIONAL
}

BandCombinationParameters-v1130 ::= SEQUENCE {
    multipleTimingAdvance-r11 ENUMERATED {supported} OPTIONAL,
    simultaneousRx-Tx-r11 ENUMERATED {supported} OPTIONAL,
    bandParameterList-r11 SEQUENCE (SIZE (1..maxSimultaneousBands-r10)) OF BandParameters-
v1130 OPTIONAL,
    ...
}

BandCombinationParameters-r11 ::= SEQUENCE {
    bandParameterList-r11 SEQUENCE (SIZE (1..maxSimultaneousBands-r10)) OF
        BandParameters-r11,
    supportedBandwidthCombinationSet-r11 SupportedBandwidthCombinationSet-r10 OPTIONAL,
    multipleTimingAdvance-r11 ENUMERATED {supported} OPTIONAL,
    simultaneousRx-Tx-r11 ENUMERATED {supported} OPTIONAL,
    bandInfoEUTRA-r11 BandInfoEUTRA,
    ...
}

BandCombinationParameters-v1250 ::= SEQUENCE {
    dc-Support-r12 SEQUENCE {
        asynchronous-r12 ENUMERATED {supported} OPTIONAL,
        supportedCellGrouping-r12 CHOICE {
            threeEntries-r12 BIT STRING (SIZE(3)),
            fourEntries-r12 BIT STRING (SIZE(7)),
            fiveEntries-r12 BIT STRING (SIZE(15))
        } OPTIONAL
    } OPTIONAL,
    supportedNAICS-2CRS-AP-r12 BIT STRING (SIZE (1..maxNAICS-Entries-r12)) OPTIONAL,
    commSupportedBandsPerBC-r12 BIT STRING (SIZE (1.. maxBands)) OPTIONAL,
    ...
}

BandCombinationParameters-v1270 ::= SEQUENCE {
    bandParameterList-v1270 SEQUENCE (SIZE (1..maxSimultaneousBands-r10)) OF
        BandParameters-v1270 OPTIONAL
}

BandCombinationParameters-r13 ::= SEQUENCE {
    differentFallbackSupported-r13 ENUMERATED {true} OPTIONAL,
    bandParameterList-r13 SEQUENCE (SIZE (1..maxSimultaneousBands-r10)) OF BandParameters-
r13,
    supportedBandwidthCombinationSet-r13 SupportedBandwidthCombinationSet-r10 OPTIONAL,
    multipleTimingAdvance-r13 ENUMERATED {supported} OPTIONAL,
    simultaneousRx-Tx-r13 ENUMERATED {supported} OPTIONAL,
    bandInfoEUTRA-r13 BandInfoEUTRA,
    dc-Support-r13 SEQUENCE {
        asynchronous-r13 ENUMERATED {supported} OPTIONAL,
        supportedCellGrouping-r13 CHOICE {
            threeEntries-r13 BIT STRING (SIZE(3)),
            fourEntries-r13 BIT STRING (SIZE(7)),
            fiveEntries-r13 BIT STRING (SIZE(15))
        } OPTIONAL
    } OPTIONAL,
    supportedNAICS-2CRS-AP-r13 BIT STRING (SIZE (1..maxNAICS-Entries-r12)) OPTIONAL,
    commSupportedBandsPerBC-r13 BIT STRING (SIZE (1.. maxBands)) OPTIONAL
}

BandCombinationParameters-v1320 ::= SEQUENCE {
    bandParameterList-v1320 SEQUENCE (SIZE (1..maxSimultaneousBands-r10)) OF
        BandParameters-v1320 OPTIONAL,
    additionalRx-Tx-PerformanceReq-r13 ENUMERATED {supported} OPTIONAL
}

BandCombinationParameters-v1380 ::= SEQUENCE {
    bandParameterList-v1380 SEQUENCE (SIZE (1..maxSimultaneousBands-r10)) OF
        BandParameters-v1380 OPTIONAL
}

```

```

}
BandCombinationParameters-v1390 ::= SEQUENCE {
    ue-CA-PowerClass-N-r13      ENUMERATED {class2}          OPTIONAL
}
BandCombinationParameters-v1430 ::= SEQUENCE {
    bandParameterList-v1430     SEQUENCE (SIZE (1..maxSimultaneousBands-r10)) OF
        BandParameters-v1430     OPTIONAL,
    v2x-SupportedTxBandCombListPerBC-r14  BIT STRING (SIZE (1.. maxBandComb-r13))
    OPTIONAL,
    v2x-SupportedRxBandCombListPerBC-r14  BIT STRING (SIZE (1.. maxBandComb-r13))
    OPTIONAL
}
BandCombinationParameters-v1450 ::= SEQUENCE {
    bandParameterList-v1450     SEQUENCE (SIZE (1..maxSimultaneousBands-r10)) OF
        BandParameters-v1450     OPTIONAL
}
BandCombinationParameters-v1470 ::= SEQUENCE {
    bandParameterList-v1470     SEQUENCE (SIZE (1..maxSimultaneousBands-r10)) OF
        BandParameters-v1470     OPTIONAL,
    srs-MaxSimultaneousCCs-r14  INTEGER (1..31)              OPTIONAL
}
BandCombinationParameters-v14b0 ::= SEQUENCE {
    bandParameterList-v14b0     SEQUENCE (SIZE (1..maxSimultaneousBands-r10)) OF
        BandParameters-v14b0     OPTIONAL
}
BandCombinationParameters-v1530 ::= SEQUENCE {
    bandParameterList-v1530     SEQUENCE (SIZE (1..maxSimultaneousBands-r10)) OF
        BandParameters-v1530     OPTIONAL,
    spt-Parameters-r15          SPT-Parameters-r15          OPTIONAL
}
-- If an additional band combination parameter is defined, which is supported for MR-DC,
-- it shall be defined in the IE CA-ParametersEUTRA in TS 38.331 [82].
BandCombinationParameters-v1610 ::= SEQUENCE {
    measGapInfoNR-r16           MeasGapInfoNR-r16           OPTIONAL,
    bandParameterList-v1610     SEQUENCE (SIZE (1..maxSimultaneousBands-r10)) OF
        BandParameters-v1610     OPTIONAL,
    interFreqDAPS-r16          SEQUENCE {
        interFreqAsyncDAPS-r16   ENUMERATED {supported}    OPTIONAL,
        interFreqMultiUL-TransmissionDAPS-r16  ENUMERATED {supported}    OPTIONAL
    }
}
BandCombinationParameters-v1630 ::= SEQUENCE {
    v2x-SupportedTxBandCombListPerBC-v1630  BIT STRING (SIZE (1..maxBandCombSidelinkNR-r16))
    OPTIONAL,
    v2x-SupportedRxBandCombListPerBC-v1630  BIT STRING (SIZE (1..maxBandCombSidelinkNR-r16))
    OPTIONAL,
    scalingFactorTxSidelink-r16             SEQUENCE (SIZE (1..maxBandCombSidelinkNR-r16)) OF
ScalingFactorSidelink-r16                 OPTIONAL,
    scalingFactorRxSidelink-r16             SEQUENCE (SIZE (1..maxBandCombSidelinkNR-r16)) OF
ScalingFactorSidelink-r16                 OPTIONAL,
    interBandPowerSharingSyncDAPS-r16      ENUMERATED {supported}    OPTIONAL,
    interBandPowerSharingAsyncDAPS-r16     ENUMERATED {supported}    OPTIONAL
}
BandCombinationParameters-v1800 ::= SEQUENCE {
    measGapInfoNR-r18           MeasGapInfoNR-r18           OPTIONAL
}
ScalingFactorSidelink-r16 ::=
    ENUMERATED {f0p4, f0p75, f0p8, f1}
SupportedBandwidthCombinationSet-r10 ::=
    BIT STRING (SIZE (1..maxBandwidthCombSet-r10))
BandParameters-r10 ::= SEQUENCE {
    bandEUTRA-r10              FreqBandIndicator,
    bandParametersUL-r10       BandParametersUL-r10         OPTIONAL,
    bandParametersDL-r10       BandParametersDL-r10         OPTIONAL
}
BandParameters-v1090 ::= SEQUENCE {

```

```

    bandEUTRA-v1090          FreqBandIndicator-v9e0          OPTIONAL,
    ...
}
BandParameters-v10i0 ::= SEQUENCE {
    bandParametersDL-v10i0    SEQUENCE (SIZE (1..maxBandwidthClass-r10)) OF CA-MIMO-ParametersDL-
v10i0
}
BandParameters-v1130 ::= SEQUENCE {
    supportedCSI-Proc-r11     ENUMERATED {n1, n3, n4}
}
BandParameters-r11 ::= SEQUENCE {
    bandEUTRA-r11             FreqBandIndicator-r11,
    bandParametersUL-r11      BandParametersUL-r10          OPTIONAL,
    bandParametersDL-r11      BandParametersDL-r10          OPTIONAL,
    supportedCSI-Proc-r11     ENUMERATED {n1, n3, n4}          OPTIONAL
}
BandParameters-v1270 ::= SEQUENCE {
    bandParametersDL-v1270    SEQUENCE (SIZE (1..maxBandwidthClass-r10)) OF CA-MIMO-
ParametersDL-v1270
}
BandParameters-r13 ::= SEQUENCE {
    bandEUTRA-r13             FreqBandIndicator-r11,
    bandParametersUL-r13      BandParametersUL-r13          OPTIONAL,
    bandParametersDL-r13      BandParametersDL-r13          OPTIONAL,
    supportedCSI-Proc-r13     ENUMERATED {n1, n3, n4}          OPTIONAL
}
BandParameters-v1320 ::= SEQUENCE {
    bandParametersDL-v1320    MIMO-CA-ParametersPerBoBC-r13
}
BandParameters-v1380 ::= SEQUENCE {
    txAntennaSwitchDL-r13     INTEGER (1..32)          OPTIONAL,
    txAntennaSwitchUL-r13     INTEGER (1..32)          OPTIONAL
}
BandParameters-v1430 ::= SEQUENCE {
    bandParametersDL-v1430    MIMO-CA-ParametersPerBoBC-v1430 OPTIONAL,
    ul-256QAM-r14             ENUMERATED {supported}          OPTIONAL,
    ul-256QAM-perCC-InfoList-r14 SEQUENCE (SIZE (2..maxServCell-r13)) OF UL-256QAM-perCC-
Info-r14          OPTIONAL,
    srs-CapabilityPerBandPairList-r14 SEQUENCE (SIZE (1..maxSimultaneousBands-r10)) OF
SRS-CapabilityPerBandPair-r14 OPTIONAL
}
BandParameters-v1450 ::= SEQUENCE {
    must-CapabilityPerBand-r14 MUST-Parameters-r14          OPTIONAL
}
BandParameters-v1470 ::= SEQUENCE {
    bandParametersDL-v1470    MIMO-CA-ParametersPerBoBC-v1470 OPTIONAL
}
BandParameters-v14b0 ::= SEQUENCE {
    srs-CapabilityPerBandPairList-v14b0 SEQUENCE (SIZE (1..maxSimultaneousBands-r10)) OF
SRS-CapabilityPerBandPair-v14b0 OPTIONAL
}
BandParameters-v1530 ::= SEQUENCE {
    ue-TxAntennaSelection-SRS-1T4R-r15     ENUMERATED {supported} OPTIONAL,
    ue-TxAntennaSelection-SRS-2T4R-2Pairs-r15 ENUMERATED {supported} OPTIONAL,
    ue-TxAntennaSelection-SRS-2T4R-3Pairs-r15 ENUMERATED {supported} OPTIONAL,
    dl-1024QAM-r15                          ENUMERATED {supported} OPTIONAL,
    qcl-TypeC-Operation-r15                 ENUMERATED {supported} OPTIONAL,
    qcl-CRI-BasedCSI-Reporting-r15         ENUMERATED {supported} OPTIONAL,
    stti-SPT-BandParameters-r15           STTI-SPT-BandParameters-r15 OPTIONAL
}
BandParameters-v1610 ::= SEQUENCE {
    intraFreqDAPS-r16 SEQUENCE {
        intraFreqAsyncDAPS-r16     ENUMERATED {supported} OPTIONAL,
        dummy                      ENUMERATED {supported} OPTIONAL,
        intraFreqTwoTAGs-DAPS-r16  ENUMERATED {supported} OPTIONAL
    }
}

```

```

    }
    addSRS-FrequencyHopping-r16 ENUMERATED {supported} OPTIONAL,
    addSRS-AntennaSwitching-r16 SEQUENCE {
        addSRS-1T2R-r16 ENUMERATED {supported} OPTIONAL,
        addSRS-1T4R-r16 ENUMERATED {supported} OPTIONAL,
        addSRS-2T4R-2pairs-r16 ENUMERATED {supported} OPTIONAL,
        addSRS-2T4R-3pairs-r16 ENUMERATED {supported} OPTIONAL
    }
    srs-CapabilityPerBandPairList-v1610 SEQUENCE (SIZE (1..maxSimultaneousBands-r10)) OF
    SRS-CapabilityPerBandPair-v1610 OPTIONAL
}

V2X-BandParameters-r14 ::= SEQUENCE {
    v2x-FreqBandEUTRA-r14 FreqBandIndicator-r11,
    bandParametersTxSL-r14 BandParametersTxSL-r14 OPTIONAL,
    bandParametersRxSL-r14 BandParametersRxSL-r14 OPTIONAL
}

V2X-BandParameters-v1530 ::= SEQUENCE {
    v2x-EnhancedHighReception-r15 ENUMERATED {supported} OPTIONAL
}

BandParametersTxSL-r14 ::= SEQUENCE {
    v2x-BandwidthClassTxSL-r14 V2X-BandwidthClassSL-r14,
    v2x-eNB-Scheduled-r14 ENUMERATED {supported} OPTIONAL,
    v2x-HighPower-r14 ENUMERATED {supported} OPTIONAL
}

BandParametersRxSL-r14 ::= SEQUENCE {
    v2x-BandwidthClassRxSL-r14 V2X-BandwidthClassSL-r14,
    v2x-HighReception-r14 ENUMERATED {supported} OPTIONAL
}

V2X-BandwidthClassSL-r14 ::= SEQUENCE (SIZE (1..maxBandwidthClass-r10)) OF V2X-BandwidthClass-r14

UL-256QAM-perCC-Info-r14 ::= SEQUENCE {
    ul-256QAM-perCC-r14 ENUMERATED {supported} OPTIONAL
}

FeatureSetDL-r15 ::= SEQUENCE {
    mimo-CA-ParametersPerBoBC-r15 MIMO-CA-ParametersPerBoBC-r15 OPTIONAL,
    featureSetPerCC-ListDL-r15 SEQUENCE (SIZE (1..maxServCell-r13)) OF FeatureSetDL-PerCC-Id-r15
}

FeatureSetDL-v1550 ::= SEQUENCE {
    dl-1024QAM-r15 ENUMERATED {supported} OPTIONAL
}

FeatureSetDL-PerCC-r15 ::= SEQUENCE {
    fourLayerTM3-TM4-r15 ENUMERATED {supported} OPTIONAL,
    supportedMIMO-CapabilityDL-MRDC-r15 MIMO-CapabilityDL-r10 OPTIONAL,
    supportedCSI-Proc-r15 ENUMERATED {n1, n3, n4} OPTIONAL
}

FeatureSetUL-r15 ::= SEQUENCE {
    featureSetPerCC-ListUL-r15 SEQUENCE (SIZE(1..maxServCell-r13)) OF FeatureSetUL-PerCC-Id-r15
}

FeatureSetUL-PerCC-r15 ::= SEQUENCE {
    supportedMIMO-CapabilityUL-r15 MIMO-CapabilityUL-r10 OPTIONAL,
    ul-256QAM-r15 ENUMERATED {supported} OPTIONAL
}

FeatureSetDL-PerCC-Id-r15 ::= INTEGER (0..maxPerCC-FeatureSets-r15)

FeatureSetUL-PerCC-Id-r15 ::= INTEGER (0..maxPerCC-FeatureSets-r15)

BandParametersUL-r10 ::= SEQUENCE (SIZE (1..maxBandwidthClass-r10)) OF CA-MIMO-ParametersUL-r10

BandParametersUL-r13 ::= CA-MIMO-ParametersUL-r10

CA-MIMO-ParametersUL-r10 ::= SEQUENCE {
    ca-BandwidthClassUL-r10 CA-BandwidthClass-r10,
    supportedMIMO-CapabilityUL-r10 MIMO-CapabilityUL-r10 OPTIONAL
}

CA-MIMO-ParametersUL-r15 ::= SEQUENCE {
    supportedMIMO-CapabilityUL-r15 MIMO-CapabilityUL-r10 OPTIONAL
}

```

```

}
BandParametersDL-r10 ::= SEQUENCE (SIZE (1..maxBandwidthClass-r10)) OF CA-MIMO-ParametersDL-r10
BandParametersDL-r13 ::= CA-MIMO-ParametersDL-r13
CA-MIMO-ParametersDL-r10 ::= SEQUENCE {
    ca-BandwidthClassDL-r10          CA-BandwidthClass-r10,
    supportedMIMO-CapabilityDL-r10  MIMO-CapabilityDL-r10          OPTIONAL
}
CA-MIMO-ParametersDL-v10i0 ::= SEQUENCE {
    fourLayerTM3-TM4-r10          ENUMERATED {supported}          OPTIONAL
}
CA-MIMO-ParametersDL-v1270 ::= SEQUENCE {
    intraBandContiguousCC-InfoList-r12          SEQUENCE (SIZE (1..maxServCell-r10)) OF
    IntraBandContiguousCC-Info-r12
}
CA-MIMO-ParametersDL-r13 ::= SEQUENCE {
    ca-BandwidthClassDL-r13          CA-BandwidthClass-r10,
    supportedMIMO-CapabilityDL-r13  MIMO-CapabilityDL-r10          OPTIONAL,
    fourLayerTM3-TM4-r13          ENUMERATED {supported}          OPTIONAL,
    intraBandContiguousCC-InfoList-r13          SEQUENCE (SIZE (1..maxServCell-r13)) OF
    IntraBandContiguousCC-Info-r12
}
CA-MIMO-ParametersDL-r15 ::= SEQUENCE {
    supportedMIMO-CapabilityDL-r15  MIMO-CapabilityDL-r10          OPTIONAL,
    fourLayerTM3-TM4-r15          ENUMERATED {supported}          OPTIONAL,
    intraBandContiguousCC-InfoList-r15          SEQUENCE (SIZE (1..maxServCell-r13)) OF
    IntraBandContiguousCC-Info-r12          OPTIONAL
}
IntraBandContiguousCC-Info-r12 ::= SEQUENCE {
    fourLayerTM3-TM4-perCC-r12          ENUMERATED {supported}          OPTIONAL,
    supportedMIMO-CapabilityDL-r12      MIMO-CapabilityDL-r10          OPTIONAL,
    supportedCSI-Proc-r12              ENUMERATED {n1, n3, n4}          OPTIONAL
}
CA-BandwidthClass-r10 ::= ENUMERATED {a, b, c, d, e, f, ...}
V2X-BandwidthClass-r14 ::= ENUMERATED {a, b, c, d, e, f, ..., c1-v1530}
MIMO-CapabilityUL-r10 ::= ENUMERATED {twoLayers, fourLayers}
MIMO-CapabilityDL-r10 ::= ENUMERATED {twoLayers, fourLayers, eightLayers}
MUST-Parameters-r14 ::= SEQUENCE {
    must-TM234-UpTo2Tx-r14          ENUMERATED {supported}          OPTIONAL,
    must-TM89-UpToOneInterferingLayer-r14          ENUMERATED {supported}          OPTIONAL,
    must-TM10-UpToOneInterferingLayer-r14          ENUMERATED {supported}          OPTIONAL,
    must-TM89-UpToThreeInterferingLayers-r14          ENUMERATED {supported}          OPTIONAL,
    must-TM10-UpToThreeInterferingLayers-r14          ENUMERATED {supported}          OPTIONAL
}
SupportedBandListEUTRA ::= SEQUENCE (SIZE (1..maxBands)) OF SupportedBandEUTRA
SupportedBandListEUTRA-v9e0 ::= SEQUENCE (SIZE (1..maxBands)) OF SupportedBandEUTRA-v9e0
SupportedBandListEUTRA-v1250 ::= SEQUENCE (SIZE (1..maxBands)) OF SupportedBandEUTRA-v1250
SupportedBandListEUTRA-v1310 ::= SEQUENCE (SIZE (1..maxBands)) OF SupportedBandEUTRA-v1310
SupportedBandListEUTRA-v1320 ::= SEQUENCE (SIZE (1..maxBands)) OF SupportedBandEUTRA-v1320
SupportedBandListEUTRA-v1800 ::= SEQUENCE (SIZE (1..maxBands)) OF SupportedBandEUTRA-v1800
SupportedBandEUTRA ::= SEQUENCE {
    bandEUTRA          FreqBandIndicator,
    halfDuplex          BOOLEAN
}
SupportedBandEUTRA-v9e0 ::= SEQUENCE {
    bandEUTRA-v9e0          FreqBandIndicator-v9e0          OPTIONAL
}

```

```

SupportedBandEUTRA-v1250 ::= SEQUENCE {
    dl-256QAM-r12          ENUMERATED {supported}    OPTIONAL,
    ul-64QAM-r12          ENUMERATED {supported}    OPTIONAL
}

SupportedBandEUTRA-v1310 ::= SEQUENCE {
    ue-PowerClass-5-r13   ENUMERATED {supported}    OPTIONAL
}

SupportedBandEUTRA-v1320 ::= SEQUENCE {
    intraFreq-CE-NeedForGaps-r13   ENUMERATED {supported}    OPTIONAL,
    ue-PowerClass-N-r13             ENUMERATED {class1, class2, class4}    OPTIONAL
}

SupportedBandEUTRA-v1800 ::= SEQUENCE {
    lowerMSD-MRDC-r18        SEQUENCE (SIZE (1..maxLowerMSD-r18)) OF LowerMSD-MRDC-r18
    OPTIONAL
}

MeasParameters ::= SEQUENCE {
    bandListEUTRA           BandListEUTRA
}

MeasParameters-v1020 ::= SEQUENCE {
    bandCombinationListEUTRA-r10   BandCombinationListEUTRA-r10
}

MeasParameters-v1130 ::= SEQUENCE {
    rsrqMeasWideband-r11          ENUMERATED {supported}    OPTIONAL
}

MeasParameters-v11a0 ::= SEQUENCE {
    benefitsFromInterruption-r11   ENUMERATED {true}    OPTIONAL
}

MeasParameters-v1250 ::= SEQUENCE {
    timerT312-r12                ENUMERATED {supported}    OPTIONAL,
    alternativeTimeToTrigger-r12   ENUMERATED {supported}    OPTIONAL,
    incMonEUTRA-r12               ENUMERATED {supported}    OPTIONAL,
    incMonUTRA-r12                ENUMERATED {supported}    OPTIONAL,
    extendedMaxMeasId-r12          ENUMERATED {supported}    OPTIONAL,
    extendedRSRQ-LowerRange-r12    ENUMERATED {supported}    OPTIONAL,
    rsrq-OnAllSymbols-r12          ENUMERATED {supported}    OPTIONAL,
    crs-DiscoverySignalsMeas-r12   ENUMERATED {supported}    OPTIONAL,
    csi-RS-DiscoverySignalsMeas-r12 ENUMERATED {supported}    OPTIONAL
}

MeasParameters-v1310 ::= SEQUENCE {
    rs-SINR-Meas-r13              ENUMERATED {supported}    OPTIONAL,
    allowedCellList-r13           ENUMERATED {supported}    OPTIONAL,
    extendedMaxObjectID-r13        ENUMERATED {supported}    OPTIONAL,
    ul-PDCP-Delay-r13             ENUMERATED {supported}    OPTIONAL,
    extendedFreqPriorities-r13     ENUMERATED {supported}    OPTIONAL,
    multiBandInfoReport-r13        ENUMERATED {supported}    OPTIONAL,
    rssi-AndChannelOccupancyReporting-r13   ENUMERATED {supported}    OPTIONAL
}

MeasParameters-v1430 ::= SEQUENCE {
    ceMeasurements-r14            ENUMERATED {supported}    OPTIONAL,
    ncsg-r14                      ENUMERATED {supported}    OPTIONAL,
    shortMeasurementGap-r14        ENUMERATED {supported}    OPTIONAL,
    perServingCellMeasurementGap-r14   ENUMERATED {supported}    OPTIONAL,
    nonUniformGap-r14             ENUMERATED {supported}    OPTIONAL
}

MeasParameters-v1520 ::= SEQUENCE {
    measGapPatterns-r15           BIT STRING (SIZE (8))    OPTIONAL
}

MeasParameters-v1530 ::= SEQUENCE {
    qoe-MeasReport-r15            ENUMERATED {supported}    OPTIONAL,
    qoe-MTSI-MeasReport-r15       ENUMERATED {supported}    OPTIONAL,
    ca-IdleModeMeasurements-r15   ENUMERATED {supported}    OPTIONAL,
    ca-IdleModeValidityArea-r15   ENUMERATED {supported}    OPTIONAL,
    heightMeas-r15                ENUMERATED {supported}    OPTIONAL,
    multipleCellsMeasExtension-r15 ENUMERATED {supported}    OPTIONAL
}

```

```

MeasParameters-v1610 ::= SEQUENCE {
    bandInfoNR-v1610 SEQUENCE (SIZE (1..maxBands)) OF MeasGapInfoNR-r16
    OPTIONAL,
    altFreqPriority-r16 ENUMERATED {supported} OPTIONAL,
    ce-DL-ChannelQualityReporting-r16 ENUMERATED {supported} OPTIONAL,
    ce-MeasRSS-Dedicated-r16 ENUMERATED {supported} OPTIONAL,
    eutra-IdleInactiveMeasurements-r16 ENUMERATED {supported} OPTIONAL,
    nr-IdleInactiveMeasFR1-r16 ENUMERATED {supported} OPTIONAL,
    nr-IdleInactiveMeasFR2-r16 ENUMERATED {supported} OPTIONAL,
    idleInactiveValidityAreaList-r16 ENUMERATED {supported} OPTIONAL,
    measGapPatterns-NRonly-r16 ENUMERATED {supported} OPTIONAL,
    measGapPatterns-NRonly-ENDC-r16 ENUMERATED {supported} OPTIONAL
}

MeasParameters-v1630 ::= SEQUENCE {
    nr-IdleInactiveBeamMeasFR1-r16 ENUMERATED {supported} OPTIONAL,
    nr-IdleInactiveBeamMeasFR2-r16 ENUMERATED {supported} OPTIONAL,
    ce-MeasRSS-DedicatedSameRBs-r16 ENUMERATED {supported} OPTIONAL
}

MeasParameters-v16c0 ::= SEQUENCE {
    nr-CellIndividualOffset-r16 ENUMERATED {supported} OPTIONAL
}

MeasParameters-v1700 ::= SEQUENCE {
    sharedSpectrumMeasNR-EN-DC-r17 SEQUENCE (SIZE (1..maxBandsNR-r15)) OF SharedSpectrumMeasNR-r17
    OPTIONAL,
    sharedSpectrumMeasNR-SA-r17 SEQUENCE (SIZE (1..maxBandsNR-r15)) OF SharedSpectrumMeasNR-r17
    OPTIONAL
}

MeasParameters-v1770 ::= SEQUENCE {
    gaplessMeas-FR2-maxCC-r17 INTEGER (1..32) OPTIONAL
}

MeasParameters-v1800 ::= SEQUENCE {
    bandInfoNR-v1800 SEQUENCE (SIZE (1..maxBands)) OF MeasGapInfoNR-r18
}

SharedSpectrumMeasNR-r17 ::= SEQUENCE {
    nr-RSSI-ChannelOccupancyReporting-r17 BOOLEAN
}

MeasGapInfoNR-r16 ::= SEQUENCE {
    interRAT-BandListNR-EN-DC-r16 InterRAT-BandListNR-r16 OPTIONAL,
    interRAT-BandListNR-SA-r16 InterRAT-BandListNR-r16 OPTIONAL
}

MeasGapInfoNR-r18 ::= SEQUENCE {
    interRAT-BandListNR-EN-DC-r18 InterRAT-BandListNR-r18 OPTIONAL,
    interRAT-BandListNR-SA-r18 InterRAT-BandListNR-r18 OPTIONAL
}

BandListEUTRA ::= SEQUENCE (SIZE (1..maxBands)) OF BandInfoEUTRA

BandCombinationListEUTRA-r10 ::= SEQUENCE (SIZE (1..maxBandComb-r10)) OF BandInfoEUTRA

BandInfoEUTRA ::= SEQUENCE {
    interFreqBandList InterFreqBandList,
    interRAT-BandList InterRAT-BandList OPTIONAL
}

InterFreqBandList ::= SEQUENCE (SIZE (1..maxBands)) OF InterFreqBandInfo

InterFreqBandInfo ::= SEQUENCE {
    interFreqNeedForGaps BOOLEAN
}

InterRAT-BandList ::= SEQUENCE (SIZE (1..maxBands)) OF InterRAT-BandInfo

InterRAT-BandListNR-r16 ::= SEQUENCE (SIZE (1..maxBandsNR-r15)) OF InterRAT-BandInfoNR-r16

InterRAT-BandListNR-r18 ::= SEQUENCE (SIZE (1..maxBandsNR-r15)) OF InterRAT-BandInfoNR-r18

InterRAT-BandInfo ::= SEQUENCE {
    interRAT-NeedForGaps BOOLEAN
}

```



```

InterRAT-BandInfoNR-r16 ::= SEQUENCE {
    interRAT-NeedForGapsNR-r16    BOOLEAN
}

InterRAT-BandInfoNR-r18 ::= SEQUENCE {
    interRAT-NeedForInterruptionNR-r18
        ENUMERATED {no-gap-with-interruption, no-gap-no-interruption}    OPTIONAL
}

IRAT-ParametersNR-r15 ::= SEQUENCE {
    en-DC-r15                ENUMERATED {supported}                OPTIONAL,
    eventB2-r15              ENUMERATED {supported}                OPTIONAL,
    supportedBandListEN-DC-r15 SupportedBandListNR-r15            OPTIONAL
}

IRAT-ParametersNR-v1540 ::= SEQUENCE {
    eutra-5GC-HO-ToNR-FDD-FR1-r15    ENUMERATED {supported}    OPTIONAL,
    eutra-5GC-HO-ToNR-TDD-FR1-r15    ENUMERATED {supported}    OPTIONAL,
    eutra-5GC-HO-ToNR-FDD-FR2-r15    ENUMERATED {supported}    OPTIONAL,
    eutra-5GC-HO-ToNR-TDD-FR2-r15    ENUMERATED {supported}    OPTIONAL,
    eutra-EPC-HO-ToNR-FDD-FR1-r15    ENUMERATED {supported}    OPTIONAL,
    eutra-EPC-HO-ToNR-TDD-FR1-r15    ENUMERATED {supported}    OPTIONAL,
    eutra-EPC-HO-ToNR-FDD-FR2-r15    ENUMERATED {supported}    OPTIONAL,
    eutra-EPC-HO-ToNR-TDD-FR2-r15    ENUMERATED {supported}    OPTIONAL,
    ims-VoiceOverNR-FR1-r15          ENUMERATED {supported}    OPTIONAL,
    ims-VoiceOverNR-FR2-r15          ENUMERATED {supported}    OPTIONAL,
    sa-NR-r15                        ENUMERATED {supported}    OPTIONAL,
    supportedBandListNR-SA-r15        SupportedBandListNR-r15    OPTIONAL
}

IRAT-ParametersNR-v1560 ::= SEQUENCE {
    ng-EN-DC-r15                ENUMERATED {supported}                OPTIONAL
}

IRAT-ParametersNR-v1570 ::= SEQUENCE {
    ss-SINR-Meas-NR-FR1-r15        ENUMERATED {supported}        OPTIONAL,
    ss-SINR-Meas-NR-FR2-r15        ENUMERATED {supported}        OPTIONAL
}

IRAT-ParametersNR-v1610 ::= SEQUENCE {
    nr-HO-ToEN-DC-r16            ENUMERATED {supported}            OPTIONAL,
    ce-EUTRA-5GC-HO-ToNR-FDD-FR1-r16    ENUMERATED {supported}    OPTIONAL,
    ce-EUTRA-5GC-HO-ToNR-TDD-FR1-r16    ENUMERATED {supported}    OPTIONAL,
    ce-EUTRA-5GC-HO-ToNR-FDD-FR2-r16    ENUMERATED {supported}    OPTIONAL,
    ce-EUTRA-5GC-HO-ToNR-TDD-FR2-r16    ENUMERATED {supported}    OPTIONAL
}

IRAT-ParametersNR-v1660 ::= SEQUENCE {
    extendedBand-n77-r16          ENUMERATED {supported}          OPTIONAL
}

IRAT-ParametersNR-v1700 ::= SEQUENCE {
    eutra-5GC-HO-ToNR-TDD-FR2-2-r17    ENUMERATED {supported}    OPTIONAL,
    eutra-EPC-HO-ToNR-TDD-FR2-2-r17    ENUMERATED {supported}    OPTIONAL,
    ce-EUTRA-5GC-HO-ToNR-TDD-FR2-2-r17    ENUMERATED {supported}    OPTIONAL,
    ims-VoiceOverNR-FR2-2-r17          ENUMERATED {supported}    OPTIONAL
}

IRAT-ParametersNR-v1710 ::= SEQUENCE {
    extendedBand-n77-2-r17          ENUMERATED {supported}          OPTIONAL
}

LowerMSD-MRDC-r18 ::= SEQUENCE {
    aggressorband1-r18            FreqBandIndicatorNR-r15,
    aggressorband2-r18            FreqBandIndicator-r11                OPTIONAL,
    msd-Information-r18            SEQUENCE (SIZE (1.. maxLowerMSD-Info-r18)) OF MSD-Information-r18
}

MSD-Information-r18 ::= SEQUENCE {
    msd-Type-r18                  ENUMERATED {harmonic, harmonicMixing, crossBandIsolation, imd2,
        imd3, imd4, imd5, all, spare8, spare7, spare6,
        spare5, spare4, spare3, spare2, spare1},
    msd-PowerClass-r18            ENUMERATED {pc1dot5, pc2, pc3},
    msd-Class-r18                 ENUMERATED {classI, classII, classIII, classIV, classV, classVI,
        classVII, classVIII }
}

```

```

EUTRA-5GC-Parameters-r15 ::= SEQUENCE {
    eutra-5GC-r15
        ENUMERATED {supported} OPTIONAL,
    eutra-EPC-HO-EUTRA-5GC-r15
        ENUMERATED {supported} OPTIONAL,
    ho-EUTRA-5GC-FDD-TDD-r15
        ENUMERATED {supported} OPTIONAL,
    ho-InterfreqEUTRA-5GC-r15
        ENUMERATED {supported} OPTIONAL,
    ims-VoiceOverMCG-BearerEUTRA-5GC-r15
        ENUMERATED {supported} OPTIONAL,
    inactiveState-r15
        ENUMERATED {supported} OPTIONAL,
    reflectiveQoS-r15
        ENUMERATED {supported} OPTIONAL
}

EUTRA-5GC-Parameters-v1610 ::= SEQUENCE {
    ce-InactiveState-r16
        ENUMERATED {supported} OPTIONAL,
    ce-EUTRA-5GC-r16
        ENUMERATED {supported} OPTIONAL
}

PDCP-ParametersNR-r15 ::= SEQUENCE {
    rohc-Profiles-r15
        ROHC-ProfileSupportList-r15,
    rohc-ContextMaxSessions-r15
        ENUMERATED {
            cs2, cs4, cs8, cs12, cs16, cs24, cs32,
            cs48, cs64, cs128, cs256, cs512, cs1024,
            cs16384, spare2, spare1} DEFAULT cs16,
    rohc-ProfilesUL-Only-r15
        SEQUENCE {
        profile0x0006-r15
            BOOLEAN
        },
    rohc-ContextContinue-r15
        ENUMERATED {supported} OPTIONAL,
    outOfOrderDelivery-r15
        ENUMERATED {supported} OPTIONAL,
    sn-SizeLo-r15
        ENUMERATED {supported} OPTIONAL,
    ims-VoiceOverNR-PDCP-MCG-Bearer-r15
        ENUMERATED {supported} OPTIONAL,
    ims-VoiceOverNR-PDCP-SCG-Bearer-r15
        ENUMERATED {supported} OPTIONAL
}

PDCP-ParametersNR-v1560 ::= SEQUENCE {
    ims-VoNR-PDCP-SCG-NGENDC-r15
        ENUMERATED {supported} OPTIONAL
}

ROHC-ProfileSupportList-r15 ::= SEQUENCE {
    profile0x0001-r15
        BOOLEAN,
    profile0x0002-r15
        BOOLEAN,
    profile0x0003-r15
        BOOLEAN,
    profile0x0004-r15
        BOOLEAN,
    profile0x0006-r15
        BOOLEAN,
    profile0x0101-r15
        BOOLEAN,
    profile0x0102-r15
        BOOLEAN,
    profile0x0103-r15
        BOOLEAN,
    profile0x0104-r15
        BOOLEAN
}

SupportedBandListNR-r15 ::= SEQUENCE (SIZE (1..maxBandsNR-r15)) OF SupportedBandNR-r15

SupportedBandNR-r15 ::= SEQUENCE {
    bandNR-r15
        FreqBandIndicatorNR-r15
}

IRAT-ParametersUTRA-FDD ::= SEQUENCE {
    supportedBandListUTRA-FDD
        SupportedBandListUTRA-FDD
}

IRAT-ParametersUTRA-v920 ::= SEQUENCE {
    e-RedirectionUTRA-r9
        ENUMERATED {supported}
}

IRAT-ParametersUTRA-v9c0 ::= SEQUENCE {
    voiceOverPS-HS-UTRA-FDD-r9
        ENUMERATED {supported} OPTIONAL,
    voiceOverPS-HS-UTRA-TDD128-r9
        ENUMERATED {supported} OPTIONAL,
    srvcc-FromUTRA-FDD-ToUTRA-FDD-r9
        ENUMERATED {supported} OPTIONAL,
    srvcc-FromUTRA-FDD-ToGERAN-r9
        ENUMERATED {supported} OPTIONAL,
    srvcc-FromUTRA-TDD128-ToUTRA-TDD128-r9
        ENUMERATED {supported} OPTIONAL,
    srvcc-FromUTRA-TDD128-ToGERAN-r9
        ENUMERATED {supported} OPTIONAL
}

IRAT-ParametersUTRA-v9h0 ::= SEQUENCE {
    mfbI-UTRA-r9
        ENUMERATED {supported}
}

SupportedBandListUTRA-FDD ::= SEQUENCE (SIZE (1..maxBands)) OF SupportedBandUTRA-FDD

SupportedBandUTRA-FDD ::= ENUMERATED {
    bandI, bandII, bandIII, bandIV, bandV, bandVI,

```

	bandVII, bandVIII, bandIX, bandX, bandXI, bandXII, bandXIII, bandXIV, bandXV, bandXVI, ..., bandXVII-8a0, bandXVIII-8a0, bandXIX-8a0, bandXX-8a0, bandXXI-8a0, bandXXII-8a0, bandXXIII-8a0, bandXXIV-8a0, bandXXV-8a0, bandXXVI-8a0, bandXXVII-8a0, bandXXVIII-8a0, bandXXIX-8a0, bandXXX-8a0, bandXXXI-8a0, bandXXXII-8a0}	
IRAT-ParametersUTRA-TDD128 ::=	SEQUENCE {	
supportedBandListUTRA-TDD128	SupportedBandListUTRA-TDD128	
}		
SupportedBandListUTRA-TDD128 ::=	SEQUENCE (SIZE (1..maxBands)) OF SupportedBandUTRA-TDD128	
SupportedBandUTRA-TDD128 ::=	ENUMERATED {	
	a, b, c, d, e, f, g, h, i, j, k, l, m, n,	
	o, p, ...}	
IRAT-ParametersUTRA-TDD384 ::=	SEQUENCE {	
supportedBandListUTRA-TDD384	SupportedBandListUTRA-TDD384	
}		
SupportedBandListUTRA-TDD384 ::=	SEQUENCE (SIZE (1..maxBands)) OF SupportedBandUTRA-TDD384	
SupportedBandUTRA-TDD384 ::=	ENUMERATED {	
	a, b, c, d, e, f, g, h, i, j, k, l, m, n,	
	o, p, ...}	
IRAT-ParametersUTRA-TDD768 ::=	SEQUENCE {	
supportedBandListUTRA-TDD768	SupportedBandListUTRA-TDD768	
}		
SupportedBandListUTRA-TDD768 ::=	SEQUENCE (SIZE (1..maxBands)) OF SupportedBandUTRA-TDD768	
SupportedBandUTRA-TDD768 ::=	ENUMERATED {	
	a, b, c, d, e, f, g, h, i, j, k, l, m, n,	
	o, p, ...}	
IRAT-ParametersUTRA-TDD-v1020 ::=	SEQUENCE {	
e-RedirectionUTRA-TDD-r10	ENUMERATED {supported}	
}		
IRAT-ParametersGERAN ::=	SEQUENCE {	
supportedBandListGERAN	SupportedBandListGERAN,	
interRAT-PS-HO-ToGERAN	BOOLEAN	
}		
IRAT-ParametersGERAN-v920 ::=	SEQUENCE {	
dtm-r9	ENUMERATED {supported}	OPTIONAL,
e-RedirectionGERAN-r9	ENUMERATED {supported}	OPTIONAL
}		
SupportedBandListGERAN ::=	SEQUENCE (SIZE (1..maxBands)) OF SupportedBandGERAN	
SupportedBandGERAN ::=	ENUMERATED {	
	gsm450, gsm480, gsm710, gsm750, gsm810, gsm850,	
	gsm900P, gsm900E, gsm900R, gsm1800, gsm1900,	
	spare5, spare4, spare3, spare2, spare1, ...}	
IRAT-ParametersCDMA2000-HRPD ::=	SEQUENCE {	
supportedBandListHRPD	SupportedBandListHRPD,	
tx-ConfigHRPD	ENUMERATED {single, dual},	
rx-ConfigHRPD	ENUMERATED {single, dual}	
}		
SupportedBandListHRPD ::=	SEQUENCE (SIZE (1..maxCDMA-BandClass)) OF BandclassCDMA2000	
IRAT-ParametersCDMA2000-1XRTT ::=	SEQUENCE {	
supportedBandList1XRTT	SupportedBandList1XRTT,	
tx-Config1XRTT	ENUMERATED {single, dual},	
rx-Config1XRTT	ENUMERATED {single, dual}	
}		
IRAT-ParametersCDMA2000-1XRTT-v920 ::=	SEQUENCE {	
e-CSFB-1XRTT-r9	ENUMERATED {supported},	
e-CSFB-ConcPS-Mob1XRTT-r9	ENUMERATED {supported}	OPTIONAL
}		
IRAT-ParametersCDMA2000-1XRTT-v1020 ::=	SEQUENCE {	

```

    e-CSFB-dual-lXRTT-r10          ENUMERATED {supported}
  }
  IRAT-ParametersCDMA2000-v1130 ::= SEQUENCE {
    cdma2000-NW-Sharing-r11        ENUMERATED {supported}      OPTIONAL
  }
  SupportedBandListlXRTT ::= SEQUENCE (SIZE (1..maxCDMA-BandClass)) OF BandclassCDMA2000
  IRAT-ParametersWLAN-r13 ::= SEQUENCE {
    supportedBandListWLAN-r13     SEQUENCE (SIZE (1..maxWLAN-Bands-r13)) OF WLAN-BandIndicator-r13
    OPTIONAL
  }
  CSG-ProximityIndicationParameters-r9 ::= SEQUENCE {
    intraFreqProximityIndication-r9  ENUMERATED {supported}      OPTIONAL,
    interFreqProximityIndication-r9  ENUMERATED {supported}      OPTIONAL,
    utran-ProximityIndication-r9     ENUMERATED {supported}      OPTIONAL
  }
  NeighCellSI-AcquisitionParameters-r9 ::= SEQUENCE {
    intraFreqSI-AcquisitionForHO-r9  ENUMERATED {supported}      OPTIONAL,
    interFreqSI-AcquisitionForHO-r9  ENUMERATED {supported}      OPTIONAL,
    utran-SI-AcquisitionForHO-r9     ENUMERATED {supported}      OPTIONAL
  }
  NeighCellSI-AcquisitionParameters-v1530 ::= SEQUENCE {
    reportCGI-NR-EN-DC-r15           ENUMERATED {supported}      OPTIONAL,
    reportCGI-NR-NoEN-DC-r15        ENUMERATED {supported}      OPTIONAL
  }
  NeighCellSI-AcquisitionParameters-v1550 ::= SEQUENCE {
    eutra-CGI-Reporting-ENDC-r15     ENUMERATED {supported}      OPTIONAL,
    eutra-GERAN-CGI-Reporting-ENDC-r15  ENUMERATED {supported}      OPTIONAL
  }
  NeighCellSI-AcquisitionParameters-v15a0 ::= SEQUENCE {
    eutra-CGI-Reporting-NEDC-r15     ENUMERATED {supported}      OPTIONAL
  }
  NeighCellSI-AcquisitionParameters-v1610 ::= SEQUENCE {
    eutra-SI-AcquisitionForHO-ENDC-r16  ENUMERATED {supported}      OPTIONAL,
    nr-AutonomousGaps-ENDC-FR1-r16     ENUMERATED {supported}      OPTIONAL,
    nr-AutonomousGaps-ENDC-FR2-r16     ENUMERATED {supported}      OPTIONAL,
    nr-AutonomousGaps-FR1-r16         ENUMERATED {supported}      OPTIONAL,
    nr-AutonomousGaps-FR2-r16         ENUMERATED {supported}      OPTIONAL
  }
  NeighCellSI-AcquisitionParameters-v1710 ::= SEQUENCE {
    gNB-ID-Length-Reporting-NR-EN-DC-r17  ENUMERATED {supported}      OPTIONAL,
    gNB-ID-Length-Reporting-NR-NoEN-DC-r17  ENUMERATED {supported}      OPTIONAL
  }
  SON-Parameters-r9 ::= SEQUENCE {
    rach-Report-r9                  ENUMERATED {supported}      OPTIONAL
  }
  SON-Parameters-v1800 ::= SEQUENCE {
    rach-ReportForNR-r18           ENUMERATED {supported}      OPTIONAL
  }
  PUR-Parameters-r16 ::= SEQUENCE {
    pur-CP-5GC-CE-ModeA-r16        ENUMERATED {supported}      OPTIONAL,
    pur-CP-5GC-CE-ModeB-r16        ENUMERATED {supported}      OPTIONAL,
    pur-UP-5GC-CE-ModeA-r16        ENUMERATED {supported}      OPTIONAL,
    pur-UP-5GC-CE-ModeB-r16        ENUMERATED {supported}      OPTIONAL,
    pur-CP-EPC-CE-ModeA-r16        ENUMERATED {supported}      OPTIONAL,
    pur-CP-EPC-CE-ModeB-r16        ENUMERATED {supported}      OPTIONAL,
    pur-UP-EPC-CE-ModeA-r16        ENUMERATED {supported}      OPTIONAL,
    pur-UP-EPC-CE-ModeB-r16        ENUMERATED {supported}      OPTIONAL,
    pur-CP-L1Ack-r16               ENUMERATED {supported}      OPTIONAL,
    pur-FrequencyHopping-r16       ENUMERATED {supported}      OPTIONAL,
    pur-PUSCH-NB-MaxTBS-r16        ENUMERATED {supported}      OPTIONAL,
    pur-RSRP-Validation-r16        ENUMERATED {supported}      OPTIONAL,
    pur-SubPRB-CE-ModeA-r16        ENUMERATED {supported}      OPTIONAL,
    pur-SubPRB-CE-ModeB-r16        ENUMERATED {supported}      OPTIONAL
  }

```

```

UE-BasedNetwPerfMeasParameters-r10 ::= SEQUENCE {
    loggedMeasurementsIdle-r10      ENUMERATED {supported}      OPTIONAL,
    standaloneGNSS-Location-r10     ENUMERATED {supported}      OPTIONAL
}

UE-BasedNetwPerfMeasParameters-v1250 ::= SEQUENCE {
    loggedMBSFNMeasurements-r12     ENUMERATED {supported}
}

UE-BasedNetwPerfMeasParameters-v1430 ::= SEQUENCE {
    locationReport-r14              ENUMERATED {supported}      OPTIONAL
}

UE-BasedNetwPerfMeasParameters-v1530 ::= SEQUENCE {
    loggedMeasBT-r15                ENUMERATED {supported}      OPTIONAL,
    loggedMeasWLAN-r15              ENUMERATED {supported}      OPTIONAL,
    immMeasBT-r15                   ENUMERATED {supported}      OPTIONAL,
    immMeasWLAN-r15                 ENUMERATED {supported}      OPTIONAL
}

UE-BasedNetwPerfMeasParameters-v1610 ::= SEQUENCE {
    ul-PDCP-AvgDelay-r16            ENUMERATED {supported}      OPTIONAL
}

UE-BasedNetwPerfMeasParameters-v1700 ::= SEQUENCE {
    loggedMeasIdleEventL1-r17       ENUMERATED {supported}      OPTIONAL,
    loggedMeasIdleEventOutOfCoverage-r17  ENUMERATED {supported}      OPTIONAL,
    loggedMeasUncomBarPre-r17       ENUMERATED {supported}      OPTIONAL,
    immMeasUncomBarPre-r17          ENUMERATED {supported}      OPTIONAL
}

UE-BasedNetwPerfMeasParameters-v1800 ::= SEQUENCE {
    sigBasedEUTRA-LoggedMeasOverrideProtect-r18  ENUMERATED {supported}      OPTIONAL
}

OTDOA-PositioningCapabilities-r10 ::= SEQUENCE {
    otdoa-UE-Assisted-r10           ENUMERATED {supported},
    interFreqRSTD-Measurement-r10   ENUMERATED {supported}      OPTIONAL
}

Other-Parameters-r11 ::= SEQUENCE {
    inDeviceCoexInd-r11             ENUMERATED {supported}      OPTIONAL,
    powerPrefInd-r11                ENUMERATED {supported}      OPTIONAL,
    ue-Rx-TxTimeDiffMeasurements-r11  ENUMERATED {supported}      OPTIONAL
}

Other-Parameters-v11d0 ::= SEQUENCE {
    inDeviceCoexInd-UL-CA-r11      ENUMERATED {supported}      OPTIONAL
}

Other-Parameters-v1360 ::= SEQUENCE {
    inDeviceCoexInd-HardwareSharingInd-r13  ENUMERATED {supported}      OPTIONAL
}

Other-Parameters-v1430 ::= SEQUENCE {
    bwPrefInd-r14                   ENUMERATED {supported}      OPTIONAL,
    rlm-ReportSupport-r14           ENUMERATED {supported}      OPTIONAL
}

OtherParameters-v1450 ::= SEQUENCE {
    overheatingInd-r14              ENUMERATED {supported}      OPTIONAL
}

Other-Parameters-v1460 ::= SEQUENCE {
    nonCSG-SI-Reporting-r14         ENUMERATED {supported}      OPTIONAL
}

Other-Parameters-v1530 ::= SEQUENCE {
    assistInfoBitForLC-r15          ENUMERATED {supported}      OPTIONAL,
    timeReferenceProvision-r15      ENUMERATED {supported}      OPTIONAL,
    flightPathPlan-r15              ENUMERATED {supported}      OPTIONAL
}

Other-Parameters-v1540 ::= SEQUENCE {
    inDeviceCoexInd-ENDC-r15       ENUMERATED {supported}      OPTIONAL
}

Other-Parameters-v1610 ::= SEQUENCE {

```

```

resumeWithStoredMCG-SCells-r16    ENUMERATED {supported}    OPTIONAL,
resumeWithMCG-SCellConfig-r16    ENUMERATED {supported}    OPTIONAL,
resumeWithStoredSCG-r16           ENUMERATED {supported}    OPTIONAL,
resumeWithSCG-Config-r16         ENUMERATED {supported}    OPTIONAL,
mcgRLF-RecoveryViaSCG-r16        ENUMERATED {supported}    OPTIONAL,
overheatingIndForSCG-r16         ENUMERATED {supported}    OPTIONAL
}

Other-Parameters-v1650 ::=      SEQUENCE {
  mpsPriorityIndication-r16      ENUMERATED {supported}    OPTIONAL
}

Other-Parameters-v1690 ::=      SEQUENCE {
  ul-RRC-Segmentation-r16       ENUMERATED {supported}    OPTIONAL
}

MBMS-Parameters-r11 ::=        SEQUENCE {
  mbms-SCell-r11                ENUMERATED {supported}    OPTIONAL,
  mbms-NonServingCell-r11       ENUMERATED {supported}    OPTIONAL
}

MBMS-Parameters-v1250 ::=      SEQUENCE {
  mbms-AsyncDC-r12              ENUMERATED {supported}    OPTIONAL
}

MBMS-Parameters-v1430 ::=      SEQUENCE {
  fembmsDedicatedCell-r14       ENUMERATED {supported}    OPTIONAL,
  fembmsMixedCell-r14           ENUMERATED {supported}    OPTIONAL,
  subcarrierSpacingMBMS-khz7dot5-r14  ENUMERATED {supported}    OPTIONAL,
  subcarrierSpacingMBMS-khz1dot25-r14  ENUMERATED {supported}    OPTIONAL
}

MBMS-Parameters-v1470 ::=      SEQUENCE {
  mbms-MaxBW-r14                CHOICE {
    implicitValue                NULL,
    explicitValue                INTEGER(2..20)
  },
  mbms-ScalingFactor1dot25-r14    ENUMERATED {n3, n6, n9, n12}    OPTIONAL,
  mbms-ScalingFactor7dot5-r14     ENUMERATED {n1, n2, n3, n4}    OPTIONAL
}

MBMS-Parameters-v1610 ::=      SEQUENCE {
  mbms-ScalingFactor2dot5-r16    ENUMERATED {n2, n4, n6, n8}    OPTIONAL,
  mbms-ScalingFactor0dot37-r16   ENUMERATED {n12, n16, n20, n24}    OPTIONAL,
  mbms-SupportedBandInfoList-r16  SEQUENCE (SIZE (1..maxBands)) OF MBMS-SupportedBandInfo-r16
}

MBMS-Parameters-v1700 ::=      SEQUENCE {
  mbms-SupportedBandInfoList-v1700  SEQUENCE (SIZE (1..maxBands)) OF MBMS-SupportedBandInfo-
v1700    OPTIONAL
}

MBMS-SupportedBandInfo-r16 ::=  SEQUENCE {
  subcarrierSpacingMBMS-khz2dot5-r16  ENUMERATED {supported}    OPTIONAL,
  subcarrierSpacingMBMS-khz0dot37-r16  SEQUENCE {
    timeSeparationSlot2-r16          ENUMERATED {supported}    OPTIONAL,
    timeSeparationSlot4-r16          ENUMERATED {supported}    OPTIONAL
  }    OPTIONAL
}

MBMS-SupportedBandInfo-v1700 ::= SEQUENCE {
  pmch-Bandwidth-n40-r17            ENUMERATED {supported}    OPTIONAL,
  pmch-Bandwidth-n35-r17            ENUMERATED {supported}    OPTIONAL,
  pmch-Bandwidth-n30-r17            ENUMERATED {supported}    OPTIONAL
}

FeMBMS-Unicast-Parameters-r14 ::= SEQUENCE {
  unicast-fembmsMixedSCell-r14      ENUMERATED {supported}    OPTIONAL,
  emptyUnicastRegion-r14            ENUMERATED {supported}    OPTIONAL
}

SCPTM-Parameters-r13 ::=        SEQUENCE {
  scptm-ParallelReception-r13       ENUMERATED {supported}    OPTIONAL,
  scptm-SCell-r13                   ENUMERATED {supported}    OPTIONAL,
  scptm-NonServingCell-r13         ENUMERATED {supported}    OPTIONAL,
  scptm-AsyncDC-r13                ENUMERATED {supported}    OPTIONAL
}

```

```

CE-Parameters-r13 ::= SEQUENCE {
    ce-ModeA-r13          ENUMERATED {supported}          OPTIONAL,
    ce-ModeB-r13          ENUMERATED {supported}          OPTIONAL
}

CE-Parameters-v1320 ::= SEQUENCE {
    intraFreqA3-CE-ModeA-r13  ENUMERATED {supported}          OPTIONAL,
    intraFreqA3-CE-ModeB-r13  ENUMERATED {supported}          OPTIONAL,
    intraFreqHO-CE-ModeA-r13  ENUMERATED {supported}          OPTIONAL,
    intraFreqHO-CE-ModeB-r13  ENUMERATED {supported}          OPTIONAL
}

CE-Parameters-v1350 ::= SEQUENCE {
    unicastFrequencyHopping-r13  ENUMERATED {supported}          OPTIONAL
}

CE-Parameters-v1370 ::= SEQUENCE {
    tm9-CE-ModeA-r13          ENUMERATED {supported}          OPTIONAL,
    tm9-CE-ModeB-r13          ENUMERATED {supported}          OPTIONAL
}

CE-Parameters-v1380 ::= SEQUENCE {
    tm6-CE-ModeA-r13          ENUMERATED {supported}          OPTIONAL
}

CE-Parameters-v1430 ::= SEQUENCE {
    ce-SwitchWithoutHO-r14      ENUMERATED {supported}          OPTIONAL
}

CE-MultiTB-Parameters-r16 ::= SEQUENCE {
    pdsch-MultiTB-CE-ModeA-r16  ENUMERATED {supported}          OPTIONAL,
    pdsch-MultiTB-CE-ModeB-r16  ENUMERATED {supported}          OPTIONAL,
    pusch-MultiTB-CE-ModeA-r16  ENUMERATED {supported}          OPTIONAL,
    pusch-MultiTB-CE-ModeB-r16  ENUMERATED {supported}          OPTIONAL,
    ce-MultiTB-64QAM-r16        ENUMERATED {supported}          OPTIONAL,
    ce-MultiTB-EarlyTermination-r16  ENUMERATED {supported}          OPTIONAL,
    ce-MultiTB-FrequencyHopping-r16  ENUMERATED {supported}          OPTIONAL,
    ce-MultiTB-HARQ-AckBundling-r16  ENUMERATED {supported}          OPTIONAL,
    ce-MultiTB-Interleaving-r16     ENUMERATED {supported}          OPTIONAL,
    ce-MultiTB-SubPRB-r16        ENUMERATED {supported}          OPTIONAL
}

CE-ResourceResvParameters-r16 ::= SEQUENCE {
    subframeResourceResvDL-CE-ModeA-r16  ENUMERATED {supported}          OPTIONAL,
    subframeResourceResvDL-CE-ModeB-r16  ENUMERATED {supported}          OPTIONAL,
    subframeResourceResvUL-CE-ModeA-r16  ENUMERATED {supported}          OPTIONAL,
    subframeResourceResvUL-CE-ModeB-r16  ENUMERATED {supported}          OPTIONAL,
    slotSymbolResourceResvDL-CE-ModeA-r16  ENUMERATED {supported}          OPTIONAL,
    slotSymbolResourceResvDL-CE-ModeB-r16  ENUMERATED {supported}          OPTIONAL,
    slotSymbolResourceResvUL-CE-ModeA-r16  ENUMERATED {supported}          OPTIONAL,
    slotSymbolResourceResvUL-CE-ModeB-r16  ENUMERATED {supported}          OPTIONAL,
    subcarrierPuncturingCE-ModeA-r16      ENUMERATED {supported}          OPTIONAL,
    subcarrierPuncturingCE-ModeB-r16      ENUMERATED {supported}          OPTIONAL
}

LAA-Parameters-r13 ::= SEQUENCE {
    crossCarrierSchedulingLAA-DL-r13      ENUMERATED {supported}          OPTIONAL,
    csi-RS-DRS-RRM-MeasurementsLAA-r13   ENUMERATED {supported}          OPTIONAL,
    downlinkLAA-r13                       ENUMERATED {supported}          OPTIONAL,
    endingDwPTS-r13                       ENUMERATED {supported}          OPTIONAL,
    secondSlotStartingPosition-r13        ENUMERATED {supported}          OPTIONAL,
    tm9-LAA-r13                           ENUMERATED {supported}          OPTIONAL,
    tm10-LAA-r13                          ENUMERATED {supported}          OPTIONAL
}

LAA-Parameters-v1430 ::= SEQUENCE {
    crossCarrierSchedulingLAA-UL-r14      ENUMERATED {supported}          OPTIONAL,
    uplinkLAA-r14                        ENUMERATED {supported}          OPTIONAL,
    twoStepSchedulingTimingInfo-r14       ENUMERATED {nPlus1, nPlus2, nPlus3} OPTIONAL,
    uss-BlindDecodingAdjustment-r14      ENUMERATED {supported}          OPTIONAL,
    uss-BlindDecodingReduction-r14       ENUMERATED {supported}          OPTIONAL,
    outOfSequenceGrantHandling-r14       ENUMERATED {supported}          OPTIONAL
}

LAA-Parameters-v1530 ::= SEQUENCE {
    aul-r15                               ENUMERATED {supported}          OPTIONAL,
    laa-PUSCH-Mode1-r15                   ENUMERATED {supported}          OPTIONAL,
    laa-PUSCH-Mode2-r15                   ENUMERATED {supported}          OPTIONAL
}

```

```

    laa-PUSCH-Mode3-r15                ENUMERATED {supported}    OPTIONAL
}

WLAN-IW-Parameters-r12 ::= SEQUENCE {
    wlan-IW-RAN-Rules-r12                ENUMERATED {supported}    OPTIONAL,
    wlan-IW-ANDSF-Policies-r12           ENUMERATED {supported}    OPTIONAL
}

LWA-Parameters-r13 ::= SEQUENCE {
    lwa-r13                               ENUMERATED {supported}    OPTIONAL,
    lwa-SplitBearer-r13                   ENUMERATED {supported}    OPTIONAL,
    wlan-MAC-Address-r13                   OCTET STRING (SIZE (6))   OPTIONAL,
    lwa-BufferSize-r13                     ENUMERATED {supported}    OPTIONAL
}

LWA-Parameters-v1430 ::= SEQUENCE {
    lwa-HO-WithoutWT-Change-r14           ENUMERATED {supported}    OPTIONAL,
    lwa-UL-r14                             ENUMERATED {supported}    OPTIONAL,
    wlan-PeriodicMeas-r14                 ENUMERATED {supported}    OPTIONAL,
    wlan-ReportAnyWLAN-r14                ENUMERATED {supported}    OPTIONAL,
    wlan-SupportedDataRate-r14            INTEGER (1..2048)         OPTIONAL
}

LWA-Parameters-v1440 ::= SEQUENCE {
    lwa-RLC-UM-r14                         ENUMERATED {supported}    OPTIONAL
}

WLAN-IW-Parameters-v1310 ::= SEQUENCE {
    rclwi-r13                               ENUMERATED {supported}    OPTIONAL
}

LWIP-Parameters-r13 ::= SEQUENCE {
    lwip-r13                               ENUMERATED {supported}    OPTIONAL
}

LWIP-Parameters-v1430 ::= SEQUENCE {
    lwip-Aggregation-DL-r14                ENUMERATED {supported}    OPTIONAL,
    lwip-Aggregation-UL-r14                ENUMERATED {supported}    OPTIONAL
}

NAICS-Capability-List-r12 ::= SEQUENCE (SIZE (1..maxNAICS-Entries-r12)) OF NAICS-Capability-Entry-
r12

NAICS-Capability-Entry-r12 ::= SEQUENCE {
    numberOfNAICS-CapableCC-r12            INTEGER(1..5),
    numberOfAggregatedPRB-r12              ENUMERATED {
        n50, n75, n100, n125, n150, n175,
        n200, n225, n250, n275, n300, n350,
        n400, n450, n500, spare},
    ...
}

SL-Parameters-r12 ::= SEQUENCE {
    commSimultaneousTx-r12                 ENUMERATED {supported}    OPTIONAL,
    commSupportedBands-r12                  FreqBandIndicatorListEUTRA-r12 OPTIONAL,
    discSupportedBands-r12                  SupportedBandInfoList-r12 OPTIONAL,
    discScheduledResourceAlloc-r12          ENUMERATED {supported}    OPTIONAL,
    disc-UE-SelectedResourceAlloc-r12       ENUMERATED {supported}    OPTIONAL,
    disc-SLSS-r12                           ENUMERATED {supported}    OPTIONAL,
    discSupportedProc-r12                    ENUMERATED {n50, n400}    OPTIONAL
}

SL-Parameters-v1310 ::= SEQUENCE {
    discSysInfoReporting-r13                ENUMERATED {supported}    OPTIONAL,
    commMultipleTx-r13                       ENUMERATED {supported}    OPTIONAL,
    discInterFreqTx-r13                      ENUMERATED {supported}    OPTIONAL,
    discPeriodicSLSS-r13                     ENUMERATED {supported}    OPTIONAL
}

SL-Parameters-v1430 ::= SEQUENCE {
    zoneBasedPoolSelection-r14              ENUMERATED {supported}    OPTIONAL,
    ue-AutonomousWithFullSensing-r14        ENUMERATED {supported}    OPTIONAL,
    ue-AutonomousWithPartialSensing-r14     ENUMERATED {supported}    OPTIONAL,
    sl-CongestionControl-r14                 ENUMERATED {supported}    OPTIONAL,
    v2x-TxWithShortResvInterval-r14         ENUMERATED {supported}    OPTIONAL,
    v2x-numberTxRxTiming-r14                INTEGER(1..16)             OPTIONAL,
    v2x-nonAdjacentPSCCH-PSSCH-r14          ENUMERATED {supported}    OPTIONAL
}

```



```

    slss-TxRx-r14                ENUMERATED {supported}                OPTIONAL,
    v2x-SupportedBandCombinationList-r14 V2X-SupportedBandCombination-r14 OPTIONAL
}

SL-Parameters-v1530 ::=          SEQUENCE {
    slss-SupportedTxFreq-r15      ENUMERATED {single, multiple}    OPTIONAL,
    sl-64QAM-Tx-r15              ENUMERATED {supported}            OPTIONAL,
    sl-TxDiversity-r15          ENUMERATED {supported}            OPTIONAL,
    ue-CategorySL-r15          UE-CategorySL-r15                OPTIONAL,
    v2x-SupportedBandCombinationList-v1530 V2X-SupportedBandCombination-v1530 OPTIONAL
}

SL-Parameters-v1540 ::=          SEQUENCE {
    sl-64QAM-Rx-r15              ENUMERATED {supported}            OPTIONAL,
    sl-RateMatchingTBSScaling-r15 ENUMERATED {supported}            OPTIONAL,
    sl-LowT2min-r15            ENUMERATED {supported}            OPTIONAL,
    v2x-SensingReportingMode3-r15 ENUMERATED {supported}            OPTIONAL
}

SL-Parameters-v1610 ::=          SEQUENCE {
    sl-ParameterNR-r16          OCTET STRING                    OPTIONAL,
    dummy                      V2X-SupportedBandCombinationEUTRA-NR-r16 OPTIONAL
}

SL-Parameters-v1630 ::=          SEQUENCE {
    v2x-SupportedBandCombinationListEUTRA-NR-r16 V2X-SupportedBandCombinationEUTRA-NR-v1630
    OPTIONAL
}

SL-Parameters-v1710 ::=          SEQUENCE {
    v2x-SupportedBandCombinationListEUTRA-NR-v1710 V2X-SupportedBandCombinationEUTRA-NR-v1710
    OPTIONAL
}

SL-Parameters-v1800 ::=          SEQUENCE {
    sl-A2X-SupportedBandCombinationList-r18      SL-A2X-SupportedBandCombination-r18      OPTIONAL,
    sl-A2X-Service-r18                          ENUMERATED {brid, daa, bridAndDAA}    OPTIONAL
}

UE-CategorySL-r15 ::=          SEQUENCE {
    ue-CategorySL-C-TX-r15          INTEGER(1..5),
    ue-CategorySL-C-RX-r15          INTEGER(1..4)
}

V2X-SupportedBandCombination-r14 ::= SEQUENCE (SIZE (1..maxBandComb-r13)) OF V2X-
BandCombinationParameters-r14

V2X-SupportedBandCombination-v1530 ::= SEQUENCE (SIZE (1..maxBandComb-r13)) OF V2X-
BandCombinationParameters-v1530

V2X-BandCombinationParameters-r14 ::= SEQUENCE (SIZE (1.. maxSimultaneousBands-r10)) OF V2X-
BandParameters-r14

V2X-BandCombinationParameters-v1530 ::= SEQUENCE (SIZE (1.. maxSimultaneousBands-r10)) OF V2X-
BandParameters-v1530

V2X-SupportedBandCombinationEUTRA-NR-r16 ::= SEQUENCE (SIZE (1..maxBandCombSidelinkNR-r16)) OF
V2X-BandParametersEUTRA-NR-r16

V2X-SupportedBandCombinationEUTRA-NR-v1630 ::= SEQUENCE (SIZE (1..maxBandCombSidelinkNR-r16)) OF
V2X-BandCombinationParametersEUTRA-NR-v1630

V2X-SupportedBandCombinationEUTRA-NR-v1710 ::= SEQUENCE (SIZE (1..maxBandCombSidelinkNR-r16)) OF
V2X-BandCombinationParametersEUTRA-NR-v1710

V2X-BandCombinationParametersEUTRA-NR-v1630 ::= SEQUENCE {
    bandListSidelinkEUTRA-NR-r16          SEQUENCE (SIZE (1.. maxSimultaneousBands-r10))
OF V2X-BandParametersEUTRA-NR-r16,
    bandListSidelinkEUTRA-NR-v1630      SEQUENCE (SIZE (1.. maxSimultaneousBands-r10))
OF V2X-BandParametersEUTRA-NR-v1630
}

V2X-BandCombinationParametersEUTRA-NR-v1710 ::= SEQUENCE (SIZE (1..maxSimultaneousBands-r10)) OF
V2X-BandParametersEUTRA-NR-v1710

V2X-BandParametersEUTRA-NR-r16 ::= CHOICE {
    eutra          SEQUENCE {
        v2x-BandParameters1-r16          V2X-BandParameters-r14          OPTIONAL,

```

```

    },
    nr
    v2x-BandParametersNR-r16
  }
}
V2X-BandParametersEUTRA-NR-v1630 ::= CHOICE {
  eutra
  nr
  tx-Sidelink-r16
  rx-Sidelink-r16
}
V2X-BandParametersEUTRA-NR-v1710 ::= SEQUENCE {
  v2x-BandParametersEUTRA-NR-v1710
}
SL-A2X-SupportedBandCombination-r18 ::= SEQUENCE (SIZE (1..maxBandComb-r13)) OF SL-A2X-
BandCombinationParameters-r18
SL-A2X-BandCombinationParameters-r18 ::= SEQUENCE (SIZE (1.. maxSimultaneousBands-r10)) OF SL-
A2X-BandParameters-r18
SL-A2X-BandParameters-r18 ::= SEQUENCE {
  a2x-FreqBandEUTRA-r18
  a2x-BandParametersTxSL-r18
  a2x-BandParametersRxSL-r18
}
BandParametersTxA2X-r18 ::= SEQUENCE {
  a2x-BandwidthClassTxSL-r18
}
BandParametersRxA2X-r18 ::= SEQUENCE {
  a2x-BandwidthClassRxSL-r18
}
SupportedBandInfoList-r12 ::= SEQUENCE (SIZE (1..maxBands)) OF SupportedBandInfo-r12
SupportedBandInfo-r12 ::= SEQUENCE {
  support-r12
}
FreqBandIndicatorListEUTRA-r12 ::= SEQUENCE (SIZE (1..maxBands)) OF FreqBandIndicator-r11
MMTEL-Parameters-r14 ::= SEQUENCE {
  delayBudgetReporting-r14
  pusch-Enhancements-r14
  recommendedBitRate-r14
  recommendedBitRateQuery-r14
}
MMTEL-Parameters-v1610 ::= SEQUENCE {
  recommendedBitRateMultiplier-r16
}
SRS-CapabilityPerBandPair-r14 ::= SEQUENCE {
  retuningInfo
  rf-RetuningTimeDL-r14
  rf-RetuningTimeUL-r14
}
SRS-CapabilityPerBandPair-v14b0 ::= SEQUENCE {
  srs-FlexibleTiming-r14
  srs-HARQ-ReferenceConfig-r14
}
SRS-CapabilityPerBandPair-v1610 ::= SEQUENCE {
  addSRS-CarrierSwitching-r16
}

```

```
HighSpeedEnhParameters-r14 ::= SEQUENCE {
    measurementEnhancements-r14      ENUMERATED {supported}      OPTIONAL,
    demodulationEnhancements-r14     ENUMERATED {supported}      OPTIONAL,
    prach-Enhancements-r14           ENUMERATED {supported}      OPTIONAL
}

HighSpeedEnhParameters-v1610 ::= SEQUENCE {
    measurementEnhancementsSCell-r16  ENUMERATED {supported}      OPTIONAL,
    measurementEnhancements2-r16      ENUMERATED {supported}      OPTIONAL,
    demodulationEnhancements2-r16     ENUMERATED {supported}      OPTIONAL,
    interRAT-enhancementNR-r16        ENUMERATED {supported}      OPTIONAL
}

-- ASN1STOP
```

<b>UE-EUTRA-Capability field descriptions</b>	<b>FDD/ TDD diff</b>
<b>accessStratumRelease</b> This field indicates the release supported by the UE. NOTE 7.	-
<b>additionalRx-Tx-PerformanceReq</b> Indicates whether the UE supports the additional Rx and Tx performance requirement for a given band combination as specified in TS 36.101 [42].	-
<b>addSRS</b> Presence of this field indicates the UE supports the additional SRS symbol(s) within the normal UL subframes in TDD as described in TS 36.213 [23].	-
<b>addSRS-1T2R</b> Indicates whether the UE supports selecting one antenna among two antennas to transmit additional SRS symbol(s) for the corresponding band of the band combination as described in TS 36.213 [23].	-
<b>addSRS-1T4R</b> Indicates whether the UE supports selecting one antenna among four antennas to transmit additional SRS symbol(s) for the corresponding band of the band combination as described in TS 36.213 [23].	-
<b>addSRS-2T4R-2Pairs</b> Indicates whether the UE supports selecting one antenna pair between two antenna pairs to transmit additional SRS symbol(s) simultaneously for the corresponding band of the band combination as described in TS 36.213 [23].	-
<b>addSRS-2T4R-3Pairs</b> Indicates whether the UE supports selecting one antenna pair among three antenna pairs to transmit additional SRS symbol(s) simultaneously for the corresponding band of the band combination as described in TS 36.213 [23].	-
<b>addSRS-AntennaSwitching (in addSRS)</b> Value <i>useBasic</i> indicates the antenna switching capabilities for additional SRS symbol(s) for a band of band combination for which the capability is not signalled in <i>bandParameterList-v1610</i> is the same as indicated by <i>bandParameterList-v1380</i> and/or <i>bandParameterList-v1530</i> for the concerned band of band combination.	-
<b>addSRS-AntennaSwitching (in bandParameterList-v1610)</b> If signalled, the field indicates the antenna switching capabilities for additional SRS symbol(s) for the concerned band of band combination.	-
<b>addSRS-CarrierSwitching (in addSRS)</b> Indicates whether carrier switching is supported for additional SRS symbol(s) for all band pairs of band combinations for which UE supports SRS carrier switching. This field is included only if <i>srs-CapabilityPerBandPairList-r14</i> is included. If this field is included, <i>addSRS-CarrierSwitching</i> (in <i>bandParameterList-v1610</i> ) is not included.	-
<b>addSRS-CarrierSwitching (in bandParameterList-v1610)</b> Indicates whether carrier switching is supported for additional SRS symbol(s) for the concerned band pair of band combination. This field is included only if <i>srs-CapabilityPerBandPairList-r14</i> is included. If this field is included, <i>addSRS-CarrierSwitching</i> (in <i>addSRS</i> ) is not included.	-
<b>addSRS-FrequencyHopping (in addSRS)</b> Indicates whether frequency hopping is supported for additional SRS symbol(s) for all bands of band combinations for which the capability is not signalled in <i>bandParameterList-v1610</i> .	-
<b>addSRS-FrequencyHopping (in bandParameterList-v1610)</b> If signalled, the field indicates whether frequency hopping is supported for additional SRS symbol(s) for the concerned band of band combination.	-
<b>allowedCellList</b> Indicates whether the UE supports EUTRA allowed-cell listing to limit the set of cells applicable for measurements.	-
<b>alternativeTBS-Indices</b> Indicates whether the UE supports alternative TBS indices $t_{BS}$ 26A and 33A as specified in TS 36.213 [23].	-
<b>alternativeTBS-Index</b> Indicates whether the UE supports alternative TBS index $I_{TBS}$ 33B as specified in TS 36.213 [23].	No
<b>alternativeTimeToTrigger</b> Indicates whether the UE supports alternativeTimeToTrigger.	No
<b>altFreqPriority</b> Indicates whether the UE supports alternative cell reselection priority.	No
<b>altMCS-Table</b> Indicates whether the UE supports the 6-bit MCS table as specified in TS 36.212 [22] and TS 36.213 [23].	Yes

<b>UE-EUTRA-Capability field descriptions</b>	<b>FDD/ TDD diff</b>
<b>aperiodicCSI-Reporting</b> Indicates whether the UE supports aperiodic CSI reporting with 3 bits of the CSI request field size as specified in TS 36.213 [23], clause 7.2.1 and/or aperiodic CSI reporting mode 1-0 and mode 1-1 as specified in TS 36.213 [23], clause 7.2.1. The first bit is set to "1" if the UE supports the aperiodic CSI reporting with 3 bits of the CSI request field size. The second bit is set to "1" if the UE supports the aperiodic CSI reporting mode 1-0 and mode 1-1.	No
<b>aperiodicCsi-ReportingSTTI</b> Indicates whether the UE supports aperiodic CSI reporting for short TTI as specified in TS 36.213 [23], clause 7.2.1.	Yes
<b>appliedCapabilityFilterCommon</b> Contains the filter, applied by the UE, common for all MR-DC related capability containers that are requested and as defined by <i>UE-CapabilityRequestFilterCommon</i> IE in TS 38.331 [82].	-
<b>assistInfoBitForLC</b> Indicates whether the UE supports assistance information bit for local cache.	-
<b>aul</b> Indicates whether the UE supports AUL as specified in TS 36.321 [6].	-
<b>bandCombinationListEUTRA</b> One entry corresponding to each supported band combination listed in the same order as in <i>supportedBandCombination</i> .	-
<b>BandCombinationParameters-v1090, BandCombinationParameters-v10i0, BandCombinationParameters-v1270</b> If included, the UE shall include the same number of entries, and listed in the same order, as in <i>BandCombinationParameters-r10</i> .	-
<b>BandCombinationParameters-v1130</b> The field is applicable to each supported CA bandwidth class combination (i.e. CA configuration in TS 36.101 [42], clause 5.6A.1) indicated in the corresponding band combination. If included, the UE shall include the same number of entries, and listed in the same order, as in <i>BandCombinationParameters-r10</i> .	-
<b>bandEUTRA</b> E-UTRA band as defined in TS 36.101 [42] and TS 36.102 [113] for NTN capable UE. In case the UE includes <i>bandEUTRA-v9e0</i> or <i>bandEUTRA-v1090</i> , the UE shall set the corresponding entry of <i>bandEUTRA</i> (i.e. without suffix) or <i>bandEUTRA-r10</i> respectively to <i>maxFBI</i> .	-
<b>bandInfoNR-v1610, bandInfoNR-v1800</b> One entry corresponding to each supported E-UTRA band listed in the same order as in <i>supportedBandListEUTRA</i> . If <i>bandInfoNR-v1610</i> is absent, network assumes gap is required when measurement is performed on any NR bands while UE is served by cell(s) belongs to a E-UTRA band listed in <i>supportedBandListEUTRA</i> except for the FR2 inter-RAT measurement which depends on the support of <i>independentGapConfig</i> .	-
<b>bandListEUTRA</b> One entry corresponding to each supported E-UTRA band listed in the same order as in <i>supportedBandListEUTRA</i> .	-
<b>bandParameterList-v1380</b> If included, the UE shall include the same number of entries listed in the same order as the band entries in the corresponding band combination.	-
<b>bandParametersUL, bandParametersDL</b> Indicates the supported parameters for the band. Each of <i>CA-MIMO-ParametersUL</i> and <i>CA-MIMO-ParametersDL</i> can be included only once for one band in a single band combination entry.	-
<b>beamformed (in MIMO-CA-ParametersPerBoBCPerTM)</b> If signalled, the field indicates for a particular transmission mode, the UE capabilities concerning beamformed EBF/ FD-MIMO operation (class B) applicable for the concerned band combination.	-
<b>beamformed (in MIMO-UE-ParametersPerTM)</b> Indicates for a particular transmission mode, the UE capabilities concerning beamformed EBF/ FD-MIMO operation (class B) applicable for band combinations for which the concerned capabilities are not signalled.	Yes
<b>benefitsFromInterruption</b> Indicates whether the UE power consumption would benefit from being allowed to cause interruptions to serving cells when performing measurements of deactivated SCell carriers for <i>measCycleSCell</i> of less than 640ms, as specified in TS 36.133 [16].	No
<b>bwPrefInd</b> Indicates whether the UE supports maximum PDSCH/PUSCH bandwidth preference indication.	-

<b>UE-EUTRA-Capability field descriptions</b>	<b>FDD/ TDD diff</b>
<b>ca-BandwidthClass</b> The CA bandwidth class supported by the UE as defined in TS 36.101 [42], Table 5.6A-1. The UE explicitly includes all the supported CA bandwidth class combinations in the band combination signalling. Support for one CA bandwidth class does not implicitly indicate support for another CA bandwidth class.	-
<b>ca-IdleModeMeasurements</b> Indicates whether UE supports reporting measurements performed during RRC_IDLE.	-
<b>ca-IdleModeValidityArea</b> Indicates whether UE supports validity area for IDLE measurements during RRC_IDLE.	-
<b>cch-IM-RefRecTypeA-OneRX-Port</b> This field defines whether the DL Category 1bis or the DL Category M2 UE supports Type A downlink control channel interference mitigation (CCH-IM) receiver "LMMSE-IRC + CRS-IC" for PDCCH/PCFICH/PHICH/EPDCCH receive processing (Enhanced downlink control channel performance requirements Type A in TS 36.101 [6]).	No
<b>cch-InterfMitigation-RefRecTypeA, cch-InterfMitigation-RefRecTypeB, cch-InterfMitigation-MaxNumCCs</b> The field <i>cch-InterfMitigation-RefRecTypeA</i> defines whether the UE supports Type A downlink control channel interference mitigation (CCH-IM) receiver "LMMSE-IRC + CRS-IC" for PDCCH/PCFICH/PHICH/EPDCCH receive processing (Enhanced downlink control channel performance requirements Type A in the TS 36.101 [6]). The field <i>cch-InterfMitigation-RefRecTypeB</i> defines whether the UE supports Type B downlink CCH-IM receiver "E-LMMSE-IRC + CRS-IC" for PDCCH/PCFICH/PHICH receive processing in synchronous networks (Enhanced downlink control channel performance requirements Type B in the TS 36.101 [6]). The UE supporting the capability defined by <i>cch-InterfMitigation-RefRecTypeB-r13</i> shall also support the capability defined by <i>cch-InterfMitigation-RefRecTypeA-r13</i> .  If the UE sets one or more of the fields <i>cch-InterfMitigation-RefRecTypeA</i> and <i>cch-InterfMitigation-RefRecTypeB</i> to "supported", the UE shall include the parameter <i>cch-InterfMitigation-MaxNumCCs</i> to indicate that the UE supports CCH-IM on at least one arbitrary downlink CC for up to <i>cch-InterfMitigation-MaxNumCCs</i> downlink CC CA configuration. The UE shall not include the parameter <i>cch-InterfMitigation-MaxNumCCs</i> if neither <i>cch-InterfMitigation-RefRecTypeA</i> nor <i>cch-InterfMitigation-RefRecTypeB</i> is present. The UE may not perform CCH-IM on more than 1 DL CCs. For example, the UE sets " <i>cch-InterfMitigation-MaxNumCCs</i> = 3" to indicate that UE supports CCH-IM on at least one DL CC for supported non-CA, 2DL CA and 3DL CA configurations. For CA scenarios, the CCH-IM is guaranteed to be supported on at least one arbitrary component carrier.	-
<b>cdma2000-NW-Sharing</b> Indicates whether the UE supports network sharing for CDMA2000.	-
<b>ce-ClosedLoopTxAntennaSelection</b> Indicates whether the UE supports UL closed-loop Tx antenna selection in CE mode A, as specified in TS 36.212 [22].	Yes
<b>ce-CQI-AlternativeTable</b> Indicates whether the UE supports alternative CQI table in CE mode A. See TS 36.213 [22].	Yes
<b>ce-CRS-IntfMitig</b> Indicates whether UE supports CRS interference mitigation, i.e., value <i>supported</i> indicates UE does not rely on the CRS outside certain PRBs and subframes as defined in TS 36.133 [16], clauses 3.6.1.2 and 3.6.1.3, and TS 36.213 [23] when operating in coverage enhancement mode.	Yes
<b>ce-CSI-RS-Feedback</b> Indicates whether the UE supports CSI-RS based feedback when the UE is operating in CE mode A, as specified in TS 36.213 [23].	Yes
<b>ce-CSI-RS-FeedbackCodebookRestriction</b> Indicates whether the UE supports CSI-RS based feedback with codebook subset restriction when the UE in CE is operating in CE mode A, as specified in TS 36.213 [23].	Yes
<b>ce-DL-ChannelQualityReporting</b> Indicates whether UE operating in CE mode supports aperiodic DL channel quality reporting in RRC_CONNECTED.	Yes
<b>ce-EUTRA-5GC</b> Indicates whether the UE operating in CE mode A or B supports E-UTRA/5GC.	Yes
<b>ce-EUTRA-5GC-HO-ToNR-FDD-FR1</b> Indicates whether the UE operating in CE mode A or B supports handover from E-UTRA/5GC to NR FDD FR1.	Yes
<b>ce-EUTRA-5GC-HO-ToNR-TDD-FR1</b> Indicates whether the UE operating in CE mode A or B supports handover from E-UTRA/5GC to NR TDD FR1.	Yes

<b>UE-EUTRA-Capability field descriptions</b>	<b>FDD/ TDD diff</b>
<b>ce-EUTRA-5GC-HO-ToNR-FDD-FR2</b> Indicates whether the UE operating in CE mode A or B supports handover from E-UTRA/5GC to NR FDD FR2.	Yes
<b>ce-EUTRA-5GC-HO-ToNR-TDD-FR2</b> Indicates whether the UE operating in CE mode A or B supports handover from E-UTRA/5GC to NR TDD FR2-1.	Yes
<b>ce-EUTRA-5GC-HO-ToNR-TDD-FR2-2</b> Indicates whether the UE operating in CE mode A or B supports handover from E-UTRA/5GC to NR TDD FR2-2.	-
<b>ce-HARQ-AckBundling</b> Indicates whether the UE supports HARQ-ACK bundling in half duplex FDD in CE mode A, as specified in TS 36.212 [22] and TS 36.213 [23].	-
<b>ce-InactiveState</b> Indicates whether UE operating in CE mode supports RRC_INACTIVE when connected to 5GC. A UE including this field also supports short eDRX cycles in RRC_INACTIVE when connected to 5GC.	No
<b>ce-MeasRSS-Dedicated, ce-MeasRSS-DedicatedSameRBs</b> Indicates whether the UE operating in CE mode A/B supports receiving neighbour cell RSS information in dedicated signalling and performing serving cell and neighbour cell measurements based on RSS in RRC_CONNECTED as specified in TS 36.306 [5] and TS 36.133 [16].	Yes
<b>ce-ModeA, ce-ModeB</b> Indicates whether the UE supports operation in CE mode A and/or B, as specified in TS 36.211 [21] and TS 36.213 [23].	-
<b>crs-ChEstMPDCCH-CE-ModeA, crs-ChEstMPDCCH-CE-ModeB</b> Indicates whether UE operating in CE mode A/B supports using CRS for improving MPDCCH channel estimation.	Yes
<b>crs-ChEstMPDCCH-CSI</b> Indicates whether UE operating in CE mode A supports CSI-based mapping for improving MPDCCH channel estimation.	Yes
<b>crs-ChEstMPDCCH-ReciprocityTDD</b> Indicates whether UE operating in CE mode A supports using CRS for improving MPDCCH channel estimation with reciprocity-based candidates in TDD.	No
<b>ceMeasurements</b> Indicates whether the UE supports intra-frequency RSRQ measurements and inter-frequency RSRP and RSRQ measurements in RRC_CONNECTED, as specified in TS 36.133 [16] and TS 36.304 [4].	-
<b>ce-MultiTB-64QAM</b> Indicates whether the UE supports downlink 64QAM for multiple TB scheduling in connected mode for PDSCH when operating in CE mode A, as specified in TS 36.211 [21] and TS 36.213 [23]. This field can be included only if <i>ce-PUSCH-SubPRB-Allocation</i> is included.	Yes
<b>ce-MultiTB-EarlyTermination</b> Indicates whether the UE supports early termination of PUSCH transmission for multiple TB scheduling in connected mode, as specified in TS 36.211 [21] and TS 36.213 [23].	Yes
<b>ce-MultiTB-FrequencyHopping</b> Indicates whether the UE supports frequency hopping for multiple TB scheduling for PDSCH/PUSCH in connected mode, as specified in TS 36.211 [21] and TS 36.213 [23].	Yes
<b>ce-MultiTB-HARQ-AckBundling</b> Indicates whether the UE supports downlink HARQ-ACK bundling for multiple TB scheduling in connected mode when operating in CE mode A, as specified in TS 36.211 [21] and TS 36.213 [23].	Yes
<b>ce-MultiTB-Interleaving</b> Indicates whether the UE supports TB interleaving for multiple TB scheduling in connected mode for PDSCH/PUSCH when operating in CE mode A or B, as specified in TS 36.211 [21] and TS 36.213 [23].	Yes
<b>ce-MultiTB-SubPRB</b> Indicates whether the UE supports sub-PRB allocation for multiple TB scheduling for PUSCH in connected mode, as specified in TS 36.211 [21] and TS 36.213 [23]. This field can be included only if <i>ce-PUSCH-SubPRB-Allocation</i> is included.	Yes
<b>ce-PDSCH-14HARQProcesses, ce-PDSCH-14HARQProcesses-Alt2</b> Indicates whether the UE supports 14-HARQ processes, as specified in TS 36.212 [22].	-
<b>ce-PDSCH-64QAM</b> Indicates whether the UE supports 64QAM for non-repeated unicast PDSCH in CE mode A.	Yes

<b>UE-EUTRA-Capability field descriptions</b>	<b>FDD/ TDD diff</b>
<b>ce-PDSCH-FlexibleStartPRB-CE-ModeA, ce-PDSCH-FlexibleStartPRB-CE-ModeB, ce-PUSCH-FlexibleStartPRB-CE-ModeA, ce-PUSCH-FlexibleStartPRB-CE-ModeB</b> This field indicates whether UE supports flexible starting PRB for PDSCH/PUSCH when operating in coverage enhancement mode A/B, as specified in TS 36.211 [21] and TS 36.213 [22].	Yes
<b>ce-PDSCH-MaxTBS</b> Indicates whether the UE supports downlink TBS of 1736 bits, as specified in TS 36.212 [22].	-
<b>ce-PDSCH-PUSCH-Enhancement</b> Indicates whether the UE supports new numbers of repetitions for PUSCH and modulation restrictions for PDSCH/PUSCH in CE mode A as specified in TS 36.212 [22] and TS 36.213 [23].	No
<b>ce-PDSCH-PUSCH-MaxBandwidth</b> Indicates the maximum supported PDSCH/PUSCH channel bandwidth in CE mode A and B, as specified in TS 36.212 [22] and TS 36.213 [23]. Value bw5 corresponds to 5 MHz and value bw20 corresponds to 20 MHz. If the field is absent the maximum PDSCH/PUSCH channel bandwidth in CE mode A and B is 1.4 MHz. If the setting of this parameter is 20 MHz, the max supported PUSCH channel bandwidth in CE mode A is 5 MHz. The maximum PUSCH channel bandwidth in CE mode B is 1.4 MHz regardless of the setting of this parameter. Parameter: transmission bandwidth configuration, see TS 36.101 [42], table 5.6-1.	Yes
<b>ce-PDSCH-TenProcesses</b> Indicates whether the UE supports 10 DL HARQ processes in FDD in CE mode A.	Yes
<b>ce-PUCCH-Enhancement</b> Indicates whether the UE supports repetition levels 64 and 128 for PUCCH in CE Mode B, as specified in TS 36.211 [21] and in TS 36.213 [23].	No
<b>ce-PUSCH-NB-MaxTBS</b> Indicates whether the UE supports 2984 bits max UL TBS in 1.4 MHz in CE mode A operation, as specified in TS 36.212 [22] and TS 36.213 [23].	Yes
<b>ce-PUSCH-SubPRB-Allocation</b> Indicates whether the UE supports sub-PRB resource allocation for PUSCH in CE mode A or B, as specified in TS 36.211 [21], TS 36.212 [22] and TS 36.213 [23].	Yes
<b>ce-RetuningSymbols</b> Indicates the number of retuning symbols in CE mode A and B as specified in TS 36.211 [21]. Value n0 corresponds to 0 retuning symbols and value n1 corresponds to 1 retuning symbol. If the field is absent the number of retuning symbols in CE mode A and B is 2.	No
<b>ce-SchedulingEnhancement</b> Indicates whether the UE supports dynamic HARQ-ACK delay for HD-FDD in CE mode A as specified in TS 36.212 [22] and TS 36.213 [23].	No
<b>ce-SRS-Enhancement</b> Indicates whether the UE supports SRS coverage enhancement in TDD with support of SRS combs 2 and 4 as specified in TS 36.213 [23]. This field can be included only if <i>ce-SRS-EnhancementWithoutComb4</i> is not included.	Yes
<b>ce-SRS-EnhancementWithoutComb4</b> Indicates whether the UE supports SRS coverage enhancement in TDD with support of SRS comb 2 but without support of SRS comb 4 as specified in TS 36.213 [23]. This field can be included only if <i>ce-SRS-Enhancement</i> is not included.	-
<b>ce-SwitchWithoutHO</b> Indicates whether the UE supports switching between normal mode and enhanced coverage mode without handover.	-
<b>ce-UL-HARQ-ACK-Feedback</b> This field indicates whether UE supports uplink HARQ ACK feedback when operating in coverage enhancement, as specified in TS36.213 [22].	Yes
<b>channelMeasRestriction</b> Indicates for a particular transmission mode whether the UE supports channel measurement restriction.	Yes
<b>cho</b> Indicates whether the UE supports conditional handover including execution condition, candidate cell configuration and maximum 8 candidate cells.	Yes
<b>cho-Failure</b> Indicates whether the UE supports conditional handover during re-establishment procedure when the selected cell is configured as candidate cell for condition handover.	Yes
<b>cho-FDD-TDD</b> Indicates whether the UE supports conditional handover between FDD and TDD cells.	No
<b>cho-TwoTriggerEvents</b> Indicates whether the UE supports 2 trigger events for same execution condition. It is mandatory supported if the UE supports <i>cho</i> .	Yes



<b>UE-EUTRA-Capability field descriptions</b>	<b>FDD/ TDD diff</b>
<b>codebook-HARQ-ACK</b> Indicates whether the UE supports determining HARQ ACK codebook size based on the DAI-based solution and/or the number of configured CCs. The first bit is set to "1" if the UE supports the DAI-based codebook size determination. The second bit is set to "1" if the UE supports the codebook determination based on the number of configured CCs.	No
<b>commMultipleTx</b> Indicates whether the UE supports multiple transmissions of sidelink communication to different destinations in one SC period. If <i>commMultipleTx-r13</i> is set to supported then the UE support 8 transmitting sidelink processes.	-
<b>commSimultaneousTx</b> Indicates whether the UE supports simultaneous transmission of EUTRA and sidelink communication (on different carriers) in all bands for which the UE indicated sidelink support in a band combination (using <i>commSupportedBandsPerBC</i> ).	-
<b>commSupportedBands</b> Indicates the bands on which the UE supports sidelink communication, by an independent list of bands i.e. separate from the list of supported E-UTRA band, as indicated in <i>supportedBandListEUTRA</i> .	-
<b>commSupportedBandsPerBC</b> Indicates, for a particular band combination, the bands on which the UE supports simultaneous reception of EUTRA and sidelink communication. If the UE indicates support simultaneous transmission (using <i>commSimultaneousTx</i> ), it also indicates, for a particular band combination, the bands on which the UE supports simultaneous transmission of EUTRA and sidelink communication. The first bit refers to the first band included in <i>commSupportedBands</i> , with value 1 indicating sidelink is supported.	-
<b>configN (in MIMO-CA-ParametersPerBoBCPerTM)</b> If signalled, the field indicates for a particular transmission mode whether the UE supports non-coded EBF/ FD-MIMO (class A) related configuration N for the concerned band combination.	-
<b>configN (in MIMO-UE-ParametersPerTM)</b> Indicates for a particular transmission mode whether the UE supports non-coded EBF/ FD-MIMO (class A) related configuration N for band combinations for which the concerned capabilities are not signalled.	Yes
<b>continueEHC-Context</b> Indicates that the UE supports EHC context continuation operation where the UE keeps the established EHC context(s) upon PDCP re-establishment, as specified in TS 36.323 [8].	No
<b>crossCarrierScheduling</b>	Yes
<b>crossCarrierScheduling-B5C</b> Indicates whether the UE supports cross carrier scheduling beyond 5 DL CCs.	No
<b>crossCarrierSchedulingLAA-DL</b> Indicates whether the UE supports cross-carrier scheduling from a licensed carrier for LAA cell(s) for downlink. This field can be included only if <i>downlinkLAA</i> is included.	-
<b>crossCarrierSchedulingLAA-UL</b> Indicates whether the UE supports cross-carrier scheduling from a licensed carrier for LAA cell(s) for uplink. This field can be included only if <i>uplinkLAA</i> is included.	-
<b>crs-DiscoverySignalsMeas</b> Indicates whether the UE supports CRS based discovery signals measurement, and PDSCH/EPDCCH RE mapping with zero power CSI-RS configured for discovery signals.	Yes
<b>crs-IM-TM1-toTM9-OneRX-Port</b> Indicates whether the DL Category 1bis UE or the DL Category M2 UE supports CRS interference mitigation (IM) while operating in the following transmission modes (TM): TM 1, TM 2, ..., TM 8 and TM 9.	No
<b>crs-InterfHandl</b> Indicates whether the UE supports CRS interference handling.	Yes
<b>crs-InterfMitigationTM10</b> The field defines whether the UE supports CRS interference mitigation in transmission mode 10. The UE supporting the <i>crs-InterfMitigationTM10</i> capability shall also support the <i>crs-InterfHandl</i> capability.	No

<b>UE-EUTRA-Capability field descriptions</b>	<b>FDD/ TDD diff</b>
<p><b>crs-InterfMitigationTM1toTM9</b> Indicates whether the UE supports CRS interference mitigation (IM) while operating in the following transmission modes (TM): TM 1, TM 2, ..., TM 8 and TM 9. The UE shall not include the field if it does not support CRS IM in TMs 1-9. If the field is present, the UE supports CRS-IM on at least one arbitrary downlink CC for up to <i>crs-InterfMitigationTM1toTM9-r13</i> downlink CC CA configuration. The UE signals <i>crs-InterfMitigationTM1toTM9-r13</i> value to indicate the maximum <i>crs-InterfMitigationTM1toTM9-r13</i> downlink CC CA configuration where UE may apply CRS IM. For example, the UE sets "<i>crs-InterfMitigationTM1toTM9-r13</i> = 3" to indicate that the UE supports CRS-IM on at least one DL CC for supported non-CA, 2DL CA and 3DL CA configurations. The UE supporting the <i>crs-InterfMitigationTM1toTM9-r13</i> capability shall also support the <i>crs-InterfHandl-r11</i> capability.</p>	-
<p><b>crs-IntfMitig</b> Indicate whether the UE supports CRS interference mitigation as specified in TS 36.133 [16], clause 3.6.1.1.</p>	Yes
<p><b>crs-LessDwPTS</b> Indicates whether the UE supports TDD special subframe configuration 10 without CRS transmission on the 5th symbol of DwPTS, i.e. <i>ssp10-CRS-LessDwPTS</i>, as specified in TS 36.211 [17].</p>	-
<p><b>csi-ReportingAdvanced, csi-ReportingAdvancedMaxPorts (in MIMO-CA-ParametersPerBoBCPerTM)</b> If signalled, the field indicates that for a particular transmission mode, the maximum number of CSI-RS ports supported by the UE for advanced CSI reporting is different in the concerned band of band combination than the value indicated by the field <i>csi-ReportingAdvanced</i> or <i>csi-ReportingAdvancedMaxPorts</i> in <i>MIMO-UE-ParametersPerTM</i>. The UE shall not include both <i>csi-ReportingAdvanced</i> and <i>csi-ReportingAdvancedMaxPorts</i> for a particular transmission mode in the concerned band of band combination.</p>	-
<p><b>csi-ReportingAdvanced (in MIMO-UE-ParametersPerTM)</b> Indicates for a particular transmission mode the maximum number of CSI-RS ports supported by the UE for advanced CSI reporting. The field <i>csi-ReportingAdvanced</i> indicates 32 CSI-RS ports. The UE shall not include both <i>csi-ReportingAdvanced</i> and <i>csi-ReportingAdvancedMaxPorts</i> for a particular transmission mode.</p>	Yes
<p><b>csi-ReportingAdvancedMaxPorts (in MIMO-UE-ParametersPerTM)</b> Indicates for a particular transmission mode the maximum number of CSI-RS ports supported by the UE for advanced CSI reporting. The field <i>csi-ReportingAdvancedMaxPorts</i> indicates 8, 12, 16, 20, 24 or 28 CSI-RS ports. The UE shall not include both <i>csi-ReportingAdvanced</i> and <i>csi-ReportingAdvancedMaxPorts</i> for a particular transmission mode.</p>	-
<p><b>csi-ReportingNP (in MIMO-CA-ParametersPerBoBCPerTM)</b> If signalled, value <i>different</i> indicates that for a particular transmission mode, the CSI reporting on non-precoded CSI-RS with 20, 24, 28 or 32 antenna ports for the concerned band of band combination is different than the value indicated by field <i>csi-ReportingNP</i> in <i>MIMO-UE-ParametersPerTM</i>.</p>	-
<p><b>csi-ReportingNP (in MIMO-UE-ParametersPerTM)</b> Indicates for a particular transmission mode whether the UE supports CSI reporting on non-precoded CSI-RS with 20, 24, 28, or 32 antenna ports for band combinations for which the concerned capabilities are not signalled in <i>MIMO-CA-ParametersPerBoBCPerTM</i>, and the FD-MIMO processing capability condition as described in NOTE 8 is satisfied.</p>	Yes
<p><b>csi-RS-DiscoverySignalsMeas</b> Indicates whether the UE supports CSI-RS based discovery signals measurement. If this field is included, the UE shall also include <i>crs-DiscoverySignalsMeas</i>.</p>	Yes
<p><b>csi-RS-DRS-RRM-MeasurementsLAA</b> Indicates whether the UE supports performing RRM measurements on LAA cell(s) based on CSI-RS-based DRS. This field can be included only if <i>downlinkLAA</i> is included.</p>	-
<p><b>csi-RS-EnhancementsTDD</b> Indicates for a particular transmission mode whether the UE supports CSI-RS enhancements applicable for TDD.</p>	Yes
<p><b>csi-SubframeSet</b> Indicates whether the UE supports REL-12 DL CSI subframe set configuration, REL-12 DL CSI subframe set dependent CSI measurement/feedback, configuration of up to 2 CSI-IM resources for a CSI process with no more than 4 CSI-IM resources for all CSI processes of one frequency if the UE supports tm10, configuration of two ZP-CSI-RS for tm1 to tm9, PDSCH RE mapping with two ZP-CSI-RS configurations, and EPDCCH RE mapping with two ZP-CSI-RS configurations if the UE supports EPDCCH. This field is only applicable for UEs supporting TDD.</p>	Yes

<b>UE-EUTRA-Capability field descriptions</b>	<b>FDD/ TDD diff</b>
<b>csi-SubframeSet2ForDormantSCell</b> Indicates whether the UE supports second CSI subframe set for periodic CSI reporting for dormant serving cells. A UE that indicates support of this field shall also indicate support for <i>dormantSCellState-r15</i> . This field is only applicable for UEs supporting TDD.	-
<b>dataInactMon</b> Indicates whether the UE supports the data inactivity monitoring as specified in TS 36.321 [6].	-
<b>dc-Support</b> Including this field indicates that the UE supports synchronous DC and power control mode 1. Including this field for a band combination entry comprising of single band entry indicates that the UE supports intra-band contiguous DC. Including this field for a band combination entry comprising of two or more band entries, indicates that the UE supports DC for these bands and that the serving cells corresponding to a band entry shall belong to one cell group (i.e. MCG or SCG). Including field <i>asynchronous</i> indicates that the UE supports asynchronous DC and power control mode 2. Including this field for a TDD/FDD band combination indicates that the UE supports TDD/FDD DC for this band combination.	-
<b>delayBudgetReporting</b> Indicates whether the UE supports delay budget reporting.	No
<b>demodulationEnhancements</b> This field defines whether the UE supports advanced receiver in SFN scenario (350 km/h) as specified in TS 36.101 [42].	-
<b>demodulationEnhancements2</b> This field defines whether the UE supports further enhanced receiver in HST-SFN scenario (up to 500 km/h velocity) as specified in TS 36.101 [42].	-
<b>densityReductionNP, densityReductionBF</b> Indicates whether the UE supports CSI-RS density reduction with values 1, 1/2 and 1/3 for non-precoded CSI-RS and beamformed CSI-RS respectively.	Yes
<b>deviceType</b> UE may set the value to " <i>noBenFromBatConsumpOpt</i> " when it does not foresee to particularly benefit from NW-based battery consumption optimisation. Absence of this value means that the device does benefit from NW-based battery consumption optimisation.	-
<b>diffFallbackCombReport</b> Indicates that the UE supports reporting of UE radio access capabilities for the CA band combinations asked by the eNB as well as, if any, reporting of different UE radio access capabilities for their fallback band combination as specified in TS 36.306 [5]. The UE does not report fallback combinations if their UE radio access capabilities are the same as the ones for the CA band combination asked by the eNB.	-
<b>differentFallbackSupported</b> Indicates that the UE supports different capabilities for at least one fallback case of this band combination.	-
<b>directMCG-SCellActivationResume</b> Indicates whether the UE supports having an E-UTRA MCG SCell configured in activated SCell state.	-
<b>directSCellActivation</b> Indicates whether the UE supports having an E-UTRA SCell configured in activated SCell state in the <i>RRCConnectionReconfiguration</i> message. This field is applicable to both LTE standalone and LTE-DC.	-
<b>directSCellHibernation</b> Indicates whether the UE supports having an SCell configured in dormant SCell state.	-
<b>directSCG-SCellActivationNEDC</b> Indicates whether the UE supports having an E-UTRA SCG SCell configured in activated SCell state in the <i>RRCConnectionReconfiguration</i> message contained in the NR <i>RRCReconfiguration</i> message, as defined in TS 36.321 [6] and TS 38.331 [82]. If the UE indicates support of <i>directSCG-SCellActivationNEDC-r16</i> , the UE shall also indicate support of <i>ne-dc</i> as specified in TS 38.331 [82].	-
<b>directSCG-SCellActivationResume</b> Indicates whether the UE supports having an E-UTRA SCG SCell configured in activated SCell state.	-
<b>discInterFreqTx</b> Indicates whether the UE support sidelink discovery announcements either a) on the primary frequency only or b) on other frequencies also, regardless of the UE configuration (e.g. CA, DC). The UE may set <i>discInterFreqTx</i> to supported when having a separate transmitter or if it can request sidelink discovery transmission gaps.	-

<b>UE-EUTRA-Capability field descriptions</b>	<b>FDD/TDD diff</b>
<b>discoverySignalsInDeactSCell</b> Indicates whether the UE supports the behaviour on DL signals and physical channels when SCell is deactivated and discovery signals measurement is configured as specified in TS 36.211 [21], clause 6.11A. This field is included only if UE supports carrier aggregation and includes <i>crs-DiscoverySignalsMeas</i> .	Yes
<b>discPeriodicSLSS</b> Indicates whether the UE supports periodic (i.e. not just one time before sidelink discovery announcement) Sidelink Synchronization Signal (SLSS) transmission and reception for sidelink discovery.	-
<b>discScheduledResourceAlloc</b> Indicates whether the UE supports transmission of discovery announcements based on network scheduled resource allocation.	-
<b>disc-UE-SelectedResourceAlloc</b> Indicates whether the UE supports transmission of discovery announcements based on UE autonomous resource selection.	-
<b>disc-SLSS</b> Indicates whether the UE supports Sidelink Synchronization Signal (SLSS) transmission and reception for sidelink discovery.	-
<b>discSupportedBands</b> Indicates the bands on which the UE supports sidelink discovery. One entry corresponding to each supported E-UTRA band, listed in the same order as in <i>supportedBandListEUTRA</i> .	-
<b>discSupportedProc</b> Indicates the number of processes supported by the UE for sidelink discovery.	-
<b>discSysInfoReporting</b> Indicates whether the UE supports reporting of system information for inter-frequency/PLMN sidelink discovery.	-
<b>dl-256QAM</b> Indicates whether the UE supports 256QAM in DL on the band.	-
<b>dl-1024QAM</b> Indicates whether the UE supports 1024QAM in DL on the band or on the band within the band combination. When <i>dl-1024QAM-ScalingFactor</i> and <i>dl-1024QAM-TotalWeightedLayers</i> are included, the UE supports 1024QAM in a set of CCs in a band combination if the CCs belong to bands indicated to support 1024QAM in that band combination and the 1024QAM processing capability condition as specified in equation 4.3.5.31-1 in TS 36.306 [5] is satisfied.	-
<b>dl-1024QAM-ScalingFactor</b> Indicates scaling factor for processing a CC configured with 1024QAM with respect to a CC not configured with 1024QAM as described in 4.3.5.31 in TS 36.306 [5]. Value <i>v1</i> indicates 1, value <i>v1dot2</i> indicates 1.2 and value <i>v1dot25</i> indicates 1.25.	-
<b>dl-1024QAM-TotalWeightedLayers</b> Indicates total number of weighted layers the UE can process for 1024QAM as described in 4.3.5.31 in TS 36.306 [5]. Actual value = (10 + indicated value x 2), i.e., value 0 indicates 10 layers, value 1 indicates 12 layers and so on.	-
<b>dl-1024QAM-Slot</b> Indicates whether the UE supports 1024QAM in DL on the band for slot TTI operation.	-
<b>dl-1024QAM-SubslotTA-1</b> Indicates whether the UE supports 1024QAM in DL on the band for subslot TTI operation with TA set 1.	-
<b>dl-1024QAM-SubslotTA-2</b> Indicates whether the UE supports 1024QAM in DL on the band for subslot TTI operation with TA set 2, <i>dmrsBasedSPDCCH-nonMBSFN</i>	-
<b>dl-DedicatedMessageSegmentation</b> Indicates whether the UE supports reception of segmented DL RRC messages.	-
<b>dmrs-BasedSPDCCH-MBSFN</b> Indicates whether the UE supports sDCI monitoring in DMRS based SPDCCH for MBSFN subframe. If UE supports this, it also provides the corresponding DMRS based SPDCCH capability in <i>min-Proc-TimelineSubslot</i> .	Yes
<b>dmrs-BasedSPDCCH-nonMBSFN</b> Indicates whether the UE supports sDCI monitoring in DMRS based SPDCCH for non-MBSFN subframe. If UE supports this, it also provides the corresponding DMRS based SPDCCH capability in <i>min-Proc-TimelineSubslot</i> .	Yes
<b>dmrs-Enhancements (in MIMO-CA-ParametersPerBoBCPerTM)</b> If signalled, the field indicates for a particular transmission mode, that for the concerned band combination the DMRS enhancements are different than the value indicated by field <i>dmrs-Enhancements</i> in <i>MIMO-UE-ParametersPerTM</i> .	-

<b>UE-EUTRA-Capability field descriptions</b>	<b>FDD/ TDD diff</b>
<b>dmrs-Enhancements (in MIMO-UE-ParametersPerTM)</b> Indicates for a particular transmission mode whether the UE supports DMRS enhancements for the indicated transmission mode.	Yes
<b>dmrs-LessUpPTS</b> Indicates whether the UE supports not to transmit DMRS for PUSCH in UpPTS.	No
<b>dmrs-OverheadReduction</b> Indicates whether the UE supports OCC4 for rank 3 and 4 transmission as specified in clause 5.3.3.1.5C of TS 36.212 [22].	Yes
<b>dmrs-PositionPattern</b> Indicates whether the UE supports uplink DMRS position pattern 'D D D' in subslot #5 with application of the 1/6 as the TBS scaling factor.	Yes
<b>dmrs-RepetitionSubslotPDSCH</b> Indicates whether the UE supports back-to-back 3/4-layer DMRS reception in two consecutive subslots across subframe boundary for subslot-PDSCH.	Yes
<b>dmrs-SharingSubslotPDSCH</b> Indicates whether the UE supports DMRS sharing in two consecutive subslots across subframe boundary for subslot-PDSCH.	Yes
<b>dormantSCellState</b> Indicates whether UE supports Dormant SCell state (i.e. SCell state with CQI and RRM measurement reporting but no PDCCH monitoring).	-
<b>downlinkLAA</b> Presence of the field indicates that the UE supports downlink LAA operation including identification of downlink transmissions on LAA cell(s) for full downlink subframes, decoding of common downlink control signalling on LAA cell(s), CSI feedback for LAA cell(s), RRM measurements on LAA cell(s) based on CRS-based DRS.	-
<b>drb-TypeSCG</b> Indicates whether the UE supports SCG bearer.	-
<b>drb-TypeSplit</b> Indicates whether the UE supports split bearer except for PDCP data transfer in UL.	-
<b>dtm</b> Indicates whether the UE supports DTM in GERAN.	-
<b>dummy</b> This field is not used in the specification. It shall not be sent by the UE.	-
<b>earlyData-UP</b> Indicates whether the UE supports UP-EDT when connected to EPC.	-
<b>earlyData-UP-5GC</b> Indicates whether the UE supports UP-EDT when connected to 5GC.	-
<b>earlySecurityReactivation</b> Indicates whether the UE supports early security reactivation when resuming a suspended RRC connection.	-
<b>e-CSFB-1XRTT</b> Indicates whether the UE supports enhanced CS fallback to CDMA2000 1xRTT or not.	Yes
<b>e-CSFB-ConcPS-Mob1XRTT</b> Indicates whether the UE supports concurrent enhanced CS fallback to CDMA2000 1xRTT and PS handover/ redirection to CDMA2000 HRPD.	Yes
<b>e-CSFB-dual-1XRTT</b> Indicates whether the UE supports enhanced CS fallback to CDMA2000 1xRTT for dual Rx/Tx configuration. This bit can only be set to supported if <i>tx-Config1XRTT</i> and <i>rx-Config1XRTT</i> are both set to dual.	Yes
<b>e-HARQ-Pattern-FDD</b> Indicates whether the UE supports enhanced HARQ pattern for TTI bundling operation for FDD.	Yes
<b>ehc</b> Indicates that the UE supports Ethernet header compression and decompression using EHC protocol, as specified in TS 36.323 [8] and in Annex A of TS 38.323 [83]. The UE indicating this capability and indicating support for at least one ROHC profile, shall support simultaneous configuration of EHC and ROHC on different DRBs.	No
<b>eLCID-Support</b> Indicates whether the UE supports LCID "10000" and MAC PDU subheader containing the eLCID field as described in TS 36.321 [6].	-
<b>emptyUnicastRegion</b> Indicates whether the UE supports unicast reception in subframes with empty unicast control region as described in TS 36.213 [23] clause 12. This field can be included only if <i>unicast-fembsMixedSCell</i> and <i>crossCarrierScheduling</i> are included.	No

<b>UE-EUTRA-Capability field descriptions</b>	<b>FDD/ TDD diff</b>
<b>en-DC</b> Indicates whether the UE supports EN-DC.	-
<b>endingDwPTS</b> Indicates whether the UE supports reception ending with a subframe occupied for a DwPTS-duration as described in TS 36.211 [21] and TS 36.213 [23]. This field can be included only if <i>downlinkLAA</i> is included.	-
<b>Enhanced-4TxCodebook</b> Indicates whether the UE supports enhanced 4Tx codebook.	No
<b>enhancedDualLayerTDD</b> Indicates whether the UE supports enhanced dual layer (PDSCH transmission mode 8) for TDD or not.	-
<b>ePDCCH</b> Indicates whether the UE can receive DCI on UE specific search space on Enhanced PDCCH.	Yes
<b>epdcch-SPT-differentCells</b> Indicates whether the UE supports EPDCCH and short processing time on different serving cells.	Yes
<b>epdcch-STTI-differentCells</b> Indicates whether the UE supports EPDCCH and sTTI on different serving cells.	Yes
<b>e-RedirectionUTRA</b>	Yes
<b>e-RedirectionUTRA-TDD</b> Indicates whether the UE supports enhanced redirection to UTRA TDD to multiple carrier frequencies both with and without using related SIB provided by <i>RRCConnectionRelease</i> or not.	Yes
<b>etws-CMAS-RxInConnCE-ModeA, etws-CMAS-RxInConn</b> Indicates whether the UE operating in CE mode A/B supports reception of ETWS/CMAS indication in RRC_CONNECTED mode as specified in TS 36.212 [22].	-
<b>eutra-5GC</b> Indicates whether the UE supports E-UTRA/5GC.	Yes
<b>eutra-5GC-HO-ToNR-FDD-FR1</b> Indicates whether the UE supports handover from E-UTRA/5GC to NR FDD FR1.	Yes
<b>eutra-5GC-HO-ToNR-TDD-FR1</b> Indicates whether the UE supports handover from E-UTRA/5GC to NR TDD FR1.	Yes
<b>eutra-5GC-HO-ToNR-FDD-FR2</b> Indicates whether the UE supports handover from E-UTRA/5GC to NR FDD FR2.	Yes
<b>eutra-5GC-HO-ToNR-TDD-FR2</b> Indicates whether the UE supports handover from E-UTRA/5GC to NR TDD FR2-1.	Yes
<b>eutra-5GC-HO-ToNR-TDD-FR2-2</b> Indicates whether the UE supports handover from E-UTRA/5GC to NR TDD FR2-2.	-
<b>eutra-CGI-Reporting-ENDC</b> Indicates whether the UE supports Intra-RAT report CGI procedure when it is configured with (NG) EN-DC wherein either MN and SN have different DRX cycles, or on-duration configured by MN does not contain on-duration configured by SN if their DRX cycles are same.	Yes
<b>eutra-CGI-Reporting-NEDC</b> Indicates whether the UE supports acquisition of relevant information from a neighbouring E-UTRA cell by reading the SI of the neighbouring cell and reporting the acquired information to the network when the NE-DC is configured.	Yes
<b>eutra-EPC-HO-ToNR-FDD-FR1</b> Indicates whether the UE supports handover from E-UTRA/EPC to NR FDD FR1.	Yes
<b>eutra-EPC-HO-ToNR-TDD-FR1</b> Indicates whether the UE supports handover from E-UTRA/EPC to NR TDD FR1.	Yes
<b>eutra-EPC-HO-ToNR-FDD-FR2</b> Indicates whether the UE supports handover from E-UTRA/EPC to NR FDD FR2.	Yes
<b>eutra-EPC-HO-ToNR-TDD-FR2</b> Indicates whether the UE supports handover from E-UTRA/EPC to NR TDD FR2-1.	Yes
<b>eutra-EPC-HO-ToNR-TDD-FR2-2</b> Indicates whether the UE supports handover from E-UTRA/EPC to NR TDD FR2-2.	-
<b>eutra-EPC-HO-EUTRA-5GC</b> Indicates whether the UE supports handover between E-UTRA/EPC and E-UTRA/5GC.	Yes
<b>eutra-IdleInactiveMeasurements</b> Indicates whether UE supports reporting measurements performed during RRC_IDLE or RRC_INACTIVE.	No

<b>UE-EUTRA-Capability field descriptions</b>	<b>FDD/ TDD diff</b>
<b>eutra-SI-AcquisitionForHO-ENDC</b> Indicates whether the UE supports, upon configuration of <i>si-RequestForHO</i> by the network, acquisition of relevant information from a neighbouring E-UTRA cell by reading the SI of the neighbouring cell using autonomous gaps and reporting the acquired information to the network.	Yes
<b>eventB2</b> Indicates whether the UE supports event B2. A UE supporting NR SA operation shall set this bit to <i>supported</i> .	-
<b>eventD1-MeasReportTrigger</b> This field indicates whether the UE supports location-based measurement report triggering in RRC_CONNECTED in earth fixed cell (i.e. event D1).	-
<b>eventD2-MeasReportTrigger</b> This field indicates whether the UE supports location-based measurement report triggering in RRC_CONNECTED in earth moving cell (i.e. event D2).	-
<b>extendedBand-n77</b> This field is only applicable for UEs that indicate support for band n77. If present, the UE supports the restriction to 3450 - 3550 MHz and 3700 - 3980 MHz ranges of band n77 in the USA as specified in Note 12 of Table 5.2-1 in TS 38.101-1 [85]. If absent, the UE supports only restriction to the 3700 - 3980 MHz range of band n77 in the USA. A UE that indicates this field shall support NS value 55 as specified in TS 38.101-1 [85].	-
<b>extendedBand-n77-2</b> This field is only applicable for UEs that indicate support for band n77. If present, the UE supports the restriction to 3450 - 3650 MHz and 3650 - 3980 ranges of band n77 in Canada as specified in Note 12 of Table 5.2-1 in TS 38.101-1 [85]. If absent, the UE supports only restriction to the 3450 - 3650 MHz range of band n77 in Canada. A UE that indicates this field shall also support NS value 57 as specified in TS 38.101-1 [85].	-
<b>extendedFreqPriorities</b> Indicates whether the UE supports extended E-UTRA frequency priorities indicated by <i>cellReselectionSubPriority</i> field. A UE supporting NR SA operation shall set this bit to <i>supported</i> .	-
<b>extendedLCID-Duplication</b> Indicates whether the UE supports use of extended LCIDs 32-38 for PDCP duplication.	-
<b>extendedLongDRX</b> Indicates whether the UE supports extended long DRX cycle values of 5.12s and 10.24s in RRC_CONNECTED.	-
<b>extendedMAC-LengthField</b> Indicates whether the UE supports the MAC header with L field of size 16 bits as specified in TS 36.321 [6], clause 6.2.1.	-
<b>extendedMaxMeasId</b> Indicates whether the UE supports extended number of measurement identities as defined by <i>maxMeasId-r12</i> .	No
<b>extendedMaxObjectld</b> Indicates whether the UE supports extended number of measurement object identities as defined by <i>maxObjectld-r13</i> .	No
<b>extendedNumberOfDRBs</b> Indicates whether the UE supports up to 15 DRBs. The UE shall support any combination of RLC AM and RLC UM entities for the configured DRBs.	-
<b>extendedPollByte</b> Indicates whether the UE supports extended pollByte values as defined by <i>pollByte-r14</i> .	-
<b>extended-RLC-LI-Field</b> Indicates whether the UE supports 15 bit RLC length indicator.	-
<b>extendedRLC-SN-SO-Field</b> Indicates whether the UE supports 16 bits of RLC sequence number and segmentation offset.	-
<b>extendedRSRQ-LowerRange</b> Indicates whether the UE supports the extended RSRQ lower value range from -34dB to -19.5dB in measurement configuration and reporting as specified in TS 36.133 [16].	No
<b>fdd-HARQ-TimingTDD</b> Indicates whether UE supports FDD HARQ timing for TDD SCell when configured with TDD PCell.	Yes
<b>featureGroupIndicators, featureGroupIndRel9Add, featureGroupIndRel10</b> The definitions of the bits in the bit string are described in Annex B.1 (for <i>featureGroupIndicators</i> and <i>featureGroupIndRel9Add</i> ) and in Annex C.1 (for <i>featureGroupIndRel10</i> ).	Yes

<b>UE-EUTRA-Capability field descriptions</b>	<b>FDD/ TDD diff</b>
<p><b>featureSetsDL-PerCC</b> In MR-DC, indicates a set of features that the UE supports on one component carrier in a bandwidth class for a band in a given band combination. The UE shall hence include at least as many <i>FeatureSetDL-PerCC-Id</i> in this list as the number of carriers it supports according to the <i>ca-bandwidthClassDL</i>, except if indicating additional functionality by reducing the number of <i>FeatureSetDownlinkPerCC-Id</i> in the feature set. The order of the elements in this list is not relevant, i.e., the network may configure any of the carriers in accordance with any of the <i>FeatureSetDL-PerCC-Id</i> in this list.</p>	-
<p><b>FeatureSetDL-PerCC-Id</b> In MR-DC, indicates the index position of the <i>FeatureSetDL-PerCC-r15</i> in the <i>featureSetsDL-PerCC-r15</i> list. Value 0 corresponds to the first element in the list, value 1 corresponds to the second element in the list, and so on. Value 32 is not used.</p>	-
<p><b>featureSetsUL-PerCC</b> In MR-DC, indicates a set of features that the UE supports on one component carrier in a bandwidth class for a band in a given band combination. The UE shall hence include at least as many <i>FeatureSetUL-PerCC-Id</i> in this list as the number of carriers it supports according to the <i>ca-bandwidthClassUL</i>, except if indicating additional functionality by reducing the number of <i>FeatureSetDownlinkPerCC-Id</i> in the feature set. The order of the elements in this list is not relevant, i.e., the network may configure any of the carriers in accordance with any of the <i>FeatureSetUL-PerCC-Id</i> in this list.</p>	-
<p><b>FeatureSetUL-PerCC-Id</b> In MR-DC, indicates the index position of the <i>FeatureSetUL-PerCC-r15</i> in the <i>featureSetsUL-PerCC-r15</i> list. Value 0 corresponds to the first element in the list, value 1 corresponds to the second element in the list, and so on. Value 32 is not used.</p>	-
<p><b>fembmsMixedCell</b> Indicates whether the UE in RRC_CONNECTED supports MBMS reception with 15 kHz subcarrier spacings via MBSFN from FeMBMS/Unicast mixed cells on a frequency indicated in an <i>MBMSInterestIndication</i> message.</p>	
<p><b>fembmsDedicatedCell</b> Indicates whether the UE in RRC_CONNECTED supports MBMS reception with 15 kHz subcarrier spacings via MBSFN from MBMS-dedicated cells on a frequency indicated in an <i>MBMSInterestIndication</i> message.</p>	
<p><b>flexibleUM-AM-Combinations</b> Indicates whether the UE supports any combination of RLC UM and RLC AM bearers as long as the total number of bearers is at most 8, regardless of what FGI20 indicates.</p>	-
<p><b>flightPathPlan</b> Indicates whether UE supports reporting of flight path plan information.</p>	-
<p><b>fourLayerTM3-TM4</b> Indicates whether the UE supports 4-layer spatial multiplexing for TM3 and TM4.</p>	-
<p><b>fourLayerTM3-TM4 (in FeatureSetDL-PerCC)</b> Indicates whether the UE supports 4-layer spatial multiplexing for TM3 and TM4 for MR-DC within the indicated feature set. If this field is absent, UE supports two layer MIMO for TM3/TM4.</p>	-
<p><b>fourLayerTM3-TM4-perCC</b> Indicates whether the UE supports 4-layer spatial multiplexing for TM3 and TM4 for the component carrier.</p>	-
<p><b>frameStructureType-SPT</b> This field indicates the supported FS-type(s) for short processing time. The UE capability is reported per band combination. The reported FS-type(s) apply to the reported <i>maxNumberCCs-SPT-r15</i> for the given band combination.</p>	-
<p><b>freqBandPriorityAdjustment</b> Indicates whether the UE supports the prioritization of frequency bands in <i>multiBandInfoList</i> over the band in <i>freqBandIndicator</i> as defined by <i>freqBandIndicatorPriority-r12</i>.</p>	-
<p><b>freqBandRetrieval</b> Indicates whether the UE supports reception of <i>requestedFrequencyBands</i>.</p>	-
<p><b>gaplessMeas-FR2-maxCC</b> Indicates whether the UE supports inter-RAT NR FR2 measurement without measurement gap as specified in clause 9.1.2 of TS 38.133 [84] while the number of configured serving cells is less than or equal to the indicated number. This field is applicable when only E-UTRA serving cells are configured. The UE reporting this field and supporting (NG)EN-DC shall not indicate support of <i>independentGapConfig</i> in <i>MeasAndMobParametersMRDC</i> (defined in TS 38.306 [87]).</p>	-



<b>UE-EUTRA-Capability field descriptions</b>	<b>FDD/ TDD diff</b>
<b>gNB-ID-Length-Reporting-NR-EN-DC</b> Indicates whether the UE supports Inter-RAT gNB ID length reporting towards NR cell when it is configured with (NG)EN-DC. If the UE supports <i>reportCGI-NR-EN-DC-r15</i> , the UE shall support the <i>gNB-ID-Length-Reporting-NR-EN-DC-r17</i> .	-
<b>gNB-ID-Length-Reporting-NR-NoEN-DC</b> Indicates whether the UE supports Inter-RAT gNB ID length reporting towards cell when it is not configured with (NG)EN-DC. If the UE supports <i>reportCGI-NR-NoEN-DC-r15</i> , the UE shall support <i>gNB-ID-Length-Reporting-NR-NoEN-DC-r17</i> .	-
<b>halfDuplex</b> If <i>halfDuplex</i> is set to true, only half duplex operation is supported for the band, otherwise full duplex operation is supported.	-
<b>heightMeas</b> Indicates whether UE supports the measurement events H1/H2.	-
<b>ho-EUTRA-5GC-FDD-TDD</b> Indicates whether the UE supports handover between E-UTRA/5GC FDD and E-UTRA/5GC TDD.	No
<b>ho-InterfreqEUTRA-5GC</b> Indicates whether the UE supports inter frequency handover within E-UTRA/5GC.	Yes
<b>hybridCSI</b> Indicates whether the UE supports hybrid CSI transmission as described in TS 36.213 [23].	Yes
<b>idleInactiveValidityAreaList</b> Indicates whether the UE supports list of validity areas for measurements during RRC_IDLE and RRC_INACTIVE.	No
<b>immMeasBT</b> Indicates whether the UE supports Bluetooth measurements in RRC connected mode.	-
<b>immMeasUnComBarPre</b> Indicates whether the UE supports uncompensated barometric pressure measurements in RRC connected mode.	-
<b>immMeasWLAN</b> Indicates whether the UE supports WLAN measurements in RRC connected mode.	-
<b>ims-VoiceOverMCG-BearerEUTRA-5GC</b> Indicates whether the UE supports IMS voice over NR PDCP for MCG bearer for E-UTRA/5GC.	No
<b>ims-VoiceOverNR-FR1</b> Indicates whether the UE supports IMS voice over NR FR1.	No
<b>ims-VoiceOverNR-FR2</b> Indicates whether the UE supports IMS voice over NR FR2-1.	No
<b>ims-VoiceOverNR-FR2-2</b> Indicates whether the UE supports IMS voice over NR FR2-2.	-
<b>ims-VoiceOverNR-PDCP-MCG-Bearer</b> Indicates whether the UE supports IMS voice over NR PDCP with only MCG RLC bearer.	Yes
<b>ims-VoiceOverNR-PDCP-SCG-Bearer</b> Indicates whether the UE supports IMS voice over NR PDCP with only SCG RLC bearer when configured with EN-DC.	Yes
<b>ims-VoNR-PDCP-SCG-NGENDC</b> Indicates whether the UE supports IMS voice over NR PDCP with only SCG RLC bearer when configured with NGEN-DC.	Yes
<b>inactiveState</b> Indicates whether the UE supports RRC_INACTIVE.	No
<b>incMonEUTRA</b> Indicates whether the UE supports increased number of E-UTRA carrier monitoring in RRC_IDLE and RRC_CONNECTED, as specified in TS 36.133 [16].	No
<b>incMonUTRA</b> Indicates whether the UE supports increased number of UTRA carrier monitoring in RRC_IDLE and RRC_CONNECTED, as specified in TS 36.133 [16].	No
<b>inDeviceCoexInd</b> Indicates whether the UE supports in-device coexistence indication as well as autonomous denial functionality.	Yes
<b>inDeviceCoexInd-ENDC</b> Indicates whether the UE supports in-device coexistence indication for (NG)EN-DC operation. This field can be included only if <i>inDeviceCoexInd</i> is included. The UE supports <i>inDeviceCoexInd-ENDC</i> in the same duplexing modes as it supports <i>inDeviceCoexInd</i> .	-

<b>UE-EUTRA-Capability field descriptions</b>	<b>FDD/ TDD diff</b>
<b><i>inDeviceCoexInd-HardwareSharingInd</i></b> Indicates whether the UE supports indicating hardware sharing problems when sending the <i>InDeviceCoexIndication</i> , as well as omitting the TDM assistance information. A UE that supports hardware sharing indication shall also indicate support of LAA operation.	-
<b><i>inDeviceCoexInd-UL-CA</i></b> Indicates whether the UE supports UL CA related in-device coexistence indication. This field can be included only if <i>inDeviceCoexInd</i> is included. The UE supports <i>inDeviceCoexInd-UL-CA</i> in the same duplexing modes as it supports <i>inDeviceCoexInd</i> .	-
<b><i>interBandTDD-CA-WithDifferentConfig</i></b> Indicates whether the UE supports inter-band TDD carrier aggregation with different UL/DL configuration combinations. The first bit indicates UE supports the configuration combination of SCell DL subframes are a subset of PCell and PSCell by SIB1 configuration and the configuration combination of SCell DL subframes are a superset of PCell and PSCell by SIB1 configuration; the second bit indicates UE supports the configuration combination of SCell DL subframes are neither superset nor subset of PCell and PSCell by SIB1 configuration. This field is included only if UE supports inter-band TDD carrier aggregation.	-
<b><i>interBandPowerSharingAsyncDAPS</i></b> Indicates whether the UE supports power sharing for asynchronous inter-band DAPS handovers.	-
<b><i>interBandPowerSharingSyncDAPS</i></b> Indicates whether the UE supports power sharing for synchronous inter-band DAPS handovers.	-
<b><i>interferenceMeasRestriction</i></b> Indicates whether the UE supports interference measurement restriction.	Yes
<b><i>interFreqAsyncDAPS</i></b> Indicates whether the UE supports asynchronous DAPS handover in source PCell and inter-frequency target PCell.	-
<b><i>interFreqBandList</i></b> One entry corresponding to each supported E-UTRA band listed in the same order as in <i>supportedBandListEUTRA</i> .	-
<b><i>interFreqDAPS</i></b> Indicates whether the UE supports DAPS handover in source PCell and inter-frequency target PCell, i.e. support of simultaneous DL reception of PDCCH and PDSCH from source and target cell. For a BC, the capability applies to every carrier pair for source and target. A UE indicating this capability shall also support synchronous DAPS handover, and single UL transmission for inter-frequency DAPS handover.	-
<b><i>interFreqMultiUL-TransmissionDAPS</i></b> Indicates that the UE supports simultaneous UL transmission in source PCell and inter-frequency target PCell.	-
<b><i>interFreqNeedForGaps</i></b> Indicates need for measurement gaps when operating on the E-UTRA band given by the entry in <i>bandListEUTRA</i> or on the E-UTRA band combination given by the entry in <i>bandCombinationListEUTRA</i> and measuring on the E-UTRA band given by the entry in <i>interFreqBandList</i> .	-
<b><i>interFreqProximityIndication</i></b> Indicates whether the UE supports proximity indication for inter-frequency E-UTRAN CSG member cells.	-
<b><i>interFreqRSTD-Measurement</i></b> Indicates whether the UE supports inter-frequency RSTD measurements for OTDOA positioning, as specified in TS 36.355 [54].	Yes
<b><i>interFreqSI-AcquisitionForHO</i></b> Indicates whether the UE supports, upon configuration of si-RequestForHO by the network, acquisition and reporting of relevant information using autonomous gaps by reading the SI from a neighbouring inter-frequency cell.	Yes
<b><i>interRAT-BandList</i></b> One entry corresponding to each supported band of another RAT listed in the same order as in the <i>interRAT-Parameters</i> . The NR bands reported in <i>SupportedBandListNR</i> are excluded from this list.	-
<b><i>interRAT-BandListNR-EN-DC</i></b> One entry corresponding to each supported NR band listed in the same order as in the <i>supportedBandListEN-DC-r15</i> . If both <i>interRAT-BandListNR-EN-DC</i> and <i>interRAT-BandListNR-SA</i> are included, the UE shall set the same <i>interRAT-NeedForGapsNR</i> value and same <i>interRAT-NeedForInterruptionNR</i> value (if any) for the same NR band.	-

<b>UE-EUTRA-Capability field descriptions</b>	<b>FDD/ TDD diff</b>
<p><b>interRAT-BandListNR-SA</b> One entry corresponding to each supported NR band listed in the same order as in the <i>supportedBandListNR-SA</i>. If both <i>interRAT-BandListNR-EN-DC</i> and <i>interRAT-BandListNR-SA</i> are included, the UE shall set the same <i>interRAT-NeedForGapsNR</i> value and same <i>interRAT-NeedForInterruptionNR</i> value (if any) for the same NR band.</p>	-
<p><b>interRAT-enhancementNR</b> Indicates whether the UE supports enhanced inter-RAT NR measurement requirements to support high speed up to 500 km/h as specified in TS 36.133 [16], when EN-DC is not configured and when EN-DC is configured.</p>	-
<p><b>interRAT-NeedForGaps</b> Indicates need for DL measurement gaps when operating on the E-UTRA band given by the entry in <i>bandListEUTRA</i> or on the E-UTRA band combination given by the entry in <i>bandCombinationListEUTRA</i> and measuring on the inter-RAT band given by the entry in the <i>interRAT-BandList</i>.</p>	-
<p><b>interRAT-NeedForGapsNR</b> Indicates need for measurement gaps when operating on the E-UTRA band given by the entry in <i>supportedBandListEUTRA</i> or on the E-UTRA band combination given by the entry in <i>supportedBandCombination-r10</i> or <i>supportedBandCombinationAdd-r11</i> or <i>supportedBandCombinationReduced-r13</i> and measuring on the NR band given by the entry in the <i>InterRAT-BandListNR</i>.</p>	-
<p><b>interRAT-NeedForInterruptionNR</b> Indicates need for interruption when operating on the E-UTRA band given by the entry in <i>supportedBandListEUTRA</i> or on the E-UTRA band combination given by the entry in <i>supportedBandCombination-r10</i> or <i>supportedBandCombinationAdd-r11</i> or <i>supportedBandCombinationReduced-r13</i> and measuring without measurement gaps on the NR band given by the entry in the <i>InterRAT-BandListNR</i>.</p>	-
<p><b>interRAT-ParametersWLAN</b> Indicates whether the UE supports WLAN measurements configured by <i>MeasObjectWLAN</i> with corresponding quantity and report configuration in the supported WLAN bands.</p>	-
<p><b>interRAT-PS-HO-ToGERAN</b> Indicates whether the UE supports inter-RAT PS handover to GERAN or not.</p>	Yes
<p><b>intraBandContiguousCC-InfoList</b> Indicates, per serving carrier of which the corresponding bandwidth class includes multiple serving carriers (i.e. bandwidth class B, C, D and so on), the maximum number of supported layers for spatial multiplexing in DL and the maximum number of CSI processes supported. The number of entries is equal to the number of component carriers in the corresponding bandwidth class. The UE shall support the setting indicated in each entry of the list regardless of the order of entries in the list. The UE shall include the field only if it supports 4-layer spatial multiplexing in transmission mode 3/4 for a subset of component carriers in the corresponding bandwidth class, or if the maximum number of supported layers for at least one component carrier is higher than <i>supportedMIMO-CapabilityDL-r10</i> in the corresponding bandwidth class, or if the number of CSI processes for at least one component carrier is higher than <i>supportedCSI-Proc-r11</i> in the corresponding band. This field may also be included for bandwidth class A but in such a case without including any sub-fields in <i>IntraBandContiguousCC-Info-r12</i> (see NOTE 6).</p>	-
<p><b>intraFreqA3-CE-ModeA</b> Indicates whether the UE when operating in CE Mode A supports <i>eventA3</i> for intra-frequency neighbouring cells.</p>	-
<p><b>intraFreqA3-CE-ModeB</b> Indicates whether the UE when operating in CE Mode B supports <i>eventA3</i> for intra-frequency neighbouring cells.</p>	-
<p><b>intraFreq-CE-NeedForGaps</b> Indicates need for measurement gaps when operating in CE on the E-UTRA band given by the entry in <i>supportedBandListEUTRA</i>.</p>	
<p><b>intraFreqAsyncDAPS</b> Indicates whether the UE supports asynchronous DAPS handover in source PCell and intra-frequency target PCell.</p>	-
<p><b>intraFreqDAPS</b> Indicates whether UE supports DAPS handover in source PCell and intra-frequency target PCell, i.e. support of simultaneous DL reception of PDCCH and PDSCH from source and target cell. A UE indicating this capability shall also support synchronous DAPS handover, and single UL transmission for intra-frequency DAPS handover.</p>	-
<p><b>intraFreqHO-CE-ModeA</b> Indicates whether the UE when operating in CE Mode A supports intra-frequency handover.</p>	-

<b>UE-EUTRA-Capability field descriptions</b>	<b>FDD/ TDD diff</b>
<b>intraFreqHO-CE-ModeB</b> Indicates whether the UE when operating in CE Mode B supports intra-frequency handover.	-
<b>intraFreqProximityIndication</b> Indicates whether the UE supports proximity indication for intra-frequency E-UTRAN CSG member cells.	-
<b>intraFreqSI-AcquisitionForHO</b> Indicates whether the UE supports, upon configuration of si-RequestForHO by the network, acquisition and reporting of relevant information using autonomous gaps by reading the SI from a neighbouring intra-frequency cell.	Yes
<b>intraFreqTwoTAGs-DAPS</b> Indicates whether the UE supports different timing advance groups in source PCell and intra-frequency target PCell. It is mandatory for <i>intraFreqDAPS</i> capable UE.	-
<b>jointEHC-ROHC-Config</b> Indicates whether the UE supports simultaneous configuration of EHC and ROHC protocols for the same DRB.	No
<b>k-Max (in MIMO-CA-ParametersPerBoBCPerTM)</b> If signalled, the field indicates for a particular transmission mode the maximum number of NZP CSI RS resource configurations supported within a CSI process applicable for the concerned band combination.	No
<b>k-Max (in MIMO-UE-ParametersPerTM)</b> Indicates for a particular transmission mode the maximum number of NZP CSI RS resource configurations supported within a CSI process applicable for band combinations for which the concerned capabilities are not signalled.	Yes
<b>laa-PUSCH-Mode1</b> Indicates whether the UE supports LAA PUSCH mode 1 as defined in TS 36.213 [23].	-
<b>laa-PUSCH-Mode2</b> Indicates whether the UE supports LAA PUSCH mode 2 as defined in TS 36.213 [23].	-
<b>laa-PUSCH-Mode3</b> Indicates whether the UE supports LAA PUSCH mode 3 as defined in TS 36.213 [23].	-
<b>locationReport</b> Indicates whether the UE supports reporting of its geographical location information to eNB.	-
<b>loggedMBSFNMeasurements</b> Indicates whether the UE supports logged measurements for MBSFN. A UE indicating support for logged measurements for MBSFN shall also indicate support for logged measurements in Idle mode.	-
<b>loggedMeasBT</b> Indicates whether the UE supports Bluetooth measurements in RRC idle mode.	-
<b>loggedMeasIdleEventL1</b> Indicates whether the UE supports event triggered logged measurements for <i>eventL1</i> in <i>camped normally</i> state.	-
<b>loggedMeasIdleEventOutOfCoverage</b> Indicates whether the UE supports event triggered logged measurements for <i>outOfCoverage</i> in <i>any cell selection</i> state.	-
<b>loggedMeasUnComBarPre</b> Indicates whether the UE supports uncompensated barometric pressure measurements in RRC_IDLE mode.	-
<b>loggedMeasurementsIdle</b> Indicates whether the UE supports logged measurements in Idle mode.	-
<b>loggedMeasWLAN</b> Indicates whether the UE supports WLAN measurements in RRC idle mode.	-
<b>logicalChannelSR-ProhibitTimer</b> Indicates whether the UE supports the <i>logicalChannelSR-ProhibitTimer</i> as defined in TS 36.321 [6].	-
<b>longDRX-Command</b> Indicates whether the UE supports Long DRX Command MAC Control Element.	-
<b>lowerMSD-MRDC</b> Indicates whether the UE supports lower maximum sensitivity degradation when the band is the victim band with sensitivity degradation as specified in TS 38.101-3 [101].	-
<b>lwa</b> Indicates whether the UE supports LTE-WLAN Aggregation (LWA). The UE which supports LWA shall also indicate support of <i>interRAT-ParametersWLAN-r13</i> .	-
<b>lwa-BufferSize</b> Indicates whether the UE supports the layer 2 buffer sizes for "with support for split bearers" as defined in Table 4.1-3 and 4.1A-3 of TS 36.306 [5] for LWA.	-

<b>UE-EUTRA-Capability field descriptions</b>	<b>FDD/ TDD diff</b>
<b><i>lwa-HO-WithoutWT-Change</i></b> Indicates whether the UE supports handover where LWA configuration is retained without WT change and using LWA end-marker for PDCP key change indication for LWA operation.	-
<b><i>lwa-RLC-UM</i></b> Indicates whether the UE supports RLC UM for LWA bearer.	-
<b><i>lwa-SplitBearer</i></b> Indicates whether the UE supports the split LWA bearer (as defined in TS 36.300 [9]).	-
<b><i>lwa-UL</i></b> Indicates whether the UE supports UL transmission over WLAN for LWA bearer.	-
<b><i>lwip</i></b> Indicates whether the UE supports LTE/WLAN Radio Level Integration with IPsec Tunnel (LWIP). The UE which supports LWIP shall also indicate support of <i>interRAT-ParametersWLAN-r13</i> .	-
<b><i>lwip-Aggregation-DL, lwip-Aggregation-UL</i></b> Indicates whether the UE supports aggregation of LTE and WLAN over DL/UL LWIP. The UE that indicates support of LWIP aggregation over DL or UL shall also indicate support of <i>lwip</i> .	-
<b><i>makeBeforeBreak</i></b> Indicates whether the UE supports intra-frequency Make-Before-Break handover, and whether the UE which indicates <i>dc-Parameters</i> supports intra-frequency Make-Before-Break SeNB change, as defined in TS 36.300 [9].	-
<b><i>measGapPatterns-NRonly</i></b> Indicates whether the UE supports gap patterns 2, 3 and 11 in LTE standalone when the frequencies to be measured within this measurement gap are all NR frequencies.	No
<b><i>measGapPatterns-NRonly-ENDC</i></b> Indicates whether the UE supports gap patterns 2, 3 and 11 in (NG)EN-DC when the frequencies to be measured within this measurement gap are all NR frequencies.	No
<b><i>maximumCCsRetrieval</i></b> Indicates whether UE supports reception of <i>requestedMaxCCsDL</i> and <i>requestedMaxCCsUL</i> .	-
<b><i>maxLayersMIMO-Indication</i></b> Indicates whether the UE supports the network configuration of <i>maxLayersMIMO</i> . If the UE supports <i>fourLayerTM3-TM4</i> or <i>intraBandContiguousCC-InfoList</i> or <i>FeatureSetDL-PerCC</i> for MR-DC, UE supports the configuration of <i>maxLayersMIMO</i> for these cases regardless of indicating <i>maxLayersMIMO-Indication</i> .	-
<b><i>maxLayersSlotOrSubslotPUSCH</i></b> Indicates the maximum number of layers for slot-PUSCH or subslot-PUSCH transmission.	Yes
<b><i>maxNumberCCs-SPT</i></b> Indicates the maximum number of supported CCs for short processing time. The UE capability is reported per band combination. The reported number of carriers applies to all the FS-type(s) <i>frameStructureType-SPT-r15</i> supported in a given band combination. Absence of the field indicates that 0 number of CCs are supported for short processing time.	-
<b><i>maxNumberDL-CCs, maxNumberUL-CCs</i></b> Indicates for each TTI combination "sTTI-SupportedCombinations", the maximum number of supported DL CCs/UL CCs for short TTI. Absence of the field indicates that 0 number of CCs are supported for short TTI.	-
<b><i>maxNumberDecoding</i></b> Indicates the maximum number of blind decodes in UE-specific search space per UE in one subframe for CA with more than 5 CCs as defined in TS 36.213 [23] which is supported by the UE. The number of blind decodes supported by the UE is the field value * 32. Only values 5 to 32 can be used in this version of the specification.	No
<b><i>maxNumberEHC-Contexts</i></b> Defines the maximum number of Ethernet header compression contexts supported by the UE across all DRBs and across UE's EHC compressor and EHC decompressor. The indicated number defines the number of contexts in addition to CID = "all zeros" as specified in Annex A of TS 38.323 [83].	No
<b><i>maxNumberROHC-ContextSessions</i></b> Set to the maximum number of concurrently active ROHC contexts supported by the UE, excluding context sessions that leave all headers uncompressed. cs2 corresponds with 2 (context sessions), cs4 corresponds with 4 and so on. The network ignores this field if the UE supports none of the ROHC profiles in <i>supportedROHC-Profiles</i> . If the UE indicates both <i>maxNumberROHC-ContextSessions</i> and <i>maxNumberROHC-ContextSessions-r14</i> , same value shall be indicated.	-
<b><i>maxNumberUpdatedCSI-Proc, maxNumberUpdatedCSI-Proc-SPT</i></b> Indicates the maximum number of CSI processes to be updated across CCs.	No

<b>UE-EUTRA-Capability field descriptions</b>	<b>FDD/ TDD diff</b>
<p><b>maxNumberUpdatedCSI-Proc-STTI-Comb77, maxNumberUpdatedCSI-Proc-STTI-Comb27, maxNumberUpdatedCSI-Proc-STTI-Comb22-Set1, maxNumberUpdatedCSI-Proc-STTI-Comb22-Set2</b></p> <p>Indicates the maximum number of CSI processes to be updated across CCs. Comb77 is applicable for {slot, slot}, Comb27 for {subslot, slot}, Comb22-Set1 for {subslot, subslot} processing timeline set 1 and the Comb22-Set2 for {subslot, subslot} processing timeline set 2.</p>	
<p><b>mbms-AsyncDC</b></p> <p>Indicates whether the UE in RRC_CONNECTED supports MBMS reception via MRB on a frequency indicated in an <i>MBMSInterestIndication</i> message, where (according to <i>supportedBandCombination</i>) the carriers that are or can be configured as serving cells in the MCG and the SCG are not synchronized. If this field is included, the UE shall also include <i>mbms-SCell</i> and <i>mbms-NonServingCell</i>. The field indicates that the UE supports the feature for xDD if <i>mbms-SCell</i> and <i>mbms-NonServingCell</i> are supported for xDD.</p>	-
<p><b>mbms-MaxBW</b></p> <p>Indicates maximum supported bandwidth (T) for MBMS reception, see TS 36.213 [23], clause 11.1. If the value is set to <i>implicitValue</i>, the corresponding value of T is calculated as specified in TS 36.213 [23], clause 11.1. If the value is set to <i>explicitValue</i>, the actual value of T = <i>explicitValue</i> * 40 MHz.</p>	-
<p><b>mbms-NonServingCell</b></p> <p>Indicates whether the UE in RRC_CONNECTED supports MBMS reception via MRB on a frequency indicated in an <i>MBMSInterestIndication</i> message, where (according to <i>supportedBandCombination</i> and to network synchronization properties) a serving cell may be additionally configured. If this field is included, the UE shall also include the <i>mbms-SCell</i> field.</p>	Yes
<p><b>mbms-ScalingFactor1dot25, mbms-ScalingFactor7dot5</b></p> <p>Indicates parameter <math>A^{(1.25 / A^{7.5})}</math>, i.e., scaling factor for processing one unit of bandwidth corresponding to subcarrier spacing of 1.25 kHz / 7.5 kHz, with respect to one unit of bandwidth corresponding to subcarrier spacing of 15 kHz. See TS 36.213 [23], clause 11.1. This field is included only if <i>subcarrierSpacingMBMS-khz1dot25 / subcarrierSpacingMBMS-khz7dot5</i> is included. This field shall be included if <i>mbms-MaxBW</i> and <i>subcarrierSpacingMBMS-khz1dot25 / subcarrierSpacingMBMS-khz7dot5</i> are included.</p>	-
<p><b>mbms-ScalingFactor0dot37, mbms-ScalingFactor2dot5</b></p> <p>Indicates parameter <math>A^{(0.37 / A^{2.5})}</math>, i.e., scaling factor for processing one unit of bandwidth corresponding to subcarrier spacing of 0.37 kHz / 2.5 kHz, with respect to one unit of bandwidth corresponding to subcarrier spacing of 15 kHz. See TS 36.213 [23], clause 11.1. This field is included only if <i>fembmsMixedCell</i> or <i>fembmsDedicatedCell</i> is included. This field shall be included if <i>subcarrierSpacingMBMS-khz0dot37 / subcarrierSpacingMBMS-khz2dot5</i> is included for at least one E-UTRA band in <i>mbms-SupportedBandInfoList</i>.</p>	-
<p><b>mbms-SCell</b></p> <p>Indicates whether the UE in RRC_CONNECTED supports MBMS reception via MRB on a frequency indicated in an <i>MBMSInterestIndication</i> message, when an SCell is configured on that frequency (regardless of whether the SCell is activated or deactivated).</p>	Yes
<p><b>mbms-SupportedBandInfoList</b></p> <p>One entry corresponding to each supported E-UTRA band listed in the same order as in <i>supportedBandListEUTRA</i>. This list is included only if <i>fembmsMixedCell</i> or <i>fembmsDedicatedCell</i> is included. If <i>mbms-SupportedBandInfoList-v1700</i> is included, the UE shall include the same number of entries, and listed in the same order, as in <i>mbms-SupportedBandInfoList-r16</i>.</p>	-
<p><b>mcgRLF-RecoveryViaSCG</b></p> <p>Indicates whether the UE supports recovery from MCG RLF via split SRB1 (if supported) and via SRB3 (if supported).</p>	-
<p><b>measGapPatterns-NRonly</b></p> <p>Indicates whether the UE supports gap patterns 2, 3 and 11 in LTE standalone when the frequencies to be measured within this measurement gap are all NR frequencies.</p>	No
<p><b>measGapPatterns-NRonly-ENDC</b></p> <p>Indicates whether the UE supports gap patterns 2, 3 and 11 in (NG)EN-DC when the frequencies to be measured within this measurement gap are all NR frequencies.</p>	No
<p><b>measurementEnhancements</b></p> <p>This field defines whether UE supports measurement enhancements in high speed scenario (350 km/h) as specified in TS 36.133 [16].</p>	-
<p><b>measurementEnhancements2</b></p> <p>This field defines whether UE supports measurement enhancements in high speed scenario (up to 500 km/h velocity) as specified in TS 36.133 [16].</p>	-

<b>UE-EUTRA-Capability field descriptions</b>	<b>FDD/ TDD diff</b>
<b>measurementEnhancementsSCell</b> This field defines whether UE supports SCell measurement enhancements in high speed scenario (350 km/h) as specified in TS 36.133 [16].	-
<b>measGapPatterns</b> Indicates whether the UE that supports NR supports gap patterns 4 to 11 in LTE standalone as specified in TS 36.133 [16], and for independent measurement gap configuration on FR1 and per-UE gap in (NG)EN-DC as specified in TS 38.133 [84]. The first/ leftmost bit covers pattern 4, and so on. Value 1 indicates that the UE supports the concerned gap pattern.	-
<b>mfbf-UTRA</b> It indicates if the UE supports the signalling requirements of multiple radio frequency bands in a UTRA FDD cell, as defined in TS 25.307 [65].	-
<b>MIMO-BeamformedCapabilityList</b> A list of pairs of {k-Max, n-MaxList} values with the n <sup>th</sup> entry indicating the values that the UE supports for each CSI process in case n CSI processes would be configured.	No
<b>MIMO-CapabilityDL</b> The number of supported layers for spatial multiplexing in DL. The field may be absent for category 0 and category 1 UE in which case the number of supported layers is 1.	-
<b>MIMO-CapabilityUL</b> The number of supported layers for spatial multiplexing in UL. Absence of the field means that the number of supported layers is 1.	-
<b>MIMO-CA-ParametersPerBoBC</b> A set of MIMO parameters provided per band of a band combination. In case a subfield is absent, the concerned capabilities are the same as indicated at the per UE level (i.e. by MIMO-UE-ParametersPerTM).	-
<b>mimo-CBSR-AdvancedCSI</b> Indicates whether UE supports CBSR for advanced CSI reporting with and without amplitude restriction as defined in TS 36.213 [23], clause 7.2.	Yes
<b>min-Proc-TimelineSubslot</b> Minimum processing timeline for subslot operation. The minimum processing timeline can belong to one of two sets of associated processing and maximum TA operation. The sets supported can be different for 1os CRS-based SPDCCH, 2os CRS-based SPDCCH and DMRS-based SPDCCH. The sequence applies to: 1. 1os CRS based SPDCCH 2. 2os CRS based SPDCCH 3. DMRS based SPDCCH	-
<b>modifiedMPR-Behavior</b> Field encoded as a bit map, where at least one bit N is set to "1" if UE supports modified MPR/A-MPR behaviour N, see TS 36.101 [42]. All remaining bits of the field are set to "0". The leading / leftmost bit (bit 0) corresponds to modified MPR/A-MPR behaviour 0, the next bit corresponds to modified MPR/A-MPR behaviour 1 and so on. Absence of this field means that UE does not support any modified MPR/A-MPR behaviour.	-
<b>mpdcch-InLteControlRegionCE-ModeA, mpdcch-InLteControlRegionCE-ModeB</b> Indicates whether UE operating in CE mode A/B supports MPDCCH reception in LTE control channel region as specified in TS 36.211 [21].	Yes
<b>mpsPriorityIndication</b> Indicates whether the UE supports <i>mpsPriorityIndication</i> on release with redirect.	-
<b>multiACK-CSI-reporting</b> Indicates whether the UE supports multi-cell HARQ ACK and periodic CSI reporting and SR on PUCCH format 3.	Yes
<b>multiBandInfoReport</b> Indicates whether the UE supports the acquisition and reporting of multi band information for <i>reportCGI</i> .	-
<b>multiClusterPUSCH-WithinCC</b>	Yes
<b>multiNS-Pmax</b> Indicates whether the UE supports the mechanisms defined for cells broadcasting <i>NS-PmaxList</i> .	-
<b>multiNS-PmaxAerial</b> Indicates whether the UE supports the mechanisms defined for cells broadcasting <i>NS-PmaxListAerial</i> and <i>freqBandInfoAerial</i> .	-
<b>multipleCellsMeasExtension</b> Indicates whether the UE supports <i>numberOfTriggeringCells</i> in the report configuration.	-

<b>UE-EUTRA-Capability field descriptions</b>	<b>FDD/ TDD diff</b>
<p><b>multipleTimingAdvance</b> Indicates whether the UE supports multiple timing advances for each band combination listed in <i>supportedBandCombination</i>. If the band combination comprised of more than one band entry (i.e., inter-band or intra-band non-contiguous band combination), the field indicates that the same or different timing advances on different band entries are supported. If the band combination comprised of one band entry (i.e., intra-band contiguous band combination), the field indicates that the same or different timing advances across component carriers of the band entry are supported. It is mandatory for UEs to support 2 TAGs for inter frequency DAPS handover.</p>	-
<p><b>multipleUplinkSPS</b> Indicates whether the UE supports multiple uplink SPS and reporting SPS assistance information. A UE indicating <i>multipleUplinkSPS</i> shall also support V2X communication via Uu, as defined in TS 36.300 [9].</p>	-
<p><b>must-CapabilityPerBand</b> Indicates that UE supports MUST, as specified in 36.212 [22], clause 5.3.3.1, on the band in the band combination.</p>	-
<p><b>must-TM234-UpTo2Tx-r14</b> Indicates that the UE supports MUST operation for TM2/3/4 using up to 2Tx.</p>	-
<p><b>must-TM89-UpToOneInterferingLayer-r14</b> Indicates that the UE supports MUST operation for TM8/9 with assistance information for up to 1 interfering layer.</p>	-
<p><b>must-TM89-UpToThreeInterferingLayers-r14</b> Indicates that the UE supports MUST operation for TM8/9 with assistance information for up to 3 interfering layers.</p>	-
<p><b>must-TM10-UpToOneInterferingLayer-r14</b> Indicates that the UE supports MUST operation for TM10 with assistance information for up to 1 interfering layer.</p>	-
<p><b>must-TM10-UpToThreeInterferingLayers-r14</b> Indicates that the UE supports MUST operation for TM10 with assistance information for up to 3 interfering layers.</p>	-
<p><b>naics-Capability-List</b> Indicates that UE supports NAICS, i.e. receiving assistance information from serving cell and using it to cancel or suppress interference of neighbouring cell(s) for at least one band combination. If not present, UE does not support NAICS for any band combination. The field <i>numberOfNAICS-CapableCC</i> indicates the number of component carriers where the NAICS processing is supported and the field <i>numberOfAggregatedPRB</i> indicates the maximum aggregated bandwidth across these of component carriers (expressed as a number of PRBs) with the restriction that NAICS is only supported over the full carrier bandwidth. The UE shall indicate the combination of {<i>numberOfNAICS-CapableCC</i>, <i>numberOfNAICS-CapableCC</i>} for every supported <i>numberOfNAICS-CapableCC</i>, e.g. if a UE supports {x CC, y PRBs} and {x-n CC, y-m PRBs} where n&gt;=1 and m&gt;=0, the UE shall indicate both.</p> <ul style="list-style-type: none"> <li>- For <i>numberOfNAICS-CapableCC</i> = 1, UE signals one value for <i>numberOfAggregatedPRB</i> from the range {50, 75, 100};</li> <li>- For <i>numberOfNAICS-CapableCC</i> = 2, UE signals one value for <i>numberOfAggregatedPRB</i> from the range {50, 75, 100, 125, 150, 175, 200};</li> <li>- For <i>numberOfNAICS-CapableCC</i> = 3, UE signals one value for <i>numberOfAggregatedPRB</i> from the range {50, 75, 100, 125, 150, 175, 200, 225, 250, 275, 300};</li> <li>- For <i>numberOfNAICS-CapableCC</i> = 4, UE signals one value for <i>numberOfAggregatedPRB</i> from the range {50, 100, 150, 200, 250, 300, 350, 400};</li> <li>- For <i>numberOfNAICS-CapableCC</i> = 5, UE signals one value for <i>numberOfAggregatedPRB</i> from the range {50, 100, 150, 200, 250, 300, 350, 400, 450, 500}.</li> </ul>	No
<p><b>nscg</b> Indicates whether the UE supports measurement NCSG Pattern Id 0, 1, 2 and 3, as specified in TS 36.133 [16]. If this field is included and the UE supports asynchronous DC, the UE shall support NCSG Pattern Id 0, 1, 2 and 3. If this field is included but the UE does not support asynchronous DC, only NCSG Pattern Id 0 and 1 shall be supported</p>	No
<p><b>ng-EN-DC</b> Indicates whether the UE supports NGEN-DC.</p>	-



<b>UE-EUTRA-Capability field descriptions</b>	<b>FDD/ TDD diff</b>
<p><b><i>n-MaxList (in MIMO-UE-ParametersPerTM)</i></b>  Indicates for a particular transmission mode the maximum number of NZP CSI RS ports supported within a CSI process applicable for band combinations for which the concerned capabilities are not signalled. For <i>k-Max</i> values exceeding 1, the UE shall include the field and signal <i>k-Max</i> minus 1 bits. The first bit indicates <i>n-Max2</i>, with value 0 indicating 8 and value 1 indicating 16. The second bit indicates <i>n-Max3</i>, with value 0 indicating 8 and value 1 indicating 16. The third bit indicates <i>n-Max4</i>, with value 0 indicating 8 and value 1 indicating 32. The fourth bit indicates <i>n-Max5</i>, with value 0 indicating 16 and value 1 indicating 32. The fifth bit indicates <i>n-Max6</i>, with value 0 indicating 16 and value 1 indicating 32. The sixth bit indicates <i>n-Max7</i>, with value 0 indicating 16 and value 1 indicating 32. The seventh bit indicates <i>n-Max8</i>, with value 0 indicating 16 and value 1 indicating 64.</p>	Yes
<p><b><i>n-MaxList (in MIMO-CA-ParametersPerBoBCPerTM)</i></b>  If signalled, the field indicates for a particular transmission mode the maximum number of NZP CSI RS ports supported within a CSI process applicable for band the concerned combination. Further details are as indicated for <i>n-MaxList</i> in <i>MIMO-UE-ParametersPerTM</i>.</p>	No
<p><b><i>NonContiguousUL-RA-WithinCC-List</i></b>  One entry corresponding to each supported E-UTRA band listed in the same order as in <i>supportedBandListEUTRA</i>.</p>	No
<p><b><i>nonPrecoded (in MIMO-UE-ParametersPerTM)</i></b>  Indicates for a particular transmission mode the UE capabilities concerning non-coded EBF/ FD-MIMO operation (class A) for band combinations for which the concerned capabilities are not signalled in <i>MIMO-CA-ParametersPerBoBCPerTM</i>, and the FD-MIMO processing capability condition as described in NOTE 8 is satisfied.</p>	Yes
<p><b><i>nonPrecoded (in MIMO-CA-ParametersPerBoBCPerTM)</i></b>  If signalled, the field indicates for a particular transmission mode, the UE capabilities concerning non-coded EBF/ FD-MIMO operation (class A) applicable for the concerned band combination.</p>	-

<b>UE-EUTRA-Capability field descriptions</b>	<b>FDD/ TDD diff</b>
<b>nonUniformGap</b> Indicates whether the UE supports measurement non uniform Pattern Id 1, 2, 3 and 4 in LTE standalone as specified in TS 36.133 [16].	No
<b>noResourceRestrictionForTTIBundling</b> Indicate whether the UE supports TTI bundling operation without resource allocation restriction.	No
<b>nonCSG-SI-Reporting</b> Indicates whether UE will report PLMN list from non-CSG cells.	-
<b>nr-AutonomousGaps-ENDC-FR1</b> Indicates whether the UE supports, upon configuration of <i>useAutonomousGapsNR</i> by the network, acquisition of relevant information from a neighbouring NR cell by reading the SI of the neighbouring cell on FR1 using autonomous gaps and reporting the acquired information to the network when it is configured with (NG)EN-DC.	Yes
<b>nr-AutonomousGaps-ENDC-FR2</b> Indicates whether the UE supports, upon configuration of <i>useAutonomousGapsNR</i> by the network, acquisition of relevant information from a neighbouring NR cell by reading the SI of the neighbouring cell on FR2 using autonomous gaps and reporting the acquired information to the network when it is configured with (NG)EN-DC.	Yes
<b>nr-AutonomousGaps-FR1</b> Indicates whether the UE supports, upon configuration of <i>useAutonomousGapsNR</i> by the network, acquisition of relevant information from a neighbouring NR cell by reading the SI of the neighbouring cell on FR1 using autonomous gaps and reporting the acquired information to the network when it is not configured with (NG)EN-DC.	Yes
<b>nr-AutonomousGaps-FR2</b> Indicates whether the UE supports, upon configuration of <i>useAutonomousGapsNR</i> by the network, acquisition of relevant information from a neighbouring NR cell by reading the SI of the neighbouring cell on FR2 using autonomous gaps and reporting the acquired information to the network when it is not configured with (NG)EN-DC.	Yes
<b>nr-CellIndividualOffset</b> Indicates whether the UE supports use of cell specific offset for NR inter-RAT measurements.	No
<b>nr-HO-ToEN-DC</b> Indicates whether the UE supports inter-RAT handover from NR to EN-DC while NR-DC or NE-DC is not configured. This field is mandatory present if EN-DC is supported.	-
<b>nr-IdleInactiveBeamMeasFR1</b> Indicates whether the UE supports performing eNB-configured SSB-based beam level RRM measurements for configured NR FR1 carrier(s) in RRC_IDLE and in RRC_INACTIVE as specified in TS 36.306 [5], clause 4.3.6.46.	No
<b>nr-IdleInactiveBeamMeasFR2</b> Indicates whether the UE supports performing eNB-configured SSB-based beam level RRM measurements for configured NR FR2 carrier(s) in RRC_IDLE and in RRC_INACTIVE as specified in TS 36.306 [5], clause 4.3.6.47.	No
<b>nr-IdleInactiveMeasFR1</b> Indicates whether UE supports reporting measurements performed on NR FR1 carrier(s) during RRC_IDLE and RRC_INACTIVE.	No
<b>nr-IdleInactiveMeasFR2</b> Indicates whether UE supports reporting measurements performed on NR FR2 carrier(s) during RRC_IDLE and RRC_INACTIVE.	No
<b>nr-RSSI-ChannelOccupancyReporting</b> Indicates whether the UE supports performing measurements and reporting of RSSI and channel occupancy on the corresponding NR band.	-
<b>ntn-Autonomous-GNSS-Fix</b> This field indicates whether the UE supports autonomous GNSS position fix in RRC_CONNECTED.	-
<b>ntn-Connectivity-EPC</b> Indicates whether the UE supports NTN access when connected to EPC. If the UE indicates this capability, the UE shall support all NTN essential features as specified in TS 36.306 [5].	-
<b>ntn-DCI-HarqDisableMultiTB-CE-ModeB</b> This field indicates whether the UE supports DCI-based HARQ feedback disabling for downlink transmission when HARQ feedback disabling per HARQ process for downlink transmission is not configured by RRC and the UE is operating in CE mode B and when configured with <i>ce-PDSCH-MultiTB-Config</i> .	-
<b>ntn-DCI-HarqDisableSingleTB-CE-ModeB</b> This field indicates whether the UE supports DCI-based HARQ feedback disabling for downlink transmission when HARQ feedback disabling per HARQ process for downlink transmission is not configured by RRC and when the UE is operating in CE mode B.	-

<b>UE-EUTRA-Capability field descriptions</b>	<b>FDD/ TDD diff</b>
<b>ntn-EventA4BasedCHO</b> This field indicates whether the UE supports Event A4-based conditional handover, i.e., <i>CondEvent A4</i> .	-
<b>ntn-GNSS-EnhScenarioSupport</b> This field indicates whether the UE supports GNSS measurement and UL transmission extension enhancements in RRC_CONNECTED for only GSO or NGSO scenario. If this field is not included, the GNSS measurement and UL transmission extension enhancements in RRC_CONNECTED that are indicated as supported are applicable for both GSO and NGSO scenario.	-
<b>ntn-HarqEnhScenarioSupport</b> This field indicates whether the UE supports UL and DL HARQ process enhancements for only GSO or NGSO scenario. If this field is not included, the UL and DL HARQ process enhancements that are indicated as supported are applicable for both GSO and NGSO scenario.	-
<b>ntn-LocationBasedCHO-EFC</b> This field indicates whether the UE supports location-based conditional handover for earth fixed cell, i.e., <i>CondEvent D1</i> .	-
<b>ntn-LocationBasedCHO-EMC</b> This field indicates whether the UE supports location-based conditional handover for earth moving cell, i.e., <i>CondEvent D2</i> .	-
<b>ntn-LocationBasedMeasTrigger-EFC</b> This field indicates whether the UE supports location-based measurement trigger in RRC_CONNECTED in earth fixed cell.	-
<b>ntn-LocationBasedMeasTrigger-EMC</b> This field indicates whether the UE supports location-based measurement trigger in RRC_CONNECTED in earth moving cell.	-
<b>ntn-OffsetTimingEnh</b> Indicates whether the UE supports timing relationship enhancement using <i>Differential Koffset</i> as specified in TS 36.321 [6] and TS 36.213 [23].	-
<b>ntn-OverriddenHarqDisableMultiTB-CE-ModeB</b> This field indicates whether the UE supports DCI-based HARQ feedback disabling for downlink transmission by overriding the RRC configuration when the UE is operating in CE mode B and when configured with <i>ce-PDSCH-MultiTB-Config</i> .	-
<b>ntn-OverriddenHarqDisableSingleTB-CE-ModeB</b> This field indicates whether the UE supports DCI-based HARQ feedback disabling for downlink transmission by overriding the RRC configuration when the UE is operating in CE mode B.	-
<b>ntn-PUR-TimerDelay</b> Indicates whether the UE supports delaying the start of the <i>pur-ResponseWindowTimer</i> for NTN, see TS 36.321 [6].	-
<b>ntn-RRC-HarqDisableMultiTB-CE-ModeA</b> This field indicates whether the UE supports HARQ feedback disabling per HARQ process for downlink transmission by RRC configuration when the UE is operating in CE mode A and when configured with <i>ce-PDSCH-MultiTB-Config</i> .	-
<b>ntn-RRC-HarqDisableMultiTB-CE-ModeB</b> This field indicates whether the UE supports HARQ feedback disabling per HARQ process for downlink transmission by RRC configuration when the UE is operating in CE mode B and when configured with <i>ce-PDSCH-MultiTB-Config</i> .	-
<b>ntn-RRC-HarqDisableSingleTB-CE-ModeA</b> This field indicates whether the UE supports HARQ feedback disabling per HARQ process for downlink transmission by RRC configuration when the UE is operating in CE mode A.	-
<b>ntn-RRC-HarqDisableSingleTB-CE-ModeB</b> This field indicates whether the UE supports HARQ feedback disabling per HARQ process for downlink transmission by RRC configuration when the UE is operating in CE mode B.	-
<b>ntn-SegmentedPrecompensationGaps</b> Indicates the minimum supported gap length between segments for segmented uplink transmission. Value <i>sym1</i> corresponds to 1 symbol, value <i>s1</i> corresponds to 1 slot, value <i>sf1</i> corresponds to 1 subframe.	-
<b>ntn-ScenarioSupport</b> Indicates whether the UE supports NTN features only for GSO or NGSO scenario. If a UE does not include this field but includes <i>ntn-Connectivity-EPC-r17</i> , the UE supports the NTN features for both GSO and NGSO scenarios.	-
<b>ntn-SemiStaticHarqDisableSPS</b> This field indicates whether the UE supports HARQ feedback transmission for the first SPS PDSCH transmission after activation when the UE is operating in CE mode A.	-

<b>UE-EUTRA-Capability field descriptions</b>	<b>FDD/ TDD diff</b>
<b>ntn-TA-report</b> Indicates whether the UE supports timing advance reporting in RRC_CONNECTED, see TS 36.321 [6].	-
<b>ntn-TimeBasedCHO</b> This field indicates whether the UE supports time-based conditional handover, i.e., <i>CondEvent T1</i> .	-
<b>ntn-TimeBasedMeasTrigger</b> This field indicates whether the UE supports time-based measurement trigger in RRC_CONNECTED.	-
<b>ntn-Triggered-GNSS-Fix</b> This field indicates whether the UE supports network triggered GNSS position fix in RRC_CONNECTED.	-
<b>ntn-UplinkHarq-ModeB-MultiTB</b> This field indicates whether the UE supports HARQ Mode B when scheduled with uplink transmission of multiple TBs. For BL UE or UE in CE, this field also indicates whether the UE supports the corresponding LCP restrictions for uplink transmission.	-
<b>ntn-UplinkHarq-ModeB-SingleTB</b> This field indicates whether the UE supports HARQ Mode B. For BL UE or UE in CE, this field also indicates whether the UE supports the corresponding LCP restrictions for uplink transmission.	-
<b>ntn-UplinkTxExtension</b> This field indicates whether the UE supports to perform UL transmission in a duration after original GNSS validity duration expires without GNSS re-acquisition.	-
<b>numberOfBlindDecodesUSS</b> Indicates the maximum number of blind decodes in UE specific search space in one subframe for CCs configured with sTTI operation supported by the UE. The number of blind decodes supported by the UE is the field value X*68. Field value ranges from 4 to 32.	Yes
<b>nzp-CSI-RS-AperiodicInfo</b> Indicates whether the UE supports aperiodic NZP CSI-RS transmission for the indicated transmission mode.	Yes
<b>nzp-CSI-RS-PeriodicInfo</b> Indicates whether the UE supports periodic NZP CSI-RS transmission for the indicated transmission mode.	Yes
<b>otdoa-UE-Assisted</b> Indicates whether the UE supports UE-assisted OTDOA positioning, as specified in TS 36.355 [54].	Yes
<b>outOfOrderDelivery</b> Same as "outOfOrderDelivery" defined in TS 38.306 [87].	No
<b>outOfSequenceGrantHandling</b> Indicates whether the UE supports PUSCH transmissions with out of sequence UL grants as defined in TS 36.213 [23]. This field can be included only if uplinkLAA is included.	-
<b>overheatingInd</b> Indicates whether the UE supports overheating assistance information.	No
<b>overheatingIndForSCG</b> Indicates whether the UE supports the inclusion of NR SCG reduced configuration in the overheating assistance information. The UE which indicates support of <i>overheatingIndForSCG</i> shall also indicate support of <i>overheatingInd</i> .	-
<b>pdccch-CandidateReductions</b> Indicates whether the UE supports PDCCH candidate reduction on UE specific search space as specified in TS 36.213 [23], clause 9.1.1.	No
<b>pdcp-Duplication</b> Indicates whether the UE supports PDCP duplication.	-
<b>pdcp-SN-Extension</b> Indicates whether the UE supports 15 bit length of PDCP sequence number.	-
<b>pdcp-SN-Extension-18bits</b> Indicates whether the UE supports 18 bit length of PDCP sequence number.	-
<b>pdcp-TransferSplitUL</b> Indicates whether the UE supports PDCP data transfer split in UL for the <i>drb-TypeSplit</i> as specified in TS 36.323 [8].	-

<b>UE-EUTRA-Capability field descriptions</b>	<b>FDD/ TDD diff</b>
<b><i>pdcp-VersionChangeWithoutHO</i></b> Indicates whether, the UE supports changing the PDCP version of DRBs, from LTE PDCP to NR PDCP and vice versa, with and without handover. A UE supporting PDCP version change shall signal field <i>pdcp-Parameters-v1610</i> . When the field <i>pdcp-VersionChangeWithoutHO</i> is not included and <i>pdcp-Parameters-v1610</i> is included, it implies the UE supports PDCP version change only with handover.	-
<b><i>pdsch-CollisionHandling</i></b> Indicates whether the UE supports PDSCH collision handling as specified in TS 36.213 [23].	No
<b><i>pdsch-InLteControlRegionCE-ModeA, pdsch-InLteControlRegionCE-ModeB</i></b> Indicates whether UE operating in CE mode A/B supports PDSCH reception in LTE control channel region as specified in TS 36.211 [21].	Yes
<b><i>pdsch-MultiTB-CE-ModeA, pdsch-MultiTB-CE-ModeB</i></b> Indicates whether the UE supports multiple TB scheduling in connected mode for PDSCH when operating in CE mode A/B, as specified in TS 36.211 [21] and TS 36.213 [23].	Yes
<b><i>pdsch-RepSubframe</i></b> Indicates whether the UE supports subframe PDSCH repetition.	Yes
<b><i>pdsch-RepSlot</i></b> Indicates whether the UE supports slot PDSCH repetition.	Yes
<b><i>pdsch-RepSubslot</i></b> Indicates whether the UE supports subslot PDSCH repetition. This field is only applicable for UEs supporting FDD.	-
<b><i>pdsch-SlotSubslotPDSCH-Decoding</i></b> Indicates whether the UE supports decoding of PDSCH and slot-PDSCH/subslot-PDSCH assigned with C-RNTI/SPS C-RNTI in the same subframe for a given carrier.	Yes
<b><i>perServingCellMeasurementGap</i></b> Indicates whether the UE supports per serving cell measurement gap indication, as specified in TS 36.133 [16].	-
<b><i>phy-TDD-ReConfig-FDD-PCell</i></b> Indicates whether the UE supports TDD UL/DL reconfiguration for TDD serving cell(s) via monitoring PDCCH with eIMTA-RNTI on a FDD PCell, and HARQ feedback according to UL and DL HARQ reference configurations. This bit can only be set to supported only if the UE supports FDD PCell and <i>phy-TDD-ReConfig-TDD-PCell</i> is set to supported.	No
<b><i>phy-TDD-ReConfig-TDD-PCell</i></b> Indicates whether the UE supports TDD UL/DL reconfiguration for TDD serving cell(s) via monitoring PDCCH with eIMTA-RNTI on a TDD PCell, and HARQ feedback according to UL and DL HARQ reference configurations, and PUCCH format 3.	Yes
<b><i>pmch-Bandwidth-n40, pmch-Bandwidth-n35, pmch-Bandwidth-n30</i></b> Indicates, for the E-UTRA band corresponding to the entry in <i>mbms-SupportedBandInfoList-v1700</i> , whether the UE in RRC_CONNECTED supports MBMS reception via MBSFN from MBMS-dedicated cells in an MBSFN area with PMCH bandwidth of 40/ 35/ 30 PRBs as described in TS 36.211 [21] and TS 36.213 [23].	-
<b><i>pmi-Disabling</i></b>	Yes
<b><i>powerClass-14dBm</i></b> Indicates whether the UE supports power class 14 dBm when operating in CE mode A or B for all the bands that are supported by the UE, as specified in TS 36.101 [42].	-
<b><i>powerPrefInd</i></b> Indicates whether the UE supports power preference indication.	No
<b><i>powerUCI-SlotPUSCH, powerUCI-SubslotPUSCH</i></b> Indicates whether the UE supports BPRE derivation based on the actual derived O_CQI. The parameter <i>uplinkPower-CSI-Payload</i> configures the UE to derive BPRE based on either the actual value of O_CQI or the largest value of O_CQI across all RI values. If the UE does not support the capability, the UE will derive BPRE based on the largest value of O_CQI across all RI values.	Yes
<b><i>prach-Enhancements</i></b> This field defines whether the UE supports random access preambles generated from restricted set type B in high speed scenario as specified in TS 36.211 [21].	-
<b><i>processingTimelineSet</i></b> Indicates, for each SPDCCH configuration, support for a set of TA values. Each set consists of two different processing timelines and associated maximum TA. Set 1 indicates support for n+4 and n+6 and set 2 indicates support for n+6 and n+8, see TS 36.211 [21], clause 8.1, The minimum processing timeline to use, out of the two options for a given set is configured by parameter <i>proc-Timeline</i> . Support of Set 1 implicitly means support of Set 2.	-
<b><i>pucch-Format4</i></b> Indicates whether the UE supports PUCCH format 4.	Yes

<b>UE-EUTRA-Capability field descriptions</b>	<b>FDD/ TDD diff</b>
<b>pucch-Format5</b> Indicates whether the UE supports PUCCH format 5.	Yes
<b>pucch-SCell</b> Indicates whether the UE supports PUCCH on SCell.	No
<b>pur-CP-EPC-CE-ModeA, pur-CP-EPC-CE-ModeB, pur-CP-5GC-CE-ModeA, pur-CP-5GC-CE-ModeB</b> Indicates whether UE operating in CE mode A/B supports CP transmission using PUR when connected to EPC/ 5GC.	Yes
<b>pur-CP-L1Ack</b> Indicates whether UE supports L1 acknowledgement in response to CP transmission using PUR when connected to EPC/ 5GC.	Yes
<b>pur-FrequencyHopping</b> Indicates whether UE supports frequency hopping for transmission using PUR.	Yes
<b>pur-PUSCH-NB-MaxTBS</b> Indicates whether the UE supports 2984 bits max UL TBS in 1.4 MHz for transmission using PUR when operating in CE mode A, as specified in TS 36.212 [22] and TS 36.213 [23].	Yes
<b>pur-RSRP-Validation</b> Indicates whether UE supports serving cell RSRP for TA validation for transmission using PUR when connected to EPC/ 5GC.	Yes
<b>pur-SubPRB-CE-ModeA, pur-SubPRB-CE-ModeB</b> Indicates whether UE supports subPRB resource allocation for PUSCH for transmission using PUR when operating in CE mode A/B.	Yes
<b>pur-UP-EPC-CE-ModeA, pur-UP-EPC-CE-ModeB, pur-UP-5GC-CE-ModeA, pur-UP-5GC-CE-ModeB</b> Indicates whether UE operating in CE mode A/B supports UP transmission using PUR when connected to EPC/ 5GC.	Yes
<b>pusch-Enhancements</b> Indicates whether the UE supports the PUSCH enhancement mode as specified in TS 36.211 [21] and TS 36.213 [23].	Yes
<b>pusch-FeedbackMode</b> Indicates whether the UE supports PUSCH feedback mode 3-2.	No
<b>pusch-MultiTB-CE-ModeA, pusch-MultiTB-CE-ModeB</b> Indicates whether the UE supports multiple TB scheduling in connected mode for PUSCH when operating in CE mode A/B, as specified in TS 36.211 [21] and TS 36.213 [23].	Yes
<b>pusch-SPS-MaxConfigSlot</b> Indicates the max number of SPS configurations across all cells for slot PUSCH.	Yes
<b>pusch-SPS-MultiConfigSlot</b> Indicates the number of multiple SPS configurations of slot PUSCH for each serving cell.	Yes
<b>pusch-SPS-MaxConfigSubframe</b> Indicates the max number of SPS configurations across all cells for subframe PUSCH.	Yes
<b>pusch-SPS-MultiConfigSubframe</b> Indicates the number of multiple SPS configurations of subframe PUSCH for each serving cell.	Yes
<b>pusch-SPS-MaxConfigSubslot</b> Indicates the max number of SPS configurations across all cells for subslot PUSCH.	-
<b>pusch-SPS-MultiConfigSubslot</b> Indicates the number of multiple SPS configurations of subslot PUSCH for each serving cell. This field is only applicable for UEs supporting FDD.	-
<b>pusch-SPS-SlotRepPCell</b> Indicates whether the UE supports SPS repetition for slot PUSCH for PCell.	Yes
<b>pusch-SPS-SlotRepPSCell</b> Indicates whether the UE supports SPS repetition for slot PUSCH for PSCell.	Yes
<b>pusch-SPS-SlotRepSCell</b> Indicates whether the UE supports SPS repetition for slot PUSCH for serving cells other than SpCell.	Yes
<b>pusch-SPS-SubframeRepPCell</b> Indicates whether the UE supports SPS repetition for subframe PUSCH for PCell.	Yes
<b>pusch-SPS-SubframeRepPSCell</b> Indicates whether the UE supports SPS repetition for subframe PUSCH for PSCell.	Yes
<b>pusch-SPS-SubframeRepSCell</b> Indicates whether the UE supports SPS repetition for subframe PUSCH for serving cells other than SpCell.	Yes
<b>pusch-SPS-SubslotRepPCell</b> Indicates whether the UE supports SPS repetition for subslot PUSCH for PCell. This field is only applicable for UEs supporting FDD.	-

<b>UE-EUTRA-Capability field descriptions</b>	<b>FDD/ TDD diff</b>
<b>pusch-SPS-SubslotRepPSCell</b> Indicates whether the UE supports SPS repetition for subslot PUSCH for PSCell. This field is only applicable for UEs supporting FDD.	-
<b>pusch-SPS-SubslotRepSCell</b> Indicates whether the UE supports SPS repetition for subslot PUSCH for serving cells other than SpCell. This field is only applicable for UEs supporting FDD.	-
<b>pusch-SRS-PowerControl-SubframeSet</b> Indicates whether the UE supports subframe set dependent UL power control for PUSCH and SRS. This field is only applicable for UEs supporting TDD.	Yes
<b>qcl-CRI-BasedCSI-Reporting</b> Indicates whether the UE supports CRI based CSI feedback for the FeCoMP feature as specified in TS 36.213 [23], clause 7.1.10.	-
<b>qcl-TypeC-Operation</b> The UE uses this field to indicate the support of all of the following three features: QCL Type-C operation for FeCoMP, the capability to support separate PDSCH RE mapping for different PDSCH CWs in non-coherent joint transmission and the capability to support handling new DMRS port to MIMO layer mapping for the CWs, as specified in TS 36.213 [23], clause 7.1.10.	-
<b>qoe-MeasReport</b> Indicates whether the UE supports QoE Measurement Collection for streaming services.	-
<b>qoe-MTSI-MeasReport</b> Indicates whether the UE supports QoE Measurement Collection for MTSI services.	-
<b>rach-Less</b> Indicates whether the UE supports RACH-less handover, and whether the UE which indicates <i>dc-Parameters</i> supports RACH-less SeNB change, as defined in TS 36.300 [9].	-
<b>rach-Report</b> Indicates whether the UE supports delivery of <i>rach-Report</i> .	-
<b>rach-ReportForNR</b> Indicates whether the UE supports NR RACH report in LTE, upon request from the network.	-
<b>rai-Support</b> Defines whether the UE supports release assistance indication (RAI) as specified in TS 36.321 [6] for BL UEs.	No
<b>rai-SupportEnh</b> Indicates whether the UE supports 2-bit RAI when connected to EPC as specified in TS 36.321 [6].	-
<b>rclwi</b> Indicates whether the UE supports RCLWI, i.e. reception of <i>rclwi-Configuration</i> . The UE which supports RLCWI shall also indicate support of <i>interRAT-ParametersWLAN-r13</i> . The UE which supports RCLWI and <i>wlan-IW-RAN-Rules</i> shall also support applying WLAN identifiers received in <i>rclwi-Configuration</i> for the access network selection and traffic steering rules when in RRC_IDLE.	-
<b>recommendedBitRate</b> Indicates whether the UE supports the bit rate recommendation message from the eNB to the UE as specified in TS 36.321 [6], clause 6.1.3.13.	No
<b>recommendedBitRateMultiplier</b> Indicates whether the UE supports the bit rate multiplier for recommended bit rate MAC CE as specified in TS 36.321 [6], clause 6.1.3.13. If this field is included, the UE shall also include the <i>recommendedBitRate</i> field.	-
<b>recommendedBitRateQuery</b> Indicates whether the UE supports the bit rate recommendation query message from the UE to the eNB as specified in TS 36.321 [6], clause 6.1.3.13. If this field is included, the UE shall also include the <i>recommendedBitRate</i> field.	No
<b>reducedCP-Latency</b> Indicates whether the UE supports reduced CP latency.	Yes
<b>reducedIntNonContComb</b> Indicates whether the UE supports receiving <i>requestReducedIntNonContComb</i> that requests the UE to exclude supported intra-band non-contiguous CA band combinations other than included in capability signalling as specified in TS 36.306 [5], clause 4.3.5.21.	-
<b>reducedIntNonContCombRequested</b> Indicates that the UE excluded supported intra-band non-contiguous CA band combinations other than included in capability signalling as specified in TS 36.306 [5,] clause 4.3.5.21.	-
<b>reflectiveQoS</b> Indicates whether the UE supports AS reflective QoS.	No

<b>UE-EUTRA-Capability field descriptions</b>	<b>FDD/ TDD diff</b>
<b>relWeightTwoLayers/ relWeightFourLayers/ relWeightEightLayers</b> Indicates relative weight of processing FD-MIMO with 2/ 4/ 8 layers with respect to non-FD-MIMO with the same number of layers, see NOTE 8. Value v1 corresponds to relative weight of 1, value v1dot25 corresponds to relative weight of 1.25 and so on. This field can be included only if the UE supports the corresponding number of layers (i.e., 2/ 4/ 8 layers).	-
<b>reportCGI-NR-EN-DC</b> Indicates whether the UE supports Inter-RAT report CGI procedure towards NR cell when it is configured with (NG)EN-DC.	Yes
<b>reportCGI-NR-NoEN-DC</b> Indicates whether the UE supports Inter-RAT report CGI procedure towards NR cell when it is not configured with (NG)EN-DC.	Yes
<b>resumeWithMCG-SCellConfig</b> Indicates whether the UE supports (re-)configuration of E-UTRA MCG SCells.	-
<b>resumeWithSCG-Config</b> Indicates whether the UE supports (re-)configuration of an NR SCG.	-
<b>resumeWithStoredMCG-SCells</b> Indicates whether the UE supports not deleting the stored E-UTRA MCG SCell configuration when initiating the resume procedure.	-
<b>resumeWithStoredSCG</b> Indicates whether the UE supports not deleting the stored NR SCG configuration when initiating the resume procedure.	-
<b>srs-CapabilityPerBandPairList</b> Indicates, for a particular pair of bands, the SRS carrier switching parameters when switching between the band pair to transmit SRS on a PUSCH-less SCell as specified in TS 36.212 [22] and TS 36.213 [23]. If included, the UE shall include a number of entries as indicated in the following, and listed in the same order, as in <i>bandParameterList</i> for the concerned band combination: <ul style="list-style-type: none"> <li>- For the first band, the UE shall include the same number of entries as in <i>bandParameterList</i> i.e. first entry corresponds to first band in <i>bandParameterList</i> and so on,</li> <li>- For the second band, the UE shall include one entry less i.e. first entry corresponds to the second band in <i>bandParameterList</i> and so on</li> <li>- And so on.</li> </ul>	-
<b>requestedBands</b> Indicates the frequency bands requested by E-UTRAN.	-
<b>requestedCCsDL, requestedCCsUL</b> Indicates the maximum number of CCs requested by E-UTRAN.	-
<b>requestedDiffFallbackComblList</b> Indicates the CA band combinations for which report of different UE capabilities is requested by E-UTRAN.	-
<b>rf-RetuningTimeDL</b> Indicates the interruption time on DL reception within a band pair during the RF retuning for switching between the band pair to transmit SRS on a PUSCH-less SCell. n0 represents 0 OFDM symbols, n0dot5 represents 0.5 OFDM symbols, n1 represents 1 OFDM symbol and so on. This field is mandatory present if switching between the band pair is supported.	-
<b>rf-RetuningTimeUL</b> Indicates the interruption time on UL transmission within a band pair during the RF retuning for switching between the band pair to transmit SRS on a PUSCH-less SCell. n0 represents 0 OFDM symbols, n0dot5 represents 0.5 OFDM symbols, n1 represents 1 OFDM symbol and so on. This field is mandatory present if switching between the band pair is supported.	-
<b>rlc-AM-Ooo-Delivery</b> Indicates whether the UE supports out-of-order delivery from RLC to PDCP for RLC AM.	-
<b>rlc-UM-Ooo-Delivery</b> Indicates whether the UE supports out-of-order delivery from RLC to PDCP for RLC UM.	-
<b>rlm-ReportSupport</b> Indicates whether the UE supports RLM event and information reporting.	-
<b>rohc-ContextContinue</b> Same as " <i>continueROHC-Context</i> " defined in TS 38.306 [87].	No
<b>rohc-ContextMaxSessions</b> Same as " <i>maxNumberROHC-ContextSessions</i> " defined in TS 38.306 [87].	No
<b>rohc-Profiles</b> Same as " <i>supportedROHC-Profiles</i> " defined in TS 38.306 [87].	No
<b>rohc-ProfilesUL-Only</b> Same as " <i>uplinkOnlyROHC-Profiles</i> " defined in TS 38.306 [87].	No



<b>UE-EUTRA-Capability field descriptions</b>	<b>FDD/ TDD diff</b>
<b>rsrqMeasWideband</b> Indicates whether the UE can perform RSRQ measurements with wider bandwidth.	Yes
<b>rsrq-OnAllSymbols</b> Indicates whether the UE can perform RSRQ measurement on all OFDM symbols and also support the extended RSRQ upper value range from -3dB to 2.5dB in measurement configuration and reporting as specified in TS 36.133 [16].	No
<b>rs-SINR-Meas</b> Indicates whether the UE can perform RS-SINR measurements in RRC_CONNECTED as specified in TS 36.214 [48].	-
<b>rssi-AndChannelOccupancyReporting</b> Indicates whether the UE supports performing measurements and reporting of RSSI and channel occupancy. This field can be included only if <i>downlinkLAA</i> is included.	-
<b>sa-NR</b> Indicates whether the UE supports standalone NR as specified in TS 38.331 [82].	No
<b>satelliteInfoConfigDedicated</b> This field indicates whether the UE can be configured via dedicated signalling with NTN assistance information (i.e., <i>satelliteId-r18</i> or ephemeris information in <i>measObjectEUTRA</i> ) to measure an NTN cell in RRC_CONNECTED.	-
<b>scalingFactorTxSidelink, scalingFactorRxSidelink</b> Indicates, for a particular band combination of EUTRA, the scaling factor, as defined in TS 38.306 [87], for the PC5 band combination(s) <i>v2x-SupportedBandCombinationListEUTRA-NR</i> on which the UE supports simultaneous transmission/reception of EUTRA and NR sidelink communication respectively, or simultaneous transmission or reception of EUTRA and joint V2X sidelink communication and NR sidelink communication respectively (as indicated by <i>v2x-SupportedTxBandCombListPerBC-v1630 / v2x-SupportedRxBandCombListPerBC-v1630</i> ). The leading / leftmost value corresponds to the first band combination included in <i>v2x-SupportedBandCombinationListEUTRA-NR</i> which is indicated with value 1 by <i>v2x-SupportedTxBandCombListPerBC-v1630 / v2x-SupportedRxBandCombListPerBC-v1630</i> , the next value corresponds to the second band combination included in <i>v2x-SupportedBandCombinationListEUTRA-NR</i> which is indicated with value 1 by <i>v2x-SupportedTxBandCombListPerBC-v1630 / v2x-SupportedRxBandCombListPerBC-v1630</i> and so on. For each value of <i>ScalingFactorSidelink-r16</i> , value f0p4 indicates the scaling factor 0.4, f0p75 indicates 0.75, and so on.	-
<b>scptm-AsyncDC</b> Indicates whether the UE in RRC_CONNECTED supports MBMS reception via SC-MRB on a frequency indicated in an <i>MBMSInterestIndication</i> message, where (according to <i>supportedBandCombination</i> ) the carriers that are or can be configured as serving cells in the MCG and the SCG are not synchronized. If this field is included, the UE shall also include <i>scptm-SCell</i> and <i>scptm-NonServingCell</i> .	Yes
<b>scptm-NonServingCell</b> Indicates whether the UE in RRC_CONNECTED supports MBMS reception via SC-MRB on a frequency indicated in an <i>MBMSInterestIndication</i> message, where (according to <i>supportedBandCombination</i> and to network synchronization properties) a serving cell may be additionally configured. If this field is included, the UE shall also include the <i>scptm-SCell</i> field.	Yes
<b>scptm-Parameters</b> Presence of the field indicates that the UE supports SC-PTM reception as specified in TS 36.306 [5].	Yes
<b>scptm-SCell</b> Indicates whether the UE in RRC_CONNECTED supports MBMS reception via SC-MRB on a frequency indicated in an <i>MBMSInterestIndication</i> message, when an SCell is configured on that frequency (regardless of whether the SCell is activated or deactivated).	Yes
<b>scptm-ParallelReception</b> Indicates whether the UE in RRC_CONNECTED supports parallel reception in the same subframe of DL-SCH transport blocks transmitted using C-RNTI/Semi-Persistent Scheduling C-RNTI and using SC-RNTI/G-RNTI as specified in TS 36.306 [5].	Yes
<b>secondSlotStartingPosition</b> Indicates whether the UE supports reception of subframes with second slot starting position as described in TS 36.211 [21] and TS 36.213 [23]. This field can be included only if <i>downlinkLAA</i> is included.	-
<b>semiOL</b> Indicates whether the UE supports semi-open-loop transmission for the indicated transmission mode.	Yes
<b>semiStaticCFI</b> Indicates whether the UE supports the semi-static configuration of CFI for subframe/slot/sub-slot operation.	Yes

<b>UE-EUTRA-Capability field descriptions</b>	<b>FDD/ TDD diff</b>
<b>semiStaticCFI-Pattern</b> Indicates whether the UE supports the semi-static configuration of CFI pattern for subframe/slot/sub-slot operation. This field is only applicable for UEs supporting TDD.	-
<b>sharedSpectrumMeasNR-EN-DC</b> Indicates whether the UE supports performing measurements and reporting of RSSI and channel occupancy on each supported NR band in EN-DC. If included, the UE shall include the same number of entries, and listed in the same order as in <i>supportedBandListEN-DC-r15</i> .	-
<b>sharedSpectrumMeasNR-SA</b> Indicates whether the UE supports performing measurements and reporting of RSSI and channel occupancy on each supported NR band in NR SA. If included, the UE shall include the same number of entries, and listed in the same order as in <i>supportedBandListNR-SA-r15</i> .	-
<b>shortCQI-ForSCellActivation</b> Indicates whether the UE supports additional CQI reporting periodicity after SCell activation.	Yes
<b>shortMeasurementGap</b> Indicates whether the UE supports shorter measurement gap length (i.e. <i>gp2</i> and <i>gp3</i> ) in LTE standalone as specified in TS 36.133 [16], and for independent measurement gap configuration on FR1 and per-UE gap in (NG)EN-DC as specified in TS38.133 [84].	No
<b>shortSPS-IntervalFDD</b> Indicates whether the UE supports uplink SPS intervals shorter than 10 subframes in FDD mode.	-
<b>shortSPS-IntervalTDD</b> Indicates whether the UE supports uplink SPS intervals shorter than 10 subframes in TDD mode.	-
<b>sigBasedEUTRA-LoggedMeasOverrideProtect</b> Indicates whether the UE supports the override protection of the signalling based logged measurements configured in E-UTRA when entering RRC_CONNECTED state in NR.	-
<b>simultaneousPUCCH-PUSCH</b> Indicates whether the UE supports simultaneous transmission of PUSCH/PUCCH and SlotOrSubslotPUSCH/SPUCCH (if supported).	Yes
<b>simultaneousRx-Tx</b> Indicates whether the UE supports simultaneous reception and transmission on different bands for each band combination listed in <i>supportedBandCombination</i> . This field is only applicable for inter-band TDD band combinations. A UE indicating support of <i>simultaneousRx-Tx</i> and <i>dc-Support-r12</i> shall support different UL/DL configurations between PCell and PSCell.	-
<b>simultaneousTx-DifferentTx-Duration</b> Indicates whether the UE supports simultaneous transmission of different transmission durations over different carriers. The different transmission durations can be of subframe, slot or subslot duration.	-
<b>skipFallbackCombinations</b> Indicates whether UE supports receiving <i>requestSkipFallbackComb</i> that requests UE to exclude fallback band combinations from capability signalling.	-
<b>skipFallbackCombRequested</b> Indicates whether <i>requestSkipFallbackComb</i> is requested by E-UTRAN.	-
<b>skipMonitoringDCI-Format0-1A</b> Indicates whether UE supports blind decoding reduction on UE specific search space by not monitoring DCI Format 0 and 1A as specified in TS 36.213 [23], clause 9.1.1.	No
<b>skipSubframeProcessing</b> This fields defines whether the UE supports aborting reception of PDSCH if the UE receives slot-PDSCH/subslot-PDSCH during an ongoing PDSCH reception and instead starts receiving the slot-PDSCH/subslot-PDSCH, as well as whether the UE supports aborting a PUSCH transmission if the UE gets a grant for a slot-PUSCH/ subslot-PUSCH transmission that overlaps with a grant received for a PUSCH transmission. The capability indicates the number of subframes that the UE may drop prior to the subframe in which it prioritizes the processing of slot/subslot PDSCH/PUSCH as described in TS 36.213 [23], clauses 7.1 and 8.0. Separate capability for UL and DL and per sTTI length in each direction: <i>skipProcessingDL-Slot</i> , <i>skipProcessingDL-Subslot</i> , <i>skipProcessingUL-Slot</i> and <i>skipProcessingUL-Subslot</i> .	-
<b>skipUplinkDynamic</b> Indicates whether the UE supports skipping of UL transmission for an uplink grant indicated on PDCCH if no data is available for transmission as described in TS 36.321 [6].	-
<b>skipUplinkSPS</b> Indicates whether the UE supports skipping of UL transmission for a configured uplink grant if no data is available for transmission as described in TS 36.321 [6].	-
<b>sl-64QAM-Rx</b> Indicates whether the UE supports 64QAM for the reception of V2X sidelink communication.	-

<b>UE-EUTRA-Capability field descriptions</b>	<b>FDD/ TDD diff</b>
<b>sl-64QAM-Tx</b> Indicates whether the UE supports 64QAM for the transmission of V2X sidelink communication.	-
<b>sl-A2X-Service</b> Indicates whether the UE supports A2X service and dedicated resource pool for A2X service. Value 'brid' indicates BRID is supported, value 'daa' indicates DAA is supported, and value 'bridAndDAA' indicates both are supported.	-
<b>sl-CongestionControl</b> Indicates whether the UE supports Channel Busy Ratio measurement and reporting of Channel Busy Ratio measurement results to eNB for V2X sidelink communication.	-
<b>sl-LowT2min</b> Indicates whether the UE supports 10ms as minimum value of T2 for resource selection procedure of V2X sidelink communication.	-
<b>sl-ParameterNR</b> Includes the <i>SidelinkParametersNR</i> IE as specified in TS 38.331 [82]. The field includes the sidelink capability for NR-PC5, where <i>multipleSR-ConfigurationsSidelink</i> , <i>logicalChannelSR-DelayTimerSidelink</i> and <i>relayParameters</i> are not applicable.	-
<b>sl-RateMatchingTBSScaling</b> Indicates whether the UE supports rate matching and TBS scaling for V2X sidelink communication.	-
<b>slotPDSCH-TxDiv-TM8</b> Indicates whether the UE supports TX diversity transmission using ports 7 and 8 for TM8 for slot PDSCH.	-
<b>slotPDSCH-TxDiv-TM9and10</b> Indicates whether the UE supports TX diversity transmission using ports 7 and 8 for TM9/10 for slot PDSCH.	Yes
<b>slotSymbolResourceResvDL-CE-ModeA, slotSymbolResourceResvDL-CE-ModeB, slotSymbolResourceResvUL-CE-ModeA, slotSymbolResourceResvUL-CE-ModeB</b> Indicates whether the UE supports slot/symbol-level time-domain resource reservation in downlink/uplink when operating in CE mode A/B, as specified in TS 36.211 [21] and TS 36.213 [23].	Yes
<b>slss-SupportedTxFreq</b> Indicates whether the UE supports the SLSS transmission on single carrier or on multiple carriers in the case of sidelink carrier aggregation.	-
<b>slss-TxRx</b> Indicates whether the UE supports SLSS/PSBCH transmission and reception in UE autonomous resource selection mode and eNB scheduled mode in a band for V2X sidelink communication.	-
<b>sl-TxDiversity</b> Indicates whether the UE supports transmit diversity for V2X sidelink communication. See TS 36.101 [42].	-
<b>sn-SizeLo</b> Same as "shortSN" defined in TS 38.306 [87].	No
<b>spatialBundling-HARQ-ACK</b> Indicates whether UE supports HARQ-ACK spatial bundling on PUCCH or PUSCH as specified in TS 36.213 [23], clauses 7.3.1 and 7.3.2.	No
<b>spdcch-differentRS-types</b> Indicates whether the UE supports monitoring of sPDCCH on RB sets with different RS types within a TTI.	Yes
<b>spdcch-Reuse</b> Indicates whether the UE supports L1 based sPDCCH reuse.	Yes
<b>sps-CyclicShift</b> Indicates whether the UE supports RRC configuration of cyclic shift for DMRS for UL SPS using 1ms TTI.	Yes
<b>sps-ServingCell</b> Indicates whether the UE supports multiple UL/DL SPS configurations simultaneously active on different serving cells as specified in TS 36.321 [6].	-
<b>sps-STTI</b> Indicates whether the UE supports SPS in DL and/or UL for slot or subslot based PDSCH and PUSCH, respectively.	Yes
<b>srs-DCI7-TriggeringFS2</b> Indicates whether the UE supports SRS triggering via DCI format 7 for FS2.	-
<b>srs-Enhancements</b> Indicates whether the UE supports SRS enhancements.	Yes

<b>UE-EUTRA-Capability field descriptions</b>	<b>FDD/ TDD diff</b>
<b>srs-EnhancementsTDD</b> Indicates whether the UE supports TDD specific SRS enhancements.	Yes
<b>srs-FlexibleTiming</b> Indicates whether the UE supports configuration of <i>soundingRS-FlexibleTiming-r14</i> for the corresponding band pair. For a TDD-TDD band pair, UE shall include at least one of <i>srs-FlexibleTiming</i> and/or <i>srs-HARQ-ReferenceConfig</i> when <i>rf-RetuningTimeDL</i> or <i>rf-RetuningTimeUL</i> corresponding to the band pair is larger than 1 OFDM symbol.	-
<b>srs-HARQ-ReferenceConfig</b> Indicates whether the UE supports configuration of <i>harq-ReferenceConfig-r14</i> for the corresponding band pair. For a TDD-TDD band pair, UE shall include at least one of <i>srs-FlexibleTiming</i> and/or <i>srs-HARQ-ReferenceConfig</i> when <i>rf-RetuningTimeDL</i> or <i>rf-RetuningTimeUL</i> corresponding to the band pair is larger than 1 OFDM symbol.	-
<b>srs-MaxSimultaneousCCs</b> Indicates the maximum number of simultaneously configurable target CCs for SRS switching (i.e., CCs for which <i>srs-SwitchFromServCellIndex</i> is configured) supported by the UE.	-
<b>srs-UpPTS-6sym</b> Indicates whether the UE supports up to 6-symbol SRS in UpPTS.	-
<b>srvcc-FromUTRA-FDD-ToGERAN</b> Indicates whether UE supports SRVCC handover from UTRA FDD PS HS to GERAN CS.	-
<b>srvcc-FromUTRA-FDD-ToUTRA-FDD</b> Indicates whether UE supports SRVCC handover from UTRA FDD PS HS to UTRA FDD CS.	-
<b>srvcc-FromUTRA-TDD128-ToGERAN</b> Indicates whether UE supports SRVCC handover from UTRA TDD 1.28Mcps PS HS to GERAN CS.	-
<b>srvcc-FromUTRA-TDD128-ToUTRA-TDD128</b> Indicates whether UE supports SRVCC handover from UTRA TDD 1.28Mcps PS HS to UTRA TDD 1.28Mcps CS.	-
<b>ss-CCH-InterfHandl</b> Indicates whether the UE supports synchronisation signal and common channel interference handling.	Yes
<b>ss-SINR-Meas-NR-FR1, ss-SINR-Meas-NR-FR2</b> Indicates whether the UE can perform NR SS-SINR measurement for a frequency range (i.e. FR1 or FR2) as specified in TS 38.215 [89].	-
<b>ssp10-TDD-Only</b> Indicates the UE supports special subframe configuration 10 when operating only in TDD carriers (i.e., not in TDD/FDD CA or TDD/FS3 CA). A UE including this field shall not include <i>tdd-SpecialSubframe-r14</i> .	-
<b>standaloneGNSS-Location</b> Indicates whether the UE is equipped with a standalone GNSS receiver that may be used to provide detailed location information in RRC measurement report and logged measurements.	-
<b>sTTI-SPT-Supported</b> Indicates whether the UE supports the features STTI and/or SPT. If the UE supports STTI and/or SPT features, the UE shall report the field <i>sTTI-SPT-Supported</i> set to <i>supported</i> in capability signalling, irrespective of whether <i>requestSTTI-SPT-Capability</i> field is present or not.	-
<b>sTTI-FD-MIMO-Coexistence</b> Indicates whether the UE supports CSI feedback for more than 8 NZP CSI-RS ports on subframe based PUSCH in any serving cell and supporting STTI in any serving cell.	-
<b>sTTI-SupportedCombinations</b> Indicates the different combinations of short TTI lengths, see field description for <i>dl-STTI-Length</i> and <i>ul-STTI-Length</i> , that the UE supports in a single PUCCH group or in two PUCCH groups. A short TTI length combination is reported for DL first followed by UL. In case of two PUCCH groups the support for the primary PUCCH group is indicated first.	-
<b>subcarrierPuncturingCE-ModeA, subcarrierPuncturingCE-ModeB</b> Indicates whether the UE supports subcarrier puncturing in downlink when operating in CE mode A/B, as specified in TS 36.211 [21] and TS 36.213 [23].	Yes
<b>subcarrierSpacingMBMS-khz7dot5, subcarrierSpacingMBMS-khz1dot25</b> Indicates the supported subcarrier spacings for MBSFN subframes in addition to 15 kHz subcarrier spacing. <i>subcarrierSpacingMBMS-khz1dot25</i> and <i>subcarrierSpacingMBMS-khz7dot5</i> indicates that the UE supports 1.25 and 7.5 kHz respectively for MBSFN subframes as described in TS 36.211 [21], clause 6.12. This field is included only if <i>fembmsMixedCell</i> or <i>fembmsDedicatedCell</i> is included.	-

<b>UE-EUTRA-Capability field descriptions</b>	<b>FDD/ TDD diff</b>
<p><b>subcarrierSpacingMBMS-khz2dot5, subcarrierSpacingMBMS-khz0dot37</b> Presence of this field indicates the supported subcarrier spacings of 2.5kHz / 0.37kHz for MBSFN subframes in addition to 15 kHz subcarrier spacing when operating on the E-UTRA band given by the entry in <i>mbms-SupportedBandInfoList</i> as described in TS 36.211 [21], clause 6.12.</p>	-
<p><b>subframeResourceResvDL-CE-ModeA, subframeResourceResvDL-CE-ModeB, subframeResourceResvUL-CE-ModeA, subframeResourceResvUL-CE-ModeB</b> Indicates whether the UE supports Subframe-level time-domain resource reservation in downlink/uplink when operating in CE mode A/B, as specified in TS 36.211 [21] and TS 36.213 [23].</p>	Yes
<p><b>subslotPDSCH-TxDiv-TM9and10</b> Indicates whether the UE supports TX diversity transmission using ports 7 and 8 for TM9/10 for subslot PDSCH.</p>	Yes
<p><b>supportedBandCombination</b> Includes the supported CA band combinations, if any, and may include all the supported non-CA bands.</p>	-
<p><b>supportedBandCombinationAdd-r11</b> Includes additional supported CA band combinations in case maximum number of CA band combinations of <i>supportedBandCombination</i> is exceeded.</p>	-
<p><b>SupportedBandCombinationAdd-v11d0, SupportedBandCombinationAdd-v1250, SupportedBandCombinationAdd-v1270, SupportedBandCombinationAdd-v1320, SupportedBandCombinationAdd-v1380, SupportedBandCombinationAdd-v1390, SupportedBandCombinationAdd-v1430, SupportedBandCombinationAdd-v1450, SupportedBandCombinationAdd-v1470, SupportedBandCombinationAdd-v14b0, SupportedBandCombinationAdd-v1530, SupportedBandCombinationAdd-v1630, SupportedBandCombinationAdd-v1800</b> If included, the UE shall include the same number of entries, and listed in the same order, as in <i>SupportedBandCombinationAdd-r11</i>.</p>	-
<p><b>SupportedBandCombinationAdd-v1610</b> If included, the UE shall include the same number of entries, and listed in the same order, as in <i>SupportedBandCombinationAdd-r11</i>. If absent, network assumes gap is required when measurement is performed on any NR bands while UE is served by cell(s) belongs to an E-UTRA CA band combinations listed in <i>SupportedBandCombinationAdd-r11</i> except for the FR2 inter-RAT measurement which depends on the support of <i>independentGapConfig</i>.</p>	-
<p><b>SupportedBandCombinationExt, SupportedBandCombination-v1090, SupportedBandCombination-v10i0, SupportedBandCombination-v1130, SupportedBandCombination-v1250, SupportedBandCombination-v1270, SupportedBandCombination-v1320, SupportedBandCombination-v1380, SupportedBandCombination-v1390, SupportedBandCombination-v1430, SupportedBandCombination-v1450, SupportedBandCombination-v1470, SupportedBandCombination-v14b0, SupportedBandCombination-v1530, SupportedBandCombination-v1630, SupportedBandCombination-v1800</b> If included, the UE shall include the same number of entries, and listed in the same order, as in <i>supportedBandCombination-r10</i>.</p>	-
<p><b>SupportedBandCombination-v1610</b> If included, the UE shall include the same number of entries, and listed in the same order, as in <i>supportedBandCombination-r10</i>. If absent, network assumes gap is required when measurement is performed on any NR bands while UE is served by cell(s) belongs to an E-UTRA CA band combinations listed in <i>supportedBandCombination-r10</i> except for the FR2 inter-RAT measurement which depends on the support of <i>independentGapConfig</i>.</p>	-
<p><b>supportedBandCombinationReduced</b> Includes the supported CA band combinations, and may include the fallback CA combinations specified in TS 36.101 [42], clause 4.3A. This field also indicates whether the UE supports reception of <i>requestReducedFormat</i>.</p>	-
<p><b>SupportedBandCombinationReduced-v1320, SupportedBandCombinationReduced-v1380, SupportedBandCombinationReduced-v1390, SupportedBandCombinationReduced-v1430, SupportedBandCombinationReduced-v1450, SupportedBandCombinationReduced-v1470, SupportedBandCombinationReduced-v14b0, SupportedBandCombinationReduced-v1530, SupportedBandCombinationReduced-v1630, SupportedBandCombinationReduced-v1800</b> If included, the UE shall include the same number of entries, and listed in the same order, as in <i>supportedBandCombinationReduced-r13</i>.</p>	-

<b>UE-EUTRA-Capability field descriptions</b>	<b>FDD/ TDD diff</b>
<p><b>SupportedBandCombinationReduced-v1610</b> If included, the UE shall include the same number of entries, and listed in the same order, as in <i>supportedBandCombinationReduced-r13</i>. If absent, network assumes gap is required when measurement is performed on any NR bands while UE is served by cell(s) belongs to an E-UTRA CA band combinations listed in <i>supportedBandCombinationReduced-r13</i> except for the FR2 inter-RAT measurement which depends on the support of <i>independentGapConfig</i>.</p>	-
<p><b>SupportedBandGERAN</b> GERAN band as defined in TS 45.005 [20].</p>	No
<p><b>SupportedBandList1XRTT</b> One entry corresponding to each supported CDMA2000 1xRTT band class.</p>	-
<p><b>SupportedBandListEUTRA</b> Includes the supported E-UTRA bands. This field shall include all bands which are indicated in <i>BandCombinationParameters</i>.</p>	-
<p><b>SupportedBandListEUTRA-v9e0, SupportedBandListEUTRA-v1250, SupportedBandListEUTRA-v1310, SupportedBandListEUTRA-v1320</b> If included, the UE shall include the same number of entries, and listed in the same order, as in <i>supportedBandListEUTRA</i> (i.e. without suffix).</p>	-
<p><b>SupportedBandListGERAN</b></p>	No
<p><b>SupportedBandListHRPD</b> One entry corresponding to each supported CDMA2000 HRPD band class.</p>	-
<p><b>SupportedBandListNR-SA</b> Includes the NR bands supported by the UE in NR-SA (for handover and redirection). The field is included in case the UE supports NR SA as specified in TS 38.331 [32] and not otherwise. The presence of this field also indicates that the UE can perform both NR SS-RSRP and SS-RSRQ measurement in the included NR band(s) as specified in TS 38.215 [89].</p>	No
<p><b>supportedBandListEN-DC</b> Includes the NR bands supported by the UE in (NG)EN-DC. The field is included in case the parameter <i>en-DC</i> or <i>ng-EN-DC</i> is present and set to <i>supported</i> and not otherwise. The presence of this field also indicates that the UE can perform both NR SS-RSRP and SS-RSRQ measurement in the included NR band(s) as specified in TS 38.215 [89].</p>	-
<p><b>supportedBandListWLAN</b> Indicates the supported WLAN bands by the UE.</p>	-
<p><b>SupportedBandUTRA-FDD</b> UTRA band as defined in TS 25.101 [17].</p>	-
<p><b>SupportedBandUTRA-TDD128</b> UTRA band as defined in TS 25.102 [18].</p>	-
<p><b>SupportedBandUTRA-TDD384</b> UTRA band as defined in TS 25.102 [18].</p>	-
<p><b>SupportedBandUTRA-TDD768</b> UTRA band as defined in TS 25.102 [18].</p>	-
<p><b>supportedBandwidthCombinationSet</b> The <i>supportedBandwidthCombinationSet</i> indicated for a band combination is applicable to all bandwidth classes indicated by the UE in this band combination. Field encoded as a bit map, where bit N is set to "1" if UE support Bandwidth Combination Set N for this band combination, see 36.101 [42]. The leading / leftmost bit (bit 0) corresponds to the Bandwidth Combination Set 0, the next bit corresponds to the Bandwidth Combination Set 1 and so on. The UE shall neither include the field for a non-CA band combination, nor for a CA band combination for which the UE only supports Bandwidth Combination Set 0.</p>	-

<b>UE-EUTRA-Capability field descriptions</b>	<b>FDD/ TDD diff</b>
<p><b>supportedCellGrouping</b> This field indicates for which mapping of serving cells to cell groups (i.e. MCG or SCG) the UE supports asynchronous DC. This field is only present for a band combination with more than two but less than six band entries where the UE supports asynchronous DC. If this field is not present but asynchronous operation is supported, the UE supports all possible mappings of serving cells to cell groups for the band combination. The bitmap size is selected based on the number of entries in the combinations, i.e., in case of three entries, the bitmap corresponding to <i>threeEntries</i> is selected and so on.</p> <p>A bit in the bit string set to 1 indicates that the UE supports asynchronous DC for the cell grouping option represented by the concerned bit position. Each bit position represents a different cell grouping option, as illustrated by a table, see NOTE 5. A cell grouping option is represented by a number of bits, each representing a particular band entry in the band combination with the left-most bit referring to the band listed first in the band combination, etc. Value 0 indicates that the carriers of the corresponding band entry are mapped to a first cell group, while value 1 indicates that the carriers of the corresponding band entry are mapped to a second cell group.</p> <p>It is noted that the mapping table does not include entries with all bits set to the same value (0 or 1) as this does not represent a DC scenario (i.e. indicating that the UE supports that all carriers of the corresponding band entry are in one cell group).</p>	-
<p><b>supportedCSI-Proc, sTTI-SupportedCSI-Proc</b> Indicates the maximum number of CSI processes supported on a component carrier within a band. Value n1 corresponds to 1 CSI process, value n3 corresponds to 3 CSI processes, and value n4 corresponds to 4 CSI processes. If this field is included, the UE shall include the same number of entries listed in the same order as in <i>BandParameters/STTI-SPT-BandParameters</i>. If the UE supports at least 1 CSI process on any component carrier, then the UE shall include this field in all bands in all band combinations.</p>	-
<p><b>supportedCSI-Proc (in FeatureSetDL-PerCC)</b> In MR-DC, indicates the number of CSI processes for the component carrier in the corresponding bandwidth class. If the UE supports at least 1 CSI process, then the UE shall include this field.</p>	-
<p><b>supportedMIMO-CapabilityDL-MRDC (in FeatureSetDL-PerCC)</b> In MR-DC, indicates the maximum number of supported layers in TM9/10 for the component carrier in the corresponding bandwidth class.</p>	-
<p><b>supportedNAICS-2CRS-AP</b> If included, the UE supports NAICS for the band combination. The UE shall include a bitmap of the same length, and in the same order, as in <i>naics-Capability-List</i>, to indicate 2 CRS AP NAICS capability of the band combination. The first/ leftmost bit points to the first entry of <i>naics-Capability-List</i>, the second bit points to the second entry of <i>naics-Capability-List</i>, and so on. For band combinations with a single component carrier, UE is only allowed to indicate <math>\{numberOfNAICS-CapableCC, numberOfAggregatedPRB\} = \{1, 100\}</math> if NAICS is supported.</p>	-
<p><b>supportedOperatorDic</b> Indicates whether the UE supports operator defined dictionary. If UE supports operator defined dictionary, the UE shall report <i>versionOfDictionary</i> and <i>associatedPLMN-ID</i> of the stored operator defined dictionary. This parameter is not required to be present if the UE is in VPLMN. In this release of the specification, UE can only support one operator defined dictionary. The <i>associatedPLMN-ID</i> is only associated to the operator defined dictionary which has no relationship with UE's HPLMN ID.</p>	-
<p><b>supportRohcContextContinue</b> Indicates whether the UE supports ROHC context continuation operation where the UE does not reset the current ROHC context upon handover.</p>	-
<p><b>supportedROHC-Profiles</b> Indicates the ROHC profiles that UE supports in both uplink and downlink.</p>	-
<p><b>supportedUplinkOnlyROHC-Profiles</b> Indicates the ROHC profiles that UE supports in uplink and not in downlink, see TS 36.323 [8]</p>	-
<p><b>supportedStandardDic</b> Indicates whether the UE supports standard dictionary for SIP and SDP as specified in TS 36.323 [8].</p>	-
<p><b>supportedUDC</b> Indicates whether the UE supports UL data compression, see TS 36.323 [8].</p>	-
<p><b>tdd-SpecialSubframe</b> Indicates whether the UE supports TDD special subframe defined in TS 36.211 [21]. A UE shall indicate <i>tdd-SpecialSubframe-r11</i> if it supports the TDD special subframes ssp7 and ssp9. A UE shall indicate <i>tdd-SpecialSubframe-r14</i> if it supports the TDD special subframe ssp10, except when <i>ssp10-TDD-Only-r14</i> is included.</p>	Yes

<b>UE-EUTRA-Capability field descriptions</b>	<b>FDD/ TDD diff</b>
<b>tdd-FDD-CA-PCellDuplex</b> The presence of this field indicates that the UE supports TDD/FDD CA in any supported band combination including at least one FDD band with <i>bandParametersUL</i> and at least one TDD band with <i>bandParametersUL</i> . The first bit is set to "1" if UE supports the TDD PCell. The second bit is set to "1" if UE supports FDD PCell. This field is included only if the UE supports band combination including at least one FDD band with <i>bandParametersUL</i> and at least one TDD band with <i>bandParametersUL</i> . If this field is included, the UE shall set at least one of the bits as "1". If this field is included with DC, then it is applicable within a CG, and the presence of this field indicates the capability of the UE to support TDD/FDD CA with at least one FDD band and at least one TDD band in the same CG, with the value indicating the support for TDD/FDD PCell (PSCell).	No
<b>tdd-TTI-Bundling</b> The presence of this field indicates whether the UE supporting TDD special subframe configuration 10 also supports TTI bundling for TDD configuration 2 and 3 when PUSCH transmission in UpPTS is configured, see TS 36.213 [23], clause 8.0. If this field is present, the <i>tdd-SpecialSubframe-r14</i> or <i>ssp10-TDD-Only-r14</i> shall be present.	Yes
<b>timeReferenceProvision</b> Indicates whether the UE supports provision of time reference in <i>DLInformationTransfer</i> message.	-
<b>timeSeparationSlot2, timeSeparationSlot4</b> Indicates whether the UE supports time staggering length of 2 slots (MBSFN reference signal pattern type 2) / 4 slots (MBSFN reference signal pattern type 1) for MBSFN-RS associated with PMCH with subcarrier spacing of 0.37 kHz for MBSFN subframes when operating on the E-UTRA band given by the entry in <i>mbms-SupportedBandInfoList</i> as described in TS 36.211 [21], clause 6.10.2.2.4.	-
<b>timerT312</b> Indicates whether the UE supports T312.	No
<b>tm5-FDD</b> Indicates whether the UE supports the PDSCH transmission mode 5 in FDD.	-
<b>tm5-TDD</b> Indicates whether the UE supports the PDSCH transmission mode 5 in TDD.	-
<b>tm6-CE-ModeA</b> Indicates whether the UE supports tm6 operation in CE mode A, see TS 36.213 [23], clause 7.2.3. This field can be included only if <i>ce-ModeA</i> is included.	Yes
<b>tm8-slotPDSCH</b> Indicates whether the UE supports configuration and decoding of TM8 for slot PDSCH in TDD.	-
<b>tm9-CE-ModeA</b> Indicates whether the UE supports tm9 operation in CE mode A, see TS 36.213 [23], clause 7.2.3. This field can be included only if <i>ce-ModeA</i> is included.	Yes
<b>tm9-CE-ModeB</b> Indicates whether the UE supports tm9 operation in CE mode B, see TS 36.213 [23], clause 7.2.3. This field can be included only if <i>ce-ModeB</i> is included.	Yes
<b>tm9-LAA</b> Indicates whether the UE supports tm9 operation on LAA cell(s). This field can be included only if <i>downlinkLAA</i> is included.	-
<b>tm9-slotSubslot</b> Indicates whether the UE supports configuration and decoding of TM9 for slot and/or subslot PDSCH for non-MBSFN.	Yes
<b>tm9-slotSubslotMBSFN</b> Indicates whether the UE supports configuration and decoding of TM9 for slot and/or subslot PDSCH for MBSFN.	Yes
<b>tm9-With-8Tx-FDD</b> Indicates whether the UE supports PDSCH transmission mode 9 with 8 CSI reference signal ports for FDD when not operating in CE mode.	Yes
<b>tm10-LAA</b> Indicates whether the UE supports tm10 operation on LAA cell(s). This field can be included only if <i>downlinkLAA</i> is included.	-
<b>tm10-slotSubslot</b> Indicates whether the UE supports configuration and decoding of TM10 for slot and/or subslot PDSCH for non-MBSFN.	Yes
<b>tm10-slotSubslotMBSFN</b> Indicates whether the UE supports configuration and decoding of TM10 for slot and/or subslot PDSCH for MBSFN.	Yes
<b>totalWeightedLayers</b> Indicates total number of weighted layers the UE can process for FD-MIMO. See NOTE 8.	-



<b>UE-EUTRA-Capability field descriptions</b>	<b>FDD/ TDD diff</b>
<b>twoAntennaPortsForPUCCH</b>	No
<p><b>twoStepSchedulingTimingInfo</b> Presence of this field indicates that the UE supports uplink scheduling using PUSCH trigger A and PUSCH trigger B (as defined in TS 36.213 [23]). This field also indicates the timing between the PUSCH trigger B and the earliest time the UE supports performing the associated UL transmission. For reception of PUSCH trigger B in subframe N, value <i>nPlus1</i> indicates that the UE supports performing the UL transmission in subframe N+1, value <i>nPlus2</i> indicates that the UE supports performing the UL transmission in subframe N+2, and so on. This field can be included only if <i>uplinkLAA</i> is included.</p>	-
<p><b>txAntennaSwitchDL, txAntennaSwitchUL</b> The presence of <i>txAntennaSwitchUL</i> indicates the UE supports transmit antenna selection for this UL band in the band combination as described in TS 36.213 [23], clauses 8.2 and 8.7. The field <i>txAntennaSwitchDL</i> indicates the entry number of the first-listed band with UL in the band combination that affects this DL. The field <i>txAntennaSwitchUL</i> indicates the entry number of the first-listed band with UL in the band combination that switches together with this UL. Value 1 means first entry, value 2 means second entry and so on. All DL and UL that switch together indicate the same entry number. For the case of carrier switching, the antenna switching capability for the target carrier configuration is indicated as follows: For UE configured with a set of component carriers belonging to a band combination <math>C_{baseline} = \{b_1(1), \dots, b_x(1), \dots, b_y(0), \dots\}</math>, where "1/0" denotes whether the corresponding band has an uplink, if a component carrier in <math>b_x</math> is to be switched to a component carrier in <math>b_y</math> (according to <i>srs-SwitchFromServCellIndex</i>), the antenna switching capability is derived based on band combination <math>C_{target} = \{b_1(1), \dots, b_x(0), \dots, b_y(1), \dots\}</math>.</p>	-
<p><b>txDiv-PUCCH1b-ChSelect</b> Indicates whether the UE supports transmit diversity for PUCCH format 1b with channel selection.</p>	Yes
<p><b>txDiv-SPUCCH</b> Indicates whether the UE supports Tx diversity on SPUCCH format 1/1a/1b/3.</p>	Yes
<p><b>tx-Sidelink, rx-Sidelink</b> Indicates that the UE supports sidelink transmission/reception on the band in the band combination. For NR sidelink transmission, <i>tx-Sidelink</i> is only applicable if the UE supports at least one of <i>sl-TransmissionMode1-r16</i> and <i>sl-TransmissionMode2-r16</i> on the band as specified in TS 38.331 [82]. For NR sidelink reception, <i>rx-Sidelink</i> is only applicable if the UE supports <i>sl-Reception-r16</i> on the band as specified in TS 38.331 [82].</p>	-
<p><b>uci-PUSCH-Ext</b> Indicates whether the UE supports an extension of UCI delivering more than 22 HARQ-ACK bits on PUSCH as specified in TS 36.212 [22], clause 5.2.2.6 and TS 36.213 [23], clause 8.6.3.</p>	No
<p><b>ue-AutonomousWithFullSensing</b> Indicates whether the UE supports transmitting PSCCH/PSSCH using UE autonomous resource selection mode with full sensing (i.e., continuous channel monitoring) for V2X sidelink communication and the UE supports maximum transmit power associated with Power class 3 V2X UE, see TS 36.101 [42].</p>	-
<p><b>ue-AutonomousWithPartialSensing</b> Indicates whether the UE supports transmitting PSCCH/PSSCH using UE autonomous resource selection mode with partial sensing (i.e., channel monitoring in a limited set of subframes) for V2X sidelink communication and the UE supports maximum transmit power associated with Power class 3 V2X UE, see TS 36.101 [42].</p>	-
<p><b>ue-Category</b> UE category as defined in TS 36.306 [5]. Set to values 1 to 12 in this version of the specification.</p>	-
<p><b>ue-CategoryDL</b> UE DL category as defined in TS 36.306 [5]. Value <i>n17</i> corresponds to UE category 17, value <i>m1</i> corresponds to UE category M1, value <i>oneBis</i> corresponds to UE category 1bis, value <i>m2</i> corresponds to UE category M2. For ASN.1 compatibility, a UE indicating DL category 0, <i>m1</i> or <i>m2</i> shall also indicate any of the categories (1..5) in <i>ue-Category</i> (without suffix), which is ignored by the eNB, a UE indicating UE category oneBis shall also indicate UE category 1 in <i>ue-Category</i> (without suffix), and a UE indicating UE category <i>m2</i> shall also indicate UE category <i>m1</i>. The field <i>ue-CategoryDL</i> is set to values 0, <i>m1</i>, <i>oneBis</i>, <i>m2</i>, 4, 6, 7, 9 to 16, <i>n17</i>, 18, 19, 20, 21, 22, 23, 24, 25, 26 in this version of the specification.</p>	-

<b>UE-EUTRA-Capability field descriptions</b>	<b>FDD/ TDD diff</b>
<b>ue-CategorySL-C-TX</b> UE SL category for V2X transmission as defined in TS 36.306 [5]. Set to values 1 to 5 in this version of the specification.	-
<b>ue-CategorySL-C-RX</b> UE SL category for V2X reception as defined in TS 36.306 [5]. Set to values 1 to 4 in this version of the specification.	-
<b>ue-CategoryUL</b> UE UL category as defined in TS 36.306 [5]. Value <i>n14</i> corresponds to UE category 14, value <i>n16</i> corresponds to UE category 16 and so on. Value <i>m1</i> corresponds to UE category M1, value <i>m2</i> corresponds to UE category M2, value <i>oneBis</i> corresponds to UE category 1bis. The field <i>ue-CategoryUL</i> is set to values <i>m1</i> , <i>m2</i> , 0, <i>oneBis</i> , 3, 5, 7, 8, 13, <i>n14</i> , 15, <i>n16</i> to <i>n21</i> or 22 to 26 in this version of the specification.	-
<b>ue-CA-PowerClass-N</b> Indicates whether the UE supports UE power class N in the E-UTRA band combination, see TS 36.101 [42] and TS 36.307 [78]. If <i>ue-CA-PowerClass-N</i> is not included, UE supports the default UE power class in the E-UTRA band combination, see TS 36.101 [42].	-
<b>ue-CE-NeedULGaps</b> Indicates whether the UE needs uplink gaps during continuous uplink transmission in FDD as specified in TS 36.211 [21] and TS 36.306 [5].	-
<b>ue-PowerClass-N, ue-PowerClass-5</b> Indicates whether the UE supports UE power class 1, 2, 4 or 5 in the E-UTRA band, see TS 36.101 [42] and TS 36.307 [79] and TS 36.102 [113] for NTN capable UE. UE includes either <i>ue-PowerClass-N</i> or <i>ue-PowerClass-5</i> . If neither <i>ue-PowerClass-N</i> nor <i>ue-PowerClass-5</i> is included, UE supports the default UE power class in the E-UTRA band, see TS 36.101 [42] and TS 36.102 [113] for NTN capable UE.	-
<b>ue-Rx-TxTimeDiffMeasurements</b> Indicates whether the UE supports Rx - Tx time difference measurements.	No
<b>ue-SpecificRefSigsSupported</b>	No
<b>ue-SSTD-Meas</b> Indicates whether the UE supports SSTD measurements between the PCell and the PSCell as specified in TS 36.214 [48] and TS 36.133 [16].	-
<b>ue-TxAntennaSelectionSupported</b> Except for the supported band combinations for which <i>bandParameterList-v1380</i> is included, TRUE indicates that the UE is capable of supporting UE transmit antenna selection such that all the supported bands in the band combination are affected by transmit antenna switching, as described in TS 36.213 [23], clause 8.7. E-UTRAN ignores this field for band combinations for which <i>bandParameterList-v1380</i> is included.	Yes
<b>ue-TxAntennaSelection-SRS-1T4R</b> Indicates whether the UE supports selecting one antenna among four antennas to transmit SRS for the corresponding band of the band combination as described in TS 36.213 [23].	-
<b>ue-TxAntennaSelection-SRS-2T4R-2Pairs</b> Indicates whether the UE supports selecting one antenna pair between two antenna pairs to transmit SRS simultaneously for the corresponding band of the band combination as described in TS 36.213 [23].	-
<b>ue-TxAntennaSelection-SRS-2T4R-3Pairs</b> Indicates whether the UE supports selecting one antenna pair among three antenna pairs to transmit SRS simultaneously for the corresponding band of the band combination as described in TS 36.213 [23].	-
<b>ul-64QAM</b> Indicates whether the UE supports 64QAM in UL on the band. This field is only present when the field <i>ue-CategoryUL</i> indicates UL UE category that supports UL 64QAM, see TS 36.306 [5], Table 4.1A-2. If the field is present for one band, the field shall be present for all bands including downlink only bands.	-
<b>ul-256QAM</b> Indicates whether the UE supports 256QAM in UL on the band in the band combination. This field is only present when the field <i>ue-CategoryUL</i> indicates UL UE category that supports 256QAM in UL, see TS 36.306 [5], Table 4.1A-2. The UE includes this field only if the field <i>ul-256QAM-perCC-InfoList</i> is not included.	-
<b>ul-256QAM (in FeatureSetUL-PerCC)</b> Indicates whether the UE supports 256QAM in UL for MR-DC within the indicated feature set. This field is only present when the field <i>ue-CategoryUL</i> indicates UL UE category that supports 256QAM in UL, see TS 36.306 [5], Table 4.1A-2.	-

<b>UE-EUTRA-Capability field descriptions</b>	<b>FDD/ TDD diff</b>
<b>ul-256QAM-perCC-InfoList</b> Indicates, per serving carrier of which the corresponding bandwidth class includes multiple serving carriers (i.e. bandwidth class B, C, D and so on), whether the UE supports 256QAM in the band combination. The number of entries is equal to the number of component carriers in the corresponding bandwidth class. The UE shall support the setting indicated in each entry of the list regardless of the order of entries in the list. This field is only present when the field <i>ue-CategoryUL</i> indicates UL UE category that supports 256QAM in UL, see TS 36.306 [5], Table 4.1A-2. The UE includes this field only if the field <i>ul-256QAM</i> is not included.	-
<b>ul-256QAM-Slot</b> Indicates whether the UE supports 256QAM in UL for slot TTI operation on the band.	-
<b>ul-256QAM-Subslot</b> Indicates whether the UE supports 256QAM in UL for subslot TTI operation on the band.	-
<b>ul-AsyncHarqSharingDiff-TTI-Lengths</b> Indicates whether the UE supports UL asynchronous HARQ sharing between different TTI lengths for an UL serving cell.	Yes
<b>ul-CoMP</b> Indicates whether the UE supports UL Coordinated Multi-Point operation.	No
<b>ul-dmrs-Enhancements</b> Indicates whether the UE supports UL DMRS enhancements as defined in TS 36.211 [21], clause 6.10.3A.	Yes
<b>ul-PDCP-AvgDelay</b> Indicates whether the UE supports UL PDCP Packet Average Delay measurement (as specified in TS 38.314 [103]) and reporting in RRC_CONNECTED.	-
<b>ul-PDCP-Delay</b> Indicates whether the UE supports UL PDCP Packet Delay per QCI measurement as specified in TS 36.314 [71].	-
<b>ul-powerControlEnhancements</b> Indicates whether UE supports UplinkPowerControlDedicated.	Yes
<b>ul-RRC-Segmentation</b> Indicates the UE supports uplink RRC segmentation of <i>UECapabilityInformation</i> .	-
<b>uplinkLAA</b> Presence of the field indicates that the UE supports uplink LAA operation.	-
<b>uss-BlindDecodingAdjustment</b> Indicates whether the UE supports blind decoding adjustment on UE specific search space as defined in TS 36.213 [22]. This field can be included only if uplinkLAA is included.	-
<b>uss-BlindDecodingReduction</b> Indicates whether the UE supports blind decoding reduction on UE specific search space by not monitoring DCI format 0A/0B/4A/4B as defined in TS 36.213 [22]. This field can be included only if uplinkLAA is included.	-
<b>unicastFrequencyHopping</b> Indicates whether the UE supports frequency hopping for unicast MPDCCH/PDSCH (configured by <i>mpdcch-pdsch-HoppingConfig</i> ) and unicast PUSCH (configured by <i>pusch-HoppingConfig</i> ).	-
<b>unicast-fembmsMixedSCell</b> Indicates whether the UE supports unicast reception from FeMBMS/Unicast mixed cell. This field is included only if UE supports carrier aggregation.	No
<b>utra-GERAN-CGI-Reporting-ENDC</b> Indicates whether the UE supports Inter-RAT report CGI procedure towards GERAN/UTRA cell when it is configured with (NG)EN-DC wherein either MN and SN have different DRX cycles, or on-duration configured by MN does not contain on-duration configured by SN if their DRX cycles are same.	Yes
<b>utran-ProximityIndication</b> Indicates whether the UE supports proximity indication for UTRAN CSG member cells.	-
<b>utran-SI-AcquisitionForHO</b> Indicates whether the UE supports, upon configuration of <i>si-RequestForHO</i> by the network, acquisition and reporting of relevant information using autonomous gaps by reading the SI from a neighbouring UMTS cell.	Yes
<b>v2x-BandParametersNR</b> Includes the NR <i>BandParametersSidelink-r16</i> IE as specified in TS 38.331 [82]. The field includes the per-band per-band-combination sidelink capability for NR-PC5.	-
<b>v2x-BandParametersEUTRA-NR-v1710</b> Includes the <i>BandParametersSidelinkEUTRA-NR-v1710</i> IE as specified in TS 38.331 [82]. The field includes the per-band per-band-combination sidelink capability for NR-PC5.	-

<b>UE-EUTRA-Capability field descriptions</b>	<b>FDD/ TDD diff</b>
<b>v2x-BandwidthClassTxSL, v2x-BandwidthClassRxSL</b> The bandwidth class for V2X sidelink transmission and reception supported by the UE as defined in TS 36.101 [42], Table 5.6G.1-3. The UE explicitly includes all the supported bandwidth class combinations for V2X sidelink transmission or reception in the band combination signalling. Support for one bandwidth class does not implicitly indicate support for another bandwidth class.	-
<b>v2x-eNB-Scheduled</b> Indicates whether the UE supports transmitting PSCCH/PSSCH using dynamic scheduling, SPS in eNB scheduled mode for V2X sidelink communication, reporting SPS assistance information and the UE supports maximum transmit power associated with Power class 3 V2X UE, see TS 36.101 [42] in a band.	-
<b>v2x-EnhancedHighReception</b> Indicates whether the UE supports reception of 30 PSCCH in a subframe and decoding of 204 RBs per subframe counting both PSCCH and PSSCH in a band for V2X sidelink communication.	-
<b>v2x-HighPower</b> Indicates whether the UE supports maximum transmit power associated with Power class 2 V2X UE for V2X sidelink transmission in a band, see TS 36.101 [42].	-
<b>v2x-HighReception</b> Indicates whether the UE supports reception of 20 PSCCH in a subframe and decoding of 136 RBs per subframe counting both PSCCH and PSSCH in a band for V2X sidelink communication.	-
<b>v2x-nonAdjacentPSCCH-PSSCH</b> Indicates whether the UE supports transmission and reception in the configuration of non-adjacent PSCCH and PSSCH for V2X sidelink communication.	-
<b>v2x-numberTxRxTiming</b> Indicates the number of multiple reference TX/RX timings counted over all the configured sidelink carriers for V2X sidelink communication.	-
<b>v2x-SensingReportingMode3</b> Indicates whether the UE supports sensing measurements and reporting of measurement results in eNB scheduled mode for V2X sidelink communication.	-
<b>v2x-SupportedBandCombinationList</b> Indicates the supported band combination list on which the UE supports simultaneous transmission and/or reception of V2X sidelink communication.	-
<b>v2x-SupportedBandCombinationListEUTRA-NR</b> Indicates the supported band combination list on which the UE supports simultaneous transmission and/or reception of NR sidelink communication only, or joint V2X sidelink communication and NR sidelink communication.	-
<b>v2x-SupportedTxBandCombListPerBC, v2x-SupportedRxBandCombListPerBC</b> Indicates, for a particular band combination of EUTRA, the supported band combination list among <i>v2x-SupportedBandCombinationList</i> on which the UE supports simultaneous transmission or reception of EUTRA and V2X sidelink communication respectively. The first bit refers to the first entry of <i>v2x-SupportedBandCombinationList</i> , with value 1 indicating V2X sidelink transmission/reception is supported.	-
<b>v2x-SupportedTxBandCombListPerBC-v1630, v2x-SupportedRxBandCombListPerBC-v1630</b> Indicates, for a particular band combination of EUTRA, the supported band combination list among <i>v2x-SupportedBandCombinationListEUTRA-NR</i> on which the UE supports simultaneous transmission or reception of EUTRA and NR sidelink communication respectively, or simultaneous transmission or reception of EUTRA and joint V2X sidelink communication and NR sidelink communication respectively. The first bit refers to the first entry of <i>v2x-SupportedBandCombinationListEUTRA-NR</i> , with value 1 indicating V2X sidelink transmission/reception is supported.	-
<b>v2x-TxWithShortResvInterval</b> Indicates whether the UE supports 20 ms and 50 ms resource reservation periods for UE autonomous resource selection and eNB scheduled resource allocation for V2X sidelink communication.	-
<b>virtualCellID-BasicSRS</b> Indicates whether the UE supports virtual cell ID for basic SRS symbol(s).	-
<b>virtualCellID-AddSRS</b> This field indicates whether the UE supports virtual cell ID for additional SRS symbol(s).	-
<b>voiceOverPS-HS-UTRA-FDD</b> Indicates whether UE supports IMS voice according to GSMA IR.58 profile in UTRA FDD.	-
<b>voiceOverPS-HS-UTRA-TDD128</b> Indicates whether UE supports IMS voice in UTRA TDD 1.28Mcps.	-

<b>UE-EUTRA-Capability field descriptions</b>	<b>FDD/ TDD diff</b>
<b>widebandPRG-Slot, widebandPRG-Subslot, widebandPRG-Subframe</b> Indicates whether the UE supports wideband precoding resource block group size for slot/subslot/subframe operation as specified in TS 36.213 [23].	-
<b>wlan-IW-RAN-Rules</b> Indicates whether the UE supports RAN-assisted WLAN interworking based on access network selection and traffic steering rules.	-
<b>wlan-IW-ANDSF-Policies</b> Indicates whether the UE supports RAN-assisted WLAN interworking based on ANDSF policies.	-
<b>wlan-MAC-Address</b> Indicates the WLAN MAC address of this UE.	-
<b>wlan-PeriodicMeas</b> Indicates whether the UE supports periodic reporting of WLAN measurements.	-
<b>wlan-ReportAnyWLAN</b> Indicates whether the UE supports reporting of WLANs not listed in the <i>measObjectWLAN</i> .	-
<b>wlan-SupportedDataRate</b> Indicates the maximum WLAN data rate supported by the UE over all LWA bearers. Actual value of supported data rate is field value * 10 Mbps (i.e., value 1 corresponds to 10 Mbps, value 2 corresponds to 20 Mbps and so on).	-
<b>zp-CSI-RS-AperiodicInfo</b> Indicates whether the UE supports aperiodic ZP-CSI-RS transmission for the indicated transmission mode.	Yes

NOTE 1: The IE *UE-EUTRA-Capability* does not include AS security capability information, since these are the same as the security capabilities that are signalled by NAS. Consequently, AS need not provide "man-in-the-middle" protection for the security capabilities.

NOTE 2: The column FDD/ TDD diff indicates if the UE is allowed to signal, as part of the additional capabilities for an XDD mode i.e. within *UE-EUTRA-CapabilityAddXDD-Mode-xNM*, a different value compared to the value signalled elsewhere within *UE-EUTRA-Capability* (i.e. the common value, supported for both XDD modes). A '-' is used to indicate that it is not possible to signal different values (used for fields for which the field description is provided for other reasons). Annex E specifies for which TDD and FDD serving cells a UE supporting TDD/FDD CA shall support a capability for which it indicates support within the capability signalling.

NOTE 2a: From REL-15 onwards, the UE is not allowed to signal different values for FDD and TDD unless yes is indicated in column FDD/ TDD diff (i.e. no need to introduce field description solely for the purpose of indicate no).

NOTE 3: The *BandCombinationParameters* for the same band combination can be included more than once.

NOTE 4: UE CA and measurement capabilities indicate the combinations of frequencies that can be configured as serving frequencies.

NOTE 5: The grouping of the cells to the first and second cell group, as indicated by *supportedCellGrouping*, is shown in the table below. The leading / leftmost bit of *supportedCellGrouping* corresponds to the Bit String Position 1.

<b>Nr of Band Entries:</b>	5	4	3
<b>Length of Bit-String:</b>	15	7	3
<b>Bit String Position</b>	<b>Cell grouping option (0= first cell group, 1= second cell group)</b>		
1	00001	0001	001
2	00010	0010	010
3	00011	0011	011
4	00100	0100	
5	00101	0101	
6	00110	0110	
7	00111	0111	
8	01000		
9	01001		
10	01010		
11	01011		
12	01100		
13	01101		
14	01110		
15	01111		

NOTE 6: UE includes the *intraBandContiguousCC-InfoList-r12* also for bandwidth class A because of the presence conditions in *BandCombinationParameters-v1270*. For example, if UE supports CA\_1A\_41D band combination, if UE includes the field *intraBandContiguousCC-InfoList-r12* for band 41, the UE includes *intraBandContiguousCC-InfoList-r12* also for band 1.

NOTE 6a: For multiple *BandParameters* entries with the same *bandEUTRA* and same *ca-BandwidthClassDL* in a supported band combination, the UE capabilities indicated by *BandParameters* are agnostic to the order in which they are indicated in the *bandParameterList*, under the condition that the set of the capabilities indicated for the concerned *bandEUTRA* (e.g. *bandParametersDL* and *bandParametersUL*) are used together, and the concerned *BandParameters* correspond to the *supportedBandwithCombinationSet* for which set of channel bandwidths for carrier(s) is the same among sub-blocks, as defined in TS 36.101 [42], Table 5.6A.1-3, Table 5.6A.1-4, Table 5.6A.1-5.

NOTE 7: For a UE that indicates release X in field *accessStratumRelease* but supports a feature specified in release X+ N (i.e. early UE implementation), the ASN.1 comprehension requirement are specified in Annex F.

NOTE 8: For a UE that does not include *mimo-WeightedLayersCapabilities-r13*, or for the case with no CC configured with FD-MIMO, the FD-MIMO processing capability condition is not applicable (i.e. considered as satisfied). For a UE that includes *mimo-WeightedLayersCapabilities-r13*, the FD-MIMO processing capability condition is satisfied if the equation 4.3.28.13-1 in TS 36.306 [5] is satisfied.

**UE-RadioPagingInfo**

The *UE-RadioPagingInfo* IE contains UE capability information needed for paging.

**UE-RadioPagingInfo information element**

```

-- ASN1START
UE-RadioPagingInfo-r12 ::= SEQUENCE {
    ue-Category-v1250          INTEGER (0)          OPTIONAL,
    ...
    [ ue-CategoryDL-v1310     ENUMERATED {m1}        OPTIONAL,
      ce-ModeA-r13            ENUMERATED {true}       OPTIONAL,

```

```

    ce-ModeB-r13                ENUMERATED {true}    OPTIONAL
  ]],
  [[
    wakeUpSignal-r15            ENUMERATED {true}    OPTIONAL,
    wakeUpSignal-TDD-r15       ENUMERATED {true}    OPTIONAL,
    wakeUpSignalMinGap-eDRX-r15  ENUMERATED {ms40, ms240, ms1000, ms2000}
  OPTIONAL,
    wakeUpSignalMinGap-eDRX-TDD-r15  ENUMERATED {ms40, ms240, ms1000, ms2000}    OPTIONAL
  ]],
  [[
    ue-CategoryDL-v1610        ENUMERATED {m2}    OPTIONAL,
    groupWakeUpSignal-r16      ENUMERATED {true}    OPTIONAL,
    groupWakeUpSignalTDD-r16   ENUMERATED {true}    OPTIONAL,
    groupWakeUpSignalAlternation-r16  ENUMERATED {true}    OPTIONAL,
    groupWakeUpSignalAlternationTDD-r16  ENUMERATED {true}    OPTIONAL
  ]],
  [[
    inactiveStatePO-Determination-r17  ENUMERATED {true}    OPTIONAL
  ]]
}
-- ASN1STOP

```

#### **UE-RadioPagingInfo field descriptions**

##### **ce-ModeA, ce-ModeB**

Indicates whether the UE supports operation in CE mode A and/or B, as specified in TS 36.211 [21] and TS 36.213 [23].

##### **groupWakeUpSignal, groupWakeUpSignalTDD**

Indicates whether the UE supports GWUS for paging in RRC\_IDLE as specified in TS 36.211 [21], TS 36.213 [23] and TS 36.304 [4]. If this field is included, the minimum gap between GWUS and associated PO for DRX is fixed as 40 ms.

##### **groupWakeUpSignalAlternation, groupWakeUpSignalAlternationTDD**

Indicates whether the UE supports GWUS with group resource alternation for paging in RRC\_IDLE as specified in TS 36.211 [21], TS 36.213 [23] and TS 36.304 [4]. If this field is included, the minimum gap between GWUS and associated PO for DRX is fixed as 40 ms.

##### **inactiveStatePO-Determination**

Indicates whether the UE other than BL UE or UE in CE supports to use the same *i\_s* in RRC\_INACTIVE state as in RRC\_IDLE state, as specified in TS 36.304 [4].

##### **ue-Category, ue-CategoryDL**

UE category as defined in TS 36.306 [5]. A category M2 UE shall also include the field *ue-CategoryDL-v1310* in this version of the specification.

##### **wakeUpSignal, wakeUpSignal-TDD**

Indicates whether the UE supports WUS for paging in RRC\_IDLE as specified in TS 36.213 [22] and TS 36.304 [4]. If this field is included, the minimum gap between WUS and associated PO for DRX is fixed as 40 ms.

##### **wakeUpSignalMinGap-eDRX, wakeUpSignalMinGap-eDRX-TDD**

Indicates the minimum gap the UE supports between WUS and associated PO for eDRX as specified in TS 36.213 [22] and TS 36.304 [4]. Value ms40 corresponds to 40 ms, ms240 corresponds to 240 ms and so on. If this field is included, the UE shall also indicate support of WUS or GWUS for paging.

## – UE-TimersAndConstants

The IE *UE-TimersAndConstants* contains timers and constants used by the UE in either RRC\_CONNECTED or RRC\_IDLE.

#### **UE-TimersAndConstants information element**

```

-- ASN1START
UE-TimersAndConstants ::=
  SEQUENCE {
    t300          ENUMERATED {
      ms100, ms200, ms300, ms400, ms600, ms1000, ms1500,
      ms2000},
    t301          ENUMERATED {
      ms100, ms200, ms300, ms400, ms600, ms1000, ms1500,
      ms2000},
    t310          ENUMERATED {
      ms0, ms50, ms100, ms200, ms500, ms1000, ms2000},
    n310          ENUMERATED {
      n1, n2, n3, n4, n6, n8, n10, n20},
    t311          ENUMERATED {

```

```

ms1000, ms3000, ms5000, ms10000, ms15000,
ms20000, ms30000},
n311      ENUMERATED {
          n1, n2, n3, n4, n5, n6, n8, n10},
...
[[ t300-v1310      ENUMERATED {
                    ms2500, ms3000, ms3500, ms4000, ms5000, ms6000, ms8000,
                    ms10000}      OPTIONAL, -- Need OR
          t301-v1310      ENUMERATED {
                    ms2500, ms3000, ms3500, ms4000, ms5000, ms6000, ms8000,
                    ms10000}      OPTIONAL -- Need OR
          ]],
[[ t310-v1330      ENUMERATED {ms4000, ms6000}
                    OPTIONAL -- Need OR
          ]],
[[ t300-r15      ENUMERATED {ms4000, ms6000, ms8000, ms10000, ms15000,
                             ms25000, ms40000, ms60000} OPTIONAL -- Cond
EDTOrPUR
  ]]
}
-- ASN1STOP

```

<b>UE-TimersAndConstants field descriptions</b>	
<b>n3xy</b>	Constants are described in clause 7.4. n1 corresponds with 1, n2 corresponds with 2 and so on.
<b>t3xy</b>	Timers are described in clause 7.3. Value ms0 corresponds with 0 ms, ms50 corresponds with 50 ms and so on. EUTRAN includes an extended value <i>t3xy-v1310</i> and <i>t3xy-v1330</i> only in the Bandwidth Reduced (BR) version of the SIB. UEs that support Coverage Enhancement (CE) mode B shall use the extended values <i>t3xy-v1310</i> and <i>t3xy-v1330</i> , if present, and ignore the value signaled by <i>t3xy</i> (without the suffix). <i>t300-r15</i> is only applicable for EDT for mobile originating calls and for UL data transmission using PUR. UE performing EDT for mobile originating calls or UL data transmission using PUR shall use <i>t300-r15</i> , if present.

Conditional presence	Explanation
<i>EDTOrPUR</i>	The field is optionally present, Need OR, if <i>edt-Parameters</i> is present in SIB2 or the UE is configured with <i>pur-Config</i> ; otherwise the field is not present and the UE shall delete any existing value for this field.

**VisitedCellInfoList**

The IE *VisitedCellInfoList* includes the mobility history information of maximum of 16 most recently visited cells or time spent outside E-UTRA. The most recently visited cell is stored first in the list. The list includes cells visited in RRC\_IDLE and RRC\_CONNECTED states.

**VisitedCellInfoList information element**

```

-- ASN1START
VisitedCellInfoList-r12 ::= SEQUENCE (SIZE (1..maxCellHistory-r12)) OF VisitedCellInfo-r12
VisitedCellInfo-r12 ::=
    SEQUENCE {
        visitedCellId-r12      CHOICE {
            cellGlobalId-r12   CellGlobalIdEUTRA,
            pci-arfcn-r12      SEQUENCE {
                physCellId-r12  PhysCellId,
                carrierFreq-r12 ARFCN-ValueEUTRA-r9
            }
        } OPTIONAL,
        timeSpent-r12         INTEGER (0..4095),
        ...
    }
-- ASN1STOP

```



**VisitedCellInfoList field descriptions****timeSpent**

This field indicates the duration of stay in the cell or outside E-UTRA approximated to the closest second. If the duration of stay exceeds 4095s, the UE shall set it to 4095s.

– **WLAN-OffloadConfig**

The IE *WLAN-OffloadConfig* includes information for traffic steering between E-UTRAN and WLAN. The fields are applicable to both RAN-assisted WLAN interworking based on access network selection and traffic steering rules and RAN-assisted WLAN interworking based on ANDSF policies unless stated otherwise in the field description.

**WLAN-OffloadConfig information element**

```

-- ASN1START
WLAN-OffloadConfig-r12 ::= SEQUENCE {
    thresholdRSRP-r12 SEQUENCE {
        thresholdRSRP-Low-r12 RSRP-Range,
        thresholdRSRP-High-r12 RSRP-Range
    } OPTIONAL, -- Need OR
    thresholdRSRQ-r12 SEQUENCE {
        thresholdRSRQ-Low-r12 RSRQ-Range,
        thresholdRSRQ-High-r12 RSRQ-Range
    } OPTIONAL, -- Need OR
    thresholdRSRQ-OnAllSymbolsWithWB-r12 SEQUENCE {
        thresholdRSRQ-OnAllSymbolsWithWB-Low-r12 RSRQ-Range,
        thresholdRSRQ-OnAllSymbolsWithWB-High-r12 RSRQ-Range
    } OPTIONAL, -- Need OP
    thresholdRSRQ-OnAllSymbols-r12 SEQUENCE {
        thresholdRSRQ-OnAllSymbolsLow-r12 RSRQ-Range,
        thresholdRSRQ-OnAllSymbolsHigh-r12 RSRQ-Range
    } OPTIONAL, -- Need OP
    thresholdRSRQ-WB-r12 SEQUENCE {
        thresholdRSRQ-WB-Low-r12 RSRQ-Range,
        thresholdRSRQ-WB-High-r12 RSRQ-Range
    } OPTIONAL, -- Need OP
    thresholdChannelUtilization-r12 SEQUENCE {
        thresholdChannelUtilizationLow-r12 INTEGER (0..255),
        thresholdChannelUtilizationHigh-r12 INTEGER (0..255)
    } OPTIONAL, -- Need OR
    thresholdBackhaul-Bandwidth-r12 SEQUENCE {
        thresholdBackhaulDL-BandwidthLow-r12 WLAN-backhaulRate-r12,
        thresholdBackhaulDL-BandwidthHigh-r12 WLAN-backhaulRate-r12,
        thresholdBackhaulUL-BandwidthLow-r12 WLAN-backhaulRate-r12,
        thresholdBackhaulUL-BandwidthHigh-r12 WLAN-backhaulRate-r12
    } OPTIONAL, -- Need OR
    thresholdWLAN-RSSI-r12 SEQUENCE {
        thresholdWLAN-RSSI-Low-r12 INTEGER (0..255),
        thresholdWLAN-RSSI-High-r12 INTEGER (0..255)
    } OPTIONAL, -- Need OR
    offloadPreferenceIndicator-r12 BIT STRING (SIZE (16)) OPTIONAL, -- Need OR
    t-SteeringWLAN-r12 T-Reselection OPTIONAL, -- Need OR
    ...
}

WLAN-backhaulRate-r12 ::= ENUMERATED
    {r0, r4, r8, r16, r32, r64, r128, r256, r512,
    r1024, r2048, r4096, r8192, r16384, r32768, r65536, r131072,
    r262144, r524288, r1048576, r2097152, r4194304, r8388608,
    r16777216, r33554432, r67108864, r134217728, r268435456,
    r536870912, r1073741824, r2147483648, r4294967296}

-- ASN1STOP

```

<b>WLAN-OffloadConfig field descriptions</b>
<p><b>offloadPreferenceIndicator</b> Indicates the offload preference indicator. Parameter: OPI in TS 24.312 [66]. Only applicable to RAN-assisted WLAN interworking based on ANDSF policies.</p>
<p><b>thresholdBackhaulDLBandwidth-High</b> Indicates the backhaul available downlink bandwidth threshold used by the UE for traffic steering to WLAN. Parameter: ThreshBackhRateDLWLAN, High in TS 36.304 [4]. Value in kilobits/second. Value rN corresponds to N kbps.</p>
<p><b>thresholdBackhaulDLBandwidth-Low</b> Indicates the backhaul available downlink bandwidth threshold used by the UE for traffic steering to E-UTRAN. Parameter: ThreshBackhRateDLWLAN, Low in TS 36.304 [4]. Value in kilobits/second. Value rN corresponds to N kbps.</p>
<p><b>thresholdBackhaulULBandwidth-High</b> Indicates the backhaul available uplink bandwidth threshold used by the UE for traffic steering to WLAN. Parameter: ThreshBackhRateULWLAN, High in TS 36.304 [4]. Value in kilobits/second. Value rN corresponds to N kbps.</p>
<p><b>thresholdBackhaulULBandwidth-Low</b> Indicates the backhaul available uplink bandwidth threshold used by the UE for traffic steering to E-UTRAN. Parameter: ThreshBackhRateULWLAN, Low in TS 36.304 [4]. Value in kilobits/second. Value rN corresponds to N kbps.</p>
<p><b>thresholdChannelUtilization-High</b> Indicates the WLAN channel utilization (BSS load) threshold used by the UE for traffic steering to E-UTRAN. Parameter: ThreshChUtilWLAN, High in TS 36.304 [4].</p>
<p><b>thresholdChannelUtilization-Low</b> Indicates the WLAN channel utilization (BSS load) threshold used by the UE for traffic steering to WLAN. Parameter: ThreshChUtilWLAN, Low in TS 36.304 [4].</p>
<p><b>thresholdRSRP-High</b> Indicates the RSRP threshold (in dBm) used by the UE for traffic steering to E-UTRAN. Parameter: ThreshServingOffloadWLAN, HighP in TS 36.304 [4].</p>
<p><b>thresholdRSRP-Low</b> Indicates the RSRP threshold (in dBm) used by the UE for traffic steering to WLAN. Parameter: ThreshServingOffloadWLAN, LowP in TS 36.304 [4].</p>
<p><b>thresholdRSRQ-High, thresholdRSRQ-OnAllSymbolsHigh, thresholdRSRQ-WB-High, thresholdRSRQ-OnAllSymbolsWithWB-High</b> Indicates the RSRQ threshold (in dB) used by the UE for traffic steering to E-UTRAN. Parameter: ThreshServingOffloadWLAN, HighQ in TS 36.304 [4]. The UE shall only apply one of threshold values of <i>thresholdRSRQ-OnAllSymbolsWithWB-High</i>, <i>thresholdRSRQ-OnAllSymbolsHigh</i>, <i>thresholdRSRQ-WB-High</i> and <i>thresholdRSRQ-High</i> as present in <i>wlan-OffloadConfigCommon</i> and forward this to upper layer. NOTE 1.</p>
<p><b>thresholdRSRQ-Low, thresholdRSRQ-OnAllSymbolsLow, thresholdRSRQ-WB-Low, thresholdRSRQ-OnAllSymbolsWithWB-Low</b> Indicates the RSRQ threshold (in dB) used by the UE for traffic steering to WLAN. Parameter: ThreshServingOffloadWLAN, LowQ in TS 36.304 [4]. The UE shall only apply one of threshold values of <i>thresholdRSRQ-OnAllSymbolsWithWB-Low</i>, <i>thresholdRSRQ-OnAllSymbolsLow</i>, <i>thresholdRSRQ-WB-Low</i> and <i>thresholdRSRQ-Low</i> as present in <i>wlan-OffloadConfigCommon</i> and forward this to upper layer. NOTE 1.</p>
<p><b>thresholdWLAN-RSSI-High</b> Indicates the WLAN RSSI threshold used by the UE for traffic steering to WLAN. Parameter: ThreshWLANRSSI, High in TS 36.304 [4]. Value 0 corresponds to -128dBm, 1 corresponds to -127dBm and so on.</p>
<p><b>thresholdWLAN-RSSI-Low</b> Indicates the WLAN RSSI threshold used by the UE for traffic steering to E-UTRAN. Parameter: ThreshWLANRSSI, Low in TS 36.304 [4]. Value 0 corresponds to -128dBm, 1 corresponds to -127dBm and so on.</p>
<p><b>t-SteeringWLAN</b> Indicates the timer value during which the rules should be fulfilled before starting traffic steering between E-UTRAN and WLAN. Parameter: TsteeringWLAN in TS 36.304 [4]. Only applicable to RAN-assisted WLAN interworking based on access network selection and traffic steering rules.</p>

NOTE 1: Within SIB17, E-UTRAN includes the fields corresponding to same RSRQ types as included in SIB1. E.g. if E-UTRAN includes *q-QualMinRSRQ-OnAllSymbols* in SIB1 it also includes *thresholdRSRQ-OnAllSymbols* in SIB17. Within the *RRCCConnectionReconfiguration* message E-UTRAN only includes *thresholdRSRQ*, setting the value according to the RSRQ type used for E-UTRAN. The UE shall apply the RSRQ fields (RSRQ threshold, high and low) corresponding to one RSRQ type i.e. the same as it applies for E-UTRAN.

## 6.3.7 MBMS information elements

## – MBMS-NotificationConfig

The IE *MBMS-NotificationConfig* specifies the MBMS notification related configuration parameters, that are applicable for all MBSFN areas.

### **MBMS-NotificationConfig** information element

```
-- ASN1START
MBMS-NotificationConfig-r9 ::=
    SEQUENCE {
        notificationRepetitionCoeff-r9    ENUMERATED {n2, n4},
        notificationOffset-r9            INTEGER (0..10),
        notificationSF-Index-r9          INTEGER (1..6)
    }
MBMS-NotificationConfig-v1430 ::=
    SEQUENCE {
        notificationSF-Index-v1430        INTEGER (7..10)
    }
-- ASN1STOP
```

### **MBMS-NotificationConfig** field descriptions

#### **notificationOffset**

Indicates, together with the *notificationRepetitionCoeff*, the radio frames in which the MCCH information change notification is scheduled i.e. the MCCH information change notification is scheduled in radio frames for which: SFN mod notification repetition period = *notificationOffset*.

#### **notificationRepetitionCoeff**

Actual change notification repetition period common for all MCCHs that are configured= shortest modification period/ *notificationRepetitionCoeff*. The 'shortest modification period' corresponds with the lowest value of *mcch-ModificationPeriod* of all MCCHs that are configured. Value n2 corresponds to coefficient 2, and so on.

#### **notificationSF-Index**

Indicates the subframe used to transmit MCCH change notifications on PDCCH. FDD: Value 1, 2, 3, 4, 5 and 6 correspond with subframe #1, #2, #3 #6, #7, and #8 respectively. Value 7, 8, 9 and 10 correspond with subframe #0, #4, #5 and #9 respectively. If *notificationSF-Index-v1430* is included, UE ignores *notificationSF-Index-r9*. TDD: Value 1, 2, 3, 4, and 5 correspond with subframe #3, #4, #7, #8, and #9 respectively.

## – MBMS-ServiceList

The IE *MBMS-ServiceList* provides the list of MBMS services which the UE is receiving or interested to receive.

### **MBMS-ServiceList** information element

```
-- ASN1START
MBMS-ServiceList-r13 ::=
    SEQUENCE (SIZE (0..maxMBMS-ServiceListPerUE-r13)) OF MBMS-
    ServiceInfo-r13
MBMS-ServiceInfo-r13 ::=
    SEQUENCE {
        tmgi-r13          TMGI-r9
    }
-- ASN1STOP
```

## – MBSFN-AreaId

The IE *MBSFN-AreaId* identifies an MBSFN area by means of a locally unique value at lower layers i.e. it concerns parameter  $N_{ID}^{MBSFN}$  in TS 36.211 [21], clause 6.10.2.1.

### **MBSFN-AreaId** information element

```
-- ASN1START
MBSFN-AreaId-r12 ::=
    INTEGER (0..255)
-- ASN1STOP
```

– *MBSFN-AreaInfoList*

The IE *MBSFN-AreaInfoList* contains the information required to acquire the MBMS control information associated with one or more MBSFN areas.

***MBSFN-AreaInfoList* information element**

```

-- ASN1START
MBSFN-AreaInfoList-r9 ::= SEQUENCE (SIZE(1..maxMBSFN-Area)) OF MBSFN-AreaInfo-r9
MBSFN-AreaInfo-r9 ::= SEQUENCE {
  mbsfn-AreaId-r9 MBSFN-AreaId-r12,
  non-MBSFNregionLength ENUMERATED {s1, s2},
  notificationIndicator-r9 INTEGER (0..7),
  mcch-Config-r9 SEQUENCE {
    mcch-RepetitionPeriod-r9 ENUMERATED {rf32, rf64, rf128, rf256},
    mcch-Offset-r9 INTEGER (0..10),
    mcch-ModificationPeriod-r9 ENUMERATED {rf512, rf1024},
    sf-AllocInfo-r9 BIT STRING (SIZE(6)),
    signallingMCS-r9 ENUMERATED {n2, n7, n13, n19}
  },
  ...,
  [[ mcch-Config-r14 SEQUENCE {
    mcch-RepetitionPeriod-v1430 ENUMERATED {rf1, rf2, rf4, rf8,
      rf16} OPTIONAL, -- Need OR
    mcch-ModificationPeriod-v1430 ENUMERATED {rf1, rf2, rf4, rf8, rf16, rf32, rf64, rf128,
      rf256, spare7} OPTIONAL, -- Need OR
  }
  subcarrierSpacingMBMS-r14 ENUMERATED {kHz7dot5, kHz1dot25} OPTIONAL -- Need OR
  ]]
}
MBSFN-AreaInfoList-r16 ::= SEQUENCE (SIZE(1..maxMBSFN-Area)) OF MBSFN-AreaInfo-r16
MBSFN-AreaInfo-r16 ::= SEQUENCE {
  mbsfn-AreaId-r16 MBSFN-AreaId-r12,
  notificationIndicator-r16 INTEGER (0..7),
  mcch-Config-r16 SEQUENCE {
    mcch-RepetitionPeriod-r16 ENUMERATED {rf1, rf2, rf4, rf8, rf16, rf32, rf64,
      rf128, rf256, spare7, spare6, spare5,
      spare4, spare3, spare2, spare1},
    mcch-ModificationPeriod-r16 ENUMERATED {rf1, rf2, rf4, rf8, rf16, rf32, rf64, rf128,
      rf256, rf512, rf1024, spare5, spare4,
      spare3, spare2, spare1},
    mcch-Offset-r16 INTEGER (0..10),
    sf-AllocInfo-r16 BIT STRING (SIZE(10)),
    signallingMCS-r16 ENUMERATED {n2, n7, n13, n19}
  },
  subcarrierSpacingMBMS-r16 ENUMERATED {kHz7dot5, kHz2dot5, kHz1dot25, kHz0dot37,
    kHz15-v1710, spare3, spare2, spare1},
  timeSeparation-r16 ENUMERATED {s12, s14} OPTIONAL, -- Need OR
  ...
}
MBSFN-AreaInfoList-r17 ::= SEQUENCE (SIZE(1..maxMBSFN-Area)) OF MBSFN-AreaInfo-r17
MBSFN-AreaInfo-r17 ::= SEQUENCE {
  mbsfn-AreaInfo-r17 MBSFN-AreaInfo-r16,
  pmch-Bandwidth-r17 ENUMERATED {n40, n35, n30, spare1},
  ...
}
-- ASN1STOP

```

<b>MBSFN-AreaInfoList field descriptions</b>
<p><b>mcch-ModificationPeriod</b> Defines periodically appearing boundaries, i.e. radio frames for which <math>\text{SFN mod } mcch\text{-ModificationPeriod} = 0</math>. The contents of different transmissions of MCCH information can only be different if there is at least one such boundary in-between them. In case <i>mcch-ModificationPeriod-v1430</i> is configured, the UE shall ignore the <i>mcch-ModificationPeriod-r9</i>.</p>
<p><b>mcch-Offset</b> Indicates, together with the <i>mcch-RepetitionPeriod</i>, the radio frames in which MCCH is scheduled i.e. MCCH is scheduled in radio frames for which: <math>\text{SFN mod } mcch\text{-RepetitionPeriod} = mcch\text{-Offset}</math>.</p>
<p><b>mcch-RepetitionPeriod</b> Defines the interval between transmissions of MCCH information, in radio frames, Value <i>rf32</i> corresponds to 32 radio frames, <i>rf64</i> corresponds to 64 radio frames and so on. In case <i>mcch-RepetitionPeriod-v1430</i> is configured, the UE shall ignore the <i>mcch-RepetitionPeriod-r9</i>.</p>
<p><b>non-MBSFNregionLength</b> Indicates how many symbols from the beginning of the subframe constitute the non-MBSFN region. This value applies in all subframes of the MBSFN area used for PMCH transmissions as indicated in the MSI. The values <i>s1</i> and <i>s2</i> correspond with 1 and 2 symbols, respectively: see TS 36.211 [21], Table 6.7-1.</p>
<p><b>notificationIndicator</b> Indicates which PDCCH bit is used to notify the UE about change of the MCCH applicable for this MBSFN area. Value 0 corresponds with the least significant bit as defined in TS 36.212 [22], clause 5.3.3.1 and so on.</p>
<p><b>pmch-Bandwidth</b> Indicates the PMCH and corresponding MBSFN-RS bandwidth applicable for this MBSFN area (parameter <math>N_{RB}^{PMCH}</math> in TS 36.211 [21] and TS 36.213 [23]). Value <i>n40</i> corresponds to 40 PRBs, <i>n35</i> corresponds to 35 PRBs and so on.</p>
<p><b>sf-AllocInfo-r9</b> Indicates the subframes of the radio frames indicated by the <i>mcch-RepetitionPeriod</i> and the <i>mcch-Offset</i>, that may carry MCCH. Value "1" indicates that the corresponding subframe is allocated. If the bitmap is set to all zeros, the corresponding MBSFN area is considered as not configured. The following mapping applies: FDD: The first/ leftmost bit defines the allocation for subframe #1 of the radio frame indicated by <i>mcch-RepetitionPeriod</i> and <i>mcch-Offset</i>, the second bit for #2, the third bit for #3, the fourth bit for #6, the fifth bit for #7 and the sixth bit for #8. TDD: The first/leftmost bit defines the allocation for subframe #3 of the radio frame indicated by <i>mcch-RepetitionPeriod</i> and <i>mcch-Offset</i>, the second bit for #4, third bit for #7, fourth bit for #8, fifth bit for #9. Uplink subframes are not allocated. The last bit is not used.</p>
<p><b>sf-AllocInfo-r16</b> Indicates the subframes of the radio frames indicated by the <i>mcch-RepetitionPeriod</i> and the <i>mcch-Offset</i>, that may carry MCCH. Value "1" indicates that the corresponding subframe is allocated. The first/ leftmost bit defines the allocation for subframe #0 of the radio frame indicated by <i>mcch-RepetitionPeriod</i> and <i>mcch-Offset</i>, the second bit for #1 and so on. When <i>subcarrierSpacingMBMS</i> indicates 0.37 kHz subcarrier spacing, a valid MBMS slot can carry MCCH if any subframe corresponding to the slot is configured to carry MCCH.</p>
<p><b>signallingMCS</b> Indicates the MCS applicable for the subframes indicated by the field <i>sf-AllocInfo</i> and for each (P)MCH that is configured for this MBSFN area, for the first subframe allocated to the (P)MCH within each MCH scheduling period (which may contain the MCH scheduling information provided by MAC). Value <i>n2</i> corresponds with the value 2 for parameter <math>I_{MCS}</math> in TS 36.213 [23], Table 7.1.7.1-1, and so on.</p>
<p><b>subcarrierSpacingMBMS</b> The value indicates subcarrier spacing for MBSFN subframes, kHz7dot5 refers to 7.5 kHz subcarrier spacing, kHz2dot5 refers to 2.5 kHz subcarrier spacing and so on as defined in TS 36.211 [21], clause 6.12. These subframes do not have non-MBSFN region. If <i>subcarrierSpacingMBMS-r14</i> is present, then <i>non-MBSFNregionLength</i> shall be ignored. E-UTRAN configures parameter <i>subcarrierSpacingMBMS</i> only when the MBSFN subframes have subcarrier spacing other than 15 kHz or when included in <i>mbsfn-AreaInfo-r17</i>. Value kHz15-r17 is applicable only when the field is included in <i>mbsfn-AreaInfo-r17</i>. If <i>subcarrierSpacingMBMS</i> indicates 0.37 kHz subcarrier spacing, the slot as defined in TS 36.211 [21], clause 4.1 is valid only when all the corresponding subframes are configured as MBSFN subframes in this slot.</p>
<p><b>timeSeparation</b> Indicates the staggering length for MBSFN-RS associated with PMCH as defined in TS 36.211 [21], clause 6.10.2.2.4. Value <i>sl2</i> refers to staggering length of 2 slots (MBSFN reference signal pattern type 2) and <i>sl4</i> refers to staggering length of 4 slots (MBSFN reference signal pattern type 1). E-UTRAN always configures this field when <i>subcarrierSpacingMBMS</i> indicates 0.37 kHz subcarrier spacing. Otherwise the field is not configured.</p>

### MBSFN-SubframeConfig

The IE *MBSFN-SubframeConfig* defines subframes that are reserved for MBSFN in downlink.

**MBSFN-SubframeConfig** information element

```

-- ASN1START
MBSFN-SubframeConfig ::=
    SEQUENCE {
        radioFrameAllocationPeriod    ENUMERATED {n1, n2, n4, n8, n16, n32},
        radioFrameAllocationOffset    INTEGER (0..7),
        subframeAllocation            CHOICE {
            oneFrame                  BIT STRING (SIZE(6)),
            fourFrames                 BIT STRING (SIZE(24))
        }
    }

MBSFN-SubframeConfig-v1430 ::=
    SEQUENCE {
        subframeAllocation-v1430     CHOICE {
            oneFrame-v1430           BIT STRING (SIZE(2)),
            fourFrames-v1430        BIT STRING (SIZE(8))
        }
    }

MBSFN-SubframeConfig-v1610 ::=
    SEQUENCE {
        subframeAllocation-v1610     CHOICE {
            oneFrame-v1610          BIT STRING (SIZE(2)),
            fourFrames-v1610        BIT STRING (SIZE(8))
        }
    }
-- ASN1STOP

```

**MBSFN-SubframeConfig** field descriptions**fourFrames**

A bit-map indicating MBSFN subframe allocation in four consecutive radio frames, "1" denotes that the corresponding subframe is allocated for MBSFN. The bitmap is interpreted as follows:

FDD: Starting from the first radioframe and from the first/leftmost bit in the bitmap, the allocation applies to subframes #1, #2, #3, #6, #7, and #8 in the sequence of the four radio-frames.

TDD: Starting from the first radioframe and from the first/leftmost bit in the bitmap, the allocation applies to subframes #3, #4, #7, #8, and #9 in the sequence of the four radio-frames. The last four bits are not used. E-UTRAN allocates uplink subframes only if *eimta-MainConfig* is configured.

**fourFrames-v1430, fourFrames-v1610**

A bit-map indicating MBSFN subframe allocation in four consecutive radio frames, "1" denotes that the corresponding subframe is allocated for MBSFN. The bitmap is interpreted as follows:

FDD: Starting from the first radioframe and from the first/leftmost bit in the bitmap, the allocation indicated by *fourFrames-v1430* applies to subframes #4 and #9 in the sequence of the four radio-frames. Starting from the first radioframe and from the first/leftmost bit in the bitmap, the allocation indicated by *fourFrames-v1610*, if present, applies to subframes #0 and #5 in the sequence of the four radio-frames.

**oneFrame**

"1" denotes that the corresponding subframe is allocated for MBSFN. The following mapping applies:

FDD: The first/leftmost bit defines the MBSFN allocation for subframe #1, the second bit for #2, third bit for #3, fourth bit for #6, fifth bit for #7, sixth bit for #8.

TDD: The first/leftmost bit defines the allocation for subframe #3, the second bit for #4, third bit for #7, fourth bit for #8, fifth bit for #9. E-UTRAN allocates uplink subframes only if *eimta-MainConfig* is configured. The last bit is not used.

**oneFrame-v1430, oneFrame-v1610**

"1" denotes that the corresponding subframe is allocated for MBSFN. The following mapping applies:

FDD: The first/leftmost bit indicated by *oneFrame-v1430* defines the MBSFN allocation for subframe #4 and the second bit for #9. The first/leftmost bit indicated by *oneFrame-v1610*, if present, defines the MBSFN allocation for subframe #0 and the second bit for #5.

**radioFrameAllocationPeriod, radioFrameAllocationOffset**

Radio-frames that contain MBSFN subframes occur when equation  $SFN \bmod radioFrameAllocationPeriod = radioFrameAllocationOffset$  is satisfied. Value *n1* for *radioFrameAllocationPeriod* denotes value 1, *n2* denotes value 2, and so on. When *fourFrames* is used for *subframeAllocation*, the equation defines the first radio frame referred to in the description below. Values *n1* and *n2* are not applicable when *fourFrames* is used.

**subframeAllocation**

Defines the subframes that are allocated for MBSFN within the radio frame allocation period defined by the *radioFrameAllocationPeriod* and the *radioFrameAllocationOffset*.

## – PMCH-InfoList

The IE *PMCH-InfoList* specifies configuration of all PMCHs of an MBSFN area, while IE *PMCH-InfoListExt* includes additional PMCHs, i.e. extends the PMCH list using the general principles specified in 5.1.2. The information provided for an individual PMCH includes the configuration parameters of the sessions that are carried by the concerned PMCH. For all PMCH that E-UTRAN includes in *PMCH-InfoList*, the list of ongoing sessions has at least one entry.

### PMCH-InfoList information element

```

-- ASN1START
PMCH-InfoList-r9 ::=
    SEQUENCE (SIZE (0..maxPMCH-PerMBSFN)) OF PMCH-Info-r9
PMCH-InfoListExt-r12 ::=
    SEQUENCE (SIZE (0..maxPMCH-PerMBSFN)) OF PMCH-InfoExt-r12
PMCH-Info-r9 ::=
    SEQUENCE {
        pmch-Config-r9          PMCH-Config-r9,
        mbms-SessionInfoList-r9 MBMS-SessionInfoList-r9,
        ...
    }
PMCH-InfoExt-r12 ::=
    SEQUENCE {
        pmch-Config-r12        PMCH-Config-r12,
        mbms-SessionInfoList-r12 MBMS-SessionInfoList-r9,
        ...
    }
MBMS-SessionInfoList-r9 ::=
    SEQUENCE (SIZE (0..maxSessionPerPMCH)) OF MBMS-SessionInfo-r9
MBMS-SessionInfo-r9 ::=
    SEQUENCE {
        tmgi-r9                TMGI-r9,
        sessionId-r9           OCTET STRING (SIZE (1))      OPTIONAL,  -- Need OR
        logicalChannelIdentity-r9 INTEGER (0..maxSessionPerPMCH-1),
        ...
    }
PMCH-Config-r9 ::=
    SEQUENCE {
        sf-AllocEnd-r9         INTEGER (0..1535),
        dataMCS-r9            INTEGER (0..28),
        mch-SchedulingPeriod-r9 ENUMERATED {
            rf8, rf16, rf32, rf64, rf128, rf256, rf512, rf1024},
        ...
    }
PMCH-Config-r12 ::=
    SEQUENCE {
        sf-AllocEnd-r12       INTEGER (0..1535),
        dataMCS-r12          CHOICE {
            normal-r12        INTEGER (0..28),
            higerOrder-r12    INTEGER (0..27)
        },
        mch-SchedulingPeriod-r12 ENUMERATED {
            rf4, rf8, rf16, rf32, rf64, rf128, rf256, rf512, rf1024},
        ...,
        [[ mch-SchedulingPeriod-v1430 ENUMERATED {rf1, rf2}          OPTIONAL  -- Need OR
        ]]
    }
TMGI-r9 ::=
    SEQUENCE {
        plmn-Id-r9            CHOICE {
            plmn-Index-r9    INTEGER (1..maxPLMN-r11),
            explicitValue-r9 PLMN-Identity
        },
        serviceId-r9         OCTET STRING (SIZE (3))
    }
-- ASN1STOP

```

<b>PMCH-InfoList field descriptions</b>	
<b>dataMCS</b>	Indicates the value for parameter $I_{MCS}$ in TS 36.213 [23], which defines the MCS applicable for the subframes of this (P)MCH as indicated by the field <i>commonSF-Alloc</i> . Value <i>normal</i> corresponds to Table 7.1.7.1-1 and value <i>higherOrder</i> corresponds to Table 7.1.7.1-1A. The MCS does however neither apply to the subframes that may carry MCCH i.e. the subframes indicated by the field <i>sf-AllocInfo</i> within <i>SystemInformationBlockType13</i> nor for the first subframe allocated to this (P)MCH within each MCH scheduling period (which may contain the MCH scheduling information provided by MAC).
<b>mch-SchedulingPeriod</b>	Indicates the MCH scheduling period i.e. the periodicity used for providing MCH scheduling information at lower layers (MAC) applicable for an MCH. Value <i>rf8</i> corresponds to 8 radio frames, <i>rf16</i> corresponds to 16 radio frames and so on. The <i>mch-SchedulingPeriod</i> starts in the radio frames for which: $SFN \bmod mch-SchedulingPeriod = 0$ . E-UTRAN configures <i>mch-SchedulingPeriod</i> of the (P)MCH listed first in <i>PMCH-InfoList</i> to be smaller than or equal to <i>mcch-RepetitionPeriod</i> . In case <i>mch-SchedulingPeriod-v1430</i> is configured, the UE shall ignore <i>mch-SchedulingPeriod-r12</i> .
<b>plmn-Index</b>	Index of the entry across the <i>plmn-IdentityList</i> fields within <i>SystemInformationBlockType1</i> .
<b>sessionId</b>	Indicates the optional MBMS Session Identity, which together with TMGI identifies a transmission or a possible retransmission of a specific MBMS session: see TS 29.061 [51], clauses 20.5, 17.7.11, and 17.7.15. The field is included whenever upper layers have assigned a session identity i.e. one is available for the MBMS session in E-UTRAN.
<b>serviceld</b>	Uniquely identifies the identity of an MBMS service within a PLMN. The field contains octet 3- 5 of the IE Temporary Mobile Group Identity (TMGI) as defined in TS 24.008 [49]. The first octet contains the third octet of the TMGI, the second octet contains the fourth octet of the TMGI and so on.
<b>sf-AllocEnd</b>	Indicates the last subframe allocated to this (P)MCH within a period identified by field <i>commonSF-AllocPeriod</i> . The subframes allocated to (P)MCH corresponding with the $n^{\text{th}}$ entry in <i>pmch-InfoList</i> are the subsequent subframes starting from either the next subframe after the subframe identified by <i>sf-AllocEnd</i> of the $(n-1)^{\text{th}}$ listed (P)MCH or, for $n=1$ , the first subframe defined by field <i>commonSF-Alloc</i> , through the subframe identified by <i>sf-AllocEnd</i> of the $n^{\text{th}}$ listed (P)MCH. Value 0 corresponds with the first subframe defined by field <i>commonSF-Alloc</i> .

## 6.3.7a SC-PTM information elements

### – SC-MTCH-InfoList

The IE *SC-MTCH-InfoList* provides the list of ongoing MBMS sessions transmitted via SC-MRB and for each MBMS session, the associated G-RNTI and scheduling information.

#### **SC-MTCH-InfoList information element**

```
-- ASN1START
SC-MTCH-InfoList-r13 ::= SEQUENCE (SIZE (0..maxSC-MTCH-r13)) OF SC-MTCH-Info-r13
SC-MTCH-Info-r13 ::= SEQUENCE {
    mbmsSessionInfo-r13 MBMSSessionInfo-r13,
    g-RNTI-r13 BIT STRING(SIZE(16)),
    sc-mtch-schedulingInfo-r13 SC-MTCH-SchedulingInfo-r13 OPTIONAL, -- Need
OP
    sc-mtch-neighbourCell-r13 BIT STRING (SIZE(maxNeighCell-SCPTM-r13)) OPTIONAL, --
Need OP
    ...,
    [[ p-a-r13 ENUMERATED {
        dB-6, dB-4dot77, dB-3, dB-1dot77,
        dB0, dB1, dB2, dB3} OPTIONAL -- Need ON
    ]]
}
MBMSSessionInfo-r13 ::= SEQUENCE {
    tmgi-r13 TMGI-r9,
    sessionId-r13 OCTET STRING (SIZE (1)) OPTIONAL -- Need OR
}
SC-MTCH-SchedulingInfo-r13 ::= SEQUENCE {
    onDurationTimerSCPTM-r13 ENUMERATED {
        psf1, psf2, psf3, psf4, psf5, psf6,
```



```

psf8, psf10, psf20, psf30, psf40,
psf50, psf60, psf80, psf100,
psf200},
drx-InactivityTimerSCPTM-r13      ENUMERATED {
psf0, psf1, psf2, psf4, psf8,
psf10, psf20, psf40,
psf80, psf160, ps320,
psf640, psf960,
psf1280, psf1920, psf2560},
schedulingPeriodStartOffsetSCPTM-r13 CHOICE {
sf10      INTEGER(0..9),
sf20      INTEGER(0..19),
sf32      INTEGER(0..31),
sf40      INTEGER(0..39),
sf64      INTEGER(0..63),
sf80      INTEGER(0..79),
sf128     INTEGER(0..127),
sf160     INTEGER(0..159),
sf256     INTEGER(0..255),
sf320     INTEGER(0..319),
sf512     INTEGER(0..511),
sf640     INTEGER(0..639),
sf1024    INTEGER(0..1023),
sf2048    INTEGER(0..2048),
sf4096    INTEGER(0..4096),
sf8192    INTEGER(0..8192)
},
...
}
-- ASN1STOP

```

#### SC-MTCH-InfoList field descriptions

##### **drx-InactivityTimerSCPTM**

Timer for SC-MTCH in TS 36.321 [6]. Value in number of PDCCH sub-frames. Value psf0 corresponds to 0 PDCCH sub-frame and behaviour as specified in 7.3.2 applies, psf1 corresponds to 1 PDCCH sub-frame, psf2 corresponds to 2 PDCCH sub-frames and so on.

##### **g-RNTI**

G-RNTI used to scramble the scheduling and transmission of a SC-MTCH.

##### **mbmsSessionInfo**

Indicates the ongoing MBMS session in a SC-MTCH.

##### **onDurationTimerSCPTM**

Timer for SC-MTCH reception in TS 36.321 [6]. Value in number of PDCCH sub-frames. Value psf1 corresponds to 1 PDCCH sub-frame, psf2 corresponds to 2 PDCCH sub-frames and so on.

##### **p-a**

Parameter:  $P_A''$ , for the SC-MTCH per G-RNTI, see TS 36.213 [23], clause 5.2. Value dB-6 corresponds to -6 dB, dB-4dot77 corresponds to -4.77 dB etc.

##### **schedulingPeriodStartOffsetSCPTM**

SCPTM-SchedulingCycle and SCPTM-SchedulingOffset in TS 36.321 [6]. The value of SCPTM-SchedulingCycle is in number of sub-frames. Value sf10 corresponds to 10 sub-frames, sf20 corresponds to 20 sub-frames and so on. The value of SCPTM-SchedulingOffset is in number of sub-frames. The E-UTRAN does not configure a maximum value 2048 for sf2048, 4096 for sf4096 or 8192 for sf8192.

##### **sc-mtch-neighbourCell**

Indicates neighbour cells which also provide this service on SC-MTCH. The first bit is set to 1 if the service is provided on SC-MTCH in the first cell in *scptmNeighbourCellList*, otherwise it is set to 0. The second bit is set to 1 if the service is provided on SC-MTCH in the second cell in *scptmNeighbourCellList*, and so on. If this field is absent, the UE shall assume that this service is not available on SC-MTCH in any neighbour cell.

##### **sc-mtch-schedulingInfo**

DRX information for the SC-MTCH. If this field is absent, the SC-MTCH may be scheduled in any subframe.

#### SC-MTCH-InfoList-BR

The IE SC-MTCH-InfoList-BR provides the list of ongoing MBMS sessions transmitted via SC-MRB and for each MBMS session, the associated G-RNTI and scheduling information.

#### SC-MTCH-InfoList-BR information element

```
-- ASN1START
```

```

SC-MTCH-InfoList-BR-r14 ::= SEQUENCE (SIZE (0..maxSC-MTCH-BR-r14)) OF SC-MTCH-Info-BR-r14

SC-MTCH-Info-BR-r14 ::= SEQUENCE {
    sc-mtch-CarrierFreq-r14 ARFCN-ValueEUTRA-r9,
    mbmsSessionInfo-r14 MBMSSessionInfo-r13,
    g-RNTI-r14 BIT STRING(SIZE(16)),
    sc-mtch-schedulingInfo-r14 SC-MTCH-SchedulingInfo-BR-r14 OPTIONAL, --
Need OP
    sc-mtch-neighbourCell-r14 BIT STRING (SIZE(maxNeighCell-SCPTM-r13)) OPTIONAL, --
Need OP
    mpcch-Narrowband-SC-MTCH-r14 INTEGER (1.. maxAvailNarrowBands-r13),
    mpcch-NumRepetition-SC-MTCH-r14 ENUMERATED {r1, r2, r4, r8, r16,
        r32, r64, r128, r256},
    mpcch-StartSF-SC-MTCH-r14 CHOICE {
        fdd-r14 ENUMERATED {v1, v1dot5, v2, v2dot5, v4,
            v5, v8, v10},
        tdd-r14 ENUMERATED {v1, v2, v4, v5, v8, v10,
            v20}
    },
    mpcch-PDSCH-HoppingConfig-SC-MTCH-r14 ENUMERATED {on, off},
    mpcch-PDSCH-CEmodeConfig-SC-MTCH-r14 ENUMERATED {ce-ModeA, ce-ModeB},
    mpcch-PDSCH-MaxBandwidth-SC-MTCH-r14 ENUMERATED {bw1dot4, bw5},
    mpcch-Offset-SC-MTCH-r14 ENUMERATED {zero, oneEighth, oneQuarter,
        threeEighth, oneHalf, fiveEighth,
        threeQuarter, sevenEighth},
    p-a-r14 ENUMERATED { dB-6, dB-4dot77, dB-3,
        dB-1dot77, dB0, dB1, dB2,
        dB3} OPTIONAL,-- Need OR
    ...
}

SC-MTCH-SchedulingInfo-BR-r14 ::= SEQUENCE {
    onDurationTimerSCPTM-r14 ENUMERATED {
        psf300, psf400, psf500, psf600,
        psf800, psf1000, psf1200, psf1600},
    drx-InactivityTimerSCPTM-r14 ENUMERATED {
        psf0, psf1, psf2, psf4, psf8, psf16,
        psf32, psf64, psf128, psf256, ps512,
        psf1024, psf2048, psf4096, psf8192, psf16384},
    schedulingPeriodStartOffsetSCPTM-r14 CHOICE {
        sf10 INTEGER(0..9),
        sf20 INTEGER(0..19),
        sf32 INTEGER(0..31),
        sf40 INTEGER(0..39),
        sf64 INTEGER(0..63),
        sf80 INTEGER(0..79),
        sf128 INTEGER(0..127),
        sf160 INTEGER(0..159),
        sf256 INTEGER(0..255),
        sf320 INTEGER(0..319),
        sf512 INTEGER(0..511),
        sf640 INTEGER(0..639),
        sf1024 INTEGER(0..1023),
        sf2048 INTEGER(0..2047),
        sf4096 INTEGER(0..4095),
        sf8192 INTEGER(0..8191)
    },
    ...
}

-- ASN1STOP

```

<b>SC-MTCH-InfoList-BR field descriptions</b>
<b>drx-InactivityTimerSCPTM</b> Timer for SC-MTCH in TS 36.321 [6]. Value in number of MPDCCH sub-frames. Value psf0 corresponds to 0 MPDCCH sub-frame and behaviour as specified in 7.3.2 applies, psf1 corresponds to 1 MPDCCH sub-frame, psf2 corresponds to 2 MPDCCH sub-frames and so on.
<b>g-RNTI</b> G-RNTI used to scramble the scheduling and transmission of a SC-MTCH
<b>mbmsSessionInfo</b> Indicates the ongoing MBMS session in a SC-MTCH.
<b>mpdcch-Narrowband-SC-MTCH</b> Narrowband for MPDCCH for SC-MTCH, see TS 36.213 [23].
<b>mpdcch-NumRepetitions-SC-MTCH</b> The maximum number of MPDCCH repetitions the UE needs to monitor for SC-MTCH, see TS 36.213 [23].
<b>mpdcch-Offset-SC-MTCH</b> Fractional period offset of starting subframes for MPDCCH search space for SC-MTCH, see TS 36.213 [23].
<b>mpdcch-PDSCH-CEmodeConfig-SC-MTCH</b> Coverage enhancement mode configuration for MPDCCH/PDSCH for SC-MTCH, see TS 36.213 [23].
<b>mpdcch-PDSCH-HoppingConfig-SC-MTCH</b> Frequency hopping configuration for MPDCCH/PDSCH for SC-MTCH, see TS 36.213 [23].
<b>mpdcch-PDSCH-MaxBandwidth-SC-MTCH</b> Maximum PDSCH channel bandwidth for SC-MTCH, see TS 36.213 [23]. Value <i>bw1dot4</i> corresponds to 1.4 MHz channel bandwidth and value <i>bw5</i> corresponds to 5 MHz channel bandwidth. Corresponding maximum TBS are specified in TS 36.213 [23], clause 7.1.7.2.
<b>mpdcch-StartSF-SC-MTCH</b> Starting subframes configuration of the MPDCCH search space for SC-MTCH, see TS 36.213 [23].
<b>onDurationTimerSCPTM</b> Timer for SC-MTCH reception in TS 36.321 [6]. Value in number of MPDCCH sub-frames. Value psf300 corresponds to 300 MPDCCH sub-frames, psf400 corresponds to 400 MPDCCH sub-frames and so on.
<b>schedulingPeriodStartOffsetSCPTM</b> <i>SCPTM-SchedulingCycle</i> and <i>SCPTM-SchedulingOffset</i> in TS 36.321 [6]. The value of <i>SCPTM-SchedulingCycle</i> is in number of sub-frames. Value sf10 corresponds to 10 sub-frames, sf20 corresponds to 20 sub-frames and so on. The value of <i>SCPTM-SchedulingOffset</i> is in number of sub-frames.
<b>sc-mtch-CarrierFreq</b> Downlink carrier used for multicast SC-MTCH transmissions.
<b>sc-mtch-neighbourCell</b> Indicates neighbour cells which also provide this service on SC-MTCH. The first bit is set to 1 if the service is provided on SC-MTCH in the first cell in <i>sctpMNeighbourCellList</i> , otherwise it is set to 0. The second bit is set to 1 if the service is provided on SC-MTCH in the second cell in <i>sctpMNeighbourCellList</i> , and so on. If this field is absent, the UE shall assume that this service is not available on SC-MTCH in any neighbour cell.
<b>sc-mtch-schedulingInfo</b> DRX information for the SC-MTCH. If this field is absent, DRX is not used for SC-MTCH reception.
<b>p-a</b> Parameter: $P_A'$ for the SC-MTCH per G-RNTI, see TS 36.213 [23], clause 5.2. Value dB-6 corresponds to -6 dB, dB-4dot77 corresponds to -4.77 dB etc.

### – SCPTM-NeighbourCellList

The IE *SCPTM-NeighbourCellList* indicates a list of neighbour cells where ongoing MBMS sessions provided via SC-MRB in the current cells are also provided.

```

-- ASN1START
SCPTM-NeighbourCellList-r13 ::= SEQUENCE (SIZE (1..maxNeighCell-SCPTM-r13)) OF PCI-ARFCN-r13
PCI-ARFCN-r13 ::= SEQUENCE {
    physCellId-r13
    carrierFreq-r13
    ARFCN-ValueEUTRA-r9 OPTIONAL
}
-- ASN1STOP

```

**SCPTM-NeighbourCellList field description****carrierFreq**

Indicates the frequency of the neighbour cell indicated by *physCellId*. Absence of the IE means that the neighbour cell is on the same frequency as the current cell.

## 6.3.8 Sidelink information elements

### – *SL-AnchorCarrierFreqList-V2X*

The IE *SL-AnchorCarrierFreqList-V2X* specifies the SL V2X anchor frequencies i.e. frequencies that include inter-carrier resource configuration for V2X sidelink communication.

#### ***SL-AnchorCarrierFreqList-V2X* information element**

```
-- ASN1START
SL-AnchorCarrierFreqList-V2X-r14 ::= SEQUENCE (SIZE (1..maxFreqV2X-r14)) OF ARFCN-ValueEUTRA-r9
-- ASN1STOP
```

### – *SL-CBR-CommonTxConfigList*

The IE *SL-CBR-CommonTxConfigList* indicates the list of PSSCH transmission parameters (such as MCS, sub-channel number, retransmission number, CR limit) in *sl-CBR-PSSCH-TxConfigList*, and the list of CBR ranges in *cbr-RangeCommonConfigList*, to configure congestion control to the UE for V2X sidelink communication.

#### ***SL-CBR-CommonTxConfigList* information element**

```
-- ASN1START
SL-CBR-CommonTxConfigList-r14 ::= SEQUENCE {
  cbr-RangeCommonConfigList-r14 SEQUENCE (SIZE (1..maxSL-V2X-CBRConfig-r14)) OF SL-CBR-Levels-
  Config-r14,
  sl-CBR-PSSCH-TxConfigList-r14 SEQUENCE (SIZE (1..maxSL-V2X-TxConfig-r14)) OF SL-CBR-PSSCH-
  TxConfig-r14
}
SL-CBR-Levels-Config-r14 ::= SEQUENCE (SIZE (1..maxCBR-Level-r14)) OF SL-CBR-r14
SL-CBR-PSSCH-TxConfig-r14 ::= SEQUENCE {
  cr-Limit-r14 INTEGER(0..10000),
  tx-Parameters-r14 SL-PSSCH-TxParameters-r14
}
SL-CBR-r14 ::= INTEGER(0..100)
-- ASN1STOP
```

<b>SL-CBR-CommonTxConfigList field descriptions</b>
<p><b>cbr-RangeCommonConfigList</b> Indicates the list of CBR ranges. Each entry of the list indicates in <i>SL-CBR-Levels-Config</i> the upper bound of the CBR range for the respective entry. The upper bounds of the CBR ranges are configured in ascending order for consecutive entries of <i>cbr-RangeCommonConfigList</i>. For the first entry of <i>cbr-RangeCommonConfigList</i> the lower bound of the CBR range is 0.</p>
<p><b>cr-Limit</b> Indicates the maximum limit on the occupancy ratio. Value 0 corresponds to 0, value 1 to 0.0001, value 2 to 0.0002, and so on (i.e. in steps of 0.0001) until value 10000, which corresponds to 1.</p>
<p><b>sl-CBR-PSSCH-TxConfigList</b> Indicates the list of available PSSCH transmission parameters (such as MCS, sub-channel number, retransmission number and CR limit) configurations.</p>
<p><b>SL-CBR</b> Value 0 corresponds to 0, value 1 to 0.01, value 2 to 0.02, and so on.</p>
<p><b>tx-Parameters</b> Indicates PSSCH transmission parameters.</p>

### – SL-CBR-PPPP-TxConfigList

The IE *SL-CBR-PPPP-TxConfigList* indicates the mapping between PSSCH transmission parameter (such as MCS, PRB number, retransmission number, CR limit) sets by using the indexes of the configurations provided in *sl-CBR-PSSCH-TxConfigList*, CBR ranges by an index to the entry of the CBR range configuration in *cbr-RangeCommonConfigList*, and PPPP ranges. It also indicates the default PSSCH transmission parameters to be used when CBR measurement results are not available.

#### **SL-CBR-PPPP-TxConfigList information element**

```

-- ASN1START
SL-CBR-PPPP-TxConfigList-r14 ::= SEQUENCE (SIZE (1..8)) OF SL-PPPP-TxConfigIndex-r14

SL-PPPP-TxConfigIndex-r14 ::= SEQUENCE {
    priorityThreshold-r14          SL-Priority-r13,
    defaultTxConfigIndex-r14      INTEGER(0..maxCBR-Level-1-r14),
    cbr-ConfigIndex-r14           INTEGER(0..maxSL-V2X-CBRConfig-1-r14),
    tx-ConfigIndexList-r14        SEQUENCE (SIZE (1..maxCBR-Level-r14)) OF Tx-ConfigIndex-r14
}

Tx-ConfigIndex-r14 ::= INTEGER(0..maxSL-V2X-TxConfig-1-r14)

SL-CBR-PPPP-TxConfigList-v1530 ::= SEQUENCE (SIZE (1..8)) OF SL-PPPP-TxConfigIndex-v1530

SL-PPPP-TxConfigIndex-v1530 ::= SEQUENCE {
    mcs-PSSCH-RangeList-r15      SEQUENCE (SIZE (1..maxCBR-Level-r14)) OF MCS-PSSCH-Range-r15
                                OPTIONAL                                --Need OR
}

MCS-PSSCH-Range-r15 ::= SEQUENCE{
    minMCS-PSSCH-r15             INTEGER (0..31),
    maxMCS-PSSCH-r15             INTEGER (0..31)
}

SL-CBR-PPPP-TxConfigList-r15 ::= SEQUENCE (SIZE (1..8)) OF SL-PPPP-TxConfigIndex-r15

SL-PPPP-TxConfigIndex-r15 ::= SEQUENCE {
    priorityThreshold-r15        SL-Priority-r13,
    defaultTxConfigIndex-r15     INTEGER(0..maxCBR-Level-1-r14),
    cbr-ConfigIndex-r15         INTEGER(0..maxSL-V2X-CBRConfig-1-r14),
    tx-ConfigIndexList-r15      SEQUENCE (SIZE (1..maxCBR-Level-r14)) OF Tx-ConfigIndex-r14,
    mcs-PSSCH-RangeList-r15     SEQUENCE (SIZE (1..maxCBR-Level-r14)) OF MCS-PSSCH-Range-r15
}
-- ASN1STOP

```

<b>SL-CBR-PPPP-TxConfigList field descriptions</b>
<p><b>cbr-ConfigIndex</b> Indicates the CBR ranges to be used by an index to the entry of the CBR range configuration in <i>cbr-RangeCommonConfigList</i>.</p>
<p><b>defaultTxConfigIndex</b> Indicates the PSSCH transmission parameters to be used by the UEs which do not have available CBR measurement results, by means of an index to the corresponding entry in <i>tx-ConfigIndexList</i>. Value 0 indicates the first entry in <i>tx-ConfigIndexList</i>. The field is ignored if the UE has available CBR measurement results.</p>
<p><b>mcs-PSSCH-RangeList</b> If included, this field applies to the PPPP(s) indicated by the <i>priorityThreshold</i> and each entry in this field sequentially corresponds to each CBR range indicated by <i>cbr-ConfigIndex</i>.</p>
<p><b>minMCS-PSSCH, maxMCS-PSSCH</b> Indicates the minimum and maximum MCS values which correspond to both the MCS table in Table 8.6.1-1 and Table 14.1.1-2 in TS 36.213 [23] used for transmission on PSSCH.</p>
<p><b>priorityThreshold</b> Indicates the upper bound of PPPP range which is associated with the configurations in <i>cbr-ConfigIndex</i> and in <i>tx-ConfigIndexList</i>. The upper bounds of the PPPP ranges are configured in ascending order for consecutive entries of <i>SL-PPPP-TxConfigIndex</i> in <i>SL-CBR-PPPP-TxConfigList</i>. For the first entry of <i>SL-PPPP-TxConfigIndex</i>, the lower bound of the PPPP range is 1.</p>
<p><b>SL-CBR-PPPP-TxConfigList-v1530</b> If included, E-UTRAN shall include the same number of entries, and listed in the same order, as in <i>SL-CBR-PPPP-TxConfigList-r14</i>.</p>
<p><b>tx-ConfigIndexList</b> Indicates the list of the PSSCH transmission parameters and CR limit by the indexes to the entries of the configurations in <i>sl-CBR-PSSCH-TxConfigList</i>. Each index in <i>tx-ConfigIndexList</i> sequentially maps to each CBR range indicated by <i>cbr-ConfigIndex</i>.</p>

## – SL-CommConfig

The IE *SL-CommConfig* specifies the dedicated configuration information for sidelink communication. In particular it concerns the transmission resource configuration for sidelink communication on the primary frequency.

### SL-CommConfig information element

```

-- ASN1START
SL-CommConfig-r12 ::= SEQUENCE {
    commTxResources-r12 CHOICE {
        release NULL,
        setup CHOICE {
            scheduled-r12 SEQUENCE {
                sl-RNTI-r12 C-RNTI,
                mac-MainConfig-r12 MAC-MainConfigSL-r12,
                sc-CommTxConfig-r12 SL-CommResourcePool-r12,
                mcs-r12 INTEGER (0..28) OPTIONAL -- Need OP
            },
            ue-Selected-r12 SEQUENCE {
                -- Pool for normal usage
                commTxPoolNormalDedicated-r12 SEQUENCE {
                    poolToReleaseList-r12 SL-TxPoolToReleaseList-r12 OPTIONAL, -- Need
ON
                    poolToAddModList-r12 SL-CommTxPoolToAddModList-r12 OPTIONAL -- Need
ON
                }
            }
        }
    } OPTIONAL, -- Need ON
    ...
    [[ commTxResources-v1310 CHOICE {
        release NULL,
        setup CHOICE {
            scheduled-v1310 SEQUENCE {
                logicalChGroupInfoList-r13 LogicalChGroupInfoList-r13,
                multipleTx-r13 BOOLEAN
            },
            ue-Selected-v1310 SEQUENCE {
                commTxPoolNormalDedicatedExt-r13 SEQUENCE {
                    poolToReleaseListExt-r13 SL-TxPoolToReleaseListExt-r13 OPTIONAL,
-- Need ON
                    poolToAddModListExt-r13 SL-CommTxPoolToAddModListExt-r13
OPTIONAL -- Need ON
                }
            }
        }
    ] ]

```

```

    }
  }
}
commTxAllowRelayDedicated-r13      BOOLEAN          OPTIONAL      OPTIONAL,    -- Need ON
                                   -- Need ON
]]
}

LogicalChGroupInfoList-r13 ::=      SEQUENCE (SIZE (1..maxLCG-r13)) OF SL-PriorityList-r13

SL-CommTxPoolToAddModList-r12 ::=   SEQUENCE (SIZE (1..maxSL-TxPool-r12)) OF SL-
CommTxPoolToAddMod-r12

SL-CommTxPoolToAddModListExt-r13 ::= SEQUENCE (SIZE (1..maxSL-TxPool-v1310)) OF SL-
CommTxPoolToAddModExt-r13

SL-CommTxPoolToAddMod-r12 ::=       SEQUENCE {
  poolIdentity-r12                    SL-TxPoolIdentity-r12,
  pool-r12                             SL-CommResourcePool-r12
}

SL-CommTxPoolToAddModExt-r13 ::=    SEQUENCE {
  poolIdentity-v1310                  SL-TxPoolIdentity-v1310,
  pool-r13                             SL-CommResourcePool-r12
}

MAC-MainConfigSL-r12 ::=            SEQUENCE {
  periodic-BSR-TimerSL                PeriodicBSR-Timer-r12      OPTIONAL,    -- Need ON
  retx-BSR-TimerSL                    RetxBsr-Timer-r12
}

-- ASN1STOP

```

#### **SL-CommConfig field descriptions**

##### ***commTxAllowRelayDedicated***

Indicates whether the UE is allowed to transmit relay related sidelink communication using the configured dedicated transmission resources i.e. either via scheduled or via UE selected resources.

##### ***commTxPoolNormalDedicated***

Indicates a pool of transmission resources the UE is allowed to use while in RRC\_CONNECTED.

##### ***logicalChGroupInfoList***

Indicates for each logical channel group the list of associated priorities, used as specified in TS 36.321 [6], in order of increasing logical channel group identity.

##### ***mcs***

Indicates the MCS as defined in TS 36.212 [23], clause 14.2.1. If not configured, the selection of MCS is up to UE implementation.

##### ***multipleTx***

Indicates whether the UE should perform multiple transmissions to different destinations in one SC period in accordance with TS 36.321 [6], clause 5.14.1.1. Value TRUE indicates that multiple transmissions should be performed.

##### ***sc-CommTxConfig***

Indicates a pool of resources for SC when E-UTRAN schedules Tx resources (i.e. when indices included in DCI format 5 indicate the actual data resources to be used as specified in TS 36.212 [22], clause 5.3.3.1.9).

##### ***scheduled***

Indicates the configuration for the case E-UTRAN schedules the transmission resources based on sidelink specific BSR from the UE.

##### ***ue-Selected***

Indicates the configuration for the case the UE selects the transmission resources from a pool of resources configured by E-UTRAN.

## – *SL-CommResourcePool*

The IE *SL-CommResourcePool* and *SL-CommResourcePoolV2X* specifies the configuration information for an individual pool of resources for sidelink communication and V2X sidelink communication respectively. The IE covers the configuration of both the sidelink control information and the data.

### **SL-CommResourcePool information element**

```
-- ASN1START
```

```

SL-CommTxPoolList-r12 ::= SEQUENCE (SIZE (1..maxSL-TxPool-r12)) OF SL-CommResourcePool-r12
SL-CommTxPoolListExt-r13 ::= SEQUENCE (SIZE (1..maxSL-TxPool-v1310)) OF SL-CommResourcePool-r12
SL-CommTxPoolListV2X-r14 ::= SEQUENCE (SIZE (1..maxSL-V2X-TxPool-r14)) OF SL-CommResourcePoolV2X-r14
SL-CommRxPoolList-r12 ::= SEQUENCE (SIZE (1..maxSL-RxPool-r12)) OF SL-CommResourcePool-r12
SL-CommRxPoolListV2X-r14 ::= SEQUENCE (SIZE (1..maxSL-V2X-RxPool-r14)) OF SL-CommResourcePoolV2X-r14

SL-CommResourcePool-r12 ::= SEQUENCE {
  sc-CP-Len-r12 SL-CP-Len-r12,
  sc-Period-r12 SL-PeriodComm-r12,
  sc-TF-ResourceConfig-r12 SL-TF-ResourceConfig-r12,
  data-CP-Len-r12 SL-CP-Len-r12,
  dataHoppingConfig-r12 SL-HoppingConfigComm-r12,
  ue-SelectedResourceConfig-r12 SEQUENCE {
    data-TF-ResourceConfig-r12 SL-TF-ResourceConfig-r12,
    trpt-Subset-r12 SL-TRPT-Subset-r12 OPTIONAL -- Need OP
  } OPTIONAL, -- Need OR
  rxParametersNCell-r12 SEQUENCE {
    tdd-Config-r12 TDD-Config OPTIONAL, -- Need OP
    syncConfigIndex-r12 INTEGER (0..15) OPTIONAL, -- Need OR
  }
  txParameters-r12 SEQUENCE {
    sc-TxParameters-r12 SL-TxParameters-r12,
    dataTxParameters-r12 SL-TxParameters-r12
  } OPTIONAL, -- Cond Tx
  ...,
  [[ priorityList-r13 SL-PriorityList-r13 OPTIONAL -- Cond Tx
  ]]
}

SL-CommResourcePoolV2X-r14 ::= SEQUENCE {
  sl-OffsetIndicator-r14 SL-OffsetIndicator-r12 OPTIONAL, -- Need OR
  sl-Subframe-r14 SubframeBitmapSL-r14,
  adjacencyPSCCH-PSSCH-r14 BOOLEAN,
  sizeSubchannel-r14 ENUMERATED {
    n4, n5, n6, n8, n9, n10, n12, n15, n16, n18, n20, n25, n30,
    n48, n50, n72, n75, n96, n100, spare13, spare12, spare11,
    spare10, spare9, spare8, spare7, spare6, spare5, spare4,
    spare3, spare2, spare1},
  numSubchannel-r14 ENUMERATED {n1, n3, n5, n8, n10, n15, n20, spare1},
  startRB-Subchannel-r14 INTEGER (0..99),
  startRB-PSCCH-Pool-r14 INTEGER (0..99) OPTIONAL, -- Need OR
  rxParametersNCell-r14 SEQUENCE {
    tdd-Config-r14 TDD-Config OPTIONAL, -- Need OP
    syncConfigIndex-r14 INTEGER (0..15)
  } OPTIONAL, -- Need OR
  dataTxParameters-r14 SL-TxParameters-r12 OPTIONAL, -- Cond Tx
  zoneID-r14 INTEGER (0..7) OPTIONAL, -- Need OR
  threshS-RSSI-CBR-r14 INTEGER (0..45) OPTIONAL, -- Need OR
  poolReportId-r14 SL-V2X-TxPoolReportIdentity-r14 OPTIONAL, -- Need OR
  cbr-pssch-TxConfigList-r14 SL-CBR-PPPP-TxConfigList-r14 OPTIONAL, -- Need OR
  resourceSelectionConfigP2X-r14 SL-P2X-ResourceSelectionConfig-r14 OPTIONAL, -- Cond P2X
  syncAllowed-r14 SL-SyncAllowed-r14 OPTIONAL, -- Need OR
  restrictResourceReservationPeriod-r14 SL-RestrictResourceReservationPeriodList-r14
  OPTIONAL, -- Need OR
  ...,
  [[ sl-MinT2ValueList-r15 SL-MinT2ValueList-r15 OPTIONAL, -- Need OR
    cbr-pssch-TxConfigList-v1530 SL-CBR-PPPP-TxConfigList-v1530 OPTIONAL, -- Need OR
  ]],
  [[ sl-A2X-Service-r18 ENUMERATED {brid, daa, bridAndDAA, spare1} OPTIONAL -- Cond A2X
  ]]
}

SL-TRPT-Subset-r12 ::= BIT STRING (SIZE (3..5))

SL-V2X-TxPoolReportIdentity-r14 ::= INTEGER (1..maxSL-PoolToMeasure-r14)

SL-MinT2ValueList-r15 ::= SEQUENCE (SIZE (1..maxSL-Prio-r13)) OF SL-MinT2Value-r15

SL-MinT2Value-r15 ::= SEQUENCE {
  priorityList-r15 SL-PriorityList-r13,
  minT2Value-r15 INTEGER (10..20)
}

```



}

-- ASN1STOP

<b>SL-CommResourcePool field descriptions</b>
<p><b>adjacencyPSCCH-PSSCH</b> Indicates whether a UE shall always transmit PSCCH and PSSCH in adjacent RBs (indicated by TRUE) or in non-adjacent RBs (indicated by FALSE) (see TS 36.213 [23]).</p>
<p><b>cbr-pssch-TxConfigList</b> Indicates the mapping between PPPPs, CBR ranges by using indexes of the entry in cbr-RangeCommonConfigList, and PSSCH transmission parameters and CR limit by using indexes of the entry in sl-CBR-PSSCH-TxConfigList. If <i>SL-CommResourcePoolV2X</i> is included in <i>MobilityControlInfoV2X</i>, it refers to <i>cbr-MobilityTxConfigList</i> for <i>cbr-RangeCommonConfigList</i> and <i>sl-CBR-PSSCH-TxConfigList</i>. If <i>SL-CommResourcePoolV2X</i> is included in <i>SL-V2X-ConfigDedicated</i>, it refers to <i>cbr-DedicatedTxConfigList</i> for <i>cbr-RangeCommonConfigList</i> and <i>sl-CBR-PSSCH-TxConfigList</i>. Otherwise, it refers to <i>cbr-CommonTxConfigList</i> included in the <i>SystemInformationBlockType21</i> of the serving cell / PCell for <i>cbr-RangeCommonConfigList</i> and <i>sl-CBR-PSSCH-TxConfigList</i>.</p>
<p><b>minT2Value</b> Indicates the minimum value of T2 that applies to the PPPP(s), as specified in TS 36.300 [9], included in <i>priorityList</i>.</p>
<p><b>numSubchannel</b> indicates the number of subchannels in the corresponding resource pool (see TS 36.213 [23]).</p>
<p><b>poolReportId</b> The identity of the transmission resource pool used for CBR measurement reporting, which is corresponding to the <i>poolIdentity</i> reported in <i>measResultListCBR</i>. This field is only present in the transmission pools configured in <i>RRCCoordinateReconfiguration</i> and <i>v2x-CommTxPoolExceptional</i>, <i>p2x-CommTxPoolNormalCommon</i>, <i>v2x-CommTxPoolNormalCommon</i>, <i>v2x-CommTxPoolNormal</i> in <i>SystemInformationBlockType21</i> or <i>SystemInformationBlockType26</i>. Otherwise, the field is absent.</p>
<p><b>resourceSelectionConfigP2X</b> Indicates the allowed resource selection mechanism(s), i.e. partial sensing and/or random selection, for P2X related V2X sidelink communication.</p>
<p><b>restrictResourceReservationPeriod</b> If configured, the field <i>restrictResourceReservationPeriod</i> configured in <i>v2x-ResourceSelectionConfig</i> shall be ignored for transmission on this pool.</p>
<p><b>sc-Period</b> Indicates the period over which resources are allocated in a cell for SC and over which scheduled and UE selected data transmissions occur, see PSCCH period in TS 36.213 [23]. Value in number of subframes. Value sf40 corresponds to 40 subframes, sf80 corresponds to 80 subframes and so on. E-UTRAN configures values sf40, sf80, sf160 and sf320 for FDD and for TDD config 1 to 5, values sf70, sf140 and sf280 for TDD config 0, and finally values sf60, sf120 and sf240 for TDD config 6.</p>
<p><b>sizeSubchannel</b> Indicates the number of PRBs of each subchannel in the corresponding resource pool (see TS 36.213 [23]). The value n5 denotes 5 PRBs; n6 denotes 6 PRBs and so on. E-UTRAN configures values n5, n6, n10, n15, n20, n25, n50, n75 and n100 in the case of <i>adjacencyPSCCH-PSSCH</i> set to TRUE; otherwise, E-UTRAN configures values n4, n5, n6, n8, n9, n10, n12, n15, n16, n18, n20, n30, n48, n72 and n96 in the case of <i>adjacencyPSCCH-PSSCH</i> set to FALSE,</p>
<p><b>sl-A2X-Service</b> Presence of this field indicates the resource pool is dedicated for A2X service, i.e., not to be used for other than A2X service. Value <i>brid</i> indicates the resource pool is for BRID, value <i>daa</i> indicates the resource pool is for DAA, and value <i>bridAndDAA</i> indicates the resource pool is for both BRID and DAA. If this field is absent in all the configured resource pools, the UE may choose non-dedicated resource pool for A2X service.</p>
<p><b>sl-minT2ValueList</b> Indicates a list of minimum value sets for the parameter T2 which is used for UE autonomous resource selection in this resource pool (see TS 36.213 [23]).</p>
<p><b>sl-OffsetIndicator</b> Indicates the offset of the first subframe of a resource pool, i.e., the starting subframe of the repeating bitmap <i>sl-Subframe</i>, within a SFN cycle. If absent, the resource pool starts from first subframe of SFN=0. This field is not applicable to V2X sidelink communication.</p>
<p><b>sl-Subframe</b> Indicates the bitmap of the resource pool, which is defined by repeating the bitmap within a SFN cycle (see TS 36.213 [23]).</p>
<p><b>startRB-PSCCH-Pool</b> Indicates the lowest RB index of the PSCCH pool (see TS 36.213 [23]). This field is absent when a pool is (pre)configured such that a UE always transmits SC and data in adjacent RBs in the same subframe.</p>
<p><b>startRB-Subchannel</b> Indicates the lowest RB index of the subchannel with the lowest index (see TS 36.213 [23]).</p>
<p><b>syncAllowed</b> Indicates the allowed synchronization reference(s) which is (are) allowed to use the configured resource pool.</p>
<p><b>syncConfigIndex</b> Indicates the synchronisation configuration that is associated with a reception pool, by means of an index to the corresponding entry of <i>commSyncConfig</i> in <i>SystemInformationBlockType18</i> for sidelink communication, or by means of an index to the corresponding entry of <i>v2x-SyncConfig</i> in <i>SystemInformationBlockType21</i> or <i>SystemInformationBlockType26</i> for V2X sidelink communication.</p>

<b>SL-CommResourcePool field descriptions</b>
<p><b>adjacencyPSCCH-PSSCH</b> Indicates whether a UE shall always transmit PSCCH and PSSCH in adjacent RBs (indicated by TRUE) or in non-adjacent RBs (indicated by FALSE) (see TS 36.213 [23]).</p>
<p><b>tdd-Config</b> TDD configuration associated with the reception pool of the cell indicated by <i>syncConfigIndex</i>. Absence of the field indicates that the duplex mode is FDD and no TDD specific physical channel configuration is applicable.</p>
<p><b>threshS-RSSI-CBR</b> Indicates the S-RSSI threshold for determining the contribution of a sub-channel to the CBR measurement, as specified in TS 36.214 [48]. Value 0 corresponds to -112 dBm, value 1 to -110 dBm, value n to (-112 + n*2) dBm, and so on.</p>
<p><b>trpt-Subset</b> Indicates the subset of T-RPT available (see TS 36.213 [23], clause 14.1.1.1). Consists of a bitmap which is used to indicate the set of available 'k' values to be used for sidelink communication (see TS 36.213 [23], clause 14.1.1.3). If T-RPT subset configuration is not signaled/ preconfigured then UE assumes the whole T-RPT set is available.</p>
<p><b>zoneID</b> Indicates the zone ID for which the UE shall use this resource pool as described in 5.10.13.2. The field is absent in <i>v2x-CommTxPoolExceptional</i>, <i>p2x-CommTxPoolNormalCommon</i>, <i>p2x-CommTxPoolNormal</i> and <i>v2x-CommRxPool</i> in SIB21, in SIB26 or in <i>mobilityControlInfoV2X</i>.</p>

<b>Conditional presence</b>	<b>Explanation</b>
A2X	The field is mandatory present when included in <i>sl-A2X-ConfigCommon</i> . Otherwise the field is optionally present, Need OP.
Tx	The field is mandatory present when included in <i>commTxPoolNormalDedicated</i> , <i>commTxPoolNormalDedicatedExt</i> , <i>commTxPoolNormalCommon</i> , <i>commTxPoolNormalCommonExt</i> , <i>commTxPoolExceptional</i> , <i>sc-CommTxConfig</i> , <i>v2x-CommTxPoolNormalCommon</i> , <i>v2x-CommTxPoolExceptional</i> , <i>v2x-CommTxPoolNormalDedicated</i> , <i>p2x-CommTxPoolNormalCommon</i> or <i>v2x-CommTxPoolNormal</i> and <i>p2x-CommTxPoolNormal</i> in <i>v2x-InterFreqInfoList</i> . Otherwise the field is not present.
P2X	The field is mandatory present when included in <i>p2x-CommTxPoolNormalCommon</i> , <i>v2x-CommTxPoolNormalDedicated</i> in <i>sl-V2X-ConfigDedicated</i> for P2X related V2X sidelink communication or <i>p2x-CommTxPoolNormal</i> in <i>v2x-InterFreqInfoList</i> . Otherwise the field is not present.

## – SL-CommTxPoolSensingConfig

The IE *SL-CommTxPoolSensingConfig* specifies V2X sidelink communication configurations used for UE autonomous resource selection.

### SL-CommTxPoolSensingConfig information element

```

-- ASN1START
SL-CommTxPoolSensingConfig-r14 ::= SEQUENCE {
    pssch-TxConfigList-r14          SL-PSSCH-TxConfigList-r14,
    threshPSSCH-RSRP-List-r14     SL-ThresPSSCH-RSRP-List-r14,
    restrictResourceReservationPeriod-r14  SL-RestrictResourceReservationPeriodList-r14
    OPTIONAL, -- Need OR
    probResourceKeep-r14          ENUMERATED {v0, v0dot2, v0dot4, v0dot6, v0dot8,
                                                spare3, spare2, spare1},
    p2x-SensingConfig-r14         SEQUENCE {
        minNumCandidateSF-r14     INTEGER (1..13),
        gapCandidateSensing-r14   BIT STRING (SIZE (10))
    }
    OPTIONAL, -- Need OR
    sl-ReselectAfter-r14         ENUMERATED {n1, n2, n3, n4, n5, n6, n7, n8, n9,
                                                spare7, spare6, spare5, spare4, spare3, spare2,
                                                spare1}
    OPTIONAL -- Need OR
}
-- ASN1STOP

```

<b>SL-CommTxPoolSensingConfig field descriptions</b>
<b>gapCandidateSensing</b> Indicates which subframe should be sensed when a certain subframe is considered as a candidate resource (see TS 36.213 [23]).
<b>minNumCandidateSF</b> Indicates the minimum number of subframes that are included in the possible candidate resources.
<b>p2x-SensingConfig</b> Indicates the sensing configuration for P2X related V2X sidelink communication transmission only.
<b>probResourceKeep</b> Indicates the probability with which the UE keeps the current resource when the resource reselection counter reaches zero for sensing based UE autonomous resource selection (see TS 36.321 [6]).
<b>pssch-TxConfigList</b> Indicates PSSCH TX parameters such as MCS, PRB number, retransmission number, associated to different UE absolute speeds and different synchronization reference types for UE autonomous resource selection (see TS 36.213 [23]).
<b>restrictResourceReservationPeriod</b> Indicates which values are allowed for the signaling of the resource reservation period in PSCCH.
<b>sl-ReselectAfter</b> Indicates the number of consecutive skipped transmissions before triggering resource reselection for V2X sidelink communication (see TS 36.321 [6]).
<b>thresPSSCH-RSRP-List</b> Indicates a list of 64 thresholds, and the threshold should be selected based on the priority in the decoded SCI and the priority in the SCI to be transmitted (see TS 36.213 [23]). A resource is excluded if it is indicated or reserved by a decoded SCI and PSSCH RSRP in the associated data resource is above a threshold.

## – SL-CP-Len

The IE *SL-CP-Len* indicates the cyclic prefix length, see TS 36.211 [21].

### SL-CP-Len information element

```
-- ASN1START
SL-CP-Len-r12 ::=          ENUMERATED {normal, extended}
-- ASN1STOP
```

## – SL-DiscConfig

The IE *SL-DiscConfig* specifies the dedicated configuration information for sidelink discovery.

### SL-DiscConfig information element

```
-- ASN1START
SL-DiscConfig-r12 ::=          SEQUENCE {
    discTxResources-r12          CHOICE {
        release                  NULL,
        setup                    CHOICE {
            scheduled-r12       SEQUENCE {
                discTxConfig-r12 SL-DiscResourcePool-r12 OPTIONAL, -- Need ON
                discTF-IndexList-r12 SL-TF-IndexPairList-r12 OPTIONAL, -- Need ON
                discHoppingConfig-r12 SL-HoppingConfigDisc-r12
                                   OPTIONAL -- Need ON
            },
            ue-Selected-r12      SEQUENCE {
                discTxPoolDedicated-r12 SEQUENCE {
                    poolToReleaseList-r12 SL-TxPoolToReleaseList-r12 OPTIONAL, -- Need
ON
                    poolToAddModList-r12 SL-DiscTxPoolToAddModList-r12 OPTIONAL -- Need
ON
                }
            }
        }
    }
    ...
    [[ discTF-IndexList-v1260     CHOICE {
        release                  NULL,
```

```

        setup
        discTF-IndexList-r12b          SEQUENCE {
            SL-TF-IndexPairList-r12b
        }
    },
    ],
    [[ discTxResourcesPS-r13          CHOICE {
        release                        NULL,
        setup                          CHOICE {
            scheduled-r13             SL-DiscTxConfigScheduled-r13,
            ue-Selected-r13          SEQUENCE {
                discTxPoolPS-Dedicated-r13    SL-DiscTxPoolDedicated-r13
            }
        }
    }
    ]],
    discTxInterFreqInfo-r13          CHOICE {
        release                        NULL,
        setup                          SEQUENCE {
            discTxCarrierFreq-r13      ARFCN-ValueEUTRA-r9          OPTIONAL, -- Need
OR
            discTxRefCarrierDedicated-r13    SL-DiscTxRefCarrierDedicated-r13    OPTIONAL, --
Need OR
            discTxInfoInterFreqListAdd-r13    SL-DiscTxInfoInterFreqListAdd-r13    OPTIONAL
        }
    }
    ],
    gapRequestsAllowedDedicated-r13    BOOLEAN          OPTIONAL, -- Need ON
    discRxGapConfig-r13                CHOICE {
        release                        NULL,
        setup                          SL-GapConfig-r13
    }
    ],
    discTxGapConfig-r13                CHOICE {
        release                        NULL,
        setup                          SL-GapConfig-r13
    }
    ],
    discSysInfoToReportConfig-r13      CHOICE {
        release                        NULL,
        setup                          SL-DiscSysInfoToReportFreqList-r13
    }
    ],
    ]],
}

SL-DiscSysInfoToReportFreqList-r13 ::= SEQUENCE (SIZE (1..maxFreq)) OF ARFCN-ValueEUTRA-r9

SL-DiscTxInfoInterFreqListAdd-r13 ::= SEQUENCE {
    discTxFreqToAddModList-r13        SEQUENCE (SIZE (1..maxFreq)) OF SL-
DiscTxResourceInfoPerFreq-r13    OPTIONAL, -- Need ON
    discTxFreqToReleaseList-r13      SEQUENCE (SIZE (1..maxFreq)) OF ARFCN-ValueEUTRA-r9
    OPTIONAL, -- Need ON
    ...
}

SL-DiscTxResourceInfoPerFreq-r13 ::= SEQUENCE {
    discTxCarrierFreq-r13            ARFCN-ValueEUTRA-r9,
    discTxResources-r13              SL-DiscTxResource-r13    OPTIONAL, -- Need OR
    discTxResourcesPS-r13            SL-DiscTxResource-r13    OPTIONAL, -- Need OR
    discTxRefCarrierDedicated-r13    SL-DiscTxRefCarrierDedicated-r13    OPTIONAL, -- Need
OR
    discCellSelectionInfo-r13        CellSelectionInfoNFreq-r13    OPTIONAL, --
Need OR
    ...
}

SL-DiscTxResource-r13 ::= CHOICE {
    release                        NULL,
    setup                          CHOICE {
        scheduled-r13             SL-DiscTxConfigScheduled-r13,
        ue-Selected-r13          SL-DiscTxPoolDedicated-r13
    }
}

SL-DiscTxPoolToAddModList-r12 ::= SEQUENCE (SIZE (1..maxSL-TxPool-r12)) OF SL-
DiscTxPoolToAddMod-r12

SL-DiscTxPoolToAddMod-r12 ::= SEQUENCE {
    poolIdentity-r12                SL-TxPoolIdentity-r12,
    pool-r12                         SL-DiscResourcePool-r12
}

```

```

SL-DiscTxConfigScheduled-r13 ::= SEQUENCE {
    discTxConfig-r13          SL-DiscResourcePool-r12 OPTIONAL, -- Need ON
    discTF-IndexList-r13     SL-TF-IndexPairList-r12b  OPTIONAL, -- Need ON
    discHoppingConfig-r13    SL-HoppingConfigDisc-r12   OPTIONAL, -- Need ON
    ...
}

SL-DiscTxPoolDedicated-r13 ::= SEQUENCE {
    poolToReleaseList-r13    SL-TxPoolToReleaseList-r12 OPTIONAL, -- Need ON
    poolToAddModList-r13    SL-DiscTxPoolToAddModList-r12 OPTIONAL -- Need ON
}

SL-TF-IndexPairList-r12 ::= SEQUENCE (SIZE (1..maxSL-TF-IndexPair-r12)) OF SL-TF-IndexPair-r12

SL-TF-IndexPair-r12 ::= SEQUENCE {
    discSF-Index-r12        INTEGER (1.. 200)          OPTIONAL, -- Need ON
    discPRB-Index-r12       INTEGER (1.. 50)           OPTIONAL  -- Need ON
}

SL-TF-IndexPairList-r12b ::= SEQUENCE (SIZE (1..maxSL-TF-IndexPair-r12)) OF SL-TF-IndexPair-r12b

SL-TF-IndexPair-r12b ::= SEQUENCE {
    discSF-Index-r12b       INTEGER (0..209)          OPTIONAL, -- Need ON
    discPRB-Index-r12b     INTEGER (0..49)           OPTIONAL  -- Need ON
}

SL-DiscTxRefCarrierDedicated-r13 ::= CHOICE {
    pCell                    NULL,
    sCell                    SCellIndex-r10
}
-- ASN1STOP

```

### SL-DiscConfig field descriptions

#### **discCellSelectionInfo**

Parameters that may be used by the UE to select/ reselect a cell on the concerned non serving frequency. If absent, the UE acquires the information from the target cell on the concerned frequency. See TS 36.304 [4], clause 11.4.

#### **discSysInfoToReportConfig**

Indicates the request to start a *SidelinkUEInformation* procedure for reporting system information acquired during an inter-frequency discovery procedure.

#### **discTF-IndexList**

Indicates a list of time-frequency resource indices pair where each pair of indices corresponds to one discovery message. E-UTRAN only configures *discTF-IndexList-r12b* when configuring the UE with scheduled SL discovery Tx resources. When receiving *discTF-IndexList-r12b*, the UE shall only consider this field (and hence ignore *discTF-IndexList-r12*, if included or previously configured).

#### **discTxConfig**

Indicates the resources configuration used when E-UTRAN schedules Tx resources (i.e. the fields *discSF-Index* and *discPRB-Index* indicate the actual resources to be used).

#### **discTxInterFreqInfo**

Indicates frequency applicable for the resources indicated by *discTxResources-r12* (i.e. original resource field may cover first inter-frequency), and possibly resource allocations on additional frequencies as may be indicated by field *discTxInfoInterFreqListAdd*.

#### **discTxRefCarrierDedicated**

Indicates if the PCell or an SCell is to be used as reference for DL measurements and synchronization, instead of the DL frequency paired with the one used to transmit sidelink discovery announcements on, see TS 36.213 [23], clause 14.3.1.

#### **discTxResources**

Indicates the resources assigned to the UE for discovery announcements, which can either be a pool from which the UE may select or a set of resources specifically assigned for use by the UE.

#### **discTxResourcesPS**

Indicates the resources assigned to the UE for PS discovery announcements, which can either be a pool from which the UE may select or a set of resources specifically assigned for use by the UE.

#### **SL-TF-IndexPair**

A pair of indices, one for the time domain and one for the frequency domain, indicating the start of resources within the pool covered by *discTxConfig*, see TS 36.211 [21], clause 9.5.6 for one discovery message. The upper limits of *discSF-Index* and *discPRB-Index* are defined in TS 36.213 [23], clause 14.3.1.

## – *SL-DiscResourcePool*

The IE *SL-DiscResourcePool* specifies the configuration information for an individual pool of resources for sidelink discovery.

### *SL-DiscResourcePool* information element

```

-- ASN1START
SL-DiscTxPoolList-r12 ::= SEQUENCE (SIZE (1..maxSL-TxPool-r12)) OF SL-DiscResourcePool-r12
SL-DiscRxPoolList-r12 ::= SEQUENCE (SIZE (1..maxSL-RxPool-r12)) OF SL-DiscResourcePool-r12
SL-DiscResourcePool-r12 ::= SEQUENCE {
  cp-Len-r12 SL-CP-Len-r12,
  discPeriod-r12 ENUMERATED {rf32, rf64, rf128,
    rf256, rf512, rf1024, rf16-v1310, spare},
  numRetx-r12 INTEGER (0..3),
  numRepetition-r12 INTEGER (1..50),
  tf-ResourceConfig-r12 SL-TF-ResourceConfig-r12,
  txParameters-r12 SEQUENCE {
    txParametersGeneral-r12 SL-TxParameters-r12,
    ue-SelectedResourceConfig-r12 SEQUENCE {
      poolSelection-r12 CHOICE {
        rsrpBased-r12 SL-PoolSelectionConfig-r12,
        random-r12 NULL
      },
      txProbability-r12 ENUMERATED {p25, p50, p75, p100}
    }
  }
  OPTIONAL -- Need OR
  OPTIONAL, -- Cond Tx
  rxParameters-r12 SEQUENCE {
    tdd-Config-r12 TDD-Config OPTIONAL, -- Need OR
    syncConfigIndex-r12 INTEGER (0..15) OPTIONAL, -- Need OR
    ...,
    [[ discPeriod-v1310 CHOICE {
      release NULL,
      setup ENUMERATED {rf4, rf6, rf7, rf8,
        rf12, rf14, rf24, rf28}
    }
    rxParamsAddNeighFreq-r13 CHOICE {
      release NULL,
      setup SEQUENCE {
        physCellId-r13 PhysCellIdList-r13
      }
    }
    OPTIONAL, -- Need ON
    txParamsAddNeighFreq-r13 CHOICE {
      release NULL,
      setup SEQUENCE {
        physCellId-r13 PhysCellIdList-r13,
        p-Max P-Max OPTIONAL, -- Need OP
        tdd-Config-r13 TDD-Config OPTIONAL, -- Cond TDD-OR
        tdd-Config-v1130 TDD-Config-v1130 OPTIONAL, -- Cond TDD-OR
        freqInfo SEQUENCE {
          ul-CarrierFreq ARFCN-ValueEUTRA OPTIONAL, -- Need OP
          ul-Bandwidth ENUMERATED {n6, n15, n25, n50, n75, n100}
            OPTIONAL, -- Need OP
        }
        additionalSpectrumEmission AdditionalSpectrumEmission
      },
      referenceSignalPower INTEGER (-60..50),
      syncConfigIndex-r13 INTEGER (0..15) OPTIONAL -- Need OR
    }
  }
  OPTIONAL -- Need ON
  ]],
  [[ txParamsAddNeighFreq-v1370 CHOICE {
    release NULL,
    setup SEQUENCE {
      freqInfo-v1370 SEQUENCE {
        additionalSpectrumEmission-v1370 AdditionalSpectrumEmission-v1010
      }
    }
  }
  OPTIONAL -- Need ON
  ]]
}
PhysCellIdList-r13 ::= SEQUENCE (SIZE (1.. maxSL-DiscCells-r13)) OF PhysCellId

```

```

SL-PoolSelectionConfig-r12 ::= SEQUENCE {
    threshLow-r12          RSRP-RangeSL2-r12,
    threshHigh-r12         RSRP-RangeSL2-r12
}
-- ASN1STOP

```

### SL-DiscResourcePool field descriptions

<b>discPeriod</b>	Indicates the period over which resources are allocated in a cell for discovery message transmission/reception, see PSDCH period in TS 36.213 [23]. Value in number of radio frames. Value rf32 corresponds to 32 radio frames, rf64 corresponds to 64 radio frames and so on. The extended values apply for PS discovery (not only for sidelink relaying). When broadcasting an extended value, E-UTRAN sets the original field to spare to ensure legacy UEs ignore the concerned pool entry.
<b>numRepetition</b>	Indicates the number of times <i>subframeBitmap</i> is repeated for mapping to subframes that occurs within a <i>discPeriod</i> . The highest value E-UTRAN uses is value 5 for FDD and TDD configuration 0, value 13 for TDD configuration 1, value 25 for TDD configuration 2, value 17 for TDD configuration 3, value 25 for TDD configuration 4, value 50 for TDD configuration 5 and value 7 for TDD configuration 6. E-UTRAN configures <i>numRepetition</i> and <i>subframeBitmap</i> such that the mapped subframes do not exceed the <i>discPeriod</i> .
<b>poolSelection</b>	Indicates the mechanism for selecting a (transmission) pool when multiple candidates are provided. E-UTRAN configures the same value (i.e. a pool selection method) for all candidate pools within one pool list ( <i>discTxPoolCommon</i> or <i>discTxPoolDedicated</i> ) but the pool selection method in different pool lists may or may not be the same.
<b>syncConfigIndex</b>	Indicates the synchronisation configuration that is associated with a reception or transmission pool, by means of an index to the corresponding entry of <i>discSyncConfig</i> in <i>SystemInformationBlockType19</i> .
<b>threshLow, threshHigh</b>	Specifies the thresholds used to select a resource pool in RSRP based pool selection. The E-UTRAN should configure <i>threshLow</i> and <i>threshHigh</i> such that the UE selects only one resource pool upon RSRP based pool selection.
<b>txProbability</b>	Indicates the probability of transmitting announcement in a discovery period when configured with a pool of resources, see TS 36.321 [6].

Conditional presence	Explanation
TDD-OR	The field is optional present for TDD, need OR; it is not present for FDD.
Tx	The field is mandatory present when included in <i>discTxPoolDedicated</i> or <i>discTxPoolCommon</i> . Otherwise the field is not present.

### SL-DiscSysInfoReport

The IE *SL-DiscSysInfoReport* contains the parameters related to sidelink discovery acquired from system information of inter-frequency cells (including inter-PLMN).

### SL-DiscSysInfoReport information element

```

-- ASN1START
SL-DiscSysInfoReport-r13 ::= SEQUENCE {
    plmn-IdentityList-r13    PLMN-IdentityList          OPTIONAL,
    cellIdentity-13         CellIdentity            OPTIONAL,
    carrierFreqInfo-13      ARFCN-ValueEUTRA-r9      OPTIONAL,
    discRxResources-r13     SL-DiscRxPoolList-r12      OPTIONAL,
    discTxPoolCommon-r13    SL-DiscTxPoolList-r12    OPTIONAL,
    discTxPowerInfo-r13     SL-DiscTxPowerInfoList-r12  OPTIONAL,
    discSyncConfig-r13      SL-SyncConfigNFreq-r13    OPTIONAL,
    discCellSelectionInfo-r13 SEQUENCE {
        q-RxLevMin-r13      Q-RxLevMin,
        q-RxLevMinOffset-r13 INTEGER (1..8)          OPTIONAL
    }
    cellReselectionInfo-r13 SEQUENCE {
        q-Hyst-r13          ENUMERATED {
            dB0, dB1, dB2, dB3, dB4, dB5, dB6, dB8, dB10,
            dB12, dB14, dB16, dB18, dB20, dB22, dB24},
        q-RxLevMin-r13      Q-RxLevMin,

```



```

    t-ReselectionEUTRA-r13          T-Reselection
  }                                OPTIONAL,
  tdd-Config-r13                   TDD-Config          OPTIONAL,
  freqInfo-r13                     SEQUENCE {
    ul-CarrierFreq-r13             ARFCN-ValueEUTRA    OPTIONAL,
    ul-Bandwidth-r13              ENUMERATED {n6, n15, n25, n50, n75, n100}
    additionalSpectrumEmission-r13 AdditionalSpectrumEmission OPTIONAL,
  }                                OPTIONAL,
  p-Max-r13                        P-Max            OPTIONAL,
  referenceSignalPower-r13         INTEGER (-60..50)  OPTIONAL,
  ...
  [[
  freqInfo-v1370                   SEQUENCE {
    additionalSpectrumEmission-v1370 AdditionalSpectrumEmission-v1010
  }                                OPTIONAL
  ]]
}
-- ASN1STOP

```

#### **SL-DiscSysInfoReport field descriptions**

##### **carrierFreqInfo**

Indicates the frequency of the cell from which the UE acquired the system information relevant for discovery

##### **cellIdentity**

Indicated the identity of the cell from which the UE acquired the system information relevant for discovery

##### **plmn-IdentityList**

Indicates the list of PLMN identity of the cell from which the UE acquired the system information relevant for discovery

#### **SL-DiscTxPowerInfo**

The IE *SL-DiscTxPowerInfo* specifies power control parameters for one or more power classes.

#### **SL-DiscTxPowerInfo information element**

```

-- ASN1START
SL-DiscTxPowerInfoList-r12 ::= SEQUENCE (SIZE (maxSL-DiscPowerClass-r12)) OF SL-DiscTxPowerInfo-r12
SL-DiscTxPowerInfo-r12 ::= SEQUENCE {
  discMaxTxPower-r12          P-Max,
  ...
}
-- ASN1STOP

```

#### **SL-DiscTxPowerInfo field descriptions**

##### **discMaxTxPower**

Indicates the P-Max parameter used to calculate the maximum transmit power a UE configured with the concerned range class, see TS 24.333 [70], clause 4.2.11. The first entry in *SL-DiscTxPowerInfoList* corresponds to UE range class 'short', the second entry corresponds to 'medium' and the third entry corresponds to 'long'.

#### **SL-GapConfig**

The IE *SL-GapConfig* indicates the gaps, requested or assigned, to enable the UE to receive or transmit sidelink discovery, intra or inter frequency (including inter-PLMN).

#### **SL-GapConfig information element**

```

-- ASN1START
SL-GapConfig-r13 ::= SEQUENCE {
  gapPatternList-r13         SL-GapPatternList-r13
}
SL-GapPatternList-r13 ::= SEQUENCE (SIZE (1..maxSL-GP-r13)) OF SL-GapPattern-r13

```

```

SL-GapPattern-r13 ::= SEQUENCE {
    gapPeriod-r13      ENUMERATED {sf40, sf60, sf70, sf80, sf120, sf140, sf160,
                                   sf240, sf280, sf320, sf640, sf1280, sf2560, sf5120,
                                   sf10240},
    gapOffset-r12     SL-OffsetIndicator-r12,
    gapSubframeBitmap-r13 BIT STRING (SIZE (1..10240)),
    ...
}
-- ASN1STOP

```

#### **SL-GapConfig field descriptions**

##### **gapOffset**

Indicates the offset from the start of SFN 0 to the start of the first *gapPeriod*. If the SFN period is not an integer multiple of *gapPeriod*, no subframes within this period (i.e. from SFN 0 to offset) are considered part of the gap.

##### **gapPeriod**

Indicates the period by which *gapSubframeBitmap* is repeated.

##### **gapSubframeBitmap**

Indicates the subframes of one or more individual gaps, not only covering the subframes of the associated discovery resources but also including e.g. re-tuning and synchronisation delays. The UE and E-UTRAN signal bit strings of valid sizes only i.e. sizes equal to or less than *gapPeriod*. Value 1 indicates that the UE is allowed to use the subframe for sidelink discovery.

## – *SL-GapRequest*

The IE *SL-GapRequest* indicates the gaps requested by the UE to receive or transmit sidelink discovery, intra or inter frequency (including inter-PLMN).

#### **SL-GapRequest information element**

```

-- ASN1START
SL-GapRequest-r13 ::= SEQUENCE (SIZE (1..maxFreq)) OF SL-GapFreqInfo-r13
SL-GapFreqInfo-r13 ::= SEQUENCE {
    carrierFreq-r13 ARFCN-ValueEUTRA-r9 OPTIONAL,
    gapPatternList-r13 SL-GapPatternList-r13
}
-- ASN1STOP

```

## – *SL-HoppingConfig*

The IE *SL-HoppingConfig* indicates the hopping configuration used for sidelink.

#### **SL-HoppingConfig information element**

```

-- ASN1START
SL-HoppingConfigComm-r12 ::= SEQUENCE {
    hoppingParameter-r12 INTEGER (0..504),
    numSubbands-r12     ENUMERATED {ns1, ns2, ns4},
    rb-Offset-r12       INTEGER (0..110)
}
SL-HoppingConfigDisc-r12 ::= SEQUENCE {
    a-r12 INTEGER (1..200),
    b-r12 INTEGER (1..10),
    c-r12 ENUMERATED {n1, n5}
}
-- ASN1STOP

```

<b>SL-HoppingConfig field descriptions</b>	
<b>a</b>	Per cell parameter: $N_{PSDCH}^{(1)}$ see TS 36.213 [23], clause 14.3.1.
<b>b</b>	Per UE parameter: $N_{PSDCH}^{(2)}$ see TS 36.213 [23], clause 14.3.1.
<b>c</b>	Per cell parameter: $N_{PSDCH}^{(3)}$ see TS 36.213 [23], clause 14.3.1.
<b>hoppingParameter</b>	Affects the hopping performed as specified in TS 36.213 [23], clauses 14.1.1.2 and 14.1.1.4. In case value 504 is received, the value used by the UE is 510.
<b>numSubbands</b>	Parameter: $N_{sb}$ see TS 36.211 [21], clause 9.3.6.
<b>rb-Offset</b>	Parameter: $N_{RB}^{HO}$ , see TS 36.211 [21], clause 9.3.6.

### – SL-InterFreqInfoListV2X

The IE *SL-InterFreqInfoListV2X* indicates synchronization and resource allocation configurations of the neighboring frequency for V2X sidelink communication.

#### SL-InterFreqInfoListV2X information element

```

-- ASN1START
SL-InterFreqInfoListV2X-r14 ::= SEQUENCE (SIZE (0..maxFreqV2X-1-r14)) OF SL-InterFreqInfoV2X-r14
SL-InterFreqInfoV2X-r14 ::= SEQUENCE {
    plmn-IdentityList-r14          PLMN-IdentityList          OPTIONAL,      -- Need OP
    v2x-CommCarrierFreq-r14       ARFCN-ValueEUTRA-r9,
    sl-MaxTxPower-r14             P-Max                  OPTIONAL,      -- Need OR
    sl-Bandwidth-r14              ENUMERATED {n6, n15, n25, n50, n75, n100} OPTIONAL,      --
Need OR
    v2x-SchedulingPool-r14        SL-CommResourcePoolV2X-r14    OPTIONAL,      -- Need
OR
    v2x-UE-ConfigList-r14        SL-V2X-UE-ConfigList-r14  OPTIONAL,      -- Need OR
    ...
    [[ additionalSpectrumEmissionV2X-r14 CHOICE {
        additionalSpectrumEmission-r14    AdditionalSpectrumEmission,
        additionalSpectrumEmission-v1440  AdditionalSpectrumEmission-v1010
    }
    OPTIONAL -- Need ON
    ]],
    [[ v2x-FreqSelectionConfigList-r15 SL-V2X-FreqSelectionConfigList-r15 OPTIONAL --Need OR
    ]]
}
-- ASN1STOP

```

<b>SL-InterFreqInfoListV2X field descriptions</b>
<p><b><i>plmn-IdentityList</i></b> Indicates PLMN identities of this frequency for reception of V2X sidelink communication. If this field is not present, the UE considers this frequency for reception of V2X sidelink communication concerns the first PLMN entry in the <i>plmn-IdentityList</i> in <i>SystemInformationBlockType1</i>.</p>
<p><b><i>sl-MaxTxPower</i></b> Indicates the maximum transmission power for transmitting V2X sidelink communication on the corresponding frequency.</p>
<p><b><i>additionalSpectrumEmissionV2X</i></b> Indicates the <i>additionalSpectrumEmission</i> value defined in TS 36.101 [42], clause 6.2.4, for V2X sidelink communication.</p>
<p><b><i>v2x-FreqSelectionConfigList</i></b> Indicates the configuration information for the carrier selection for V2X sidelink communication transmission. The configuration applies to the carrier frequency identified by <i>v2x-CommCarrierFreq</i> (i.e. carrier specific configuration).</p>
<p><b><i>v2x-SchedulingPool</i></b> Indicates the resource pool for inter-carrier scheduled resource allocation. This field is configured in RRC dedicated signalling only when <i>scheduled</i> is configured in IE <i>SL-V2X-ConfigDedicated</i>.</p>
<p><b><i>v2x-UE-ConfigList</i></b> Indicates the inter-carrier resource configuration. If there is only one entry in the list without <i>physCellId</i> configured, the configuration is applied to the frequency identified by <i>v2x-CommCarrierFreq</i> (i.e. carrier specific configuration); if the entry of this field includes <i>physCellIdList</i>, the configuration is applied to the cell(s) identified by <i>physCellIdList</i> (i.e. cell specific configuration).</p>

### – *SL-NR-AnchorCarrierFreqList*

The IE *SL-NR-AnchorCarrierFreqList* specifies the NR anchor frequencies i.e. frequencies that include inter-carrier resource configuration for V2X sidelink communication.

#### ***SL-NR-AnchorCarrierFreqList* information element**

```
-- ASN1START
SL-NR-AnchorCarrierFreqList-r16 ::= SEQUENCE (SIZE (1..maxFreqSL-NR-r16)) OF ARFCN-ValueNR-r15
-- ASN1STOP
```

### – *SL-V2X-UE-ConfigList*

The IE *SL-V2X-UE-ConfigList* indicates inter-frequency resource configuration per-carrier or per-cell.

#### ***SL-V2X-UE-ConfigList* information element**

```
-- ASN1START
SL-V2X-UE-ConfigList-r14 ::= SEQUENCE (SIZE (1.. maxCellIntra)) OF SL-V2X-InterFreqUE-Config-r14
SL-V2X-InterFreqUE-Config-r14 ::= SEQUENCE {
  physCellIdList-r14 PhysCellIdList-r13 OPTIONAL, -- Need OR
  typeTxSync-r14 SL-TypeTxSync-r14 OPTIONAL, -- Need OR
  v2x-SyncConfig-r14 SL-SyncConfigListNFreqV2X-r14 OPTIONAL, -- Need OR
  v2x-CommRxPool-r14 SL-CommRxPoolListV2X-r14 OPTIONAL, -- Need
OR
  v2x-CommTxPoolNormal-r14 SL-CommTxPoolListV2X-r14 OPTIONAL, --
Need OR
  p2x-CommTxPoolNormal-r14 SL-CommTxPoolListV2X-r14 OPTIONAL, --
Need OR
  v2x-CommTxPoolExceptional-r14 SL-CommResourcePoolV2X-r14 OPTIONAL, -- Need OR
  v2x-ResourceSelectionConfig-r14 SL-CommTxPoolSensingConfig-r14 OPTIONAL, -- Need OR
  zoneConfig-r14 SL-ZoneConfig-r14 OPTIONAL, -- Need OR
  offsetDFN-r14 INTEGER (0..1000) OPTIONAL, -- Need OR
  ...
}
-- ASN1STOP
```

<b>SL-V2X-UE-ConfigList</b> field descriptions
<p><b>offsetDFN</b> Indicates the timing offset for the UE to determine DFN timing when GNSS is used for timing reference. Value 0 corresponds to 0 milliseconds, value 1 corresponds to 0.001 milliseconds, value 2 corresponds to 0.002 milliseconds, and so on.</p>
<p><b>p2x-CommTxPoolNormal</b> Indicates the resources on a carrier frequency by which the UE may transmit P2X related V2X sidelink communication.</p>
<p><b>physCellIdList</b> If configured, the resource configuration is applicable for the cell(s) identified by this field. Otherwise, the resource configuration is for a given carrier frequency.</p>
<p><b>typeTxSync</b> Indicates the prioritized synchronization type (i.e. eNB or GNSS) for performing V2X sidelink communication on a carrier frequency.</p>
<p><b>v2x-CommRxPool</b> Indicates the resources on a carrier frequency by which the UE may receive V2X sidelink communication. This field is absent within <i>v2x-InterFreqInfoList</i> included in <i>RRCConnectionReconfiguration</i> except if received with <i>MobilityControlInfo</i> or <i>MobilityControlInfoV2X</i>.</p>
<p><b>v2x-CommTxPoolExceptional</b> Indicates the resources on a carrier frequency by which the UE may transmit V2X sidelink communication in exceptional conditions, as specified in 5.10.13.</p>
<p><b>v2x-CommTxPoolNormal</b> Indicates the resources on a carrier frequency by which the UE may transmit V2X sidelink communication.</p>
<p><b>v2x-SyncConfig</b> Indicates the synchronization configuration used for transmission/reception of SLSS on the given frequency.</p>

### – SL-OffsetIndicator

The IE *SL-OffsetIndicator* indicates the offset of the pool of resources relative to SFN 0 of the cell from which it was obtained or, when out of coverage, relative to DFN 0.

#### SL-OffsetIndicator information element

```

-- ASN1START
SL-OffsetIndicator-r12 ::=          CHOICE {
    small-r12                INTEGER (0..319),
    large-r12                 INTEGER (0..10239)
}
SL-OffsetIndicatorSync-r12 ::=    INTEGER (0..39)
SL-OffsetIndicatorSync-v1430 ::=  INTEGER (40..159)
SL-OffsetIndicatorSync-r14 ::=    INTEGER (0..159)
-- ASN1STOP

```

<b>SL-OffsetIndicator</b> field descriptions
<p><b>SL-OffsetIndicator</b> In <i>sc-TF-ResourceConfig</i>, it indicates the offset of the first period of pool of resources within a SFN cycle. For <i>data-TF-ResourceConfig</i>, it corresponds to the <i>offsetIndicator</i> as defined in TS 36.213 [23], clause 14.1.3.</p>
<p><b>SL-OffsetIndicatorSync</b> For sidelink discovery and sidelink communication, synchronisation resources are present in those SFN and subframes which satisfy the relation: <math>(SFN * 10 + \text{Subframe Number}) \bmod 40 = SL\text{-OffsetIndicatorSync}</math>. For V2X sidelink communication, synchronisation resources are present in those SFN and subframes which satisfy the relation: <math>(SFN * 10 + \text{Subframe Number}) \bmod 160 = SL\text{-OffsetIndicatorSync}</math>.</p>

## – *SL-P2X-ResourceSelectionConfig*

The IE *SL-P2X-ResourceSelectionConfig* includes the configuration of resource selection for P2X related V2X sidelink communication. E-UTRAN configures at least one resource selection mechanism.

### **SL-P2X-ResourceSelectionConfig information element**

```
-- ASN1START
SL-P2X-ResourceSelectionConfig-r14 ::= SEQUENCE {
    partialSensing-r14      ENUMERATED {true}      OPTIONAL, -- Need OR
    randomSelection-r14    ENUMERATED {true}      OPTIONAL  -- Need OR
}
-- ASN1STOP
```

#### **SL-P2X-ResourceSelectionConfig field descriptions**

##### ***partialSensing***

Indicates that partial sensing is allowed for UE autonomous resource selection in a resource pool.

##### ***randomSelection***

Indicates that random selection is allowed for UE autonomous resource selection in a resource pool.

## – *SL-PeriodComm*

The IE *SL-PeriodComm* indicates the period over which resources allocated in a cell for sidelink communication.

### **SL-PeriodComm information element**

```
-- ASN1START
SL-PeriodComm-r12 ::= ENUMERATED {sf40, sf60, sf70, sf80, sf120, sf140,
    sf160, sf240, sf280, sf320, spare6, spare5,
    spare4, spare3, spare2, spare}
-- ASN1STOP
```

## – *SL-Priority*

The IE *SL-Priority* indicates the one or more priorities of resource pool used for sidelink communication, or of a logical channel group used in case of scheduled sidelink communication resources, see TS 36.321 [6].

### **SL-Priority information element**

```
-- ASN1START
SL-PriorityList-r13 ::= SEQUENCE (SIZE (1..maxSL-Prio-r13)) OF SL-Priority-r13
SL-Priority-r13 ::= INTEGER (1..8)
-- ASN1STOP
```

## – *SL-PSSCH-TxConfigList*

The IE *SL-PSSCH-TxConfigList* indicates PSSCH transmission parameters. When lower layers select parameters from the range indicated in IE *SL-PSSCH-TxConfigList*, the UE considers both configurations in IE *SL-PSSCH-TxConfigList* and the CBR-dependent configurations represented in IE *SL-CBR-PPPP-TxConfigList*. Only one IE *SL-PSSCH-TxConfig* is provided per *typeTxSync*.

### **SL-PSSCH-TxConfigList information element**

```
-- ASN1START
SL-PSSCH-TxConfigList-r14 ::= SEQUENCE (SIZE (1..maxPSSCH-TxConfig-r14)) OF SL-PSSCH-TxConfig-r14
```

```

SL-PSSCH-TxConfig-r14 ::= SEQUENCE {
    typeTxSync-r14          SL-TypeTxSync-r14          OPTIONAL, -- Need OR
    thresUE-Speed-r14      ENUMERATED {kmph60, kmph80, kmph100, kmph120,
    kmph140, kmph160, kmph180, kmph200},
    parametersAboveThres-r14 SL-PSSCH-TxParameters-r14,
    parametersBelowThres-r14 SL-PSSCH-TxParameters-r14,
    ...,
    [[ parametersAboveThres-v1530 SL-PSSCH-TxParameters-v1530 OPTIONAL, -- Need OR
      parametersBelowThres-v1530 SL-PSSCH-TxParameters-v1530 OPTIONAL -- Need OR
    ]]
}

SL-PSSCH-TxParameters-r14 ::= SEQUENCE {
    minMCS-PSSCH-r14      INTEGER (0..31),
    maxMCS-PSSCH-r14      INTEGER (0..31),
    minSubchannel-NumberPSSCH-r14 INTEGER (1..20),
    maxSubchannel-NumberPSSCH-r14 INTEGER (1..20),
    allowedRetxNumberPSSCH-r14 ENUMERATED {n0, n1, both, spare1},
    maxTxPower-r14        SL-TxPower-r14              OPTIONAL -- Cond CBR
}

SL-PSSCH-TxParameters-v1530 ::= SEQUENCE {
    minMCS-PSSCH-r15      INTEGER (0..31),
    maxMCS-PSSCH-r15      INTEGER (0..31)
}

-- ASN1STOP

```

#### ***SL-PSSCH-TxConfigList* field descriptions**

<b><i>allowedRetxNumberPSSCH</i></b>	Indicates the allowed retransmission number for transmissions on PSSCH (see TS 36.213 [23]). The value n0 indicates no retransmission for a transport block allowed; the value n1 indicates that the UE shall perform one retransmission for a transport block; and the value both indicates that the UE may autonomously select no retransmission or one retransmission for a transport block.
<b><i>maxTxPower</i></b>	Indicates the maximum transmission power for transmission on PSSCH and PSCCH (see TS 36.213 [23]).
<b><i>minMCS-PSSCH, maxMCS-PSSCH</i></b>	Indicates the minimum and maximum MCS values used for transmissions on PSSCH (see TS 36.213 [23]). If included, <i>minMCS-PSSCH-r14</i> and <i>maxMCS-PSSCH-r14</i> correspond to the MCS table in Table 8.6.1-1 with 64QAM indices overridden by 16QAM used for transmission on PSSCH. If included, <i>minMCS-PSSCH-r15</i> and <i>maxMCS-PSSCH-r15</i> correspond to both the MCS table in Table 8.6.1-1 and Table 14.1.1-2 in TS 36.213 [23] used for transmission on PSSCH.
<b><i>minSubchannel-NumberPSSCH, maxSubchannel-NumberPSSCH</i></b>	Indicates the minimum and maximum number of sub-channels which may be used for transmissions on PSSCH (see TS 36.213 [23]).
<b><i>thresUE-Speed</i></b>	Indicates a UE speed threshold.
<b><i>typeTxSync</i></b>	Indicates the synchronization reference type (see TS 36.213 [23]). For configurations by the eNB, only <i>gnss</i> and <i>enb</i> can be configured; and for pre-configuration, only <i>gnss</i> and <i>ue</i> can be configured. If the field is absent, the configuration is applicable for all synchronization reference types.
<b><i>parametersAboveThres</i></b>	Indicates TX parameters for the UE speed above <i>thresUE-Speed</i> .
<b><i>parametersBelowThres</i></b>	Indicates TX parameters for the UE speed below <i>thresUE-Speed</i> .

Conditional presence	Explanation
CBR	The field is optionally present, need OR, in IE <i>SL-CBR-CommonTxConfigList-r14</i> , or in IE <i>SL-CBR-PreconfigTxConfigList-r14</i> . Otherwise the field is not present. Need OR.

#### ***SL-Reliability***

The IE *SL-Reliability* indicates one or more reliabilities of a logical channel group used in case of scheduled sidelink communication resources or traffic reliability(ies) associated with the reported traffic pattern for V2X sidelink communication; see TS 36.321 [6].

**SL-Reliability information element**

```

-- ASN1START
SL-ReliabilityList-r15 ::=      SEQUENCE (SIZE (1..maxSL-Reliability-r15)) OF SL-Reliability-r15
SL-Reliability-r15 ::=          INTEGER (1..8)
-- ASN1STOP

```

**SL-RestrictResourceReservationPeriodList**

The IE *SL-RestrictResourceReservationPeriodList* indicates which values are allowed for the signaling of the resource reservation period in PSCCH for V2X sidelink communication, see TS 36.321 [6].

**SL-RestrictResourceReservationPeriodList information element**

```

-- ASN1START
SL-RestrictResourceReservationPeriodList-r14 ::= SEQUENCE (SIZE (1..maxReservationPeriod-r14)) OF
SL-RestrictResourceReservationPeriod-r14
SL-RestrictResourceReservationPeriod-r14 ::=      ENUMERATED {v0dot2, v0dot5, v1, v2, v3, v4, v5,
v6, v7, v8, v9, v10, spare4, spare3, spare2, spare1}
-- ASN1STOP

```

**SL-RestrictResourceReservationPeriodList field descriptions****SL-RestrictResourceReservationPeriod**

Value *v0dot2* means *SL-RestrictResourceReservationPeriod* is set to 0.2, value *v0dot5* means *SL-RestrictResourceReservationPeriod* is set to 0.5, value *v1* means *SL-RestrictResourceReservationPeriod* is set to 1, and so on. Value *v0dot2* and value *v0dot5* are configured in a pool-specific manner only. E-UTRAN should not set value *v0dot2* and *v0dot5* for transmission pool for P2X related V2X sidelink communication.

**SLSSID**

The IE *SLSSID* identifies a cell and is used by the receiving UE to detect asynchronous neighbouring cells, and by transmitting UEs to extend the synchronisation signals beyond the cell's coverage area.

**SLSSID information element**

```

-- ASN1START
SLSSID-r12 ::=      INTEGER (0..167)
-- ASN1STOP

```

**SL-SyncAllowed**

The IE *SL-SyncAllowed* indicates the allowed the synchronization references for a transmission resource pool for V2X sidelink communication.

**SL-SyncAllowed information element**

```

-- ASN1START
SL-SyncAllowed-r14 ::= SEQUENCE {
  gnss-Sync-r14      ENUMERATED {true}      OPTIONAL, -- Need OR
  enb-Sync-r14       ENUMERATED {true}      OPTIONAL, -- Need OR
  ue-Sync-r14        ENUMERATED {true}      OPTIONAL, -- Need OR
}
-- ASN1STOP

```



<b>SL-SyncAllowed field descriptions</b>
<p><b>enb-Sync</b> If configured, the (pre-) configured resources can be used if the UE is directly or indirectly synchronized to eNB (i.e., synchronized to a reference UE which is directly synchronized to eNB).</p>
<p><b>gnss-Sync</b> If configured, the (pre-) configured resources can be used if the UE is directly or indirectly synchronized to GNSS (i.e. synchronized to a reference UE which is directly synchronized to GNSS).</p>
<p><b>ue-Sync</b> If configured, the (pre-) configured resources can be used if the UE is synchronized to a reference UE which is synchronized to neither GNSS nor eNB directly or indirectly.</p>

## – SL-SyncConfig

The IE *SL-SyncConfig* specifies the configuration information concerning reception of synchronisation signals from neighbouring cells as well as concerning the transmission of synchronisation signals for sidelink communication and sidelink discovery.

### SL-SyncConfig information element

```

-- ASN1START
SL-SyncConfigList-r12 ::= SEQUENCE (SIZE (1..maxSL-SyncConfig-r12)) OF SL-SyncConfig-r12
SL-SyncConfigListV2X-r14 ::= SEQUENCE (SIZE (1.. maxSL-V2X-SyncConfig-r14)) OF SL-SyncConfig-r12
SL-SyncConfig-r12 ::= SEQUENCE {
    syncCP-Len-r12 SL-CP-Len-r12,
    syncOffsetIndicator-r12 SL-OffsetIndicatorSync-r12,
    slssid-r12 SLSSID-r12,
    txParameters-r12 SEQUENCE {
        syncTxParameters-r12 SL-TxParameters-r12,
        syncTxThreshIC-r12 RSRP-RangeSL-r12,
        syncInfoReserved-r12 BIT STRING (SIZE (19)) OPTIONAL -- Need OR
    } OPTIONAL, -- Need OR
    rxParamsNCell-r12 SEQUENCE {
        physCellId-r12 PhysCellId,
        discSyncWindow-r12 ENUMERATED {w1, w2} OPTIONAL, -- Need OR
    }
    ...,
    [[ syncTxPeriodic-r13 ENUMERATED {true} OPTIONAL -- Need OR
    ]],
    [[ syncOffsetIndicator-v1430 SL-OffsetIndicatorSync-v1430 OPTIONAL, -- Need OR
    gnss-Sync-r14 ENUMERATED {true} OPTIONAL -- Need OR
    ]],
    [[ syncOffsetIndicator2-r14 SL-OffsetIndicatorSync-r14 OPTIONAL, -- Need OR
    syncOffsetIndicator3-r14 SL-OffsetIndicatorSync-r14 OPTIONAL -- Need OR
    ]],
    [[ slss-TxDisabled-r15 ENUMERATED {true} OPTIONAL -- Need OR
    ]]
}

SL-SyncConfigListNFreq-r13 ::= SEQUENCE (SIZE (1..maxSL-SyncConfig-r12)) OF SL-SyncConfigNFreq-r13
SL-SyncConfigListNFreqV2X-r14 ::= SEQUENCE (SIZE (1..maxSL-V2X-SyncConfig-r14)) OF SL-SyncConfigNFreq-r13
SL-SyncConfigNFreq-r13 ::= SEQUENCE {
    asyncParameters-r13 SEQUENCE {
        syncCP-Len-r13 SL-CP-Len-r12,
        syncOffsetIndicator-r13 SL-OffsetIndicatorSync-r12,
        slssid-r13 SLSSID-r12
    } OPTIONAL, -- Need OR
    txParameters-r13 SEQUENCE {
        syncTxParameters-r13 SL-TxParameters-r12,
        syncTxThreshIC-r13 RSRP-RangeSL-r12,
        syncInfoReserved-r13 BIT STRING (SIZE (19)) OPTIONAL, -- Need OR
        syncTxPeriodic-r13 ENUMERATED {true} OPTIONAL, -- Need OR
    }
    rxParameters-r13 SEQUENCE {
        discSyncWindow-r13 ENUMERATED {w1, w2} OPTIONAL, -- Need OR
    }
    ...,
}

```

```
[[ syncOffsetIndicator-v1430      SL-OffsetIndicatorSync-v1430  OPTIONAL,  -- Need OR
   gnss-Sync-r14                  ENUMERATED {true}            OPTIONAL  -- Need OR
]],
[[ syncOffsetIndicator2-r14       SL-OffsetIndicatorSync-r14    OPTIONAL,  -- Need OR
   syncOffsetIndicator3-r14       SL-OffsetIndicatorSync-r14    OPTIONAL  -- Need OR
]],
[[ slss-TxDisabled-r15           ENUMERATED {true}            OPTIONAL  -- Need OR
]]
}
-- ASN1STOP
```

<b>SL-SyncConfig field descriptions</b>
<p><b>discSyncWindow</b> Indicates the synchronization window over which the UE expects that SLSS or discovery resources indicated by the pool configuration (see TS 36.213 [23], clause 14.4). The value <i>w1</i> denotes 5 milliseconds. The value <i>w2</i> denotes the length corresponding to normal cyclic prefix divided by 2.</p>
<p><b>gnss-Sync</b> if configured, the synchronization configuration is used for SLSS transmission/reception when the UE is synchronized to GNSS, by using <i>slssid=0</i> and ignoring <i>slssid-r12</i> configured. If not configured, the synchronization configuration is used for SLSS transmission/reception when the UE is synchronized to eNB, by using the configured <i>slssid-r12</i>.</p>
<p><b>slss-TxDisabled</b> Value TRUE indicates that the carrier, even though equipped with synchronisation resources, cannot be used as a synchronisation carrier frequency to transmit SLSS or PSBCH. This parameter cannot be included in <i>SystemInformationBlockType21</i> or <i>SystemInformationBlockType26</i>.</p>
<p><b>syncCP-Len</b> In case of V2X sidelink communications this field is always configured to <i>normal</i>.</p>
<p><b>syncInfoReserved</b> Reserved for future use.</p>
<p><b>syncOffsetIndicator</b> E-UTRAN should ensure <i>syncOffsetIndicator</i> is set to the same value as <i>syncOffsetIndicator1</i> or <i>syncOffsetIndicator2</i> in <i>preconfigSync</i> within <i>SL-Preconfiguration</i>, if configured. If <i>syncOffsetIndicator-v1430</i> is configured, the UE shall ignore the field <i>syncOffsetIndicator-r12</i>. E-UTRAN should ensure <i>syncOffsetIndicator</i> is set to the same value as <i>syncOffsetIndicator1</i> in <i>v2x-CommPreconfigSync</i> within <i>SL-V2X-Preconfiguration</i>, if configured. E-UTRAN should ensure <i>syncOffsetIndicator2</i> is set to the same value as <i>syncOffsetIndicator2</i> in <i>v2x-CommPreconfigSync</i> within <i>SL-V2X-Preconfiguration</i>, if configured. E-UTRAN should ensure <i>syncOffsetIndicator3</i> is set to the same value as <i>syncOffsetIndicator3</i> in <i>v2x-CommPreconfigSync</i> within <i>SL-V2X-Preconfiguration</i>, if configured. E-UTRAN should ensure all values in <i>syncOffsetIndicator</i> are same across all carrier frequencies configured for UEs performing V2X sidelink communication on multiple carrier frequencies. For <i>SL-V2X-Preconfiguration</i>, all values in <i>syncOffsetIndicator</i> should be same across all carrier frequencies configured for UEs performing V2X sidelink communication on multiple carrier frequencies.</p>
<p><b>syncTxPeriodic</b> Indicates whether in each discovery period in which UE transmits discovery, the UE transmits SLSS once or periodically (i.e. every 40ms). In the latter case (periodic) the UE also transmits the <i>MasterInformationBlock-SL</i> message alongside. E-UTRAN configures this field only for synchronisation configurations applicable for PS discovery.</p>
<p><b>syncTxThreshIC</b> Indicates the threshold used while in coverage. In case the RSRP measurement of the cell chosen for transmission of sidelink communication/ discovery announcements/ V2X sidelink communication, or of the cell used as reference for DL measurements and synchronization, is below the level indicated by this field, the UE may transmit SLSS (i.e. become synchronisation reference) when performing the corresponding sidelink transmission..</p>
<p><b>txParameters</b> Includes parameters relevant only for transmission. E-UTRAN includes the field in one entry per list, as included in <i>commSyncConfig</i> or <i>discSyncConfig</i>.</p>

## – SL-TF-ResourceConfig

The IE *SL-TF-ResourceConfig* specifies a set of time/ frequency resources used for sidelink.

### SL-TF-ResourceConfig information element

```

-- ASN1START
SL-TF-ResourceConfig-r12 ::=          SEQUENCE {
    prb-Num-r12                        INTEGER (1..100),
    prb-Start-r12                      INTEGER (0..99),
    prb-End-r12                        INTEGER (0..99),
    offsetIndicator-r12                SL-OffsetIndicator-r12,
    subframeBitmap-r12                 SubframeBitmapSL-r12
}

SubframeBitmapSL-r12 ::=             CHOICE {
    bs4-r12                            BIT STRING (SIZE (4)),
    bs8-r12                            BIT STRING (SIZE (8)),
    bs12-r12                           BIT STRING (SIZE (12)),
    bs16-r12                           BIT STRING (SIZE (16)),
    bs30-r12                           BIT STRING (SIZE (30)),
    bs40-r12                           BIT STRING (SIZE (40)),
    bs42-r12                           BIT STRING (SIZE (42))
}

```

```

SubframeBitmapSL-r14 ::= CHOICE {
    bs10-r14          BIT STRING (SIZE (10)),
    bs16-r14          BIT STRING (SIZE (16)),
    bs20-r14          BIT STRING (SIZE (20)),
    bs30-r14          BIT STRING (SIZE (30)),
    bs40-r14          BIT STRING (SIZE (40)),
    bs50-r14          BIT STRING (SIZE (50)),
    bs60-r14          BIT STRING (SIZE (60)),
    bs100-r14         BIT STRING (SIZE (100))
}
-- ASN1STOP

```

#### SL-TF-ResourceConfig field descriptions

##### **prb-Start, prb-End, prb-Num**

Sidelink transmissions on a sub-frame can occur on PRB with index greater than or equal to *prb-Start* and less than *prb-Start + prb-Num*, and on PRB with index greater than *prb-End - prb-Num* and less than or equal to *prb-End*. Even for neighbouring cells, *prb-Start* and *prb-End* are relative to PRB #0 of the cell from which it was obtained. See TS 36.213 [23], clauses 14.1.3, 14.2.3 and 14.3.3.

##### **subframeBitmap**

Indicates the subframe bitmap indicating resources used for sidelink. For sidelink communication, E-UTRAN configures value *bs40* for FDD and the following values for TDD: value *bs42* for configuration0, value *bs16* for configuration1, value *bs8* for configuration2, value *bs12* for configuration3, value *bs8* for configuration4, value *bs4* for configuration5 and value *bs30* for configuration6. For V2X sidelink communication, E-UTRAN configures value *bs16*, *bs20* or *bs100* for FDD or Frame Structure Type 1 as defined in TS 36.211 [21], and the following values for TDD or Frame Structure Type 2 as defined in TS 36.211 [21]: value *bs60* for configuration0, value *bs40* for configuration1, value *bs20* for configuration2, value *bs30* for configuration3, value *bs20* for configuration4, value *bs10* for configuration5 and value *bs50* for configuration6.

#### – SL-TxPower

The IE *SL-TxPower* is used to limit the UE's sidelink transmission power on a carrier frequency. The unit is dBm. Value minusinfinity corresponds to –infinity.

#### SL-TxPower information element

```

-- ASN1START
SL-TxPower-r14 ::= CHOICE {
    minusinfinity-r14  NULL,
    txPower-r14        INTEGER (-41..31)
}
-- ASN1STOP

```

#### – SL-TypeTxSync

The IE *SL-TypeTxSync* indicates the synchronization reference type.

#### SL-TypeTxSync information element

```

-- ASN1START
SL-TypeTxSync-r14 ::= ENUMERATED {gnss, enb, ue}
-- ASN1STOP

```

#### – SL-ThresPSSCH-RSRP-List

IE *SL-ThresPSSCH-RSRP-List* indicates a threshold used for sensing based UE autonomous resource selection (see TS 36.213 [23]). A resource is excluded if it is indicated or reserved by a decoded SCI and PSSCH RSRP in the associated data resource is above the threshold defined by IE *SL-ThresPSSCH-RSRP-List*.

**SL-ThresPSSCH-RSRP-List information element**

```
-- ASN1START
SL-ThresPSSCH-RSRP-List-r14 ::= SEQUENCE (SIZE (64)) OF SL-ThresPSSCH-RSRP-r14
SL-ThresPSSCH-RSRP-r14 ::= INTEGER (0..66)
-- ASN1STOP
```

**SL-ThresPSSCH-RSRP-List field descriptions****SL-ThresPSSCH-RSRP**

Value 0 corresponds to minus infinity dBm, value 1 corresponds to -128dBm, value 2 corresponds to -126dBm, value n corresponds to  $(-128 + (n-1)*2)$  dBm and so on, value 66 corresponds to infinity dBm.

**SL-TxParameters**

The IE *SL-TxParameters* identifies a set of parameters configured for sidelink transmission, used for communication, discovery and synchronisation.

**SL-TxParameters information element**

```
-- ASN1START
SL-TxParameters-r12 ::= SEQUENCE {
    alpha-r12 Alpha-r12,
    p0-r12 P0-SL-r12
}
P0-SL-r12 ::= INTEGER (-126..31)
-- ASN1STOP
```

**SL-TxParameters field descriptions****alpha**

Parameter(s):  $\alpha_{PSSCH,1}$ ,  $\alpha_{PSSCH,2}$ ,  $\alpha_{PSSCH,3}$ ,  $\alpha_{PSSCH,4}$ ,  $\alpha_{PSCCH,1}$ ,  $\alpha_{PSCCH,2}$ ,  $\alpha_{PSDCH,1}$ ,  $\alpha_{PSSS}$  See TS 36.213 [23], clauses 14.1.1.5, 14.2.1.3, 14.3.1 and 14.4, where al0 corresponds to 0, al04 corresponds to value 0.4, al05 to 0.5, al06 to 0.6, al07 to 0.7, al08 to 0.8, al09 to 0.9 and al1 corresponds to 1. This field applies for sidelink power control.

**p0**

Parameter:  $P_{O\_PSSCH,1}$ ,  $P_{O\_PSSCH,2}$ ,  $P_{O\_PSSCH,3}$ ,  $P_{O\_PSSCH,4}$ ,  $P_{O\_PSCCH,1}$ ,  $P_{O\_PSCCH,2}$ ,  $P_{O\_PSDCH,1}$ ,  $P_{O\_PSSS}$  see TS 36.213 [23], clauses 14.1.1.5, 14.2.1.3, 14.3.1 and 14.4, unit dBm.

**SL-TxPoolIdentity**

The IE *SL-TxPoolIdentity* identifies an individual pool entry configured for sidelink transmission, used for communication and discovery.

**SL-TxPoolIdentity information element**

```
-- ASN1START
SL-TxPoolIdentity-r12 ::= INTEGER (1.. maxSL-TxPool-r12)
SL-TxPoolIdentity-v1310 ::= INTEGER (maxSL-TxPool-r12Plus1-r13.. maxSL-TxPool-r13)
SL-V2X-TxPoolIdentity-r14 ::= INTEGER (1.. maxSL-V2X-TxPool-r14)
-- ASN1STOP
```

– *SL-TxPoolToReleaseList*

The IE *SL-TxPoolToReleaseList* is used to release one or more individual pool entries used for sidelink transmission, for communication and discovery.

***SL-TxPoolToReleaseList* information element**

```
-- ASN1START
SL-TxPoolToReleaseList-r12 ::= SEQUENCE (SIZE (1..maxSL-TxPool-r12)) OF SL-TxPoolIdentity-r12
SL-TxPoolToReleaseListExt-r13 ::= SEQUENCE (SIZE (1..maxSL-TxPool-v1310)) OF SL-TxPoolIdentity-v1310
-- ASN1STOP
```

– *SL-V2X-ConfigDedicated*

The IE *SL-V2X-ConfigDedicated* specifies the dedicated configuration information for V2X sidelink communication.

***SL-V2X-ConfigDedicated* information element**

```
-- ASN1START
SL-V2X-ConfigDedicated-r14 ::= SEQUENCE {
  commTxResources-r14 CHOICE {
    release NULL,
    setup CHOICE {
      scheduled-r14 SEQUENCE {
        sl-V-RNTI-r14 C-RNTI,
        mac-MainConfig-r14 MAC-MainConfigSL-r12,
        v2x-SchedulingPool-r14 SL-CommResourcePoolV2X-r14 OPTIONAL, -- Need ON
        mcs-r14 INTEGER (0..31) OPTIONAL, -- Need OR
        logicalChGroupInfoList-r14 LogicalChGroupInfoList-r13
      },
      ue-Selected-r14 SEQUENCE {
        -- Pool for normal usage
        v2x-CommTxPoolNormalDedicated-r14 SEQUENCE {
          poolToReleaseList-r14 SL-TxPoolToReleaseListV2X-r14 OPTIONAL, -- Need ON
          poolToAddModList-r14 SL-TxPoolToAddModListV2X-r14 OPTIONAL, --
Need ON
          v2x-CommTxPoolSensingConfig-r14 SL-CommTxPoolSensingConfig-r14
OPTIONAL -- Need ON
        }
      }
    }
  },
  v2x-InterFreqInfoList-r14 SL-InterFreqInfoListV2X-r14 OPTIONAL, -- Need ON
  thresSL-TxPrioritization-r14 SL-Priority-r13 OPTIONAL, -- Need
OR
  typeTxSync-r14 SL-TypeTxSync-r14 OPTIONAL, -- Need OR
  cbr-DedicatedTxConfigList-r14 SL-CBR-CommonTxConfigList-r14 OPTIONAL, -- Need OR
  ...,
  [[ commTxResources-v1530 CHOICE {
    release NULL,
    setup CHOICE {
      scheduled-v1530 SEQUENCE {
        logicalChGroupInfoList-v1530 LogicalChGroupInfoList-v1530 OPTIONAL, --
Need OR
        mcs-r15 INTEGER (0..31) OPTIONAL -- Need OR
      },
      ue-Selected-v1530 SEQUENCE {
        v2x-FreqSelectionConfigList-r15 SL-V2X-FreqSelectionConfigList-r15 OPTIONAL --
Need OR
      }
    }
  } OPTIONAL, -- Need ON
  v2x-PacketDuplicationConfig-r15 SL-V2X-PacketDuplicationConfig-r15 OPTIONAL, -- Need OR
  syncFreqList-r15 SL-V2X-SyncFreqList-r15 OPTIONAL, -- Need OR
  slss-TxMultiFreq-r15 ENUMERATED {true} OPTIONAL -- Need OR
  ]],
  [[
    slss-TxDisabled-r15 ENUMERATED {true} OPTIONAL -- Need OR
```

```

    ]]
  }
LogicalChGroupInfoList-v1530 ::= SEQUENCE (SIZE (1..maxLCG-r13)) OF SL-ReliabilityList-r15
SL-TxPoolToAddModListV2X-r14 ::= SEQUENCE (SIZE (1.. maxSL-V2X-TxPool-r14)) OF SL-
TxPoolToAddMod-r14
SL-TxPoolToAddMod-r14 ::= SEQUENCE {
  poolIdentity-r14 SL-V2X-TxPoolIdentity-r14,
  pool-r14 SL-CommResourcePoolV2X-r14
}
SL-TxPoolToReleaseListV2X-r14 ::= SEQUENCE (SIZE (1.. maxSL-V2X-TxPool-r14)) OF SL-V2X-
TxPoolIdentity-r14
-- ASN1STOP

```

### SL-V2X-ConfigDedicated field descriptions

#### **cbr-DedicatedTxConfigList**

Indicates the dedicated list of CBR range division and the list of PSSCH TX configurations available to configure congestion control to the UE for V2X sidelink communication.

#### **logicalChGroupInfoList**

Indicates for each logical channel group the list of associated priorities and reliabilities, used as specified in TS 36.321 [6], in order of increasing logical channel group identity. If E-UTRAN includes *logicalChGroupInfoList-v1530*, it includes the same number of entries, and listed in the same order, as in *logicalChGroupInfoList-r14*, and a logical channel group identity of the same entry in *logicalChGroupInfoList-r14* and in *logicalChGroupInfo-v1530* is associated with both the priorities (as in *logicalChGroupInfoList-r14*) and reliabilities (as in *logicalChGroupInfoList-v1530*) of that entry. If *logicalChGroupInfoList-v1530* is not included, this field indicates for each logical channel group the list of associated priorities.

#### **mcs**

Indicates the MCS as defined in TS 36.213 [23], clause 14.2.1. If not configured, the selection of MCS is up to UE implementation. If included, *mcs-r14* corresponds to the MCS table in Table 8.6.1-1 with 64QAM indices overridden by 16QAM used for transmission on PSSCH. If included, *mcs-r15* corresponds to both the MCS table in Table 8.6.1-1 in TS 36.213 [23] and the MCS table supporting 64QAM in Table 14.1.1-2 in TS 36.213 [23] used for transmission on PSSCH. If this field is present, E-UTRAN shall configure both *mcs-r14* and *mcs-r15*.

#### **scheduled**

Indicates the configuration for the case E-UTRAN schedules the transmission resources based on sidelink specific BSR from the UE.

#### **sl-V-RNTI**

Indicates the RNTI used for DCI dynamically scheduling sidelink resources for V2X sidelink communication.

#### **slss-TxDisabled**

Value TRUE indicates that the primary carrier, even though equipped with synchronisation resources, cannot be used as a synchronisation carrier frequency to transmit SLSS or PSBCH.

#### **thresSL-TxPrioritization**

Indicates the threshold used to determine whether SL V2X transmission is prioritized over uplink transmission if they overlap in time (see TS 36.321 [6]). This value shall overwrite *thresSL-TxPrioritization* configured in *SIB21* or *SL-V2X-Preconfiguration* if any.

#### **typeTxSync**

Indicates the prioritized synchronization type (i.e. eNB or GNSS) for performing V2X sidelink communication on PCell.

#### **ue-Selected**

Indicates the configuration for the case the UE selects the transmission resources from a pool of resources configured by E-UTRAN.

#### **v2x-InterFreqInfoList**

Indicates synchronization and resource allocation configurations of other carrier frequencies than the serving carrier frequency for V2X sidelink communication. For inter-carrier scheduled resource allocation, CIF=1 in DCI-5A corresponds to the first entry in this frequency list, CIF=2 corresponds to the second entry, and so on (see TS 36.213 [23]). CIF=0 in DCI-5A corresponds to the frequency where the DCI is received.

#### **v2x-SchedulingPool**

Indicates a pool of resources when E-UTRAN schedules Tx resources for V2X sidelink communications.

## – *SL-V2X-FreqSelectionConfigList*

The IE *SL-V2X-FreqSelectionConfigList* specifies the configuration information for carrier selection for V2X sidelink communication transmission using UE autonomous resource selection.

### ***SL-V2X-FreqSelectionConfigList* information element**

```
-- ASN1START
SL-V2X-FreqSelectionConfigList-r15 ::= SEQUENCE (SIZE (1..8)) OF SL-V2X-FreqSelectionConfig-r15
SL-V2X-FreqSelectionConfig-r15 ::=
    SEQUENCE {
        priorityList-r15                SL-PriorityList-r13,
        threshCBR-FreqReselection-r15  SL-CBR-r14           OPTIONAL,  -- Need OR
        threshCBR-FreqKeeping-r15     SL-CBR-r14           OPTIONAL  -- Need OR
    }
-- ASN1STOP
```

### **SL-V2X-FreqSelectionConfig field descriptions**

#### ***priorityList***

Indicates the list of PPPP(s) which is associated with the configurations in *threshCBR-FreqReselection* and in *threshCBR-FreqKeeping*.

#### ***threshCBR-FreqReselection***

Indicates the CBR threshold to determine whether the carrier frequency can be (re)selected for the transmission of V2X sidelink communication. See TS 36.321 [6].

#### ***threshCBR-FreqKeeping***

Indicates the CBR threshold to determine whether the UE can keep using the carrier which was selected for the transmission of V2X sidelink communication. See TS 36.321 [6].

## – *SL-V2X-PacketDuplicationConfig*

The IE *SL-V2X-PacketDuplicationConfig* specifies the configuration information for sidelink packet duplication for V2X sidelink communication transmission.

### ***SL-V2X-PacketDuplicationConfig* information element**

```
-- ASN1START
SL-V2X-PacketDuplicationConfig-r15 ::= SEQUENCE {
    threshSL-Reliability-r15    SL-Reliability-r15,
    allowedCarrierFreqConfig-r15  SL-PPPR-Dest-CarrierFreqList-r15           OPTIONAL,  -- Need OR
    ...
}
SL-PPPR-Dest-CarrierFreqList-r15 ::= SEQUENCE (SIZE (1..maxSL-Dest-r12)) OF SL-PPPR-Dest-CarrierFreq
SL-PPPR-Dest-CarrierFreq ::= SEQUENCE {
    destinationInfoList-r15    SL-DestinationInfoList-r12           OPTIONAL,  -- Need OR
    allowedCarrierFreqList-r15  SL-AllowedCarrierFreqList-r15           OPTIONAL  -- Need OR
}
SL-AllowedCarrierFreqList-r15 ::= SEQUENCE {
    allowedCarrierFreqSet1     SEQUENCE (SIZE (1..maxFreqV2X-r14)) OF ARFCN-ValueEUTRA-r9,
    allowedCarrierFreqSet2     SEQUENCE (SIZE (1..maxFreqV2X-r14)) OF ARFCN-ValueEUTRA-r9
}
-- ASN1STOP
```



<b>SL-V2X-PacketDuplicationConfig field descriptions</b>	
<b><i>allowedCarrierFreqList, allowedCarrierFreqSet1, allowedCarrierFreqSet2</i></b>	Indicates, for V2X sidelink communication, the set of carrier frequencies applicable for the transmission of the MAC SDUs from the sidelink logical channels whose associated destination are included in <i>destinationInfoList</i> (see TS 36.321 [6]). If present, E-UTRAN shall ensure <i>allowedCarrierFreqSet1</i> and <i>allowedCarrierFreqSet2</i> do not include the same carrier frequency.
<b><i>threshSL-Reliability</i></b>	Indicates the reliability threshold used to determine whether sidelink packet duplication is configured and activated for V2X sidelink communication transmission. See TS 36.323 [8] and TS 36.321 [6].

## – **SL-V2X-SyncFreqList**

The IE *SL-V2X-SyncFreqList* specifies the list of candidate synchronisation carrier frequencies used for V2X sidelink communication.

### **SL-V2X-SyncFreqList information element**

```
-- ASN1START
SL-V2X-SyncFreqList-r15 ::= SEQUENCE (SIZE (1..maxFreqV2X-r14)) OF ARFCN-ValueEUTRA-r9
-- ASN1STOP
```

## – **SL-ZoneConfig**

The IE *SL-ZoneConfig* indicates zone configurations used for V2X sidelink communication.

### **SL-ZoneConfig information element**

```
-- ASN1START
SL-ZoneConfig-r14 ::= SEQUENCE {
    zoneLength-r14    ENUMERATED { m5, m10, m20, m50, m100, m200, m500, spare1 },
    zoneWidth-r14     ENUMERATED { m5, m10, m20, m50, m100, m200, m500, spare1 },
    zoneIdLongiMod-r14 INTEGER (1..4),
    zoneIdLatiMod-r14 INTEGER (1..4)
}
-- ASN1STOP
```

<b>SL-ZoneConfig field descriptions</b>	
<b><i>zoneLength</i></b>	Indicates the length of each geographic zone. Value m5 corresponds to 5 meters, m10 corresponds to 10 meters and so on.
<b><i>zoneWidth</i></b>	Indicates the width of each geographic zone. Value m5 corresponds to 5 meters, m10 corresponds to 10 meters and so on.
<b><i>zoneIdLongiMod</i></b>	Indicates the total number of zones that is configured with respect to longitude.
<b><i>zoneIdLatiMod</i></b>	Indicates the total number of zones that is configured with respect to latitude.

<b>Conditional presence</b>	<b>Explanation</b>
<i>EDTorPUR</i>	The field is optionally present, Need OR, if <i>edt-Parameters</i> or <i>cp-PUR-5GC</i> or <i>cp-PUR-EPC</i> or <i>up-PUR-5GC</i> or <i>up-PUR-EPC</i> is present in SIB2-NB; otherwise the field is not present and the UE shall delete any existing value for this field.
<i>TDD</i>	The field is optionally present, Need OR, in TDD mode. Otherwise, the field is not present.

## 6.4 RRC multiplicity and type constraint values

### – Multiplicity and type constraint definitions

```

-- ASN1START
maxAccessCat-1-r15          INTEGER ::= 63 -- Maximum number of Access Categories - 1
maxACDC-Cat-r13            INTEGER ::= 16 -- Maximum number of ACDC categories (per PLMN)
maxAvailNarrowBands-r13    INTEGER ::= 16 -- Maximum number of narrowbands
maxAvailNarrowBands-1-r16  INTEGER ::= 15 -- Maximum number of narrowbands minus one
maxBandComb-r10            INTEGER ::= 128 -- Maximum number of band combinations.
maxBandComb-r11            INTEGER ::= 256 -- Maximum number of additional band combinations.
maxBandComb-r13            INTEGER ::= 384 -- Maximum number of band combinations in Rel-13
maxBandCombSidelinkNR-r16  INTEGER ::= 512 -- Maximum number of NR sidelink band combinations
maxBands                   INTEGER ::= 64 -- Maximum number of bands listed in EUTRA UE caps
maxBandsNR-r15             INTEGER ::= 1024 -- Maximum number of NR bands listed in EUTRA UE
caps
maxBandsENDC-r16           INTEGER ::= 10 -- Maximum number of NR bands from across all the PLMNs
-- sharing the serving cell in EN-DC for the forwarding
-- of upperLayerIndication.
maxBandwidthClass-r10      INTEGER ::= 16 -- Maximum number of supported CA BW classes per band
maxBandwidthCombSet-r10    INTEGER ::= 32 -- Maximum number of bandwidth combination sets per
-- supported band combination
maxBarringInfoSet-r15      INTEGER ::= 8 -- Maximum number of UAC barring information sets
maxBT-IdReport-r15         INTEGER ::= 32 -- Maximum number of Bluetooth IDs to report
maxBT-Name-r15             INTEGER ::= 4 -- Maximum number of Bluetooth name
maxCBR-Level-r14           INTEGER ::= 16 -- Maximum number of CBR levels
maxCBR-Level-1-r14         INTEGER ::= 15
maxCBR-Report-r14          INTEGER ::= 72 -- Maximum number of CBR results in a report
maxCDMA-BandClass          INTEGER ::= 32 -- Maximum value of the CDMA band classes
maxCE-Level-r13            INTEGER ::= 4 -- Maximum number of CE levels
maxExcludedCell            INTEGER ::= 16 -- Maximum number of exclude-listed physical cell
identity
-- ranges listed in SIB type 4 and 5
maxCellHistory-r12         INTEGER ::= 16 -- Maximum number of visited EUTRA cells reported
maxCellInfoGERAN-r9        INTEGER ::= 32 -- Maximum number of GERAN cells for which system in-
-- formation can be provided as redirection assistance
maxCellInfoUTRA-r9         INTEGER ::= 16 -- Maximum number of UTRA cells for which system
-- information can be provided as redirection
-- assistance
maxCellMeasIdle-r15        INTEGER ::= 8 -- Maximum number of neighbouring inter-frequency
-- cells per carrier measured in RRC_IDLE and
RRC_INACTIVE
maxCellNR-r17              INTEGER ::= 8 -- Maximum number of NR cells
maxCombIDC-r11             INTEGER ::= 128 -- Maximum number of reported UL CA or
-- MR-DC combinations
maxCSI-IM-r11              INTEGER ::= 3 -- Maximum number of CSI-IM configurations
-- (per carrier frequency)
maxCSI-IM-r12              INTEGER ::= 4 -- Maximum number of CSI-IM configurations
-- (per carrier frequency)
minCSI-IM-r13              INTEGER ::= 5 -- Minimum number of CSI IM configurations from which
-- REL-13 extension is used
maxCSI-IM-r13              INTEGER ::= 24 -- Maximum number of CSI-IM configurations
-- (per carrier frequency)
maxCSI-IM-v1310            INTEGER ::= 20 -- Maximum number of additional CSI-IM configurations
-- (per carrier frequency)
maxCSI-Proc-r11            INTEGER ::= 4 -- Maximum number of CSI processes (per carrier
-- frequency)
maxCSI-RS-NZP-r11          INTEGER ::= 3 -- Maximum number of CSI RS resource
-- configurations using non-zero Tx power
-- (per carrier frequency)
minCSI-RS-NZP-r13          INTEGER ::= 4 -- Minimum number of CSI RS resource from which
-- REL-13 extension is used
maxCSI-RS-NZP-r13          INTEGER ::= 24 -- Maximum number of CSI RS resource
-- configurations using non-zero Tx power
-- (per carrier frequency)
maxCSI-RS-NZP-v1310        INTEGER ::= 21 -- Maximum number of additional CSI RS resource
-- configurations using non-zero Tx power
-- (per carrier frequency)
maxCSI-RS-ZP-r11           INTEGER ::= 4 -- Maximum number of CSI RS resource
-- configurations using zero Tx power(per carrier
-- frequency)
maxCQI-ProcExt-r11         INTEGER ::= 3 -- Maximum number of additional periodic CQI
-- configurations (per carrier frequency)
maxFreqUTRA-TDD-r10        INTEGER ::= 6 -- Maximum number of UTRA TDD carrier frequencies for
-- which system information can be provided as

```

		-- redirection assistance
maxCellInter	INTEGER ::= 16	-- Maximum number of neighbouring inter-frequency cells listed in SIB type 5
maxCellIntra	INTEGER ::= 16	-- Maximum number of neighbouring intra-frequency cells listed in SIB type 4
maxCellListGERAN	INTEGER ::= 3	-- Maximum number of lists of GERAN cells
maxCellMeas	INTEGER ::= 32	-- Maximum number of entries in each of the cell lists in a measurement object
maxCellRARReportNR-r18	INTEGER ::= 8	-- Maximum number of unique Cells identities of RA reports included in the NR RA report container
maxCellReport	INTEGER ::= 8	-- Maximum number of reported cells/CSI-RS resources
maxCellsFTD	INTEGER ::= 3	-- Maximum number of cells for SFTD reporting
maxCellAllowedNR-r16	INTEGER ::= 16	-- Maximum number of allowlisted NR cells in SIB24
maxCondConfig-r16	INTEGER ::= 8	-- Maximum number of conditional configurations
maxConfigSPS-r14	INTEGER ::= 8	-- Maximum number of simultaneous SPS configurations
maxConfigSPS-r15	INTEGER ::= 6	-- Maximum number of simultaneous SPS configurations configured with SPS C-RNTI
maxCSI-RS-Meas-r12	INTEGER ::= 96	-- Maximum number of entries in the CSI-RS list in a measurement object
maxDRB	INTEGER ::= 11	-- Maximum number of Data Radio Bearers
maxDRBExt-r15	INTEGER ::= 4	-- Maximum number of additional DRBs
maxDRB-r15	INTEGER ::= 15	-- Highest value of extended maximum number of DRBs
maxDS-Duration-r12	INTEGER ::= 5	-- Maximum number of subframes in a discovery signals occasion
maxDS-ZTP-CSI-RS-r12	INTEGER ::= 5	-- Maximum number of zero transmission power CSI-RS for a serving cell concerning discovery signals
maxEARFCN	INTEGER ::= 65535	-- Maximum value of EUTRA carrier frequency
maxEARFCN-Plus1	INTEGER ::= 65536	-- Lowest value extended EARFCN range
maxEARFCN2	INTEGER ::= 262143	-- Highest value extended EARFCN range
maxEPDCCH-Set-r11	INTEGER ::= 2	-- Maximum number of EPDCCH sets
maxFBI	INTEGER ::= 64	-- Maximum value of fequency band indicator
maxFBI-NR-r15	INTEGER ::= 1024	-- Highest value FBI range for NR.
maxFBI-Plus1	INTEGER ::= 65	-- Lowest value extended FBI range
maxFBI2	INTEGER ::= 256	-- Highest value extended FBI range
maxFeatureSets-r15	INTEGER ::= 256	-- Total number of feature sets (size of pool)
maxPerCC-FeatureSets-r15	INTEGER ::= 32	-- Total number of CC-specific feature sets (size of the pool)
maxFreq	INTEGER ::= 8	-- Maximum number of carrier frequencies
maxFreq-l-r16	INTEGER ::= 7	-- Maximum number of carrier frequencies
maxFreqIDC-r11	INTEGER ::= 32	-- Maximum number of carrier frequencies that are affected by the IDC problems
maxFreqIdle-r15	INTEGER ::= 8	-- Maximum number of carrier frequencies for IDLE mode measurements configured by eNB
maxFreqMBMS-r11	INTEGER ::= 5	-- Maximum number of carrier frequencies for which an MBMS capable UE may indicate an interest
maxFreqNB-IoT-r16	INTEGER ::= 8	-- Maximum number of NB-IoT carrier frequencies that can be provided as assistance information for inter-RAT cell selection
maxFreqNR-r15	INTEGER ::= 5	-- Maximum number of NR carrier frequencies for which a UE may provide measurement results upon NR SCG failure
maxFreqSL-NR-r16	INTEGER ::= 8	-- Maximum number of NR anchor carrier frequencies on which configurations for V2X sidelink communication are provided
maxFreqV2X-r14	INTEGER ::= 8	-- Maximum number of carrier frequencies for which V2X sidelink communication can be configured
maxFreqV2X-l-r14	INTEGER ::= 7	-- Highest index of frequencies
maxGERAN-SI	INTEGER ::= 10	-- Maximum number of GERAN SI blocks that can be provided as part of NACC information
maxGNFG	INTEGER ::= 16	-- Maximum number of GERAN neighbour freq groups
maxGWUS-Groups-l-r16	INTEGER ::= 31	-- Maximum number of groups minus one for each probability group
maxGWUS-Resources-r16	INTEGER ::= 4	-- Maximum number of GWUS resources for each group
maxGWUS-ProbThresholds-r16	INTEGER ::= 3	-- Maximum number of paging probability thresholds
maxIdleMeasCarriers-r15	INTEGER ::= 3	-- Maximum number of neighbouring inter-frequency carriers measured in RRC_IDLE and
RRC_INACTIVE		
maxIdleMeasCarriersExt-r16	INTEGER ::= 5	-- Additional number of neighbouring inter-frequency carriers measured in RRC_IDLE and
RRC_INACTIVE		
maxIdleMeasCarriers-r16	INTEGER ::= 8	-- Maximum number of neighbouring inter-frequency/inter-RAT carriers measured in RRC_IDLE
and RRC_INACTIVE		
maxLCG-r13	INTEGER ::= 4	-- Maximum number of logical channel groups
maxLogMeasReport-r10	INTEGER ::= 520	-- Maximum number of logged measurement entries that can be reported by the UE in one message
maxLowerMSD-r18	INTEGER ::= 256	-- Maximum number of lower MSD capability sets for a victim band

maxLowerMSD-Info-r18	INTEGER ::= 64	-- Maximum number of lower MSD capability sets for -- a band combination
maxMBSFN-Allocations	INTEGER ::= 8	-- Maximum number of MBSFN frame allocations with -- different offset
maxMBSFN-Area	INTEGER ::= 8	
maxMBSFN-Area-1	INTEGER ::= 7	
maxMBMS-ServiceListPerUE-r13	INTEGER ::= 15	-- Maximum number of services which the UE can -- include in the MBMS interest indication
maxMeasId	INTEGER ::= 32	
maxMeasId-Plus1	INTEGER ::= 33	
maxMeasId-r12	INTEGER ::= 64	
maxMultiBands	INTEGER ::= 8	-- Maximum number of additional frequency bands -- that a cell belongs to
maxMultiBandsNR-r15	INTEGER ::= 32	-- Maximum number of additional NR frequency bands -- that a cell belongs to
maxMultiBandsNR-1-r15	INTEGER ::= 31	
maxNS-Pmax-r10	INTEGER ::= 8	-- Maximum number of NS and P-Max values per band
maxNAICS-Entries-r12	INTEGER ::= 8	-- Maximum number of supported NAICS combination(s)
maxNeighCell-r12	INTEGER ::= 8	-- Maximum number of neighbouring cells in NAICS -- configuration (per carrier frequency)
maxNeighCell-SCPTM-r13	INTEGER ::= 8	-- Maximum number of SCPTM neighbour cells
maxNrofPCI-PerSMTC-r16	INTEGER ::= 64	-- Maximum number of PCIs per SMTC
maxNrofS-NSSAI-r15	INTEGER ::= 8	-- Maximum number of S-NSSAI
maxObjectId	INTEGER ::= 32	
maxObjectId-Plus1-r13	INTEGER ::= 33	
maxObjectId-r13	INTEGER ::= 64	
maxP-a-PerNeighCell-r12	INTEGER ::= 3	-- Maximum number of power offsets for a neighbour cell -- in NAICS configuration
maxPageRec	INTEGER ::= 16	--
maxPhysCellIdRange-r9	INTEGER ::= 4	-- Maximum number of physical cell identity ranges
maxPLMN-r11	INTEGER ::= 6	-- Maximum number of PLMNs
maxPLMN-1-r14	INTEGER ::= 5	-- Maximum number of PLMNs minus one
maxPLMN-r15	INTEGER ::= 8	-- Maximum number of PLMNs for RNA configuration
maxPLMN-NR-r15	INTEGER ::= 12	-- Maximum number of NR PLMNs
maxPNOffset	INTEGER ::= 511	-- Maximum number of CDMA2000 PNOFFSETS
maxPMCH-PerMBSFN	INTEGER ::= 15	
maxPSSCH-TxConfig-r14	INTEGER ::= 16	-- Maximum number of PSSCH TX configurations
maxQuantSetsNR-r15	INTEGER ::= 2	-- Maximum number of NR quantity configuration sets
maxQCI-r13	INTEGER ::= 6	-- Maximum number of QCIs
maxRAT-Capabilities	INTEGER ::= 8	-- Maximum number of interworking RATs (incl EUTRA)
maxRE-MapQCL-r11	INTEGER ::= 4	-- Maximum number of PDSCH RE Mapping configurations -- (per carrier frequency)
maxReportConfigId	INTEGER ::= 32	
maxReservationPeriod-r14	INTEGER ::= 16	-- Maximum number of resource reservation periodicities -- for sidelink V2X communication
maxRS-Index-r15	INTEGER ::= 64	-- Maximum number of RS indices
maxRS-Index-1-r15	INTEGER ::= 63	-- Highest value of RS index as used to identify -- RS index in RRM reports.
maxRS-IndexCellQual-r15	INTEGER ::= 16	-- Maximum number of RS indices averaged to derive -- cell quality for RRM.
maxRS-IndexReport-r15	INTEGER ::= 32	-- Maximum number of RS indices for RRM.
maxRSTD-Freq-r10	INTEGER ::= 3	-- Maximum number of frequency layers for RSTD -- measurement
maxSAI-MBMS-r11	INTEGER ::= 64	-- Maximum number of MBMS service area identities -- broadcast per carrier frequency
maxSat-r17	INTEGER ::= 4	-- Maximum number of satellites
maxSCell-r10	INTEGER ::= 4	-- Maximum number of SCells
maxSCell-r13	INTEGER ::= 31	-- Highest value of extended number range of SCells
maxSCellGroups-r15	INTEGER ::= 4	-- Maximum number of SCell common parameter groups
maxSC-MTCH-r13	INTEGER ::= 1023	-- Maximum number of SC-MTCHs in one cell
maxSC-MTCH-BR-r14	INTEGER ::= 128	-- Maximum number of SC-MTCHs in one cell for feMTC
maxSL-CommRxPoolNFFreq-r13	INTEGER ::= 32	-- Maximum number of individual sidelink communication -- Rx resource pools on neighbouring freq
maxSL-CommRxPoolPreconf-v1310	INTEGER ::= 12	-- Maximum number of additional preconfigured -- sidelink communication Rx resource pool entries
maxSL-TxPool-r12Plus1-r13	INTEGER ::= 5	-- First additional individual sidelink -- Tx resource pool
maxSL-TxPool-v1310	INTEGER ::= 4	-- Maximum number of additional sidelink -- Tx resource pool entries
maxSL-TxPool-r13	INTEGER ::= 8	-- Maximum number of individual sidelink -- Tx resource pools
maxSL-CommTxPoolPreconf-v1310	INTEGER ::= 7	-- Maximum number of additional preconfigured -- sidelink Tx resource pool entries
maxSL-Dest-r12	INTEGER ::= 16	-- Maximum number of sidelink destinations
maxSL-DiscCells-r13	INTEGER ::= 16	-- Maximum number of cells with similar sidelink -- configurations
maxSL-DiscPowerClass-r12	INTEGER ::= 3	-- Maximum number of sidelink power classes
maxSL-DiscRxPoolPreconf-r13	INTEGER ::= 16	-- Maximum number of preconfigured sidelink

```

maxSL-DiscSysInfoReportFreq-r13 INTEGER ::= 8 -- discovery Rx resource pool entries
-- Maximum number of frequencies to include in a
maxSL-DiscTxPoolPreconf-r13 INTEGER ::= 4 -- SidelinkUEInformation for SI reporting
-- Maximum number of preconfigured sidelink
-- discovery Tx resource pool entries
maxSL-GP-r13 INTEGER ::= 8 -- Maximum number of gap patterns that can be requested
-- for a frequency or assigned
maxSL-PoolToMeasure-r14 INTEGER ::= 72 -- Maximum number of TX resource pools for CBR
-- measurement and report

maxSL-Prio-r13 INTEGER ::= 8 -- Maximum number of entries in sidelink priority list
maxSL-RxPool-r12 INTEGER ::= 16 -- Maximum number of individual sidelink Rx resource
pools
maxSL-Reliability-r15 INTEGER ::= 8 -- Maximum number of entries in sidelink reliability list
maxSL-SyncConfig-r12 INTEGER ::= 16 -- Maximum number of sidelink Sync configurations
maxSL-TF-IndexPair-r12 INTEGER ::= 64 -- Maximum number of sidelink Time Freq resource index
-- pairs
maxSL-TxPool-r12 INTEGER ::= 4 -- Maximum number of individual sidelink Tx resource
pools
maxSL-V2X-RxPool-r14 INTEGER ::= 16 -- Maximum number of RX resource pools for
-- V2X sidelink communication
maxSL-V2X-RxPoolPreconf-r14 INTEGER ::= 16 -- Maximum number of RX resource pools for
-- V2X sidelink communication
maxSL-V2X-TxPool-r14 INTEGER ::= 8 -- Maximum number of TX resource pools for
-- V2X sidelink communication
maxSL-V2X-TxPoolPreconf-r14 INTEGER ::= 8 -- Maximum number of TX resource pools for
-- V2X sidelink communication
maxSL-V2X-SyncConfig-r14 INTEGER ::= 16 -- Maximum number of sidelink Sync configurations
-- for V2X sidelink communication
maxSL-V2X-CBRConfig-r14 INTEGER ::= 4 -- Maximum number of CBR range configurations
-- for V2X sidelink communication congestion
-- control
maxSL-V2X-CBRConfig-1-r14 INTEGER ::= 3
maxSL-V2X-TxConfig-r14 INTEGER ::= 64 -- Maximum number of TX parameter configurations
-- for V2X sidelink communication congestion
-- control
maxSL-V2X-TxConfig-1-r14 INTEGER ::= 63
maxSL-V2X-CBRConfig2-r14 INTEGER ::= 8 -- Maximum number of CBR range configurations in
-- pre-configuration for V2X sidelink
-- communication congestion control
maxSL-V2X-CBRConfig2-1-r14 INTEGER ::= 7
maxSL-V2X-TxConfig2-r14 INTEGER ::= 128 -- Maximum number of TX parameter
-- configurations in pre-configuration for V2X
-- sidelink communication congestion control
maxSL-V2X-TxConfig2-1-r14 INTEGER ::= 127
maxSTAG-r11 INTEGER ::= 3 -- Maximum number of STAGs
maxServCell-r10 INTEGER ::= 5 -- Maximum number of Serving cells
maxServCell-r13 INTEGER ::= 32 -- Highest value of extended number range of Serving
cells
maxServCellNR-r15 INTEGER ::= 16 -- Maximum number of NR serving cells
maxServiceCount INTEGER ::= 16 -- Maximum number of MBMS services that can be included
-- in an MBMS counting request and response
maxServiceCount-1 INTEGER ::= 15
maxSessionPerPMCH INTEGER ::= 29
maxSessionPerPMCH-1 INTEGER ::= 28
maxSIB INTEGER ::= 32 -- Maximum number of SIBs
maxSIB-1 INTEGER ::= 31
maxSI-Message INTEGER ::= 32 -- Maximum number of SI messages
maxSimultaneousBands-r10 INTEGER ::= 64 -- Maximum number of simultaneously aggregated bands
maxSubframePatternIDC-r11 INTEGER ::= 8 -- Maximum number of subframe reservation patterns
-- that the UE can simultaneously recommend to the
-- E-UTRAN for use.
maxTAC-r17 INTEGER ::= 12 -- Maximum number of Tracking Area Codes
-- broadcast in a cell
maxTrafficPattern-r14 INTEGER ::= 8 -- Maximum number of periodical traffic patterns
-- that the UE can simultaneously report to the
-- E-UTRAN.
maxUTRA-FDD-Carrier INTEGER ::= 16 -- Maximum number of UTRA FDD carrier frequencies
maxUTRA-TDD-Carrier INTEGER ::= 16 -- Maximum number of UTRA TDD carrier frequencies
maxWayPoint-r15 INTEGER ::= 20 -- Maximum number of flight path information waypoints
maxWLAN-Id-r12 INTEGER ::= 16 -- Maximum number of WLAN identifiers
maxWLAN-Bands-r13 INTEGER ::= 8 -- Maximum number of WLAN bands
maxWLAN-Id-r13 INTEGER ::= 32 -- Maximum number of WLAN identifiers
maxWLAN-Channels-r13 INTEGER ::= 16 -- maximum number of WLAN channels used in
-- WLAN-CarrierInfo
maxWLAN-CarrierInfo-r13 INTEGER ::= 8 -- Maximum number of WLAN Carrier Information
maxWLAN-Id-Report-r14 INTEGER ::= 32 -- Maximum number of WLAN IDs to report
maxWLAN-Name-r15 INTEGER ::= 4 -- Maximum number of WLAN name

```

```
-- ASN1STOP
NOTE: The value of maxDRB aligns with SA2.
```

## – End of EUTRA-RRC-Definitions

```
-- ASN1START
END
-- ASN1STOP
```

## 6.5 PC5 RRC messages

NOTE: The messages included in this clause reflect the current status of the discussions. Additional messages may be included at a later stage.

### 6.5.1 General message structure

#### – *PC5-RRC-Definitions*

This ASN.1 segment is the start of the PC5 RRC PDU definitions.

```
-- ASN1START
PC5-RRC-Definitions DEFINITIONS AUTOMATIC TAGS ::=
BEGIN
IMPORTS
    TDD-ConfigSL-r12
FROM EUTRA-RRC-Definitions;
-- ASN1STOP
```

#### – *SBCCH-SL-BCH-Message*

The *SBCCH-SL-BCH-Message* class is the set of RRC messages that may be sent from the UE to the UE via SL-BCH on the SBCCH logical channel.

```
-- ASN1START
SBCCH-SL-BCH-Message ::= SEQUENCE {
    message          SBCCH-SL-BCH-MessageType
}
SBCCH-SL-BCH-MessageType ::=
MasterInformationBlock-SL
-- ASN1STOP
```

#### – *SBCCH-SL-BCH-Message-V2X*

The *SBCCH-SL-BCH-Message-V2X* class is the set of RRC messages that may be sent from the UE to the UE via SL-BCH on the SBCCH logical channel for V2X sidelink communication.

```
-- ASN1START
SBCCH-SL-BCH-Message-V2X-r14 ::= SEQUENCE {
    message          SBCCH-SL-BCH-MessageType-V2X-r14
}
SBCCH-SL-BCH-MessageType-V2X-r14 ::=
MasterInformationBlock-SL-V2X-r14
-- ASN1STOP
```

## 6.5.2 Message definitions

### – *MasterInformationBlock-SL*

The *MasterInformationBlock-SL* includes the information transmitted by a UE transmitting SLSS, i.e. acting as synchronisation reference, via SL-BCH.

Signalling radio bearer: N/A

RLC-SAP: TM

Logical channel: SBCCH

Direction: UE to UE

#### **MasterInformationBlock-SL**

```
-- ASN1START
MasterInformationBlock-SL ::= SEQUENCE {
    sl-Bandwidth-r12          ENUMERATED {
        n6, n15, n25, n50, n75, n100},
    tdd-ConfigSL-r12        TDD-ConfigSL-r12,
    directFrameNumber-r12   BIT STRING (SIZE (10)),
    directSubframeNumber-r12 INTEGER (0..9),
    inCoverage-r12          BOOLEAN,
    reserved-r12            BIT STRING (SIZE (19))
}
-- ASN1STOP
```

#### **MasterInformationBlock-SL field descriptions**

##### **directFrameNumber**

Indicates the frame number in which SLSS and SL-BCH are transmitted. The subframe in the frame corresponding to *directFrameNumber* is indicated by *directSubframeNumber*.

##### **inCoverage**

Value *TRUE* indicates that the UE transmitting the *MasterInformationBlock-SL* is in E-UTRAN coverage.

##### **sl-Bandwidth**

Parameter: transmission bandwidth configuration. n6 corresponds to 6 resource blocks, n15 to 15 resource blocks and so on.

### – *MasterInformationBlock-SL-V2X*

The *MasterInformationBlock-SL-V2X* includes the information transmitted by a UE transmitting SLSS, i.e. acting as synchronisation reference, via SL-BCH for V2X sidelink communication.

Signalling radio bearer: N/A

RLC-SAP: TM

Logical channel: SBCCH

Direction: UE to UE

#### **MasterInformationBlock-SL-V2X**

```
-- ASN1START
MasterInformationBlock-SL-V2X-r14 ::= SEQUENCE {
    sl-Bandwidth-r14          ENUMERATED {
        n6, n15, n25, n50, n75, n100},
    tdd-ConfigSL-r14        TDD-ConfigSL-r12,
    directFrameNumber-r14   BIT STRING (SIZE (10)),
}
-- ASN1STOP
```

```

directSubframeNumber-r14      INTEGER (0..9),
inCoverage-r14                BOOLEAN,
reserved-r14                  BIT STRING (SIZE (27))
}
-- ASN1STOP
    
```

<b>MasterInformationBlock-SL-V2X field descriptions</b>
<p><b>directFrameNumber</b> Indicates the frame number in which SLSS and SL-BCH for V2X sidelink communication are transmitted. The subframe in the frame corresponding to <i>directFrameNumber</i> is indicated by <i>directSubframeNumber</i>.</p>
<p><b>inCoverage</b> Value <i>TRUE</i> indicates that the UE transmitting the <i>MasterInformationBlock-SL-V2X</i> for V2X sidelink communication is in E-UTRAN coverage.</p>
<p><b>sl-Bandwidth</b> Parameter: transmission bandwidth configuration. n6 corresponds to 6 resource blocks, n15 to 15 resource blocks and so on.</p>

– End of *PC5-RRC-Definitions*

```

-- ASN1START
END
-- ASN1STOP
    
```

## 6.6 Direct Indication Information

Direct Indication information is transmitted on MPDCCH using P-RNTI but without associated *Paging* message or using SI-RNTI. Table 6.6-1 defines the Direct Indication information on MPDCCH using P-RNTI, see TS 36.212 [22], clause 5.3.3.1.14. Table 6.6-2 defines the Direct Indication on MPDCCH using SI-RNTI in RRC\_CONNECTED, see TS 36.212 [22], clauses 5.3.3.1.12 and 5.3.3.1.13.

When bit n is set to 1, UE shall behave as if the corresponding field is set in the *Paging* message, see 5.3.2.3. Bit 1 is the least significant bit.

**Table 6.6-1: Direct Indication information using P-RNTI**

Bit	Direct Indication information
1	<i>systemInfoModification</i>
2	<i>etws-Indication</i>
3	<i>emas-Indication</i>
4	<i>eab-ParamModification</i>
5	<i>systemInfoModification-eDRX</i>
6	<i>uac-ParamModification</i>
6, 7, 8	Not used, and shall be ignored by UE if received.

**Table 6.6-2: Direct Indication information using SI-RNTI**

Bit	Direct Indication information
1	<i>etws-Indication</i>
2	<i>emas-Indication</i>



3, 4, 5, 6, 7, 8	Not used, and shall be ignored by UE if received.
---------------------	---

## 6.6a Direct Indication FeMBMS

On MBMS-dedicated cell and on FeMBMS/Unicast-mixed cell, a Direct Indication FeMBMS is transmitted on PDCCH together with 8-bit MCCH change notification using M-RNTI, see TS 36.212 [22], clause 5.3.3.1.4. Table 6.6a-1 defines the Direct Indication FeMBMS.

When the first bit is set to 1, UE shall behave as if *systemInfoModification* field is set in the *Paging* message and when the second bit is set to 1, UE shall behave as if both *etws-Indication* and *emas-Indication* are set in the *Paging* message, see 5.3.2.3. Bit 1 is the least significant bit.

**Table 6.6a-1: Direct Indication FeMBMS**

Bit	Direct Indication FeMBMS
1	<i>systemInfoModification</i>
2	<i>etws-Indication</i> and <i>emas-Indication</i>

## 6.7 NB-IoT RRC messages

### 6.7.1 General NB-IoT message structure

```
-- ASN1START
NBIOT-RRC-Definitions DEFINITIONS AUTOMATIC TAGS ::=
BEGIN
IMPORTS
    RRCConnectionReestablishmentReject,
    SecurityModeCommand,
    SecurityModeComplete,
    SecurityModeFailure,
    AdditionalSpectrumEmission,
    ARFCN-ValueEUTRA-r9,
    CarrierFreqsGERAN,
    CellGlobalIdEUTRA,
    CellIdentity,
    C-RNTI,
    DedicatedInfoNAS,
    DRB-Identity,
    GNSS-PositionFixDuration-r18,
    GNSS-ValidityDuration-r17,
    InitialUE-Identity,
    IntraFreqExcludedCellList,
    IntraFreqNeighCellList,
    I-RNTI-r15,
    LocationInfo-r10,
    maxAccessCat-1-r15,
    maxBands,
    maxExcludedCell,
    maxCellInter,
    maxCellIntra,
    maxFBI2,
    maxFreq,
    maxMultiBands,
    maxNrofS-NSSAI-r15,
    maxPageRec,
    maxPLMN-r11,
    maxSAI-MBMS-r11,
    maxSat-r17,
    maxSIB,
    maxSIB-1,
    MBMS-SAI-r11,
```

```

MBMS-SAI-List-r11,
MBMSSessionInfo-r13,
NeighSatelliteInfoList-r18,
NextHopChainingCount,
NG-5G-S-TMSI-r15,
PagingUE-Identity,
PLMN-Identity,
PLMN-IdentityList2,
P-Max,
PowerRampingParameters,
PreambleTransMax,
PhysCellId,
Q-OffsetRange,
Q-QualMin-r9,
Q-RxLevMin,
ReestabUE-Identity,
RegisteredAMF-r15,
RegisteredMME,
ReselectionThreshold,
ResumeIdentity-r13,
RRC-TransactionIdentifier,
RSRP-Range,
S-NSSAI-r15,
S-TMSI,
SatelliteId-r18,
SatelliteInfoList-r17,
SatelliteInfoList-v1800,
ServingSatelliteInfo-r17,
ServingSatelliteInfo-v1820,
SetupRelease,
ShortMAC-I,
SystemInformationBlockType16-r11,
SystemInfoValueTagSI-r13,
T-Reordering,
T-ReorderingExt-r17,
TimeAlignmentTimer,
TimeSinceFailure-r11,
TimeOffsetUTC-r17,
TMGI-r9,
TrackingAreaCode,
TrackingAreaCode-5GC-r15,
UAC-AC1-SelectAssistInfo-r15,
DataInactivityTimer-r14

```

```
FROM EUTRA-RRC-Definitions;
```

```
-- ASN1STOP
```

### – *BCCH-BCH-Message-NB*

The *BCCH-BCH-Message-NB* class is the set of RRC messages that may be sent from the E-UTRAN to the UE via BCH on the BCCH logical channel in FDD.

```

-- ASN1START
BCCH-BCH-Message-NB ::= SEQUENCE {
    message                BCCH-BCH-MessageType-NB
}
BCCH-BCH-MessageType-NB ::= MasterInformationBlock-NB
-- ASN1STOP

```

### – *BCCH-BCH-Message-TDD-NB*

The *BCCH-BCH-Message-TDD-NB* class is the set of RRC messages that may be sent from the E-UTRAN to the UE via BCH on the BCCH logical channel in TDD.

```
-- ASN1START
```

```

BCCH-BCH-Message-TDD-NB ::= SEQUENCE {
    message          BCCH-BCH-MessageType-TDD-NB-r15
}

BCCH-BCH-MessageType-TDD-NB-r15 ::= MasterInformationBlock-TDD-NB-r15

-- ASN1STOP

```

### – *BCCH-DL-SCH-Message-NB*

The *BCCH-DL-SCH-Message-NB* class is the set of RRC messages that may be sent from the E-UTRAN to the UE via DL-SCH on the BCCH logical channel.

```

-- ASN1START

BCCH-DL-SCH-Message-NB ::= SEQUENCE {
    message          BCCH-DL-SCH-MessageType-NB
}

BCCH-DL-SCH-MessageType-NB ::= CHOICE {
    c1              CHOICE {
        systemInformation-r13          SystemInformation-NB,
        systemInformationBlockType1-r13 SystemInformationBlockType1-NB
    },
    messageClassExtension SEQUENCE {}
}

-- ASN1STOP

```

### – *PCCH-Message-NB*

The *PCCH-Message-NB* class is the set of RRC messages that may be sent from the E-UTRAN to the UE on the PCCH logical channel.

```

-- ASN1START

PCCH-Message-NB ::= SEQUENCE {
    message          PCCH-MessageType-NB
}

PCCH-MessageType-NB ::= CHOICE {
    c1              CHOICE {
        paging-r13          Paging-NB
    },
    messageClassExtension SEQUENCE {}
}

-- ASN1STOP

```

### – *DL-CCCH-Message-NB*

The *DL-CCCH-Message-NB* class is the set of RRC messages that may be sent from the E-UTRAN to the UE on the downlink CCCH logical channel.

```

-- ASN1START

DL-CCCH-Message-NB ::= SEQUENCE {
    message          DL-CCCH-MessageType-NB
}

DL-CCCH-MessageType-NB ::= CHOICE {
    c1              CHOICE {
        rrcConnectionReestablishment-r13          RRCConnectionReestablishment-NB,
        rrcConnectionReestablishmentReject-r13   RRCConnectionReestablishmentReject,
        rrcConnectionReject-r13                 RRCConnectionReject-NB,
        rrcConnectionSetup-r13                  RRCConnectionSetup-NB,
        rrcEarlyDataComplete-r15                RRCEarlyDataComplete-NB-r15,
        spare3 NULL, spare2 NULL, spare1 NULL
    }
}

```

```

    },
    messageClassExtension SEQUENCE {}
}
-- ASN1STOP

```

### – *DL-DCCH-Message-NB*

The *DL-DCCH-Message-NB* class is the set of RRC messages that may be sent from the E-UTRAN to the UE on the downlink DCCH logical channel.

```

-- ASN1START
DL-DCCH-Message-NB ::= SEQUENCE {
    message DL-DCCH-MessageType-NB
}
DL-DCCH-MessageType-NB ::= CHOICE {
    c1 CHOICE {
        dlInformationTransfer-r13 DLInformationTransfer-NB,
        rrcConnectionReconfiguration-r13 RRCConnectionReconfiguration-NB,
        rrcConnectionRelease-r13 RRCConnectionRelease-NB,
        securityModeCommand-r13 SecurityModeCommand,
        ueCapabilityEnquiry-r13 UECapabilityEnquiry-NB,
        rrcConnectionResume-r13 RRCConnectionResume-NB,
        ueInformationRequest-r16 UEInformationRequest-NB-r16,
        spare1 NULL
    },
    messageClassExtension SEQUENCE {}
}
-- ASN1STOP

```

### – *UL-CCCH-Message-NB*

The *UL-CCCH-Message-NB* class is the set of RRC messages that may be sent from the UE to the E-UTRAN on the uplink CCCH logical channel.

```

-- ASN1START
UL-CCCH-Message-NB ::= SEQUENCE {
    message UL-CCCH-MessageType-NB
}
UL-CCCH-MessageType-NB ::= CHOICE {
    c1 CHOICE {
        rrcConnectionReestablishmentRequest-r13 RRCConnectionReestablishmentRequest-NB,
        rrcConnectionRequest-r13 RRCConnectionRequest-NB,
        rrcConnectionResumeRequest-r13 RRCConnectionResumeRequest-NB,
        rrcEarlyDataRequest-r15 RREarlyDataRequest-NB-r15
    },
    messageClassExtension SEQUENCE {}
}
-- ASN1STOP

```

### – *SC-MCCH-Message-NB*

The *SC-MCCH-Message-NB* class is the set of RRC messages that may be sent from the E-UTRAN to the NB-IoT UE on the SC-MCCH logical channel.

```

-- ASN1START
SC-MCCH-Message-NB ::= SEQUENCE {
    message SC-MCCH-MessageType-NB
}

```

```

SC-MCCH-MessageType-NB ::= CHOICE {
  c1 CHOICE {
    scptmConfiguration-r14 SCPTMConfiguration-NB-r14
  },
  messageClassExtension SEQUENCE {}
}
-- ASN1STOP

```

## – *UL-DCCH-Message-NB*

The *UL-DCCH-Message-NB* class is the set of RRC messages that may be sent from the UE to the E-UTRAN on the uplink DCCH logical channel.

```

-- ASN1START
UL-DCCH-Message-NB ::= SEQUENCE {
  message UL-DCCH-MessageType-NB
}
UL-DCCH-MessageType-NB ::= CHOICE {
  c1 CHOICE {
    rrcConnectionReconfigurationComplete-r13 RRCConnectionReconfigurationComplete-NB,
    rrcConnectionReestablishmentComplete-r13 RRCConnectionReestablishmentComplete-NB,
    rrcConnectionSetupComplete-r13 RRCConnectionSetupComplete-NB,
    securityModeComplete-r13 SecurityModeComplete,
    securityModeFailure-r13 SecurityModeFailure,
    ueCapabilityInformation-r13 UECapabilityInformation-NB,
    ulInformationTransfer-r13 ULInformationTransfer-NB,
    rrcConnectionResumeComplete-r13 RRCConnectionResumeComplete-NB,
    ueInformationResponse-r16 UEInformationResponse-NB-r16,
    purConfigurationRequest-r16 PURConfigurationRequest-NB-r16,
    spare6 NULL, spare5 NULL, spare4 NULL,
    spare3 NULL, spare2 NULL, spare1 NULL
  },
  messageClassExtension SEQUENCE {}
}
-- ASN1STOP

```

## 6.7.2 NB-IoT Message definitions

### – *DLInformationTransfer-NB*

The *DLInformationTransfer-NB* message is used for the downlink transfer of NAS dedicated information.

Signalling radio bearer: SRB1 or SRB1bis

RLC-SAP: AM

Logical channel: DCCH

Direction: E-UTRAN to UE

#### ***DLInformationTransfer-NB* message**

```

-- ASN1START
DLInformationTransfer-NB ::= SEQUENCE {
  rrc-TransactionIdentifier RRC-TransactionIdentifier,
  criticalExtensions CHOICE {
    c1 CHOICE {
      dlInformationTransfer-r13 DLInformationTransfer-NB-r13-IEs,
      spare1 NULL
    },
    criticalExtensionsFuture SEQUENCE {}
}

```

```

}
}
DLInformationTransfer-NB-r13-IEs ::= SEQUENCE {
    dedicatedInfoNAS-r13          DedicatedInfoNAS,
    lateNonCriticalExtension      OCTET STRING                OPTIONAL,
    nonCriticalExtension          SEQUENCE {}                        OPTIONAL
}
-- ASN1STOP

```

### ***MasterInformationBlock-NB***

The *MasterInformationBlock-NB* includes the system information transmitted on BCH in FDD.

Signalling radio bearer: N/A

RLC-SAP: TM

Logical channel: BCCH

Direction: E-UTRAN to UE

### ***MasterInformationBlock-NB***

```

-- ASN1START
MasterInformationBlock-NB ::= SEQUENCE {
    systemFrameNumber-MSB-r13    BIT STRING (SIZE (4)),
    hyperSFN-LSB-r13            BIT STRING (SIZE (2)),
    schedulingInfoSIB1-r13      INTEGER (0..15),
    systemInfoValueTag-r13      INTEGER (0..31),
    ab-Enabled-r13              BOOLEAN,
    operationModeInfo-r13       CHOICE {
        inband-SamePCI-r13      Inband-SamePCI-NB-r13,
        inband-DifferentPCI-r13 Inband-DifferentPCI-NB-r13,
        guardband-r13          Guardband-NB-r13,
        standalone-r13         Standalone-NB-r13
    },
    additionalTransmissionSIB1-r15 BOOLEAN,
    ab-Enabled-5GC-r16          BOOLEAN,
    partEARFCN-r17             CHOICE {
        spare                  BIT STRING (SIZE (2)),
        earfcn-LSB             BIT STRING (SIZE (2))
    },
    spare                       BIT STRING (SIZE (6))
}

Guardband-NB-r13 ::= SEQUENCE {
    rasterOffset-r13           ChannelRasterOffset-NB-r13,
    spare                      BIT STRING (SIZE (3))
}

Inband-SamePCI-NB-r13 ::= SEQUENCE {
    eutra-CRS-SequenceInfo-r13 INTEGER (0..31)
}

Inband-DifferentPCI-NB-r13 ::= SEQUENCE {
    eutra-NumCRS-Ports-r13     ENUMERATED {same, four},
    rasterOffset-r13           ChannelRasterOffset-NB-r13,
    spare                      BIT STRING (SIZE (2))
}

Standalone-NB-r13 ::= SEQUENCE {
    spare                      BIT STRING (SIZE (5))
}
-- ASN1STOP

```

<b>MasterInformationBlock-NB field descriptions</b>
<b>ab-Enabled</b> Value TRUE indicates that access barring is enabled for UEs connected to EPC.
<b>ab-Enabled-5GC</b> Value TRUE indicates that access barring is enabled for UEs connected to 5GC.
<b>additionalTransmissionSIB1</b> Value TRUE indicates that additional SIB1-NB transmissions are present. See TS 36.211 [21] and TS 36.213 [23]. E-UTRAN only configures <i>additionalTransmissionSIB1</i> to <i>TRUE</i> if <i>schedulingInfoSIB1</i> indicates that the number of NPDSCH repetitions is 16, see TS 36.213 [23], Table 16.4.1.3-3.
<b>earfcn-LSB</b> Indicates the 2 least significant bits of the EARFCN for NTN bands where 100 kHz raster is used, see TS 36.102 [113].
<b>eutra-CRS-SequenceInfo</b> Information of the carrier containing NPSS/NSSS/NPBCH. Each value is associated with an E-UTRA PRB index as an offset from the middle of the LTE system sorted out by channel raster offset. See TS 36.211[21] and TS 36.213 [23].
<b>eutra-NumCRS-Ports</b> Number of E-UTRA CRS antenna ports, either the same number of ports as NRS or 4 antenna ports. See TS 36.211 [21], TS 36.212 [22], and TS 36.213 [23].
<b>hyperSFN-LSB</b> Indicates the 2 least significant bits of hyper SFN. The remaining bits are present in <i>SystemInformationBlockType1-NB</i> .
<b>operationModeInfo</b> Deployment scenario (in-band/guard-band/standalone) and related information. See TS 36.211 [21] and TS 36.213 [23]. <i>Inband-SamePCI</i> indicates an in-band deployment and that the NB-IoT and LTE cell share the same physical cell id and have the same number of NRS and CRS ports. <i>Inband-DifferentPCI</i> indicates an in-band deployment and that the NB-IoT and LTE cell have different physical cell id. <i>guardband</i> indicates a guard-band deployment. <i>standalone</i> indicates a standalone deployment.
<b>schedulingInfoSIB1</b> This field contains an index to a table specified in TS 36.213 [23], Table 16.4.1.3-3, that defines <i>SystemInformationBlockType1-NB</i> scheduling information.
<b>systemFrameNumber-MSB</b> Defines the 4 most significant bits of the SFN. As indicated in TS 36.211 [21], the 6 least significant bits of the SFN are acquired implicitly by decoding the NPBCH.
<b>systemInfoValueTag</b> Common for all SIBs other than MIB-NB, SIB14-NB, SIB16-NB, SIB31-NB and SIB33-NB.

## – *MasterInformationBlock-TDD-NB*

The *MasterInformationBlock-TDD-NB* includes the system information transmitted on BCH in TDD.

Signalling radio bearer: N/A

RLC-SAP: TM

Logical channel: BCCH

Direction: E-UTRAN to UE

### **MasterInformationBlock-TDD-NB**

```
-- ASN1START
MasterInformationBlock-TDD-NB-r15 ::= SEQUENCE {
    systemFrameNumber-MSB-r15      BIT STRING (SIZE (4)),
    hyperSFN-LSB-r15               BIT STRING (SIZE (2)),
    schedulingInfoSIB1-r15         INTEGER (0..15),
    systemInfoValueTag-r15        INTEGER (0..31),
    ab-Enabled-r15                 BOOLEAN,
    operationModeInfo-r15         CHOICE {
        inband-SamePCI-TDD-NB-r15  Inband-SamePCI-TDD-NB-r15,
        inband-DifferentPCI-r15    Inband-DifferentPCI-TDD-NB-r15,
        guardband-r15              GuardbandTDD-NB-r15,
        standalone-r15             StandaloneTDD-NB-r15
    },
    sib1-CarrierInfo-r15          ENUMERATED {anchor, non-anchor},
}
```

```

    ab-Enabled-5GC-r16          BOOLEAN,
    spare                       BIT STRING (SIZE (8))
}

GuardbandTDD-NB-r15 ::=      SEQUENCE {
    rasterOffset-r15          ChannelRasterOffset-NB-r13,
    sib-GuardbandInfo-r15     CHOICE {
        sib-GuardbandAnchor-r15    SIB-GuardbandAnchorTDD-NB-r15,
        sib-GuardbandGuardband-r15 SIB-GuardbandGuardbandTDD-NB-r15,
        sib-GuardbandInbandSamePCI-r15 SIB-GuardbandInbandSamePCI-TDD-NB-r15,
        sib-GuardbandInbandDiffPCI-r15 SIB-GuardbandInbandDiffPCI-TDD-NB-r15
    },
    eutra-Bandwidth-r15      ENUMERATED {bw5or10, bw15or20}
}

Inband-SamePCI-TDD-NB-r15 ::= SEQUENCE {
    eutra-CRS-SequenceInfo-r15 INTEGER (0..31),
    sib-InbandLocation-r15     ENUMERATED {lower, higher}
}

Inband-DifferentPCI-TDD-NB-r15 ::= SEQUENCE {
    eutra-NumCRS-Ports-r15    ENUMERATED {same, four},
    rasterOffset-r15          ChannelRasterOffset-NB-r13,
    sib-InbandLocation-r15    ENUMERATED {lower, higher},
    spare                     BIT STRING (SIZE (2))
}

StandaloneTDD-NB-r15 ::= SEQUENCE {
    sib-StandaloneLocation-r15 ENUMERATED {lower, higher},
    spare                     BIT STRING (SIZE (5))
}

SIB-GuardbandAnchorTDD-NB-r15 ::= SEQUENCE {
    spare                     BIT STRING (SIZE (1))
}

SIB-GuardbandGuardbandTDD-NB-r15 ::= SEQUENCE {
    sib-GuardbandGuardbandLocation-r15 ENUMERATED {same, opposite}
}

SIB-GuardbandInbandSamePCI-TDD-NB-r15 ::= SEQUENCE {
    spare                     BIT STRING (SIZE (1))
}

SIB-GuardbandInbandDiffPCI-TDD-NB-r15 ::= SEQUENCE {
    sib-EUTRA-NumCRS-Ports-r15 ENUMERATED {same, four}
}

-- ASN1STOP

```



<b>MasterInformationBlock-TDD-NB field descriptions</b>
<p><b>ab-Enabled</b> Value TRUE indicates that access barring is enabled for UEs connected to EPC.</p>
<p><b>ab-Enabled-5GC</b> Value TRUE indicates that access barring is enabled for UEs connected to 5GC.</p>
<p><b>eutra-Bandwidth</b> EUTRA system bandwidth. Value <i>bw5or10</i> corresponds to bandwidth 5 or 10 MHz, value <i>bw15or20</i> corresponds to bandwidth 15 or 20 MHz. If the value of <i>eutra-Bandwidth</i> is <i>bw5or10</i> and <i>rasterOffset</i> is set to <i>khz7dot5</i> or <i>khz-7dot5</i>, the E-UTRA system bandwidth is 5 MHz. If the value of <i>eutra-Bandwidth</i> is <i>bw5or10</i> and <i>rasterOffset</i> is set to <i>khz2dot5</i> or <i>khz-2dot5</i>, the E-UTRA system bandwidth is 10 MHz. If the value of <i>eutra-Bandwidth</i> is <i>bw15or20</i> and <i>rasterOffset</i> is set to <i>khz7dot5</i> or <i>khz-7dot5</i>, the E-UTRA system bandwidth is 15 MHz. If the value of <i>eutra-Bandwidth</i> is <i>bw15or20</i> and <i>rasterOffset</i> is set to <i>khz2dot5</i> or <i>khz-2dot5</i>, the E-UTRA system bandwidth is 20 MHz. When the E-UTRA system bandwidth is 5 MHz or 15 MHz, if the value of <i>sib-GuardbandInfo</i> is <i>sib-GuardbandInbandSamePCI</i> or <i>sib-GuardbandinbandDiffPCI</i>, the offset between the anchor carrier and the non-anchor carrier used for SIB1 and/or SI transmission is 45 kHz.</p>
<p><b>eutra-CRS-SequencelInfo</b> Information of the carrier containing NPSS/NSSS/NPBCH. Each value is associated with an E-UTRA PRB index as an offset from the middle of the LTE system sorted out by channel raster offset. See TS 36.211 [21] and TS 36.213 [23].</p>
<p><b>eutra-NumCRS-Ports, sib-eutra-NumCRS-Ports</b> Number of E-UTRA CRS antenna ports, either the same number of ports as NRS or 4 antenna ports. See TS 36.211 [21], TS 36.212 [22], and TS 36.213 [23].</p>
<p><b>hyperSFN-LSB</b> Indicates the 2 least significant bits of hyper SFN. The remaining bits are present in <i>SystemInformationBlockType1-NB</i>.</p>
<p><b>operationModelInfo</b> Deployment scenario (in-band/guard-band/standalone) and related information. See TS 36.211 [21] and TS 36.213 [23]. <i>Inband-SamePCI</i> indicates an in-band deployment and that the NB-IoT and LTE cell share the same physical cell id and have the same number of NRS and CRS ports. <i>Inband-DifferentPCI</i> indicates an in-band deployment and that the NB-IoT and LTE cell have different physical cell id. <i>guardband</i> indicates a guard-band deployment. <i>standalone</i> indicates a standalone deployment. When <i>operationmodelInfo</i> is set to <i>guardband</i>, if <i>rasterOffset</i> is set to <i>khz-7dot5</i> or <i>khz-2dot5</i>, the guardband anchor carrier is at the higher edge of the LTE carrier. If <i>rasterOffset</i> is set to <i>khz7dot5</i> or <i>khz2dot5</i>, the guardband anchor carrier is at the lower edge of the LTE carrier</p>
<p><b>schedulingInfoSIB1</b> This field contains an index to a table specified in TS 36.213 [23], Table 16.4.1.3-5 or Table 16.4.1.3-7 when <i>sib1-CarrierInfo</i> is set to <i>anchor</i> or to <i>non-anchor</i> respectively, that defines <i>SystemInformationBlockType1-NB</i> scheduling information. If <i>sib1-CarrierInfo</i> is set to <i>non-anchor</i>, E-UTRAN configures a value between 0 and 7.</p>
<p><b>sib-GuardbandGuardbandLocation</b> Location of the non-anchor carrier used for SIB1 and/or SI transmission when <i>operationmodelInfo</i> is set to <i>guardband</i> and the non-anchor carrier is in guardband. See TS 36.213 [23]. Value <i>same</i> corresponds to the carrier adjacent to the anchor carrier on the outer side of the guardband, value <i>opposite</i> corresponds to the carrier closest to the edge of the LTE carrier in the opposite guardband.</p>
<p><b>sib-GuardbandInfo</b> Information of the carrier used for SIB1 and/or SI transmission when <i>operationmodelInfo</i> is set to <i>guardband</i>. See TS 36.213 [23]. <i>sib-GuardbandAnchor</i> indicates the anchor carrier. <i>sib-GuardbandGuardband</i> indicates a non-anchor carrier in guardband mode. <i>sib-GuardbandInbandSamePCI</i> or <i>sib-GuardbandinbandDiffPCI</i> indicates a non-anchor carrier in inband mode, and at the edge of the LTE carrier and on the same side as the anchor carrier.</p>
<p><b>sib-InbandLocation</b> Location of the non-anchor carrier used for SIB1 and/or SI transmission when <i>operationmodelInfo</i> is set to <i>inband-SamePCI</i> or <i>inband-DifferentPCI</i>, and <i>sib1-CarrierInfo</i> value and/or <i>tdd-SI-CarrierInfo</i> in SIB1-NB is set to <i>non-anchor</i>. See TS 36.213 [23]. Value <i>lower</i> corresponds to the lower adjacent carrier relative to the anchor carrier and value <i>higher</i> corresponds to the higher adjacent carrier relative to the anchor carrier. If both <i>sib1-CarrierInfo</i> value and <i>tdd-SI-CarrierInfo</i> value in SIB1-NB are set to <i>anchor</i>, the UE ignores <i>sib-InbandLocation</i>.</p>

<b>MasterInformationBlock-TDD-NB field descriptions</b>
<p><b>sib-StandaloneLocation</b> Location of the non-anchor carrier used for SIB1 and/or SI transmission when <i>operationmodeInfo</i> is set to <i>standalone</i>, and <i>sib1-CarrierInfo</i> value and/or <i>tdt-SI-CarrierInfo</i> in SIB1-NB is set to <i>non-anchor</i>. See TS 36.213 [23]. Value <i>lower</i> corresponds to the lower adjacent carrier relative to the anchor carrier and value <i>higher</i> corresponds to the higher adjacent carrier relative to the anchor carrier. If both <i>sib1-CarrierInfo</i> value and <i>tdt-SI-CarrierInfo</i> value in SIB1-NB are set to <i>anchor</i>, the UE ignores <i>sib-StandaloneLocation</i>.</p>
<p><b>sib1-CarrierInfo</b> Carrier used for SIB1 transmission. See TS 36.213 [23], clause 16.4.1.3. Value <i>anchor</i> corresponds to anchor carrier, value <i>non-anchor</i> corresponds to non-anchor carrier.</p>
<p><b>systemFrameNumber-MSB</b> Defines the 4 most significant bits of the SFN. As indicated in TS 36.211 [21], the 6 least significant bits of the SFN are acquired implicitly by decoding the NPBCH.</p>
<p><b>systemInfoValueTag</b> Common for all SIBs other than MIB-NB, SIB14-NB and SIB16-NB.</p>

## – Paging-NB

The *Paging-NB* message is used for the notification of one or more UEs.

Signalling radio bearer: N/A

RLC-SAP: TM

Logical channel: PCCH

Direction: E-UTRAN to UE

### **Paging-NB message**

```

-- ASN1START
Paging-NB ::= SEQUENCE {
    pagingRecordList-r13          PagingRecordList-NB-r13          OPTIONAL,  -- Need ON
    systemInfoModification-r13   ENUMERATED {true}          OPTIONAL,  -- Need ON
    systemInfoModification-edrx-r13  ENUMERATED {true}          OPTIONAL,  -- Need ON
    nonCriticalExtension          Paging-NB-v1610-IEs          OPTIONAL
}

Paging-NB-v1610-IEs ::= SEQUENCE {
    pagingRecordList-v1610      PagingRecordList-NB-v1610      OPTIONAL,  -- Need ON
    nonCriticalExtension        SEQUENCE {}                  OPTIONAL
}

PagingRecordList-NB-r13 ::= SEQUENCE (SIZE (1..maxPageRec)) OF PagingRecord-NB-r13
PagingRecordList-NB-v1610 ::= SEQUENCE (SIZE (1..maxPageRec)) OF PagingRecord-NB-v1610
PagingRecord-NB-r13 ::= SEQUENCE {
    ue-Identity-r13
    ...
}

PagingRecord-NB-v1610 ::= SEQUENCE {
    mt-EDT-r16                  ENUMERATED {true}          OPTIONAL  -- Need ON
}
-- ASN1STOP

```

<b>Paging-NB field descriptions</b>
<b>mt-EDT</b> Indication of mobile-terminated EDT.
<b>pagingRecordList</b> If E-UTRAN includes <i>pagingRecordList-v1610</i> , it includes the same number of entries, and listed in the same order, as in <i>pagingRecordList</i> (i.e. without suffix).
<b>systemInfoModification</b> If present: indication of a BCCH modification other than for <i>SystemInformationBlockType14-NB</i> (SIB14-NB), <i>SystemInformationBlockType16-NB</i> (SIB16-NB) and <i>SystemInformationBlockType31-NB</i> (SIB31-NB). This indication does not apply to UEs using eDRX cycle longer than the BCCH modification period.
<b>systemInfoModification-eDRX</b> If present: indication of a BCCH modification other than for <i>SystemInformationBlockType14-NB</i> (SIB14-NB), <i>SystemInformationBlockType16-NB</i> (SIB16-NB) and <i>SystemInformationBlockType31-NB</i> (SIB31-NB). This indication applies only to UEs using eDRX cycle longer than the BCCH modification period.
<b>ue-Identity</b> Provides the NAS identity of the UE that is being paged.

## – *PURConfigurationRequest-NB*

The *PURConfigurationRequest-NB* message is used by the UE to transfer PUR related information to the E-UTRAN.

Signalling radio bearer: SRB1 or SRB1bis

RLC-SAP: AM

Logical channel: DCCH

Direction: UE to E-UTRAN

### ***PURConfigurationRequest-NB* message**

```
-- ASN1START
PURConfigurationRequest-NB-r16 ::= SEQUENCE {
    criticalExtensions          CHOICE {
        purConfigurationRequest-r16  PURConfigurationRequest-NB-r16-IEs,
        criticalExtensionsFuture      SEQUENCE {}
    }
}

PURConfigurationRequest-NB-r16-IEs ::= SEQUENCE {
    pur-ConfigRequest-r16          PUR-ConfigRequest-NB-r16          OPTIONAL,
    lateNonCriticalExtension        OCTET STRING                OPTIONAL,
    nonCriticalExtension            SEQUENCE {}                    OPTIONAL
}

PUR-ConfigRequest-NB-r16 ::= CHOICE{
    pur-ReleaseRequest             NULL,
    pur-SetupRequest              SEQUENCE {
        requestedNumOccasions-r16  ENUMERATED {one, infinite},
        requestedPeriodicityAndOffset-r16  PUR-PeriodicityAndOffset-NB-r16,
        requestedTBS-r16           ENUMERATED {b328, b376, b424, b472, b504, b552, b584,
                                             b616, b680, b744, b776, b808, b872, b904,
                                             b936, b968, b1000, b1032, b1096, b1128,
                                             b1192, b1224, b1256, b1352, b1384, b1544,
                                             b1608, b1736, b1800, b2024, b2280, b2536},
        rrc-ACK-r16                ENUMERATED {true}                OPTIONAL
    }
}
-- ASN1STOP
```

<b>PURConfigurationRequest-NB field descriptions</b>
<b>requestedNumOccasions</b> Indicates the requested number of PUR occasions. Value <i>one</i> corresponds to one occasion and value <i>infinite</i> corresponds to infinite occasions.
<b>requestedPeriodicityAndOffset</b> Indicates the requested periodicity of the PUR occasions and time offset until the first PUR occasion.
<b>requestedTBS</b> Indicates the requested TBS. Value <i>b328</i> corresponds to 328 bits, value <i>b376</i> corresponds to 376 bits, and so on.
<b>rrc-ACK</b> Indicates RRC response message is preferred by the UE for acknowledging the reception of a transmission using PUR.

## – RRCConnectionReconfiguration-NB

The *RRCConnectionReconfiguration-NB* message is the command to modify an RRC connection. It may convey information for resource configuration (including RBs, MAC main configuration and physical channel configuration) including any associated dedicated NAS information.

Signalling radio bearer: SRB1

RLC-SAP: AM

Logical channel: DCCH

Direction: E-UTRAN to UE

### **RRCConnectionReconfiguration-NB message**

```
-- ASN1START
RRCConnectionReconfiguration-NB ::= SEQUENCE {
    rrc-TransactionIdentifier          RRC-TransactionIdentifier,
    criticalExtensions                 CHOICE {
        c1                             CHOICE {
            rrcConnectionReconfiguration-r13    RRCConnectionReconfiguration-NB-r13-IEs,
            spare1 NULL
        },
        criticalExtensionsFuture             SEQUENCE {}
    }
}

RRCConnectionReconfiguration-NB-r13-IEs ::= SEQUENCE {
    dedicatedInfoNASList-r13          SEQUENCE (SIZE(1..maxDRB-NB-r13)) OF
                                        DedicatedInfoNAS                      OPTIONAL, -- Need ON
    radioResourceConfigDedicated-r13 RadioResourceConfigDedicated-NB-r13 OPTIONAL, -- Need ON
    fullConfig-r13                    ENUMERATED {true}                       OPTIONAL, -- Cond
    Reestab
        lateNonCriticalExtension       OCTET STRING                          OPTIONAL,
        nonCriticalExtension            RRCConnectionReconfiguration-NB-v16f0-IEs OPTIONAL
}

RRCConnectionReconfiguration-NB-v16f0-IEs ::= SEQUENCE {
    obtainLocationNB-r16              ENUMERATED {setup}                      OPTIONAL, -- Need OR
    nonCriticalExtension               SEQUENCE {}                          OPTIONAL
}
-- ASN1STOP
```

<b>RRCConnectionReconfiguration-NB field descriptions</b>
<b>dedicatedInfoNASList</b> This field is used to transfer UE specific NAS layer information between the network and the UE. The RRC layer is transparent for each PDU in the list.
<b>fullConfig</b> Indicates the full configuration option is applicable for the RRC Connection Reconfiguration message.

Conditional presence	Explanation
<i>Reestab</i>	This field is optionally present, need ON upon the first reconfiguration after RRC connection re-establishment; otherwise the field is not present.

### – *RRCCONNECTIONRECONFIGURATIONCOMPLETE-NB*

The *RRCCONNECTIONRECONFIGURATIONCOMPLETE-NB* message is used to confirm the successful completion of an RRC connection reconfiguration.

Signalling radio bearer: SRB1

RLC-SAP: AM

Logical channel: DCCH

Direction: UE to E-UTRAN

#### ***RRCCONNECTIONRECONFIGURATIONCOMPLETE-NB* message**

```
-- ASN1START
RRCCONNECTIONRECONFIGURATIONCOMPLETE-NB ::= SEQUENCE {
    rrc-TransactionIdentifier      RRC-TransactionIdentifier,
    criticalExtensions              CHOICE {
        rrcConnectionReconfigurationComplete-r13  RRCCONNECTIONRECONFIGURATIONCOMPLETE-NB-r13-IEs,
        criticalExtensionsFuture                  SEQUENCE {}
    }
}

RRCCONNECTIONRECONFIGURATIONCOMPLETE-NB-r13-IEs ::= SEQUENCE {
    lateNonCriticalExtension      OCTET STRING          OPTIONAL,
    nonCriticalExtension          SEQUENCE {}           OPTIONAL
}
-- ASN1STOP
```

### – *RRCCONNECTIONREESTABLISHMENT-NB*

The *RRCCONNECTIONREESTABLISHMENT-NB* message is used to re-establish SRB1.

Signalling radio bearer: SRB0

RLC-SAP: TM

Logical channel: CCCH

Direction: E-UTRAN to UE

#### ***RRCCONNECTIONREESTABLISHMENT-NB* message**

```
-- ASN1START
RRCCONNECTIONREESTABLISHMENT-NB ::= SEQUENCE {
    rrc-TransactionIdentifier      RRC-TransactionIdentifier,
    criticalExtensions              CHOICE {
        cl                                  CHOICE {
            rrcConnectionReestablishment-r13  RRCCONNECTIONREESTABLISHMENT-NB-r13-IEs,
            spare1 NULL
        },
        criticalExtensionsFuture          SEQUENCE {}
    }
}

RRCCONNECTIONREESTABLISHMENT-NB-r13-IEs ::= SEQUENCE {
    radioResourceConfigDedicated-r13      RadioResourceConfigDedicated-NB-r13,
    nextHopChainingCount-r13              NextHopChainingCount,
    lateNonCriticalExtension              OCTET STRING          OPTIONAL,
    nonCriticalExtension                  RRCCONNECTIONREESTABLISHMENT-NB-v1430-IEs  OPTIONAL
}
```

```

}
RRCConnectionReestablishment-NB-v1430-IEs ::= SEQUENCE {
  dl-NAS-MAC                BIT STRING (SIZE (16))  OPTIONAL,  -- Cond Reestablish-CP
  nonCriticalExtension      SEQUENCE {}             OPTIONAL
}
-- ASN1STOP

```

#### ***RRCConnectionReestablishment-NB* field descriptions**

##### ***dl-NAS-MAC***

Downlink authentication token, see TS 33.401 [32]. If this field is present, the UE shall ignore the field *nextHopChainingCount*.

Conditional presence	Explanation
<i>Reestablish-CP</i>	This field is mandatory present for NB-IoT UE using the Control Plane CIoT EPS/5GS optimisation; otherwise the field is not present.

### ***RRCConnectionReestablishmentComplete-NB***

The *RRCConnectionReestablishmentComplete-NB* message is used to confirm the successful completion of an RRC connection re-establishment.

Signalling radio bearer: SRB1 or SRB1bis

RLC-SAP: AM

Logical channel: DCCH

Direction: UE to E-UTRAN

#### ***RRCConnectionReestablishmentComplete-NB* message**

```

-- ASN1START
RRCConnectionReestablishmentComplete-NB ::= SEQUENCE {
  rrc-TransactionIdentifier  RRC-TransactionIdentifier,
  criticalExtensions         CHOICE {
    rrcConnectionReestablishmentComplete-r13  RRCConnectionReestablishmentComplete-NB-r13-IEs,
    criticalExtensionsFuture                  SEQUENCE {}
  }
}
RRCConnectionReestablishmentComplete-NB-r13-IEs ::= SEQUENCE {
  lateNonCriticalExtension  OCTET STRING                OPTIONAL,
  nonCriticalExtension      RRCConnectionReestablishmentComplete-NB-v1470-IEs  OPTIONAL
}
RRCConnectionReestablishmentComplete-NB-v1470-IEs ::= SEQUENCE {
  measResultServCell-r14    MeasResultServCell-NB-r14    OPTIONAL,
  nonCriticalExtension      RRCConnectionReestablishmentComplete-NB-v1610-IEs  OPTIONAL
}
RRCConnectionReestablishmentComplete-NB-v1610-IEs ::= SEQUENCE {
  rlf-InfoAvailable-r16     ENUMERATED {true}           OPTIONAL,
  anr-InfoAvailable-r16     ENUMERATED {true}           OPTIONAL,
  nonCriticalExtension      RRCConnectionReestablishmentComplete-NB-v1710-IEs  OPTIONAL
}
RRCConnectionReestablishmentComplete-NB-v1710-IEs ::= SEQUENCE {
  gnss-ValidityDuration-r17 GNSS-ValidityDuration-r17    OPTIONAL,
  nonCriticalExtension      RRCConnectionReestablishmentComplete-NB-v1800-IEs  OPTIONAL
}
RRCConnectionReestablishmentComplete-NB-v1800-IEs ::= SEQUENCE {
  gnss-PositionFixDuration-r18 GNSS-PositionFixDuration-r18  OPTIONAL,
  nonCriticalExtension      SEQUENCE {}                 OPTIONAL
}

```

```
-- ASN1STOP
```

### ***RRCCONNECTIONREESTABLISHMENTCOMPLETE-NB field descriptions***

#### ***anr-InfoAvailable***

Indicates the availability of ANR measurement information.

#### ***measResultServCell***

This field refers to the last idle mode measurement results taken of the serving cell.

#### ***rlf-InfoAvailable***

Indicates the availability of radio link failure related information.

## ***RRCCONNECTIONREESTABLISHMENTREQUEST-NB***

The *RRCCONNECTIONREESTABLISHMENTREQUEST-NB* message is used to request the reestablishment of an RRC connection.

Signalling radio bearer: SRB0

RLC-SAP: TM

Logical channel: CCCH

Direction: UE to E-UTRAN

### ***RRCCONNECTIONREESTABLISHMENTREQUEST-NB message***

```
-- ASN1START

RRCCONNECTIONREESTABLISHMENTREQUEST-NB ::= SEQUENCE {
    criticalExtensions          CHOICE {
        rrcConnectionReestablishmentRequest-r13
                                RRCCONNECTIONREESTABLISHMENTREQUEST-NB-r13-IEs,
        later                   CHOICE {
            rrcConnectionReestablishmentRequest-r14
                                RRCCONNECTIONREESTABLISHMENTREQUEST-NB-r14-IEs,
            later                 CHOICE {
                rrcConnectionReestablishmentRequest-r16
                                RRCCONNECTIONREESTABLISHMENTREQUEST-5GC-NB-r16-IEs,
                criticalExtensionsFuture SEQUENCE {}
            }
        }
    }
}

RRCCONNECTIONREESTABLISHMENTREQUEST-NB-r13-IEs ::= SEQUENCE {
    ue-Identity-r13          ReestabUE-Identity,
    reestablishmentCause-r13 ReestablishmentCause-NB-r13,
    cqi-NPDCCH-r14          CQI-NPDCCH-NB-r14,
    earlyContentionResolution-r14 BOOLEAN,
    spare                    BIT STRING (SIZE (20))
}

RRCCONNECTIONREESTABLISHMENTREQUEST-NB-r14-IEs ::= SEQUENCE {
    ue-Identity-r14          ReestabUE-Identity-CP-NB-r14,
    reestablishmentCause-r14 ReestablishmentCause-NB-r13,
    cqi-NPDCCH-r14          CQI-NPDCCH-Short-NB-r14,
    earlyContentionResolution-r14 BOOLEAN,
    spare                    BIT STRING (SIZE (1))
}

RRCCONNECTIONREESTABLISHMENTREQUEST-5GC-NB-r16-IEs ::= SEQUENCE {
    ue-Identity-r16          ReestabUE-Identity-CP-5GC-NB-r16,
    reestablishmentCause-r16 ReestablishmentCause-NB-r13,
    cqi-NPDCCH-r16          CQI-NPDCCH-Short-NB-r14,
    spare                    BIT STRING (SIZE (1))
}

ReestablishmentCause-NB-r13 ::= ENUMERATED {
    reconfigurationFailure, otherFailure,
    spare2, spare1}

ReestabUE-Identity-CP-NB-r14 ::= SEQUENCE {
    s-TMSI-r14
}

```

```

    ul-NAS-MAC-r14                BIT STRING (SIZE (16)),
    ul-NAS-Count-r14              BIT STRING (SIZE (5))
}

ReestabUE-Identity-CP-5GC-NB-r16 ::= SEQUENCE {
    truncated5G-S-TMSI-r16        BIT STRING (SIZE (40)),
    ul-NAS-MAC-r16                BIT STRING (SIZE (16)),
    ul-NAS-Count-r16              BIT STRING (SIZE (5))
}

-- ASN1STOP

```

#### ***RRCCONNECTIONREESTABLISHMENTREQUEST-NB* field descriptions**

##### ***earlyContentionResolution***

Value TRUE indicates UE supports MAC PDU containing the UE contention resolution identity MAC control element without RRC response message. This field is always set to TRUE in this version of the specification.

##### ***reestablishmentCause***

Indicates the failure cause that triggered the re-establishment procedure.  
eNB is not expected to reject a *RRCCONNECTIONREESTABLISHMENTREQUEST* due to unknown cause value being used by the UE.

##### ***truncated5G-S-TMSI***

For description of this field see TS 23.003 [27].

##### ***ue-Identity***

UE identity included to retrieve UE context and to facilitate contention resolution by lower layers.

##### ***ul-NAS-Count***

For description of this field see TS 33.401 [32] for EPC, and TS 33.501 [86] for 5GC.

##### ***ul-NAS-MAC***

For description of this field see TS 33.401 [32] for EPC, and TS 33.501 [86] for 5GC.

#### ***RRCCONNECTIONREJECT-NB***

The *RRCCONNECTIONREJECT-NB* message is used to reject the RRC connection establishment or RRC connection resume or to reject the EDT procedure.

Signalling radio bearer: SRB0

RLC-SAP: TM

Logical channel: CCCH

Direction: E-UTRAN to UE

#### ***RRCCONNECTIONREJECT-NB* message**

```

-- ASN1START

RRCCONNECTIONREJECT-NB ::= SEQUENCE {
    criticalExtensions      CHOICE {
        c1                  CHOICE {
            rrcConnectionReject-r13    RRCCONNECTIONREJECT-NB-r13-IEs,
            spare1 NULL
        },
        criticalExtensionsFuture      SEQUENCE {}
    }
}

RRCCONNECTIONREJECT-NB-r13-IEs ::= SEQUENCE {
    extendedWaitTime-r13      INTEGER (1..1800),
    rrc-SuspendIndication-r13  ENUMERATED {true}           OPTIONAL, -- Need ON
    lateNonCriticalExtension   OCTET STRING           OPTIONAL,
    nonCriticalExtension        SEQUENCE {}           OPTIONAL
}

-- ASN1STOP

```



<b><i>RRConnectionReject-NB</i> field descriptions</b>
<b><i>extendedWaitTime</i></b> Value in seconds.
<b><i>rrc-SuspendIndication</i></b> If present, this field indicates that the UE should remain suspended and not release its stored context.

## – *RRConnectionRelease-NB*

The *RRConnectionRelease-NB* message is used to command the release of an RRC connection, or to complete an UP-EDT procedure.

Signalling radio bearer: SRB1 or SRB1bis

RLC-SAP: AM

Logical channel: DCCH

Direction: E-UTRAN to UE

### ***RRConnectionRelease-NB* message**

```
-- ASN1START
RRConnectionRelease-NB ::= SEQUENCE {
    rrc-TransactionIdentifier      RRC-TransactionIdentifier,
    criticalExtensions             CHOICE {
        c1                        CHOICE {
            rrcConnectionRelease-r13  RRConnectionRelease-NB-r13-IEs,
            spare1 NULL
        },
        criticalExtensionsFuture      SEQUENCE {}
    }
}

RRConnectionRelease-NB-r13-IEs ::= SEQUENCE {
    releaseCause-r13              ReleaseCause-NB-r13,
    resumeIdentity-r13            ResumeIdentity-r13                OPTIONAL, -- Need OR
    extendedWaitTime-r13         INTEGER (1..1800)            OPTIONAL, -- Need ON
    redirectedCarrierInfo-r13     RedirectedCarrierInfo-NB-r13  OPTIONAL, -- Need ON
    lateNonCriticalExtension      OCTET STRING                OPTIONAL,
    nonCriticalExtension          RRConnectionRelease-NB-v1430-IEs  OPTIONAL
}

RRConnectionRelease-NB-v1430-IEs ::= SEQUENCE {
    redirectedCarrierInfo-v1430    RedirectedCarrierInfo-NB-v1430  OPTIONAL, -- Cond
    redirection
    extendedWaitTime-CPdata-r14   INTEGER (1..1800)            OPTIONAL, -- Cond NoExtendedWaitTime
    nonCriticalExtension          RRConnectionRelease-NB-v1530-IEs  OPTIONAL
}

RRConnectionRelease-NB-v1530-IEs ::= SEQUENCE {
    drb-ContinueROHC-r15          ENUMERATED {true}            OPTIONAL, -- Cond UP-EDT
    nextHopChainingCount-r15     NextHopChainingCount          OPTIONAL, -- Cond EarlySec
    nonCriticalExtension          RRConnectionRelease-NB-v1550-IEs  OPTIONAL
}

RRConnectionRelease-NB-v1550-IEs ::= SEQUENCE {
    redirectedCarrierInfo-v1550    RedirectedCarrierInfo-NB-v1550  OPTIONAL, -- Cond
    redirection-TDD
    nonCriticalExtension          RRConnectionRelease-NB-v15b0-IEs  OPTIONAL
}

RRConnectionRelease-NB-v15b0-IEs ::= SEQUENCE {
    noLastCellUpdate-r15         ENUMERATED {true}            OPTIONAL, -- Need OP
    nonCriticalExtension          RRConnectionRelease-NB-v1610-IEs  OPTIONAL
}

RRConnectionRelease-NB-v1610-IEs ::= SEQUENCE {
    resumeIdentity-r16            I-RNTI-r15                  OPTIONAL, -- Need OR
    anr-MeasConfig-r16           ANR-MeasConfig-NB-r16       OPTIONAL, -- Need OP
    pur-Config-r16               SetupRelease {PUR-Config-NB-r16}
    nonCriticalExtension          RRConnectionRelease-NB-v1700-IEs  OPTIONAL
}
```

```

}
RRCConnectionRelease-NB-v1700-IEs ::= SEQUENCE {
    cbp-Index-r17          INTEGER (1..2)          OPTIONAL,  -- Need OR
    nonCriticalExtension  SEQUENCE {}            OPTIONAL
}

ReleaseCause-NB-r13 ::= ENUMERATED {loadBalancingTAUrequired, other,
                                     rrc-Suspend, spare1}

RedirectedCarrierInfo-NB-r13 ::= CarrierFreq-NB-r13

RedirectedCarrierInfo-NB-v1430 ::= SEQUENCE {
    redirectedCarrierOffsetDedicated-r14  ENUMERATED{
        dB1, dB2, dB3, dB4, dB5, dB6, dB8, dB10,
        dB12, dB14, dB16, dB18, dB20, dB22, dB24, dB26},
    t322-r14                               ENUMERATED{
        min5, min10, min20, min30, min60, min120, min180,
        spare1}
}

RedirectedCarrierInfo-NB-v1550 ::= CarrierFreq-NB-v1550

-- ASN1STOP

```

### **RRCConnectionRelease-NB field descriptions**

#### **cbp-Index**

Index to the coverage-based paging configuration. Value 1 corresponds to the first entry in *cbp-ConfigList* and value 2 corresponds to the second entry in *cbp-ConfigList* in *SystemInformationBlockType22-NB*.

#### **drb-ContinueROHC**

This field indicates whether to continue or reset the header compression protocol context for the DRBs configured with the header compression protocol. Presence of the field indicates that the header compression protocol context continues when UE initiates UP-EDT in the same cell, while absence indicates that the header compression protocol context is reset.

#### **extendedWaitTime**

Value in seconds.

#### **extendedWaitTime-CPdata**

Wait time for data transfer using the Control Plane Clot EPS optimisation. Value in seconds. See TS 24.301 [35].

#### **noLastCellUpdate**

Presence of the field indicates that the last used cell for (G)WUS shall not be updated.

#### **redirectedCarrierInfo**

The *redirectedCarrierInfo* indicates a carrier frequency (downlink for FDD) and is used to redirect the UE to a NB-IoT carrier frequency, by means of the cell selection upon leaving RRC\_CONNECTED as specified in TS 36.304 [4].

#### **redirectedCarrierOffsetDedicated**

Parameter "Qoffsetdedicated<sub>frequency</sub>" in TS 36.304 [4]. For NB-IoT carrier frequencies, a UE that supports multi-band cells considers the *redirectedCarrierOffsetDedicated* to be common for all overlapping bands (i.e. regardless of the EARFCN that is used).

#### **releaseCause**

The *releaseCause* is used to indicate the reason for releasing the RRC Connection.

E-UTRAN should not set the *releaseCause* to *loadBalancingTAURequired* if the *extendedWaitTime* is present and/or if the UE is connected to 5GC.

#### **resumIdentity**

UE identity to facilitate UE context retrieval at eNB. E-UTRAN configures *resumIdentity-r13* only when the UE is connected to EPC and configures *resumIdentity-r16* only when the UE is connected to 5GC.

#### **t322**

Timer T322 as described in clause 7.3. Value minN corresponds to N minutes.

Conditional presence	Explanation
<i>NoExtendedWaitTime</i>	The field is optionally present, Need ON, if the <i>extendedWaitTime</i> is not included; otherwise the field is not present.
<i>Redirection</i>	The field is optionally present, Need ON, if <i>redirectedCarrierInfo</i> is included; otherwise the field is not present.
<i>Redirection-TDD</i>	The field is optionally present, Need ON, if <i>redirectedCarrierInfo</i> is included in TDD mode. Otherwise, the field is not present.
<i>UP-EDT</i>	The field is optionally present, Need ON, if the UE supports UP-EDT or UP transmission using PUR and <i>releaseCause</i> is set to <i>rrc-Suspend</i> ; otherwise the field is not present.
<i>EarlySec</i>	For EPC, the field is optionally present, Need ON, if the UE supports early security reactivation or UP-EDT or UP transmission using PUR and <i>releaseCause</i> is set to <i>rrc-Suspend</i> ; otherwise the field is not present. For 5GC, the field is mandatory present if <i>releaseCause</i> is set to <i>rrc-Suspend</i> ; otherwise the field is not present.

## – *RRCCConnectionRequest-NB*

The *RRCCConnectionRequest-NB* message is used to request the establishment of an RRC connection.

Signalling radio bearer: SRB0

RLC-SAP: TM

Logical channel: CCCH

Direction: UE to E-UTRAN

### ***RRCCConnectionRequest-NB* message**

```
-- ASN1START
RRCCConnectionRequest-NB ::= SEQUENCE {
    criticalExtensions      CHOICE {
        rrcConnectionRequest-r13      RRCCConnectionRequest-NB-r13-IEs,
        later                          CHOICE {
            rrcConnectionRequest-r16  RRCCConnectionRequest-5GC-NB-r16-IEs,
            criticalExtensionsFuture    SEQUENCE {}
        }
    }
}

RRCCConnectionRequest-NB-r13-IEs ::= SEQUENCE {
    ue-Identity-r13          InitialUE-Identity,
    establishmentCause-r13  EstablishmentCause-NB-r13,
    multiToneSupport-r13    ENUMERATED {true}           OPTIONAL,
    multiCarrierSupport-r13 ENUMERATED {true}           OPTIONAL,
    earlyContentionResolution-r14 BOOLEAN,
    cqi-NPDCCH-r14          CQI-NPDCCH-NB-r14,
    spare                    BIT STRING (SIZE (17))
}

RRCCConnectionRequest-5GC-NB-r16-IEs ::= SEQUENCE {
    ue-Identity-r16          InitialUE-Identity-5GC-NB-r16,
    establishmentCause-r16  ENUMERATED {
        mt-Access, mo-Signalling, mo-Data, mo-ExceptionData,
        spare4, spare3, spare2, spare1},
    cqi-NPDCCH-r16          CQI-NPDCCH-NB-r14,
    spare                    BIT STRING (SIZE (11))
}

InitialUE-Identity-5GC-NB-r16 ::= CHOICE {
    ng-5G-S-TMSI-r15        NG-5G-S-TMSI-r15,
    randomValue              BIT STRING (SIZE (48))
}
-- ASN1STOP
```

<b><i>RRCCONNECTIONREQUEST-NB</i> field descriptions</b>
<b><i>earlyContentionResolution</i></b> Value TRUE indicates UE supports MAC PDU containing the UE contention resolution identity MAC control element without RRC response message. This field is always set to TRUE in this version of the specification.
<b><i>establishmentCause</i></b> Provides the establishment cause for the RRC connection request as provided by the upper layers. eNB is not expected to reject a <i>RRCCONNECTIONREQUEST</i> due to unknown cause value being used by the UE.
<b><i>multiCarrierSupport</i></b> If present, this field indicates that the UE supports multi-carrier operation in the mode, FDD or TDD, used for access.
<b><i>multiToneSupport</i></b> If present, this field indicates that the UE supports UL multi-tone transmissions on NPUSCH in the mode, FDD or TDD, used for access.
<b><i>randomValue</i></b> Integer value in the range 0 to $2^{48} - 1$ .
<b><i>ue-Identity</i></b> UE identity included to facilitate contention resolution by lower layers.

### *RRCCONNECTIONRESUME-NB*

The *RRCCONNECTIONRESUME-NB* message is used to resume the suspended RRC connection.

Signalling radio bearer: SRB1

RLC-SAP: AM

Logical channel: DCCH

Direction: E-UTRAN to UE

### ***RRCCONNECTIONRESUME-NB* message**

```

-- ASN1START
RRCCONNECTIONRESUME-NB ::= SEQUENCE {
    rrc-TransactionIdentifier RRC-TransactionIdentifier,
    criticalExtensions CHOICE {
        c1 CHOICE {
            rrcConnectionResume-r13 RRCConnectionResume-NB-r13-IEs,
            spare1 NULL
        },
        criticalExtensionsFuture SEQUENCE {}
    }
}

RRCCONNECTIONRESUME-NB-r13-IEs ::= SEQUENCE {
    radioResourceConfigDedicated-r13 RadioResourceConfigDedicated-NB-r13 OPTIONAL, --
Need ON
    nextHopChainingCount-r13 NextHopChainingCount,
    drb-ContinueROHC-r13 ENUMERATED {true} OPTIONAL, -- Need OP
    lateNonCriticalExtension OCTET STRING OPTIONAL,
    nonCriticalExtension RRCCONNECTIONRESUME-NB-v1610-IEs OPTIONAL
}

RRCCONNECTIONRESUME-NB-v1610-IEs ::= SEQUENCE {
    fullConfig-r16 ENUMERATED {true} OPTIONAL, -- Cond 5GC
    nonCriticalExtension RRCCONNECTIONRESUME-NB-v16f0-IEs OPTIONAL
}

RRCCONNECTIONRESUME-NB-v16f0-IEs ::= SEQUENCE {
    obtainLocationNB-r16 ENUMERATED {setup} OPTIONAL, -- Need OR
    nonCriticalExtension SEQUENCE {} OPTIONAL
}
-- ASN1STOP

```

<b><i>RRCConnectionResume-NB</i> field descriptions</b>	
<b><i>drb-ContinueROHC</i></b>	This field indicates whether to continue or reset the header compression protocol context for the DRBs configured with the header compression protocol. Presence of the field indicates that the header compression protocol context continues while absence indicates that the header compression protocol context is reset.
<b><i>fullConfig</i></b>	Indicates that the full configuration option is applicable for the <i>RRCConnectionResume-NB</i> message.

<b>Conditional presence</b>	<b>Explanation</b>
5GC	The field is optionally present, Need ON, if the UE is connected to 5GC; otherwise the field is not present.

## – *RRCConnectionResumeComplete-NB*

The *RRCConnectionResumeComplete-NB* message is used to confirm the successful completion of an RRC connection resumption

Signalling radio bearer: SRB1

RLC-SAP: AM

Logical channel: DCCH

Direction: UE to E-UTRAN

### ***RRCConnectionResumeComplete-NB* message**

```
-- ASN1START
RRCConnectionResumeComplete-NB ::= SEQUENCE {
    rrc-TransactionIdentifier      RRC-TransactionIdentifier,
    criticalExtensions             CHOICE {
        rrcConnectionResumeComplete-r13      RRCConnectionResumeComplete-NB-r13-IEs,
        criticalExtensionsFuture             SEQUENCE {}
    }
}

RRCConnectionResumeComplete-NB-r13-IEs ::= SEQUENCE {
    selectedPLMN-Identity-r13      INTEGER (1..maxPLMN-r11)      OPTIONAL,
    dedicatedInfoNAS-r13           DedicatedInfoNAS      OPTIONAL,
    lateNonCriticalExtension       OCTET STRING      OPTIONAL,
    nonCriticalExtension           RRCConnectionResumeComplete-NB-v1470-IEs      OPTIONAL
}

RRCConnectionResumeComplete-NB-v1470-IEs ::= SEQUENCE {
    measResultServCell-r14         MeasResultServCell-NB-r14      OPTIONAL,
    nonCriticalExtension           RRCConnectionResumeComplete-NB-v1610-IEs      OPTIONAL
}

RRCConnectionResumeComplete-NB-v1610-IEs ::= SEQUENCE {
    rlf-InfoAvailable-r16         ENUMERATED {true}      OPTIONAL,
    anr-InfoAvailable-r16         ENUMERATED {true}      OPTIONAL,
    nonCriticalExtension           RRCConnectionResumeComplete-NB-v1710-IEs      OPTIONAL
}

RRCConnectionResumeComplete-NB-v1710-IEs ::= SEQUENCE {
    gnss-ValidityDuration-r17     GNSS-ValidityDuration-r17      OPTIONAL,
    nonCriticalExtension           RRCConnectionResumeComplete-NB-v1800-IEs      OPTIONAL
}

RRCConnectionResumeComplete-NB-v1800-IEs ::= SEQUENCE {
    gnss-PositionFixDuration-r18  GNSS-PositionFixDuration-r18  OPTIONAL,
    nonCriticalExtension           SEQUENCE {}      OPTIONAL
}
-- ASN1STOP
```

<b><i>RRCCConnectionResumeComplete-NB</i> field descriptions</b>
<b><i>anr-InfoAvailable</i></b> Indicates the availability of ANR measurement information.
<b><i>measResultServCell</i></b> This field refers to the last idle mode measurement results taken of the serving cell.
<b><i>rlf-InfoAvailable</i></b> Indicates the availability of radio link failure related information.
<b><i>selectedPLMN-Identity</i></b> Index of the PLMN selected by the UE from the <i>plmn-IdentityList</i> included in <i>SystemInformationBlockType1-NB</i> . 1 if the 1st PLMN is selected from the <i>plmn-IdentityList</i> included in SIB1-NB, 2 if the 2nd PLMN is selected from the <i>plmn-IdentityList</i> included in SIB1-NB and so on.

## – *RRCCConnectionResumeRequest-NB*

The *RRCCConnectionResumeRequest-NB* message is used to request the resumption of a suspended RRC connection or to perform UP-EDT.

Signalling radio bearer: SRB0

RLC-SAP: TM

Logical channel: CCCH

Direction: UE to E-UTRAN

### ***RRCCConnectionResumeRequest-NB* message**

```
-- ASN1START

RRCCConnectionResumeRequest-NB ::= SEQUENCE {
    criticalExtensions          CHOICE {
        rrcConnectionResumeRequest-r13  RRCCConnectionResumeRequest-NB-r13-IEs,
        later                           CHOICE {
            rrcConnectionResumeRequest-r16  RRCCConnectionResumeRequest-5GC-NB-r16-IEs,
            criticalExtensionsFuture        SEQUENCE {}
        }
    }
}

RRCCConnectionResumeRequest-NB-r13-IEs ::= SEQUENCE {
    resumeID-r13                ResumeIdentity-r13,
    shortResumeMAC-I-r13        ShortMAC-I,
    resumeCause-r13             EstablishmentCause-NB-r13,
    earlyContentionResolution-r14  BOOLEAN,
    cqi-NPDCCH-r14              CQI-NPDCCH-NB-r14,
    anr-InfoAvailable-r16       BOOLEAN,
    spare                       BIT STRING (SIZE (3))
}

RRCCConnectionResumeRequest-5GC-NB-r16-IEs ::= SEQUENCE {
    resumeID-r16                I-RNTI-r15,
    shortResumeMAC-I-r16        ShortMAC-I,
    resumeCause-r16             EstablishmentCause-NB-r13,
    cqi-NPDCCH-r16              CQI-NPDCCH-NB-r14,
    spare                       BIT STRING (SIZE (4))
}

-- ASN1STOP
```

<b><i>RRCCONNECTIONRESUMEREQUEST-NB</i> field descriptions</b>
<b><i>anr-InfoAvailable</i></b> Indicates the availability of ANR measurement information when the UE is performing UP-EDT.
<b><i>earlyContentionResolution</i></b> Value TRUE indicates UE supports MAC PDU containing the UE contention resolution identity MAC control element without RRC response message. This field is always set to TRUE in this version of the specification.
<b><i>resumeCause</i></b> Provides the resume cause for the RRC connection resume request as provided by the upper layers. eNB is not expected to reject a <i>RRCCONNECTIONRESUMEREQUEST</i> due to unknown cause value being used by the UE.
<b><i>resumeID</i></b> UE identity to facilitate UE context retrieval at eNB.
<b><i>shortResumeMAC-I</i></b> Authentication token to facilitate UE authentication at eNB.

## – *RRCCONNECTIONSETUP-NB*

The *RRCCONNECTIONSETUP-NB* message is used to establish SRB1 and SRB1bis.

Signalling radio bearer: SRB0

RLC-SAP: TM

Logical channel: CCCH

Direction: E-UTRAN to UE

### ***RRCCONNECTIONSETUP-NB* message**

```

-- ASN1START
RRCCONNECTIONSETUP-NB ::= SEQUENCE {
    rrc-TransactionIdentifier RRC-TransactionIdentifier,
    criticalExtensions CHOICE {
        c1 CHOICE {
            rrcConnectionSetup-r13 RRCConnectionSetup-NB-r13-IEs,
            spare1 NULL
        },
        criticalExtensionsFuture SEQUENCE {}
    }
}

RRCCONNECTIONSETUP-NB-r13-IEs ::= SEQUENCE {
    radioResourceConfigDedicated-r13 RadioResourceConfigDedicated-NB-r13,
    lateNonCriticalExtension OCTET STRING OPTIONAL,
    nonCriticalExtension RRCConnectionSetup-NB-v1610-IEs OPTIONAL
}

RRCCONNECTIONSETUP-NB-v1610-IEs ::= SEQUENCE {
    dedicatedInfoNAS-r16 DedicatedInfoNAS OPTIONAL, -- Need ON
    nonCriticalExtension SEQUENCE {} OPTIONAL
}
-- ASN1STOP

```

<b><i>RRCCONNECTIONSETUP-NB</i> field descriptions</b>
<b><i>dedicatedInfoNAS</i></b> Downlink NAS PDU in case of mobile terminated CP-EDT. E-UTRAN may include this field only if the <i>RRCCONNECTIONSETUP</i> is in response to <i>RRCEarlyDataRequest</i> with establishment cause <i>mt-Access</i> .

## – *RRCCONNECTIONSETUPCOMPLETE-NB*

The *RRCCONNECTIONSETUPCOMPLETE-NB* message is used to confirm the successful completion of an RRC connection establishment.

Signalling radio bearer: SRB1bis

RLC-SAP: AM

Logical channel: DCCH

Direction: UE to E-UTRAN

### ***RRCConnectionSetupComplete-NB message***

```

-- ASN1START
RRCConnectionSetupComplete-NB ::= SEQUENCE {
    rrc-TransactionIdentifier      RRC-TransactionIdentifier,
    criticalExtensions              CHOICE {
        rrcConnectionSetupComplete-r13  RRCConnectionSetupComplete-NB-r13-IEs,
        criticalExtensionsFuture         SEQUENCE {}
    }
}

RRCConnectionSetupComplete-NB-r13-IEs ::= SEQUENCE {
    selectedPLMN-Identity-r13      INTEGER (1..maxPLMN-r11),
    s-TMSI-r13                     S-TMSI                      OPTIONAL,
    registeredMME-r13              RegisteredMME                OPTIONAL,
    dedicatedInfoNAS-r13           DedicatedInfoNAS,
    attachWithoutPDN-Connectivity-r13  ENUMERATED {true}          OPTIONAL,
    up-CIoT-EPS-Optimisation-r13    ENUMERATED {true}          OPTIONAL,
    lateNonCriticalExtension        OCTET STRING                 OPTIONAL,
    nonCriticalExtension            RRCConnectionSetupComplete-NB-v1430-IEs OPTIONAL
}

RRCConnectionSetupComplete-NB-v1430-IEs ::= SEQUENCE {
    gummei-Type-r14                ENUMERATED { mapped}       OPTIONAL,
    dcn-ID-r14                     INTEGER (0..65535)          OPTIONAL,
    nonCriticalExtension            RRCConnectionSetupComplete-NB-v1470-IEs OPTIONAL
}

RRCConnectionSetupComplete-NB-v1470-IEs ::= SEQUENCE {
    measResultServCell-r14         MeasResultServCell-NB-r14  OPTIONAL,
    nonCriticalExtension            RRCConnectionSetupComplete-NB-v1610-IEs OPTIONAL
}

RRCConnectionSetupComplete-NB-v1610-IEs ::= SEQUENCE {
    ng-5G-S-TMSI-r16               NG-5G-S-TMSI-r15           OPTIONAL,
    registeredAMF-r16              RegisteredAMF-r15           OPTIONAL,
    gummei-Type-v1610              ENUMERATED {mappedFrom5G}  OPTIONAL,
    guami-Type-r16                 ENUMERATED {native, mapped} OPTIONAL,
    s-NSSAI-list-r16               SEQUENCE(SIZE (1..maxNrofS-NSSAI-r15)) OF
        S-NSSAI-r15              OPTIONAL,
    ng-U-DataTransfer-r16           ENUMERATED {true}          OPTIONAL,
    up-CIoT-5GS-Optimisation-r16   ENUMERATED {true}          OPTIONAL,
    rlf-InfoAvailable-r16          ENUMERATED {true}          OPTIONAL,
    anr-InfoAvailable-r16          ENUMERATED {true}          OPTIONAL,
    pur-ConfigID-r16               PUR-ConfigID-NB-r16        OPTIONAL,
    nonCriticalExtension            RRCConnectionSetupComplete-NB-v1710-IEs OPTIONAL
}

RRCConnectionSetupComplete-NB-v1710-IEs ::= SEQUENCE {
    gnss-ValidityDuration-r17       GNSS-ValidityDuration-r17  OPTIONAL,
    nonCriticalExtension            RRCConnectionSetupComplete-NB-v1800-IEs  OPTIONAL
}

RRCConnectionSetupComplete-NB-v1800-IEs ::= SEQUENCE {
    gnss-PositionFixDuration-r18    GNSS-PositionFixDuration-r18  OPTIONAL,
    nonCriticalExtension            SEQUENCE {}                       OPTIONAL
}
-- ASN1STOP

```



<b><i>RRConnectionSetupComplete-NB</i></b> field descriptions	
<b><i>anr-InfoAvailable</i></b>	This field is used to indicate the availability of ANR measurement information.
<b><i>attachWithoutPDN-Connectivity</i></b>	This field is used to indicate that the UE performs an Attach without PDN connectivity procedure, as indicated by the upper layers, TS 24.301 [35].
<b><i>dcn-ID</i></b>	The Dedicated Core Network Identity, see TS 23.401 [41].
<b><i>guami-Type</i></b>	This field is used to indicate whether the GUAMI included is native (derived from native 5G-GUTI) or mapped (from EPS, derived from EPS GUTI) as specified in TS 24.501 [95].
<b><i>gummei-Type</i></b>	This field is used to indicate that the GUMMEI included is mapped (from 2G/3G identifiers or 5G identifiers) as indicated by the upper layers, TS 24.301 [35] and TS 24.501 [95]. The value <i>mapped</i> indicates the GUMMEI is mapped from 2G/3G identifiers, and <i>mappedFrom5G</i> indicates the GUMMEI is mapped from 5G identifiers. A UE shall not include both <i>gummei-Type-r14</i> and <i>gummei-Type-v1610</i> .
<b><i>measResultServCell</i></b>	This field refers to the last idle mode measurement results taken of the serving cell.
<b><i>ng-U-DataTransfer</i></b>	This field is included when the UE supports NG-U data transfer, as indicated by the upper layers, see TS 24.501 [95].
<b><i>registeredAMF</i></b>	This field is used to transfer the GUAMI of the AMF where the UE is registered, as provided by upper layers, see TS 23.003 [27].
<b><i>registeredMME</i></b>	This field is used to transfer the GUMMEI of the MME where the UE is registered, as provided by upper layers.
<b><i>rlf-InfoAvailable</i></b>	This field is used to indicate the availability of radio link failure related information.
<b><i>selectedPLMN-Identity</i></b>	Index of the PLMN selected by the UE from the <i>plmn-IdentityList</i> included in <i>SystemInformationBlockType1-NB</i> . 1 if the 1st PLMN is selected from the <i>plmn-IdentityList</i> included in SIB1, 2 if the 2nd PLMN is selected from the <i>plmn-IdentityList</i> included in SIB1 and so on.
<b><i>s-NSSAI-List</i></b>	This field is a list of S-NSSAI as indicated by the upper layers. The UE can report up to eight S-NSSAI per NSSAI, see TS 23.003 [27].
<b><i>up-CIoT-5GS-Optimisation</i></b>	This field is included when the UE supports User plane CiOT 5GS Optimisation, as indicated by the upper layers, see TS 24.501 [95].
<b><i>up-CIoT-EPS-Optimisation</i></b>	This field is included when the UE supports S1-U data transfer or the User plane CiOT EPS Optimisation, as indicated by the upper layers, see TS 24.301 [35].

## – ***RRCEarlyDataComplete-NB***

The *RRCEarlyDataComplete-NB* message is used to confirm the successful completion of the CP-EDT procedure.

Signalling radio bearer: SRB0

RLC-SAP: TM

Logical channel: CCCH

Direction: E-UTRAN to UE

### ***RRCEarlyDataComplete-NB*** message

```
-- ASN1START
RRCEarlyDataComplete-NB-r15 ::= SEQUENCE {
    criticalExtensions          CHOICE {
        rrcEarlyDataComplete-r15  RRCEarlyDataComplete-NB-r15-IEs,
        criticalExtensionsFuture   SEQUENCE {}
    }
}

RRCEarlyDataComplete-NB-r15-IEs ::= SEQUENCE {
    dedicatedInfoNAS-r15      DedicatedInfoNAS          OPTIONAL,  -- Need ON
    extendedWaitTime-r15     INTEGER (1..1800)          OPTIONAL,  -- Need ON
}
```

```

    redirectedCarrierInfo-r15          RedirectedCarrierInfo-NB-r13  OPTIONAL,  -- Need ON
    redirectedCarrierInfoExt-r15       RedirectedCarrierInfo-NB-v1430 OPTIONAL,  -- Cond
Redirection
  nonCriticalExtension                RRCEarlyDataComplete-NB-v1590-IEs  OPTIONAL
}
RRCEarlyDataComplete-NB-v1590-IEs ::= SEQUENCE {
  lateNonCriticalExtension            OCTET STRING                  OPTIONAL,
  nonCriticalExtension                RRCEarlyDataComplete-NB-v1700-IEs OPTIONAL
}
RRCEarlyDataComplete-NB-v1700-IEs ::= SEQUENCE {
  cbp-Index-r17                      INTEGER (1..2)                OPTIONAL,  -- Need OR
  nonCriticalExtension                SEQUENCE {}                  OPTIONAL
}
-- ASN1STOP

```

#### RRCEarlyDataComplete-NB field descriptions

##### **cbp-Index**

Index to the coverage-based paging configuration. Value 1 corresponds to the first entry in *cbp-ConfigList* and value 2 corresponds to the second entry in *cbp-ConfigList* in *SystemInformationBlockType22-NB*.

##### **extendedWaitTime**

Value in seconds.

Conditional presence	Explanation
<i>Redirection</i>	The field is optionally present, Need ON, if <i>redirectedCarrierInfo</i> is included; otherwise the field is not present.

#### RRCEarlyDataRequest-NB

The *RRCEarlyDataRequest-NB* message is used to initiate CP-EDT.

Signalling radio bearer: SRB0

RLC-SAP: TM

Logical channel: CCCH

Direction: UE to E-UTRAN

#### RRCEarlyDataRequest-NB message

```

-- ASN1START
RRCEarlyDataRequest-NB-r15 ::= SEQUENCE {
  criticalExtensions              CHOICE {
    rrcEarlyDataRequest-r15       RRCEarlyDataRequest-NB-r15-IEs,
    later                          CHOICE {
      rrcEarlyDataRequest-r16     RRCEarlyDataRequest-5GC-NB-r16-IEs,
      criticalExtensionsFuture     SEQUENCE {}
    }
  }
}
RRCEarlyDataRequest-NB-r15-IEs ::= SEQUENCE {
  s-TMSI-r15                     S-TMSI,
  establishmentCause-r15         ENUMERATED {mo-Data, mo-ExceptionData, delayTolerantAccess,
mt-Access-v1610},
  cqi-NPDCCH-r15                 CQI-NPDCCH-NB-r14              OPTIONAL,
  dedicatedInfoNAS-r15           DedicatedInfoNAS,
  nonCriticalExtension            RRCEarlyDataRequest-NB-v1590-IEs  OPTIONAL
}
RRCEarlyDataRequest-NB-v1590-IEs ::= SEQUENCE {
  lateNonCriticalExtension        OCTET STRING                  OPTIONAL,
  nonCriticalExtension            SEQUENCE {}                  OPTIONAL
}
RRCEarlyDataRequest-5GC-NB-r16-IEs ::= SEQUENCE {

```

```

ng-5G-S-TMSI-r16          NG-5G-S-TMSI-r15,
establishmentCause-r16    ENUMERATED {mo-Data, mo-ExceptionData, mt-Access, spare1},
cqi-NPDCCH-r16           CQI-NPDCCH-NB-r14          OPTIONAL,
dedicatedInfoNAS-r16     DedicatedInfoNAS,
lateNonCriticalExtension  OCTET STRING              OPTIONAL,
nonCriticalExtension      SEQUENCE {}              OPTIONAL
}
-- ASN1STOP

```

#### **RRCEarlyDataRequest-NB field descriptions**

##### **establishmentCause**

Provides the establishment cause for the RRC early data request as provided by the upper layers.  
 eNB is not expected to reject a *RRCEarlyDataRequest* due to unknown cause value being used by the UE.

### **SCPTMConfiguration-NB**

The *SCPTMConfiguration-NB* message contains the control information applicable for MBMS services transmitted via SC-MRB.

Signalling radio bearer: N/A

RLC-SAP: UM

Logical channel: SC-MCCH

Direction: E-UTRAN to UE

#### **SCPTMConfiguration-NB message**

```

-- ASN1START
SCPTMConfiguration-NB-r14 ::= SEQUENCE {
  sc-mtch-InfoList-r14      SC-MTCH-InfoList-NB-r14,
  sctm-NeighbourCellList-r14 SCPTM-NeighbourCellList-NB-r14  OPTIONAL,  -- Need OP
  lateNonCriticalExtension  OCTET STRING              OPTIONAL,
  nonCriticalExtension      SCPTMConfiguration-NB-v1610 OPTIONAL
}

SCPTMConfiguration-NB-v1610 ::= SEQUENCE {
  sc-mtch-InfoListMultiTB-r16 SC-MTCH-InfoList-NB-r14,
  multiTB-Gap-r16             ENUMERATED {sf16, sf32, sf64, sf128}  OPTIONAL,  -- Need OR
  nonCriticalExtension        SEQUENCE {}              OPTIONAL
}
-- ASN1STOP

```

#### **SCPTMConfiguration-NB field descriptions**

##### **multiTB-Gap**

Indicates the scheduling gap for SC-MTCH using multiple TB scheduling, see TS 36.211 [21] and TS 36.213 [23]. Value *sf16* corresponds to 16 subframes, *sf32* corresponds to 32 subframes, and so on. If the field is absent, there is no scheduling gap.

##### **sc-mtch-InfoList**

Provides the configuration of each SC-MTCH not using multiple TB scheduling in the current cell.

##### **sc-mtch-InfoListMultiTB**

Provides the configuration of each SC-MTCH using multiple TB scheduling in the current cell. The total number of signalled SC-MTCH configuration in *sc-mtch-InfoList* and *sc-mtch-InfoListMultiTB* cannot be more than *maxSC-MTCH-NB-r14*.

##### **sctm-NeighbourCellList**

List of neighbour cells providing MBMS services via SC-MRB. When absent, the UE shall assume that MBMS services listed in the *SCPTMConfiguration-NB* message are not provided via SC-MRB in any neighbour cell.

## – SystemInformation-NB

The *SystemInformation-NB* message is used to convey one or more System Information Blocks. All the SIBs included are transmitted with the same periodicity.

Signalling radio bearer: N/A

RLC-SAP: TM

Logical channel: BCCH

Direction: E-UTRAN to UE

### SystemInformation-NB message

```
-- ASN1START
SystemInformation-NB ::= SEQUENCE {
    criticalExtensions          CHOICE {
        systemInformation-r13  SystemInformation-NB-r13-IEs,
        criticalExtensionsFuture SEQUENCE {}
    }
}
SystemInformation-NB-r13-IEs ::= SEQUENCE {
    sib-TypeAndInfo-r13      SEQUENCE (SIZE (1..maxSIB)) OF CHOICE {
        sib2-r13              SystemInformationBlockType2-NB-r13,
        sib3-r13              SystemInformationBlockType3-NB-r13,
        sib4-r13              SystemInformationBlockType4-NB-r13,
        sib5-r13              SystemInformationBlockType5-NB-r13,
        sib14-r13             SystemInformationBlockType14-NB-r13,
        sib16-r13             SystemInformationBlockType16-NB-r13,
        ...,
        sib15-v1430           SystemInformationBlockType15-NB-r14,
        sib20-v1430           SystemInformationBlockType20-NB-r14,
        sib22-v1430           SystemInformationBlockType22-NB-r14,
        sib23-v1530           SystemInformationBlockType23-NB-r15,
        sib27-v1610           SystemInformationBlockType27-NB-r16,
        sib31-v1700           SystemInformationBlockType31-NB-r17,
        sib32-v1700           SystemInformationBlockType32-NB-r17,
        sib33-v1800           SystemInformationBlockType33-NB-r18
    },
    lateNonCriticalExtension   OCTET STRING                               OPTIONAL,
    nonCriticalExtension       SEQUENCE {}                               OPTIONAL
}
-- ASN1STOP
```

## – SystemInformationBlockType1-NB

The *SystemInformationBlockType1-NB* message contains information relevant when evaluating if a UE is allowed to access a cell and defines the scheduling of other system information.

Signalling radio bearer: N/A

RLC-SAP: TM

Logical channel: BCCH

Direction: E-UTRAN to UE

### SystemInformationBlockType1-NB message

```
-- ASN1START
SystemInformationBlockType1-NB ::= SEQUENCE {
    hyperSFN-MSB-r13          BIT STRING (SIZE (8)),
    cellAccessRelatedInfo-r13 SEQUENCE {
        plmn-IdentityList-r13  PLMN-IdentityList-NB-r13,
        trackingAreaCode-r13   TrackingAreaCode,
        cellIdentity-r13       CellIdentity,
        cellBarred-r13         ENUMERATED {barred, notBarred},
    }
}
```

```

        intraFreqReselection-r13          ENUMERATED {allowed, notAllowed}
    },
    cellSelectionInfo-r13                 SEQUENCE {
        q-RxLevMin-r13                    Q-RxLevMin,
        q-QualMin-r13                     Q-QualMin-r9
    },
    p-Max-r13                             P-Max                OPTIONAL,    -- Need OP
    freqBandIndicator-r13                 FreqBandIndicator-NB-r13,
    freqBandInfo-r13                     NS-PmaxList-NB-r13        OPTIONAL,    -- Need OR
    multiBandInfoList-r13                 MultiBandInfoList-NB-r13  OPTIONAL,    -- Need OR
    downlinkBitmap-r13                   DL-Bitmap-NB-r13         OPTIONAL,    -- Cond SIB1
    eutraControlRegionSize-r13            ENUMERATED {n1, n2, n3}   OPTIONAL,    -- Cond inband
    nrs-CRS-PowerOffset-r13               ENUMERATED {dB-6,        dB-4dot77, dB-3,
        dB-1dot77, dB0,        dB1,
        dB1dot23, dB2,        dB3,
        dB4,        dB4dot23, dB5,
        dB6,        dB7,        dB8,
        dB9}            OPTIONAL,    -- Cond inband-SamePCI
    schedulingInfoList-r13                 SchedulingInfoList-NB-r13,
    si-WindowLength-r13                   ENUMERATED {ms160, ms320, ms480, ms640,
        ms960, ms1280, ms1600, spare1},
    si-RadioFrameOffset-r13               INTEGER (1..15)          OPTIONAL,    -- Need OP
    systemInfoValueTagList-r13            SystemInfoValueTagList-NB-r13  OPTIONAL,    -- Need OR
    lateNonCriticalExtension              OCTET STRING              OPTIONAL,
    nonCriticalExtension                   SystemInformationBlockType1-NB-v1350  OPTIONAL
}

SystemInformationBlockType1-NB-v1350 ::= SEQUENCE {
    cellSelectionInfo-v1350               CellSelectionInfo-NB-v1350  OPTIONAL,    -- Cond Qrxlevmin
    nonCriticalExtension                   SystemInformationBlockType1-NB-v1430  OPTIONAL
}

SystemInformationBlockType1-NB-v1430 ::= SEQUENCE {
    cellSelectionInfo-v1430               CellSelectionInfo-NB-v1430  OPTIONAL,    -- Need OR
    nonCriticalExtension                   SystemInformationBlockType1-NB-v1450  OPTIONAL
}

SystemInformationBlockType1-NB-v1450 ::= SEQUENCE {
    nrs-CRS-PowerOffset-v1450             ENUMERATED {dB-6,        dB-4dot77, dB-3,
        dB-1dot77, dB0,        dB1,
        dB1dot23, dB2,        dB3,
        dB4,        dB4dot23, dB5,
        dB6,        dB7,        dB8,
        dB9}            OPTIONAL,    -- Cond inband-SamePCI-
}

ExceptAnchor
nonCriticalExtension                     SystemInformationBlockType1-NB-v1530
OPTIONAL
}

SystemInformationBlockType1-NB-v1530 ::= SEQUENCE {
    tdd-Parameters-r15                    SEQUENCE {
        tdd-Config-r15                    TDD-Config-NB-r15,
        tdd-SI-CarrierInfo-r15            ENUMERATED {anchor, non-anchor},
        tdd-SI-SubframesBitmap-r15        DL-Bitmap-NB-r13          OPTIONAL,    -- Cond TDD-SI-
NonAnchor
    } OPTIONAL,    -- Cond TDD
    schedulingInfoList-v1530              SchedulingInfoList-NB-v1530  OPTIONAL,    -- Need OR
    nonCriticalExtension                   SystemInformationBlockType1-NB-v1610  OPTIONAL
}

SystemInformationBlockType1-NB-v1610 ::= SEQUENCE {
    cellAccessRelatedInfo-5GC-r16         SEQUENCE {
        plmn-IdentityList-r16             PLMN-IdentityList-5GC-NB-r16,
        trackingAreaCode-5GC-r16          TrackingAreaCode-5GC-r15,
        cellIdentity-r16                  CellIdentity                OPTIONAL,    -- Need OP
        cellBarred-5GC-r16                ENUMERATED {barred, notBarred}
    } OPTIONAL,    -- Need OR
    nonCriticalExtension                   SystemInformationBlockType1-NB-v1700  OPTIONAL
}

SystemInformationBlockType1-NB-v1700 ::= SEQUENCE {
    cellAccessRelatedInfo-NTN-r17         SEQUENCE {
        cellBarred-NTN-r17                ENUMERATED {barred, notBarred},
        plmn-IdentityList-v1700           PLMN-IdentityList-NB-v1700  OPTIONAL,    -- Need OR
    } OPTIONAL,    -- Need OR
    nonCriticalExtension                   SEQUENCE {}                OPTIONAL
}

```

```

PLMN-IdentityList-NB-r13 ::= SEQUENCE (SIZE (1..maxPLMN-r11)) OF PLMN-IdentityInfo-NB-r13
PLMN-IdentityList-5GC-NB-r16 ::= SEQUENCE (SIZE (1..maxPLMN-r11)) OF PLMN-IdentityInfo-5GC-NB-r16
PLMN-IdentityList-NB-v1700 ::= SEQUENCE (SIZE (1..maxPLMN-r11)) OF PLMN-IdentityInfo-NB-v1700
PLMN-IdentityInfo-NB-r13 ::= SEQUENCE {
    plmn-Identity-r13 PLMN-Identity,
    cellReservedForOperatorUse-r13 ENUMERATED {reserved, notReserved},
    attachWithoutPDN-Connectivity-r13 ENUMERATED {true} OPTIONAL -- Need OP
}
PLMN-IdentityInfo-5GC-NB-r16 ::= SEQUENCE {
    plmn-Identity-5GC-r16 CHOICE {
        plmn-Identity-r16 PLMN-Identity,
        plmn-Index-r16 INTEGER (1..maxPLMN-r11)
    },
    cellReservedForOperatorUse-r16 ENUMERATED {reserved, notReserved},
    ng-U-DataTransfer-r16 ENUMERATED {true} OPTIONAL, -- Need OR
    up-CIoT-5GS-Optimisation-r16 ENUMERATED {true} OPTIONAL -- Need OR
}
PLMN-IdentityInfo-NB-v1700 ::= SEQUENCE {
    trackingAreaList-r17 TrackingAreaList-NB-r17 OPTIONAL -- Need OP
}
TrackingAreaList-NB-r17 ::= SEQUENCE (SIZE (1..maxTAC-NB-r17)) OF TrackingAreaCode
SchedulingInfoList-NB-r13 ::= SEQUENCE (SIZE (1..maxSI-Message-NB-r13)) OF SchedulingInfo-NB-r13
SchedulingInfoList-NB-v1530 ::= SEQUENCE (SIZE (1..maxSI-Message-NB-r13)) OF SchedulingInfo-NB-v1530
SchedulingInfo-NB-r13 ::= SEQUENCE {
    si-Periodicity-r13 ENUMERATED {rf64, rf128, rf256, rf512,
        rf1024, rf2048, rf4096, spare},
    si-RepetitionPattern-r13 ENUMERATED {every2ndRF, every4thRF, every8thRF, every16thRF},
    sib-MappingInfo-r13 SIB-MappingInfo-NB-r13,
    si-TB-r13 ENUMERATED {b56, b120, b208, b256, b328, b440, b552, b680}
}
SchedulingInfo-NB-v1530 ::= SEQUENCE {
    sib-MappingInfo-v1530 SIB-MappingInfo-NB-v1530 OPTIONAL -- Need OR
}
SystemInfoValueTagList-NB-r13 ::= SEQUENCE (SIZE (1..maxSI-Message-NB-r13)) OF SystemInfoValueTagSI-r13
SIB-MappingInfo-NB-r13 ::= SEQUENCE (SIZE (0..maxSIB-1)) OF SIB-Type-NB-r13
SIB-MappingInfo-NB-v1530 ::= SEQUENCE (SIZE (1..8)) OF SIB-Type-NB-v1530
SIB-Type-NB-r13 ::= ENUMERATED {
    sibType3-NB-r13, sibType4-NB-r13, sibType5-NB-r13,
    sibType14-NB-r13, sibType16-NB-r13, sibType15-NB-r14,
    sibType20-NB-r14, sibType22-NB-r14}
SIB-Type-NB-v1530 ::= ENUMERATED {
    sibType23-NB-r15, sibType27-NB-r16, sibType31-NB-r17,
    sibType32-NB-r17, sibType33-NB-r18, spare3, spare2,
    spare1
}
CellSelectionInfo-NB-v1350 ::= SEQUENCE {
    delta-RxLevMin-v1350 INTEGER (-8..-1)
}
CellSelectionInfo-NB-v1430 ::= SEQUENCE {
    powerClass14dBm-Offset-r14 ENUMERATED {dB-6, dB-3, dB3, dB6, dB9, dB12} OPTIONAL, --
    Need OP
    ce-authorisationOffset-r14 ENUMERATED {dB5, dB10, dB15, dB20, dB25, dB30, dB35}
    OPTIONAL -- Need OP
}
-- ASN1STOP

```

<b>SystemInformationBlockType1-NB field descriptions</b>
<p><b>attachWithoutPDN-Connectivity</b> If present, the field indicates that attach without PDN connectivity as specified in TS 24.301 [35] is supported for this PLMN.</p>
<p><b>ce-authorisationOffset</b> Parameter "Qoffset<sub>authorization</sub>" in TS 36.304 [4]. Value in dB. Value dB5 corresponds to 5 dB, dB10 corresponds to 10 dB and so on. If the field is absent, the value of 0 dB shall be used for "Qoffset<sub>authorization</sub>".</p>
<p><b>cellBarred</b> Barred means the cell is barred for connectivity to EPC, as defined in TS 36.304 [4].</p>
<p><b>cellBarred-5GC</b> Barred means the cell is barred for connectivity to 5GC, as defined in TS 36.304 [4].</p>
<p><b>cellBarred-NTN</b> Barred means the cell is barred for connectivity to NTN, as defined in TS 36.304 [4]. E-UTRAN always includes <i>cellBarred-NTN</i> and sets <i>cellBarred</i> to 'barred' in an NTN cell.</p>
<p><b>cellIdentity</b> Indicates the cell identity. If the field is absent in <i>cellAccessRelatedInfo-5GC</i>, the cell identity indicated by the <i>cellIdentity</i> field included in <i>cellAccessRelatedInfo</i> for EPC is used when connected to 5GC.</p>
<p><b>cellReservedForOperatorUse</b> As defined in TS 36.304 [4].</p>
<p><b>cellSelectionInfo</b> Cell selection information as specified in TS 36.304 [4].</p>
<p><b>downlinkBitmap</b> For FDD, NB-IoT downlink subframe configuration for downlink transmission as specified in TS 36.213 [23], clause 16.4. For TDD, NB-IoT downlink, uplink and special subframes configuration for transmission on the anchor carrier as specified in TS 36.213 [23], clause 16.4. If the bitmap is not present, the UE shall assume that all subframes are valid (except for subframes carrying NPSS/NSSS/NPBCH/SIB1-NB) as specified in TS 36.213 [23], clause 16.4.</p>
<p><b>utraControlRegionSize</b> Indicates the control region size of the E-UTRA cell for the in-band operation mode, see TS 36.213 [23]. Unit is in number of OFDM symbols.</p>
<p><b>freqBandInfo</b> A list of <i>additionalPmax</i> and <i>additionalSpectrumEmission</i> values as defined in TS 36.101 [42], clause 6.2.4F and TS 36.102 [113], clause 6.2B.3 for the NTN capable UE, for the frequency band in <i>freqBandIndicator</i>.</p>
<p><b>hyperSFN-MSB</b> Indicates the 8 most significant bits of hyper-SFN. Together with hyperSFN-LSB in MIB-NB, the complete hyper-SFN is built up. hyper-SFN is incremented by one when the SFN wraps around.</p>
<p><b>intraFreqReselection</b> Used to control cell reselection to intra-frequency cells when the highest ranked cell is barred, or treated as barred by the UE, as specified in TS 36.304 [4].</p>
<p><b>multiBandInfoList</b> A list of additional frequency band indicators, <i>additionalPmax</i> and <i>additionalSpectrumEmission</i> values, as defined in TS 36.101 [42], table 5.5-1 and TS 36.102 [113], table 5.2-1 for the NTN capable UE. If the UE supports the frequency band in the <i>freqBandIndicator</i> IE it shall apply that frequency band. Otherwise, the UE shall apply the first listed band which it supports in the <i>multiBandInfoList</i> IE.</p>
<p><b>ng-U-DataTransfer</b> Indicates whether the NG-U data transfer as specified in TS 24.501 [95] is supported.</p>
<p><b>nrs-CRS-PowerOffset</b> NRS power offset between NRS and E-UTRA CRS, see TS 36.213 [23], clause 16.2.2. Unit in dB. Default value of 0.</p>
<p><b>plmn-IdentityList</b> List of PLMN identities. The first listed PLMN-Identity is the primary PLMN. If <i>plmn-IdentityList-v1700</i> is included, E-UTRAN includes the same number of entries, and listed in the same order, as in <i>plmn-IdentityList-r13</i>.</p>
<p><b>plmn-Index</b> Index of the PLMN in the <i>plmn-IdentityList</i> field included in <i>cellAccessRelatedInfo</i> for EPC, indicating the same PLMN ID is used when connected to 5GC.</p>
<p><b>powerClass14dBm-Offset</b> Parameter "Poffset" in TS 36.304 [4]. Only applicable for UE supporting <i>powerClassNB-14dBm</i>. Value in dB. Value dB-6 corresponds to -6 dB, dB-3 corresponds to -3 dB and so on. If the field is absent, the UE applies the (default) value of 0 dB for "Poffset" in TS 36.304 [4].</p>
<p><b>p-Max</b> Value applicable for the cell. If absent the UE applies the maximum power according to the UE capability.</p>
<p><b>q-QualMin</b> Parameter "Q<sub>qualmin</sub>" in TS 36.304 [4].</p>
<p><b>q-RxLevMin, delta-RxLevMin</b> Parameter Q<sub>rxlevmin</sub> in TS 36.304 [4]. If <i>delta-RxLevMin</i> is not included, actual value Q<sub>rxlevmin</sub> = <i>q-RxLevMin</i> * 2 [dBm]. If <i>delta-RxLevMin</i> is included, actual value Q<sub>rxlevmin</sub> = (<i>q-RxLevMin</i> + <i>delta-RxLevMin</i>) * 2 [dBm].</p>

<b>SystemInformationBlockType1-NB field descriptions</b>
<p><b>schedulingInfoList</b> Indicates additional scheduling information of SI messages. The <i>schedulingInfoList-v1530</i> (if present) provides additional SIBs mapped into the SI message scheduled via <i>schedulingInfoList-r13</i>. If E-UTRAN includes <i>schedulingInfoList-v1530</i>, it includes the same number of entries, and listed in the same order, as in <i>schedulingInfoList-r13</i>.</p>
<p><b>si-Periodicity</b> Periodicity of the SI-message in radio frames, such that <i>rf256</i> denotes 256 radio frames, <i>rf512</i> denotes 512 radio frames, and so on.</p>
<p><b>si-RadioFrameOffset</b> Offset in number of radio frames to calculate the start of the SI window. If the field is absent, no offset is applied.</p>
<p><b>si-RepetitionPattern</b> Indicates the starting radio frames within the SI window used for SI message transmission. Value <i>every2ndRF</i> corresponds to every 2 radio frames, value <i>every4thRF</i> corresponds to every 4 radio frames and so on. The first transmission of the SI message is transmitted from the first radio frame of the SI window.</p>
<p><b>si-TB</b> This field indicates the transport block size in number of bits and the corresponding number of consecutive NB-IoT downlink subframes that are used to broadcast the SI message. Value <i>b56</i> corresponds to 56 bits, <i>b120</i> corresponds to 120 bits and so on. TBS of 56 bits and 120 bits are transmitted over 2 sub-frames, other TBS are transmitted over 8 sub-frames, see TS 36.213 [23], Table 16.4.1.5.1-1.</p>
<p><b>si-WindowLength</b> Common SI scheduling window for all SIs. Unit in milliseconds, where <i>ms160</i> denotes 160 milliseconds, <i>ms320</i> denotes 320 milliseconds and so on.</p>
<p><b>sib-MappingInfo</b> List of the SIBs mapped to this <i>SystemInformation</i> message. There is no mapping information of SIB2-NB; it is always present in the first <i>SystemInformation</i> message listed in the <i>schedulingInfoList-r13</i> list. If present, <i>sib-MappingInfo-v1530</i> indicates one or more additional SIBs mapped to the concerned SI message listed in the <i>schedulingInfoList-r13</i> list. If <i>schedulingInfoList-v1530</i> is present, E-UTRAN ensures that the total number of entries of this field plus <i>sib-MappingInfo-r13</i> shall not exceed the value of <i>maxSIB-1</i>.</p>
<p><b>systemInfoValueTagList</b> Indicates SI message specific value tags. It includes the same number of entries, and listed in the same order, as in <i>SchedulingInfoList</i>.</p>
<p><b>systemInfoValueTagSI</b> SI message specific value tag as specified in Clause 5.2.1.3. Common for all SIBs within the SI message other than SIB14-NB, SIB31-NB, and SIB33-NB.</p>
<p><b>tdd-Config</b> Indicates the the TDD specific physical channel configuration.</p>
<p><b>tdd-SI-CarrierInfo</b> Carrier used for SI message transmission. Value <i>anchor</i> corresponds to anchor carrier, value <i>non-anchor</i> corresponds to non-anchor carrier. See TS 36.213 [23]. When <i>tdd-SI-CarrierInfo</i> set to value <i>non-anchor</i> then <i>sib-GuardbandInfo</i> in MIB-TDD-NB (in case of <i>operationmodeInfo</i> is set to <i>guardband</i>) or <i>sib-InbandLocation</i> in MIB-TDD-NB (in case of <i>operationmodeInfo</i> is set to <i>inband-SamePCI</i> or <i>inband-DifferentPCI</i>) or <i>sib-StandaloneLocation</i> in MIB-TDD-NB (in case of <i>operationmodeInfo</i> is set to <i>standalone</i>) defines which non-anchor carrier is used (see MIB-NB-TDD).</p>
<p><b>tdd-SI-SubframesBitmap</b> NB-IoT downlink, uplink and special subframes configuration for transmission on the carrier carrying the SI message as specified in TS 36.213 [23], clause 16.4.</p>
<p><b>trackingAreaCode, trackingAreaCode-5GC</b> A <i>trackingAreaCode</i> that is common for all the PLMNs listed in <i>plmn-IdentityList-r13</i> or <i>plmn-IdentityList-r16</i> respectively.</p>
<p><b>trackingAreaList</b> A list of tracking area codes for the PLMN listed. For the first entry in <i>plmn-IdentityList-v1700</i>: If this field is present, the list of tracking area codes include the tracking area code in <i>trackingAreaCode-r13</i> and the tracking area codes in <i>trackingAreaList</i>. If this field is absent, only <i>trackingAreaCode-r13</i> applies. For other entries in <i>plmn-IdentityList-v1700</i>: If this field is present, the list of tracking area codes include the tracking area codes in <i>trackingAreaList</i>. If this field is absent, the list of tracking area codes of the preceding entry in <i>plmn-IdentityList-v1700</i> applies. The total number of signalled tracking area codes across all PLMNs cannot be more than <i>maxTAC-NB-r17</i>.</p>
<p><b>up-CIoT-5GS-Optimisation</b> Indicates whether the UE is allowed to resume the connection with User plane CIoT 5GS Optimisation, see TS24.501 [95].</p>



Conditional presence	Explanation
<i>inband</i>	In FDD: The field is mandatory present if IE <i>operationModeInfo</i> in MIB-NB is set to <i>inband-SamePCI</i> or <i>inband-DifferentPCI</i> . Otherwise the field is not present. In TDD: The field is mandatory present if: - IE <i>operationModeInfo</i> in MIB-TDD-NB is set to <i>inband-SamePCI</i> or <i>inband-DifferentPCI</i> or - IE <i>operationModeInfo</i> in MIB-TDD-NB is set to <i>guardband</i> and IE <i>sib-GuardbandInfo</i> in MIB-TDD-NB is set to <i>sib-GuardbandInbandSamePCI</i> or <i>sib-GuardbandinbandDiffPCI</i> and IE <i>tdt-SI-CarrierInfo</i> is set to non-anchor
<i>inband-SamePCI</i>	The field is mandatory present, if IE <i>operationModeInfo</i> in MIB-NB is set to <i>inband-SamePCI</i> . Otherwise the field is not present.
<i>inband-SamePCI-ExceptAnchor</i>	The field is optionally present if IE <i>operationModeInfo</i> in MIB-NB is set to a value other than <i>inband-SamePCI</i> , and at least one non-anchor carrier is inband carrier and uses the same PCI as the E-UTRA carrier. Otherwise the field is not present.
<i>Qrxlevmin</i>	This field is optionally present, Need OR, if <i>q-RxLevMin</i> is set to the minimum value. Otherwise the field is not present.
<i>SIB1</i>	The field is mandatory present if IE <i>additionalTransmissionSIB1</i> in MIB-NB is set to <i>TRUE</i> . Otherwise the field is optionally present, Need OP.
<i>TDD</i>	The field is mandatory present for TDD; otherwise the field is not present and the UE shall delete any existing value for this field.
<i>TDD-SI-NonAnchor</i>	The field is mandatory present for TDD if <i>si-CarrierInfo</i> is set to <i>non-anchor</i> ; otherwise the field is not present and the UE shall delete any existing value for this field.

### – *UECapabilityEnquiry-NB*

The *UECapabilityEnquiry-NB* message is used to request the transfer of UE radio access capabilities for NB-IoT.

Signalling radio bearer: SRB1 or SRB1bis

RLC-SAP: AM

Logical channel: DCCH

Direction: E-UTRAN to UE

### *UECapabilityEnquiry-NB* message

```
-- ASN1START
UECapabilityEnquiry-NB ::= SEQUENCE {
    rrc-TransactionIdentifier    RRC-TransactionIdentifier,
    criticalExtensions          CHOICE {
        c1                     CHOICE {
            ueCapabilityEnquiry-r13    UECapabilityEnquiry-NB-r13-IEs,
            spare1                   NULL
        },
        criticalExtensionsFuture      SEQUENCE {}
    }
}

UECapabilityEnquiry-NB-r13-IEs ::= SEQUENCE {
    lateNonCriticalExtension    OCTET STRING          OPTIONAL,
    nonCriticalExtension        SEQUENCE {}          OPTIONAL
}
-- ASN1STOP
```

### – *UECapabilityInformation-NB*

The *UECapabilityInformation-NB* message is used to transfer of UE radio access capabilities requested by the E-UTRAN.

Signalling radio bearer: SRB1 or SRB1bis

RLC-SAP: AM

Logical channel: DCCH

Direction: UE to E-UTRAN

### ***UECapabilityInformation-NB* message**

```
-- ASN1START
UECapabilityInformation-NB ::= SEQUENCE {
    rrc-TransactionIdentifier      RRC-TransactionIdentifier,
    criticalExtensions             CHOICE {
        ueCapabilityInformation-r13  UECapabilityInformation-NB-r13-IEs,
        criticalExtensionsFuture     SEQUENCE {}
    }
}

UECapabilityInformation-NB-r13-IEs ::= SEQUENCE {
    ue-Capability-r13             UE-Capability-NB-r13,
    ue-RadioPagingInfo-r13       UE-RadioPagingInfo-NB-r13,
    lateNonCriticalExtension      OCTET STRING OPTIONAL,
    nonCriticalExtension          UECapabilityInformation-NB-Ext-r14-IEs
                                OPTIONAL
}

UECapabilityInformation-NB-Ext-r14-IEs ::= SEQUENCE {
    ue-Capability-ContainerExt-r14 OCTET STRING (CONTAINING UE-Capability-NB-Ext-r14-IEs),
    nonCriticalExtension           SEQUENCE {} OPTIONAL
}
-- ASN1STOP
```

### ***UECapabilityInformation-NB* field descriptions**

#### ***ue-RadioPagingInfo***

This field contains UE capability information used for paging.

### ***UEInformationRequest-NB***

The *UEInformationRequest-NB* is the command used by E-UTRAN to retrieve information from the UE.

Signalling radio bearer: SRB1

RLC-SAP: AM

Logical channel: DCCH

Direction: E-UTRAN to UE

### ***UEInformationRequest-NB* message**

```
-- ASN1START
UEInformationRequest-NB-r16 ::= SEQUENCE {
    rrc-TransactionIdentifier      RRC-TransactionIdentifier,
    criticalExtensions             CHOICE {
        ueInformationRequest-r16    UEInformationRequest-NB-r16-IEs,
        criticalExtensionsFuture     SEQUENCE {}
    }
}

UEInformationRequest-NB-r16-IEs ::= SEQUENCE {
    rach-ReportReq-r16            BOOLEAN,
    rlf-ReportReq-r16             BOOLEAN,
    anr-ReportReq-r16            BOOLEAN,
    lateNonCriticalExtension      OCTET STRING OPTIONAL,
    nonCriticalExtension          SEQUENCE {} OPTIONAL
}
-- ASN1STOP
```

```
-- ASN1STOP
```

### ***UEInformationRequest-NB*** field descriptions

#### ***anr-ReportReq***

Indicates whether the UE shall report, if available, ANR measurement information.

#### ***rach-ReportReq***

Indicates whether the UE shall report, if available, information about the random access procedure.

#### ***rlf-ReportReq***

Indicates whether the UE shall report, if available, information about radio link failure.

## ***UEInformationResponse-NB***

The *UEInformationResponse-NB* message is used by the UE to transfer the information requested by the E-UTRAN.

Signalling radio bearer: SRB1

RLC-SAP: AM

Logical channel: DCCH

Direction: UE to E-UTRAN

### ***UEInformationResponse-NB*** message

```
-- ASN1START
```

```

UEInformationResponse-NB-r16 ::= SEQUENCE {
  rrc-TransactionIdentifier RRC-TransactionIdentifier,
  criticalExtensions CHOICE {
    ueInformationResponse-r16 UEInformationResponse-NB-r16-IEs,
    criticalExtensionsFuture SEQUENCE {}
  }
}

UEInformationResponse-NB-r16-IEs ::= SEQUENCE {
  rach-Report-r16 RACH-Report-NB-r16 OPTIONAL,
  rlf-Report-r16 RLF-Report-NB-r16 OPTIONAL,
  anr-MeasReport-r16 ANR-MeasReport-NB-r16 OPTIONAL,
  lateNonCriticalExtension OCTET STRING OPTIONAL,
  nonCriticalExtension SEQUENCE {}
}

RACH-Report-NB-r16 ::= SEQUENCE {
  numberOfPreamblesSent-r16 INTEGER (1..64),
  contentionDetected-r16 BOOLEAN,
  initialNRSRP-Level-r16 INTEGER (0..2),
  edt-Fallback-r16 BOOLEAN
}

RLF-Report-NB-r16 ::= SEQUENCE {
  failedPCellId-r16 CellGlobalIdEUTRA,
  reestablishmentCellId-r16 CellGlobalIdEUTRA OPTIONAL,
  locationInfo-r16 LocationInfo-r10 OPTIONAL,
  measResultLastServCell-r16 SEQUENCE {
    nrsrpResult-r16 NRSRP-Range-NB-r14,
    nrsrqResult-r16 NRSRQ-Range-NB-r14 OPTIONAL
  },
  timeSinceFailure-r16 TimeSinceFailure-r11 OPTIONAL
}
-- ASN1STOP
```

<i>UEInformationResponse-NB</i> field descriptions
<b><i>anr-MeasReport</i></b> Indicates the ANR measurement information.
<b><i>contentionDetected</i></b> Value TRUE indicates that contention was detected for at least one of the transmitted preambles, see TS 36.321 [6].
<b><i>edt-Fallback</i></b> Value TRUE indicates that EDT fallback indication was received from the lower layers, see TS 36.321 [6].
<b><i>failedPCellId</i></b> Indicates the PCell in which RLF is detected.
<b><i>initialNRSRP-Level</i></b> Indicates the NRSRP level of the NPRACH resource selected for the first preamble transmission.
<b><i>measResultLastServCell</i></b> Refers to the last measurement results taken in the PCell, where radio link failure happened.
<b><i>numberOfPreamblesSent</i></b> Indicates the number of RACH preambles that were transmitted. Corresponds to parameter PREAMBLE_TRANSMISSION_COUNTER in TS 36.321 [6].
<b><i>reestablishmentCellId</i></b> Indicates the cell in which the re-establishment attempt was made after connection failure.
<b><i>timeSinceFailure</i></b> Indicates the time that elapsed since the connection failure. Value in seconds. The maximum value 172800 means 172800s or longer.

## – *ULInformationTransfer-NB*

The *ULInformationTransfer-NB* message is used for the uplink transfer of NAS information.

Signalling radio bearer: SRB1 or SRB1bis

RLC-SAP: AM

Logical channel: DCCH

Direction: UE to E-UTRAN

### *ULInformationTransfer-NB* message

```

-- ASN1START
ULInformationTransfer-NB ::= SEQUENCE {
    criticalExtensions          CHOICE {
        ulInformationTransfer-r13      ULInformationTransfer-NB-r13-IEs,
        criticalExtensionsFuture      SEQUENCE {}
    }
}
ULInformationTransfer-NB-r13-IEs ::= SEQUENCE {
    dedicatedInfoNAS          DedicatedInfoNAS,
    lateNonCriticalExtension   OCTET STRING           OPTIONAL,
    nonCriticalExtension       SEQUENCE {}                 OPTIONAL
}
-- ASN1STOP

```

## 6.7.3 NB-IoT information elements

### 6.7.3.1 NB-IoT System information blocks

#### – *SystemInformationBlockType2-NB*

The IE *SystemInformationBlockType2-NB* contains radio resource configuration information that is common for all UEs.

NOTE: UE timers and constants related to functionality for which parameters are provided in another SIB are included in the corresponding SIB.

**SystemInformationBlockType2-NB information element**

```

-- ASN1START
SystemInformationBlockType2-NB-r13 ::= SEQUENCE {
  radioResourceConfigCommon-r13      RadioResourceConfigCommonSIB-NB-r13,
  ue-TimersAndConstants-r13          UE-TimersAndConstants-NB-r13,
  freqInfo-r13                       SEQUENCE {
    ul-CarrierFreq-r13                CarrierFreq-NB-r13          OPTIONAL,  -- Need OP
    additionalSpectrumEmission-r13    AdditionalSpectrumEmission
  },
  timeAlignmentTimerCommon-r13       TimeAlignmentTimer,
  multiBandInfoList-r13              SEQUENCE (SIZE (1..maxMultiBands)) OF AdditionalSpectrumEmission
  OPTIONAL,  -- Need OR
  lateNonCriticalExtension           OCTET STRING                OPTIONAL,
  . . .
  [[ cp-Reestablishment-r14          ENUMERATED {true}          OPTIONAL  -- Need
OP
  ]],
  [[ servingCellMeasInfo-r14        ENUMERATED {true}          OPTIONAL,  -- Need
OR
  cqi-Reporting-r14                 ENUMERATED {true}          OPTIONAL  -- Need
OR
  ]],
  [[ enhancedPHR-r15                ENUMERATED {true}          OPTIONAL,  -- Need OR
  freqInfo-v1530                    SEQUENCE {
    tdd-UL-DL-AlignmentOffset-r15    TDD-UL-DL-AlignmentOffset-NB-r15
  } OPTIONAL,  -- Cond TDD
  cp-EDT-r15                         ENUMERATED {true}          OPTIONAL,  -- Need OR
  up-EDT-r15                         ENUMERATED {true}          OPTIONAL  -- Need OR
  ]],
  [[ earlySecurityReactivation-r16   ENUMERATED {true}          OPTIONAL,  -- Need OR
  cp-EDT-5GC-r16                     ENUMERATED {true}          OPTIONAL,  -- Need OR
  up-EDT-5GC-r16                     ENUMERATED {true}          OPTIONAL,  -- Need OR
  cp-PUR-EPC-r16                     ENUMERATED {true}          OPTIONAL,  -- Need OR
  up-PUR-EPC-r16                     ENUMERATED {true}          OPTIONAL,  -- Need OR
  cp-PUR-5GC-r16                     ENUMERATED {true}          OPTIONAL,  -- Need OR
  up-PUR-5GC-r16                     ENUMERATED {true}          OPTIONAL,  -- Need OR
  rai-ActivationEnh-r16              ENUMERATED {true}          OPTIONAL  -- Need OR
  ]],
  [[ gnss-PositionFixDurationReporting-r18  ENUMERATED {true}          OPTIONAL  -- Need OR
  ]]
}
-- ASN1STOP

```

<b>SystemInformationBlockType2-NB field descriptions</b>	
<b>additionalSpectrumEmission</b> The UE requirements related to IE <i>AdditionalSpectrumEmission</i> are defined in TS 36.101 [42], clause 6.2.4F and TS 36.102 [113], clause 6.2B.3 for NTN capable UE.	
<b>cp-EDT</b> For FDD: This field indicates whether the UE is allowed to initiate CP-EDT when connected to EPC, see 5.3.3.1b.	
<b>cp-EDT-5GC</b> For FDD: This field indicates whether the UE is allowed to initiate CP-EDT when connected to 5GC, see 5.3.3.1b.	
<b>cp-PUR-5GC</b> For FDD: Indicates whether CP transmission using PUR is allowed in the cell when connected to 5GC, see 5.3.3.1c.	
<b>cp-PUR-EPC</b> For FDD: Indicates whether CP transmission using PUR is allowed in the cell when connected to EPC, see 5.3.3.1c.	
<b>cp-Reestablishment</b> This field indicates if the NB-IoT UE is allowed to trigger RRC connection re-establishment when AS security has not been activated.	
<b>cqi-Reporting</b> For FDD: This field indicates if downlink channel quality reporting in <i>RRCCConnectionReestablishmentRequest-NB</i> , <i>RRCCConnectionRequest-NB</i> , <i>RRCCConnectionResumeRequest-NB</i> and <i>RRCEarlyDataRequest-NB</i> message is allowed.	
<b>earlySecurityReactivation</b> Indicates that early security reactivation when resuming a suspended RRC connection as specified in 5.3.3.18 is supported.	
<b>enhancedPHR</b> For FDD: This field indicates if the NB-IoT UE is allowed to report enhanced PHR in MSG3 as specified in TS 36.321 [6].	
<b>gnss-PositionFixDurationReporting</b> If present, this field indicates that UEs capable of performing GNSS position fix in RRC_CONNECTED are configured to include the time duration required to acquire a GNSS position in <i>RRCCConnectionSetupComplete-NB</i> , <i>RRCCConnectionResumeComplete-NB</i> , and <i>RRCCConnectionReestablishmentComplete-NB</i> .	
<b>multiBandInfoList</b> A list of <i>additionalSpectrumEmission</i> i.e. one for each additional frequency band included in <i>multiBandInfoList</i> in <i>SystemInformationBlockType1-NB</i> , listed in the same order.	
<b>rai-ActivationEnh</b> Indicates whether the UE is allowed to report the AS Release Assistance Indication using the DCQR and AS RAI MAC CE as specified in TS 36.321 [6] when connected to EPC.	
<b>servingCellMeasInfo</b> This field indicates if serving cell idle mode measurement reporting in <i>RRCCConnectionReestablishmentComplete-NB</i> , <i>RRCCConnectionResumeComplete-NB</i> and <i>RRCCConnectionSetupComplete-NB</i> is allowed.	
<b>tdd-UL-DL-AlignmentOffset</b> Indicates the offset between the UL carrier frequency center with respect to DL carrier frequency center for the anchor carrier.	
<b>ul-CarrierFreq</b> For FDD: Uplink carrier frequency as defined in TS 36.101 [42], clause 5.7.3F and TS 36.102 [113], clause 5.4B.2. If <i>operationModeInfo</i> in the MIB-NB is set to <i>standalone</i> and the field is absent, the value of the carrier frequency is determined by the TX-RX frequency separation defined in TS 36.101 [42], table 5.7.4-1, and the value of the carrier frequency offset is 0. If <i>operationModeInfo</i> in the MIB-NB is not set to <i>standalone</i> , the field is mandatory present. For TDD: This field is absent and the uplink carrier frequency is same as the downlink frequency.	
<b>up-EDT</b> For FDD: This field indicates whether the UE is allowed to initiate UP-EDT when connected to EPC, see 5.3.3.1b.	
<b>up-EDT-5GC</b> For FDD: This field indicates whether the UE is allowed to initiate UP-EDT when connected to 5GC, see 5.3.3.1b.	
<b>up-PUR-5GC</b> For FDD: Indicates whether UP transmission using PUR is allowed in the cell when connected to 5GC, see 5.3.3.1c.	
<b>up-PUR-EPC</b> For FDD: Indicates whether UP transmission using PUR is allowed in the cell when connected to EPC, see 5.3.3.1c.	

Conditional presence	Explanation
TDD	The field is mandatory present for TDD; otherwise the field is not present and the UE shall delete any existing value for this field.

### SystemInformationBlockType3-NB

The IE *SystemInformationBlockType3-NB* contains cell re-selection information common for intra-frequency, and inter-frequency cell re-selection as well as intra-frequency cell re-selection information other than neighbouring cell related.

**SystemInformationBlockType3-NB information element**

```

-- ASN1START
SystemInformationBlockType3-NB-r13 ::= SEQUENCE {
  cellReselectionInfoCommon-r13 SEQUENCE {
    q-Hyst-r13 ENUMERATED {
      dB0, dB1, dB2, dB3, dB4, dB5, dB6, dB8, dB10,
      dB12, dB14, dB16, dB18, dB20, dB22, dB24
    }
  },
  cellReselectionServingFreqInfo-r13 SEQUENCE {
    s-NonIntraSearch-r13 ReselectionThreshold
  },
  intraFreqCellReselectionInfo-r13 SEQUENCE {
    q-RxLevMin-r13 Q-RxLevMin,
    q-QualMin-r13 Q-QualMin-r9 OPTIONAL, -- Need OP
    p-Max-r13 P-Max OPTIONAL, -- Need OP
    s-IntraSearchP-r13 ReselectionThreshold,
    t-Reselection-r13 T-Reselection-NB-r13
  },
  freqBandInfo-r13 NS-PmaxList-NB-r13 OPTIONAL, -- Need OR
  multiBandInfoList-r13 SEQUENCE (SIZE (1..maxMultiBands)) OF
    NS-PmaxList-NB-r13 OPTIONAL, -- Need OR
  lateNonCriticalExtension OCTET STRING OPTIONAL,
  ...,
  [[ intraFreqCellReselectionInfo-v1350 IntraFreqCellReselectionInfo-NB-v1350 OPTIONAL -- Cond
  Qrxlevmin
  ]],
  OR
  [[ intraFreqCellReselectionInfo-v1360 IntraFreqCellReselectionInfo-NB-v1360 OPTIONAL -- Need
  OR
  ]],
  OR
  [[ intraFreqCellReselectionInfo-v1430 IntraFreqCellReselectionInfo-NB-v1430 OPTIONAL -- Need
  OR
  ]],
  OR
  [[ cellReselectionInfoCommon-v1450 CellReselectionInfoCommon-NB-v1450 OPTIONAL -- Need
  OR
  ]],
  [[ nsss-RRM-Config-r15 NSSS-RRM-Config-NB-r15 OPTIONAL, -- Need OR
  npbch-RRM-Config-r15 ENUMERATED {enabled} OPTIONAL -- Need OR
  ]],
  [[ connMeasConfig-r17 ConnMeasConfig-NB-r17 OPTIONAL, -- Need OR
  t-Service-r17 TimeOffsetUTC-r17 OPTIONAL -- Need OR
  ]],
  [[ satelliteAssistanceInfo-r18 SEQUENCE (SIZE(1..maxSat-r17)) OF SatelliteId-r18 OPTIONAL
  -- Need OR
  ]],
  ]],
}

IntraFreqCellReselectionInfo-NB-v1350 ::= SEQUENCE {
  delta-RxLevMin-v1350 INTEGER (-8..-1)
}

IntraFreqCellReselectionInfo-NB-v1360 ::= SEQUENCE {
  s-IntraSearchP-v1360 ReselectionThreshold-NB-v1360
}

IntraFreqCellReselectionInfo-NB-v1430 ::= SEQUENCE {
  powerClass14dBm-Offset-r14 ENUMERATED {dB-6, dB-3, dB3, dB6, dB9, dB12} OPTIONAL, --
  Need OP
  ce-AuthorisationOffset-r14 ENUMERATED {dB5, dB10, dB15, dB20, dB25, dB30, dB35} OPTIONAL
  -- Need OP
}

CellReselectionInfoCommon-NB-v1450 ::= SEQUENCE {
  s-SearchDeltaP-r14 ENUMERATED {dB6, dB9, dB12, dB15}
}

ConnMeasConfig-NB-r17 ::= SEQUENCE {
  s-MeasureIntra-r17 NRSRP-Range-NB-r14,
  s-MeasureInter-r17 NRSRP-Range-NB-r14 OPTIONAL, -- Need OP
  neighCellMeasCriteria-r17 SEQUENCE {
    s-MeasureDeltaP-r17 ENUMERATED {dB6, dB9, dB12, dB15},
    t-MeasureDeltaP-r17 ENUMERATED {s15, s30, s45, s60}
  } OPTIONAL -- Need OR
}

-- ASN1STOP

```

<b>SystemInformationBlockType3-NB field descriptions</b>	
<b>ce-AuthorisationOffset</b>	Parameter "Qoffset <sub>authorization</sub> " in TS 36.304 [4]. Value in dB. Value dB5 corresponds to 5 dB, dB10 corresponds to 10 dB and so on. If the field is absent, the UE applies the value of <i>ce-authorizationOffset</i> in <i>SystemInformationBlockType1-NB</i> .
<b>multiBandInfoList</b>	A list of <i>additionalPmax</i> and <i>additionalSpectrumEmission</i> values as defined in TS 36.101 [42], clause 6.2.4F and TS 36.102 [113], clause 6.2B.3 for NTN capable UE, applicable for the intra-frequency neighbouring NB-IoT cells if the UE selects the frequency band from <i>freqBandIndicator</i> in <i>SystemInformationBlockType1-NB</i> .
<b>npbch-RRM-Config</b>	For FDD: Configuration for NPBCH-based RRM measurements. See TS 36.214 [24]. If enabled, NPBCH can be used in addition to NRS for RRM measurements for serving cell.
<b>nsss-RRM-Config</b>	For FDD: Configuration for NSSS-based RRM measurements for the serving cell.
<b>powerClass14dBm-Offset</b>	Parameter "Poffset" in TS 36.304 [4], only applicable for UE supporting <i>powerClassNB-14dBm</i> . Value in dB. Value dB-6 corresponds to -6 dB, dB-3 corresponds to -3 dB and so on. If the field is absent, the UE applies the (default) value of 0 dB for "Poffset" in TS 36.304 [4].
<b>p-Max</b>	Value applicable for the intra-frequency neighbouring E-UTRA cells. If absent the UE applies the maximum power according to the UE capability.
<b>q-Hyst</b>	Parameter $Q_{hyst}$ in TS 36.304 [4], Value in dB. Value dB1 corresponds to 1 dB, dB2 corresponds to 2 dB and so on.
<b>q-QualMin</b>	Parameter "Q <sub>qualmin</sub> " in TS 36.304 [4], applicable for intra-frequency neighbour cells. If the field is not present, the UE applies the (default) value of negative infinity for Q <sub>qualmin</sub> .
<b>q-RxLevMin, delta-RxLevMin</b>	Parameter "Q <sub>rxlevmin</sub> " in TS 36.304 [4], applicable for intra-frequency neighbour cells. If <i>delta-RxLevMin</i> is not included, actual value $Q_{rxlevmin} = q-RxLevMin * 2$ [dBm]. If <i>delta-RxLevMin</i> is included, actual value $Q_{rxlevmin} = (q-RxLevMin + delta-RxLevMin) * 2$ [dBm].
<b>s-IntraSearchP</b>	Parameter "S <sub>intraSearchP</sub> " in TS 36.304 [4]. In case <i>s-IntraSearchP-v1360</i> is included, the UE shall ignore <i>s-IntraSearchP</i> (i.e. without suffix).
<b>s-MeasureDeltaP</b>	Threshold of change in serving cell NRSRP to trigger neighbour cell measurement in RRC_CONNECTED state.
<b>s-MeasureInter</b>	NRSRP threshold to trigger inter-frequency neighbour cell measurement in RRC_CONNECTED state. If the field is absent in <i>connMeasConfig</i> , the UE applies the value of <i>s-MeasureIntra</i> .
<b>s-MeasureIntra</b>	NRSRP threshold to trigger intra-frequency neighbour cell measurement in RRC_CONNECTED state.
<b>s-NonIntraSearch</b>	Parameter "S <sub>nonIntraSearchP</sub> " in TS 36.304 [4].
<b>s-SearchDeltaP</b>	Parameter "S <sub>searchDeltaP</sub> " in TS 36.304 [4]. This parameter is only applicable for UEs supporting relaxed monitoring as specified in TS 36.306 [5]. Value dB6 corresponds to 6 dB, dB9 corresponds to 9 dB and so on.
<b>satelliteAssistanceInfo</b>	List of satellite ID(s), used to associate with the satellite assistance information for intra-frequency neighbour cell measurements.
<b>t-MeasureDeltaP</b>	Duration after which the UE is not required to perform neighbour cell measurement in RRC_CONNECTED when <i>s-MeasureDeltaP</i> criterion is fulfilled.
<b>t-Reselection</b>	Parameter "T <sub>reselctionNB-IoT_Intra</sub> " in TS 36.304 [4].
<b>t-Service</b>	Time information on when an NTN cell is going to stop serving the area it is currently covering. This field applies for service link switches in NTN quasi-Earth fixed cells and feeder link switches for both NTN quasi-Earth fixed and earth-moving cells.

Conditional presence	Explanation
Qrxlevmin	This field is optionally present, Need OR, if <i>q-RxLevMin</i> is set to the minimum value. Otherwise the field is not present.



## – SystemInformationBlockType4-NB

The IE *SystemInformationBlockType4-NB* contains neighbouring cell related information relevant only for intra-frequency cell re-selection. The IE includes cells with specific re-selection parameters.

### SystemInformationBlockType4-NB information element

```
-- ASN1START
SystemInformationBlockType4-NB-r13 ::= SEQUENCE {
    intraFreqNeighCellList-r13      IntraFreqNeighCellList OPTIONAL, -- Need OR
    intraFreqExcludedCellList-r13  IntraFreqExcludedCellList OPTIONAL, -- Need OR
    lateNonCriticalExtension        OCTET STRING OPTIONAL,
    . . .
    [[ nsss-RRM-Config-r15          Nsss-RRM-Config-NB-r15 OPTIONAL, -- Need OR
       intraFreqNeighCellList-v1530 IntraFreqNeighCellList-NB-v1530 OPTIONAL -- Need OR
    ]]
}

IntraFreqNeighCellList-NB-v1530 ::= SEQUENCE (SIZE (1..maxCellIntra)) OF IntraFreqNeighCellInfo-
NB-v1530

IntraFreqNeighCellInfo-NB-v1530 ::= SEQUENCE {
    nsss-RRM-Config-r15          Nsss-RRM-Config-NB-r15 OPTIONAL -- Cond Nsss-RRM
}
-- ASN1STOP
```

### SystemInformationBlockType4-NB field descriptions

<b><i>intraFreqExcludedCellList</i></b>
List of exclude-listed intra-frequency neighbouring cells.
<b><i>intraFreqNeighCellList</i></b>
List of intra-frequency neighbouring cells with specific cell re-selection parameters.
<b><i>nsss-RRM-Config</i></b>
For FDD: Configuration for Nsss-based RRM measurements. If <i>intraFreqNeighCellList-NB-v1530</i> is present then for a cell which is included in <i>intraFreqNeighCellList</i> , the UE applies the <i>nsss-RRM-Config</i> configured in the corresponding entry of <i>IntraFreqNeighCellList-NB-v1530</i> . Otherwise, the UE applies the <i>nsss-RRM-Config</i> configured in <i>SystemInformationBlockType4-NB-r13</i> .

Conditional presence	Explanation
Nsss-RRM	This field is optionally present, Need OR, when <i>nsss-RRM-Config</i> is present in <i>SystemInformationBlockType4-NB</i> . Otherwise, the field is not present, and the UE shall delete any existing value for this field.

## – SystemInformationBlockType5-NB

The IE *SystemInformationBlockType5-NB* contains information relevant only for inter-frequency cell re-selection i.e. information about other NB-IoT frequencies and inter-frequency neighbouring cells relevant for cell re-selection. The IE includes cell re-selection parameters common for a frequency as well as cell specific re-selection parameters.

### SystemInformationBlockType5-NB information element

```
-- ASN1START
SystemInformationBlockType5-NB-r13 ::= SEQUENCE {
    interFreqCarrierFreqList-r13  InterFreqCarrierFreqList-NB-r13,
    t-Reselection-r13             T-Reselection-NB-r13,
    lateNonCriticalExtension        OCTET STRING OPTIONAL,
    . . .
    [[ scptm-FreqOffset-r14        INTEGER (1..8) OPTIONAL -- Need OP
    ]],
    [[ interFreqCarrierFreqList-v1820 InterFreqCarrierFreqList-NB-v1820 OPTIONAL -- Need
OP
    ]],
}
-- ASN1STOP
```

```

InterFreqCarrierFreqList-NB-r13 ::= SEQUENCE (SIZE (1..maxFreq)) OF InterFreqCarrierFreqInfo-NB-r13

InterFreqCarrierFreqList-NB-v1820 ::= SEQUENCE (SIZE (1..maxFreq)) OF InterFreqCarrierFreqInfo-NB-v1820

InterFreqCarrierFreqInfo-NB-r13 ::= SEQUENCE {
    dl-CarrierFreq-r13          CarrierFreq-NB-r13,
    q-RxLevMin-r13             Q-RxLevMin,
    q-QualMin-r13              Q-QualMin-r9          OPTIONAL,      -- Need OP
    p-Max-r13                  P-Max                OPTIONAL,      -- Need OP
    q-OffsetFreq-r13           Q-OffsetRange         DEFAULT dB0,
    interFreqNeighCellList-r13 InterFreqNeighCellList-NB-r13 OPTIONAL,      -- Need OR
    interFreqExcludedCellList-r13 InterFreqExcludedCellList-NB-r13 OPTIONAL,      --
Need OR
    multiBandInfoList-r13      MultiBandInfoList-NB-r13  OPTIONAL,      -- Need OR
    ...,
    [[ delta-RxLevMin-v1350     INTEGER (-8..-1)      OPTIONAL      -- Cond Qrxlevmin
    ]],
    [[ powerClass14dBm-Offset-r14 ENUMERATED {dB-6, dB-3, dB3, dB6, dB9, dB12}
OPTIONAL,      -- Need OP
    ce-AuthorisationOffset-r14 ENUMERATED {dB5, dB10, dB15, dB20, dB25, dB30, dB35}
OPTIONAL      -- Need OP
    ]],
    [[ nsss-RRM-Config-r15      NSSS-RRM-Config-NB-r15  OPTIONAL,      -- Need OR
    interFreqNeighCellList-v1530 InterFreqNeighCellList-NB-v1530 OPTIONAL -- Need OR
    ]],
    [[ dl-CarrierFreq-v1550     CarrierFreq-NB-v1550  OPTIONAL -- Cond TDD
    ]]
}

InterFreqCarrierFreqInfo-NB-v1820 ::= SEQUENCE {
    satelliteAssistanceInfo-r18 SEQUENCE (SIZE(1..maxSat-r17)) OF SatelliteId-r18  OPTIONAL  --
Need OR
}

InterFreqNeighCellList-NB-r13 ::= SEQUENCE (SIZE (1..maxCellInter)) OF PhysCellId

InterFreqNeighCellList-NB-v1530 ::= SEQUENCE (SIZE (1..maxCellInter)) OF InterFreqNeighCellInfo-NB-v1530

InterFreqNeighCellInfo-NB-v1530 ::= SEQUENCE {
    nsss-RRM-Config-r15        NSSS-RRM-Config-NB-r15  OPTIONAL      -- Cond NSSS-RRM
}

InterFreqExcludedCellList-NB-r13 ::= SEQUENCE (SIZE (1..maxExcludedCell)) OF PhysCellId

-- ASN1STOP

```

<b>SystemInformationBlockType5-NB field descriptions</b>	
<b>ce-AuthorisationOffset</b>	Parameter "Qoffset <sub>authorization</sub> " in TS 36.304 [4]. Value in dB. Value dB5 corresponds to 5 dB, dB10 corresponds to 10 dB and so on. If the field is absent, the UE applies the value of <i>ce-authorisationOffset</i> in <i>SystemInformationBlockType1-NB</i> .
<b>interFreqExcludedCellList</b>	List of exclude-listed inter-frequency neighbouring cells.
<b>interFreqCarrierFreqList</b>	List of neighbouring inter-frequencies. E-UTRAN does not configure more than one entry for the same physical frequency regardless of the E-ARFCN used to indicate this.
<b>interFreqNeighCellList</b>	List of inter-frequency neighbouring cells. E-UTRAN may include <i>interFreqNeighCellList</i> when including <i>InterFreqNeighCellList-NB-v1530</i> to provide cell specific NSSS-based measurement configuration. The UE that does not support NSSS-based RRM measurements shall ignore this field in this version of the specification.
<b>multiBandInfoList</b>	Indicates the list of frequency bands, with the associated <i>additionalPmax</i> and <i>additionalSpectrumEmission</i> values as defined in TS 36.101 [42], clause 6.2.4, in addition to the band represented by dl-CarrierFreq for which cell reselection parameters are common.
<b>nsss-RRM-Config</b>	For FDD: Configuration for NSSS-based RRM measurements. If <i>InterFreqNeighCellList-NB-v1530</i> is present then for a cell which is included in <i>interFreqNeighCellList</i> , the UE applies the <i>nsss-RRM-Config</i> configured in the corresponding entry of <i>InterFreqNeighCellList-NB-v1530</i> . Otherwise, the UE applies the <i>nsss-RRM-Config</i> configured in <i>InterFreqCarrierFreqInfo</i> .
<b>p-Max</b>	Value applicable for the neighbouring NB-IoT cells on this carrier frequency. If absent the UE applies the maximum power according to the UE capability.
<b>powerClass14dBm-Offset</b>	Parameter "Poffset" in TS 36.304 [4], only applicable for UE supporting <i>powerClassNB-14dBm</i> . Value in dB. Value dB-6 corresponds to -6 dB, dB-3 corresponds to -3 dB and so on. If the field is absent, the UE applies the (default) value of 0 dB for "Poffset" in TS 36.304 [4].
<b>q-OffsetFreq</b>	Parameter "Qoffset <sub>frequency</sub> " in TS 36.304 [4].
<b>q-QualMin</b>	Parameter "Q <sub>qualmin</sub> " in TS 36.304 [4]. If the field is not present, the UE applies the (default) value of negative infinity for Q <sub>qualmin</sub> .
<b>q-RxlevMin, delta-RxLevMin</b>	Parameter "Q <sub>RxLevmin</sub> " in TS 36.304 [4]. If <i>delta-RxLevMin</i> is not included, actual value Q <sub>Rxlevmin</sub> = <i>q-RxLevMin</i> * 2 [dBm]. If <i>delta-RxLevMin</i> is included, actual value Q <sub>Rxlevmin</sub> = ( <i>q-RxLevMin</i> + <i>delta-RxLevMin</i> ) * 2 [dBm].
<b>satelliteAssistanceInfo</b>	List of satellite ID(s), used to associate with the satellite assistance information for neighbour cell measurements on this frequency. If the field is not present for a frequency and <i>SystemInformationBlockType33-NB</i> is broadcast, the UE considers the cells on the frequency to be terrestrial cells.
<b>scptm-FreqOffset</b>	Parameter Qoffset <sub>SCPTM</sub> in TS 36.304 [4]. Actual value Qoffset <sub>SCPTM</sub> = field value * 2 [dB]. If the field is absent, the UE uses infinite dBs for the SC-PTM frequency offset with cell ranking as specified in TS 36.304 [4].
<b>t-Reselection</b>	Parameter "Treselction <sub>NB-IoT_Inter</sub> " in TS 36.304 [4].

Conditional presence	Explanation
<i>NSSS-RRM</i>	This field is optionally present, Need OR, when <i>nsss-RRM-Config</i> is present in <i>InterFreqCarrierFreqInfo</i> . Otherwise, the field is not present, and the UE shall delete any existing value for this field.
<i>Qrxlevmin</i>	This field is optionally present, Need OR, if <i>q-RxLevMin</i> is set to the minimum value. Otherwise the field is not present.
<i>TDD</i>	The field is optionally present, Need OR, in TDD. Otherwise, the field is not present.

– **SystemInformationBlockType14-NB**

The IE *SystemInformationBlockType14-NB* contains the AB parameters for EPC and 5GC.

**SystemInformationBlockType14-NB information element**

-- ASN1START

```

SystemInformationBlockType14-NB-r13 ::= SEQUENCE {
    ab-Param-r13                CHOICE {
        ab-Common-r13          AB-Config-NB-r13,
        ab-PerPLMN-List-r13    SEQUENCE (SIZE (1..maxPLMN-r11)) OF AB-ConfigPLMN-NB-r13
    }
    lateNonCriticalExtension    OCTET STRING
    . . .
    [[ ab-PerNRSRP-r15          ENUMERATED {thresh1, thresh2} OPTIONAL -- Need OR
    ]],
    [[ uac-Param-r16           UAC-Param-NB-r16           OPTIONAL -- Need OR
    ]]
}

AB-ConfigPLMN-NB-r13 ::= SEQUENCE {
    ab-Config-r13              AB-Config-NB-r13           OPTIONAL -- Need OR
}

AB-Config-NB-r13 ::= SEQUENCE {
    ab-Category-r13           ENUMERATED {a, b, c},
    ab-BarringBitmap-r13      BIT STRING (SIZE(10)),
    ab-BarringForExceptionData-r13 ENUMERATED {true} OPTIONAL, -- Need OP
    ab-BarringForSpecialAC-r13 BIT STRING (SIZE(5))
}

UAC-Param-NB-r16 ::= CHOICE {
    uac-BarringCommon         UAC-Barring-NB-r16,
    uac-BarringPerPLMN-List   SEQUENCE (SIZE (1..maxPLMN-r11)) OF UAC-Barring-NB-r16
}

UAC-Barring-NB-r16 ::= SEQUENCE {
    uac-BarringPerCatList-r16 UAC-BarringPerCatList-NB-r16 OPTIONAL, -- Need OR
    uac-ACL-SelectAssistInfo-r16 UAC-ACL-SelectAssistInfo-r15 OPTIONAL, -- Need OR
    uac-BarringForAccessIdentity-r16 BIT STRING (SIZE(7))
}

UAC-BarringPerCatList-NB-r16 ::= SEQUENCE (SIZE (1..maxAccessCat-1-r15)) OF UAC-BarringPerCat-NB-r16

UAC-BarringPerCat-NB-r16 ::= SEQUENCE {
    uac-accessCategory-r16     INTEGER (1..maxAccessCat-1-r15),
    uac-BarringFactor-r16      ENUMERATED {p00, p05, p10, p15, p20, p25, p30, p40,
                                           p50, p60, p70, p75, p80, p85, p90, p95},
    uac-BarringTime-r16        ENUMERATED {s4, s8, s16, s32, s64, s128, s256, s512}
}

-- ASN1STOP

```

### SystemInformationBlockType14-NB field descriptions

#### **ab-BarringBitmap**

Access class barring for AC 0-9. The first/ leftmost bit is for AC 0, the second bit is for AC 1, and so on.

#### **ab-BarringForExceptionData**

Indicates whether ExceptionData is subject to access barring.

#### **ab-BarringForSpecialAC**

Access class barring for AC 11-15. The first/ leftmost bit is for AC 11, the second bit is for AC 12, and so on.

#### **ab-Category**

Indicates the category of UEs for which AB applies. Value *a* corresponds to all UEs, value *b* corresponds to the UEs that are neither in their HPLMN nor in a PLMN that is equivalent to it, and value *c* corresponds to the UEs that are neither in the PLMN listed as most preferred PLMN of the country where the UEs are roaming in the operator-defined PLMN selector list on the USIM, nor in their HPLMN nor in a PLMN that is equivalent to their HPLMN, see TS 22.011 [10].

#### **ab-Common**

The AB parameters applicable for all PLMN(s).

#### **ab-Param**

The AB parameters for connectivity to EPC

#### **ab-PerNRSRP**

Access barring per NRSRP. Value *thresh1* corresponds to the first entry configured in *rsrp-ThresholdsPrachInfoList*, value *thresh2* corresponds to the second entry configured in *rsrp-ThresholdsPrachInfoList*.

#### **ab-PerPLMN-List**

The AB parameters per PLMN, listed in the same order as the PLMN(s) occur in *plmn-IdentityList* in *SystemInformationBlockType1-NB*.

<b>SystemInformationBlockType14-NB field descriptions</b>
<b>ab-BarringBitmap</b> Access class barring for AC 0-9. The first/ leftmost bit is for AC 0, the second bit is for AC 1, and so on.
<b>ab-BarringForExceptionData</b> Indicates whether ExceptionData is subject to access barring.
<b>ab-BarringForSpecialAC</b> Access class barring for AC 11-15. The first/ leftmost bit is for AC 11, the second bit is for AC 12, and so on.
<b>uac-AC1-SelectAssistInfo</b> Information used to determine whether Access Category 1 applies to the UE, as defined in TS 22.261 [96]. The field is forwarded to upper layers, if present.
<b>uac-accessCategory</b> The Access Category according to TS 22.261 [96].
<b>uac-BarringCommon</b> The UAC parameters applicable for all PLMN(s).
<b>uac-BarringFactor</b> Represents the probability that access attempt would be allowed during access barring check.
<b>uac-BarringForAccessIdentity</b> Indicates whether access attempt is allowed for each Access Identity. The leftmost bit, bit 0 in the bit string corresponds to Access Identity 1, bit 1 in the bit string corresponds to Access Identity 2, bit 2 in the bit string corresponds to Access Identity 11, bit 3 in the bit string corresponds to Access Identity 12, and so on. Value 0 means that access attempt is allowed for the corresponding access identity.
<b>uac-BarringPerCatList</b> Access control parameters for each access category for the specific PLMN.
<b>uac-BarringPerPLMN-List</b> The UAC parameters per PLMN, listed in the same order as the PLMN(s) occur in <i>plmn-IdentityList</i> in <i>SystemInformationBlockType1-NB</i> .
<b>uac-BarringTime</b> The average time in seconds before a new access attempt is to be performed after an access attempt was barred at access barring check for the same access category, see 5.3.16.5.
<b>uac-Param</b> The UAC parameters for connectivity to 5GC.

## – SystemInformationBlockType15-NB

The IE *SystemInformationBlockType15-NB* contains the MBMS Service Area Identities (SAI) of the current and/ or neighbouring carrier frequencies.

### SystemInformationBlockType15-NB information element

```
-- ASN1START
SystemInformationBlockType15-NB-r14 ::= SEQUENCE {
    mbms-SAI-IntraFreq-r14          MBMS-SAI-List-r11          OPTIONAL,  -- Need OR
    mbms-SAI-InterFreqList-r14    MBMS-SAI-InterFreqList-NB-r14  OPTIONAL,  -- Need OR
    lateNonCriticalExtension        OCTET STRING                OPTIONAL,
    ...
}
MBMS-SAI-InterFreqList-NB-r14 ::= SEQUENCE (SIZE (1..maxFreq)) OF MBMS-SAI-InterFreq-NB-r14
MBMS-SAI-InterFreq-NB-r14 ::= SEQUENCE {
    dl-CarrierFreq-r14             CarrierFreq-NB-r13,
    mbms-SAI-List-r14             MBMS-SAI-List-r11,
    multiBandInfoList-r14         AdditionalBandInfoList-NB-r14  OPTIONAL  -- Need OR
}
-- ASN1STOP
```

<b>SystemInformationBlockType15-NB field descriptions</b>
<b>mbms-SAI-InterFreqList</b> Contains a list of neighboring frequencies including additional frequency bands, if any, that provide MBMS services and the corresponding MBMS SAIs.
<b>mbms-SAI-IntraFreq</b> Contains the list of MBMS SAIs for the current frequency. A duplicate MBMS SAI indicates that this and all following SAIs are not offered by this cell but only by neighbour cells on the current frequency. For MBMS service continuity, the UE shall use all MBMS SAIs listed in <i>mbms-SAI-IntraFreq</i> to derive the MBMS frequencies of interest.
<b>mbms-SAI-List</b> Contains a list of MBMS SAIs for a specific frequency.
<b>multiBandInfoList</b> A list of additional frequency bands applicable for the cells participating in the SC-PTM transmission.

## – SystemInformationBlockType16-NB

The IE *SystemInformationBlockType16-NB* contains information related to GPS time and Coordinated Universal Time (UTC). The UE may use the parameters provided in this system information block to obtain the UTC, the GPS and the local time.

```
-- ASN1START
SystemInformationBlockType16-NB-r13 ::= SystemInformationBlockType16-r11
-- ASN1STOP
```

## – SystemInformationBlockType20-NB

For FDD, the IE *SystemInformationBlockType20-NB* contains the information required to acquire the control information associated with transmission of MBMS using SC-PTM.

### SystemInformationBlockType20-NB information element

```
-- ASN1START
SystemInformationBlockType20-NB-r14 ::= SEQUENCE {
  npdcch-SC-MCCH-Config-r14          NPDCCH-SC-MCCH-Config-NB-r14,
  sc-mcch-CarrierConfig-r14          CHOICE {
    dl-CarrierConfig-r14              DL-CarrierConfigCommon-NB-r14,
    dl-CarrierIndex-r14              INTEGER (0.. maxNonAnchorCarriers-NB-r14)
  },
  sc-mcch-RepetitionPeriod-r14       ENUMERATED {rf32, rf128, rf512, rf1024,
                                                    rf2048, rf4096, rf8192, rf16384},
  sc-mcch-Offset-r14                 INTEGER (0..10),
  sc-mcch-ModificationPeriod-r14     ENUMERATED { rf32, rf128, rf256, rf512, rf1024,
                                                    rf2048, rf4096, rf8192, rf16384, rf32768,
                                                    rf65536, rf131072, rf262144, rf524288,
                                                    rf1048576, spare1},
  sc-mcch-SchedulingInfo-r14         SC-MCCH-SchedulingInfo-NB-r14      OPTIONAL,  -- Need
OP
  lateNonCriticalExtension            OCTET STRING                      OPTIONAL,
  ...
}

NPDCCH-SC-MCCH-Config-NB-r14 ::= SEQUENCE {
  npdcch-NumRepetitions-SC-MCCH-r14  ENUMERATED {r1, r2, r4, r8, r16,
                                                    r32, r64, r128, r256,
                                                    r512, r1024, r2048},
  npdcch-StartSF-SC-MCCH-r14         ENUMERATED {v1dot5, v2, v4, v8,
                                                    v16, v32, v48, v64},
  npdcch-Offset-SC-MCCH-r14          ENUMERATED {zero, oneEighth, oneQuarter,
                                                    threeEighth, oneHalf, fiveEighth,
                                                    threeQuarter, sevenEighth}
}

SC-MCCH-SchedulingInfo-NB-r14 ::= SEQUENCE {
  onDurationTimerSCPTM-r14           ENUMERATED {
    pp1, pp2, pp3, pp4,
    pp8, pp16, pp32, spare},
  drx-InactivityTimerSCPTM-r14      ENUMERATED {
```

```

        schedulingPeriodStartOffsetSCPTM-r14 CHOICE {
            sf10 INTEGER(0..9),
            sf20 INTEGER(0..19),
            sf32 INTEGER(0..31),
            sf40 INTEGER(0..39),
            sf64 INTEGER(0..63),
            sf80 INTEGER(0..79),
            sf128 INTEGER(0..127),
            sf160 INTEGER(0..159),
            sf256 INTEGER(0..255),
            sf320 INTEGER(0..319),
            sf512 INTEGER(0..511),
            sf640 INTEGER(0..639),
            sf1024 INTEGER(0..1023),
            sf2048 INTEGER(0..2047),
            sf4096 INTEGER(0..4095),
            sf8192 INTEGER(0..8191)
        },
        ...
    }
-- ASN1STOP

```

### SystemInformationBlockType20-NB field descriptions

<b>dl-CarrierConfig</b>	Downlink carrier used for SC-MCCH. E-UTRAN cannot configure a downlink carrier operating in mixed operation mode.
<b>dl-CarrierIndex</b>	Index to a downlink carrier signalled in system information. Value '0' corresponds to the anchor carrier, value '1' corresponds to the first entry in <i>dl-ConfigList</i> in <i>SystemInformationBlockType22-NB</i> , value '2' corresponds to the second entry in <i>dl-ConfigList</i> and so on.
<b>drx-InactivityTimerSCPTM</b>	Timer for SC-MCCH reception in TS 36.321 [6]. Value in number of NPDCCH periods. Value pp1 corresponds to 1 NPDCCH period, pp2 corresponds to 2 NPDCCH periods and so on.
<b>npdcch-NumRepetitions-SC-MCCH</b>	The maximum number of NPDCCH repetitions the UE needs to monitor for SC-MCCH multicast search space, see TS 36.213 [23].
<b>npdcch-Offset-SC-MCCH</b>	Fractional period offset of starting subframe for NPDCCH multicast search space for SC-MCCH, see TS 36.213 [23].
<b>npdcch-StartSF-SC-MCCH</b>	Starting subframes configuration of the NPDCCH multicast search space for SC-MCCH, see TS 36.213 [23].
<b>onDurationTimerSCPTM</b>	Timer for SC-MCCH reception in TS 36.321 [6]. Value in number of NPDCCH periods. Value pp1 corresponds to 1 NPDCCH period, pp2 corresponds to 2 NPDCCH periods and so on.
<b>schedulingPeriodStartOffsetSCPTM</b>	<i>SCPTM-SchedulingCycle</i> and <i>SCPTM-SchedulingOffset</i> in TS 36.321 [6]. The value of <i>SCPTM-SchedulingCycle</i> is in number of sub-frames. Value sf10 corresponds to 10 sub-frames, sf20 corresponds to 20 sub-frames and so on. The value of <i>SCPTM-SchedulingOffset</i> is in number of sub-frames.
<b>sc-mcch-CarrierConfig</b>	Downlink carrier that is used for SC-MCCH.
<b>sc-mcch-ModificationPeriod</b>	Defines periodically appearing boundaries, i.e. radio frames for which $(H-SFN * 1024 + SFN) \bmod sc-mcch-ModificationPeriod = 0$ . The contents of different transmissions of SC-MCCH information can only be different if there is at least one such boundary in-between them. Value rf32 corresponds to 32 radio frames, value rf128 corresponds to 128 radio frames and so on.
<b>sc-mcch-Offset</b>	Indicates, together with the <i>sc-mcch-RepetitionPeriod</i> , the boundary of the repetition period: $(H-SFN * 1024 + SFN) \bmod sc-mcch-RepetitionPeriod = sc-mcch-Offset$ .
<b>sc-mcch-RepetitionPeriod</b>	Defines the interval between transmissions of SC-MCCH information, in radio frames. Value rf32 corresponds to 32 radio frames, rf128 corresponds to 128 radio frames and so on.
<b>sc-mcch-SchedulingInfo</b>	DRX information for the SC-MCCH. If the field is absent, DRX is not used for SC-MCCH reception.

## SystemInformationBlockType22-NB

The IE *SystemInformationBlockType22-NB* contains radio resource configuration for paging and random access procedure on non-anchor carriers.

### SystemInformationBlockType22-NB information element

```

-- ASN1START
SystemInformationBlockType22-NB-r14 ::= SEQUENCE {
    dl-ConfigList-r14          DL-ConfigCommonList-NB-r14  OPTIONAL,  -- Need OR
    ul-ConfigList-r14          UL-ConfigCommonList-NB-r14  OPTIONAL,  -- Need OR
    pagingWeightAnchor-r14     PagingWeight-NB-r14      OPTIONAL,  -- Cond pcch-config
    nprach-ProbabilityAnchorList-r14  NPRACH-ProbabilityAnchorList-NB-r14  OPTIONAL,  -- Cond
nprach-config
    lateNonCriticalExtension    OCTET STRING                OPTIONAL,
    ...,
    [[ mixedOperationModeConfig-r15  SEQUENCE {
        dl-ConfigListMixed-r15        DL-ConfigCommonList-NB-r14  OPTIONAL,  -- Cond dl-
ConfigList
        ul-ConfigListMixed-r15        UL-ConfigCommonList-NB-r14  OPTIONAL,  -- Cond ul-
ConfigList
        pagingDistribution-r15         ENUMERATED {true}          OPTIONAL,  -- Need OR
        nprach-Distribution-r15        ENUMERATED {true}          OPTIONAL,  -- Need OR
    }
    ]],
    ul-ConfigList-r15          UL-ConfigCommonListTDD-NB-r15  OPTIONAL,  -- Cond TDD
    ]],
    [[ coverageBasedPagingConfig-r17  CoverageBasedPagingConfig-NB-r17  OPTIONAL  -- Need OR
    ]]
}

DL-ConfigCommonList-NB-r14 ::= SEQUENCE (SIZE (1.. maxNonAnchorCarriers-NB-r14)) OF
    DL-ConfigCommon-NB-r14

UL-ConfigCommonList-NB-r14 ::= SEQUENCE (SIZE (1.. maxNonAnchorCarriers-NB-r14)) OF
    UL-ConfigCommon-NB-r14

UL-ConfigCommonListTDD-NB-r15 ::= SEQUENCE (SIZE (1.. maxNonAnchorCarriers-NB-r14)) OF
    UL-ConfigCommonTDD-NB-r15

CoverageBasedPagingConfig-NB-r17 ::= SEQUENCE {
    cbp-HystTimer-r17  ENUMERATED {ms2560, ms7680, ms12800, ms17920, ms23040, ms28160, ms33280,
ms40960},
    cbp-ConfigList-r17 SEQUENCE (SIZE (1.. 2)) OF CBP-Config-NB-r17
}

CBP-Config-NB-r17 ::= SEQUENCE {
    nrsrpMin-r17  RSRP-Range,
    nB-r17  ENUMERATED {fourT, twoT, oneT, halfT, quarterT, one8thT, one16thT, one32ndT,
one64thT, one128thT, one256thT, one512thT, one1024thT, spare3,
spare2, spare1} OPTIONAL,  -- Need OP
    ue-SpecificDRX-CycleMin-r17  ENUMERATED {rf32, rf64, rf128, rf256}  OPTIONAL  -- Need OR
}

DL-ConfigCommon-NB-r14 ::= SEQUENCE {
    dl-CarrierConfig-r14  DL-CarrierConfigCommon-NB-r14,
    pcch-Config-r14       PCCH-Config-NB-r14  OPTIONAL,  -- Need OR
    ...,
    [[ wus-Config-r15      WUS-ConfigPerCarrier-NB-r15  OPTIONAL  -- Cond WUS
    ]],
    [[ gwus-Config-r16     WUS-ConfigPerCarrier-NB-r15  OPTIONAL  -- Cond GWUS
    ]],
    [[ pcch-Config-r17     PCCH-Config-NB-r17  OPTIONAL  -- Cond pcch-config2
    ]]
}

PCCH-Config-NB-r14 ::= SEQUENCE {
    npdcch-NumRepetitionPaging-r14  ENUMERATED {
        r1, r2, r4, r8, r16, r32, r64, r128,
        r256, r512, r1024, r2048,
        spare4, spare3, spare2, spare1} OPTIONAL,  -- Need OP
    pagingWeight-r14  PagingWeight-NB-r14  DEFAULT w1,
    ...
}

PCCH-Config-NB-r17 ::= SEQUENCE {
    cbp-Index-r17  INTEGER (1..2),

```



```

    npdcch-NumRepetitionPaging-r17 ENUMERATED {r1, r2, r4, r8, r16, r32, r64, r128},
    pagingWeight-r17                PagingWeight-NB-r14 DEFAULT w1,
    ...
}

PagingWeight-NB-r14 ::=          ENUMERATED {w1, w2, w3, w4, w5, w6, w7, w8,
                                           w9, w10, w11, w12, w13, w14, w15, w16}

UL-ConfigCommonNB-r14 ::=      SEQUENCE {
    ul-CarrierFreq-r14          CarrierFreq-NB-r13,
    nprach-ParametersList-r14   NPRACH-ParametersList-NB-r14 OPTIONAL, -- Need OR
    ...,
    [[ nprach-ParametersListEDT-r15   NPRACH-ParametersList-NB-r14 OPTIONAL -- Cond EDT
    ]],
    [[ rsrp-ThresholdsPrachInfoList-r16   RSRP-ThresholdsNPRACH-InfoList-NB-r13 OPTIONAL -- Need
OR
    ]]
}

UL-ConfigCommonTDD-NB-r15 ::= SEQUENCE {
    tdd-UL-DL-AlignmentOffset-r15   TDD-UL-DL-AlignmentOffset-NB-r15,
    nprach-ParametersListTDD-r15    NPRACH-ParametersListTDD-NB-r15 OPTIONAL, -- Need OR
    ...
}

NPRACH-ProbabilityAnchorList-NB-r14 ::= SEQUENCE (SIZE (1.. maxNPRACH-Resources-NB-r13)) OF
    NPRACH-ProbabilityAnchor-NB-r14

NPRACH-ProbabilityAnchor-NB-r14 ::= SEQUENCE {
    nprach-ProbabilityAnchor-r14     ENUMERATED {
        zero, oneSixteenth, oneFifteenth, oneFourteenth,
        oneThirteenth, oneTwelfth, oneEleventh, oneTenth,
        oneNinth, oneEighth, oneSeventh, oneSixth,
        oneFifth, oneFourth, oneThird, oneHalf}
    OPTIONAL -- Need OP
}

-- ASN1STOP

```

<b>SystemInformationBlockType2-NB field descriptions</b>
<p><b>cbp-ConfigList</b> List of coverage-based paging configurations.</p>
<p><b>cbp-HystTimer</b> The minimum duration, in milliseconds, a UE configured with coverage-based paging uses the same carrier for paging, see TS 36.304 [4]. Value <i>ms2560</i> corresponds to 2560ms, value <i>ms7680</i> corresponds to 7680ms, and so on.</p>
<p><b>cbp-Index</b> Index to the coverage-based paging configuration associated with the downlink carrier. Value 1 corresponds to the first entry in <i>cbp-ConfigList</i>, and value 2 corresponds to the second entry in the <i>cbp-ConfigList</i>.</p>
<p><b>dl-CarrierConfig</b> For FDD: Provides the configuration of the DL non-anchor carrier. For TDD: Provides the configuration of the non-anchor carrier.</p>
<p><b>dl-ConfigList, dl-ConfigListMixed</b> For FDD: List of DL non-anchor carriers and associated configuration that can be used for paging and/or random access. E-UTRAN configures DL non-anchor carriers operating in mixed operation mode only in <i>dl-ConfigListMixed</i> and only a UE that supports mixed operation mode uses the carriers in <i>dl-ConfigListMixed</i>. A given carrier is either signalled in the <i>dl-ConfigList</i> or in <i>dl-ConfigListMixed</i>. If <i>dl-ConfigListMixed</i> is present and at least one of the carriers in <i>dl-ConfigListMixed</i> is configured for paging: <ul style="list-style-type: none"> <li>- If <i>pagingDistribution</i> is present, the UE supporting mixed operation mode creates a combined list of DL carriers for paging by appending <i>dl-ConfigListMixed</i> to the <i>dl-ConfigList</i> while maintaining the order among <i>dl-ConfigList</i> and <i>dl-ConfigListMixed</i>; the total number of signalled DL non-anchor carriers cannot be more than <i>maxNonAnchorCarriers-NB-r14</i>.</li> <li>- If <i>pagingDistribution</i> is absent, the UE supporting mixed operation mode uses the list of DL carriers for paging provided in <i>dl-ConfigListMixed</i> and considers <i>pagingWeightAnchor</i> being set to w0, i.e. the anchor carrier is not used.</li> </ul> Otherwise, the <i>pagingDistribution</i> field is not applicable and the UE shall ignore the value. For TDD: List of non-anchor carriers and associated configuration that can be used for paging and/or random access.</p>
<p><b>gwus-Config</b> For FDD: Carrier specific GWUS Configuration. If both <i>gwus-Config</i> and <i>wus-Config</i> are present for the carrier, E-UTRAN configures the same value for both fields.</p>
<p><b>mixedOperationModeConfig</b> For FDD: Provides the configuration of DL and UL non-anchor carriers that can be used for paging and random access by a UE that supports mixed operation mode. For TDD: This parameter is absent.</p>
<p><b>nB</b> Parameter: nB is used as one of parameters to derive the Paging Frame and Paging Occasion according to TS 36.304 [4]. Value in multiples of 'T' as defined in TS 36.304 [4]. A value of fourT corresponds to 4 * T, a value of twoT corresponds to 2 * T and so on. If the field is absent, the value of <i>nB</i> configured in <i>SystemInformationBlockType2-NB</i> in IE <i>pcch-Config</i> applies.</p>
<p><b>npdcch-NumRepetitionPaging</b> Maximum number of repetitions for NPDCCH common search space (CSS) for paging, see TS 36.213 [23], clause 16.6. If the field is absent, the value of <i>npdcch-NumRepetitionPaging</i> configured in <i>SystemInformationBlockType2-NB</i> in IE <i>pcch-Config</i> applies.</p>
<p><b>nprach-Distribution</b> Indicates which UL carriers a UE supporting mixed operation mode uses for random access as defined in description of <i>ul-ConfigList</i>, <i>ul-ConfigListMixed</i>.</p>
<p><b>nprach-ParametersList, nprach-ParametersList-EDT</b> Configure NPRACH parameters for each NPRACH resource on one non-anchor UL carrier. Up to three NPRACH resources can be configured on one non-anchor UL carrier. Each NPRACH resource is associated with a different number of NPRACH repetitions. NPRACH resources in <i>nprach-ParametersListEDT</i> are used to initiate EDT. Each NPRACH resource is associated with a maximum TBS signalled in the corresponding entry of <i>edt-TBS-InfoList</i> in <i>SystemInformationBlockType2-NB</i>. E-UTRAN includes the same number of entries, and listed in the same order, as in <i>nprach-ParametersList</i> in <i>SystemInformationBlockType2-NB</i>.</p>
<p><b>nprach-ParametersListTDD</b> For TDD: Configure NPRACH parameters for each NPRACH resource on one non-anchor UL carrier. Up to three NPRACH resources can be configured on one non-anchor UL carrier. Each NPRACH resource is associated with a different number of NPRACH repetitions. E-UTRAN includes the same number of entries in <i>nprach-ParametersListTDD</i>, and listed in the same order, as in <i>nprach-ParametersListTDD</i> in <i>SystemInformationBlockType2-NB</i>.</p>

<p><b><i>nprach-ProbabilityAnchor</i></b> Configure the selection probability for the anchor carrier NPRACH resource, see TS 36.321 [6]. Value zero corresponds to a probability of 0, oneSixteenth corresponds to the probability of 1/16, oneFifteenth corresponds to the probability of 1/15, and so on. If the field is absent, the selection probability of the anchor carrier NPRACH resource is 1. All non-anchor carriers NPRACH resources have equal probability between them. If there is no NPRACH resource defined on the anchor carrier for one repetition level in <i>nprach-ParametersList-EDT</i>, (respectively <i>nprach-ParametersListFmt2</i>, <i>nprach-ParametersListFmt2-EDT</i>), the UE shall use the value 'zero' and ignore the signalled value of <i>nprach-ProbabilityAnchor</i> for this repetition level for the NPRACH resources defined by <i>nprach-ParametersList-EDT</i> (respectively <i>nprach-ParametersListFmt2</i>, <i>nprach-ParametersListFmt2-EDT</i>).</p>
<p><b><i>nprach-ProbabilityAnchorList</i></b> Configures the selection probability for each NPRACH resource on the anchor carrier. E-UTRAN includes the same number of entries, and listed in the same order, as in <i>nprach-ParametersList</i> in <i>SystemInformationBlockType2-NB</i>.</p>
<p><b><i>nrsrpMin</i></b> The minimum serving cell NRSRP applicable to the coverage-based paging carrier configuration, see TS 36.304 [4].</p>
<p><b><i>pagingDistribution</i></b> Indicates which DL carriers a UE supporting mixed operation mode monitors for paging as defined in description of <i>dl-ConfigList</i>, <i>dl-ConfigListMixed</i>.</p>
<p><b><i>pagingWeight</i></b> Weight of the non-anchor paging carrier for uneven paging load distribution across the carriers. Value <i>w1</i> corresponds to a relative weight of 1, <i>w2</i> corresponds to a relative weight of 2, and so on. The paging load for a carrier 'i' is equal to <math>w(i)/W</math> where i is equal to 0 for the anchor carrier and equal to the index of the carrier in the <i>dl-ConfigList</i> / <i>dl-ConfigListMixed</i> for a non-anchor carrier, <i>W</i> is the sum of the weights of all paging carriers. To avoid correlation between paging carrier and paging occasion, the weights should be assigned such that: <math>nB * W \leq 16384</math>.</p>
<p><b><i>pagingWeightAnchor</i></b> Weight of the anchor carrier for uneven paging load distribution across the carriers. Value <i>w1</i> corresponds to a relative weight of 1, <i>w2</i> corresponds to a relative weight of 2, and so on. If the field is absent, the (default) value of <i>w0</i> is applied, i.e. the anchor carrier is not used for paging.</p>
<p><b><i>pcch-Config</i></b> Configure the PCCH parameters for the non-anchor DL carrier.</p>
<p><b><i>rsrp-ThresholdsPrachInfoList</i></b> The criterion for UE to select an NPRACH resource on the non-anchor carrier. The threshold values are related to the anchor carrier NRSRP measurement. See TS 36.321 [6]. E-UTRAN includes the same number of entries, and listed in the same order, as in <i>rsrp-ThresholdsPrachInfoList</i> in <i>SystemInformationBlockType2-NB</i>. A UE that supports <i>powerClassNB-14dBm-r14</i> shall correct the RSRP threshold values before applying them as follows: <math>RSRP \text{ threshold} = \text{Signalled RSRP threshold} - \min\{0, (14 - \min(23, P\text{-Max}))\}</math> where <i>P-Max</i> is the value of <i>p-Max</i> field in <i>SystemInformationBlockType1-NB</i>.</p>
<p><b><i>tdd-UL-DL-AlignmentOffset</i></b> Indicates the offset between the UL carrier frequency center with respect to DL carrier frequency center for the non-anchor carrier.</p>
<p><b><i>ue-SpecificDRX-CycleMin</i></b> Minimum UE specific DRX cycle for the coverage-based paging configuration, see TS 36.304 [4]. Value <i>rf32</i> corresponds to 32 radio frames, <i>rf64</i> corresponds to 64 radio frames and so on. If present, E-UTRAN ensures PCCH configuration does not lead to CSS overlap for <i>ue-SpecificDRX-CycleMin</i>.</p>
<p><b><i>ul-CarrierFreq</i></b> For FDD: UL carrier frequency of the non-anchor carrier as defined in TS 36.101 [42], clause 5.7.3F and TS 36.108 [114], clause 5.4B.2. For TDD: This field is absent and the uplink carrier frequency is same as the downlink frequency.</p>
<p><b><i>ul-ConfigList</i>, <i>ul-ConfigListMixed</i></b> For FDD: List of UL non-anchor carriers and associated configuration that can be used for random access. E-UTRAN configures UL non-anchor carriers operating in mixed operation mode only in <i>ul-ConfigListMixed</i> and only a UE that supports mixed operation mode uses the carriers in <i>ul-ConfigListMixed</i>. A given carrier is either signalled in the <i>ul-ConfigList</i> or in <i>ul-ConfigListMixed</i>. If <i>ul-ConfigListMixed</i> is present and at least one of the carriers in <i>ul-ConfigListMixed</i> is configured for random access: <ul style="list-style-type: none"> <li>- If <i>nprach-Distribution</i> is present, the UE supporting mixed operation mode creates a combined list of UL carriers for random access by appending <i>ul-ConfigListMixed</i> to the <i>ul-ConfigList</i> while maintaining the order among both <i>ul-ConfigList</i> and <i>ul-ConfigListMixed</i>; the total number of signalled UL non-anchor carriers cannot be more than <i>maxNonAnchorCarriers-NB-r14</i>.</li> <li>- If <i>nprach-Distribution</i> is absent, the UE supporting mixed operation mode uses the list of UL carriers for random access provided in <i>ul-ConfigListMixed</i> and considers <i>nprach-ProbabilityAnchor</i> being set to zero for each NPRACH resource, i.e. the anchor carrier is not used for random access.</li> </ul> Otherwise, the <i>nprach-Distribution</i> field is not applicable and the UE shall ignore the value. For TDD: E-UTRAN configures <i>ul-ConfigList-r15</i> and includes the same number of entries as in <i>dl-ConfigList</i>. The UL carrier frequency of the non-anchor carrier is same as the DL carrier frequency.</p>

***wus-Config***

For FDD: Carrier specific WUS Configuration.

Conditional presence	Explanation
<i>dl-ConfigList</i>	This field is optionally present, Need OR, if the field <i>dl-ConfigList</i> is present. Otherwise the field is not present.
<i>EDT</i>	The field is optionally present, Need OR, if <i>edt-Parameters</i> in <i>SystemInformationBlockType2-NB</i> is present; otherwise the field is not present and the UE shall delete any existing value for this field.
<i>GWUS</i>	This field is optionally present, Need OR, if <i>gwus-Config-r16</i> is present in <i>SystemInformationBlockType2-NB</i> . Otherwise the field is not present.
<i>pcch-config</i>	This field is optionally present, Need OP, if the field <i>dl-ConfigList</i> is present and at least one of the carriers in <i>dl-ConfigList</i> is configured for paging. Otherwise the field is not present and only the anchor carrier is used for paging.
<i>pcch-config2</i>	This field is optionally present, need OR, if the field <i>pcch-Config-r14</i> is not present for the same carrier and <i>coverageBasedPagingConfig</i> is present. Otherwise the field is not present and the UE shall delete any existing value for this field.
<i>nprach-config</i>	This field is mandatory present, if the field <i>ul-ConfigList</i> is present and at least one of the carriers in <i>ul-ConfigList</i> is configured for random access. Otherwise the field is not present and only the anchor carrier is used for random access.
<i>TDD</i>	This field is optionally present, Need OR, for TDD. Otherwise the field is not present.
<i>ul-ConfigList</i>	This field is optionally present, Need OR, if the field <i>ul-ConfigList</i> is present. Otherwise the field is not present.
<i>WUS</i>	This field is mandatory present, if the field <i>wus-Config</i> is present in <i>SystemInformationBlockType2-NB</i> . Otherwise the field is not present, Need OR.

### – *SystemInformationBlockType23-NB*

For FDD, the IE *SystemInformationBlockType23-NB* contains radio resource configuration for NPRACH resources using preamble format 2 on non-anchor carriers.

#### ***SystemInformationBlockType23-NB*** information element

```

-- ASN1START
SystemInformationBlockType23-NB-r15 ::= SEQUENCE {
    ul-ConfigList-v1530                UL-ConfigCommonList-NB-v1530    OPTIONAL, -- Need OR
    ul-ConfigListMixed-v1530          UL-ConfigCommonList-NB-v1530    OPTIONAL, -- Need OR
    lateNonCriticalExtension           OCTET STRING                     OPTIONAL,
    ...
}
UL-ConfigCommonList-NB-v1530 ::=
    SEQUENCE (SIZE (1.. maxNonAnchorCarriers-NB-r14)) OF
        UL-ConfigCommon-NB-v1530
UL-ConfigCommon-NB-v1530 ::=
    SEQUENCE {
        nprach-ParametersListFmt2-r15    NPRACH-ParametersListFmt2-NB-r15    OPTIONAL, -- Need OR
        nprach-ParametersListFmt2EDT-r15 NPRACH-ParametersListFmt2-NB-r15    OPTIONAL, -- Cond
        EDT
        ...
    }
-- ASN1STOP

```

**SystemInformationBlockType23-NB field descriptions*****nprach-ParametersListFmt2*, *nprach-ParametersListFmt2EDT***

Configures NPRACH parameters for each NPRACH resource format 2 on one UL carrier. Up to three NPRACH resources can be configured on one carrier. Each NPRACH resource is associated with a different number of NPRACH repetitions.

E-UTRAN includes the same number of entries, and listed in the same order, as in *nprach-ParametersList* in *SystemInformationBlockType2-NB*.

The NPRACH resources in *nprach-ParametersListFmt2EDT* are used to initiate EDT. Each NPRACH resource is associated with a TBS signalled in the corresponding entry of *edt-TBS-InfoList*.

E-UTRAN configures the NPRACH resources format 2 so that they do not overlap in time domain with the NPRACH resources configured in *nprach-ParametersList* and *nprach-ParametersListEDT* on the same UL carrier.

If there is no NPRACH resource in *nprach-ParametersListFmt2* (respectively *nprach-ParametersListFmt2EDT*) on any UL carrier, including the anchor carrier, for one NPRACH repetition level, the UE uses the NPRACH resources in *nprach-ParametersList* (respectively *nprach-ParametersListEDT*) for this NPRACH repetition level. Otherwise, the UE uses only NPRACH resources in *nprach-ParametersListFmt2* (respectively *nprach-ParametersListFmt2EDT*).

If E-UTRAN configures NPRACH resources format 2 in one NPRACH repetition level, the E-UTRAN configures NPRACH resources format 2 in all NPRACH repetition levels upwards.

***ul-ConfigList*, *ul-ConfigListMixed***

*ul-ConfigList* (respectively *ul-ConfigListMixed*) is parallel to *ul-ConfigList* (respectively *ul-ConfigListMixed*) in *SystemInformationBlockType22-NB*.

E-UTRAN includes the same number of entries and in the same order in *ul-ConfigList* (respectively *ul-ConfigListMixed*) in *SystemInformationBlockType23-NB* as in *ul-ConfigList* (respectively *ul-ConfigListMixed*) in *SystemInformationBlockType22-NB*. The UE combines each entry in *ul-ConfigList* (respectively *ul-ConfigListMixed*) in *SystemInformationBlockType23-NB* with the corresponding entry in *ul-ConfigList* (respectively *ul-ConfigListMixed*) in *SystemInformationBlockType22-NB*.

Conditional presence	Explanation
<i>EDT</i>	The field is optionally present, Need OR, if <i>edt-Parameters</i> in <i>SystemInformationBlockType2-NB</i> is present; otherwise the field is not present and the UE shall delete any existing value for this field.

**SystemInformationBlockType27-NB**

The IE *SystemInformationBlockType27-NB* contains information relevant only for inter-RAT cell selection i.e. assistance information about E-UTRA frequencies and/ or GERAN frequencies for cell selection.

**SystemInformationBlockType27-NB information element**

```
-- ASN1START
SystemInformationBlockType27-NB-r16 ::= SEQUENCE {
    carrierFreqListEUTRA-r16          CarrierFreqListEUTRA-NB-r16    OPTIONAL,  -- Need OR
    carrierFreqsListGERAN-r16        CarrierFreqsListGERAN-NB-r16   OPTIONAL,  -- Need OR
    lateNonCriticalExtension          OCTET STRING                    OPTIONAL,
    ...
}

CarrierFreqListEUTRA-NB-r16 ::= SEQUENCE (SIZE (1..maxFreqEUTRA-NB-r16)) OF
    CarrierFreqEUTRA-NB-r16

CarrierFreqsListGERAN-NB-r16 ::= SEQUENCE (SIZE (1..maxFreqsGERAN-NB-r16)) OF
    CarrierFreqsGERAN-NB-r16

CarrierFreqEUTRA-NB-r16 ::= SEQUENCE {
    carrierFreq-r16                  ARFCN-ValueEUTRA-r9,
    sib1-r16                          ENUMERATED {supported}          OPTIONAL,  -- Need OR
    sib1-BR-r16                       ENUMERATED {supported}          OPTIONAL,  -- Need OR
    ...
}

CarrierFreqsGERAN-NB-r16 ::= SEQUENCE {
    carrierFreqs-r16                  CarrierFreqsGERAN,
    ec-GSM-IOT-r16                    ENUMERATED {supported}          OPTIONAL,  -- Need OR
    peo-r16                             ENUMERATED {supported}          OPTIONAL,  -- Need OR
    ...
}
```

```
-- ASN1STOP
```

<b>SystemInformationBlockType27-NB field descriptions</b>
<b>carrierFreq</b> E-UTRAN carrier frequency.
<b>carrierFreqListEUTRA</b> Provides a list of neighbouring E-UTRA carrier frequencies, which may be searched for neighbouring E-UTRAN cells.
<b>carrierFreqs</b> The list of GERAN carrier frequencies organised into one group of GERAN carrier frequencies.
<b>carrierFreqsListGERAN</b> Provides a list of neighbouring GERAN carrier frequencies, which may be searched for neighbouring GERAN cells. The GERAN carrier frequencies are organised in groups and the parameters are indicated per group of GERAN carrier frequencies.
<b>ec-GSM-IOT</b> Indicates that the GERAN carrier frequencies support EC-GSM-IOT.
<b>peo</b> Indicates that the GERAN carrier frequencies support Power Efficient Operation (PEO).
<b>sib1</b> Indicates that SIB1 is scheduled in the E-UTRAN cells.
<b>sib1-BR</b> Indicates that SIB1-BR is scheduled in the E-UTRAN cells.

### – SystemInformationBlockType31-NB

The IE *SystemInformationBlockType31-NB* contains satellite assistance information. *SystemInformationBlockType31-NB* is only signalled in a NTN cell.

#### SystemInformationBlockType31-NB information element

```
-- ASN1START
SystemInformationBlockType31-NB-r17 ::= SEQUENCE {
    servingSatelliteInfo-r17      ServingSatelliteInfo-r17,
    lateNonCriticalExtension      OCTET STRING                OPTIONAL,
    . . . ,
    [[ servingSatelliteInfo-v1820 ServingSatelliteInfo-v1820    OPTIONAL -- Need OR
    ]]
}
-- ASN1STOP
```

### – SystemInformationBlockType32-NB

The IE *SystemInformationBlockType32-NB* contains satellite assistance information for prediction of discontinuous coverage. *SystemInformationBlockType32-NB* is only signalled in a NTN cell.

#### SystemInformationBlockType32-NB information element

```
-- ASN1START
SystemInformationBlockType32-NB-r17 ::= SEQUENCE {
    satelliteInfoList-r17        SatelliteInfoList-r17    OPTIONAL, -- Need OR
    lateNonCriticalExtension      OCTET STRING                OPTIONAL,
    . . . ,
    [[ satelliteInfoList-v1800    SatelliteInfoList-v1800  OPTIONAL -- Need OR
    ]],
    [[ satelliteInfoList-v1830    SatelliteInfoList-NB-v1830  OPTIONAL -- Need OR
    ]]
}
SatelliteInfoList-NB-v1830 ::= SEQUENCE (SIZE (1..maxSat-r17)) OF CarrierFreqList-NB-r18
CarrierFreqList-NB-r18 ::= SEQUENCE {
    carrierFreqList-r18          SEQUENCE (SIZE (1..maxFreq)) OF CarrierFreq-NB-r13
}
-- ASN1STOP
```

**SystemInformationBlockType32-NB field descriptions****carrierFreqList**

Includes a list of NB-IoT frequencies, see TS 36.304 [4].

**satelliteInfoList**

List of satellite information. If E-UTRAN includes *satelliteInfoList-v1830*, it includes the same number of entries, and listed in the same order, as in *satelliteInfoList-r17*.

In this version of the specification, E-UTRAN does not include *satelliteInfoList-v1800*.

**SystemInformationBlockType33-NB**

The IE *SystemInformationBlockType33-NB* contains satellite assistance information for neighbour cells.

**SystemInformationBlockType33-NB information element**

```
-- ASN1START
SystemInformationBlockType33-NB-r18 ::= SEQUENCE {
  neighSatelliteInfoList-r18      NeighSatelliteInfoList-r18      OPTIONAL, -- Need OR
  neighValidityDuration-r18      ENUMERATED {s5, s10, s15, s20, s25, s30, s35, s40,
                                                s45, s50, s55, s60, s120, s180, s240, s900}
                                   OPTIONAL, -- Need OP
  lateNonCriticalExtension        OCTET STRING                      OPTIONAL,
  ...
}
-- ASN1STOP
```

**6.7.3.2 NB-IoT Radio resource control information elements****CarrierConfigDedicated-NB**

The IE *CarrierConfigDedicated-NB* is used to specify a carrier in NB-IoT.

**CarrierConfigDedicated-NB information elements**

```
-- ASN1START
CarrierConfigDedicated-NB-r13 ::= SEQUENCE {
  dl-CarrierConfig-r13           DL-CarrierConfigDedicated-NB-r13,
  ul-CarrierConfig-r13           UL-CarrierConfigDedicated-NB-r13
}

DL-CarrierConfigDedicated-NB-r13 ::= SEQUENCE {
  dl-CarrierFreq-r13             CarrierFreq-NB-r13,
  downlinkBitmapNonAnchor-r13   CHOICE {
    useNoBitmap-r13              NULL,
    useAnchorBitmap-r13          NULL,
    explicitBitmapConfiguration-r13 DL-Bitmap-NB-r13,
    spare                          NULL
  }
                                   OPTIONAL, -- Need ON
  dl-GapNonAnchor-r13           CHOICE {
    useNoGap-r13                 NULL,
    useAnchorGapConfig-r13       NULL,
    explicitGapConfiguration-r13 DL-GapConfig-NB-r13,
    spare                          NULL
  }
                                   OPTIONAL, -- Need ON
  inbandCarrierInfo-r13         SEQUENCE {
    samePCI-Indicator-r13        CHOICE {
      samePCI-r13                SEQUENCE {
        indexToMidPRB-r13        INTEGER (-55..54)
      },
      differentPCI-r13           SEQUENCE {
        eutra-NumCRS-Ports-r13   ENUMERATED {same, four}
      }
    }
  }
                                   OPTIONAL, -- Cond anchor-guardband-or-standalone
  eutraControlRegionSize-r13    ENUMERATED {n1, n2, n3}
}
-- ASN1STOP
```



```

    ...
    [[ nrs-PowerOffsetNonAnchor-v1330      ENUMERATED {dB-12, dB-10, dB-8, dB-6,
                                                    dB-4, dB-2, dB0, dB3}
                                           OPTIONAL      -- Need ON
    ]],
    [[ dl-GapNonAnchor-v1530              DL-GapConfig-NB-v1530      OPTIONAL      -- Cond TDD1
    ]],
    [[ dl-CarrierFreq-v1550              CarrierFreq-NB-v1550      OPTIONAL      -- Cond TDD1
    ]]
}

UL-CarrierConfigDedicated-NB-r13 ::= SEQUENCE {
    ul-CarrierFreq-r13      CarrierFreq-NB-r13      OPTIONAL,      -- Need OP
    ...
    [[ tdd-UL-DL-AlignmentOffset-r15      TDD-UL-DL-AlignmentOffset-NB-r15      OPTIONAL      --
Cond TDD
    ]]
}

-- ASN1STOP

```

### **CarrierConfigDedicated-NB field descriptions**

<b>dl-CarrierConfig</b>	Downlink carrier used for all unicast transmissions.
<b>dl-CarrierFreq</b>	DL carrier frequency. The downlink carrier is not in a E-UTRA PRB which contains E-UTRA PSS/SSS/PBCH.
<b>dl-GapNonAnchor</b>	Downlink transmission gap configuration for the anchor/ non-anchor carrier, see TS 36.211 [21], clause 10.2.3.4. E-UTRAN may configure <i>dl-GapNonAnchor-v1530</i> only if <i>dl-GapNonAnchor-r13</i> is set to <i>explicitGapConfiguration</i> .
<b>downlinkBitmapNonAnchor</b>	For FDD: NB-IoT downlink subframe configuration for downlink transmission on the anchor/ non-anchor carrier. See TS 36.213 [23], clause 16.4. For TDD: NB-IoT downlink, uplink and special subframes configuration for transmission on the anchor/ non-anchor carrier. See TS 36.213 [23], clause 16.4.
<b>eutraControlRegionSize</b>	Indicates the control region size of the E-UTRA cell for the in-band operation mode, see TS 36.213 [23]. Unit is in number of OFDM symbols. If <i>operationModeInfo</i> in MIB-NB is set to <i>inband-SamePCI</i> or <i>inband-DifferentPCI</i> , it should be set to the value broadcast in SIB1-NB.
<b>eutra-NumCRS-Ports</b>	Number of E-UTRA CRS antenna ports, either the same number of ports as NRS or 4 antenna ports. See TS 36.211 [21], TS 36.212 [22], and TS 36.213 [23].
<b>inbandCarrierInfo</b>	Provides the configuration of the anchor/ non-anchor inband carrier. If <i>operationModeInfo</i> is set to standalone in the MIB-NB, E-UTRAN only configures this field if the UE supports mixed operation mode.
<b>indexToMidPRB</b>	The PRB index is signaled by offset from the middle of the EUTRA system.
<b>nrs-PowerOffsetNonAnchor</b>	Provides the power offset of the downlink narrowband reference-signal EPRE of the anchor/ non-anchor carrier relative to the anchor carrier, unit in dB. Value dB-12 corresponds to -12 dB, dB-10 corresponds to -10 dB and so on. See TS 36.213 [23], clause 16.2.2.
<b>samePCI-Indicator</b>	This parameter specifies whether the anchor/ non-anchor carrier reuses the same PCI as the EUTRA carrier.
<b>ul-CarrierConfig</b>	Uplink anchor/ non-anchor carrier used for all unicast transmissions.
<b>ul-CarrierFreq</b>	For FDD: UL carrier frequency as defined in TS 36.101 [42], clause 5.7.3F and TS 36.108 [114], clause 5.4B.2. If absent, the same TX-RX frequency separation and carrier frequency offset as for the anchor carrier applies. For TDD: This field is absent and the uplink carrier frequency is equal to the downlink frequency.

Conditional presence	Explanation
<i>non-anchor-inband</i>	The field is mandatory present if the anchor/ non-anchor carrier is an inband carrier; otherwise it is not present.
<i>anchor-guardband-or-standalone</i>	The field is mandatory present if <i>operationModeInfo</i> is set to <i>guardband</i> or <i>standalone</i> in the MIB; otherwise it is not present.
<i>TDD</i>	The field is mandatory present for TDD; otherwise the field is not present and the UE shall delete any existing value for this field.
<i>TDD1</i>	The field is optionally present, Need OR, for TDD; otherwise the field is not present and the UE shall delete any existing value for this field.

## CarrierFreq-NB

The IE *CarrierFreq-NB* is used to provide the NB-IoT carrier frequency, as defined in TS 36.101 [42] and TS 36.108 [114].

### CarrierFreq-NB information elements

```
-- ASN1START
CarrierFreq-NB-r13 ::= SEQUENCE {
  carrierFreq-r13      ARFCN-ValueEUTRA-r9,
  carrierFreqOffset-r13  ENUMERATED {
    v-10, v-9, v-8, v-7, v-6, v-5, v-4, v-3, v-2, v-1, v-0dot5,
    v0, v1, v2, v3, v4, v5, v6, v7, v8, v9
  } OPTIONAL -- Need ON
}
CarrierFreq-NB-v1550 ::= SEQUENCE {
  carrierFreqOffset-v1550  ENUMERATED {v-8dot5, v-4dot5, v3dot5, v7dot5}
}
-- ASN1STOP
```

### CarrierFreq-NB field descriptions

#### **carrierFreq**

Provides the ARFCN applicable for the NB-IoT carrier frequency as defined in TS 36.101 [42], Table 5.7.3-1 and TS 36.108 [114], Table 5.4A.2-1.

#### **carrierFreqOffset**

Offset of the NB-IoT channel number to EARFCN as defined in TS 36.101 [42], clause 5.7.3F and TS 36.108 [114], clause 5.4B.2. Value v-10 means -10, v-9 means -9, and so on. E-UTRAN may configure the values v-8dot5, v-4dot5, v3dot5 and v7dot5 only for a carrier in a TDD band.

For TDD, the UE shall use the value signalled in *carrierFreqOffset-v1550*, if present, and ignore the value signalled in *carrierFreqOffset-r13*.

## ChannelRasterOffset-NB

The IE *ChannelRasterOffset-NB* is used to specify the NB-IoT offset from LTE channel raster. Unit in kHz in set { -7.5, -2.5, 2.5, 7.5} See TS 36.211[21] and TS 36.213 [23].

### ChannelRasterOffset-NB information element

```
-- ASN1START
ChannelRasterOffset-NB-r13 ::= ENUMERATED {khz-7dot5, khz-2dot5, khz2dot5, khz7dot5}
-- ASN1STOP
```

## DL-Bitmap-NB

The IE *DL-Bitmap-NB* is used to specify the set of NB-IoT downlink subframes for downlink transmission.

**DL-Bitmap-NB information element**

```

-- ASN1START
DL-Bitmap-NB-r13 ::= CHOICE {
    subframePattern10-r13 BIT STRING (SIZE (10)),
    subframePattern40-r13 BIT STRING (SIZE (40))
}
-- ASN1STOP

```

**DL-Bitmap-NB field descriptions****subframePattern10, subframePattern40**

For FDD: NB-IoT downlink subframe configuration over 10ms or 40ms for inband and 10ms for standalone/guardband.

For TDD: NB-IoT downlink, uplink and special subframes configuration over 10ms or 40ms for inband and 10ms for standalone/guardband.

The first/leftmost bit corresponds to the subframe #0 of the radio frame satisfying  $SFN \bmod x = 0$ , where  $x$  is the size of the bit string divided by 10. Value 0 in the bitmap indicates that the corresponding subframe is invalid for transmission. Value 1 in the bitmap indicates that the corresponding subframe is valid for transmission.

**DL-CarrierConfigCommon-NB**

The IE *DL-CarrierConfigCommon-NB* is used to specify the common configuration of a DL non-anchor carrier in NB-IoT.

**DL-CarrierConfigCommon-NB information elements**

```

-- ASN1START
DL-CarrierConfigCommon-NB-r14 ::= SEQUENCE {
    dl-CarrierFreq-r14 CarrierFreq-NB-r13,
    downlinkBitmapNonAnchor-r14 CHOICE {
        useNoBitmap-r14 NULL,
        useAnchorBitmap-r14 NULL,
        explicitBitmapConfiguration-r14 DL-Bitmap-NB-r13
    },
    dl-GapNonAnchor-r14 CHOICE {
        useNoGap-r14 NULL,
        useAnchorGapConfig-r14 NULL,
        explicitGapConfiguration-r14 DL-GapConfig-NB-r13
    },
    inbandCarrierInfo-r14 SEQUENCE {
        samePCI-Indicator-r14 CHOICE {
            samePCI-r14 SEQUENCE {
                indexToMidPRB-r14 INTEGER (-55..54)
            },
            differentPCI-r14 SEQUENCE {
                eutra-NumCRS-Ports-r14 ENUMERATED {same, four}
            }
        } OPTIONAL, -- Cond anchor-guardband-or-standalone
        eutraControlRegionSize-r14 ENUMERATED {n1, n2, n3}
    } OPTIONAL, -- Cond non-anchor-inband
    nrs-PowerOffsetNonAnchor-r14 ENUMERATED {dB-12, dB-10, dB-8, dB-6,
        dB-4, dB-2, dB0, dB3} DEFAULT dB0,
    ...
    [[ dl-GapNonAnchor-v1530 DL-GapConfig-NB-v1530 OPTIONAL -- Cond TDD
    ]],
    [[ dl-CarrierFreq-v1550 CarrierFreq-NB-v1550 OPTIONAL -- Cond TDD
    ]]
}
-- ASN1STOP

```

<b>DL-CarrierConfigCommon-NB field descriptions</b>
<b>dl-CarrierFreq</b> DL carrier frequency. The downlink carrier is not in a E-UTRA PRB which contains E-UTRA PSS/SSS/PBCH.
<b>dl-GapNonAnchor</b> Downlink transmission gap configuration for the non-anchor carrier, see TS 36.211 [21], clause 10.2.3.4. E-UTRAN may configure <i>dl-GapNonAnchor-v1530</i> only if <i>dl-GapNonAnchor-r14</i> is set to <i>explicitGapConfiguration</i> .
<b>downlinkBitmapNonAnchor</b> For FDD: NB-IoT downlink subframe configuration for downlink transmission on the non-anchor carrier. See TS 36.213 [23], clause 16.4. For TDD: NB-IoT downlink, uplink and special subframes configuration for transmission on the anchor/ non-anchor carrier. See TS 36.213 [23], clause 16.4.
<b>eutraControlRegionSize</b> Indicates the control region size of the E-UTRA cell for the in-band operation mode, see TS 36.213 [23]. Unit is in number of OFDM symbols. If <i>operationModeInfo</i> in MIB-NB is set to <i>inband-SamePCI</i> or <i>inband-DifferentPCI</i> , it should be set to the value broadcast in SIB1-NB.
<b>eutra-NumCRS-Ports</b> Number of E-UTRA CRS antenna ports, either the same number of ports as NRS or 4 antenna ports. See TS 36.211 [21], TS 36.212 [22], and TS 36.213 [23].
<b>inbandCarrierInfo</b> Provides the configuration of a non-anchor inband carrier.
<b>indexToMidPRB</b> The PRB index is signaled by offset from the middle of the EUTRA system.
<b>nrs-PowerOffsetNonAnchor</b> Provides the downlink narrowband reference-signal EPRE offset of the non-anchor carrier relative to the downlink narrowband reference-signal EPRE of the anchor carrier, unit in dB. Value dB-12 corresponds to -12 dB, dB-10 corresponds to -10 dB and so on. See TS 36.213 [23], clause 16.2.2.
<b>samePCI-Indicator</b> This parameter specifies whether the non-anchor carrier reuses the same PCI as the EUTRA carrier.

<b>Conditional presence</b>	<b>Explanation</b>
<i>non-anchor-inband</i>	The field is mandatory present if the non-anchor carrier is an inband carrier; otherwise it is not present.
<i>anchor-guardband-or-standalone</i>	The field is mandatory present, if <i>operationModeInfo</i> is set to <i>guardband</i> or <i>standalone</i> in the MIB; otherwise it is not present.
<i>TDD</i>	The field is optionally present, Need OR, for TDD; otherwise the field is not present and the UE shall delete any existing value for this field.

## DL-GapConfig-NB

The IE *DL-GapConfig-NB* is used to specify the downlink gap configuration for NPDCCH and NPDSCH. Downlink gaps apply to all NPDCCH/NPDSCH transmissions except for BCCH.

### DL-GapConfig-NB information element

```

-- ASN1START
DL-GapConfig-NB-r13 ::= SEQUENCE {
    dl-GapThreshold-r13      ENUMERATED {n32, n64, n128, n256},
    dl-GapPeriodicity-r13   ENUMERATED {sf64, sf128, sf256, sf512},
    dl-GapDurationCoeff-r13 ENUMERATED {oneEighth, oneFourth, threeEighth, oneHalf}
}
DL-GapConfig-NB-v1530 ::= SEQUENCE {
    dl-GapPeriodicity-v1530 ENUMERATED {sf1024}
}
-- ASN1STOP

```

**DL-GapConfig-NB field descriptions****dl-GapDurationCoeff**

Coefficient to calculate the gap duration of a DL transmission: dl-GapDurationCoeff \* dl-GapPeriodicity, Duration in number of subframes. See TS 36.211 [21], clause 10.2.3.4.

**dl-GapPeriodicity**

Periodicity of a DL transmission gap in number of subframes. See TS 36.211 [21], clause 10.2.3.4.

Value *sf64* corresponds to 64 subframes, value *sf128* corresponds to 128 subframes, value *sf256* corresponds to 256 subframes and so on. E-UTRAN may configure the value *sf64* only in FDD mode and the value *sf1024* only in TDD mode.

The UE shall use the value signalled in *dl-GapPeriodicity-v1530*, if present, and ignore the value signaled in *dl-GapPeriodicity-r13*.

**dl-GapThreshold**

Threshold on the maximum number of repetitions configured for NPDCCH before application of DL transmission gap configuration. See TS 36.211 [21], clause 10.2.3.4.

**GWUS-Config-NB**

The IE *GWUS-Config-NB* is used to specify the GWUS configuration. For UEs supporting GWUS, E-UTRAN uses GWUS to indicate that the UE shall attempt to receive paging in that cell, see TS 36.304 [4].

**GWUS-Config-NB information element**

```
-- ASN1START
GWUS-Config-NB-r16 ::= SEQUENCE {
    groupAlternation-r16      ENUMERATED {true}          OPTIONAL, -- Need OR
    commonSequence-r16       ENUMERATED {g0, g126}         OPTIONAL, -- Need OR
    timeParameters-r16       WUS-Config-NB-r15            OPTIONAL, -- Cond noWUSr15
    resourceConfigDRX-r16    GWUS-ResourceConfig-NB-r16,
    resourceConfig-eDRX-Short-r16 GWUS-ResourceConfig-NB-r16 OPTIONAL, -- Need OP
    resourceConfig-eDRX-Long-r16 GWUS-ResourceConfig-NB-r16 OPTIONAL, -- Cond timeOffset
    probThreshList-r16       GWUS-ProbThreshList-NB-r16   OPTIONAL, -- Cond probabilityBased
    ...
}

GWUS-ResourceConfig-NB-r16 ::= SEQUENCE {
    resourcePosition-r16      ENUMERATED {primary, secondary},
    numGroupsList-r16         GWUS-NumGroupsList-NB-r16    OPTIONAL, -- Need OP
    groupsForServiceList-r16  GWUS-GroupsForServiceList-NB-r16 OPTIONAL
                                -- Cond probabilityBased
}

GWUS-ProbThreshList-NB-r16 ::= SEQUENCE (SIZE (1..maxGWUS-ProbThresholds-NB-r16)) OF
    GWUS-Paging-ProbThresh-NB-r16

GWUS-Paging-ProbThresh-NB-r16 ::= ENUMERATED {p20, p30, p40, p50, p60, p70, p80, p90}

GWUS-NumGroupsList-NB-r16 ::= SEQUENCE (SIZE (1..maxGWUS-Resources-NB-r16)) OF
    GWUS-NumGroups-NB-r16

GWUS-NumGroups-NB-r16 ::= ENUMERATED {n1, n2, n4, n8}

GWUS-GroupsForServiceList-NB-r16 ::= SEQUENCE (SIZE (1..maxGWUS-ProbThresholds-NB-r16)) OF
    INTEGER (1..maxGWUS-Groups-1-NB-r16)
-- ASN1STOP
```

<b>GWUS-Config-NB field descriptions</b>
<p><b>commonSequence</b> Presence of the field indicates common WUS sequence is configured. Value <i>g0</i> indicates common WUS sequence for the shared WUS resource is <i>g=0</i>, value <i>g126</i> indicates common WUS sequence for the shared WUS resource is <i>g=126</i>, see TS 36.211 [21].</p>
<p><b>groupAlternation</b> Presence of the field enables WUS group alternation between the two WUS resources for the gap type, see TS 36.304 [4].</p>
<p><b>groupsForServiceList</b> Number of WUS groups for each paging probability group, see TS 36.304 [4]. The first entry corresponds to the first paging probability group, second entry corresponds to the second paging probability group, and so on. E-UTRAN includes the same number of entries and in the same order in <i>groupsForServiceList</i> and <i>probThreshList</i>. Total number of WUS groups in this list cannot be more than total number of WUS groups in <i>numGroupsList</i>.</p>
<p><b>numGroupsList</b> List of WUS groups for each WUS resource, see TS 36.304 [4]. First entry corresponds to the first resource, the second entry corresponds to the second resource. <i>numGroupsList</i> shall be present in <i>resourceConfigDRX</i>. If <i>numGroupsList</i> is not present in <i>resourceConfig-eDRX-Short</i>, parameters for DRX WUS resource applies for short eDRX WUS resource. If <i>numGroupsList</i> is not present in <i>resourceConfig-eDRX-Long</i>, parameters for short eDRX WUS resource applies for long eDRX WUS resource.</p>
<p><b>probThreshList</b> Paging probability thresholds corresponding to the paging probability groups, see TS 36.304 [4]. Value <i>p20</i> corresponds to 20%, value <i>p30</i> corresponds to 30%, and so on.</p>
<p><b>resourceConfigDRX, resourceConfig-eDRX-Short, resourceConfig-eDRX-Long</b> WUS resource configured for each gap type, see TS 36.304 [4]. If <i>resourceConfig-eDRX-Short</i> is not present, DRX WUS parameters apply for short eDRX WUS resource. If <i>resourceConfig-eDRX-Long</i> is not present, short eDRX WUS parameters apply for long eDRX WUS resource.</p>
<p><b>resourcePosition</b> Indicates the position of the WUS resource corresponding to the first entry in <i>numGroupsList</i>. Value <i>primary</i> indicates that the end of the WUS resource is defined by the timeoffset value for the corresponding gap type, value <i>secondary</i> indicates that the end of the WUS resource is immediately before the WUS resource configured by <i>wus-Config</i>. E-UTRAN may only configure <i>secondary</i> when only one entry exists in <i>numGroupsList</i> and <i>wus-Config</i> is present in <i>SystemInformationBlockType2-NB</i>. If two entries exist in <i>numGroupsList</i>, the position for the second WUS resource corresponds to value <i>secondary</i>.</p>
<p><b>timeParameters</b> Time domain WUS configuration information. For individual field descriptions, see <i>WUS-Config-NB</i>. If the field is absent, the parameters in <i>wus-Config</i> apply.</p>

<b>Conditional presence</b>	<b>Explanation</b>
<i>noWUSr15</i>	The field is mandatory present if <i>wus-Config-r15</i> is not present in <i>SystemInformationBlockType2-NB</i> ; otherwise the field is not present.
<i>probabilityBased</i>	The field is mandatory present if paging probability based WUS group selection is configured; otherwise the field is not present, and the UE shall delete any existing value for this field.
<i>timeOffset</i>	The field is optionally present, Need OP, if <i>timeOffset-eDRX-Long</i> is present in <i>timeParameters</i> ; otherwise the field is not present, and the UE shall delete any existing value for this field.

## LogicalChannelConfig-NB

The IE *LogicalChannelConfig-NB* is used to configure the logical channel parameters.

### LogicalChannelConfig-NB information element

```

-- ASN1START
LogicalChannelConfig-NB-r13 ::= SEQUENCE {
    priority-r13                INTEGER (1..16)           OPTIONAL,    -- Cond UL
    logicalChannelSR-Prohibit-r13  BOOLEAN                OPTIONAL,    -- Need ON
    ...
}
-- ASN1STOP

```

<b>LogicalChannelConfig-NB field descriptions</b>	
<b>logicalChannelSR-Prohibit</b>	Value <i>TRUE</i> indicates that the <i>logicalChannelSR-ProhibitTimer</i> is enabled for the logical channel. If <i>logicalChannelSR-Prohibit</i> is configured (i.e. indicates value <i>TRUE</i> ), E-UTRAN also configures <i>logicalChannelSR-ProhibitTimer</i> . See TS 36.321 [6].
<b>priority</b>	Logical channel priority in TS 36.321 [6]. Value is an integer.

<b>Conditional presence</b>	<b>Explanation</b>
<i>UL</i>	The field is mandatory present for UL logical channels; otherwise it is not present.

## MAC-MainConfig-NB

The IE *MAC-MainConfig-NB* is used to specify the MAC main configuration for signalling and data radio bearers.

### MAC-MainConfig-NB information element

```
-- ASN1START
MAC-MainConfig-NB-r13 ::= SEQUENCE {
    ul-SCH-Config-r13 SEQUENCE {
        periodicBSR-Timer-r13 PeriodicBSR-Timer-NB-r13 OPTIONAL, -- Need ON
        retxBSR-Timer-r13 RetxBSR-Timer-NB-r13 OPTIONAL, -- Need ON
    }
    drx-Config-r13 DRX-Config-NB-r13 OPTIONAL, -- Need ON
    timeAlignmentTimerDedicated-r13 TimeAlignmentTimer,
    logicalChannelSR-Config-r13 CHOICE {
        release NULL,
        setup SEQUENCE {
            logicalChannelSR-ProhibitTimer-r13 ENUMERATED {
                pp2, pp8, pp32, pp128, pp512,
                pp1024, pp2048, spare
            }
        }
    } OPTIONAL, -- Need ON
    ...
    [[ rai-Activation-r14 ENUMERATED {true} OPTIONAL, -- Need OR
    dataInactivityTimerConfig-r14 CHOICE {
        release NULL,
        setup SEQUENCE {
            dataInactivityTimer-r14 DataInactivityTimer-r14
        }
    } OPTIONAL -- Need ON
    ]],
    [[ drx-Cycle-v1430 ENUMERATED {
        sf1280, sf2560, sf5120, sf10240
    } OPTIONAL -- Need ON
    ]],
    [[ ra-CFRA-Config-r14 ENUMERATED {true} OPTIONAL -- Need ON
    ]],
    [[ offsetThresholdTA-r17 SetupRelease {OffsetThresholdTA-NB-r17}
    OPTIONAL -- Need ON
    ]],
    ]],
}

PeriodicBSR-Timer-NB-r13 ::= ENUMERATED {
    pp2, pp4, pp8, pp16, pp64, pp128, infinity, spare}

RetxBSR-Timer-NB-r13 ::= ENUMERATED {
    pp4, pp16, pp64, pp128, pp256, pp512, infinity, spare}

DRX-Config-NB-r13 ::= CHOICE {
    release NULL,
    setup SEQUENCE {
        onDurationTimer-r13 ENUMERATED {
            pp1, pp2, pp3, pp4, pp8, pp16, pp32, spare},
        drx-InactivityTimer-r13 ENUMERATED {
            pp0, pp1, pp2, pp3, pp4, pp8, pp16, pp32},
        drx-RetransmissionTimer-r13 ENUMERATED {
            pp0, pp1, pp2, pp4, pp6, pp8, pp16, pp24,
            pp33, spare7, spare6, spare5,
            spare4, spare3, spare2, spare1},
    }
}
```

```

drx-Cycle-r13          ENUMERATED {
                        sf256, sf512, sf1024, sf1536, sf2048, sf3072,
                        sf4096, sf4608, sf6144, sf7680, sf8192, sf9216,
                        spare4, spare3, spare2, spare1},
drx-StartOffset-r13   INTEGER (0..255),
drx-ULRetransmissionTimer-r13  ENUMERATED {
                        pp0, pp1, pp2, pp4, pp6, pp8, pp16, pp24,
                        pp33, pp40, pp64, pp80, pp96,
                        pp112, pp128, pp160, pp320}
}
}
OffsetThresholdTA-NB-r17 ::= ENUMERATED {
                              ms0dot5, ms1, ms2, ms3, ms4, ms5, ms6 ,ms7,
                              ms8, ms9, ms10, ms11, ms12, ms13, ms14, ms15}
-- ASN1STOP

```

### MAC-MainConfig-NB field descriptions

<b>drx-Config</b>	Used to configure DRX as specified in TS 36.321 [6].
<b>drx-Cycle</b>	<i>longDRX-Cycle</i> in TS 36.321 [6]. The value of <i>longDRX-Cycle</i> is in number of sub-frames. Value <i>sf256</i> corresponds to 256 sub-frames, <i>sf512</i> corresponds to 512 sub-frames and so on. In case <i>drx-Cycle-v1430</i> is signalled, the UE shall ignore <i>drx-Cycle-r13</i> .
<b>drx-StartOffset</b>	<i>drxStartOffset</i> in TS 36.321 [6]. Value is in number of sub-frames by step of ( <i>drx-cycle</i> / 256).
<b>drx-InactivityTimer</b>	Timer for DRX in TS 36.321 [6]. Value in number of PDCCH periods. Value <i>pp0</i> corresponds to 0 PDCCH period and behaviour as specified in 7.3.2 applies, <i>pp1</i> corresponds to 1 PDCCH period, <i>pp2</i> corresponds to 2 PDCCH periods and so on.
<b>drx-RetransmissionTimer</b>	Timer for DRX in TS 36.321 [6]. Value in number of PDCCH periods. Value <i>pp0</i> corresponds to 0 PDCCH period and behaviour as specified in 7.3.2 applies, <i>pp1</i> corresponds to 1 PDCCH period, <i>pp2</i> corresponds to 2 PDCCH periods and so on.
<b>drx-ULRetransmissionTimer</b>	Timer for DRX in TS 36.321 [6]. Value in number of PDCCH periods. Value <i>pp0</i> corresponds to 0 PDCCH period and behaviour as specified in 7.3.2 applies, value <i>pp1</i> corresponds to 1 PDCCH period, <i>pp2</i> corresponds to 2 PDCCH periods and so on.
<b>logicalChannelSR-ProhibitTimer</b>	Timer used to delay the transmission of an SR. See TS 36.321 [6]. Value in number of PDCCH periods. Value <i>pp2</i> corresponds to 2 PDCCH periods, <i>pp8</i> corresponds to 8 PDCCH periods and so on.
<b>offsetThresholdTA</b>	Offset for TA reporting as specified in TS 36.321 [6]. Value <i>ms0dot5</i> corresponds to 0.5 millisecond, value <i>ms1</i> corresponds to 1 millisecond and so on.
<b>periodicBSR-Timer</b>	Timer for BSR reporting in TS 36.321 [6]. Value in number of PDCCH periods. Value <i>pp2</i> corresponds to 2 PDCCH periods, <i>pp4</i> corresponds to 4 PDCCH periods and so on.
<b>ra-CFRA-Config</b>	Activation of contention free random access (CFRA), see TS 36.321 [6].
<b>rai-Activation</b>	Activation of release assistance indication (RAI) in TS 36.321 [6].
<b>retxBSR-Timer</b>	Timer for BSR reporting in TS 36.321 [6]. Value in number of PDCCH periods. Value <i>pp4</i> corresponds to 4 PDCCH periods, <i>pp16</i> corresponds to 16 PDCCH periods and so on.
<b>onDurationTimer</b>	Timer for DRX in TS 36.321 [6]. Value in number of PDCCH periods. Value <i>pp1</i> corresponds to 1 PDCCH period, <i>pp2</i> corresponds to 2 PDCCH periods and so on.
<b>timeAlignmentTimer</b>	Indicates the value of the time alignment timer, see TS 36.321 [6].

### NPDCCH-ConfigDedicated-NB

The IE *NPDCCH-ConfigDedicated-NB* specifies the subframes and resource blocks for NPDCCH monitoring.



**NPDCCH-ConfigDedicated-NB information element**

```

-- ASN1START
NPDCCH-ConfigDedicated-NB-r13 ::= SEQUENCE {
    npdcch-NumRepetitions-r13      ENUMERATED {r1, r2, r4, r8, r16, r32, r64, r128,
                                                r256, r512, r1024, r2048,
                                                spare4, spare3, spare2, spare1},
    npdcch-StartSF-USS-r13        ENUMERATED {v1dot5, v2, v4, v8, v16, v32, v48, v64},
    npdcch-Offset-USS-r13        ENUMERATED {zero, oneEighth, oneFourth, threeEighth}
}
NPDCCH-ConfigDedicated-NB-v1530 ::= SEQUENCE {
    npdcch-StartSF-USS-v1530      ENUMERATED {v96, v128}
}
-- ASN1STOP

```

**NPDCCH-ConfigDedicated-NB field descriptions****npdcch-NumRepetitions**

Maximum number of repetitions for NPDCCH UE specific search space (USS), see TS 36.213 [23], clause 16.6. UE monitors one set of values (consisting of aggregation level, number of repetitions and number of blind decodes) according to the configured maximum number of repetitions.

**npdcch-Offset-USS**

Fractional period offset of starting subframe for NPDCCH UE specific search space (USS), see TS 36.213 [23], clause 16.6.

**npdcch-StartSF-USS**

Starting subframe configuration for an NPDCCH UE-specific search space, see TS 36.213 [23], clause 16.6. Value v1dot5 corresponds to 1.5, value 2 corresponds to 2 and so on. E-UTRAN may configure values v1dot5 and v2 only in FDD mode and values v96 and v128 only in TDD mode.

The UE shall use the value signalled in *npdcch-StartSF-USS-v1530*, if present, and ignore the value signalled in *npdcch-StartSF-USS-r13*.

**NPDSCH-Config-NB**

The IE *NPDSCH-ConfigCommon-NB* is used to specify the common NPDSCH configuration. The IE *NPDSCH-ConfigDedicated-NB* is used to specify the UE specific NPDSCH configuration.

**NPDSCH-Config-NB information element**

```

-- ASN1START
NPDSCH-ConfigCommon-NB-r13 ::= SEQUENCE {
    nrs-Power-r13      INTEGER (-60..50)
}
NPDSCH-ConfigDedicated-NB-r16 ::= SEQUENCE {
    npdsch-MultiTB-Config-r16      NPDSCH-MultiTB-Config-NB-r16      OPTIONAL      -- Cond twoHARQ
}
NPDSCH-MultiTB-Config-NB-r16 ::= SEQUENCE {
    multiTB-Config-r16      ENUMERATED {interleaved, nonInterleaved},
    harq-AckBundling-r16     ENUMERATED {true}      OPTIONAL      -- Cond interleaved
}
NPDSCH-ConfigDedicated-NB-v1710 ::= SEQUENCE {
    npdsch-16QAM-Config-r17      SetupRelease {NPDSCH-16QAM-Config-NB-r17}
}
NPDSCH-ConfigDedicated-NB-v1800 ::= SEQUENCE {
    downlinkHARQ-FeedbackDisabledBitmap-NB-r18      SetupRelease {DownlinkHARQ-FeedbackDisabledBitmap-NB-r18}      OPTIONAL,      -- Need ON
    downlinkHARQ-FeedbackDisabledDCI-NB-r18      ENUMERATED {true}      OPTIONAL      -- Need OR
}
NPDSCH-16QAM-Config-NB-r17 ::= SEQUENCE {
    nrs-PowerRatio-r17      ENUMERATED {dB-6, dB-4dot77, dB-3, dB-1dot77, dB0, dB1, dB2, dB3}
    OPTIONAL,      -- Need OR
    nrs-PowerRatioWithCRS-r17      ENUMERATED {dB-6, dB-4dot77, dB-3, dB-1dot77, dB0, dB1, dB2, dB3}
    OPTIONAL      -- Cond InBand
}

```

```

}
DownlinkHARQ-FeedbackDisabledBitmap-NB-r18 ::= BIT STRING (SIZE(2))
-- ASN1STOP

```

### NPDSCH-Config-NB field descriptions

<b>downlinkHARQ-FeedbackDisabledBitmap-NB</b>	Used to disable the DL HARQ feedback, sent in the uplink, per HARQ process ID, see TS 36.321 [6]. The first/leftmost bit corresponds to HARQ process ID 0, the next bit to HARQ process ID 1. The bit corresponding to HARQ process ID that is not configured shall be ignored. A bit set to one identifies a HARQ process with disabled DL HARQ feedback and a bit set to zero identifies a HARQ process with enabled DL HARQ feedback.
<b>downlinkHARQ-FeedbackDisabledDCI-NB</b>	Presence of this field indicates that DCI indication is used to directly indicate or override RRC configuration for disabling HARQ feedback
<b>harq-AckBundling</b>	For FDD: Activation of HARQ ACK bundling for DL multiple TBs scheduling with interleaved transmission, see TS 36.213 [23].
<b>npdsch-16QAM-Config</b>	Activation of 16QAM for DL, see TS 36.213 [23].
<b>nrs-Power</b>	Provides the downlink narrowband reference-signal EPRE, see TS 36.213 [23], clause 16.2. The actual value in dBm.
<b>nrs-PowerRatio</b>	The power ratio of NPDSCH EPRE to NRS EPRE in symbols without NRS for standalone and guardband deployments, or in symbols without NRS nor CRS for in-band deployments. See TS 36.213 [23].
<b>nrs-PowerRatioWithCRS</b>	The power ratio of NPDSCH EPRE to NRS EPRE in symbols with CRS for inband deployments, see TS 36.213 [23].
<b>multiTB-Config</b>	For FDD: Activation of multiple TBs scheduling in DL, see TS 36.213 [23]. Value <i>interleaved</i> indicates that multiple TBs scheduling with interleaved transmission is enabled, value <i>nonInterleaved</i> indicates that multiple TBs scheduling without interleaved transmission is enabled.

Conditional presence	Explanation
<i>InBand</i>	The field is mandatory present if carrier is inband; otherwise, the field is not present and the UE shall delete any existing value for this field.
<i>interleaved</i>	The field is optionally present, Need OR, if <i>multiTB-Config</i> is set to <i>interleaved</i> ; otherwise the field is not present and the UE shall delete any existing value for this field.
<i>twoHARQ</i>	The field is optionally present, Need OR, if <i>twoHARQ-ProcessesConfig</i> is configured; otherwise the field is not present and the UE shall delete any existing value for this field.

### NPRACH-ConfigSIB-NB

The IE *NPRACH-ConfigSIB-NB* is used to specify the NPRACH configuration for the anchor and non-anchor carriers.

### NPRACH-ConfigSIB-NB information elements

```

-- ASN1START
NPRACH-ConfigSIB-NB-r13 ::= SEQUENCE {
    nprach-CP-Length-r13          ENUMERATED {us66dot7, us266dot7},
    rsrp-ThresholdsPrachInfoList-r13  RSRP-ThresholdsNPRACH-InfoList-NB-r13  OPTIONAL,  -- Need
OR
    nprach-ParametersList-r13      NPRACH-ParametersList-NB-r13
}
NPRACH-ConfigSIB-NB-v1330 ::= SEQUENCE {
    nprach-ParametersList-v1330    NPRACH-ParametersList-NB-v1330
}
NPRACH-ConfigSIB-NB-v1450 ::= SEQUENCE {
    maxNumPreambleAttemptCE-r14    ENUMERATED {n3, n4, n5, n6, n7, n8, n10, spare1}
}
NPRACH-ConfigSIB-NB-v1530 ::= SEQUENCE {
    tdd-Parameters-r15              SEQUENCE {
        nprach-PreambleFormat-r15   ENUMERATED {
            fmt0, fmt1, fmt2, fmt0-a, fmt1-a},

```

```

dummy                ENUMERATED {
                        n1, n2, n4, n8, n16, n32, n64, n128,
                        n256, n512, n1024},
nprach-ParametersListTDD-r15  NPRACH-ParametersListTDD-NB-r15
} OPTIONAL,          -- Cond TDD
fmt2-Parameters-r15        SEQUENCE {
nprach-ParametersListFmt2-r15  NPRACH-ParametersListFmt2-NB-r15 OPTIONAL,  -- Need OR
nprach-ParametersListFmt2EDT-r15  NPRACH-ParametersListFmt2-NB-r15 OPTIONAL  -- Cond EDT2
} OPTIONAL,          -- Need OR
edt-Parameters-r15        SEQUENCE {
edt-SmallTBS-Subset-r15        ENUMERATED {true}                OPTIONAL,  -- Need OR
edt-TBS-InfoList-r15          EDT-TBS-InfoList-NB-r15,
nprach-ParametersListEDT-r15  NPRACH-ParametersList-NB-r14  OPTIONAL  -- Need OR
} OPTIONAL          -- Cond EDT1
}

NPRACH-ConfigSIB-NB-v1550 ::= SEQUENCE {
tdd-Parameters-v1550          SEQUENCE {
nprach-ParametersListTDD-v1550  NPRACH-ParametersListTDD-NB-v1550
}
}

NPRACH-ParametersList-NB-r13 ::= SEQUENCE (SIZE (1.. maxNPRACH-Resources-NB-r13)) OF NPRACH-Parameters-NB-r13

NPRACH-ParametersList-NB-v1330 ::= SEQUENCE (SIZE (1.. maxNPRACH-Resources-NB-r13)) OF NPRACH-Parameters-NB-v1330

NPRACH-Parameters-NB-r13 ::= SEQUENCE {
nprach-Periodicity-r13        ENUMERATED {ms40, ms80, ms160, ms240,
ms320, ms640, ms1280, ms2560},
nprach-StartTime-r13          ENUMERATED {ms8, ms16, ms32, ms64,
ms128, ms256, ms512, ms1024},
nprach-SubcarrierOffset-r13   ENUMERATED {n0, n12, n24, n36, n2, n18, n34, spare1},
nprach-NumSubcarriers-r13     ENUMERATED {n12, n24, n36, n48},
nprach-SubcarrierMSG3-RangeStart-r13  ENUMERATED {zero, oneThird, twoThird, one},
maxNumPreambleAttemptCE-r13   ENUMERATED {n3, n4, n5, n6, n7, n8, n10, spare1},
numRepetitionsPerPreambleAttempt-r13  ENUMERATED {n1, n2, n4, n8, n16, n32, n64, n128},
npdcch-NumRepetitions-RA-r13  ENUMERATED {r1, r2, r4, r8, r16, r32, r64, r128,
r256, r512, r1024, r2048,
spare4, spare3, spare2, spare1},
npdcch-StartSF-CSS-RA-r13     ENUMERATED {v1dot5, v2, v4, v8, v16, v32, v48, v64},
npdcch-Offset-RA-r13         ENUMERATED {zero, oneEighth, oneFourth, threeEighth}
}

NPRACH-Parameters-NB-v1330 ::= SEQUENCE {
nprach-NumCBRA-StartSubcarriers-r13  ENUMERATED {n8, n10, n11, n12, n20, n22, n23, n24,
n32, n34, n35, n36, n40, n44, n46, n48}
}

NPRACH-ParametersList-NB-r14 ::= SEQUENCE (SIZE (1.. maxNPRACH-Resources-NB-r13)) OF
NPRACH-Parameters-NB-r14

NPRACH-Parameters-NB-r14 ::= SEQUENCE {
nprach-Parameters-r14        SEQUENCE {
nprach-Periodicity-r14        ENUMERATED {ms40, ms80, ms160, ms240,
ms320, ms640, ms1280, ms2560}
OPTIONAL,          -- NEED OP
nprach-StartTime-r14          ENUMERATED {ms8, ms16, ms32, ms64,
ms128, ms256, ms512, ms1024}
OPTIONAL,          -- NEED OP
nprach-SubcarrierOffset-r14   ENUMERATED {n0, n12, n24, n36, n2, n18, n34, spare1}
OPTIONAL,          -- NEED OP
nprach-NumSubcarriers-r14     ENUMERATED {n12, n24, n36, n48}
OPTIONAL,          -- NEED OP
nprach-SubcarrierMSG3-RangeStart-r14  ENUMERATED {zero, oneThird, twoThird, one}
OPTIONAL,          -- NEED OP
npdcch-NumRepetitions-RA-r14  ENUMERATED {r1, r2, r4, r8, r16, r32, r64, r128,
r256, r512, r1024, r2048,
spare4, spare3, spare2, spare1}
OPTIONAL,          -- NEED OP
npdcch-StartSF-CSS-RA-r14     ENUMERATED {v1dot5, v2, v4, v8, v16, v32, v48, v64}
OPTIONAL,          -- NEED OP
npdcch-Offset-RA-r14         ENUMERATED {zero, oneEighth, oneFourth, threeEighth}
OPTIONAL,          -- NEED OP
nprach-NumCBRA-StartSubcarriers-r14  ENUMERATED {n8, n10, n11, n12, n20, n22, n23, n24,
n32, n34, n35, n36, n40, n44, n46, n48}
OPTIONAL,          -- NEED OP

```

```

        npdcch-CarrierIndex-r14                INTEGER (1..maxNonAnchorCarriers-NB-r14)
                                                OPTIONAL,    -- Need OP
    }
    } OPTIONAL    -- Need OR
}

NPRACH-ParametersListTDD-NB-r15 ::= SEQUENCE (SIZE (1.. maxNPRACH-Resources-NB-r13)) OF
    NPRACH-ParametersTDD-NB-r15

NPRACH-ParametersTDD-NB-r15 ::= SEQUENCE {
    nprach-Parameters-r15                SEQUENCE {
        nprach-Periodicity-r15          ENUMERATED {ms80, ms160, ms320, ms640,
                                                    ms1280, ms2560, ms5120, ms10240}
                                                    OPTIONAL,    -- NEED OP
        nprach-StartTime-r15            ENUMERATED {ms10, ms20, ms40, ms80,
                                                    ms160, ms320, ms640, ms1280,
                                                    ms2560, ms5120, spare6, spare5,
                                                    spare4, spare3, spare2, spare1}
                                                    OPTIONAL,    -- NEED OP
        nprach-SubcarrierOffset-r15     ENUMERATED {n0, n12, n24, n36, n2, n18, n34, spare1}
                                                    OPTIONAL,    -- NEED OP
        nprach-NumSubcarriers-r15       ENUMERATED {n12, n24, n36, n48}
                                                    OPTIONAL,    -- NEED OP
        nprach-SubcarrierMSG3-RangeStart-r15  ENUMERATED {zero, oneThird, twoThird, one}
                                                    OPTIONAL,    -- NEED OP
        npdcch-NumRepetitions-RA-r15    ENUMERATED {r1, r2, r4, r8, r16, r32, r64, r128,
                                                    r256, r512, r1024, r2048,
                                                    spare4, spare3, spare2, spare1}
                                                    OPTIONAL,    -- NEED OP
        npdcch-StartSF-CSS-RA-r15      ENUMERATED {v4, v8, v16, v32, v48, v64, v96, v128}
                                                    OPTIONAL,    -- NEED OP
        npdcch-Offset-RA-r15           ENUMERATED {zero, oneEighth, oneFourth, threeEighth}
                                                    OPTIONAL,    -- NEED OP
        nprach-NumCBRA-StartSubcarriers-r15  ENUMERATED {n8, n10, n11, n12, n20, n22, n23, n24,
                                                    n32, n34, n35, n36, n40, n44, n46, n48}
                                                    OPTIONAL,    -- NEED OP
    }
    } OPTIONAL    -- Need OR
}

NPRACH-ParametersListTDD-NB-v1550 ::= SEQUENCE (SIZE (1.. maxNPRACH-Resources-NB-r13)) OF
    NPRACH-ParametersTDD-NB-v1550

NPRACH-ParametersTDD-NB-v1550 ::= SEQUENCE {
    maxNumPreambleAttemptCE-v1550      ENUMERATED {n3, n4, n5, n6, n7, n8, n10, spare1},
    numRepetitionsPerPreambleAttempt-v1550  ENUMERATED {n1, n2, n4, n8, n16, n32, n64, n128,
                                                    n256, n512, n1024}
}

NPRACH-ParametersListFmt2-NB-r15 ::= SEQUENCE (SIZE (1.. maxNPRACH-Resources-NB-r13)) OF NPRACH-
ParametersFmt2-NB-r15

NPRACH-ParametersFmt2-NB-r15 ::= SEQUENCE {
    nprach-Parameters-r15                SEQUENCE {
        nprach-Periodicity-r15          ENUMERATED {ms40, ms80, ms160, ms320,
                                                    ms640, ms1280, ms2560, ms5120}
                                                    OPTIONAL,    -- NEED OP
        nprach-StartTime-r15            ENUMERATED {ms8, ms16, ms32, ms64,
                                                    ms128, ms256, ms512, ms1024}
                                                    OPTIONAL,    -- NEED OP
        nprach-SubcarrierOffset-r15     ENUMERATED {n0, n36, n72, n108, n6, n54, n102, n42,
                                                    n78, n90, n12, n24, n48, n84, n60, n18}
                                                    OPTIONAL,    -- NEED OP
        nprach-NumSubcarriers-r15       ENUMERATED {n36, n72, n108, n144}
                                                    OPTIONAL,    -- NEED OP
        nprach-SubcarrierMSG3-RangeStart-r15  ENUMERATED {zero, oneThird, twoThird, one}
                                                    OPTIONAL,    -- NEED OP
        npdcch-NumRepetitions-RA-r15    ENUMERATED {r1, r2, r4, r8, r16, r32, r64, r128,
                                                    r256, r512, r1024, r2048,
                                                    spare4, spare3, spare2, spare1}
                                                    OPTIONAL,    -- NEED OP
        npdcch-StartSF-CSS-RA-r15      ENUMERATED {v1dot5, v2, v4, v8, v16, v32, v48, v64}
                                                    OPTIONAL,    -- NEED OP
        npdcch-Offset-RA-r15           ENUMERATED {zero, oneEighth, oneFourth, threeEighth}
                                                    OPTIONAL,    -- NEED OP
        nprach-NumCBRA-StartSubcarriers-r15  ENUMERATED {
                                                    n24, n30, n33, n36, n60, n66, n69, n72,
                                                    n96, n102, n105, n108, n120, n132, n138, n144}
    }
}

```

```
        npdcch-CarrierIndex-r15                OPTIONAL, -- NEED OP
        INTEGER (1..maxNonAnchorCarriers-NB-r14)
        OPTIONAL, -- Need OP
    }
    ...
} OPTIONAL -- Need OR
}

NPRACH-TxDurationFmt01-NB-r17 ::= SEQUENCE {
    nprach-TxDurationFmt01-r17    ENUMERATED {n2, n4, n8, n16, n32, n64}
}

NPRACH-TxDurationFmt2-NB-r17 ::= SEQUENCE {
    nprach-TxDurationFmt2-r17    ENUMERATED {n1, n2, n4, n8, n16}
}

RSRP-ThresholdsNPRACH-InfoList-NB-r13 ::= SEQUENCE (SIZE(1..2)) OF RSRP-Range

EDT-TBS-InfoList-NB-r15 ::= SEQUENCE (SIZE (1.. maxNPRACH-Resources-NB-r13)) OF EDT-TBS-NB-r15

EDT-TBS-NB-r15 ::= SEQUENCE {
    edt-SmallTBS-Enabled-r15    BOOLEAN,
    edt-TBS-r15                  ENUMERATED {b328, b408, b504, b584, b680, b808, b936, b1000}
}

-- ASN1STOP
```

<b>NPRACH-ConfigSIB-NB field descriptions</b>
<p><b>dummy</b> This field is not used in the specification. If received it shall be ignored by the UE.</p>
<p><b>edt-SmallTBS-Enabled</b> Value TRUE indicates UE performing EDT is allowed to select TBS smaller than <i>edt-TBS</i> for Msg3 according to the corresponding NPRACH resource, as specified in TS 36.213 [23].</p>
<p><b>edt-SmallTBS-Subset</b> Presence indicates only two of the TBS values can be used according to <i>edt-TBS</i> corresponding to the NPRACH resource, as specified in TS 36.213 [23]. When the field is not present, any of the TBS values according to <i>edt-TBS</i> corresponding to the NPRACH resource can be used. This field is applicable for a NPRACH resource only when <i>edt-SmallTBS-Enabled</i> is included for the corresponding NPRACH resource.</p>
<p><b>edt-TBS</b> Largest TBS for Msg3 for a NPRACH resource applicable to a UE performing EDT. Value in bits. Value b328 corresponds to 328 bits, value b408 corresponds to 408 bits and so on. See TS 36.213 [23].</p>
<p><b>maxNumPreambleAttemptCE</b> Maximum number of preamble transmission attempts per NPRACH resource. See TS 36.321 [6]. If the UE supports enhanced random access power control and <i>maxNumPreambleAttemptCE-r14</i> is included, the UE shall use <i>maxNumPreambleAttemptCE-r14</i> instead of <i>maxNumPreambleAttemptCE-r13</i> for the first entry in <i>nprach-ParametersList</i>. <i>maxNumPreambleAttemptCE-r13</i> applies to FDD and <i>maxNumPreambleAttemptCE-v1550</i> applies to TDD.</p>
<p><b>npdcch-CarrierIndex</b> For FDD: Index of the carrier in the list of DL non anchor carriers. The first entry in the list has index '1', the second entry has index '2' and so on. If the UE supports mixed operation mode and <i>dl-ConfigListMixed</i> is present in <i>systemInformationBlockType22-NB</i>, the UE creates a combined list of DL carriers for random access by appending <i>dl-ConfigListMixed</i> to the <i>dl-ConfigList</i> while maintaining the order among both <i>dl-ConfigList</i> and <i>dl-ConfigListMixed</i>; only the first <i>maxNonAnchorCarriers-NB-r14</i> DL non-anchor carriers in the concatenated list can be used for random access. If the field is absent in the entry in <i>nprach-ParametersListEDT</i> in <i>SystemInformationBlockType22-NB</i>, the value of <i>npdcch-CarrierIndex</i> in the corresponding entry of <i>nprach-ParametersList</i> applies, if present. If the field is absent in an entry in <i>nprach-ParametersListFmt2EDT</i> in <i>SystemInformationBlockType23-NB</i>, the value of <i>npdcch-CarrierIndex</i> in the corresponding entry of <i>nprach-ParametersListFmt2</i> applies, if present. Otherwise, the DL anchor carrier is used. For TDD: This parameter is absent and the same carrier is used in uplink and downlink.</p>
<p><b>npdcch-NumRepetitions-RA</b> Maximum number of repetitions for NPDCCH common search space (CSS) for RAR, Msg3 retransmission and Msg4, see TS 36.213 [23], clause 16.6. See NOTE.</p>
<p><b>npdcch-Offset-RA</b> Fractional period offset of starting subframe for NPDCCH common search space (CSS Type 2), see TS 36.213 [23], clause 16.6. See NOTE.</p>
<p><b>npdcch-StartSF-CSS-RA</b> Starting subframe configuration for NPDCCH common search space (CSS), including RAR, Msg3 retransmission, and Msg4, see TS 36.213 [23], clause 16.6. See NOTE.</p>
<p><b>nprach-CP-Length</b> Cyclic prefix length for NPRACH transmission (<math>T_{CP}</math>), see TS 36.211 [21], clause 10.1.6. Value <i>us66dot7</i> corresponds to 66.7 microseconds and value <i>us266dot7</i> corresponds to 266.7 microseconds. If the UE uses a NPRACH resource for preamble format 2, the UE ignores the value signalled in <i>nprach-CP-Length</i> and considers the value to be 800 microseconds.</p>
<p><b>nprach-NumCBRA-StartSubcarriers</b> The number of start subcarriers from which a UE can randomly select a start subcarrier as specified in TS 36.321 [6]. If <i>nprach-Config-v1330</i> is not included in <i>SystemInformationBlockType2-NB</i>, the UE sets the value of <i>nprach-NumCBRA-StartSubcarriers-r13</i> to the value signalled by <i>nprach-NumSubcarriers-r13</i> for the corresponding NPRACH resource. The start subcarrier indices that the UE is allowed to randomly select from, are given by: <math>nprach-SubcarrierOffset + [0, nprach-NumCBRA-StartSubcarriers - 1]</math>. See NOTE.</p>
<p><b>nprach-NumSubcarriers</b> Number of sub-carriers in a NPRACH resource, see TS 36.211 [21], clause 10.1.6. In number of subcarriers. See NOTE.</p>

<b>NPRACH-ConfigSIB-NB field descriptions</b>
<p><b><i>nprach-ParametersList, nprach-ParametersListEDT</i></b> Configures NPRACH parameters for each NPRACH resource. Up to three PRACH resources can be configured in <i>nprach-ParametersList</i> in a cell. Each NPRACH resource is associated with a different number of NPRACH repetitions. E-UTRAN includes the same number of entries, and listed in the same order for <i>nprach-ParametersListEDT</i>, as in <i>nprach-ParametersList</i> in <i>SystemInformationBlockType2-NB</i>. The NPRACH resources in <i>nprach-ParametersListEDT</i> are used to initiate EDT. Each NPRACH resource is associated with a TBS signalled in the corresponding entry of <i>edt-TBS-InfoList</i>. For TDD: The UE shall use <i>nprach-ParametersListTDD</i> and ignore <i>nprach-ParametersList</i>.</p>
<p><b><i>nprach-ParametersListTDD</i></b> For TDD: Configure NPRACH parameters for each NPRACH. Up to three NPRACH resources can be configured in a cell. Each NPRACH resource is associated with a different number of NPRACH repetitions.</p>
<p><b><i>nprach-ParametersListFmt2, nprach-ParametersListFmt2EDT</i></b> Configures NPRACH parameters for each NPRACH resource format 2. Up to three NPRACH resources can be configured on one carrier. Each NPRACH resource is associated with a different number of NPRACH repetitions. E-UTRAN includes the same number of entries, and listed in the same order, as in <i>nprach-ParametersList</i> in <i>SystemInformationBlockType2-NB</i>. The NPRACH resources in <i>nprach-ParametersListFmt2EDT</i> are used to initiate EDT. Each NPRACH resource is associated with a TBS signalled in the corresponding entry of <i>edt-TBS-InfoList</i>. E-UTRAN configures the NPRACH resources format 2 so that they do not overlap in time domain with the NPRACH resources configured in <i>nprach-ParametersList</i> and <i>nprach-ParametersListEDT</i>. If there is no NPRACH resource in <i>nprach-ParametersListFmt2</i> (respectively <i>nprach-ParametersListFmt2EDT</i>) on any UL carrier for one NPRACH repetition level, the UE uses the NPRACH resources in <i>nprach-ParametersList</i> (respectively <i>nprach-ParametersListEDT</i>) for this NPRACH repetition level. Otherwise, the UE uses only NPRACH resources in <i>nprach-ParametersListFmt2</i> (respectively <i>nprach-ParametersListFmt2EDT</i>).</p>
<p><b><i>nprach-Periodicity</i></b> Periodicity of a NPRACH resource, see TS 36.211 [21], clause 10.1.6. Unit in millisecond. See NOTE.</p>
<p><b><i>nprach-PreambleFormat</i></b> TDD: TDD preamble format, see TS 36.211 [21], clause 10.1.6, Value <i>fmt0</i> corresponds to preamble format 0, value <i>fmt1</i> corresponds to preamble format 1 and so on.</p>
<p><b><i>nprach-StartTime</i></b> Start time of the NPRACH resource in one period, see TS 36.211 [21], clause 10.1.6. Unit in millisecond. See NOTE.</p>
<p><b><i>nprach-SubcarrierOffset</i></b> Frequency location of the NPRACH resource, see TS 36.211 [21], clause 10.1.6. In number of subcarriers, offset from sub-carrier 0. See NOTE.</p>
<p><b><i>nprach-SubcarrierMSG3-RangeStart</i></b> Fraction for calculating the starting subcarrier index of the range reserved for indication of UE support for multi-tone Msg3 transmission, within the NPRACH resource, see TS 36.211 [21], clause 10.1.6. Multi-tone Msg3 transmission is not supported for {32, 64, 128} repetitions of NPRACH. For at least one of the NPRACH resources with the number of NPRACH repetitions other than {32, 64, 128}, the value of <i>nprach-SubcarrierMSG3-RangeStart</i> should not be 0. If <i>nprach-SubcarrierMSG3-RangeStart</i> is equal to zero, no start subcarrier index for the single-tone Msg3 NPRACH is allocated and the start subcarrier indexes for the multi-tone Msg3 NPRACH partition are given by <i>nprach-SubcarrierOffset</i> + [0, <i>nprach-NumCBRA-StartSubcarriers</i> - 1]. If <i>nprach-SubcarrierMSG3-RangeStart</i> is equal to oneThird or twoThird, the start subcarrier indexes for the two partitions are given by: <math>nprach-SubcarrierOffset + [0, \text{FLOOR} (nprach-NumCBRA-StartSubcarriers * nprach-SubcarrierMSG3-RangeStart) - 1]</math> for the single-tone Msg3 NPRACH partition; <math>nprach-SubcarrierOffset + [\text{FLOOR} (nprach-NumCBRA-StartSubcarriers * nprach-SubcarrierMSG3-RangeStart), nprach-NumCBRA-StartSubcarriers - 1]</math> for the multi-tone Msg3 NPRACH partition; If <i>nprach-SubcarrierMSG3-RangeStart</i> is equal to one, the start subcarrier indexes for the single-tone Msg3 NPRACH are given by <i>nprach-SubcarrierOffset</i> + [0, <i>nprach-NumCBRA-StartSubcarriers</i> - 1] and no start subcarrier index for the multi-tone Msg3 NPRACH partition is allocated. See NOTE.</p>
<p><b><i>nprach-TxDurationFmt01</i></b> Duration of PRACH segment transmission for PRACH resource format 0 and format 1 in NTN transmission, see TS 36.213 [23]. Unit in duration of preamble repetition unit, i.e., 4 * (TCP+TSEQ). Value <i>n2</i> corresponds to the duration of 2 preamble repetition units, value <i>n4</i> corresponds to the duration of 4 preamble repetition units and so on.</p>
<p><b><i>nprach-TxDurationFmt2</i></b> Duration of PRACH segment transmission for PRACH resource format 2 in NTN transmission, see TS 36.213 [23]. Unit in duration of preamble repetition unit, i.e., 6 * (TCP+TSEQ). Value <i>n1</i> corresponds to the duration of 1 preamble repetition unit, value <i>n2</i> corresponds to the duration of 2 preamble repetition units and so on.</p>

<b>NPRACH-ConfigSIB-NB field descriptions</b>	
<b>numRepetitionsPerPreambleAttempt</b>	Number of NPRACH repetitions per attempt for each NPRACH resource, See TS 36.211 [21], clause 10.1.6. <i>numRepetitionsPerPreambleAttempt-r13</i> applies to FDD and <i>numRepetitionsPerPreambleAttempt-v1550</i> applies to TDD.
<b>rsrp-ThresholdsPrachInfoList</b>	The criterion for UEs to select a NPRACH resource. Up to 2 RSRP threshold values can be signalled. The first element corresponds to RSRP threshold 1, the second element corresponds to RSRP threshold 2. See TS 36.321 [6]. If absent, there is only one NPRACH resource. A UE that supports <i>powerClassNB-14dBm-r14</i> shall correct the RSRP threshold values before applying them as follows: RSRP threshold = Signalled RSRP threshold - min{0, (14-min(23, P-Max))} where P-Max is the value of <i>p-Max</i> field in <i>SystemInformationBlockType1-NB</i> .

## NOTE:

- If the field is absent in an entry of *nprach-ParametersList* in *SystemInformationBlockType22-NB*, the value of the same field in the corresponding entry of *nprach-ParametersList* in *SystemInformationBlockType2-NB* applies.
- If the field is absent in the entry in *nprach-ParametersListEDT*, the value of the same field in the corresponding entry of *nprach-ParametersList* on the same UL carrier applies, if present. Otherwise, the value of the same field in the corresponding entry of *nprach-ParametersList* in *SystemInformationBlockType2-NB* applies.
- If the field is absent in an entry of *nprach-ParametersListTDD* in *SystemInformationBlockType22-NB*, the value of the same field in the corresponding entry of *nprach-ParametersListTDD* in *SystemInformationBlockType2-NB* applies. The field is mandatory present in *nprach-ParametersListTDD* in *SystemInformationBlockType2-NB*.
- If the field is absent in an entry of *nprach-ParametersListFmt2* in *SystemInformationBlockType23-NB*, the value of the same field, if present, in the corresponding entry of *nprach-ParametersListFmt2* in *SystemInformationBlockType2-NB* applies. Otherwise the value of the same field, if present, in the corresponding entry of the first occurrence of *nprach-ParametersListFmt2* in the non anchor carrier list applies. Otherwise, the value of the same field in the corresponding entry of *nprach-ParametersList* in *SystemInformationBlockType2-NB* applies.
- If the field is absent in an entry of *nprach-ParametersListFmt2* in *SystemInformationBlockType2-NB*, the value of the same field in the corresponding entry of *nprach-ParametersList* in *SystemInformationBlockType2-NB* applies.
- If the field is absent in an entry of *nprach-ParametersListFmt2EDT* in *SystemInformationBlockType23-NB*, the value of the same field, if present, in the corresponding entry of *nprach-ParametersListFmt2* on the same UL carrier applies. Otherwise, the value of the same field, if present, in the corresponding entry of *nprach-ParametersListFmt2* in *SystemInformationBlockType2-NB* applies. Otherwise the value of the same field, if present, in the corresponding entry of the first occurrence of *nprach-ParametersListFmt2* in the non anchor carrier list applies. Otherwise, the value of the same field in the corresponding entry of *nprach-ParametersList* in *SystemInformationBlockType2-NB* applies.
- If the field is absent in an entry of *nprach-ParametersListFmt2EDT* in *SystemInformationBlockType2-NB*, the value of the same field, if present, in the corresponding entry of *nprach-ParametersListFmt2* in *SystemInformationBlockType2-NB* applies. Otherwise the value of the same field in the corresponding entry of *nprach-ParametersList* in *SystemInformationBlockType2-NB* applies.

Conditional presence	Explanation
<i>EDT1</i>	The field is mandatory present if <i>cp-EDT</i> , <i>cp-EDT-5GC</i> , <i>up-EDT</i> or <i>up-EDT-5GC</i> in <i>SystemInformationBlockType2-NB</i> is present; otherwise the field is not present and the UE shall delete any existing value for this field.
<i>EDT2</i>	The field is optionally present, Need OR, if <i>edt-Parameters</i> is present; otherwise the field is not present and the UE shall delete any existing value for this field.
<i>TDD</i>	This field is mandatory present for TDD; otherwise the field is not present and the UE shall delete any existing value for this field.



## – NPUSCH-Config-NB

The IE *NPUSCH-ConfigCommon-NB* is used to specify the common NPUSCH configuration. The IE *NPUSCH-ConfigDedicated-NB* is used to specify the UE specific NPUSCH configuration.

### NPUSCH-Config-NB information element

```

-- ASN1START
NPUSCH-ConfigCommon-NB-r13 ::= SEQUENCE {
  ack-NACK-NumRepetitions-Msg4-r13 SEQUENCE (SIZE(1.. maxNPRACH-Resources-NB-r13)) OF
                                     ACK-NACK-NumRepetitions-NB-r13,
  srs-SubframeConfig-r13           ENUMERATED {
                                     sc0, sc1, sc2, sc3, sc4, sc5, sc6, sc7,
                                     sc8, sc9, sc10, sc11, sc12, sc13, sc14, sc15
                                     } OPTIONAL, -- Need OR
  dmrs-Config-r13                 SEQUENCE {
    threeTone-BaseSequence-r13     INTEGER (0..12)          OPTIONAL, -- Need OP
    threeTone-CyclicShift-r13      INTEGER (0..2)          OPTIONAL, -- Need OP
    sixTone-BaseSequence-r13       INTEGER (0..14)         OPTIONAL, -- Need OP
    sixTone-CyclicShift-r13        INTEGER (0..3)          OPTIONAL, -- Need OP
    twelveTone-BaseSequence-r13    INTEGER (0..30)         OPTIONAL, -- Need OP
  } OPTIONAL, -- Need OR
  ul-ReferenceSignalsNPUSCH-r13    UL-ReferenceSignalsNPUSCH-NB-r13
}

UL-ReferenceSignalsNPUSCH-NB-r13 ::= SEQUENCE {
  groupHoppingEnabled-r13          BOOLEAN,
  groupAssignmentNPUSCH-r13        INTEGER (0..29)
}

NPUSCH-ConfigDedicated-NB-r13 ::= SEQUENCE {
  ack-NACK-NumRepetitions-r13      ACK-NACK-NumRepetitions-NB-r13 OPTIONAL, -- Need ON
  npusch-AllSymbols-r13            BOOLEAN          OPTIONAL, -- Cond SRS
  groupHoppingDisabled-r13         ENUMERATED {true}  OPTIONAL, -- Need OR
}

NPUSCH-ConfigDedicated-NB-v1610 ::= SEQUENCE {
  npusch-MultiTB-Config-r16        ENUMERATED {interleaved, nonInterleaved}
}

NPUSCH-ConfigDedicated-NB-v1700 ::= SEQUENCE {
  npusch-16QAM-Config-r17          ENUMERATED {true}  OPTIONAL, -- Need OR
}

NPUSCH-ConfigDedicated-NB-v1800 ::= SEQUENCE {
  uplinkHARQ-Mode-r18              SetupRelease {UplinkHARQ-Mode-NB-r18}
}

NPUSCH-TxDuration-NB-r17 ::= SEQUENCE {
  npusch-TxDuration-r17            ENUMERATED {ms2, ms4, ms8, ms16, ms32, ms64, ms128, ms256}
}

ACK-NACK-NumRepetitions-NB-r13 ::= ENUMERATED {r1, r2, r4, r8, r16, r32, r64, r128}

UplinkHARQ-Mode-NB-r18 ::= BIT STRING (SIZE(2))
-- ASN1STOP

```

<b>NPUSCH-Config-NB field descriptions</b>	
<b>ack-NACK-NumRepetitions</b>	Number of repetitions for the ACK NACK resource unit carrying HARQ response to NPDSCH, see TS 36.213 [23], clause 16.4.2. If this field is absent and no value was configured via dedicated signalling, the value used for reception of Msg4 is used.
<b>ack-NACK-NumRepetitions-Msg4</b>	Number of repetitions for ACK/NACK HARQ response to NPDSCH containing Msg4 per NPRACH resource, see TS 36.213 [23], clause 16.4.2.
<b>groupAssignmentNPUSCH</b>	See TS 36.211 [21], clause 10.1.4.1.3.
<b>groupHoppingDisabled</b>	See TS 36.211 [21], clause 10.1.4.1.3.
<b>groupHoppingEnabled</b>	See TS 36.211 [21], clause 10.1.4.1.3.
<b>npusch-16QAM-Config</b>	Activation of 16QAM for UL, see TS 36.213 [23].
<b>npusch-AllSymbols</b>	If set to TRUE, the UE shall use all NB-IoT symbols for NPUSCH transmission. If set to FALSE, the UE punctures the NPUSCH transmissions in the symbols that collides with SRS. If the field is not present, the UE uses all NB-IoT symbols for NPUSCH transmission. See TS 36.211 [21], clause 10.1.3.6.
<b>npusch-MultiTB-Config</b>	For FDD: Activation of multiple TBs scheduling in UL, see TS 36.213 [23]. Value <i>interleaved</i> indicates that multiple TBs scheduling with interleaved transmission is enabled, value <i>nonInterleaved</i> indicates that multiple TBs scheduling without interleaved transmission is enabled.
<b>npusch-TxDuration</b>	Duration of NPUSCH segment transmission in NTN transmission, see TS 36.213 [23]. Unit in ms. Value <i>ms2</i> corresponds to 2 ms, value <i>ms4</i> corresponds to 4 ms and so on.
<b>sixTone-BaseSequence</b>	The base sequence of DMRS sequence in a cell for 6 tones transmission; see TS 36.211 [21], clause 10.1.4.1.2. If absent, it is given by NB-IoT CellID mod 14. Value 14 is not used.
<b>sixTone-CyclicShift</b>	Define 4 cyclic shifts for the 6-tone case, see TS 36.211 [21], clause 10.1.4.1.2.
<b>srs-SubframeConfig</b>	SRS SubframeConfiguration. See TS 36.211 [21], table 5.5.3.3-1. Value <i>sc0</i> corresponds to value 0, <i>sc1</i> to value 1 and so on.
<b>threeTone-BaseSequence</b>	The base sequence of DMRS sequence in a cell for 3 tones transmission; see TS 36.211 [21], clause 10.1.4.1.2. If absent, it is given by NB-IoT CellID mod 12. Value 12 is not used.
<b>threeTone-CyclicShift</b>	Define 3 cyclic shifts for the 3-tone case, see TS 36.211 [21], clause 10.1.4.1.2.
<b>twelveTone-BaseSequence</b>	The base sequence of DMRS sequence in a cell for 12 tones transmission; see TS 36.211 [21], clause 10.1.4.1.2. If absent, it is given by NB-IoT CellID mod 30. Value 30 is not used.
<b>ul-ReferenceSignalsNPUSCH</b>	Used to specify parameters needed for the transmission on NPUSCH.
<b>uplinkHARQ-Mode</b>	Used to set the HARQ mode per HARQ process ID, see TS 36.321 [6]. The first/leftmost bit corresponds to HARQ process ID 0, the next bit to HARQ process ID 1. The bit corresponding to HARQ process ID that is not configured shall be ignored. A bit set to one identifies a HARQ process with HARQ mode A and a bit set to zero identifies a HARQ process with HARQ mode B. This field applies for SRBs and DRBs.

Conditional presence	Explanation
SRS	This field is optionally present, need OP, if <i>srs-SubframeConfig</i> is broadcasted. Otherwise, the IE is not present.

## – PDCP-Config-NB

The IE *PDCP-Config-NB* is used to set the configurable PDCP parameters for data radio bearers.

### PDCP-Config-NB information element

```
-- ASN1START
PDCP-Config-NB-r13 ::= SEQUENCE {
    discardTimer-r13      ENUMERATED {
```

```

ms5120, ms10240, ms20480, ms40960,
ms81920, infinity, spare2, spare1
} OPTIONAL, -- Cond Setup
headerCompression-r13 CHOICE {
  notUsed NULL,
  rohc SEQUENCE {
    maxCID-r13 INTEGER (1..16383) DEFAULT 15,
    profiles-r13 SEQUENCE {
      profile0x0002 BOOLEAN,
      profile0x0003 BOOLEAN,
      profile0x0004 BOOLEAN,
      profile0x0006 BOOLEAN,
      profile0x0102 BOOLEAN,
      profile0x0103 BOOLEAN,
      profile0x0104 BOOLEAN
    }
  },
  ...
},
...
[[ cipheringDisabled-r16 ENUMERATED {true} OPTIONAL -- Cond ConnectedTo5GC
]]
}
-- ASN1STOP

```

PDCP-Config-NB field descriptions	
<b><i>cipheringDisabled</i></b>	If included, ciphering is disabled for this DRB regardless of which ciphering algorithm is configured for the SRB/DRBs. E-UTRAN may include this field only when the UE is connected to 5GC. The value for this field cannot be changed after the DRB is set up.
<b><i>discardTimer</i></b>	Indicates the discard timer value specified in TS 36.323 [8]. Value in milliseconds. Value ms5120 means 5120 ms, ms10240 means 10240 ms and so on.
<b><i>headerCompression</i></b>	E-UTRAN does not reconfigure header compression except optionally upon RRC Connection Resumption.
<b><i>maxCID</i></b>	Indicates the value of the MAX_CID parameter as specified in TS 36.323 [8]. The total value of MAX_CIDs across all bearers for the UE should be less than or equal to the value of <i>maxNumberROHC-ContextSessions</i> parameter as indicated by the UE.
<b><i>profiles</i></b>	The profiles used by both compressor and decompressor in both UE and E-UTRAN. The field indicates which of the ROHC profiles specified in TS 36.323 [8] are supported, i.e. value <i>true</i> indicates that the profile is supported. Profile 0x0000 shall always be supported when the use of ROHC is configured. If support of two ROHC profile identifiers with the same 8 LSB's is signalled, only the profile corresponding to the highest value shall be applied.

Conditional presence	Explanation
<i>ConnectedTo5GC</i>	The field is optionally present, need OR, if the UE is connected to 5GC. Otherwise the field is not present and the UE shall delete any existing value for this field.
<i>Setup</i>	The field is mandatory present in case of radio bearer setup. Otherwise the field is optionally present, need ON.

**PhysicalConfigDedicated-NB**

The IE *PhysicalConfigDedicated-NB* is used to specify the UE specific physical channel configuration.

**PhysicalConfigDedicated-NB information element**

```

-- ASN1START
PhysicalConfigDedicated-NB-r13 ::= SEQUENCE {
  carrierConfigDedicated-r13 CarrierConfigDedicated-NB-r13 OPTIONAL, -- Need ON
  npdcch-ConfigDedicated-r13 NPDCCH-ConfigDedicated-NB-r13 OPTIONAL, -- Need ON
  npusch-ConfigDedicated-r13 NPUSCH-ConfigDedicated-NB-r13 OPTIONAL, -- Need ON
  uplinkPowerControlDedicated-r13 UplinkPowerControlDedicated-NB-r13 OPTIONAL, -- Need ON
  ...,
  [[ twoHARQ-ProcessesConfig-r14 ENUMERATED {true} OPTIONAL -- Need OR
  ]],
  [[ interferenceRandomisationConfig-r14 ENUMERATED {true} OPTIONAL -- Need OR
  ]]
}
-- ASN1STOP

```

```

]],
[[ npdcch-ConfigDedicated-v1530      NPDCCH-ConfigDedicated-NB-v1530      OPTIONAL      -- Cond TDD
]],
[[ additionalTxSIB1-Config-v1540      ENUMERATED {true}      OPTIONAL      -- Cond additionalSIB1
]],
[[ npusch-ConfigDedicated-v1610      NPUSCH-ConfigDedicated-NB-v1610
                                     OPTIONAL,      -- Cond twoHARQ
   npdsch-ConfigDedicated-r16        NPDSCH-ConfigDedicated-NB-r16
                                     OPTIONAL,      -- Need ON
   resourceReservationConfigDL-r16    SetupRelease {ResourceReservationConfig-NB-r16}
                                     OPTIONAL,      -- Cond dl-NonAnchor
   resourceReservationConfigUL-r16    SetupRelease {ResourceReservationConfig-NB-r16}
                                     OPTIONAL,      -- Cond ul-NonAnchor
]],
[[ ntn-ConfigDedicated-r17            SEQUENCE {
   npusch-TxDuration-r17              SetupRelease {NPUSCH-TxDuration-NB-r17}
} OPTIONAL, -- Cond NTN
   npdsch-ConfigDedicated-v1700      NPDSCH-ConfigDedicated-NB-v1710 OPTIONAL,      -- Need ON
   uplinkPowerControlDedicated-v1700 UplinkPowerControlDedicated-NB-v1700 OPTIONAL --
Cond npusch-16QAM
]],
[[
[[ uplinkSegmentedPrecompensationGap-r17 ENUMERATED {sym1,s11,s12}      OPTIONAL      -- Need OR
]],
[[ npusch-ConfigDedicated-v1740      NPUSCH-ConfigDedicated-NB-v1700 OPTIONAL      -- Need ON
]],
[[ npdsch-ConfigDedicated-v1800      NPDSCH-ConfigDedicated-NB-v1800 OPTIONAL,      -- Need ON
   npusch-ConfigDedicated-v1800      NPUSCH-ConfigDedicated-NB-v1800 OPTIONAL      -- Need ON
]]
]]
}
-- ASN1STOP

```

#### **PhysicalConfigDedicated-NB field descriptions**

<b>additionalTxSIB1-Config</b> Indicates if subframe #3 not containing additional SIB1 transmission is a NB-IoT DL subframe, as specified in TS 36.213 [23], clause 16.4.
<b>carrierConfigDedicated</b> Anchor/ non-anchor carrier used for all unicast transmissions.
<b>interferenceRandomisationConfig</b> For FDD: Interference randomisation enabled in connected mode, except for random access procedure in connected mode, see TS 36.211 [21]. For random access in connected mode interference randomisation on non-anchor is used and is not used on anchor carrier, see TS 36.211 [21]. For TDD: the parameter is not present.
<b>npdcch-ConfigDedicated</b> NPDCCH configuration.
<b>npdsch-ConfigDedicated</b> NPDSCH configuration.
<b>npusch-ConfigDedicated</b> UL unicast configuration.
<b>resourceReservationConfigDL</b> Configuration of downlink reserved resources, e.g. for NB-IoT co-existence with NR, see TS 36.211 [21], TS 36.212 [22], and TS 36.213 [23].
<b>resourceReservationConfigUL</b> Configuration of uplink reserved resources, e.g. for NB-IoT co-existence with NR, see TS 36.211 [21], TS 36.212 [22], and TS 36.213 [23].
<b>twoHARQ-ProcessesConfig</b> Activation of two HARQ processes, see TS 36.212 [22] and TS 36.213 [23].
<b>uplinkPowerControlDedicated</b> UL power control parameter.
<b>uplinkSegmentedPrecompensationGap</b> Indicates the gap value between segments for NPUSCH for TA pre-compensation. Value <i>sym1</i> corresponds to 1 symbol, value <i>s/1</i> corresponds to 1 slot, value <i>s/2</i> corresponds to 2 slots.

Conditional presence	Explanation
<i>additionalSIB1</i>	This field is optionally present, Need OR, if <i>additionalTransmissionSIB1</i> is set to TRUE in <i>MasterInformationBlock-NB</i> ; otherwise it is not present.
<i>dl-NonAnchor</i>	The field is optionally present, Need ON, for a DL non-anchor carrier; otherwise the field is not present and the UE shall delete any existing value for this field.
<i>npusch-16QAM</i>	This field is mandatory present, if <i>npusch-16QAM-Config-r17</i> is true; otherwise the field is not present and the UE shall delete any existing value for this field.
<i>NTN</i>	The field is optionally present, Need ON, for NTN. Otherwise, the field is not present and the UE shall delete any existing value for this field.
<i>TDD</i>	The field is optionally present, Need OR, for TDD; otherwise the field is not present and the UE shall delete any existing value for this field.
<i>twoHARQ</i>	The field is optionally present, Need OR, if <i>twoHARQ-ProcessesConfig</i> is configured; otherwise the field is not present and the UE shall delete any existing value for this field.
<i>ul-NonAnchor</i>	The field is optionally present, Need ON, for an UL non-anchor carrier; otherwise the field is not present and the UE shall delete any existing value for this field.

## PUR-Config-NB

The IE *PUR-Config-NB* is used to specify PUR configuration.

### PUR-Config-NB information element

```
-- ASN1START
PUR-Config-NB-r16 ::= SEQUENCE {
    pur-ConfigID-r16 PUR-ConfigID-NB-r16 OPTIONAL, --Need OR
    pur-TimeAlignmentTimer-r16 INTEGER (1..8) OPTIONAL, --Need OR
    pur-NRSRP-ChangeThreshold-r16 SetupRelease {PUR-NRSRP-ChangeThreshold-NB-r16}
                                     OPTIONAL, --Need ON
    pur-ImplicitReleaseAfter-r16 ENUMERATED {n2, n4, n8, spare} OPTIONAL, --Need OR
    pur-RNTI-r16 C-RNTI OPTIONAL, --Need ON
    pur-ResponseWindowTimer-r16 ENUMERATED {pp1, pp2, pp3, pp4, pp8, pp16, pp32, pp64}
                                     OPTIONAL, --Need ON
    pur-StartTimeParameters-r16 SEQUENCE {
        periodicityAndOffset-r16 PUR-PeriodicityAndOffset-NB-r16,
        startSFN-r16 INTEGER (0..1023),
        startSubframe-r16 INTEGER (0..9),
        hsfN-LSB-Info-r16 BIT STRING (SIZE(1))
    }
    OPTIONAL, --Need ON
    pur-NumOccasions-r16 ENUMERATED {one, infinite},
    pur-PhysicalConfig-r16 SEQUENCE {
        carrierConfig-r16 CarrierConfigDedicated-NB-r13,
        npusch-NumRUsIndex-r16 INTEGER (0..7),
        npusch-NumRepetitionsIndex-r16 INTEGER (0..7),
        npusch-SubCarrierSetIndex-r16 CHOICE {
            khz15 INTEGER (0..18),
            khz3dot75 INTEGER (0..47)
        },
        npusch-MCS-r16 CHOICE {
            singleTone INTEGER (0..10),
            multiTone INTEGER (0..13)
        },
        p0-UE-NPUSCH-r16 INTEGER (-8..7),
        alpha-r16 ENUMERATED {a10, a104, a105, a106,
                               a107, a108, a109, a11},
        npusch-CyclicShift-r16 ENUMERATED {n0, n6},
        npdcch-Config-r16 NPDCCH-ConfigDedicated-NB-r13
    }
    OPTIONAL, -- Need ON
    ...
    [[
        pur-PhysicalConfig-v1650 SEQUENCE {
            ack-NACK-NumRepetitions-r16 ACK-NACK-NumRepetitions-NB-r13
        }
        OPTIONAL --Need ON
    ]],
    [[
        pur-PhysicalConfig-v1700 SEQUENCE {
            pur-UL-16QAM-Config-r17 SetupRelease {PUR-UL-16QAM-Config-NB-r17} OPTIONAL, -- Need
ON
            pur-DL-16QAM-Config-r17 SetupRelease {NPDSCH-16QAM-Config-NB-r17} OPTIONAL -- Need
ON
        }
        OPTIONAL -- Need ON
    ]]
}
```

```
}  
PUR-NRSRP-ChangeThreshold-NB-r16 ::= SEQUENCE {  
    increaseThresh-r16          NRSRP-ChangeThresh-NB-r16,  
    decreaseThresh-r16          NRSRP-ChangeThresh-NB-r16 OPTIONAL --Need OP  
}  
  
PUR-UL-16QAM-Config-NB-r17 ::= SEQUENCE {  
    uplinkPowerControlDedicated-r17 UplinkPowerControlDedicated-NB-v1700  
}  
  
NRSRP-ChangeThresh-NB-r16 ::= ENUMERATED {dB4, dB6, dB8, dB10, dB14, dB18, dB22, dB26, dB30, dB34,  
spare6, spare5, spare4, spare3, spare2, spare1}  
  
-- ASN1STOP
```

<b>PUR-Config-NB field descriptions</b>
<p><b>ack-NACK-NumRepetitions</b> Number of repetitions for the ACK NACK resource unit carrying HARQ response to NPDSCH, see TS 36.213 [23], clause 16.4.2. If this field is absent and no value was configured via <i>pur-Config</i>, the value of <i>ack-NACK-NumRepetitions</i> used for HARQ response to NPDSCH containing this <i>RRCCConnectionRelease-NB</i> message applies.</p>
<p><b>alpha</b> Parameter: <math>\alpha_c(3)</math>. See TS 36.213 [23], clause 16.2.1.1.1.</p>
<p><b>carrierConfig</b> Carrier used for PUR.</p>
<p><b>hsfn-LSB-Info</b> LSB of the H-SFN corresponding to the last subframe of the first transmission of <i>RRCCConnectionRelease</i> message containing <i>pur-Config</i>.</p>
<p><b>npdcch-Config</b> NPDCCH configuration for PUR.</p>
<p><b>npusch-CyclicShift</b> Parameter: <math>n_{cs}</math>. See TS 36.211 [21], clause 10.1.4.1.2. Value <i>n0</i> corresponds to value 0 and value <i>n6</i> corresponds to value 6.</p>
<p><b>npusch-MCS</b> Index to tables specified in TS 36.213 [23], Table 16.5.1.2-1 and Table 16.5.1.2-2 for single tone and multi tone respectively, that defines modulation and TBS index for NPUSCH for PUR. If 16QAM UL for PUR is configured, value <i>singleTone</i> is not applicable, signalled value of <i>multiTone</i> shall be less than or equal to 7, and actual value = signalled value + 14.</p>
<p><b>npusch-NumRepetitionsIndex</b> Index to a table specified in TS 36.213 [23], Table 16.5.1.1-3, that defines number of repetitions for NPUSCH for PUR.</p>
<p><b>npusch-NumRUsIndex</b> Index to a table specified in TS 36.213 [23], Table 16.5.1.1-2, that defines number of resource units for NPUSCH for PUR.</p>
<p><b>npusch-SubCarrierSetIndex</b> For NPUSCH transmission with subcarrier spacing 3.75 kHz, indicates the subcarrier used for PUR specified in TS 36.213 [23]. For NPUSCH transmission with subcarrier spacing 15 kHz, index to a table specified in TS 36.213 [23], Table 16.5.1.1-1, that defines the set of subcarriers for NPUSCH for PUR.</p>
<p><b>p0-UE-NPUSCH</b> Parameter: <math>P_{O\_UE\_NPUSCH,c}(3)</math>. See TS 36.213 [23], clause 16.2.1.1.1, unit dB.</p>
<p><b>pur-DL-16QAM-Config</b> Activation of 16QAM for downlink, see TS 36.213 [23].</p>
<p><b>pur-ImplicitReleaseAfter</b> Number of consecutive PUR occasions that can be skipped before implicit release of PUR configuration. Value <i>n2</i> corresponds to 2 PUR occasions, value <i>n4</i> corresponds to 4 PUR occasions, and so on.</p>
<p><b>pur-NRSRP-ChangeThreshold</b> Threshold(s) of change in serving cell NRSRP in dB for TA validation. Value <i>dB4</i> corresponds to 4 dB, value <i>dB6</i> corresponds to 6 dB, and so on. When <i>pur-NRSRP-ChangeThreshold</i> is set to <i>setup</i>, if <i>decreaseThresh</i> is absent the value of <i>increaseThresh</i> is also used for <i>decreaseThresh</i>.</p>
<p><b>pur-NumOccasions</b> Number of PUR occasions. Value <i>one</i> corresponds to 1 PUR occasion, and value <i>infinite</i> corresponds to an infinite number of PUR occasions.</p>
<p><b>pur-PeriodicityAndOffset</b> Indicates the periodicity for the PUR occasions and time offset until the first PUR occasion.</p>
<p><b>pur-ResponseWindowTimer</b> Duration of the PUR response window in TS 36.321 [6]. Value in PDCCH periods. Value <i>pp2</i> corresponds to 2 PDCCH periods, <i>pp3</i> corresponds to 3 PDCCH periods, and so on. The value considered by the UE is: <math>pur-ResponseWindowTimer = \text{Min}(\text{signaled value} \times \text{PDCCH period}, 10.24\text{s})</math>.</p>
<p><b>pur-TimeAlignmentTimer</b> Value of the time alignment timer for PUR. Value in number of periodicity of PUR.</p>
<p><b>pur-UL-16QAM-Config</b> Activation of 16QAM for uplink, see TS 36.213 [23].</p>

– **PUR-ConfigID-NB**

The IE *PUR-ConfigID-NB* is used to indicate the PUR configuration identity.

### **PUR-ConfigID-NB information element**

-- ASN1START

```
PUR-ConfigID-NB-r16 ::= BIT STRING (SIZE(20))
-- ASN1STOP
```

## – *PUR-PeriodicityAndOffset-NB*

The IE *PUR-PeriodicityAndOffset* is used to indicate H-SFN of the first PUR occasion and periodicity of the subsequent PUR occasions. The value of periodicity is in the unit of H-SFN duration (i.e., 10.24s). Value *periodicity8* corresponds to periodicity of 8 H-SFN, value *periodicity16* corresponds to periodicity of 16 H-SFN and so on. The value of offset is in the unit of H-SFN duration (i.e., 10.24s).

### *PUR-PeriodicityAndOffset-NB* information element

```
-- ASN1START
PUR-PeriodicityAndOffset-NB-r16 ::= CHOICE {
  periodicity8      INTEGER (1..7),
  periodicity16     INTEGER (1..15),
  periodicity32     INTEGER (1..31),
  periodicity64     INTEGER (1..63),
  periodicity128    INTEGER (1..127),
  periodicity256    INTEGER (1..257),
  periodicity512    INTEGER (1..511),
  periodicity1024   INTEGER (1..1023),
  periodicity2048   INTEGER (1..2047),
  periodicity4096   INTEGER (1..4095),
  periodicity8192   INTEGER (1..8191)
}
-- ASN1STOP
```

## – *RACH-ConfigCommon-NB*

The IE *RACH-ConfigCommon-NB* is used to specify the generic random access parameters.

### *RACH-ConfigCommon-NB* information element

```
-- ASN1START
RACH-ConfigCommon-NB-r13 ::= SEQUENCE {
  preambleTransMax-CE-r13      PreambleTransMax,
  powerRampingParameters-r13   PowerRampingParameters,
  rach-InfoList-r13            RACH-InfoList-NB-r13,
  connEstFailOffset-r13        INTEGER (0..15)                OPTIONAL, -- Need OP
  ...,
  [[ powerRampingParameters-v1450 PowerRampingParameters-NB-v1450 OPTIONAL -- Need OR
  ]],
  [[ rach-InfoList-v1530          RACH-InfoList-NB-v1530 OPTIONAL -- Cond EDT
  ]]
}
RACH-InfoList-NB-r13 ::= SEQUENCE (SIZE (1.. maxNPRACH-Resources-NB-r13)) OF RACH-Info-NB-r13
RACH-InfoList-NB-v1530 ::= SEQUENCE (SIZE (1.. maxNPRACH-Resources-NB-r13)) OF RACH-Info-NB-v1530
RACH-Info-NB-r13 ::= SEQUENCE {
  ra-ResponseWindowSize-r13    ENUMERATED {
    pp2, pp3, pp4, pp5, pp6, pp7, pp8, pp10},
  mac-ContentionResolutionTimer-r13 ENUMERATED {
    pp1, pp2, pp3, pp4, pp8, pp16, pp32, pp64}
}
RACH-Info-NB-v1530 ::= SEQUENCE {
  mac-ContentionResolutionTimer-r15 ENUMERATED {
    pp1, pp2, pp3, pp4, pp8, pp16, pp32, pp64}
}
PowerRampingParameters-NB-v1450 ::= SEQUENCE {
  preambleInitialReceivedTargetPower-v1450 ENUMERATED {
    dBm-130, dBm-128, dBm-126, dBm-124, dBm-122,
    dBm-88, dBm-86, dBm-84, dBm-82, dBm-80}
}
```



```

powerRampingParametersCE1-r14          OPTIONAL, -- Need OR
powerRampingStepCE1-r14                SEQUENCE {
preambleInitialReceivedTargetPowerCE1-r14  ENUMERATED {dB0, dB2, dB4, dB6},
                                           ENUMERATED {
dBrm-130, dBrm-128, dBrm-126, dBrm-124, dBrm-122,
dBrm-120, dBrm-118, dBrm-116, dBrm-114, dBrm-112,
dBrm-110, dBrm-108, dBrm-106, dBrm-104, dBrm-102,
dBrm-100, dBrm-98, dBrm-96, dBrm-94, dBrm-92,
dBrm-90, dBrm-88, dBrm-86, dBrm-84, dBrm-82, dBrm-80}
} OPTIONAL -- Need OR
}
-- ASN1STOP

```

<b>RACH-ConfigCommon-NB field descriptions</b>	
<b>connEstFailOffset</b>	Parameter "Qoffset <sub>temp</sub> " in TS 36.304 [4]. If the field is not present the value of infinity shall be used for "Qoffset <sub>temp</sub> ".
<b>mac-ContentionResolutionTimer</b>	Timer for contention resolution in TS 36.321 [6]. Value in PDCCH periods. Value pp1 corresponds to 1 PDCCH period, pp2 corresponds to 2 PDCCH periods and so on. <i>mac-ContentionResolutionTimer-r15</i> is only applicable for EDT. UE performing EDT shall use <i>mac-ContentionResolutionTimer-r15</i> , if present. For FDD: The value considered by the UE is: <i>mac-ContentionResolutionTimer</i> = Min (signaled value x PDCCH period, 10.24s). For TDD: The value considered by the UE is: <i>mac-ContentionResolutionTimer</i> = Min (signaled value x PDCCH period, 20.48s).
<b>powerRampingParameters, powerRampingParametersCE1</b>	Power ramping step and preamble initial received target power – same as TS 36.213 [23] and TS 36.321 [6]. For FDD, if the UE does not support enhanced random access power control and more than one repetition level is configured in the cell, then the UE transmits NPRACH with max power except for the lowest repetition level. Otherwise, the UE uses NPRACH power ramping. For FDD, if the UE supports enhanced random access power control and <i>powerRampingParameters-v1450</i> is signalled, or for TDD, the UE uses NPRACH power ramping across repetition levels as specified in TS 36.321 [6]. If <i>preambleInitialReceivedTargetPower-v1450</i> is present, the UE shall use <i>preambleInitialReceivedTargetPower-v1450</i> instead of <i>preambleInitialReceivedTargetPower</i> (i.e. without suffix). If <i>powerRampingParametersCE1</i> is present, the UE shall use <i>powerRampingParametersCE1</i> instead of <i>powerRampingParameters</i> for NPRACH power ramping in the second repetition level.
<b>preambleTransMax-CE</b>	Maximum number of preamble transmission in TS 36.321 [6]. Value is an integer.
<b>ra-ResponseWindowSize</b>	Duration of the RA response window in TS 36.321 [6]. Value in PDCCH periods. Value pp2 corresponds to 2 PDCCH periods, pp3 corresponds to 3 PDCCH periods and so on. For FDD: The value considered by the UE is: <i>ra-ResponseWindowSize</i> = Min (signaled value x PDCCH period, 10.24s). For TDD: The value considered by the UE is: <i>ra-ResponseWindowSize</i> = Min (signaled value x PDCCH period, 20.48s).

Conditional presence	Explanation
EDT	The field is optionally present, Need OR, if <i>edt-Parameters</i> is present; otherwise the field is not present and the UE shall delete any existing value for this field.

### RadioResourceConfigCommonSIB-NB

The IE *RadioResourceConfigCommonSIB-NB* is used to specify common radio resource configurations in the system information, e.g., the random access parameters and the static physical layer parameters.

#### RadioResourceConfigCommonSIB-NB information element

```

-- ASN1START
RadioResourceConfigCommonSIB-NB-r13 ::= SEQUENCE {
rach-ConfigCommon-r13          RACH-ConfigCommon-NB-r13,
bcch-Config-r13                 BCCH-Config-NB-r13,
pcch-Config-r13                 PCCH-Config-NB-r13,
nprach-Config-r13               NPRACH-ConfigSIB-NB-r13,
npdsch-ConfigCommon-r13         NPDSCH-ConfigCommon-NB-r13,
npusch-ConfigCommon-r13         NPUSCH-ConfigCommon-NB-r13,
dl-Gap-r13                       DL-GapConfig-NB-r13 OPTIONAL, -- Need OP
}
-- ASN1STOP

```

```

uplinkPowerControlCommon-r13      UplinkPowerControlCommon-NB-r13,
...
[[ nprach-Config-v1330             NPRACH-ConfigSIB-NB-v1330  OPTIONAL      -- Need OR
]],
[[ nprach-Config-v1450             NPRACH-ConfigSIB-NB-v1450  OPTIONAL      -- Cond
EnhPowerControl
]],
[[ nprach-Config-v1530             NPRACH-ConfigSIB-NB-v1530  OPTIONAL,     -- Need OR
   dl-Gap-v1530                    DL-GapConfig-NB-v1530     OPTIONAL,     -- Cond TDD
   wus-Config-r15                   WUS-Config-NB-r15         OPTIONAL      -- Need OR
]],
[[ nprach-Config-v1550             NPRACH-ConfigSIB-NB-v1550  OPTIONAL      -- Cond TDD1
]],
[[
   gwus-Config-r16                  GWUS-Config-NB-r16        OPTIONAL,     -- Need OR
   nrs-NonAnchorConfig-r16          ENUMERATED {true}         OPTIONAL,     -- Need OR
   ue-SpecificDRX-CycleMin-r16     ENUMERATED {rf32, rf64, rf128, rf256, rf512,
                                                             rf1024}         OPTIONAL      -- Need OR
]],
[[ ntn-ConfigCommon-r17            SEQUENCE {
   ta-Report-r17                    ENUMERATED {enabled}      OPTIONAL,     -- Need OR
   t318-r17                          ENUMERATED {
     ms0, ms200, ms500, ms1000, ms2000, ms4000, ms8000},
   nprach-TxDurationFmt01-r17       NPRACH-TxDurationFmt01-NB-r17  OPTIONAL,     -- Need OR
   nprach-TxDurationFmt2-r17       NPRACH-TxDurationFmt2-NB-r17  OPTIONAL,     -- Need OR
   npusch-TxDuration-r17           NPUSCH-TxDuration-NB-r17    OPTIONAL      -- Need OR
} OPTIONAL      -- Cond NTN
]]
}

BCCH-Config-NB-r13 ::=
  modificationPeriodCoeff-r13
}

PCCH-Config-NB-r13 ::=
  defaultPagingCycle-r13
  nB-r13
  npdcch-NumRepetitionPaging-r13
}

-- ASN1STOP

```

<b>RadioResourceConfigCommonSIB-NB field descriptions</b>
<p><b>defaultPagingCycle</b> Default paging cycle, used to derive 'T' in TS 36.304 [4]. Value <i>rf128</i> corresponds to 128 radio frames, <i>rf256</i> corresponds to 256 radio frames and so on.</p>
<p><b>dl-Gap</b> Downlink transmission gap configuration for the anchor carrier. See TS 36.211 [21], clause 10.2.3.4. If the field is absent, there is no gap.</p>
<p><b>gwus-Config</b> For FDD: GWUS Configuration.</p>
<p><b>modificationPeriodCoeff</b> Actual modification period, expressed in number of radio frames= <i>modificationPeriodCoeff</i> * <i>defaultPagingCycle</i>. <i>n16</i> corresponds to value 16, <i>n32</i> corresponds to value 32, and so on. The BCCH modification period should be larger or equal to 40.96s.</p>
<p><b>nB</b> Parameter: nB is used as one of parameters to derive the Paging Frame and Paging Occasion according to TS 36.304 [4]. Value in multiples of 'T' as defined in TS 36.304 [4]. A value of fourT corresponds to 4 * T, a value of twoT corresponds to 2 * T and so on.</p>
<p><b>npdcch-NumRepetitionPaging</b> Maximum number of repetitions for NPDCCH common search space (CSS) for paging, see TS 36.213 [23], clause 16.6.</p>
<p><b>nrs-NonAnchorConfig</b> For FDD: Indicates if NRS are present on non-anchor paging carriers even when no paging NPDCCH is transmitted, see TS 36.211 [21], clause 10.2.6.</p>
<p><b>t318</b> The value of timer T318. Value <i>ms0</i> corresponds with 0 ms, <i>ms50</i> corresponds with 50 ms and so on.</p>
<p><b>ta-Report</b> When this field is included in <i>SystemInformationBlockType2-NB</i>, it indicates reporting of timing advance is enabled during Random Access due to RRC connection establishment, RRC connection resume or RRC connection reestablishment, see TS 36.321 [6], clause 5.4.9.</p>
<p><b>ue-SpecificDRX-CycleMin</b> Minimum UE specific DRX cycle in the cell, see TS 36.304 [4], clause 7.1. Value <i>rf32</i> corresponds to 32 radio frames, <i>rf64</i> corresponds to 64 radio frames and so on. If present, E-UTRAN ensures PCCH configuration does not lead to CSS overlap for <i>ue-SpecificDRX-CycleMin</i>. If the field is not present, use of UE specific DRX cycle is not allowed in the cell.</p>
<p><b>wus-Config</b> For FDD: WUS Configuration.</p>

<b>Conditional presence</b>	<b>Explanation</b>
<i>EnhPowerControl</i>	This field is optional present, Need OR, if <i>PowerRampingParameters-NB-v1450</i> is included in SIB2-NB. Otherwise the field is not present.
<i>NTN</i>	The field is mandatory present for NTN. Otherwise, the field is not present.
<i>TDD</i>	The field is optionally present, Need OR, for TDD; otherwise the field is not present and the UE shall delete any existing value for this field.
<i>TDD1</i>	The field is mandatory present for TDD; otherwise the field is not present and the UE shall delete any existing value for this field.

### RadioResourceConfigDedicated-NB

The IE *RadioResourceConfigDedicated-NB* is used to setup/modify/release RBs, to modify the MAC main configuration, and to modify dedicated physical configuration.

#### RadioResourceConfigDedicated-NB information element

```
-- ASN1START
RadioResourceConfigDedicated-NB-r13 ::= SEQUENCE {
  srb-ToAddModList-r13          SRB-ToAddModList-NB-r13          OPTIONAL,  -- Need ON
  drb-ToAddModList-r13          DRB-ToAddModList-NB-r13          OPTIONAL,  -- Need ON
  drb-ToReleaseList-r13         DRB-ToReleaseList-NB-r13         OPTIONAL,  -- Need ON
  mac-MainConfig-r13           CHOICE {
    explicitValue-r13           MAC-MainConfig-NB-r13,
    defaultValue-r13           NULL
  }
  physicalConfigDedicated-r13   PhysicalConfigDedicated-NB-r13   OPTIONAL,  -- Need ON
  rlf-TimersAndConstants-r13    RLF-TimersAndConstants-NB-r13    OPTIONAL,  -- Need ON
  ...
-- ASN1END
```

```

[[ schedulingRequestConfig-r15          SchedulingRequestConfig-NB-r15  OPTIONAL  -- Need ON
]],
[[ newUE-Identity-r16                  C-RNTI                                OPTIONAL  -- Need OP
]],
[[ gnss-AutonomousEnabled-r18          ENUMERATED {true}                    OPTIONAL, -- Need OR
   ul-TransmissionExtensionEnabled-r18 ENUMERATED {true}                    OPTIONAL, -- Need OR
   ul-TransmissionExtensionValue-r18  ENUMERATED {sf500, sf750, sf1280, sf1920,
                                                    sf2560, sf5120, sf10240, spare1}
                                           OPTIONAL, -- Need OR
]]
}

SRB-ToAddModList-NB-r13 ::=          SEQUENCE (SIZE (1)) OF SRB-ToAddMod-NB-r13

SRB-ToAddMod-NB-r13 ::=              SEQUENCE {
  rlc-Config-r13                     CHOICE {
    explicitValue                     RLC-Config-NB-r13,
    defaultValue                       NULL
  } OPTIONAL,                        -- Cond Setup
  logicalChannelConfig-r13           CHOICE {
    explicitValue                     LogicalChannelConfig-NB-r13,
    defaultValue                       NULL
  } OPTIONAL,                        -- Cond Setup
  ...,
  [[ rlc-Config-v1430                 RLC-Config-NB-v1430                OPTIONAL  -- Need ON
  ]],
  [[ rlc-Config-v1700                 RLC-Config-NB-v1700                OPTIONAL  -- Need ON
  ]]
}

DRB-ToAddModList-NB-r13 ::=          SEQUENCE (SIZE (1..maxDRB-NB-r13)) OF DRB-ToAddMod-NB-r13

DRB-ToAddMod-NB-r13 ::=              SEQUENCE {
  eps-BearerIdentity-r13              INTEGER (0..15)                      OPTIONAL, -- Cond DRB-Setup-
EPC
  drb-Identity-r13                    DRB-Identity,
  pdcp-Config-r13                     PDCP-Config-NB-r13                  OPTIONAL, -- Cond Setup
  rlc-Config-r13                       RLC-Config-NB-r13                  OPTIONAL, -- Cond Setup
  logicalChannelIdentity-r13           INTEGER (3..10)                     OPTIONAL, -- Cond DRB-Setup
  logicalChannelConfig-r13             LogicalChannelConfig-NB-r13        OPTIONAL, -- Cond Setup
  ...,
  [[ rlc-Config-v1430                 RLC-Config-NB-v1430                OPTIONAL  -- Need ON
  ]],
  [[ pdu-Session-r16                  PDU-SessionID-NB-r16              OPTIONAL  -- Cond DRB-Setup-5GC
  ]],
  [[ rlc-Config-v1700                 RLC-Config-NB-v1700                OPTIONAL  -- Need ON
  ]]
}

PDU-SessionID-NB-r16 ::=             INTEGER (0..255)

DRB-ToReleaseList-NB-r13 ::=         SEQUENCE (SIZE (1..maxDRB-NB-r13)) OF DRB-Identity

-- ASN1STOP

```

<b>RadioResourceConfigDedicated-NB field descriptions</b>
<b>gnss-AutonomousEnabled</b> Presence of this field indicates that autonomous GNSS re-acquisition using an autonomous gap is enabled by network.
<b>logicalChannelConfig</b> For SRB a choice is used to indicate whether the logical channel configuration is signalled explicitly or set to the default logical channel configuration for SRB1 as specified in 9.2.1.1.
<b>logicalChannelIdentity</b> The logical channel identity for both UL and DL for a DRB. Value 3 is not used.
<b>mac-MainConfig</b> The default MAC MAIN configuration is specified in 9.2.2.
<b>newUE-Identity</b> C-RNTI used after moving to RRC_CONNECTED in response to transmission using PUR.
<b>pdu-Session</b> Identity of the PDU session whose QoS flow is mapped to the DRB.
<b>physicalConfigDedicated</b> The default dedicated physical configuration is specified in 9.2.4.
<b>rlc-Config</b> For SRBs a choice is used to indicate whether the RLC configuration is signalled explicitly or set to the values defined in the default RLC configuration for SRB1 in 9.2.1.1. RLC AM is the only applicable RLC mode for SRB1 and SRB1bis.
<b>schedulingRequestConfig</b> For FDD: Scheduling request configuration.
<b>ul-TransmissionExtensionEnabled</b> Presence of this field indicates that UL transmission extension after original GNSS validity duration expires is enabled by the network.
<b>ul-TransmissionExtensionValue</b> Indicates the duration after original GNSS validity duration expires within which UL transmission is allowed. Value in number of sub-frames, value <i>sf500</i> corresponds to 500 sub-frames, <i>sf750</i> corresponds to 750 sub-frames and so on.

<b>Conditional presence</b>	<b>Explanation</b>
<i>DRB-Setup</i>	The field is mandatory present if the corresponding DRB is being set up; otherwise it is not present.
<i>DRB-Setup-5GC</i>	The field is mandatory present if the corresponding DRB is being set up when connected to 5GC; otherwise it is not present.
<i>DRB-Setup-EPC</i>	The field is mandatory present if the corresponding DRB is being set up when connected to EPC; otherwise it is not present.
<i>Setup</i>	The field is mandatory present if the corresponding SRB/DRB is being setup; otherwise the field is optionally present, need ON.

## ResourceReservationConfig-NB

The IE *ResourceReservationConfig-NB* is used to specify the reserved downlink or uplink resources on a NB-IoT carrier, e.g. for deployment within a NR carrier.

### ResourceReservationConfig-NB information element

```

-- ASN1START
ResourceReservationConfig-NB-r16 ::= SEQUENCE {
    periodicity-r16          ENUMERATED {ms10, ms20, ms40, ms80, ms160, spare3, spare2, spare1},
    startPosition-r16       INTEGER (0..15),
    resourceReservation-r16 CHOICE {
        subframeBitmap-r16 CHOICE {
            subframePattern10ms BIT STRING (SIZE (10)),
            subframePattern40ms BIT STRING (SIZE (40))
        },
        slotConfig-r16      SEQUENCE {
            slotBitmap-r16  CHOICE {
                slotPattern10ms BIT STRING (SIZE (20)),
                slotPattern40ms BIT STRING (SIZE (80))
            },
            symbolBitmap-r16 CHOICE {
                symbolBitmapFddDl SEQUENCE {
                    symbolBitmap1-r16 BIT STRING (SIZE (5)) OPTIONAL, -- Cond Bitmap1
                    symbolBitmap2-r16 BIT STRING (SIZE (5)) OPTIONAL, -- Cond Bitmap2
                }
            }
        }
    },
}

```

```

symbolBitmapFddUlOrTdd SEQUENCE {
  symbolBitmap1-r16 BIT STRING (SIZE (7)) OPTIONAL, -- Cond Bitmap1
  symbolBitmap2-r16 BIT STRING (SIZE (7)) OPTIONAL, -- Cond Bitmap2
}
}
},
...
}
-- ASN1STOP

```

<b>ResourceReservationConfig field descriptions</b>
<p><b>periodicity</b> Periodicity of the reserved resource. Value <i>ms10</i> corresponds to 10 milliseconds, value <i>ms20</i> corresponds to 20 milliseconds, and so on.</p>
<p><b>slotPattern10ms, slotPattern40ms</b> For FDD: Downlink slot-level resource reservation configuration over 10ms or 40ms. Parameter slot-reserved-resource-config-DL in TS 36.211 [21] and TS 36.213 [23] The first/leftmost 2-bits corresponds to the subframe #0 of the radio frame satisfying <math>SFN \bmod x = startPosition</math>, where <math>x</math> is the periodicity of the reserved resource divided by 10. Two bits for each subframe coded as: 00: both slots are not reserved 01: the first slot is not reserved, the second slot is reserved 10: the first slot is reserved, the second slot is not reserved 11: both slots are reserved</p>
<p><b>startPosition</b> Start time of the resource reservation pattern in one period. Unit in multiple of 10 milliseconds. E-UTRAN configures the value of <i>startPosition</i> such as <math>startPosition * 10 &lt; periodicity</math>.</p>
<p><b>subframePattern10ms, subframePattern40ms</b> For FDD: Downlink subframe-level resource reservation configuration over 10ms or 40ms. Parameters valid-subframe-config-DL in TS 36.211 [21] and TS 36.213 [23]. The first/leftmost bit corresponds to the subframe #0 of the radio frame satisfying <math>SFN \bmod x = startPosition</math>, where <math>x</math> is the periodicity of the reserved resource divided by 10. Value 0 indicates that the corresponding subframe is not reserved, value 1 indicates that the corresponding subframe is reserved.</p>
<p><b>symbolBitmap</b> Symbol-level resource reservation for one subframe. E-UTRAN configures <i>symbolConfigFddDL</i> for a DL FDD NB-IoT carrier. E-UTRAN configures <i>symbolConfigFddULOrTdd</i> for an UL FDD NB-IoT carrier or a TDD NB-IoT carrier.</p>
<p><b>symbolBitmap1, symbolBitmap2</b> Symbol-level resource reservation over the first or the second slot of one subframe, see TS 36.211 [21]. The first/leftmost bit corresponds to the symbol #0 in the slot. Value 0 indicates that the corresponding symbol is not reserved, value 1 indicates that the corresponding symbol is reserved. If <i>symbolBitmap1</i> is absent, value '01' in the <i>slotBitmap</i> corresponds to the second slot being reserved. If <i>symbolBitmap2</i> is absent, value '10' in the <i>slotBitmap</i> corresponds to the first slot being reserved.</p>
<p><b>symbolBitmapFddDL</b> For FDD: Downlink symbol-level resource reservation over the first and the second slot of one subframe, see TS 36.211 [21]. Symbols that carry NRS are not reserved.</p>
<p><b>symbolBitmapFddUlOrTdd</b> For FDD: Uplink symbol-level resource reservation over the first and the second slot of one subframe, see TS 36.211 [21]. For TDD: Uplink or downlink symbol-level resource reservation over the first and the second slot of one subframe, see TS 36.211 [21]. Symbols that carry NRS are not reserved.</p>

Conditional presence	Explanation
<i>Bitmap1</i>	The field is optional present, need OR, if value of <i>slotBitmap</i> corresponding to at least one subframe is '01'; otherwise the field is not present.
<i>Bitmap2</i>	The field is optional present, need OR, if value of <i>slotBitmap</i> corresponding to at least one subframe is '10'; otherwise the field is not present.

– **RLC-Config-NB**

The IE *RLC-Config-NB* is used to specify the RLC configuration of SRBs and DRBs.

**RLC-Config-NB information element**

```

-- ASN1START
RLC-Config-NB-r13 ::= CHOICE {
  am          SEQUENCE {
    ul-AM-RLC-r13          UL-AM-RLC-NB-r13,
    dl-AM-RLC-r13          DL-AM-RLC-NB-r13
  },
  ...,
  um-Bi-Directional-r15    NULL,
  um-Uni-Directional-UL-r15 NULL,
  um-Uni-Directional-DL-r15 NULL
}

RLC-Config-NB-v1430 ::= SEQUENCE {
  t-Reordering-r14          T-Reordering          OPTIONAL          -- Cond twoHARQ
}

RLC-Config-NB-v1700 ::= SEQUENCE {
  t-ReorderingExt-r17          SetupRelease {T-ReorderingExt-r17}
}

UL-AM-RLC-NB-r13 ::= SEQUENCE {
  t-PollRetransmit-r13        T-PollRetransmit-NB-r13,
  maxRetxThreshold-r13        ENUMERATED {t1, t2, t3, t4, t6, t8, t16, t32}
}

DL-AM-RLC-NB-r13 ::= SEQUENCE {
  enableStatusReportSN-Gap-r13 ENUMERATED {true} OPTIONAL
}

T-PollRetransmit-NB-r13 ::= ENUMERATED {
  ms250, ms500, ms1000, ms2000, ms3000, ms4000,
  ms6000, ms10000, ms15000, ms25000, ms40000, ms60000,
  ms90000, ms120000, ms180000, ms300000-v1530}

-- ASN1STOP

```

**RLC-Config-NB field descriptions**

<b>enableStatusReportSN-Gap</b>	Indicates that status reporting due to detection of reception failure is enabled, as specified in TS 36.322 [7].
<b>maxRetxThreshold</b>	Parameter for RLC AM in TS 36.322 [7]. Value t1 corresponds to 1 retransmission, t2 to 2 retransmissions and so on.
<b>t-PollRetransmit</b>	Timer for RLC AM in TS 36.322 [7], in milliseconds. Value msX means X ms, msY means Y ms and so on. E-UTRAN may configure the value <i>msX-v1530</i> (with suffix) only in TDD mode.
<b>t-Reordering</b>	Timer for reordering in TS 36.322 [7], in milliseconds.
<b>t-ReorderingExt</b>	Timer for reordering in TS 36.322 [7], in milliseconds. The UE shall use the extended value <i>t-ReorderingExt-r17</i> , if present, and ignore the value signaled by <i>t-Reordering-r14</i> . E-UTRAN may configure <i>t-ReorderingExt</i> only if <i>twoHARQ-ProcessesConfig</i> is set to TRUE.

Conditional presence	Explanation
<i>twoHARQ</i>	The field is mandatory present if <i>twoHARQ-ProcessesConfig</i> is set to TRUE. Otherwise, the field is not present and, if previously configured, the timer is released.

**RLF-TimersAndConstants-NB**

The IE *RLF-TimersAndConstants-NB* contains UE specific timers and constants applicable for UEs in RRC\_CONNECTED.

**RLF-TimersAndConstants-NB information element**

```

-- ASN1START

```

```

RLF-TimersAndConstants-NB-r13 ::= CHOICE {
  release      NULL,
  setup       SEQUENCE {
    t301-r13   ENUMERATED {
      ms2500, ms4000, ms6000, ms10000,
      ms15000, ms25000, ms40000, ms60000},
    t310-r13   ENUMERATED {
      ms0, ms200, ms500, ms1000, ms2000, ms4000, ms8000},
    n310-r13   ENUMERATED {
      n1, n2, n3, n4, n6, n8, n10, n20},
    t311-r13   ENUMERATED {
      ms1000, ms3000, ms5000, ms10000, ms15000,
      ms20000, ms30000},
    n311-r13   ENUMERATED {
      n1, n2, n3, n4, n5, n6, n8, n10},
    . . .
    [[ t311-v1350
      ENUMERATED {
        ms40000, ms60000, ms90000, ms120000}
        OPTIONAL -- Need OR
    ]],
    [[ t301-v1530
      ENUMERATED {
        ms80000, ms100000, ms120000}
        OPTIONAL, -- Cond TDD
      t311-v1530
      ENUMERATED {
        ms160000, ms200000}
        OPTIONAL -- Cond TDD
    ]]
  }
}
-- ASN1STOP

```

#### **RLF-TimersAndConstants-NB field descriptions**

##### **n3xy**

Constants are described in clause 7.4. n1 corresponds with 1, n2 corresponds with 2 and so on.

##### **t3xy**

Timers are described in clause 7.3. Value ms0 corresponds with 0 ms, ms200 corresponds with 200 ms and so on. The UE shall use the extended values *t311-v1350*, *t301-v1530* and *t311-v1530*, if present, and ignore the value signaled by *t311-r13*, *t301-r13* and *t311-r13* respectively.

Conditional presence	Explanation
<i>TDD</i>	The field is optionally present, Need OR, in TDD mode. Otherwise, the field is not present.

### – SchedulingRequestConfig-NB

The IE *SchedulingRequestConfig-NB* is used to specify the Scheduling Request related parameters.

#### **SchedulingRequestConfig-NB information element**

```

-- ASN1START
SchedulingRequestConfig-NB-r15 ::= SEQUENCE {
  sr-WithHARQ-ACK-Config-r15   ENUMERATED {true} OPTIONAL,
  sr-WithoutHARQ-ACK-Config-r15 SR-WithoutHARQ-ACK-Config-NB-r15 OPTIONAL, -- Need
ON
  sr-SPS-BSR-Config-r15       SR-SPS-BSR-Config-NB-r15          OPTIONAL, -- Need ON
  . . .
  [[ sr-WithoutHARQ-ACK-Config-v1700 SR-WithoutHARQ-ACK-Config-NB-v1700 OPTIONAL -- Need ON
  ]]
}
SR-WithoutHARQ-ACK-Config-NB-r15 ::= CHOICE {
  release      NULL,
  setup       SEQUENCE {
    sr-ProhibitTimer-r15   INTEGER (0..7) OPTIONAL, -- Need ON
    sr-NPRACH-Resource-r15 SR-NPRACH-Resource-NB-r15 OPTIONAL -- Need ON
  }
}
-- ASN1STOP

```



```

SR-WithoutHARQ-ACK-Config-NB-v1700 ::= SEQUENCE {
    sr-ProhibitTimerOffset-r17          SetupRelease {SR-ProhibitTimerOffset-NB-r17}
                                        OPTIONAL -- Need ON
}

SR-NPRACH-Resource-NB-r15 ::= SEQUENCE {
    nprach-CarrierIndex-r15             INTEGER (0..maxNonAnchorCarriers-NB-r14),
    nprach-ResourceIndex-r15           INTEGER (1..maxNPRACH-Resources-NB-r13),
    nprach-SubCarrierIndex-r15         CHOICE {
        nprach-Fmt0Fmt1-r15            INTEGER (0..47),
        nprach-Fmt2-r15                INTEGER (0..143)
    },
    p0-SR-r15                           INTEGER (-126..24),
    alpha-r15                            ENUMERATED {a10, a104, a105, a106, a107, a108, a109, a11}}

SR-SPS-BSR-Config-NB-r15 ::= CHOICE {
    release                               NULL,
    setup                                 SEQUENCE {
        semiPersistSchedC-RNTI-r15     C-RNTI,
        semiPersistSchedIntervalUL-r15 ENUMERATED {sf128, sf256, sf512, sf1024,
                                                    sf1280, sf2048, sf2560, sf5120}
    }
}

SR-ProhibitTimerOffset-NB-r17 ::= ENUMERATED {
    ms90, ms180, ms270, ms360, ms450, ms540, ms1080, spare}

-- ASN1STOP

```

<b>SchedulingRequestConfig-NB field descriptions</b>
<p><b>alpha</b></p> <p>Parameter: <math>\alpha_c</math>. Fractional power control parameter for SR without HARQ-ACK. See TS 36.213 [23], clause 16.2.1.2.1, where value <i>a10</i> corresponds to 0, value <i>a104</i> corresponds to 0.4, value <i>a105</i> to 0.5, value <i>a106</i> to 0.6, value <i>a107</i> to 0.7, value <i>a108</i> to 0.8, value <i>a109</i> to 0.9 and value <i>a11</i> corresponds to 1.</p>
<p><b>nprach-CarrierIndex</b></p> <p>Index of the carrier in the list of UL non anchor carriers in <i>SystemInformationBlockType22-NB</i>. The first entry in the list has index '1', the second entry has index '2' and so on. Value '0' indicates the anchor carrier.</p>
<p><b>nprach-ResourceIndex</b></p> <p>Index of the NPRACH resource in the list of NPRACH resources in <i>NPRACH-ParametersList</i> or <i>NPRACH-ParametersList-Fmt2</i> for the UL carrier indicated by <i>nprach-CarrierIndex</i>. The first entry in the list has index '1', the second entry has index '2' and so on.</p> <p>E-UTRAN configures a NPRACH resource in <i>NPRACH-ParametersList-Fmt2</i> only to UEs that have reported support of NPRACH resource Format2.</p>
<p><b>nprach-SubCarrierIndex</b></p> <p>Index of the subcarrier in the NPRACH resource in <i>NPRACH-ParametersList</i> or or <i>NPRACH-ParametersList-Fmt2</i> for the indicated UL carrier.</p> <p>E-UTRAN does not configure <i>nprach-SubcarrierIndex</i> to a smaller value than <i>nprach-SubcarrierOffset</i> + <i>nprach-NumCBRA-StartSubcarriers</i> for the indicated NPRACH resource.</p>
<p><b>p0-SR</b></p> <p>Parameter: <math>P_{O\_SR,c}</math>. Target power for SR without HARQ-ACK. See TS 36.213 [23], clause 16.2.1.2.1, unit dBm.</p>
<p><b>semiPersistSchedC-RNTI</b></p> <p>Semi-persistent Scheduling C-RNTI, see TS 36.321 [6].</p>
<p><b>semiPersistSchedIntervalUL</b></p> <p>Semi-persistent scheduling interval in uplink, see TS 36.321 [6]. Value in number of sub-frames. Value <i>sf128</i> corresponds to 128 sub-frames, value <i>sf256</i> corresponds to 256 sub-frames and so on.</p>
<p><b>sr-NPRACH-Resource</b></p> <p>NPRACH resource for physical layer SR without HARQ-ACK, see TS 36.211 [21] and TS 36.213 [23].</p>
<p><b>sr-ProhibitTimer</b></p> <p>Timer for SR transmission on the NPRACH resource for SR in TS 36.321 [6]. Value in number of SR period, where the SR period is equal to the field <i>nprach-Periodicity</i> of the NPRACH resource. Value 0 means that behaviour as specified in 7.3.2 applies. Value 1 corresponds to one SR period, Value 2 corresponds to 2*SR period and so on. If <i>sr-ProhibitTimerOffset</i> is present, actual value of <i>sr-ProhibitTimer</i> = CEIL (<i>sr-ProhibitTimerOffset</i>/ SR period) + signalled value of <i>sr-ProhibitTimer</i>.</p>
<p><b>sr-ProhibitTimerOffset</b></p> <p>Time offset for SR transmission on the NPRACH resource for SR in TS 36.321 [6]. Value in milliseconds. Value <i>ms90</i> corresponds to 90 ms, value <i>ms180</i> corresponds to 180 ms and so on.</p>
<p><b>sr-WithHARQ-ACK-Config</b></p> <p>Activation of physical layer SR with HARQ ACK, see TS 36.213 [23].</p>
<p><b>sr-WithoutHARQ-ACK-Config</b></p> <p>Activation of physical layer SR without HARQ ACK, see TS 36.211 [21] and TS 36.213 [23].</p> <p>E-UTRAN cannot configure <i>sr-WithoutHARQ-ACK-Config</i> together with <i>sr-SPS-BSR-Config</i>.</p>

## – TDD-Config-NB

The IE *TDD-Config-NB* is used to specify the TDD specific physical channel configuration.

### TDD-Config information element

```

-- ASN1START
TDD-Config-NB-r15 ::=
    subframeAssignment-r15
    specialSubframePatterns-r15
}
SEQUENCE {
    ENUMERATED {
        sa1, sa2, sa3, sa4, sa5},
    ENUMERATED {
        ssp0, ssp1, ssp2, ssp3, ssp4, ssp5, ssp6, ssp7,
        ssp8, ssp9, ssp10, ssp10-CRS-LessDwPTS}
}
-- ASN1STOP

```

**TDD-Config field descriptions****specialSubframePatterns**

Indicates Configuration as in TS 36.211 [21], table 4.2-1 where ssp0 points to Configuration 0, ssp1 to Configuration 1 etc. Value *ssp10-CRS-LessDwPTS* corresponds to ssp10 without CRS transmission on the 5th symbol of DwPTS.

**subframeAssignment**

Indicates DL/UL subframe configuration where sa1 points to Configuration1, sa2 to Configuration 2 and so on, as specified in TS 36.211 [21], table 4.2-2.

E-UTRAN configures the same value for serving cells residing on same frequency band.

– **TDD-UL-DL-AlignmentOffset-NB**

The IE *TDD-UL-DL-AlignmentOffset-NB* is used to specify the offset between the UL carrier frequency center with respect to DL carrier frequency center. This information should be used to calculate the Mul value, see TS 36.101 [42].

**TDD-UL-DL-AlignmentOffset-NB information element**

```
-- ASN1START
TDD-UL-DL-AlignmentOffset-NB-r15 ::= ENUMERATED { khz-7dot5, khz0, khz7dot5}
-- ASN1STOP
```

– **UplinkPowerControl-NB**

The IE *UplinkPowerControlCommon-NB* and IE *UplinkPowerControlDedicated-NB* are used to specify parameters for uplink power control in the system information and in the dedicated signalling, respectively.

**UplinkPowerControl-NB information elements**

```
-- ASN1START

UplinkPowerControlCommon-NB-r13 ::= SEQUENCE {
    p0-NominalNPUSCH-r13          INTEGER (-126..24),
    alpha-r13                     ENUMERATED {a10, a104, a105, a106, a107, a108, a109, a11},
    deltaPreambleMsg3-r13        INTEGER (-1..6)
}

UplinkPowerControlDedicated-NB-r13 ::= SEQUENCE {
    p0-UE-NPUSCH-r13             INTEGER (-8..7)
}

UplinkPowerControlDedicated-NB-v1700 ::= SEQUENCE {
    deltaMCS-Enabled-r17         ENUMERATED {en0, en1}
}

-- ASN1STOP
```

<b>UplinkPowerControl-NB field descriptions</b>
<p><b>alpha</b> Parameter: <math>\alpha_c(1)</math>. See TS 36.213 [23], clause 16.2.1.1, where al0 corresponds to 0, al04 corresponds to value 0.4, al05 to 0.5, al06 to 0.6, al07 to 0.7, al08 to 0.8, al09 to 0.9 and al1 corresponds to 1.</p>
<p><b>deltaMCS-Enabled</b> Parameter: <math>K_S</math>. See TS 36.213 [23], clause 16.2.1.1.1. Value <i>en0</i> corresponds to value 0 corresponding to state "disabled" and value <i>en1</i> corresponds to value 1.25 corresponding to state "enabled".</p>
<p><b>deltaPreambleMsg3</b> Parameter: <math>\Delta_{\text{PREAMBLE\_Msg3}}</math>. See TS 36.213 [23], clause 16.2.1.1. Actual value = IE value * 2 [dB].</p>
<p><b>p0-NominalNPUSCH</b> Parameter: <math>P_{\text{O\_NOMINAL\_NPUSCH,c}}(1)</math>. See TS 36.213 [23], clause 16.2.1.1, unit dBm.</p>
<p><b>p0-UE-NPUSCH</b> Parameter: <math>P_{\text{O\_UE\_NPUSCH,c}}(1)</math>. See TS 36.213 [23], clause 16.2.1.1, unit dB.</p>

## – WUS-Config-NB

The IE *WUS-Config-NB* is used to specify the WUS configuration. For UEs supporting WUS, E-UTRAN uses WUS to indicate that the UE shall attempt to receive paging in that cell, see TS 36.304 [4].

### **WUS-Config-NB information element**

```
-- ASN1START
WUS-Config-NB-r15 ::= SEQUENCE {
    maxDurationFactor-r15          WUS-MaxDurationFactor-NB-r15,
    numPOs-r15                    ENUMERATED {n1, n2, n4}          DEFAULT n1,
    numDRX-CyclesRelaxed-r15      ENUMERATED {n1, n2, n4, n8},
    timeOffsetDRX-r15             ENUMERATED {ms40, ms80, ms160, ms240},
    timeOffset-eDRX-Short-r15     ENUMERATED {ms40, ms80, ms160, ms240},
    timeOffset-eDRX-Long-r15      ENUMERATED {ms1000, ms2000} OPTIONAL, -- Need OP
    ...
}

WUS-ConfigPerCarrier-NB-r15 ::= SEQUENCE {
    maxDurationFactor-r15          WUS-MaxDurationFactor-NB-r15
}

WUS-MaxDurationFactor-NB-r15 ::= ENUMERATED {one128th, one64th, one32th, one16th,
    oneEighth, oneQuarter, oneHalf}
-- ASN1STOP
```

<b>WUS-Config-NB field descriptions</b>
<p><b>maxDurationFactor</b> Maximum WUS duration, expressed as a ratio of Rmax for Type 1-CSS. Value <i>one128th</i> means <math>R_{max} * 1/128</math>, value <i>one64th</i> means <math>R_{max} * 1/64</math> and so on. The value <math>L_{NWUS\_max}</math> in TS 36.213 [23] considered by the UE is : <math>maxDuration = \text{Max}(\text{signalled value} * R_{max}, 1)</math> where Rmax is the value of <i>npdcch-NumRepetitionPaging</i> for the carrier.</p>
<p><b>numDRX-CyclesRelaxed</b> Maximum number of consecutive DRX cycles during which the UE may use WUS for synchronisation and skip serving cell measurements, see TS 36.133 [16]. Value n1 corresponds to 1 DRX cycle, value n2 corresponds to 2 DRX cycles and so on.</p>
<p><b>numPOs</b> Number of consecutive Paging Occasions (PO) mapped to one Wake Up Signal (WUS), applicable to UEs configured to use extended DRX, see TS 36.304 [4]. Value n1 corresponds to 1 PO and value n2 corresponds to 2 POs and so on.</p>
<p><b>timeOffsetDRX</b> When DRX is used, non-zero gap from the end of the configured maximum WUS duration to the associated PO, see TS 36.304 [4], clause 7.4 and TS 36.211 [21]. In milliseconds. Value <i>ms40</i> corresponds to 40ms, value <i>ms80</i> corresponds to 80 ms and so on.</p>
<p><b>timeOffset-eDRX-Short</b> When eDRX is used, the short non-zero gap from the end of the configured maximum WUS duration to the associated PO, see TS 36.304 [4], clause 7.4 and TS 36.211 [21]. In milliseconds. Value <i>ms40</i> corresponds to 40ms, value <i>ms80</i> corresponds to 80 ms and so on. E-UTRAN configures <i>timeOffset-eDRX-Short</i> to a value longer than or equal to <i>timeOffsetDRX</i>.</p>
<p><b>timeOffset-eDRX-Long</b> When eDRX is used, the long non-zero gap from the end of the configured maximum WUS duration to the associated PO, see TS 36.304 [4], clause 7.4 and TS 36.211 [21]. In milliseconds. Value <i>ms1000</i> corresponds to 1000 ms, value <i>ms2000</i> corresponds to 2000 ms.</p>

### 6.7.3.3 NB-IoT Security control information elements

Void

### 6.7.3.4 NB-IoT Mobility control information elements

#### – *AdditionalBandInfoList-NB*

##### ***AdditionalBandInfoList-NB information element***

```
-- ASN1START
AdditionalBandInfoList-NB-r14 ::= SEQUENCE (SIZE (1..maxMultiBands)) OF FreqBandIndicator-NB-r13
-- ASN1STOP
```

#### – *FreqBandIndicator-NB*

The IE *FreqBandIndicator-NB* indicates the E-UTRA operating band as defined in TS 36.101 [42], table 5.5-1 and TS 36.102 [113], table 5.2-1 for NTN capable UE.

##### ***FreqBandIndicator-NB information element***

```
-- ASN1START
FreqBandIndicator-NB-r13 ::= INTEGER (1.. maxFBI2)
-- ASN1STOP
```

#### – *MultiBandInfoList-NB*

##### ***MultiBandInfoList-NB information element***

```
-- ASN1START
```

```

MultiBandInfoList-NB-r13 ::= SEQUENCE (SIZE (1..maxMultiBands)) OF MultiBandInfo-NB-r13
MultiBandInfo-NB-r13 ::= SEQUENCE {
    freqBandIndicator-r13      FreqBandIndicator-NB-r13      OPTIONAL,  -- Need OR
    freqBandInfo-r13          NS-PmaxList-NB-r13            OPTIONAL,  -- Need OR
}
-- ASN1STOP

```

### – *NS-PmaxList-NB*

The IE *NS-PmaxList-NB* concerns a list of *additionalPmax* and *additionalSpectrumEmission* as defined in TS 36.101 [42], clause 6.2.4F and TS 36.102 [113], clause 6.2B.3 for NTN capable UE, for a given frequency band. E-UTRAN does not include the same value of *additionalSpectrumEmission* in *SystemInformationBlockType2-NB* within this list.

#### **NS-PmaxList-NB information element**

```

-- ASN1START
NS-PmaxList-NB-r13 ::= SEQUENCE (SIZE (1..maxNS-Pmax-NB-r13)) OF NS-PmaxValue-NB-r13
NS-PmaxValue-NB-r13 ::= SEQUENCE {
    additionalPmax-r13          P-Max                      OPTIONAL,  -- Need OR
    additionalSpectrumEmission-r13 AdditionalSpectrumEmission
}
-- ASN1STOP

```

### – *ReselectionThreshold-NB*

The IE *ReselectionThreshold-NB* is used to indicate an Rx level threshold for cell reselection. Actual value of threshold = field value \* 2 [dB].

#### **ReselectionThreshold-NB information element**

```

-- ASN1START
ReselectionThreshold-NB-v1360 ::= INTEGER (32..63)
-- ASN1STOP

```

### – *T-Reselection-NB*

The IE *T-Reselection-NB* concerns the cell reselection timer  $T_{\text{reselction}}_{\text{RAT}}$  for NB-IoT.

Value in seconds. s0 means 0 second and behaviour as specified in 7.3.2 applies, s3 means 3 seconds and so on.

#### **T-Reselection-NB information element**

```

-- ASN1START
T-Reselection-NB-r13 ::= ENUMERATED {s0, s3, s6, s9, s12, s15, s18, s21}
-- ASN1STOP

```

## 6.7.3.5 NB-IoT Measurement information elements

### – *ANR-MeasConfig-NB*

The IE *ANR-MeasConfig-NB* is used to convey the configuration of the measurements to be performed by the UE in RRC\_IDLE for ANR.

**ANR-MeasConfig-NB information element**

```

-- ASN1START
ANR-MeasConfig-NB-r16 ::= SEQUENCE {
    anr-QualityThreshold-r16      NRSRP-Range-NB-r14,
    anr-CarrierList-r16          ANR-CarrierList-NB-r16,
    ...
}

ANR-CarrierList-NB-r16 ::= SEQUENCE (SIZE (1..maxFreqANR-NB-r16)) OF ANR-Carrier-NB-r16

ANR-Carrier-NB-r16 ::= SEQUENCE {
    carrierFreqIndex-r16        INTEGER (1..maxFreq),
    excludedCellList-r16        ANR-ExcludedCellList-NB-r16 OPTIONAL,      -- Need OP
    ...
}

ANR-ExcludedCellList-NB-r16 ::= SEQUENCE (SIZE (1..maxExcludedCell)) OF PhysCellId

-- ASN1STOP

```

**ANR-MeasConfig-NB field descriptions****anr-CarrierList**

List of NB-IoT carriers to be measured for ANR.

**anr-QualityThreshold**

Indicates the quality threshold for reporting the CGI of the strongest cell.

**carrierFreqIndex**

Index of the carrier frequency in *interFreqCarrierFreqList* in *SystemInformationBlockType5-NB*.

**excludedCellList**

List of exclude-listed neighbouring cells for ANR reporting.

**ANR-MeasReport-NB**

The IE *ANR-MeasReport-NB* includes the ANR measurements information.

**ANR-MeasReport-NB information element**

```

-- ASN1START
ANR-MeasReport-NB-r16 ::= SEQUENCE {
    servCellIdentity-r16        CellGlobalIdEUTRA          OPTIONAL,
    measResultServCell-r16      MeasResultServCell-NB-r14,
    relativeTimeStamp-r16       INTEGER (0..95),
    measResultList-r16          SEQUENCE (SIZE (1..maxFreqANR-NB-r16)) OF ANR-MeasResult-NB-
r16,
    ...
}

ANR-MeasResult-NB-r16 ::= SEQUENCE {
    carrierFreq-r16             CarrierFreq-NB-r13,
    physCellId-r16              PhysCellId                OPTIONAL,
    measResultLastServCell-r16  MeasResultServCell-NB-r14,
    measResult-r16              NRSRP-Range-NB-r14          OPTIONAL,
    cgi-Info-r16                SEQUENCE {
        cellGlobalId-r16        CellGlobalIdEUTRA,
        trackingAreaCode-r16    TrackingAreaCode,
        plmn-IdentityList-r16   PLMN-IdentityList2        OPTIONAL
    } OPTIONAL
}

-- ASN1STOP

```

<b>ANR-MeasReport-NB field descriptions</b>	
<b>carrierFreq</b>	Indicates the carrier frequency of the reported cell.
<b>cgi-info</b>	Broadcast information of the reported cell.
<b>measResult</b>	Measured result of the reported cell.
<b>measResultList</b>	List of measured results for the maximum number of reported carrier frequencies.
<b>measResultLastServCell</b>	The last measurement results taken in the serving cell when the measured results of the reported cell is stored.
<b>measResultServingCell</b>	Measurement results taken in the serving cell when the configuration of the measurements is received.
<b>plmn-IdentityList</b>	The list of PLMN Identity read from the broadcast information of the reported cell.
<b>relativeTimeStamp</b>	Indicates the time when the ANR measurements are complete, measured relative to the time when the configuration of the measurements was received. Value in hours.
<b>servingCellIdentity</b>	Indicates the cell where the measurement configuration was received. If the field is absent, it is the same as the current serving cell.

### – CQI-NPDCCH-NB

The IE *CQI-NPDCCH-NB* represents the downlink channel quality measurement of the NB-IoT carrier where the random access response is received. The codepoints for the CQI-NPDCCH measurements are according to the mapping table in TS 36.133 [16]. The value *noMeasurements* indicates no measurement reporting.

#### CQI-NPDCCH-NB information element

```
-- ASN1START
CQI-NPDCCH-NB-r14 ::= ENUMERATED {
    noMeasurements, candidateRep-A, candidateRep-B, candidateRep-C,
    candidateRep-D, candidateRep-E, candidateRep-F, candidateRep-G,
    candidateRep-H, candidateRep-I, candidateRep-J, candidateRep-K,
    candidateRep-L}
-- ASN1STOP
```

### – CQI-NPDCCH-Short-NB

The IE *CQI-NPDCCH-Short-NB* represents the short version of the downlink channel quality measurement of the NB-IoT carrier where the random access response is received. The codepoints for the CQI-NPDCCH-Short measurements are according to the mapping table in TS 36.133 [16]. The value *noMeasurements* indicates no measurement reporting.

#### CQI-NPDCCH-Short-NB information element

```
-- ASN1START
CQI-NPDCCH-Short-NB-r14 ::= ENUMERATED {
    noMeasurements, candidateRep-1, candidateRep-2, candidateRep-3}
-- ASN1STOP
```

### – MeasResultServCell-NB

The IE *MeasResultServCell-NB* covers the measured results for the serving cell.

#### MeasResultServCell-NB information element

```
-- ASN1START
MeasResultServCell-NB-r14 ::= SEQUENCE {
```



```

nrsrpResult-r14          NRSRP-Range-NB-r14 ,
nrsrqResult-r14         NRSRQ-Range-NB-r14
}
-- ASN1STOP

```

### – *NRSRP-Range-NB*

The IE *NRSRP-Range-NB* specifies the value range used in NRSRP measurements and thresholds. Integer value for NRSRP measurements according to mapping table in TS 36.133 [16], Table 9.1.22.9-1.

#### ***NRSRP-Range-NB* information element**

```

-- ASN1START
NRSRP-Range-NB-r14 ::=          INTEGER(0..113)
-- ASN1STOP

```

### – *NRSRQ-Range-NB*

The IE *NRSRQ-Range-NB* specifies the value range used in NRSRQ measurements and thresholds. Integer value for RSRQ measurements is according to mapping table in TS 36.133 [16], Table 9.1.22.14-1. The UE shall not report values 0 and 34.

#### ***NRSRQ-Range-NB* information element**

```

-- ASN1START
NRSRQ-Range-NB-r14 ::=          INTEGER(-30..46)
-- ASN1STOP

```

### – *NSSS-RRM-Config-NB*

The IE *NSSS-RRM-Config-NB* provides the configuration for NSSS-based RRM measurements. See TS 36.133 [16], TS 36.211 [21] and TS 36.214 [48]. The UE only performs NSSS-based RRM measurement on cells for which the configuration has been provided.

#### ***NSSS-RRM-Config-NB* information element**

```

-- ASN1START
NSSS-RRM-Config-NB-r15 ::=          SEQUENCE {
    nsss-RRM-PowerOffset-r15          ENUMERATED {dB-3, dB0, dB3},
    nsss-NumOccDiffPrecoders-r15     ENUMERATED {n1, n2, n4, n8} OPTIONAL  -- Need OP
}
-- ASN1STOP

```

#### ***NSSS-RRM-Config-NB* field descriptions**

##### ***nsss-RRM-PowerOffset***

NSSS to NRS ratio for the serving cell as specified in TS 36.214 [48]. Value in dB. Value dB-3 corresponds to -3 dB, dB0 corresponds to 0 dB and so on.

##### ***nsss-NumOccDiffPrecoders***

Number of consecutive NSSS occasions that use different precoders for NSSS transmission. See TS 36.211 [21]. Value *n1* corresponds to 1 occasion, *n2* corresponds to 2 occasions and so on.

For value *n2*, *n4*, and *n8*, UE may assume for *nsss-NumOccDiffPrecoders* consecutive NSSS occasions, E-UTRAN uses different precoders for NSSS transmission. For value *n1*, UE may assume that E-UTRAN always uses the same precoder.

If the field is absent, the UE makes no assumption on the antenna port(s) used for NSSS.

### 6.7.3.6 NB-IoT Other information elements

#### – *EstablishmentCause-NB*

The IE *EstablishmentCause-NB* provides the establishment cause for the RRC connection request or the RRC connection resume request as provided by the upper layers.

#### ***EstablishmentCause-NB* information element**

```
-- ASN1START
EstablishmentCause-NB-r13 ::=          ENUMERATED {
                                        mt-Access, mo-Signalling, mo-Data, mo-ExceptionData,
                                        delayTolerantAccess-v1330, mt-EDT-v1610, spare2, spare1}
-- ASN1STOP
```

#### – *UE-Capability-NB*

The IE *UE-Capability-NB* is used to convey the NB-IoT UE Radio Access Capability Parameters, see TS 36.306 [5]. The IE *UE-Capability-NB* is transferred in NB-IoT only.

#### ***UE-Capability-NB* information element**

```
-- ASN1START
UE-Capability-NB-r13 ::=          SEQUENCE {
  accessStratumRelease-r13        AccessStratumRelease-NB-r13,
  ue-Category-NB-r13              ENUMERATED {nb1}                OPTIONAL,
  multipleDRB-r13                 ENUMERATED {supported}          OPTIONAL,
  pdcp-Parameters-r13             PDCP-Parameters-NB-r13          OPTIONAL,
  phyLayerParameters-r13          PhyLayerParameters-NB-r13,
  rf-Parameters-r13              RF-Parameters-NB-r13,
  dummy                           SEQUENCE {}                OPTIONAL
}

UE-Capability-NB-Ext-r14-IEs ::= SEQUENCE {
  ue-Category-NB-r14              ENUMERATED {nb2}                OPTIONAL,
  mac-Parameters-r14              MAC-Parameters-NB-r14          OPTIONAL,
  phyLayerParameters-v1430        PhyLayerParameters-NB-v1430    OPTIONAL,
  rf-Parameters-v1430             RF-Parameters-NB-v1430,
  nonCriticalExtension            UE-Capability-NB-v1440-IEs    OPTIONAL
}

UE-Capability-NB-v1440-IEs ::= SEQUENCE {
  phyLayerParameters-v1440        PhyLayerParameters-NB-v1440    OPTIONAL,
  nonCriticalExtension            UE-Capability-NB-v14x0-IEs    OPTIONAL
}

UE-Capability-NB-v14x0-IEs ::= SEQUENCE {
-- Following field is only to be used for late REL-14 extensions
  lateNonCriticalExtension        OCTET STRING                    OPTIONAL,
  nonCriticalExtension            UE-Capability-NB-v1530-IEs    OPTIONAL
}

UE-Capability-NB-v1530-IEs ::= SEQUENCE {
  earlyData-UP-r15                ENUMERATED {supported}          OPTIONAL,
  rlc-Parameters-r15              RLC-Parameters-NB-r15,
  mac-Parameters-v1530            MAC-Parameters-NB-v1530,
  phyLayerParameters-v1530        PhyLayerParameters-NB-v1530    OPTIONAL,
  tdd-UE-Capability-r15           TDD-UE-Capability-NB-r15      OPTIONAL,
  nonCriticalExtension            UE-Capability-NB-v15x0-IEs    OPTIONAL
}

UE-Capability-NB-v15x0-IEs ::= SEQUENCE {
-- Following field is only to be used for late REL-15 extensions
  lateNonCriticalExtension        OCTET STRING                    OPTIONAL,
  nonCriticalExtension            UE-Capability-NB-v1610-IEs    OPTIONAL
}

UE-Capability-NB-v1610-IEs ::= SEQUENCE {
  earlySecurityReactivation-r16   ENUMERATED {supported}          OPTIONAL,
```

```

earlyData-UP-5GC-r16          ENUMERATED {supported}          OPTIONAL,
pur-Parameters-r16            PUR-Parameters-NB-r16            OPTIONAL,
mac-Parameters-v1610         MAC-Parameters-NB-v1610,
phyLayerParameters-v1610     PhyLayerParameters-NB-v1610     OPTIONAL,
son-Parameters-r16           SON-Parameters-NB-r16           OPTIONAL,
measParameters-r16           MeasParameters-NB-r16,
tdd-UE-Capability-v1610     TDD-UE-Capability-NB-v1610     OPTIONAL,
nonCriticalExtension         UE-Capability-NB-v16x0-IEs     OPTIONAL
}

UE-Capability-NB-v16x0-IEs ::= SEQUENCE {
-- Following field is only to be used for late REL-16 extensions
  lateNonCriticalExtension    OCTET STRING (CONTAINING UE-EUTRA-Capability-v16f0-IEs)
    OPTIONAL,
  nonCriticalExtension        UE-Capability-NB-v1700-IEs     OPTIONAL
}

-- Late non-critical extensions
UE-EUTRA-Capability-v16f0-IEs ::= SEQUENCE {
  son-Parameters-v16f0       SON-Parameters-NB-v16f0,
  nonCriticalExtension        SEQUENCE {}                    OPTIONAL
}

-- Regular non-critical extensions
UE-Capability-NB-v1700-IEs ::= SEQUENCE {
  coverageBasedPaging-r17    ENUMERATED {supported}          OPTIONAL,
  phyLayerParameters-v1700   PhyLayerParameters-NB-v1700,
  ntn-Parameters-r17         NTN-Parameters-NB-r17           OPTIONAL,
  nonCriticalExtension        UE-Capability-NB-v1710-IEs     OPTIONAL
}

UE-Capability-NB-v1710-IEs ::= SEQUENCE {
  measParameters-v1710       MeasParameters-NB-v1710        OPTIONAL,
  rf-Parameters-v1710        RF-Parameters-NB-v1710,
  tdd-UE-Capability-v1710    TDD-UE-Capability-NB-v1710,
  nonCriticalExtension        UE-Capability-NB-v1720-IEs     OPTIONAL
}

UE-Capability-NB-v1720-IEs ::= SEQUENCE {
  ntn-Parameters-v1720       NTN-Parameters-NB-v1720,
  nonCriticalExtension        UE-Capability-NB-v1800-IEs     OPTIONAL
}

UE-Capability-NB-v1800-IEs ::= SEQUENCE {
  ntn-Parameters-v1800       NTN-Parameters-NB-v1800        OPTIONAL,
  nonCriticalExtension        SEQUENCE {}                    OPTIONAL
}

TDD-UE-Capability-NB-r15 ::= SEQUENCE {
  ue-Category-NB-r15         ENUMERATED {nb2}                OPTIONAL,
  phyLayerParametersRel13-r15 PhyLayerParameters-NB-r13      OPTIONAL,
  phyLayerParametersRel14-r15 PhyLayerParameters-NB-v1430    OPTIONAL,
  phyLayerParameters-v1530   PhyLayerParameters-NB-v1530    OPTIONAL,
  ...
}

TDD-UE-Capability-NB-v1610 ::= SEQUENCE {
  slotSymbolResourceResvDL-r16  ENUMERATED {supported}          OPTIONAL,
  slotSymbolResourceResvUL-r16  ENUMERATED {supported}          OPTIONAL,
  subframeResourceResvDL-r16    ENUMERATED {supported}          OPTIONAL,
  subframeResourceResvUL-r16    ENUMERATED {supported}          OPTIONAL
}

TDD-UE-Capability-NB-v1710 ::= SEQUENCE {
  phyLayerParameters-v1710      PhyLayerParameters-NB-v1700     OPTIONAL
}

AccessStratumRelease-NB-r13 ::= ENUMERATED {rel13, rel14, rel15, rel16, rel17, rel18, spare2,
spare1, ...}

PDCP-Parameters-NB-r13 ::= SEQUENCE {
  supportedROHC-Profiles-r13    SEQUENCE {
    profile0x0002              BOOLEAN,
    profile0x0003              BOOLEAN,
    profile0x0004              BOOLEAN,
    profile0x0006              BOOLEAN,
    profile0x0102              BOOLEAN,
    profile0x0103              BOOLEAN,

```

```

        profile0x0104                BOOLEAN
    },
    maxNumberROHC-ContextSessions-r13  ENUMERATED {cs2, cs4, cs8, cs12}    DEFAULT cs2,
    ...
}

RLC-Parameters-NB-r15 ::= SEQUENCE {
    rlc-UM-r15                ENUMERATED {supported}                    OPTIONAL
}

MAC-Parameters-NB-r14 ::= SEQUENCE {
    dataInactMon-r14          ENUMERATED {supported}                    OPTIONAL,
    rai-Support-r14           ENUMERATED {supported}                    OPTIONAL
}

MAC-Parameters-NB-v1530 ::= SEQUENCE {
    sr-SPS-BSR-r15           ENUMERATED {supported}                    OPTIONAL
}

MAC-Parameters-NB-v1610 ::= SEQUENCE {
    rai-SupportEnh-r16       ENUMERATED {supported}                    OPTIONAL
}

NTN-Parameters-NB-r17 ::= SEQUENCE {
    ntn-Connectivity-EPC-r17  ENUMERATED {supported}                    OPTIONAL,
    ntn-TA-Report-r17         ENUMERATED {supported}                    OPTIONAL,
    ntn-PUR-TimerDelay-r17    ENUMERATED {supported}                    OPTIONAL,
    ntn-OffsetTimingEnh-r17   ENUMERATED {supported}                    OPTIONAL,
    ntn-ScenarioSupport-r17   ENUMERATED {ngso,gso}                    OPTIONAL
}

NTN-Parameters-NB-v1720 ::= SEQUENCE {
    ntn-SegmentedPrecompensationGaps-r17  ENUMERATED {sym1,s11,s12}    OPTIONAL
}

NTN-Parameters-NB-v1800 ::= SEQUENCE {
    ntn-LocationBasedMeasTrigger-EFC-r18  ENUMERATED {supported}        OPTIONAL,
    ntn-LocationBasedMeasTrigger-EMC-r18  ENUMERATED {supported}        OPTIONAL,
    ntn-TimeBasedMeasTrigger-r18         ENUMERATED {supported}        OPTIONAL,
    ntn-RRC-HarqDisableSingleTB-r18      ENUMERATED {supported}        OPTIONAL,
    ntn-OverriddenHarqDisableSingleTB-r18 ENUMERATED {supported}        OPTIONAL,
    ntn-DCI-HarqDisableSingleTB-r18     ENUMERATED {supported}        OPTIONAL,
    ntn-RRC-HarqDisableMultiTB-r18      ENUMERATED {supported}        OPTIONAL,
    ntn-OverriddenHarqDisableMultiTB-r18 ENUMERATED {supported}        OPTIONAL,
    ntn-DCI-HarqDisableMultiTB-r18     ENUMERATED {supported}        OPTIONAL,
    ntn-UplinkHarq-ModeB-SingleTB-r18   ENUMERATED {supported}        OPTIONAL,
    ntn-UplinkHarq-ModeB-MultiTB-r18    ENUMERATED {supported}        OPTIONAL,
    ntn-HarqEnhScenarioSupport-r18      ENUMERATED {ngso,gso}        OPTIONAL,
    ntn-Triggered-GNSS-Fix-r18          ENUMERATED {supported}        OPTIONAL,
    ntn-Autonomous-GNSS-Fix-r18         ENUMERATED {supported}        OPTIONAL,
    ntn-UplinkTxExtension-r18           ENUMERATED {supported}        OPTIONAL,
    ntn-GNSS-EnhScenarioSupport-r18     ENUMERATED {ngso,gso}        OPTIONAL
}

MeasParameters-NB-r16 ::= SEQUENCE {
    dl-ChannelQualityReporting-r16       ENUMERATED {supported}        OPTIONAL
}

MeasParameters-NB-v1710 ::= SEQUENCE {
    connModeMeasIntraFreq-r17           ENUMERATED {supported}        OPTIONAL,
    connModeMeasInterFreq-r17          ENUMERATED {supported}        OPTIONAL
}

PhyLayerParameters-NB-r13 ::= SEQUENCE {
    multiTone-r13                       ENUMERATED {supported}        OPTIONAL,
    multiCarrier-r13                    ENUMERATED {supported}        OPTIONAL
}

PhyLayerParameters-NB-v1430 ::= SEQUENCE {
    multiCarrier-NPRACH-r14             ENUMERATED {supported}        OPTIONAL,
    twoHARQ-Processes-r14              ENUMERATED {supported}        OPTIONAL
}

PhyLayerParameters-NB-v1440 ::= SEQUENCE {
    interferenceRandomisation-r14      ENUMERATED {supported}        OPTIONAL
}

PhyLayerParameters-NB-v1530 ::= SEQUENCE {

```

```

mixedOperationMode-r15          ENUMERATED {supported}          OPTIONAL,
sr-WithHARQ-ACK-r15            ENUMERATED {supported}          OPTIONAL,
sr-WithoutHARQ-ACK-r15        ENUMERATED {supported}          OPTIONAL,
nprach-Format2-r15            ENUMERATED {supported}          OPTIONAL,
additionalTransmissionSIB1-r15 ENUMERATED {supported}          OPTIONAL,
npusch-3dot75kHz-SCS-TDD-r15  ENUMERATED {supported}          OPTIONAL
}

PhyLayerParameters-NB-v1610 ::= SEQUENCE {
  npdsch-MultiTB-r16           ENUMERATED {supported}          OPTIONAL,
  npdsch-MultiTB-Interleaving-r16 ENUMERATED {supported}          OPTIONAL,
  npusch-MultiTB-r16           ENUMERATED {supported}          OPTIONAL,
  npusch-MultiTB-Interleaving-r16 ENUMERATED {supported}          OPTIONAL,
  multiTB-HARQ-AckBundling-r16  ENUMERATED {supported}          OPTIONAL,
  slotSymbolResourceResvDL-r16  ENUMERATED {supported}          OPTIONAL,
  slotSymbolResourceResvUL-r16  ENUMERATED {supported}          OPTIONAL,
  subframeResourceResvDL-r16    ENUMERATED {supported}          OPTIONAL,
  subframeResourceResvUL-r16    ENUMERATED {supported}          OPTIONAL
}

PUR-Parameters-NB-r16 ::= SEQUENCE {
  pur-CP-EPC-r16               ENUMERATED {supported}          OPTIONAL,
  pur-CP-5GC-r16               ENUMERATED {supported}          OPTIONAL,
  pur-UP-EPC-r16               ENUMERATED {supported}          OPTIONAL,
  pur-UP-5GC-r16               ENUMERATED {supported}          OPTIONAL,
  pur-NRSRP-Validation-r16     ENUMERATED {supported}          OPTIONAL,
  pur-CP-L1Ack-r16             ENUMERATED {supported}          OPTIONAL
}

PhyLayerParameters-NB-v1700 ::= SEQUENCE {
  npdsch-16QAM-r17             ENUMERATED {supported}          OPTIONAL
}

RF-Parameters-NB-r13 ::= SEQUENCE {
  supportedBandList-r13        SupportedBandList-NB-r13,
  multiNS-Pmax-r13             ENUMERATED {supported}          OPTIONAL
}

RF-Parameters-NB-v1430 ::= SEQUENCE {
  powerClassNB-14dBm-r14      ENUMERATED {supported}          OPTIONAL
}

RF-Parameters-NB-v1710 ::= SEQUENCE {
  supportedBandList-v1710     SupportedBandList-NB-v1710  OPTIONAL
}

SupportedBandList-NB-r13 ::= SEQUENCE (SIZE (1..maxBands)) OF SupportedBand-NB-r13

SupportedBandList-NB-v1710 ::= SEQUENCE (SIZE (1..maxBands)) OF SupportedBand-NB-v1710

SupportedBand-NB-r13 ::= SEQUENCE {
  band-r13                     FreqBandIndicator-NB-r13,
  powerClassNB-20dBm-r13      ENUMERATED {supported}          OPTIONAL
}

SupportedBand-NB-v1710 ::= SEQUENCE {
  npusch-16QAM-r17            ENUMERATED {supported}          OPTIONAL
}

SON-Parameters-NB-r16 ::= SEQUENCE {
  anr-Report-r16              ENUMERATED {supported}          OPTIONAL,
  rach-Report-r16             ENUMERATED {supported}          OPTIONAL
}

SON-Parameters-NB-v16f0 ::= SEQUENCE {
  locationInfo-r16            ENUMERATED {supported}          OPTIONAL
}

-- ASN1STOP

```

<b>UE-Capability-NB field descriptions</b>	<b>FDD/TDD appl</b>	<b>FDD/TDD diff</b>
<b>accessStratumRelease</b> This field indicates the release supported by the UE.	FDD/TDD	No
<b>additionalTransmissionSIB1</b> Indicates whether the UE supports additional SIB1 transmission as specified in TS 36.213 [23].	FDD	-
<b>anr-Report</b> Indicates whether the UE supports ANR measurements in RRC_IDLE.	FDD/TDD	No
<b>connModeMeasIntraFreq, connModeMeasInterFreq</b> Indicates whether the UE in RRC_CONNECTED supports neighbour cell measurements.	FDD/TDD	No
<b>coverageBasedPaging</b> Indicates whether the UE in RRC_IDLE supports coverage based paging carrier selection as defined in TS 36.304 [4].	FDD/TDD	No
<b>dataInactMon</b> Indicates whether the UE supports the data inactivity monitoring as specified in TS 36.321 [6].	FDD/TDD	No
<b>dl-ChannelQualityReporting-r16</b> Indicates whether the UE supports DL channel quality reporting in connected mode as specified in TS 36.321 [6].	FDD	-
<b>dummy</b> This field is not used in the specification. It shall not be sent by the UE.	NA	NA
<b>earlyData-UP, earlyData-UP-5GC</b> Indicates whether the UE supports EDT for User plane CIoT EPS/5GS optimisations, as defined in TS 24.301 [35] and 24.501 [95] respectively.	FDD	-
<b>earlySecurityReactivation</b> Indicates whether the UE supports early security reactivation when resuming a suspended RRC connection.	FDD/TDD	No
<b>interferenceRandomisation</b> For FDD: Indicates whether the UE supports interference randomisation in connected mode as defined in TS.36.211 [21].	FDD	-
<b>locationInfo</b> Indicates whether the UE supports reporting of <i>locationInfo</i> in RLF report.	FDD/TDD	No
<b>maxNumberROHC-ContextSessions</b> Set to the maximum number of concurrently active ROHC contexts supported by the UE, excluding context sessions that leave all headers uncompressed. cs2 corresponds with 2 (context sessions), cs4 corresponds with 4 and so on. The network ignores this field if the UE supports none of the ROHC profiles in <i>supportedROHC-Profiles</i> .	FDD/TDD	No
<b>mixedOperationMode</b> Defines whether the UE supports multi-carrier operation with mixed operation mode, standalone or inband/guardband, between the anchor carrier and the non-anchor carrier for unicast, paging, and random access as specified in TS 36.300 [9].	FDD	-
<b>multiCarrier</b> Defines whether the UE supports multi -carrier operation.	FDD/TDD	Yes
<b>multicarrier-NPRACH</b> Defines whether the UE supports NPRACH on non-anchor carrier as specified in TS 36.321 [6].	FDD/TDD	Yes
<b>multipleDRB</b> Defines whether the UE supports multiple DRBs.	FDD/TDD	No
<b>multiNS-Pmax</b> Defines whether the UE supports the mechanisms defined for NB-IoT cells broadcasting <i>NS-PmaxList-NB</i> .	FDD/TDD	No
<b>multiTB-HARQ-AckBundling</b> Indicates whether the UE supports HARQ ACK bundling for interleaved transmission for DL. If <i>multiTB-HARQ-AckBundling</i> is included, the UE shall also indicate support for <i>npdsch-MultiTB-Interleaving</i> .	FDD	-
<b>multiTone</b> Defines whether the UE supports UL multi-tone transmissions on NPUSCH.	FDD/TDD	Yes
<b>npdsch-16QAM</b> Indicates whether the UE supports 16QAM for DL unicast as defined in TS 36.213 [23].	FDD/TDD	Yes
<b>npdsch-MultiTB</b> Indicates whether the UE supports multiple TBs scheduling in RRC_CONNECTED for DL. If <i>npdsch-MultiTB</i> is included, the UE shall also indicate support for <i>twoHARQ-Processes</i> .	FDD	-
<b>npdsch-MultiTB-Interleaving</b> Indicates whether the UE supports interleaved transmission when multiple TBs is scheduled in RRC_CONNECTED for DL.	FDD	-

<b>UE-Capability-NB field descriptions</b>	<b>FDD/TDD appl</b>	<b>FDD/TDD diff</b>
<b><i>nprach-Format2</i></b> Defines whether the UE supports NPRACH resources using preamble format 2.	FDD	-
<b><i>npusch-16QAM</i></b> Indicates whether the UE supports 16QAM for UL unicast on the band as defined in TS 36.213 [23].	FDD/TDD	No
<b><i>npusch-3dot75kHz-SCS-TDD</i></b> Indicates whether the UE supports NPUSCH with 3.75kHz SCS for TDD.	TDD	-
<b><i>npusch-MultiTB</i></b> Indicates whether the UE supports multiple TBs scheduling in RRC_CONNECTED for UL. If <i>npusch-MultiTB</i> is included, the UE shall also indicate support for <i>twoHARQ-Processes</i> .	FDD	-
<b><i>npusch-MultiTB-Interleaving</i></b> Indicates whether the UE supports interleaved transmission when multiple TBs is scheduled in RRC_CONNECTED for UL.	FDD	-
<b><i>ntn-Autonomous-GNSS-Fix</i></b> This field indicates whether the UE supports autonomous GNSS position fix in RRC_CONNECTED.	FDD	-
<b><i>ntn-Connectivity-EPC</i></b> Indicates whether the UE supports NTN access when connected to EPC. If the UE indicates this capability, the UE shall support all NTN essential features as specified in TS 36.306 [5].	FDD	-
<b><i>ntn-DCI-HarqDisableMultiTB</i></b> This field indicates whether the UE supports DCI-based HARQ feedback disabling for downlink transmission when HARQ feedback disabling per HARQ process for downlink transmission is not configured by RRC and when configured with <i>npdsch-MultiTB-Config</i> .	FDD	-
<b><i>ntn-DCI-HarqDisableSingleTB</i></b> This field indicates whether the UE supports DCI-based HARQ feedback disabling for downlink transmission when HARQ feedback disabling per HARQ process for downlink transmission is not configured by RRC.	FDD	-
<b><i>ntn-GNSS-EnhScenarioSupport</i></b> This field indicates whether the UE supports GNSS measurement and UL transmission extension enhancements in RRC_CONNECTED for only GSO or NGSO scenario. If this field is not included, the GNSS measurement and UL transmission extension enhancements in RRC_CONNECTED that are indicated as supported are applicable for both GSO and NGSO scenario.	FDD	-
<b><i>ntn-HarqEnhScenarioSupport</i></b> This field indicates whether the UE supports UL and DL HARQ process enhancements for only GSO or NGSO scenario. If this field is not included, the UL and DL HARQ process enhancements that are indicated as supported are applicable for both GSO and NGSO scenario.	FDD	-
<b><i>ntn-LocationBasedMeasTrigger-EFC</i></b> This field indicates whether the UE supports location-based measurement trigger in RRC_CONNECTED in earth fixed cell.	FDD	-
<b><i>ntn-LocationBasedMeasTrigger-EMC</i></b> This field indicates whether the UE supports location-based measurement trigger in RRC_CONNECTED in earth moving cell.	FDD	-
<b><i>ntn-OffsetTimingEnh</i></b> Indicates whether the UE supports timing relationship enhancement using <i>Differential Koffset</i> as specified in TS 36.321 [6] and TS 36.213 [23].	FDD	-
<b><i>ntn-OverriddenHarqDisableMultiTB</i></b> This field indicates whether the UE supports DCI-based HARQ feedback disabling for downlink transmission by overriding the RRC configuration when configured with <i>npdsch-MultiTB-Config</i> .	FDD	-
<b><i>ntn-OverriddenHarqDisableSingleTB</i></b> This field indicates whether the UE supports DCI-based HARQ feedback disabling for downlink transmission by overriding the RRC configuration.	FDD	-
<b><i>ntn-PUR-TimerDelay</i></b> Indicates whether the UE supports delaying the start of the <i>pur-ResponseWindowTimer</i> for NTN, see TS 36.321 [6].	FDD	-
<b><i>ntn-RRC-HarqDisableMultiTB</i></b> This field indicates whether the UE supports HARQ feedback disabling per HARQ process for downlink transmission by RRC configuration when configured with <i>npdsch-MultiTB-Config</i> .	FDD	-
<b><i>ntn-RRC-HarqDisableSingleTB</i></b> This field indicates whether the UE supports HARQ feedback disabling per HARQ process for downlink transmission by RRC configuration.	FDD	-

<b>UE-Capability-NB field descriptions</b>	<b>FDD/TDD appl</b>	<b>FDD/TDD diff</b>
<b>ntn-SegmentedPrecompensationGaps</b> Indicates the minimum supported gap length between segments for segmented uplink transmission. Value <i>sym1</i> corresponds to 1 symbol, value <i>s1</i> corresponds to 1 slot, value <i>s2</i> corresponds to 2 slots.	FDD	-
<b>ntn-ScenarioSupport</b> Indicates whether the UE supports NTN features for only GSO or NGSO scenario. If a UE does not include this field but includes <i>ntn-Connectivity-EPC-r17</i> , the UE supports the NTN features for both GSO and NGSO scenarios.	FDD	-
<b>ntn-TA-report</b> Indicates whether the UE supports timing advance reporting in RRC_CONNECTED, see TS 36.321 [6].	FDD	-
<b>ntn-TimeBasedMeasTrigger</b> This field indicates whether the UE supports time-based measurement trigger in RRC_CONNECTED.	FDD	-
<b>ntn-Triggered-GNSS-Fix</b> This field indicates whether the UE supports network triggered GNSS position fix in RRC_CONNECTED.	FDD	-
<b>ntn-UplinkHarq-ModeB-MultiTB</b> This field indicates whether the UE supports HARQ Mode B when scheduled with uplink transmission of multiple TBs.	FDD	-
<b>ntn-UplinkHarq-ModeB-SingleTB</b> This field indicates whether the UE supports HARQ Mode B.	FDD	-
<b>ntn-UplinkTxExtension</b> This field indicates whether the UE supports to perform UL transmission in a duration after original GNSS validity duration expires without GNSS re-acquisition.	FDD	-
<b>powerClassNB-14dBm</b> Defines whether the UE supports power class 14dBm in all the bands supported by the UE as specified in TS 36.101 [42]. If <i>powerClassNB-20dBm</i> is included, the UE shall not include the field <i>powerClassNB-14dBm</i> .	FDD/TDD	No
<b>powerClassNB-20dBm</b> Defines whether the UE supports power class 20dBm in NB-IoT for the band, as specified in TS 36.101 [42] and TS 36.102 [113] for NTN capable UE. If neither <i>powerClassNB-14dBm</i> nor <i>powerClassNB-20dBm</i> is included, UE supports power class 23 dBm in the NB-IoT band.	FDD/TDD	No
<b>pur-CP-EPC, pur-CP-5GC</b> Indicates whether the UE supports transmission using PUR for Control plane CloT EPS/5GS optimisations, as defined in TS 24.301 [35] and TS 24.501 [95] respectively.	FDD	-
<b>pur-CP-L1Ack</b> Indicates whether UE supports L1 acknowledgement in response to CP transmission using PUR. If <i>pur-CP-L1Ack</i> is included, the UE shall also indicate support for <i>pur-CP-EPC</i> or <i>pur-CP-5GC</i> .	FDD	-
<b>pur-NRSRP-Validation</b> Indicates whether UE supports serving cell NRSRP for TA validation for transmission using PUR. If <i>pur-NRSRP-Validation</i> is included, the UE shall also indicate support for <i>pur-CP-EPC</i> , <i>pur-CP-5GC</i> , <i>pur-UP-EPC</i> or <i>pur-CP-5GC</i> .	FDD	-
<b>pur-UP-EPC, pur-UP-5GC</b> Indicates whether the UE supports transmission using PUR for User plane CloT EPS/5GS optimisations, as defined in TS 24.301 [35] and TS 24.501 [95] respectively.	FDD	-
<b>rach-Report</b> Indicates whether the UE supports delivery of <i>rach-Report</i> .	FDD/TDD	No
<b>rai-Support</b> Defines whether the UE supports release assistance indication (RAI) as specified in TS 36.321 [6].	FDD/TDD	No
<b>rai-SupportEnh</b> Indicates whether the UE supports AS Release Assistance Indication via the DCQR and AS RAI MAC CE when connected to EPC as specified in TS 36.321 [6].	FDD/TDD	No
<b>rlc-UM</b> Defines whether the UE supports RLC UM as specified in TS 36.322 [7].	FDD/TDD	No
<b>slotSymbolResourceResvDL</b> Indicates whether the UE supports slot/symbol-level time-domain DL resource reservation, e.g. for NB-IoT coexistence with NR. If <i>slotSymbolResourceResvDL</i> is included, the UE shall also indicate support for <i>subframeResourceResvDL</i> .	FDD/TDD	Yes



<b>UE-Capability-NB field descriptions</b>	<b>FDD/TDD appl</b>	<b>FDD/TDD diff</b>
<b>slotSymbolResourceResvUL</b> Indicates whether the UE supports slot/symbol-level time-domain UL resource reservation, e.g. for NB-IoT coexistence with NR. If <i>slotSymbolResourceResvUL</i> is included, the UE shall also indicate support for <i>subframeResourceResvUL</i> .	FDD/TDD	Yes
<b>supportedBandList, supportedBandList-v1710</b> Includes the supported NB-IoT bands as defined in TS 36.101 [42] and TS 36.102 [113] for NTN capable UE. If <i>supportedBandList-v1710</i> is included, the UE shall include the same number of entries, and listed in the same order, as in <i>supportedBandList-r13</i> .	FDD/TDD	No
<b>sr-SPS-BSR</b> Defines whether the UE supports SR using SPS BSR as specified in TS 36.321 [6].	FDD	-
<b>sr-withHARQ-ACK</b> Defines whether the UE supports physical layer SR with HARQ ACK as specified in TS 36.213 [23].	FDD	-
<b>sr-withoutHARQ-ACK</b> Defines whether the UE supports physical layer SR without HARQ ACK as specified in TS 36.211 [21] and TS 36.213 [23].	FDD	-
<b>subframeResourceResvDL</b> Indicates whether the UE supports subframe-level time-domain DL resource reservation, e.g. for NB-IoT coexistence with NR.	FDD/TDD	Yes
<b>subframeResourceResvUL</b> Indicates whether the UE supports subframe-level time-domain UL resource reservation, e.g. for NB-IoT coexistence with NR.	FDD/TDD	Yes
<b>supportedROHC-Profiles</b> List of supported ROHC profiles as defined in TS 36.323 [8].	FDD/TDD	No
<b>twoHARQ-Processes</b> Defines whether the UE supports two HARQ processes operation in DL and UL as specified in TS 36.212 [22] and TS 36.213 [23].	FDD/TDD	Yes
<b>ue-Category-NB</b> UE category as defined in TS 36.306 [5]. Value nb1 corresponds to UE category NB1, value nb2 corresponds to UE category NB2. A UE shall always include the field <i>ue-Category-NB-r13</i> in this version of the specification.	FDD/TDD	Yes

NOTE 1: The IE *UE-Capability-NB* does not include AS security capability information, since these are the same as the security capabilities that are signalled by NAS. Consequently AS need not provide "man-in-the-middle" protection for the security capabilities.

NOTE 2: The column 'FDD/TDD appl' indicates the applicability to the xDD mode: 'FDD' means applicable to FDD only, 'TDD' means applicable to TDD only and 'FDD/TDD' means applicable to FDD and TDD.

NOTE 3: The column 'FDD/TDD diff' indicates if the UE is allowed to signal a different value for FDD and TDD when the capability applies to both FDD and TDD modes. '-' is used when the capability applies to one mode only, 'No' is used for dual mode capabilities where a common value is signalled for both modes, and 'Yes' is used for dual mode capabilities where a separate value is signalled for each mode. Common capabilities and FDD capabilities are reported in the fields of *UE-Capability-NB* except field *tdd-UE-Capability*. TDD capabilities are reported in *tdd-UE-Capability*.

## – *UE-RadioPagingInfo-NB*

The IE *UE-RadioPagingInfo-NB* contains UE NB-IoT capability information needed for paging.

### ***UE-RadioPagingInfo-NB* information element**

```
-- ASN1START
UE-RadioPagingInfo-NB-r13 ::= SEQUENCE {
    ue-Category-NB-r13      ENUMERATED {nb1}          OPTIONAL,
    . . .
    [[ multiCarrierPaging-r14  ENUMERATED {true}          OPTIONAL
    ]],
    [[ mixedOperationMode-r15  ENUMERATED {supported}      OPTIONAL,
    wakeUpSignal-r15         ENUMERATED {true}           OPTIONAL,
```

```

        wakeUpSignalMinGap-eDRX-r15  ENUMERATED {ms40, ms240, ms1000, ms2000}  OPTIONAL,
        multiCarrierPagingTDD-r15    ENUMERATED {true}                        OPTIONAL
    ]],
    [[
        ue-Category-NB-r16            ENUMERATED {nb2}                        OPTIONAL,
        groupWakeUpSignal-r16         ENUMERATED {true}                      OPTIONAL,
        groupWakeUpSignalAlternation-r16  ENUMERATED {true}                OPTIONAL
    ]]
}
-- ASN1STOP

```

### UE-RadioPagingInfo-NB field descriptions

#### groupWakeUpSignal

Indicates whether the UE in RRC\_IDLE supports GWUS without group resource alternation for paging in DRX in FDD as specified in TS 36.211 [21], TS 36.213 [23] and TS 36.304 [4]. If this field is included, the minimum gap between GWUS and associated PO for DRX is fixed as 40 ms.

#### groupWakeUpSignalAlternation

Indicates whether the UE in RRC\_IDLE supports GWUS with group resource alternation for paging in DRX in FDD as specified in TS 36.211 [21], TS 36.213 [23] and TS 36.304 [4]. If this field is included, the minimum gap between GWUS and associated PO for DRX is fixed as 40 ms.

#### mixedOperationMode

Indicates whether the UE supports multi-carrier operation with mixed operation mode, standalone or inband/guardband, between the anchor carrier and non-anchor carrier for unicast, paging, and random access, as specified in TS 36.300 [9].

#### multiCarrierPaging

Indicates whether the UE supports paging on non-anchor carriers as defined in TS 36.304 [4].

#### multiCarrierPagingTDD

Indicates whether the UE supports paging on non-anchor carriers for TDD as defined in TS 36.304 [4].

#### ue-Category-NB

UE NB-IoT category as defined in TS 36.306 [5]. Value *nb1* corresponds to UE category NB1, value *nb2* corresponds to UE category NB2.

A UE shall always include the field *ue-Category-NB-r13* in this version of the specification.

#### wakeUpSignal

Indicates whether the UE supports WUS for paging in DRX in FDD as specified in TS 36.304 [4]. If this field is included, the minimum gap between WUS and associated PO for DRX is fixed as 40 ms.

#### wakeUpSignalMinGap-eDRX

Indicates the minimum gap the UE supports between WUS or GWUS and associated PO in case of eDRX in FDD, as specified in TS 36.304 [4]. Value *ms40* corresponds to 40 ms, value *ms240* corresponds to 240 ms and so on. If this field is included, the UE shall also indicate support for WUS or GWUS for paging in DRX.

## UE-TimersAndConstants-NB

The IE *UE-TimersAndConstants-NB* contains timers and constants used by the UE in either RRC\_CONNECTED or RRC\_IDLE.

### UE-TimersAndConstants-NB information element

```

-- ASN1START
UE-TimersAndConstants-NB-r13 ::= SEQUENCE {
    t300-r13          ENUMERATED {
                        ms2500, ms4000, ms6000, ms10000,
                        ms15000, ms25000, ms40000, ms60000},
    t301-r13          ENUMERATED {
                        ms2500, ms4000, ms6000, ms10000,
                        ms15000, ms25000, ms40000, ms60000},
    t310-r13          ENUMERATED {
                        ms0, ms200, ms500, ms1000, ms2000, ms4000, ms8000},
    n310-r13          ENUMERATED {
                        n1, n2, n3, n4, n6, n8, n10, n20},
    t311-r13          ENUMERATED {
                        ms1000, ms3000, ms5000, ms10000, ms15000,
                        ms20000, ms30000},
    n311-r13          ENUMERATED {
                        n1, n2, n3, n4, n5, n6, n8, n10},
    ...,
    [[ t311-v1350     ENUMERATED {
                        ms40000, ms60000, ms90000, ms120000}

```

```

]]],
[[ t300-v1530 ENUMERATED {
    ms80000, ms100000, ms120000} OPTIONAL, -- Cond TDD
    t301-v1530 ENUMERATED {
    ms80000, ms100000, ms120000} OPTIONAL, -- Cond TDD
    t311-v1530 ENUMERATED {
    ms160000, ms200000} OPTIONAL, -- Cond TDD
    t300-r15 ENUMERATED {ms6000, ms10000, ms15000, ms25000, ms40000,
    ms60000, ms80000, ms120000} OPTIONAL -- Cond
EDTorPUR
]]
}
-- ASN1STOP

```

### UE-TimersAndConstants-NB field descriptions

#### **n3xy**

Constants are described in clause 7.4. n1 corresponds with 1, n2 corresponds with 2 and so on.

#### **t3xy**

Timers are described in clause 7.3. Value ms0 corresponds with 0 ms, ms200 corresponds with 200 ms and so on. The UE shall use the extended values *t311-v1350*, *t300-v1530*, *t301-v1530* and *t311-v1530*, if present, and ignore the value signaled by *t311-r13*, *t300-r13*, *t301-r13* and *t311-r13* respectively. *t300-r15* is only applicable for EDT or transmission using PUR with uplink data. UE performing EDT or transmission using PUR with uplink data shall use *t300-r15*, if present.

## 6.7.3.7 NB-IoT MBMS information elements

Void

### 6.7.3.7a NB-IoT SC-PTM information elements

#### – SC-MTCH-InfoList-NB

The IE *SC-MTCH-InfoList-NB* provides the list of ongoing MBMS sessions transmitted via SC-MRB and for each MBMS session, the associated G-RNTI and scheduling information.

### SC-MTCH-InfoList-NB information element

```

-- ASN1START
SC-MTCH-InfoList-NB-r14 ::= SEQUENCE (SIZE (0.. maxSC-MTCH-NB-r14)) OF SC-MTCH-Info-NB-r14
SC-MTCH-Info-NB-r14 ::= SEQUENCE {
    sc-mtch-CarrierConfig-r14 CHOICE {
        dl-CarrierConfig-r14 DL-CarrierConfigCommon-NB-r14,
        dl-CarrierIndex-r14 INTEGER (0.. maxNonAnchorCarriers-NB-r14)
    },
    mbmsSessionInfo-r14 MBMSSessionInfo-r13,
    g-RNTI-r14 BIT STRING (SIZE(16)),
    sc-mtch-SchedulingInfo-r14 SC-MTCH-SchedulingInfo-NB-r14 OPTIONAL, -- Need OP
    sc-mtch-NeighbourCell-r14 BIT STRING (SIZE(maxNeighCell-SCPTM-NB-r14)) OPTIONAL, --
Need OP
    npdcch-NPDSCH-MaxTBS-SC-MTCH-r14 ENUMERATED {n680, n2536},
    npdcch-NumRepetitions-SC-MTCH-r14 ENUMERATED {r1, r2, r4, r8, r16,
        r32, r64, r128, r256,
        r512, r1024, r2048, spare4,
        spare3, spare2, spare1},
    npdcch-StartSF-SC-MTCH-r14 ENUMERATED {vldot5, v2, v4, v8,
        v16, v32, v48, v64},
    npdcch-Offset-SC-MTCH-r14 ENUMERATED {zero, oneEighth, oneQuarter,
        threeEighth, oneHalf, fiveEighth,
        threeQuarter, sevenEighth},
    ...
}
SC-MTCH-SchedulingInfo-NB-r14 ::= SEQUENCE {
    onDurationTimerSCPTM-r14 ENUMERATED {
        pp1, pp2, pp3, pp4,

```

```

drx-InactivityTimerSCPTM-r14          pp8, pp16, pp32, spare},
ENUMERATED {
  pp0, pp1, pp2, pp3,
  pp4, pp8, pp16, pp32},
schedulingPeriodStartOffsetSCPTM-r14 CHOICE {
  sf10          INTEGER(0..9),
  sf20          INTEGER(0..19),
  sf32          INTEGER(0..31),
  sf40          INTEGER(0..39),
  sf64          INTEGER(0..63),
  sf80          INTEGER(0..79),
  sf128         INTEGER(0..127),
  sf160         INTEGER(0..159),
  sf256         INTEGER(0..255),
  sf320         INTEGER(0..319),
  sf512         INTEGER(0..511),
  sf640         INTEGER(0..639),
  sf1024        INTEGER(0..1023),
  sf2048        INTEGER(0..2047),
  sf4096        INTEGER(0..4095),
  sf8192        INTEGER(0..8191)
},
...
}
-- ASN1STOP

```

### SC-MTCH-InfoList-NB field descriptions

<b>dl-CarrierConfig</b>
Downlink carrier used for SC-MTCH. E-UTRAN cannot configure a downlink carrier operating in mixed operation mode.
<b>dl-CarrierIndex</b>
Index to a downlink carrier signalled in system information. Value '0' corresponds to the anchor carrier, value '1' corresponds to the first entry in <i>dl-ConfigList</i> in <i>SystemInformationBlockType22-NB</i> , value '2' corresponds to the second entry in <i>dl-ConfigList</i> and so on.
<b>drx-InactivityTimerSCPTM</b>
Timer for SC-MTCH reception in TS 36.321 [6]. Value in number of NPDCCH periods. Value pp1 corresponds to 1 NPDCCH period, pp2 corresponds to 2 NPDCCH periods and so on.
<b>g-RNTI</b>
G-RNTI used to scramble the scheduling and transmission of a SC-MTCH.
<b>mbmsSessionInfo</b>
Indicates the ongoing MBMS session in a SC-MTCH.
<b>npdcch-NPDSCH-MaxTBS-SC-MTCH</b>
Maximum NPDSCH TBS for the SC-MTCH, see TS 36.213 [23]. Value <i>n680</i> corresponds to 680 bits and value <i>n2536</i> corresponds to 2536 bits.
<b>npdcch-NumRepetition-SC-MTCH</b>
The maximum number of NPDCCH repetitions the UE needs to monitor for SC-MTCH multicast search space, see TS 36.213 [23].
<b>npdcch-Offset-SC-MTCH</b>
Fractional period offset of starting subframe for NPDCCH multicast search space for SC-MTCH, see TS 36.213 [23].
<b>npdcch-startSF-SC-MTCH</b>
Starting subframes configuration of the NPDCCH multicast search space for SC-MTCH, see TS 36.213 [23].
<b>onDurationTimerSCPTM</b>
Timer for SC-MTCH reception in TS 36.321 [6]. Value in number of NPDCCH periods. Value pp1 corresponds to 1 NPDCCH period, pp2 corresponds to 2 NPDCCH periods and so on.
<b>schedulingPeriodStartOffsetSCPTM</b>
<i>SCPTM-SchedulingCycle</i> and <i>SCPTM-SchedulingOffset</i> in TS 36.321 [6]. The value of <i>SCPTM-SchedulingCycle</i> is in number of sub-frames. Value sf10 corresponds to 10 sub-frames, sf20 corresponds to 20 sub-frames and so on. The value of <i>SCPTM-SchedulingOffset</i> is in number of sub-frames.
<b>sc-mtch-CarrierConfig</b>
Downlink carrier that is used for SC-MTCH.
<b>sc-mtch-NeighbourCell</b>
Indicates neighbour cells which also provide this service on SC-MTCH. The first bit is set to 1 if the service is provided on SC-MTCH in the first cell in <i>scptmNeighbourCellList</i> , otherwise it is set to 0. The second bit is set to 1 if the service is provided on SC-MTCH in the second cell in <i>scptmNeighbourCellList</i> , and so on. If this field is absent, the UE shall assume that this service is not available on SC-MTCH in any neighbour cell.
<b>sc-mtch-SchedulingInfo</b>
DRX information for the SC-MTCH. If this field is absent, DRX is not used for the SC-MTCH.

## – SCPTM-NeighbourCellList-NB

The IE *SCPTM-NeighbourCellList-NB* indicates a list of neighbour cells where ongoing MBMS sessions provided via SC-MRB in the current cells are also provided.

```
-- ASN1START
SCPTM-NeighbourCellList-NB-r14 ::= SEQUENCE (SIZE (1..maxNeighCell-SCPTM-NB-r14)) OF PCI-ARFCN-NB-r14
PCI-ARFCN-NB-r14 ::= SEQUENCE {
    physCellId-r14          PhysCellId,
    carrierFreq-r14        CarrierFreq-NB-r13    OPTIONAL  -- Need OP
}
-- ASN1STOP
```

### SCPTM-NeighbourCellList-NB field descriptions

#### **physCellId**

Physical Cell Identity of the neighbour cell.

#### **carrierFreq**

Carrier frequency of the neighbour cell.

Absence of the IE means that the neighbour cell is on the same frequency as the current cell.

## 6.7.4 NB-IoT RRC multiplicity and type constraint values

### – Multiplicity and type constraint definitions

```
-- ASN1START
maxFreqANR-NB-r16          INTEGER ::= 2    -- Maximum number of NB-IOT carrier frequencies that can
-- be configured or reported for ANR measurement
maxFreqEUTRA-NB-r16       INTEGER ::= 8    -- Maximum number of EUTRAN carrier frequencies that can
-- be provided as assistance information for inter-RAT
-- cell selection
maxFreqsGERAN-NB-r16      INTEGER ::= 8    -- Maximum number of groups of GERAN carrier frequencies
-- that can be provided as assistance information for
-- inter-RAT cell selection
maxGWUS-Groups-1-NB-r16   INTEGER ::= 15   -- Maximum number of groups for each paging probability
-- group
maxGWUS-Resources-NB-r16  INTEGER ::= 2    -- Maximum number of GWUS resources for each gap
maxGWUS-ProbThresholds-NB-r16 INTEGER ::= 3 -- Maximum number of paging probability thresholds
maxNPRACH-Resources-NB-r13 INTEGER ::= 3    -- Maximum number of NPRACH resources for NB-IoT
maxNonAnchorCarriers-NB-r14 INTEGER ::= 15 -- Maximum number of non-anchor carriers for NB-IoT
maxDRB-NB-r13             INTEGER ::= 2    -- Maximum number of Data Radio Bearers for NB-IoT
maxNeighCell-SCPTM-NB-r14 INTEGER ::= 8    -- Maximum number of SCPTM neighbour cells
maxNS-Pmax-NB-r13        INTEGER ::= 4    -- Maximum number of NS and P-Max values per band
maxSC-MTCH-NB-r14        INTEGER ::= 64   -- Maximum number of SC-MTCHs in one cell for NB-IoT
maxSI-Message-NB-r13     INTEGER ::= 8    -- Maximum number of SI messages for NB-IoT
maxTAC-NB-r17            INTEGER ::= 12   -- Maximum number of Tracking Area Codes
-- broadcast in a cell
-- ASN1STOP
```

### – End of NBIOT-RRC-Definitions

```
-- ASN1START
END
-- ASN1STOP
```

## 6.7.5 Direct Indication Information

Direct Indication information is transmitted on NPDCCH using P-RNTI but without associated *Paging-NB* message. Table 6.7.5-1 defines the Direct Indication information, see TS 36.212 [22], clause 6.4.3.3.

When bit *n* is set to 1, the UE shall behave as if the corresponding field is set in the *Paging-NB* message, see 5.3.2.3. Bit 1 is the least significant bit.

**Table 6.7.5-1: Direct Indication information**

Bit	Field in <i>Direct Indication information</i>
1	<i>systemInfoModification</i>
2	<i>systemInfoModification-eDRX</i>
3, 4, 5, 6, 7, 8	Not used, and shall be ignored by UE if received

# 7 Variables and constants

## 7.1 UE variables

NOTE: To facilitate the specification of the UE behavioural requirements, UE variables are represented using ASN.1. Unless explicitly specified otherwise, it is however up to UE implementation how to store the variables. The optionality of the IEs in ASN.1 is used only to indicate that the values may not always be available.

### – *EUTRA-UE-Variables*

This ASN.1 segment is the start of the E-UTRA UE variable definitions.

```
-- ASN1START
EUTRA-UE-Variables DEFINITIONS AUTOMATIC TAGS ::=
BEGIN
IMPORTS
  AbsoluteTimeInfo-r10,
  AreaConfiguration-r10,
  AreaConfiguration-v1130,
  ARFCN-ValueNR-r15,
  BT-NameList-r15,
  CarrierFreqGERAN,
  CellIdentity,
  CellList-r15,
  CondReconfigurationToAddModList-r16,
  ConnEstFailReport-r11,
  EUTRA-CarrierList-r15,
  SpeedStateScaleFactors,
  C-RNTI,
  LoggedEventTriggerConfig-r17,
  LoggingDuration-r10,
  LoggingInterval-r10,
  LogMeasInfo-r10,
  MeasCSI-RS-Id-r12,
  MeasId,
  MeasId-v1250,
  MeasIdToAddModList,
  MeasIdToAddModListExt-r12,
  MeasIdToAddModList-v1310,
  MeasIdToAddModListExt-v1310,
  MeasObjectToAddModList,
  MeasObjectToAddModList-v9e0,
  MeasObjectToAddModListExt-r13,
  MeasResultListExtIdle-r16,
  MeasResultListIdle-r15,
  MeasResultListIdleNR-r16,
```

```

MeasScaleFactor-r12,
MobilityStateParameters,
NeighCellConfig,
NR-CarrierList-r16,
PhysCellId,
PhysCellIdCDMA2000,
PhysCellIdGERAN,
PhysCellIdUTRA-FDD,
PhysCellIdUTRA-TDD,
PLMN-Identity,
PLMN-IdentityList3-r11,
QuantityConfig,
ReportConfigToAddModList,
RLF-Report-r9,
TargetMBSFN-AreaList-r12,
TraceReference-r10,
Tx-ResourcePoolMeasList-r14,
VisitedCellInfoList-r12,
maxCellMeas,
maxCSI-RS-Meas-r12,
maxMeasId,
maxMeasId-r12,
maxRS-Index-r15,
PhysCellIdNR-r15,
RS-IndexNR-r15,
UL-DelayConfig-r13,
ValidityAreaList-r16,
WLAN-CarrierInfo-r13,
WLAN-Identifiers-r12,
WLAN-Id-List-r13,
WLAN-NameList-r15,
WLAN-Status-r13,
WLAN-Status-v1430,
WLAN-SuspendConfig-r14

```

```
FROM EUTRA-RRC-Definitions;
```

```
-- ASN1STOP
```

### – *VarConditionalReconfiguration*

The UE variable *VarConditionalReconfiguration* includes the accumulated configuration of conditional reconfigurations (i.e. conditional handovers, conditional PSCell addition or inter-SN conditional PSCell change) including the configurations of triggering conditions to be monitored and the stored *RRCCConnectionReconfiguration* per target candidate, to be applied upon the fulfilment of the associated triggering conditions.

#### ***VarConditionalReconfiguration* UE variable**

```

-- ASN1START
VarConditionalReconfiguration ::= SEQUENCE {
  -- Conditional reconfigurations list
  condReconfigurationList-r16          CondReconfigurationToAddModList-r16
  OPTIONAL
}
-- ASN1STOP

```

### – *VarConnEstFailReport*

The UE variable *VarConnEstFailReport* includes the connection establishment failure information.

#### ***VarConnEstFailReport* UE variable**

```

-- ASN1START
VarConnEstFailReport-r11 ::=          SEQUENCE {
  connEstFailReport-r11              ConnEstFailReport-r11,
  plmn-Identity-r11                  PLMN-Identity
}

```

```
-- ASN1STOP
```

## – *VarLogMeasConfig*

The UE variable *VarLogMeasConfig* includes the configuration of the logging of measurements to be performed by the UE while in RRC\_IDLE, covering intra-frequency, inter-frequency, inter-RAT mobility and MBSFN related measurements. If MBSFN logging is configured, the UE performs logging of measurements while in both RRC\_IDLE and RRC\_CONNECTED. Otherwise, the UE performs logging of measurements only while in RRC\_IDLE.

### **VarLogMeasConfig UE variable**

```
-- ASN1START
VarLogMeasConfig-r10 ::=          SEQUENCE {
    areaConfiguration-r10          AreaConfiguration-r10      OPTIONAL,
    loggingDuration-r10           LoggingDuration-r10,
    loggingInterval-r10          LoggingInterval-r10
}
VarLogMeasConfig-r11 ::=          SEQUENCE {
    areaConfiguration-r10          AreaConfiguration-r10      OPTIONAL,
    areaConfiguration-v1130        AreaConfiguration-v1130    OPTIONAL,
    loggingDuration-r10           LoggingDuration-r10,
    loggingInterval-r10          LoggingInterval-r10
}
VarLogMeasConfig-r12 ::=          SEQUENCE {
    areaConfiguration-r10          AreaConfiguration-r10      OPTIONAL,
    areaConfiguration-v1130        AreaConfiguration-v1130    OPTIONAL,
    loggingDuration-r10           LoggingDuration-r10,
    loggingInterval-r10          LoggingInterval-r10,
    targetMBSFN-AreaList-r12      TargetMBSFN-AreaList-r12    OPTIONAL
}
VarLogMeasConfig-r15 ::=          SEQUENCE {
    areaConfiguration-r10          AreaConfiguration-r10      OPTIONAL,
    areaConfiguration-v1130        AreaConfiguration-v1130    OPTIONAL,
    loggingDuration-r10           LoggingDuration-r10,
    loggingInterval-r10          LoggingInterval-r10,
    targetMBSFN-AreaList-r12      TargetMBSFN-AreaList-r12    OPTIONAL,
    bt-NameList-r15              BT-NameList-r15            OPTIONAL,
    wlan-NameList-r15            WLAN-NameList-r15          OPTIONAL
}
VarLogMeasConfig-r17 ::=          SEQUENCE {
    areaConfiguration-r10          AreaConfiguration-r10      OPTIONAL,
    areaConfiguration-v1130        AreaConfiguration-v1130    OPTIONAL,
    loggingDuration-r10           LoggingDuration-r10,
    loggingInterval-r10          LoggingInterval-r10,
    targetMBSFN-AreaList-r12      TargetMBSFN-AreaList-r12    OPTIONAL,
    bt-NameList-r15              BT-NameList-r15            OPTIONAL,
    wlan-NameList-r15            WLAN-NameList-r15          OPTIONAL,
    loggedEventTriggerConfig-r17   LoggedEventTriggerConfig-r17  OPTIONAL,
    measUncomBarPre-r17          ENUMERATED {true}            OPTIONAL
}
-- ASN1STOP
```

## – *VarLogMeasReport*

The UE variable *VarLogMeasReport* includes the logged measurements information.

### **VarLogMeasReport UE variable**

```
-- ASN1START
VarLogMeasReport-r10 ::=          SEQUENCE {
    traceReference-r10            TraceReference-r10,
    traceRecordingSessionRef-r10  OCTET STRING (SIZE (2)),
    tce-Id-r10                   OCTET STRING (SIZE (1)),
}
-- ASN1STOP
```



```

    plmn-Identity-r10          PLMN-Identity,
    absoluteTimeInfo-r10      AbsoluteTimeInfo-r10,
    logMeasInfoList-r10       LogMeasInfoList2-r10
  }
}

VarLogMeasReport-r11 ::=
  traceReference-r10          TraceReference-r10,
  traceRecordingSessionRef-r10 OCTET STRING (SIZE (2)),
  tce-Id-r10                  OCTET STRING (SIZE (1)),
  plmn-IdentityList-r11       PLMN-IdentityList3-r11,
  absoluteTimeInfo-r10        AbsoluteTimeInfo-r10,
  logMeasInfoList-r10         LogMeasInfoList2-r10,
  sigLoggedMeasType-r18       ENUMERATED {true}
}

LogMeasInfoList2-r10 ::=
  SEQUENCE (SIZE (1..maxLogMeas-r10)) OF LogMeasInfo-r10

-- ASN1STOP

```

### – *VarMeasConfig*

The UE variable *VarMeasConfig* includes the accumulated configuration of the measurements to be performed by the UE, covering intra-frequency, inter-frequency and inter-RAT mobility related measurements.

**NOTE:** The amount of measurement configuration information, which a UE is required to store, is specified in clause 11.1. If the number of frequencies configured for a particular RAT exceeds the minimum performance requirements specified in TS 36.133 [16], it is up to UE implementation which frequencies of that RAT are measured. If the total number of frequencies for all RATs provided to the UE in the measurement configuration exceeds the minimum performance requirements specified in TS 36.133 [16], it is up to UE implementation which frequencies/RATs are measured.

#### ***VarMeasConfig* UE variable**

```

-- ASN1START
VarMeasConfig ::=
  -- Measurement identities
  measIdList          MeasIdToAddModList          OPTIONAL,
  measIdListExt-r12   MeasIdToAddModListExt-r12   OPTIONAL,
  measIdList-v1310    MeasIdToAddModList-v1310    OPTIONAL,
  measIdListExt-v1310 MeasIdToAddModListExt-v1310 OPTIONAL,
  -- Measurement objects
  measObjectList      MeasObjectToAddModList      OPTIONAL,
  measObjectListExt-r13 MeasObjectToAddModListExt-r13 OPTIONAL,
  measObjectList-v9i0 MeasObjectToAddModList-v9e0 OPTIONAL,
  -- Reporting configurations
  reportConfigList    ReportConfigToAddModList    OPTIONAL,
  -- Other parameters
  quantityConfig       QuantityConfig              OPTIONAL,
  measScaleFactor-r12  MeasScaleFactor-r12         OPTIONAL,
  s-Measure            INTEGER (-140..-44)         OPTIONAL,
  speedStatePars       CHOICE {
    release            NULL,
    setup              SEQUENCE {
      mobilityStateParameters MobilityStateParameters,
      timeToTrigger-SF    SpeedStateScaleFactors
    }
  }
  allowInterruptions-r11 BOOLEAN                  OPTIONAL
}
-- ASN1STOP

```

### – *VarMeasIdleConfig*

The UE variable *VarMeasIdleConfig* includes the configuration of the measurements to be performed by the UE while in RRC\_IDLE or RRC\_INACTIVE for E-UTRA inter-frequency and inter-RAT (i.e. NR) measurements.

**VarMeasIdleConfig UE variable**

```

-- ASN1START
VarMeasIdleConfig-r15 ::= SEQUENCE {
    measIdleCarrierListEUTRA-r15          EUTRA-CarrierList-r15          OPTIONAL,
    measIdleDuration-r15                  ENUMERATED {sec10, sec30, sec60, sec120,
                                                    sec180, sec240, sec300}
}

VarMeasIdleConfig-r16 ::= SEQUENCE {
    measIdleCarrierListNR-r16            NR-CarrierList-r16            OPTIONAL,
    validityAreaList-r16                ValidityAreaList-r16        OPTIONAL
}
-- ASN1STOP

```

**VarMeasIdleReport**

The UE variable *VarMeasIdleReport* includes the logged measurements information.

**VarMeasIdleReport UE variable**

```

-- ASN1START
VarMeasIdleReport-r15 ::= SEQUENCE {
    measReportIdle-r15                  MeasResultListIdle-r15
}

VarMeasIdleReport-r16 ::= SEQUENCE {
    measReportIdle-r16                  MeasResultListExtIdle-r16          OPTIONAL,
    measReportIdleNR-r16                MeasResultListIdleNR-r16          OPTIONAL
}
-- ASN1STOP

```

**VarMeasReportList**

The UE variable *VarMeasReportList* includes information about the measurements for which the triggering conditions have been met.

**VarMeasReportList UE variable**

```

-- ASN1START
VarMeasReportList ::= SEQUENCE (SIZE (1..maxMeasId)) OF VarMeasReport
VarMeasReportList-r12 ::= SEQUENCE (SIZE (1..maxMeasId-r12)) OF VarMeasReport

VarMeasReport ::= SEQUENCE {
    -- List of measurement that have been triggered
    measId                      MeasId,
    measId-v1250                MeasId-v1250          OPTIONAL,
    cellsTriggeredList          CellsTriggeredList    OPTIONAL,
    csi-RS-TriggeredList-r12    CSI-RS-TriggeredList-r12  OPTIONAL,
    poolsTriggeredList-r14      Tx-ResourcePoolMeasList-r14 OPTIONAL,
    numberOfReportsSent         INTEGER
}

CellsTriggeredList ::= SEQUENCE (SIZE (1..maxCellMeas)) OF CHOICE {
    physCellIdEUTRA            PhysCellId,
    physCellIdUTRA             CHOICE {
        fdd                    PhysCellIdUTRA-FDD,
        tdd                    PhysCellIdUTRA-TDD
    },
    physCellIdGERAN            SEQUENCE {
        carrierFreq            CarrierFreqGERAN,
        physCellId             PhysCellIdGERAN
    },
    physCellIdCDMA2000         PhysCellIdCDMA2000,
    wlan-Identifiers-r13       WLAN-Identifiers-r12,
    physCellIdNR-r15           SEQUENCE {

```

```

        carrierFreq          ARFCN-ValueNR-r15,
        physCellId          PhysCellIdNR-r15,
        rs-IndexList-r15    SSB-IndexList-r15          OPTIONAL
    }
}
CSI-RS-TriggeredList-r12 ::= SEQUENCE (SIZE (1..maxCSI-RS-Meas-r12)) OF MeasCSI-RS-Id-r12
SSB-IndexList-r15 ::= SEQUENCE (SIZE (1..maxRS-Index-r15)) OF RS-IndexNR-r15
-- ASN1STOP

```

### – *VarMobilityHistoryReport*

The UE variable *VarMobilityHistoryReport* includes the mobility history information.

```

-- ASN1START
VarMobilityHistoryReport-r12 ::= VisitedCellInfoList-r12
-- ASN1STOP

```

### – *VarPendingRnaUpdate*

The UE variable *VarPendingRnaUpdate* indicates whether there is a pending RNAU procedure or not. The setting of this BOOLEAN variable to TRUE means that there is a pending RANU procedure.

#### ***VarPendingRnaUpdate* UE variable**

```

-- ASN1START
VarPendingRnaUpdate-r15 ::= SEQUENCE {
    pendingRnaUpdate          BOOLEAN          OPTIONAL
}
-- ASN1STOP

```

### – *VarRLF-Report*

The UE variable *VarRLF-Report* includes the radio link failure information or handover failure information.

#### ***VarRLF-Report* UE variable**

```

-- ASN1START
VarRLF-Report-r10 ::= SEQUENCE {
    rlf-Report-r10          RLF-Report-r9,
    plmn-Identity-r10      PLMN-Identity
}
VarRLF-Report-r11 ::= SEQUENCE {
    rlf-Report-r10          RLF-Report-r9,
    plmn-IdentityList-r11  PLMN-IdentityList3-r11
}
-- ASN1STOP

```

### – *VarShortINACTIVE-MAC-Input*

The UE variable *VarShortINACTIVE-MAC-Input* specifies the input used to generate the *shortResume-MAC-I* during RRC Connection Resume procedure for RRC\_INACTIVE.

#### ***VarShortINACTIVE-MAC-Input* UE variable**

```

-- ASN1START

```

```

VarShortINACTIVE-MAC-Input-r15 ::= SEQUENCE {
    cellIdentity-r15          CellIdentity,
    physCellId-r15           PhysCellId,
    c-RNTI-r15                C-RNTI
}
-- ASN1STOP

```

#### ***VarShortINACTIVE-MAC-Input* field descriptions**

***cellIdentity***

An input variable used to calculate the *shortResume-MAC-I*. Set to CellIdentity included in *cellIdentity* (without suffix) in SIB1 of the current cell.

***c-RNTI***

Set to C-RNTI that the UE had in the PCell it was connected to prior to suspension of the RRC connection.

***physCellId***

Set to the physical cell identity of the PCell the UE was connected to prior to suspension of the RRC connection.

### – *VarShortMAC-Input*

The UE variable *VarShortMAC-Input* specifies the input used to generate the shortMAC-I.

#### ***VarShortMAC-Input* UE variable**

```

-- ASN1START
VarShortMAC-Input ::= SEQUENCE {
    cellIdentity          CellIdentity,
    physCellId           PhysCellId,
    c-RNTI                C-RNTI
}
-- ASN1STOP

```

#### ***VarShortMAC-Input* field descriptions**

***cellIdentity***

An input variable used to calculate the *shortMAC-I*. Set to CellIdentity included in *cellIdentity* (without suffix) in SIB1 of the current cell.

***c-RNTI***

Set to C-RNTI that the UE had in the PCell it was connected to prior to the failure.

***physCellId***

Set to the physical cell identity of the PCell the UE was connected to prior to the failure.

### – *VarShortResumeMAC-Input*

The UE variable *VarShortResumeMAC-Input* specifies the input used to generate the *shortResumeMAC-I* during RRC Connection Resume procedure.

#### ***VarShortResumeMAC-Input* UE variable**

```

-- ASN1START
VarShortResumeMAC-Input-r13 ::= SEQUENCE {
    cellIdentity-r13          CellIdentity,
    physCellId-r13           PhysCellId,
    c-RNTI-r13                C-RNTI,
    resumeDiscriminator-r13   BIT STRING(SIZE(1))
}
-- ASN1STOP

```

<b>VarShortResumeMAC-Input field descriptions</b>
<b>cellIdentity</b> An input variable used to calculate the <i>shortResumeMAC-I</i> . Set to CellIdentity included in <i>cellIdentity</i> (without suffix) in SIB1 of the current cell.
<b>c-RNTI</b> Set to C-RNTI that the UE had in the PCell it was connected to prior to suspension of the RRC connection.
<b>physCellId</b> Set to the physical cell identity of the PCell the UE was connected to prior to suspension of the RRC connection.
<b>resumeDiscriminator</b> A constant that allows differentiation in the calculation of the MAC-I for <i>shortResumeMAC-I</i> The resumeDiscriminator is set to '1'

## – **VarWLAN-MobilityConfig**

The UE variable *VarWLAN-MobilityConfig* includes information about WLAN for access selection and mobility.

### **VarWLAN-MobilityConfig UE variable**

```
-- ASN1START
VarWLAN-MobilityConfig ::=
    SEQUENCE {
        wlan-MobilitySet-r13          WLAN-Id-List-r13          OPTIONAL,
        successReportRequested        ENUMERATED {true}          OPTIONAL,
        wlan-SuspendConfig-r14        WLAN-SuspendConfig-r14    OPTIONAL
    }
-- ASN1STOP
```

<b>VarWLAN-MobilityConfig field descriptions</b>
<b>wlan-MobilitySet</b> Indicates the WLAN mobility set configured.
<b>successReportRequested</b> Indicates whether the UE shall report successful connection to WLAN. Applicable to LWA and LWIP.

## – **VarWLAN-Status**

The UE variable *VarWLAN-Status* includes information about the status of WLAN connection for LWA, RCLWI or LWIP.

### **VarWLAN-Status UE variable**

```
-- ASN1START
VarWLAN-Status-r13 ::=
    SEQUENCE {
        status-r13          WLAN-Status-r13,
        status-r14          WLAN-Status-v1430  OPTIONAL
    }
-- ASN1STOP
```

<b>VarWLAN-Status field descriptions</b>
<b>status</b> Indicates the connection status to WLAN and causes for connection failures.

## – **Multiplicity and type constraint definitions**

This clause includes multiplicity and type constraints applicable (only) for UE variables.

```
-- ASN1START
maxLogMeas-r10          INTEGER ::= 4060 -- Maximum number of logged measurement entries
                        -- that can be stored by the UE
-- ASN1STOP
```

```
-- ASN1STOP
```

– *End of EUTRA-UE-Variables*

```
-- ASN1START
```

```
END
```

```
-- ASN1STOP
```

## 7.1a NB-IoT UE variables

NOTE: To facilitate the specification of the UE behavioural requirements, UE variables are represented using ASN.1. Unless explicitly specified otherwise, it is however up to UE implementation how to store the variables. The optionality of the IEs in ASN.1 is used only to indicate that the values may not always be available.

– *NB-IoT-UE-Variables*

This ASN.1 segment is the start of the NB-IoT UE variable definitions.

```
-- ASN1START
NB-IoT-UE-Variables DEFINITIONS AUTOMATIC TAGS ::=
BEGIN
IMPORTS
    CellGlobalIdEUTRA,
    maxFreq,
    PLMN-IdentityList3-r11
FROM EUTRA-RRC-Definitions
    VarShortMAC-Input,
    VarShortResumeMAC-Input-r13
FROM EUTRA-UE-Variables
    ANR-CarrierList-NB-r16,
    ANR-MeasResult-NB-r16,
    maxFreqANR-NB-r16,
    MeasResultServCell-NB-r14,
    NRSRP-Range-NB-r14,
    RLF-Report-NB-r16
FROM NB-IoT-RRC-Definitions;
-- ASN1STOP
```

– *VarANR-MeasConfig-NB*

The UE variable *VarANR-MeasConfig-NB* includes the configuration of the measurements to be performed by the UE in RRC\_IDLE for ANR. The UE performs these measurements once while in RRC\_IDLE and only in the cell where it receives the measurement configuration.

### ***VarANR-MeasConfig-NB***

```
-- ASN1START
VarANR-MeasConfig-NB-r16 ::= SEQUENCE {
    anr-QualityThreshold-r16          NRSRP-Range-NB-r14,
    anr-CarrierList-r16              ANR-CarrierList-NB-r16
}
-- ASN1STOP
```

### – *VarANR-MeasReport-NB*

The UE variable *VarANR-MeasReport-NB* includes the stored ANR measurements information.

#### ***VarANR-MeasReport-NB***

```
-- ASN1START
VarANR-MeasReport-NB-r16 ::= SEQUENCE {
    plmn-IdentityList-r16          PLMN-IdentityList3-r11,
    servCellIdentity-r16          CellGlobalIdEUTRA,
    measResultServCell-r16        MeasResultServCell-NB-r14,
    relativeTimeStamp-r16         INTEGER (0..95),
    measResultList-r16            SEQUENCE (SIZE (1..maxFreqANR-NB-r16)) OF ANR-MeasResult-NB-r16
}
-- ASN1STOP
```

### – *VarRLF-Report-NB*

The UE variable *VarRLF-Report-NB* includes the radio link failure information.

#### ***VarRLF-Report-NB UE variable***

```
-- ASN1START
VarRLF-Report-NB-r16 ::= SEQUENCE {
    rlf-Report-r16                RLF-Report-NB-r16,
    plmn-IdentityList-r16         PLMN-IdentityList3-r11
}
-- ASN1STOP
```

### – *VarShortMAC-Input-NB*

The UE variable *VarShortMAC-Input-NB* specifies the input used to generate the shortMAC-I.

#### ***VarShortMAC-Input-NB UE variable***

```
-- ASN1START
VarShortMAC-Input-NB-r13 ::= VarShortMAC-Input
-- ASN1STOP
```

### – *VarShortResumeMAC-Input-NB*

The UE variable *VarShortResumeMAC-Input-NB* specifies the input used to generate the *shortResumeMAC-I* during RRC Connection Resume procedure.

#### ***VarShortResumeMAC-Input-NB UE variable***

```
-- ASN1START
VarShortResumeMAC-Input-NB-r13 ::= VarShortResumeMAC-Input-r13
-- ASN1STOP
```

– End of *NB-IOT-UE-Variables*

```
-- ASN1START  
END  
-- ASN1STOP
```

## 7.2 Counters

Counter	Reset	Incremented	When reaching max value



## 7.3 Timers

### 7.3.1 Timers (Informative)

Timer	Start	Stop	At expiry
T300 NOTE1	Transmission of <i>RRCCONNECTIONREQUEST</i> or <i>RRCCONNECTIONRESUME REQUEST</i> or <i>RRCEARLYDATAREQUEST</i>	Reception of <i>RRCCONNECTIONSETUP</i> , <i>RRCCONNECTIONREJECT</i> or <i>RRCCONNECTIONRESUME</i> or <i>RRCEARLYDATACOMPLETE</i> or <i>RRCCONNECTIONRELEASE</i> for UP-EDT, cell re-selection and upon abortion of connection establishment by upper layers	Perform the actions as specified in 5.3.3.6
T301 NOTE1	Transmission of <i>RRCCONNECTIONREESTABLISHMENTREQUEST</i>	Reception of <i>RRCCONNECTIONREESTABLISHMENT</i> or <i>RRCCONNECTIONREESTABLISHMENTREJECT</i> message as well as when the selected cell becomes unsuitable	Go to RRC_IDLE
T302	Reception of <i>RRCCONNECTIONREJECT</i> while performing RRC connection establishment or reception of <i>RRCCONNECTIONRELEASE</i> including <i>waitTime</i>	Upon entering RRC_CONNECTED and upon cell re-selection, or upon reception of <i>RRCEARLYDATACOMPLETE</i> or <i>RRCCONNECTIONRELEASE</i> for UP-EDT or <i>RRCCONNECTIONRELEASE</i> for UP transmission using PUR, or upon reception of <i>RRCCONNECTIONREJECT</i> message for E-UTRA/5GC.	Inform upper layers about barring alleviation as specified in 5.3.3.7
T303	Access barred while performing RRC connection establishment for mobile originating calls	Upon entering RRC_CONNECTED and upon cell re-selection, or upon reception of <i>RRCEARLYDATACOMPLETE</i> or <i>RRCCONNECTIONRELEASE</i> for UP-EDT or <i>RRCCONNECTIONRELEASE</i> for UP transmission using PUR.	Inform upper layers about barring alleviation as specified in 5.3.3.7
T304	Reception of <i>RRCCONNECTIONRECONFIGURATION</i> message including the <i>MobilityControl Info</i> or reception of <i>MobilityFromEUTRACommand</i> message including <i>CellChangeOrder</i> or upon conditional reconfiguration execution i.e. when applying a stored <i>RRCCONNECTIONRECONFIGURATION</i> message including the <i>MobilityControl Info</i> .	Criterion for successful completion of handover within E-UTRA, handover to E-UTRA or cell change order is met (the criterion is specified in the target RAT in case of inter-RAT)	In case of cell change order from E-UTRA or intra E-UTRA handover, initiate the RRC connection re-establishment procedure; In case of handover to E-UTRA, perform the actions defined in the specifications applicable for the source RAT; If any DAPS bearer is configured and if there is no RLF in source PCell, initiate the failure information procedure.
T305	Access barred while performing RRC connection establishment for mobile originating signalling	Upon entering RRC_CONNECTED and upon cell re-selection, or upon reception of <i>RRCEARLYDATACOMPLETE</i> or <i>RRCCONNECTIONRELEASE</i> for UP-EDT or <i>RRCCONNECTIONRELEASE</i> for UP transmission using PUR.	Inform upper layers about barring alleviation as specified in 5.3.3.7

Timer	Start	Stop	At expiry
T306	Access barred while performing RRC connection establishment for mobile originating CS fallback.	Upon entering RRC_CONNECTED and upon cell re-selection, or upon reception of <i>RRCEarlyDataComplete</i> or <i>RRCCConnectionRelease</i> for UP-EDT or <i>RRCCConnectionRelease</i> for UP transmission using PUR.	Inform upper layers about barring alleviation as specified in 5.3.3.7
T307	Reception of <i>RRCCConnectionReconfiguration</i> message including <i>MobilityControlInfoSCG</i>	Successful completion of random access on the PSCell, upon initiating re-establishment and upon SCG release	Initiate the SCG failure information procedure as specified in 5.6.13.
T308	Access barred due to ACDC while performing RRC connection establishment subject to ACDC	Upon entering RRC_CONNECTED and upon cell re-selection, or upon reception of <i>RRCEarlyDataComplete</i> or <i>RRCCConnectionRelease</i> for UP-EDT or <i>RRCCConnectionRelease</i> for UP transmission using PUR.	Inform upper layers about barring alleviation for ACDC as specified in 5.3.3.7
T309 NOTE1	When access attempt is barred at access barring check for an Access Category. The UE shall maintain one instance of this timer per Access Category.	Upon entering RRC_CONNECTED, upon cell (re)selection, upon reception of <i>RRCCConnectionRelease</i> , upon change of PCell while in RRC_CONNECTED, or upon reception of <i>MobilityFromEUTRACommand</i> .	Perform the actions as specified in 5.3.16.4.
T310 NOTE1 NOTE2	Upon detecting physical layer problems for the PCell i.e. upon receiving N310 consecutive out-of-sync indications from lower layers	Upon receiving N311 consecutive in-sync indications from lower layers for the PCell, upon triggering the handover procedure, upon initiating the connection re-establishment procedure, and upon initiating the MCG failure information procedure, upon expiry of <i>t-Service</i> or being out of the current serving cell coverage in discontinuous coverage scenario.	If security is not activated and the UE is not a NB-IoT UE that supports RRC connection re-establishment for the Control Plane CIoT EPS/5GS optimisation: go to RRC_IDLE else: initiate the MCG failure information procedure as specified in 5.6.26 or the connection re-establishment procedure as specified in 5.3.7.
T311 NOTE1	Upon initiating the RRC connection re-establishment procedure	Selection of a suitable E-UTRA cell or a cell using another RAT.	Go to RRC_IDLE
T312 NOTE2	Upon triggering a measurement report for a measurement identity for which T312 has been configured and <i>useT312</i> has been set to true, while T310 is running	Upon receiving N311 consecutive in-sync indications from lower layers, upon triggering the handover procedure, upon initiating the connection re-establishment procedure, upon initiating the MCG failure information procedure, and upon the expiry of T310	Initiate the MCG failure information procedure as specified in 5.6.26 or the connection re-establishment procedure as specified in 5.3.7.
T313 NOTE2	Upon detecting physical layer problems for the PSCell i.e. upon receiving N313 consecutive out-of-sync indications from lower layers	Upon receiving N314 consecutive in-sync indications from lower layers for the PSCell, upon initiating the connection re-establishment procedure, upon SCG release and upon receiving <i>RRCCConnectionReconfiguration</i> including <i>MobilityControlInfoSCG</i>	Inform E-UTRAN about the SCG radio link failure by initiating the SCG failure information procedure as specified in 5.6.13.

Timer	Start	Stop	At expiry
T314 NOTE2	Upon early detecting physical layer problems for the PCell i.e. upon receiving N310 consecutive "early-out-of-sync" indications from lower layers.	Upon receiving N311 consecutive in-sync indications from lower layers for the PCell, upon triggering the handover procedure and upon initiating the connection re-establishment procedure	Initiate the UE Assistance Information procedure to report early detection of physical layer problems in accordance with 5.6.10.
T315 NOTE2	Upon detecting physical layer improvements of the PCell i.e. upon receiving N311 consecutive "early-in-sync" indications from lower layers.	Upon receiving N310 consecutive "early-out-of-sync" indications from lower layers for the PCell.	Initiate the UE Assistance Information procedure to report detection of physical layer improvements in accordance with 5.6.10.
T316	Upon transmission of the <i>MCGFailureInformation</i> message	Upon receiving <i>RRCCConnectionRelease</i> , <i>RRCCConnectionReconfiguration</i> with <i>mobilityControlInfo</i> , <i>MobilityFromEUTRACommand</i> , or upon initiating the re-establishment procedure,	Perform the actions as specified in 5.6.26.5.
T317 NOTE1	Start or restart from the subframe indicated by <i>epochTime</i> upon reception of <i>SystemInformationBlockType31</i> ( <i>SystemInformationBlockType31-NB</i> in NB-IoT), or upon reception of <i>RRCCConnectionReconfiguration</i> message for the target cell including <i>mobilityControlInfo</i> , or upon conditional reconfiguration execution i.e. when applying a stored <i>RRCCConnectionReconfiguration</i> message for the target cell including <i>mobilityControlInfo</i> .	Stop T317, if it is running, for the source cell upon reception of <i>RRCCConnectionReconfiguration</i> message including <i>mobilityControlInfo</i> , or upon conditional reconfiguration execution i.e. when applying a stored <i>RRCCConnectionReconfiguration</i> message including <i>mobilityControlInfo</i> .	Perform the actions as specified in 5.3.18.
T318 NOTE1	Upon starting acquisition of <i>SystemInformationBlockType31</i> ( <i>SystemInformationBlockType31-NB</i> in NB-IoT) in RRC_CONNECTED	Upon successful acquisition of <i>SystemInformationBlockType31</i> ( <i>SystemInformationBlockType31-NB</i> in NB-IoT) if broadcast, and optionally after successful acquisition of <i>SystemInformationBlockType33</i> ( <i>SystemInformationBlockType33-NB</i> in NB-IoT) if broadcast, in RRC_CONNECTED, as specified in 5.3.18.	If security is not activated and the UE is not a NB-IoT UE that supports RRC connection re-establishment for the Control Plane Clot EPS optimisation: go to RRC_IDLE else: initiate the connection re-establishment procedure as specified in 5.3.7.
T320	Upon receiving <i>t320</i> or upon cell (re)selection to E-UTRA from another RAT with validity time configured for dedicated priorities (in which case the remaining validity time is applied).	Upon entering RRC_CONNECTED, when PLMN selection is performed on request by NAS, when the UE enters RRC_IDLE from RRC_INACTIVE, or upon cell (re)selection to another RAT (in which case the timer is carried on to the other RAT), or upon reception of <i>RRCEarlyDataComplete</i> or <i>RRCCConnectionRelease</i> for UP-EDT or <i>RRCCConnectionRelease</i> for UP transmission using PUR.	Discard the cell reselection priority information provided by dedicated signalling.

Timer	Start	Stop	At expiry
T321	Upon receiving <i>measConfig</i> including a <i>reportConfig</i> with the <i>purpose</i> set to <i>reportCGI</i>	Upon acquiring the information needed to set all fields of <i>cellGlobalId</i> for the requested cell, upon receiving <i>measConfig</i> that includes removal of the <i>reportConfig</i> with the <i>purpose</i> set to <i>reportCGI</i> and upon detecting that a cell is not broadcasting SIB1.	Initiate the measurement reporting procedure, stop performing the related measurements and remove the corresponding <i>measId</i>
T322 NOTE1	Upon receiving <i>redirectedCarrierOffsetDedicated</i> included in <i>RedirectedCarrierInfo</i>	Upon entering RRC_CONNECTED, when PLMN selection is performed on request by NAS, or upon cell (re)selection to another frequency or RAT, or upon reception of <i>RRCEarlyDataComplete</i> or <i>RRCCConnectionRelease</i> for UP-EDT or <i>RRCCConnectionRelease</i> for UP transmission using PUR.	Release <i>redirectedCarrierOffsetDedicated</i> .
T323	Upon receiving <i>t323</i> .	Upon entering RRC_CONNECTED, when PLMN selection is performed on request by NAS, when the UE enters RRC_IDLE from RRC_INACTIVE, or upon cell (re)selection to another RAT, or upon reception of <i>RRCEarlyDataComplete</i> or <i>RRCCConnectionRelease</i> for UP-EDT or <i>RRCCConnectionRelease</i> for UP transmission using PUR.	Discard the <i>altFreqPriorities</i> provided by dedicated signalling. UE shall apply the cell reselection priority information broadcast in the system information via <i>cellReselectionPriority</i> and <i>cellReselectionSubPriority</i> .
T325	Timer (re)started upon receiving <i>RRCCConnectionReject</i> message with <i>deprioritisationTimer</i> .		Stop deprioritisation of all frequencies or E-UTRA signalled by <i>RRCCConnectionReject</i> .
T326 NOTE1	Upon entering RRC_CONNECTED, upon update to <i>NRSRP<sub>Ref</sub></i> .	Upon leaving RRC_CONNECTED.	Stop performing connected mode neighbour cell measurement.
T330	Upon receiving <i>LoggedMeasurementConfiguration</i> message	Upon log volume exceeding the suitable UE memory, upon initiating the release of <i>LoggedMeasurementConfiguration</i> procedure	Perform the actions specified in 5.6.6.4
T331	Upon receiving <i>RRCCConnectionRelease</i> message including <i>measIdleConfig</i> .	Upon receiving <i>RRCCConnectionSetup</i> , <i>RRCCConnectionResume</i> , <i>RRCCConnectionRelease</i> with an idle/inactive measurement configuration or indication to release the configuration, if <i>validityArea</i> is configured, upon cell selection/reselection to a cell that does not belong to the <i>validityArea</i> (if configured), or upon reselecting to an inter-RAT cell.	Perform the actions specified in 5.6.20.3.
T340 NOTE2	Upon transmitting <i>UEAssistanceInformation</i> message with <i>powerPrefIndication</i> set to <i>normal</i>	Upon releasing <i>powerPrefIndication</i> during the connection re-establishment procedure	No action.

Timer	Start	Stop	At expiry
T341 NOTE2	Upon transmitting <i>UEAssistanceInformation</i> message with <i>bw-Preference</i> .	Upon resuming an RRC connection or upon releasing <i>bw-Preference</i> during the connection re-establishment procedure	No action.
T342 NOTE2	Upon transmitting <i>UEAssistanceInformation</i> message with <i>delayBudgetReport</i> .	Upon releasing <i>delayBudgetReportingConfig</i> during the connection re-establishment and connection resume procedures	No action.
T343 NOTE2	Upon transmitting <i>UEAssistanceInformation</i> message with <i>RLM-Report</i> including <i>earlyOutOfSync</i> .	Upon initiating the connection re-establishment procedure	No action.
T344 NOTE2	Upon transmitting <i>UEAssistanceInformation</i> message with <i>RLM-Report</i> including <i>earlyInSync</i> .	Upon initiating the connection re-establishment procedure	No action.
T345	Upon transmitting <i>UEAssistanceInformation</i> message with <i>overheatingAssistance</i>	Upon releasing <i>overheatingAssistance</i> during the connection re-establishment procedure, or connection resume procedure.	No action.
T346	Upon transmitting <i>UEAssistanceInformation</i> message with <i>scg-DeactivationPreference</i>	Upon releasing <i>scg-DeactivationPreferenceConfig</i> during the RRC connection establishment or re-establishment procedures, or upon reconfiguration of <i>scg-DeactivationPreferenceConfig</i> to <i>release</i> .	No action.
T350	Upon entering RRC_IDLE if <i>t350</i> has been received in <i>wlan-OffloadInfo</i> .	Upon entering RRC_CONNECTED, or upon cell reselection.	Perform the actions specified in 5.6.12.4.
T351	Reception of <i>RRCCConnectionReconfiguration</i> message including the association <i>Timer</i> in <i>WLAN-MobilityConfig</i> .	Upon successful connection to WLAN, upon WLAN connection failure, upon leaving RRC_CONNECTED, upon triggering the handover procedure, or upon initiating the connection re-establishment procedure.	Perform WLAN Connection Status Reporting specified in 5.6.15.2.
T360	Upon performing the redistribution target selection as specified in TS 36.304 [4].	Upon entering RRC_CONNECTED, upon receiving a Paging message including <i>redistributionIndication</i> ; upon reselecting a cell not belonging to the redistribution target.	Stop considering a frequency or cell to be redistribution target, and perform the redistribution target selection if the condition specified in TS 36.304 [4] is met.
T370	Upon receiving <i>SL-DiscConfig</i> including a <i>discSysInfoToReportConfig</i> set to <i>setup</i> .	Upon initiating the transmission of <i>SidelinkUEInformation</i> including <i>discSysInfoReportFreqList</i> , upon receiving <i>SL-DiscConfig</i> including <i>discSysInfoToReportConfig</i> set to <i>release</i> , upon handover and re-establishment.	Release <i>discSysInfoToReportConfig</i> .
T380	Upon reception of <i>periodic-RNAU-timer</i> in <i>RRCCConnectionRelease</i> .	Upon reception of <i>RRCCConnectionResume</i> , <i>RRCCConnectionRelease</i> or <i>RRCCConnectionSetup</i> .	Initiate the RAN notification area update procedure

Timer	Start	Stop	At expiry
T390 NOTE1	Upon GNSS validity duration expiry if <i>ul-TransmissionExtensionEnabled</i> is configured.	Upon leaving RRC_CONNECTED, or upon reception of network triggered GNSS measurement, or upon initiating the connection re-establishment procedure, or upon indication that a new GNSS position becomes valid during available idle periods in RRC_CONNECTED.	Perform the actions as specified in 5.3.3.21.
NOTE1: Only the timers marked with "NOTE1" are applicable to NB-IoT. NOTE2: The behaviour as specified in 7.3.2 applies.			

### 7.3.2 Timer handling

When the UE applies zero value for a timer, the timer shall be started and immediately expire unless explicitly stated otherwise.

## 7.4 Constants

Constant	Usage
N310	Maximum number of consecutive "out-of-sync" or "early-out-of-sync" indications for the PCell received from lower layers
N311	Maximum number of consecutive "in-sync" or "early-in-sync" indications for the PCell received from lower layers
N313	Maximum number of consecutive "out-of-sync" indications for the PSCell received from lower layers
N314	Maximum number of consecutive "in-sync" indications for the PSCell received from lower layers

## 8 Protocol data unit abstract syntax

### 8.1 General

The RRC PDU contents in clause 6, clause 9.3.2 and clause 10 are described using abstract syntax notation one (ASN.1) as specified in ITU-T Rec. X.680 [13] and X.681 [14]. Transfer syntax for RRC PDUs is derived from their ASN.1 definitions by use of Packed Encoding Rules, unaligned as specified in ITU-T Rec. X.691 [15].

The following encoding rules apply in addition to what has been specified in X.691:

- When a bit string value is placed in a bit-field as specified in 15.6 to 15.11 in X.691, the leading bit of the bit string value shall be placed in the leading bit of the bit-field, and the trailing bit of the bit string value shall be placed in the trailing bit of the bit-field.

NOTE: The terms 'leading bit' and 'trailing bit' are defined in ITU-T Rec. X.680. When using the 'bstring' notation, the leading bit of the bit string value is on the left, and the trailing bit of the bit string value is on the right.

- When decoding types constrained with the ASN.1 Contents Constraint ("CONTAINING"), automatic decoding of the contained type should not be performed because errors in the decoding of the contained type should not cause the decoding of the entire RRC message PDU to fail. It is recommended that the decoder first decodes the outer PDU type that contains the OCTET STRING or BIT STRING with the Contents Constraint, and then decodes the contained type that is nested within the OCTET STRING or BIT STRING as a separate step.

- When decoding a) RRC message PDUs, b) BIT STRING constrained with a Contents Constraint, or c) OCTET STRING constrained with a Contents Constraint, PER decoders are required to never report an error if there are extraneous zero or non-zero bits at the end of the encoded RRC message PDU, BIT STRING or OCTET STRING.

## 8.2 Structure of encoded RRC messages

An RRC PDU, which is the bit string that is exchanged between peer entities/ across the radio interface contains the basic production as defined in X.691.

RRC PDUs shall be mapped to and from PDCP SDUs (in case of DCCH) or RLC SDUs (in case of PCCH, BCCH, BR-BCCH, CCCH or MCCH) upon transmission and reception as follows:

- when delivering an RRC PDU as a PDCP SDU to the PDCP layer for transmission, the first bit of the RRC PDU shall be represented as the first bit in the PDCP SDU and onwards; and
- when delivering an RRC PDU as an RLC SDU to the RLC layer for transmission, the first bit of the RRC PDU shall be represented as the first bit in the RLC SDU and onwards; and
- upon reception of a PDCP SDU from the PDCP layer, the first bit of the PDCP SDU shall represent the first bit of the RRC PDU and onwards; and
- upon reception of an RLC SDU from the RLC layer, the first bit of the RLC SDU shall represent the first bit of the RRC PDU and onwards.

## 8.3 Basic production

The 'basic production' is obtained by applying UNALIGNED PER to the abstract syntax value (the ASN.1 description) as specified in X.691. It always contains a multiple of 8 bits.

## 8.4 Extension

The following rules apply with respect to the use of protocol extensions:

- A transmitter compliant with this version of the specification shall, unless explicitly indicated otherwise on a PDU type basis, set the extension part empty. Transmitters compliant with a later version may send non-empty extensions;
- A transmitter compliant with this version of the specification shall set spare bits to zero;

## 8.5 Padding

If the encoded RRC message does not fill a transport block, the RRC layer shall add padding bits. This applies to PCCH, BCCH and BR-BCCH.

Padding bits shall be set to 0 and the number of padding bits is a multiple of 8.



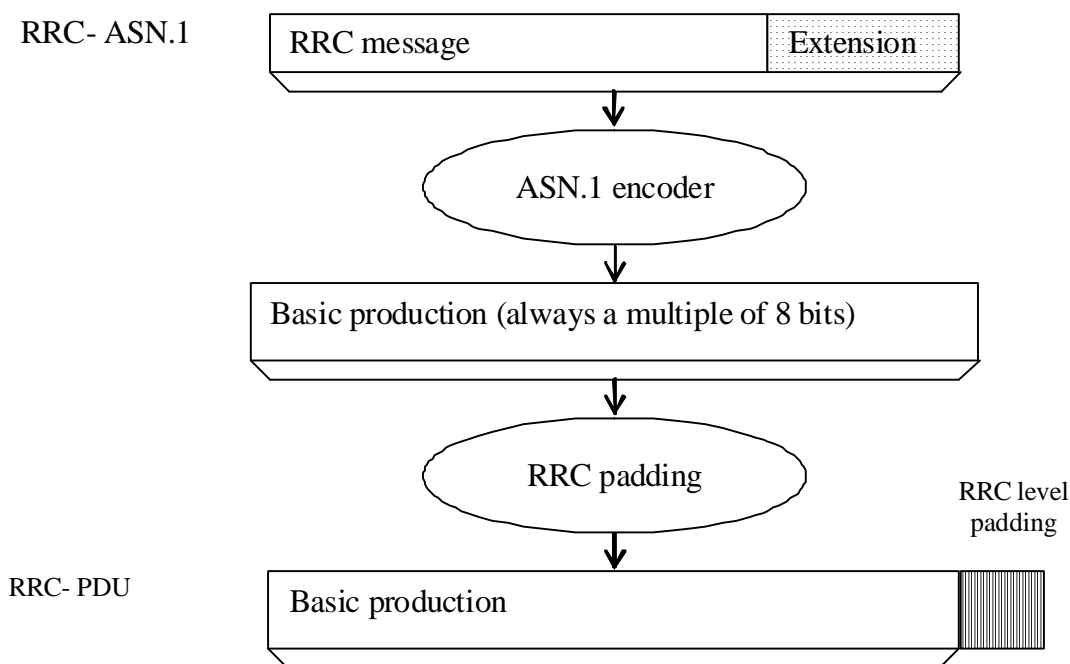

Figure 8.5-1: RRC level padding

## 9 Specified and default radio configurations

Specified and default configurations are configurations of which the details are specified in the standard. Specified configurations are fixed while default configurations can be modified using dedicated signalling.

### 9.1 Specified configurations

#### 9.1.1 Logical channel configurations

##### 9.1.1.1 BCCH configuration

Parameters

Name	Value	Semantics description	Ver
PDCP configuration	N/A		
RLC configuration	TM		
MAC configuration	TM		

NOTE: RRC will perform padding, if required due to the granularity of the TF signalling, as defined in 8.5.

##### 9.1.1.2 CCCH configuration

Parameters

Name	Value	Semantics description	Ver
PDCP configuration	N/A		
RLC configuration	TM		

Name	Value	Semantics description	Ver
MAC configuration		Normal MAC headers are used	
Logical channel configuration			
<i>priority</i>	1	Highest priority	
<i>prioritisedBitRate</i>	infinity		
<i>bucketSizeDuration</i>	N/A		
<i>logicalChannelGroup</i>	0		
<i>logicalChannelSR-Mask-r9</i>	release		v920

### 9.1.1.3 PCCH configuration

Parameters

Name	Value	Semantics description	Ver
PDCP configuration	N/A		
RLC configuration	TM		
MAC configuration	TM		

NOTE: RRC will perform padding, if required due to the granularity of the TF signalling, as defined in 8.5.

### 9.1.1.4 MCCH and MTCH configuration

Parameters

Name	Value	Semantics description	Ver
PDCP configuration	N/A		
RLC configuration	UM		
<i>sn-FieldLength</i>	size5		
<i>t-Reordering</i>	0		

### 9.1.1.5 SBCCH configuration

Parameters

Name	Value	Semantics description	Ver
PDCP configuration	N/A		
RLC configuration	TM		
MAC configuration	TM		

NOTE: RRC will perform padding, if required due to the granularity of the TF signalling, as defined in 8.5.

### 9.1.1.6 STCH configuration

Parameters

Name	Value	Semantics description	Ver
PDCP configuration			
discardTimer	Undefined	Up to UE implementation	
pdcp-SN-Size	16		
maxCID	15		
profiles			
t-Reordering (PDCP)	Undefined	Only used for V2X sidelink communication. Selected by the receiving UE, up to UE implementation	V1520
RLC configuration		Uni-directional UM RLC UM window size is set to 0	
		Uni-directional UM RLC UM window size is set to 0 for sidelink communication	v1440
<i>sn-FieldLength</i>	5		
logicalChannelIdentity	Undefined	Selected by the transmitting UE, up to UE implementation	
Logical channel configuration			
priority	Undefined	Selected by the transmitting UE, up to UE implementation	
prioritisedBitRate	Undefined	Selected by the transmitting UE, up to UE implementation	
bucketSizeDuration	Undefined	Selected by the transmitting UE, up to UE implementation	
logicalChannelGroup	3		
t-Reordering	Undefined	Only used for V2X sidelink communication. Selected by the receiving UE, up to UE implementation	v1440
MAC configuration			

### 9.1.1.7 SC-MCCH and SC-MTCH configuration

Parameters

Name	Value	Semantics description	Ver
PDCP configuration	N/A		
RLC configuration	UM		
<i>sn-FieldLength</i>	size5		
<i>t-Reordering</i>	0		

### 9.1.1.8 BR-BCCH configuration

Parameters

Name	Value	Semantics description	Ver
PDCP configuration	N/A		
RLC configuration	TM		
MAC configuration	TM		

NOTE: RRC will perform padding, if required due to the granularity of the TF signalling, as defined in 8.5.

## 9.1.2 SRB configurations

### 9.1.2.1 SRB1

Parameters

Name	Value	Semantics description	Ver
RLC configuration			
<i>logicalChannelIdentity</i>	1		

### 9.1.2.1a SRB1bis

Parameters

Name	Value	Semantics description	Ver
RLC configuration			
<i>logicalChannelIdentity</i>	3		

### 9.1.2.2 SRB2

Parameters

Name	Value	Semantics description	Ver
RLC configuration			
<i>logicalChannelIdentity</i>	2		

### 9.1.2.3 SRB4

Parameters

Name	Value	Semantics description	Ver
RLC configuration			
<i>logicalChannelIdentity</i>	4		

## 9.2 Default radio configurations

The following clauses only list default values for REL-8 parameters included in protocol version v8.5.0. For all fields introduced in a later protocol version, the default value is "released" unless explicitly specified otherwise. If UE is to apply default configuration while it is configured with some critically extended fields, the UE shall apply the original version with only default values. For the following fields, introduced in a protocol version later than v8.5.0, the default corresponds with "value not applicable":

- *codeBookSubsetRestriction-v920*;
- *pmi-RI-Report*;

NOTE 1: Value "N/A" indicates that the UE does not apply a specific value (i.e. upon switching to a default configuration, E-UTRAN can not assume the UE keeps the previously configured value). This implies that E-UTRAN needs to configure a value before invoking the related functionality.

NOTE 2: In general, the signalling should preferably support a "release" option for fields introduced after v8.5.0. The "value not applicable" should be used restrictively, mainly limited to for fields which value is relevant only if another field is set to a value other than its default.

## 9.2.1 SRB configurations

### 9.2.1.1 SRB1

#### Parameters

Name	Value	NB-IoT	Semantics description	Ver
RLC configuration CHOICE	am	am		
<i>ul-RLC-Config</i>				
> <i>t-PollRetransmit</i>	ms45	ms25000		
> <i>pollPDU</i>	infinity	N/A		
> <i>pollByte</i>	infinity	N/A		
> <i>maxRetxThreshold</i>	t4	t4		
<i>dl-RLC-Config</i>				
> <i>t-Reordering</i>	ms35	released		
> <i>t-StatusProhibit</i>	ms0	N/A		
> <i>enableStatusReportSN-Gap</i>	N/A	disabled		
Logical channel configuration				
<i>priority</i>	1	1	Highest priority	
<i>prioritisedBitRate</i>	infinity	N/A		
<i>bucketSizeDuration</i>	N/A	N/A		
<i>logicalChannelGroup</i>	0	N/A		
<i>logicalChannelSR-Prohibit</i>	N/A	TRUE		

### 9.2.1.2 SRB2

#### Parameters

Name	Value	Semantics description	Ver
RLC configuration CHOICE	am		
<i>ul-RLC-Config</i>			
> <i>t-PollRetransmit</i>	ms45		
> <i>pollPDU</i>	infinity		
> <i>pollByte</i>	infinity		
> <i>maxRetxThreshold</i>	t4		
<i>dl-RLC-Config</i>			
> <i>t-Reordering</i>	ms35		
> <i>t-StatusProhibit</i>	ms0		
Logical channel configuration			

Name	Value	Semantics description	Ver
<i>priority</i>	3		
<i>prioritisedBitRate</i>	infinity		
<i>bucketSizeDuration</i>	N/A		
<i>logicalChannelGroup</i>	0		

## 9.2.2 Default MAC main configuration

Parameters

Name	Value	NB-IoT	Semantics description	Ver
MAC main configuration				
<i>maxHARQ-tx</i>	n5	N/A		
<i>periodicBSR-Timer</i>	infinity	pp8		
<i>retxBSR-Timer</i>	sf2560	infinity		
<i>ttxBundling</i>	FALSE	N/A		
<i>drx-Config</i>	release	N/A		
<i>phr-Config</i>	release	N/A		

## 9.2.3 Default semi-persistent scheduling configuration

SPS-Config			
> <i>sps-ConfigDL</i>	release		
> <i>sps-ConfigUL</i>	release		

## 9.2.4 Default physical channel configuration

Parameters (not applicable for NB-IoT)

Name	Value	Semantics description	Ver
<i>PDSCH-ConfigDedicated</i>			
> <i>p-a</i>	dB0		
<i>PUCCH-ConfigDedicated</i>			
> <i>tdd-AckNackFeedbackMode</i>	bundling	Only valid for TDD mode	
> <i>ackNackRepetition</i>	release		
<i>PUSCH-ConfigDedicated</i>			
> <i>betaOffset-ACK-Index</i>	10		
> <i>betaOffset-RI-Index</i>	12		
> <i>betaOffset-CQI-Index</i>	15		

Name	Value	Semantics description	Ver
<i>UplinkPowerControlDedicated</i>			
> <i>p0-UE-PUSCH</i>	0		
> <i>deltaMCS-Enabled</i>	en0 (disabled)		
> <i>accumulationEnabled</i>	TRUE		
> <i>p0-UE-PUCCH</i>	0		
> <i>pSRS-Offset</i>	7		
> <i>filterCoefficient</i>	fc4		
<i>tpc-pdcch-ConfigPUCCH</i>	release		
<i>tpc-pdcch-ConfigPUSCH</i>	release		
<i>CQI-ReportConfig</i>			
> <i>CQI-ReportPeriodic</i>	release		
> <i>cqi-ReportModeAperiodic</i>	N/A		
> <i>nomPDSCH-RS-EPRE-Offset</i>	N/A		
<i>SoundingRS-UL-ConfigDedicated</i>	release		
<i>AntennaInfoDedicated</i>			
> <i>transmissionMode</i>	tm1, tm2	If the number of PBCH antenna ports is one, tm1 is used as default; otherwise tm2 is used as default	
> <i>codebookSubsetRestriction</i>	N/A		
> <i>ue-TransmitAntennaSelection</i>	release		
<i>SchedulingRequestConfig</i>	release		

## Parameters applicable for NB-IoT

Name	Value	Semantics description	Ver
<i>NPUSCH-ConfigDedicated-NB</i>			
> <i>ack-NACK-NumRepetitions</i>	N/A		
> <i>npusch-AllSymbols</i>	TRUE		
<i>UplinkPowerControlDedicated</i>			
> <i>p0-UE-NPUSCH</i>	0		

## 9.2.5 Default values timers and constants

## Parameters

Name	Value	Semantics description	Ver
t310	ms1000		
n310	n1		
t311	ms1000		
n311	n1		

## 9.3 Sidelink pre-configured parameters

### 9.3.1 Specified parameters

This clause only list parameters which value is specified in the standard.

Parameters

Name	Value	Semantics description	Ver
<i>preconfigSync</i> >syncTxParameters >>alpha	0		
<i>preconfigComm</i> >sc-TxParameters >>alpha >dataTxParameters >>alpha	0 0		
<i>v2x-CommPreconfigSync</i> >syncTxParameters >>alpha	0		
<i>v2x-CommTxPoolList, p2x-CommTxPoolList</i> >dataTxParameters >>alpha	0		

### 9.3.2 Pre-configurable parameters

This ASN.1 segment is the start of the E-UTRA definitions of pre-configured sidelink parameters.

NOTE 1: Upper layers are assumed to provide a set of pre-configured parameters that are valid at the current UE location if any, see TS 24.334 [69], clause 10.2.

```
-- ASN1START
EUTRA-Sidelink-Preconf DEFINITIONS AUTOMATIC TAGS ::=
BEGIN
IMPORTS
    AdditionalSpectrumEmission,
    AdditionalSpectrumEmission-v1010,
    ARFCN-ValueEUTRA-r9,
    FilterCoefficient,
    maxCBR-Level-r14,
    maxCBR-Level-1-r14,
    maxFreq,
    maxFreqV2X-r14,
    maxSL-TxPool-r12,
    maxSL-CommRxPoolPreconf-v1310,
    maxSL-CommTxPoolPreconf-v1310,
    maxSL-DiscRxPoolPreconf-r13,
    maxSL-DiscTxPoolPreconf-r13,
    maxSL-V2X-CBRConfig2-r14,
    maxSL-V2X-CBRConfig2-1-r14,
    maxSL-V2X-RxPoolPreconf-r14,
```



```

maxSL-V2X-TxConfig2-r14,
maxSL-V2X-TxConfig2-1-r14,
maxSL-V2X-TxPoolPreconf-r14,
MCS-PSSCH-Range-r15,
P-Max,
ReselectionInfoRelay-r13,
SL-AnchorCarrierFreqList-V2X-r14,
SL-CBR-Levels-Config-r14,
SL-CBR-PSSCH-TxConfig-r14,
SL-CommTxPoolSensingConfig-r14,
SL-CP-Len-r12,
SL-HoppingConfigComm-r12,
SL-NR-AnchorCarrierFreqList-r16,
SL-OffsetIndicator-r12,
SL-OffsetIndicatorSync-r12,
SL-OffsetIndicatorSync-v1430,
SL-PeriodComm-r12,
RSRP-RangeSL3-r12,
SL-MinT2ValueList-r15,
SL-PriorityList-r13,
SL-TF-ResourceConfig-r12,
SL-TRPT-Subset-r12,
SL-TxParameters-r12,
SL-ZoneConfig-r14,
P0-SL-r12,
TDD-ConfigSL-r12,
SubframeBitmapSL-r14,
SL-P2X-ResourceSelectionConfig-r14,
SL-RestrictResourceReservationPeriodList-r14,
SL-SyncAllowed-r14,
SL-OffsetIndicatorSync-r14,
SL-Priority-r13,
SL-V2X-FreqSelectionConfigList-r15,
SL-V2X-PacketDuplicationConfig-r15,
SL-V2X-SyncFreqList-r15
FROM EUTRA-RRC-Definitions;

-- ASN1STOP

```

## – SL-Preconfiguration

The IE *SL-Preconfiguration* includes the sidelink pre-configured parameters.

### SL-Preconfiguration information elements

```

-- ASN1START
SL-Preconfiguration-r12 ::= SEQUENCE {
  preconfigGeneral-r12          SL-PreconfigGeneral-r12,
  preconfigSync-r12            SL-PreconfigSync-r12,
  preconfigComm-r12            SL-PreconfigCommPoolList4-r12,
  ...,
  [[ preconfigComm-v1310        SEQUENCE {
    commRxPoolList-r13          SL-PreconfigCommRxPoolList-r13,
    commTxPoolList-r13          SL-PreconfigCommTxPoolList-r13      OPTIONAL
  }
  preconfigDisc-r13            SEQUENCE {
    discRxPoolList-r13          SL-PreconfigDiscRxPoolList-r13,
    discTxPoolList-r13          SL-PreconfigDiscTxPoolList-r13      OPTIONAL
  }
  preconfigRelay-r13           SL-PreconfigRelay-r13      OPTIONAL
]]
}

SL-PreconfigGeneral-r12 ::= SEQUENCE {
  -- PDCP configuration
  rohc-Profiles-r12            SEQUENCE {
    profile0x0001-r12           BOOLEAN,
    profile0x0002-r12           BOOLEAN,
    profile0x0004-r12           BOOLEAN,
    profile0x0006-r12           BOOLEAN,
    profile0x0101-r12           BOOLEAN,
    profile0x0102-r12           BOOLEAN,

```

```

        profile0x0104-r12                BOOLEAN
    },
    -- Physical configuration
    carrierFreq-r12                       ARFCN-ValueEUTRA-r9,
    maxTxPower-r12                         P-Max,
    additionalSpectrumEmission-r12        AdditionalSpectrumEmission,
    sl-bandwidth-r12                       ENUMERATED {n6, n15, n25, n50, n75, n100},
    tdd-ConfigSL-r12                       TDD-ConfigSL-r12,
    reserved-r12                            BIT STRING (SIZE (19)),
    ...
    [[ additionalSpectrumEmission-v1440     AdditionalSpectrumEmission-v1010     OPTIONAL
    ]]
}

SL-PreconfigSync-r12 ::= SEQUENCE {
    syncCP-Len-r12                        SL-CP-Len-r12,
    syncOffsetIndicator1-r12              SL-OffsetIndicatorSync-r12,
    syncOffsetIndicator2-r12              SL-OffsetIndicatorSync-r12,
    syncTxParameters-r12                  P0-SL-r12,
    syncTxThreshOoC-r12                   RSRP-RangeSL3-r12,
    filterCoefficient-r12                 FilterCoefficient,
    syncRefMinHyst-r12                    ENUMERATED {dB0, dB3, dB6, dB9, dB12},
    syncRefDiffHyst-r12                   ENUMERATED {dB0, dB3, dB6, dB9, dB12, dBinf},
    ...
    [[ syncTxPeriodic-r13                  ENUMERATED {true}                OPTIONAL
    ]]
}

SL-PreconfigCommPoolList4-r12 ::= SEQUENCE (SIZE (1..maxSL-TxPool-r12)) OF SL-PreconfigCommPool-r12

SL-PreconfigCommRxPoolList-r13 ::= SEQUENCE (SIZE (1..maxSL-CommRxPoolPreconf-v1310)) OF SL-PreconfigCommPool-r12

SL-PreconfigCommTxPoolList-r13 ::= SEQUENCE (SIZE (1..maxSL-CommTxPoolPreconf-v1310)) OF SL-PreconfigCommPool-r12

SL-PreconfigCommPool-r12 ::= SEQUENCE {
    -- This IE is same as SL-CommResourcePool with rxParametersNCell absent
    sc-CP-Len-r12                        SL-CP-Len-r12,
    sc-Period-r12                        SL-PeriodComm-r12,
    sc-TF-ResourceConfig-r12             SL-TF-ResourceConfig-r12,
    sc-TxParameters-r12                   P0-SL-r12,
    data-CP-Len-r12                       SL-CP-Len-r12,
    data-TF-ResourceConfig-r12           SL-TF-ResourceConfig-r12,
    dataHoppingConfig-r12                 SL-HoppingConfigComm-r12,
    dataTxParameters-r12                  P0-SL-r12,
    trpt-Subset-r12                       SL-TRPT-Subset-r12,
    ...
    [[ priorityList-r13                   SL-PriorityList-r13             OPTIONAL    -- For Tx
    ]]
}

SL-PreconfigDiscRxPoolList-r13 ::= SEQUENCE (SIZE (1..maxSL-DiscRxPoolPreconf-r13)) OF SL-PreconfigDiscPool-r13

SL-PreconfigDiscTxPoolList-r13 ::= SEQUENCE (SIZE (1..maxSL-DiscTxPoolPreconf-r13)) OF SL-PreconfigDiscPool-r13

SL-PreconfigDiscPool-r13 ::= SEQUENCE {
    -- This IE is same as SL-DiscResourcePool with rxParameters absent
    cp-Len-r13                            SL-CP-Len-r12,
    discPeriod-r13                        ENUMERATED {rf4, rf6, rf7, rf8, rf12, rf14, rf16, rf24, rf28,
    rf32, rf64, rf128, rf256, rf512, rf1024, spare},
    numRetx-r13                            INTEGER (0..3),
    numRepetition-r13                      INTEGER (1..50),
    tf-ResourceConfig-r13                  SL-TF-ResourceConfig-r12,
    txParameters-r13                       SEQUENCE {
        txParametersGeneral-r13            P0-SL-r12,
        txProbability-r13                  ENUMERATED {p25, p50, p75, p100}
    }
    ...
}

SL-PreconfigRelay-r13 ::= SEQUENCE {
    reselectionInfoOoC-r13                 ReselectionInfoRelay-r13
}

```

-- ASN1STOP

<b>SL-Preconfiguration field descriptions</b>
<p><b>carrierFreq</b> Indicates the carrier frequency for out of coverage sidelink communication and sidelink discovery. In case of FDD it is uplink carrier frequency and the corresponding downlink frequency can be determined from the default TX-RX frequency separation defined in TS 36.101 [42], table 5.7.3-1.</p>
<p><b>additionalSpectrumEmission</b> The UE requirements related to IE <i>AdditionalSpectrumEmission</i> are defined in TS 36.101 [42], clause 6.2.4. If <i>additionalSpectrumEmissionExt-r14</i> is configured, the UE only considers <i>additionalSpectrumEmissionExt-r14</i> (and ignores <i>additionalSpectrumEmission-r12</i>).</p>
<p><b>commRxPoolList</b> Indicates a list of reception pools for sidelink communication in addition to the resource pools indicated by <i>preconfigComm</i>.</p>
<p><b>commTxPoolList</b> Indicates a list of transmission pools for sidelink communication in addition to the first resource pool within <i>preconfigComm</i>.</p>
<p><b>preconfigComm</b> Indicates a list of resource pools. The first resource pool in the list is used for both reception and transmission of sidelink communication. The other resource pools, if present, are only used for reception of sidelink communication.</p>
<p><b>syncRefDiffHyst</b> Hysteresis when evaluating a SyncRef UE using relative comparison. Value <i>dB0</i> corresponds to 0 dB, <i>dB3</i> to 3 dB and so on, value <i>dBInf</i> corresponds to infinite dB.</p>
<p><b>syncRefMinHyst</b> Hysteresis when evaluating a SyncRef UE using absolute comparison. Value <i>dB0</i> corresponds to 0 dB, <i>dB3</i> to 3 dB and so on.</p>

NOTE 1: The network may configure one or more of the reception only resource pools in *preconfigComm* to cover reception from in coverage UEs using scheduled resource allocation. For such a resource pool the network should set all bits of *subframeBitmap* to 1 and *offsetIndicator* to indicate the subframe immediately following the sidelink control information.

NOTE 2: The network should ensure that the resources defined by the first entry in *preconfigComm* (used for transmission by an out of coverage UE) do not overlap with those of the pool(s) covering scheduled transmissions by in coverage UEs. Furthermore, the network should ensure that for none of the entries in *preconfigComm* the resources defined by *sc-TF-ResourceConfig* overlap.

## – SL-V2X-Preconfiguration

The IE *SL-V2X-Preconfiguration* includes the sidelink pre-configured parameters used for V2X sidelink communication.

### SL-V2X-Preconfiguration information elements

-- ASN1START

```

SL-V2X-Preconfiguration-r14 ::= SEQUENCE {
    v2x-PreconfigFreqList-r14          SL-V2X-PreconfigFreqList-r14,
    anchorCarrierFreqList-r14         SL-AnchorCarrierFreqList-V2X-r14           OPTIONAL,
    cbr-PreconfigList-r14             SL-CBR-PreconfigTxConfigList-r14         OPTIONAL,
    . . .
    [[ v2x-PacketDuplicationConfig-r15 SL-V2X-PacketDuplicationConfig-r15         OPTIONAL,
       syncFreqList-r15               SL-V2X-SyncFreqList-r15                 OPTIONAL,
       slss-TxMultiFreq-r15           ENUMERATED {true}                       OPTIONAL,
       v2x-TxProfileList-r15          SL-V2X-TxProfileList-r15              OPTIONAL
    ]],
    [[ anchorCarrierFreqListNR-r16     SL-NR-AnchorCarrierFreqList-r16         OPTIONAL
    ]]
}

SL-CBR-PreconfigTxConfigList-r14 ::= SEQUENCE {
    cbr-RangeCommonConfigList-r14     SEQUENCE (SIZE (1..maxSL-V2X-CBRConfig2-r14)) OF SL-CBR-Levels-
Config-r14,
    sl-CBR-PSSCH-TxConfigList-r14     SEQUENCE (SIZE (1..maxSL-V2X-TxConfig2-r14)) OF SL-CBR-PSSCH-
TxConfig-r14
}

```

```

SL-V2X-PreconfigFreqList-r14 ::= SEQUENCE (SIZE (1..maxFreqV2X-r14)) OF SL-V2X-PreconfigFreqInfo-r14

SL-V2X-PreconfigFreqInfo-r14 ::= SEQUENCE {
    v2x-CommPreconfigGeneral-r14      SL-PreconfigGeneral-r12,
    v2x-CommPreconfigSync-r14         SL-PreconfigV2X-Sync-r14          OPTIONAL,
    v2x-CommRxPoolList-r14            SL-PreconfigV2X-RxPoolList-r14,
    v2x-CommTxPoolList-r14            SL-PreconfigV2X-TxPoolList-r14,
    p2x-CommTxPoolList-r14            SL-PreconfigV2X-TxPoolList-r14,
    v2x-ResourceSelectionConfig-r14   SL-CommTxPoolSensingConfig-r14  OPTIONAL,
    zoneConfig-r14                     SL-ZoneConfig-r14                OPTIONAL,
    syncPriority-r14                    ENUMERATED {gnss, enb},
    thresSL-TxPrioritization-r14      SL-Priority-r13                  OPTIONAL,
    offsetDFN-r14                       INTEGER (0..1000)                 OPTIONAL,
    . . . ,
    [[ v2x-FreqSelectionConfigList-r15 SL-V2X-FreqSelectionConfigList-r15 OPTIONAL
    ]]
}

SL-PreconfigV2X-RxPoolList-r14 ::= SEQUENCE (SIZE (1..maxSL-V2X-RxPoolPreconf-r14)) OF SL-V2X-PreconfigCommPool-r14

SL-PreconfigV2X-TxPoolList-r14 ::= SEQUENCE (SIZE (1..maxSL-V2X-TxPoolPreconf-r14)) OF SL-V2X-PreconfigCommPool-r14

SL-V2X-PreconfigCommPool-r14 ::= SEQUENCE {
-- This IE is same as SL-CommResourcePoolV2X with rxParametersNCell absent
    sl-OffsetIndicator-r14            SL-OffsetIndicator-r12          OPTIONAL,
    sl-Subframe-r14                   SubframeBitmapSL-r14,
    adjacencyPSCCH-PSSCH-r14         BOOLEAN,
    sizeSubchannel-r14                ENUMERATED {
        n4, n5, n6, n8, n9, n10, n12, n15, n16, n18, n20, n25, n30,
        n48, n50, n72, n75, n96, n100, spare13, spare12, spare11,
        spare10, spare9, spare8, spare7, spare6, spare5, spare4,
        spare3, spare2, spare1},
    numSubchannel-r14                 ENUMERATED {n1, n3, n5, n8, n10, n15, n20, spare1},
    startRB-Subchannel-r14            INTEGER (0..99),
    startRB-PSCCH-Pool-r14            INTEGER (0..99)                  OPTIONAL,
    dataTxParameters-r14              P0-SL-r12,
    zoneID-r14                         INTEGER (0..7)                    OPTIONAL,
    threshS-RSSI-CBR-r14               INTEGER (0..45)                  OPTIONAL,
    cbr-pssch-TxConfigList-r14        SL-CBR-PPPP-TxPreconfigList-r14 OPTIONAL,
    resourceSelectionConfigP2X-r14     SL-P2X-ResourceSelectionConfig-r14 OPTIONAL,
    syncAllowed-r14                    SL-SyncAllowed-r14              OPTIONAL,
    restrictResourceReservationPeriod-r14 SL-RestrictResourceReservationPeriodList-r14 OPTIONAL,
    . . . ,
    [[ sl-MinT2ValueList-r15           SL-MinT2ValueList-r15          OPTIONAL,
    cbr-pssch-TxConfigList-v1530      SL-CBR-PPPP-TxPreconfigList-v1530 OPTIONAL
    ]]
}

SL-PreconfigV2X-Sync-r14 ::= SEQUENCE {
    syncOffsetIndicators-r14          SL-V2X-SyncOffsetIndicators-r14,
    syncTxParameters-r14              P0-SL-r12,
    syncTxThreshOoC-r14               RSRP-RangeSL3-r12,
    filterCoefficient-r14              FilterCoefficient,
    syncRefMinHyst-r14                ENUMERATED {dB0, dB3, dB6, dB9, dB12},
    syncRefDiffHyst-r14               ENUMERATED {dB0, dB3, dB6, dB9, dB12, dBinf},
    . . . ,
    [[ slss-TxDisabled-r15             ENUMERATED {true}              OPTIONAL
    ]]
}

SL-V2X-SyncOffsetIndicators-r14 ::= SEQUENCE {
    syncOffsetIndicator1-r14           SL-OffsetIndicatorSync-r14,
    syncOffsetIndicator2-r14           SL-OffsetIndicatorSync-r14,
    syncOffsetIndicator3-r14           SL-OffsetIndicatorSync-r14          OPTIONAL
}

SL-CBR-PPPP-TxPreconfigList-r14 ::= SEQUENCE (SIZE (1..8)) OF SL-PPPP-TxPreconfigIndex-r14

SL-PPPP-TxPreconfigIndex-r14 ::= SEQUENCE {
    priorityThreshold-r14              SL-Priority-r13,
    defaultTxConfigIndex-r14           INTEGER(0..maxCBR-Level-1-r14),
    cbr-ConfigIndex-r14                INTEGER(0..maxSL-V2X-CBRConfig2-1-r14),
    tx-ConfigIndexList-r14             SEQUENCE (SIZE (1..maxCBR-Level-r14)) OF Tx-PreconfigIndex-r14
}

```

```
Tx-PreconfigIndex-r14 ::=          INTEGER(0..maxSL-V2X-TxConfig2-l-r14)
SL-CBR-PPPP-TxPreconfigList-v1530 ::= SEQUENCE (SIZE (1..8)) OF SL-PPPP-TxPreconfigIndex-v1530
SL-PPPP-TxPreconfigIndex-v1530 ::= SEQUENCE {
    mcs-PSSCH-Range-r15          SEQUENCE (SIZE (1..maxCBR-Level-r14)) OF MCS-PSSCH-Range-r15
    OPTIONAL
}
SL-V2X-TxProfileList-r15 ::= SEQUENCE (SIZE (1..256)) OF SL-V2X-TxProfile-r15
SL-V2X-TxProfile-r15 ::= ENUMERATED {
    rel14, rel15, spare6, spare5, spare4,
    spare3, spare2, spare1, ...}
END
-- ASN1STOP
```

<b>SL-V2X-Preconfiguration field descriptions</b>
<p><b>adjacencyPSCCH-PSSCH</b> Indicates whether a UE always transmits PSCCH and PSSCH in adjacent RBs (indicated by TRUE) or it may transmit PSCCH and PSSCH in non-adjacent RBs (indicated by FALSE). This parameter appears only when a pool is configured such that a UE transmits PSCCH and the associated PSSCH in the same subframe.</p>
<p><b>anchorCarrierFreqList</b> Indicates carrier frequencies which may include inter-carrier resource configuration for V2X sidelink communication.</p>
<p><b>anchorCarrierFreqListNR</b> Indicates NR carrier frequencies which may include inter-carrier resource configuration for V2X sidelink communication.</p>
<p><b>cbr-PreconfigList</b> Indicates the preconfigured list of CBR ranges and the list of PSSCH transmission configurations available to configure congestion control to the UE for V2X sidelink communication.</p>
<p><b>cbr-pssch-TxConfigList</b> Indicates the mapping between PPPPs, CBR ranges by using indexes of the entry in <i>cbr-RangeCommonConfigList</i> in <i>cbr-PreconfigList</i>, and PSSCH transmission parameters and CR limits by using indexes of the entry in <i>sl-CBR-PSSCH-TxConfigList</i> in <i>cbr-PreconfigList</i>.</p>
<p><b>numSubchannel</b> Indicates the number of subchannels in the corresponding resource pool.</p>
<p><b>offsetDFN</b> Indicates the timing offset for the UE to determine DFN timing when GNSS is used for timing reference. Value 0 corresponds to 0 milliseconds, value 1 corresponds to 0.001 milliseconds, value 2 corresponds to 0.002 milliseconds, and so on.</p>
<p><b>resourceSelectionConfigP2X</b> Indicates the allowed resource selection mechanism(s), i.e. partial sensing and/or random selection, for P2X related V2X sidelink communication.</p>
<p><b>restrictResourceReservationPeriod</b> If configured, the field <i>restrictResourceReservationPeriod</i> configured in <i>v2x-ResourceSelectionConfig</i> shall be ignored for transmission on this pool.</p>
<p><b>sizeSubchannel</b> Indicates the number of PRBs of each subchannel in the corresponding resource pool. The value n5 denotes 5 PRBs; n6 denotes 6 PRBs and so on. The values n5, n6, n10, n15, n20, n25, n50, n75 and n100 apply in the case of <i>adjacencyPSCCH-PSSCH</i> set to TRUE; the values n4, n5, n6, n8, n9, n10, n12, n15, n16, n18, n20, n30, n48, n72 and n96 apply in the case of <i>adjacencyPSCCH-PSSCH</i> set to FALSE.</p>
<p><b>sl-OffsetIndicator</b> Indicates the offset of the first subframe of a resource pool within a SFN cycle. If absent, the resource pool starts from first subframe of SFN=0. This field is not applicable to V2X sidelink communication.</p>
<p><b>sl-Subframe</b> Indicates the bitmap of the resource pool, which is defined by repeating the bitmap within a SFN cycle (see TS 36.213 [23]).</p>
<p><b>startRB-Subchannel</b> Indicates the lowest RB index of the subchannel with the lowest index.</p>
<p><b>startRB-PSCCH-Pool</b> Indicates the lowest RB index of the PSCCH pool.</p>
<p><b>syncAllowed</b> Indicates the allowed synchronization reference(s) which is (are) allowed to use the pre-configured resource pool.</p>
<p><b>syncPriority</b> Indicates the synchronization priority order. In case the UE does not detect any cell which configures synchronization configuration on the carrier frequency in <i>anchorCarrierFreqList</i>, if this field is set to <i>gnss</i>, the UE shall prioritize GNSS over the UE directly synchronized to eNB; if this field is set to <i>enb</i>, the UE shall prioritize the UE directly synchronized to eNB over GNSS.</p>
<p><b>thresSL-TxPrioritization</b> Indicates the threshold used to determine whether SL V2X transmission is prioritized over uplink transmission if they overlap in time (see TS 36.321 [6]).</p>
<p><b>threshS-RSSI-CBR</b> Indicates the S-RSSI threshold for determining the contribution of a sub-channel to the CBR measurement, as specified in TS 36.214 [48]. Value 0 corresponds to -112 dBm, value 1 to -110 dBm, value n to (-112 + n*2) dBm, and so on.</p>
<p><b>v2x-CommRxPoolList</b> Indicates a list of reception pools for V2X sidelink communication.</p>
<p><b>v2x-CommTxPoolList</b> Indicates a list of transmission pools for V2X sidelink communication.</p>
<p><b>v2x-ResourceSelectionConfig</b> Indicates V2X sidelink communication configurations used for UE autonomous resource selection.</p>

<i>SL-V2X-Preconfiguration</i> field descriptions
<p><b><i>v2x-TxProfileList</i></b> Indicates for each Tx profile the corresponding transmission format, used as specified in TS 36.321 [6], in order of increasing Tx profile pointer identities. For each entry, Value REL14 indicates that the UE shall use Release 14 compatible format (i.e. using MCS table in Table 8.6.1-1 with 64 QAM indices overridden by 16QAM in TS 36.213 [23] and not Rel-15 feature) to transmit the corresponding V2X packet. Value REL15 indicates that the UE shall use Release 15 format (i.e. using rate matching, TBS scaling, MCS table in Table 8.6.1 and, if applicable, the MCS indices supporting 64QAM in Table 8.6.1 and Table 14.1.1-2 in TS 36.213 [23]) to transmit the corresponding V2X packet. If <i>v2x-TxProfileList</i> is not configured by upper layers, the UE shall use Release 14 compatible format to transmit the corresponding V2X packet.</p>
<p><b><i>zoneConfig</i></b> Indicates zone configurations used for V2X sidelink communication in 5.10.13.2.</p>
<p><b><i>zoneID</i></b> Indicates the zone ID for which the UE shall use this resource pool as described in 5.10.13.2. The field is absent in <i>v2x-CommRxPoolList</i> and <i>p2x-CommTxPoolList</i> in <i>SL-V2X-PreconfigFreqInfo</i>.</p>

## 10 Radio information related interactions between network nodes

### 10.1 General

This clause specifies RRC messages that are transferred between network nodes. These RRC messages may be transferred to or from the UE via another Radio Access Technology. Consequently, these messages have similar characteristics as the RRC messages that are transferred across the E-UTRA radio interface, i.e. the same transfer syntax and protocol extension mechanisms apply.

### 10.2 Inter-node RRC messages

#### 10.2.1 General

This clause specifies RRC messages that are sent either across the X2- or the S1-interface, either to or from the eNB, unless explicitly stated otherwise, i.e. a single 'logical channel' is used for all RRC messages transferred across network nodes. The information could originate from or be destined for another RAT.

#### – *EUTRA-InterNodeDefinitions*

This ASN.1 segment is the start of the E-UTRA inter-node PDU definitions.

```
-- ASN1START
EUTRA-InterNodeDefinitions DEFINITIONS AUTOMATIC TAGS ::=
BEGIN
IMPORTS
    AntennaInfoCommon,
    AntennaInfoDedicated-v10i0,
    ARFCN-ValueEUTRA,
    ARFCN-ValueEUTRA-v9e0,
    ARFCN-ValueEUTRA-r9,
    CellIdentity,
    C-RNTI,
    DAPS-PowerCoordinationInfo-r16,
    DL-DCCH-Message,
    DRB-Identity,
    DRB-ToReleaseList,
    DRB-ToReleaseList-r15,
    FreqBandIndicator-r11,
    InDeviceCoexIndication-r11,
    LWA-Config-r13,
    MasterInformationBlock,
```

```

maxBands,
maxFreq,
maxDRB,
maxDRBExt-r15,
maxDRB-r15,
maxSCell-r10,
maxSCell-r13,
maxServCell-r10,
maxServCell-r13,
MBMSInterestIndication-r11,
MeasConfig,
MeasGapConfig,
MeasGapConfigPerCC-List-r14,
MeasResultForRSSI-r13,
MeasResultListWLAN-r13,
OtherConfig-r9,
PhysCellId,
P-Max,
PowerCoordinationInfo-r12,
SidelinkUEInformation-r12,

SL-CommConfig-r12,
SL-DiscConfig-r12,
SubframeAssignment-r15,
RadioResourceConfigDedicated,
RadioResourceConfigDedicated-v13c0,
RadioResourceConfigDedicated-v1370,
RAN-NotificationAreaInfo-r15,
RCLWI-Configuration-r13,
RSRP-Range,
RSRQ-Range,
RSRQ-Range-v1250,
RS-SINR-Range-r13,
SCellToAddModList-r10,
SCellToAddModList-v13c0,
SCellToAddModListExt-r13,
SCellToAddModListExt-v13c0,
SCG-ConfigPartSCG-r12,
SCG-ConfigPartSCG-v12f0,
SCG-ConfigPartSCG-v13c0,
SecurityAlgorithmConfig,
SCellIndex-r10,
SCellIndex-r13,
SCellToReleaseList-r10,
SCellToReleaseListExt-r13,
ServCellIndex-r10,
ServCellIndex-r13,
ShortMAC-I,
MeasResultServFreqListNR-r15,
MeasResultSSTD-r13,
SL-V2X-ConfigDedicated-r14,
SystemInformationBlockType1,
SystemInformationBlockType1-v890-IEs,
SystemInformationBlockType2,
TDM-PatternConfig-r15,
UEAssistanceInformation-r11,
UECapabilityInformation,
UE-CapabilityRAT-ContainerList,
UE-RadioPagingInfo-r12,
WLANConnectionStatusReport-r13,
WLAN-OffloadConfig-r12
FROM EUTRA-RRC-Definitions;

-- ASN1STOP

```

## 10.2.2 Message definitions

### – *HandoverCommand*

This message is used to transfer the handover command generated by the target eNB.



Direction: target eNB to source eNB/ source RAN

### **HandoverCommand message**

```
-- ASN1START
HandoverCommand ::=
    SEQUENCE {
        criticalExtensions      CHOICE {
            c1
                CHOICE {
                    handoverCommand-r8      HandoverCommand-r8-IEs,
                    spare7 NULL,
                    spare6 NULL, spare5 NULL, spare4 NULL,
                    spare3 NULL, spare2 NULL, spare1 NULL
                },
            criticalExtensionsFuture      SEQUENCE {}
        }
    }

HandoverCommand-r8-IEs ::=
    SEQUENCE {
        handoverCommandMessage      OCTET STRING (CONTAINING DL-DCCH-Message),
        nonCriticalExtension          SEQUENCE {} OPTIONAL
    }
-- ASN1STOP
```

#### **HandoverCommand field descriptions**

##### **handoverCommandMessage**

Contains the entire DL-DCCH-Message including the *RRCConnectionReconfiguration* message used to perform handover within E-UTRAN or handover to E-UTRAN, generated (entirely) by the target eNB.

NOTE: The source BSC, in case of inter-RAT handover from GERAN to E-UTRAN, expects that the HandoverCommand message includes DL-DCCH-Message only. Thus, criticalExtensionsFuture, spare1-spare7 and nonCriticalExtension should not be used regardless whether the source RAT is E-UTRAN, UTRAN or GERAN.

### **HandoverPreparationInformation**

This message is used to transfer the E-UTRA RRC information used by the target eNB or target ng-eNB during handover preparation or UE context retrieval, e.g. in case of resume or re-establishment, including UE capability information.

Direction: source eNB/ source RAN to target eNB or target ng-eNB

### **HandoverPreparationInformation message**

```
-- ASN1START
HandoverPreparationInformation ::= SEQUENCE {
    criticalExtensions      CHOICE {
        c1
            CHOICE {
                handoverPreparationInformation-r8      HandoverPreparationInformation-r8-IEs,
                spare7 NULL,
                spare6 NULL, spare5 NULL, spare4 NULL,
                spare3 NULL, spare2 NULL, spare1 NULL
            },
        criticalExtensionsFuture      SEQUENCE {}
    }
}

HandoverPreparationInformation-r8-IEs ::= SEQUENCE {
    ue-RadioAccessCapabilityInfo      UE-CapabilityRAT-ContainerList,
    as-Config                          AS-Config OPTIONAL,          -- Cond HO
    rrm-Config                          RRM-Config OPTIONAL,
    as-Context                          AS-Context OPTIONAL,      -- Cond HO
    nonCriticalExtension                HandoverPreparationInformation-v920-IEs OPTIONAL
}

HandoverPreparationInformation-v920-IEs ::= SEQUENCE {
    ue-ConfigRelease-r9                ENUMERATED {
```

```

rel9, rel10, rel11, rel12, v10j0, v11e0,
v1280, rel13, ..., rel14, rel15, rel16, rel17, rel18}
OPTIONAL, -- Cond HO2
nonCriticalExtension HandoverPreparationInformation-v9d0-IEs OPTIONAL
}
HandoverPreparationInformation-v9d0-IEs ::= SEQUENCE {
lateNonCriticalExtension OCTET STRING (CONTAINING HandoverPreparationInformation-
v9j0-IEs) OPTIONAL,
nonCriticalExtension HandoverPreparationInformation-v9e0-IEs OPTIONAL
}
-- Late non-critical extensions:
HandoverPreparationInformation-v9j0-IEs ::= SEQUENCE {
-- Following field is only for pre REL-10 late non-critical extensions
lateNonCriticalExtension OCTET STRING OPTIONAL,
nonCriticalExtension HandoverPreparationInformation-v10j0-IEs OPTIONAL
}
HandoverPreparationInformation-v10j0-IEs ::= SEQUENCE {
as-Config-v10j0 AS-Config-v10j0 OPTIONAL,
nonCriticalExtension HandoverPreparationInformation-v10x0-IEs OPTIONAL
}
HandoverPreparationInformation-v10x0-IEs ::= SEQUENCE {
-- Following field is only for late non-critical extensions from REL-10 to REL-12
lateNonCriticalExtension OCTET STRING OPTIONAL,
nonCriticalExtension HandoverPreparationInformation-v13c0-IEs OPTIONAL
}
HandoverPreparationInformation-v13c0-IEs ::= SEQUENCE {
as-Config-v13c0 AS-Config-v13c0 OPTIONAL,
-- Following field is only for late non-critical extensions from REL-13
nonCriticalExtension SEQUENCE {} OPTIONAL
}
-- Regular non-critical extensions:
HandoverPreparationInformation-v9e0-IEs ::= SEQUENCE {
as-Config-v9e0 AS-Config-v9e0 OPTIONAL, -- Cond HO2
nonCriticalExtension HandoverPreparationInformation-v1130-IEs OPTIONAL
}
HandoverPreparationInformation-v1130-IEs ::= SEQUENCE {
as-Context-v1130 AS-Context-v1130 OPTIONAL, -- Cond HO2
nonCriticalExtension HandoverPreparationInformation-v1250-IEs
OPTIONAL
}
HandoverPreparationInformation-v1250-IEs ::= SEQUENCE {
ue-SupportedEARFCN-r12 ARFCN-ValueEUTRA-r9 OPTIONAL, -- Cond HO3
as-Config-v1250 AS-Config-v1250 OPTIONAL, -- Cond HO2
nonCriticalExtension HandoverPreparationInformation-v1320-IEs
OPTIONAL
}
HandoverPreparationInformation-v1320-IEs ::= SEQUENCE {
as-Config-v1320 AS-Config-v1320 OPTIONAL, -- Cond HO2
as-Context-v1320 AS-Context-v1320 OPTIONAL, -- Cond HO2
nonCriticalExtension HandoverPreparationInformation-v1430-IEs
OPTIONAL
}
HandoverPreparationInformation-v1430-IEs ::= SEQUENCE {
as-Config-v1430 AS-Config-v1430 OPTIONAL, -- Cond HO2
makeBeforeBreakReq-r14 ENUMERATED {true} OPTIONAL, -- Cond HO2
nonCriticalExtension HandoverPreparationInformation-v1530-IEs OPTIONAL
}
HandoverPreparationInformation-v1530-IEs ::= SEQUENCE {
ran-NotificationAreaInfo-r15 RAN-NotificationAreaInfo-r15 OPTIONAL,
nonCriticalExtension HandoverPreparationInformation-v1540-IEs
OPTIONAL
}
HandoverPreparationInformation-v1540-IEs ::= SEQUENCE {
sourceRB-ConfigIntra5GC-r15 OCTET STRING OPTIONAL, --Cond HO4
nonCriticalExtension HandoverPreparationInformation-v1610-IEs OPTIONAL
}

```

```

HandoverPreparationInformation-v1610-IEs ::= SEQUENCE {
  as-Context-v1610          AS-Context-v1610          OPTIONAL,  --Cond HO5
  nonCriticalExtension      HandoverPreparationInformation-v1620-IEs  OPTIONAL
}

HandoverPreparationInformation-v1620-IEs ::= SEQUENCE {
  as-Context-v1620          AS-Context-v1620          OPTIONAL,  --Cond HO2
  nonCriticalExtension      HandoverPreparationInformation-v1630-IEs  OPTIONAL
}

HandoverPreparationInformation-v1630-IEs ::= SEQUENCE {
  as-Context-v1630          AS-Context-v1630          OPTIONAL,  --Cond HO2
  nonCriticalExtension      HandoverPreparationInformation-v1700-IEs  OPTIONAL
}

HandoverPreparationInformation-v1700-IEs ::= SEQUENCE {
  as-Config-v1700          AS-Config-v1700          OPTIONAL,  --Cond HO5
  nonCriticalExtension      SEQUENCE { }              OPTIONAL
}

-- ASN1STOP

```

### **HandoverPreparationInformation field descriptions**

#### **as-Config**

The radio resource configuration. Applicable in case of intra-E-UTRA handover, resume or re-establishment. If the target receives an incomplete *MeasConfig* and/or *RadioResourceConfigDedicated* in the *as-Config*, the target eNB may decide to apply the full configuration option based on the *ue-ConfigRelease*.

#### **as-Context**

Local E-UTRAN context required by the target eNB.

#### **makeBeforeBreakReq**

To request the target eNB to add the *makeBeforeBreak* indication in the *mobilityControlInfo* in case of intra-frequency handover.

#### **rrm-Config**

Local E-UTRAN context used depending on the target node's implementation, which is mainly used for the RRM purpose. May also be provided at inter-RAT handover from NR.

#### **sourceRB-ConfigIntra5GC**

NR radio bearer config used at intra5GC handover, resume or re-establishment, as defined by *RadioBearerConfig* IE in TS 38.331 [82].

#### **ue-ConfigRelease**

Indicates the RRC protocol release or version applicable for the current UE configuration. This could be used by target eNB to decide if the full configuration approach should be used. If this field is not present, the target assumes that the current UE configuration is based on the release 8 version of RRC protocol. NOTE 1.

#### **ue-RadioAccessCapabilityInfo**

For E-UTRA radio access capabilities, it is up to E-UTRA how the backward compatibility among *supportedBandCombinationReduced*, *supportedBandCombination* and *supportedBandCombinationAdd* is ensured. If *supportedBandCombinationReduced* and *supportedBandCombination/supportedBandCombinationAdd* are included into *ueCapabilityRAT-Container*, it can be assumed that the value of fields, *requestedBands*, *reducedIntNonContCombRequested* and *requestedCCsXL* are consistent with all supported band combination fields. NOTE 2

#### **ue-SupportedEARFCN**

Includes UE supported EARFCN of the handover target E-UTRA cell if the target E-UTRA cell belongs to multiple frequency bands.

NOTE 1: The source typically sets the *ue-ConfigRelease* to the release corresponding with the current dedicated radio configuration. The source may however also consider the common radio resource configuration e.g. in case interoperability problems would appear if the UE temporary continues extensions of this part of the configuration in a target PCell not supporting them.

NOTE 2: The following table indicates per source RAT whether RAT capabilities are included or not.

Source RAT	E-UTRA capabilities	UTRA capabilities	GERAN capabilities	MR DC capabilities	NR capabilities
UTRAN	Included	May be included, ignored by eNB if received	May be included	Excluded	Excluded
GERAN CS	Excluded	May be included, ignored by eNB if received	Included	Excluded	Excluded
GERAN PS	Excluded	May be included, ignored by eNB if received	Included	Excluded	Excluded
E-UTRAN	May be included if UE Radio Capability ID as specified in 23.502 [102] is used for the UE. Included otherwise.	May be included	May be included	May be included	May be included
NR	May be included if UE Radio Capability ID as specified in 23.502 [102] is used for the UE. Included otherwise.	Excluded	Excluded	May be included	May be included

Conditional presence	Explanation
<i>HO</i>	The field is mandatory present in case of handover or UE context retrieval, e.g. in case of resume or re-establishment within E-UTRA; otherwise the field is not present.
<i>HO2</i>	The field is optional present in case of handover or UE context retrieval, e.g. in case of resume or re-establishment within E-UTRA; otherwise the field is not present.
<i>HO3</i>	The field is optional present in case of handover from GERAN to E-UTRA, otherwise the field is not present.
<i>HO4</i>	The field is mandatory present in case of handover or UE context retrieval, e.g. in case of resume or re-establishment within E-UTRA/5GC and optional present in case of handover from NR to E-UTRA/5GC; otherwise the field is not present.
<i>HO5</i>	The field is optional present in case of handover within E-UTRA, or handover from NR to E-UTRA; otherwise the field is not present.

## – SCG-Config

This message is used to transfer the SCG radio configuration generated by the SeNB.

Direction: Secondary eNB to master eNB

### SCG-Config message

```
-- ASN1START
SCG-Config-r12 ::=
    criticalExtensions
        c1
            scg-Config-r12
            spare7 NULL,
            spare6 NULL, spare5 NULL, spare4 NULL,
            spare3 NULL, spare2 NULL, spare1 NULL
        },
        criticalExtensionsFuture
            SEQUENCE {}
    }
}

SCG-Config-r12-IEs ::=
    scg-RadioConfig-r12
    nonCriticalExtension
        SEQUENCE {
            SCG-ConfigPartSCG-r12
            SCG-Config-v12i0a-IEs
        }
        OPTIONAL,
        OPTIONAL

SCG-Config-v12i0a-IEs ::=
    SEQUENCE {
        -- Following field is only for late non-critical extensions from REL-12
```

```

    lateNonCriticalExtension      OCTET STRING (CONTAINING SCG-Config-v12i0b-IEs) OPTIONAL,
    nonCriticalExtension          SCG-Config-v13c0-IEs                OPTIONAL
  }

SCG-Config-v12i0b-IEs ::=
  scg-RadioConfig-v12i0
  nonCriticalExtension
  }

SCG-Config-v13c0-IEs ::=
  scg-RadioConfig-v13c0
  -- Following field is only for late non-critical extensions from REL-13 onwards
  nonCriticalExtension
  }

-- ASN1STOP

```

### SCG-Config field descriptions

#### scg-RadioConfig-r12

Includes the change of the dedicated SCG configuration and, upon addition of an SCG cell, the common SCG configuration.

The SeNB only includes a new SCG cell in response to a request from MeNB, but may include release of an SCG cell release or release of the SCG part of an SCG/Split DRB without prior request from MeNB. The SeNB does not use this field to initiate release of the SCG.

### SCG-ConfigInfo

This message is used by MeNB to request the SeNB to perform certain actions e.g. to establish, modify or release an SCG, and it may include additional information e.g. to assist the SeNB with assigning the SCG configuration.

Direction: Master eNB to secondary eNB

### SCG-ConfigInfo message

```

-- ASN1START

SCG-ConfigInfo-r12 ::=
  criticalExtensions
  c1
    scg-ConfigInfo-r12
    spare7 NULL,
    spare6 NULL, spare5 NULL, spare4 NULL,
    spare3 NULL, spare2 NULL, spare1 NULL
  },
  criticalExtensionsFuture
  }

SCG-ConfigInfo-r12-IEs ::=
  radioResourceConfigDedMCG-r12      RadioResourceConfigDedicated      OPTIONAL,
  sCellToAddModListMCG-r12           SCellToAddModList-r10              OPTIONAL,
  measGapConfig-r12                  MeasGapConfig                       OPTIONAL,
  powerCoordinationInfo-r12          PowerCoordinationInfo-r12          OPTIONAL,
  scg-RadioConfig-r12                SCG-ConfigPartSCG-r12              OPTIONAL,
  eutra-CapabilityInfo-r12           OCTET STRING (CONTAINING UECapabilityInformation) OPTIONAL,
  scg-ConfigRestrictInfo-r12         SCG-ConfigRestrictInfo-r12        OPTIONAL,
  mbmsInterestIndication-r12         OCTET STRING (CONTAINING
    MBMSInterestIndication-r11)      OPTIONAL,
  measResultServCellListSCG-r12      MeasResultServCellListSCG-r12     OPTIONAL,
  drb-ToAddModListSCG-r12            DRB-InfoListSCG-r12               OPTIONAL,
  drb-ToReleaseListSCG-r12          DRB-ToReleaseList                  OPTIONAL,
  sCellToAddModListSCG-r12          SCellToAddModListSCG-r12          OPTIONAL,
  sCellToReleaseListSCG-r12         SCellToReleaseList-r10            OPTIONAL,
  p-Max-r12                          P-Max                              OPTIONAL,
  nonCriticalExtension                SCG-ConfigInfo-v1310-IEs         OPTIONAL
  }

SCG-ConfigInfo-v1310-IEs ::=
  measResultSSTD-r13                 MeasResultSSTD-r13                OPTIONAL,
  sCellToAddModListMCG-Ext-r13       SCellToAddModListExt-r13          OPTIONAL,
  measResultServCellListSCG-Ext-r13  MeasResultServCellListSCG-Ext-r13 OPTIONAL,
  sCellToAddModListSCG-Ext-r13       SCellToAddModListSCG-Ext-r13     OPTIONAL,

```

```

sCellToReleaseListSCG-Ext-r13 SCG-ConfigInfo-v1330-IEs OPTIONAL,
nonCriticalExtension SCG-ConfigInfo-v1430-IEs OPTIONAL
}
SCG-ConfigInfo-v1330-IEs ::= SEQUENCE {
  measResultListRSSI-SCG-r13 MeasResultListRSSI-SCG-r13 OPTIONAL,
  nonCriticalExtension SCG-ConfigInfo-v1430-IEs OPTIONAL
}
SCG-ConfigInfo-v1430-IEs ::= SEQUENCE {
  makeBeforeBreakSCG-Req-r14 ENUMERATED {true} OPTIONAL,
  measGapConfigPerCC-List MeasGapConfigPerCC-List-r14 OPTIONAL,
  nonCriticalExtension SCG-ConfigInfo-v1530-IEs OPTIONAL
}
SCG-ConfigInfo-v1530-IEs ::= SEQUENCE {
  drb-ToAddModListSCG-r15 DRB-InfoListSCG-r15 OPTIONAL,
  drb-ToReleaseListSCG-r15 DRB-ToReleaseList-r15 OPTIONAL,
  nonCriticalExtension SEQUENCE {} OPTIONAL
}
DRB-InfoListSCG-r12 ::= SEQUENCE (SIZE (1..maxDRB)) OF DRB-InfoSCG-r12
DRB-InfoListSCG-r15 ::= SEQUENCE (SIZE (1..maxDRB-r15)) OF DRB-InfoSCG-r12
DRB-InfoSCG-r12 ::= SEQUENCE {
  eps-BearerIdentity-r12 INTEGER (0..15) OPTIONAL, -- Cond DRB-Setup
  drb-Identity-r12 DRB-Identity,
  drb-Type-r12 ENUMERATED {split, scg} OPTIONAL, -- Cond DRB-Setup
  ...
}
SCellToAddModListSCG-r12 ::= SEQUENCE (SIZE (1..maxSCell-r10)) OF Cell-ToAddMod-r12
SCellToAddModListSCG-Ext-r13 ::= SEQUENCE (SIZE (1..maxSCell-r13)) OF Cell-ToAddMod-r12
Cell-ToAddMod-r12 ::= SEQUENCE {
  sCellIndex-r12 SCellIndex-r10,
  cellIdentification-r12 SEQUENCE {
    physCellId-r12 PhysCellId,
    dl-CarrierFreq-r12 ARFCN-ValueEUTRA-r9
  } OPTIONAL, -- Cond SCellAdd
  measResultCellToAdd-r12 SEQUENCE {
    rsrpResult-r12 RSRP-Range,
    rsrqResult-r12 RSRQ-Range
  } OPTIONAL, -- Cond SCellAdd2
  ...
  [[
    sCellIndex-r13 SCellIndex-r13 OPTIONAL,
    measResultCellToAdd-v1310 SEQUENCE {
      rs-sinr-Result-r13 RS-SINR-Range-r13
    } OPTIONAL -- Cond SCellAdd2
  ]]
}
MeasResultServCellListSCG-r12 ::= SEQUENCE (SIZE (1..maxServCell-r10)) OF MeasResultServCellSCG-r12
MeasResultServCellListSCG-Ext-r13 ::= SEQUENCE (SIZE (1..maxServCell-r13)) OF MeasResultServCellSCG-r12
MeasResultServCellSCG-r12 ::= SEQUENCE {
  servCellId-r12 ServCellIndex-r10,
  measResultSCell-r12 SEQUENCE {
    rsrpResultSCell-r12 RSRP-Range,
    rsrqResultSCell-r12 RSRQ-Range
  },
  ...
  [[
    servCellId-r13 ServCellIndex-r13 OPTIONAL,
    measResultSCell-v1310 SEQUENCE {
      rs-sinr-ResultSCell-r13 RS-SINR-Range-r13
    } OPTIONAL
  ]]
}
MeasResultListRSSI-SCG-r13 ::= SEQUENCE (SIZE (1..maxServCell-r13)) OF MeasResultRSSI-SCG-r13
MeasResultRSSI-SCG-r13 ::= SEQUENCE {
  servCellId-r13 ServCellIndex-r13,
  measResultForRSSI-r13 MeasResultForRSSI-r13
}

```

```

}
SCG-ConfigRestrictInfo-r12 ::= SEQUENCE {
    maxSCH-TB-BitsDL-r12      INTEGER (1..100),
    maxSCH-TB-BitsUL-r12     INTEGER (1..100)
}
-- ASN1STOP

```

<b>SCG-ConfigInfo field descriptions</b>	
<b>drb-ToAddModListSCG</b>	Includes DRBs the SeNB is requested to establish or modify (DRB type change).
<b>drb-ToReleaseListSCG</b>	Includes DRBs the SeNB is requested to release.
<b>makeBeforeBreakSCG-Req</b>	To request the target eNB to add the <i>makeBeforeBreakSCG</i> indication in the <i>mobilityControlInfoSCG</i> in case of intra-frequency SCG change.
<b>maxSCH-TB-BitsXL</b>	Indicates the maximum DL-SCH/UL-SCH TB bits that may be scheduled in a TTI. Specified as a percentage of the value defined for the applicable UE category.
<b>measGapConfig</b>	Includes the current measurement gap configuration.
<b>measResultListRSSI-SCG</b>	Includes RSSI measurement results of SCG (serving) cells
<b>measResultSSTD</b>	Includes measurement results of UE SFN and Subframe Timing Difference between the PCell and the PSCell.
<b>measResultServCellListSCG</b>	Includes measurement results of SCG (serving) cells.
<b>radioResourceConfigDedMCG</b>	Includes the current dedicated MCG radio resource configuration.
<b>sCellIndex</b>	If <i>sCellIndex-r13</i> is present, <i>sCellIndex-r12</i> shall be ignored.
<b>sCellToAddModListMCG, sCellToAddModListMCG-Ext</b>	Includes the current MCG SCell configuration. Field <i>sCellToAddModListMCG</i> is used to add the first 4 SCells with <i>sCellIndex-r10</i> while <i>sCellToAddModListMCG-Ext</i> is used to add the rest.
<b>sCellToAddModListSCG, sCellToAddModListSCG-Ext</b>	Includes SCG cells the SeNB is requested to establish. Measurement results may be provided for these cells. Field <i>sCellToAddModListSCG</i> is used to add the first 4 SCells with <i>sCellIndex-r12</i> while <i>sCellToAddModListSCG-Ext</i> is used to add the rest.
<b>sCellToReleaseListSCG, sCellToReleaseListSCG-Ext</b>	Includes SCG cells the SeNB is requested to release.
<b>scg-RadioConfig</b>	Includes the current dedicated SCG configuration.
<b>scg-ConfigRestrictInfo</b>	Includes fields for which MeNB explicitly indicates the restriction to be observed by SeNB.
<b>servCellId</b>	If <i>servCellId-r13</i> is present, <i>servCellId-r12</i> shall be ignored.
<b>p-Max</b>	Cell specific value i.e. as broadcast by PCell.

Conditional presence	Explanation
<i>DRB-Setup</i>	The field is mandatory present in case DRB establishment is requested; otherwise the field is not present.
<i>SCellAdd</i>	The field is mandatory present in case SCG cell establishment is requested; otherwise the field is not present.
<i>SCellAdd2</i>	The field is optional present in case SCG cell establishment is requested; otherwise the field is not present.

## – UE Paging Coverage Information

This message is used to transfer UE paging coverage information, covering both upload to and download from the EPC/5GC.

Direction: eNB to/from EPC, ng-eNB to/from 5GC

### ***UEPagingCoverageInformation* message**

```
-- ASN1START
UEPagingCoverageInformation ::= SEQUENCE {
    criticalExtensions          CHOICE {
        c1                     CHOICE {
            uePagingCoverageInformation-r13          UEPagingCoverageInformation-r13-IEs,
            spare7 NULL,
            spare6 NULL, spare5 NULL, spare4 NULL,
            spare3 NULL, spare2 NULL, spare1 NULL
        },
        criticalExtensionsFuture          SEQUENCE {}
    }
}

UEPagingCoverageInformation-r13-IEs ::= SEQUENCE {
    mpdcch-NumRepetition-r13          INTEGER (1..256)          OPTIONAL,
    nonCriticalExtension              SEQUENCE {}          OPTIONAL
}
-- ASN1STOP
```

#### ***UEPagingCoverageInformation* field descriptions**

##### ***mpdcch-NumRepetition***

Number of repetitions for MPDCCH. The value is an estimate of the required number of repetitions for MPDCCH for paging.

### – ***UERadioAccessCapabilityInformation***

This message is used to transfer UE radio access capability information, covering both upload to and download from the EPC/5GC.

Direction: eNB to/from EPC, ng-eNB to/from 5GC

### ***UERadioAccessCapabilityInformation* message**

```
-- ASN1START
UERadioAccessCapabilityInformation ::= SEQUENCE {
    criticalExtensions          CHOICE {
        c1                     CHOICE {
            ueRadioAccessCapabilityInformation-r8          UERadioAccessCapabilityInformation-r8-IEs,
            spare7 NULL,
            spare6 NULL, spare5 NULL, spare4 NULL,
            spare3 NULL, spare2 NULL, spare1 NULL
        },
        criticalExtensionsFuture          SEQUENCE {}
    }
}

UERadioAccessCapabilityInformation-r8-IEs ::= SEQUENCE {
    ue-RadioAccessCapabilityInfo          OCTET STRING (CONTAINING UECapabilityInformation),
    nonCriticalExtension              SEQUENCE {}          OPTIONAL
}
-- ASN1STOP
```



**UERadioAccessCapabilityInformation field descriptions****ue-RadioAccessCapabilityInfo**

Including E-UTRA, GERAN, CDMA2000-1xRTT Bandclass, NR and MR-DC radio access capabilities (separated). UTRA radio access capabilities are not included. For E-UTRA radio access capabilities, it is up to E-UTRA how the backward compatibility among *supportedBandCombinationReduced*, *supportedBandCombination* and *supportedBandCombinationAdd* is ensured. If *supportedBandCombinationReduced* and *supportedBandCombination/supportedBandCombinationAdd* are included into *ueCapabilityRAT-Container*, it can be assumed that the value of fields, *requestedBands*, *reducedIntNonContCombRequested* and *requestedCCsXL* are consistent with all supported band combination fields.

**UERadioPagingInformation**

This message is used to transfer radio paging information, covering both upload to and download from the EPC/5GC.

Direction: eNB to/ from EPC, ng-eNB to/from 5GC

**UERadioPagingInformation message**

```
-- ASN1START
UERadioPagingInformation ::= SEQUENCE {
    criticalExtensions          CHOICE {
        c1                     CHOICE {
            ueRadioPagingInformation-r12          UERadioPagingInformation-r12-IEs,
            spare7 NULL,
            spare6 NULL, spare5 NULL, spare4 NULL,
            spare3 NULL, spare2 NULL, spare1 NULL
        },
        criticalExtensionsFuture          SEQUENCE {}
    }
}

UERadioPagingInformation-r12-IEs ::= SEQUENCE {
    ue-RadioPagingInfo-r12          OCTET STRING (CONTAINING UE-RadioPagingInfo-r12),
    nonCriticalExtension          UERadioPagingInformation-v1310-IEs          OPTIONAL
}

UERadioPagingInformation-v1310-IEs ::= SEQUENCE {
    supportedBandListEUTRAForPaging-r13          SEQUENCE (SIZE (1..maxBands)) OF FreqBandIndicator-r11
OPTIONAL,
    nonCriticalExtension          UERadioPagingInformation-v1610-IEs          OPTIONAL
}

UERadioPagingInformation-v1610-IEs ::= SEQUENCE {
    accessStratumRelease-r16          ENUMERATED {true}          OPTIONAL,
    nonCriticalExtension          SEQUENCE {}          OPTIONAL
}
-- ASN1STOP
```

**UERadioPagingInformation field descriptions****accessStratumRelease**

Indicates that the UE supports reception of *accessType-r16* in the Paging message.

**supportedBandListEUTRAForPaging**

Indicates the UE supported frequency bands which is derived by the eNB from *UE-EUTRA-Capability*.

**ue-RadioPagingInfo**

The field is used to transfer UE capability information used for paging. The eNB generates the *ue-RadioPagingInfo* and the contained UE capability information is absent when not supported by the UE.

## 10.3 Inter-node RRC information element definitions

### – AS-Config

The *AS-Config* IE contains information about RRC configuration information in the source eNB which can be utilized by target eNB to determine the need to change the RRC configuration during the handover preparation phase. The information can also be used after the handover is successfully performed or during the RRC connection re-establishment or resume.

#### AS-Config information element

```
-- ASN1START
AS-Config ::= SEQUENCE {
    sourceMeasConfig           MeasConfig,
    sourceRadioResourceConfig  RadioResourceConfigDedicated,
    sourceSecurityAlgorithmConfig SecurityAlgorithmConfig,
    sourceUE-Identity          C-RNTI,
    sourceMasterInformationBlock MasterInformationBlock,
    sourceSystemInformationBlockType1 SystemInformationBlockType1(WITH COMPONENTS
        {..., nonCriticalExtension ABSENT}),
    sourceSystemInformationBlockType2 SystemInformationBlockType2,
    antennaInfoCommon         AntennaInfoCommon,
    sourceDl-CarrierFreq       ARFCN-ValueEUTRA,
    ...
    [[ sourceSystemInformationBlockType1Ext OCTET STRING (CONTAINING
        SystemInformationBlockType1-v890-IEs) OPTIONAL,
        sourceOtherConfig-r9 OtherConfig-r9
        -- sourceOtherConfig-r9 should have been optional. A target eNB compliant with this transfer
        -- syntax should support receiving an AS-Config not including this extension addition group
        -- e.g. from a legacy source eNB
    ]],
    [[ sourceSCellConfigList-r10 SCellToAddModList-r10 OPTIONAL
    ]],
    [[ sourceConfigSCG-r12 SCG-Config-r12 OPTIONAL
    ]],
    [[ as-ConfigNR-r15 AS-ConfigNR-r15 OPTIONAL
    ]],
    [[ as-Config-v1550 AS-Config-v1550 OPTIONAL
    ]],
    [[ as-ConfigNR-v1570 AS-ConfigNR-v1570 OPTIONAL
    ]],
    [[ as-ConfigNR-v1620 AS-ConfigNR-v1620 OPTIONAL
    ]],
}

AS-Config-v9e0 ::= SEQUENCE {
    sourceDl-CarrierFreq-v9e0 ARFCN-ValueEUTRA-v9e0
}

AS-Config-v10j0 ::= SEQUENCE {
    antennaInfoDedicatedPCell-v10i0 AntennaInfoDedicated-v10i0 OPTIONAL
}

AS-Config-v1250 ::= SEQUENCE {
    sourceWlan-OffloadConfig-r12 WLAN-OffloadConfig-r12 OPTIONAL,
    sourceSL-CommConfig-r12 SL-CommConfig-r12 OPTIONAL,
    sourceSL-DiscConfig-r12 SL-DiscConfig-r12 OPTIONAL
}

AS-Config-v1320 ::= SEQUENCE {
    sourceSCellConfigList-r13 SCellToAddModListExt-r13 OPTIONAL,
    sourceRCLWI-Configuration-r13 RCLWI-Configuration-r13 OPTIONAL
}

AS-Config-v13c0 ::= SEQUENCE {
    radioResourceConfigDedicated-v13c01 RadioResourceConfigDedicated-v1370 OPTIONAL,
    radioResourceConfigDedicated-v13c02 RadioResourceConfigDedicated-v13c0 OPTIONAL,
    sCellToAddModList-v13c0 SCellToAddModList-v13c0 OPTIONAL,
    sCellToAddModListExt-v13c0 SCellToAddModListExt-v13c0 OPTIONAL
}

AS-Config-v1430 ::= SEQUENCE {
    sourceSL-V2X-CommConfig-r14 SL-V2X-ConfigDedicated-r14 OPTIONAL,

```

```

    sourceLWA-Config-r14          LWA-Config-r13          OPTIONAL,
    sourceWLAN-MeasResult-r14     MeasResultListWLAN-r13  OPTIONAL
  }
AS-ConfigNR-r15 ::=              SEQUENCE {
    sourceRB-ConfigNR-r15        OCTET STRING             OPTIONAL,
    sourceRB-ConfigSN-NR-r15     OCTET STRING             OPTIONAL,
    sourceOtherConfigSN-NR-r15   OCTET STRING             OPTIONAL
  }
AS-ConfigNR-v1570 ::=           SEQUENCE {
    sourceSCG-ConfiguredNR-r15   ENUMERATED {true}
  }
AS-Config-v1550 ::=             SEQUENCE {
    tdm-PatternConfig-r15        SEQUENCE {
      subframeAssignment-r15     SubframeAssignment-r15,
      harq-Offset-r15            INTEGER (0.. 9)
    }
    p-MaxEUTRA-r15              P-Max                    OPTIONAL
  }
AS-ConfigNR-v1620 ::=           SEQUENCE {
    tdm-PatternConfig2-r16       TDM-PatternConfig-r15
  }
AS-Config-v1700 ::=             SEQUENCE {
    scg-State-r17                ENUMERATED { deactivated }  OPTIONAL
  }
-- ASN1STOP

```

**NOTE:** The *AS-Config* re-uses information elements primarily created to cover the radio interface signalling requirements. Consequently, the information elements may include some parameters that are not relevant for the target eNB e.g. the SFN as included in the *MasterInformationBlock*.

<b>AS-Config field descriptions</b>
<b>antennaInfoCommon</b> This field provides information about the number of antenna ports in the source PCell.
<b>p-MaxEUTRA</b> Indicates the <i>p-MaxEUTRA</i> in the source PCell.
<b>scg-State</b> Indicates that the SCG is deactivated.
<b>sourceOtherConfigSN-NR</b> Other NR config set by SN (cell group, measurements) in case of (NG)EN-DC i.e. as defined by the <i>RRCReconfiguration</i> message in TS 38.331 [82].
<b>sourceRB-ConfigNR</b> NR radio bearer config, as defined by <i>RadioBearerConfig</i> IE in TS 38.331 [82]. The field may e.g. be set by MN in case of (NG)EN-DC, by source eNB connected to 5GCN.
<b>sourceRB-ConfigSN-NR</b> NR radio bearer config set by SN in case of (NG)EN-DC or of SN terminated RB without SCG, as defined by <i>RadioBearerConfig</i> IE in TS 38.331 [82].
<b>sourceDL-CarrierFreq</b> Provides the parameter Downlink EARFCN in the source PCell, see TS 36.101 [42]. If the source eNB provides <i>AS-Config-v9e0</i> , it sets <i>sourceDL-CarrierFreq</i> (i.e. without suffix) to <i>maxEARFCN</i> .
<b>sourceLWA-Config</b> LWA configuration in the source PCell when handover is triggered.
<b>sourceOtherConfig</b> Provides other configuration in the source PCell.
<b>sourceMasterInformationBlock</b> <i>MasterInformationBlock</i> transmitted in the source PCell.
<b>sourceMeasConfig</b> Measurement configuration in the source cell. The measurement configuration for all measurements existing in the source eNB when handover is triggered shall be included. See 10.5.
<b>sourceRCLWI-Configuration</b> RCLWI Configuration in the source PCell.
<b>sourceSL-CommConfig</b> This field covers the sidelink communication configuration.
<b>sourceSL-DiscConfig</b> This field covers the sidelink discovery configuration.
<b>sourceRadioResourceConfig</b> Radio configuration in the source PCell. The radio resource configuration for all radio bearers existing in the source PCell when handover is triggered shall be included. See 10.5.
<b>sourceSCellConfigList</b> Radio resource configuration (common and dedicated) of the SCells configured in the source eNB.
<b>sourceSCG-ConfiguredNR</b> Value <i>true</i> indicates that the UE is configured with NR SCG in source configuration. The field is included only if <i>sourceOtherConfigSN-NR</i> is not included.
<b>sourceSecurityAlgorithmConfig</b> This field provides the AS integrity protection (SRBs) and AS ciphering (SRBs and DRBs) algorithm configuration used in the source PCell.
<b>sourceSystemInformationBlockType1</b> <i>SystemInformationBlockType1</i> (or <i>SystemInformationBlockType1-BR</i> ) transmitted in the source PCell.
<b>sourceSystemInformationBlockType2</b> <i>SystemInformationBlockType2</i> transmitted in the source PCell.
<b>sourceSL-V2X-CommConfig</b> Indicates the V2X sidelink communication related configurations configured in the source eNB.
<b>sourceWLAN-MeasResult</b> WLAN measurement results in the source PCell when handover is triggered.
<b>tdm-PatternConfig</b> Indicates the <i>tdm-PatternConfig</i> configured to the UE in the source PCell.
<b>tdm-PatternConfig2</b> Indicates the <i>tdm-PatternConfig2</i> configured to the UE in the source PCell.

## – AS-Context

The IE *AS-Context* is used to transfer local E-UTRAN context required by the target eNB.

**AS-Context information element**

```

-- ASN1START
AS-Context ::=
    SEQUENCE {
        reestablishmentInfo
            ReestablishmentInfo OPTIONAL -- Cond HO
    }
AS-Context-v1130 ::=
    SEQUENCE {
        idc-Indication-r11
            OCTET STRING (CONTAINING
                InDeviceCoexIndication-r11) OPTIONAL, -- Cond HO2
        mbmsInterestIndication-r11
            OCTET STRING (CONTAINING
                MBMSInterestIndication-r11) OPTIONAL, -- Cond HO2
        ueAssistanceInformation-r11
            OCTET STRING (CONTAINING
                UEAssistanceInformation-r11) OPTIONAL, -- Cond HO2
        ...,
        [[ sidelinkUEInformation-r12
            OCTET STRING (CONTAINING
                SidelinkUEInformation-r12) OPTIONAL -- Cond HO2
        ]],
        [[ sourceContextEN-DC-r15
            OCTET STRING
            OPTIONAL -- Cond HO2
        ]],
        [[ selectedbandCombinationInfoEN-DC-v1540
            OCTET STRING
            OPTIONAL -- Cond HO2
        ]]
    }
AS-Context-v1320 ::=
    SEQUENCE {
        wlanConnectionStatusReport-r13
            OCTET STRING (CONTAINING
                WLANConnectionStatusReport-r13) OPTIONAL -- Cond HO2
    }
AS-Context-v1610 ::=
    SEQUENCE {
        sidelinkUEInformationNR-r16
            OCTET STRING OPTIONAL, -- Cond HO3
        ueAssistanceInformationNR-r16
            OCTET STRING OPTIONAL, -- Cond HO3
        configRestrictInfoDAPS-r16
            ConfigRestrictInfoDAPS-r16 OPTIONAL -- Cond HO2
    }
AS-Context-v1620 ::=
    SEQUENCE {
        ueAssistanceInformationNR-SCG-r16
            OCTET STRING OPTIONAL -- Cond HO2
    }
AS-Context-v1630 ::=
    SEQUENCE {
        configRestrictInfoDAPS-v1630
            ConfigRestrictInfoDAPS-v1630 OPTIONAL -- Cond HO2
    }
ConfigRestrictInfoDAPS-r16 ::=
    SEQUENCE {
        maxSCH-TB-BitsDL-r16
            INTEGER (1..100) OPTIONAL, -- Cond HO2
        maxSCH-TB-BitsUL-r16
            INTEGER (1..100) OPTIONAL -- Cond HO2
    }
ConfigRestrictInfoDAPS-v1630 ::=
    SEQUENCE {
        daps-PowerCoordinationInfo-r16
            DAPS-PowerCoordinationInfo-r16 OPTIONAL -- Cond HO2
    }
-- ASN1STOP

```

<b>AS-Context field descriptions</b>
<b>idc-Indication</b> Including information used for handling the IDC problems.
<b>maxSCH-TB-BitsXL</b> Indicates the maximum DL-SCH/UL-SCH TB bits that may be scheduled in a TTI during DAPS HO. Specified as a percentage of the value defined for the applicable UE category.
<b>reestablishmentInfo</b> Including information needed for the RRC connection re-establishment.
<b>sourceContextEN-DC</b> (NG)EN-DC related context information, in particular regarding the UE capability coordination, as defined by the <i>ConfigRestrictInfoSCG</i> IE specified in TS 38.331 [82].
<b>selectedBandCombinationInfoEN-DC</b> Including the <i>BandCombinationInfoSN</i> IE specified in TS 38.331 [82]. See NOTE 1.
<b>sidelinkUEInformationNR</b> Including sidelink UE information as defined by the <i>SidelinkUEInformationNR</i> message specified in TS 38.331 [82].
<b>ueAssistanceInformation</b> Including UE assistance information as defined by the <i>UEAssistanceInformation</i> message e.g. concerning power preference, overheating.
<b>ueAssistanceInformationNR</b> Including sidelink UE assistance information as defined by the <i>UEAssistanceInformation</i> message specified in TS 38.331 [82].
<b>ueAssistanceInformationNR-SCG</b> Includes for each UE assistance feature associated with the NR SCG as specified in TS 38.331 [82], the information last reported by the UE in the NR <i>UEAssistanceInformation</i> message for the NR SCG, if any.

<b>Conditional presence</b>	<b>Explanation</b>
<i>HO</i>	The field is mandatory present in case of handover within E-UTRA; otherwise the field is not present.
<i>HO2</i>	The field is optional present in case of handover within E-UTRA; otherwise the field is not present.
<i>HO3</i>	The field is optional present in case of handover within E-UTRA, or handover from NR to E-UTRA; otherwise the field is not present.

NOTE 1: If the field is present, it is used to help target MN to decide appropriate LTE band for SCell frequency measurement in case of inter-MN handover without SN change.

### – *ReestablishmentInfo*

The *ReestablishmentInfo* IE contains information needed for the RRC connection re-establishment.

#### ***ReestablishmentInfo* information element**

```

-- ASN1START
ReestablishmentInfo ::=          SEQUENCE {
    sourcePhysCellId             PhysCellId,
    targetCellShortMAC-I         ShortMAC-I,
    additionalReestabInfoList    AdditionalReestabInfoList          OPTIONAL,
    ...
}

AdditionalReestabInfoList ::=    SEQUENCE ( SIZE (1..maxReestabInfo) ) OF AdditionalReestabInfo

AdditionalReestabInfo ::=       SEQUENCE{
    cellIdentity                 CellIdentity,
    key-eNodeB-Star             Key-eNodeB-Star,
    shortMAC-I                   ShortMAC-I
}

Key-eNodeB-Star ::=            BIT STRING (SIZE (256))
-- ASN1STOP

```

<b>ReestablishmentInfo field descriptions</b>
<p><b>additionalReestabInfoList</b> Contains a list of shortMAC-I and KeNB* for cells under control of the target eNB, required for potential re-establishment by the UE in these cells to succeed.</p>
<p><b>Key-eNodeB-Star</b> Parameter KeNB*: See TS 33.401 [32], clause 7.2.8.4. If the cell identified by <i>cellIdentity</i> belongs to multiple frequency bands, the source eNB selects the DL-EARFCN for the KeNB* calculation using the same logic as UE uses when selecting the DL-EARFCN in IDLE as defined in clause 6.2.2. This parameter is only used for X2 handover, and for S1 handover, it shall be ignored by target eNB.</p>
<p><b>sourcePhyCellId</b> The physical cell identity of the source PCell, used to determine the UE context in the target eNB at re-establishment.</p>
<p><b>targetCellShortMAC-I</b> The ShortMAC-I for the handover target PCell, in order for potential re-establishment to succeed.</p>

## – RRM-Config

The *RRM-Config* IE contains information about UE specific RRM information before the handover which can be utilized by target eNB.

### RRM-Config information element

```

-- ASN1START
RRM-Config ::=
  ue-InactiveTime
  SEQUENCE {
    ENUMERATED {
      s1, s2, s3, s5, s7, s10, s15, s20,
      s25, s30, s40, s50, min1, min1s20c, min1s40,
      min2, min2s30, min3, min3s30, min4, min5, min6,
      min7, min8, min9, min10, min12, min14, min17, min20,
      min24, min28, min33, min38, min44, min50, hr1,
      hr1min30, hr2, hr2min30, hr3, hr3min30, hr4, hr5, hr6,
      hr8, hr10, hr13, hr16, hr20, day1, day1hr12, day2,
      day2hr12, day3, day4, day5, day7, day10, day14, day19,
      day24, day30, dayMoreThan30} OPTIONAL,
    ...
    [[ candidateCellInfoList-r10 CandidateCellInfoList-r10 OPTIONAL
    ]],
    [[ candidateCellInfoListNR-r15 MeasResultServFreqListNR-r15 OPTIONAL
    ]]
  }

CandidateCellInfoList-r10 ::= SEQUENCE (SIZE (1..maxFreq)) OF CandidateCellInfo-r10

CandidateCellInfo-r10 ::= SEQUENCE {
  -- cellIdentification
  physCellId-r10 PhysCellId,
  dl-CarrierFreq-r10 ARFCN-ValueEUTRA,
  -- available measurement results
  rsrpResult-r10 RSRP-Range OPTIONAL,
  rsrqResult-r10 RSRQ-Range OPTIONAL,
  ...
  [[ dl-CarrierFreq-v1090 ARFCN-ValueEUTRA-v9e0 OPTIONAL
  ]],
  [[ rsrqResult-v1250 RSRQ-Range-v1250 OPTIONAL
  ]],
  [[ rs-sinr-Result-r13 RS-SINR-Range-r13 OPTIONAL
  ]]
}
-- ASN1STOP

```

<i>RRM-Config</i> field descriptions
<p><b><i>candidateCellInfoList</i></b> A list of the best cells on each frequency for which measurement information was available, in order of decreasing RSRP.</p>
<p><b><i>candidateCellInfoListNR</i></b> A list of NR cells including serving cells and best neighbour cells on each SSB frequency, for which measurement results were available, and for each cell the best beams.</p>
<p><b><i>dl-CarrierFreq</i></b> The source includes <i>dl-CarrierFreq-v1090</i> if and only if <i>dl-CarrierFreq-r10</i> is set to <i>maxEARFCN</i>.</p>
<p><b><i>ue-InactiveTime</i></b> Duration while UE has not received or transmitted any user data. Thus the timer is still running in case e.g., UE measures the neighbour cells for the HO purpose. Value s1 corresponds to 1 second, s2 corresponds to 2 seconds and so on. Value min1 corresponds to 1 minute, value min1s20 corresponds to 1 minute and 20 seconds, value min1s40 corresponds to 1 minute and 40 seconds and so on. Value hr1 corresponds to 1 hour, hr1min30 corresponds to 1 hour and 30 minutes and so on.</p>

## 10.4 Inter-node RRC multiplicity and type constraint values

### – Multiplicity and type constraints definitions

```
-- ASN1START
maxReestabInfo          INTEGER ::= 32 -- Maximum number of KeNB* and shortMAC-I forwarded
                        -- at handover for re-establishment preparation
-- ASN1STOP
```

### – End of *EUTRA-InterNodeDefinitions*

```
-- ASN1START
END
-- ASN1STOP
```

## 10.5 Mandatory information in *AS-Config*

The *AS-Config* transferred between source eNB and target-eNB shall include all IEs necessary to describe the AS context. The conditional presence in clause 6 is only applicable for eNB to UE communication.

The "need" or "cond" statements are not applied in case of sending the IEs from source eNB to target eNB. Some fields shall be included regardless of the "need" or "cond" e.g. *discardTimer*. The *AS-Config* re-uses information elements primarily created to cover the radio interface signalling requirements. The information elements may include some parameters that are not relevant for the target eNB e.g. the SFN as included in the *MasterInformationBlock*.

All the fields in the *AS-Config* as defined in 10.3 that are introduced after v9.2.0 and that are optional for eNB to UE communication shall be included, if the functionality is configured, except for the fields *sourceOtherConfigSN-NR* and *sourceRB-ConfigSN-NR* in *AS-ConfigNR*. The fields in the *AS-Config* that are defined before and including v9.2.0 shall be included as specified in the following.

Within the *sourceRadioResourceConfig*, *sourceMeasConfig* and *sourceOtherConfig*, the source eNB shall include fields that are optional for eNB to UE communication, if the functionality is configured unless explicitly specified otherwise in the following:

- in accordance with a condition that is explicitly stated to be applicable; or
- a default value is defined for the concerned field; and the configured value is the same as the default value that is defined; or



- the need of the field is OP and the current UE configuration corresponds with the behaviour defined for absence of the field;

The following fields, if the functionality is configured, are not mandatory for the source eNB to include in the *AS-Config* since delta signalling by the target eNB for these fields is not supported:

- *semiPersistSchedC-RNTI*
- *measGapConfig*

For the measurement configuration, a corresponding operation as 5.5.6.1 and 5.5.2.2a is executed by target eNB.

## 10.6 Inter-node NB-IoT messages

### 10.6.1 General

This clause specifies NB-IoT RRC messages that are sent either across the X2- or the S1-interface, either to or from the eNB, i.e. a single 'logical channel' is used for all NB-IoT RRC messages transferred across network nodes.

#### – *NB-IoT-InterNodeDefinitions*

This ASN.1 segment is the start of the NB-IoT inter-node PDU definitions.

```
-- ASN1START
NBIOT-InterNodeDefinitions DEFINITIONS AUTOMATIC TAGS ::=
BEGIN
IMPORTS
    C-RNTI,
    PhysCellId,
    SecurityAlgorithmConfig,
    ShortMAC-I
FROM EUTRA-RRC-Definitions

    AdditionalReestabInfoList
FROM EUTRA-InterNodeDefinitions

    CarrierFreq-NB-r13,
    CarrierFreq-NB-v1550,
    RadioResourceConfigDedicated-NB-r13,
    UECapabilityInformation-NB,
    UE-Capability-NB-r13,
    UE-Capability-NB-Ext-r14-IEs,
    UE-RadioPagingInfo-NB-r13
FROM NBIOT-RRC-Definitions;
-- ASN1STOP
```

### 10.6.2 Message definitions

#### – *HandoverPreparationInformation-NB*

This message is used to transfer the UE context from the eNB where the RRC connection has been suspended and transfer it to the eNB where the RRC Connection has been requested to be resumed.

Direction: source eNB to target eNB

#### ***HandoverPreparationInformation-NB* message**

```
-- ASN1START
HandoverPreparationInformation-NB ::= SEQUENCE {
    criticalExtensions
        c1 CHOICE {
            CHOICE{
```

```

        handoverPreparationInformation-r13      HandoverPreparationInformation-NB-IEs,
        spare3 NULL, spare2 NULL, spare1 NULL
    },
    criticalExtensionsFuture                    SEQUENCE {}
}
}

HandoverPreparationInformation-NB-IEs ::= SEQUENCE {
    ue-RadioAccessCapabilityInfo-r13          UE-Capability-NB-r13,
    as-Config-r13                             AS-Config-NB,
    rrm-Config-r13                             RRM-Config-NB                OPTIONAL,
    as-Context-r13                             AS-Context-NB                OPTIONAL,
    nonCriticalExtension                       HandoverPreparationInformation-NB-v1380-IEs
    OPTIONAL
}

HandoverPreparationInformation-NB-v1380-IEs ::= SEQUENCE {
    lateNonCriticalExtension                   OCTET STRING                OPTIONAL,
    nonCriticalExtension                       HandoverPreparationInformation-NB-Ext-r14-IEs  OPTIONAL
}

HandoverPreparationInformation-NB-Ext-r14-IEs ::= SEQUENCE {
    ue-RadioAccessCapabilityInfoExt-r14      OCTET STRING (CONTAINING UE-Capability-NB-Ext-r14-IEs)
    OPTIONAL,
    nonCriticalExtension                       SEQUENCE {}                OPTIONAL
}

-- ASN1STOP

```

#### **HandoverPreparationInformation-NB field descriptions**

**as-Config**

The radio resource configuration.

**as-Context**

The local E-UTRAN context required by the target eNB.

**rrm-Config**

The local E-UTRAN context used depending on the target node's implementation, which is mainly used for the RRM purpose.

**ue-RadioAccessCapabilityInfo, ue-RadioAccessCapabilityInfoExt**

The NB-IoT UE Radio Access Capability Parameters, see TS 36.306 [5].

### – **UEPagingCoverageInformation-NB**

This message is used to transfer UE paging coverage information for NB-IoT, covering both upload to and download from the EPC/5GC.

Direction: eNB to/from EPC, ng-eNB to/from 5GC

#### **UEPagingCoverageInformation-NB message**

```

-- ASN1START

UEPagingCoverageInformation-NB ::= SEQUENCE {
    criticalExtensions                       CHOICE {
        c1                                   CHOICE {
            uePagingCoverageInformation-r13  UEPagingCoverageInformation-NB-IEs,
            spare3 NULL, spare2 NULL, spare1 NULL
        },
        criticalExtensionsFuture             SEQUENCE {}
    }
}

UEPagingCoverageInformation-NB-IEs ::= SEQUENCE {
-- the possible value(s) can differ from those sent on Uu
    npdcch-NumRepetitionPaging-r13         INTEGER (1..2048)  OPTIONAL,
    nonCriticalExtension                     UEPagingCoverageInformation-NB-v1700-IEs  OPTIONAL
}

UEPagingCoverageInformation-NB-v1700-IEs ::= SEQUENCE {
    cbp-Index-r17                           INTEGER (1..2)  OPTIONAL, -- Cond CBP
    nonCriticalExtension                       SEQUENCE {}  OPTIONAL
}

-- ASN1STOP

```

```
-- ASN1STOP
```

#### **UEPagingCoverageInformation-NB field descriptions**

**cbp-Index**

Index to the coverage-based paging configuration signalled to the UE during RRC connection release. Value 1 corresponds to the first entry in *cbp-ConfigList* and value 2, corresponds to the second entry in *cbp-ConfigList*.

**npdcch-NumRepetitionPaging**

Number of repetitions for NPDCCH, see TS 36.211 [21]. This value is an estimate of the required number of repetitions for NPDCCH.

Conditional presence	Explanation
<i>CBP</i>	This field is mandatory present if <i>cbp-Index</i> has been provided to UE via dedicated signaling (see <i>RRConnectionRelease-NB</i> and <i>RRCEarlyDataComplete-NB</i> ). Otherwise this field is not present.

### **UERadioAccessCapabilityInformation-NB**

This message is used to transfer UE NB-IoT Radio Access capability information, covering both upload to and download from the EPC/5GC.

Direction: eNB to/from EPC, ng-eNB to/from 5GC

#### **UERadioAccessCapabilityInformation-NB message**

```
-- ASN1START
UERadioAccessCapabilityInformation-NB ::= SEQUENCE {
    criticalExtensions          CHOICE {
        c1                      CHOICE {
            ueRadioAccessCapabilityInformation-r13
            spare3 NULL, spare2 NULL, spare1 NULL
        },
        criticalExtensionsFuture SEQUENCE {}
    }
}

UERadioAccessCapabilityInformation-NB-IEs ::= SEQUENCE {
    ue-RadioAccessCapabilityInfo-r13      OCTET STRING (CONTAINING UE-Capability-NB-r13),
    nonCriticalExtension                  UERadioAccessCapabilityInformation-NB-v1380-IEs
    OPTIONAL
}

UERadioAccessCapabilityInformation-NB-v1380-IEs ::= SEQUENCE {
    lateNonCriticalExtension              OCTET STRING OPTIONAL,
    nonCriticalExtension                  UERadioAccessCapabilityInformation-NB-r14-IEs
    OPTIONAL
}

UERadioAccessCapabilityInformation-NB-r14-IEs ::= SEQUENCE {
    ue-RadioAccessCapabilityInfo-r14      OCTET STRING (CONTAINING UECapabilityInformation-NB)
    OPTIONAL,
    nonCriticalExtension                  SEQUENCE {} OPTIONAL
}
-- ASN1STOP
```

#### **UERadioAccessCapabilityInformation-NB field descriptions**

**ue-RadioAccessCapabilityInfo**

The NB-IoT UE Radio Access Capability Parameters, see TS 36.306 [5].

– *UERadioPagingInformation-NB*

This message is used to transfer NB-IoT radio paging information, covering both upload to and download from the EPC/5GC.

Direction: eNB to/from EPC, ng-eNB to/from 5GC

***UERadioPagingInformation-NB* message**

```
-- ASN1START
UERadioPagingInformation-NB ::= SEQUENCE {
    criticalExtensions          CHOICE {
        c1                      CHOICE {
            ueRadioPagingInformation-r13    UERadioPagingInformation-NB-IEs,
            spare3 NULL, spare2 NULL, spare1 NULL
        },
        criticalExtensionsFuture          SEQUENCE {}
    }
}

UERadioPagingInformation-NB-IEs ::= SEQUENCE {
    ue-RadioPagingInfo-r13          OCTET STRING (CONTAINING UE-RadioPagingInfo-NB-r13),
    nonCriticalExtension            SEQUENCE {}                                OPTIONAL
}
-- ASN1STOP
```

***UERadioPagingInformation-NB* field descriptions**

***ue-RadioPagingInfo***

The field is used to transfer UE NB-IoT capability information used for paging. The eNB generates the *ue-RadioPagingInfo* and the contained UE capability information is absent when not supported by the UE.

## 10.7 Inter-node NB-IoT RRC information element definitions

– *AS-Config-NB*

The *AS-Config-NB* IE contains information about NB-IoT RRC configuration information in the source eNB which can be utilized by target eNB.

***AS-Config-NB* information element**

```
-- ASN1START
AS-Config-NB ::= SEQUENCE {
    sourceRadioResourceConfig-r13    RadioResourceConfigDedicated-NB-r13,
    sourceSecurityAlgorithmConfig-r13 SecurityAlgorithmConfig,
    sourceUE-Identity-r13            C-RNTI,
    sourceDL-CarrierFreq-r13         CarrierFreq-NB-r13,
    . . . ,
    [[ sourceDL-CarrierFreq-v1550     CarrierFreq-NB-v1550    OPTIONAL    -- Cond TDD
    ]]
}
-- ASN1STOP
```

<b>AS-Config-NB field descriptions</b>
<b>sourceDL-CarrierFreq</b> Provides the parameter Downlink EARFCN in the source PCell, see TS 36.101 [42].
<b>sourceRadioResourceConfig</b> Radio configuration in the source PCell. The radio resource configuration for all radio bearers existing in the source PCell shall be included. See 10.9.
<b>sourceSecurityAlgorithmConfig</b> This field provides the AS integrity protection (SRBs) and AS ciphering (SRBs and DRBs) algorithm configuration used in the source PCell.

<b>Conditional presence</b>	<b>Explanation</b>
<i>TDD</i>	The field is optionally present in case of TDD; otherwise the field is not present.

## – *AS-Context-NB*

The IE *AS-Context-NB* is used to transfer the UE context required by the target eNB.

### **AS-Context-NB information element**

```
-- ASN1START
AS-Context-NB ::=
    SEQUENCE {
        reestablishmentInfo-r13          ReestablishmentInfo-NB          OPTIONAL,
        ...
    }
-- ASN1STOP
```

<b>AS-Context-NB field descriptions</b>
<b>reestablishmentInfo</b> Including information needed for the RRC connection re-establishment.

## – *ReestablishmentInfo-NB*

The *ReestablishmentInfo-NB* IE contains information needed for the RRC connection re-establishment.

### **ReestablishmentInfo-NB information element**

```
-- ASN1START
ReestablishmentInfo-NB ::=
    SEQUENCE {
        sourcePhysCellId-r13          PhysCellId,
        targetCellShortMAC-I-r13      ShortMAC-I,
        additionalReestabInfoList-r13 AdditionalReestabInfoList          OPTIONAL,
        ...
    }
-- ASN1STOP
```

<b>ReestablishmentInfo-NB field descriptions</b>
<b>additionalReestabInfoList</b> Contains a list of shortMAC-I and KeNB* for cells under control of the target eNB, required for potential re-establishment by the UE in these cells to succeed.
<b>sourcePhysCellId</b> The physical cell identity of the source PCell, used to determine the UE context in the target eNB at re-establishment.
<b>targetCellShortMAC-I</b> The ShortMAC-I for the target PCell, in order for potential re-establishment to succeed.

## – RRM-Config-NB

The *RRM-Config-NB* IE contains information about UE specific RRM information which can be utilized by target eNB.

### RRM-Config-NB information element

```
-- ASN1START
RRM-Config-NB ::=
  ue-InactiveTime
  SEQUENCE {
    ENUMERATED {
      s1, s2, s3, s5, s7, s10, s15, s20,
      s25, s30, s40, s50, min1, min1s20, min1s40,
      min2, min2s30, min3, min3s30, min4, min5, min6,
      min7, min8, min9, min10, min12, min14, min17, min20,
      min24, min28, min33, min38, min44, min50, hr1,
      hr1min30, hr2, hr2min30, hr3, hr3min30, hr4, hr5, hr6,
      hr8, hr10, hr13, hr16, hr20, day1, day1hr12, day2,
      day2hr12, day3, day4, day5, day7, day10, day14, day19,
      day24, day30, dayMoreThan30} OPTIONAL,
    ...
  }
-- ASN1STOP
```

#### RRM-Config-NB field descriptions

##### **ue-InactiveTime**

Duration while UE has not received or transmitted any user data. Value s1 corresponds to 1 second, s2 corresponds to 2 seconds and so on. Value min1 corresponds to 1 minute, value min1s20 corresponds to 1 minute and 20 seconds, value min1s40 corresponds to 1 minute and 40 seconds and so on. Value hr1 corresponds to 1 hour, hr1min30 corresponds to 1 hour and 30 minutes and so on.

## 10.8 Inter-node RRC multiplicity and type constraint values

### – Multiplicity and type constraints definitions

### – End of *NB-IoT-InterNodeDefinitions*

```
-- ASN1START
END
-- ASN1STOP
```

## 10.9 Mandatory information in *AS-Config-NB*

The *AS-Config-NB* transferred between source eNB and target-eNB shall include all IEs necessary to describe the AS context. The conditional presence in clause 6 is only applicable for eNB to UE communication.

The "Need" or "Cond" statements are not applied in case of sending the IEs from source eNB to target eNB. Some information elements shall be included regardless of the "Need" or "Cond" e.g. *discardTimer*. The *AS-Config-NB* re-uses information elements primarily created to cover the radio interface signalling requirements.

Within the *sourceRadioResourceConfig*, the source eNB shall include fields that are optional for eNB to UE communication, if the functionality is configured unless explicitly specified otherwise in the following:

- in accordance with a condition that is explicitly stated to be applicable; or
- a default value is defined for the concerned field; and the configured value is the same as the default value that is defined; or

- the need of the field is OP and the current UE configuration corresponds with the behaviour defined for absence of the field;

## 11 UE capability related constraints and performance requirements

### 11.1 UE capability related constraints

The following table lists constraints regarding the UE capabilities that E-UTRAN is assumed to take into account.

Parameter	Description	Value	NB-IoT
#DRBs	The number of DRBs that a UE shall support	8, 15 NOTE2 NOTE3	(0, 1, 2) NOTE1
#RLC-AM	The number of RLC AM entities that a UE shall support	10, 17	(2, 3) NOTE1
#minCellperMeasObjectEUTRA	The minimum number of neighbour cells (excluding exclude-listed cells) that a UE shall be able to store within a MeasObjectEUTRA. NOTE.	32	N/A
#minExcludedCellRangesperMeasObjectEUTRA	The minimum number of exclude-listed cell PCI ranges that a UE shall be able to store within a MeasObjectEUTRA	32	N/A
#minCellperMeasObjectUTRA	The minimum number of neighbour cells that a UE shall be able to store within a MeasObjectUTRA. NOTE.	32	N/A
#minCellperMeasObjectGERAN	The minimum number of neighbour cells that a UE shall be able to store within a measObjectGERAN. NOTE.	32	N/A
#minCellperMeasObjectCDMA2000	The minimum number of neighbour cells that a UE shall be able to store within a measObjectCDMA2000. NOTE.	32	N/A
#minExcludedCellperMeasObjectNR	The minimum number of exclude-listed cells that a UE shall be able to store within a MeasObjectNR	32	N/A
#minCellTotal	The minimum number of neighbour cells (excluding exclude-listed cells) that UE shall be able to store in total in all measurement objects configured	256	N/A
NOTE:	In case of CGI reporting, the limit regarding the cells E-UTRAN can configure includes the cell for which the UE is requested to report CGI i.e. the amount of neighbour cells that can be included is at most (# minCellperMeasObjectRAT - 1), where RAT represents EUTRA/UTRA/GERAN/CDMA2000 respectively.		
NOTE 1:	#DRBs based on UE capability, #RLC-AM =#DRBs + 2.		
NOTE 2:	'15' applies when the UE supports <i>extendedNumberOfDRBs-r15</i> . For one MAC entity, the maximum number of DRBs configured with PDCP duplication and with RLC entity(ies) associated with this MAC entity is 8.		
NOTE 3:	The requirement is applicable in EN-DC, NGEN-DC and LTE standalone.		

### 11.2 Processing delay requirements for RRC procedures

The UE performance requirements for RRC procedures are specified in the following tables, by means of a value N:

N = the number of 1ms subframes from the end of reception of the E-UTRAN -> UE message on the UE physical layer up to when the UE shall be ready for the reception of uplink grant for the UE -> E-UTRAN response message with no access delay other than the TTI-alignment (e.g. excluding delays caused by scheduling, the random access procedure or physical layer synchronisation).

NOTE: No processing delay requirements are specified for RN-specific procedures.

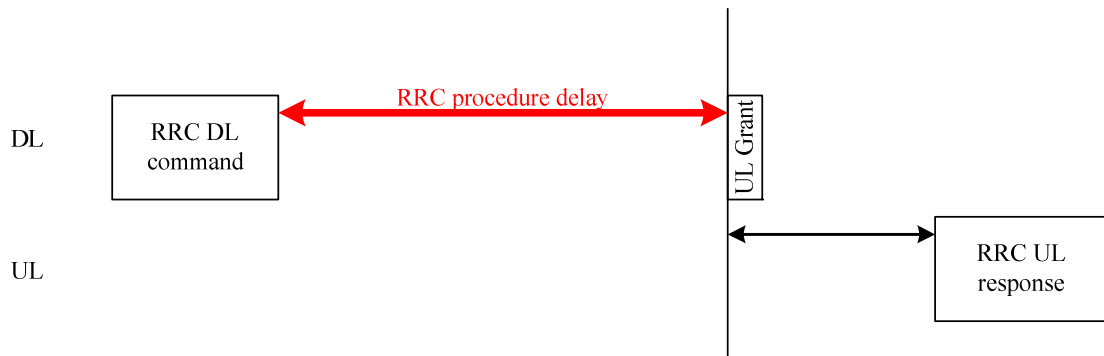

Figure 11.2-1: Illustration of RRC procedure delay

Table 11.2-1: UE performance requirements for RRC procedures for UEs other than NB-IoT UEs



Procedure title:	E-UTRAN -> UE	UE -> E-UTRAN	N	Notes
<b>RRC Connection Control Procedures</b>				
RRC connection establishment	<i>RRCCConnectionSetup</i> or <i>RRCCConnectionResume</i>	<i>RRCCConnectionSetupComplete</i> or <i>RRCCConnectionResumeComplete</i>	15 or 3	N = 3 applies for the case of reception of <i>RRCCConnectionResume</i> if <i>reducedCP-LatencyEnabled</i> is configured, the UE supports reduced CP latency, and the RRC message only includes MAC and PHY (re-)configurations and does not include (re-)configurations of DRX, SPS, SCells, and MIMO. Further, the UL grant is sent using PDCCH DCI format 0 in common search space. In this scenario, the RRC procedure delay can extend beyond the reception of the UL grant, up to 7 ms.  For other cases N = 15 applies.
RRC connection release	<i>RRCCConnectionRelease</i>		NA	
RRC connection re-configuration (radio resource configuration, possibly including configuration of conditional reconfigurations)	<i>RRCCConnectionReconfiguration</i>	<i>RRCCConnectionReconfigurationComplete</i>	15	Same requirement is applicable regardless of the number of target candidates being configured, if conditional reconfigurations are included in the message,
RRC connection re-configuration (measurement configuration)	<i>RRCCConnectionReconfiguration</i>	<i>RRCCConnectionReconfigurationComplete</i>	15	
RRC connection re-configuration (intra-LTE mobility)	<i>RRCCConnectionReconfiguration</i>	<i>RRCCConnectionReconfigurationComplete</i>	15	
RRC connection reconfiguration (SCell addition/release)	<i>RRCCConnectionReconfiguration</i>	<i>RRCCConnectionReconfigurationComplete</i>	20	
RRC connection reconfiguration (SCG establishment/ release, SCG cell addition/ release)	<i>RRCCConnectionReconfiguration</i>	<i>RRCCConnectionReconfigurationComplete</i>	20	
RRC connection re-configuration (NR measurement configuration)	<i>RRCCConnectionReconfiguration</i>	<i>RRCCConnectionReconfigurationComplete</i>	15	
RRC connection reconfiguration (NR SCG establishment/ /modification/release)	<i>RRCCConnectionReconfiguration</i>	<i>RRCCConnectionReconfigurationComplete</i>	20	
RRC connection re-configuration (intra-LTE mobility with NR SCG establishment/ /modification/release)	<i>RRCCConnectionReconfiguration</i>	<i>RRCCConnectionReconfigurationComplete</i>	20	

Procedure title:	E-UTRAN -> UE	UE -> E-UTRAN	N	Notes
RRC connection re-configuration	<i>DL DedicatedMessageSegment</i>	<i>RRCConnectionReconfigurationComplete</i>	20+(Nseg-1)*10	Nseg is number of RRC segments
RRC connection re-establishment	<i>RRCConnectionReestablishment</i>	<i>RRCConnectionReestablishmentComplete</i>	15	
Initial security activation	<i>SecurityModeCommand</i>	<i>SecurityModeCommandComplete/SecurityModeCommandFailure</i>	10	
Initial security activation + RRC connection re-configuration (RB establishment)	<i>SecurityModeCommand, RRCConnectionReconfiguration</i>	<i>RRCConnectionReconfigurationComplete</i>	20	The two DL messages are transmitted in the same TTI
EDT or transmission using PUR	<i>RRCEarlyDataComplete</i> or <i>RRCConnectionRelease</i>		NA	
Paging	<i>Paging</i>		NA	
RRC connection resume (SCG establishment/restoration/release)	<i>RRCConnectionResume</i>	<i>RRCConnectionResumeComplete</i>	20	
RRC connection resume (MCG SCell addition/restoration/release)	<i>RRCConnectionResume</i>	<i>RRCConnectionResumeComplete</i>	20	
RRC connection resume	<i>DL DedicatedMessageSegment</i>	<i>RRCConnectionResumeComplete</i>	20+(Nseg-1)*10	Nseg is number of RRC segments
<b>Inter RAT mobility</b>				
Handover to E-UTRA	<i>RRCConnectionReconfiguration (sent by other RAT)</i>	<i>RRCConnectionReconfigurationComplete</i>	NA	The performance of this procedure is specified in TS 45.010 [50] in case of handover from GSM and TS 25.133 [29], TS 25.123 [30] in case of handover from UTRA, and TS 38.133 [84] in case of handover from NR.
Handover from E-UTRA	<i>MobilityFromEUTRACommand</i>		NA	The performance of this procedure is specified in TS 36.133 [16]
Handover from E-UTRA to CDMA2000	<i>HandoverFromEUTRAPreparationRequest (CDMA2000)</i>		NA	Used to trigger the handover preparation procedure with a CDMA2000 RAT. The performance of this procedure is specified in TS 36.133 [16]
<b>Measurement procedures</b>				
Measurement Reporting		<i>MeasurementReport</i>	NA	
<b>Other procedures</b>				
UE capability transfer	<i>UECapabilityEnquiry</i>	<i>UECapabilityInformation</i>	10/ 80	N = 80 applies in case the UE has to report at least one of the following UE capabilities. - MR-DC band combinations. - NR band combinations - EUTRA feature sets

Procedure title:	E-UTRAN -> UE	UE -> E-UTRAN	N	Notes
UE capability transfer	<i>UECapabilityEnquiry</i>	<i>ULDedicatedMessageSegment</i>	80	
Counter check	<i>CounterCheck</i>	<i>CounterCheckResponse</i>	10	
Proximity indication		<i>ProximityIndication</i>	NA	
UE information	<i>UEInformationRequest</i>	<i>UEInformationResponse</i>	15	
MBMS counting	<i>MBMSCountingRequest</i>	<i>MBMSCountingResponse</i>	NA	
MBMS interest indication		<i>MBMSInterestIndication</i>	NA	
In-device coexistence indication		<i>InDeviceCoexIndication</i>	NA	
UE assistance information		<i>UEAssistanceInformation</i>	NA	
SCG failure information		<i>SCGFailureInformation</i>	NA	
NR SCG failure information		<i>SCGFailureInformationNR</i>	NA	
Sidelink UE information		<i>SidelinkUEInformation</i>	NA	
WLAN Connection Status Reporting		<i>WLANConnectionStatusReport</i>	NA	
PUR Configuration Request		<i>PURConfigurationRequest</i>	NA	

Table 11.2-2: UE performance requirements for RRC procedures for NB-IoT UEs

Procedure title:	E-UTRAN -> UE	UE -> E-UTRAN	N	Notes
<b>RRC Connection Control Procedures</b>				
RRC connection establishment	<i>RRCCConnectionSetup-p-NB</i> or <i>RRCCConnectionResume-NB</i>	<i>RRCCConnectionSetupComplete-NB</i> or <i>RRCCConnectionResumeComplete-NB</i>	45	
RRC connection release	<i>RRCCConnectionRelease-NB</i>		NA	
RRC connection re-configuration (radio resource configuration)	<i>RRCCConnectionReconfiguration-NB</i>	<i>RRCCConnectionReconfigurationComplete-NB</i>	45	
RRC connection re-establishment	<i>RRCCConnectionReestablishment-NB</i>	<i>RRCCConnectionReestablishmentComplete-NB</i>	45	
Initial security activation	<i>SecurityModeCommand</i>	<i>SecurityModeCommandComplete/SecurityModeCommandFailure</i>	35	
Initial security activation + RRC connection re-configuration (RB establishment)	<i>SecurityModeCommand</i> , <i>RRCCConnectionReconfiguration-NB</i>	<i>RRCCConnectionReconfigurationComplete-NB</i>	55	The two DL messages are transmitted in the same TTI
EDT or transmission using PUR	<i>RRCEarlyDataComplete-NB</i> or <i>RRCCConnectionRelease-NB</i>		NA	
Paging	<i>Paging-NB</i>		NA	
<b>Other procedures</b>				
UE capability transfer	<i>UECapabilityEnquiry-NB</i>	<i>UECapabilityInformation-NB</i>	35	
UE information	<i>UEInformationRequest-NB</i>	<i>UEInformationResponse-NB</i>	45	
PUR Configuration Request		<i>PURConfigurationRequest-NB</i>	NA	

## 11.3 Void

---

# Annex A (informative): Guidelines, mainly on use of ASN.1

## A.1 Introduction

The following clauses contain guidelines for the specification of RRC protocol data units (PDUs) with ASN.1.

## A.2 Procedural specification

### A.2.1 General principles

The procedural specification provides an overall high level description regarding the UE behaviour in a particular scenario.

It should be noted that most of the UE behaviour associated with the reception of a particular field is covered by the applicable parts of the PDU specification. The procedural specification may also include specific details of the UE behaviour upon reception of a field, but typically this should be done only for cases that are not easy to capture in the PDU clause e.g. general actions, more complicated actions depending on the value of multiple fields.

Likewise, the procedural specification need not specify the UE requirements regarding the setting of fields within the messages that are sent to E-UTRAN i.e. this may also be covered by the PDU specification.

### A.2.2 More detailed aspects

The following more detailed conventions should be used:

- Bullets:
  - Capitals should be used in the same manner as in other parts of the procedural text i.e. in most cases no capital applies since the bullets are part of the sentence starting with 'The UE shall:'
  - All bullets, including the last one in a clause, should end with a semi-colon i.e. an ';'.
- Conditions
  - Whenever multiple conditions apply, a semi-colon should be used at the end of each conditions with the exception of the last one, i.e. as in 'if cond1; or cond2:'

## A.3 PDU specification

### A.3.1 General principles

#### A.3.1.1 ASN.1 clauses

The RRC PDU contents are formally and completely described using abstract syntax notation (ASN.1), see X.680 [13], X.681 (02/2002) [14].

The complete ASN.1 code is divided into a number of ASN.1 clauses in the specifications. In order to facilitate the extraction of the complete ASN.1 code from the specification, each ASN.1 clause begins with a text paragraph consisting entirely of an *ASN.1 start tag*, which consists of a double hyphen followed by a single space and the text string "ASN1START" (in all upper case letters). Each ASN.1 clause ends with a text paragraph consisting entirely of an *ASN.1 stop tag*, which consists of a double hyphen followed by a single space and the text "ASN1STOP" (in all upper case letters):

```
-- ASN1START  
-- ASN1STOP
```

The text paragraphs containing the ASN.1 start and stop tags should not contain any ASN.1 code significant for the complete description of the RRC PDU contents. The complete ASN.1 code may be extracted by copying all the text paragraphs between an ASN.1 start tag and the following ASN.1 stop tag in the order they appear, throughout the specification.

NOTE: A typical procedure for extraction of the complete ASN.1 code consists of a first step where the entire RRC PDU contents description (ultimately the entire specification) is saved into a plain text (ASCII) file format, followed by a second step where the actual extraction takes place, based on the occurrence of the ASN.1 start and stop tags.

### A.3.1.2 ASN.1 identifier naming conventions

The naming of identifiers (i.e., the ASN.1 field and type identifiers) should be based on the following guidelines:

- Message (PDU) identifiers should be ordinary mixed case without hyphenation. These identifiers, e.g., the *RRCConnectionModificationCommand*, should be used for reference in the procedure text. Abbreviated forms of these identifiers should not be used.
- Type identifiers other than PDU identifiers should be ordinary mixed case, with hyphenation used to set off acronyms only where an adjacent letter is a capital, e.g., *EstablishmentCause*, *SelectedPLMN* (not *Selected-PLMN*, since the "d" in "Selected" is lowercase), *InitialUE-Identity* and *MeasSFN-SFN-TimeDifference*.
- Field identifiers shall start with a lowercase letter and use mixed case thereafter, e.g., *establishmentCause*. If a field identifier begins with an acronym (which would normally be in upper case), the entire acronym is lowercase (*plmn-Identity*, not *PLMN-Identity*). The acronym is set off with a hyphen (*ue-Identity*, not *ueIdentity*), in order to facilitate a consistent search pattern with corresponding type identifiers.
- Identifiers that are likely to be keywords of some language, especially widely used languages, such as C++ or Java, should be avoided to the extent possible.
- Identifiers, other than PDU identifiers, longer than 25 characters should be avoided where possible. It is recommended to use abbreviations, which should be done in a consistent manner i.e. use 'Meas' instead of 'Measurement' for all occurrences. Examples of typical abbreviations are given in table A.3.1.2.1-1 below.
- *For future extension:* When an extension is introduced a suffix is added to the identifier of the concerned ASN.1 field and/ or type. A suffix of the form "-rX" is used, with X indicating the release, for ASN.1 fields or types introduced in a later release (i.e. a release later than the original/ first release of the protocol) as well as for ASN.1 fields or types for which a revision is introduced in a later release replacing a previous version, e.g., *Foo-r9* for the Rel-9 version of the ASN.1 type *Foo*. A suffix of the form "-rXb" is used for the first revision of a field that it appears in the same release (X) as the original version of the field, "-rXc" for a second intra-release revision and so on. A suffix of the form "-vXYZ" is used for ASN.1 fields or types that only are an extension of a corresponding earlier field or type (see clause A.4), e.g., *AnElement-v10b0* for the extension of the ASN.1 type *AnElement* introduced in version 10.11.0 of the specification. A number 0...9, 10, 11, etc. is used to represent the first part of the version number, indicating the release of the protocol. Lower case letters a, b, c, etc. are used to represent the second (and third) part of the version number if they are greater than 9. In the procedural specification, in field descriptions as well as in headings suffices are not used, unless there is a clear need to distinguish the extension from the original field.
- More generally, in case there is a need to distinguish different variants of an ASN.1 field or IE, a suffix should be added at the end of the identifiers e.g. *MeasObjectUTRA*, *ConfigCommon*. When there is no particular need to distinguish the fields (e.g. because the field is included in different IEs), a common field identifier name may be used. This may be attractive e.g. in case the procedural specification is the same for the different variants.

**Table A.3.1.2-1: Examples of typical abbreviations used in ASN.1 identifiers**

Abbreviation	Abbreviated word
Comm	Communication
Conf	Confirmation
Config	Configuration
Disc	Discovery
DL	Downlink
Ext	Extension
Freq	Frequency
Id	Identity
Ind	Indication
Info	Information
Meas	Measurement
Neigh	Neighbour(ing)
Param(s)	Parameter(s)
Persist	Persistent
Phys	Physical
Proc	Process
Reestab	Reestablishment
Req	Request
Rx	Reception
Sched	Scheduling
Sync	Synchronisation
Thresh	Threshold
Tx/ Transm	Transmission
UL	Uplink

NOTE: The table A.3.1.2.1-1 is not exhaustive. Additional abbreviations may be used in ASN.1 identifiers when needed.

### A.3.1.3 Text references using ASN.1 identifiers

A text reference into the RRC PDU contents description from other parts of the specification is made using the ASN.1 field or type identifier of the referenced element. The ASN.1 field and type identifiers used in text references should be in the *italic font style*. The "do not check spelling and grammar" attribute in Word should be set. Quotation marks (i.e., " ") should not be used around the ASN.1 field or type identifier.

A reference to an RRC PDU type should be made using the corresponding ASN.1 type identifier followed by the word "message", e.g., a reference to the *RRCCConnectionRelease* message.

A reference to a specific part of an RRC PDU, or to a specific part of any other ASN.1 type, should be made using the corresponding ASN.1 field identifier followed by the word "field", e.g., a reference to the *prioritisedBitRate* field in the example below.

```
-- /example/ ASN1START
LogicalChannelConfig ::=
    ul-SpecificParameters
        priority
        prioritisedBitRate
        bucketSizeDuration
        logicalChannelGroup
    } OPTIONAL
SEQUENCE {
    SEQUENCE {
        Priority,
        PrioritisedBitRate,
        BucketSizeDuration,
        INTEGER (0..3)
    }
}
-- ASN1STOP
```

NOTE: All the ASN.1 start tags in the ASN.1 clauses, used as examples in this annex to the specification, are deliberately distorted, in order not to include them when the ASN.1 description of the RRC PDU contents is extracted from the specification.

A reference to a specific type of information element should be made using the corresponding ASN.1 type identifier preceded by the acronym "IE", e.g., a reference to the IE *LogicalChannelConfig* in the example above.

References to a specific type of information element should only be used when those are generic, i.e., without regard to the particular context wherein the specific type of information element is used. If the reference is related to a particular context, e.g., an RRC PDU type (message) wherein the information element is used, the corresponding field identifier in that context should be used in the text reference.

A reference to a specific value of an ASN.1 field should be made using the corresponding ASN.1 value without using quotation marks around the ASN.1 value, e.g., 'if the *status* field is set to value *true*'.

### A.3.2 High-level message structure

Within each logical channel type, the associated RRC PDU (message) types are alternatives within a CHOICE, as shown in the example below.

```
-- /example/ ASN1START

DL-DCCH-Message ::= SEQUENCE {
    message          DL-DCCH-MessageType
}

DL-DCCH-MessageType ::= CHOICE {
    c1               CHOICE {
        dlInformationTransfer          DLInformationTransfer,
        handoverFromEUTRAPreparationRequest  HandoverFromEUTRAPreparationRequest,
        mobilityFromEUTRACCommand        MobilityFromEUTRACCommand,
        rrcConnectionReconfiguration     RRCConnectionReconfiguration,
        rrcConnectionRelease             RRCConnectionRelease,
        securityModeCommand              SecurityModeCommand,
        ueCapabilityEnquiry              UECapabilityEnquiry,
        spare1 NULL
    },
    messageClassExtension SEQUENCE {}
}

-- ASN1STOP
```

A nested two-level CHOICE structure is used, where the alternative PDU types are alternatives within the inner level *c1* CHOICE.

Spare alternatives (i.e., *spare1* in this case) may be included within the *c1* CHOICE to facilitate future extension. The number of such spare alternatives should not extend the total number of alternatives beyond an integer-power-of-two number of alternatives (i.e., eight in this case).

Further extension of the number of alternative PDU types is facilitated using the *messageClassExtension* alternative in the outer level CHOICE.

### A.3.3 Message definition

Each PDU (message) type is specified in an ASN.1 clause similar to the one shown in the example below.

```
-- /example/ ASN1START

RRCConnectionReconfiguration ::= SEQUENCE {
    rrc-TransactionIdentifier      RRC-TransactionIdentifier,
    criticalExtensions             CHOICE {
        c1                         CHOICE {
            rrcConnectionReconfiguration-r8  RRCConnectionReconfiguration-r8-IEs,
            spare3 NULL, spare2 NULL, spare1 NULL
        },
        criticalExtensionsFuture SEQUENCE {}
    }
}

RRCConnectionReconfiguration-r8-IEs ::= SEQUENCE {
    -- Enter the IEs here.
    ...
}

-- ASN1STOP
```



Hooks for *critical* and *non-critical* extension should normally be included in the PDU type specification. How these hooks are used is further described in clause A.4.

Critical extensions are characterised by a redefinition of the PDU contents and need to be governed by a mechanism for protocol version agreement between the encoder and the decoder of the PDU, such that the encoder is prevented from sending a critically extended version of the PDU type, which is not comprehended by the decoder.

Critical extension of a PDU type is facilitated by a two-level CHOICE structure, where the alternative PDU contents are alternatives within the inner level *c1* CHOICE. Spare alternatives (i.e., *spare3* down to *spare1* in this case) may be included within the *c1* CHOICE. The number of spare alternatives to be included in the original PDU specification should be decided case by case, based on the expected rate of critical extension in the future releases of the protocol.

Further critical extension, when the spare alternatives from the original specifications are used up, is facilitated using the *criticalExtensionsFuture* in the outer level CHOICE.

In PDU types where critical extension is not expected in the future releases of the protocol, the inner level *c1* CHOICE and the spare alternatives may be excluded, as shown in the example below.

```
-- /example/ ASN1START
RRCConnectionReconfigurationComplete ::= SEQUENCE {
    rrc-TransactionIdentifier      RRC-TransactionIdentifier,
    criticalExtensions              CHOICE {
        rrcConnectionReconfigurationComplete-r8
        criticalExtensionsFuture   RRCConnectionReconfigurationComplete-r8-IEs,
    }
}
RRCConnectionReconfigurationComplete-r8-IEs ::= SEQUENCE {
    -- Enter the IEs here. --
    ...
}
-- ASN1STOP
```

Non-critical extensions are characterised by the addition of new information to the original specification of the PDU type. If not comprehended, a non-critical extension may be skipped by the decoder, whilst the decoder is still able to complete the decoding of the comprehended parts of the PDU contents.

Non-critical extensions at locations other than the end of the message or other than at the end of a field contained in a BIT or OCTET STRING are facilitated by use of the ASN.1 extension marker "...". The original specification of a PDU type should normally include the extension marker at the end of the sequence of information elements contained.

Non-critical extensions at the end of the message or at the end of a field that is contained in a BIT or OCTET STRING are facilitated by use of an empty sequence that is marked OPTIONAL e.g. as shown in the following example:

```
-- /example/ ASN1START
RRCMessage-r8-IEs ::=
    SEQUENCE {
        field1          InformationElement1,
        field2          InformationElement2,
        nonCriticalExtension SEQUENCE {} OPTIONAL
    }
-- ASN1STOP
```

The ASN.1 clause specifying the contents of a PDU type may be followed by a *field description* table where a further description of, e.g., the semantic properties of the fields may be included. The general format of this table is shown in the example below. The field description table is absent in case there are no fields for which further description needs to be provided e.g. because the PDU does not include any fields, or because an IE is defined for each field while there is nothing specific regarding the use of this IE that needs to be specified.

<b>%PDU-TypeIdentifier% field descriptions</b>
<b>%field identifier%</b> Field description.
<b>%field identifier%</b> Field description.

The field description table has one column. The header row shall contain the ASN.1 type identifier of the PDU type.

The following rows are used to provide field descriptions. Each row shall include a first paragraph with a *field identifier* (in **bold and italic** font style) referring to the part of the PDU to which it applies. The following paragraphs at the same row may include (in regular font style), e.g., semantic description, references to other specifications and/or specification of value units, which are relevant for the particular part of the PDU.

The parts of the PDU contents that do not require a field description shall be omitted from the field description table.

### A.3.4 Information elements

Each IE (information element) type is specified in an ASN.1 clause similar to the one shown in the example below.

```
-- /example/ ASN1START

PRACH-ConfigSIB ::=
    rootSequenceIndex      SEQUENCE {
    prach-ConfigInfo        INTEGER (0..1023),
                           PRACH-ConfigInfo
    }

PRACH-Config ::=
    rootSequenceIndex      SEQUENCE {
    prach-ConfigInfo        INTEGER (0..1023),
                           PRACH-ConfigInfo
    } OPTIONAL -- Need ON

PRACH-ConfigInfo ::=
    prach-ConfigIndex      SEQUENCE {
    highSpeedFlag           ENUMERATED {ffs},
    zeroCorrelationZoneConfig ENUMERATED {ffs}
    }

-- ASN1STOP
```

IEs should be introduced whenever there are multiple fields for which the same set of values apply. IEs may also be defined for other reasons e.g. to break down a ASN.1 definition in to smaller pieces.

A group of closely related IE type definitions, like the IEs *PRACH-ConfigSIB* and *PRACH-Config* in this example, are preferably placed together in a common ASN.1 clause. The IE type identifiers should in this case have a common base, defined as the *generic type identifier*. It may be complemented by a suffix to distinguish the different variants. The "*PRACH-Config*" is the generic type identifier in this example, and the "*SIB*" suffix is added to distinguish the variant. The clause heading and generic references to a group of closely related IEs defined in this way should use the generic type identifier.

The same principle should apply if a new version, or an extension version, of an existing IE is created for *critical* or *non-critical* extension of the protocol (see clause A.4). The new version, or the extension version, of the IE is included in the same ASN.1 clause defining the original. A suffix is added to the type identifier, using the naming conventions defined in clause A.3.1.2, indicating the release or version of the where the new version, or extension version, was introduced.

Local IE type definitions, like the IE *PRACH-ConfigInfo* in the example above, may be included in the ASN.1 clause and be referenced in the other IE types defined in the same ASN.1 clause. The use of locally defined IE types should be encouraged, as a tool to break up large and complex IE type definitions. It can improve the readability of the code. There may also be a benefit for the software implementation of the protocol end-points, as these IE types are typically provided by the ASN.1 compiler as independent data elements, to be used in the software implementation.

An IE type defined in a local context, like the IE *PRACH-ConfigInfo*, should not be referenced directly from other ASN.1 clauses in the RRC specification. An IE type which is referenced in more than one ASN.1 clause should be defined in a separate clause, with a separate heading and a separate ASN.1 clause (possibly as one in a set of closely

related IE types, like the IEs *PRACH-ConfigSIB* and *PRACH-Config* in the example above). Such IE types are also referred to as 'global IEs'.

**NOTE:** Referring to an IE type, that is defined as a local IE type in the context of another ASN.1 clause, does not generate an ASN.1 compilation error. Nevertheless, using a locally defined IE type in that way makes the IE type definition difficult to find, as it would not be visible at an outline level of the specification. It should be avoided.

The ASN.1 clause specifying the contents of one or more IE types, like in the example above, may be followed by a *field description* table, where a further description of, e.g., the semantic properties of the fields of the information elements may be included. This table may be absent, similar as indicated in clause A.3.3 for the specification of the PDU type. The general format of the *field description* table is the same as shown in clause A.3.3 for the specification of the PDU type.

### A.3.5 Fields with optional presence

A field with optional presence may be declared with the keyword **DEFAULT**. It identifies a default value to be assumed, if the sender does not include a value for that field in the encoding:

```
-- /example/ ASN1START
PreambleInfo ::=
    numberOfRA-Preambles          SEQUENCE {
                                   INTEGER (1..64)          DEFAULT 1,
                                   ...
    }
-- ASN1STOP
```

Alternatively, a field with optional presence may be declared with the keyword **OPTIONAL**. It identifies a field for which a value can be omitted. The omission carries semantics, which is different from any normal value of the field:

```
-- /example/ ASN1START
PRACH-Config ::=
    rootSequenceIndex            SEQUENCE {
                                   INTEGER (0..1023),
                                   PRACH-ConfigInfo          OPTIONAL    -- Need ON
    }
-- ASN1STOP
```

The semantics of an optionally present field, in the case it is omitted, should be indicated at the end of the paragraph including the keyword **OPTIONAL**, using a short comment text with a need statement. The need statement includes the keyword "Need", followed by one of the predefined semantics tags (OP, ON or OR) defined in clause 6.1. If the semantics tag **OP** is used, the semantics of the absent field are further specified either in the field description table following the ASN.1 clause, or in procedure text.

The addition of **OPTIONAL** keywords for capability groups is based on the following guideline. If there is more than one field in the lower level IE, then **OPTIONAL** keyword is added at the group level. If there is only one field in the lower level IE, **OPTIONAL** keyword is not added at the group level.

### A.3.6 Fields with conditional presence

A field with conditional presence is declared with the keyword **OPTIONAL**. In addition, a short comment text shall be included at the end of the paragraph including the keyword **OPTIONAL**. The comment text includes the keyword "Cond", followed by a condition tag associated with the field ("UL" in this example):

```
-- /example/ ASN1START
LogicalChannelConfig ::=
    ul-SpecificParameters        SEQUENCE {
                                   SEQUENCE {
                                       priority          INTEGER (0),
                                       ...
                                   }          OPTIONAL
    }
-- ASN1STOP
```

When conditionally present fields are included in an ASN.1 clause, the field description table after the ASN.1 clause shall be followed by a *conditional presence* table. The conditional presence table specifies the conditions for including the fields with conditional presence in the particular ASN.1 clause.

Conditional presence	Explanation
UL	<b>Specification of the conditions for including the field associated with the condition tag = "UL". Semantics in case of optional presence under certain conditions may also be specified.</b>

The conditional presence table has two columns. The first column (heading: "Conditional presence") contains the condition tag (in *italic* font style), which links the fields with a condition tag in the ASN.1 clause to an entry in the table. The second column (heading: "Explanation") contains a text specification of the conditions and requirements for the presence of the field. The second column may also include semantics, in case of an optional presence of the field, under certain conditions i.e. using the same predefined tags as defined for optional fields in A.3.5.

Conditional presence should primarily be used when presence of a field depends on the presence and/ or value of other fields within the same message. If the presence of a field depends on whether another feature/ function has been configured, while this function can be configured independently e.g. by another message and/ or at another point in time, the relation is best reflected by means of a statement in the field description table.

If the ASN.1 clause does not include any fields with conditional presence, the conditional presence table shall not be included.

Whenever a field is only applicable in specific cases e.g. TDD, use of conditional presence should be considered.

### A.3.7 Guidelines on use of lists with elements of SEQUENCE type

Where an information element has the form of a list (the SEQUENCE OF construct in ASN.1) with the type of the list elements being a SEQUENCE data type, an information element shall be defined for the list elements even if it would not otherwise be needed.

For example, a list of PLMN identities with reservation flags is defined as in the following example:

```
-- /example/ ASN1START
PLMN-IdentityInfoList ::=                SEQUENCE (SIZE (1..6)) OF PLMN-IdentityInfo
PLMN-IdentityInfo ::=                   SEQUENCE {
    plmn-Identity                        PLMN-Identity,
    cellReservedForOperatorUse           ENUMERATED {reserved, notReserved}
}
-- ASN1STOP
```

rather than as in the following (bad) example, which may cause generated code to contain types with unpredictable names:

```
-- /bad example/ ASN1START
PLMN-IdentityList ::=                   SEQUENCE (SIZE (1..6)) OF SEQUENCE {
    plmn-Identity                        PLMN-Identity,
    cellReservedForOperatorUse           ENUMERATED {reserved, notReserved}
}
-- ASN1STOP
```

### A.3.8 Guidelines on use of parameterised type SetupRelease

The usage of the parameterised type *SetupRelease* is like a function call using an information element as parameter. I.e. to use it, an IE has to be defined that specifies the sequence of fields that apply for choice value *setup*. Let's take an example.

```
-- /example/ ASN1START
```

```

InformationElementA ::= SEQUENCE {
    field1          BOOLEAN,
    field2          CHOICE {
        release     NULL,
        setup       SEQUENCE {
            field2a  INTEGER (0..7)          OPTIONAL, -- Need OR
            field2b  InformationElement2b
        }
    }
}
-- ASN1STOP

```

Using *SetupRelease* this example can be specified as follows:

```

-- /example/ ASN1START

InformationElementA ::= SEQUENCE {
    field1          BOOLEAN,
    field2          SetupRelease { InformationElement2 } OPTIONAL -- Need ON
}

InformationElement2 ::= SEQUENCE {
    field2a         INTEGER (0..7)          OPTIONAL, -- Need OR
    field2b         InformationElement2b
}
-- ASN1STOP

```

The two versions are equivalent in abstract syntax i.e. use of *SetupRelease* is like an editorial change.

## A.4 Extension of the PDU specifications

### A.4.1 General principles to ensure compatibility

It is essential that extension of the protocol does not affect interoperability i.e. it is essential that implementations based on different versions of the RRC protocol are able to interoperate. In particular, this requirement applies for the following kind of protocol extensions:

- Introduction of new PDU types (i.e. these should not cause unexpected behaviour or damage).
- Introduction of additional fields in an extensible PDUs (i.e. it should be possible to ignore uncomprehended extensions without affecting the handling of the other parts of the message).
- Introduction of additional values of an extensible field of PDUs. If used, the behaviour upon reception of an uncomprehended value should be defined.

It should be noted that the PDU extension mechanism may depend on the logical channel used to transfer the message e.g. for some PDUs an implementation may be aware of the protocol version of the peer in which case selective ignoring of extensions may not be required.

The non-critical extension mechanism is the primary mechanism for introducing protocol extensions i.e. the critical extension mechanism is used merely when there is a need to introduce a 'clean' message version. Such a need appears when the last message version includes a large number of non-critical extensions, which results in issues like readability, overhead associated with the extension markers. The critical extension mechanism may also be considered when it is complicated to accommodate the extensions by means of non-critical extension mechanisms.

### A.4.2 Critical extension of messages and fields

The mechanisms to critically extend a message are defined in A.3.3. There are both "outer branch" and "inner branch" mechanisms available. The "outer branch" consists of a CHOICE having the name *criticalExtensions*, with two values, *c1* and *criticalExtensionsFuture*. The *criticalExtensionsFuture* branch consists of an empty SEQUENCE, while the *c1* branch contains the "inner branch" mechanism.

The "inner branch" structure is a CHOICE with values of the form "*MessageName-rX-IEs*" (e.g., "*RRCConnectionReconfiguration-r8-IEs*") or "*spareX*", with the spare values having type NULL. The "-rX-IEs" structures contain the *complete* structure of the message IEs for the appropriate release; i.e., the critical extension branch for the Rel-10 version of a message includes all Rel-8 and Rel-9 fields (that are not obviated in the later version), rather than containing only the additional Rel-10 fields.

The following guidelines may be used when deciding which mechanism to introduce for a particular message, i.e. only an 'outer branch', or an 'outer branch' in combination with an 'inner branch' including a certain number of spares:

- For certain messages, e.g. initial uplink messages, messages transmitted on a broadcast channel, critical extension may not be applicable.
- An outer branch may be sufficient for messages not including any fields.
- The number of spares within inner branch should reflect the likelihood that the message will be critically extended in future releases (since each release with a critical extension for the message consumes one of the spare values). The estimation of the critical extension likelihood may be based on the number, size and changeability of the fields included in the message.
- In messages where an inner branch extension mechanism is available, all spare values of the inner branch should be used before any critical extensions are added using the outer branch.

The following example illustrates the use of the critical extension mechanism by showing the ASN.1 of the original and of a later release

```
-- /example/ ASN1START                                -- Original release
RRCMessage ::=
  rrc-TransactionIdentifier                            SEQUENCE {
  criticalExtensions                                  CHOICE {
    c1                                               CHOICE{
      rrcMessage-r8                                RRCMessage-r8-IEs,
      spare3 NULL, spare2 NULL, spare1 NULL
    },
    criticalExtensionsFuture                        SEQUENCE {}
  }
}
-- ASN1STOP
```

```
-- /example/ ASN1START                                -- Later release
RRCMessage ::=
  rrc-TransactionIdentifier                            SEQUENCE {
  criticalExtensions                                  CHOICE {
    c1                                               CHOICE{
      rrcMessage-r8                                RRCMessage-r8-IEs,
      rrcMessage-r10                              RRCMessage-r10-IEs,
      rrcMessage-r11                              RRCMessage-r11-IEs,
      rrcMessage-r14                              RRCMessage-r14-IEs
    },
    later                                           CHOICE {
      c2                                               CHOICE{
        rrcMessage-r16                              RRCMessage-r16-IEs,
        spare7 NULL, spare6 NULL, spare5 NULL, spare4 NULL,
        spare3 NULL, spare2 NULL, spare1 NULL
      },
      criticalExtensionsFuture                      SEQUENCE {}
    }
  }
}
-- ASN1STOP
```

It is important to note that critical extensions may also be used at the level of individual fields i.e. a field may be replaced by a critically extended version. When sending the extended version, the original version may also be included (e.g. original field is mandatory, EUTRAN is unaware if UE supports the extended version). In such cases, a UE supporting both versions may be required to ignore the original field. The following example illustrates the use of the critical extension mechanism by showing the ASN.1 of the original and of a later release

```

-- /example/ ASN1START                                -- Original release
RRCMessage ::=
  rrc-TransactionIdentifier                            SEQUENCE {
  criticalExtensions                                  RRC-TransactionIdentifier,
  c1                                                  CHOICE {
    rrcMessage-r8                                    RRCMessage-r8-IEs,
    spare3 NULL, spare2 NULL, spare1 NULL
  },
  criticalExtensionsFuture                            SEQUENCE {}
}

RRCMessage-rN-IEs ::= SEQUENCE {
  field1-rN                                          ENUMERATED {
    value1, value2, value3, value4} OPTIONAL, -- Need ON
  field2-rN                                          InformationElement2-rN      OPTIONAL, -- Need ON
  nonCriticalExtension                               RRCConnectionReconfiguration-vMxy-IEs  OPTIONAL
}

RRCConnectionReconfiguration-vMxy-IEs ::= SEQUENCE {
  field2-rM                                          InformationElement2-rM      OPTIONAL, -- Cond NoField2rN
  nonCriticalExtension                               SEQUENCE {}                 OPTIONAL
}

-- ASN1STOP

```

Conditional presence	Explanation
<i>NoField2rN</i>	The field is optionally present, need ON, if <i>field2-rN</i> is absent. Otherwise the field is not present

Finally, it is noted that a critical extension may be introduced in the same release as the one in which the original field was introduced e.g. to correct an essential ASN.1 error. In such cases a UE capability may be introduced, to assist E-UTRAN in deciding whether or not to use the critically extension.

## A.4.3 Non-critical extension of messages

### A.4.3.1 General principles

The mechanisms to extend a message in a non-critical manner are defined in A.3.3. W.r.t. the use of extension markers, the following additional guidelines apply:

- When further non-critical extensions are added to a message that has been critically extended, the inclusion of these non-critical extensions in earlier critical branches of the message should be avoided when possible.
- The extension marker ("...") is the primary non-critical extension mechanism that is used unless a length determinant is not required. Examples of cases where a length determinant is not required:
  - at the end of a message,
  - at the end of a structure contained in a BIT STRING or OCTET STRING
- When an extension marker is available, non-critical extensions are preferably placed at the location (e.g. the IE) where the concerned parameter belongs from a logical/ functional perspective (referred to as the '*default extension location*')
- It is desirable to aggregate extensions of the same release or version of the specification into a group, which should be placed at the lowest possible level.
- In specific cases it may be preferable to place extensions elsewhere (referred to as the '*actual extension location*') e.g. when it is possible to aggregate several extensions in a group. In such a case, the group should be placed at the lowest suitable level in the message.
- In case placement at the default extension location affects earlier critical branches of the message, locating the extension at a following higher level in the message should be considered.

- In case an extension is not placed at the default extension location, an IE should be defined. The IE's ASN.1 definition should be placed in the same ASN.1 clause as the default extension location. In case there are intermediate levels in-between the actual and the default extension location, an IE may be defined for each level. Intermediate levels are primarily introduced for readability and overview. Hence intermediate levels need not always be introduced e.g. they may not be needed when the default and the actual extension location are within the same ASN.1 clause.

#### A.4.3.2 Further guidelines

Further to the general principles defined in the previous clause, the following additional guidelines apply regarding the use of extension markers:

- Extension markers within SEQUENCE
  - Extension markers are primarily, but not exclusively, introduced at the higher nesting levels
  - Extension markers are introduced for a SEQUENCE comprising several fields as well as for information elements whose extension would result in complex structures without it (e.g. re-introducing another list)
  - Extension markers are introduced to make it possible to maintain important information structures e.g. parameters relevant for one particular RAT
  - Extension markers are also used for size critical messages (i.e. messages on BCCH, BR-BCCH, PCCH and CCCH), although introduced somewhat more carefully
  - The extension fields introduced (or frozen) in a specific version of the specification are grouped together using double brackets.
- Extension markers within ENUMERATED
  - Spare values are used until the number of values reaches the next power of 2, while the extension marker caters for extension beyond that limit
  - A suffix of the form "vXYZ" is used for the identifier of each new value, e.g. "value-vXYZ".
- Extension markers within CHOICE:
  - Extension markers are introduced when extension is foreseen and when comprehension is not required by the receiver i.e. behaviour is defined for the case where the receiver cannot comprehend the extended value (e.g. ignoring an optional CHOICE field). It should be noted that defining the behaviour of a receiver upon receiving a not comprehended choice value is not required if the sender is aware whether or not the receiver supports the extended value.
  - A suffix of the form "vXYZ" is used for the identifier of each new choice value, e.g. "choice-vXYZ".

Non-critical extensions at the end of a message/ of a field contained in an OCTET or BIT STRING:

- When a nonCriticalExtension is actually used, a "Need" statement should not be provided for the field, which always is a group including at least one extension and a field facilitating further possible extensions. For simplicity, it is recommended not to provide a "Need" statement when the field is not actually used either.

Further, more general, guidelines:

- In case a need statement is not provided for a group, a "Need" statement is provided for all individual extension fields within the group i.e. including for fields that are not marked as OPTIONAL. The latter is to clarify the action upon absence of the whole group.

#### A.4.3.3 Typical example of evolution of IE with local extensions

The following example illustrates the use of the extension marker for a number of elementary cases (sequence, enumerated, choice). The example also illustrates how the IE may be revised in case the critical extension mechanism is used.



NOTE In case there is a need to support further extensions of release n while the ASN.1 of release (n+1) has been frozen, without requiring the release n receiver to support decoding of release (n+1) extensions, more advanced mechanisms are needed e.g. including multiple extension markers.

```
-- /example/ ASN1START
InformationElement1 ::=          SEQUENCE {
  field1                          ENUMERATED {
                                   value1, value2, value3, value4-v880,
                                   ..., value5-v960 },
  field2                          CHOICE {
    field2a                        BOOLEAN,
    field2b                        InformationElement2b,
    ...,
    field2c-v960                   InformationElement2c-r9
  },
  ...,
  [[ field3-r9                     InformationElement3-r9          OPTIONAL      -- Need OR
  ]],
  [[ field3-v9a0                   InformationElement3-v9a0    OPTIONAL,      -- Need OR
  field4-r9                         InformationElement4          OPTIONAL      -- Need OR
  ]]
}

InformationElement1-r10 ::=      SEQUENCE {
  field1                          ENUMERATED {
                                   value1, value2, value3, value4-v880,
                                   value5-v960, value6-v1170, spare2, spare1, ... },
  field2                          CHOICE {
    field2a                        BOOLEAN,
    field2b                        InformationElement2b,
    field2c-v960                   InformationElement2c-r9,
    ...,
    field2d-v12b0                  INTEGER (0..63)
  },
  field3-r9                        InformationElement3-r10          OPTIONAL,      -- Need OR
  field4-r9                        InformationElement4                OPTIONAL,      -- Need OR
  field5-r10                       BOOLEAN,
  field6-r10                       InformationElement6-r10          OPTIONAL,      -- Need OR
  ...,
  [[ field3-v1170                   InformationElement3-v1170    OPTIONAL      -- Need OR
  ]]
}

-- ASN1STOP
```

Some remarks regarding the extensions of *InformationElement1* as shown in the above example:

- The *InformationElement1* is initially extended with a number of non-critical extensions. In release 10 however, a critical extension is introduced for the message using this IE. Consequently, a new version of the IE *InformationElement1* (i.e. *InformationElement1-r10*) is defined in which the earlier non-critical extensions are incorporated by means of a revision of the original field.
- The *value4-v880* is replacing a spare value defined in the original protocol version for *field1*. Likewise *value6-v1170* replaces *spare3* that was originally defined in the r10 version of *field1*
- Within the critically extended release 10 version of *InformationElement1*, the names of the original fields/ IEs are not changed, unless there is a real need to distinguish them from other fields/ IEs. E.g. the *field1* and *InformationElement4* were defined in the original protocol version (release 8) and hence not tagged. Moreover, the *field3-r9* is introduced in release 9 and not re-tagged; although, the *InformationElement3* is also critically extended and therefore tagged *InformationElement3-r10* in the release 10 version of *InformationElement1*.

#### A.4.3.4 Typical examples of non critical extension at the end of a message

The following example illustrates the use of non-critical extensions at the end of the message or at the end of a field that is contained in a BIT or OCTET STRING i.e. when an empty sequence is used.

```
-- /example/ ASN1START
RRCMessage-r8-IEs ::=          SEQUENCE {
  field1                          InformationElement1,
```

```

    field2                InformationElement2,
    field3                InformationElement3
    nonCriticalExtension  RRCMessage-v860-IEs
  }
  OPTIONAL, -- Need ON
  OPTIONAL

RRCMessage-v860-IEs ::= SEQUENCE {
    field4-v860          InformationElement4
    field5-v860          BOOLEAN
    nonCriticalExtension RRCMessage-v940-IEs
  }
  OPTIONAL, -- Need OP
  OPTIONAL, -- Cond C54
  OPTIONAL

RRCMessage-v940-IEs ::= SEQUENCE {
    field6-v940          InformationElement6-r9
    nonCriticalExtensions SEQUENCE {}
  }
  OPTIONAL, -- Need OR
  OPTIONAL

-- ASN1STOP

```

Some remarks regarding the extensions shown in the above example:

- The *InformationElement4* is introduced in the original version of the protocol (release 8) and hence no suffix is used.

#### A.4.3.5 Examples of non-critical extensions not placed at the default extension location

The following example illustrates the use of non-critical extensions in case an extension is not placed at the default extension location.

##### – *ParentIE-WithEM*

The IE *ParentIE-WithEM* is an example of a high level IE including the extension marker (EM). The root encoding of this IE includes two lower level IEs *ChildIE1-WithoutEM* and *ChildIE2-WithoutEM* which not include the extension marker. Consequently, non-critical extensions of the Child-IEs have to be included at the level of the Parent-IE.

The example illustrates how the two extension IEs *ChildIE1-WithoutEM-vNx0* and *ChildIE2-WithoutEM-vNx0* (both in release N) are used to connect non-critical extensions with a default extension location in the lower level IEs to the actual extension location in this IE.

#### ***ParentIE-WithEM* information element**

```

-- /example/ ASN1START
ParentIE-WithEM ::= SEQUENCE {
  -- Root encoding, including:
  childIE1-WithoutEM      ChildIE1-WithoutEM      OPTIONAL, -- Need ON
  childIE2-WithoutEM      ChildIE2-WithoutEM      OPTIONAL, -- Need ON
  ...,
  [[ childIE1-WithoutEM-vNx0 ChildIE1-WithoutEM-vNx0 OPTIONAL, -- Need ON
     childIE2-WithoutEM-vNx0 ChildIE2-WithoutEM-vNx0 OPTIONAL, -- Need ON
  ]]
}
-- ASN1STOP

```

Some remarks regarding the extensions shown in the above example:

- The fields *childIEx-WithoutEM-vNx0* may not really need to be optional (depends on what is defined at the next lower level).
- In general, especially when there are several nesting levels, fields should be marked as optional only when there is a clear reason.

## – *ChildIE1-WithoutEM*

The IE *ChildIE1-WithoutEM* is an example of a lower level IE, used to control certain radio configurations including a configurable feature which can be setup or released using the local IE *ChIE1-ConfigurableFeature*. The example illustrates how the new field *chIE1-NewField* is added in release N to the configuration of the configurable feature. The example is based on the following assumptions:

- when initially configuring as well as when modifying the new field, the original fields of the configurable feature have to be provided also i.e. as if the extended ones were present within the setup branch of this feature.
- when the configurable feature is released, the new field should be released also.
- when omitting the original fields of the configurable feature the UE continues using the existing values (which is used to optimise the signalling for features that typically continue unchanged upon handover).
- when omitting the new field of the configurable feature the UE releases the existing values and discontinues the associated functionality (which may be used to support release of unsupported functionality upon handover to an eNB supporting an earlier protocol version).

The above assumptions, which affect the use of conditions and need codes, may not always apply. Hence, the example should not be re-used blindly.

### ***ChildIE1-WithoutEM* information elements**

```
-- /example/ ASN1START
ChildIE1-WithoutEM ::= SEQUENCE {
  -- Root encoding, including:
  chIE1-ConfigurableFeature      ChIE1-ConfigurableFeature      OPTIONAL      -- Need ON
}
ChildIE1-WithoutEM-vNx0 ::= SEQUENCE {
  chIE1-ConfigurableFeature-vNx0 ChIE1-ConfigurableFeature-vNx0 OPTIONAL      -- Cond ConfigF
}
ChIE1-ConfigurableFeature ::= CHOICE {
  release      NULL,
  setup        SEQUENCE {
    -- Root encoding
  }
}
ChIE1-ConfigurableFeature-vNx0 ::= SEQUENCE {
  chIE1-NewField-rN      INTEGER (0..31)
}
-- ASN1STOP
```

Conditional presence	Explanation
<i>ConfigF</i>	The field is optional present, need OR, in case of <i>chIE1-ConfigurableFeature</i> is included and set to "setup"; otherwise the field is not present and the UE shall delete any existing value for this field.

## – *ChildIE2-WithoutEM*

The IE *ChildIE2-WithoutEM* is an example of a lower level IE, typically used to control certain radio configurations. The example illustrates how the new field *chIE1-NewField* is added in release N to the configuration of the configurable feature.

### ***ChildIE2-WithoutEM* information element**

```
-- /example/ ASN1START
ChildIE2-WithoutEM ::= CHOICE {
  release      NULL,
  setup        SEQUENCE {
    -- Root encoding
  }
}
```

```

}
ChildIE2-WithoutEM-vNx0 ::= SEQUENCE {
  chIE2-NewField-rN          INTEGER (0..31)          OPTIONAL  -- Cond ConfigF
}
-- ASN1STOP

```

Conditional presence	Explanation
<i>ConfigF</i>	The field is optional present, need OR, in case of <i>chIE2-ConfigurableFeature</i> is included and set to "setup"; otherwise the field is not present and the UE shall delete any existing value for this field.

## A.5 Guidelines regarding inclusion of transaction identifiers in RRC messages

The following rules provide guidance on which messages should include a Transaction identifier

- 1: DL messages on CCCH that move UE to RRC\_IDLE should not include the RRC transaction identifier.
- 2: All network initiated DL messages by default should include the RRC transaction identifier.
- 3: All UL messages that are direct response to a DL message with an RRC Transaction identifier should include the RRC Transaction identifier.
- 4: All UL messages that require a direct DL response message should include an RRC transaction identifier.
- 5: All UL messages that are not in response to a DL message nor require a corresponding response from the network should not include the RRC Transaction identifier.

## A.6 Protection of RRC messages (informative)

The following list provides information which messages can be sent (unprotected) prior to security activation and which messages can be sent unprotected after security activation. Those messages indicated "-" in "P" column should never be sent unprotected by eNB or UE. Further requirements are defined in the procedural text.

P...Messages that can be sent (unprotected) prior to security activation

A - I...Messages that can be sent without integrity protection after security activation

A - C...Messages that can be sent unciphered after security activation

NA... Message can never be sent after security activation

Message	P	A-I	A-C	Comment
CSFBParametersRequestCDMA2000	+	-	-	
CSFBParametersResponseCDMA2000	+	-	-	
CounterCheck	-	-	-	
CounterCheckResponse	-	-	-	
DLDedicatedMessageSegment	NOTE 1			
DLInformationTransfer	+	-	-	
FailureInformation	-	-	-	
HandoverFromEUTRAPreparationRequest (CDMA2000)	-	-	-	
InDeviceCoexIndication	-	-	-	
InterFreqRSTDMeasurementIndication	-	-	-	
LoggedMeasurementsConfiguration	-	-	-	
MasterInformationBlock	+	+	+	
MasterInformationBlock-MBMS	+	+	+	
MBMSCountingRequest	+	+	+	
MBMSCountingResponse	-	-	-	
MBMSInterestIndication	+	-	-	
MBSFNAreaConfiguration	+	+	+	
MeasReportAppLayer	-	-	-	
MeasurementReport	-	-	-	Measurement configuration may be sent prior to security activation. But: In order to protect privacy of UEs, MEASUREMENT REPORT is only sent from the UE after successful security activation.
MCGFailureInformation	-	-	-	
MobilityFromEUTRACommand	-	-	-	
Paging	+	+	+	
ProximityIndication	-	-	-	
PURConfigurationRequest	+	-	-	Except if the UE is using Control plane Clot EPS/5GS optimisation, the message is only sent from the UE after successful security activation.
RNReconfiguration	-	-	-	
RNReconfigurationComplete	-	-	-	
RRCCoalitionReconfiguration	+	-	-	The message shall not be sent unprotected before security activation if it is used to perform handover or to establish SRB2, SRB4 and DRBs
RRCCoalitionReconfigurationComplete	+	-	-	Unprotected, if sent as response to RRCCoalitionReconfiguration which was sent before security activation
RRCCoalitionReestablishment	-	+	+	This message is not protected by PDCP operation.
RRCCoalitionReestablishmentComplete	-	-	-	
RRCCoalitionReestablishmentReject	-	+	+	One reason to send this may be that the security context has been lost, therefore sent as unprotected.
RRCCoalitionReestablishmentRequest	-	-	+	This message is not protected by PDCP operation. However, a short MAC-I is included.
RRCCoalitionReject	+	+	+	Except for resumption of an RRC connection after early security reactivation in accordance with conditions in 5.3.3.18, A-I and A-C are NA.

Message	P	A-I	A-C	Comment
RRCConnectionRelease	+	-	-	Justification for P: If the RRC connection only for signalling not requiring DRBs or ciphered messages, or the signalling connection has to be released prematurely, this message is sent as unprotected. For resumption of an RRC connection after early security reactivation in accordance with conditions in 5.3.3.18, the message is only sent after successful security activation. <i>RRCConnectionRelease</i> message sent before security activation cannot include <i>rrc-InactiveConfig</i> , <i>redirectedCarrierInfo</i> , <i>idleModeMobilityControlInfo</i> information fields when UE is connected to 5G.
RRCConnectionRequest	+	NA	NA	
RRCConnectionResume	-	-	+	When this message is transmitted, security is activated but suspended. Integrity verification is done after the message received by RRC. For resumption of an RRC connection after early security reactivation in accordance with conditions in 5.3.3.18, the message is only sent after successful security activation. For RRC_INACTIVE state or after early security reactivation, the message is protected with both integrity and ciphering.
RRCConnectionResumeRequest	-	-	+	This message is not protected by PDCP operation. However, a short MAC-I is included.
RRCConnectionResumeComplete	-	-	-	
RRCConnectionSetup	+	NA	NA	
RRCConnectionSetupComplete	+	NA	NA	
RRCEarlyDataRequest	+	NA	NA	
RRCEarlyDataComplete	+	NA	NA	
SCGFailureInformation	-	-	-	
SCGFailureInformationNR	-	-	-	
SCPTMConfiguration	+	+	+	
SecurityModeCommand	+	NA	NA	Integrity protection applied, but no ciphering (integrity verification done after the message received by RRC)
SecurityModeComplete	-	NA	NA	Integrity protection applied, but no ciphering. Ciphering is applied after completing the procedure.
SecurityModeFailure	+	NA	NA	Neither integrity protection nor ciphering applied.
SidelinkUEInformation	+	-	-	
SystemInformation	+	+	+	
SystemInformationBlockType1	+	+	+	
SystemInformationBlockType1-MBMS	+	+	+	
UEAssistanceInformation	-	-	-	
UECapabilityEnquiry	+	-	-	Except if the UE is using Control plane CIoT EPS optimisation, E-UTRAN should retrieve UE capabilities only after AS security activation.
UECapabilityInformation	+	-	-	
UEInformationRequest	-	-	-	
UEInformationResponse	-	-	-	In order to protect privacy of UEs, UEInformationResponse is only sent from the UE after successful security activation
ULDedicatedMessageSegment	+	-	-	
ULHandoverPreparationTransfer (CDMA2000)	-	-	-	This message should follow HandoverFromEUTRAPreparationRequest
ULInformationTransfer	+	-	-	

Message	P	A-I	A-C	Comment
ULInformationTransferIRAT	NOTE 2			
ULInformationTransferMRDC	-	-	-	
WLANConnectionStatusReport	-	-	-	
NOTE 1: This message type carries segments of other RRC messages. The protection of an instance of this message is the same as for the message which this message is carrying.				
NOTE 2: This message type carries other RRC messages. The protection of an instance of this message is the same as for the message which this message is carrying.				

## A.7 Miscellaneous

The following miscellaneous conventions should be used:

- References: Whenever another specification is referenced, the specification number and optionally the relevant clause, table or figure, should be indicated in addition to the pointer to the References clause e.g. as follows: 'see TS 36.212 [22, 5.3.3.1.6]'.
- UE capabilities: TS 36.306 [5] specifies that E-UTRAN should in general respect the UE's capabilities. Hence there is no need to include statement clarifying that E-UTRAN, when setting the value of a certain configuration field, shall respect the related UE capabilities unless there is a particular need e.g. particularly complicated cases.

# Annex B (normative): Release 8 and 9 AS feature handling

## B.1 Feature group indicators

This annex contains the definitions of the bits in fields *featureGroupIndicators* (in Table B.1-1) and *featureGroupIndRel9Add* (in Table B.1-1a).

In this release of the protocol, the UE shall include the fields *featureGroupIndicators* in the IE *UE-EUTRA-Capability* and *featureGroupIndRel9Add* in the IE *UE-EUTRA-Capability-v9a0*. All the functionalities defined within the field *featureGroupIndicators* defined in Table B.1-1 or Table B.1-1a are mandatory for the UE (with exceptions for category M1 and M2 UEs), if the related capability (frequency band, RAT, SR-VCC or Inter-RAT ANR) is also supported. For a specific indicator, if all functionalities for a feature group listed in Table B.1-1 have been implemented and tested, the UE shall set the indicator as one (1), else (i.e. if any one of the functionalities in a feature group listed in Table B.1-1 or Table B.1-1a, which have not been implemented or tested), the UE shall set the indicator as zero (0).

The UE shall set all indicators that correspond to RATs not supported by the UE as zero (0).

The UE shall set all indicators, which do not have a definition in Table B.1-1 or Table B.1-1a, as zero (0).

If the optional fields *featureGroupIndicators* or *featureGroupIndRel9Add* are not included by a UE of a future release, the network may assume that all features pertaining to the RATs supported by the UE, respectively listed in Table B.1-1 or Table B.1-1a and deployed in the network, have been implemented and tested by the UE.

In Table B.1-1, a 'VoLTE capable UE' corresponds to a UE which is IMS voice capable and a 'MCPTT capable UE' corresponds to a UE which supports MCPTT voice application as defined in TS 23.179 [73].

The indexing in Table B.1-1a starts from index 33, which is the leftmost bit in the field *featureGroupIndRel9Add*.

**Table B.1-1: Definitions of feature group indicators**

Index of indicator (bit number)	Definition (description of the supported functionality, if indicator set to one)	Notes	If indicated "Yes" the feature shall be implemented and successfully tested for this version of the specification	FDD/TDD diff
1 (leftmost bit)	<ul style="list-style-type: none"> <li>- Intra-subframe frequency hopping for PUSCH scheduled by UL grant</li> <li>- DCI format 3a (TPC commands for PUCCH and PUSCH with single bit power adjustments)</li> <li>- Aperiodic CQI/PMI/RI reporting on PUSCH: Mode 2-0 – UE selected subband CQI without PMI</li> <li>- Aperiodic CQI/PMI/RI reporting on PUSCH: Mode 2-2 – UE selected subband CQI with multiple PMI</li> </ul>	- set to 1 by category M1 and M2 UEs that have implemented and successfully tested "Aperiodic CQI/PMI/RI reporting on PUSCH: Mode 2-0 – UE selected subband CQI without PMI"		Yes
2	<ul style="list-style-type: none"> <li>- Simultaneous CQI and ACK/NACK on PUCCH, i.e. PUCCH format 2a and 2b</li> <li>- Absolute TPC command for PUSCH</li> <li>- Resource allocation type 1 for PDSCH</li> <li>- Periodic CQI/PMI/RI reporting on PUCCH: Mode 2-0 – UE selected subband CQI without PMI</li> <li>- Periodic CQI/PMI/RI reporting on PUCCH: Mode 2-1 – UE selected subband CQI with single PMI</li> </ul>	- If a category M1 or M2 UE does not support this feature group, this bit shall be set to 0.		Yes
3	<ul style="list-style-type: none"> <li>- 5bit RLC UM SN</li> <li>- 7bit PDCP SN</li> </ul>	- can only be set to 1 if the UE has set bit number 7 to 1.	Yes, if UE supports VoLTE, MCPTT, or both.	No



			Yes, if UE supports SRVCC to EUTRAN from GERAN.	
--	--	--	---	--

4	- Short DRX cycle	- can only be set to 1 if the UE has set bit number 5 to 1. - not supported by category M1 or M2 UE		Yes
5	- Long DRX cycle - DRX command MAC control element		Yes	No
6	- Prioritised bit rate		Yes	No
7	- RLC UM	- can only be set to 0 if the UE does neither support VoLTE nor MCPTT	Yes, if UE supports VoLTE, MCPTT, or both. Yes, if UE supports SRVCC to EUTRAN from GERAN.	No
8	- EUTRA RRC_CONNECTED to UTRA FDD or UTRA TDD CELL_DCH PS handover, if the UE supports either only UTRAN FDD or only UTRAN TDD  - EUTRA RRC_CONNECTED to UTRA FDD CELL_DCH PS handover, if the UE supports both UTRAN FDD and UTRAN TDD	- can only be set to 1 if the UE has set bit number 22 to 1	Yes (except for category M1 and M2 UEs) for FDD, if UE supports UTRA FDD.	Yes
9	- EUTRA RRC_CONNECTED to GERAN GSM_Dedicated handover	- related to SR-VCC - can only be set to 1 if the UE has set bit number 23 to 1	Yes (except for category M1 and M2 UEs), if UE supports SRVCC to EUTRAN from GERAN.	Yes
10	- EUTRA RRC_CONNECTED to GERAN (Packet_) Idle by Cell Change Order - EUTRA RRC_CONNECTED to GERAN (Packet_) Idle by Cell Change Order with NACC (Network Assisted Cell Change)			Yes
11	- EUTRA RRC_CONNECTED to CDMA2000 1xRTT CS Active handover	- related to SR-VCC - can only be set to 1 if the UE has sets bit number 24 to 1		Yes
12	- EUTRA RRC_CONNECTED to CDMA2000 HRPD Active handover	- can only be set to 1 if the UE has set bit number 26 to 1		Yes
13	- Inter-frequency handover (within FDD or TDD)	- can only be set to 1 if the UE has set bit number 25 to 1	Yes (except for category M1 and M2 UEs), unless UE only supports band 13	No
14	- Measurement reporting event: Event A4 – Neighbour > threshold - Measurement reporting event: Event A5 – Serving < threshold1 & Neighbour > threshold2		Yes (except for category M1 and M2 UEs)	No
15	- Measurement reporting event: Event B1 – Neighbour > threshold for UTRAN FDD or UTRAN TDD, if the UE supports either only UTRAN FDD or only UTRAN TDD and has set bit number 22 to 1  - Measurement reporting event: Event B1 – Neighbour > threshold for UTRAN FDD or UTRAN TDD, if the UE supports both UTRAN FDD and UTRAN TDD and has set bit number 22 or 39 to 1, respectively  - Measurement reporting event: Event B1 – Neighbour > threshold for GERAN, 1xRTT or HRPD, if the UE has set bit number 23, 24 or 26 to 1, respectively	- can only be set to 1 if the UE has set at least one of the bit number 22, 23, 24, 26 or 39 to 1. - even if the UE sets bits 41, it shall still set bit 15 to 1 if measurement reporting event B1 is tested for all RATs supported by UE - If a category M1 or M2 UE does not support this feature group, this bit shall be set to 0.	Yes for FDD, if UE supports only UTRAN FDD and does not support UTRAN TDD or GERAN or 1xRTT or HRPD	Yes

16	<p>- Intra-frequency periodical measurement reporting where <i>triggerType</i> is set to <i>periodical</i> and <i>purpose</i> is set to <i>reportStrongestCells</i></p> <p>- Inter-frequency periodical measurement reporting where <i>triggerType</i> is set to <i>periodical</i> and <i>purpose</i> is set to <i>reportStrongestCells</i>, if the UE has set bit number 25 to 1</p> <p>- Inter-RAT periodical measurement reporting where <i>triggerType</i> is set to <i>periodical</i> and <i>purpose</i> is set to <i>reportStrongestCells</i> for UTRAN FDD or UTRAN TDD, if the UE supports either only UTRAN FDD or only UTRAN TDD and has set bit number 22 to 1</p> <p>- Inter-RAT periodical measurement reporting where <i>triggerType</i> is set to <i>periodical</i> and <i>purpose</i> is set to <i>reportStrongestCells</i> for UTRAN FDD or UTRAN TDD, if the UE supports both UTRAN FDD and UTRAN TDD and has set bit number 22 or 39 to 1, respectively</p> <p>- Inter-RAT periodical measurement reporting where <i>triggerType</i> is set to <i>periodical</i> and <i>purpose</i> is set to <i>reportStrongestCells</i> for GERAN, 1xRTT or HRPD, if the UE has set bit number 23, 24 or 26 to 1, respectively.</p> <p>NOTE: Event triggered periodical reporting (i.e., with <i>triggerType</i> set to <i>event</i> and with <i>reportAmount</i> &gt; 1) is a mandatory functionality of event triggered reporting and therefore not the subject of this bit.</p>	<p>- If a category M1 or M2 UE does not support this feature group, this bit shall be set to 0.</p>	Yes	No
17	<p>Intra-frequency ANR features (including the case of (NG)EN-DC wherein MN and SN have the same DRX cycle and on-duration configured by MN completely contains on-duration configured by SN) including:</p> <p>- Intra-frequency periodical measurement reporting where <i>triggerType</i> is set to <i>periodical</i> and <i>purpose</i> is set to <i>reportStrongestCells</i></p> <p>- Intra-frequency periodical measurement reporting where <i>triggerType</i> is set to <i>periodical</i> and <i>purpose</i> is set to <i>reportCGI</i>.</p>	<p>- can only be set to 1 if the UE has set bit number 5 to 1.</p> <p>- If a category M1 or M2 UE does not support this feature group, this bit shall be set to 0.</p>	Yes	No
18	<p>Inter-frequency ANR features (including the case of (NG)EN-DC wherein MN and SN have the same DRX cycle and on-duration configured by MN completely contains on-duration configured by SN) including:</p> <p>- Inter-frequency periodical measurement reporting where <i>triggerType</i> is set to <i>periodical</i> and <i>purpose</i> is set to <i>reportStrongestCells</i></p> <p>- Inter-frequency periodical measurement reporting where <i>triggerType</i> is set to <i>periodical</i> and <i>purpose</i> is set to <i>reportCGI</i></p>	<p>- can only be set to 1 if the UE has set bit number 5 and bit number 25 to 1.</p> <p>- If a category M1 or M2 UE does not support this feature group, this bit shall be set to 0.</p>	Yes, unless UE only supports band 13	No

<p>19</p>	<p>Inter-RAT ANR features (including the case of (NG)EN-DC wherein MN and SN have the same DRX cycle and on-duration configured by MN completely contains on-duration configured by SN) including:</p> <ul style="list-style-type: none"> <li>- Inter-RAT periodical measurement reporting where <i>triggerType</i> is set to <i>periodical</i> and <i>purpose</i> is set to <i>reportStrongestCells</i> for GERAN, if the UE has set bit number 23 to 1</li> <li>- Inter-RAT periodical measurement reporting where <i>triggerType</i> is set to <i>periodical</i> and <i>purpose</i> is set to <i>reportStrongestCellsForSON</i> for UTRAN FDD or UTRAN TDD, if the UE supports either only UTRAN FDD or only UTRAN TDD and has set bit number 22 to 1</li> <li>- Inter-RAT periodical measurement reporting where <i>triggerType</i> is set to <i>periodical</i> and <i>purpose</i> is set to <i>reportStrongestCellsForSON</i> for UTRAN FDD or UTRAN TDD, if the UE supports both UTRAN FDD and UTRAN TDD and has set bit number 22 or 39 to 1, respectively</li> <li>- Inter-RAT periodical measurement reporting where <i>triggerType</i> is set to <i>periodical</i> and <i>purpose</i> is set to <i>reportStrongestCellsForSON</i> for 1xRTT or HRPD, if the UE has set bit number 24 or 26 to 1, respectively</li> <li>- Inter-RAT periodical measurement reporting where <i>triggerType</i> is set to <i>periodical</i> and <i>purpose</i> is set to <i>reportCGI</i> for UTRAN FDD or UTRAN TDD, if the UE supports either only UTRAN FDD or only UTRAN TDD and has set bit number 22 to 1</li> <li>- Inter-RAT periodical measurement reporting where <i>triggerType</i> is set to <i>periodical</i> and <i>purpose</i> is set to <i>reportCGI</i> for UTRAN FDD or UTRAN TDD, if the UE supports both UTRAN FDD and UTRAN TDD and has set bit number 22 or 39 to 1, respectively</li> <li>- Inter-RAT periodical measurement reporting where <i>triggerType</i> is set to <i>periodical</i> and <i>purpose</i> is set to <i>reportCGI</i> for GERAN, 1xRTT or HRPD, if the UE has set bit number 23, 24 or 26 to 1, respectively</li> </ul>	<ul style="list-style-type: none"> <li>- can only be set to 1 if the UE has set bit number 5 to 1 and the UE has set at least one of the bit number 22, 23, 24 or 26 to 1.</li> <li>- even if the UE sets bits 33 to 37, it shall still set bit 19 to 1 if inter-RAT ANR features are tested for all RATs for which inter-RAT measurement reporting is indicated as tested</li> </ul>		<p>Yes</p>
-----------	---	---	--	------------

20	<p>If bit number 7 is set to 0: - SRB1 and SRB2 for DCCH + 8x AM DRB</p> <p>If bit number 7 is set to 1: - SRB1 and SRB2 for DCCH + 8x AM DRB - SRB1 and SRB2 for DCCH + 5x AM DRB + 3x UM DRB</p> <p>NOTE: UE which indicate support for a DRB combination also support all subsets of the DRB combination. Therefore, release of DRB(s) never results in an unsupported DRB combination.</p>	<p>- Regardless of what bit number 7 and bit number 20 is set to, UE shall support at least SRB1 and SRB2 for DCCH + 4x AM DRB</p> <p>- Regardless of what bit number 20 is set to, if bit number 7 is set to 1, UE shall support at least SRB1 and SRB2 for DCCH + 4x AM DRB + 1x UM DRB</p> <p>- If <i>flexibleUM-AM-Combinations</i> is included the UE shall support any combination of RLC UM and RLC AM bearers as long as the total number of bearers is at most 8, regardless of what FGI20 indicates</p>	Yes	No
21	<p>- Predefined intra- and inter-subframe frequency hopping for PUSCH with <math>N_{sb} &gt; 1</math></p> <p>- Predefined inter-subframe frequency hopping for PUSCH with <math>N_{sb} &gt; 1</math></p>	- If a category M1 or M2 UE does not support this feature group, this bit shall be set to 0.		No
22	<p>- UTRAN FDD or UTRAN TDD measurements, reporting and measurement reporting event B2 in E-UTRA connected mode, if the UE supports either only UTRAN FDD or only UTRAN TDD</p> <p>- UTRAN FDD measurements, reporting and measurement reporting event B2 in E-UTRA connected mode, if the UE supports both UTRAN FDD and UTRAN TDD</p>	- If a category M1 or M2 UE does not support this feature group, this bit shall be set to 0.	Yes for FDD, if UE supports UTRA FDD	Yes
23	- GERAN measurements, reporting and measurement reporting event B2 in E-UTRA connected mode	- If a category M1 or M2 UE does not support this feature group, this bit shall be set to 0.		Yes
24	- 1xRTT measurements, reporting and measurement reporting event B2 in E-UTRA connected mode	- If a category M1 or M2 UE does not support this feature group, this bit shall be set to 0.	Yes for FDD, if UE supports enhanced 1xRTT CSFB for FDD Yes for TDD, if UE supports enhanced 1xRTT CSFB for TDD	Yes
25	<p>- Inter-frequency measurements and reporting in E-UTRA connected mode</p> <p>NOTE: The UE setting this bit to 1 and indicating support for FDD and TDD frequency bands in the UE capability signalling implements and is tested for FDD measurements while the UE is in TDD, and for TDD measurements while the UE is in FDD.</p>	- A category M1 or M2 UE shall set this bit to 1 only if <i>ceMeasurements-r14</i> is supported.	Yes, unless UE only supports band 13	No

26	- HRPD measurements, reporting and measurement reporting event B2 in E-UTRA connected mode	- If a category M1 or M2 UE does not support this feature group, this bit shall be set to 0.	Yes for FDD, if UE supports HRPD	Yes
27	- EUTRA RRC_CONNECTED to UTRA FDD or UTRA TDD CELL_DCH CS handover, if the UE supports either only UTRAN FDD or only UTRAN TDD  - EUTRA RRC_CONNECTED to UTRA FDD CELL_DCH CS handover, if the UE supports both UTRAN FDD and UTRAN TDD	- related to SR-VCC - can only be set to 1 if the UE has set bit number 8 to 1 and supports SR-VCC from EUTRA defined in TS 24.008 [49] - If a category M1 or M2 UE does not support this feature group, this bit shall be set to 0.	Yes for FDD, if UE supports VoLTE and UTRA FDD	Yes
28	- TTI bundling	- If a category M1 or M2 UE does not support this feature group, this bit shall be set to 0.	Yes for FDD	Yes
29	- Semi-Persistent Scheduling	- If a category M1 or M2 UE does not support this feature group, this bit shall be set to 0.		Yes
30	- Handover between FDD and TDD	- can only be set to 1 if the UE has set bit number 13 to 1		No
31	- Indicates whether the UE supports the mechanisms defined for cells broadcasting multi band information i.e. comprehending <i>multiBandInfoList</i> , disregarding in RRC_CONNECTED the related system information fields and understanding the EARFCN signalling for all bands, that overlap with the bands supported by the UE, and that are defined in the earliest version of TS 36.101 [42] that includes all UE supported bands.		Yes	No
32	Undefined			

NOTE: The column FDD/ TDD diff indicates if the UE is allowed to signal different values for FDD and TDD.

**Table B.1-1a: Definitions of feature group indicators**

Index of indicator (bit number)	Definition (description of the supported functionality, if indicator set to one)	Notes	If indicated "Yes" the feature shall be implemented and successfully tested for this version of the specification	FDD/ TDD diff
33 (leftmost bit)	Inter-RAT ANR features for UTRAN FDD (including the case of (NG)EN-DC wherein MN and SN have the same DRX cycle and on-duration configured by MN completely contains on-duration configured by SN) including: - Inter-RAT periodical measurement reporting where <i>triggerType</i> is set to <i>periodical</i> and <i>purpose</i> is set to <i>reportStrongestCellsForSON</i> - Inter-RAT periodical measurement reporting where <i>triggerType</i> is set to <i>periodical</i> and <i>purpose</i> is set to <i>reportCGI</i>	- can only be set to 1 if the UE has set bit number 5 and bit number 22 to 1.		Yes
34	Inter-RAT ANR features for GERAN (including the case of (NG)EN-DC wherein MN and SN have the same DRX cycle and on-duration configured by MN completely contains on-duration configured by SN) including: - Inter-RAT periodical measurement reporting where <i>triggerType</i> is set to <i>periodical</i> and <i>purpose</i> is set to <i>reportStrongestCells</i> - Inter-RAT periodical measurement reporting where <i>triggerType</i> is set to <i>periodical</i> and <i>purpose</i> is set to <i>reportCGI</i>	- can only be set to 1 if the UE has set bit number 5 and bit number 23 to 1.		Yes
35	Inter-RAT ANR features for 1xRTT (including the case of (NG)EN-DC wherein MN and SN have the same DRX cycle and on-duration configured by MN completely contains on-duration configured by SN) including: - Inter-RAT periodical measurement reporting where <i>triggerType</i> is set to <i>periodical</i> and <i>purpose</i> is set to <i>reportStrongestCellsForSON</i> - Inter-RAT periodical measurement reporting where <i>triggerType</i> is set to <i>periodical</i> and <i>purpose</i> is set to <i>reportCGI</i>	- can only be set to 1 if the UE has set bit number 5 and bit number 24 to 1.		Yes
36	Inter-RAT ANR features for HRPD (including the case of (NG)EN-DC wherein MN and SN have the same DRX cycle and on-duration configured by MN completely contains on-duration configured by SN) including: - Inter-RAT periodical measurement reporting where <i>triggerType</i> is set to <i>periodical</i> and <i>purpose</i> is set to <i>reportStrongestCellsForSON</i> - Inter-RAT periodical measurement reporting where <i>triggerType</i> is set to <i>periodical</i> and <i>purpose</i> is set to <i>reportCGI</i>	- can only be set to 1 if the UE has set bit number 5 and bit number 26 to 1.		Yes



37	Inter-RAT ANR features for UTRAN TDD (including the case of (NG)EN-DC wherein MN and SN have the same DRX cycle and on-duration configured by MN completely contains on-duration configured by SN) including: - Inter-RAT periodical measurement reporting where <i>triggerType</i> is set to <i>periodical</i> and <i>purpose</i> is set to <i>reportStrongestCellsForSON</i> - Inter-RAT periodical measurement reporting where <i>triggerType</i> is set to <i>periodical</i> and <i>purpose</i> is set to <i>reportCGI</i>	- can only be set to 1 if the UE has set bit number 5 and at least one of the bit number 22 (for UEs supporting only UTRA TDD) or the bit number 39 to 1.		Yes
38	- EUTRA RRC_CONNECTED to UTRA TDD CELL_DCH PS handover, if the UE supports both UTRAN FDD and UTRAN TDD	- can only be set to 1 if the UE has set bit number 39 to 1		Yes
39	- UTRAN TDD measurements, reporting and measurement reporting event B2 in E-UTRA connected mode, if the UE supports both UTRAN FDD and UTRAN TDD	- If a category M1 or M2 UE does not support this feature group, this bit shall be set to 0.		Yes
40	- EUTRA RRC_CONNECTED to UTRA TDD CELL_DCH CS handover, if the UE supports both UTRAN FDD and UTRAN TDD	- related to SR-VCC - can only be set to 1 if the UE has set bit number 38 to 1		Yes
41	Measurement reporting event: Event B1 – Neighbour > threshold for UTRAN FDD, if the UE supports UTRAN FDD and has set bit number 22 to 1	- If a category M1 or M2 UE does not support this feature group, this bit shall be set to 0.	Yes for FDD, unless UE has set bit number 15 to 1	Yes
42	- DCI format 3a (TPC commands for PUCCH and PUSCH with single bit power adjustments)	- If a category M1 or M2UE supports this feature group, this bit shall be set to 1. For a UE of all other categories, this bit shall be set to 0.		Yes
43	Undefined			
44	Undefined			
45	Undefined			
46	Undefined			
47	Undefined			
48	Undefined			
49	Undefined			
50	Undefined			
51	Undefined			
52	Undefined			
53	Undefined			
54	Undefined			
55	Undefined			
56	Undefined			
57	Undefined			
58	Undefined			
59	Undefined			
60	Undefined			
61	Undefined			
62	Undefined			
63	Undefined			
64	Undefined			

NOTE: The column FDD/ TDD diff indicates if the UE is allowed to signal different values for FDD and TDD. Annex E specifies for which TDD and FDD serving cells a UE supporting TDD/FDD CA shall support a feature for which it indicates support within the FGI signalling.

### Clarification for mobility from EUTRAN and inter-frequency handover within EUTRAN

There are several feature groups related to mobility from E-UTRAN and inter-frequency handover within EUTRAN. The description of these features is based on the assumption that we have 5 main "functions" related to mobility from E-UTRAN:

- A. Support of measurements and cell reselection procedure in idle mode
- B. Support of RRC release with redirection procedure in connected mode
- C. Support of Network Assisted Cell Change in connected mode
- D. Support of measurements and reporting in connected mode
- E. Support of handover procedure in connected mode

All functions can be applied for mobility to Inter-frequency to EUTRAN, GERAN, UTRAN, CDMA2000 HRPD and CDMA2000 1xRTT except for function C) which is only applicable for mobility to GERAN. Table B.1-2 below summarises the mobility functions that are supported based on the UE capability signaling (band support) and the setting of the feature group support indicators.

**Table B.1-2: Mobility from E-UTRAN**

Feature	GERAN	UTRAN	HRPD	1xRTT	EUTRAN
A. Measurements and cell reselection procedure in E-UTRA idle mode	Supported if GERAN band support is indicated	Supported if UTRAN band support is indicated	Supported if CDMA2000 HRPD band support is indicated	Supported if CDMA2000 1xRTT band support is indicated	Supported for supported bands
B. RRC release with blind redirection procedure in E-UTRA connected mode	Supported if GERAN band support is indicated	Supported if UTRAN band support is indicated	Supported if CDMA2000 HRPD band support is indicated	Supported if CDMA2000 1xRTT band support is indicated	Supported for supported bands
C. Cell Change Order (with or without) Network Assisted Cell Change) in E-UTRA connected mode	Group 10	N.A.	N.A.	N.A.	N.A.
D. Inter-frequency/RAT measurements, reporting and measurement reporting event B2 (for inter-RAT) in E-UTRA connected mode	Group 23	Group 22/39	Group 26	Group 24	Group 25
E. Inter-frequency/RAT handover procedure in E-UTRA connected mode	Group 9 (GSM_connected handover) Separate UE capability bit defined in TS 36.306 [5] for PS handover	Group 8/38 (PS handover) or Group 27/40 (SRVCC handover)	Group 12	Group 11	Group 13 (within FDD TDD) Group 30 (between FDD and TDD)

In case measurements and reporting function is not supported by UE, the network may still issue the mobility procedures redirection (B) and CCO (C) in a blind fashion.

## B.2 CSG support

In this release of the protocol, it is mandatory for the UE to support a minimum set of CSG functionality consisting of:

- Identifying whether a cell is CSG or not;
- Ignoring CSG cells in cell selection/reselection.

Additional CSG functionality in AS, i.e. the requirement to detect and camp on CSG cells when the " Permitted CSG list" is available or when manual CSG selection is triggered by the user, are related to the corresponding NAS features. This additional AS functionality consists of:

- Manual CSG selection;
- Autonomous CSG search;
- Implicit priority handling for cell reselection with CSG cells.

It is possible that this additional CSG functionality in AS is not supported or tested in early UE implementations.

Note that since the above AS features relate to idle mode operations, the capability support is not signalled to the network. For these reasons, no "feature group indicator" is assigned to this feature to indicate early support in Rel-8.

# Annex C (normative):Release 10 AS feature handling

## C.1 Feature group indicators

This annex contains the definitions of the bits in field *featureGroupIndRel10*.

In this release of the protocol, the UE shall include the field *featureGroupIndRel10* in the IE *UE-EUTRA-Capability-v1020-IEs*. All the functionalities defined within the field *featureGroupIndRel10* defined in Table C.1-1 are mandatory for the UE, if the related capability (spatial multiplexing in UL, PDSCH transmission mode 9, carrier aggregation, handover to EUTRA, or RAT) is also supported. For a specific indicator, if all functionalities for a feature group listed in Table C.1-1 have been implemented and tested, the UE shall set the indicator as one (1), else (i.e. if any one of the functionalities in a feature group listed in Table C.1-1 have not been implemented or tested), the UE shall set the indicator as zero (0).

The UE shall set all indicators that correspond to RATs not supported by the UE as zero (0).

The UE shall set all indicators, which do not have a definition in Table C.1-1, as zero (0).

If the optional field *featureGroupIndRel10* is not included by a UE of a future release, the network may assume that all features, listed in Table C.1-1 and deployed in the network, have been implemented and tested by the UE.

The indexing in Table C.1-1 starts from index 101, which is the leftmost bit in the field *featureGroupIndRel10*.

**Table C.1-1: Definitions of feature group indicators**

Index of indicator	Definition (description of the supported functionality, if indicator set to one)	Notes	If indicated "Yes" the feature shall be implemented and successfully tested for this version of the specification	FDD/TDD diff
101 (leftmost bit)	- DMRS with OCC (orthogonal cover code) and SGH (sequence group hopping) disabling	- if the UE supports two or more layers for spatial multiplexing in UL, this bit shall be set to 1. - If a category 0 or 1bis UE does not support this feature, this bit shall be set to 0.		No
102	- Trigger type 1 SRS (aperiodic SRS) transmission (Up to X ports)  NOTE: X = number of supported layers on given band			Yes
103	- PDSCH transmission mode 9 when up to 4 CSI reference signal ports are configured and when not operating in CE mode	- for Category 8 UEs, this bit shall be set to 1. - for Category 11 and higher UEs, this bit shall be set to 1.  - for DL Category 11 and higher UEs (except for DL Category 13), this bit shall be set to 1.	Yes for the UE categories listed in the column "Notes"	Yes

104	<ul style="list-style-type: none"> <li>- PDSCH transmission mode 9 for TDD when 8 CSI reference signal ports are configured and when not operating in CE mode</li> </ul>	<ul style="list-style-type: none"> <li>- if the UE does not support TDD, this bit is irrelevant, and shall be set to 0.</li> <li>- this bit is not applicable to FDD (capability signalling exists for FDD for this feature).</li> <li>- for Category 8 UEs, this bit shall be set to 1.</li> <li>- for Category 11 and higher UEs, this bit shall be set to 1.</li> <li>- for DL Category 11 and higher UEs (except for DL Category 13), this bit shall be set to 1.</li> </ul>	Yes for TDD, for the UE categories listed in the column "Notes"	No
105	<ul style="list-style-type: none"> <li>- Periodic CQI/PMI/RI reporting on PUCCH: Mode 2-0 – UE selected subband CQI without PMI, when PDSCH transmission mode 9 is configured</li> <li>- Periodic CQI/PMI/RI reporting on PUCCH: Mode 2-1 – UE selected subband CQI with single PMI, when PDSCH transmission mode 9 and up to 4 CSI reference signal ports are configured</li> </ul>	<ul style="list-style-type: none"> <li>- this bit can be set to 1 only if indices 2 (Table B.1-1) and 103 are set to 1.</li> <li>- For UEs capable of TDD-FDD CA, this bit can be set to 1 for both FDD and TDD if index 2 is set to 1 for both FDD and TDD, and index 103 is set to 1 for at least one of FDD and TDD duplex modes.</li> </ul>		Yes

106	- Periodic CQI/PMI/RI/PTI reporting on PUCCH: Mode 2-1 – UE selected subband CQI with single PMI, when PDSCH transmission mode 9 and 8 CSI reference signal ports are configured	- this bit can be set to 1 only if the UE supports PDSCH transmission mode 9 with 8 CSI reference signal ports (i.e., for TDD, if index 104 is set to 1, and for FDD, if <i>tm9-With-8Tx-FDD-r10</i> is set to 'supported') and if index 2 (Table B.1-1) is set to 1. - For UEs capable of TDD-FDD CA, this bit can be set to 1 for both FDD and TDD if at least one of index 104 and <i>tm9-With-8Tx-FDD-r10</i> is set to 1/'supported', and if index 2 is set to 1 for both FDD and TDD.		Yes
107	- Aperiodic CQI/PMI/RI reporting on PUSCH: Mode 2-0 – UE selected subband CQI without PMI, when PDSCH transmission mode 9 is configured - Aperiodic CQI/PMI/RI reporting on PUSCH: Mode 2-2 – UE selected subband CQI with multiple PMI, when PDSCH transmission mode 9 and up to 4 CSI reference signal ports are configured	- this bit can be set to 1 only if indices 1 (Table B.1-1) and 103 are set to 1. - For UEs capable of TDD-FDD CA, this bit can be set to 1 for both FDD and TDD if index 1 is set to 1 for both FDD and TDD, and index 103 is set to 1 for at least one of FDD and TDD duplex modes.		Yes
108	- Aperiodic CQI/PMI/RI reporting on PUSCH: Mode 2-2 – UE selected subband CQI with multiple PMI, when PDSCH transmission mode 9 and 8 CSI reference signal ports are configured	- this bit can be set to 1 only if the UE supports PDSCH transmission mode 9 with 8 CSI reference signal ports (i.e., for TDD, if index 104 is set to 1, and for FDD, if <i>tm9-With-8Tx-FDD-r10</i> is set to 'supported') and if index 1 (Table B.1-1) is set to 1. - For UEs capable of TDD-FDD CA, this bit can be set to 1 for both FDD and TDD if at least one of index 104 and <i>tm9-With-8Tx-FDD-r10</i> is set to 1/'supported', and if index 1 is set to 1 for both FDD and TDD.		Yes
109	- Periodic CQI/PMI/RI reporting on PUCCH Mode 1-1, submode 1	- this bit can be set to 1 only if the UE supports PDSCH transmission mode 9 with 8 CSI reference signal ports (i.e., for TDD, if index 104 is set to 1, and for FDD, if <i>tm9-With-8Tx-FDD-r10</i> is set to 'supported'). - For UEs capable of TDD-FDD CA, this bit can be set to 1 for both FDD and TDD if at least one of index 104 and <i>tm9-With-8Tx-FDD-r10</i> is set to 1/'supported'.		Yes

110	- Periodic CQI/PMI/RI reporting on PUCCH Mode 1-1, submode 2	- this bit can be set to 1 only if the UE supports PDSCH transmission mode 9 with 8 CSI reference signal ports (i.e., for TDD, if index 104 is set to 1, and for FDD, if <i>tm9-With-8Tx-FDD-r10</i> is set to 'supported'). - For UEs capable of TDD-FDD CA, this bit can be set to 1 for both FDD and TDD if at least one of index 104 and <i>tm9-With-8Tx-FDD-r10</i> is set to 1/'supported'.		Yes
111	- Measurement reporting trigger Event A6	- this bit can be set to 1 only if the UE supports carrier aggregation.		Yes
112	- SCell addition within the handover to EUTRA procedure	- this bit can be set to 1 only if the UE supports carrier aggregation and the handover to EUTRA procedure.		Yes
113	- Trigger type 0 SRS (periodic SRS) transmission on X Serving Cells  NOTE: X = number of supported component carriers in a given band combination	- this bit can be set to 1 only if the UE supports carrier aggregation in UL.		Yes
114	- Reporting of both UTRA CPICH RSCP and Ec/N0 in a Measurement Report	- this bit can be set to 1 only if index 22 (Table B.1-1) is set to 1.		No
115	- time domain ICIC RLM/RRM measurement subframe restriction for the serving cell - time domain ICIC RRM measurement subframe restriction for neighbour cells - time domain ICIC CSI measurement subframe restriction	- If a category M1 or M2 UE does not support this feature group, this bit shall be set to 0.		Yes
116	- Relative transmit phase continuity for spatial multiplexing in UL	- this bit can be set to 1 only if the UE supports two or more layers for spatial multiplexing in UL.		Yes
117	Undefined			
118	Undefined			
119	Undefined			
120	Undefined			
121	Undefined			
122	Undefined			
123	Undefined			
124	Undefined			
125	Undefined			
126	Undefined			
127	Undefined			
128	Undefined			
129	Undefined			
130	Undefined			
131	Undefined			
132	Undefined			

NOTE: The column FDD/ TDD diff indicates if the UE is allowed to signal different values for FDD and TDD. Annex E specifies for which TDD and FDD serving cells a UE supporting TDD/FDD CA shall support a feature for which it indicates support within the FGI signalling.

## Annex D (informative): Descriptive background information

### D.1 Signalling of Multiple Frequency Band Indicators (Multiple FBI)

#### D.1.1 Mapping between frequency band indicator and multiple frequency band indicator

This clause describes the use of the Multiple Frequency Band Indicator (MFBI) lists and the E-UTRA frequency bands in *SystemInformationBlockType1* by means of an example as shown in Figure D.1.1-1. In this example:

- E-UTRAN cell belongs to band B90 and also bands B6, B7, B91, and B92.
- The *freqBandIndicatorPriority* field is not present in *SystemInformationBlockType1*.
- E-UTRAN uses B64 to indicate the presence of B90 in *freqBandIndicator-v9e0*.
- For the MFBI list of this cell, E-UTRAN uses B64 in *MultiBandInfoList* to indicate the position and priority of the bands in *MultiBandInfoList-v9e0*.
- The UE, after reading *SystemInformationBlockType1*, generates an MFBI list with priority of B91, B6, B92, and B7. If the UE supports the frequency band in the *freqBandIndicator-v9e0* IE it applies that frequency band. Otherwise, the UE applies the first listed band in the MFBI list which it supports.

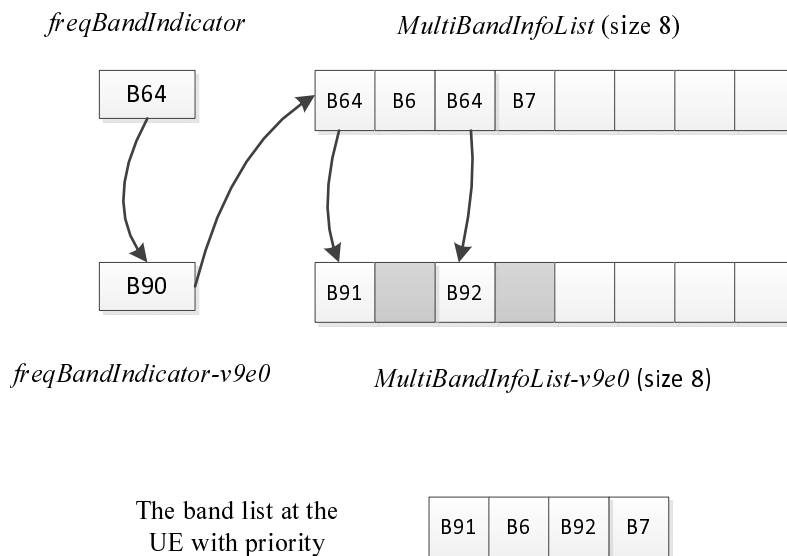

Figure D.1.1-1: Mapping of frequency bands to *MultiBandInfoList/ MultiBandInfoList-v9e0*

#### D.1.2 Mapping between inter-frequency neighbour list and multiple frequency band indicator

This clause describes the use of the Multiple Frequency Band Indicator (MFBI) lists and the E-UTRA frequencies signalled in *SystemInformationBlockType5* by means of an example as shown in Figure D.1.2-1. In this example:

- E-UTRAN includes 4 frequencies (EARFCNs): the bands associated with f1 and f4 belong to bands lower than 64; the bands associated with f2 and f3 belong to bands larger than 64. The reserved EARFCN value of 65535 is used to indicate the presence of *ARFCN-ValueEUTRA-v9e0*.



- The band associated with f1 has two overlapping bands, B1 and B2 (lower than 64); the band associated with f2 has one overlapping band, B91; the band associated with f3 has four overlapping bands B3, B4, B92, and B93; the band associated with f4 does not have overlapping bands.
- E-UTRAN includes 4 lists in both *interFreqCarrierFreqList-v8h0* and *interFreqCarrierFreqList-v9e0* and ensure the order of the lists is matching. Each list corresponds to one EARFCN and contains up to 8 bands. The first list corresponds to f1, the second list corresponds to f2, and so on. The grey lists mean not including *MultiBandInfoList* or *MultiBandInfoList-v9e0*, i.e. the corresponding EARFCN does not have any overlapping frequency bands in *MultiBandInfoList* or *MultiBandInfoList-v9e0*.

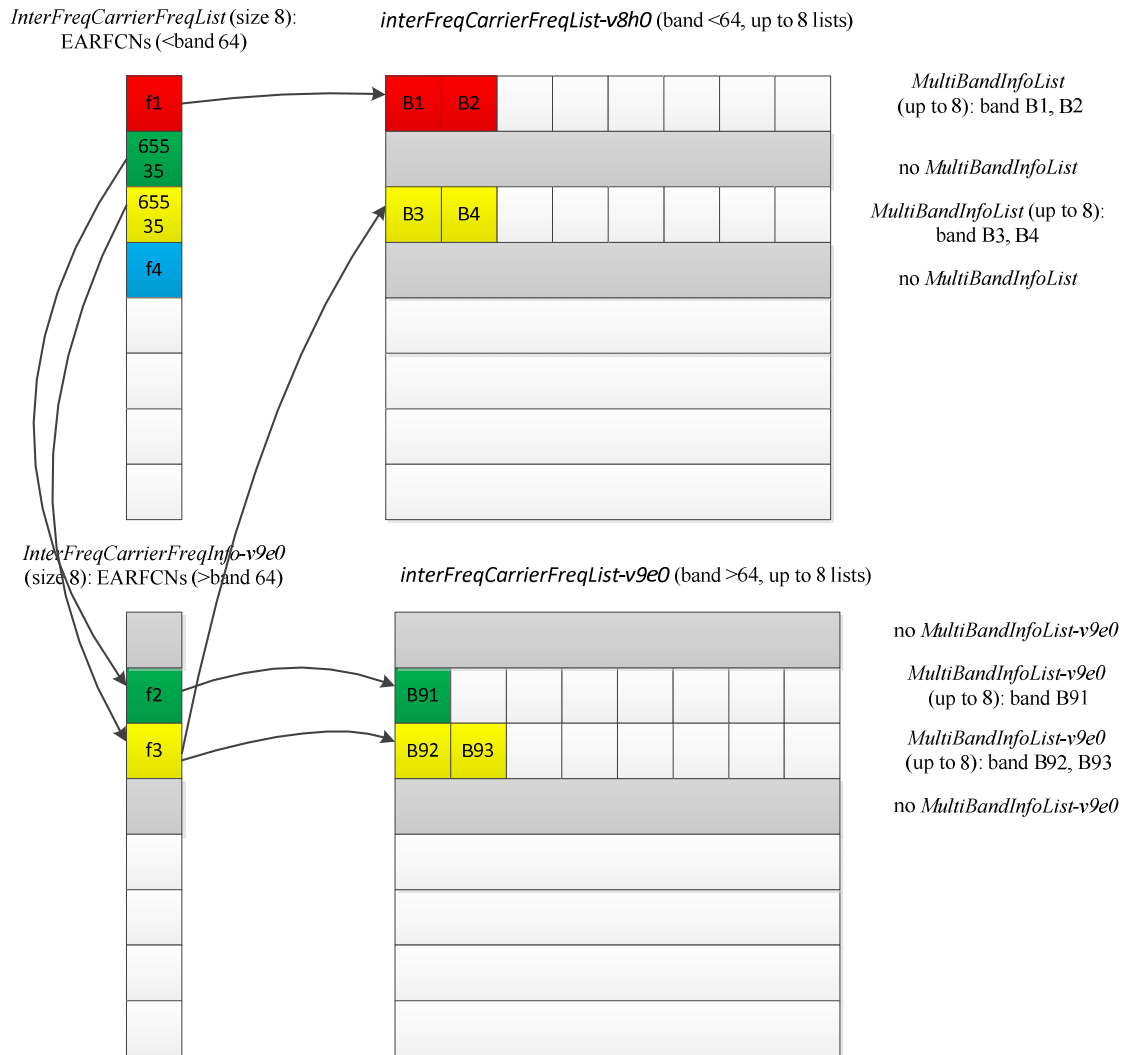

Figure D.1.2-1: Mapping of EARFCNs to MultiBandInfoList/MultiBandInfoList-v9e0

### D.1.3 Mapping between UTRA FDD frequency list and multiple frequency band indicator

This clause describes the use of the Multiple Frequency Band Indicator (MFBI) lists and the UTRA FDD frequencies signalled in *SystemInformationBlockType6* by means of an example as shown in Figure D.1.3-1. In this example:

- E-UTRAN includes 4 UTRA FDD frequencies (UARFCNs).
- The bands associated with f1 and f4 have no overlapping bands. The band associated with f2 has two overlapping bands, B1 and B2. The band associated with f3 has one overlapping band, B3.
- E-UTRAN includes 4 lists in *carrierFreqListUTRA-FDD-v8h0* with the first and fourth entry not including *MultiBandInfoList*.

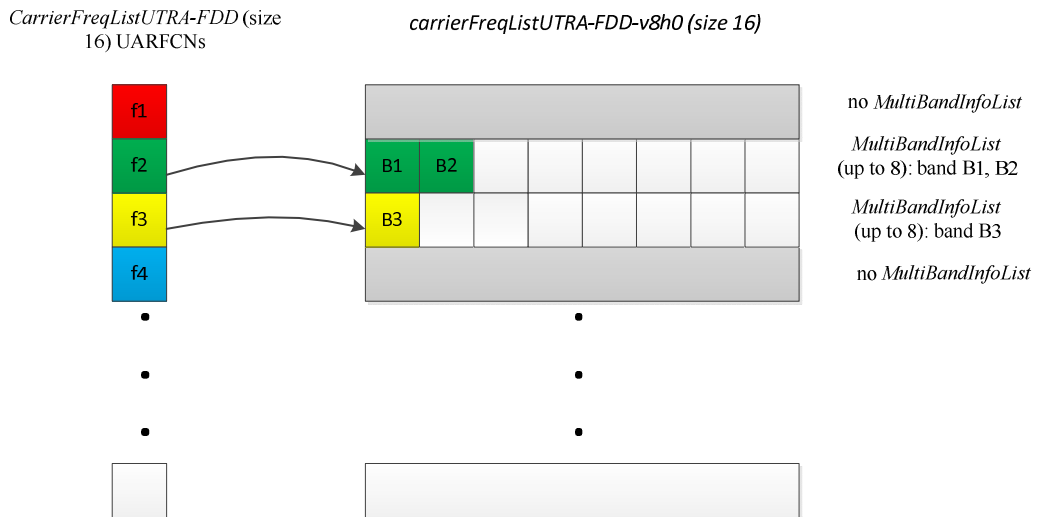

Figure D.1.3-1: Mapping of UARFCNs to *MultiBandInfoList*

## Annex E (normative): TDD/FDD differentiation of FGIs/capabilities in TDD-FDD CA

Annex E specifies for which TDD and FDD serving cells a UE supporting TDD/FDD CA shall support a feature/capability for which it indicates support within the FGI/capability signalling.

A UE that indicates support for TDD/ FDD CA:

- For the fields for which the UE is allowed to indicate different support for FDD and TDD, the UE shall support the feature on the PCell and/or SCell(s), as specified in tables E-1, E-2 and E-3 in accordance to the following rules:
  - PCell: the UE shall support the feature for the PCell, if the UE indicates support of the feature for the PCell duplex mode;
  - SCell: the UE shall support the feature for SCell(s), if the UE indicates support of the feature for the SCell duplex mode;
  - Per serving cell: the UE shall support the feature for a serving cell if the UE indicates support of the feature for the serving cell's duplex mode;
  - All serving cells: UE shall support the feature if the UE indicates support of the feature for both TDD and FDD duplex modes;
- For the fields where the UE is not allowed to indicate different support for FDD and TDD, the UE shall support the feature for PCell and SCell(s) if the UE indicates support of the feature via the common FGI/capability bit.

**Table E-1: Rel-8/9 FGIs for which FDD/TDD differentiation is allowed (from Annex B)**

Index of indicator	Classification
1	Per serving cell
2	All serving cells
4	All serving cells
8	PCell
9	PCell
10	PCell
11	PCell
12	PCell
15	PCell
19	PCell
22	PCell
23	PCell
24	PCell
26	PCell
27	PCell
28	PCell
29	PCell
33	PCell
34	PCell
35	PCell
36	PCell
37	PCell
38	PCell
39	PCell
40	PCell
41	PCell

**Table E-2: Rel-10 FGIs for which FDD/TDD differentiation is allowed (from Annex C)**

Index of indicator	Classification
102	Per serving cell
103	Per serving cell
105	All serving cells
106	All serving cells
107	All serving cells
108	All serving cells
109	All serving cells
110	All serving cells
111	SCell
112	PCell
113	Per serving cell
115	PCell
116	Per serving cell

**Table E-3: Rel-12 UE-EUTRA capabilities for which FDD/TDD differentiation is allowed**

UE-EUTRA-Capability	Classification
crossCarrierScheduling	All serving cells
e-CSFB-1XRTT	PCell
e-CSFB-ConcPS-Mob1XRTT	PCell
e-CSFB-dual-1XRTT	PCell
ePDCCH	Per serving cell
e-RedirectionUTRA	PCell
e-RedirectionUTRA-TDD	PCell
inDeviceCoexInd	All serving cells
interFreqRSTD-Measurement	PCell
interFreqSI-AcquisitionForHO	PCell
interRAT-PS-HO-ToGERAN	PCell
intraFreqSI-AcquisitionForHO	PCell
mbms-Scell	SCell
mbms-NonServingCell	SCell
multiACK-CSlreporting	PCell
multiClusterPUSCH-WithinCC	Per serving cell
otdoa-UE-Assisted	PCell
pmi-Disabling	Per serving cell
rsrqMeasWideband	Per serving cell
simultaneousPUCCH-PUSCH	All serving cells
ss-CCH-InterfHandl	PCell
txDiv-PUCCH1b-ChSelect	PCell
ue-TxAntennaSelectionSupported	All serving cells
utran-SI-AcquisitionForHO	PCell

## Annex F (normative): UE requirements on ASN.1 comprehension

This clause specifies UE requirements regarding the ASN.1 transfer syntax support i.e. the ASN.1 definitions to be comprehended by the UE.

A UE that indicates release X in field *accessStratumRelease* shall comprehend the entire transfer syntax (ASN.1) of release X, in particular at least the first version upon ASN.1 freeze. The UE is however not required to support dedicated signalling related transfer syntax associated with optional features it does not support.

In case a UE that indicates release X in field *accessStratumRelease* supports a feature specified in release X+ N (i.e. early UE implementation) additional requirements apply.

### Critical extensions (dedicated signaling)

If the early implemented feature involves one or more critical extensions (i.e. case of dedicated signaling), the UE shall comprehend the parts of the transfer syntax (ASN.1) of release X+ N that are related to the feature implemented early. This in particular concerns the ASN.1 parts related to configuration of the feature. The UE obviously also has to support the ASN.1 parts related to indicating support of the feature (in UE capabilities).

If configuration of an early implemented feature introduced in release X+ N involves a message or field that has been critically extended, the UE shall support configuration of all features supported by the UE that are associated with sub-fields of this critical extension. Apart from the early implemented feature(s), the UE need however not support functionality beyond what is defined in the release the UE indicates in access stratum release.

Let's consider the example of a UE indicating value X in field *accessStratumRelease* that supports the features associated with fields A1, A3 and A5 of *InformationElementA* (see ASN.1 below). The feature implemented early is associated with field A5, and can only be configured by the -rX+N version of *InformationElementA*. In such case, the UE should support configuration of the features associated with fields A1, A3 and A5 by the -rX+N version of *InformationElementA*. If however one of the features was modified, e.g. the feature associated with *fieldA3*, E-UTRAN should assume the UE only supports the feature according to the release it indicated in field *accessStratumRelease* (X). I.e. UE is neither required to support the additional code-point (*n80-vX+N0*) nor the additional sub-field (*fieldA3a*).

```

InformationElementA-rX ::= SEQUENCE {
    fieldA1-rX      InformationElementA1-rX      OPTIONAL, -- Need ON
    fieldA2-rX      InformationElementA2-rX      OPTIONAL, -- Need OR
    fieldA3-rX      InformationElementA3-rX      OPTIONAL, -- Need OR
}

InformationElementA-rX+N ::= SEQUENCE {
    fieldA1-rX+N    InformationElementA1-rX      OPTIONAL, -- Need ON
    fieldA2-rX+N    InformationElementA2-rX      OPTIONAL, -- Need OR
    fieldA3-rX+N    InformationElementA3-rX+N    OPTIONAL, -- Need OR
    fieldA4-rX+N    InformationElementA4-rX+N    OPTIONAL, -- Need OR
    fieldA5-rX+N    InformationElementA5-rX+N    OPTIONAL, -- Need OR
}

InformationElementA3-rX+N ::= SEQUENCE {
    fieldA1a-rX+N   InformationElementA1a-rX      OPTIONAL, -- Need ON
    fieldA2a-rX+N   ENUMERATED {n10, n20, n40,
                                n80-vX+N0}      OPTIONAL, -- Need OR
    fieldA3a-rX+N   InformationElementA3a-rX+N    OPTIONAL, -- Need OR
}

```

### Non-critical extensions (broadcast signaling)

If the early implemented feature involves one or more non-critical extensions in broadcast signaling (i.e. system information), the UE shall comprehend the parts of the transfer syntax (ASN.1) of release X+ N that are related to the feature implemented early. The SIB(s) containing the release X+ N fields related to the early implemented features may also include other extensions concerning releases from X upto X+N. The UE shall comprehend such intermediate fields (but again is not required to support the functionality associated with these intermediate fields, in case this concerns optional features not supported by the UE).

---

## Annex G (normative): List of CRs Containing Early Implementable Features and Corrections

This annex lists the Change Requests (CRs) whose changes may be implemented by a UE of an earlier release than which the CR was approved in (i.e. CRs that contain on their coversheets the sentence "Implementation of this CR from Rel-N will not cause interoperability issues").

**Table G-1: List of CRs Containing Early Implementable Features and Corrections**

<b>TDoc Number (RP-xxxxxx): CR Title</b>	<b>CR Number(s)</b>	<b>CR Revision Number(s)</b>	<b>Earliest Implementable Release</b>	<b>Additional Information</b>
RP-181233: Successful acknowledgement of RRCConnectionRelease for BL and CE UE	3324	1	Release 13	<i>RRCConnectionRelease</i> message, for which the poll bit is not set, can be considered successfully acknowledged when UE has sent HARQ ACK feedback.
RP-182674: CR for T312 on LTE HetNet mobility	3506	5	Release 12	Remove T312 in leaving condition for event trigger.
RP-182671: Corrections on paging monitoring and SI acquisition in RRC_CONNECTED for BL UEs and UEs in CE	3647	2	Release 13	
RP-190548: Update description of ack-NACK-NumRepetitions	3899	2	Release 13	
RP-190548: Corrections of NB-IoT Access Barring	3900	2	Release 13	
RP-191382: SI update notification and access barring in NB-IoT	4020	2	Release 13	
RP-192195 : Correction on handling of SCell(s) during Make Before Break handover	3986	3	Release 14	
RP-192940: Stop using redirectedCarrierOffsetDedicated after reselection to another frequency	4144	1	Release 14	
RP-200338: Corrections to T312 and Discovery Signals measurement	4198	1	Release 12	
RP-200367: Correction on H1 and H2 events	4103	2	Release 15	
RP-201166: Allowing PDCP version change without handover	4262	2	Release 15	
RP-201166: upperLayerIndication enhancements	4266	3	Release 15	
RP-201192: Relaxed serving cell measurement for UEs using WUS	4344	-	Release 15	
RP-202780: Corrections to the field descriptions for TDD/FDD capability differentiation, and to nMaxResource value range	4389	5	Release 12	The CR corrects multiple UE capability field descriptions introduced in various releases, the changes are early implementable back to the release in which the corresponding capability was introduced.
RP-202789: Correction on uac-AC1-SelectAssistInfo	4488	2	Release 15	
RP-211481: Clarification on the initiation of RNA update	4651	1	Release 15	
RP-212596: Distinguishing support of extended band n77	4723	2	Release 15	
RP-220472: Introduction of carrier specific NRSRP thresholds for NPRACH resource selection	4777	1	Release 14	
RP-221738: Distinguishing support of band n77 restrictions in Canada	4799	2	Release 15	



RP-232570: Addition of extended number range for NS value	4917	6	Release 16	
RP-233884: Correction to flightPathInfoAvailable when connected to 5GC	4959	2	Release 15	
RP-233883: Protection against improper reselection to GERAN/UTRAN [RESELECTION_TO GSM_AND_UTRAN]	4971	1	Release 15	
NOTE 1: In case a CR has mirror CR(s), the mirror CR(s) are not listed. NOTE 2: The Additional Information column briefly describes the content of a CR in cases where the CR title may not be descriptive enough. If the CR title is descriptive enough, then the Additional Information column may be left blank.				

## Annex H (informative): Change history

Change history							
Date	TSG #	TSG Doc.	CR	R ev	Cat	Subject/Comment	New version
12/2007	RP-38	RP-070920	-			Approved at TSG-RAN #38 and placed under Change Control	8.0.0
03/2008	RP-39	RP-080163	0001	4		CR to 36.331 with Miscellaneous corrections	8.1.0
03/2008	RP-39	RP-080164	0002	2		CR to 36.331 to convert RRC to agreed ASN.1 format	8.1.0
05/2008	RP-40	RP-080361	0003	1		CR to 36.331 on Miscellaneous clarifications/ corrections	8.2.0
09/2008	RP-41	RP-080693	0005	-		CR on Miscellaneous corrections and clarifications	8.3.0
12/2008	RP-42	RP-081021	0006	-		Miscellaneous corrections and clarifications	8.4.0
03/2009	RP-43	RP-090131	0007	-		Correction to the Counter Check procedure	8.5.0
	RP-43	RP-090131	0008	-		CR to 36.331-UE Actions on Receiving SIB11	8.5.0
	RP-43	RP-090131	0009	1		Spare usage on BCCH	8.5.0
	RP-43	RP-090131	0010	-		Issues in handling optional IE upon absence in GERAN NCL	8.5.0
	RP-43	RP-090131	0011	-		CR to 36.331 on Removal of useless RLC re-establishment at RB release	8.5.0
	RP-43	RP-090131	0012	1		Clarification to RRC level padding at PCCH and BCCH	8.5.0
	RP-43	RP-090131	0013	-		Removal of Inter-RAT message	8.5.0
	RP-43	RP-090131	0014	-		Padding of the SRB-ID for security input	8.5.0
	RP-43	RP-090131	0015	-		Validity of ETWS SIB	8.5.0
	RP-43	RP-090131	0016	1		Configuration of the Two-Intervals-SPS	8.5.0
	RP-43	RP-090131	0017	-		Corrections on Scaling Factor Values of Qhyst	8.5.0
	RP-43	RP-090131	0018	1		Optionality of srsMaxUppts	8.5.0
	RP-43	RP-090131	0019	-		CR for discussion on field name for common and dedicated IE	8.5.0
	RP-43	RP-090131	0020	-		Corrections to Connected mode mobility	8.5.0
	RP-43	RP-090131	0021	-		Clarification regarding the measurement reporting procedure	8.5.0
	RP-43	RP-090131	0022	1		Corrections on s-Measure	8.5.0
	RP-43	RP-090131	0023	1		R1 of CR0023 (R2-091029) on combination of SPS and TTI bundling for TDD	8.5.0
	RP-43	RP-090131	0024	-		L3 filtering for path loss measurements	8.5.0
	RP-43	RP-090131	0025	1		S-measure handling for reportCGI	8.5.0
	RP-43	RP-090131	0026	1		Measurement configuration clean up	8.5.0
	RP-43	RP-090131	0027	-		Alignment of measurement quantities for UTRA	8.5.0
	RP-43	RP-090131	0028	-		CR to 36.331 on L1 parameters ranges alignment	8.5.0
	RP-43	RP-090131	0029	-		Default configuration for transmissionMode	8.5.0
	RP-43	RP-090131	0030	-		CR to 36.331 on RRC Parameters for MAC, RLC and PDCP	8.5.0
	RP-43	RP-090131	0031	1		CR to 36.331 - Clarification on Configured PRACH Freq Offset	8.5.0
	RP-43	RP-090131	0032	-		Clarification on TTI bundling configuration	8.5.0
	RP-43	RP-090131	0033	1		Update of R2-091039 on Inter-RAT UE Capability	8.5.0
	RP-43	RP-090133	0034	-		Feature Group Support Indicators	8.5.0
	RP-43	RP-090131	0036	-		Corrections to RLF detection	8.5.0
	RP-43	RP-090131	0037	-		Indication of Dedicated Priority	8.5.0
	RP-43	RP-090131	0038	2		Security Clean up	8.5.0
	RP-43	RP-090131	0039	-		Correction of TTT value range	8.5.0
	RP-43	RP-090131	0040	-		Correction on CDMA measurement result IE	8.5.0
	RP-43	RP-090131	0041	1		Clarification of Measurement Reporting	8.5.0
	RP-43	RP-090131	0042	-		Spare values in DL and UL Bandwidth in MIB and SIB2	8.5.0
	RP-43	RP-090131	0044	1		Clarifications to System Information Block Type 8	8.5.0
	RP-43	RP-090131	0045	-		Reception of ETWS secondary notification	8.5.0
	RP-43	RP-090131	0046	1		Validity time for ETWS message Id and Sequence No	8.5.0
	RP-43	RP-090131	0047	-		CR for Timers and constants values used during handover to E-UTRA	8.5.0
	RP-43	RP-090131	0048	-		Inter-RAT Security Clarification	8.5.0
	RP-43	RP-090131	0049	-		CR to 36.331 on consistent naming of 1xRTT identifiers	8.5.0
	RP-43	RP-090131	0050	-		Capturing RRC behavior regarding NAS local release	8.5.0
	RP-43	RP-090131	0051	-		Report CGI before T321 expiry and UE null reporting	8.5.0
	RP-43	RP-090131	0052	-		System Information and 3 hour validity	8.5.0
	RP-43	RP-090131	0053	1		Inter-Node AS Signalling	8.5.0
	RP-43	RP-090131	0054	-		Set of values for the parameter "messagePowerOffsetGroupB"	8.5.0
	RP-43	RP-090131	0055	-		CR to paging reception for ETWS capable UEs in RRC_CONNECTED	8.5.0
	RP-43	RP-090131	0056	1		CR for CSG related items in 36.331	8.5.0
	RP-43	RP-090131	0057	1		SRS common configuration	8.5.0
	RP-43	RP-090131	0058	-		RRC processing delay	8.5.0
	RP-43	RP-090131	0059	-		CR for HNB Name	8.5.0
	RP-43	RP-090131	0060	3		Handover to EUTRA delta configuration	8.5.0
	RP-43	RP-090131	0063	-		Delivery of Message Identifier and Serial Number to upper layers for ETWS	8.5.0
	RP-43	RP-090131	0066	-		Clarification on the maximum size of cell lists	8.5.0
	RP-43	RP-090131	0067	-		Missing RRC messages in 'Protection of RRC messages'	8.5.0
	RP-43	RP-090131	0069	1		Clarification on NAS Security Container	8.5.0
	RP-43	RP-090131	0071	-		Extension of range of CQI/PMI configuration index	8.5.0
	RP-43	RP-090131	0072	1		Access barring alleviation in RRC connection establishment	8.5.0
	RP-43	RP-090367	0077	6		Corrections to feature group support indicators	8.5.0
	RP-43	RP-090131	0078	-		CR from email discussion to capture DRX and TTT handling	8.5.0
	RP-43	RP-090131	0079	1		Need Code handling on BCCH messages	8.5.0
	RP-43	RP-090131	0080	-		Unification of T300 and T301 and removal of miscellaneous FFSS	8.5.0

	RP-43	RP-090131	0084	1		Proposed CR modifying the code-point definitions of neighbourCellConfiguration	8.5.0
	RP-43	RP-090131	0087	2		Remove Redundant Optionality in SIB8	8.5.0
	RP-43	RP-090131	0089	-		Corrections to the generic error handling	8.5.0
	RP-43	RP-090131	0090	-		Configurability of T301	8.5.0
	RP-43	RP-090131	0091	1		Correction related to TTT	8.5.0
	RP-43	RP-090131	0095	-		CR for 36.331 on SPS-config	8.5.0
	RP-43	RP-090131	0096	2		CR for Deactivation of periodical measurement	8.5.0
	RP-43	RP-090131	0099	2		SMC and reconfiguration	8.5.0
	RP-43	RP-090131	0101	-		TDD handover	8.5.0
	RP-43	RP-090131	0102	-		Corrections to system information acquisition	8.5.0
	RP-43	RP-090131	0106	-		Some Corrections and Clarifications to 36.331	8.5.0
	RP-43	RP-090131	0109	-		Clarification on the Maximum number of ROHC context sessions parameter	8.5.0
	RP-43	RP-090131	0110	-		Transmission of rrm-Config at Inter-RAT Handover	8.5.0
	RP-43	RP-090131	0111	1		Use of SameRefSignalsInNeighbor parameter	8.5.0
	RP-43	RP-090131	0112	-		Default serving cell offset for measurement event A3	8.5.0
	RP-43	RP-090131	0114	-		dl-EARFCN missing in HandoverPreparationInformation	8.5.0
	RP-43	RP-090131	0115	-		Cleanup of references to 36.101	8.5.0
	RP-43	RP-090131	0117	-		Correction to the value range of UE-Categories	8.5.0
	RP-43	RP-090131	0122	1		Correction on RRC connection re-establishment	8.5.0
	RP-43	RP-090131	0124	-		Performing Measurements to report CGI for CDMA2000	8.5.0
	RP-43	RP-090131	0125	-		CDMA2000-SystemTimeInfo in VarMeasurementConfiguration	8.5.0
	RP-43	RP-090131	0126	-		UE Capability Information for CDMA2000 1xRTT	8.5.0
	RP-43	RP-090131	0127	-		CDMA2000 related editorial changes	8.5.0
	RP-43	RP-090131	0128	-		Draft CR to 36.331 on State mismatch recovery at re-establishment	8.5.0
	RP-43	RP-090131	0129	1		Draft CR to 36.331 on Renaming of AC barring related IEs	8.5.0
	RP-43	RP-090131	0130	2		Draft CR to 36.331 on Inheriting of dedicated priorities at inter-RAT reselection	8.5.0
	RP-43	RP-090131	0135	-		Proposed CR to 36.331 Description alignment for paging parameter, nB	8.5.0
	RP-43	RP-090131	0139	2		Miscellaneous corrections and clarifications resulting from ASN.1 review	8.5.0
	RP-43	RP-090131	0141	1		Correction regarding Redirection Information fo GERAN	8.5.0
	RP-43	RP-090131	0142	-		Further ASN.1 review related issues	8.5.0
	RP-43	RP-090131	0143	-		Periodic measurements	8.5.0
	RP-43	RP-090131	0144	1		Further analysis on code point "OFF" for ri-ConfigIndex	8.5.0
	RP-43	RP-090131	0145	1		Adding and deleting same measurement or configuration in one message	8.5.0
	RP-43	RP-090131	0147	-		Corrections to IE dataCodingScheme in SIB11	8.5.0
	RP-43	RP-090131	0148	-		Clarification on Mobility from E-UTRA	8.5.0
	RP-43	RP-090131	0149	-		36.331 CR related to "not applicable"	8.5.0
	RP-43	RP-090131	0150	1		UE radio capability transfer	8.5.0
	RP-43	RP-090131	0151	-		CR to 36.331 on value of CDMA band classes	8.5.0
	RP-43	RP-090131	0152	-		Corrections to DRB modification	8.5.0
	RP-43	RP-090131	0153	-		Correction to presence condition for pdcp-config	8.5.0
	RP-43	RP-090131	0155	-		TDD HARQ-ACK feedback mode	8.5.0
	RP-43	RP-090275	0157	-		Corrections regarding use of carrierFreq for CDMA (SIB8) and GERAN (measObject)	8.5.0
	RP-43	RP-090321	0156	1		Sending of GERAN SI/PSI information at Inter-RAT Handover	8.5.0
	RP-43	RP-090339	0158	-		Clarification of CSG support	8.5.0
06/2009	RP-44	RP-090516	0159	-		Octet alignment of VarShortMAC-Input	8.6.0
	RP-44	RP-090516	0160	3		Minor corrections to the feature grouping	8.6.0
	RP-44	RP-090516	0161	-		Security clarification	8.6.0
	RP-44	RP-090516	0162	1		Sending of GERAN SI/PSI information at Inter-RAT Handover	8.6.0
	RP-44	RP-090516	0163	1		Correction of UE measurement model	8.6.0
	RP-44	RP-090516	0164	-		Restricting the reconfiguration of UM RLC SN field size	8.6.0
	RP-44	RP-090516	0165	1		36.331 CR on Clarification on cell change order from GERAN to E-UTRAN	8.6.0
	RP-44	RP-090516	0166	-		36.331 CR - Handling of expired TAT and failed D-SR	8.6.0
	RP-44	RP-090516	0167	1		Proposed CR to 36.331 Clarification on mandatory information in AS-Config	8.6.0
	RP-44	RP-090516	0168	2		Miscellaneous small corrections	8.6.0
	RP-44	RP-090516	0173	-		Clarification on the basis of delta signalling	8.6.0
	RP-44	RP-090516	0177	-		CR on Alignment of CCCH and DCCH handling of missing mandatory field	8.6.0
	RP-44	RP-090516	0180	2		Handling of Measurement Context During HO Preparation	8.6.0
	RP-44	RP-090516	0181	-		Clarification of key-eNodeB-Star in AdditionalReestabInfo	8.6.0
	RP-44	RP-090516	0182	1		UE Capability Transfer	8.6.0
	RP-44	RP-090516	0186	1		Clarification regarding mobility from E-UTRA in-between SMC and SRB2/DRB setup	8.6.0
	RP-44	RP-090516	0188	1		Correction and completion of specification conventions	8.6.0
	RP-44	RP-090516	0195	2		RB combination in feature group indicator	8.6.0
	RP-44	RP-090516	0196	1		CR for need code for fields in mobilityControllInfo	8.6.0
	RP-44	RP-090497	0197	-		Alignment of pusch-HoppingOffset with 36.211	8.6.0
	RP-44	RP-090570	0198	-		Explicit srb-Identity values for SRB1 and SRB2	8.6.0
	RP-44	RP-090516	0199	-		Removing use of <i>defaultValue</i> for <i>mac-MainConfig</i>	8.6.0
09/2009	RP-45	RP-090906	0200	-		Proposed update of the feature grouping	8.7.0
	RP-45	RP-090906	0201	-		Clarification on measurement object configuration for serving frequency	8.7.0
	RP-45	RP-090906	0202	-		Correction regarding SRVCC	8.7.0

	RP-45	RP-090906	0203	-		Indication of DRB Release during HO	8.7.0
	RP-45	RP-090906	0204	1		Correction regarding application of dedicated resource configuration upon handover	8.7.0
	RP-45	RP-090906	0205	-		REL-9 protocol extensions in RRC	8.7.0
	RP-45	RP-090906	0206	-		In-order delivery of NAS PDUs at RRC connection reconfiguration	8.7.0
	RP-45	RP-090906	0207	-		Correction on Threshold of Measurement Event	8.7.0
	RP-45	RP-090906	0210	-		Clarification on dedicated resource of RA procedure	8.7.0
	RP-45	RP-090906	0213	1		Cell barring when MasterInformationBlock or SystemInformationBlock1 is missing	8.7.0
	RP-45	RP-090915	0218	-		Security threat with duplicate detection for ETWS	8.7.0
	RP-45	RP-090906	0224	-		Clarification on supported handover types in feature grouping	8.7.0
	RP-45	RP-090906	0250	1		Handling of unsupported / non-comprehended frequency band and emission requirement	8.7.0
	RP-45	RP-090906	0251	-		RB combinations in feature group indicator 20	8.7.0
09/2009	RP-45	RP-090934	0220	1		Introduction of Per-QCI radio link failure timers (option 1)	9.0.0
	RP-45	RP-090926	0222	-		Null integrity protection algorithm	9.0.0
	RP-45	RP-090926	0223	-		Emergency Support Indicator in BCCH	9.0.0
	RP-45	RP-090934	0230	2		CR to 36.331 for Enhanced CSFB to 1xRTT with concurrent PS handover	9.0.0
	RP-45	RP-090934	0243	-		REL-9 on Miscellaneous editorial corrections	9.0.0
	RP-45	RP-090934	0247	-		Periodic CQI/PMI/RI masking	9.0.0
	RP-45	RP-090933	0252	-		Introduction of CMAS	9.0.0
12/2009	RP-46	RP-091346	0253	1		(Rel-9)-clarification on the description of redirectedCarrierInfo	9.1.0
	RP-46	RP-091346	0254	1		Adding references to RRC processing delay for inter-RAT mobility messages	9.1.0
	RP-46	RP-091314	0256	-		Alignment of srs-Bandwidth with 36.211	9.1.0
	RP-46	RP-091341	0257	5		Baseline CR capturing eMBMS agreements	9.1.0
	RP-46	RP-091343	0258	3		Capturing agreements on inbound mobility	9.1.0
	RP-46	RP-091314	0260	-		Clarification of preRegistrationZoneID/secondaryPreRegistrationZoneID	9.1.0
	RP-46	RP-091346	0261	-		Clarification on NCC for IRAT HO	9.1.0
	RP-46	RP-091314	0263	-		Clarification on P-max	9.1.0
	RP-46	RP-091314	0265	1		Clarification on the definition of maxCellMeas	9.1.0
	RP-46	RP-091346	0266	-		Correction of q-RxLevMin reference in SIB7	9.1.0
	RP-46	RP-091346	0267	-		Correction on SPS-Config field descriptions	9.1.0
	RP-46	RP-091346	0268	1		correction on the definition of CellsTriggeredList	9.1.0
	RP-46	RP-091345	0269	-		Correction relating to CMAS UE capability	9.1.0
	RP-46	RP-091314	0271	1		Feature grouping bit for SRVCC handover	9.1.0
	RP-46	RP-091314	0272	1		Correction and completion of extension guidelines	9.1.0
	RP-46	RP-091344	0273	-		RACH optimization Stage-3	9.1.0
	RP-46	RP-091345	0274	-		Stage 3 correction for CMAS	9.1.0
	RP-46	RP-091346	0276	1		SR prohibit mechanism for UL SPS	9.1.0
	RP-46	RP-091346	0277	-		Parameters used for enhanced 1xRTT CS fallback	9.1.0
	RP-46	RP-091346	0281	-		Correction on UTRAN UE Capability transfer	9.1.0
	RP-46	RP-091346	0285	-		Maximum number of CDMA2000 neighbors in SIB8	9.1.0
	RP-46	RP-091340	0288	1		Introduction of UE Rx-Tx Time Difference measurement	9.1.0
	RP-46	RP-091346	0297	-		Introduction of SR prohibit timer	9.1.0
	RP-46	RP-091346	0298	-		Remove FFSs from RAN2 specifications	9.1.0
	RP-46	RP-091343	0301	1		Renaming Allowed CSG List (36.331 Rel-9)	9.1.0
	RP-46	RP-091346	0305	-		Re-introduction of message segment discard time	9.1.0
	RP-46	RP-091346	0306	1		Application of ASN.1 extension guidelines	9.1.0
	RP-46	RP-091346	0309	1		Support for Dual Radio 1xCsFB	9.1.0
	RP-46	RP-091346	0311	-		Shorter SR periodicity	9.1.0
	RP-46	RP-091342	0316	-		CR to 36.331 for Introduction of Dual Layer Transmission	9.1.0
	RP-46	RP-091343	0318	1		Draft CR to 36.331 on Network ordered SI reporting	9.1.0
	RP-46	RP-091346	0322	-		UE e1xcfsb capabilities correction	9.1.0
	RP-46	RP-091331	0327	1		Clarification on coding of ETWS related IEs	9.1.0
03/2010	RP-47	RP-100285	0331	-		Clarification of CGI reporting	9.2.0
	RP-47	RP-100305	0332	-		Clarification on MCCH change notification	9.2.0
	RP-47	RP-100308	0333	-		Clarification on measurement for serving cell only	9.2.0
	RP-47	RP-100306	0334	-		Clarification on proximity indication configuraiton in handover to E-UTRA	9.2.0
	RP-47	RP-100308	0335	-		Clarification on radio resource configuration in handover to E-UTRA procedure	9.2.0
	RP-47	RP-100308	0336	-		Clarification on UE maximum transmission power	9.2.0
	RP-47	RP-100308	0337	-		Correction to field descriptions of UE-EUTRA-Capability	9.2.0
	RP-47	RP-100305	0338	-		Correction to MBMS scheduling terminology	9.2.0
	RP-47	RP-100308	0339	-		Corrections to SIB8	9.2.0
	RP-47	RP-100306	0340	-		CR 36.331 R9 for Unifying SI reading for ANR and inbound mobility	9.2.0
	RP-47	RP-100308	0341	1		CR to 36.331 for 1xRTT pre-registration information in SIB8	9.2.0
	RP-47	RP-100305	0342	-		CR to 36.331 on corrections for MBMS	9.2.0
	RP-47	RP-100306	0343	1		CR to 36.331 on CSG identity reporting	9.2.0
	RP-47	RP-100308	0344	2		CR to 36.331 on Optionality of Rel-9 UE features	9.2.0
	RP-47	RP-100308	0345	1		CR to 36.331 on Service Specific Acces Control (SSAC)	9.2.0
	RP-47	RP-100308	0346	-		Introduction of power-limited device indication in UE capability.	9.2.0
	RP-47	RP-100305	0347	-		Missing agreement in MCCH change notification.	9.2.0
	RP-47	RP-100305	0348	1		Corrections related to MCCH change notification and value ranges	9.2.0

	RP-47	RP-100306	0349	2		Prohibit timer for proximity indication	9.2.0
	RP-47	RP-100306	0350	1		Proximity Indication after handover and re-establishment	9.2.0
	RP-47	RP-100305	0351	-		Specifying the exact mapping of notificationIndicator in SIB13 to PDCCH bits	9.2.0
	RP-47	RP-100308	0352	-		Corrections out of ASN.1 review scope	9.2.0
	RP-47	RP-100308	0353	-		CR on clarification of system information change	9.2.0
	RP-47	RP-100285	0358	-		Measurement Result CDMA2000 Cell	9.2.0
	RP-47	RP-100304	0361	-		Correction on the range of UE Rx-Tx time difference measurement result	9.2.0
	RP-47	RP-100305	0362	-		Small clarifications regarding MBMS	9.2.0
	RP-47	RP-100308	0363	-		Introduction of REL-9 indication within field accessStratumRelease	9.2.0
	RP-47	RP-100306	0364	-		Extending mobility description to cover inbound mobility	9.2.0
	RP-47	RP-100308	0365	1		Clarification regarding enhanced CSFB to 1XRTT	9.2.0
	RP-47	RP-100308	0368	-		Handling of dedicated RLF timers	9.2.0
	RP-47	RP-100305	0370	1		Clarification on UE's behavior of receiving MBMS service	9.2.0
	RP-47	RP-100305	0371	-		MBMS Service ID and Session ID	9.2.0
	RP-47	RP-100305	0372	1		Inclusion of non-MBSFN region length in SIB13	9.2.0
	RP-47	RP-100309	0374	1		CR to 36.331 for e1xCSFB access class barring parameters in SIB8	9.2.0
	RP-47	RP-100308	0375	-		Multiple 1xRTT/HRPD target cells in MobilityFromEUTRACommand	9.2.0
	RP-47	RP-100308	0376	-		Independent support indicators for Dual-Rx CSFB and S102 in SIB8	9.2.0
	RP-47	RP-100285	0378	-		Clarification on DRX StartOffset for TDD	9.2.0
	RP-47	RP-100308	0379	1		Miscellaneous corrections from REL-9 ASN.1 review	9.2.0
	RP-47	RP-100308	0381	-		Need codes and missing conventions	9.2.0
	RP-47	RP-100308	0383	1		Introduction of Full Configuration Handover for handling earlier eNB releases	9.2.0
	RP-47	RP-100308	0385	-		Clarification to SFN reference in RRC	9.2.0
	RP-47	RP-100308	0390	-		RSRP and RSRQ based Thresholds	9.2.0
	RP-47	RP-100189	0392	3		Redirection enhancements to GERAN	9.2.0
	RP-47	RP-100308	0398	-		Cell reselection enhancements CR for 36.331	9.2.0
	RP-47	RP-100307	0401	3		CR on UE-originated RLF reporting for MRO SON use case	9.2.0
	RP-47	RP-100309	0402	3		CR to 36.331 on Redirection enhancements to UTRAN	9.2.0
	RP-47	RP-100306	0403	2		Proximity status indication handling at mobility	9.2.0
	RP-47	RP-100305	0404	-		Upper layer aspect of MBSFN area id	9.2.0
	RP-47	RP-100308	0405	-		Redirection for enhanced 1xRTT CS fallback with concurrent PSHO	9.2.0
	RP-47	RP-100301	0406	-		Avoiding interleaving transmission of CMAS notifications	9.2.0
	RP-47	RP-100308	0407	1		Introduction of UE GERAN DTM capability indicator	9.2.0
	RP-47	RP-100381	0408	2		Introducing provisions for late ASN.1 corrections	9.2.0
	RP-47	RP-100245	0411	-		Correction/ alignment of REL-9 UE capability signalling	9.2.0
06/2010	RP-48	RP-100553	0412	-		Clarification for mapping between warning message and CB-data	9.3.0
	RP-48	RP-100556	0413	-		Clarification of radio link failure related actions	9.3.0
	RP-48	RP-100554	0414	-		Clarification on UE actions upon leaving RRC_CONNECTED	9.3.0
	RP-48	RP-100553	0415	-		Correction on CMAS system information	9.3.0
	RP-48	RP-100554	0416	1		Corrections to MBMS	9.3.0
	RP-48	RP-100536	0418	-		Decoding of unknown future extensions	9.3.0
	RP-48	RP-100556	0419	1		Miscellaneous small corrections and clarifications	9.3.0
	RP-48	RP-100551	0420	-		Prohibit timer for proximity indication	9.3.0
	RP-48	RP-100556	0421	-		RLF report for MRO correction	9.3.0
	RP-48	RP-100546	0423	1		Missing UTRA bands in IRAT-ParametersUTRA-FDD	9.3.0
	RP-48	RP-100556	0424	-		Correction on handling of dedicated RLF timers	9.3.0
	RP-48	RP-100556	0431	1		Protection of RRC messages	9.3.0
	RP-48	RP-100556	0433	-		Handling missing Essential system information	9.3.0
	RP-48	RP-100551	0434	1		Clarification on UMTS CSG detected cell reporting in LTE	9.3.0
	RP-48	RP-100556	0436	-		Introducing provisions for late corrections	9.3.0
	RP-48	RP-100556	0437	-		Clarification regarding / alignment of REL-9 UE capabilities	9.3.0
09/2010	RP-49	RP-100845	0440	-		Correction to 3GPP2 reference for interworking with cdma2000 1x	9.4.0
	RP-49	RP-100851	0441	-		Clarification on UL handover preparation transfer	9.4.0
	RP-49	RP-100851	0442	1		Clarifications regarding fullConfiguration	9.4.0
	RP-49	RP-100851	0443	-		Clarifications regarding handover to E-UTRAN	9.4.0
	RP-49	RP-100854	0444	-		Correction on the table of conditionally mandatory Release 9 features	9.4.0
	RP-49	RP-100851	0445	-		Corrections to TS36.331 on MeasConfig IE	9.4.0
	RP-49	RP-100853	0446	2		CR to 36.331 on clarification for MBMS PTM RBs	9.4.0
	RP-49	RP-100851	0447	-		Introduction of late corrections container for E-UTRA UE capabilities	9.4.0
	RP-49	RP-100851	0448	-		Renaming of containers for late non-critical extensions	9.4.0
	RP-49	RP-100851	0452	-		Clarifications Regarding Redirection from LTE	9.4.0
	RP-49	RP-100845	0456	-		Description of multi-user MIMO functionality in feature group indicator table	9.4.0
	RP-49	RP-100845	0458	-		Correct the PEMAX_H to PEMAX	9.4.0
	RP-49	RP-100851	0460	-		Clarification for feature group indicator bit 11	9.4.0
	RP-49	RP-100851	0465	1		Clarification of FGI setting for inter-RAT features not supported by the UE	9.4.0
	RP-49	RP-101008	0475	1		FGI settings in Rel-9	9.4.0
12/2010	RP-50	RP-101197	0483	-		Clarification on Meaning of FGI Bits	9.5.0
	RP-50	RP-101197	0485	-		Clarification regarding reconfiguration of the quantityConfig	9.5.0
	RP-50	RP-101210	0486	1		Corrections to the presence of IE regarding DRX and CQI	9.5.0
	RP-50	RP-101210	0493	-		The field descriptions of MeasObjectEUTRA	9.5.0
	RP-50	RP-101197	0498	1		Clarification of FGI settings non ANR periodical measurement reporting	9.5.0
	RP-50	RP-101209	0500	-		Corrections to RLF Report	9.5.0
	RP-50	RP-101206	0519	1		T321 timer fix	9.5.0

	RP-50	RP-101197	0524	-	Restriction of AC barring parameter setting	9.5.0
	RP-50	RP-101210	0525	-	Removal of SEQUENCE OF SEQUENCE in UEInformationResponse	9.5.0
	RP-50	RP-101197	0526	1	Clarification regarding default configuration value N/A	9.5.0
	RP-50	RP-101431	0532	-	Splitting FGI bit 3	9.5.0
	RP-50	RP-101183	0476	4	36.331 CR on Introduction of Minimization of Drive Tests	10.0.0
	RP-50	RP-101293	0477	4	AC-Barring for Mobile Originating CSFB call	10.0.0
	RP-50	RP-101214	0478	-	Addition of UE-EUTRA-Capability descriptions	10.0.0
	RP-50	RP-101214	0481	-	Clarification on Default Configuration for CQI-ReportConfig	10.0.0
	RP-50	RP-101215	0487	-	CR to 36.331 adding e1xCSFB support for dual Rx/Tx UE	10.0.0
	RP-50	RP-101227	0488	1	Introduction of Carrier Aggregation and UL/ DL MIMO	10.0.0
	RP-50	RP-101228	0489	1	Introduction of relays in RRC	10.0.0
	RP-50	RP-101214	0490	1	Priority indication for CSFB with re-direction	10.0.0
	RP-50	RP-101214	0491	-	SIB Size Limitations	10.0.0
	RP-50	RP-101214	0513	-	Combined Quantity Report for IRAT measurement of UTRAN	10.0.0
	RP-50	RP-101214	0527	1	UE power saving and Local release	10.0.0
	RP-50	RP-101429	0530	1	Inclusion of new UE categories in Rel-10	10.0.0
03/2011	RP-51	RP-110282	0533	-	36331_CRxxx Protection of Logged Measurements Configuration	10.1.0
	RP-51	RP-110294	0534	1	Stage-3 CR for MBMS enhancement	10.1.0
	RP-51	RP-110282	0535	-	Clean up MDT-related text	10.1.0
	RP-51	RP-110282	0536	-	Clear MDT configuration and logs when the UE is not registered	10.1.0
	RP-51	RP-110280	0537	-	Correction to the field description of nB	10.1.0
	RP-51	RP-110289	0538	-	CR on impact on UP with remove&add approach_2	10.1.0
	RP-51	RP-110282	0539	-	CR to 36.331 on corrections for MDT	10.1.0
	RP-51	RP-110290	0543	-	Introduction of CA/MIMO capability signalling and measurement capability signalling in CA	10.1.0
	RP-51	RP-110282	0544	-	MDT PDU related clarifications	10.1.0
	RP-51	RP-110282	0545	-	Correction on release of logged measurement configuration while in another RAT	10.1.0
	RP-51	RP-110289	0546	-	Miscellaneous Corrections for CA Running RRC CR	10.1.0
	RP-51	RP-110280	0547	1	Miscellaneous small clarifications and corrections	10.1.0
	RP-51	RP-110293	0548	4	Necessary changes for RLF reporting enhancements	10.1.0
	RP-51	RP-110282	0549	1	Memory size for logged measurements capable UE	10.1.0
	RP-51	RP-110289	0550	-	Parameters confusion of non-CA and CA configurations	10.1.0
	RP-51	RP-110272	0553	-	Presence condition for cellSelectionInfo-v920 in SIB1	10.1.0
	RP-51	RP-110282	0554	1	Removal of MDT configuration at T330 expiry	10.1.0
	RP-51	RP-110289	0556	1	Signalling aspects of existing LTE-A parameters	10.1.0
	RP-51	RP-110280	0557	1	Some Corrections on measurement	10.1.0
	RP-51	RP-110291	0558	-	Stored system information for RNs	10.1.0
	RP-51	RP-110291	0559	-	Support of Integrity Protection for Relay	10.1.0
	RP-51	RP-110290	0561	2	Updates of L1 parameters for CA and UL/DL MIMO	10.1.0
	RP-51	RP-110291	0571	1	Note for Dedicated SIB for RNs	10.1.0
	RP-51	RP-110272	0579	-	Correction to cs-fallbackIndicator field description	10.1.0
	RP-51	RP-110289	0580	-	Clarification to the default configuration of sCellDeactivationTimer	10.1.0
	RP-51	RP-110289	0581	-	Miscellaneous corrections to TS 36.331 on Carrier Aggregation	10.1.0
	RP-51	RP-110280	0584	-	Correction of configuration description in SIB2	10.1.0
	RP-51	RP-110265	0587	-	Clarification of band indicator in handover from E-UTRAN to GERAN	10.1.0
	RP-51	RP-110285	0588	1	36331_CRxxxx Support of Delay Tolerant access requests	10.1.0
	RP-51	RP-110292	0590	-	Update of R2-110807 on CSI measurement resource restriction for time domain ICIC	10.1.0
	RP-51	RP-110292	0591	-	Update of R2-110821 on RRM/RLM resource restriction for time domain ICIC	10.1.0
	RP-51	RP-110290	0592	-	Corrections on UE capability related parameters	10.1.0
	RP-51	RP-110282	0596	-	Validity time for location information in Immediate MDT	10.1.0
	RP-51	RP-110280	0597	-	CR to 36.331 adding UE capability indicator for dual Rx/Tx e1xCSFB	10.1.0
	RP-51	RP-110289	0598	-	Miscellaneous corrections to CA	10.1.0
	RP-51	RP-110280	0599	-	Further correction to combined measurement report of UTRAN	10.1.0
	RP-51	RP-110280	0600	-	Correction to the reference of ETWS	10.1.0
	RP-51	RP-110269	0602	1	Introduction of OTDOA inter-freq RSTD measurement indication procedure	10.1.0
	RP-51	RP-110280	0603	-	Correction of use of RRCConnectionReestablishment message for contention resolution	10.1.0
	RP-51	RP-110282	0604	-	CR to 36.331 on MDT neighbour cell measurements logging	10.1.0
	RP-51	RP-110272	0609	-	Minor ASN.1 corrections for the UEInformationResponse message	10.1.0
	RP-51	RP-110280	0613	-	Clarification regarding dedicated RLF timers and constants	10.1.0
	RP-51	RP-110282	0615	-	Release of Logged Measurement Configuration	10.1.0
	RP-51	RP-110280	0616	-	Some corrections on TS 36.331	10.1.0
	RP-51	RP-110280	0623	-	AC barring procedure clean up	10.1.0
	RP-51	RP-110282	0624	-	Counter proposal to R2-110826 on UE capabilities for MDT	10.1.0
	RP-51	RP-110280	0628	1	UE information report for RACH	10.1.0
	RP-51	RP-110289	0629	2	Measurement on the deactivated SCells	10.1.0
	RP-51	RP-110282	0632	1	Trace configuration parameters for Logged MDT	10.1.0
	RP-51	RP-110282	0635	-	Clarification on stop condition for timer T3330	10.1.0
	RP-51	RP-110282	0637	-	User consent for MDT	10.1.0
	RP-51	RP-110280	0638	-	Correction on the range of CQI resource index	10.1.0

	RP-51	RP-110272	0640	1		Small corrections to ETWS & CMAS system information	10.1.0
	RP-51	RP-110290	0641	1		UE capability signaling structure w.r.t carrier aggregation, MIMO and measurement gap	10.1.0
	RP-51	RP-110289	0642	1		Normal PHR and the multiple uplink carriers	10.1.0
	RP-51	RP-110280	0643	1		Corrections to TS36.331 on SIB2 handling	10.1.0
	RP-51	RP-110280	0644	1		Adding a Power Management indication in PHR	10.1.0
	RP-51	RP-110289	0646	1		Clarification for CA and TTI bundling in RRC	10.1.0
	RP-51	RP-110443	0648	1		Updates to FGI settings	10.1.0
06/2011	RP-52	RP-110836	0651	-		Add MBMS counting procedure to processing delay requirement for RRC procedure clause 11.2	10.2.0
	RP-52	RP-110830	0653	-		Add pre Rel-10 procedures to processing delay requirement for RRC procedure clause 11.2	10.2.0
	RP-52	RP-110847	0654	1		Addition of a specific reference for physical configuration fields	10.2.0
	RP-52	RP-110839	0656	-		Clarification of inter-frequency RSTD measurement indication procedure	10.2.0
	RP-52	RP-110830	0658	-		Clarification of optionality of UE features without capability	10.2.0
	RP-52	RP-110839	0660	-		Clarification on the definition of maxCellBlack	10.2.0
	RP-52	RP-110839	0661	-		Clarification on upper layer requested connection release	10.2.0
	RP-52	RP-110850	0662	3		Clarification regarding eICIC measurements	10.2.0
	RP-52	RP-110839	0663	-		CR for s-measure handling	10.2.0
	RP-52	RP-110851	0664	1		CR on clarification of RLF Report in Carrier Aggregation	10.2.0
	RP-52	RP-110830	0669	-		FGI bit for handover between LTE FDD/TDD	10.2.0
	RP-52	RP-110847	0670	2		Further updates on L1 parameters	10.2.0
	RP-52	RP-110839	0671	2		General error handling for extension fields	10.2.0
	RP-52	RP-110851	0672	2		Additional information for RLF report	10.2.0
	RP-52	RP-110843	0673	-		Introduction of TCE ID for logged MDT	10.2.0
	RP-52	RP-110670	0674	4		Miscellaneous corrections (related to review in preparation for ASN.1 freeze)	10.2.0
	RP-52	RP-110843	0675	-		PLMN check for MDT logging	10.2.0
	RP-52	RP-110839	0677	-		UE actions upon leaving RRC_CONNECTED	10.2.0
	RP-52	RP-110847	0678	-		Clarification on bandEUTRA-r10 and supportedBandListEUTRA	10.2.0
	RP-52	RP-110837	0679	-		Updated value range for the Extended Wait Timer	10.2.0
	RP-52	RP-110839	0680	1		Value range of DRX-InactivityTimer	10.2.0
	RP-52	RP-110828	0693	1		Correction for SR-VCC and QCI usage	10.2.0
	RP-52	RP-110847	0694	-		Restructuring of CQI-ReportConfig-r10	10.2.0
	RP-52	RP-110839	0695	2		Correction on DL allocations in MBSFN subframes	10.2.0
	RP-52	RP-110850	0700	-		Reference SFN for MeasSubframePattern	10.2.0
	RP-52	RP-110846	0701	-		Clarifications to CA related field descriptions	10.2.0
	RP-52	RP-110847	0702	-		Corrections to codebookSubsetRestriction and SRS parameters	10.2.0
	RP-52	RP-110834	0704	-		Corrections to the handling of ri-ConfigIndex for TM9	10.2.0
	RP-52	RP-110715	0710	2		UE capabilities for Rel-10 LTE features with eICIC measurement restrictions as FGI (Alt.1)	10.2.0
	RP-52	RP-110839	0713	-		CR to 36.331 on redirected ultra-TDD carrier frequency	10.2.0
	RP-52	RP-110839	0714	-		Explicit AS signalling for mapped PTMSI/GUTI	10.2.0
	RP-52	RP-110847	0718	-		Counter proposal for Updates of mandatory information in AS-Config	10.2.0
	RP-52	RP-110839	0719	-		CR for Reconfiguration of discardTimer in PDCP-Config	10.2.0
	RP-52	RP-110847	0723	-		On the missing multiplicity of UE capability parameters	10.2.0
	RP-52	RP-110830	0735	-		Radio frame alignment of CSA and MSP	10.2.0
	RP-52	RP-110847	0740	-		Reconfiguration involving critically extended IEs (using fullFieldConfig i.e. option 2)	10.2.0
	RP-52	RP-110839	0744	-		Counter proposal to R2-112753 on CR to remove CSG Identity validity limited to CSG cell	10.2.0
	RP-52	RP-110839	0746	1		Increase of prioritisedBitRate	10.2.0
	RP-52	RP-110847	0747	-		CA and MIMO Capabilities in LTE Rel-10	10.2.0
09/2011	RP-53	RP-111297	0752	-		TS36.331 Correction	10.3.0
	RP-53	RP-111297	0754	-		maxNumberROHC-ContextSessions when no ROHC profile is supported	10.3.0
	RP-53	RP-111280	0757	-		Correction to Subframe Allocation End in PMCH-Info	10.3.0
	RP-53	RP-111288	0761	-		Correction on PUCCH configuration for Un interface	10.3.0
	RP-53	RP-111297	0762	-		Miscellaneous corrections to 36.331	10.3.0
	RP-53	RP-111278	0764	2		36.331 correction on CSG identity validity to allow introduction of CSG RAN sharing	10.3.0
	RP-53	RP-111283	0770	2		AdditionalSpectrumEmissions in CA	10.3.0
	RP-53	RP-111297	0773	-		CR to 36.331 on Small correction of PHR parameter	10.3.0
	RP-53	RP-111283	0775	2		Clarifications to P-max on CA	10.3.0
	RP-53	RP-111280	0784	-		Clarification on for which subframes signalling MCS applies	10.3.0
	RP-53	RP-111283	0792	-		Corrections in RRC	10.3.0
	RP-53	RP-111297	0793	-		Replace the tables with exception list in 10.5 AS-Config	10.3.0
	RP-53	RP-111297	0796	-		Corrections to the field descriptions	10.3.0
	RP-53	RP-111283	0798	-		Configuration of simultaneous PUCCH&PUSCH	10.3.0
	RP-53	RP-111297	0806	-		Corrections to release of csi-SubframePatternConfig and cqi-Mask	10.3.0
	RP-53	RP-111272	0810	-		GERAN SI format for cell change order&PS handover& enhanced redirection to GERAN	10.3.0
	RP-53	RP-111283	0811	-		Corrections to PUCCH-Config field descriptions	10.3.0
12/2011	RP-54	RP-111711	0812	1		Clarification of PCI range for CSG cells	10.4.0
	RP-54	RP-111716	0813	-		Clarifications to Default Radio Configurations	10.4.0
	RP-54	RP-111716	0814	1		Corrections to enhancedDualLayerTDD	10.4.0



	RP-54	RP-111716	0815	-	Miscellaneous small corrections	10.4.0
	RP-54	RP-111716	0816	1	Correction on notation of SRS transmission comb	10.4.0
	RP-54	RP-111706	0823	1	36.331 CR SPS reconfiguration	10.4.0
	RP-54	RP-111716	0827	2	Clarification of list sizes in measurement configuration stored by UE	10.4.0
	RP-54	RP-111706	0835	-	Clarification of the event B1 and ANR related FGI bits	10.4.0
	RP-54	RP-111714	0840	1	Clarification on MBSFN and measurement resource restrictions	10.4.0
	RP-54	RP-111706	0845	-	Clarification on parallel message transmission upon connection re-establishment	10.4.0
03/2012	RP-55	RP-120326	0855	1	Limiting MBMS counting responses to within the PLMN	10.5.0
	RP-55	RP-120321	0857	-	CR to 36.331 on cdma2000 band classes and references	10.5.0
	RP-55	RP-120326	0862	1	Clarification on MBSFN and measurement resource restrictions	10.5.0
	RP-55	RP-120325	0871	-	On SIB10/11 Reception Timing	10.5.0
	RP-55	RP-120326	0875	1	Clarification on MBMS counting for uncipherable services	10.5.0
	RP-55	RP-120325	0876	-	Minor correction regarding limited service access on non-CSG-member cell	10.5.0
	RP-55	RP-120326	0894	-	Time to keep RLF Reporting logs	10.5.0
	RP-55	RP-120356	0895	1	Introducing means to signal different FDD/TDD Capabilities/FGIs for Dual-xDD UE	10.5.0
	RP-55	RP-120321	0899	-	Clarification on SRB2 resumption upon connection re-establishment (parallel message transmission)	10.5.0
	RP-55	RP-120321	0900	1	Duplicated ASN.1 naming correction	10.5.0
06/2012	RP-56	RP-120805	0909	-	SPS Reconfiguration	10.6.0
	RP-56	RP-120805	0912	1	Change in Scheduling Information for ETWS	10.6.0
	RP-56	RP-120807	0914	-	Clarification of mch-SchedulingPeriod configuration	10.6.0
	RP-56	RP-120808	0916	1	Change in Scheduling Information for CMAS	10.6.0
	RP-56	RP-120814	0919	1	Introducing means to signal different REL-10 FDD/TDD Capabilities/FGIs for Dual-xDD UE	10.6.0
	RP-56	RP-120812	0920	1	Clarification on setting of dedicated NS value for CA by E-UTRAN	10.6.0
	RP-56	RP-120808	0931	-	T321 value for UTRA SI acquisition	10.6.0
	RP-56	RP-120813	0957	1	Korean Public Alert System (KPAS) in relation to CMAS	10.6.0
	RP-56	RP-120812	0969	1	Introduction of supported bandwidth combinations for CA	10.6.0
	RP-56	RP-120734	0970	1	Introduction of multiple frequency band indicator	10.6.0
	RP-56	RP-120825	0934	-	Introduction of a new security algorithm ZUC	11.0.0
	RP-56	RP-120813	0973	1	EU-Alert in relation to CMAS	11.0.0
09/2012	RP-57	RP-121371	0982	1	Introduction of EAB	11.1.0
	RP-57	RP-121381	0990	-	Additional special subframe configuration related correction	11.1.0
	RP-57	RP-121423	1000	4	36.331 CR introducing In-Device Coexistence (IDC)	11.1.0
	RP-57	RP-121359	1008	-	Voice support Capabilities	11.1.0
	RP-57	RP-121361	1013	-	Differentiating UTRAN modes in FGIs	11.1.0
	RP-57	RP-121368	1022	1	Introduction of absolute priority based measurements and reselection in CELL_FACH State in 36.331	11.1.0
	RP-57	RP-121370	1024	-	Introducing MDT enhancements for REL-11	11.1.0
	RP-57	RP-121349	1025	2	Introducing Carrier aggregation enhancements for REL-11	11.1.0
	RP-57	RP-121375	1026	-	Introducing MBMS enhancements for REL-11	11.1.0
	RP-57	RP-121376	1052	2	Signaling support for CRS interference management in eCIC	11.1.0
	RP-57	RP-121395	1055	-	CR on scell measurement cycle	11.1.0
	RP-57	RP-121395	1056	-	CR on measurement report	11.1.0
	RP-57	RP-121378	1057	3	Introduction of 'Power preference indication'	11.1.0
	RP-57	RP-121280	1060	-	Correction for PUCCH/SRS Release	11.1.0
12/2012	RP-58	RP-121933	1063	-	Correction related to differentiating UTRAN modes in FGIs	11.2.0
	RP-58	RP-121936	1065	-	Processing delay for RRCConnectionReconfiguration	11.2.0
	RP-58	RP-121953	1066	2	Addition of the stage-3 agreements on IDC	11.2.0
	RP-58	RP-121951	1067	3	Carrier Aggregation Enhancement RAN1 parameters	11.2.0
	RP-58	RP-121957	1068	1	Clarification of SR period	11.2.0
	RP-58	RP-121957	1069	1	Clarification on HandoverCommand message	11.2.0
	RP-58	RP-121957	1070	-	Clarification on mobility related issues	11.2.0
	RP-58	RP-121946	1071	1	Correction of the signaling for Uncertainty and Confidence	11.2.0
	RP-58	RP-121940	1072	2	Corrections to MBMS Service Continuity	11.2.0
	RP-58	RP-121940	1073	-	CR to 36.331 on SIB15 acquisition	11.2.0
	RP-58	RP-121957	1074	1	Handling of 1xCSFB failure	11.2.0
	RP-58	RP-121957	1075	-	Miscellaneous corrections	11.2.0
	RP-58	RP-121958	1076	1	RAN overload control using RRC connection Rejection	11.2.0
	RP-58	RP-121954	1077	-	RRC support for CoMP in UL	11.2.0
	RP-58	RP-121951	1078	-	Some clarification to Carrier aggregation enhancements	11.2.0
	RP-58	RP-121939	1079	1	Validity of EAB SIB and acquisition of SIB1	11.2.0
	RP-58	RP-121922	1085	-	Clarification for Multiple Frequency Band Indicators feature	11.2.0
	RP-58	RP-121924	1089	1	Moving the TM5 capability	11.2.0
	RP-58	RP-121959	1093	1	CR to 36.331 on introducing ROHC context continue for intra-ENB handover	11.2.0
	RP-58	RP-121946	1100	-	Correction on MDT multi-PLMN support	11.2.0
	RP-58	RP-121953	1102	-	Clarification and alignment of handling of other configuration	11.2.0
	RP-58	RP-121970	1103	6	Introducing support for Coordinated Multi-Point (CoMP) operation	11.2.0
	RP-58	RP-121922	1105	2	Introducing further UE aspects regarding multi band cells	11.2.0
	RP-58	RP-121947	1120	-	CR to 36.331 on additional information in RLF report for inter-RAT MRO	11.2.0
	RP-58	RP-121952	1125	1	Correction on Power preference indication	11.2.0

	RP-58	RP-121950	1127	1		SIB1 provisioning via dedicated signalling	11.2.0
	RP-58	RP-121936	1128	2		Measurement reporting of Scells	11.2.0
	RP-58	RP-121956	1129	1		Introduction of EPDCCH parameters in TS 36.331	11.2.0
	RP-58	RP-121961	1130	2		Introduction of Rel-11 UE capabilities	11.2.0
	RP-58	RP-121958	1131	-		Introduction of wideband RSRQ measurements	11.2.0
	RP-58	RP-121958	1146	-		Introduction of network sharing for CDMA2000 inter-working	11.2.0
	RP-58	RP-121960	1157	-		Broadcast of Time Info by Using a New SIB	11.2.0
	RP-58	RP-121957	1175	-		GERAN measurement object at ANR	11.2.0
03/2013	RP-59	RP-130246	1182	2		Miscellaneous corrections from review preceeding ASN.1 freeze	11.3.0
	RP-59	RP-130243	1186	2		DL COMP capability related correction	11.3.0
	RP-59	RP-130231	1193	1		Mandatory supporting of B1 measurement to UMTS FDD (FGI bit 15)	11.3.0
	RP-59	RP-130241	1197	-		Clarification on MBMS Service Continuity	11.3.0
	RP-59	RP-130241	1198	-		IDC Problem Reporting	11.3.0
	RP-59	RP-130247	1210	-		Corrections on definition of CSG member cell	11.3.0
	RP-59	RP-130237	1211	-		Extension of FBI and EARFCN	11.3.0
	RP-59	RP-130228	1220	-		Invalidation of ETWS with security feature	11.3.0
	RP-59	RP-130225	1224	-		Invalid measurement configuration with different (E)ARFCN	11.3.0
	RP-59	RP-130241	1231	2		PPI and IDC indication upon handover	11.3.0
	RP-59	RP-130227	1235	1		Correcting further UE aspects regarding multi band cells	11.3.0
	RP-59	RP-130248	1236	1		Behaviour in case of excessive dedicated priority information	11.3.0
	RP-59	RP-130225	1241	-		Clarification on EARFCN signalling in Mobility control info	11.3.0
	RP-59	RP-130241	1244	-		IDC-SubframePattern length for FDD	11.3.0
	RP-59	RP-130249	1252	-		Introduction of wideband RSRQ measurements in RRC_IDLE	11.3.0
	RP-59	RP-130240	1255	-		Optional support of RLF report for inter-RAT MRO	11.3.0
	RP-59	RP-130233	1258	2		The presence of bandcombination for non-CA capable UEs	11.3.0
	RP-59	RP-130248	1259	-		Correction for event A5	11.3.0
	RP-59	RP-130332	1265	-		Mandating the settings of FGI bit 14, 27 and 28 to true	11.3.0
06/2013	RP-60	RP-130805	1267	-		Clarification on the redirection to UTRA-TDD frequency in case of CSFB High Priority	11.4.0
	RP-60	RP-130804	1269	1		Correction of wrong reference	11.4.0
	RP-60	RP-130809	1270	-		Clarification to support of deprioritisation feature	11.4.0
	RP-60	RP-130809	1271	-		Clarification on KASME key usage	11.4.0
	RP-60	RP-130808	1272	-		Correction on multi-TA capability	11.4.0
	RP-60	RP-130808	1273	-		MBMS interest indication upon handover/ re-establishment	11.4.0
	RP-60	RP-130808	1274	-		Conditions RI reference inheriting CSI process (DL CoMP)	11.4.0
	RP-60	RP-130808	1275	-		Clarification on NZP CSI-RS resource configuration for UE supporting 1 CSI process	11.4.0
	RP-60	RP-130808	1276	-		Corrections to field description of pdsch-Start-r11	11.4.0
	RP-60	RP-130809	1277	-		Need code corrections in Rel-11 RRC	11.4.0
	RP-60	RP-130808	1278	-		Miscellaneous small corrections	11.4.0
	RP-60	RP-130809	1279	1		FDD/TDD diff column correction for FGI31	11.4.0
	RP-60	RP-130804	1282	-		measCycleSCell upon SCell configuration	11.4.0
	RP-60	RP-130809	1294	-		Clarification on RRC Connection Reconfiguration with Critical Extension	11.4.0
	RP-60	RP-130802	1298	-		Security key generation in case of MFBI	11.4.0
	RP-60	RP-130804	1303	1		Clarification on inclusion of non-CA band combinations	11.4.0
	RP-60	RP-130809	1308	-		CR on ROHC parameter configuration in Rel-11 RRC	11.4.0
	RP-60	RP-130804	1315	2		Clarification on UE CA capability	11.4.0
	RP-60	RP-130809	1321	-		Updating 3GPP2 specification references	11.4.0
	RP-60	RP-130805	1323	-		Clarification on the configuration of the extended PHR	11.4.0
	RP-60	RP-130805	1324	-		Clarifications on SystemTimeInfoCDMA2000 IE	11.4.0
	RP-60	RP-130808	1325	-		MFBI impact on MBMS service continuity	11.4.0
	RP-60	RP-130819	1329	1		MFBI aspects for dedicated signalling	11.4.0
09/2013	RP-61	RP-131311	1335	-		Clarification on PhysCellIdRange	11.5.0
	RP-61	RP-131311	1339	1		Correction on the first subframe of the measurement gap	11.5.0
	RP-61	RP-131319	1340	1		Correction for MFBI in SIB15 and SIB6	11.5.0
	RP-61	RP-131319	1343	-		Clarification of MFBI impact on MBMS service continuity	11.5.0
	RP-61	RP-131238	1344	2		Clarification of UE action for otherwise in conditions	11.5.0
	RP-61	RP-131311	1348	-		Corrections to the 3GPP2 specification references in 36.331	11.5.0
	RP-61	RP-131318	1353	-		Clarifications regarding the usage of "rlf-Cause" in case of handover failure	11.5.0
12/2013	RP-62	RP-131986	1366	-		Introduction of capability bit for UTRA MFBI	11.6.0
	RP-62	RP-131984	1368	1		Addition of inter-frequency RSTD measurement capability indicator for OTDOA	11.6.0
	RP-62	RP-131989	1370	-		Clarification on supportedBand	11.6.0
	RP-62	RP-132003	1371	-		Capturing mandatory/optional agreements on Rel-11 UE features	11.6.0
	RP-62	RP-131995	1372	-		Clarification on otherwise behaviour	11.6.0
	RP-62	RP-131995	1373	-		Corrections of the 3GPP2 references in TS 36.331	11.6.0
	RP-62	RP-131991	1374	-		measResultLastServCell for SON-HOF report	11.6.0
	RP-62	RP-131729	1375	1		Clarification to timeInfoUTC field in SIB16	11.6.0
	RP-62	RP-131991	1389	-		Clarification on eRedirection to UMTS TDD with multiple UMTS TDD frequencies	11.6.0
	RP-62	RP-131995	1390	-		Delta signalling for critical extension	11.6.0
	RP-62	RP-132005	1391	-		Capability signalling for CSI processes	11.6.0
	RP-62	RP-131991	1395	1		Clarifications on Measurement	11.6.0

	RP-62	RP-131984	1397	-		Correction to InterFreqRSTDMeasurementIndication field descriptions	11.6.0
	RP-62	RP-131984	1404	-		Correction of Inter-frequency RSTD indication for multiple frequencies	11.6.0
	RP-62	RP-131993	1405	1		Enabling SRVCC from GERAN without forwarding UE-EUTRA-Capability	11.6.0
	RP-62	RP-131995	1409	1		System information and change monitoring procedure	11.6.0
	RP-62	RP-131991	1410	1		Correction on presence of codebookSubsetRestriction-r10	11.6.0
	RP-62	RP-131998	1376	-		Introducing UE support for inbound mobility to a shared CSG cell	12.0.0
	RP-62	RP-132002	1378	2		Introduction of support of further DL MIMO enhancement	12.0.0
	RP-62	RP-131988	1379	-		CR for SSAC in CONNECTED	12.0.0
	RP-62	RP-132002	1406	-		Update of CMAS reference to E-UTRAN specific clauses in TS23.041	12.0.0
03/2014	RP-63	RP-140359	1424	1		CR on introduction of Cell-specific time-to-trigger	12.1.0
	RP-63	RP-140346	1435	-		UE autonomous modification of cells Triggered upon serving cell addition/release	12.1.0
	RP-63	RP-140359	1436	1		Introduction of T312	12.1.0
	RP-63	RP-140362	1439	1		Introduction of UE-supported EARFCN list in handover preparation information for MFBI	12.1.0
	RP-63	RP-140352	1442	-		Correction of Connection Establishment Failure Report	12.1.0
	RP-63	RP-140356	1450	1		Clarification on the presence of TDD special subframe	12.1.0
	RP-63	RP-140359	1453	-		Introduction of UE mobility history reporting (option 2)	12.1.0
	RP-63	RP-140340	1455	1		Clarification regarding need codes, conditions and ASN.1 defaults for extension fields	12.1.0
	RP-63	RP-140340	1456	-		ASN.1 issue with inter-node signalling (AS-Config)	12.1.0
	RP-63	RP-140357	1457	1		Clarification for the SIB occurrence in a single SI message	12.1.0
	RP-63	RP-140364	1462	-		New UE categories for DL 450Mbps class	12.1.0
	RP-63	RP-140354	1463	-		IoT indication for inter-band TDD CA with different UL/DL configuration	12.1.0
06/2014	RP-64	RP-140869	1471	-		Removal of comment line from EUTRA-UE-Variables imports	12.2.0
	RP-64	RP-140871	1475	-		Correction on measObjectList in VarMeasConfig	12.2.0
	RP-64	RP-140879	1477	-		Minor correction inbound mobility to shared CSG cell	12.2.0
	RP-64	RP-140873	1478	-		Clarification on precedence of SCell SI provided dedicatedly	12.2.0
	RP-64	RP-140887	1479	-		Support of the enhancement for TTI bundling for FDD	12.2.0
	RP-64	RP-140885	1490	-		Corrections on timer T312	12.2.0
	RP-64	RP-140885	1486	-		Correction to the description of physCellIdRange in MeasObjectEUTRA	12.2.0
	RP-64	RP-140885	1506	-		Corrections to UE mobility history information	12.2.0
	RP-64	RP-140873	1489	-		ACK/NACK feedback mode on PUSCH	12.2.0
	RP-64	RP-140878	1556	-		SIB15 enhancement for service availability information	12.2.0
	RP-64	RP-140888	1557	-		Introduction of FDD/TDD CA UE capability	12.2.0
	RP-64	RP-140871	1545	-		Clarification of E-UTRA MFBI signalling	12.2.0
	RP-64	RP-140892	1520	1		Extended RLC LI field	12.2.0
	RP-64	RP-140873	1517	1		Network-requested CA Band Combination Capability Signalling	12.2.0
	RP-64	RP-140873	1554	1		Allowing TDD/FDD split for FGI111 and FGI112	12.2.0
	RP-64	RP-140871	1551	1		Inter-RAT ANR capability signalling in FGI33 when UE supports UTRA TDD only	12.2.0
	RP-64	RP-140884	1495	1		Introduction of TDD eMTC	12.2.0
	RP-64	RP-140885	1499	1		Minor Corrections to T312	12.2.0
	RP-64	RP-140892	1510	1		Introduction of RRC Connection Establishment failure temporary Qoffset handling	12.2.0
	RP-64	RP-140849	1555	2		Introduction of UE capability for eMBMS reception on SCell and Non-Serving Cell	12.2.0
09/2014	RP-65	RP-141494	1632	-		FDD&TDD split for CA	12.3.0
	RP-65	RP-141505	1599	-		UE capabilities for Hetnet mobility in TS 36.331	12.3.0
	RP-65	RP-141499	1584	-		Introduction of UE eMTC capabilities	12.3.0
	RP-65	RP-141511	1567	-		Corrections to extended RLC LI field	12.3.0
	RP-65	RP-141511	1603	-		TAI reporting of last serving cell	12.3.0
	RP-65	RP-141498	1630	1		Correction to Network-requested CA Band Combination Capability Signalling	12.3.0
	RP-65	RP-141496	1577	1		Clarification on double indication of SAI in SIB15	12.3.0
	RP-65	RP-141496	1597	-		Clarification on MBMSCountingResponse	12.3.0
	RP-65	RP-141496	1623	-		Clarification on the setting of SupportedBandCombination-v1130	12.3.0
	RP-65	RP-141489	1574	1		Correction of E-UTRAN UE capabilities description in HandoverPreparationInformation message field descriptions	12.3.0
	RP-65	RP-141507	1570	-		Introducing MBSFN measurement by extension of logged measurements	12.3.0
	RP-65	RP-141510	1572	1		Introduction of ACB skip for MMTEL voice/video and SMS	12.3.0
	RP-65	RP-141496	1615	1		Clarification on determining MBMS frequencies of interest in MBMSInterestIndication	12.3.0
	RP-65	RP-141506	1579	1		Introduction of signaling support for low complexity UEs	12.3.0
	RP-65	RP-141499	1601	1		Rel-12 ASN.1 correction	12.3.0
	RP-65	RP-141511	1560	1		Introduction of shorter MCH scheduling period	12.3.0
	RP-65	RP-141493	1611	-		Clarification for time-domain resource restriction pattern applicable to neighbour cell RSRQ measurements	12.3.0
	RP-65	RP-141511	1559	2		Correction to stop condition for "Chiba offset"	12.3.0
	RP-65	RP-141115	1636	-		Mandating the FGI bit 31 to true	12.3.0
	RP-65	RP-141618	1566	2		Connected mode procedures and RRC signaling of WLAN/3GPP Radio Interworking for LTE	12.3.0
12/2014	RP-66	RP-142122	1643	-		Clarification on WLAN interworking	12.4.0
	RP-66	RP-142122	1644	-		Correction on handling of dedicated parameters during re-establishment	12.4.0
	RP-66	RP-142122	1645	-		Corrections to WLAN/3GPP Radio Interworking for LTE	12.4.0

	RP-66	RP-142122	1646	-		Reduction of possible values for WLAN backhaul rate thresholds in LTE	12.4.0
	RP-66	RP-142140	1648	-		PDCP SN size change during HO for RLC-UM mode bearers	12.4.0
	RP-66	RP-142124	1651	-		Support of TTI bundling without resource allocation restriction for LTE coverage enhancements for Rel-12	12.4.0
	RP-66	RP-142123	1652	-		Corrections to eIMTA capabilities	12.4.0
	RP-66	RP-142140	1653	-		ACB, ACB-skip, CSFB and SSAC signalling per PLMN	12.4.0
	RP-66	RP-142122	1642	1		Minor corrections regarding WLAN interworking	12.4.0
	RP-66	RP-142115	1659	-		Correction of remaining TBD for Rel-10 FGIs	12.4.0
	RP-66	RP-142117	1663	-		New UE categories for DL 600Mbps	12.4.0
	RP-66	RP-142135	1687	-		Introduction of Dual Connectivity	12.4.0
	RP-66	RP-142140	1697	1		Prohibit timer for SR	12.4.0
	RP-66	RP-142133	1666	-		Support of 256QAM in TS 36.331 (per band 256QAM capability report)	12.4.0
	RP-66	RP-142128	1690	1		Introduction of increased number of frequencies to monitor	12.4.0
	RP-66	RP-142140	1696	2		Introduction of extended RSRQ value range and new RSRQ definition	12.4.0
	RP-66	RP-142115	1650	1		Introduction of signalling for serving cell interruptions	12.4.0
	RP-66	RP-142123	1655	-		Correction for p0-Persistent-SubframeSet2 Handling	12.4.0
	RP-66	RP-142134	1681	-		Introduction of missing Rel-12 UE capabilities	12.4.0
	RP-66	RP-142140	1647	1		Extended RLC LI field correction	12.4.0
	RP-66	RP-142140	1656	-		Outstanding Need OP for non-critical extension removal	12.4.0
	RP-66	RP-142140	1669	2		Clarification on statusReportRequired handling	12.4.0
	RP-66	RP-142131	1698	2		MCH BLER and RSRQ update for MBSFN MDT	12.4.0
	RP-66	RP-142130	1699	1		Optionality support of UE mandatory features for Category 0 UEs	12.4.0
	RP-66	RP-142123	1661	-		Further Clarifications on eIMTA and eICIC	12.4.0
	RP-66	RP-142113	1686	1		UE capability for modified MPR behavior	12.4.0
	RP-66	RP-142132	1664	1		Support of Discovery Signals measurement in TS 36.331	12.4.0
	RP-66	RP-142139	1670	2		RRC Parameters for NAICS	12.4.0
	RP-66	RP-141979	1700	-		UE capability signaling for WLAN/3GPP radio interworking	12.4.0
	RP-66	-	-	-		MCC editorial update	12.4.1
03/2015	RP-67	RP-150373	1737	-		Clarification on the setting of measScaleFactor without reducedMeasPerformance	12.5.0
	RP-67	RP-150371	1747	-		Clarification on Measurement Configuration handling	12.5.0
	RP-67	RP-150371	1765	-		Clarification to usage of field deltaTxD-OffsetPUCCH-Format1bCS-r11 in dedicated uplink power control parameter signalling	12.5.0
	RP-67	RP-150370	1751	-		Clarification on CSI measurement subframe set	12.5.0
	RP-67	RP-150368	1795	-		The absence of supportedMIMO-CapabilityUL-r10	12.5.0
	RP-67	RP-150370	1798	-		Presence of codebookSubsetRestriction	12.5.0
	RP-67	RP-150377	1768	2		Miscellaneous changes resulting from review for REL-12 ASN.1 freeze	12.5.0
	RP-67	RP-150374	1770	2		Introduction of ProSe	12.5.0
06/2015	RP-68	RP-150921	1800	-		Correction field description of networkControlledSyncTx	12.6.0
	RP-68	RP-150921	1801	-		Clarification on SCG reconfiguration	12.6.0
	RP-68	RP-150921	1802	-		Correction for aperiodic CSI trigger	12.6.0
	RP-68	RP-150920	1804	-		Correction on handling of wlan-OffloadConfigDedicated upon leaving RRC_CONNECTED	12.6.0
	RP-68	RP-150921	1805	-		Reconfiguration of SPS	12.6.0
	RP-68	RP-150916	1809	-		CR on Aperiodic CSI Reporting for 1.4MHz cell	12.6.0
	RP-68	RP-150921	1815	-		Clarification on PDCP reconfiguration	12.6.0
	RP-68	RP-150921	1816	-		Correction to SCG change	12.6.0
	RP-68	RP-150921	1817	-		Minor corrections for PSCell configuration in DC	12.6.0
	RP-68	RP-150921	1818	-		CR on ROHC for split bearer	12.6.0
	RP-68	RP-150921	1819	-		Clarification on FDD/TDD differentiation of FGIs/capabilities in TDD-FDD CA	12.6.0
	RP-68	RP-150921	1803	1		Correction to SCG and split bearer configuration	12.6.0
	RP-68	RP-150921	1810	1		Clarifications on use of preconfigComm for direct communication	12.6.0
	RP-68	RP-150921	1811	1		Miscellaneous corrections (a.o. Sidelink)	12.6.0
	RP-68	RP-150921	1813	1		Conditions for establishing RRC Connection for sidelink transmission	12.6.0
	RP-68	RP-150921	1814	1		Correction on field description on SL-TF-ResourceConfig	12.6.0
	RP-68	RP-150917	1806	1		Mandatory present of supportedMIMO-CapabilityDL-r10	12.6.0
	RP-68	RP-150923	1853	-		Clarification on Cell barring for downlink only bands	12.6.0
	RP-68	RP-150917	1852	-		Clarification regarding no MBMS sessions ongoing	12.6.0
	RP-68	RP-150917	1827	1		Correction to additionalSpectrumEmission	12.6.0
	RP-68	RP-150923	1820	4		Clarification on extended RSRQ range support	12.6.0
	RP-68	RP-150917	1838	-		Restriction to CA capability signalling	12.6.0
	RP-68	RP-150921	1823	-		Clarification on PUCCH and SRS	12.6.0
	RP-68	RP-150926	1849	-		Introduction of new DL UE categories 15&16	12.6.0
	RP-68	RP-150923	1824	-		Clean-up corrections to TS 36.331	12.6.0
	RP-68	RP-150918	1846	1		Correction to IDC signalling	12.6.0
	RP-68	RP-150921	1822	1		Change of LCID upon DC-specific DRB reconfiguration	12.6.0
	RP-68	RP-150921	1832	1		Correction to PHR format	12.6.0
	RP-68	RP-150921	1842	1		Correction on conditions for sidelink operation	12.6.0
	RP-68	RP-150811	1834	2		Correction on the SL-TF-IndexPair values for ProSe Direct Discovery	12.6.0
09/2015	RP-69	RP-151443	1866	-		Correction on UE band combination capability	12.7.0
	RP-69	RP-151438	1869	-		Correction on Restriction to CA capability signalling	12.7.0
	RP-69	RP-151443	1884	-		The support of UL64QAM	12.7.0
	RP-69	RP-151442	1889	-		Small corrections concerning RadioResourceConfig	12.7.0

	RP-69	RP-151441	1900	-		Sidelink discovery related corrections	12.7.0
	RP-69	RP-151440	1905	2		Clarification of Beacon RSSI Encoding	12.7.0
	RP-69	RP-151439	1911	1		CR for IDC signalling enhancement for UL CA	12.7.0
	RP-69	RP-151440	1880	2		Clarification on cell selection sequence upon leaving RRC_CONNECTED	12.7.0
	RP-69	RP-151438	1908	-		Correction to additionalSpectrumEmission - Option 1	12.7.0
	RP-69	RP-151439	1879	1		Correction on the reference of EPDCCH	12.7.0
	RP-69	RP-151441	1891	1		Introducing general handling and guidelines concerning critical extensions within a release	12.7.0
	RP-69	RP-151443	1909	1		Applicability of longCodeState1XRTT for 1xRTT IRAT ANR	12.7.0
	RP-69	RP-151441	1912	1		Sidelink terminology alignment in TS 36.331	12.7.0
	RP-69	RP-151442	1906	2		Clarification for NAICS capability signalling	12.7.0
	RP-69	RP-151467	1861	2		Additional MIMO/CSI capability for intra-band contiguous CA	12.7.0
	RP-69	RP-151466	1887	2		Signalling for 4-layer MIMO with TM3 and TM4	12.7.0
	RP-69	RP-151625	1914	2		Allowing NAICS with TM10	12.7.0
12/2015	RP-70	RP-152053	1916	-		Correction on SCG release	12.8.0
	RP-70	RP-152053	1932	-		Clarification to SCG RLF timers and constants reconfiguration	12.8.0
	RP-70	RP-152053	1933	-		Correction to triggerQuantityCSI-RS	12.8.0
	RP-70	RP-152053	1946	-		Correction to NAICS field descriptions	12.8.0
	RP-70	RP-152055	1947	-		Correction of need code definition terminology	12.8.0
	RP-70	RP-152050	1964	-		Clarification on FDD/TDD difference for UL CA IDC indication	12.8.0
	RP-70	RP-152046	1975	-		Correction to SystemTimeInfoCDMA2000 IE	12.8.0
	RP-70	RP-152053	1928	1		highPriorityAccess for MMTEL voice, MMTEL video and SMS	12.8.0
	RP-70	RP-152053	1986	1		Correction to the support of Mobility State reporting	12.8.0
	RP-70	RP-152046	1971	1		MaxLayerMIMO in HandoverPreparationInformation	12.8.0
	RP-70	RP-152046	1987	-		Correction to ASN.1 field names for 4-layer TM3/4	12.8.0
	RP-70	RP-152053	1969	1		Correction on measurement identity autonomous removal in dual connectivity	12.8.0
	RP-70	RP-152053	1979	1		Clarification on tdd-FDD-CA-PCellDuplex	12.8.0
	RP-70	RP-152049	1919	2		Alternative new maximum transport block sizes for DL 64QAM and 256QAM in TM9/10	12.8.0
	RP-70	RP-152050	1934	1		Some general RRC issues	12.8.0
	RP-70	RP-152055	1965	1		Correction on capability rsrq-OnAllSymbols	12.8.0
	RP-70	RP-152056	1931	2		Addition of establishment cause for mobile-originating VoLTE calls and network indication in SIB2	12.8.0
	RP-70	RP-152048	1927	2		CR to correct UE messages to be sent only after security activation	12.8.0
	RP-70	RP-152053	1973	3		Clarification of MCG	12.8.0
	RP-70	RP-152113	1923	4		Enabling multiple NS and P-Max operation per cell	12.8.0
12/2015	RP-70	RP-152084	1917	-		MCCH acquisition for 1.4MHz MBSFN	13.0.0
	RP-70	RP-152084	1937	-		Paging optimization	13.0.0
	RP-70	RP-152084	1972	-		White-list of cells for EUTRA measurement reporting	13.0.0
	RP-70	RP-152074	1920	1		Introduction of Dual Connectivity enhancements in Rel-13	13.0.0
	RP-70	RP-152078	1983	2		Introduction of Licensed-Assisted Access using LTE	13.0.0
	RP-70	RP-152075	1952	1		Extension of Frequency Priorities	13.0.0
	RP-70	RP-152075	1949	1		Introduction of RS-SINR measurements using non critical extension	13.0.0
	RP-70	RP-152079	1961	2		Introducing EBF FD MIMO parameters	13.0.0
	RP-70	RP-152081	1935	1		Removing SCG change restrictions regarding upon handover	13.0.0
	RP-70	RP-152066	1984	1		Introduction of Application specific Congestion control for Data Communication in LTE	13.0.0
	RP-70	RP-152071	1872	6		36331 CR for capturing B5C and SCell on PUCCH	13.0.0
	RP-70	RP-152073	1953	2		Introducing CRS interference mitigation on SCell	13.0.0
	RP-70	RP-152080	1939	3		Introduction of SC-PTM	13.0.0
	RP-70	RP-152082	1941	2		Introduction of Rel-13 MDT enhancements	13.0.0
	RP-70	RP-152075	1955	3		Introduction of load redistribution in RRC_IDLE	13.0.0
	RP-70	RP-152076	1988	-		Introducing extended DRX	13.0.0
	RP-70	RP-152084	1957	3		Clarification on FGI bits setting for MCPTT	13.0.0
	RP-70	RP-152072	1936	2		Introducing eSL	13.0.0
03/2016	RP-71	RP-160454	2001	2		eD2D changes resulting from review for ASN.1 freeze	13.1.0
	RP-71	RP-160468	2002	2		Miscellaneous changes resulting from review for ASN.1 freeze	13.1.0
	RP-71	RP-160470	2005	1		Corrections and missing agreement on the eCA	13.1.0
	RP-71	RP-160470	2006	2		corrections on RSSI measurement	13.1.0
	RP-71	RP-160457	2008	3		Introduction of LTE-WLAN Aggregation	13.1.0
	RP-71	RP-160470	2010	2		Corrections on SC-PTM	13.1.0
	RP-71	RP-160470	2016	-		Support of extended RLC AM SN for SCG	13.1.0
	RP-71	RP-160470	2017	1		Miscellaneous corrections for SC-PTM	13.1.0
	RP-71	RP-160519	2020	2		EBF/FD-MIMO changes related to remaining issues	13.1.0
	RP-71	RP-160467	2022	1		Correction on the RRC signalling configuration for 4Tx MIMO	13.1.0
	RP-71	RP-160462	2039	2		Applicability of longCodeState1XRTT	13.1.0
	RP-71	RP-160470	2040	1		Further clarifications on Rel-13 MDT enhancements	13.1.0
	RP-71	RP-160470	2042	3		Capability for CA enhancement	13.1.0
	RP-71	RP-160470	2043	1		Some corrections on CA enhancement	13.1.0
	RP-71	RP-160460	2048	1		The introduction of UE capability concerning extended E-UTRA frequency priorities	13.1.0
	RP-71	RP-160457	2051	2		Introduction of RAN controlled LTE-WLAN interworking	13.1.0

	RP-71	RP-160459	2054	4		Stage-3 text updates for bearer Identification within IPsec Tunnel and IPsec establishment parameters	13.1.0
	RP-71	RP-160459	2055	4		Introduction of LWIP UE capabilities	13.1.0
	RP-71	RP-160460	2061	1		UE capabilities for LAA	13.1.0
	RP-71	RP-160470	2062	1		Minor corrections for CA enhancements	13.1.0
	RP-71	RP-160467	2066	1		Maximum UL timing difference for DC	13.1.0
	RP-71	RP-160467	2068	1		T321 for Category 0 UE	13.1.0
	RP-71	RP-160503	2069	3		Addition of low complexity UEs and coverage enhancement features	13.1.0
	RP-71	RP-160454	2070	2		eD2D Capability	13.1.0
	RP-71	RP-160470	2072	1		SC-PTM corrections following ASN.1 review	13.1.0
	RP-71	RP-160467	2074	1		Procedural clarification on PSCell change involving PSCell release	13.1.0
	RP-71	RP-160464	2075	2		Modification of network requested CA band combination retrieval for intra-band non-contiguous CA	13.1.0
	RP-71	RP-160470	2087	1		ANR in case of MFBI	13.1.0
	RP-71	RP-160467	2090	-		Clarification on the leftmost bit for the supportedCellGrouping	13.1.0
	RP-71	RP-160467	2094	-		Clarification on the value range of guaranteed power for the MeNB and SeNB	13.1.0
	RP-71	RP-160455	2096	-		36.331 CR on TM10 CRS-IM UE capability report signalling introduction	13.1.0
	RP-71	RP-160456	2097	2		Miscellaneous corrections to TS 36.331 related to eDRX	13.1.0
	RP-71	RP-160470	2098	-		Guideline on handling of uplink spare values	13.1.0
	RP-71	RP-160465	2100	-		In-Device Coexistence for UL CA change of victim system	13.1.0
	RP-71	RP-160470	2101	-		Clarification on initial RSSI measurement reporting	13.1.0
	RP-71	RP-160470	2102	-		Introduction of capability on PDSCH collision handling	13.1.0
	RP-71	RP-160470	2103	1		Introduction of the extension of measObjectId range	13.1.0
	RP-71	RP-160470	2105	1		The correction on the description of 5.5.4.1	13.1.0
	RP-71	RP-160470	2106	-		Introduction of sf60 DRX cycle	13.1.0
	RP-71	RP-160467	2109	1		Clarification on NAICS subset capability	13.1.0
	RP-71	RP-160470	2110	-		SC-PTM reception on non-Pcell	13.1.0
	RP-71	RP-160470	2111	-		MBMS interest indication by SC-PTM capable UE	13.1.0
	RP-71	RP-160460	2112	1		Additional Layer 1 capabilities for Rel-13 CA enhancements	13.1.0
06/2016	RP-72	RP-161080	2114	-		Corrections to MTCe in TS 36.331	13.2.0
	RP-72	RP-161080	2115	2		Miscellaneous corrections to TS 36.331	13.2.0
	RP-72	RP-161080	2116	1		Inter-node signalling	13.2.0
	RP-72	RP-161080	2117	-		Clarification on SC-PTM	13.2.0
	RP-72	RP-161076	2118	1		UE capability of an additional Rx and Tx requirement for a CA band combination	13.2.0
	RP-72	RP-161073	2125	-		drb-identity change in full configuration	13.2.0
	RP-72	RP-161080	2126	-		Miscellaneous correction for sidelink	13.2.0
	RP-72	RP-161080	2127	-		Corrections for conditions of sidelink operation	13.2.0
	RP-72	RP-161080	2130	1		Correction on conditions for establishing RRC Connection for sidelink communication	13.2.0
	RP-72	RP-161080	2131	1		Corrections for sidelink communication transmission	13.2.0
	RP-72	RP-161080	2132	1		Correction to WLAN measurements	13.2.0
	RP-72	RP-161080	2133	1		Small corrections to LWIP	13.2.0
	RP-72	RP-161080	2134	1		Small eSL related corrections	13.2.0
	RP-72	RP-161080	2135	1		Alignment of RCLWI configuration	13.2.0
	RP-72	RP-161080	2136	1		Configuration of LWA and LWIP upon handover	13.2.0
	RP-72	RP-161080	2137	1		Introducing EBF/FD-MIMO capabilities	13.2.0
	RP-72	RP-161077	2140	-		Clarification regarding IDC indication upon change of UL CA affecting GNSS	13.2.0
	RP-72	RP-161080	2143	3		Correction of periodic CSI reporting and clarification on p-C and CBSR signalling	13.2.0
	RP-72	RP-161080	2144	-		CR on SI window combining for MTC	13.2.0
	RP-72	RP-161080	2145	-		Avoiding simultaneous configuration of LWA and DC for a UE	13.2.0
	RP-72	RP-161080	2146	-		Miscellaneous RRC corrections for LWA	13.2.0
	RP-72	RP-161080	2147	1		Autonomous WLAN measurement ID removal	13.2.0
	RP-72	RP-161080	2149	1		Correction to channel number range	13.2.0
	RP-72	RP-161080	2150	-		Correction of backhaul bandwidth description	13.2.0
	RP-72	RP-161080	2151	1		Correction on frequency hopping signaling	13.2.0
	RP-72	RP-161075	2152	1		Support of CRS-Assistance signaling for the DL Control Channel IM	13.2.0
	RP-72	RP-161078	2154	-		Correction on condition nonFullConfig in dual connectivity	13.2.0
	RP-72	RP-161080	2159	1		Correction on system information handling in eMTC	13.2.0
	RP-72	RP-161080	2160	1		Correction on essential system information missing	13.2.0
	RP-72	RP-161080	2162	-		Steering command during T350	13.2.0
	RP-72	RP-161080	2163	1		UE behaviours while configured with steeringCommandWLAN (release)	13.2.0
	RP-72	RP-161077	2166	1		Correction of IE name "systemInformationBlockType1Dedicated"	13.2.0
	RP-72	RP-161080	2167	-		Clarification of timer description for MCLD	13.2.0
	RP-72	RP-161080	2169	-		Clarification on the usage of threshold conditions for sidelink relay UE	13.2.0
	RP-72	RP-161080	2170	-		Corrections to LWA	13.2.0
	RP-72	RP-161080	2171	-		Variable Handling for RCLWI	13.2.0
	RP-72	RP-161080	2174	1		Correction on configuration of PRACH and MPDCCH for RA procedure for BL UEs or UEs in CE	13.2.0
	RP-72	RP-161080	2175	-		Clarification on LWA	13.2.0
	RP-72	RP-161080	2176	1		Miscellaneous corrections	13.2.0

	RP-72	RP-161080	2180	-		Correction on FDD/TDD differentiation for Rel-13 capabilities	13.2.0
	RP-72	RP-161080	2181	1		Correction on the definition of sc-mcch-duration	13.2.0
	RP-72	RP-161080	2182	-		System information acquisition for SC-PTM reception on non-Pcell	13.2.0
	RP-72	RP-161080	2183	-		Corrections on capability report for eCA	13.2.0
	RP-72	RP-161080	2185	1		Corrections to RS-SINR configuration	13.2.0
	RP-72	RP-161080	2186	1		UL UE Categories support for 64 QAM	13.2.0
	RP-72	RP-161080	2188	1		Correction on SI update for eDRX	13.2.0
	RP-72	RP-161080	2189	-		Add the field description for mpdcch-NarrowbandsToMonitor-r13	13.2.0
	RP-72	RP-161080	2192	-		WLAN measurements and user preference	13.2.0
	RP-72	RP-161080	2193	1		Miscellaneous corrections resulting from REL-13 ASN.1 review	13.2.0
	RP-72	RP-161080	2195	-		Correction to eMTC message classes and logical channels	13.2.0
	RP-72	RP-161080	2198	-		Some eCA related corrections	13.2.0
	RP-72	RP-161080	2199	1		PUCCH SCell corrections	13.2.0
	RP-72	RP-161080	2200	1		Small corrections of timer description for Sidelink	13.2.0
	RP-72	RP-161080	2201	-		Clarification of use of extended timer values for UEs that support CE mode B	13.2.0
	RP-72	RP-161080	2202	2		Correction to UL SPS operation	13.2.0
	RP-72	RP-161080	2203	1		UE Power Class in UE capability signaling	13.2.0
	RP-72	RP-161080	2204	-		Correction to FD-MIMO field descriptions	13.2.0
	RP-72	RP-161080	2205	1		Miscellaneous eMTC corrections	13.2.0
	RP-72	RP-161080	2206	-		Further miscellaneous eMTC corrections	13.2.0
	RP-72	RP-161080	2207	-		Correction to Initial CE Level	13.2.0
	RP-72	RP-161080	2209	2		Feature Group Indicators and UE capabilities for eMTC	13.2.0
	RP-72	RP-161080	2210	2		CR to capture CIoT optimizations for non-NB-IoT UEs	13.2.0
	RP-72	RP-161080	2211	-		Valid subframes for FDD and TDD DL transmissions	13.2.0
	RP-72	RP-161080	2216	1		Avoiding conflict between rel13 LWA/LWIP and rel12 RALWI	13.2.0
	RP-72	RP-161078	2220	-		Clarification on the presence of ul-64QAM-r12 for DL-only bands	13.2.0
	RP-72	RP-161080	2221	-		Correction on keeping SCG upon inter eNB handover	13.2.0
	RP-72	RP-161080	2222	-		The granularity of LWAAP entity	13.2.0
	RP-72	RP-161080	2223	-		Clarification on WLAN measurement	13.2.0
	RP-72	RP-161080	2224	-		The handling of WLAN status monitoring	13.2.0
	RP-72	RP-161080	2226	1		Clarification on the handover from the MeNB to the SeNB	13.2.0
	RP-72	RP-161080	2230	1		Restricting Unattended Data Traffic	13.2.0
	RP-72	RP-161211	2231	7		Introduction of NB-IoT Tin 36.331	13.2.0
	RP-72	RP-161080	2233	-		Correction to T302 and T308 conflict issue	13.2.0
	RP-72	RP-161080	2234	1		Various corrections to MTCe related ASN.1 code and field descriptions	13.2.0
	RP-72	RP-161080	2235	-		Clarification to field description for the timer T360	13.2.0
	RP-72	RP-161080	2236	-		Clarification to ordering of Rel13 Frequency priority lists	13.2.0
	RP-72	RP-161080	2238	1		Introduction of LWIP counter	13.2.0
	RP-72	RP-161080	2239	1		Clarification on EpcchSetConfig for eMTC	13.2.0
	RP-72	RP-161080	2240	2		Skipping fallback "2DL + 1UL" CA in UE capability report in Rel 13	13.2.0
	RP-72	RP-161270	2241	3		NAS timer settings for eMTC	13.2.0
09/2016	RP-73	RP-161758	2242	1		Correction to access barring checking for network sharing case	13.3.0
	RP-73	RP-161757	2244	1		Correction to LWIP and LWA	13.3.0
	RP-73	RP-161754	2245	2		Backward compatibility of CA band combination signalling	13.3.0
	RP-73	RP-161756	2248	1		Correction on measurement reporting for WLAN	13.3.0
	RP-73	RP-161756	2249	1		Correction on WLAN authentication	13.3.0
	RP-73	RP-161756	2250	2		Corrections to simultaneous configuration of LWA, RCLWI and LWIP	13.3.0
	RP-73	RP-161756	2253	-		Correction on WLAN connection management	13.3.0
	RP-73	RP-161758	2254	1		Corrections to TS36.331	13.3.0
	RP-73	RP-161758	2258	2		Issue on resume procedure	13.3.0
	RP-73	RP-161758	2262	-		Corrections to NB-IoT in 36.331	13.3.0
	RP-73	RP-161758	2263	-		Cleanup of the NB-IoT ASN.1	13.3.0
	RP-73	RP-161758	2266	3		Miscellaneous corrections to clause 4 and 5 for NB-IoT	13.3.0
	RP-73	RP-161751	2268	3		Clarification to intra-band contiguous CA capabilities	13.3.0
	RP-73	RP-161759	2269	-		Clarification on RRC processing delay for CIoT	13.3.0
	RP-73	RP-161759	2270	2		Supporting new UE Rx – Tx time difference mapping table	13.3.0
	RP-73	RP-161758	2272	1		Alignment of procedure when handling up-CIoT-EPS-Optimisation	13.3.0
	RP-73	RP-161754	2273	1		Simplification of UE capability reporting procedure	13.3.0
	RP-73	RP-161752	2274	2		Corrections on system information acquisition for Sidelink discovery	13.3.0
	RP-73	RP-161756	2275	1		Small corrections regarding (WLAN) measurement reporting	13.3.0
	RP-73	RP-161758	2279	-		Correction on cell reselection procedure while T300 is running	13.3.0
	RP-73	RP-161758	2280	1		Correction on full configuration	13.3.0
	RP-73	RP-161758	2281	1		Correction on SRB addition and modification	13.3.0
	RP-73	RP-161756	2282	1		Clarifications on RCLWI	13.3.0
	RP-73	RP-161758	2283	1		Introduction of DelayTolerantAccess establishment cause in NB-IoT	13.3.0
	RP-73	RP-161762	2284	1		Maximum number of simultaneous UL PDCP delay measurements for FeMDT	13.3.0
	RP-73	RP-161762	2287	2		Clarification on DRX cycle used by the UE	13.3.0
	RP-73	RP-161755	2288	1		Invalidation of stored system information in connected mode	13.3.0
	RP-73	RP-161755	2289	1		Clarification on bit mapping of fdd-DownlinkOrTddSubframeBitmapLC and fdd-UplinkSubframeBitmapLC	13.3.0
	RP-73	RP-161759	2290	-		Correction on C-IoT optimizations for non-NB-IoT UE	13.3.0
	RP-73	RP-161749	2295	1		Clarification on timer handling for zero value	13.3.0

	RP-73	RP-161759	2299	-		Measurement configuration during RRC resume in CloT	13.3.0
	RP-73	RP-161755	2301	1		Correction on UEPagingCoverageInformation	13.3.0
	RP-73	RP-161749	2305	1		DRB re-setup in Full Configuration	13.3.0
	RP-73	RP-161755	2306	1		Rel-13 correction for eMTC parameter values	13.3.0
	RP-73	RP-161753	2307	1		CR on forwarding LAA measurement results for DC	13.3.0
	RP-73	RP-161756	2309	1		Clarification on associationTimer	13.3.0
	RP-73	RP-161756	2310	-		Clarification on PDCP-Config and statusFeedback for LWA	13.3.0
	RP-73	RP-161756	2311	1		Order of addition and removal of WLAN-Identifiers	13.3.0
	RP-73	RP-161756	2313	-		Multiple WLAN measurement objects on the same frequency	13.3.0
	RP-73	RP-161755	2315	-		Correction about eMTC frequency hopping parameters	13.3.0
	RP-73	RP-161753	2317	1		Handling of tdd-Config-r10 for LAA Scell	13.3.0
	RP-73	RP-161760	2318	1		Introduction of 1.2Gbps and 1.6Gbps UE categories in Rel-13	13.3.0
	RP-73	RP-161755	2320	2		Extended T310 timer values for eMTC	13.3.0
	RP-73	RP-161761	2323	1		Introducing UE capability of Rel 13 CCH IM	13.3.0
	RP-73	RP-161761	2324	1		Introducing UE capability of CRS-IM for TM 1-9	13.3.0
	RP-73	RP-161827	2325	2		Continuous uplink transmission in eMTC	13.3.0
	RP-73	RP-161755	2328	1		Correction on PUSCH repetition numbers for CE Mode A	13.3.0
	RP-73	RP-161755	2329	-		Frequency hopping configuration for paging	13.3.0
	RP-73	RP-161758	2334	2		Reservation of RA resources in NB-IoT	13.3.0
	RP-73	RP-161754	2336	1		Extended PHR corrections	13.3.0
	RP-73	RP-161756	2337	1		Corrections for LWA/LWIP	13.3.0
	RP-73	RP-161762	2338	3		Correction on 12/16-port CSI-RS resource configuration for FD-MIMO	13.3.0
	RP-73	RP-161755	2339	2		Corrections in Rel-13 eMTC SI acquisition	13.3.0
	RP-73	RP-161758	2342	-		Correction of downlink gap applicability for NB-IoT	13.3.0
	RP-73	RP-161751	2344	1		Indication of the maxLayersMIMO	13.3.0
	RP-73	RP-161758	2346	-		nrs-Power signaling for NB-IoT non-anchor carrier	13.3.0
09/2016	RP-73	RP-161746	2261	1		Introducing V2V to TS 36.331	14.0.0
	RP-73	RP-161745	2340	1		Introduction of enhanced LAA for LTE	14.0.0
	RP-73	RP-161747	2341	-		Introduction of L2 Latency reduction techniques	14.0.0
12/2016	RP-74	RP-162318	2362	-		Clarification on the RRC connection resume procedure	14.1.0
	RP-74	RP-162313	2364	1		Clarification on AS-Config	14.1.0
	RP-74	RP-162316	2366	1		Corrections to LWA release	14.1.0
	RP-74	RP-162327	2373	1		Signalling of LWIP aggregation	14.1.0
	RP-74	RP-162318	2375	1		Miscellaneous corrections to TS 36.331	14.1.0
	RP-74	RP-162317	2377	-		Clarification on valid value range of codebookConfigNx fields	14.1.0
	RP-74	RP-162321	2378	-		Miscellaneous corrections to eLAA	14.1.0
	RP-74	RP-162311	2381	-		FDD&TDD diff for mbms-AsyncDC	14.1.0
	RP-74	RP-162316	2386	-		Corrections to WLAN status monitoring	14.1.0
	RP-74	RP-162314	2389	-		Clarification to the security mode command procedure for NB-IoT	14.1.0
	RP-74	RP-162318	2391	-		Clarification on UE power class 2 indication	14.1.0
	RP-74	RP-162312	2394	-		Correction on UE behavior in Paging procedure	14.1.0
	RP-74	RP-162314	2396	-		Corrections to NB-IoT SystemInformationBlockType2 handling	14.1.0
	RP-74	RP-162314	2398	1		Data available for transmission	14.1.0
	RP-74	RP-162315	2400	1		Correction on Downlink power allocation for SC-PTM	14.1.0
	RP-74	RP-162328	2402	-		Corrections on V2V in TS 36.331	14.1.0
	RP-74	RP-162314	2403	-		Correction on field description of up/cp-CIoT-EPS-Optimisation	14.1.0
	RP-74	RP-162327	2404	-		Extension of PollByte	14.1.0
	RP-74	RP-162317	2407	-		Clarification on Rel-13 CCH-IM UE capability	14.1.0
	RP-74	RP-162317	2411	-		Configuration of DMTC for neighbour and serving cells in LAA carrier frequency	14.1.0
	RP-74	RP-162314	2413	-		Clarification on uplink carrier frequency	14.1.0
	RP-74	RP-162314	2415	-		NB-IoT RRC Processing Delays	14.1.0
	RP-74	RP-162314	2420	1		Correction of connection suspension related aspects	14.1.0
	RP-74	RP-162317	2422	-		Clarification regarding on CSI-RS resource configuration for FD-MIMO	14.1.0
	RP-74	RP-162316	2424	-		Clearing of measurements upon reporting WLAN unavailability	14.1.0
	RP-74	RP-162313	2428	-		Minor changes regarding UE category	14.1.0
	RP-74	RP-162309	2435	1		Correction of NOTE 3 in UE-EUTRA-Capability related to multiple CA-MIMO-ParametersDL/UL	14.1.0
	RP-74	RP-162311	2441	1		Clarification on reporting of the plmn-IdentityList	14.1.0
	RP-74	RP-162317	2446	2		Correction on SSTD Measurement Reporting	14.1.0
	RP-74	RP-162322	2448	1		Introduce Enhancements for High Speed in 36.331	14.1.0
	RP-74	RP-162312	2451	-		System information update for eDRX UEs	14.1.0
	RP-74	RP-162317	2453	1		Correction on ACDC handling	14.1.0
	RP-74	RP-162328	2457	1		Correction and Clarification to TS 36.331	14.1.0
	RP-74	RP-162313	2459	1		Correction to frequency hopping configuration	14.1.0
	RP-74	RP-162314	2461	-		Correction to non-anchor carrier configuration	14.1.0
	RP-74	RP-162329	2462	1		UE capabilities for Latency Reduction	14.1.0
	RP-74	RP-162311	2466	1		Corrections on sidelink pre-configurations and default configurations	14.1.0
	RP-74	RP-162317	2469	-		Minor corrections for Rel-13 eD2D	14.1.0
	RP-74	RP-162324	2471	3		Introduction of SRS switching for LTE	14.1.0
	RP-74	RP-162325	2473	1		Introduction of MUST	14.1.0
	RP-74	RP-162314	2474	-		Clarification on system information acquisition for NB-IoT	14.1.0
	RP-74	RP-162314	2476	-		Editorial correction for NB-IoT	14.1.0



	RP-74	RP-162314	2478	-		Acknowledgement delay of RRCConnectionRelease message in NB-IoT	14.1.0
	RP-74	RP-162320	2484	-		Introduction of new UL category in Rel-13	14.1.0
	RP-74	RP-162327	2485	-		Addition of eCall over IMS Indication in SIB1	14.1.0
	RP-74	RP-162313	2488	-		DMRS scrambling sequence initialization parameter for MPDCCH	14.1.0
	RP-74	RP-162313	2490	-		RSRP threshold when only CE level 0 is used	14.1.0
	RP-74	RP-162313	2492	-		Correction on fdd-DownlinkOrTddSubframeBitmapBR	14.1.0
	RP-74	RP-162313	2495	-		Correction to presence of uplink frequency hopping interval parameter	14.1.0
	RP-74	RP-162315	2497	1		Correction to SC-PTM scheduling period start offset	14.1.0
	RP-74	RP-162316	2504	-		Correction to WLAN measurement configuration	14.1.0
	RP-74	RP-162328	2509	1		Introducing Shorter Resource Reservation Periodicities for V2X	14.1.0
	RP-74	RP-162313	2519	1		Acknowledgement delay of RRCConnectionRelease message for eMTC UEs	14.1.0
	RP-74	RP-162314	2525	-		Correction on channel bandwidth definition for NB-IoT	14.1.0
	RP-74	RP-162316	2534	1		Clarifications on empty WLAN identifiers	14.1.0
	RP-74	RP-162316	2542	1		Clarifications on empty WLAN identifiers in Mobility Set for RCLWI	14.1.0
	RP-74	RP-162350	2546	-		timeInfoUTC in SIB16	14.1.0
	RP-74	RP-162313	2547	-		Clarification on fdd-DownlinkOrTddSubframeBitmapBR	14.1.0
	RP-74	RP-162321	2548	2		Introduction of capabilities for eLAA	14.1.0
	RP-74	RP-162309	2552	-		Clarification on prioritization of multiple Pmax values	14.1.0
	RP-74	RP-162329	2553	-		CR on RV setting with UL skipping	14.1.0
	RP-74	RP-162314	2555	1		Correction of default physical channel configuration for NB-IoT	14.1.0

03/2017	RP-75	RP-170639	2559	2	A	Signalling of 1Rx UE category	14.2.0
	RP-75	RP-170636	2560	1	B	Introducing Rel-14 FeMTC into RRC	14.2.0
	RP-75	RP-170643	2563	1	F	Correction on V2X sidelink communication in TS 36.331	14.2.0
	RP-75	RP-170668	2565	1	B	Introduction of a new special subframe configuration	14.2.0
	RP-75	RP-170652	2576	1	A	Providing SIB1-BR via dedicated RRC signalling	14.2.0
	RP-75	RP-170641	2577	1	B	Introduction of eDECOR	14.2.0
	RP-75	RP-170636	2578	1	B	Introduction of SC-PTM for FeMTC and NB-IoT enhancements	14.2.0
	RP-75	RP-170629	2580	1	B	Introducing RRC parameters for eFD-MIMO (REL-14)	14.2.0
	RP-75	RP-170657	2582	1	A	Indication of S1-U data transfer	14.2.0
	RP-75	RP-170650	2585	1	A	Addition of extended EARFCNs in SCGFailureInformation message	14.2.0
	RP-75	RP-170652	2587	-	A	Clarification on the configuration of the extended values for nB	14.2.0
	RP-75	RP-170652	2589	-	A	Clarification on the support of FGI 42 for category M1 UE	14.2.0
	RP-75	RP-170656	2591	1	A	Miscellaneous corrections to NB-IoT	14.2.0
	RP-75	RP-170643	2592	1	F	Corrections to resource reservation period for V2X	14.2.0
	RP-75	RP-170651	2598	-	A	Correction on the initiation of WLAN connection status report	14.2.0
	RP-75	RP-170654	2600	-	A	Correction on longDRX-CycleStartOffset	14.2.0
	RP-75	RP-170643	2601	2	F	Correction and Clarification to TS 36.331	14.2.0
	RP-75	RP-170653	2603	2	A	Correction on mpdcch-pdsch-HoppingConfig	14.2.0
	RP-75	RP-170636	2613	3	B	FeMTC UE CE mode and maximum PDSCH/PUSCH BW preference indication	14.2.0
	RP-75	RP-170635	2615	2	B	Introduce V2X in TS 36.331	14.2.0
	RP-75	RP-170643	2616	2	F	Introduce a new parameter for V2X resource reselection	14.2.0
	RP-75	RP-170656	2622	2	A	Extension of $Q_{RxLevMin}$ value range	14.2.0
	RP-75	RP-170655	2624	-	A	Clarification on prioritization of multiple Pmax values	14.2.0
	RP-75	RP-170637	2625	2	B	Introduction of NB-IoT Enhancements other than Multicast	14.2.0
	RP-75	RP-170651	2627	1	A	Corrections to WLAN status monitoring	14.2.0
	RP-75	RP-170642	2635	1	B	Introduction of data inactivity timer	14.2.0
	RP-75	RP-170654	2637	-	A	Correction of reference to GERAN specification	14.2.0
	RP-75	RP-170652	2641	1	A	IOT indication for unicast MPDCCH/PDSCH/PUSCH frequency hopping	14.2.0
	RP-75	RP-170632	2642	3	B	Introducing 256QAM in UL	14.2.0
	RP-75	RP-170654	2644	-	A	Correction ClIoT cell indications to UE NAS	14.2.0
	RP-75	RP-170633	2645	1	B	Introduction of FeMBMS to 36.331	14.2.0
	RP-75	RP-170643	2646	1	F	Corrections to the exceptional pool	14.2.0
	RP-75	RP-170653	2651	2	A	New S-criteria for enhanced coverage in idle mode	14.2.0
	RP-75	RP-170651	2655	-	A	Corrections in UE capability reporting	14.2.0
	RP-75	RP-170642	2660	2	C	Functional modification of retrieving different UE capabilities for a fallback band combination	14.2.0
	RP-75	RP-170638	2663	2	B	Introduction of Voice and Video enhancements for LTE	14.2.0
	RP-75	RP-170654	2665	1	A	The support of UL 64QAM	14.2.0
	RP-75	RP-170645	2666	1	F	Miscellaneous Corrections on SRS Switching	14.2.0
	RP-75	RP-170646	2667	1	B	Introduction of SRS switching capability for LTE	14.2.0
	RP-75	RP-170652	2671	-	A	Clarification for pucch-NumRepetitionCE-format2-r13 for CE mode B	14.2.0
	RP-75	RP-170643	2673	-	F	Correction on the preconfigured power control parameter for V2X sidelink communication	14.2.0
	RP-75	RP-170653	2675	2	A	Correction of pusch-hoppingOffset	14.2.0
	RP-75	RP-170628	2676	3	B	Introduction of Enhanced LTE-WLAN Aggregation (eLWA)	14.2.0
	RP-75	RP-170651	2678	-	A	Need behaviour of availableAdmissionCapacityRequestWLAN	14.2.0
	RP-75	RP-170644	2685	1	B	Addition of geographical location reporting in 36.331	14.2.0
	RP-75	RP-170630	2689	3	B	Introduction of mobility enhancement solutions in RRC	14.2.0
	RP-75	RP-170651	2694	-	A	Clarification on data handling for LWA bearer	14.2.0
	RP-75	RP-170634	2696	2	B	CR for introduction of NCSG and per CC measurement gap	14.2.0
	RP-75	RP-170634	2697	1	B	CR for introduction of NCSG, short measurement gaps and configuration of CC measurement gap	14.2.0
	RP-75	RP-170321	2698	-	F	Correction to PRACH resource configuration for high speed scenario	14.2.0
	RP-75	RP-170807	2701	1	A	Feature optionality for Cat.1bis UE	14.2.0
	RP-75	RP-170656	2703	-	A	Extension of timer T311	14.2.0
	RP-75					Fixed ASN.1 syntax check error ("PLMN-IdentityList-MBMS-14" -> "PLMN-IdentityList-MBMS-r14")	14.2.1
	RP-75					Updated the version number on the cover sheet	14.2.2
06/2017	RP-76	RP-171226	2705	2	F	Correction to exceptional pool usage in TS 36.331	14.3.0
	RP-76	RP-171237	2706	1	F	Support eDECOR for NB-IoT	14.3.0
	RP-76	RP-171231	2709	1	F	Correction on UE capabilities for eLAA	14.3.0
	RP-75	RP-171243	2711	3	A	Correction on WLAN connection status report monitoring for LWIP	14.3.0
	RP-76	RP-171236	2712	3	F	Correction on eLWA	14.3.0
	RP-76	RP-171225	2713	2	B	Introduction of new Transport Block Size for DL 256QAM	14.3.0
	RP-76	RP-171236	2714	2	F	UE capabilities for eLWA	14.3.0
	RP-76	RP-171227	2715	2	B	Introducing a new SL master information block for V2X sidelink communication	14.3.0
	RP-76	RP-171236	2720	2	F	Clarifications to eLWA	14.3.0
	RP-76	RP-171247	2728	2	B	Introduction of a new UL UE category for 300Mbps with 64QAM	14.3.0
	RP-76	RP-171425	2872	3	F	Miscellaneous general corrections and clarifications resulting from ASN.1 review	14.3.0
	RP-76	RP-171223	2734	2	F	Introduction of SFN indication in handover message	14.3.0

	RP-76	RP-171224	2737	1	F	Correction to SIB-Type-NB	14.3.0
	RP-76	RP-171233	2741	5	F	Clarification of intra-frequency applicability of makeBeforeBreak HO	14.3.0
	RP-76	RP-171224	2745	3	F	Correction to the value range of ce-AuthorisationOffset	14.3.0
	RP-76	RP-171224	2746	2	C	Introduction of Overload Control for Control plane data only	14.3.0
	RP-76	RP-171223	2748	2	F	SC-MCCH information change notification for FeMTC and NB-IoT enhancements	14.3.0
	RP-76	RP-171223	2749	1	F	Alignment of the parameter names for SC-PTM DRX for SC-MCCH and SC-MTCH	14.3.0
	RP-76	RP-171233	2752	3	F	Corrections to RACH-less handover and SCG change	14.3.0
	RP-76	RP-171222	2759	7	F	Corrections to per-CC measurement gap configuration and add the support for UE reporting of numFreqEffectiveReduced when frequencies are configured for reduced measurement performance	14.3.0
	RP-76	RP-171233	2760	1	F	Corrections to make before break mobility	14.3.0
	RP-76	RP-171243	2768	2	F	Clarification regarding requesting fallback combinations with different capabilities	14.3.0
	RP-76	RP-171226	2771	1	F	Leap second change for DFN timing	14.3.0
	RP-76	RP-171244	2773	1	A	Correction to RACH CE level info list	14.3.0
	RP-76	RP-171223	2775	2	C	CE mode configuration/deconfiguration without handover	14.3.0
	RP-76	RP-171227	2791	3	F	Correction on V2X Rx pool for inter-frequency configuration in 36.331	14.3.0
	RP-76	RP-171248	2795	1	A	Entry-Level UE Support UL 64QAM	14.3.0
	RP-76	RP-171235	2797	1	F	FDD TDD difference for VoLTE capability	14.3.0
	RP-76	RP-171242	2804	1	A	Setting of FGI 107 and 108 in case of TDD-FDD CA	14.3.0
	RP-76	RP-171226	2813	1	F	Correction of RRCConnectionReconfiguration reception for V2X	14.3.0
	RP-76	RP-171227	2820	-	F	CR on V2X miscellaneous RRC corrections	14.3.0
	RP-76	RP-171224	2823	2	B	Introduction of RRC connection re-establishment for NB-IoT control plane	14.3.0
	RP-76	RP-171243	2826	-	A	Miscellaneous corrections to CA enhancements	14.3.0
	RP-76	RP-171244	2828	2	A	Clarification to MIB repetitions	14.3.0
	RP-76	RP-171243	2830	3	A	LAA/WiFi sharing indication	14.3.0
	RP-76	RP-171225	2831	-	B	Enable Uplink-Only RoHC operations	14.3.0
	RP-76	RP-171245	2833	1	A	Clarification on contention based random access for NB-IoT	14.3.0
	RP-76	RP-171245	2836	-	A	Editorial correction on ab-Barring parameter	14.3.0
	RP-76	RP-171223	2842	-	F	Correction to FGI 25	14.3.0
	RP-76	RP-171223	2844	1	F	Correction to InterFreqRSTDMeasurementIndication message	14.3.0
	RP-76	RP-171223	2845	2	B	Introduction of enhanced RLM reporting	14.3.0
	RP-76	RP-171245	2848	1	A	Correction on the UE AS context handling	14.3.0
	RP-76	RP-171245	2849	1	A	Correction on attach without PDN connectivity	14.3.0
	RP-76	RP-171233	2851	1	F	Miscellaneous RRC corrections on mobility enhancement	14.3.0
	RP-76	RP-171245	2853	1	A	Clarification on logicalChannelSR-ProhibitTimer for NB-IOT	14.3.0
	RP-76	RP-171223	2854	2	F	Correction to SC-MCCH and SC-MTCH configuration without delta configuration	14.3.0
	RP-76	RP-171230	2869	1	F	Correction of SRS switching	14.3.0
	RP-76	RP-171223	2870	2	F	Miscellaneous feMTC corrections and clarifications resulting from ASN.1 review	14.3.0
	RP-76	RP-171237	2871	-	F	Miscellaneous eDECOR corrections and clarifications resulting from ASN.1 review	14.3.0
	RP-76	RP-171221	2873	1	F	Miscellaneous feMBMS corrections and clarifications resulting from ASN.1 review	14.3.0
	RP-76	RP-171221	2874	1	B	UE capabilities for feMBMS	14.3.0
	RP-76	RP-171224	2876	1	F	Long DRX values with regular wake-up cycle – Option 1	14.3.0
	RP-76	RP-171244	2879	-	A	Correction on terminology of SI for eMTC	14.3.0
	RP-76	RP-171223	2882	1	F	Correction on the description of ce-srsEnhancement for FeMTC	14.3.0
	RP-76	RP-171223	2883	2	B	Measurement gap sharing for FeMTC intra- and inter-frequency measurement	14.3.0
	RP-76	RP-171223	2884	1	F	Minor correction in TS 36.331 for feMTC	14.3.0
	RP-76	RP-171223	2885	2	F	Corrections on reconfiguration between CE mode and normal mode in eMTC	14.3.0
	RP-76	R2-1705852	2887	1	F	Clarification regarding eFD-MIMO configuration (REL-14)	14.3.0
	RP-76	RP-171235	2889	1	F	Correction of issues related to ASN.1 review for eVoLTE	14.3.0
	RP-76	RP-171230	2890	1	F	Merging of retuningTimeBandPairList with regular supported BC capabilities (ASN.1 review issue S.059)	14.3.0
	RP-76	RP-171222	2891	-	F	Consistent gap pattern configuration for serving cells	14.3.0
	RP-76	RP-171407	2903	2	B	Introduction of UE capability for V2X in 36.331	14.3.0
	RP-76	RP-171227	2905	1	F	Correction on V2X behavior in 36.331	14.3.0
	RP-76	RP-171246	2912	2	B	EUTRAN sharing enhancement	14.3.0
	RP-76	RP-171244	2919	-	A	Clarification on additionalSpectrumEmission for eMTC	14.3.0
	RP-76	RP-171245	2920	-	A	Clarification on additionalSpectrumEmission for NB-IoT	14.3.0
	RP-76	RP-171224	2927	-	F	Correction to CarrierConfigDedicated-NB	14.3.0
	RP-76	RP-171224	2929	2	F	Miscellaneous NB-IoT corrections and clarifications resulting from ASN.1 review	14.3.0
	RP-76	RP-171245	2931	2	A	Extension of SINtraSearchP value range	14.3.0
	RP-76	RP-171223	2932	-	F	Maximum PDSCH/PUSCH BW preference indication handling for handover	14.3.0
	RP-76	RP-171225	2938	3	F	Revert PDCP state variable HFN and SN back to the values used in the source cell	14.3.0
	RP-76	RP-171236	2942	1	F	ASN.1 corrections for eLWA	14.3.0
	RP-76	RP-171241	2943	-	A	Clarification on UE capability and early feature support	14.3.0

	RP-76	RP-171243	2944	-	A	Clarification regarding EBF-FDMIMO configuration (REL-13)	14.3.0
	RP-76	RP-171245	2945	1	A	Generic clarification of "first bit" as leftmost bit	14.3.0
	RP-76	RP-171229	2948	-	B	Introduction of UE capabilities for high speed	14.3.0
	RP-76	RP-171229	2949	-	F	Correction of high speed	14.3.0
	RP-76	RP-171227	2950	-	F	CR on reduction of SIB21 size	14.3.0
	RP-76	RP-171244	2952	1	A	Configuration of preamble groups for CE levels and preamble groups A/B	14.3.0
	RP-76	RP-171244	2954	1	A	Extension of RSRP range for eMTC	14.3.0
	RP-76	RP-171169	2958	-	C	FeMBMS/unicast-mixed carrier flag in measurement object	14.3.0
09/2017	RP-77	RP-171919	2807	4	A	Correction to PUCCH-ConfigDedication	14.4.0
	RP-77	RP-171914	2961	2	F	Correction on SPS assistance information in TS 36.331	14.4.0
	RP-77	RP-171914	2977	1	F	Miscellaneous correction to V2X in TS 36.331	14.4.0
	RP-77	RP-171914	2978	2	B	Introduction of new NS values for V2X sidelink communication	14.4.0
	RP-77	RP-171918	2980	3	A	Adding abstract syntax notation one chapter of sidelink pre-configuration.	14.4.0
	RP-77	RP-171914	2983	1	F	Correction on TTI bundling for TDD configurations 2 and 3	14.4.0
	RP-77	RP-171911	2984	2	F	Corrections on the use of plmn-IdentityList in field descriptions	14.4.0
	RP-77	RP-171915	2985	2	F	RRC Connection Re-establishment for Control Plane Clot EPS Optimization	14.4.0
	RP-77	RP-171919	2989	-	A	Clarification that DL only bands are not supported in NB-IoT	14.4.0
	RP-77	RP-171915	2990	1	F	Cleanup for NB-IoT Enhancements	14.4.0
	RP-77	RP-171920	2992	2	A	Clarification on SI repetition pattern	14.4.0
	RP-77	RP-171914	2993	2	F	CR on condition for RRC connection establishment and condition for sidelink UE information for V2X sidelink communication	14.4.0
	RP-77	RP-171913	2994	2	F	Correction on RACH-less SeNB Change	14.4.0
	RP-77	RP-171915	2995	-	F	Corrections on eVoLTE	14.4.0
	RP-77	RP-171914	2997	2	F	Corrections to random selection for P2X related V2X sidelink communication	14.4.0
	RP-77	RP-171916	3002	2	A	additionalSpectrumEmission extension	14.4.0
	RP-77	RP-171915	3008	1	F	Correction of field descriptions for recommendedBitRate and recommendedBitRateQuery	14.4.0
	RP-77	RP-171919	3014	2	A	RRM Measurement Clarification on Discovery Signals for LAA	14.4.0
	RP-77	RP-171919	3018	-	A	Correction in PUSCH Config description	14.4.0
	RP-77	RP-171913	3022	-	F	Cat-M1 indication by Cat-M2 UE	14.4.0
	RP-77	RP-171920	3025	1	A	Clarification on the freqHoppingParametersDL during handover	14.4.0
	RP-77	RP-171920	3027	1	A	Clarification on rsrp-ThresholdsPrachInfoList during handover	14.4.0
	RP-77	RP-171913	3028	-	F	Clarification on systemInformationBlockType2Dedicated	14.4.0
	RP-77	RP-171920	3030	2	A	Clarification on Bandwidth Reduced operation	14.4.0
	RP-77	RP-171915	3036	-	F	Correction for connEstFailOffset	14.4.0
	RP-77	RP-171911	3040	-	F	Clarification on LWIP aggregation	14.4.0
	RP-77	RP-171913	3041	1	F	Correction to eLAA configuration	14.4.0
	RP-77	RP-171914	3042	2	C	Packet Reordering for Sidelink	14.4.0
	RP-77	RP-171920	3044	1	A	Corrections on TS 36.331 for Rel-13 MTC	14.4.0
	RP-77	RP-171913	3047	-	F	Corrections on Bandwidth preference indication for Rel-14 MTC	14.4.0
	RP-77	RP-171913	3048	1	F	Corrections on TS 36.331 for Rel-14 MTC	14.4.0
	RP-77	RP-171914	3051	2	F	Clarification on NCSG UE capability	14.4.0
	RP-77	RP-171914	3052	1	F	Corrections to UL 256 QAM capability field descriptions	14.4.0
	RP-77	RP-171914	3054	1	F	Clarification on per CC measurement gap	14.4.0
	RP-77	RP-171915	3055	1	C	Introduction of RLC UM support for LWA	14.4.0
	RP-77	RP-171919	3057	-	A	Correction on eCA with Dual Connectivity	14.4.0
	RP-77	RP-171913	3059	-	F	Clarification of the PTAG value for the RACH-less handover	14.4.0
	RP-77	RP-171920	3063	1	A	Clarification on number of RACH CE levels vs number of RSRP thresholds	14.4.0
	RP-77	RP-171915	3064	1	F	Correction to contention free random access	14.4.0
	RP-77	RP-171913	3065	2	C	Introduction of Release Assistance Indication	14.4.0
	RP-77	RP-171920	3067	2	A	TM9 capabilities in CE mode	14.4.0
	RP-77	RP-171915	3068	1	F	Introduction of interference randomisation in NB-IoT	14.4.0
	RP-77	RP-171919	3070	-	A	Clarification on PUCCH SCell change	14.4.0
12/2017	RP-78	RP-172615	2968	5	F	Cleaning up CQI and CSI-RS-related configurations (related to Rel-14 ASN.1 review issue N.099)	14.5.0
	RP-78	RP-172615	2982	8	B	Introduction of the overheating indication	14.5.0
	RP-78	RP-172616	3037	4	F	Target cell optional PBCH repetition status indication	14.5.0
	RP-78	RP-172624	3046	3	A	Corrections on paging monitoring in RRC_CONNECTED in Rel-13 eMTC	14.5.0
	RP-78	RP-172721	3071	3	B	Introduction of DL 2Gbps Category	14.5.0
	RP-78	RP-172617	3072	3	F	Correction to Inter-frequency reception for V2X sidelink communication	14.5.0
	RP-78	RP-172617	3073	4	F	CR on SIB21 reading	14.5.0
	RP-78	RP-172622	3081	2	A	UE capabilities for Tx antenna selection	14.5.0
	RP-78	RP-172617	3084	3	F	Transmission of P2X sidelink communication in Exceptional Pool	14.5.0
	RP-78	RP-172617	3085	2	F	Correction on SubframeBitmap Configuration in Band 47	14.5.0
	RP-78	RP-172616	3088	1	F	Correction on SRS switching capabilities field description	14.5.0
	RP-78	RP-172617	3090	2	F	Clarification on Interference Randomisation in NB-IoT in 36.331	14.5.0
	RP-78	RP-172616	3091	1	F	MUST capability	14.5.0
	RP-78	RP-172624	3096	4	A	Corrections on field description of cellSelectionInfoCE for eMTC	14.5.0
	RP-78	RP-172617	3107	2	F	Correction to UE capabilities	14.5.0
	RP-78	RP-172623	3108	1	A	Define requirement for reception of number of simultaneous SC-PTM services	14.5.0
	RP-78	RP-172616	3110	3	B	Signaling of NCSG Support for Inter-F Measurement	14.5.0
	RP-78	RP-172623	3112	2	A	Clarification on csi-RS-ConfigNZPId	14.5.0

	RP-78	RP-172617	3113	4	F	Correction to UE-Capability-NB extension and provision for late rel-13 corrections	14.5.0
	RP-78	RP-172624	3120	1	F	Alignment of FGI4 (Short DRX) for Cat M1 and M2	14.5.0
	RP-78	RP-172616	3127	-	F	UE capability for support of SRS enhancements without support of comb 4	14.5.0
	RP-78	RP-172624	3129	1	F	MBSFN subframes for target cell during handover to CE cell	14.5.0
	RP-78	RP-172615	3132	3	C	Reject of unprotected redirect to GERAN	14.5.0
	RP-78	RP-172616	3135	2	F	Correction to actions related to InterFreqRSTDMeasurementIndication message	14.5.0
	RP-78	RP-172616	3137	1	F	Clarification on srs-UpPtsAdd in SRS coverage enhancement	14.5.0
	RP-78	RP-172616	3138	1	F	Scheduling information of SIB1-BR when skipping MIB during HO	14.5.0
	RP-78	RP-172624	3140	1	A	Introducing a definition for the term UE in CE	14.5.0
	RP-78	RP-172617	3153	2	F	NRS-CRS power offset configuration for NB-IoT	14.5.0
	RP-78	RP-172617	3154	3	C	Introduction of relaxed monitoring in NB-IoT	14.5.0
	RP-78	RP-172617	3157	1	F	Successful acknowledgement of RRCConnectionRelease	14.5.0
	RP-78	RP-172624	3160	1	A	TM6 capabilities in CE mode	14.5.0
	RP-78	RP-172616	3169	1	F	Correction on the field description of ce-PDSCH-TenProcesses	14.5.0
	RP-78	RP-172617	3175	1	F	Small corrections to CarrierConfigDedicated, T322 and t-reordering default configuration	14.5.0
	RP-78	RP-172617	3176	1	F	Correction to random access power control in 36.331	14.5.0
	RP-78	RP-172616	3180	1	B	Introduction of a new configuration for ssp10 with less CRS	14.5.0
	RP-78	RP-172617	3184	-	F	Correction on zone configuration in transmission pool selection	14.5.0
	RP-78	RP-172622	3190	-	A	DCI monitoring subframes for eIMTA	14.5.0
	RP-78	RP-172623	3194	-	F	SFN desynchronization between eNB and eDRX UE	14.5.0
12/2017	RP-78	RP-172614	3115	3	B	Introducing support for NR, changes relevant for NSA	15.0.0
01/2018						Removed ASN.1 errors to make it pass the syntax check	15.0.1
03/2018	RP-79	RP-180491	3208	2	F	Miscellaneous corrections from review in preparation for ASN.1 freeze	15.1.0
	RP-79	RP-180443	3217	-	A	Correction on SRS carrier switching	15.1.0
	RP-79	RP-180443	3222	-	A	Correction to field description for HARQ-ACK delay for Rel-14 MTC	15.1.0
	RP-79	RP-180445	3224	1	A	Correction to RRCConnectionReestablishment message in 36.331	15.1.0
	RP-79	RP-180448	3245	2	A	Introduction of LTE DL 1.4Gbps Category	15.1.0
	RP-79	RP-180442	3256	1	A	Correction to handling of p-Max procedure for high-power UEs	15.1.0
	RP-79	RP-180446	3263	2	A	Correction on Override of the highPriorityAccess Establishment Cause by the mo-VoiceCall value	15.1.0
	RP-79	RP-180442	3267	1	A	Different power class support for band combinations	15.1.0
	RP-79	RP-180444	3272	1	A	Clarifications on V2X resource selection in the absence of positioning information	15.1.0
	RP-79	RP-180446	3274	1	A	Correction to GERAN redirection without security	15.1.0
	RP-79	RP-180441	3277	1	A	Correction to pucch-ConfigDedicated for fallback configuration	15.1.0
	RP-79	RP-180446	3279	2	A	Signalling for reading shared PLMN information from non-CSG cells	15.1.0
	RP-79	RP-180443	3282	-	A	Clarification to PUCCH Configuration for LAA SCells	15.1.0
	RP-79	RP-180441	3296	2	A	Clarification on the NPRACH starting subcarrier partitioning for multi-tone Msg3 transmission	15.1.0
	RP-79	RP-180443	3297	2	A	Introduction of support of relaxed monitoring for BL and CE UE	15.1.0
	RP-79	RP-180444	3301	1	A	Correction on SI-offsetIndicator for the sidelink resource pool	15.1.0
	RP-79	RP-180441	3306	-	A	RRC Corrections for RRC Resume	15.1.0
06/2018	RP-80	RP_181230	3293	2	A	Removal of the FDD/TDD diff restriction for crs-InterfHandl IE	15.2.0
	RP-80	RP-181171	3303	5	C	Qualcomm Incorporated, Gemalto N.V	15.2.0
	RP-80	RP-181235	3307	3	A	Small correction on PhysicalConfigDedicated-NB	15.2.0
	RP-80	RP-181234	3312	2	A	Correction on SPS assistance information in TS 36.331	15.2.0
	RP-80	RP-181233	3324	1	F	Successful acknowledgement of RRCConnectionRelease for BL and CE UE	15.2.0
	RP-80	RP-181230	3357	2	A	Correction for IDC hardware sharing problems	15.2.0
	RP-80	RP-181234	3360	2	A	Corrections to syncOffsetIndicator Configuration	15.2.0
	RP-80	RP-181236	3365	3	A	Correction on UE capabilities	15.2.0
	RP-80	RP-181231	3370	1	A	Clarification on ue-TxAntennaSelectionSupported when bandParameterList-v1380 is included	15.2.0
	RP-80	RP-181216	3386	3	F	Miscellaneous EN-DC related corrections	15.2.0
	RP-80	RP-181229	3394	1	F	Handling of Pmax for PC2 and uplink intra-band contiguous CA capable UEs	15.2.0
	RP-80	RP-181236	3396	1	A	Correction for support of alternative TBS indices	15.2.0
	RP-80	RP-181233	3399	1	A	Clarification on RACH-less configuration release	15.2.0
	RP-80	RP-181233	3426	-	A	Clarification on RRC reconfiguration without handover for switching EC to NC	15.2.0
	RP-80	RP-181233	3427	-	A	Correction on extended RSRP measurement reporting for BL UE or UE in CE	15.2.0
	RP-80	RP-181232	3430	1	A	Correction to handling of p-Max procedure for high-power UEs	15.2.0
	RP-80	RP-181236	3433	-	A	Clarification on cellIdentity for shortMAC-I	15.2.0
	RP-80	RP-181236	3439	2	A	Introduction of DL Channel Quality reporting	15.2.0
	RP-80	RP-181235	3441	1	A	Introduction of serving cell idle mode measurements reporting in 36.331	15.2.0
	RP-80	RP-181235	3442	1	A	Correction to T310 timer description and editorials	15.2.0
	RP-80	RP-181234	3454	1	A	Corrections to CBR Measurement Report Triggering	15.2.0
	RP-80	RP-181224	3466	1	A	Correction on delta-RxLevMinCE1	15.2.0
	RP-80	RP-181234	3468	1	A	Introduce the short value of sc-mcch repetition period and sc-mcch modification period out of 'br-BCCH-Config-r14'.	15.2.0
	RP-80	RP-181233	3470	-	A	Merged CR: UE capabilities for handling of multiple numerologies in FeMBMS, SRS carrier switching, and advanced CSI in FD-MIMO	15.2.0

	RP-80	RP-181416	3406	2	A	Corrections to additionalSpectrumEmission extension	15.2.0
	RP-80					Added <CR> to UE-EUTRA-Capability-v1520-IEs ASN.1 structure to make it pass the syntax	15.2.1
	RP-80					Corrects ASN.1 consistency problems between releases 13, 14 and 15.	15.2.2
09/2018	RP-81	RP-181953	3144	3	B	Introduction of QoE Measurement Collection for LTE	15.3.0
	RP-81	RP-181951	3178	6	B	Introduce assistance information for local cache 36.331 CR	15.3.0
	RP-81	RP-181939	3186	8	B	Introducing support for NR, changes only relevant for SA	15.3.0
	RP-81	RP-182130	3202	9	B	Introduction of shortened TTI and processing time for LTE	15.3.0
	RP-81	RP-181955	3211	7	B	Introduction of DEFLATE based UDC Solution	15.3.0
	RP-81	RP-181960	3226	10	B	Enhancement of SRS antenna switching in TS 36.331	15.3.0
	RP-81	RP-181947	3227	6	B	Support of 1024QAM in TS 36.331	15.3.0
	RP-81	RP-181964	3251	6	B	Introduction of further enhancements to CoMP	15.3.0
	RP-81	RP-181945	3333	8	B	Introduction of further NB-IoT enhancements other than EDT in TS 36.331	15.3.0
	RP-81	RP-181949	3341	6	B	Introduction of time reference provision	15.3.0
	RP-81	RP-182000	3342	7	B	Introduction of Bluetooth and WLAN measurement collection in MDT	15.3.0
	RP-81	RP-181960	3343	5	B	Running 36.331 CR for HSDN	15.3.0
	RP-81	RP-181944	3389	4	B	Introduction of EDT for eMTC and NB-IoT enhancements	15.3.0
	RP-81	RP-182081	3390	5	B	Introduction of Rel-15 eMTC enhancements (other than EDT)	15.3.0
	RP-81	RP-182006	3391	8	B	Signalling for euCA (Enhancing LTE CA Utilization)	15.3.0
	RP-81	RP-182146	3397	3	B	Advanced CSI CBR CBR parameter and related capability for FD-MIMO	15.3.0
	RP-81	RP-181960	3407	1	B	Avoiding FGI20 limitation	15.3.0
	RP-81	RP-182119	3408	6	B	Implementing network-based CRS interference mitigation	15.3.0
	RP-81	RP-181992	3423	5	B	Introduction of eV2X in TS 36.331	15.3.0
	RP-81	RP-181962	3436	2	A	Correction on the field description of enable256QAM	15.3.0
	RP-81	RP-182005	3437	7	B	Introduction of Release-15 Aerial functionality	15.3.0
	RP-81	RP-181961	3445	1	A	Clarification to Security mode failure in NB-IoT	15.3.0
	RP-81	RP-181958	3446	2	B	Introduction of increased number of E-UTRAN data bearers	15.3.0
	RP-81	RP-181952	3450	3	B	Addition of broadcast of positioning assistance data	15.3.0
	RP-81	RP-181960	3453	4	B	Control Plane latency reduction	15.3.0
	RP-81	RP-181946	3473	4	B	Introduce feLAA in TS 36.331	15.3.0
	RP-81	RP-181949	3474	3	B	Introduction of Ultra Reliable Low Latency Communication for LTE	15.3.0
	RP-81	RP-181950	3475	2	B	Capture NR agreements into 36.331 for E-UTRA connected to 5GC	15.3.0
	RP-81	RP-181939	3481	1	F	Miscellaneous EN-DC related corrections	15.3.0
	RP-81	RP-181961	3489	-	A	Correcting a typo in aperiodicCSI-Trigger	15.3.0
	RP-81	RP-181945	3491	2	F	Correcting inconsistent ASN.1 for NB-IoT	15.3.0
	RP-81	RP-181963	3497	1	A	Correction to RRC Connection Re-establishment for the control plane	15.3.0
	RP-81	RP-181960	3499	1	B	Introduction of modulation enhancements	15.3.0
	RP-81	RP-181961	3502	1	A	Radio resource configuration handling when resuming a suspended RRC connection	15.3.0
	RP-81	RP-181962	3516	1	A	Correction to the description of UE capability for V2X sidelink communication	15.3.0
	RP-81	RP-181962	3518	-	A	Correction on the duplex mode configuration for Rx pool	15.3.0
	RP-81	RP-181960	3523	1	C	Introduction of Geofencing information in CMAS	15.3.0
	RP-81	RP-181962	2531	-	A	Correction on V2X TX pool selection	15.3.0
	RP-81	RP-181962	3533	1	A	CR on Clarification of Configuring codebookConfigNx for Rel-15	15.3.0
	RP-81	RP-181962	3538	-	A	Clarification for the asynchronous HARQ with the LTE mobility enhancements	15.3.0
	RP-81	RP-181962	3539	-	A	Correction for Zoning	15.3.0
	RP-81	RP-181960	3541	-	B	UE UL categories for 1024QAM	15.3.0
12/2018	RP-82	RP-182681	3495	3	A	Editorial restructuring of NPRACH resource configuration	15.4.0
	RP-82	RP-182674	3506	5	F	CR for T312 on LTE HetNet mobility	15.4.0
	RP-82	RP-182655	3525	3	F	Introduction of including EUTRA UE capability for MRDC usage	15.4.0
	RP-82	RP-182680	3544	3	F	Correction for sidelink measurement periodical triggering condition	15.4.0
	RP-82	RP-182678	3548	3	F	Correction on UE capability for eV2X	15.4.0
	RP-82	RP-182675	3551	2	F	Clarification on RRC state transition	15.4.0
	RP-82	RP-182675	3553	1	F	Addition of RAN specific Access Category	15.4.0
	RP-82	RP-182675	3554	1	F	Clarification to no barring configuration for Implicit UAC	15.4.0
	RP-82	RP-182675	3555	1	F	Correction to Access Category and barring config determination for Implicit UAC	15.4.0
	RP-82	RP-182679	3557	3	A	Correction on maximum symbols for PUSCH transmission in UpPTS	15.4.0
	RP-82	RP-182674	3560	3	F	Corrections on the IDLE state measurement	15.4.0
	RP-82	RP-182677	3563	4	A	Corrections to eCA configuration	15.4.0
	RP-82	RP-182677	3566	4	F	Clarification to UE capabilities for CA	15.4.0
	RP-82	RP-182674	3567	1	F	Corrections to euCA	15.4.0
	RP-82	RP-182679	3572	2	F	Correction on SPS configuration for HRLLC	15.4.0
	RP-82	RP-182655	3576	3	F	Correction to DRB release	15.4.0
	RP-82	RP-182652	3577	2	F	Correction to inter-RAT measurement for NR	15.4.0
	RP-82	RP-182655	3578	1	F	Clarification on capabilities transferring	15.4.0
	RP-82	RP-182681	3580	2	F	Corrections to random access power control for TDD in 36.331	15.4.0
	RP-82	RP-182681	3581	2	F	Miscellaneous corrections and cleanup for NB-IoT Rel-15	15.4.0
	RP-82	RP-182681	3582	3	F	Corrections to EDT in 36.331	15.4.0
	RP-82	RP-182650	3583	2	F	CR for security handling upon handover to eLTE in 36.331	15.4.0
	RP-82	RP-182678	3584	4	F	Miscellaneous corrections in TS 36.331 on eV2X	15.4.0
	RP-82	RP-182681	3585	1	F	Update description of consecutive precoders used for NSSS	15.4.0

	RP-82	RP-182676	3586	2	F	Miscellaneous corrections on E-UTRA connected to 5GCN	15.4.0
	RP-82	RP-182675	3587	1	F	Open issues on E-UTRA connected to 5GC for UAC	15.4.0
	RP-82	RP-182675	3588	2	F	Open issues on E-UTRA connected to 5GC for INACTIVE	15.4.0
	RP-82	RP-182676	3589	3	F	TS36.331 CR on UE capabilities for mobility and E-UTRA/5GC	15.4.0
	RP-82	RP-182652	3592	2	F	[E201] CR to 36.331 on handling of mapped GUMMEI/GUAMI at idle mode mobility between 5GS and EPS	15.4.0
	RP-82	RP-182676	3593	2	F	Access barring check after handover for eLTE	15.4.0
	RP-82	RP-182672	3596	4	C	SI message scheduling enhancement to avoid conflicts between legacy and positioning System Information	15.4.0
	RP-82	RP-182657	3597	5	F	Corrections for handover between NR and E-UTRA in TS36.331	15.4.0
	RP-82	RP-182652	3599	2	F	UE capability for IDC mechanism for EN-DC operation	15.4.0
	RP-82	RP-182655	3600	2	F	Cleanup on handover to EUTRA procedure	15.4.0
	RP-82	RP-182675	3601	2	F	Correction of CN type indication for RRC Redirection from E-UTRA/5GC to E-UTRA/5GC or E-UTRAN	15.4.0
	RP-82	RP-182651	3602	2	F	RSRP result in SFTD measurement report	15.4.0
	RP-82	RP-182681	3605	4	F	Corrections and clarifications for MO EDT	15.4.0
	RP-82	RP-182674	3607	2	F	Small correction to pos-schedulingInfoList in SIB1-BR (RIL Z107)	15.4.0
	RP-82	RP-182675	3614	2	F	Correction on system information blocks acquisition	15.4.0
	RP-82	RP-182679	3616	2	F	Clarification on UDC configuration	15.4.0
	RP-82	RP-182681	3619	3	F	Correction to additional SIB1 in eFeNB-IoT	15.4.0
	RP-82	RP-182653	3622	2	F	UE context handling during handover to LTE-5GC	15.4.0
	RP-82	RP-182652	3628	2	F	CR to 36.331 on addition of CGI reporting timer T321 for NR	15.4.0
	RP-82	RP-182653	3629	2	F	Corrections regarding RLC failure reporting	15.4.0
	RP-82	RP-182656	3634	2	F	Some NR SA related corrections	15.4.0
	RP-82	RP-182662	3638	3	F	Correction on sorting for reporting of NR cell measurements	15.4.0
	RP-82	RP-182671	3642	2	F	Clarifications on system information acquisition time enhancements in Rel-15	15.4.0
	RP-82	RP-182680	3643	2	F	Various sTTI corrections	15.4.0
	RP-82	RP-182671	3647	2	F	Corrections on paging monitoring and SI acquisition in RRC_CONNECTED for BL UEs and UEs in CE	15.4.0
	RP-82	RP-182679	3651	3	F	Correction on Bluetooth and WLAN measurement collection in MDT	15.4.0
	RP-82	RP-182679	3652	1	F	Correction on SRB4 for QoE measurement collection	15.4.0
	RP-82	RP-182675	3653	2	F	Corrections for E-UTRA connected to 5GC	15.4.0
	RP-82	RP-182679	3654	2	F	Corrections on time reference information	15.4.0
	RP-82	RP-182679	3655	2	F	Correction on UE behaviour about referenceSFN	15.4.0
	RP-82	RP-182674	3656	1	F	Correction on flight path information	15.4.0
	RP-82	RP-182674	3657	1	F	Correction on measurement triggering based on number of cells	15.4.0
	RP-82	RP-182674	3658	2	F	Correction on triggering idle mode measurement	15.4.0
	RP-82	RP-182680	3660	2	F	SPS for TDD sTTI	15.4.0
	RP-82	RP-182680	3661	3	F	skipUplinkTxSPS for short TTI option 1	15.4.0
	RP-82	RP-182680	3663	2	F	correction on power control	15.4.0
	RP-82	RP-182678	3665	4	F	Clarification for SLSS_TxDisabled	15.4.0
	RP-82	RP-182680	3666	2	F	Correction for sTTI	15.4.0
	RP-82	RP-182682	3673	4	F	CR to 36.331 on the ambiguity of CellIdentity in Resume/Short MAC-I calculation	15.4.0
	RP-82	RP-182653	3674	1	F	Correction to FDD/TDD Diff for NR PDCP Capabilities	15.4.0
	RP-82	RP-182678	3675	3	F	Removal of redefinition of MCS-PSSCH-Range-r15	15.4.0
	RP-82	RP-182679	3676	1	F	Corrections to multiple SPS configurations after sTTI and HRLLC merge	15.4.0
	RP-82	RP-182650	3678	1	F	Clarification on measObjectNR of SFTD between PCell and PSCell	15.4.0
	RP-82	RP-182656	3679	2	F	Clarification on B events in EN-DC	15.4.0
	RP-82	RP-182671	3680	1	F	Correction on the measurement gaps for dense PRS	15.4.0
	RP-82	RP-182672	3681	2	F	Normative Annex of CRs Containing Early Implementable Features and Corrections	15.4.0
	RP-82	RP-182680	3687	2	A	Discard the AS context and Resumeld when initiating the establishment of a RRC Connection	15.4.0
	RP-82	RP-182676	3691	1	F	Clarification of features not supported in NB-IoT	15.4.0
	RP-82	RP-182681	3692	2	F	Additional Corrections to EDT in 36.331	15.4.0
	RP-82	RP-182675	3695	F	Corrections to procedure upon Reception of the RRCConnectionSetup	15.4.0	
	RP-82	RP-182682	3697	A	Clarification for additional SRS symbols	15.4.0	
	RP-82	RP-182649	3698	F	Correction for E-UTRA connected to 5GC Procedures	15.4.0	
	RP-82	RP-182678	3700	1	F	CR on carrier frequency indication in SidelinkUEInformation	15.4.0
	RP-82	RP-182679	3707	1	F	Support of multiple UL SPS configurations and configuration of repetition	15.4.0
	RP-82	RP-182674	3708	1	F	Clarification on s-Measure for IDLE mode measurements	15.4.0
	RP-82	RP-182681	3709	2	F	Indications of RRC connection resumption and establishment to upper layers during EDT	15.4.0
	RP-82	RP-182671	3712	1	F	Exclusion of 1.4 MHz system bandwidth for flexible starting PRB	15.4.0
	RP-82	RP-182676	3713	2	F	TS36.331 CR on [103bis#43][LTE/eLTE] Capture NR agreements	15.4.0
	RP-82	RP-182651	3714	F	MO configuration with SSB SCS for a given SSB frequency	15.4.0	
	RP-82	RP-182677	3717	A	UL power control information for PUCCH format 4/5 in SIB	15.4.0	
	RP-82	RP-182676	3718	1	F	Ignore NCC on reception of resume message	15.4.0
	RP-82	RP-182674	3727	A	Clarification on csi-RS-ConfigNRP-EMIMO configuration	15.4.0	
	RP-82	RP-182662	3728	1	F	Frequency band indication in MeasObjectNR	15.4.0
	RP-82	RP-182679	3729	F	Correction on FeLAA in TS 36.331	15.4.0	
	RP-82	RP-182677	3734	1	A	n1PUCCH-AN-CS-ListP1-r13 ASN.1 error correction	15.4.0

	RP-82	RP-182679	3739	1	F	Correction of field descriptions for NW based CRS interference mitigation	15.4.0
	RP-82	RP-182666	3740	2	F	Clarification for setting of maxLayersMIMO in LTE during EN-DC operation	15.4.0
	RP-82	RP-182666	3741	4	F	Alternative signalling option for SupportedBandListNR	15.4.0
	RP-82	RP-182676	3745	2	F	Supporting MME and AMF overload control	15.4.0
	RP-82	RP-182675	3746	1	F	Corrections for Inter-system intra-E-UTRA handover in TS36.331	15.4.0
	RP-82	RP-182676	3747	3	F	Corrections for handover preparation in 36.331	15.4.0
	RP-82	RP-182659	3749	1	F	EN-DC configurations upon re-establishment	15.4.0
	RP-82	RP-182680	3750		F	Correction of SPSCConfigDL-STTI	15.4.0
	RP-82	RP-182679	3751		F	RRC corrections for URLLC	15.4.0
	RP-82	RP-182679	3752	2	F	Clarification of primary and secondary RLC entity	15.4.0
	RP-82	RP-182680	3755		F	Clarification for cgi-ReportPeriodic	15.4.0
	RP-82	RP-182674	3758		F	Correction on T331 description	15.4.0
	RP-82	RP-182674	3759		F	Correction on validityArea description	15.4.0
	RP-82	RP-182680	3763		F	Correction on interFreqNeighCellList	15.4.0
	RP-82	RP-182666	3764	2	F	CR to 36.331 on corrections related to inter-RAT CGI reporting towards NR	15.4.0
	RP-82	RP-182671	3769	3	F	Correction on the use of PRACH resource pool for EDT	15.4.0
	RP-82	RP-182667	3775	2	F	Correction concerning IDC reporting	15.4.0
	RP-82	RP-182672	3776	1	B	MBMS reception in Receive Only Mode (ROM)	15.4.0
	RP-82	RP-182667	3778	4	F	Various NR carrier frequency definition corrections	15.4.0
	RP-82	RP-182668	3779	2	F	Correction to UE capability procedures in 36.331	15.4.0
	RP-82	RP-182654	3781		F	CR to 36.331 on reporting of NR serving frequencies which the UE is not configured to measure	15.4.0
	RP-82	RP-182666	3787	2	F	Correction to description of parameter CarrierFreq	15.4.0
	RP-82	RP-182675	3789		F	Correction on the usage of delayTolerantAccess	15.4.0
	RP-82	RP-182676	3794	1	F	Introducing PDCP suspend procedure	15.4.0
	RP-82	RP-182681	3796	1	F	Clarification to UE states for EDT	15.4.0
	RP-82	RP-182667	3799	2	F	CR on PSCell (SPCell of SN) change (36.331)	15.4.0
	RP-82	RP-182674	3800	3	F	Signalling of CRS IM and CCH-IM for UE cat 1bis and cat M2	15.4.0
	RP-82	RP-182672	3803	5	B	Support for Logging of 'Any cell selection' state	15.4.0
	RP-82	RP-182663	3805	2	F	Addition of selected BC in AS-Context for EN-DC	15.4.0
	RP-82	RP-182662	3807		F	Correction on the terminology scg-ChangeFailure	15.4.0
	RP-82	RP-182662	3808		F	CR to 36331 on release after completion of inter-RAT HO	15.4.0
	RP-82	RP-182662	3809		F	Clarification on supportedMIMO-CapabilityDL-r15	15.4.0
	RP-82	RP-182663	3810		F	CR to 36.331 on alignment of use of fullI-RNTI and I-RNTI in paging and InactiveConfig (Alt.2)	15.4.0
	RP-82	RP-182667	3811	1	F	Clarification on the candidateCellInfoListNR in RRM-Config	15.4.0
	RP-82	RP-182676	3812		F	TS36.331 CR on [104#23][LTE/5GC] Capture NR agreements	15.4.0
	RP-82	RP-182679	3813		F	Addition of SRB duplication in SCG	15.4.0
03/2019	RP-83	RP-190553	3785	3	F	CR to mandate FGI 103 and 104	15.5.0
	RP-83	RP-190550	3818	2	F	Clarification on RRC connection resume	15.5.0
	RP-83	RP-190550	3820	2	F	Clarification on RRC connection establishment	15.5.0
	RP-83	RP-190637	3821	3	F	CR to 36.331 on clarification of autonomous gap in EN-DC	15.5.0
	RP-83	RP-190546	3824	3	F	CR on adding ssb-ToMeasure in SIB24 and MeasObjectNR	15.5.0
	RP-83	RP-190542	3825	1	F	Clarification for EN-DC SN change scenario	15.5.0
	RP-83	RP-190542	3826	1	F	Clarification on UE Capability Request Filtering	15.5.0
	RP-83	RP-190551	3833	1	F	Clarification to MeasResults for IDLE mode measurements	15.5.0
	RP-83	RP-190551	3834	2	F	Corrections to SCell group handling	15.5.0
	RP-83	RP-190551	3836	1	F	Clarification of mode 3 sensing parameter in TS 36.331	15.5.0
	RP-83	RP-190549	3839	1	A	Correction to systemInformationBlockType2Dedicated	15.5.0
	RP-83	RP-190551	3840	1	F	Corrections to mpdcch-UL-HARQ-ACK-FeedbackConfig	15.5.0
	RP-83	RP-190547	3843	1	A	Missing inter-node SCG field	15.5.0
	RP-83	RP-190542	3849	1	F	NR UE capability filtering in E-UTRAN	15.5.0
	RP-83	RP-190551	3857	3	F	Removal of parameter alpha in WUS configuration	15.5.0
	RP-83	RP-190550	3858	1	F	Miscellaneous Corrections for eLTE	15.5.0
	RP-83	RP-190549	3860	-	A	Correction on UE capability signalling for simultaneous antenna and carrier switching	15.5.0
	RP-83	RP-190553	3861	1	F	UE capability for eLCID support	15.5.0
	RP-83	RP-190542	3866	1	F	Corrections on NR NS-Pmax and frequency band list configuration in SIB24	15.5.0
	RP-83	RP-190552	3872	1	F	Correction on SPUCCH-Config	15.5.0
	RP-83	RP-190550	3873	-	F	Correction on the field description of h1-ThresholdOffset	15.5.0
	RP-83	RP-190552	3874	1	F	Correction on QoE measurement collection for LTE	15.5.0
	RP-83	RP-190549	3875	1	A	Clarification to Permitted MaxCID for ROHC and Uplink-Only ROHC	15.5.0
	RP-83	RP-190550	3878	2	F	Small corrections on TS 36.331	15.5.0
	RP-83	RP-190551	3879	2	F	Clarifications on mixed operation mode	15.5.0
	RP-83	RP-190551	3882	-	F	Corrections to TDD parameters - Option 2	15.5.0
	RP-83	RP-190551	3883	1	F	Correction to carrierFreqOffset in TDD	15.5.0
	RP-83	RP-190553	3886	1	F	Corrections for MBMS reception in Receive Only Mode (ROM)	15.5.0
	RP-83	RP-190542	3887	1	F	Minor NR related changes to 36331	15.5.0
	RP-83	RP-190550	3890	1	F	Introduction of UE capabilities on DMRS overhead reduction	15.5.0
	RP-83	RP-190540	3891	-	F	Correction to Q-QualMin value range	15.5.0
	RP-83	RP-190542	3892	1	F	Supporting bearer type change with LCID change	15.5.0
	RP-83	RP-190551	3897	3	F	Correction to field description in IE RSS-Config	15.5.0
	RP-83	RP-190546	3889	2	F	Changes related to CA and or DC duplication	15.5.0



	RP-83	RP-190548	3899	2	F	Update description of ack-NACK-NumRepetitions	15.5.0
	RP-83	RP-190548	3900	2	F	Corrections of NB-IoT Access Barring	15.5.0
	RP-83	RP-190543	3902	1	F	Release and addition of the DRB	15.5.0
	RP-83	RP-190550	3908	2	F	Clarification on counter check procedure for eLTE	15.5.0
	RP-83	RP-190551	3910	1	F	Miscellaneous CRs for euCA	15.5.0
	RP-83	RP-190549	3912	-	A	Clarification on ssp mapping rules for ssp10-CRS-LessDwPTS	15.5.0
	RP-83	RP-190550	3913	1	F	Correction to simultaneous configuration of altCQI-Table-1024QAM and altCQI-Table	15.5.0
	RP-83	RP-190550	3914	-	F	DL 1024QAM capability in FeatureSetsEUTRA	15.5.0
	RP-83	RP-190550	3918	3	F	Correction to fallback to the RRC connection establishment	15.5.0
	RP-83	RP-190550	3929	3	F	Addition of missing condition in SCell release	15.5.0
	RP-83	RP-190542	3932	1	F	Clearing of SFTD measurements at handover and re-establishment	15.5.0
	RP-83	RP-190543	3937	2	F	Introduction of tdm-PatternConfig and p-MaxEUTRA in AS-Config	15.5.0
	RP-83	RP-190541	3938	-	F	Corrections on FeatureSetDL-PerCC-Id and FeatureSetUL-PerCC-Id	15.5.0
	RP-83	RP-190549	3940	-	A	UE capability for support of special subframe configuration 10 with TDD-only CA	15.5.0
	RP-83	RP-190543	3941	-	F	CR to 36.331 on clarification of gap release during HO	15.5.0
	RP-83	RP-190550	3942	-	F	Capture NR agreements into eLTE	15.5.0
04/2019	RP-83					Correction to the implementation of CR#3913	15.5.1
06/2019	RP-84	RP-191378	3947	3	F	Corrections to SIB24 configuration on SS-RSSI measurements	15.6.0
	RP-84	RP-191375	3953	3	F	CR to 36.331 on SFTD measurement	15.6.0
	RP-84	RP-191385	3956	2	F	Correction of TDD UL DL Alignment offset	15.6.0
	RP-84	RP-191386	3957	2	F	Correction to sTTI field	15.6.0
	RP-84	RP-191381	3958	5	F	Alignment of definition of upperLayerIndication with the definition in the GSMA 5GSI LS	15.6.0
	RP-84	RP-191377	3962	1	F	CR to 36.331 on clarification of ANR FGIs and capability under EN-DC	15.6.0
	RP-84	RP-191385	3963	4	F	Corrections on the idle mode measurement	15.6.0
	RP-84	RP-191383	3967	1	A	UE capability signalling for FD-MIMO processing capabilities	15.6.0
	RP-84	RP-191374	3968	-	F	RRC processing delay for UE capability transfer	15.6.0
	RP-84	RP-191377	3969	1	F	Handling of SMTC configuration	15.6.0
	RP-84	RP-191374	3970	-	F	Clarification on filters used to generate FeatureSets (36.331)	15.6.0
	RP-84	RP-191383	3972	-	A	Correction to NPRACH resource default configuration	15.6.0
	RP-84	RP-191385	3973	-	F	Corrections to NSSS-based RRM measurements	15.6.0
	RP-84	RP-191385	3974	-	F	Correction to sourceDL-CarrierFreq in TDD	15.6.0
	RP-84	RP-191384	3975	2	F	Correction to conditions for initiating EDT	15.6.0
	RP-84	RP-191383	3980	-	A	Additional UE capability signalling for SRS carrier switching	15.6.0
	RP-84	RP-191384	3981	-	F	Miscellaneous Corrections for UAC in eLTE	15.6.0
	RP-84	RP-191384	3982	1	F	Capture NR agreements in eLTE	15.6.0
	RP-84	RP-191380	3984	2	F	LTE changes for FullConfig for Inter-RAT intra-system HO	15.6.0
	RP-84	RP-191381	3990	4	F	Correction on intra-band fallback behavior with FeatureSetsPerCC	15.6.0
	RP-84	RP-191384	3991	1	F	Correction on cell reselection while T302 is running	15.6.0
	RP-84	RP-191384	3992	2	F	Correction on leaving RRC_CONNECTED	15.6.0
	RP-84	RP-191384	3993	2	F	Correction on inter-RAT cell reselection in RRC_INACTIVE	15.6.0
	RP-84	RP-191378	3994	1	F	Minor NR related changes to 36.331	15.6.0
	RP-84	RP-191387	3995	1	F	Editorial/ minor corrections collected by Rapporteur	15.6.0
	RP-84	RP-191381	3996	2	F	Corrections regarding EN-DC terminology	15.6.0
	RP-84	RP-191381	3998	1	F	Clarification on inter-RAT mobility	15.6.0
	RP-84	RP-191382	4001	1	A	Correction to dual connectivity	15.6.0
	RP-84	RP-191378	4002	2	B	Introducing NR changes for late drop (resulting from ASN1 review)	15.6.0
	RP-84	RP-191384	4003	-	F	Correction on edt-LastPreamble field description	15.6.0
	RP-84	RP-191384	4006	2	F	Clarification to the description of cellSelectionInfoCE	15.6.0
	RP-84	RP-191385	4008	1	F	Correct reference for serving cell relaxation with WUS	15.6.0
	RP-84	RP-191387	4009	1	F	Missing messages in "Protection of RRC messages" table	15.6.0
	RP-84	RP-191382	4010	1	A	Correction in the field description of aperiodicCSI-Trigger	15.6.0
	RP-84	RP-191383	4015	1	A	Corrections on UE capability for eFD-MIMO	15.6.0
	RP-84	RP-191378	4017	1	F	Correction on UE Capability Transfer for Featureset in EN-DC	15.6.0
	RP-84	RP-191382	4020	2	F	SI update notification and access barring in NB-IoT	15.6.0
	RP-84	RP-191384	4022	1	F	Correction on Idle mode measurement in RRC_INACTIVE	15.6.0
	RP-84	RP-191384	4023	1	F	Power boost values for MWUS	15.6.0
	RP-84	RP-191385	4025	-	F	CR on carrier frequency selection for V2X SL communication transmission	15.6.0
09/2019	RP-85	RP-192195	3986	3	F	Correction on handling of SCell(s) during Make Before Break handover	15.7.0
	RP-85	RP-192197	4028	2	F	Clarification for mixed operation mode	15.7.0
	RP-85	RP-192197	4030	1	F	Correction on the field description of nprach-SubCarrierIndex	15.7.0
	RP-85	RP-192298	4031	-	C	Additional capability signalling for 1024QAM support	15.7.0
	RP-85	RP-192196	4032	-	F	Correcting algorithm key derivation for LTE/5GC in connection resume	15.7.0
	RP-85	RP-192194	4034	1	F	Clarification to fullConfig in EN-DC	15.7.0
	RP-85	RP-192192	4035	1	F	Clarification on mobility of UE configured with SN terminated DRB without SCG	15.7.0
	RP-85	RP-192192	4038	1	F	Missing reportAddNeighMeas in ReportConfigInterRAT	15.7.0
	RP-85	RP-192196	4042	2	F	Intra-E-UTRA inter-system HO	15.7.0
	RP-85	RP-192196	4043	-	F	Support of Idle mode measurement in E-UTRA/5GC	15.7.0
	RP-85	RP-192196	4044	-	F	PDU session release indication to upper layers during Full Configuration in eLTE	15.7.0

	RP-85	RP-192192	4055	1	F	Correction of the condition HO-toEUTRAN	15.7.0
	RP-85	RP-192198	4056	2	F	Editorial/ minor corrections collected by Rapporteur	15.7.0
	RP-85	RP-192192	4058	1	F	Correction to s-Measure for NE-DC (36.331)	15.7.0
	RP-85	RP-192190	4061	-	F	Correction of security algorithms at inter-RAT handover to LTE-5GC (Alt1)	15.7.0
	RP-85	RP-192193	4062	1	F	Adding P-EUTRA for supporting power coordination in NE-DC	15.7.0
	RP-85	RP-192195	4064	1	A	Correction to the description of of DL channel quality	15.7.0
	RP-85	RP-192197	4066	-	F	Correction to table references for SIB1 scheduling in TDD	15.7.0
	RP-85	RP-192197	4068	-	F	Correction to the field description of numDRX-CyclesRelaxed in WUS-Config-NB	15.7.0
	RP-85	RP-192190	4070	-	F	Support of SUO case1 in NE-DC	15.7.0
	RP-85	RP-192196	4071	-	F	Clarification on inter-node message	15.7.0
	RP-85	RP-192197	4072	1	F	Correction to sTTI and sPT capability reporting	15.7.0
	RP-85	RP-192196	4073	-	F	Correction to ROHC handling	15.7.0
	RP-85	RP-192194	4077	3	F	AS-ConfigNR at handover with (NG)EN-DC	15.7.0
	RP-85	RP-192192	4079	1	F	Miscellaneous Corrections on 36.331 for MR-DC	15.7.0
	RP-85	RP-192190	4080	-	F	Correction on 36.331 for reconfiguration of SCG part of DRBs in NE-DC	15.7.0
	RP-85	RP-192194	4081	2	F	Support of LCID change for (NG)EN-DC and NE-DC	15.7.0
	RP-85	RP-192198	4086	1	F	Corrections to SIB12 for CMAS geo-fencing	15.7.0
	RP-85	RP-192196	4091	1	F	Correction on RRC connection release indication after handover	15.7.0
	RP-85	RP-192196	4092	1	F	Correction on stop condition of T380	15.7.0
	RP-85	RP-192194	4097	1	F	Correction on overheating indication and RLM report	15.7.0
	RP-85	RP-192279	4098	1	F	CR to introduce NR SS-SINR measurement capability in LTE	15.7.0
	RP-85	RP-192193	4100	-	F	MR-DC measurement gap pattern capability	15.7.0
12/2019	RP-86	RP-192940	4113	1	A	Correction on T322	15.8.0
	RP-86	RP-192935	4115	1	F	Reconfiguration failure in NE-DC	15.8.0
	RP-86	RP-192936	4117	3	F	Miscellaneous corrections for late drop	15.8.0
	RP-86	RP-192934	4119	2	F	Corrections to power limitations in (NG)EN-DC	15.8.0
	RP-86	RP-192941	4120	4	F	Correction to SIB5 acquisition for idle mode measurements	15.8.0
	RP-86	RP-192938	4128	2	F	Correction to field conditions in NE-DC	15.8.0
	RP-86	RP-192941	4142	1	F	Corrections to Application layer measurement reporting and UE capability signalling	15.8.0
	RP-86	RP-192941	4143	1	F	Allow Delta Configuration of ParametersListFmt2 and ParametersListEDTFmt2 in SIB2-NB	15.8.0
	RP-86	RP-192940	4144	1	F	Stop using redirectedCarrierOffsetDedicated after reselection to another frequency.	15.8.0
	RP-86	RP-192937	4145	1	F	Correction to AS security key update	15.8.0
	RP-86	RP-192936	4148	1	F	On performing L3 filtering of NR related measurements	15.8.0
	RP-86	RP-192941	4150	-	F	Correction to nonCriticalExtension of RRCConnectionRelease	15.8.0
	RP-86	RP-192939	4160	2	A	Clarification on sCellIndex and SCell lists	15.8.0
	RP-86	RP-192941	4161	2	F	Correction to early measurement reporting results	15.8.0
	RP-86	RP-192941	4177	2	F	Clarification on UE Inactive AS context	15.8.0
	RP-86	RP-192941	4183	-	F	Restoring SDAP and RoHC contexts during Resumption	15.8.0
	RP-86	RP-192936	4185	-	F	Correction for the establishment of LTE RLC bearers for (NG)EN-DC and NE-DC	15.8.0
03/2020	RP-87	RP-200338	4041	4	C	Security requirement for UE capability enquiry for LTE	15.9.0
	RP-87	RP-200338	4104	5	F	Clarification on default configuration and SRB1 for UP-EDT and RRC_INACTIVE	15.9.0
	RP-87	RP-200338	4151	3	F	Correction to full configuration	15.9.0
	RP-87	RP-200334	4168	2	F	Clarification on candidate NR frequencies for IDC in EN-DC	15.9.0
	RP-87	RP-200338	4195	1	F	Correction on LTE early measurement	15.9.0
	RP-87	RP-200338	4198	1	F	Corrections to T312 and Discovery Signals measurement	15.9.0
	RP-87	RP-200338	4199	-	F	Introduction of provisions for late non-critical extensions	15.9.0
	RP-87	RP-200334	4210	-	F	Correction of UE assistance information	15.9.0
	RP-87	RP-200338	4211	2	F	Minor corrections collected by Rapporteur	15.9.0
	RP-87	RP-200337	4213	1	A	Clarification on gap sharing configuration at handover and re-establishment	15.9.0
03/2020	RP-87	RP-200367	4026	3	C	Addition of broadcast of barometric pressure assistance data	16.0.0
	RP-87	RP-200368	4049	2	B	Introduction of RLOS support indicator and RLOS request indicator	16.0.0
	RP-87	RP-200366	4095	4	B	Introduction of RRC parameters and UE capabilities for enhanced high speed scenario	16.0.0
	RP-87	RP-200358	4099	2	F	NAS handling error of nas-Container for security key derivation	16.0.0
	RP-87	RP-200367	4103	2	C	Correction on H1 and H2 events	16.0.0
	RP-87	RP-200357	4114	2	B	Introduction of a second SMTC for inter-RAT cell reselection	16.0.0
	RP-87	RP-200367	4134	3	C	Broadcast of TBS assistance data	16.0.0
	RP-87	RP-200357	4136	2	C	Introduction of voice fallback indication	16.0.0
	RP-87	RP-200365	4137	6	B	CR of TS 36.331 for introducing NavIC in LTE – core part	16.0.0
	RP-87	RP-200357	4167	2	B	Early security re-activation at RRC Connection Resume	16.0.0
	RP-87	RP-200367	4172	3	C	Correction on non-3GPP paging	16.0.0
	RP-87	RP-200358	4187	2	B	Autonomous gap support for CGI reading	16.0.0
	RP-87	RP-200351	4189	1	B	Introduction of UE CapabilityInformation segmentation in 36.331	16.0.0
	RP-87	RP-200363	4190	1	B	Introduction of LTE-based 5G terrestrial broadcast	16.0.0
	RP-87	RP-200360	4191	1	B	Introduction of Rel-16 eMTC enhancements	16.0.0
	RP-87	RP-200361	4192	1	B	Introduction of additional enhancements for NB-IoT in TS 36.331	16.0.0
	RP-87	RP-200358	4200	1	B	Introduction of DL RRC segmentation	16.0.0

	RP-87	RP-200364	4205	1	B	Introduction of Even further Mobility enhancement in E-UTRAN	16.0.0
	RP-87	RP-200345	4215	-	B	Introduction of PPP-RTK (SSR)	16.0.0
	RP-87	RP-200348	4216	3	B	CR for 36.331 for CA&DC enh	16.0.0
	RP-87	RP-200354	4218	2	B	CR on enhancements on LTE MDT and SON	16.0.0
	RP-87	RP-200362	4219	1	B	Introduction of DL MIMO efficiency enhancement	16.0.0
	RP-87	RP-200357	4220	-	B	Introduction of wideband PRG size	16.0.0
	RP-87	RP-200357	4221	1	C	UDC reconfiguration for RRC connection re-establishment case	16.0.0
	RP-87	RP-200346	4222	1	B	Introduction of 5G V2X with NR Sidelink in TS 36.331	16.0.0
	RP-87	RP-200352	4228	1	B	Introduction of NR IIoT	16.0.0
	RP-87	RP-200359	4230	-	B	Recommended Bit Rate/Query for FLUS and MTSI	16.0.0
	RP-87	RP-200358	4232	-	B	Support of inter-RAT handover from NR to EN-DC in TS 36.331	16.0.0
	RP-87	RP-200349	4233	-	B	36.331 CR on Integrated Access and Backhaul	16.0.0
	RP-87	RP-200347	4234	-	B	Introduction of NR Mobility enhancements	16.0.0
07/2020	RP-88	RP-201166	4197	5	B	Introduction of NeedForGap capability for NR measurement	16.1.0
	RP-88	RP-201191	4229	6	B	Introduce of alternative cell reselection priority for EN-DC	16.1.0
	RP-88	RP-201191	4236	2	F	Correction on establishment cause value upon enhanced EPS voice fallback	16.1.0
	RP-88	RP-201192	4239	3	F	Miscellaneous Rel-16 eMTC corrections	16.1.0
	RP-88	RP-201168	4240	2	A	CR on RLC out-of-order delivery configuration	16.1.0
	RP-88	RP-201174	4245	2	B	CR for 36.331 for Power Savings	16.1.0
	RP-88	RP-201180	4256	2	F	Correction to transfer of UE capabilities at HO for RACS and correction of ASN.1 review issues [N012] [N013]	16.1.0
	RP-88	RP-201169	4258	2	A	Clarification on avoiding keystream repeat due to COUNT reuse	16.1.0
	RP-88	RP-201194	4259	2	F	Correction on the configuration of subframe #0 and #5 for MCH in MBMS dedicated cell	16.1.0
	RP-88	RP-201178	4260	2	F	CR for 36.331 on CA/DC Enhancements	16.1.0
	RP-88	RP-201166	4262	3	F	Allowing PDCP version change without handover	16.1.0
	RP-88	RP-201172	4263	3	B	Mobility to NR operating with shared spectrum access	16.1.0
	RP-88	RP-201166	4266	3	C	upperLayerIndication enhancements	16.1.0
	RP-88	RP-201178	4283	2	B	Introduction of UE capabilities for eDCCA	16.1.0
	RP-88	RP-201193	4287	3	F	Miscellaneous corrections to 36.331 for Rel-16 NB-IoT	16.1.0
	RP-88	RP-201160	4289	1	A	UE measurement capability requirements for NR	16.1.0
	RP-88	RP-201195	4290	2	F	Updates for R16 LTE Mobility Enhancements and LTE updates for R16 NR Mobility Enhancements	16.1.0
	RP-88	RP-201159	4293	-	A	Avoiding security risk for RLC AM and RLC UM bearers during termination point change	16.1.0
	RP-88	RP-201186	4294	1	B	CR to 36.331 on introduction of mandatory gap patterns in Rel-16	16.1.0
	RP-88	RP-201181	4299	2	B	IIOT capabilities introduction to TS 36.331	16.1.0
	RP-88	RP-201181	4300	-	F	Correction of NR IIoT	16.1.0
	RP-88	RP-201169	4305	2	A	Correction to the LTE Rel-15 TDD/FDD capability differentiation	16.1.0
	RP-88	RP-201195	4306	1	B	UE Capability for Rel-16 LTE even further mobility enhancement	16.1.0
	RP-88	RP-201194	4307	-	F	MBMS UE capabilities per band for subcarrier spacing of 2.5 kHz and 0.37 kHz	16.1.0
	RP-88	RP-201190	4315	3	F	General changes resulting from ASN.1 review for LTE RRC REL-16	16.1.0
	RP-88	RP-201169	4321	1	A	Corrections on the number of DRBs	16.1.0
	RP-88	RP-201184	4323	3	F	Corrections on MDT and SON	16.1.0
	RP-88	RP-201191	4324	1	F	36.331 CR for overheating in (NG)EN-DC and NR-DC	16.1.0
	RP-88	RP-201185	4326	2	B	Introduction of signalling for high-speed train scenarios	16.1.0
	RP-88	RP-201197	4334	1	B	Introduction of UE capabilities for DL MIMO efficiency enhancement	16.1.0
	RP-88	RP-201194	4335	-	F	Correction on MCCH configuration for 0.37kHz SCS	16.1.0
	RP-88	RP-201176	4336	2	F	Corrections on V2X functionalities in TS 36.331	16.1.0
	RP-88	RP-201168	4342	2	A	Minor changes collected by Rapporteur	16.1.0
	RP-88	RP-201168	4343	1	A	Correction of AUL HARQ process	16.1.0
	RP-88	RP-201192	4344	-	F	Relaxed serving cell measurement for UEs using WUS	16.1.0
	RP-88	RP-201176	4345	-	B	CR for NR V2X UE capability	16.1.0
	RP-88	RP-201165	4346	2	A	Introduction of CGI reporting capability	16.1.0
	RP-88					Removal of a double "v1610" suffix to make ASN.1 to pass the syntax check	16.1.1
09/2020	RP-89	RP-201927	4349	1	B	CR for V2X UE capability	16.2.0
	RP-89	RP-201933	4353	2	F	Corretion on the RLF for LTE DAPS	16.2.0
	RP-89	RP-201933	4357	1	F	Correction on NB-IoT process under conditionalReconfiguration	16.2.0
	RP-89	RP-201928	4358	1	F	Clarification on resource reservation for eMTC	16.2.0
	RP-89	RP-201933	4359	1	F	Correction to conditional configurations	16.2.0
	RP-89	RP-201922	4361	1	F	Add tdm-PatternConfig2 in the inter-node message	16.2.0
	RP-89	RP-201933	4362	2	F	Correction on LTE MOB capability	16.2.0
	RP-89	RP-201938	4364	2	F	Correction on the Presence Condition for drb-ToAddModList	16.2.0
	RP-89	RP-201922	4366	1	F	Correction on the Configuration of sCellState for 36.331	16.2.0
	RP-89	RP-201927	4371	2	F	Correction on cross-RAT V2X functionality in TS 36.331	16.2.0
	RP-89	RP-201930	4374	-	F	Time misalignment in DAPS DRB configuration (Alt.2)	16.2.0
	RP-89	RP-201927	4376	1	F	Addition of the missing NR anchor carrier pre-configuration for V2X SL communication in TS 36.331	16.2.0
	RP-89	RP-201923	4379	1	F	CR to 36.331 on F1-C traffic over LTE	16.2.0
	RP-89	RP-201928	4380	2	F	Corrections for Rel-16 NB-IoT and eMTC	16.2.0
	RP-89	RP-201936	4383	1	A	Clarification on UL 256QAM	16.2.0
	RP-89	RP-201933	4384	-	F	Correction on TS 36.331 for DAPS UE capabilities	16.2.0

	RP-89	RP-201933	4385	-	F	Incorrect restriction for RLC UM radio bearers	16.2.0
	RP-89	RP-201922	4391	1	F	Misc corrections for Rel-16 DCCA	16.2.0
	RP-89	RP-201921	4393	2	F	Correction regarding placement of cell specific SSB QCL information	16.2.0
	RP-89	RP-201930	4396	-	F	Correction to update of CHO configuration	16.2.0
	RP-89	RP-201933	4404	2	F	Timer handling upon initiation of RRC re-establishment	16.2.0
	RP-89	RP-201933	4406	-	F	No support of DAPS HO for a CHO candidate cell	16.2.0
	RP-89	RP-201933	4409	1	F	Correction on TS36.331 for CHO	16.2.0
	RP-89	RP-201933	4411	-	F	Correction for SRB handling of DAPS HOF (36.331)	16.2.0
	RP-89	RP-201933	4414	1	F	Minor changes collected by Rapporteur	16.2.0
	RP-89	RP-201927	4416	1	F	Miscellaneous corrections on TS 36.331	16.2.0
	RP-89	RP-201932	4418	1	F	Correction to RRC connection release procedure without security for EN-DC cell reselection	16.2.0
	RP-89	RP-201923	4419	-	F	Correction of on the IP address requesting in EN-DC	16.2.0
	RP-89	RP-201938	4421	1	A	Correction for Qrxlevmin description in SIB24	16.2.0
	RP-89	RP-201963	4422	2	F	CR on LTE EHC configuration	16.2.0
	RP-89	RP-201933	4425	2	F	CR to 36.331 on SLSS ID	16.2.0
	RP-89	RP-201933	4426	-	F	drb-continueROHC for DAPS	16.2.0
	RP-89	RP-201928	4433	-	F	Correction on RRC Connection re-establishment	16.2.0
	RP-89	RP-201928	4434	1	F	Corrections to connection to 5GC for eMTC	16.2.0
	RP-89	RP-201927	4435	-	F	Adding a note for joint success and failure in crossRAT SL	16.2.0
	RP-89	RP-201923	4436	-	F	Corrections on the BH RLF failure for IAB to TS 36.331	16.2.0
	RP-89	RP-201929	4437	1	F	Misc. corrections CR for 36.331 for Power Savings	16.2.0
	RP-89	RP-201931	4438	-	F	Correction to SON features	16.2.0
	RP-89	RP-201924	4439	-	F	Miscellaneous IAB Corrections	16.2.0
	RP-89	RP-201933	4440	-	F	Restructuring DAPS capabilities	16.2.0
	RP-89	RP-201939	4445	-	C	Modification of SI scheduling for extended SIBs	16.2.0
	RP-89	RP-201936	4447	-	A	System support for Wake Up Signal	16.2.0
	RP-89	RP-201928	4448	-	F	TA timer corrections for PUR	16.2.0
	RP-89					Two left-over revision marks removed	16.2.1
12/2020	RP-90	RP-202780	4390	5	A	Corrections to the field descriptions for TDD/FDD capability differentiation, and to nMaxResource value range	16.3.0
	RP-90	RP-202784	4431	3	A	Clarification to UE capabilities for non-contiguous intra-band CA	16.3.0
	RP-90	RP-202769	4449	1	B	Update on V2X UE capability	16.3.0
	RP-90	RP-202787	4452	-	A	Removal of DelayBudgetReport message in stage 3	16.3.0
	RP-90	RP-202779	4453	-	F	Corrections to UE capabilities and SIB25	16.3.0
	RP-90	RP-202777	4454	-	F	Correction on UAI during handover	16.3.0
	RP-90	RP-202770	4456	1	F	Correction to 36.331 on UE capability of direct SCell activation	16.3.0
	RP-90	RP-202772	4459	1	F	Miscellaneous corrections to TS 36.331 for IAB	16.3.0
	RP-90	RP-202770	4463	1	F	Capability for beam level NR early measurement reporting	16.3.0
	RP-90	RP-202780	4471	2	A	Correction on ROHC configuration	16.3.0
	RP-90	RP-202780	4472	1	F	Minor changes collected by Rapporteur	16.3.0
	RP-90	RP-202780	4481	-	F	Correction to CP RRC Connection Reestablishment in 5GC	16.3.0
	RP-90	RP-202779	4482	1	F	Addition of missing RSS capability for eMTC	16.3.0
	RP-90	RP-202782	4486	1	F	Clarification on no support of CA or DC with DAPS	16.3.0
	RP-90	RP-202789	4488	2	F	Correction on uac-AC1-SelectAssistInfo	16.3.0
	RP-90	RP-202783	4489	1	F	Miscellaneous corrections on overheating assistance information for NR SCG	16.3.0
	RP-90	RP-202770	4492	1	F	Misc corrections for Rel-16 DCCA	16.3.0
	RP-90	RP-202770	4493	1	F	Correction on early measurement capabilities and descriptions	16.3.0
	RP-90	RP-202783	4494	2	F	Correction regarding overheating assistance for SCG	16.3.0
	RP-90	RP-202770	4495	1	F	Correction on SCG-related fields in RRCConnection Resume	16.3.0
	RP-90	RP-202770	4496	-	C	Processing delay requirements for RRC resume	16.3.0
	RP-90	RP-202772	4501	-	F	Support of Rel-16 features for SCG in EN-DC	16.3.0
	RP-90	RP-202769	4508	1	F	Miscellaneous corrections on TS 36.331	16.3.0
	RP-90	RP-202782	4516	-	F	Restriction on PHR for DAPS	16.3.0
	RP-90	RP-202782	4517	3	F	Introducing power sharing for DAPS handover	16.3.0
	RP-90	RP-202775	4522	-	F	Correction on T321 for autonomous gap based CGI in FR2	16.3.0
	RP-90	RP-202782	4530	-	F	Miscellaneous corrections for conditional reconfiguration	16.3.0
	RP-90	RP-202782	4531	-	F	UE capability corrections to Mobility Enhancements (LTE)	16.3.0
	RP-90	RP-202782	4532	-	F	Miscellaneous corrections for DAPS (LTE)	16.3.0
	RP-90	RP-202786	4534	1	A	Clarification for SIBs scheduled in schedulingInfoListExt and posSchedulingInfoList	16.3.0
	RP-90	RP-202785	4536	-	A	Capturing ul-256QAM-r15 capability	16.3.0
	RP-90	RP-202776	4538	-	F	RRC corrections on NR and LTE SON and MDT	16.3.0
03/2021	RP-91	RP-210700	4458	2	A	Correction to RRC resume and re-establishment	16.4.0
	RP-91	RP-210698	4480	3	F	Clarification on TA validation for PUR	16.4.0
	RP-91	RP-210698	4483	4	F	Clarification to the DRX cycle in RRC_IDLE and RRC_INACTIVE	16.4.0
	RP-91	RP-210690	4542	1	F	Correction on the Handling of Reconfiguration within RRC Resume	16.4.0
	RP-91	RP-210690	4543	1	F	Clarification on Fast MCG Link Recovery	16.4.0
	RP-91	RP-210703	4549	1	F	Minor changes collected by Rapporteur for Rel-16	16.4.0
	RP-91	RP-210699	4551	1	F	BufferSize reconfiguration for UDC after RRC connection re-establishment	16.4.0
	RP-91	RP-210698	4555	1	F	Clarification on SIB change notification in RRC_INACTIVE	16.4.0
	RP-91	RP-210698	4556	1	F	Correction on paging narrowband selection	16.4.0

	RP-91	RP-210703	4557	-	F	Correction to measResultPCell impacting EN-DC	16.4.0
	RP-91	RP-210698	4562	1	F	Dummifying intraFreqMultiUL-TransmissionDAPS-r16 capability	16.4.0
	RP-91	RP-210698	4563	1	F	Correction to UAC parameters acquisition	16.4.0
	RP-91	RP-210698	4564	-	F	Correction to SIB29 acquisition	16.4.0
	RP-91	RP-210700	4566	-	A	Correction to the applicability of CRS muting configuration	16.4.0
	RP-91	RP-210698	4567	1	F	Correction on Drb-ContinueROHC for UP-PUR	16.4.0
	RP-91	RP-210690	4568	1	F	Misc corrections for Rel-16 DCCA	16.4.0
	RP-91	RP-210699	4572	1	F	LTE RRC processing time with segmentation	16.4.0
	RP-91	RP-210692	4573	2	F	Correction on LTE Mobility Enhancement	16.4.0
	RP-91	RP-210698	4583	-	F	Corrections to DAPS handover in LTE	16.4.0
	RP-91	RP-210699	4584	1	F	Correction on handling of overheatingAssistanceConfigForSCG when SCG is released	16.4.0
	RP-91	RP-210691	4588	-	F	Corrections on the P-max for IAB	16.4.0
	RP-91	RP-210693	4589	3	F	Corrections on EUTRA MDT and SON (Rapporteur CR)	16.4.0
	RP-91	RP-210700	4593	1	A	Correction on NPRACH resources in SIB2-NB and SIB23-NB	16.4.0
	RP-91	RP-210701	4596	-	A	Reconfiguring RoHC and setting the drb-ContinueROHC simultaneously	16.4.0
	RP-91	RP-210701	4597	-	A	Correction on IDC indication	16.4.0
	RP-91	RP-210693	4599	-	D	Editorial corrections on SON and MDT	16.4.0
	RP-91	RP-210689	4602	-	F	Protection of sidelinkUEInformation and ULInformationTransferIRAT	16.4.0
	RP-91	RP-210698	4603	-	F	Correction on LTE Mobility Enhancement	16.4.0
	RP-91	RP-210698	4604	1	F	Note to clarify UE handling of non-DAPS bearer	16.4.0
	RP-91	RP-210690	4605	-	F	CR on serving cell reporting	16.4.0
06/2021	RP-92	RP-211487	4579	6	C	Redirection with MPS Indication [Redirect_MPS_I]	16.5.0
	RP-92	RP-211481	4612	2	A	Corrections on the acquisition of a posSI message	16.5.0
	RP-92	RP-211471	4622	2	F	Misc corrections for Rel-16 DCCA	16.5.0
	RP-92	RP-211479	4627	1	F	CR on T312 handling in DAPS HO	16.5.0
	RP-92	RP-211479	4628	2	F	CR on configuration release in DAPS HO	16.5.0
	RP-92	RP-211470	4631	3	F	Miscellaneous corrections on TS 36.331 for NR V2X	16.5.0
	RP-92	RP-211472	4633	2	F	Miscellaneous corrections on F1 over LTE for IAB	16.5.0
	RP-92	RP-211484	4641	2	A	Correction on T325	16.5.0
	RP-92	RP-211479	4644	1	F	Transmission of InDeviceCoexistence, UEAssistanceInformation, MBMSInterestIndication, or SidelinkUEInformation after conditional handover	16.5.0
	RP-92	RP-211482	4647	1	A	CR on RRC processing delay	16.5.0
	RP-92	RP-211472	4649	1	F	IAB LTE changes	16.5.0
	RP-92	RP-211481	4651	1	F	Clarification on the initiation of RNA update	16.5.0
	RP-92	RP-211475	4654	1	F	Inter-RAT RRM measurement on NR-U	16.5.0
	RP-92	RP-211481	4657	1	A	Corrections to Positioning SI message scheduling for eMTC and NB-IoT	16.5.0
	RP-92	RP-211479	4658	1	F	36.331 Correction on Failure Recovery via CHO for Inter-RAT Handover Failure	16.5.0
	RP-92	RP-211470	4659	1	F	Clarification on priority of LTE PSSS/SSSS/PSBCH	16.5.0
	RP-92	RP-211481	4668	1	F	Clarify systemInfoUnchanged-BR also transmitted in RSS	16.5.0
	RP-92	RP-211479	4679	1	F	Add ack-NACK-NumRepetitions for PUR-Config-NB	16.5.0
	RP-92	RP-211486	4681	1	A	Clarification on RRC full config for PSCell change	16.5.0
	RP-92	RP-211481	4684	2	A	Minor changes collected by Rapporteur for Rel-16	16.5.0
	RP-92	RP-211479	4686	-	F	Miscellaneous corrections to DAPS handover	16.5.0
	RP-92	RP-211471	4689	-	F	SON-MDT Changes agreed in RAN2#114 meeting	16.5.0
09/2021	RP-93	RP-212441	4690	2	F	Miscellaneous corrections on TS 36.331	16.6.0
	RP-93	RP-212443	4697	-	F	Corrections on RLF Report Storage in 36.331	16.6.0
	RP-93	RP-212439	4701	1	A	Correction on the Release Cause for RRC_INACTIVE UE	16.6.0
	RP-93	RP-212441	4706	1	F	Modification of measId for conditional reconfiguration	16.6.0
	RP-93	RP-212443	4711	-	F	On PDCP queuing delay value measurement	16.6.0
	RP-93	RP-212441	4713	1	F	Correction on ULInformationTransferMRDC	16.6.0
	RP-93	RP-212440	4714	-	F	Correction on Redirection with MPS Indication	16.6.0
	RP-93	RP-212441	4715	1	F	Corrections on RRC reconfiguration for fast MCG link recovery	16.6.0
	RP-93	RP-212437	4719	1	A	Minor changes collected by Rapporteur	16.6.0
	RP-93	RP-212441	4720	1	F	36.331 Correction on ReportConfigEUTRA for CHO/CPAC	16.6.0
	RP-93	RP-212441	4721	-	F	No support for CHO with SCG configuration	16.6.0
	RP-93	RP-212440	4722	2	F	CR to 36.331 on correcting Rel-15 failure type definition	16.6.0
	RP-93	RP-212596	4723	2	C	Distinguishing support of extended band n77	16.6.0
12/2021	RP-94	RP-213340	4692	2	A	Addition of scheduling restrictions of positioning SI messages for eMTC	16.7.0
	RP-94	RP-213345	4725	1	F	Discard of received segments of RRC messages	16.7.0
	RP-94	RP-213342	4734	1	F	Correction to DL Multi-TB scheduling in NB-IoT	16.7.0
	RP-94	RP-213342	4736	1	F	Correction on condReconfigurationToApply field description	16.7.0
	RP-94	RP-213345	4744	1	F	SCG Overheating termination indication in EN-DC	16.7.0
	RP-94	RP-213342	4748	-	F	Removal of RSS based RSRQ measurements	16.7.0
03/2022	RP-95	RP-220472	4754	1	A	Dummify empty sequence in FlightPathInfoReport-r15 and other corrections	16.8.0
	RP-95	RP-220473	4764	-	F	Correction on conditional reconfiguraiton execution for only one triggered cell	16.8.0
	RP-95	RP-220473	4766	1	F	Minor changes collected by Rapporteur	16.8.0
	RP-95	RP-220472	4777	1	F	Introduction of carrier specific NRSRP thresholds for NPRACH resource selection	16.8.0
	RP-95	RP-220472	4779	-	F	Correction on delta configuration for UAI overheating in EN-DC	16.8.0
03/2022	RP-95	RP-220506	4600	2	D	Inclusive Language Review for TS 36.331	17.0.0
	RP-95	RP-220835	4729	4	F	Addition of NR-U RSSI/CO measurement UE capability	17.0.0

	RP-95	RP-220837	4730	1	B	Introduction of mobility-state-based cell reselection for NR HSDN [NR_HSDN]	17.0.0
	RP-95	RP-220508	4750	2	B	Introduction of new bands and bandwidth allocation for LTE-based 5G terrestrial broadcast	17.0.0
	RP-95	RP-220837	4752	-	B	Introduction of event-based trigger for LTE MDT logging [LTE-Event-MDT]	17.0.0
	RP-95	RP-220837	4755	1	B	Introduction of MINT [MINT]	17.0.0
	RP-95	RP-220837	4756	1	B	On introducing height information reporting in MDT reports [LTE-Height-MDT]	17.0.0
	RP-95	RP-220472	4759	1	F	Correction on PO determination for UE in inactive state	17.0.0
	RP-95	RP-220507	4760	1	B	Introduction of NB-IoT/eMTC Enhancements	17.0.0
	RP-95	RP-220479	4762	2	B	Introduction of R17 PositioningEnh in LTE RRC spec	17.0.0
	RP-95	RP-220495	4763	1	B	Introducing support of UP IP for EPC connected architectures using NR PDCP	17.0.0
	RP-95	RP-220488	4769	1	B	Introduction of MUSIM for LTE	17.0.0
	RP-95	RP-220509	4771	1	B	Support of Non-Terrestrial Network in NB-IoT and eMTC	17.0.0
	RP-95	RP-220485	4774	1	B	Introduction of further multi-RAT dual-connectivity enhancements	17.0.0
	RP-95	RP-220475	4778	-	B	UE capabilities for the support of NR 71GHz	17.0.0
	RP-95	RP-220508	4780	-	B	UE capabilities for new bands and bandwidth allocation for LTE-based 5G terrestrial broadcast	17.0.0
06/2022	RP-96	RP-221758	4781	2	F	Introduction of UE capability for Rel-17 sidelink	17.1.0
	RP-96	RP-221712	4783	-	A	Correction on per-FS capability	17.1.0
	RP-96	RP-221738	4794	1	F	Corrections on the general ASN.1 issues	17.1.0
	RP-96	RP-221737	4798	1	B	Addition of missing functionalities and corrections to support of Non-Terrestrial Network in NB-IoT and eMTC	17.1.0
	RP-96	RP-221738	4799	2	C	Distinguishing support of band n77 restrictions in Canada [n77 Canada]	17.1.0
	RP-96	RP-221757	4803	1	F	Corrections to R17 NB-IoT/eMTC Enhancements	17.1.0
	RP-96	RP-221714	4806	1	A	Correction to application layer measurement and reporting	17.1.0
	RP-96	RP-221730	4808	1	F	Corrections on MUSIM in LTE	17.1.0
	RP-96	RP-221738	4810	1	B	Introducing single-bit approach for MINT [MINT]	17.1.0
	RP-96	RP-221728	4813	2	F	Corrections for further MRDC enhancements	17.1.0
	RP-96	RP-221715	4820	2	F	Overheating assistance info for FR2-2 in (NG)EN-DC - RIL E801	17.1.0
	RP-96	RP-221738	4821	1	B	Introduction of gNB ID length reporting in the NR CGI report [gNB_ID_Length]	17.1.0
	RP-96	RP-221730	4822	-	F	Correction on UE behavior for NAS-based busy indication in RRC_INACTIVE	17.1.0
	RP-96	RP-221738	4823	-	C	Support of CHO with SCG configuration - 36331 [CHOwithDCkept]	17.1.0
	RP-96	RP-221758	4824	-	F	Introduction of capability filter for Rel-17 sidelink	17.1.0
	RP-96	RP-221758	4826	-	C	Introduction of uplink RRC Segmentation capability	17.1.0
09/2022	RP-97	RP-222522	4832	1	F	Miscellaneous corrections to TS 36.331 for IoT NTN	17.2.0
	RP-97	RP-222517	4837	1	A	Clarification on schedulingInfoList in NB-IoT	17.2.0
	RP-97	RP-222518	4846	1	A	Corrections on CHO recovery	17.2.0
	RP-97	RP-222516	4850	-	A	Correction on NR serving frequency results reporting for event-triggered measurement (R17)	17.2.0
	RP-97	RP-222521	4855	1	A	Correction of overheating for NR SCG	17.2.0
	RP-97	RP-222528	4859	-	F	Clarification on NR sidelink relay related configuration	17.2.0
	RP-97	RP-222519	4862	1	A	Miscellaneous changes collected by Rapporteur	17.2.0
	RP-97	RP-222519	4865	2	A	SPS deactivation upon carrier reconfiguration	17.2.0
	RP-97	RP-222522	4866	1	F	Correction on npusch-MCS field description	17.2.0
	RP-97	RP-222522	4867	3	F	Corrections for further MR-DC enhancements	17.2.0
	RP-97	RP-222525	4869	3	F	MeasConfig corrections for above 71 GHz operation	17.2.0
	RP-97	RP-222521	4871	-	A	Correction on mpsPriorityIndication	17.2.0
12/2022	RP-98	RP-223414	4878	2	F	Correction to disasterRoamingFromAnyPLMN [MINT]	17.3.0
	RP-98	RP-223409	4884	2	F	Miscellaneous corrections to TS 36.331 for IoT NTN	17.3.0
	RP-98	RP-223408	4887	-	A	Correction on inclusion of reconnectCellId (36.331)	17.3.0
	RP-98	RP-223414	4889	-	F	Correction on ue-ConfigRelease	17.3.0
	RP-98	RP-223404	4896	-	A	Clarification on p-maxNR	17.3.0
	RP-98	RP-223405	4899	-	F	Support of Multiple CSI Subframe Sets on CQI-ReportPeriodicScell	17.3.0
03/2023	RP-99	RP-230696	4900	2	F	Miscellaneous corrections to TS 36.331 for IoT NTN	17.4.0
	RP-99	RP-230688	4903	-	F	CR to 36.331 on NPUSCH-ConfigDedicated-NB-v1700	17.4.0
	RP-99	RP-230696	4908	-	F	Correction on handling of T317 timer during HO	17.4.0
	RP-99	RP-230687	4910	2	A	Corrections in TS 36.331 on IFRI handling by IAB-MT for eIAB	17.4.0
	RP-99	RP-230687	4912	2	A	Introduction of cell-specific offset for inter-RAT measurement in LTE for NR neighbors [CIO-IRAT-HO-ToNR]	17.4.0
	RP-99	RP-230687	4915	1	A	Correction on UL RRC segmentation processing delay requirements	17.4.0
	RP-99	RP-230696	4919	-	F	Correction for T317 in the Timers table	17.4.0
06/2023	RP-100	RP-231412	4920	3	F	Correction on scg-State in RRCConnectionReconfiguration including the mobilityControlInfo	17.5.0
	RP-100	RP-231417	4928	4	F	CR to 36.331 on T317 and T318	17.5.0
	RP-100	RP-231417	4930	5	F	Alignment of NPRACH preamble descriptions with RAN1 specification for IoT-NTN parameters	17.5.0
	RP-100	RP-231417	4933	1	F	Correction on definition of ta-Report	17.5.0
	RP-100	RP-231412	4935	3	F	Correction on QoE configuration release	17.5.0
	RP-100	RP-231417	4936	-	F	IoT NTN RRC Correction on PUCCH TX duration	17.5.0
09/2023	RP-101	RP-232570	4917	6	F	Addition of extended number range for NS value	17.6.0

	RP-101	RP-232568	4937	3	F	Clarify the reference point for timing info in SIB16(-NB) and DLInformationTransfer in IoT NTN	17.6.0
	RP-101	RP-232566	4940	1	A	Correction to NS-value utilization	17.6.0
	RP-101	RP-232568	4945	2	F	Miscellaneous RRC corrections for IoT NTN	17.6.0
	RP-101	RP-232568	4952	1	F	RRC Correction on including GNSS validity duration and dedicated SIB31	17.6.0
	RP-101	RP-232567	4954	1	A	Redirection with MPS correction for resume cause	17.6.0
	RP-101	RP-232565	4958	-	A	Correction on location configuration for WLAN and BT for SON and MDT features	17.6.0
12/2023	RP-102	RP-233885	4966	1	A	Corrections to inter-node RRC messages for 5GC	17.7.0
	RP-102	RP-233890	4968	1	F	Introduction of UE capability for inter-RAT NR FR2 measurements without measurement gap	17.7.0
	RP-102	RP-233887	4972	1	F	Correction on SIB31 signalling only in NTN cell	17.7.0
	RP-102	RP-233887	4975	-	F	Clarification on ul-SyncValidityDuration in SIB31	17.7.0
	RP-102	RP-233887	4978	1	F	Corrections to SystemInformationBlockType31 for IoT NTN	17.7.0
	RP-102	RP-233888	4979	2	F	Correction on transmission of SSR Assistance Data based on BDS B1C	17.7.0
12/2023	RP-102	RP-233915	4929	6	B	Introduction of measurements without gap with interruption	18.0.0
	RP-102	RP-233883	4931	4	B	GNSS LOS/NLOS posSIB broadcast assistance information [GNSS LOS/NLOS]	18.0.0
	RP-102	RP-233883	4955	2	C	SSR Satellite PCV Residuals [Rel18PCV]	18.0.0
	RP-102	RP-233884	4959	2	F	Correction to flightPathInfoAvailable when connected to 5GC	18.0.0
	RP-102	RP-233891	4964	1	B	Introduction of IoT NTN enhancements	18.0.0
	RP-102	RP-233892	4967	1	B	Introduction of Enhanced LTE Support for UAV (Uncrewed Aerial Vehicles)	18.0.0
	RP-102	RP-233883	4970	1	B	Network support and clarification of redirection to 3G [REDIRECTION to 3G]	18.0.0
	RP-102	RP-233883	4971	1	B	Protection against improper reselection to GERAN/UTRAN [RESELECTION_TO GSM_AND_UTRAN]	18.0.0
	RP-102	RP-233909	4973	1	B	CR to 36331 for introducing SON/MDT features in Rel-18	18.0.0
	RP-102	RP-233909	4974	-	B	CR to 36.331 for UE capability for R18 SONMDT	18.0.0
03/2024	RP-103	RP-240654	4985	-	A	Removal of references to unknown RAN4 specification	18.1.0
	RP-103	RP-240651	4988	1	F	Correction on Event A3, A4 and A5 for LTE CHO	18.1.0
	RP-103	RP-240674	4989	1	F	Corrections to TS 36.331 for R18 SONMDT	18.1.0
	RP-103	RP-240660	4990	1	F	Corrections to IOT NTN	18.1.0
	RP-103	RP-240683	4991	1	B	Lower MSD capability for EN-DC	18.1.0
	RP-103	RP-240661	4992	1	F	Corrections for Enhanced LTE Support for UAV (Uncrewed Aerial Vehicles)	18.1.0
	RP-103	RP-240704	4993	1	B	Introduction of mIAB Inter-RAT cell reselection enhancements for 36.331 [TEI18_MIAB_IRAT]	18.1.0
	RP-103	RP-240652	4997	3	A	Correction on UE location information in NB-IoT RLF report	18.1.0
06/2024	RP-104	RP-241584	4983	4	B	Introduction of NR support for dedicated spectrum less than 5MHz for FR1	18.2.0
	RP-104	RP-241546	5000	1	F	Correction on redirection to GERAN [Redirect_to_GERAN]	18.2.0
	RP-104	RP-241557	5004	3	F	Corrections to Enhanced LTE Support for UAV (Uncrewed Aerial Vehicles)	18.2.0
	RP-104	RP-241556	5021	1	F	Corrections to IOT NTN	18.2.0
	RP-104	RP-241575	5022	1	F	Corrections to TS 36.331 for R18 SONMDT	18.2.0
	RP-104	RP-241544	5027	3	F	Miscellaneous Corrections for TS 36.331	18.2.0
09/2024	RP-105	RP-242235	5035	-	A	Correction on the field of scg-State	18.3.0
	RP-105	RP-242231	5040	1	F	Correction to UE capabilities and configuration	18.3.0
	RP-105	RP-242232	5046	2	A	Correction to MIB-MBMS systemFrameNumber field description	18.3.0
	RP-105	RP-242237	5049	1	F	Miscellaneous corrections to TS 36.331 for IoT NTN	18.3.0
	RP-105					Added one missing carriage return	18.3.1

---

# History

<b>Document history</b>		
V18.1.0	May 2024	Publication
V18.2.0	August 2024	Publication
V18.3.1	October 2024	Publication