

ETSI TS 136 355 V11.4.0 (2013-09)



Technical Specification

**LTE;
Evolved Universal Terrestrial Radio Access (E-UTRA);
LTE Positioning Protocol (LPP)
(3GPP TS 36.355 version 11.4.0 Release 11)**



Reference

RTS/TSGR-0236355vb40

Keywords

LTE

ETSI

650 Route des Lucioles
F-06921 Sophia Antipolis Cedex - FRANCE

Tel.: +33 4 92 94 42 00 Fax: +33 4 93 65 47 16

Siret N° 348 623 562 00017 - NAF 742 C
Association à but non lucratif enregistrée à la
Sous-Préfecture de Grasse (06) N° 7803/88

Important notice

Individual copies of the present document can be downloaded from:

<http://www.etsi.org>

The present document may be made available in more than one electronic version or in print. In any case of existing or perceived difference in contents between such versions, the reference version is the Portable Document Format (PDF). In case of dispute, the reference shall be the printing on ETSI printers of the PDF version kept on a specific network drive within ETSI Secretariat.

Users of the present document should be aware that the document may be subject to revision or change of status. Information on the current status of this and other ETSI documents is available at

<http://portal.etsi.org/tb/status/status.asp>

If you find errors in the present document, please send your comment to one of the following services:

http://portal.etsi.org/chaicor/ETSI_support.asp

Copyright Notification

No part may be reproduced except as authorized by written permission.
The copyright and the foregoing restriction extend to reproduction in all media.

© European Telecommunications Standards Institute 2013.
All rights reserved.

DECT™, **PLUGTESTS™**, **UMTS™** and the ETSI logo are Trade Marks of ETSI registered for the benefit of its Members.
3GPP™ and **LTE™** are Trade Marks of ETSI registered for the benefit of its Members and
of the 3GPP Organizational Partners.
GSM® and the GSM logo are Trade Marks registered and owned by the GSM Association.

Intellectual Property Rights

IPRs essential or potentially essential to the present document may have been declared to ETSI. The information pertaining to these essential IPRs, if any, is publicly available for **ETSI members and non-members**, and can be found in ETSI SR 000 314: *"Intellectual Property Rights (IPRs); Essential, or potentially Essential, IPRs notified to ETSI in respect of ETSI standards"*, which is available from the ETSI Secretariat. Latest updates are available on the ETSI Web server (<http://ipr.etsi.org>).

Pursuant to the ETSI IPR Policy, no investigation, including IPR searches, has been carried out by ETSI. No guarantee can be given as to the existence of other IPRs not referenced in ETSI SR 000 314 (or the updates on the ETSI Web server) which are, or may be, or may become, essential to the present document.

Foreword

This Technical Specification (TS) has been produced by ETSI 3rd Generation Partnership Project (3GPP).

The present document may refer to technical specifications or reports using their 3GPP identities, UMTS identities or GSM identities. These should be interpreted as being references to the corresponding ETSI deliverables.

The cross reference between GSM, UMTS, 3GPP and ETSI identities can be found under <http://webapp.etsi.org/key/queryform.asp>.

Contents

Intellectual Property Rights	2
Foreword.....	2
Foreword.....	8
1 Scope	9
2 References	9
3 Definitions and Abbreviations.....	10
3.1 Definitions	10
3.2 Abbreviations	10
4 Functionality of Protocol.....	11
4.1 General	11
4.1.1 LPP Configuration	11
4.1.2 LPP Sessions and Transactions.....	12
4.1.3 LPP Position Methods	12
4.1.4 LPP Messages	12
4.2 Common LPP Session Procedure	13
4.3 LPP Transport	14
4.3.1 Transport Layer Requirements	14
4.3.2 LPP Duplicate Detection	14
4.3.3 LPP Acknowledgement	14
4.3.3.1 General	14
4.3.3.2 Procedure related to Acknowledgement.....	14
4.3.4 LPP Retransmission.....	15
4.3.4.1 General	15
4.3.4.2 Procedure related to Retransmission	15
5 LPP Procedures	16
5.1 Procedures related to capability transfer	16
5.1.1 Capability Transfer procedure.....	16
5.1.2 Capability Indication procedure	17
5.1.3 Reception of LPP Request Capabilities.....	17
5.1.4 Transmission of LPP Provide Capabilities	18
5.2 Procedures related to Assistance Data Transfer.....	18
5.2.1 Assistance Data Transfer procedure	18
5.2.2 Assistance Data Delivery procedure	18
5.2.3 Transmission of LPP Request Assistance Data	19
5.2.4 Reception of LPP Provide Assistance Data	19
5.3 Procedures related to Location Information Transfer	19
5.3.1 Location Information Transfer procedure	19
5.3.2 Location Information Delivery procedure.....	20
5.3.3 Reception of Request Location Information.....	21
5.3.4 Transmission of Provide Location Information	21
5.4 Error Handling Procedures	21
5.4.1 General.....	21
5.4.2 Procedures related to Error Indication	21
5.4.3 LPP Error Detection.....	22
5.4.4 Reception of an LPP Error Message	22
5.5 Abort Procedure	22
5.5.1 General.....	22
5.5.2 Procedures related to Abort	22
5.5.3 Reception of an LPP Abort Message	23
6 Information Element Abstract Syntax Definition.....	23
6.1 General	23
6.2 LPP PDU Structure	24

–	LPP-PDU-Definitions	24
–	LPP-Message	24
–	LPP-MessageBody	25
–	LPP-TransactionID	25
6.3	Message Body IEs	26
–	RequestCapabilities	26
–	ProvideCapabilities	26
–	RequestAssistanceData	27
–	ProvideAssistanceData	27
–	RequestLocationInformation	27
–	ProvideLocationInformation	28
–	Abort	28
–	Error	29
6.4	Common IEs	29
6.4.1	Common Lower-Level IEs	29
–	AccessTypes	29
–	ARFCN-ValueEUTRA	29
–	ARFCN-ValueUTRA	30
–	CellGlobalIdEUTRA-AndUTRA	30
–	CellGlobalIdGERAN	30
–	ECGI	31
–	Ellipsoid-Point	31
–	Ellipsoid-PointWithUncertaintyCircle	31
–	EllipsoidPointWithUncertaintyEllipse	31
–	EllipsoidPointWithAltitude	32
–	EllipsoidPointWithAltitudeAndUncertaintyEllipsoid	32
–	EllipsoidArc	32
–	EPDU-Sequence	33
–	HorizontalVelocity	33
–	HorizontalWithVerticalVelocity	33
–	HorizontalVelocityWithUncertainty	34
–	HorizontalWithVerticalVelocityAndUncertainty	34
–	LocationCoordinateTypes	34
–	Polygon	34
–	PositioningModes	35
–	VelocityTypes	35
6.4.2	Common Positioning	35
–	CommonIEsRequestCapabilities	35
–	CommonIEsProvideCapabilities	35
–	CommonIEsRequestAssistanceData	36
–	CommonIEsProvideAssistanceData	36
–	CommonIEsRequestLocationInformation	36
–	CommonIEsProvideLocationInformation	39
–	CommonIEsAbort	40
–	CommonIEsError	40
6.5	Positioning Method IEs	41
6.5.1	OTDOA Positioning	41
6.5.1.1	OTDOA Assistance Data	41
–	OTDOA-ProvideAssistanceData	41
6.5.1.2	OTDOA Assistance Data Elements	41
–	OTDOA-ReferenceCellInfo	41
–	PRS-Info	42
–	OTDOA-NeighbourCellInfoList	43
6.5.1.3	OTDOA Assistance Data Request	45
–	OTDOA-RequestAssistanceData	45
6.5.1.4	OTDOA Location Information	45
–	OTDOA-ProvideLocationInformation	45
6.5.1.5	OTDOA Location Information Elements	46
–	OTDOA-SignalMeasurementInformation	46
–	OTDOA-MeasQuality	47
6.5.1.6	OTDOA Location Information Request	48
–	OTDOA-RequestLocationInformation	48

6.5.1.7	OTDOA Capability Information	48
-	OTDOA-ProvideCapabilities	48
6.5.1.8	OTDOA Capability Information Request	49
-	OTDOA-RequestCapabilities.....	49
6.5.1.9	OTDOA Error Elements	49
-	OTDOA-Error.....	49
-	OTDOA-LocationServerErrorCauses	49
-	OTDOA-TargetDeviceErrorCauses	50
6.5.2	A-GNSS Positioning.....	50
6.5.2.1	GNSS Assistance Data.....	50
-	A-GNSS-ProvideAssistanceData	50
-	GNSS-CommonAssistData	50
-	GNSS-GenericAssistData	51
6.5.2.2	GNSS Assistance Data Elements	51
-	GNSS-ReferenceTime.....	51
-	GNSS-SystemTime	52
-	GPS-TOW-Assist.....	53
-	NetworkTime	53
-	GNSS-ReferenceLocation	55
-	GNSS-IonosphericModel.....	55
-	KlobucharModelParameter	55
-	NeQuickModelParameter.....	56
-	GNSS-EarthOrientationParameters.....	57
-	GNSS-TimeModelList	57
-	GNSS-DifferentialCorrections	58
-	GNSS-NavigationModel	60
-	StandardClockModelList	62
-	NAV-ClockModel.....	63
-	CNAV-ClockModel	63
-	GLONASS-ClockModel	65
-	SBAS-ClockModel	65
-	NavModelKeplerianSet.....	65
-	NavModelNAV-KeplerianSet.....	66
-	NavModelCNAV-KeplerianSet	68
-	NavModel-GLONASS-ECEF.....	69
-	NavModel-SBAS-ECEF	70
-	GNSS-RealTimeIntegrity.....	71
-	GNSS-DataBitAssistance.....	72
-	GNSS-AcquisitionAssistance.....	73
-	GNSS-Almanac.....	76
-	AlmanacKeplerianSet	77
-	AlmanacNAV-KeplerianSet.....	78
-	AlmanacReducedKeplerianSet.....	79
-	AlmanacMidiAlmanacSet	80
-	AlmanacGLONASS-AlmanacSet	81
-	AlmanacECEF-SBAS-AlmanacSet.....	82
-	GNSS-UTC-Model	83
-	UTC-ModelSet1	83
-	UTC-ModelSet2.....	84
-	UTC-ModelSet3.....	85
-	UTC-ModelSet4.....	85
-	GNSS-AuxiliaryInformation	86
6.5.2.3	GNSS Assistance Data Request	87
-	A-GNSS-RequestAssistanceData.....	87
-	GNSS-CommonAssistDataReq.....	87
-	GNSS-GenericAssistDataReq.....	88
6.5.2.4	GNSS Assistance Data Request Elements	89
-	GNSS-ReferenceTimeReq	89
-	GNSS-ReferenceLocationReq	89
-	GNSS-IonosphericModelReq.....	89
-	GNSS-EarthOrientationParametersReq	90
-	GNSS-TimeModelListReq.....	90

–	GNSS-DifferentialCorrectionsReq.....	90
–	GNSS-NavigationModelReq.....	91
–	GNSS-RealTimeIntegrityReq.....	92
–	GNSS-DataBitAssistanceReq.....	93
–	GNSS-AcquisitionAssistanceReq.....	93
–	GNSS-AlmanacReq.....	94
–	GNSS-UTC-ModelReq.....	94
–	GNSS-AuxiliaryInformationReq.....	94
6.5.2.5	GNSS Location Information.....	95
–	A-GNSS-ProvideLocationInformation.....	95
6.5.2.6	GNSS Location Information Elements.....	95
–	GNSS-SignalMeasurementInformation.....	95
–	MeasurementReferenceTime.....	95
–	GNSS-MeasurementList.....	97
–	GNSS-LocationInformation.....	100
6.5.2.7	GNSS Location Information Request.....	101
–	A-GNSS-RequestLocationInformation.....	101
6.5.2.8	GNSS Location Information Request Elements.....	101
–	GNSS-PositioningInstructions.....	101
6.5.2.9	GNSS Capability Information.....	102
–	A-GNSS-ProvideCapabilities.....	102
6.5.2.10	GNSS Capability Information Elements.....	103
–	GNSS-CommonAssistanceDataSupport.....	103
–	GNSS-ReferenceTimeSupport.....	104
–	GNSS-ReferenceLocationSupport.....	104
–	GNSS-IonosphericModelSupport.....	104
–	GNSS-EarthOrientationParametersSupport.....	104
–	GNSS-GenericAssistanceDataSupport.....	105
–	GNSS-TimeModelListSupport.....	105
–	GNSS-DifferentialCorrectionSupport.....	106
–	GNSS-NavigationModelSupport.....	106
–	GNSS-RealTimeIntegritySupport.....	107
–	GNSS-DataBitAssistanceSupport.....	107
–	GNSS-AcquisitionAssistanceSupport.....	107
–	GNSS-AlmanacSupport.....	107
–	GNSS-UTC-ModelSupport.....	108
–	GNSS-AuxiliaryInformationSupport.....	108
6.5.2.11	GNSS Capability Information Request.....	108
–	A-GNSS-RequestCapabilities.....	108
6.5.2.12	GNSS Error Elements.....	109
–	A-GNSS-Error.....	109
–	GNSS-LocationServerErrorCauses.....	109
–	GNSS-TargetDeviceErrorCauses.....	109
6.5.2.13	Common GNSS Information Elements.....	110
–	GNSS-ID.....	110
–	GNSS-ID-Bitmap.....	110
–	GNSS-SignalID.....	110
–	GNSS-SignalIDs.....	111
–	SBAS-ID.....	112
–	SBAS-IDs.....	112
–	SV-ID.....	112
6.5.3	Enhanced Cell ID Positioning.....	113
6.5.3.1	E-CID Location Information.....	113
–	ECID-ProvideLocationInformation.....	113
6.5.3.2	E-CID Location Information Elements.....	113
–	ECID-SignalMeasurementInformation.....	113
6.5.3.3	E-CID Location Information Request.....	114
–	ECID-RequestLocationInformation.....	114
6.5.3.4	E-CID Capability Information.....	114
–	ECID-ProvideCapabilities.....	114
6.5.3.5	E-CID Capability Information Request.....	115
–	ECID-RequestCapabilities.....	115

6.5.3.6	E-CID Error Elements.....	115
–	ECID-Error.....	115
–	ECID-LocationServerErrorCauses.....	115
–	ECID-TargetDeviceErrorCauses.....	116
–	End of LPP-PDU-Definitions.....	116
Annex A (informative):	Change History	117
History		119

Foreword

This Technical Specification has been produced by the 3rd Generation Partnership Project (3GPP).

The contents of the present document are subject to continuing work within the TSG and may change following formal TSG approval. Should the TSG modify the contents of the present document, it will be re-released by the TSG with an identifying change of release date and an increase in version number as follows:

Version x.y.z

where:

- x the first digit:
 - 1 presented to TSG for information;
 - 2 presented to TSG for approval;
 - 3 or greater indicates TSG approved document under change control.
- y the second digit is incremented for all changes of substance, i.e. technical enhancements, corrections, updates, etc.
- z the third digit is incremented when editorial only changes have been incorporated in the document.

1 Scope

The present document contains the definition of the LTE Positioning Protocol (LPP).

2 References

The following documents contain provisions which, through reference in this text, constitute provisions of the present document.

- References are either specific (identified by date of publication, edition number, version number, etc.) or non-specific.
- For a specific reference, subsequent revisions do not apply.
- For a non-specific reference, the latest version applies. In the case of a reference to a 3GPP document (including a GSM document), a non-specific reference implicitly refers to the latest version of that document *in the same Release as the present document*.

- [1] 3GPP TR 21.905: "Vocabulary for 3GPP Specifications".
- [2] 3GPP TS 36.305: "Stage 2 functional specification of User Equipment (UE) positioning in E-UTRAN".
- [3] 3GPP TS 23.271: "Functional stage 2 description of Location Services (LCS)".
- [4] IS-GPS-200, Revision D, Navstar GPS Space Segment/Navigation User Interfaces, March 7th, 2006.
- [5] IS-GPS-705, Navstar GPS Space Segment/User Segment L5 Interfaces, September 22, 2005.
- [6] IS-GPS-800, Navstar GPS Space Segment/User Segment L1C Interfaces, September 4, 2008.
- [7] IS-QZSS, Quasi Zenith Satellite System Navigation Service Interface Specifications for QZSS, Ver.1.1, July 31, 2009.
- [8] Galileo OS Signal in Space ICD (OS SIS ICD), Draft 0, Galileo Joint Undertaking, May 23rd, 2006.
- [9] Global Navigation Satellite System GLONASS Interface Control Document, Version 5.1, 2008.
- [10] Specification for the Wide Area Augmentation System (WAAS), US Department of Transportation, Federal Aviation Administration, DTFA01-96-C-00025, 2001.
- [11] RTCM-SC104, RTCM Recommended Standards for Differential GNSS Service (v.2.3), August 20, 2001.
- [12] 3GPP TS 36.331: "Evolved Universal Terrestrial Radio Access (E-UTRA); Radio Resource Control (RRC); Protocol specification".
- [13] 3GPP TS 25.331: " Radio Resource Control (RRC); Protocol Specification".
- [14] 3GPP TS 44.031: "Location Services (LCS); Mobile Station (MS) - Serving Mobile Location Centre (SMLC) Radio Resource LCS Protocol (RRLP)".
- [15] 3GPP TS 23.032: 'Universal Geographical Area Description (GAD)'.
- [16] 3GPP TS 36.211: "Evolved Universal Terrestrial Radio Access (E-UTRA); Physical Channels and Modulation".
- [17] 3GPP TS 36.214: "Evolved Universal Terrestrial Radio Access (E-UTRA); Physical layer – Measurements".

- [18] 3GPP TS 36.133: "Evolved Universal Terrestrial Radio Access (E-UTRA); Requirements for support of radio resource management".
- [19] 3GPP TS 23.003: "Numbering, addressing and identification".
- [20] OMA-TS-LPPe-V1_0, LPP Extensions Specification, Open Mobile Alliance.
- [21] 3GPP TS 36.101: "Evolved Universal Terrestrial Radio Access (E-UTRA); User Equipment (UE) radio transmission and reception".
- [22] ITU-T Recommendation X.691 (07/2002) "Information technology - ASN.1 encoding rules: Specification of Packed Encoding Rules (PER)" (Same as the ISO/IEC International Standard 8825-2).

3 Definitions and Abbreviations

3.1 Definitions

For the purposes of the present document, the terms and definitions given in [1], [2] and [3] apply. Other definitions are provided below.

Location Server: a physical or logical entity (e.g., E-SMLC or SUPL SLP) that manages positioning for a target device by obtaining measurements and other location information from one or more positioning units and providing assistance data to positioning units to help determine this. A Location Server may also compute or verify the final location estimate.

Reference Source: a physical entity or part of a physical entity that provides signals (e.g., RF, acoustic, infra-red) that can be measured (e.g., by a Target Device) in order to obtain the location of a Target Device.

Target Device: the device that is being positioned (e.g., UE or SUPL SET).

Observed Time Difference Of Arrival (OTDOA): The time interval that is observed by a target device between the reception of downlink signals from two different cells. If a signal from cell 1 is received at the moment t_1 , and a signal from cell 2 is received at the moment t_2 , the OTDOA is $t_2 - t_1$.

3.2 Abbreviations

For the purposes of the present document, the following abbreviations apply.

ADR	Accumulated Delta-Range
A-GNSS	Assisted-GNSS
ARFCN	Absolute Radio Frequency Channel Number
BTS	Base Transceiver Station (GERAN)
CID	Cell-ID (positioning method)
CNAV	Civil Navigation
CRS	Cell-specific Reference Signals
ECEF	Earth-Centered, Earth-Fixed
ECGI	Evolved Cell Global Identifier
ECI	Earth-Centered-Inertial
E-CID	Enhanced Cell-ID (positioning method)
EGNOS	European Geostationary Navigation Overlay Service
E-SMLC	Enhanced Serving Mobile Location Centre
E-UTRAN	Evolved Universal Terrestrial Radio Access Network
EOP	Earth Orientation Parameters
EPDU	External Protocol Data Unit
FDMA	Frequency Division Multiple Access
FEC	Forward Error Correction
FTA	Fine Time Assistance
GAGAN	GPS Aided Geo Augmented Navigation
GLONASS	GLobal'naya NAVigatsionnaya Sputnikovaya Sistema (Engl.: Global Navigation Satellite System)

GNSS	Global Navigation Satellite System
GPS	Global Positioning System
ICD	Interface Control Document
IOD	Issue of Data
IS	Interface Specification
LPP	LTE Positioning Protocol
LPPa	LTE Positioning Protocol Annex
LSB	Least Significant Bit
MO-LR	Mobile Originated Location Request
MSAS	Multi-functional Satellite Augmentation System
MSB	Most Significant Bit
msd	mean solar day
MT-LR	Mobile Terminated Location Request
NAV	Navigation
NICT	National Institute of Information and Communications Technology
NI-LR	Network Induced Location Request
OTDOA	Observed Time Difference Of Arrival
PRC	Pseudo-Range Correction
PRS	Positioning Reference Signals
PDU	Protocol Data Unit
PZ-90	Parametry Zemli 1990 Goda – Parameters of the Earth Year 1990
QZS	Quasi Zenith Satellite
QZSS	Quasi-Zenith Satellite System
QZST	Quasi-Zenith System Time
RF	Radio Frequency
RRC	Range-Rate Correction Radio Resource Control
RSRP	Reference Signal Received Power
RSRQ	Reference Signal Received Quality
RSTD	Reference Signal Time Difference
RU	Russia
SBAS	Space Based Augmentation System
SET	SUPL Enabled Terminal
SFN	System Frame Number
SLP	SUPL Location Platform
SUPL	Secure User Plane Location
SV	Space Vehicle
TLM	Telemetry
TOD	Time Of Day
TOW	Time Of Week
UDRE	User Differential Range Error
ULP	User Plane Location Protocol
USNO	US Naval Observatory
UT1	Universal Time No.1
UTC	Coordinated Universal Time
WAAS	Wide Area Augmentation System
WGS-84	World Geodetic System 1984

4 Functionality of Protocol

4.1 General

4.1.1 LPP Configuration

LPP is used point-to-point between a location server (E-SMLC or SLP) and a target device (UE or SET) in order to position the target device using position-related measurements obtained by one or more reference sources. Figure 4.1.1-1 shows the configuration as applied to the control- and user-plane location solutions for E-UTRAN (as defined in [2] and [3]).

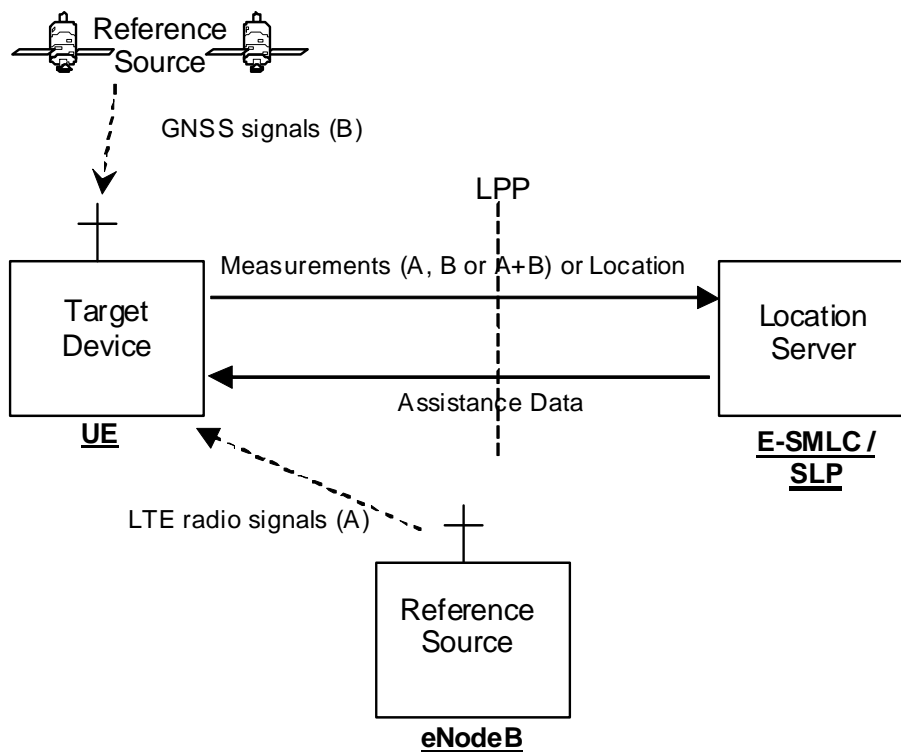

Figure 4.1.1-1: LPP Configuration for Control- and User-Plane Positioning in E-UTRAN

4.1.2 LPP Sessions and Transactions

An LPP session is used between a Location Server and the target device in order to obtain location related measurements or a location estimate or to transfer assistance data. A single LPP session is used to support a single location request (e.g., for a single MT-LR, MO-LR or NI-LR). Multiple LPP sessions can be used between the same endpoints to support multiple different location requests (as required by [3]). Each LPP session comprises one or more LPP transactions, with each LPP transaction performing a single operation (capability exchange, assistance data transfer, or location information transfer). In E-UTRAN the LPP transactions are realized as LPP procedures. The instigator of an LPP session will always instigate the first LPP transaction, but subsequent transactions may be instigated by either end. LPP transactions within a session may occur serially or in parallel. LPP transactions are indicated at the LPP protocol level with a transaction ID in order to associate messages with one another (e.g., request and response).

Messages within a transaction are linked by a common transaction identifier.

4.1.3 LPP Position Methods

Internal LPP positioning methods and associated signalling content are defined in this specification.

This version of the specification defines OTDOA, A-GNSS, and E-CID positioning methods.

4.1.4 LPP Messages

Each LPP transaction involves the exchange of one or more LPP messages between the location server and the target device. The general format of an LPP message consists of a set of common fields followed by a body. The body (which may be empty) contains information specific to a particular message type. Each message type contains information specific to one or more positioning methods and/or information common to all positioning methods.

The common fields are as follows:

Field	Role
Transaction ID	Identify messages belonging to the same transaction
Transaction End Flag	Indicate when a transaction (e.g. one with periodic responses) has ended
Sequence Number	Enable detection of a duplicate LPP message at a receiver
Acknowledgement	Enable an acknowledgement to be requested and/or returned for any LPP message

NOTE: Use of the Transaction ID and Transaction End fields conform to the procedures in clause 5 and are independent of the means used to transport LPP messages (e.g., whether using a NAS MO-LR Request, NAS Generic Transport or user-plane solution).

The following message types are defined:

- Request Capabilities;
- Provide Capabilities;
- Request Assistance Data;
- Provide Assistance Data;
- Request Location Information;
- Provide Location Information;
- Abort;
- Error.

4.2 Common LPP Session Procedure

The purpose of this procedure is to support an LPP session comprising a sequence of LPP transactions. The procedure is described in Figure 4.2-1.

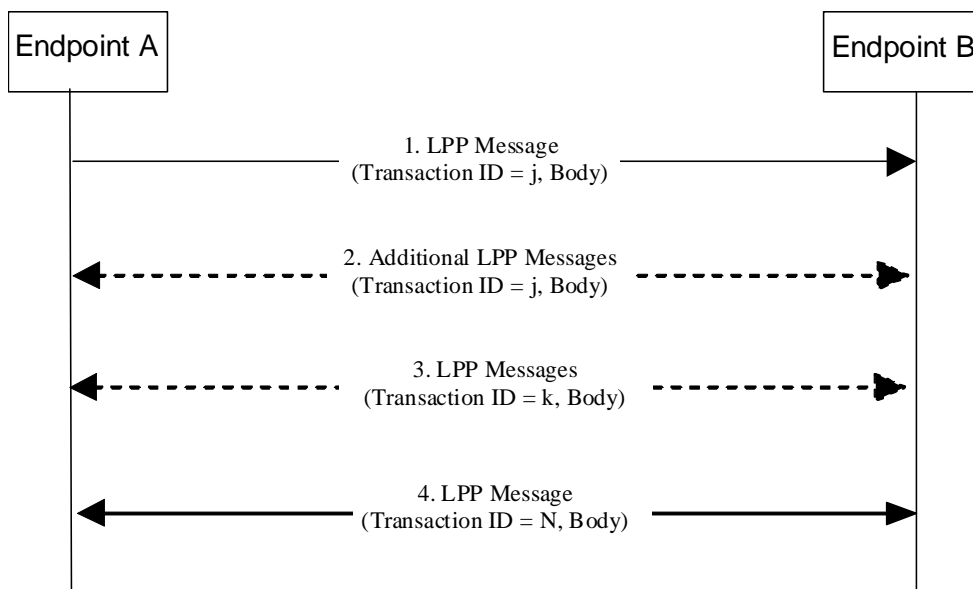

Figure 4.2-1 LPP Session Procedure

1. Endpoint A, which may be either the target or the server, initiates an LPP session by sending an LPP message for an initial LPP transaction *j* to the other endpoint B (which has an opposite role to A).
2. Endpoints A and B may exchange further messages to continue the transaction started in step 1.
3. Either endpoint may instigate further transactions by sending additional LPP messages.

4. A session is terminated by a final transaction N in which LPP messages will be exchanged between the two endpoints.

Within each transaction, all constituent messages shall contain the same transaction identifier. The last message sent in each transaction shall have the IE *endTransaction* set to TRUE. Transactions that occur in parallel shall use different transaction IDs; transaction IDs for completed transactions may be reused at any time after the final message of the previous transaction with the same ID is known to have been received.

4.3 LPP Transport

4.3.1 Transport Layer Requirements

LPP requires reliable, in-sequence delivery of LPP messages from the underlying transport layers. This section describes the transport capabilities that are available within LPP. A UE implementing LPP for the control-plane solution shall support LPP reliable transport (including all three of duplicate detection, acknowledgement, and retransmission).

LPP reliable transport functionality is not used in the user-plane solution.

The following requirements in subclauses 4.3.2, 4.3.3, and 4.3.4 for LPP reliable transport apply only when the capability is supported.

4.3.2 LPP Duplicate Detection

A sender shall include a sequence number in all LPP messages sent for a particular location session. The sequence number shall be distinct for different LPP messages sent in the same direction in the same location session (e.g., may start at zero in the first LPP message and increase monotonically in each succeeding LPP message). Sequence numbers used in the uplink and downlink are independent (e.g., can be the same).

A receiver shall record the most recent received sequence number for each location session. If a message is received carrying the same sequence number as that last received for the associated location session, it shall be discarded. Otherwise (i.e., if the sequence number is different or if no sequence number was previously received or if no sequence number is included), the message shall be processed.

Sending and receiving sequence numbers shall be deleted in a server when the associated location session is terminated and shall be deleted in a target device when there has been no activity for a particular location session for 10 minutes.

NOTE: For LPP control-plane use, a target device can be aware of a location session from information provided at the NAS level for downlink transport of an LPP message.

4.3.3 LPP Acknowledgement

4.3.3.1 General

Each LPP message may carry an acknowledgement request and/or an acknowledgement indicator. A LPP message including an acknowledgement request (i.e., that include the IE *ackRequested* set to TRUE) shall also include a sequence number. Upon reception of an LPP message which includes the IE *ackRequested* set to TRUE, a receiver returns an LPP message with an acknowledgement response (i.e., that includes the *ackIndicator* IE set to the same sequence number of the message being acknowledged). An acknowledgement response may contain no LPP message body (in which case only the sequence number being acknowledged is significant); alternatively, the acknowledgement may be sent in an LPP message along with an LPP message body. An acknowledgement is returned for each received LPP message that requested an acknowledgement including any duplicate(s). Once a sender receives an acknowledgement for an LPP message, and provided any included sequence number is matching, it is permitted to send the next LPP message. No message reordering is needed at the receiver since this stop-and-wait method of sending ensures that messages normally arrive in the correct order.

When an LPP message is transported via a NAS MO-LR request, the message does not request an acknowledgement.

4.3.3.2 Procedure related to Acknowledgement

Figure 4.3.3.2-1 shows the procedure related to acknowledgement.

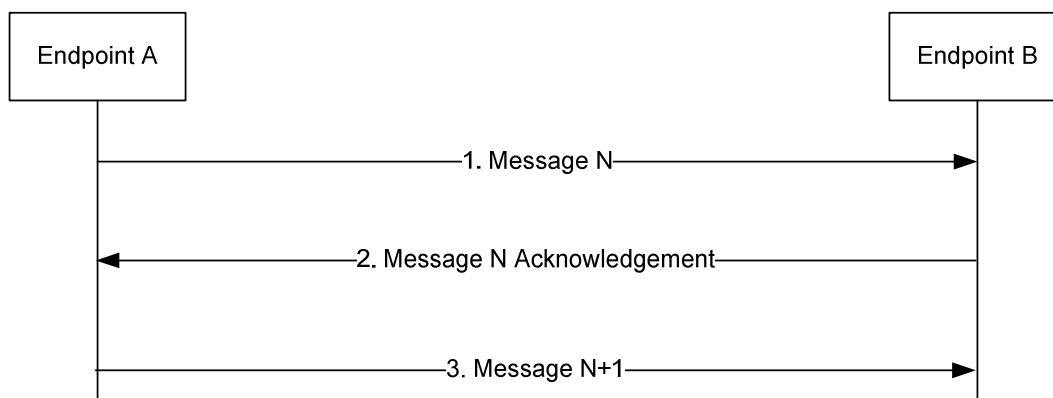

Figure 4.3.3.2-1: LPP Acknowledgement procedure

1. Endpoint A sends an LPP message N to Endpoint B which includes the IE *ackRequested* set to TRUE and a sequence number.
2. If LPP message N is received and Endpoint B is able to decode the *ackRequested* value and sequence number, Endpoint B shall return an acknowledgement for message N . The acknowledgement shall contain the IE *ackIndicator* set to the same sequence number as that in message N .
3. When the acknowledgement for LPP message N is received and provided the included *ackIndicator* IE matches the sequence number sent in message N , Endpoint A sends the next LPP message $N+1$ to Endpoint B when this message is available.

4.3.4 LPP Retransmission

4.3.4.1 General

This capability builds on the acknowledgement and duplicate detection capabilities. When an LPP message which requires acknowledgement is sent and not acknowledged, it is resent by the sender following a timeout period up to three times. If still unacknowledged after that, the sender aborts all LPP activity for the associated session. The timeout period is determined by the sender implementation but shall not be less than a minimum value of 250ms.

4.3.4.2 Procedure related to Retransmission

Figure 4.3.4.2-1 shows the procedure related to retransmission when combined with acknowledgement and duplicate detection.

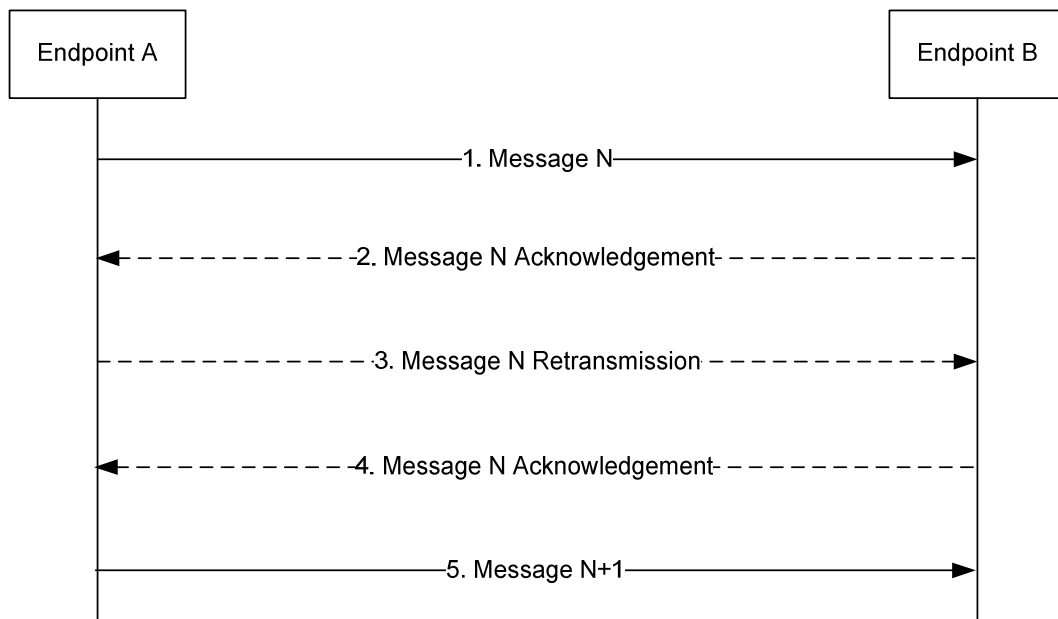

Figure 4.3.4.2-1: LPP Retransmission procedure

1. Endpoint A sends an LPP message N to Endpoint B for a particular location session and includes a request for acknowledgement along with a sequence number.
2. If LPP message N is received and Endpoint B is able to decode the *ackRequested* value and sequence number (regardless of whether the message body can be correctly decoded), Endpoint B shall return an acknowledgement for message N . If the acknowledgement is received by Endpoint A (such that the acknowledged message can be identified and sequence numbers are matching), Endpoint A skips steps 3 and 4.
3. If the acknowledgement in step 2 is not received after a timeout period, Endpoint A shall retransmit LPP message N and shall include the same sequence number as in step 1.
4. If LPP message N in step 3 is received and Endpoint B is able to decode the *ackRequested* value and sequence number (regardless of whether the message body can be correctly decoded and whether or not the message is considered a duplicate), Endpoint B shall return an acknowledgement. Steps 3 may be repeated one or more times if the acknowledgement in step 4 is not received after a timeout period by Endpoint A. If the acknowledgement in step 4 is still not received after sending three retransmissions, Endpoint A shall abort all procedures and activity associated with LPP support for the particular location session.
5. Once an acknowledgement in step 2 or step 4 is received, Endpoint A sends the next LPP message $N+1$ for the location session to Endpoint B when this message is available.

5 LPP Procedures

5.1 Procedures related to capability transfer

The purpose of the procedures that are grouped together in this section is to enable the transfer of capabilities from the target device to the server. Capabilities in this context refer to positioning and protocol capabilities related to LPP and the positioning methods supported by LPP.

These procedures instantiate the Capability Transfer transaction from 3GPP TS 36.305 [2].

5.1.1 Capability Transfer procedure

The Capability Transfer procedure is shown in Figure 5.1.1-1.

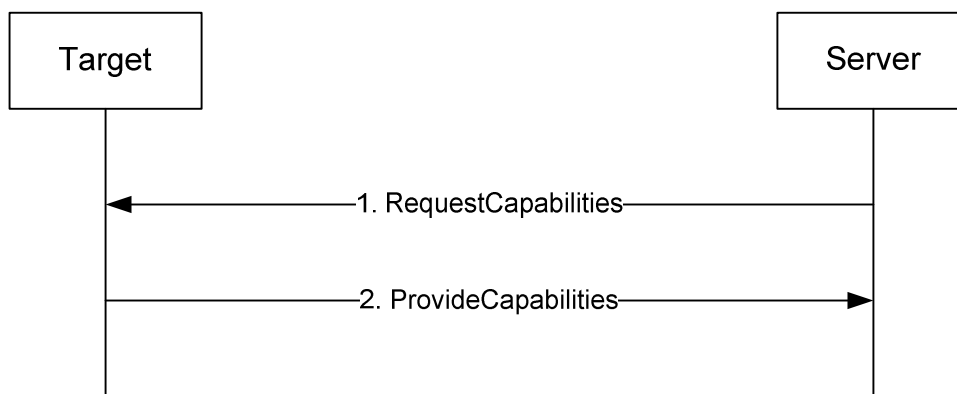

Figure 5.1.1-1: LPP Capability Transfer procedure

1. The server sends a *RequestCapabilities* message to the target. The server may indicate the types of capability needed.
2. The target responds with a *ProvideCapabilities* message to the server. The capabilities shall correspond to any capability types specified in step 1. This message shall include the *endTransaction* IE set to TRUE.

5.1.2 Capability Indication procedure

The Capability Indication procedure allows the target to provide unsolicited capabilities to the server and is shown in Figure 5.1.2-1.

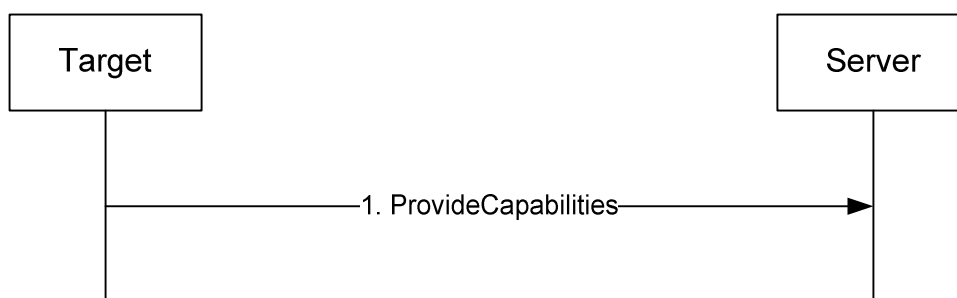

Figure 5.1.2-1: LPP Capability Indication procedure

1. The target sends a *ProvideCapabilities* message to the server. This message shall include the *endTransaction* IE set to TRUE.

5.1.3 Reception of LPP Request Capabilities

Upon receiving a *RequestCapabilities* message, the target device shall generate a *ProvideCapabilities* message as a response.

The target device shall:

- 1> for each positioning method for which a request for capabilities is included in the message:
 - 2> if the target device supports this positioning method:
 - 3> include the capabilities of the device for that supported positioning method in the response message;
- 1> set the IE *LPP-TransactionID* in the response message to the same value as the IE *LPP-TransactionID* in the received message;
- 1> deliver the response message to lower layers for transmission.

5.1.4 Transmission of LPP Provide Capabilities

When triggered to transmit a *ProvideCapabilities* message, the target device shall:

- 1> for each positioning method whose capabilities are to be indicated:
 - 2> set the corresponding IE to include the device"s capabilities;
 - 2> if OTDOA capabilities are to be indicated:
 - 3> include the IE *supportedBandListEUTRA*;
- 1> deliver the response to lower layers for transmission.

5.2 Procedures related to Assistance Data Transfer

The purpose of the procedures in this section is to enable the target to request assistance data from the server to assist in positioning, and to enable the server to transfer assistance data to the target in the absence of a request.

These procedures instantiate the Assistance Data Transfer transaction from 3GPP TS 36.305 [2].

5.2.1 Assistance Data Transfer procedure

The Assistance Data Transfer procedure is shown in Figure 5.2.1-1.

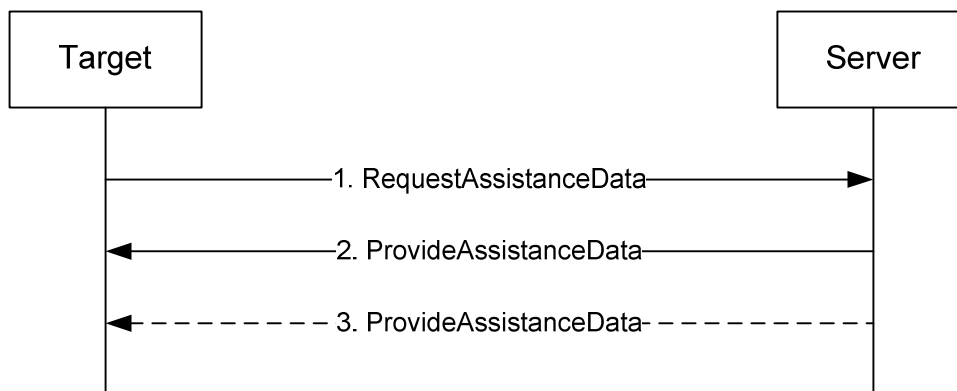

Figure 5.2.1-1: LPP Assistance data transfer procedure

1. The target sends a *RequestAssistanceData* message to the server.
2. The server responds with a *ProvideAssistanceData* message to the target containing assistance data. The transferred assistance data should match or be a subset of the assistance data requested in step 1. The server may also provide any not requested information that it considers useful to the target . If step 3 does not occur, this message shall set the *endTransaction* IE to TRUE.
3. The server may transmit one or more additional *ProvideAssistanceData* messages to the target containing further assistance data. The transferred assistance data should match or be a subset of the assistance data requested in step 1. The server may also provide any not requested information that it considers useful to the target. The last message shall include the *endTransaction* IE set to TRUE.

5.2.2 Assistance Data Delivery procedure

The Assistance Data Delivery procedure allows the server to provide unsolicited assistance data to the target and is shown in Figure 5.2.2-1.

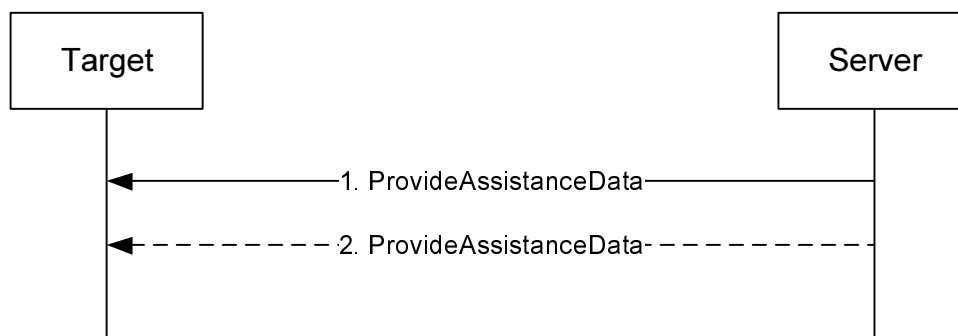

Figure 5.2.2-1: LPP Assistance data transfer procedure

1. The server sends a *ProvideAssistanceData* message to the target containing assistance data. If step 2 does not occur, this message shall set the *endTransaction* IE to TRUE.
2. The server may transmit one or more additional *ProvideAssistanceData* messages to the target containing additional assistance data. The last message shall include the *endTransaction* IE set to TRUE.

5.2.3 Transmission of LPP Request Assistance Data

When triggered to transmit a *RequestAssistanceData* message, the target device shall:

- 1> set the IEs for the positioning-method-specific request for assistance data to request the data indicated by upper layers.

5.2.4 Reception of LPP Provide Assistance Data

Upon receiving a *ProvideAssistanceData* message, the target device shall:

- 1> for each positioning method contained in the message:
 - 2> deliver the related assistance data to upper layers.

5.3 Procedures related to Location Information Transfer

The purpose of the procedures in this section is to enable the server to request location measurement data and/or a location estimate from the target, and to enable the target to transfer location measurement data and/or a location estimate to a server in the absence of a request.

These procedures instantiate the Location Information Transfer transaction in 3GPP TS 36.305 [2].

- NOTE: The service layer (e.g. NAS or OMA SUPL ULP) would be used to transfer information associated with a location request from a target to a server (MO-LR).

5.3.1 Location Information Transfer procedure

The Location Information Transfer procedure is shown in Figure 5.3.1-1.

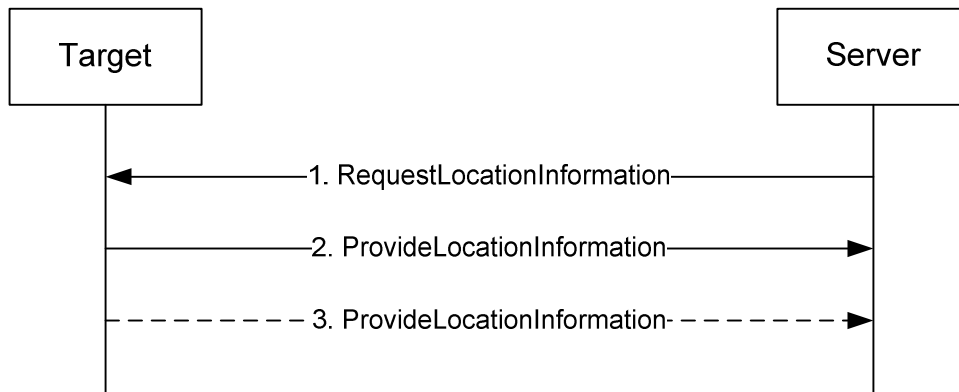

Figure 5.3.1-1: LPP Location Information transfer procedure

1. The server sends a *RequestLocationInformation* message to the target to request location information, indicating the type of location information needed and potentially the associated QoS.
2. The target sends a *ProvideLocationInformation* message to the server to transfer location information. The location information transferred should match or be a subset of the location information requested in step 1 unless the server explicitly allows additional location information. If step 3 does not occur, this message shall set the *endTransaction* IE to TRUE.
3. If requested in step 1, the target sends additional *ProvideLocationInformation* messages to the server to transfer location information. The location information transferred should match or be a subset of the location information requested in step 1 unless the server explicitly allows additional location information. The last message shall include the *endTransaction* IE set to TRUE.

5.3.2 Location Information Delivery procedure

The Location Information Delivery allows the target to provide unsolicited location information to the server. The procedure is shown in Figure 5.3.2-1.

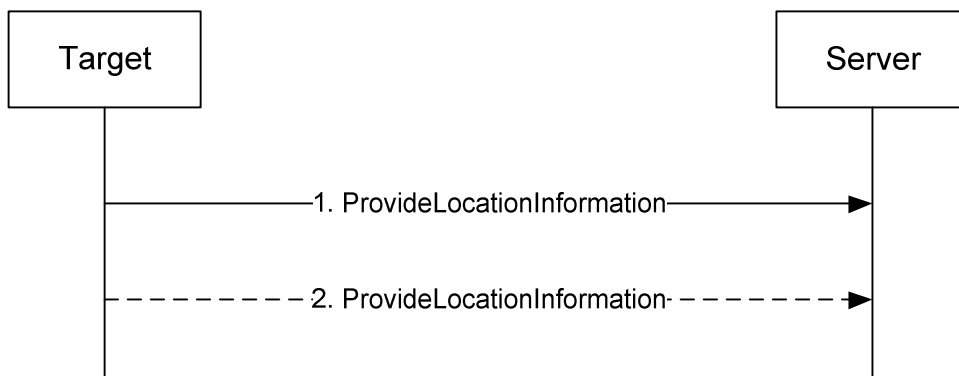

Figure 5.3.2-1: LPP Location Information Delivery procedure

1. The target sends a *ProvideLocationInformation* message to the server to transfer location information. If step 2 does not occur, this message shall set the *endTransaction* IE to TRUE.
2. The target may send one or more additional *ProvideLocationInformation* messages to the server containing additional location information data. The last message shall include the *endTransaction* IE set to TRUE.

5.3.3 Reception of Request Location Information

Upon receiving a *RequestLocationInformation* message, the target device shall:

- 1> if the requested information is compatible with the target device capabilities and configuration:
 - 2> include the requested information in a *ProvideLocationInformation* message;
 - 2> set the IE *LPP-TransactionID* in the response to the same value as the IE *LPP-TransactionID* in the received message;
 - 2> deliver the *ProvideLocationInformation* message to lower layers for transmission.
- 1> otherwise:
 - 2> if one or more positioning methods are included that the target device does not support:
 - 3> continue to process the message as if it contained only information for the supported positioning methods;
 - 3> handle the signaling content of the unsupported positioning methods by LPP error detection as in 5.4.3.

5.3.4 Transmission of Provide Location Information

When triggered to transmit *ProvideLocationInformation* message, the target device shall:

- 1> for each positioning method contained in the message:
 - 2> set the corresponding IE to include the available location information;
- 1> deliver the response to lower layers for transmission.

5.4 Error Handling Procedures

5.4.1 General

This sub-clause describes how a receiving entity (target device or location server) behaves in cases when it receives erroneous or unexpected data or detects that certain data are missing.

5.4.2 Procedures related to Error Indication

Figure 5.4.2-1 shows the Error indication procedure.

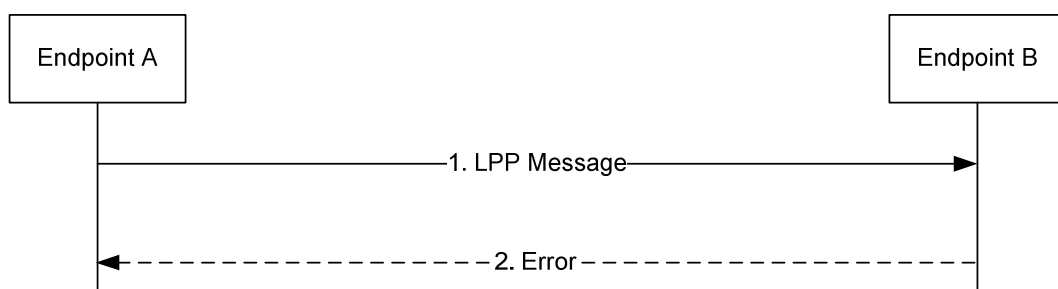

Figure 5.4.2-1: LPP Error Indication procedure

1. Endpoint A sends an LPP message to Endpoint B.
2. Endpoint B determines that the LPP message in step 1 contains an error. Endpoint B returns an *Error* message to Endpoint A indicating the error or errors and discards the message in step 1. If Endpoint B is able to determine that the erroneous LPP message in step 1 is an LPP Error or Abort Message, Endpoint B discards the message in step 1 without returning an *Error* message to Endpoint A.

5.4.3 LPP Error Detection

Upon receiving any LPP message, the receiving entity shall attempt to decode the message and verify the presence of any errors and:

- 1> if decoding errors are encountered:
 - 2> if the receiver can not determine that the received message is an LPP *Error* or *Abort* message:
 - 3> return an LPP *Error* message to the sender and include the received *LPP-TransactionID*, if this was decoded, and type of error;
 - 3> discard the received message and stop the error detection procedure;
- 1> if the message is a duplicate of a previously received message:
 - 2> discard the message and stop the error detection procedure;
- 1> if the *LPP-TransactionID* matches the *LPP-TransactionID* for a procedure that is still ongoing for the same session and the message type is invalid for the current state of the procedure:
 - 2> abort the ongoing procedure;
 - 2> return an LPP *Error* message to the sender and include the received transaction ID and type of error;
 - 2> discard the message and stop the error detection procedure;
- 1> if the message type is an LPP *RequestCapabilities* and some of the requested information is not supported:
 - 2> return any information that can be provided in a normal response.
- 1> if the message type is an LPP *RequestAssistanceData* or *RequestLocationInformation* and some or all of the requested information is not supported:
 - 2> return any information that can be provided in a normal response, which includes indications on other information that is not supported.

5.4.4 Reception of an LPP Error Message

Upon receiving an *Error* message, a device shall:

- 1> abort any ongoing procedure associated with the *LPP-TransactionID* if included in the received message.

The device may:

- 1> restart the aborted procedure taking into consideration the returned error information.

5.5 Abort Procedure

5.5.1 General

The purpose of the abort procedure is to allow the target device or location server to abort an ongoing procedure due to some unexpected event (e.g., cancellation of a location request by an LCS client). It can also be used to stop an ongoing procedure (e.g., periodic location reporting from the target device).

5.5.2 Procedures related to Abort

Figure 5.5.2-1 shows the Abort procedure.

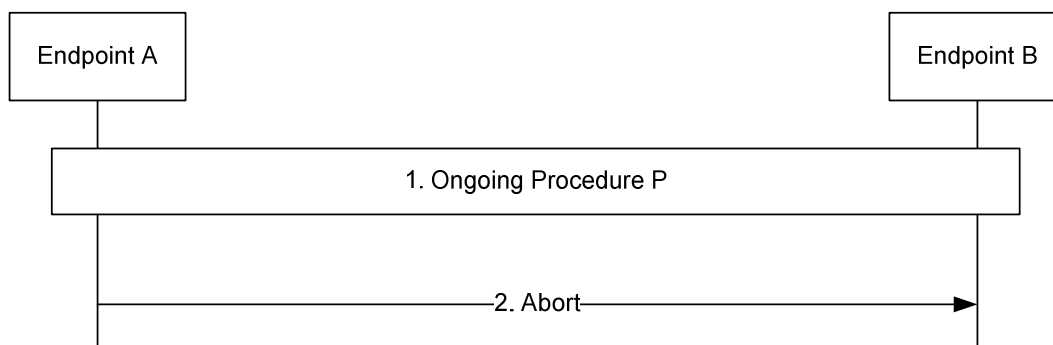

Figure 5.5.2-1: LPP Abort procedure

1. A procedure P is ongoing between endpoints A and B.
2. Endpoint A determines that the procedure must be aborted and sends an *Abort* message to Endpoint B carrying the transaction ID for procedure P. Endpoint B aborts procedure P.

5.5.3 Reception of an LPP Abort Message

Upon receiving an *Abort* message, a device shall:

- 1> abort any ongoing procedure associated with the transaction ID indicated in the message.

6 Information Element Abstract Syntax Definition

6.1 General

The contents of each LPP message is specified in sub-clause 6.2 using ASN.1 to specify the message syntax and using tables when needed to provide further detailed information about the information elements specified in the message syntax.

The ASN.1 in this section uses the same format and coding conventions as described in Annex A of [12].

Transfer syntax for LPP messages is derived from their ASN.1 definitions by use of Basic Packed Encoding Rules (BASIC-PER), Unaligned Variant, as specified in ITU-T Rec. X.691 [22]. The encoded LPP message always contains a multiple of 8 bits.

Transfer syntax for LPP IEs is derived from their ASN.1 definitions by use of Basic Packed Encoding Rules (BASIC-PER), Unaligned Variant, as specified in ITU-T Rec. X.691 [22]. The encoded LPP IE always contains a multiple of 8 bits. This applies when a single LPP IE is encoded as the basic production, i.e. for other purposes than encoding the LPP IE within an LPP message.

The need for information elements to be present in a message or an abstract type, i.e., the ASN.1 fields that are specified as OPTIONAL in the abstract notation (ASN.1), is specified by means of comment text tags attached to the OPTIONAL statement in the abstract syntax. The meaning of each tag is specified in table 6.1-1. These tags are used in the downlink (server to target) direction only.

Table 6.1-1: Meaning of abbreviations used to specify the need for information elements to be present

Abbreviation	Meaning
Cond <i>conditionTag</i>	<i>Conditionally present</i> An information element for which the need is specified by means of conditions. For each <i>conditionTag</i> , the need is specified in a tabular form following the ASN.1 segment. In case, according to the conditions, a field is not present, the target takes no action and where applicable shall continue to use the existing value (and/or the associated functionality) unless explicitly stated otherwise in the description of the field itself.
Need OP	<i>Optionally present</i>

Abbreviation	Meaning
	An information element that is optional to signal. For downlink messages, the target is not required to take any special action on absence of the IE beyond what is specified in the procedural text or the field description table following the ASN.1 segment. The target behaviour on absence should be captured either in the procedural text or in the field description.
Need ON	<i>Optionally present, No action</i> An information element that is optional to signal. If the message is received by the target, and in case the information element is absent, the target takes no action and where applicable shall continue to use the existing value (and/or the associated functionality).
Need OR	<i>Optionally present, Release</i> An information element that is optional to signal. If the message is received by the target, and in case the information element is absent, the target shall discontinue/ stop using/ delete any existing value (and/ or the associated functionality).

When specifying information elements which are to be represented by BIT STRINGS, if not otherwise specifically stated in the field description of the concerned IE or elsewhere, the following principle applies with regards to the ordering of bits:

- The first bit (leftmost bit) contains the most significant bit (MSB);
- the last bit (rightmost bit) contains the least significant bit (LSB).

6.2 LPP PDU Structure

– LPP-PDU-Definitions

This ASN.1 segment is the start of the LPP PDU definitions.

```
-- ASN1START

LPP-PDU-Definitions {
itu-t (0) identified-organization (4) etsi (0) mobileDomain (0)
eps-Access (21) modules (3) lpp (7) version1 (1) lpp-PDU-Definitions (1) }

DEFINITIONS AUTOMATIC TAGS ::=

BEGIN

-- ASN1STOP
```

– LPP-Message

The *LPP-Message* provides the complete set of information for an invocation or response pertaining to an LPP transaction.

```
-- ASN1START

LPP-Message ::= SEQUENCE {
  transactionID      LPP-TransactionID  OPTIONAL,  -- Need ON
  endTransaction    BOOLEAN,
  sequenceNumber    SequenceNumber      OPTIONAL,  -- Need ON
  acknowledgement   Acknowledgement    OPTIONAL,  -- Need ON
  lpp-MessageBody   LPP-MessageBody     OPTIONAL  -- Need ON
}

SequenceNumber ::= INTEGER (0..255)

Acknowledgement ::= SEQUENCE {
  ackRequested      BOOLEAN,
  ackIndicator      SequenceNumber      OPTIONAL
}

-- ASN1STOP
```

LPP-Message field descriptions	
transactionID	This field is omitted if an <i>lpp-MessageBody</i> is not present (i.e. in an LPP message sent only to acknowledge a previously received message) or if it is not available to the transmitting entity (e.g., in an <i>LPP-Error</i> message triggered by a message that could not be parsed). If present, this field shall be ignored at a receiver in an LPP message for which the <i>lpp-MessageBody</i> is not present.
endTransaction	This field indicates whether an LPP message is the last message carrying an <i>lpp-MessageBody</i> in a transaction (TRUE) or not last (FALSE).
sequenceNumber	This field may be included when LPP operates over the control plane and an <i>lpp-MessageBody</i> is included but shall be omitted otherwise.
acknowledgement	This field is included in an LPP acknowledgement and in any LPP message requesting an acknowledgement when LPP operates over the control plane and is omitted otherwise
ackRequested	This field indicates whether an LPP acknowledgement is requested (TRUE) or not (FALSE). A value of TRUE may only be included when an <i>lpp-MessageBody</i> is included.
ackIndicator	This field indicates the sequence number of the message being acknowledged.
lpp-MessageBody	This field may be omitted in case the message is sent only to acknowledge a previously received message.

– LPP-MessageBody

The *LPP-MessageBody* identifies the type of an LPP message and contains all LPP information specifically associated with that type.

```
-- ASN1START
LPP-MessageBody ::= CHOICE {
  c1 CHOICE {
    requestCapabilities      RequestCapabilities,
    provideCapabilities      ProvideCapabilities,
    requestAssistanceData    RequestAssistanceData,
    provideAssistanceData    ProvideAssistanceData,
    requestLocationInformation RequestLocationInformation,
    provideLocationInformation ProvideLocationInformation,
    abort                    Abort,
    error                    Error,
    spare7 NULL, spare6 NULL, spare5 NULL, spare4 NULL,
    spare3 NULL, spare2 NULL, spare1 NULL, spare0 NULL
  },
  messageClassExtension SEQUENCE {}
}
-- ASN1STOP
```

– LPP-TransactionID

The *LPP-TransactionID* identifies a particular LPP transaction and the initiator of the transaction.

```
-- ASN1START
LPP-TransactionID ::= SEQUENCE {
  initiator      Initiator,
  transactionNumber TransactionNumber,
  ...
}

Initiator ::= ENUMERATED {
  locationServer,
  targetDevice,
  ...
}

TransactionNumber ::= INTEGER (0..255)
-- ASN1STOP
```

6.3 Message Body IEs

– RequestCapabilities

The *RequestCapabilities* message body in a LPP message is used by the location server to request the target device capability information for LPP and the supported individual positioning methods.

```
-- ASN1START
RequestCapabilities ::= SEQUENCE {
    criticalExtensions      CHOICE {
        c1                  CHOICE {
            requestCapabilities-r9      RequestCapabilities-r9-IEs,
            spare3 NULL, spare2 NULL, spare1 NULL
        },
        criticalExtensionsFuture      SEQUENCE {}
    }
}

RequestCapabilities-r9-IEs ::= SEQUENCE {
    commonIEsRequestCapabilities      CommonIEsRequestCapabilities      OPTIONAL, -- Need ON
    a-gnss-RequestCapabilities        A-GNSS-RequestCapabilities        OPTIONAL, -- Need ON
    otdoa-RequestCapabilities         OTDOA-RequestCapabilities         OPTIONAL, -- Need ON
    ecid-RequestCapabilities          ECID-RequestCapabilities          OPTIONAL, -- Need ON
    epdu-RequestCapabilities          EPDU-Sequence                    OPTIONAL, -- Need ON
    ...
}
-- ASN1STOP
```

RequestCapabilities field descriptions

commonIEsRequestCapabilities

This IE is provided for future extensibility and should not be included in this version of the protocol.

– ProvideCapabilities

The *ProvideCapabilities* message body in a LPP message indicates the LPP capabilities of the target device to the location server.

```
-- ASN1START
ProvideCapabilities ::= SEQUENCE {
    criticalExtensions      CHOICE {
        c1                  CHOICE {
            provideCapabilities-r9      ProvideCapabilities-r9-IEs,
            spare3 NULL, spare2 NULL, spare1 NULL
        },
        criticalExtensionsFuture      SEQUENCE {}
    }
}

ProvideCapabilities-r9-IEs ::= SEQUENCE {
    commonIEsProvideCapabilities      CommonIEsProvideCapabilities      OPTIONAL,
    a-gnss-ProvideCapabilities        A-GNSS-ProvideCapabilities        OPTIONAL,
    otdoa-ProvideCapabilities         OTDOA-ProvideCapabilities         OPTIONAL,
    ecid-ProvideCapabilities          ECID-ProvideCapabilities          OPTIONAL,
    epdu-ProvideCapabilities          EPDU-Sequence                    OPTIONAL,
    ...
}
-- ASN1STOP
```

ProvideCapabilities field descriptions**commonIEsProvideCapabilities**

This IE is provided for future extensibility and should not be included in this version of the protocol.

RequestAssistanceData

The *RequestAssistanceData* message body in a LPP message is used by the target device to request assistance data from the location server.

```
-- ASN1START
RequestAssistanceData ::= SEQUENCE {
    criticalExtensions      CHOICE {
        c1                  CHOICE {
            requestAssistanceData-r9      RequestAssistanceData-r9-IEs,
            spare3 NULL, spare2 NULL, spare1 NULL
        },
        criticalExtensionsFuture      SEQUENCE {}
    }
}

RequestAssistanceData-r9-IEs ::= SEQUENCE {
    commonIEsRequestAssistanceData      CommonIEsRequestAssistanceData      OPTIONAL,
    a-gnss-RequestAssistanceData      A-GNSS-RequestAssistanceData      OPTIONAL,
    otdoa-RequestAssistanceData      OTDOA-RequestAssistanceData      OPTIONAL,
    epdu-RequestAssistanceData      EPDU-Sequence      OPTIONAL,
    ...
}
-- ASN1STOP
```

ProvideAssistanceData

The *ProvideAssistanceData* message body in a LPP message is used by the location server to provide assistance data to the target device either in response to a request from the target device or in an unsolicited manner.

```
-- ASN1START
ProvideAssistanceData ::= SEQUENCE {
    criticalExtensions      CHOICE {
        c1                  CHOICE {
            provideAssistanceData-r9      ProvideAssistanceData-r9-IEs,
            spare3 NULL, spare2 NULL, spare1 NULL
        },
        criticalExtensionsFuture      SEQUENCE {}
    }
}

ProvideAssistanceData-r9-IEs ::= SEQUENCE {
    commonIEsProvideAssistanceData      CommonIEsProvideAssistanceData      OPTIONAL, -- Need ON
    a-gnss-ProvideAssistanceData      A-GNSS-ProvideAssistanceData      OPTIONAL, -- Need ON
    otdoa-ProvideAssistanceData      OTDOA-ProvideAssistanceData      OPTIONAL, -- Need ON
    epdu-Provide-Assistance-Data      EPDU-Sequence      OPTIONAL, -- Need ON
    ...
}
-- ASN1STOP
```

ProvideAssistanceData field descriptions**commonIEsProvideAssistanceData**

This IE is provided for future extensibility and should not be included in this version of the protocol.

RequestLocationInformation

The *RequestLocationInformation* message body in a LPP message is used by the location server to request positioning measurements or a position estimate from the target device.

```

-- ASN1START
RequestLocationInformation ::= SEQUENCE {
    criticalExtensions      CHOICE {
        c1                  CHOICE {
            requestLocationInformation-r9  RequestLocationInformation-r9-IEs,
            spare3 NULL, spare2 NULL, spare1 NULL
        },
        criticalExtensionsFuture  SEQUENCE {}
    }
}

RequestLocationInformation-r9-IEs ::= SEQUENCE {
    commonIEsRequestLocationInformation
        CommonIEsRequestLocationInformation  OPTIONAL, -- Need ON
    a-gnss-RequestLocationInformation  A-GNSS-RequestLocationInformation  OPTIONAL, -- Need ON
    otdoa-RequestLocationInformation  OTDOA-RequestLocationInformation  OPTIONAL, -- Need ON
    ecid-RequestLocationInformation  ECID-RequestLocationInformation  OPTIONAL, -- Need ON
    epdu-RequestLocationInformation  EPDU-Sequence  OPTIONAL, -- Need ON
    ...
}
-- ASN1STOP

```

***RequestLocationInformation* field descriptions**

commonIEsRequestLocationInformation

This field specifies the location information type requested by the location server and optionally other configuration information associated with the requested location information. This field should always be included in this version of the protocol.

– ProvideLocationInformation

The *ProvideLocationInformation* message body in a LPP message is used by the target device to provide positioning measurements or position estimates to the location server.

```

-- ASN1START
ProvideLocationInformation ::= SEQUENCE {
    criticalExtensions      CHOICE {
        c1                  CHOICE {
            provideLocationInformation-r9  ProvideLocationInformation-r9-IEs,
            spare3 NULL, spare2 NULL, spare1 NULL
        },
        criticalExtensionsFuture  SEQUENCE {}
    }
}

ProvideLocationInformation-r9-IEs ::= SEQUENCE {
    commonIEsProvideLocationInformation
        CommonIEsProvideLocationInformation  OPTIONAL,
    a-gnss-ProvideLocationInformation  A-GNSS-ProvideLocationInformation  OPTIONAL,
    otdoa-ProvideLocationInformation  OTDOA-ProvideLocationInformation  OPTIONAL,
    ecid-ProvideLocationInformation  ECID-ProvideLocationInformation  OPTIONAL,
    epdu-ProvideLocationInformation  EPDU-Sequence  OPTIONAL,
    ...
}
-- ASN1STOP

```

– Abort

The *Abort* message body in a LPP message carries a request to abort an ongoing LPP procedure.

```

-- ASN1START
Abort ::= SEQUENCE {
    criticalExtensions      CHOICE {
        c1                  CHOICE {
            abort-r9        Abort-r9-IEs,
            spare3 NULL, spare2 NULL, spare1 NULL
        },
    }
}

```

```

        criticalExtensionsFuture    SEQUENCE {}
    }
}
Abort-r9-IEs ::= SEQUENCE {
    commonIEsAbort    CommonIEsAbort    OPTIONAL,    -- Need ON
    ...,
    epdu-Abort        EPDU-Sequence     OPTIONAL    -- Need ON
}
-- ASN1STOP

```

– Error

The *Error* message body in a LPP message carries information concerning a LPP message that was received with errors.

```

-- ASN1START
Error ::= CHOICE {
    error-r9                Error-r9-IEs,
    criticalExtensionsFuture SEQUENCE {}
}
Error-r9-IEs ::= SEQUENCE {
    commonIEsError    CommonIEsError    OPTIONAL,    -- Need ON
    ...,
    epdu-Error        EPDU-Sequence     OPTIONAL    -- Need ON
}
-- ASN1STOP

```

6.4 Common IEs

Common IEs comprise IEs that are applicable to more than one LPP positioning method.

6.4.1 Common Lower-Level IEs

– AccessTypes

The IE *AccessTypes* is used to indicate several cellular access types using a bit map.

```

-- ASN1START
AccessTypes ::= SEQUENCE {
    accessTypes    BIT STRING {
        eutra    (0),
        ultra    (1),
        gsm       (2) } (SIZE (1..8)),
    ...
}
-- ASN1STOP

```

AccessTypes field descriptions

accessTypes

This field specifies the cellular access type(s). This is represented by a bit string, with a one-value at the bit position means the particular access type is addressed; a zero-value means not addressed.

– ARFCN-ValueEUTRA

The IEs *ARFCN-ValueEUTRA* and *ARFCN-ValueEUTRA-v9a0* are used to indicate the ARFCN of the E-UTRA carrier frequency, as defined in [12].

```

-- ASN1START

```

```

ARFCN-ValueEUTRA ::= INTEGER (0..maxEARFCN)
ARFCN-ValueEUTRA-v9a0 ::= INTEGER (maxEARFCN-Plus1..maxEARFCN2)
maxEARFCN          INTEGER ::= 65535    -- Maximum value of EUTRA carrier frequency
maxEARFCN-Plus1   INTEGER ::= 65536    -- Lowest value extended EARFCN range
maxEARFCN2        INTEGER ::= 262143   -- Highest value extended EARFCN range
-- ASN1STOP

```

NOTE: For fields using the original value range, as defined by IE *ARFCN-ValueEUTRA* i.e. without suffix, value *maxEARFCN* indicates that the E-UTRA carrier frequency is indicated by means of an extension.

– ARFCN-ValueUTRA

The IE *ARFCN-ValueUTRA* is used to indicate the ARFCN of the UTRA carrier frequency, as defined in [13].

```

-- ASN1START
ARFCN-ValueUTRA ::= INTEGER (0..16383)
-- ASN1STOP

```

– CellGlobalIdEUTRA-AndUTRA

The IE *CellGlobalIdEUTRA-AndUTRA* specifies the global Cell Identifier for E-UTRA or UTRA, the globally unique identity of a cell in E-UTRA or UTRA.

```

-- ASN1START
CellGlobalIdEUTRA-AndUTRA ::= SEQUENCE {
  plmn-Identity      SEQUENCE {
    mcc      SEQUENCE (SIZE (3)) OF INTEGER (0..9),
    mnc      SEQUENCE (SIZE (2..3)) OF INTEGER (0..9)
  },
  cellIdentity      CHOICE {
    eutra  BIT STRING (SIZE (28)),
    utra   BIT STRING (SIZE (32))
  },
  ...
}
-- ASN1STOP

```

CellGlobalIdEUTRA-AndUTRA field descriptions

plmn-Identity

This field identifies the PLMN of the cell as defined in [12].

cellIdentity

This field defines the identity of the cell within the context of the PLMN as defined in [12] and [13]. The size of the bit string allows for the 32-bit extended UTRAN cell ID; in case the cell ID is shorter, the first bits of the string are set to 0.

– CellGlobalIdGERAN

The IE *CellGlobalIdGERAN* specifies the global Cell Identifier for GERAN, the globally unique identity of a cell in GERAN.

```

-- ASN1START
CellGlobalIdGERAN ::= SEQUENCE {
  plmn-Identity      SEQUENCE {
    mcc      SEQUENCE (SIZE (3)) OF INTEGER (0..9),
    mnc      SEQUENCE (SIZE (2..3)) OF INTEGER (0..9)
  },
  locationAreaCode  BIT STRING (SIZE (16)),
}
-- ASN1STOP

```

```

    cellIdentity      BIT STRING (SIZE (16)),
    ...
}
-- ASN1STOP

```

CellGlobalIdGERAN field descriptions

plmn-Identity
This field identifies the PLMN of the cell.
locationAreaCode
This field is a fixed length code identifying the location area within a PLMN.
cellIdentity
This field specifies the cell Identifier which is unique within the context of the GERAN location area.

– ECGI

The IE *ECGI* specifies the Evolved Cell Global Identifier (ECGI), the globally unique identity of a cell in E-UTRA [12].

```

-- ASN1START
ECGI ::= SEQUENCE {
    mcc          SEQUENCE (SIZE (3))    OF INTEGER (0..9),
    mnc          SEQUENCE (SIZE (2..3)) OF INTEGER (0..9),
    cellidentity BIT STRING (SIZE (28))
}
-- ASN1STOP

```

– Ellipsoid-Point

The IE *Ellipsoid-Point* is used to describe a geographic shape as defined in 3GPP TS 23.032 [15].

```

-- ASN1START
Ellipsoid-Point ::= SEQUENCE {
    latitudeSign      ENUMERATED {north, south},
    degreesLatitude   INTEGER (0..8388607),      -- 23 bit field
    degreesLongitude  INTEGER (-8388608..8388607) -- 24 bit field
}
-- ASN1STOP

```

– Ellipsoid-PointWithUncertaintyCircle

The IE *Ellipsoid-PointWithUncertaintyCircle* is used to describe a geographic shape as defined in 3GPP TS 23.032 [15].

```

-- ASN1START
Ellipsoid-PointWithUncertaintyCircle ::= SEQUENCE {
    latitudeSign      ENUMERATED {north, south},
    degreesLatitude   INTEGER (0..8388607),      -- 23 bit field
    degreesLongitude  INTEGER (-8388608..8388607), -- 24 bit field
    uncertainty       INTEGER (0..127)
}
-- ASN1STOP

```

– EllipsoidPointWithUncertaintyEllipse

The IE *EllipsoidPointWithUncertaintyEllipse* is used to describe a geographic shape as defined in 3GPP TS 23.032 [15].

```

-- ASN1START
EllipsoidPointWithUncertaintyEllipse ::= SEQUENCE {
    latitudeSign          ENUMERATED {north, south},
    degreesLatitude      INTEGER (0..8388607),          -- 23 bit field
    degreesLongitude     INTEGER (-8388608..8388607),   -- 24 bit field
    uncertaintySemiMajor INTEGER (0..127),
    uncertaintySemiMinor INTEGER (0..127),
    orientationMajorAxis INTEGER (0..179),
    confidence           INTEGER (0..100)
}
-- ASN1STOP

```

– EllipsoidPointWithAltitude

The IE *EllipsoidPointWithAltitude* is used to describe a geographic shape as defined in 3GPP TS 23.032 [15].

```

-- ASN1START
EllipsoidPointWithAltitude ::= SEQUENCE {
    latitudeSign          ENUMERATED {north, south},
    degreesLatitude      INTEGER (0..8388607),          -- 23 bit field
    degreesLongitude     INTEGER (-8388608..8388607),   -- 24 bit field
    altitudeDirection    ENUMERATED {height, depth},
    altitude             INTEGER (0..32767)              -- 15 bit field
}
-- ASN1STOP

```

– EllipsoidPointWithAltitudeAndUncertaintyEllipsoid

The IE *EllipsoidPointWithAltitudeAndUncertaintyEllipsoid* is used to describe a geographic shape as defined in 3GPP TS 23.032 [15].

```

-- ASN1START
EllipsoidPointWithAltitudeAndUncertaintyEllipsoid ::= SEQUENCE {
    latitudeSign          ENUMERATED {north, south},
    degreesLatitude      INTEGER (0..8388607),          -- 23 bit field
    degreesLongitude     INTEGER (-8388608..8388607),   -- 24 bit field
    altitudeDirection    ENUMERATED {height, depth},
    altitude             INTEGER (0..32767),            -- 15 bit field
    uncertaintySemiMajor INTEGER (0..127),
    uncertaintySemiMinor INTEGER (0..127),
    orientationMajorAxis INTEGER (0..179),
    uncertaintyAltitude  INTEGER (0..127),
    confidence           INTEGER (0..100)
}
-- ASN1STOP

```

– EllipsoidArc

The IE *EllipsoidArc* is used to describe a geographic shape as defined in 3GPP TS 23.032 [15].

```

-- ASN1START
EllipsoidArc ::= SEQUENCE {
    latitudeSign          ENUMERATED {north, south},
    degreesLatitude      INTEGER (0..8388607),          -- 23 bit field
    degreesLongitude     INTEGER (-8388608..8388607),   -- 24 bit field
    innerRadius          INTEGER (0..65535),            -- 16 bit field,
    uncertaintyRadius    INTEGER (0..127),
    offsetAngle          INTEGER (0..179),
    includedAngle        INTEGER (0..179),
    confidence           INTEGER (0..100)
}
-- ASN1STOP

```

– EPDU-Sequence

The *EPDU-Sequence* contains IEs that are defined externally to LPP by other organizations.

```
-- ASN1START
EPDU-Sequence ::= SEQUENCE (SIZE (1..maxEPDU)) OF EPDU

maxEPDU INTEGER ::= 16

EPDU ::= SEQUENCE {
    ePDU-Identifier      EPDU-Identifier,
    ePDU-Body           EPDU-Body
}

EPDU-Identifier ::= SEQUENCE {
    ePDU-ID             EPDU-ID,
    ePDU-Name          EPDU-Name      OPTIONAL,
    ...
}

EPDU-ID ::= INTEGER (1..256)

EPDU-Name ::= VisibleString (SIZE (1..32))

EPDU-Body ::= OCTET STRING
-- ASN1STOP
```

EPDU-Sequence field descriptions

EPDU-ID

This field provides a unique integer ID for the externally defined positioning method. Its value is assigned to the external entity that defines the EPDU. See table External PDU Identifier Definition for a list of external PDU identifiers defined in this version of the specification.

EPDU-Name

This field provides an optional character encoding which can be used to provide a quasi-unique name for an external PDU – e.g., by containing the name of the defining organization and/or the name of the associated public or proprietary standard for the EPDU.

EPDU-Body

The content and encoding of this field are defined externally to LPP.

External PDU Identifier Definition

EPDU-ID	EPDU Defining entity	Method name	Reference
1	OMA LOC	OMA LPP extensions (LPPe)	OMA-TS-LPPe-V1_0 [20]

– HorizontalVelocity

The IE *HorizontalVelocity* is used to describe a velocity shape as defined in 3GPP TS 23.032 [15].

```
-- ASN1START
HorizontalVelocity ::= SEQUENCE {
    bearing          INTEGER(0..359),
    horizontalSpeed  INTEGER(0..2047)
}
-- ASN1STOP
```

– HorizontalWithVerticalVelocity

The IE *HorizontalWithVerticalVelocity* is used to describe a velocity shape as defined in 3GPP TS 23.032 [15].

```

-- ASN1START
HorizontalWithVerticalVelocity ::= SEQUENCE {
    bearing                INTEGER(0..359),
    horizontalSpeed        INTEGER(0..2047),
    verticalDirection      ENUMERATED{upward, downward},
    verticalSpeed          INTEGER(0..255)
}
-- ASN1STOP

```

HorizontalVelocityWithUncertainty

The IE *HorizontalVelocityWithUncertainty* is used to describe a velocity shape as defined in 3GPP TS 23.032 [15].

```

-- ASN1START
HorizontalVelocityWithUncertainty ::= SEQUENCE {
    bearing                INTEGER(0..359),
    horizontalSpeed        INTEGER(0..2047),
    uncertaintySpeed       INTEGER(0..255)
}
-- ASN1STOP

```

HorizontalWithVerticalVelocityAndUncertainty

The IE *HorizontalWithVerticalVelocityAndUncertainty* is used to describe a velocity shape as defined in 3GPP TS 23.032 [15].

```

-- ASN1START
HorizontalWithVerticalVelocityAndUncertainty ::= SEQUENCE {
    bearing                INTEGER(0..359),
    horizontalSpeed        INTEGER(0..2047),
    verticalDirection      ENUMERATED{upward, downward},
    verticalSpeed          INTEGER(0..255),
    horizontalUncertaintySpeed  INTEGER(0..255),
    verticalUncertaintySpeed  INTEGER(0..255)
}
-- ASN1STOP

```

LocationCoordinateTypes

The IE *LocationCoordinateTypes* defines a list of possible geographic shapes as defined in 3GPP TS 23.032 [15].

```

-- ASN1START
LocationCoordinateTypes ::= SEQUENCE {
    ellipsoidPoint                BOOLEAN,
    ellipsoidPointWithUncertaintyCircle  BOOLEAN,
    ellipsoidPointWithUncertaintyEllipse  BOOLEAN,
    polygon                        BOOLEAN,
    ellipsoidPointWithAltitude        BOOLEAN,
    ellipsoidPointWithAltitudeAndUncertaintyEllipsoid  BOOLEAN,
    ellipsoidArc                     BOOLEAN,
    ...
}
-- ASN1STOP

```

Polygon

The IE *Polygon* is used to describe a geographic shape as defined in 3GPP TS 23.032 [15].

```

-- ASN1START

```

```

Polygon ::= SEQUENCE (SIZE (3..15)) OF PolygonPoints

PolygonPoints ::= SEQUENCE {
    latitudeSign          ENUMERATED {north, south},
    degreesLatitude       INTEGER (0..8388607),          -- 23 bit field
    degreesLongitude      INTEGER (-8388608..8388607)    -- 24 bit field
}

-- ASN1STOP

```

PositioningModes

The IE *PositioningModes* is used to indicate several positioning modes using a bit map.

```

-- ASN1START

PositioningModes ::= SEQUENCE {
    posModes          BIT STRING {
        standalone (0),
        ue-based (1),
        ue-assisted (2) } (SIZE (1..8)),
    ...
}

-- ASN1STOP

```

PositioningModes field descriptions

posModes

This field specifies the positioning mode(s). This is represented by a bit string, with a one-value at the bit position means the particular positioning mode is addressed; a zero-value means not addressed.

VelocityTypes

The IE *VelocityTypes* defines a list of possible velocity shapes as defined in 3GPP TS 23.032 [15].

```

-- ASN1START

VelocityTypes ::= SEQUENCE {
    horizontalVelocity          BOOLEAN,
    horizontalWithVerticalVelocity    BOOLEAN,
    horizontalVelocityWithUncertainty    BOOLEAN,
    horizontalWithVerticalVelocityAndUncertainty    BOOLEAN,
    ...
}

-- ASN1STOP

```

6.4.2 Common Positioning

CommonIEsRequestCapabilities

The *CommonIEsRequestCapabilities* carries common IEs for a Request Capabilities LPP message Type.

```

-- ASN1START

CommonIEsRequestCapabilities ::= SEQUENCE {
    ...
}

-- ASN1STOP

```

CommonIEsProvideCapabilities

The *CommonIEsProvideCapabilities* carries common IEs for a Provide Capabilities LPP message Type.

```
-- ASN1START
CommonIEsProvideCapabilities ::= SEQUENCE {
    ...
}
-- ASN1STOP
```

CommonIEsRequestAssistanceData

The *CommonIEsRequestAssistanceData* carries common IEs for a Request Assistance Data LPP message Type.

```
-- ASN1START
CommonIEsRequestAssistanceData ::= SEQUENCE {
    primaryCellID      ECGI          OPTIONAL,  -- Cond EUTRA
    ...
}
-- ASN1STOP
```

Conditional presence	Explanation
EUTRA	The field is mandatory present for E-UTRA access. The field shall be omitted for non-EUTRA user plane support.

CommonIEsRequestAssistanceData field descriptions

primaryCellID	This parameter identifies the current primary cell for the target device.
----------------------	---

CommonIEsProvideAssistanceData

The *CommonIEsProvideAssistanceData* carries common IEs for a Provide Assistance Data LPP message Type.

```
-- ASN1START
CommonIEsProvideAssistanceData ::= SEQUENCE {
    ...
}
-- ASN1STOP
```

CommonIEsRequestLocationInformation

The *CommonIEsRequestLocationInformation* carries common IEs for a Request Location Information LPP message Type.

```
-- ASN1START
CommonIEsRequestLocationInformation ::= SEQUENCE {
    locationInformationType      LocationInformationType,
    triggeredReporting            TriggeredReportingCriteria OPTIONAL,  -- Cond ECID
    periodicalReporting          PeriodicalReportingCriteria OPTIONAL,  -- Need ON
    additionalInformation        AdditionalInformation    OPTIONAL,  -- Need ON
    qos                          QoS                    OPTIONAL,  -- Need ON
    environment                  Environment            OPTIONAL,  -- Need ON
    locationCoordinateTypes      LocationCoordinateTypes OPTIONAL,  -- Need ON
    velocityTypes                VelocityTypes        OPTIONAL,  -- Need ON
    ...
}

LocationInformationType ::= ENUMERATED {
    locationEstimateRequired,
    locationMeasurementsRequired,
    locationEstimatePreferred,
    locationMeasurementsPreferred,
    ...
}
```

```

}
PeriodicalReportingCriteria ::= SEQUENCE {
    reportingAmount      ENUMERATED {
        ra1, ra2, ra4, ra8, ra16, ra32,
        ra64, ra-Infinity
    } DEFAULT ra-Infinity,
    reportingInterval    ENUMERATED {
        noPeriodicalReporting, ri0-25,
        ri0-5, ri1, ri2, ri4, ri8, ri16, ri32, ri64
    }
}

TriggeredReportingCriteria ::= SEQUENCE {
    cellChange           BOOLEAN,
    reportingDuration    ReportingDuration,
    ...
}

ReportingDuration ::= INTEGER (0..255)

AdditionalInformation ::= ENUMERATED {
    onlyReturnInformationRequested,
    mayReturnAdditionalInformation,
    ...
}

QoS ::= SEQUENCE {
    horizontalAccuracy    HorizontalAccuracy    OPTIONAL,    -- Need ON
    verticalCoordinateRequest    BOOLEAN,
    verticalAccuracy      VerticalAccuracy      OPTIONAL,    -- Need ON
    responseTime          ResponseTime          OPTIONAL,    -- Need ON
    velocityRequest       BOOLEAN,
    ...
}

HorizontalAccuracy ::= SEQUENCE {
    accuracy      INTEGER(0..127),
    confidence    INTEGER(0..100),
    ...
}

VerticalAccuracy ::= SEQUENCE {
    accuracy      INTEGER(0..127),
    confidence    INTEGER(0..100),
    ...
}

ResponseTime ::= SEQUENCE {
    time          INTEGER (1..128),
    ...
}

Environment ::= ENUMERATED {
    badArea,
    notBadArea,
    mixedArea,
    ...
}

-- ASN1STOP

```

Conditional presence	Explanation
ECID	The field is optionally present, need ON, if ECID is requested. Otherwise it is not present.

CommonIEsRequestLocationInformation field descriptions

CommonEsRequestLocationInformation field descriptions**locationInformationType**

This IE indicates whether the server requires a location estimate or measurements. For "*locationEstimateRequired*", the target device shall return a location estimate if possible, or indicate a location error if not possible. For "*locationMeasurementsRequired*", the target device shall return measurements if possible, or indicate a location error if not possible. For "*locationEstimatePreferred*", the target device shall return a location estimate if possible, but may also or instead return measurements for any requested position methods for which a location estimate is not possible. For "*locationMeasurementsPreferred*", the target device shall return location measurements if possible, but may also or instead return a location estimate for any requested position methods for which return of location measurements is not possible.

triggeredReporting

This IE indicates that triggered reporting is requested and comprises the following subfields:

- **cellChange**: If this field is set to TRUE, the target device provides requested location information each time the primary cell has changed.
- **reportingDuration**: Maximum duration of triggered reporting in seconds. A value of zero is interpreted to mean an unlimited (i.e. "infinite") duration. The target device should continue triggered reporting for the *reportingDuration* or until an LPP *Abort* or LPP *Error* message is received.

The *triggeredReporting* field should not be included by the location server and shall be ignored by the target device if the *periodicalReporting* IE or *responseTime* IE is included in *CommonEsRequestLocationInformation*.

periodicalReporting

This IE indicates that periodic reporting is requested and comprises the following subfields:

- **reportingAmount** indicates the number of periodic location information reports requested. Enumerated values correspond to 1, 2, 4, 8, 16, 32, 64, or infinite/indefinite number of reports. If the *reportingAmount* is "*infinite/indefinite*", the target device should continue periodic reporting until an LPP *Abort* message is received. The value "*ra1*" shall not be used by a sender.
- **reportingInterval** indicates the interval between location information reports and the response time requirement for the first location information report. Enumerated values ri0-25, ri0-5, ri1, ri2, ri4, ri8, ri16, ri32, ri64 correspond to reporting intervals of 1, 2, 4, 8, 10, 16, 20, 32, and 64 seconds, respectively. Measurement reports containing no measurements or no location estimate are required when a *reportingInterval* expires before a target device is able to obtain new measurements or obtain a new location estimate. The value "*noPeriodicalReporting*" shall not be used by a sender.

additionalInformation

This IE indicates whether a target device is allowed to return additional information to that requested. If this IE indicates "*onlyReturnInformationRequested*" then the target device shall not return any additional information to that requested by the server. If this IE indicates "*mayReturnAdditionalInformation*" then the target device may return additional information to that requested by the server. If a location estimate is returned, any additional information is restricted to that associated with a location estimate (e.g. might include velocity if velocity was not requested but cannot include measurements). If measurements are returned, any additional information is restricted to additional measurements (e.g. might include E-CID measurements if A-GNSS measurements were requested but not E-CID measurements).

qos

This IE indicates the quality of service and comprises a number of sub-fields. In the case of measurements, some of the sub-fields apply to the location estimate that could be obtained by the server from the measurements provided by the target device assuming that the measurements are the only sources of error. Fields are as follows:

- **horizontalAccuracy** indicates the maximum horizontal error in the location estimate at an indicated confidence level. The "*accuracy*" corresponds to the encoded uncertainty as defined in 3GPP TS 23.032 [15] and "*confidence*" corresponds to confidence as defined in 3GPP TS 23.032 [15].
- **verticalCoordinateRequest** indicates whether a vertical coordinate is required (TRUE) or not (FALSE)
- **verticalAccuracy** indicates the maximum vertical error in the location estimate at an indicated confidence level and is only applicable when a vertical coordinate is requested. The "*accuracy*" corresponds to the encoded uncertainty altitude as defined in 3GPP TS 23.032 [15] and "*confidence*" corresponds to confidence as defined in 3GPP TS 23.032 [15].
- **responseTime** indicates the maximum response time as measured between receipt of the *RequestLocationInformation* and transmission of a *ProvideLocationInformation*. This is given as an integer number of seconds between 1 and 128. If the *periodicalReporting* IE is included in *CommonEsRequestLocationInformation*, this field should not be included by the location server and shall be ignored by the target device (if included).
- **velocityRequest** indicates whether velocity (or measurements related to velocity) is requested (TRUE) or not (FALSE).

All QoS requirements shall be obtained by the target device to the degree possible but it is permitted to return a response that does not fulfill all QoS requirements if some were not attainable. The single exception is response-time which shall always be fulfilled – even if that means not fulfilling other QoS requirements.

CommonIEsRequestLocationInformation field descriptions
<p>environment This field provides the target device with information about expected multipath and non line of sight (NLOS) in the current area. The following values are defined:</p> <ul style="list-style-type: none"> • badArea: possibly heavy multipath and NLOS conditions (e.g. bad urban or urban). • notBadArea: no or light multipath and usually LOS conditions (e.g. suburban or rural). • mixedArea: environment that is mixed or not defined. <p>If this field is absent, a default value of "mixedArea" applies.</p>
<p>locationCoordinateTypes This field provides a list of the types of location estimate that the target device may return when a location estimate is obtained by the target.</p>
<p>velocityTypes This fields provides a list of the types of velocity estimate that the target device may return when a velocity estimate is obtained by the target.</p>

– CommonIEsProvideLocationInformation

The *CommonIEsProvideLocationInformation* carries common IEs for a Provide Location Information LPP message Type.

```
-- ASN1START

CommonIEsProvideLocationInformation ::= SEQUENCE {
    locationEstimate          LocationCoordinates    OPTIONAL,
    velocityEstimate          Velocity                OPTIONAL,
    locationError             LocationError            OPTIONAL,
    ...
}

LocationCoordinates ::= CHOICE {
    ellipsoidPoint                Ellipsoid-Point,
    ellipsoidPointWithUncertaintyCircle Ellipsoid-PointWithUncertaintyCircle,
    ellipsoidPointWithUncertaintyEllipse EllipsoidPointWithUncertaintyEllipse,
    polygon                       Polygon,
    ellipsoidPointWithAltitude     EllipsoidPointWithAltitude,
    ellipsoidPointWithAltitudeAndUncertaintyEllipsoid EllipsoidPointWithAltitudeAndUncertaintyEllipsoid,
    ellipsoidArc                  EllipsoidArc,
    ...
}

Velocity ::= CHOICE {
    horizontalVelocity                HorizontalVelocity,
    horizontalWithVerticalVelocity    HorizontalWithVerticalVelocity,
    horizontalVelocityWithUncertainty HorizontalVelocityWithUncertainty,
    horizontalWithVerticalVelocityAndUncertainty HorizontalWithVerticalVelocityAndUncertainty,
    ...
}

LocationError ::= SEQUENCE {
    locationfailurecause          LocationFailureCause,
    ...
}

LocationFailureCause ::= ENUMERATED {
    undefined,
    requestedMethodNotSupported,
    positionMethodFailure,
    periodicLocationMeasurementsNotAvailable,
    ...
}

-- ASN1STOP
```

CommonIEsProvideLocationInformation field descriptions**locationEstimate**

This field provides a location estimate using one of the geographic shapes defined in 3GPP TS 23.032 [15]. Coding of the values of the various fields internal to each geographic shape follow the rules in [15]. The conditions for including this field are defined for the *locationInformationType* field in a Request Location Information message.

velocityEstimate

This field provides a velocity estimate using one of the velocity shapes defined in 3GPP TS 23.032 [15]. Coding of the values of the various fields internal to each velocity shape follow the rules in [15].

locationError

This field shall be included if and only if a location estimate and measurements are not included in the LPP PDU. The field includes information concerning the reason for the lack of location information. The *LocationFailureCause* "periodicLocationMeasurementsNotAvailable" shall be used by the target device if periodic location reporting was requested, but no measurements or location estimate are available when *the reportingInterval* expired.

– CommonIEsAbort

The *CommonIEsAbort* carries common IEs for an Abort LPP message Type.

```
-- ASN1START
CommonIEsAbort ::= SEQUENCE {
  abortCause      ENUMERATED {
    undefined,
    stopPeriodicReporting,
    targetDeviceAbort,
    networkAbort,
    ...
  }
}
-- ASN1STOP
```

CommonIEsAbort field descriptions**abortCause**

This IE defines the request to abort an ongoing procedure. The abort cause "stopPeriodicReporting" should be used by the location server to stop any ongoing location reporting configured as *periodicalReporting* or *triggeredReporting* in the *CommonIEsRequestLocationInformation*.

– CommonIEsError

The *CommonIEsError* carries common IEs for an Error LPP message Type.

```
-- ASN1START
CommonIEsError ::= SEQUENCE {
  errorCause      ENUMERATED {
    undefined,
    lppMessageHeaderError,
    lppMessageBodyError,
    epduError,
    incorrectDataValue,
    ...
  }
}
-- ASN1STOP
```

CommonIEsError field descriptions**errorCause**

This IE defines the cause for an error. "lppMessageHeaderError", "lppMessageBodyError" and "epduError" is used if a receiver is able to detect a coding error in the LPP header (i.e., in the common fields), LPP message body or in an EPDU, respectively.

6.5 Positioning Method IEs

6.5.1 OTDOA Positioning

6.5.1.1 OTDOA Assistance Data

– OTDOA-ProvideAssistanceData

The IE *OTDOA-ProvideAssistanceData* is used by the location server to provide assistance data to enable UE-assisted downlink OTDOA. It may also be used to provide OTDOA positioning specific error reason.

Throughout Section 6.5.1, "assistance data reference cell" refers to the cell defined by the IE *OTDOA-ReferenceCellInfo* (see section 6.5.1.2). "RSTD reference cell" applies only in Section 6.5.1.5.

NOTE: The location server should include at least one cell for which the SFN can be obtained by the target device, e.g. the serving cell, in the assistance data, either as the assistance data reference cell or in the neighbor cell list. Otherwise the target device will be unable to perform the OTDOA measurement and the positioning operation will fail.

```
-- ASN1START
OTDOA-ProvideAssistanceData ::= SEQUENCE {
    otdoa-ReferenceCellInfo      OTDOA-ReferenceCellInfo      OPTIONAL,  -- Need ON
    otdoa-NeighbourCellInfo      OTDOA-NeighbourCellInfoList  OPTIONAL,  -- Need ON
    otdoa-Error                  OTDOA-Error                  OPTIONAL,  -- Need ON
    ...
}
-- ASN1STOP
```

6.5.1.2 OTDOA Assistance Data Elements

– OTDOA-ReferenceCellInfo

The IE *OTDOA-ReferenceCellInfo* is used by the location server to provide assistance data reference cell information for OTDOA assistance data. The slot number offsets and expected RSTDs in *OTDOA-NeighbourCellInfoList* are provided relative to the cell defined by this IE. If *earfcnRef* of this assistance data reference cell is different from that of the serving cell, the LPP layer shall inform lower layers to start performing inter-frequency RSTD measurements with this cell and provide to lower layers the information about this assistance data reference cell, e.g. EARFCN and PRS positioning occasion information.

NOTE: The location server should always include the PRS configuration of the assistance data reference and neighbour cells. Otherwise the UE may not meet the accuracy requirements as defined in [18].

```
-- ASN1START
OTDOA-ReferenceCellInfo ::= SEQUENCE {
    physCellId                INTEGER (0..503),
    cellGlobalId              ECGI                        OPTIONAL,  -- Need ON
    earfcnRef                  ARFCN-ValueEUTRA           OPTIONAL,  -- Cond NotSameAsServ0
    antennaPortConfig          ENUMERATED {ports1-or-2, ports4, ... }
                                OPTIONAL,                -- Cond NotSameAsServ1
    cpLength                   ENUMERATED { normal, extended, ... },
    prsInfo                    PRS-Info                   OPTIONAL,  -- Cond PRS
    ...
    [[ earfcnRef-v9a0          ARFCN-ValueEUTRA-v9a0      OPTIONAL  -- Cond NotSameAsServ2
    ]]
}
-- ASN1STOP
```

Conditional presence	Explanation
<i>NotSameAsServ0</i>	This field is absent if <i>earfcnRef-v9a0</i> is present. Otherwise, the field is mandatory present if the EARFCN of the OTDOA assistance data reference cell is not the same as the EARFCN of the target devices"s current primary cell.
<i>NotSameAsServ1</i>	The field is mandatory present if the antenna port configuration of the OTDOA assistance data reference cell is not the same as the antenna port configuration of the target devices"s current primary cell.
<i>NotSameAsServ2</i>	The field is absent if <i>earfcnRef</i> is present. Otherwise, the field is mandatory present if the EARFCN of the OTDOA assistance data reference cell is not the same as the EARFCN of the target devices"s current primary cell.
<i>PRS</i>	The field is mandatory present if positioning reference signals are available in the assistance data reference cell [16]; otherwise it is not present.

OTDOA-ReferenceCellInfo field descriptions

<i>physCellId</i>	This field specifies the physical cell identity of the assistance data reference cell, as defined in [12].
<i>cellGlobalId</i>	This field specifies the ECGI, the globally unique identity of a cell in E-UTRA, of the assistance data reference cell, as defined in [12]. The server should include this field if it considers that it is needed to resolve ambiguity in the cell indicated by <i>physCellId</i> .
<i>earfcnRef</i>	This field specifies the EARFCN of the assistance data reference cell.
<i>antennaPortConfig</i>	This field specifies whether 1 (or 2) antenna port(s) or 4 antenna ports for cell specific reference signals (CRS) are used in the assistance data reference cell.
<i>cpLength</i>	This field specifies the cyclic prefix length of the assistance data reference cell PRS if the <i>prsInfo</i> field is present, otherwise this field specifies the cyclic prefix length of the assistance data reference cell CRS.
<i>prsInfo</i>	This field specifies the PRS configuration of the assistance data reference cell.

– PRS-Info

The IE *PRS-Info* provides the information related to the configuration of PRS in a cell.

```

-- ASN1START
PRS-Info ::= SEQUENCE {
    prs-Bandwidth          ENUMERATED { n6, n15, n25, n50, n75, n100, ... },
    prs-ConfigurationIndex INTEGER (0..4095),
    numDL-Frames          ENUMERATED { sf-1, sf-2, sf-4, sf-6, ... },
    ...,
    prs-MutingInfo-r9     CHOICE {
        po2-r9            BIT STRING (SIZE(2)),
        po4-r9            BIT STRING (SIZE(4)),
        po8-r9            BIT STRING (SIZE(8)),
        po16-r9           BIT STRING (SIZE(16)),
        ...
    }
}
-- ASN1STOP

```

PRS-Info field descriptions

<i>prs-Bandwidth</i>	This field specifies the bandwidth that is used to configure the positioning reference signals on. Enumerated values are specified in number of resource blocks (n6 corresponds to 6 resource blocks, n15 to 15 resource blocks and so on) and define 1.4, 3, 5, 10, 15 and 20 MHz bandwidth.
<i>prs-ConfigurationIndex</i>	This field specifies the positioning reference signals configuration index I_{PRS} as defined in [16].
<i>numDL-Frames</i>	This field specifies the number of consecutive downlink subframes N_{PRS} with positioning reference signals, as defined in [16]. Enumerated values define 1, 2, 4, or 6 consecutive subframes.

PRS-Info field descriptions***prs-MutingInfo***

This field specifies the PRS muting configuration of the cell. The PRS muting configuration is defined by a periodic PRS muting sequence with periodicity T_{REP} where T_{REP} , counted in the number of PRS positioning occasions [18], can be 2, 4, 8, or 16 which is also the length of the selected bit string that represents this PRS muting sequence. If a bit in the PRS muting sequence is set to "0", then the PRS is muted in the corresponding PRS positioning occasion. A PRS positioning occasion comprises of N_{PRS} downlink positioning subframes as defined in [16]. The first bit of the PRS muting sequence corresponds to the first PRS positioning occasion that starts after the beginning of the assistance data reference cell SFN=0. The sequence is valid for all subframes after the target device has received the *prs-MutingInfo*. If this field is not present the target device may assume that the PRS muting is not in use for the cell.

When the SFN of the assistance data reference cell is not known to the UE and *prs-MutingInfo* is provided for a cell in the *OTDOA-NeighbourCellInfoList* IE, the UE may assume no PRS is transmitted by that cell.

When the UE receives a 16-bit muting pattern (po16-r9) and PRS periodicity T_{PRS} of 1280 subframes for the same cell, the UE shall assume an 8-bit muting pattern (po8-r9) based on the first half of the 16-bit muting pattern.

OTDOA-NeighbourCellInfoList

The IE *OTDOA-NeighbourCellInfoList* is used by the location server to provide neighbour cell information for OTDOA assistance data. The *OTDOA-NeighbourCellInfoList* is sorted in the decreasing order of priority for measurement to be performed by the target device, with the first cell in the list being the highest priority for measurement. The exact sorting of the list is left to server implementation. The target device should provide the available measurements in the same order as provided by the server. If inter-frequency neighbour cells are included in *OTDOA-NeighbourCellInfoList*, where an inter-frequency is a E-UTRA frequency which is different from the E-UTRA serving cell frequency, the LPP layer shall inform lower layers to start performing inter-frequency RSTD measurements for these neighbour cells and also provide to lower layers the information about these neighbour cells, e.g. EARFCN and PRS positioning occasion information.

```
-- ASN1START

OTDOA-NeighbourCellInfoList ::= SEQUENCE (SIZE (1..maxFreqLayers)) OF OTDOA-NeighbourFreqInfo
OTDOA-NeighbourFreqInfo ::= SEQUENCE (SIZE (1..24)) OF OTDOA-NeighbourCellInfoElement

OTDOA-NeighbourCellInfoElement ::= SEQUENCE {
    physCellId                INTEGER (0..503),
    cellGlobalId              ECGI
    earfcn                    ARFCN-ValueEUTRA OPTIONAL, -- Need ON
                                -- Cond NotSameAsRef0
    cpLength                  ENUMERATED {normal, extended, ...}
                                OPTIONAL, -- Cond NotSameAsRef1
    prsInfo                   PRS-Info OPTIONAL, -- Cond NotSameAsRef2
    antennaPortConfig         ENUMERATED {ports-1-or-2, ports-4, ...}
                                OPTIONAL, -- Cond NotsameAsRef3
    slotNumberOffset          INTEGER (0..19) OPTIONAL, -- Cond NotSameAsRef4
    prs-SubframeOffset        INTEGER (0..1279) OPTIONAL, -- Cond InterFreq
    expectedRSTD              INTEGER (0..16383),
    expectedRSTD-Uncertainty  INTEGER (0..1023),
    ...,
    [[ earfcn-v9a0            ARFCN-ValueEUTRA-v9a0 OPTIONAL -- Cond NotSameAsRef5
    ]]
}

maxFreqLayers  INTEGER ::= 3

-- ASN1STOP
```

Conditional presence	Explanation
<i>NotsameAsRef0</i>	The field is absent if <i>earfcn-v9a0</i> is present. If <i>earfcn-v9a0</i> is not present, the field is mandatory present if the EARFCN is not the same as for the assistance data reference cell; otherwise it is not present.
<i>NotsameAsRef1</i>	The field is mandatory present if the cyclic prefix length is not the same as for the assistance data reference cell; otherwise it is not present.
<i>NotsameAsRef2</i>	The field is mandatory present if the PRS configuration is not the same as for the assistance data reference cell; otherwise it is not present.
<i>NotsameAsRef3</i>	The field is mandatory present if the antenna port configuration is not the same as for the assistance data reference cell; otherwise it is not present.
<i>NotsameAsRef4</i>	The field is mandatory present if the slot timing is not the same as for the assistance data reference cell; otherwise it is not present.
<i>NotSameAsRef5</i>	The field is absent if <i>earfcn</i> is present. If <i>earfcn</i> is not present, the field is mandatory present if the EARFCN is not the same as for the assistance data reference cell; otherwise it is not present.
<i>InterFreq</i>	The field is optionally present, need OP, if the EARFCN is not the same as for the assistance data reference cell; otherwise it is not present.

OTDOA-NeighbourCellInfoList field descriptions

<i>physCellId</i> This field specifies the physical cell identity of the neighbour cell, as defined in [12].
<i>cellGlobalId</i> This field specifies the ECGI, the globally unique identity of a cell in E-UTRA, of the neighbour cell, as defined in [12]. The server should provide this field if it considers that it is needed to resolve any ambiguity in the cell identified by <i>physCellId</i> .
<i>earfcn</i> This field specifies the EARFCN of the neighbor cell.
<i>cpLength</i> This field specifies the cyclic prefix length of the neighbour cell PRS if PRS are present in this neighbor cell, otherwise this field specifies the cyclic prefix length of CRS in this neighbor cell.
<i>prsInfo</i> This field specifies the PRS configuration of the neighbour cell. When the EARFCN of the neighbour cell is the same as for the assistance data reference cell, the target device may assume that each PRS positioning occasion in the neighbour cell at least partially overlaps with a PRS positioning occasion in the assistance data reference cell where the maximum offset between the transmitted PRS positioning occasions may be assumed to not exceed half a subframe. When the EARFCN of the neighbour cell is the same as for the assistance data reference cell, the target may assume that this cell has the same PRS periodicity (T_{prs}) as the assistance data reference cell.
<i>antennaPortConfig</i> This field specifies whether 1 (or 2) antenna port(s) or 4 antenna ports for cell specific reference signals are used.
<i>slotNumberOffset</i> This field specifies the slot number offset at the transmitter between this cell and the assistance data reference cell. The <i>slotNumberOffset</i> together with the current slot number of the assistance data reference cell may be used to calculate the current slot number of this cell which may further be used to generate the CRS sequence by the target device. The offset corresponds to the number of full slots counted from the beginning of a radio frame of the assistance data reference cell to the beginning of the closest subsequent radio frame of this cell. If this field is absent, the slot timing is the same as for the assistance data reference cell.
<i>prs-SubframeOffset</i> This field specifies the offset between the first PRS subframe in the assistance data reference cell on the reference carrier frequency layer and the first PRS subframe in the closest subsequent PRS positioning occasion of this cell on the other carrier frequency layer. The value is given in number of full sub-frames. If the ARFCN is not the same as for the assistance data reference cell and the field is not present but PRS are available on this cell, the receiver shall consider the PRS subframe offset for this cell to be 0.
<i>expectedRSTD</i> If PRS is transmitted: This field indicates the RSTD value that the target device is expected to measure between this cell and the assistance data reference cell. The <i>expectedRSTD</i> field takes into account the expected propagation time difference as well as transmit time difference of PRS positioning occasions between the two cells. The RSTD value can be negative and is calculated as (<i>expectedRSTD</i> -8192). The resolution is $3 \times T_s$, with $T_s = 1/(15000 \times 2048)$ seconds. If PRS is not transmitted: This field indicates the RSTD value that the target device is expected to measure between this cell and the assistance data reference cell. The <i>expectedRSTD</i> field takes into account the expected propagation time difference as well as transmit time difference between the two cells. The RSTD value can be negative and is calculated as (<i>expectedRSTD</i> -8192). The resolution is $3 T_s$, with $T_s = 1/(15000 \times 2048)$ seconds.

OTDOA-NeighbourCellInfoList field descriptions**expectedRSTD-Uncertainty**

If PRS is transmitted:

This field indicates the uncertainty in *expectedRSTD* value. The uncertainty is related to the location server's a-priori estimation of the target device location. The *expectedRSTD* and *expectedRSTD-Uncertainty* together define the search window for the target device.

The scale factor of the *expectedRSTD-Uncertainty* field is $3 \times T_s$, with $T_s = 1 / (15000 \times 2048)$ seconds.

The target device may assume that the beginning of the PRS positioning occasion of the neighbour cell is received within the search window of size $[- \text{expectedRSTD-Uncertainty} \times 3 \times T_s, \text{expectedRSTD-Uncertainty} \times 3 \times T_s]$ centered at $T_{\text{REF}} + 1 \text{ millisecond} \times N + (\text{expectedRSTD} - 8192) \times 3 \times T_s$, where T_{REF} is the reception time of the beginning of the PRS positioning occasion of the assistance data reference cell at the target device antenna connector, $N = 0$ when the EARFCN of the neighbour cell is equal to that of the assistance data reference cell, and $N = \text{prs-SubframeOffset}$ otherwise.

If PRS is not transmitted:

This field indicates the uncertainty in *expectedRSTD* value. The uncertainty is related to the location server's a-priori estimation of the target device location. The *expectedRSTD* and *expectedRSTD-Uncertainty* together define the search window for the target device. The scale factor of the *expectedRSTD-Uncertainty* field is $3 \times T_s$, with $T_s = 1 / (15000 \times 2048)$ seconds.

If T_x is the reception time of the beginning of the subframe X of the assistance data reference cell at the target device antenna connector, the target device may assume that the beginning of the closest subframe of this neighbour cell to subframe X is received within the search window of size $[- \text{expectedRSTD-Uncertainty} \times 3 \times T_s, \text{expectedRSTD-Uncertainty} \times 3 \times T_s]$ centered at $T_x + (\text{expectedRSTD} - 8192) \times 3 \times T_s$.

6.5.1.3 OTDOA Assistance Data Request

– OTDOA-RequestAssistanceData

The IE *OTDOA-RequestAssistanceData* is used by the target device to request assistance data from a location server.

```
-- ASN1START
OTDOA-RequestAssistanceData ::= SEQUENCE {
    physCellId      INTEGER (0..503),
    ...
}
-- ASN1STOP
```

OTDOA-RequestAssistanceData field descriptions**physCellId**

This field specifies the physical cell identity of the current primary cell of the target device.

6.5.1.4 OTDOA Location Information

– OTDOA-ProvideLocationInformation

The IE *OTDOA-ProvideLocationInformation* is used by the target device to provide OTDOA location measurements to the location server. It may also be used to provide OTDOA positioning specific error reason.

```
-- ASN1START
OTDOA-ProvideLocationInformation ::= SEQUENCE {
    otdoaSignalMeasurementInformation  OTDOA-SignalMeasurementInformation  OPTIONAL,
    otdoa-Error                        OTDOA-Error                        OPTIONAL,
    ...
}
-- ASN1STOP
```

6.5.1.5 OTDOA Location Information Elements

– OTDOA-SignalMeasurementInformation

The IE *OTDOA-SignalMeasurementInformation* is used by the target device to provide RSTD measurements to the location server. The RSTD measurements are provided for a neighbour cell and the RSTD reference cell, both of which are provided in the IE *OTDOA-ProvideAssistanceData*. The RSTD reference cell may or may not be the same as the assistance data reference cell provided in *OTDOA-ReferenceCellInfo*. If the target device stops reporting inter-frequency RSTD measurements, where the inter-frequency RSTD measurement is an OTDOA RSTD measurement with at least one cell on a frequency different from the serving cell frequency, the LPP layer shall inform lower layers that inter-frequency RSTD measurements are stopped.

```
-- ASN1START
OTDOA-SignalMeasurementInformation ::= SEQUENCE {
    systemFrameNumber      BIT STRING (SIZE (10)),
    physCellIdRef          INTEGER (0..503),
    cellGlobalIdRef        ECGI                      OPTIONAL,
    earfcnRef              ARFCN-ValueEUTRA          OPTIONAL,      -- Cond NotSameAsRef0
    referenceQuality        OTDOA-MeasQuality        OPTIONAL,
    neighbourMeasurementList NeighbourMeasurementList,
    ...,
    [[ earfcnRef-v9a0       ARFCN-ValueEUTRA-v9a0    OPTIONAL      -- Cond NotSameAsRef1
    ]]
}

NeighbourMeasurementList ::= SEQUENCE (SIZE(1..24)) OF NeighbourMeasurementElement

NeighbourMeasurementElement ::= SEQUENCE {
    physCellIdNeighbor      INTEGER (0..503),
    cellGlobalIdNeighbour   ECGI                      OPTIONAL,
    earfcnNeighbour         ARFCN-ValueEUTRA          OPTIONAL,      -- Cond NotSameAsRef2
    rstd                    INTEGER (0..12711),
    rstd-Quality            OTDOA-MeasQuality,
    ...,
    [[ earfcnNeighbour-v9a0 ARFCN-ValueEUTRA-v9a0    OPTIONAL      -- Cond NotSameAsRef3
    ]]
}
-- ASN1STOP
```

Conditional presence	Explanation
<i>NotSameAsRef0</i>	The field is absent if the corresponding <i>earfcnRef-v9a0</i> is present. Otherwise, the target device shall include this field if the ARFCN of the RSTD reference cell is not the same as the ARFCN of the assistance data reference cell provided in the OTDOA assistance data.
<i>NotSameAsRef1</i>	The field is absent if the corresponding <i>earfcnRef</i> is present. Otherwise, the target device shall include this field if the ARFCN of the RSTD reference cell is not the same as the ARFCN of the assistance data reference cell provided in the OTDOA assistance data.
<i>NotSameAsRef2</i>	The field is absent if the corresponding <i>earfcnNeighbour-v9a0</i> is present. Otherwise, the target device shall include this field if the ARFCN of this neighbor cell is not the same as the <i>earfcnRef</i> for the RSTD reference cell.
<i>NotSameAsRef3</i>	The field is absent if the corresponding <i>earfcnNeighbour</i> is present. Otherwise, the target device shall include this field if the ARFCN of this neighbor cell is not the same as the <i>earfcnRef</i> for the RSTD reference cell.

OTDOA-SignalMeasurementInformation field descriptions	
systemFrameNumber	This field specifies the SFN of the RSTD reference cell containing the starting subframe of the PRS positioning occasion if PRS are available on the RSTD reference cell, or subframe of the CRS for RSTD measurements if PRS are not available on the RSTD reference cell during which the most recent neighbour cell RSTD measurement was performed.
physCellIdRef	This field specifies the physical cell identity of the RSTD reference cell.
cellGlobalIdRef	This field specifies the ECGI, the globally unique identity of a cell in E-UTRA, of the RSTD reference cell. The target shall provide this IE if it knows the ECGI of the RSTD reference cell.
earfcnRef	This field specifies the E-UTRA carrier frequency of the RSTD reference cell.

OTDOA-SignalMeasurementInformation field descriptions
<p>referenceQuality This field specifies the target device's best estimate of the quality of the TOA measurement from the RSTD reference cell, $T_{\text{SubframeRxRef}}$, where $T_{\text{SubframeRxRef}}$ is the time of arrival of the signal from the RSTD reference cell.</p>
<p>neighbourMeasurementList This list contains the measured RSTD values for neighbour cells together with the RSTD reference cell, along with quality for each measurement.</p>
<p>physCellIdNeighbor This field specifies the physical cell identity of the neighbour cell for which the RSTDs are provided.</p>
<p>cellGlobalIdNeighbour This field specifies the ECGI, the globally unique identity of a cell in E-UTRA, of the neighbour cell for which the RSTDs are provided. The target device shall provide this IE if it was able to determine the ECGI of the neighbour cell at the time of measurement.</p>
<p>earfcnNeighbour This field specifies the E-UTRA carrier frequency of the neighbour cell used for the RSTD measurements.</p>
<p>rstd This field specifies the relative timing difference between this neighbour cell and the RSTD reference cell, as defined in [17]. Mapping of the measured quantity is defined as in [18] subclause 9.1.10.3.</p>
<p>rstd-Quality This field specifies the target device's best estimate of the quality of the measured <i>rstd</i>.</p>

– OTDOA-MeasQuality

```
-- ASN1START
OTDOA-MeasQuality ::= SEQUENCE {
    error-Resolution      BIT STRING (SIZE (2)),
    error-Value          BIT STRING (SIZE (5)),
    error-NumSamples     BIT STRING (SIZE (3))          OPTIONAL,
    ...
}
-- ASN1STOP
```

OTDOA-MeasQuality field descriptions																				
<p>error-Resolution This field specifies the resolution R used in <i>error-Value</i> field. The encoding on two bits is as follows:</p> <table style="margin-left: 20px;"> <tr><td>'00'</td><td>5 meters</td></tr> <tr><td>'01'</td><td>10 meters</td></tr> <tr><td>'10'</td><td>20 meters</td></tr> <tr><td>'11'</td><td>30 meters.</td></tr> </table>	'00'	5 meters	'01'	10 meters	'10'	20 meters	'11'	30 meters.												
'00'	5 meters																			
'01'	10 meters																			
'10'	20 meters																			
'11'	30 meters.																			
<p>error-Value This field specifies the target device's best estimate of the uncertainty of the OTDOA (or TOA) measurement. The encoding on five bits is as follows:</p> <table style="margin-left: 20px;"> <tr><td>'00000'</td><td>0</td><td>to</td><td>(R*1-1) meters</td></tr> <tr><td>'00001'</td><td>R*1</td><td>to</td><td>(R*2-1) meters</td></tr> <tr><td>'00010'</td><td>R*2</td><td>to</td><td>(R*3-1) meters</td></tr> <tr><td>...</td><td></td><td></td><td></td></tr> <tr><td>'11111'</td><td>R*31</td><td></td><td>meters or more;</td></tr> </table> <p>where R is the resolution defined by <i>error-Resolution</i> field. E.g. , R=20 m corresponds to 0-19 m, 20-39 m, ..., 620+ m.</p>	'00000'	0	to	(R*1-1) meters	'00001'	R*1	to	(R*2-1) meters	'00010'	R*2	to	(R*3-1) meters	...				'11111'	R*31		meters or more;
'00000'	0	to	(R*1-1) meters																	
'00001'	R*1	to	(R*2-1) meters																	
'00010'	R*2	to	(R*3-1) meters																	
...																				
'11111'	R*31		meters or more;																	

OTDOA-MeasQuality field descriptions**error-NumSamples**

If the *error-Value* field provides the sample uncertainty of the OTDOA (or TOA) measurement, this field specifies how many measurements have been used by the target device to determine this (i.e., sample size). Following 3 bit encoding is used:

"000"	Not the baseline metric
'001'	5-9
'010'	10-14
'011'	15-24
'100'	25-34
'101'	35-44
'110'	45-54
'111'	55 or more.

In case of the value "000", the *error-Value* field contains the target device's best estimate of the uncertainty of the OTDOA (or TOA) measurement not based on the baseline metric. E.g., other measurements such as signal-to-noise-ratio or signal strength can be utilized to estimate the *error-Value*.

If this field is absent, the value of this field is "000".

6.5.1.6 OTDOA Location Information Request

– OTDOA-RequestLocationInformation

The IE *OTDOA-RequestLocationInformation* is used by the location server to request OTDOA location measurements from a target device. Details of the required measurements (e.g. details of assistance data reference cell and neighbour cells) are conveyed in the *OTDOA-ProvideAssistanceData* IE in a separate Provide Assistance Data message.

```
-- ASN1START
OTDOA-RequestLocationInformation ::= SEQUENCE {
    assistanceAvailability    BOOLEAN,
    ...
}
-- ASN1STOP
```

OTDOA-RequestLocationInformation field descriptions**assistanceAvailability**

This field indicates whether the target device may request additional OTDOA assistance data from the server. TRUE means allowed and FALSE means not allowed.

6.5.1.7 OTDOA Capability Information

– OTDOA-ProvideCapabilities

The IE *OTDOA-ProvideCapabilities* is used by the target device to indicate its capability to support OTDOA and to provide its OTDOA positioning capabilities to the location server.

```
-- ASN1START
OTDOA-ProvideCapabilities ::= SEQUENCE {
    otdoa-Mode    BIT STRING { ue-assisted (0) } (SIZE (1..8)),
    ...,
    supportedBandListEUTRA    SEQUENCE (SIZE (1..maxBands)) OF SupportedBandEUTRA    OPTIONAL,
    supportedBandListEUTRA-v9a0 SEQUENCE (SIZE (1..maxBands)) OF SupportedBandEUTRA-v9a0    OPTIONAL
}
maxBands INTEGER ::= 64
SupportedBandEUTRA ::= SEQUENCE {
    bandEUTRA    INTEGER (1..maxFBI)
}
SupportedBandEUTRA-v9a0 ::= SEQUENCE {
    bandEUTRA-v9a0    INTEGER (maxFBI-Plus1..maxFBI2)    OPTIONAL
}
```

```

maxFBI                INTEGER ::= 64 -- Maximum value of frequency band indicator
maxFBI-Plus1          INTEGER ::= 65 -- lowest value extended FBI range
maxFBI2               INTEGER ::= 256 -- highest value extended FBI range

-- ASN1STOP

```

OTDOA-ProvideCapabilities field descriptions

otdoa-Mode

This field specifies the OTDOA mode(s) supported by the target device. This is represented by a bit string, with a one-value at the bit position means the particular OTDOA mode is supported; a zero-value means not supported. A zero-value in all bit positions in the bit string means OTDOA positioning method is not supported by the target device.

SupportedBandEUTRA

One entry corresponding to each supported E-UTRA band as defined in TS 36.101 [21]. In case the target device includes *bandEUTRA-v9a0*, the target device shall set the corresponding entry of *bandEUTRA* (i.e. without suffix) to *maxFBI*.

6.5.1.8 OTDOA Capability Information Request

– OTDOA-RequestCapabilities

The IE *OTDOA-RequestCapabilities* is used by the location server to request the capability of the target device to support OTDOA and to request OTDOA positioning capabilities from a target device.

```

-- ASN1START

OTDOA-RequestCapabilities ::= SEQUENCE {
    ...
}

-- ASN1STOP

```

6.5.1.9 OTDOA Error Elements

– OTDOA-Error

The IE *OTDOA-Error* is used by the location server or target device to provide OTDOA error reasons to the target device or location server, respectively.

```

-- ASN1START

OTDOA-Error ::= CHOICE {
    locationServerErrorCauses      OTDOA-LocationServerErrorCauses,
    targetDeviceErrorCauses       OTDOA-TargetDeviceErrorCauses,
    ...
}

-- ASN1STOP

```

– OTDOA-LocationServerErrorCauses

The IE *OTDOA-LocationServerErrorCauses* is used by the location server to provide OTDOA error reasons to the target device.

```

-- ASN1START

OTDOA-LocationServerErrorCauses ::= SEQUENCE {
    cause      ENUMERATED {
        undefined,
        assistanceDataNotSupportedByServer,
        assistanceDataSupportedButCurrentlyNotAvailableByServer,
        ...
    },
    ...
}

-- ASN1STOP

```

```
-- ASN1STOP
```

– OTDOA-TargetDeviceErrorCauses

The IE *OTDOA-TargetDeviceErrorCauses* is used by the target device to provide OTDOA error reasons to the location server.

```
-- ASN1START
OTDOA-TargetDeviceErrorCauses ::= SEQUENCE {
  cause      ENUMERATED {
    undefined,
    assistance-data-missing,
    unableToMeasureReferenceCell,
    unableToMeasureAnyNeighbourCell,
    attemptedButUnableToMeasureSomeNeighbourCells,
    ...
  },
  ...
}
-- ASN1STOP
```

6.5.2 A-GNSS Positioning

6.5.2.1 GNSS Assistance Data

– A-GNSS-ProvideAssistanceData

The IE *A-GNSS-ProvideAssistanceData* is used by the location server to provide assistance data to enable UE-based and UE-assisted A-GNSS. It may also be used to provide GNSS positioning specific error reasons.

```
-- ASN1START
A-GNSS-ProvideAssistanceData ::= SEQUENCE {
  gnss-CommonAssistData      GNSS-CommonAssistData      OPTIONAL, -- Need ON
  gnss-GenericAssistData     GNSS-GenericAssistData     OPTIONAL, -- Need ON
  gnss-Error                  A-GNSS-Error               OPTIONAL, -- Need ON
  ...
}
-- ASN1STOP
```

– GNSS-CommonAssistData

The IE *GNSS-CommonAssistData* is used by the location server to provide assistance data which can be used for any GNSS (e.g., GPS, Galileo, GLONASS, etc.).

```
-- ASN1START
GNSS-CommonAssistData ::= SEQUENCE {
  gnss-ReferenceTime          GNSS-ReferenceTime        OPTIONAL, -- Need ON
  gnss-ReferenceLocation     GNSS-ReferenceLocation     OPTIONAL, -- Need ON
  gnss-IonosphericModel      GNSS-IonosphericModel      OPTIONAL, -- Need ON
  gnss-EarthOrientationParameters GNSS-EarthOrientationParameters OPTIONAL, -- Need ON
  ...
}
-- ASN1STOP
```

– GNSS-GenericAssistData

The IE *GNSS-GenericAssistData* is used by the location server to provide assistance data for a specific GNSS (e.g., GPS, Galileo, GLONASS, etc.). The specific GNSS for which the provided assistance data are applicable is indicated by the IE *GNSS-ID* and (if applicable) by the IE *SBAS-ID*. Assistance for up to 16 GNSSs can be provided.

```
-- ASN1START
GNSS-GenericAssistData ::= SEQUENCE (SIZE (1..16)) OF GNSS-GenericAssistDataElement
GNSS-GenericAssistDataElement ::= SEQUENCE {
  gnss-ID                GNSS-ID,
  sbas-ID                SBAS-ID                OPTIONAL, -- Cond GNSS-ID-SBAS
  gnss-TimeModels        GNSS-TimeModelList    OPTIONAL, -- Need ON
  gnss-DifferentialCorrections GNSS-DifferentialCorrections OPTIONAL, -- Need ON
  gnss-NavigationModel    GNSS-NavigationModel  OPTIONAL, -- Need ON
  gnss-RealTimeIntegrity  GNSS-RealTimeIntegrity  OPTIONAL, -- Need ON
  gnss-DataBitAssistance  GNSS-DataBitAssistance  OPTIONAL, -- Need ON
  gnss-AcquisitionAssistance GNSS-AcquisitionAssistance OPTIONAL, -- Need ON
  gnss-Almanac            GNSS-Almanac          OPTIONAL, -- Need ON
  gnss-UTC-Model          GNSS-UTC-Model        OPTIONAL, -- Need ON
  gnss-AuxiliaryInformation GNSS-AuxiliaryInformation OPTIONAL, -- Need ON
  ...
}
-- ASN1STOP
```

Conditional presence	Explanation
<i>GNSS-ID-SBAS</i>	The field is mandatory present if the <i>GNSS-ID</i> = <i>sbas</i> ; otherwise it is not present.

6.5.2.2 GNSS Assistance Data Elements

– GNSS-ReferenceTime

The IE *GNSS-ReferenceTime* is used by the location server to provide the GNSS specific system time with uncertainty and the relationship between GNSS system time and network air-interface timing of the eNodeB/NodeB/BTS transmission in the reference cell.

If the IE *networkTime* is present, the IEs *gnss-SystemTime* and *networkTime* provide a valid relationship between GNSS system time and air-interface network time, as seen at the approximate location of the target device, i.e. the propagation delay from the the eNodeB/NodeB/BTS to the target device shall be compensated for by the location server. Depending on implementation, the relation between GNSS system time and air-interface network time may have varying accuracy. The uncertainty of this timing relation is provided in the IE *referenceTimeUnc*. If the propagation delay from the eNodeB/NodeB/BTS to the target device is not accurately known, the location server shall use the best available approximation of the propagation delay and take the corresponding delay uncertainty into account in the calculation of the IE *referenceTimeUnc*.

If the IE *networkTime* is not present, the IE *gnssSystemTime* is an estimate of current GNSS system time at time of reception of the IE *GNSS-ReferenceTime* by the target device. The location server should achieve an accuracy of +/- 3 seconds for this estimate including allowing for the transmission delay between the location server and the target device. Note that the target device should further compensate *gnss-SystemTime* for the time between the reception of *GNSS-ReferenceTime* and the time when the *gnss-SystemTime* is used.

The location server shall provide a value for the *gnss-TimeID* only for GNSSs supported by the target device.

The IE *GNSS-ReferenceTimeForOneCell* can be provided multiple times (up to 16) to provide fine time assistance for several (neighbour) cells.

```
-- ASN1START
GNSS-ReferenceTime ::= SEQUENCE {
  gnss-SystemTime        GNSS-SystemTime,
  referenceTimeUnc        INTEGER (0..127)        OPTIONAL, -- Cond noFTA
  gnss-ReferenceTimeForCells SEQUENCE (SIZE (1..16)) OF
    GNSS-ReferenceTimeForOneCell  OPTIONAL, -- Need ON
  ...
}
-- ASN1STOP
```

```

GNSS-ReferenceTimeForOneCell ::= SEQUENCE {
    networkTime          NetworkTime,
    referenceTimeUnc     INTEGER (0..127),
    bsAlign              ENUMERATED {true} OPTIONAL,
    ...
}
-- ASN1STOP

```

Conditional presence	Explanation
<i>noFTA</i>	The field may be present if <i>gnss-ReferenceTimeForCells</i> is absent; otherwise it is not present.

GNSS-ReferenceTime field descriptions	
gnss-SystemTime	This field provides the specific GNSS system time.
networkTime	This field specifies the cellular network time at the epoch corresponding to <i>gnss-SystemTime</i> .
referenceTimeUnc	<p>This field provides the accuracy of the relation between <i>gnssSystemTime</i> and <i>networkTime</i> time if IE <i>networkTime</i> is provided. When IE <i>networkTime</i> is not provided, this field can be included to provide the accuracy of the provided <i>gnssSystemTime</i>.</p> <p>If GNSS TOD is the given GNSS time, then the true GNSS time, corresponding to the provided network time as observed at the target device location, lies in the interval [GNSS TOD - <i>referenceTimeUnc</i>, GNSS TOD + <i>referenceTimeUnc</i>].</p> <p>The uncertainty <i>r</i>, expressed in microseconds, is mapped to a number <i>K</i>, with the following formula:</p> $r = C * (((1+x)^K) - 1)$ <p>with <i>C</i> = 0.5 and <i>x</i> = 0.14. To encode any higher value of uncertainty than that corresponding in the above formula to <i>K</i>=127, the same value, <i>K</i>=127, shall also be used. The uncertainty is then coded on 7 bits, as the binary encoding of <i>K</i>. Example values for the <i>referenceTimeUnc</i> Format: see table K to uncertainty relation below.</p>
bsAlign	<p>This flag, if present, indicates that the transmission timings of all cells sharing, depending on the RAT, the same carrier frequency and Tracking Area/Location Area/Routing Area as the cell indicated, are frame aligned. This information allows the target device to derive the GNSS - cellular time relation for any of these cells based on the timing relation information provided in GNSS-ReferenceTime. The flag should be set consistently in all these cells. This flag does not guarantee SFN alignment.</p>

K to uncertainty relation

Value of K	Value of uncertainty
0	0 nanoseconds
1	70 nanoseconds
2	149.8 nanoseconds
-	-
50	349.62 microseconds
-	-
127	≥ 8.43 seconds

GNSS-SystemTime

```

-- ASN1START
GNSS-SystemTime ::= SEQUENCE {
    gnss-TimeID          GNSS-ID,
    gnss-DayNumber       INTEGER (0..32767),
    gnss-TimeOfDay       INTEGER (0..86399),
    gnss-TimeOfDayFrac-msec INTEGER (0..999) OPTIONAL, -- Need ON
    notificationOfLeapSecond BIT STRING (SIZE(2)) OPTIONAL, -- Cond gnss-TimeID-glonass
    gps-TOW-Assist       GPS-TOW-Assist OPTIONAL, -- Cond gnss-TimeID-gps
    ...
}
-- ASN1STOP

```

Conditional presence	Explanation
<i>gnss-TimeID-glonass</i>	The field may be present if <i>gnss-TimeID</i> =`glonass`; otherwise it is not present.
<i>gnss-TimeID-gps</i>	The field may be present if <i>gnss-TimeID</i> =`gps`; otherwise it is not present.

GNSS-SystemTime field descriptions	
<i>gnss-TimeID</i>	This field specifies the GNSS for which the <i>GNSS-SystemTime</i> is provided.
<i>gnss-DayNumber</i>	This field specifies the sequential number of days from the origin of the GNSS System Time as follows: GPS, QZSS, SBAS – Days from January 6 th 1980 00:00:00 UTC(USNO); Galileo – TBD; GLONASS – Days from January 1 st 1996.
<i>gnss-TimeOfDay</i>	This field specifies the integer number of seconds from the GNSS day change.
<i>gnss-TimeOfDayFrac-msec</i>	This field specifies the fractional part of the <i>gnssTimeOfDay</i> field in 1-milli-seconds resolution. The total GNSS TOD is <i>gnss-TimeOfDay</i> + <i>gnssTimeOfDayFrac-msec</i> .
<i>notificationOfLeapSecond</i>	This field specifies the notification of forthcoming leap second correction, as defined by parameter KP in [9, Table 4.7].
<i>gps-TOW-Assist</i>	This field contains several fields in the Telemetry (TLM) Word and Handover Word (HOW) that are currently being broadcast by the respective GPS satellites. Combining this information with GPS TOW enables the target device to know the entire 1.2-second (60-bit) pattern of TLM and HOW that is transmitted at the start of each six-second NAV subframe by the particular GPS satellite.

– GPS-TOW-Assist

```
-- ASN1START
GPS-TOW-Assist ::= SEQUENCE (SIZE(1..64)) OF GPS-TOW-AssistElement
GPS-TOW-AssistElement ::= SEQUENCE {
    satelliteID      INTEGER (1..64),
    tlmWord          INTEGER (0..16383),
    antiSpoof       INTEGER (0..1),
    alert           INTEGER (0..1),
    tlmRsvdBits     INTEGER (0..3),
    ...
}
-- ASN1STOP
```

GPS-TOW-Assist field descriptions	
<i>satelliteID</i>	This field identifies the satellite for which the <i>GPS-TOW-Assist</i> is applicable. This field is identical to the GPS PRN Signal No. defined in [4].
<i>tlmWord</i>	This field contains a 14-bit value representing the Telemetry Message (TLM) being broadcast by the GPS satellite identified by the particular <i>satelliteID</i> , with the MSB occurring first in the satellite transmission, as defined in [4].
<i>antiSpoof</i>	This field contains the Anti-Spoof flag that is being broadcast by the GPS satellite identified by <i>satelliteID</i> , as defined in [4].
<i>alert</i>	This field contains the Alert flag that is being broadcast by the GPS satellite identified by <i>satelliteID</i> , as defined in [4].
<i>tlmRsvdBits</i>	This field contains the two reserved bits in the TLM Word being broadcast by the GPS satellite identified by <i>satelliteID</i> , with the MSB occurring first in the satellite transmission, as defined in [4].

– NetworkTime

```
-- ASN1START
NetworkTime ::= SEQUENCE {
    secondsFromFrameStructureStart      INTEGER(0..12533),
```

```

fractionalSecondsFromFrameStructureStart  INTEGER(0..3999999),
frameDrift                                INTEGER (-64..63)  OPTIONAL,  -- Cond GNSSsynch
cellID      CHOICE {
  eUTRA      SEQUENCE {
    physCellId      INTEGER (0..503),
    cellGlobalIdEUTRA  CellGlobalIdEUTRA-AndUTRA  OPTIONAL,  -- Need ON
    earfcn          ARFCN-ValueEUTRA,
    ...
    [[ earfcn-v9a0  ARFCN-ValueEUTRA-v9a0  OPTIONAL  -- Cond EARFCN-max
    ]]
  },
  uTRA      SEQUENCE {
    mode      CHOICE {
      fdd      SEQUENCE {
        primary-CPICH-Info  INTEGER (0..511),
        ...
      },
      tdd      SEQUENCE {
        cellParameters      INTEGER (0..127),
        ...
      }
    },
    cellGlobalIdUTRA  CellGlobalIdEUTRA-AndUTRA  OPTIONAL,  -- Need ON
    uarfcn            ARFCN-ValueUTRA,
    ...
  },
  gSM      SEQUENCE {
    bcchCarrier      INTEGER (0..1023),
    bsic              INTEGER (0..63),
    cellGlobalIdGERAN  CellGlobalIdGERAN  OPTIONAL,  -- Need ON
    ...
  },
  ...
},
...
}
-- ASN1STOP

```

Conditional presence	Explanation
<i>EARFCN-max</i>	The field is mandatory present if the corresponding <i>earfcn</i> (i.e. without suffix) is set to <i>maxEARFCN</i> . Otherwise the field is not present.
<i>GNSSsynch</i>	The field is present and set to 0 if <i>NetworkTime</i> is synchronized to <i>gnss-SystemTime</i> ; otherwise the field is optionally present, need OR.

NetworkTime field descriptions

<p>secondsFromFrameStructureStart This field specifies the number of seconds from the beginning of the longest frame structure in the corresponding air interface. In case of E-UTRA, the SFN cycle length is 10.24 seconds. In case of UTRA, the SFN cycle length is 40.96 seconds. In case of GSM, the hyperframe length is 12533.76 seconds.</p>
<p>fractionalSecondsFromFrameStructureStart This field specifies the fractional part of the <i>secondsFromFrameStructureStart</i> in 250 ns resolution. The total time since the particular frame structure start is <i>secondsFromFrameStructureStart</i> + <i>fractionalSecondsFromFrameStructureStart</i></p>
<p>frameDrift This field specifies the drift rate of the GNSS-network time relation with scale factor 2^{-30} seconds/second, in the range from $-5.9605e-8$ to $+5.8673e-8$ sec/sec.</p>
<p>cellID This field specifies the cell for which the GNSS-network time relation is provided.</p>
<p>physCellId This field specifies the physical cell identity of the reference cell (E-UTRA), as defined in [12], for which the GNSS network time relation is provided.</p>
<p>cellGlobalIdEUTRA This field specifies the Evolved Cell Global Identifier (ECGI), the globally unique identity of a cell in E-UTRA, of the reference cell for the GNSS-network time relation, as defined in [12].</p>
<p>earfcn This field specifies E-ARFCN of the reference cell for the GNSS-network time relation (E-UTRA). In case the server includes <i>earfcn-v9a0</i>, the server shall set the corresponding <i>earfcn</i> (i.e. without suffix) to <i>maxEARFCN</i>.</p>

primary-CPICH-Info This field specifies the physical cell identity of the reference cell (UTRA) for the GNSS-network time relation, as defined in [13].
cellParameters This field specifies the physical cell identity of the reference cell (UTRA) for the GNSS-network time relation, as defined in [13].
cellGlobalIdUTRA The field specifies the global UTRAN Cell Identifier, the globally unique identity of a cell in UTRA, of the reference cell for the GNSS-network time relation, as defined in [13].
uarfcn This field specifies ARFCN of the reference cell for the GNSS-network time relation (UTRA).
bcchCarrier This field specifies the absolute GSM RF channel number of the BCCH of the reference base station (GERAN) for the GNSS-network time relation, as defined in [14].
bsic This field specifies the Base Station Identity Code of the reference base station (GERAN) for the GNSS-network time relation, as defined in [14].
cellGlobalIdGERAN This field specifies the Cell Global Identification (CGI), the globally unique identity of a cell in GERAN, of the reference base station for the GNSS-network time relation.

– GNSS-ReferenceLocation

The IE *GNSS-ReferenceLocation* is used by the location server to provide the target device with a-priori knowledge of its location in order to improve GNSS receiver performance. The IE *GNSS-ReferenceLocation* is provided in WGS-84 reference system.

```
-- ASN1START
GNSS-ReferenceLocation ::= SEQUENCE {
    threeDlocation          EllipsoidPointWithAltitudeAndUncertaintyEllipsoid,
    ...
}
-- ASN1STOP
```

– GNSS-IonosphericModel

The IE *GNSS-IonosphericModel* is used by the location server to provide parameters to model the propagation delay of the GNSS signals through the ionosphere. Proper use of these fields allows a single-frequency GNSS receiver to remove parts of the ionospheric delay from the pseudorange measurements. Two Ionospheric Models are supported: The Klobuchar model as defined in [4], and the NeQuick model as defined in [8].

```
-- ASN1START
GNSS-IonosphericModel ::= SEQUENCE {
    klobucharModel          KlobucharModelParameter          OPTIONAL,  -- Need ON
    neQuickModel            NeQuickModelParameter            OPTIONAL,  -- Need ON
    ...
}
-- ASN1STOP
```

– KlobucharModelParameter

```
-- ASN1START
KlobucharModelParameter ::= SEQUENCE {
    dataID                  BIT STRING (SIZE (2)),
    alfa0                   INTEGER (-128..127),
    alfa1                   INTEGER (-128..127),
    alfa2                   INTEGER (-128..127),
    alfa3                   INTEGER (-128..127),
    beta0                   INTEGER (-128..127),
    beta1                   INTEGER (-128..127),
    beta2                   INTEGER (-128..127),
}
-- ASN1STOP
```



```

    beta3          INTEGER (-128..127),
    ...
}
-- ASN1STOP

```

***KlobucharModelParameter* field descriptions**

<i>dataID</i>
When <i>dataID</i> has the value "11" it indicates that the parameters have been generated by QZSS, and the parameters have been specialized and are applicable within the area defined in [7]. When <i>dataID</i> has the value "00" it indicates the parameters are applicable worldwide [4,7]. All other values for <i>dataID</i> are reserved.
<i>alpha0</i>
This field specifies the α_0 parameter of the Klobuchar model, as specified in [4]. Scale factor 2^{-30} seconds.
<i>alpha1</i>
This field specifies the α_1 parameter of the Klobuchar model, as specified in [4]. Scale factor 2^{-27} seconds/semi-circle.
<i>alpha2</i>
This field specifies the α_2 parameter of the Klobuchar model, as specified in [4]. Scale factor 2^{-24} seconds/semi-circle ² .
<i>alpha3</i>
This field specifies the α_3 parameter of the Klobuchar model, as specified in [4]. Scale factor 2^{-24} seconds/semi-circle ³ .
<i>beta0</i>
This field specifies the β_0 parameter of the Klobuchar model, as specified in [4]. Scale factor 2^{11} seconds.
<i>beta1</i>
This field specifies the β_1 parameter of the Klobuchar model, as specified in [4]. Scale factor 2^{14} seconds/semi-circle.
<i>beta2</i>
This field specifies the β_2 parameter of the Klobuchar model, as specified in [4]. Scale factor 2^{16} seconds/semi-circle ² .
<i>beta3</i>
This field specifies the β_3 parameter of the Klobuchar model, as specified in [4]. Scale factor 2^{16} seconds/semi-circle ³ .

– NeQuickModelParameter

```

-- ASN1START
NeQuickModelParameter ::= SEQUENCE {
    ai0          INTEGER (0..4095),
    ai1          INTEGER (0..4095),
    ai2          INTEGER (0..4095),
    ionoStormFlag1  INTEGER (0..1)      OPTIONAL,  -- Need OP
    ionoStormFlag2  INTEGER (0..1)      OPTIONAL,  -- Need OP
    ionoStormFlag3  INTEGER (0..1)      OPTIONAL,  -- Need OP
    ionoStormFlag4  INTEGER (0..1)      OPTIONAL,  -- Need OP
    ionoStormFlag5  INTEGER (0..1)      OPTIONAL,  -- Need OP
    ...
}
-- ASN1STOP

```

***NeQuickModelParameter* field descriptions**

<i>ai0, ai1, ai2</i>
These fields are used to estimate the ionospheric distortions on pseudoranges as described in [8] on page 71.
<i>ionoStormFlag1, ionoStormFlag2, ionoStormFlag3, ionoStormFlag4, ionoStormFlag5</i>
These fields specify the ionosphere storm flags (1,...,5) for five different regions as described in [8] on page 71. If the ionosphere storm flag for a region is not present the target device shall treat the ionosphere storm condition as unknown.

– GNSS-EarthOrientationParameters

The IE *GNSS-EarthOrientationParameters* is used by the location server to provide parameters to construct the ECEF and ECI coordinate transformation as defined in [4]. The IE *GNSS-EarthOrientationParameters* indicates the relationship between the Earth's rotational axis and WGS-84 reference system.

```
-- ASN1START
GNSS-EarthOrientationParameters ::= SEQUENCE {
    teop                INTEGER (0..65535),
    pmX                 INTEGER (-1048576..1048575),
    pmXdots             INTEGER (-16384..16383),
    pmY                 INTEGER (-1048576..1048575),
    pmYdots             INTEGER (-16384..16383),
    deltaUT1           INTEGER (-1073741824..1073741823),
    deltaUT1dots       INTEGER (-262144..262143),
    ...
}
-- ASN1STOP
```

GNSS-EarthOrientationParameters field descriptions

teop	This field specifies the EOP data reference time in seconds, as specified in [4]. Scale factor 2^1 seconds.
pmX	This field specifies the X-axis polar motion value at reference time in arc-seconds, as specified in [4]. Scale factor 2^{20} arc-seconds.
pmXdots	This field specifies the X-axis polar motion drift at reference time in arc-seconds/day, as specified in [4]. Scale factor 2^{21} arc-seconds/day.
pmY	This field specifies the Y-axis polar motion value at reference time in arc-seconds, as specified in [4]. Scale factor 2^{20} arc-seconds.
pmYdots	This field specifies the Y-axis polar motion drift at reference time in arc-seconds/day, as specified in [4]. Scale factor 2^{21} arc-seconds/day.
deltaUT1	This field specifies the UT1-UTC difference at reference time in seconds, as specified in [4]. Scale factor 2^{24} seconds.
deltaUT1dots	This field specifies the Rate of UT1-UTC difference at reference time in seconds/day, as specified in [4]. Scale factor 2^{25} seconds/day.

– GNSS-TimeModelList

The IE *GNSS-TimeModelList* is used by the location server to provide the GNSS-GNSS system time offset between the GNSS system time indicated by IE *GNSS-ID* in IE *GNSS-GenericAssistDataElement* to the GNSS system time indicated by IE *gnss-TO-ID*. Several *GNSS-TimeModelElement* IEs can be included with different *gnss-TO-ID* fields.

```
-- ASN1START
GNSS-TimeModelList ::= SEQUENCE (SIZE (1..15)) OF GNSS-TimeModelElement
GNSS-TimeModelElement ::= SEQUENCE {
    gnss-TimeModelRefTime    INTEGER (0..65535),
    tA0                      INTEGER (-67108864..67108863),
    tA1                      INTEGER (-4096..4095)                OPTIONAL, -- Need ON
    tA2                      INTEGER (-64..63)                    OPTIONAL, -- Need ON
    gnss-TO-ID               INTEGER (1..15),
    weekNumber               INTEGER (0..8191)                    OPTIONAL, -- Need ON
    deltaT                   INTEGER (-128..127)                OPTIONAL, -- Need ON
    ...
}
-- ASN1STOP
```

GNSS-TimeModelElement field descriptions	
gnss-TimeModelRefTime	This field specifies the reference time of week for <i>GNSS-TimeModelElement</i> and it is given in GNSS specific system time. Scale factor 2^4 seconds.
tA0	This field specifies the bias coefficient of the <i>GNSS-TimeModelElement</i> . Scale factor 2^{-35} seconds.
tA1	This field specifies the drift coefficient of the <i>GNSS-TimeModelElement</i> . Scale factor of 2^{-51} seconds/second.
tA2	This field specifies the drift rate correction coefficient of the <i>GNSS-TimeModelElement</i> . Scale factor of 2^{-68} seconds/second ² .
gnss-TO-ID	This field specifies the GNSS system time of the GNSS for which the <i>GNSS-TimeModelElement</i> is applicable. <i>GNSS-TimeModelElement</i> contains parameters to convert GNSS system time from the system indicated by <i>GNSS-ID</i> to GNSS system time indicated by <i>gnss-TO-ID</i> . The conversion is defined in [4,5,6]. See table of <i>gnss-TO-ID</i> to Indication relation below.
weekNumber	This field specifies the reference week of the <i>GNSS-TimeModelElement</i> given in GNSS specific system time. Scale factor 1 week.
deltaT	This field specifies the integer number of seconds of the GNSS-GNSS time offset provided in the <i>GNSS-TimeModelElement</i> . Scale factor 1 second.

gnss-TO-ID to Indication relation

Value of <i>gnss-TO-ID</i>	Indication
1	GPS
2	Galileo
3	QZSS
4	GLONASS
5-15	reserved

– GNSS-DifferentialCorrections

The IE *GNSS-DifferentialCorrections* is used by the location server to provide differential GNSS corrections to the target device for a specific GNSS. Differential corrections can be provided for up to 3 signals per GNSS.

```
-- ASN1START
GNSS-DifferentialCorrections ::= SEQUENCE {
    dgnss-RefTime      INTEGER (0..3599),
    dgnss-SgnTypeList  DGNSS-SgnTypeList,
    ...
}

DGNSS-SgnTypeList ::= SEQUENCE (SIZE (1..3)) OF DGNSS-SgnTypeElement

DGNSS-SgnTypeElement ::= SEQUENCE {
    gnss-SignalID      GNSS-SignalID,
    gnss-StatusHealth  INTEGER (0..7),
    dgnss-SatList      DGNSS-SatList,
    ...
}

DGNSS-SatList ::= SEQUENCE (SIZE (1..64)) OF DGNSS-CorrectionsElement

DGNSS-CorrectionsElement ::= SEQUENCE {
    svID                SV-ID,
    iod                 BIT STRING (SIZE(11)),
    udre                INTEGER (0..3),
    pseudoRangeCor      INTEGER (-2047..2047),
    rangeRateCor        INTEGER (-127..127),
    udreGrowthRate      INTEGER (0..7)          OPTIONAL,  -- Need ON
    udreValidityTime    INTEGER (0..7)          OPTIONAL,  -- Need ON
}
```

```

}
...
-- ASN1STOP

```

GNSS-DifferentialCorrections field descriptions

dgnss-RefTime

This field specifies the time for which the DGNSS corrections are valid, modulo 1 hour. *dgnss-RefTime* is given in GNSS specific system time.

Scale factor 1-second.

dgnss-SgnTypeList

This list includes differential correction data for different GNSS signal types, identified by *GNSS-SignalID*.

gnss-StatusHealth

This field specifies the status of the differential corrections. The values of this field and their respective meanings are defined as in table *gnss-StatusHealth* Value to Indication relation below.

The first six values in this field indicate valid differential corrections. When using the values described below, the "UDRE Scale Factor" value is applied to the UDRE values contained in the element. The purpose is to indicate an estimate in the amount of error in the corrections.

The value "110" indicates that the source of the differential corrections (e.g., reference station or external DGNSS network) is currently not being monitored. The value "111" indicates that the corrections provided by the source are invalid, as judged by the source.

dgnss-SatList

This list includes differential correction data for different GNSS satellites, identified by *SV-ID*.

iod

This field specifies the Issue of Data field which contains the identity for the *GNSS-NavigationModel*.

udre

This field provides an estimate of the uncertainty (1- σ) in the corrections for the particular satellite. The value in this field shall be multiplied by the UDRE Scale Factor in the *gnss-StatusHealth* field to determine the final UDRE estimate for the particular satellite. The meanings of the values for this field are shown in the table *udre* Value to Indication relation below.

pseudoRangeCor

This field specifies the correction to the pseudorange for the particular satellite at *dgnss-RefTime*, t_0 . The value of this field is given in meters and the scale factor is 0.32 meters in the range of ± 655.04 meters. The method of calculating this field is described in [11].

If the location server has received a request for GNSS assistance data from a target device which included a request for the GNSS Navigation Model and DGNSS, the location server shall determine, for each satellite, if the navigation model stored by the target device is still suitable for use with DGNSS corrections and if so and if DGNSS corrections are supported the location server should send DGNSS corrections without including the GNSS Navigation Model. The *iod* value sent for a satellite shall always be the IOD value that corresponds to the navigation model for which the pseudo-range corrections are applicable.

The target device shall only use the *pseudoRangeCor* value when the IOD value received matches its available navigation model.

Pseudo-range corrections are provided with respect to GNSS specific geodetic datum (e.g., PZ-90.02 if *GNSS-ID* indicates GLONASS).

Scale factor 0.32 meters.

rangeRateCor

This field specifies the rate-of-change of the pseudorange correction for the particular satellite, using the satellite ephemeris and clock corrections identified by the *iod* field. The value of this field is given in meters per second and the resolution is 0.032 meters/sec in the range of ± 4.064 meters/sec. For some time $t_1 > t_0$, the corrections for *iod* are estimated by

$$\text{PRC}(t_1, \text{IOD}) = \text{PRC}(t_0, \text{IOD}) + \text{RRC}(t_0, \text{IOD}) \cdot (t_1 - t_0) ,$$

and the target device uses this to correct the pseudorange it measures at t_1 , $\text{PR}_m(t_1, \text{IOD})$, by

$$\text{PR}(t_1, \text{IOD}) = \text{PR}_m(t_1, \text{IOD}) + \text{PRC}(t_1, \text{IOD}) .$$

The location server shall always send the RRC value that corresponds to the PRC value that it sends. The target device shall only use the RRC value when the *iod* value received matches its available navigation model.

Scale factor 0.032 meters/second.

udreGrowthRate

This field provides an estimate of the growth rate of uncertainty (1- σ) in the corrections for the particular satellite identified by *SV-ID*. The estimated UDRE at time value specified in the *udreValidityTime* t_1 is calculated as follows:

$$\text{UDRE}(t_0+t_1) = \text{UDRE}(t_0) \times \text{udreGrowthRate} ,$$

where t_0 is the DGNSS Reference Time *dgnss-RefTime* for which the corrections are valid, t_1 is the *udreValidityTime* field, $\text{UDRE}(t_0)$ is the value of the *udre* field, and *udreGrowthRate* field is the factor as shown in the table Value of *udreGrowthRate* to Indication relation below.

udreValidityTime

This field specifies the time when the *udreGrowthRate* field applies and is included if *udreGrowthRate* is included. The meaning of the values for this field is as shown in the table Value of *udreValidityTime* to Indication relation below.

gnss-StatusHealth Value to Indication relation

gnss-StatusHealth Value	Indication
000	UDRE Scale Factor = 1.0
001	UDRE Scale Factor = 0.75
010	UDRE Scale Factor = 0.5
011	UDRE Scale Factor = 0.3
100	UDRE Scale Factor = 0.2
101	UDRE Scale Factor = 0.1
110	Reference Station Transmission Not Monitored
111	Data is invalid - disregard

udre Value to Indication relation

udre Value	Indication
00	UDRE \leq 1.0 m
01	1.0 m < UDRE \leq 4.0 m
10	4.0 m < UDRE \leq 8.0 m
11	8.0 m < UDRE

Value of udreGrowthRate to Indication relation

Value of udreGrowthRate	Indication
000	1.5
001	2
010	4
011	6
100	8
101	10
110	12
111	16

Value of udreValidityTime to Indication relation

Value of udreValidityTime	Indication [seconds]
000	20
001	40
010	80
011	160
100	320
101	640
110	1280
111	2560

GNSS-NavigationModel

The IE *GNSS-NavigationModel* is used by the location server to provide precise navigation data to the GNSS capable target device. In response to a request from a target device for GNSS Assistance Data, the location server shall determine whether to send the navigation model for a particular satellite to a target device based upon factors like the T-Toe limit specified by the target device and any request from the target device for DGNSS (see also *GNSS-DifferentialCorrections*). GNSS Orbit Model can be given in Keplerian parameters or as state vector in Earth-Centered Earth-Fixed coordinates, dependent on the *GNSS-ID* and the target device capabilities. The meaning of these parameters is defined in relevant ICDs of the particular GNSS and GNSS specific interpretations apply. For example, GPS and QZSS use the same model parameters but some parameters have a different interpretation [7].

-- ASN1START

```

GNSS-NavModel ::= SEQUENCE {
    nonBroadcastIndFlag    INTEGER (0..1),
    gnss-SatelliteList    GNSS-NavModelSatelliteList,
    ...
}

GNSS-NavModelSatelliteList ::= SEQUENCE (SIZE(1..64)) OF GNSS-NavModelSatelliteElement

GNSS-NavModelSatelliteElement ::= SEQUENCE {
    svID                  SV-ID,
    svHealth              BIT STRING (SIZE(8)),
    iod                   BIT STRING (SIZE(11)),
    gnss-ClockModel       GNSS-ClockModel,
    gnss-OrbitModel       GNSS-OrbitModel,
    ...
}

GNSS-ClockModel ::= CHOICE {
    standardClockModelList StandardClockModelList,      -- Model-1
    nav-ClockModel          NAV-ClockModel,              -- Model-2
    cnav-ClockModel         CNAV-ClockModel,             -- Model-3
    glonass-ClockModel      GLONASS-ClockModel,         -- Model-4
    sbas-ClockModel         SBAS-ClockModel,             -- Model-5
    ...
}

GNSS-OrbitModel ::= CHOICE {
    keplerianSet           NavModelKeplerianSet,         -- Model-1
    nav-KeplerianSet       NavModelNAV-KeplerianSet,     -- Model-2
    cnav-KeplerianSet      NavModelCNAV-KeplerianSet,    -- Model-3
    glonass-ECEF           NavModel-GLONASS-ECEF,       -- Model-4
    sbas-ECEF              NavModel-SBAS-ECEF,          -- Model-5
    ...
}

-- ASN1STOP
    
```

GNSS-NavModel field descriptions	
nonBroadcastIndFlag	This field indicates if the <i>GNSS-NavModel</i> elements are not derived from satellite broadcast data or are given in a format not native to the GNSS. A value of 0 means the <i>GNSS-NavModel</i> data elements correspond to GNSS satellite broadcasted data; a value of 1 means the <i>GNSS-NavModel</i> data elements are not derived from satellite broadcast.
gnss-SatelliteList	This list provides ephemeris and clock corrections for GNSS satellites indicated by <i>SV-ID</i> .
svHealth	This field specifies the satellite's current health. The health values are GNSS system specific. The interpretation of <i>svHealth</i> depends on the <i>GNSS-ID</i> and is as shown in table GNSS to <i>svHealth</i> Bit String(8) relation below.
iod	This field specifies the Issue of Data and contains the identity for GNSS Navigation Model. In case of broadcasted GPS NAV ephemeris, the <i>iod</i> contains the IODC as described in [4]. In case of broadcasted Modernized GPS ephemeris, the <i>iod</i> contains the 11-bit parameter t_{oe} as defined in [4, Table 30-1] [6, Table 3.5-1]. In case of broadcasted SBAS ephemeris, the <i>iod</i> contains the 8 bits Issue of Data as defined in [10] Message Type 9. In case of broadcasted QZSS QZS-L1C/L2C/L5 ephemeris, the <i>iod</i> contains the IODC as described in [7]. In case of broadcasted QZSS QZS-L1C/L2C/L5 ephemeris, the <i>iod</i> contains the 11-bit parameter t_{oe} as defined in [7]. In case of broadcasted GLONASS ephemeris, the <i>iod</i> contains the parameter t_b as defined in [9]. In the case of broadcasted Galileo ephemeris, the <i>iod</i> contains the IOD index as described in [8]. The interpretation of <i>iod</i> depends on the <i>GNSS-ID</i> and is as shown in table GNSS to <i>iod</i> Bit String(11) relation below.

GNSS to svHealth Bit String(8) relation

GNSS	svHealth Bit String(8)							
	Bit 1 (MSB)	Bit 2	Bit 3	Bit 4	Bit 5	Bit 6	Bit 7	Bit 8 (LSB)
GPS L1/CA ⁽¹⁾	SV Health [4]						"0" (reserved)	"0" (reserved)
Modernized GPS ⁽²⁾	L1C Health [6]	L1 Health [4,5]	L2 Health [4,5]	L5 Health [4,5]	"0" (reserved)	"0" (reserved)	"0" (reserved)	"0" (reserved)
SBAS ⁽³⁾	Ranging On (0), Off(1)	Corrections On(0), Off(1)	Integrity On(0), Off(1)	"0" (reserved)	"0" (reserved)	"0" (reserved)	"0" (reserved)	"0" (reserved)

	[10]	[10]	1)[10]						
QZSS ⁽⁴⁾ QZS-L1	SV Health [7]						"0" (reserved)	"0" (reserved)	
QZSS ⁽⁵⁾ QZS- L1C/L2C/L5	L1C Health [7]	L1 Health [7]	L2 Health [7]	L5 Health [7]	"0" (reserved)	"0" (reserved)	"0" (reserved)	"0" (reserved)	
GLONASS	B _n (MSB) [9, page 30]	F _T [9, Table 4.4]				"0" (reserved)	"0" (reserved)	"0" (reserved)	
Galileo [8, pages 75- 76]	E5a Data Validity Status	E5b Data Validity Status	E1-B Data Validity Status	E5a Signal Health Status See [8], Table 67	"0" (reserved)	"0" (reserved)	"0" (reserved)		
<p>Note 1: If GNSS-ID indicates "gps", and GNSS Orbit Model-2 is included, this interpretation of <i>svHealth</i> applies.</p> <p>Note 2: If GNSS-ID indicates "gps", and GNSS Orbit Model-3 is included, this interpretation of <i>svHealth</i> applies. If a certain signal is not supported on the satellite indicated by <i>SV-ID</i>, the corresponding health bit shall be set to "1" (i.e., signal can not be used).</p> <p>Note 3: <i>svHealth</i> in case of GNSS-ID indicates "sbas" includes the 5 LSBs of the Health included in GEO Almanac Message Parameters (Type 17) [10].</p> <p>Note 4: If GNSS-ID indicates "qzss", and GNSS Orbit Model-2 is included, this interpretation of <i>svHealth</i> applies.</p> <p>Note 5: If GNSS-ID indicates "qzss", and GNSS Orbit Model-3 is included, this interpretation of <i>svHealth</i> applies.</p>									

GNSS to iod Bit String(11) relation

GNSS	iod Bit String(11)										
	Bit 1 (MSB)	Bit 2	Bit 3	Bit 4	Bit 5	Bit 6	Bit 7	Bit 8	Bit 9	Bit 10	Bit 11 (LSB)
GPS L1/CA	"0"	Issue of Data, Clock [4]									
Modernized GPS	t _{oe} (seconds, scale factor 300, range 0 – 604500) [4,5,6]										
SBAS	"0"	"0"	"0"	Issue of Data ([10], Message Type 9)							
QZSS QZS-L1	"0"	Issue of Data, Clock [7]									
QZSS QZS- L1C/L2C/L5	t _{oe} (seconds, scale factor 300, range 0 – 604500) [7]										
GLONASS	"0"	"0"	"0"	"0"	t _b (minutes, scale factor 15, range 0 – 1425) [9]						
Galileo	"0"	IOD [8]									

StandardClockModelList

```

-- ASN1START
StandardClockModelList ::= SEQUENCE (SIZE(1..2)) OF StandardClockModelElement
StandardClockModelElement ::= SEQUENCE {
    stanClockToc    INTEGER (0..16383),
    stanClockAF2    INTEGER (-2048..2047),
    stanClockAF1    INTEGER (-131072..131071),
    stanClockAF0    INTEGER (-134217728..134217727),
    stanClockTgd    INTEGER (-512..511)                OPTIONAL, -- Need ON
    stanModelID     INTEGER (0..1)                    OPTIONAL, -- Need ON
    ...
}
-- ASN1STOP
    
```

StandardClockModelList field descriptions

<p>standardClockModelList <i>gnss-ClockModel</i> Model-1 contains one or two clock model elements depending on the GNSS. If included, clock Model-1 shall be included once or twice depending on the target device capability. If the target device is supporting multiple Galileo signals, the location server shall include both F/Nav and I/Nav clock models in <i>gnss-ClockModel</i> if the location server assumes the target device to perform location information calculation using multiple signals.</p>
<p>stanClockToc Parameter t_{oc} defined in [8]. Scale factor 60 seconds.</p>
<p>stanClockAF2 Parameter af₂ defined in [8]. Scale factor 2⁶⁵ seconds/second².</p>

StandardClockModelList field descriptions
<p>stanClockAF1 Parameter a_{f1} defined in [8]. Scale factor 2^{-45} seconds/second.</p>
<p>stanClockAF0 Parameter a_{f0} defined in [8]. Scale factor 2^{-33} seconds.</p>
<p>stanClockTgd Parameter T_{GD} defined in [8]. Scale factor 2^{32} seconds. This field is required if the target device supports only single frequency Galileo signal.</p>
<p>stanModelID This field specifies the identity of the clock model according to the table Value of stanModelID to Identity relation below. This field is required if the location server includes both F/Nav and I/Nav Galileo clock models in <i>gnss-ClockModel</i>.</p>

Value of stanModelID to Identity relation

Value of stanModelID	Identity
0	I/Nav
1	F/Nav

– NAV-ClockModel

```
-- ASN1START
NAV-ClockModel ::= SEQUENCE {
    navToc          INTEGER (0..37799),
    navaf2          INTEGER (-128..127),
    navaf1          INTEGER (-32768..32767),
    navaf0          INTEGER (-2097152..2097151),
    navTgd          INTEGER (-128..127),
    ...
}
-- ASN1STOP
```

NAV-ClockModel field descriptions
<p>navToc Parameter t_{oc}, time of clock (seconds) [4,7] Scale factor 2^4 seconds.</p>
<p>navaf2 Parameter a_{f2}, clock correction polynomial coefficient (sec/sec²) [4,7]. Scale factor 2^{55} seconds/second².</p>
<p>navaf1 Parameter a_{f1}, clock correction polynomial coefficient (sec/sec) [4,7]. Scale factor 2^{43} seconds/second.</p>
<p>navaf0 Parameter a_{f0}, clock correction polynomial coefficient (seconds) [4,7]. Scale factor 2^{31} seconds.</p>
<p>navTgd Parameter T_{GD}, group delay (seconds) [4,7]. Scale factor 2^{31} seconds.</p>

– CNAV-ClockModel

```
-- ASN1START
CNAV-ClockModel ::= SEQUENCE {
    cnavToc          INTEGER (0..2015),
    cnavTop          INTEGER (0..2015),
    cnavURA0        INTEGER (-16..15),
    cnavURA1        INTEGER (0..7),

```



```

cnavURA2      INTEGER (0..7),
cnavAf2       INTEGER (-512..511),
cnavAf1       INTEGER (-524288..524287),
cnavAf0       INTEGER (-33554432..33554431),
cnavTgd       INTEGER (-4096..4095),
cnavISCl1cp   INTEGER (-4096..4095)      OPTIONAL, -- Need ON
cnavISCl1cd   INTEGER (-4096..4095)      OPTIONAL, -- Need ON
cnavISCl1ca   INTEGER (-4096..4095)      OPTIONAL, -- Need ON
cnavISCl2c    INTEGER (-4096..4095)      OPTIONAL, -- Need ON
cnavISCl5i5   INTEGER (-4096..4095)      OPTIONAL, -- Need ON
cnavISCl5q5   INTEGER (-4096..4095)      OPTIONAL, -- Need ON
...
}
-- ASN1STOP

```

CNAV-ClockModel field descriptions

<p>cnavToc Parameter t_{oc}, clock data reference time of week (seconds) [4,5,6,7]. Scale factor 300 seconds.</p>
<p>cnavTop Parameter t_{op}, clock data predict time of week (seconds) [4,5,6,7]. Scale factor 300 seconds</p>
<p>cnavURA0 Parameter URA_{oc} Index, SV clock accuracy index (dimensionless) [4,5,6,7].</p>
<p>cnavURA1 Parameter URA_{oc1} Index, SV clock accuracy change index (dimensionless) [4,5,6,7].</p>
<p>cnavURA2 Parameter URA_{oc2} Index, SV clock accuracy change rate index (dimensionless) [4,5,6,7].</p>
<p>cnavAf2 Parameter a_{r2-n_1}, SV clock drift rate correction coefficient (sec/sec^2) [4,5,6,7]. Scale factor 2^{-60} seconds/second².</p>
<p>cnavAf1 Parameter a_{r1-n_1}, SV clock drift correction coefficient (sec/sec) [4,5,6,7]. Scale factor 2^{-48} seconds/second.</p>
<p>cnavAf0 Parameter a_{r0-n_1}, SV clock bias correction coefficient (seconds) [4,5,6,7]. Scale factor 2^{-35} seconds.</p>
<p>cnavTgd Parameter T_{GD}, Group delay correction (seconds) [4,5,6,7]. Scale factor 2^{-35} seconds.</p>
<p>cnavISCl1cp Parameter ISC_{L1CP}, inter signal group delay correction (seconds) [6,7]. Scale factor 2^{-35} seconds. The location server should include this field if the target device is GPS capable and supports the $L1_C$ signal.</p>
<p>cnavISCl1cd Parameter ISC_{L1CD}, inter signal group delay correction (seconds) [6,7]. Scale factor 2^{-35} seconds. The location server should include this field if the target device is GPS capable and supports the $L1_C$ signal.</p>
<p>cnavISCl1ca Parameter ISC_{L1CA}, inter signal group delay correction (seconds) [4,5,7]. Scale factor 2^{-35} seconds. The location server should include this field if the target device is GPS capable and supports the $L1_{CA}$ signal.</p>
<p>cnavISCl2c Parameter ISC_{L2C}, inter signal group delay correction (seconds) [4,5,7]. Scale factor 2^{-35} seconds. The location server should include this field if the target device is GPS capable and supports the $L2_C$ signal.</p>
<p>cnavISCl5i5 Parameter ISC_{L5i5}, inter signal group delay correction (seconds) [5,7]. Scale factor 2^{-35} seconds. The location server should include this field if the target device is GPS capable and supports the $L5$ signal.</p>
<p>cnavISCl5q5 Parameter ISC_{L5Q5}, inter signal group delay correction (seconds) [5,7]. Scale factor 2^{-35} seconds. The location server should include this field if the target device is GPS capable and supports the $L5$ signal.</p>

GLONASS-ClockModel

```

-- ASN1START
GLONASS-ClockModel ::= SEQUENCE {
    gloTau          INTEGER (-2097152..2097151),
    gloGamma        INTEGER (-1024..1023),
    gloDeltaTau     INTEGER (-16..15)           OPTIONAL,  -- Need ON
    ...
}
-- ASN1STOP

```

GLONASS-ClockModel field descriptions

gloTau

Parameter $\tau_n(t_b)$, satellite clock offset (seconds) [9].
Scale factor 2^{30} seconds.

gloGamma

Parameter $\gamma_n(t_b)$, relative frequency offset from nominal value (dimensionless) [9].
Scale factor 2^{40} .

gloDeltaTau

Parameter $\Delta\tau_n$, time difference between transmission in G2 and G1 (seconds) [9].
Scale factor 2^{30} seconds.

The location server should include this parameter if the target device is dual frequency GLONASS receiver capable.

SBAS-ClockModel

```

-- ASN1START
SBAS-ClockModel ::= SEQUENCE {
    sbasTo          INTEGER (0..5399),
    sbasAgfo        INTEGER (-2048..2047),
    sbasAgf1        INTEGER (-128..127),
    ...
}
-- ASN1STOP

```

SBAS-ClockModel field descriptions

sbasTo

Parameter t_0 [10].
Scale factor 16 seconds.

sbasAgfo

Parameter a_{Gfo} [10].
Scale factor 2^{31} seconds.

sbasAgf1

Parameter a_{Gf1} [10].
Scale factor 2^{40} seconds/second.

NavModelKeplerianSet

```

-- ASN1START
NavModelKeplerianSet ::= SEQUENCE {
    keplerToe       INTEGER (0 .. 16383),
    keplerW         INTEGER (-2147483648..2147483647),
    keplerDeltaN    INTEGER (-32768..32767),
    keplerM0        INTEGER (-2147483648..2147483647),
    keplerOmegaDot  INTEGER (-8388608.. 8388607),
    keplerE         INTEGER (0..4294967295),
    keplerIDot      INTEGER (-8192..8191),
    keplerAPowerHalf INTEGER (0.. 4294967295),
    keplerI0        INTEGER (-2147483648..2147483647),
    keplerOmega0    INTEGER (-2147483648..2147483647),
    keplerCrs       INTEGER (-32768..32767),
    keplerCis       INTEGER (-32768..32767),
    keplerCus       INTEGER (-32768..32767),

```

```

    keplerCrc      INTEGER (-32768..32767),
    keplerCic      INTEGER (-32768..32767),
    keplerCuc      INTEGER (-32768..32767),
    ...
}
-- ASN1STOP

```

NavModelKeplerianSet field descriptions

<p>keplerToe Parameter t_{oe}, time-of-ephemeris in seconds [8]. Scale factor 60 seconds.</p>
<p>keplerW Parameter ω, argument of perigee (semi-circles) [8]. Scale factor 2^{-31} semi-circles.</p>
<p>keplerDeltaN Parameter Δn, mean motion difference from computed value (semi-circles/sec) [8]. Scale factor 2^{-43} semi-circles/second.</p>
<p>keplerM0 Parameter M_0, mean anomaly at reference time (semi-circles) [8]. Scale factor 2^{-31} semi-circles.</p>
<p>keplerOmegaDot Parameter $OMEGA_{dot}$, longitude of ascending node of orbit plane at weekly epoch (semi-circles/sec) [8]. Scale factor 2^{-43} semi-circles/second.</p>
<p>keplerE Parameter e, eccentricity [8]. Scale factor 2^{-33}.</p>
<p>KeplerIDot Parameter $Idot$, rate of inclination angle (semi-circles/sec) [8]. Scale factor 2^{-43} semi-circles/second.</p>
<p>keplerAPowerHalf Parameter \sqrt{a}, semi-major Axis in (meters)^{1/2} [8]. Scale factor 2^{-19} meters^{1/2}.</p>
<p>keplerI0 Parameter i_0, inclination angle at reference time (semi-circles) [8]. Scale factor 2^{-31} semi-circles.</p>
<p>keplerOmega0 Parameter $OMEGA_0$, longitude of ascending node of orbit plane at weekly epoch (semi-circles) [8]. Scale factor 2^{-31} semi-circles.</p>
<p>keplerCrs Parameter C_{rs}, amplitude of the sine harmonic correction term to the orbit radius (meters) [8]. Scale factor 2^{-5} meters.</p>
<p>keplerCis Parameter C_{is}, amplitude of the sine harmonic correction term to the angle of inclination (radians) [8]. Scale factor 2^{-29} radians.</p>
<p>keplerCus Parameter C_{us}, amplitude of the sine harmonic correction term to the argument of latitude (radians) [8]. Scale factor 2^{-29} radians.</p>
<p>keplerCrc Parameter C_{rc}, amplitude of the cosine harmonic correction term to the orbit radius (meters) [8]. Scale factor 2^{-5} meters.</p>
<p>keplerCic Parameter C_{ic}, amplitude of the cosine harmonic correction term to the angle of inclination (radians) [8]. Scale factor 2^{-29} radians.</p>
<p>keplerCuc Parameter C_{uc}, amplitude of the cosine harmonic correction term to the argument of latitude (radians) [8]. Scale factor 2^{-29} radians.</p>

NavModelNAV-KeplerianSet

```

-- ASN1START
NavModelNAV-KeplerianSet ::= SEQUENCE {
    navURA      INTEGER (0..15),
    navFitFlag   INTEGER (0..1),

```

```

navToe          INTEGER (0..37799),
navOmega        INTEGER (-2147483648..2147483647),
navDeltaN       INTEGER (-32768..32767),
navM0           INTEGER (-2147483648..2147483647),
navOmegaADot    INTEGER (-8388608..8388607),
navE            INTEGER (0..4294967295),
navIDot         INTEGER (-8192..8191),
navAPowerHalf   INTEGER (0..4294967295),
navI0           INTEGER (-2147483648..2147483647),
navOmegaA0      INTEGER (-2147483648..2147483647),
navCrs          INTEGER (-32768..32767),
navCis          INTEGER (-32768..32767),
navCus          INTEGER (-32768..32767),
navCrc          INTEGER (-32768..32767),
navCic          INTEGER (-32768..32767),
navCuc          INTEGER (-32768..32767),
addNAVparam     SEQUENCE {
    ephemerisCodeOnL2  INTEGER (0..3),
    ephemerisL2Pflag   INTEGER (0..1),
    ephemerisSF1Rsvd   SEQUENCE {
        reserved1      INTEGER (0..8388607),    -- 23-bit field
        reserved2      INTEGER (0..16777215),   -- 24-bit field
        reserved3      INTEGER (0..16777215),   -- 24-bit field
        reserved4      INTEGER (0..65535)       -- 16-bit field
    },
    ephemerisAODA      INTEGER (0..31)
} OPTIONAL, -- Need ON
...
}
-- ASN1STOP

```

NavModelNAV-KeplerianSet field descriptions

navURA Parameter URA Index, SV accuracy (dimensionless) [4,7].
navFitFlag Parameter Fit Interval Flag, fit interval indication (dimensionless) [4,7]
navToe Parameter t_{oe} , time of ephemeris (seconds) [4,7]. Scale factor 2^4 seconds.
navOmega Parameter ω , argument of perigee (semi-circles) [4,7]. Scale factor 2^{31} semi-circles.
navDeltaN Parameter Δn , mean motion difference from computed value (semi-circles/sec) [4,7]. Scale factor 2^{43} semi-circles/second.
navM0 Parameter M_0 , mean anomaly at reference time (semi-circles) [4,7]. Scale factor 2^{31} semi-circles.
navOmegaADot Parameter $\dot{\Omega}$, rate of right ascension (semi-circles/sec) [4,7]. Scale factor 2^{43} semi-circles/second.
navE Parameter e , eccentricity (dimensionless) [4,7]. Scale factor 2^{33} .
navIDot Parameter \dot{I} , rate of inclination angle (semi-circles/sec) [4,7]. Scale factor 2^{43} semi-circles/second.
navAPowerHalf Parameter \sqrt{A} , square root of semi-major axis (meters ^{1/2}) [4,7]. Scale factor 2^{19} meters ^{1/2} .
navI0 Parameter i_0 , inclination angle at reference time (semi-circles) [4,7]. Scale factor 2^{31} semi-circles.
navOmegaA0 Parameter Ω_0 , longitude of ascending node of orbit plane at weekly epoch (semi-circles) [4,7]. Scale factor 2^{31} semi-circles.

NavModelNAV-KeplerianSet field descriptions
<p>navCrs Parameter C_{rs}, amplitude of sine harmonic correction term to the orbit radius (meters) [4,7]. Scale factor 2^{-5} meters.</p>
<p>navCis Parameter C_{is}, amplitude of sine harmonic correction term to the angle of inclination (radians) [4,7]. Scale factor 2^{-29} radians.</p>
<p>navCus Parameter C_{us}, amplitude of sine harmonic correction term to the argument of latitude (radians) [4,7]. Scale factor 2^{-29} radians.</p>
<p>navCrc Parameter C_{rc}, amplitude of cosine harmonic correction term to the orbit radius (meters) [4,7]. Scale factor 2^{-5} meters.</p>
<p>navCic Parameter C_{ic}, amplitude of cosine harmonic correction term to the angle of inclination (radians) [4,7]. Scale factor 2^{-29} radians.</p>
<p>navCuc Parameter C_{uc}, amplitude of cosine harmonic correction term to the argument of latitude (radians) [4,7]. Scale factor 2^{-29} radians.</p>
<p>addNAVparam These fields include data and reserved bits in the GPS NAV message [4,14]. These additional navigation parameters, if provided by the location server, allow the target device to perform data wipe-off similar to what is done by the target device with the <i>GNSS-DataBitAssistance</i>.</p>

NavModelCNAV-KeplerianSet

```

-- ASN1START
NavModelCNAV-KeplerianSet ::= SEQUENCE {
    cnavTop          INTEGER (0..2015),
    cnavURAindex    INTEGER (-16..15),
    cnavDeltaA       INTEGER (-33554432..33554431),
    cnavAdot         INTEGER (-16777216..16777215),
    cnavDeltaNo      INTEGER (-65536..65535),
    cnavDeltaNoDot   INTEGER (-4194304..4194303),
    cnavMo           INTEGER (-4294967296..4294967295),
    cnavE            INTEGER (0..8589934591),
    cnavOmega        INTEGER (-4294967296..4294967295),
    cnavOMEGA0       INTEGER (-4294967296..4294967295),
    cnavDeltaOmegaDot INTEGER (-65536..65535),
    cnavIo           INTEGER (-4294967296..4294967295),
    cnavIoDot        INTEGER (-16384..16383),
    cnavCis          INTEGER (-32768..32767),
    cnavCic          INTEGER (-32768..32767),
    cnavCrs          INTEGER (-8388608..8388607),
    cnavCrc          INTEGER (-8388608..8388607),
    cnavCus          INTEGER (-1048576..1048575),
    cnavCuc          INTEGER (-1048576..1048575),
    ...
}
-- ASN1STOP

```

NavModelCNAV-KeplerianSet field descriptions
<p>cnavTop Parameter t_{op}, data predict time of week (seconds) [4,5,6,7]. Scale factor 300 seconds.</p>
<p>cnavURAindex Parameter URA_{oe} Index, SV accuracy (dimensionless) [4,5,6,7].</p>
<p>cnavDeltaA Parameter ΔA, semi-major axis difference at reference time (meters) [4,5,6,7]. Scale factor 2^{-9} meters.</p>
<p>cnavAdot Parameter \dot{A}, change rate in semi-major axis (meters/sec) [4,5,6,7]. Scale factor 2^{-21} meters/sec.</p>
<p>cnavDeltaNo Parameter Δn_0, mean motion difference from computed value at reference time (semi-circles/sec) [4,5,6,7]. Scale factor 2^{-44} semi-circles/second.</p>

NavModelCNAV-KeplerianSet field descriptions
<p>cnavDeltaNoDot Parameter $\Delta\dot{n}_0$, rate of mean motion difference from computed value (semi-circles/sec²) [4,5,6,7]. Scale factor 2^{-57} semi-circles/second².</p>
<p>cnavMo Parameter M_{0-n}, mean anomaly at reference time (semi-circles) [4,5,6,7]. Scale factor 2^{-32} semi-circles.</p>
<p>cnavE Parameter e_n, eccentricity (dimensionless) [4,5,6,7]. Scale factor 2^{-34}.</p>
<p>cnavOmega Parameter ω_n, argument of perigee (semi-circles) [4,5,6,7]. Scale factor 2^{-32} semi-circles.</p>
<p>cnavOMEGA0 Parameter Ω_{0-n}, reference right ascension angle (semi-circles) [4,5,6,7]. Scale factor 2^{-32} semi-circles.</p>
<p>cnavDeltaOmegaDot Parameter $\Delta\dot{\Omega}$, rate of right ascension difference (semi-circles/sec) [4,5,6,7]. Scale factor 2^{-44} semi-circles/second.</p>
<p>cnavIo Parameter i_{0-n}, inclination angle at reference time (semi-circles) [4,5,6,7]. Scale factor 2^{-32} semi-circles.</p>
<p>cnavIoDot Parameter i_{0-n}-DOT, rate of inclination angle (semi-circles/sec) [4,5,6,7]. Scale factor 2^{-44} semi-circles/second..</p>
<p>cnavCis Parameter C_{is-n}, amplitude of sine harmonic correction term to the angle of inclination (radians) [4,5,6,7]. Scale factor 2^{-30} radians.</p>
<p>cnavCic Parameter C_{ic-n}, amplitude of cosine harmonic correction term to the angle of inclination (radians) [4,5,6,7]. Scale factor 2^{-30} radians.</p>
<p>cnavCrs Parameter C_{rs-n}, amplitude of sine harmonic correction term to the orbit radius (meters) [4,5,6,7]. Scale factor 2^{-8} meters.</p>
<p>cnavCrc Parameter C_{rc-n}, amplitude of cosine harmonic correction term to the orbit radius (meters) [4,5,6,7]. Scale factor 2^{-8} meters.</p>
<p>cnavCus Parameter C_{us-n}, amplitude of the sine harmonic correction term to the argument of latitude (radians) [4,5,6,7]. Scale factor 2^{-30} radians.</p>
<p>cnavCuc Parameter C_{uc-n}, amplitude of cosine harmonic correction term to the argument of latitude (radians) [4,5,6,7]. Scale factor 2^{-30} radians.</p>

NavModel-GLONASS-ECEF

```

-- ASN1START
NavModel-GLONASS-ECEF ::= SEQUENCE {
    gloEn          INTEGER (0..31),
    gloP1          BIT STRING (SIZE(2)),
    gloP2          BOOLEAN,
    gloM           INTEGER (0..3),
    gloX           INTEGER (-67108864..67108863),
    gloXdot        INTEGER (-8388608..8388607),
    gloXdotdot     INTEGER (-16..15),
    gloY           INTEGER (-67108864..67108863),
    gloYdot        INTEGER (-8388608..8388607),
    gloYdotdot     INTEGER (-16..15),
    gloZ           INTEGER (-67108864..67108863),
    gloZdot        INTEGER (-8388608..8388607),
    gloZdotdot     INTEGER (-16..15),
    ...
}
-- ASN1STOP

```

NavModel-GLONASS-ECEF field descriptions
<p>gloEn Parameter E_n, age of data (days) [9]. Scale factor 1 days.</p>
<p>gloP1 Parameter P1, time interval between two adjacent values of t_b (minutes) [9].</p>
<p>gloP2 Parameter P2, change of t_b flag (dimensionless) [9].</p>
<p>gloM Parameter M, type of satellite (dimensionless) [9].</p>
<p>gloX Parameter $x_n(t_b)$, x-coordinate of satellite at time t_b (kilometers) [9]. Scale factor 2^{-11} kilometers.</p>
<p>gloXdot Parameter $\dot{x}_n(t_b)$, x-coordinate of satellite velocity at time t_b (kilometers/sec) [9]. Scale factor 2^{-20} kilometers/second.</p>
<p>gloXdotdot Parameter $\ddot{x}_n(t_b)$, x-coordinate of satellite acceleration at time t_b (kilometers/sec²) [9]. Scale factor 2^{-30} kilometers/second².</p>
<p>gloY Parameter $y_n(t_b)$, y-coordinate of satellite at time t_b (kilometers) [9]. Scale factor 2^{-11} kilometers.</p>
<p>gloYdot Parameter $\dot{y}_n(t_b)$, y-coordinate of satellite velocity at time t_b (kilometers/sec) [9]. Scale factor 2^{-20} kilometers/second.</p>
<p>gloYdotdot Parameter $\ddot{y}_n(t_b)$, y-coordinate of satellite acceleration at time t_b (kilometers/sec²) [9]. Scale factor 2^{-30} kilometers/second².</p>
<p>gloZ Parameter $z_n(t_b)$, z-coordinate of satellite at time t_b (kilometers) [9]. Scale factor 2^{-11} kilometers.</p>
<p>gloZdot Parameter $\dot{z}_n(t_b)$, z-coordinate of satellite velocity at time t_b (kilometers/sec) [9]. Scale factor 2^{-20} kilometers/second.</p>
<p>gloZdotdot Parameter $\ddot{z}_n(t_b)$, z-coordinate of satellite acceleration at time t_b (kilometers/sec²) [9]. Scale factor 2^{-30} kilometers/second².</p>

NavModel-SBAS-ECEF

```

-- ASN1START
NavModel-SBAS-ECEF ::= SEQUENCE {
    sbasTo          INTEGER (0..5399)                OPTIONAL,  -- Cond ClockModel
    sbasAccuracy    BIT STRING (SIZE(4)),
    sbasXg          INTEGER (-536870912..536870911),
    sbasYg          INTEGER (-536870912..536870911),
    sbasZg          INTEGER (-16777216..16777215),
    sbasXgDot       INTEGER (-65536..65535),
    sbasYgDot       INTEGER (-65536..65535),
    sbasZgDot       INTEGER (-131072..131071),
    sbasXgDotDot    INTEGER (-512..511),
    sbasYgDotDot    INTEGER (-512..511),
    sbasZgDotDot    INTEGER (-512..511),
    ...
}
-- ASN1STOP

```

Conditional presence	Explanation
<i>ClockModel</i>	This field is mandatory present if <i>gnss-ClockModel</i> Model-5 is not included; otherwise it is not present.

<i>NavModel-SBAS-ECEF</i> field descriptions
<i>sbasTo</i> Parameter t_0 , time of applicability (seconds) [10]. Scale factor 16 seconds.
<i>sbasAccuracy</i> Parameter Accuracy, (dimensionless) [10].
<i>sbasXg</i> Parameter X_G , (meters) [10]. Scale factor 0.08 meters.
<i>sbasYg</i> Parameter Y_G , (meters) [10]. Scale factor 0.08 meters.
<i>sbasZg</i> Parameter Z_G , (meters) [10]. Scale factor 0.4 meters.
<i>sbasXgDot</i> Parameter X_G , Rate-of-Change, (meters/sec) [10]. Scale factor 0.000625 meters/second.
<i>sbasYgDot</i> Parameter Y_G , Rate-of-Change, (meters/sec) [10]. Scale factor 0.000625 meters/second.
<i>sbasZgDot</i> Parameter Z_G , Rate-of-Change, (meters/sec) [10]. Scale factor 0.004 meters/second.
<i>sbasXgDotDot</i> Parameter X_G , Acceleration, (meters/sec ²) [10]. Scale factor 0.0000125 meters/second ² .
<i>sbasYgDotDot</i> Parameter Y_G , Acceleration, (meters/sec ²) [10]. Scale factor 0.0000125 meters/second ² .
<i>sbasZgDotDot</i> Parameter Z_G Acceleration, (meters/sec ²) [10]. Scale factor 0.0000625 meters/second ² .

– GNSS-RealTimeIntegrity

The IE *GNSS-RealTimeIntegrity* is used by the location server to provide parameters that describe the real-time status of the GNSS constellations. *GNSS-RealTimeIntegrity* data communicates the health of the GNSS signals to the mobile in real-time.

The location server shall always transmit the *GNSS-RealTimeIntegrity* with the current list of unhealthy signals (i.e., not only for signals/SVs currently visible at the reference location), for any GNSS positioning attempt and whenever GNSS assistance data are sent. If the number of bad signals is zero, then the *GNSS-RealTimeIntegrity* IE shall be omitted.

```
-- ASN1START
GNSS-RealTimeIntegrity ::= SEQUENCE {
    gnss-BadSignalList  GNSS-BadSignalList,
    ...
}
GNSS-BadSignalList ::= SEQUENCE (SIZE(1..64)) OF BadSignalElement
BadSignalElement ::= SEQUENCE {
    badSVID             SV-ID,
    badSignalID        GNSS-SignalIDs  OPTIONAL,  -- Need OP
    ...
}
-- ASN1STOP
```

GNSS-RealTimeIntegrity field descriptions
<p>gnss-BadSignalList This field specifies a list of satellites with bad signal or signals.</p>
<p>badSVID This field specifies the GNSS SV-ID of the satellite with bad signal or signals.</p>
<p>badSignalID This field identifies the bad signal or signals of a satellite. This is represented by a bit string in <i>GNSS-SignalIDs</i>, with a one-value at a bit position means the particular GNSS signal type of the SV is unhealthy; a zero-value means healthy. Absence of this field means that all signals on the specific SV are bad.</p>

GNSS-DataBitAssistance

The IE *GNSS-DataBitAssistance* is used by the location server to provide data bit assistance data for specific satellite signals for data wipe-off. The data bits included in the assistance data depends on the GNSS and its signal.

```

-- ASN1START
GNSS-DataBitAssistance ::= SEQUENCE {
    gnss-TOD                INTEGER (0..3599),
    gnss-TODfrac            INTEGER (0..999)    OPTIONAL,    -- Need ON
    gnss-DataBitsSatList   GNSS-DataBitsSatList,
    ...
}

GNSS-DataBitsSatList ::= SEQUENCE (SIZE(1..64)) OF GNSS-DataBitsSatElement

GNSS-DataBitsSatElement ::= SEQUENCE {
    svID                    SV-ID,
    gnss-DataBitsSgnList   GNSS-DataBitsSgnList,
    ...
}

GNSS-DataBitsSgnList ::= SEQUENCE (SIZE(1..8)) OF GNSS-DataBitsSgnElement

GNSS-DataBitsSgnElement ::= SEQUENCE {
    gnss-SignalType        GNSS-SignalID,
    gnss-DataBits          BIT STRING (SIZE (1..1024)),
    ...
}
-- ASN1STOP

```

GNSS-DataBitAssistance field descriptions
<p>gnss-TOD This field specifies the reference time of the first bit of the data in <i>GNSS-DataBitAssistance</i> in integer seconds in GNSS specific system time, modulo 1 hour. Scale factor 1 second.</p>
<p>gnss-TODfrac This field specifies the fractional part of the <i>gnss-TOD</i> in 1-milli-second resolution. Scale factor 1 millisecond. The total GNSS TOD is <i>gnss-TOD</i> + <i>gnss-TODfrac</i>.</p>
<p>gnss-DataBitsSatList This list specifies the data bits for a particular GNSS satellite SV-ID and signal <i>GNSS-SignalID</i>.</p>
<p>svID This field specifies the GNSS SV-ID of the satellite for which the <i>GNSS-DataBitAssistance</i> is given.</p>
<p>gnss-SignalType This field identifies the GNSS signal type of the <i>GNSS-DataBitAssistance</i>.</p>

GNSS-DataBitAssistance field descriptions**gnss-DataBits**

Data bits are contained in GNSS system and data type specific format.

In case of GPS L1 C/A, it contains the NAV data modulation bits as defined in [4] .

In case of Modernized GPS L1C, it contains the encoded and interleaved modulation symbols as defined in [6] section 3.2.3.1. In case of Modernized GPS L2C, it contains either the NAV data modulation bits, the FEC encoded NAV data modulation symbols, or the FEC encoded CNAV data modulation symbols, dependent on the current signal configuration of this satellite as defined in [4, Table 3-III]. In case of Modernized GPS L5, it contains the FEC encoded CNAV data modulation symbols as defined in [5].

In case of SBAS, it contains the FEC encoded data modulation symbols as defined in [10].

In case of QZSS QZS-L1, it contains the NAV data modulation bits as defined in [7] section 5.2. In case of QZSS QZS-L1C, it contains the encoded and interleaved modulation symbols as defined in [7] section 5.3. In case of QZSS QZS-L2C, it contains the encoded modulation symbols as defined in [7] section 5.5. In case of QZSS QZS-L5, it contains the encoded modulation symbols as defined in [7] section 5.6.

In case of GLONASS, it contains the 100 sps differentially Manchester encoded modulation symbols as defined in [9] section 3.3.2.2.

In case of Galileo, it contains the FEC encoded and interleaved modulation symbols. The logical levels 1 and 0 correspond to signal levels -1 and +1, respectively.

GNSS-AcquisitionAssistance

The IE *GNSS-AcquisitionAssistance* is used by the location server to provide parameters that enable fast acquisition of the GNSS signals. Essentially, these parameters describe the range and derivatives from respective satellites to the reference location at the reference time *GNSS-SystemTime* provided in IE *GNSS-ReferenceTime*.

Whenever *GNSS-AcquisitionAssistance* is provided by the location server, the IE *GNSS-ReferenceTime* shall be provided as well. E.g., even if the target device request for assistance data includes only a request for *GNSS-AcquisitionAssistance*, the location server shall also provide the corresponding IE *GNSS-ReferenceTime*.

Figure 6.5.2.2-1 illustrates the relation between some of the fields, using GPS TOW as exemplary reference.

```
-- ASN1START
GNSS-AcquisitionAssistance ::= SEQUENCE {
    gnss-SignalID          GNSS-SignalID,
    gnss-AcquisitionAssistList  GNSS-AcquisitionAssistList,
    ...,
    confidence-r10          INTEGER (0..100)    OPTIONAL    -- Need ON
}

GNSS-AcquisitionAssistList ::= SEQUENCE (SIZE(1..64)) OF GNSS-AcquisitionAssistElement

GNSS-AcquisitionAssistElement ::= SEQUENCE {
    svID                   SV-ID,
    doppler0                INTEGER (-2048..2047),
    doppler1                INTEGER (0..63),
    dopplerUncertainty      INTEGER (0..4),
    codePhase               INTEGER (0..1022),
    intCodePhase            INTEGER (0..127),
    codePhaseSearchWindow  INTEGER (0..31),
    azimuth                 INTEGER (0..511),
    elevation                INTEGER (0..127),
    ...,
    codePhase1023           BOOLEAN          OPTIONAL,    -- Need OP
    dopplerUncertaintyExt-r10  ENUMERATED {
        d60,
        d80,
        d100,
        d120,
        noInformation, ... }    OPTIONAL    -- Need ON
}
-- ASN1STOP
```

GNSS-AcquisitionAssistance field descriptions

GNSS-AcquisitionAssistance field descriptions
<p>gnss-SignalID This field specifies the GNSS signal for which the acquisition assistance are provided.</p>
<p>gnss-AcquisitionAssistList These fields provide a list of acquisition assistance data for each GNSS satellite.</p>
<p>confidence This field specifies the confidence level of the reference location area or volume used to calculate the acquisition assistance parameters (search windows). A high percentage value (e.g., 98% or more) indicates to the target device that the provided search windows are reliable. The location server should include this field to indicate the confidence level of the provided information.</p>
<p>svID This field specifies the GNSS SV-ID of the satellite for which the <i>GNSS-AcquisitionAssistance</i> is given.</p>
<p>doppler0 This field specifies the Doppler (0th order term) value. A positive value in Doppler defines the increase in satellite signal frequency due to velocity towards the target device. A negative value in Doppler defines the decrease in satellite signal frequency due to velocity away from the target device. Doppler is given in unit of m/s by multiplying the Doppler value in Hz by the nominal wavelength of the assisted signal. Scale factor 0.5 m/s in the range from -1024 m/s to +1023.5 m/s.</p>
<p>doppler1 This field specifies the Doppler (1st order term) value. A positive value defines the rate of increase in satellite signal frequency due to acceleration towards the target device. A negative value defines the rate of decrease in satellite signal frequency due to acceleration away from the target device. Scale factor $1/210 \text{ m/s}^2$ in the range from -0.2 m/s^2 to $+0.1 \text{ m/s}^2$. Actual value of Doppler (1st order term) is calculated as $(-42 + \text{doppler1}) * 1/210 \text{ m/s}^2$, with <i>doppler1</i> in the range of 0...63.</p>
<p>dopplerUncertainty This field specifies the Doppler uncertainty value. It is defined such that the Doppler experienced by a stationary target device is in the range [Doppler–Doppler Uncertainty] to [Doppler+Doppler Uncertainty]. Doppler Uncertainty is given in unit of m/s by multiplying the Doppler Uncertainty value in Hz by the nominal wavelength of the assisted signal. Defined values: 2.5 m/s, 5 m/s, 10 m/s, 20 m/s, 40 m/s as encoded by an integer <i>n</i> in the range 0-4 according to: $2^{-n}(40) \text{ m/s}; n = 0 - 4$. If the <i>dopplerUncertaintyExt</i> field is present, the target device that supports the <i>dopplerUncertaintyExt</i> shall ignore this field.</p>
<p>codePhase This field together with the <i>codePhase1023</i> field specifies the code phase, in units of milli-seconds, in the range from 0 to 1 millisecond scaled by the nominal chipping rate of the GNSS signal, where increasing values of the field signify increasing predicted signal code phases, as seen by a receiver at the reference location at the reference time. The reference location would typically be an apriori estimate of the target device location. Scale factor 2^{-10} ms in the range from 0 to $(1 \cdot 2^{-10}) \text{ ms}$. Note: The value $(1 \cdot 2^{-10}) \text{ ms}$ is encoded using the <i>codePhase1023</i> IE.</p>
<p>intCodePhase This field contains integer code phase (expressed modulo 128 ms). The satellite integer milli-seconds code phase currently being transmitted at the reference time, as seen by a receiver at the reference location is calculated as reference time (expressed in milli-seconds) minus (<i>intCodePhase</i> + (<i>n</i>×128 ms)), as shown in Figure 6.5.2.2-1, with <i>n</i> = ...-2,-1,0,1,2.... Scale factor 1 ms in the range from 0 to 127 ms.</p>
<p>codePhaseSearchWindow This field contains the code phase search window. The code phase search window accounts for the uncertainty in the estimated target device location but not any uncertainty in reference time. It is defined such that the expected code phase is in the range [Code Phase–Code Phase Search Window] to [Code Phase+Code Phase Search Window] given in units of milli-seconds. Range 0-31, mapping according to the table <i>codePhaseSearchWindow Value to Interpretation Code Phase Search Window [ms]</i> relation shown below.</p>
<p>azimuth This field specifies the azimuth angle. An angle of <i>x</i> degrees means the satellite azimuth <i>a</i> is in the range $(x \leq a < x+0.703125)$ degrees. Scale factor 0.703125 degrees.</p>
<p>elevation This field specifies the elevation angle. An angle of <i>y</i> degrees means the satellite elevation <i>e</i> is in the range $(y \leq e < y+0.703125)$ degrees. Scale factor 0.703125 degrees.</p>
<p>codePhase1023 This field if set to TRUE indicates that the code phase has the value $1023 \times 2^{-10} = (1 \cdot 2^{-10}) \text{ ms}$. This field may only be set to TRUE if the value provided in the <i>codePhase</i> IE is 1022. If this field is set to FALSE, the code phase is the value provided in the <i>codePhase</i> IE in the range from 0 to $(1 - 2 \times 2^{-10}) \text{ ms}$. If this field is not present and the <i>codePhase</i> IE has the value 1022, the target device may assume that the code phase is between $(1 - 2 \times 2^{-10})$ and $(1 - 2^{-10}) \text{ ms}$.</p>

GNSS-AcquisitionAssistance field descriptions***dopplerUncertaintyExt***

If this field is present, the target device that supports this field shall ignore the *dopplerUncertainty* field. The location server should include this field only if supported by the target device.

This field specifies the Doppler uncertainty value. It is defined such that the Doppler experienced by a stationary target device is in the range [Doppler–Doppler Uncertainty] to [Doppler+Doppler Uncertainty]. Doppler Uncertainty is given in unit of m/s by multiplying the Doppler Uncertainty value in Hz by the nominal wavelength of the assisted signal.

Enumerated values define 60 m/s, 80 m/s, 100 m/s, 120 m/s, and "No Information".

codePhaseSearchWindow Value to Interpretation Code Phase Search Window [ms] relation

codePhaseSearchWindow Value	Interpretation Code Phase Search Window [ms]
'00000'	No information
'00001'	0,002
'00010'	0,004
'00011'	0,008
'00100'	0,012
'00101'	0,016
'00110'	0,024
'00111'	0,032
'01000'	0,048
'01001'	0,064
'01010'	0,096
'01011'	0,128
'01100'	0,164
'01101'	0,200
'01110'	0,250
'01111'	0,300
'10000'	0,360
'10001'	0,420
'10010'	0,480
'10011'	0,540
'10100'	0,600
'10101'	0,660
'10110'	0,720
'10111'	0,780
'11000'	0,850
'11001'	1,000
'11010'	1,150
'11011'	1,300
'11100'	1,450
'11101'	1,600
'11110'	1,800
'11111'	2,000

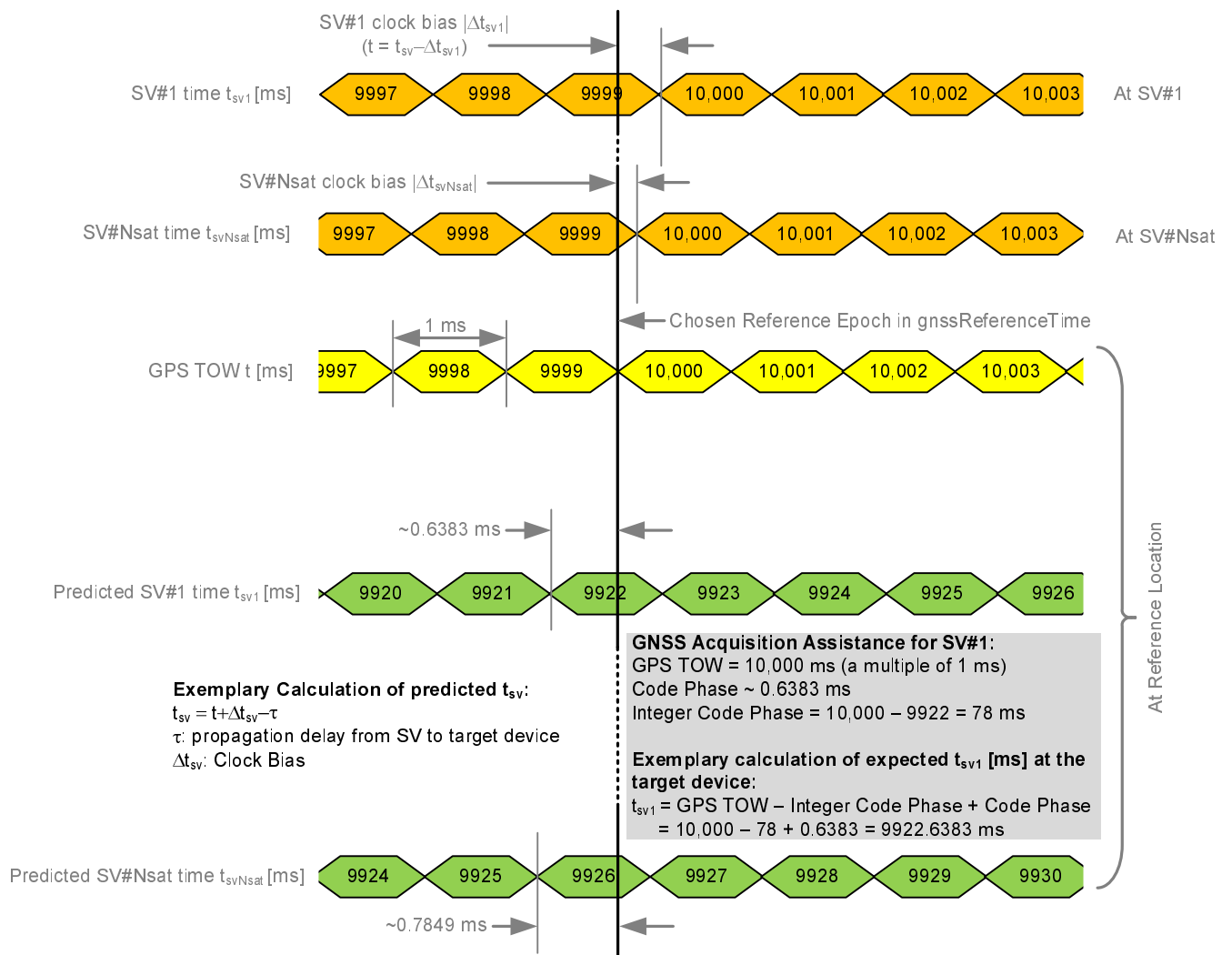

Figure 6.5.2.2-1: Exemplary calculation of some GNSS Acquisition Assistance fields.

GNSS-Almanac

The IE *GNSS-Almanac* is used by the location server to provide the coarse, long-term model of the satellite positions and clocks. The meaning of these parameters is defined in relevant ICDs of the particular GNSS and GNSS specific interpretations apply. For example, GPS and QZSS use the same model parameters but some parameters have a different interpretation [7]. *GNSS-Almanac* is useful for receiver tasks that require coarse accuracy, such as determining satellite visibility. The model is valid for up to a few weeks, typically. Since it is a long-term model, the field should be provided for all satellites available in the GNSS constellation (i.e., not only for SVs visible at the reference location and including SVs flagged as unhealthy in almanac). The *completeAlmanacProvided* field indicates whether or not the location server provided almanacs for the complete GNSS constellation.

```
-- ASN1START
GNSS-Almanac ::= SEQUENCE {
    weekNumber          INTEGER (0..255)    OPTIONAL,  -- Need ON
    toa                 INTEGER (0..255)    OPTIONAL,  -- Need ON
    ioda               INTEGER (0..3)      OPTIONAL,  -- Need ON
    completeAlmanacProvided  BOOLEAN,
    gns-AlmanacList     GNSS-AlmanacList,
    ...
}

GNSS-AlmanacList ::= SEQUENCE (SIZE(1..64)) OF GNSS-AlmanacElement

GNSS-AlmanacElement ::= CHOICE {
    keplerianAlmanacSet    AlmanacKeplerianSet,      -- Model-1
    keplerianNAV-Almanac  AlmanacNAV-KeplerianSet,  -- Model-2
}
```

```

keplerianReducedAlmanac AlmanacReducedKeplerianSet, -- Model-3
keplerianMidiAlmanac   AlmanacMidiAlmanacSet,   -- Model-4
keplerianGLONASS       AlmanacGLONASS-AlmanacSet, -- Model-5
ecef-SBAS-Almanac      AlmanacECEF-SBAS-AlmanacSet, -- Model-6
...
}
-- ASN1STOP

```

GNSS-Almanac field descriptions

weekNumber	This field specifies the almanac reference week number in GNSS specific system time to which the almanac reference time <i>toa</i> is referenced, modulo 256 weeks. This field is required for non-GLONASS GNSS.
toa	This field specifies the almanac reference time given in GNSS specific system time, in units of seconds with a scale factor of 2^{12} . This field is required for non-GLONASS GNSS.
ioda	This field specifies the issue of data. This field is required for Galileo GNSS.
completeAlmanacProvided	If set to TRUE, the <i>gnss-AlmanacList</i> contains almanacs for the complete GNSS constellation indicated by <i>GNSS-ID</i> .
gnss-AlmanacList	This list contains the almanac model for each GNSS satellite in the GNSS constellation.

AlmanacKeplerianSet

```

-- ASN1START
AlmanacKeplerianSet ::= SEQUENCE {
    svID                SV-ID,
    kepAlmanacE         INTEGER (0..2047),
    kepAlmanacDeltaI    INTEGER (-1024..1023),
    kepAlmanacOmegaDot  INTEGER (-1024..1023),
    kepSVHealth         INTEGER (0..15),
    kepAlmanacAPowerHalf INTEGER (-65536..65535),
    kepAlmanacOmega0    INTEGER (-32768..32767),
    kepAlmanacW         INTEGER (-32768..32767),
    kepAlmanacM0        INTEGER (-32768..32767),
    kepAlmanacAF0       INTEGER (-8192..8191),
    kepAlmanacAF1       INTEGER (-1024..1023),
    ...
}
-- ASN1STOP

```

AlmanacKeplerianSet field descriptions

svID	This field identifies the satellite for which the GNSS Almanac Model is given.
kepAlmanacE	Parameter <i>e</i> , eccentricity, dimensionless [8]. Scale factor 2^{16} .
kepAlmanacDeltaI	Parameter δ_i , semi-circles [8]. Scale factor 2^{-14} semi-circles.
kepAlmanacOmegaDot	Parameter OMEGADOT, longitude of ascending node of orbit plane at weekly epoch (semi-circles/sec) [8]. Scale factor 2^{-33} semi-circles/seconds.
kepSVHealth	Parameter SV Health KP, dimensionless. This field specifies the SV Health status in GNSS almanac model using Keplerian parameters. In Galileo case this field shall contain the I/NAV health status bits [8].
kepAlmanacAPowerHalf	Parameter $\delta A^{1/2}$, Semi-Major Axis delta (meters) $^{1/2}$ [8]. Scale factor 2^{-9} meters $^{1/2}$.
kepAlmanacOmega0	Parameter OMEGA ₀ , longitude of ascending node of orbit plane at weekly epoch (semi-circles) [8]. Scale factor 2^{15} semi-circles.

<i>AlmanacKeplerianSet</i> field descriptions
<p><i>kepAlmanacW</i> Parameter ω, argument of perigee (semi-circles) [8]. Scale factor 2^{-15} semi-circles.</p>
<p><i>kepAlmanacM0</i> Parameter M_0, mean anomaly at reference time (semi-circles) [8]. Scale factor 2^{-15} semi-circles.</p>
<p><i>kepAlmanacAF0</i> Parameter af_0, seconds [8]. Scale factor 2^{-19} seconds.</p>
<p><i>kepAlmanacAF1</i> Parameter af_1, sec/sec [8]. Scale factor 2^{-38} seconds/second.</p>

– AlmanacNAV-KeplerianSet

```

-- ASN1START
AlmanacNAV-KeplerianSet ::= SEQUENCE {
    svID                SV-ID,
    navAlmE             INTEGER (0..65535),
    navAlmDeltaI        INTEGER (-32768..32767),
    navAlmOMEGADOT     INTEGER (-32768..32767),
    navAlmSVHealth     INTEGER (0..255),
    navAlmSqrtA        INTEGER (0..16777215),
    navAlmOMEGAo       INTEGER (-8388608..8388607),
    navAlmOmega        INTEGER (-8388608..8388607),
    navAlmMo           INTEGER (-8388608..8388607),
    navAlmaf0          INTEGER (-1024..1023),
    navAlmaf1          INTEGER (-1024..1023),
    ...
}
-- ASN1STOP

```

<i>AlmanacNAV-KeplerianSet</i> field descriptions
svID This field identifies the satellite for which the GNSS Almanac Model is given.
navAlmE Parameter e, eccentricity, dimensionless [4,7]. Scale factor 2^{21} .
navAlmDeltaI Parameter δi , correction to inclination, semi-circles [4,7]. Scale factor 2^{19} semi-circles.
navAlmOMEGADOT Parameter $\dot{\Omega}$, rate of right ascension, semi-circles/sec [4,7]. Scale factor 2^{38} semi-circles/second.
navAlmSVHealth Parameter SV Health, satellite health [4,7].
navAlmSqrtA Parameter \sqrt{A} , square root of the semi-major axis, meters ^{1/2} [4,7] Scale factor 2^{11} meters ^{1/2} .
navAlmOMEGAo Parameter Ω_0 , longitude of ascending node of orbit plane at weekly epoch, semi-circles [4,7]. Scale factor 2^{23} semi-circles.
navAlmOmega Parameter ω , argument of perigee semi-circles [4,7]. Scale factor 2^{23} semi-circles.
navAlmMo Parameter M_0 , mean anomaly at reference time semi-circles [4,7]. Scale factor 2^{23} semi-circles.
navAlmaf0 Parameter a_0 , apparent satellite clock correction seconds [4,7]. Scale factor 2^{20} seconds.
navAlmaf1 Parameter a_1 , apparent satellite clock correction sec/sec [4,7]. Scale factor 2^{38} semi-circles seconds/second.

AlmanacReducedKeplerianSet

```

-- ASN1START
AlmanacReducedKeplerianSet ::= SEQUENCE {
    svID                SV-ID,
    redAlmDeltaA        INTEGER (-128..127),
    redAlmOmega0        INTEGER (-64..63),
    redAlmPhi0          INTEGER (-64..63),
    redAlmL1Health      BOOLEAN,
    redAlmL2Health      BOOLEAN,
    redAlmL5Health      BOOLEAN,
    ...
}
-- ASN1STOP

```

<i>AlmanacReducedKeplerianSet</i> field descriptions
svID This field identifies the satellite for which the GNSS Almanac Model is given.
redAlmDeltaA Parameter δ_A , meters [4,5,6,7]. Scale factor 2^{+9} meters.
redAlmOmega0 Parameter Ω_0 , semi-circles [4,5,6,7]. Scale factor 2^{-6} semi-circles.
redAlmPhi0 Parameter Φ_0 , semi-circles [4,5,6,7]. Scale factor 2^{-6} semi-circles.
redAlmL1Health Parameter L1 Health, dimensionless [4,5,6,7].
redAlmL2Health Parameter L2 Health, dimensionless [4,5,6,7].
redAlmL5Health Parameter L5 Health, dimensionless [4,5,6,7].

– AlmanacMidiAlmanacSet

```
-- ASN1START
AlmanacMidiAlmanacSet ::= SEQUENCE {
    svID                SV-ID,
    midiAlmE            INTEGER (0..2047),
    midiAlmDeltaI       INTEGER (-1024..1023),
    midiAlmOmegaDot     INTEGER (-1024..1023),
    midiAlmSqrtA        INTEGER (0..131071),
    midiAlmOmega0       INTEGER (-32768..32767),
    midiAlmOmega        INTEGER (-32768..32767),
    midiAlmMo           INTEGER (-32768..32767),
    midiAlmaf0          INTEGER (-1024..1023),
    midiAlmaf1          INTEGER (-512..511),
    midiAlmL1Health    BOOLEAN,
    midiAlmL2Health    BOOLEAN,
    midiAlmL5Health    BOOLEAN,
    ...
}
-- ASN1STOP
```

AlmanacMidiAlmanacSet field descriptions
svID This field identifies the satellite for which the GNSS Almanac Model is given.
midiAlmE Parameter e, dimensionless [4,5,6,7]. Scale factor 2^{-16} .
midiAlmDeltaI Parameter δ_i , semi-circles [4,5,6,7]. Scale factor 2^{-14} semi-circles.
midiAlmOmegaDot Parameter $\dot{\Omega}$, semi-circles/sec [4,5,6,7]. Scale factor 2^{-33} semi-circles/second.
midiAlmSqrtA Parameter \sqrt{A} , meters ^{1/2} [4,5,6,7]. Scale factor 2^{-4} meters ^{1/2} .
midiAlmOmega0 Parameter Ω_0 , semi-circles [4,5,6,7]. Scale factor 2^{-15} semi-circles.
midiAlmOmega Parameter ω , semi-circles [4,5,6,7]. Scale factor 2^{-15} semi-circles.
midiAlmMo Parameter M_0 , semi-circles [4,5,6,7]. Scale factor 2^{-15} semi-circles.
midiAlmaf0 Parameter a_{f0} , seconds [4,5,6,7]. Scale factor 2^{20} seconds.
midiAlmaf1 Parameter a_{f1} , sec/sec [4,5,6,7]. Scale factor 2^{37} seconds/second.
midiAlmL1Health Parameter L1 Health, dimensionless [4,5,6,7].
midiAlmL2Health Parameter L2 Health, dimensionless [4,5,6,7].
midiAlmL5Health Parameter L5 Health, dimensionless [4,5,6,7].

AlmanacGLONASS-AlmanacSet

```

-- ASN1START
AlmanacGLONASS-AlmanacSet ::= SEQUENCE {
    gloAlm-NA                INTEGER (1..1461),
    gloAlmNA                 INTEGER (1..24),
    gloAlmHA                 INTEGER (0..31),
    gloAlmLambdaA           INTEGER (-1048576..1048575),
    gloAlmtLambdaA          INTEGER (0..2097151),
    gloAlmDeltaIa           INTEGER (-131072..131071),
    gloAlmDeltaTA           INTEGER (-2097152..2097151),
    gloAlmDeltaTdotA        INTEGER (-64..63),
    gloAlmEpsilonA          INTEGER (0..32767),
    gloAlmOmegaA            INTEGER (-32768..32767),
    gloAlmTauA              INTEGER (-512..511),
    gloAlmCA                 INTEGER (0..1),
    gloAlmMA                 BIT STRING (SIZE(2))
    ...
}
-- ASN1STOP

```

<i>AlmanacGLONASS-AlmanacSet</i> field descriptions
<i>gloAlmNA</i> Parameter N^A , days [9]. Scale factor 1 days.
<i>gloAlmna</i> Parameter n^A , dimensionless [9].
<i>gloAlmHA</i> Parameter H_n^A , dimensionless [9].
<i>gloAlmLambdaA</i> Parameter λ_n^A , semi-circles [9]. Scale factor 2^{20} semi-circles.
<i>gloAlmlambdaA</i> Parameter $t_{\lambda_n}^A$, seconds [9]. Scale factor 2^5 seconds.
<i>gloAlmDeltala</i> Parameter Δ_i^A , semi-circles [9]. Scale factor 2^{20} semi-circles.
<i>gloAlmDeltaTA</i> Parameter ΔT_n^A , sec/orbit period [9]. Scale factor 2^9 seconds/orbit period.
<i>gloAlmDeltaTdotA</i> Parameter $\Delta T_DOT_n^A$, sec/orbit period ² [9]. Scale factor 2^{14} seconds/orbit period ² .
<i>gloAlmEpsilonA</i> Parameter ϵ_n^A , dimensionless [9]. Scale factor 2^{20} .
<i>gloAlmOmegaA</i> Parameter ω_n^A , semi-circles [9]. Scale factor 2^{15} semi-circles.
<i>gloAlmTauA</i> Parameter τ_n^A , seconds [9]. Scale factor 2^{18} seconds.
<i>gloAlmCA</i> Parameter C_n^A , dimensionless [9].
<i>gloAlmMA</i> Parameter M_n^A , dimensionless [9]. This parameter is present if its value is nonzero; otherwise it is not present.

– AlmanacECEF-SBAS-AlmanacSet

```

-- ASN1START
AlmanacECEF-SBAS-AlmanacSet ::= SEQUENCE {
    sbasAlmDataID    INTEGER (0..3),
    svID             SV-ID,
    sbasAlmHealth    BIT STRING (SIZE(8)),
    sbasAlmXg        INTEGER (-16384..16383),
    sbasAlmYg        INTEGER (-16384..16383),
    sbasAlmZg        INTEGER (-256..255),
    sbasAlmXgdot     INTEGER (-4..3),
    sbasAlmYgdot     INTEGER (-4..3),
    sbasAlmZgdot     INTEGER (-8..7),
    sbasAlmTo        INTEGER (0..2047),
    ...
}
-- ASN1STOP

```

AlmanacECEF-SBAS-AlmanacSet field descriptions
<i>sbasAlmDataID</i> Parameter Data ID, dimensionless [10].
<i>svID</i> This field identifies the satellite for which the GNSS Almanac Model is given.
<i>sbasAlmHealth</i> Parameter Health, dimensionless [10].
<i>sbasAlmXg</i> Parameter X_G , meters [10]. Scale factor 2600 meters.
<i>sbasAlmYg</i> Parameter Y_G , meters [10]. Scale factor 2600 meters.
<i>sbasAlmZg</i> Parameter Z_G , meters [10]. Scale factor 26000 meters.
<i>sbasAlmXgdot</i> Parameter X_G Rat-of-Change, meters/sec [10]. Scale factor 10 meters/second.
<i>sbasAlmYgDot</i> Parameter Y_G Rate-of-Change, meters/sec [10]. Scale factor 10 meters/second.
<i>sbasAlmZgDot</i> Parameter Z_G Rate-of-Change, meters/sec [10]. Scale factor 40.96 meters/second.
<i>sbasAlmTo</i> Parameter t_0 , seconds [10]. Scale factor 64 meters/seconds.

– GNSS-UTC-Model

The IE *GNSS-UTC-Model* is used by the location server to provide several sets of parameters needed to relate GNSS system time to Universal Time Coordinate (UTC), as defined in [4,5,6,7,8,9,10].

The UTC time standard, UTC(k), is GNSS specific. E.g., if *GNSS-ID* indicates GPS, *GNSS-UTC-Model* contains a set of parameters needed to relate GPS system time to UTC(USNO); if *GNSS-ID* indicates QZSS, *GNSS-UTC-Model* contains a set of parameters needed to relate QZST to UTC(NICT); if *GNSS-ID* indicates GLONASS, *GNSS-UTC-Model* contains a set of parameters needed to relate GLONASS system time to UTC(RU); if *GNSS-ID* indicates SBAS, *GNSS-UTC-Model* contains a set of parameters needed to relate SBAS network time for the SBAS indicated by *SBAS-ID* to the UTC standard defined by the UTC Standard ID.

```
-- ASN1START
GNSS-UTC-Model ::= CHOICE {
    utcModel1      UTC-ModelSet1,  -- Model-1
    utcModel2      UTC-ModelSet2,  -- Model-2
    utcModel3      UTC-ModelSet3,  -- Model-3
    utcModel4      UTC-ModelSet4,  -- Model-4
    ...
}
-- ASN1STOP
```

– UTC-ModelSet1

```
-- ASN1START
UTC-ModelSet1 ::= SEQUENCE {
    gnss-Utc-A1      INTEGER (-8388608..8388607),
    gnss-Utc-A0      INTEGER (-2147483648..2147483647),
    gnss-Utc-Tot     INTEGER (0..255),
    gnss-Utc-WNt     INTEGER (0..255),
    gnss-Utc-DeltaTls INTEGER (-128..127),
    gnss-Utc-WNlsf   INTEGER (0..255),
    gnss-Utc-DN      INTEGER (-128..127),
    gnss-Utc-DeltaTlsf INTEGER (-128..127),
    ...
}
```

```
}
-- ASN1STOP
```

UTC-ModelSet1 field descriptions

gnss-Utc-A1 Parameter A_1 , scale factor 2^{-50} seconds/second [4,7,8].
gnss-Utc-A0 Parameter A_0 , scale factor 2^{-30} seconds [4,7,8].
gnss-Utc-Tot Parameter t_{ot} , scale factor 2^{12} seconds [4,7,8].
gnss-Utc-WNt Parameter WN_t , scale factor 1 week [4,7,8].
gnss-Utc-DeltaTls Parameter Δt_{LS} , scale factor 1 second [4,7,8].
gnss-Utc-WNlsf Parameter WN_{LSF} , scale factor 1 week [4,7,8].
gnss-Utc-DN Parameter DN, scale factor 1 day [4,7,8].
gnss-Utc-DeltaTlsf Parameter Δt_{LSF} , scale factor 1 second [4,7,8].

UTC-ModelSet2

```
-- ASN1START
UTC-ModelSet2 ::= SEQUENCE {
    utcA0          INTEGER (-32768..32767),
    utcA1          INTEGER (-4096..4095),
    utcA2          INTEGER (-64..63),
    utcDeltaTls   INTEGER (-128..127),
    utcTot         INTEGER (0..65535),
    utcWNot        INTEGER (0..8191),
    utcWNlsf       INTEGER (0..255),
    utcDN          BIT STRING (SIZE(4)),
    utcDeltaTlsf  INTEGER (-128..127),
    ...
}
-- ASN1STOP
```

UTC-ModelSet2 field descriptions

utcA0 Parameter A_{0-n} , bias coefficient of GNSS time scale relative to UTC time scale (seconds) [4,5,6,7]. Scale factor 2^{-35} seconds.
utcA1 Parameter A_{1-n} , drift coefficient of GNSS time scale relative to UTC time scale (sec/sec) [4,5,6,7]. Scale factor 2^{-51} seconds/second.
utcA2 Parameter A_{2-n} , drift rate correction coefficient of GNSS time scale relative to UTC time scale (sec/sec ²) [4,5,6,7]. Scale factor 2^{68} seconds/second ² .
utcDeltaTls Parameter Δt_{LS} , current or past leap second count (seconds) [4,5,6,7]. Scale factor 1 second.
utcTot Parameter t_{ot} , time data reference time of week (seconds) [4,5,6,7]. Scale factor 2^4 seconds.
utcWNot Parameter WN_{ot} , time data reference week number (weeks) [4,5,6,7]. Scale factor 1 week.
utcWNlsf Parameter WN_{LSF} , leap second reference week number (weeks) [4,5,6,7]. Scale factor 1 week.
utcDN Parameter DN, leap second reference day number (days) [4,5,6,7]. Scale factor 1 day.

UTC-ModelSet2 field descriptions**utcDeltaTlsf**

Parameter Δt_{LSF} , current or future leap second count (seconds) [4,5,6,7].
Scale factor 1 second.

UTC-ModelSet3

```
-- ASN1START
UTC-ModelSet3 ::= SEQUENCE {
    nA          INTEGER (1..1461),
    tauC        INTEGER (-2147483648..2147483647),
    b1          INTEGER (-1024..1023)          OPTIONAL,  -- Cond GLONASS-M
    b2          INTEGER (-512..511)          OPTIONAL,  -- Cond GLONASS-M
    kp          BIT STRING (SIZE(2))         OPTIONAL,  -- Cond GLONASS-M
    ...
}
-- ASN1STOP
```

Conditional presence	Explanation
GLONASS-M	The field is mandatory present if GLONASS-M satellites are present in the current GLONASS constellation; otherwise it is not present.

UTC-ModelSet3 field descriptions**nA**

Parameter N^A , calendar day number within four-year period beginning since the leap year (days) [9].
Scale factor 1 day.

tauC

Parameter τ_c , GLONASS time scale correction to UTC(SU) (seconds) [9].
Scale factor 2^{-31} seconds.

b1

Parameter B1, coefficient to determine $\Delta UT1$ (seconds) [9].
Scale factor 2^{-10} seconds.

b2

Parameter B2, coefficient to determine $\Delta UT1$ (seconds/msd) [9].
Scale factor 2^{-16} seconds/msd.

kp

Parameter KP, notification of expected leap second correction (dimensionless) [9].

UTC-ModelSet4

```
-- ASN1START
UTC-ModelSet4 ::= SEQUENCE {
    utcA1wnt    INTEGER (-8388608..8388607),
    utcA0wnt    INTEGER (-2147483648..2147483647),
    utcTot      INTEGER (0..255),
    utcWNt      INTEGER (0..255),
    utcDeltaTls  INTEGER (-128..127),
    utcWNlsf    INTEGER (0..255),
    utcDN       INTEGER (-128..127),
    utcDeltaTlsf  INTEGER (-128..127),
    utcStandardID  INTEGER (0..7),
    ...
}
-- ASN1STOP
```

UTC-ModelSet4 field descriptions**utcA1wnt**

Parameter A_{1WNT} , sec/sec ([10], Message Type 12).
Scale factor 2^{-50} seconds/second.

<i>UTC-ModelSet4</i> field descriptions
<p><i>utcA0wnt</i> Parameter A_{0WNT}, seconds ([10], Message Type 12). Scale factor 2^{-30} seconds.</p>
<p><i>utcTot</i> Parameter t_{ot}, seconds ([10], Message Type 12). Scale factor 2^{12} seconds.</p>
<p><i>utcWnt</i> Parameter W_{Nt}, weeks ([10], Message Type 12). Scale factor 1 week.</p>
<p><i>utcDeltaTIs</i> Parameter Δt_{LS}, seconds ([10], Message Type 12). Scale factor 1 second.</p>
<p><i>utcWNIsf</i> Parameter W_{NLSF}, weeks ([10], Message Type 12). Scale factor 1 week.</p>
<p><i>utcDN</i> Parameter DN, days ([10], Message Type 12). Scale factor 1 day.</p>
<p><i>utcDeltaTIsf</i> Parameter Δt_{LSF}, seconds ([10], Message Type 12). Scale factor 1 second.</p>
<p><i>utcStandardID</i> If <i>GNSS-ID</i> indicates "sbas", this field indicates the UTC standard used for the SBAS network time indicated by <i>SBAS-ID</i> to UTC relation as defined in the table Value of UTC Standard ID to UTC Standard relation shown below ([10], Message Type 12).</p>

Value of UTC Standard ID to UTC Standard relation

Value of UTC Standard ID	UTC Standard
0	UTC as operated by the Communications Research Laboratory (CRL), Tokyo, Japan
1	UTC as operated by the National Institute of Standards and Technology (NIST)
2	UTC as operated by the U. S. Naval Observatory (USNO)
3	UTC as operated by the International Bureau of Weights and Measures (BIPM)
4-7	Reserved for future definition

– GNSS-AuxiliaryInformation

The IE *GNSS-AuxiliaryInformation* is used by the location server to provide additional information dependent on the *GNSS-ID*. If *GNSS-AuxiliaryInformation* is provided together with other satellite dependent GNSS assistance data (i.e., any of *GNSS-DifferentialCorrections*, *GNSS-NavigationModel*, *GNSS-DataBitAssistance*, or *GNSS-AcquisitionAssistance* IEs), the *GNSS-AuxiliaryInformation* should be provided for the same satellites and in the same LPP message as the other satellite dependent GNSS assistance data.

```

-- ASN1START
GNSS-AuxiliaryInformation ::= CHOICE {
    gnss-ID-GPS      GNSS-ID-GPS,
    gnss-ID-GLONASS GNSS-ID-GLONASS,
    ...
}

GNSS-ID-GPS ::= SEQUENCE (SIZE(1..64)) OF GNSS-ID-GPS-SatElement

GNSS-ID-GPS-SatElement ::= SEQUENCE {
    svID           SV-ID,
    signalsAvailable GNSS-SignalIDs,
    ...
}

GNSS-ID-GLONASS ::= SEQUENCE (SIZE(1..64)) OF GNSS-ID-GLONASS-SatElement

GNSS-ID-GLONASS-SatElement ::= SEQUENCE {
    svID           SV-ID,
    signalsAvailable GNSS-SignalIDs,
    channelNumber  INTEGER (-7..13) OPTIONAL, -- Cond FDMA

```

```

}
...
-- ASN1STOP

```

Conditional presence	Explanation
<i>FDMA</i>	The field is mandatory present if the GLONASS SV indicated by <i>svID</i> broadcasts FDMA signals; otherwise it is not present.

GNSS-AuxiliaryInformation field descriptions	
<i>gnss-ID-GPS</i>	This choice may only be present if <i>GNSS-ID</i> indicates GPS.
<i>gnss-ID-GLONASS</i>	This choice may only be present if <i>GNSS-ID</i> indicates GLONASS.
<i>svID</i>	This field specifies the GNSS SV for which the <i>GNSS-AuxiliaryInformation</i> is given.
<i>signalsAvailable</i>	This field indicates the ranging signals supported by the satellite indicated by <i>svID</i> . This field is given as a bit string as defined in <i>GNSS-SignalIDs</i> for a particular GNSS. If a bit is set to "1" it indicates that the satellite identified by <i>svID</i> transmits ranging signals according to the signal correspondence in <i>GNSS-SignalIDs</i> . If a bit is set to "0" it indicates that the corresponding signal is not supported on the satellite identified by <i>svID</i> .
<i>channelNumber</i>	This field indicates the GLONASS carrier frequency number of the satellite identified by <i>svID</i> , as defined in [9].

6.5.2.3 GNSS Assistance Data Request

– A-GNSS-RequestAssistanceData

The IE *A-GNSS-RequestAssistanceData* is used by the target device to request GNSS assistance data from a location server.

```

-- ASN1START
A-GNSS-RequestAssistanceData ::= SEQUENCE {
  gnss-CommonAssistDataReq      GNSS-CommonAssistDataReq      OPTIONAL, -- Cond CommonADReq
  gnss-GenericAssistDataReq     GNSS-GenericAssistDataReq  OPTIONAL, -- Cond GenADReq
  ...
}
-- ASN1STOP

```

Conditional presence	Explanation
<i>CommonADReq</i>	The field is mandatory present if the target device requests <i>GNSS-CommonAssistData</i> ; otherwise it is not present.
<i>GenADReq</i>	This field is mandatory present if the target device requests <i>GNSS-GenericAssistData</i> for one or more specific GNSS; otherwise it is not present.

– GNSS-CommonAssistDataReq

The IE *GNSS-CommonAssistDataReq* is used by the target device to request assistance data that are applicable to any GNSS from a location server.

```

-- ASN1START
GNSS-CommonAssistDataReq ::= SEQUENCE {
  gnss-ReferenceTimeReq          GNSS-ReferenceTimeReq          OPTIONAL, -- Cond RefTimeReq
  gnss-ReferenceLocationReq     GNSS-ReferenceLocationReq     OPTIONAL, -- Cond RefLocReq
  gnss-IonosphericModelReq      GNSS-IonosphericModelReq      OPTIONAL, -- Cond IonoModReq
  gnss-EarthOrientationParametersReq GNSS-EarthOrientationParametersReq OPTIONAL, -- Cond EOPReq
  ...
}
-- ASN1STOP

```



```
}
-- ASN1STOP
```

Conditional presence	Explanation
<i>RefTimeReq</i>	The field is mandatory present if the target device requests <i>GNSS-ReferenceTime</i> ; otherwise it is not present.
<i>RefLocReq</i>	This field is mandatory present if the target device requests <i>GNSS-ReferenceLocation</i> ; otherwise it is not present.
<i>IonoModReq</i>	This field is mandatory present if the target device requests <i>GNSS-IonosphericModel</i> ; otherwise it is not present.
<i>EOPReq</i>	This field is mandatory present if the target device requests <i>GNSS-EarthOrientationParameters</i> ; otherwise it is not present.

– GNSS-GenericAssistDataReq

The IE *GNSS-GenericAssistDataReq* is used by the target device to request assistance data from a location server for one or more specific GNSS (e.g., GPS, Galileo, GLONASS, etc.). The specific GNSS for which the assistance data are requested is indicated by the IE *GNSS-ID* and (if applicable) by the IE *SBAS-ID*. Assistance for up to 16 GNSSs can be requested.

```
-- ASN1START
GNSS-GenericAssistDataReq ::= SEQUENCE (SIZE (1..16)) OF GNSS-GenericAssistDataReqElement
GNSS-GenericAssistDataReqElement ::= SEQUENCE {
  gnss-ID                GNSS-ID,
  sbas-ID                SBAS-ID                                OPTIONAL, -- Cond GNSS-ID-SBAS
  gnss-TimeModelsReq    GNSS-TimeModelListReq                OPTIONAL, -- Cond TimeModReq
  gnss-DifferentialCorrectionsReq GNSS-DifferentialCorrectionsReq    OPTIONAL, -- Cond DGNSS-Req
  gnss-NavigationModelReq GNSS-NavigationModelReq                OPTIONAL, -- Cond NavModReq
  gnss-RealTimeIntegrityReq GNSS-RealTimeIntegrityReq            OPTIONAL, -- Cond RTIReq
  gnss-DataBitAssistanceReq GNSS-DataBitAssistanceReq            OPTIONAL, -- Cond DataBitsReq
  gnss-AcquisitionAssistanceReq GNSS-AcquisitionAssistanceReq        OPTIONAL, -- Cond AcquAssistReq
  gnss-AlmanacReq       GNSS-AlmanacReq                        OPTIONAL, -- Cond AlmanacReq
  gnss-UTCModelReq      GNSS-UTC-ModelReq                      OPTIONAL, -- Cond UTCModReq
  gnss-AuxiliaryInformationReq GNSS-AuxiliaryInformationReq        OPTIONAL, -- Cond AuxInfoReq
  ...
}
-- ASN1STOP
```

Conditional presence	Explanation
<i>GNSS-ID-SBAS</i>	The field is mandatory present if the <i>GNSS-ID = sbas</i> ; otherwise it is not present.
<i>TimeModReq</i>	The field is mandatory present if the target device requests <i>GNSS-TimeModelList</i> ; otherwise it is not present.
<i>DGNSS-Req</i>	The field is mandatory present if the target device requests <i>GNSS-DifferentialCorrections</i> ; otherwise it is not present.
<i>NavModReq</i>	The field is mandatory present if the target device requests <i>GNSS-NavigationModel</i> ; otherwise it is not present.
<i>RTIReq</i>	The field is mandatory present if the target device requests <i>GNSS-RealTimeIntegrity</i> ; otherwise it is not present.
<i>DataBitsReq</i>	The field is mandatory present if the target device requests <i>GNSS-DataBitAssistance</i> ; otherwise it is not present.
<i>AcquAssistReq</i>	The field is mandatory present if the target device requests <i>GNSS-AcquisitionAssistance</i> ; otherwise it is not present.
<i>AlmanacReq</i>	The field is mandatory present if the target device requests <i>GNSS-Almanac</i> ; otherwise it is not present.
<i>UTCModReq</i>	The field is mandatory present if the target device requests <i>GNSS-UTCModel</i> ; otherwise it is not present.
<i>AuxInfoReq</i>	The field is mandatory present if the target device requests <i>GNSS-AuxiliaryInformation</i> ; otherwise it is not present.

6.5.2.4 GNSS Assistance Data Request Elements

– GNSS-ReferenceTimeReq

The IE *GNSS-ReferenceTimeReq* is used by the target device to request the *GNSS-ReferenceTime* assistance from the location server.

```
-- ASN1START
GNSS-ReferenceTimeReq ::= SEQUENCE {
    gnss-TimeReqPrefList    SEQUENCE (SIZE (1..8)) OF GNSS-ID,
    gps-TOW-assistReq      BOOLEAN                OPTIONAL, -- Cond gps
    notOfLeapSecReq        BOOLEAN                OPTIONAL, -- Cond glonass
    ...
}
-- ASN1STOP
```

Conditional presence	Explanation
<i>gps</i>	The field is mandatory present if <i>gnss-TimeReqPrefList</i> includes a <i>GNSS-ID= "gps"</i> ; otherwise it is not present.
<i>glonass</i>	The field is mandatory present if <i>gnss-TimeReqPrefList</i> includes a <i>GNSS-ID= "glonass"</i> ; otherwise it is not present.

<i>GNSS-ReferenceTimeReq</i> field descriptions	
<i>gnss-TimeReqPrefList</i>	This field is used by the target device to request the system time for a specific GNSS, specified by GNSS-ID in the order of preference. The first <i>GNSS-ID</i> in the list is the most preferred GNSS for reference time, the second <i>GNSS-ID</i> is the second most preferred, etc.
<i>gps-TOW-assistReq</i>	This field is used by the target device to request the <i>gps-TOW-Assist</i> field in <i>GNSS-SystemTime</i> . TRUE means requested.
<i>notOfLeapSecReq</i>	This field is used by the target device to request the <i>notificationOfLeapSecond</i> field in <i>GNSS-SystemTime</i> . TRUE means requested.

– GNSS-ReferenceLocationReq

The IE *GNSS-ReferenceLocationReq* is used by the target device to request the *GNSS-ReferenceLocation* assistance from the location server.

```
-- ASN1START
GNSS-ReferenceLocationReq ::= SEQUENCE {
    ...
}
-- ASN1STOP
```

– GNSS-IonosphericModelReq

The IE *GNSS-IonosphericModelReq* is used by the target device to request the *GNSS-IonosphericModel* assistance from the location server.

```
-- ASN1START
GNSS-IonosphericModelReq ::= SEQUENCE {
    klobucharModelReq      BIT STRING (SIZE(2))    OPTIONAL, -- Cond klobuchar
    neQuickModelReq        NULL                    OPTIONAL, -- Cond nequick
    ...
}
-- ASN1STOP
```

Conditional presence	Explanation
<i>klobuchar</i>	The field is mandatory present if the target device requests <i>klobucharModel</i> ; otherwise it is not present. The BIT STRING defines the dataID requested, defined in IE <i>KlobucharModelParameter</i> .
<i>nequick</i>	The field is mandatory present if the target device requests <i>neQuickModel</i> ; otherwise it is not present.

– GNSS-EarthOrientationParametersReq

The IE *GNSS-EarthOrientationParametersReq* is used by the target device to request the *GNSS-EarthOrientationParameters* assistance from the location server.

```
-- ASN1START
GNSS-EarthOrientationParametersReq ::= SEQUENCE {
    ...
}
-- ASN1STOP
```

– GNSS-TimeModelListReq

The IE *GNSS-TimeModelListReq* is used by the target device to request the *GNSS-TimeModelElement* assistance from the location server.

```
-- ASN1START
GNSS-TimeModelListReq ::= SEQUENCE (SIZE(1..15)) OF GNSS-TimeModelElementReq
GNSS-TimeModelElementReq ::= SEQUENCE {
    gnss-TO-IDsReq  INTEGER (1..15),
    deltaTreq       BOOLEAN,
    ...
}
-- ASN1STOP
```

***GNSS-TimeModelElementReq* field descriptions**

gnss-TO-IDsReq

This field specifies the requested *gnss-TO-ID*. The meaning and encoding is the same as the *gnss-TO-ID* field in the *GNSS-TimeModelElement* IE.

deltaTreq

This field specifies whether or not the location server is requested to include the *deltaT* field in the *GNSS-TimeModelElement* IE. TRUE means requested.

– GNSS-DifferentialCorrectionsReq

The IE *GNSS-DifferentialCorrectionsReq* is used by the target device to request the *GNSS-DifferentialCorrections* assistance from the location server.

```
-- ASN1START
GNSS-DifferentialCorrectionsReq ::= SEQUENCE {
    dgnss-SignalsReq  GNSS-SignalIDs,
    dgnss-ValidityTimeReq  BOOLEAN,
    ...
}
-- ASN1STOP
```

***GNSS-DifferentialCorrectionsReq* field descriptions**

GNSS-DifferentialCorrectionsReq field descriptions**dgNSS-SignalsReq**

This field specifies the GNSS Signal(s) for which the *GNSS-DifferentialCorrections* are requested. A one-value at a bit position means DGNSS corrections for the specific signal are requested; a zero-value means not requested. The target device shall set a maximum of three bits to value "one".

dgNSS-ValidityTimeReq

This field specifies whether the *udreGrowthRate* and *udreValidityTime* in *GNSS-DifferentialCorrections* are requested or not. TRUE means requested.

GNSS-NavigationModelReq

The IE *GNSS-NavigationModelReq* is used by the target device to request the *GNSS-NavigationModel* assistance from the location server.

```
-- ASN1START

GNSS-NavigationModelReq ::= CHOICE {
    storedNavList      StoredNavListInfo,
    reqNavList        ReqNavListInfo,
    ...
}

StoredNavListInfo ::= SEQUENCE {
    gnss-WeekOrDay      INTEGER (0..4095),
    gnss-Toe            INTEGER (0..255),
    t-toeLimit          INTEGER (0..15),
    satListRelatedDataList  SatListRelatedDataList OPTIONAL,
    ...
}

SatListRelatedDataList ::= SEQUENCE (SIZE (1..64)) OF SatListRelatedDataElement

SatListRelatedDataElement ::= SEQUENCE {
    svID                SV-ID,
    iod                 BIT STRING (SIZE(11)),
    clockModelID        INTEGER (1..8) OPTIONAL,
    orbitModelID        INTEGER (1..8) OPTIONAL,
    ...
}

ReqNavListInfo ::= SEQUENCE {
    svReqList           BIT STRING (SIZE (64)),
    clockModelID-PrefList  SEQUENCE (SIZE (1..8)) OF INTEGER (1..8) OPTIONAL,
    orbitModelID-PrefList  SEQUENCE (SIZE (1..8)) OF INTEGER (1..8) OPTIONAL,
    addNavparamReq      BOOLEAN OPTIONAL, -- Cond orbitModelID-2
    ...
}

-- ASN1STOP
```

Conditional presence	Explanation
<i>orbitModelID-2</i>	The field is mandatory present if <i>orbitModelID-PrefList</i> is absent or includes a Model-ID = "2"; otherwise it is not present.

GNSS-NavigationModelReq field descriptions**storedNavList**

This list provides information to the location server about which *GNSS-NavigationModel* data the target device has currently stored for the particular GNSS indicated by *GNSS-ID*.

reqNavList

This list provides information to the location server which *GNSS-NavigationModel* data are requested by the target device.

gnss-WeekOrDay

If *GNSS-ID* does not indicate "glonass", this field defines the GNSS Week number of the assistance currently held by the target device.

If *GNSS-ID* is set to "glonass", this field defines the calendar number of day within the four-year interval starting from 1st of January in a leap year, as defined by the parameter N_T in [9] of the assistance currently held by the target device.

GNSS-<i>NavigationModelReq</i> field descriptions	
<i>gnss-Toe</i>	If <i>GNSS-ID</i> does not indicate "glonass", this field defines the GNSS time of ephemeris in hours of the latest ephemeris set contained by the target device. If <i>GNSS-ID</i> is set to "glonass", this field defines the time of ephemeris in units of 15 minutes of the latest ephemeris set contained by the target device (range 0 to 95 representing time values between 0 and 1425 minutes). In this case, values 96 to 255 shall not be used by the sender.
<i>t-toeLimit</i>	If <i>GNSS-ID</i> does not indicate "glonass", this IE defines the ephemeris age tolerance of the target device in units of hours. If <i>GNSS-ID</i> is set to "glonass", this IE defines the ephemeris age tolerance of the target device in units of 30 minutes.
<i>satListRelatedDataList</i>	This list defines the clock and orbit models currently held by the target device for each SV. This field is not included if the target device does not have any stored clock and orbit models for any SV.
<i>svID</i>	This field identifies the particular GNSS satellite.
<i>iod</i>	This field identifies the issue of data currently held by the target device.
<i>clockModelID, orbitModelID</i>	These fields define the clock and orbit model number currently held by the target device. If these fields are absent, the default interpretation of the table GNSS-ID to clockModelID & orbitModelID relation below applies.
<i>svReqList</i>	This field defines the SV for which the navigation model assistance is requested. Each bit position in this BIT STRING represents a <i>SV-ID</i> . Bit 0 represents <i>SV-ID</i> =0 and bit 63 represents <i>SV-ID</i> =63. A one-value at a bit position means the navigation model data for the corresponding <i>SV-ID</i> is requested, a zero-value means not requested.
<i>clockModelIDPrefList, orbitModelID-PrefList</i>	These fields define the Model-IDs of the clock and orbit models that the target device wishes to obtain in the order of preference. The first Model-ID in the list is the most preferred model, the second Model-ID the second most preferred, etc. If these fields are absent, the default interpretation of the table GNSS-ID to clockModelID-PrefList & orbitModelIDPrefList relation below applies.
<i>addNavparamReq</i>	This field specifies whether the location server is requested to include the <i>addNAVparam</i> fields in <i>GNSS-<i>NavigationModel</i></i> IE (<i>NavModel-NAVKeplerianSet</i> field) or not. TRUE means requested.

GNSS-ID to clockModelID & orbitModelID relation

<i>GNSS-ID</i>	<i>clockModelID</i>	<i>orbitModelID</i>
gps	2	2
sbas	5	5
qzss	2	2
galileo	1	1
glonass	4	4

GNSS-ID to clockModelID-PrefList & orbitModelID-PrefList relation

<i>GNSS-ID</i>	<i>clockModelID-PrefList</i>	<i>orbitModelID-PrefList</i>
gps	Model-2	Model-2
sbas	Model-5	Model-5
qzss	Model-2	Model-2
galileo	Model-1	Model-1
glonass	Model-4	Model-4

– GNSS-RealTimeIntegrityReq

The IE *GNSS-RealTimeIntegrityReq* is used by the target device to request the *GNSS-RealTimeIntegrity* assistance from the location server.

```
-- ASN1START
GNSS-RealTimeIntegrityReq ::= SEQUENCE {
    ...
}
-- ASN1STOP
```

– GNSS-DataBitAssistanceReq

The IE *GNSS-DataBitAssistanceReq* is used by the target device to request the *GNSS-DataBitAssistance* assistance from the location server.

```
-- ASN1START
GNSS-DataBitAssistanceReq ::= SEQUENCE {
    gnss-TOD-Req          INTEGER (0..3599),
    gnss-TOD-FracReq     INTEGER (0..999)          OPTIONAL,
    dataBitInterval      INTEGER (0..15),
    gnss-SignalType      GNSS-SignalIDs,
    gnss-DataBitsReq     GNSS-DataBitsReqSatList OPTIONAL,
    ...
}

GNSS-DataBitsReqSatList ::= SEQUENCE (SIZE(1..64)) OF GNSS-DataBitsReqSatElement

GNSS-DataBitsReqSatElement ::= SEQUENCE {
    svID                 SV-ID,
    ...
}
-- ASN1STOP
```

GNSS-DataBitAssistanceReq field descriptions

gnss-TOD-Req

This field specifies the reference time for the first data bit requested in GNSS specific system time, modulo 1 hour. Scale factor 1 second.

gnss-TOD-FracReq

This field specifies the fractional part of *gnss-TOD-Req* in 1-milli-second resolution. Scale factor 1 millisecond.

dataBitInterval

This field specifies the time length for which the Data Bit Assistance is requested. The *GNSS-DataBitAssistance* shall be relative to the time interval (*gnss-TOD-Req*, *gnss-TOD-Req* + *dataBitInterval*).

The *dataBitInterval* *r*, expressed in seconds, is mapped to a binary number *K* with the following formula:

$$r = 0.1 \times 2^K$$

Value *K*=15 means that the time interval is not specified.

gnss-SignalType

This field specifies the GNSS Signal(s) for which the *GNSS-DataBitAssistance* are requested. A one-value at a bit position means *GNSS-DataBitAssistance* for the specific signal is requested; a zero-value means not requested.

gnss-DataBitsReq

This list contains the SV-IDs for which the *GNSS-DataBitAssistance* is requested.

– GNSS-AcquisitionAssistanceReq

The IE *GNSS-AcquisitionAssistanceReq* is used by the target device to request the *GNSS-AcquisitionAssistance* assistance from the location server.

```
-- ASN1START
GNSS-AcquisitionAssistanceReq ::= SEQUENCE {
    gnss-SignalID-Req    GNSS-SignalID,
    ...
}
-- ASN1STOP
```

GNSS-AcquisitionAssistanceReq field descriptions

gnss-SignalID-Req

This field specifies the GNSS signal type for which *GNSSAcquisitionAssistance* is requested.

– GNSS-AlmanacReq

The IE *GNSS-AlmanacReq* is used by the target device to request the *GNSS-Almanac* assistance from the location server.

```
-- ASN1START
GNSS-AlmanacReq ::= SEQUENCE {
    modelID          INTEGER(1..8)    OPTIONAL,
    ...
}
-- ASN1STOP
```

GNSS-AlmanacReq field descriptions

modelID

This field specifies the Almanac Model ID requested. If this field is absent, the default interpretation as in the table GNSS-ID to modelID relation below applies.

GNSS-ID to modelID relation

GNSS-ID	modelID
gps	2
sbas	6
qzss	2
galileo	1
glonass	5

– GNSS-UTC-ModelReq

The IE *GNSS-UTC-ModelReq* is used by the target device to request the *GNSS-UTC-Model* assistance from the location server.

```
-- ASN1START
GNSS-UTC-ModelReq ::= SEQUENCE {
    modelID          INTEGER(1..8)    OPTIONAL,
    ...
}
-- ASN1STOP
```

GNSS-UTC-ModelReq field descriptions

modelID

This field specifies the *GNSS-UTCModel* set requested. If this field is absent, the default interpretation as in the table GNSS-ID to modelID relation below applies.

GNSS-ID to modelID relation

GNSS-ID	modelID
gps	1
sbas	4
qzss	1
galileo	1
glonass	3

– GNSS-AuxiliaryInformationReq

The IE *GNSS-AuxiliaryInformationReq* is used by the target device to request the *GNSS-AuxiliaryInformation* assistance from the location server.

```
-- ASN1START
GNSS-AuxiliaryInformationReq ::= SEQUENCE {
    ...
}
-- ASN1STOP
```

6.5.2.5 GNSS Location Information

– A-GNSS-ProvideLocationInformation

The IE *A-GNSS-ProvideLocationInformation* is used by the target device to provide location measurements (e.g., pseudo-ranges, location estimate, velocity) to the location server, together with time information. It may also be used to provide GNSS positioning specific error reason.

```
-- ASN1START
A-GNSS-ProvideLocationInformation ::= SEQUENCE {
    gnss-SignalMeasurementInformation    GNSS-SignalMeasurementInformation    OPTIONAL,
    gnss-LocationInformation             GNSS-LocationInformation             OPTIONAL,
    gnss-Error                           A-GNSS-Error                           OPTIONAL,
    ...
}
-- ASN1STOP
```

6.5.2.6 GNSS Location Information Elements

– GNSS-SignalMeasurementInformation

The IE *GNSS-SignalMeasurementInformation* is used by the target device to provide GNSS signal measurement information to the location server and GNSS-network time association if requested by the location server. This information includes the measurements of code phase, Doppler, C/N_0 and optionally accumulated carrier phase, also called accumulated deltarange (ADR), which enable the UE-assisted GNSS method where position is computed in the location server. Figure 6.5.2.6-1 illustrates the relation between some of the fields.

```
-- ASN1START
GNSS-SignalMeasurementInformation ::= SEQUENCE {
    measurementReferenceTime    MeasurementReferenceTime,
    gnss-MeasurementList        GNSS-MeasurementList,
    ...
}
-- ASN1STOP
```

GNSS-SignalMeasurementInformation field descriptions

measurementReferenceTime

This field specifies the GNSS system time for which the information provided in *gnss-MeasurementList* is valid. It may also include network time, if requested by the location server and supported by the target device.

gnss-MeasurementList

This field provides GNSS signal measurement information for up to 16 GNSSs.

– MeasurementReferenceTime

The IE *MeasurementReferenceTime* is used to specify the time when the measurements provided in *A-GNSS-ProvideLocationInformation* are valid. It may also include GNSS-network time association, in which case reported measurements shall be valid for the cellular frame boundary defined in the network time association.

```
-- ASN1START
MeasurementReferenceTime ::= SEQUENCE {
```



```

gnss-TOD-msec      INTEGER (0..3599999),
gnss-TOD-frac     INTEGER (0..3999)          OPTIONAL,
gnss-TOD-unc      INTEGER (0..127)          OPTIONAL,
gnss-TimeID       GNSS-ID,
networkTime       CHOICE {
  eUTRA           SEQUENCE {
    physCellId    INTEGER (0..503),
    cellGlobalId  CellGlobalIdEUTRA-AndUTRA  OPTIONAL,
    systemFrameNumber BIT STRING (SIZE (10)),
    ...
  },
  uTRA           SEQUENCE {
    mode          CHOICE {
      fdd         SEQUENCE {
        primary-CPICH-Info INTEGER (0..511),
        ...
      },
      tdd         SEQUENCE {
        cellParameters  INTEGER (0..127),
        ...
      }
    },
    cellGlobalId  CellGlobalIdEUTRA-AndUTRA  OPTIONAL,
    referenceSystemFrameNumber
      INTEGER (0..4095),
    ...
  },
  gSM            SEQUENCE {
    bcchCarrier   INTEGER (0..1023),
    bsic          INTEGER (0..63),
    cellGlobalId  CellGlobalIdGERAN          OPTIONAL,
    referenceFrame
      SEQUENCE {
        referenceFN   INTEGER (0..65535),
        referenceFNMSB INTEGER (0..63)      OPTIONAL,
        ...
      },
    deltaGNSS-TOD INTEGER (0..127)          OPTIONAL,
    ...
  }
  ...
}
OPTIONAL,
...
}
-- ASN1STOP

```

MeasurementReferenceTime field descriptions

gnss-TOD-msec

This field specifies the GNSS TOD for which the measurements and/or location estimate are valid. The 22 bits of GNSS TOD are the least significant bits. The most significant bits shall be derived by the location server to unambiguously derive the GNSS TOD.

The value for GNSS TOD is derived from the GNSS specific system time indicated in *gnss-TimeID* rounded down to the nearest millisecond unit.

Scale factor 1 millisecond.

gnss-TOD-frac

This field specifies the fractional part of the GNSS TOD in 250 ns resolution. The total GNSS TOD is given by *gnss-TOD-msec* + *gnss-TOD-frac*.

Scale factor 250 nanoseconds.

gnss-TOD-unc

This field provides the accuracy of the relation GNSS-network time when GNSS-network time association is provided. When GNSS-network time association is not provided, this element can be included to provide the accuracy of the reported *gnss-TOD-msec*.

If GNSS TOD is the given GNSS time, then the true GNSS time, corresponding to the provided network time if applicable, as observed at the target device location, lies in the interval [GNSS TOD – *gnss-TOD-unc*, GNSS TOD + *gnss-TOD-unc*].

The uncertainty *r*, expressed in microseconds, is mapped to a number *K*, with the following formula:

$$r = C * (((1+x)^K) - 1)$$

with *C* = 0.5 and *x* = 0.14. To encode any higher value of uncertainty than that corresponding in the above formula to *K*=127, the same value, *K*=127, shall also be used. The uncertainty is then coded on 7 bits, as the binary encoding of *K*. Examples of *gnss-TOD-unc* value are as in the table Value of *K* to Value of uncertainty relation below.

This field shall be included if the target device provides GNSS-network time relationship.

MeasurementReferenceTime field descriptions	
gnss-TimeID	This field specifies the GNSS system time for which the <i>gnss-TOD-msec</i> (and <i>gnss-TOD-frac</i> if applicable) is provided.
networkTime	These fields specify the network time event which the GNSS TOD time stamps. This field shall be included if the target device provides GNSS-network time relationship.
physCellId	This field identifies the reference cell, as defined in [12], that is used for the GNSS-network time relation.
cellGlobalId	This field specifies the globally unique cell identifier (Evolved Cell Global Identifier (ECGI) in E-UTRA, global UTRAN Cell Identifier in UTRA, or Cell Global Identification (CGI) in GERAN) of the reference cell, as defined in [12] for E-UTRA and [13] for UTRA, for which the GNSS network time relation is provided.
systemFrameNumber	This field specifies the system frame number in E-UTRA which the GNSS time time stamps, as defined in [12].
mode	This field identifies the reference cell for the GNSS-network time relation, as defined in [13].
referenceSystemFrameNumber	This field specifies the system frame number in UTRA, as defined in [13], which is used for time stamping.
bcchCarrier, bscic	This field identifies the reference cell for the GNSS-network time relation in GERAN, as defined in [14].
referenceFN, referenceFNMSB	These fields specify the frame number in GERAN which the GNSS time time stamps, as defined in [14]. The time of the reference frame boundary is as observed by the target device, i.e. without Timing Advance compensation. The <i>referenceFNMSB</i> field indicates the most significant bits of the frame number of the reference BTS corresponding to the <i>GNSS-MeasurementList</i> . Starting from the complete GSM frame number denoted FN, the target device calculates Reference FN MSB as $\text{Reference FN MSB} = \text{floor}(\text{FN}/42432)$ The complete GSM frame number FN can then be reconstructed in the location server by combining the fields <i>referenceFN</i> with <i>referenceFNMSB</i> in the following way $\text{FN} = \text{referenceFNMSB} * 42432 + \text{referenceFN}$
deltaGNSS-TOD	This field specifies the difference in milliseconds between <i>gnss-TOD-msec</i> reported and the milli-second part of the SV time <i>tsv_1</i> of the first SV in the list reported from the target device, as defined in [14]. The <i>deltaGNSS-TOD</i> is defined as $\text{deltaGNSS-TOD} = \text{gnss-TOD-msec} - \text{fix}(\text{tsv}_1)$ where <i>fix()</i> denotes rounding to the nearest integer towards zero.

Value of K to Value of uncertainty relation

Value of K	Value of uncertainty
0	0 microseconds
1	0.07 microseconds
2	0.1498 microseconds
-	-
50	349.62 microseconds
-	-
127	≥ 8430000 microseconds

– GNSS-MeasurementList

The IE *GNSS-MeasurementList* is used by the target device to provide measurements of code phase, Doppler, C/N_0 and optionally accumulated carrier phase, also called accumulated deltarange (ADR).

```
-- ASN1START
GNSS-MeasurementList ::= SEQUENCE (SIZE(1..16)) OF GNSS-MeasurementForOneGNSS
GNSS-MeasurementForOneGNSS ::= SEQUENCE {
    gnss-ID                GNSS-ID,
    gnss-SgnMeasList       GNSS-SgnMeasList,
    ...
}
GNSS-SgnMeasList ::= SEQUENCE (SIZE(1..8)) OF GNSS-SgnMeasElement
```

```

GNSS-SgnMeasElement ::= SEQUENCE {
    gnss-SignalID          GNSS-SignalID,
    gnss-CodePhaseAmbiguity INTEGER (0..127)          OPTIONAL,
    gnss-SatMeasList      GNSS-SatMeasList,
    ...
}

GNSS-SatMeasList ::= SEQUENCE (SIZE(1..64)) OF GNSS-SatMeasElement

GNSS-SatMeasElement ::= SEQUENCE {
    svID                  SV-ID,
    cNo                   INTEGER (0..63),
    mpathDet              ENUMERATED {notMeasured (0), low (1), medium (2), high (3), ...},
    carrierQualityInd     INTEGER (0..3)              OPTIONAL,
    codePhase              INTEGER (0..2097151),
    integerCodePhase      INTEGER (0..127)           OPTIONAL,
    codePhaseRMSError     INTEGER (0..63),
    doppler                INTEGER (-32768..32767)   OPTIONAL,
    adr                    INTEGER (0..33554431)     OPTIONAL,
    ...
}

-- ASN1STOP

```

GNSS-MeasurementList field descriptions

gnss-ID	This field identifies the GNSS constellation on which the GNSS signal measurements were measured. Measurement information for up to 16 GNSSs can be included.
gnss-SgnMeasList	This list provides GNSS signal measurement information for up to 8 GNSS signal types per GNSS.
gnss-SignalID	This field identifies the signal on which GNSS signal measurement parameters were measured.
gnss-CodePhaseAmbiguity	This field provides the ambiguity of the code phase measurement. It is given in units of milli-seconds in the range between 0 and 127 milli-seconds. The total code phase for a satellite <i>k</i> (Satk) is given modulo this <i>gnss-CodePhaseAmbiguity</i> and is reconstructed with: $Code_Phase_Tot(Satk) = codePhase(Satk) + integerCodePhase(Satk) + n * gnss-CodePhaseAmbiguity$, $n = 0, 1, 2, \dots$ If there is no code phase ambiguity, the <i>gnss-CodePhaseAmbiguity</i> shall be set to 0. The field is optional. If <i>gnss-CodePhaseAmbiguity</i> is absent, the default value is 1 milli-second.
gnss-SatMeasList	This list provides GNSS signal measurement information for up to 64 GNSS satellites.
svID	This field identifies the satellite on which the GNSS signal measurements were measured.
cNo	This field provides an estimate of the carrier-to-noise ratio of the received signal from the particular satellite. The target device shall set this field to the value of the satellite C/N_0 , as referenced to the antenna connector, in units of 1 dB-Hz, in the range from 0 to 63 dB-Hz. Scale factor 1 dB-Hz.
mpathDet	This field contains the multipath indicator value, defined in the table Value of mpathDet to Multipath Indication relation below.
carrierQualityInd	This field indicates the quality of a carrier phase measurement. The LSB indicates the data polarity, that is, if the data from a specific satellite is received inverted, this is indicated by setting the LSB value to "1". In the case the data is not inverted, the LSB is set to "0". The MSB indicates if accumulation of the carrier phase has been continuous, that is, without cycle slips since the previous measurement report. If the carrier phase accumulation has been continuous, the MSB value is set to "1X". Otherwise, the MSB is set to "0X". This field is optional but shall be included if the <i>adr</i> field is included. See table Bit to Polarity Indication relation below.
codePhase	This field contains the whole and fractional value of the code-phase measurement made by the target device for the particular satellite signal at the time of measurement in the units of ms. GNSS specific code phase measurements (e.g. chips) are converted into unit of ms by dividing the measurements by the nominal values of the measured signal chipping rate. Scale factor 2^{21} milli-seconds, in the range from 0 to $(1-2^{-21})$ milli-seconds.
integerCodePhase	This field indicates the integer milli-second part of the code phase that is expressed modulo the <i>gnss-CodePhaseAmbiguity</i> . The value of the ambiguity is given in the <i>gnss-CodePhaseAmbiguity</i> field. The <i>integerCodePhase</i> is optional. If <i>integerCodePhase</i> is absent, the default value is 0 milli-second. Scale factor 1 milli-second, in the range from 0 to 127 milli-seconds.

GNSS-MeasurementList field descriptions	
codePhaseRMSError	This field contains the pseudorange RMS error value. This parameter is specified according to a floating-point representation shown in the table below.
doppler	This field contains the Doppler measured by the target device for the particular satellite signal. This information can be used to compute the 3-D velocity of the target device. Doppler measurements are converted into unit of m/s by multiplying the Doppler measurement in Hz by the nominal wavelength of the measured signal. Scale factor 0.04 meter/seconds. This field is optional, but shall be included, if the <i>velocityRequest</i> in <i>CommonEsRequestLocationInformation</i> is set to TRUE.
adr	This field contains the ADR measurement measured by the target device for the particular satellite signal. This information can be used to compute the 3-D velocity or high-accuracy position of the target device. ADR measurements are converted into units of meter by multiplying the ADR measurement by the nominal wavelength of the measured signal. Scale factor 2^{-10} meters, in the range from 0 to 32767.5 meters. This field is optional, but shall be included, if the <i>adrMeasReq</i> in <i>GNSS-PositioningInstructions</i> is set to TRUE and if ADR measurements are supported by the target device (i.e., <i>adrSupport</i> is set to TRUE in <i>A-GNSS-ProvideCapabilities</i>).

Value of *mpathDet* to Multipath Indication relation

Value of <i>mpathDet</i>	Multipath Indication
00	Not measured
01	Low, MP error < 5m
10	Medium, 5m < MP error < 43m
11	High, MP error > 43m

Bit toPolarity Indication relation

Value	Polarity Indication
0	Data Direct, carrier phase not continuous
1	Data Inverted, carrier phase not continuous
2	Data Direct, carrier phase continuous
3	Data Inverted, carrier phase continuous

floating-point representation

Index	Mantissa	Exponent	Floating-Point value, x_i	Pseudorange value, P
0	000	000	0.5	$P < 0.5$
1	001	000	0.5625	$0.5 \leq P < 0.5625$
I	x	y	$0.5 * (1 + x/8) * 2^y$	$x_{i-1} \leq P < x_i$
62	110	111	112	$104 \leq P < 112$
63	111	111	--	$112 \leq P$

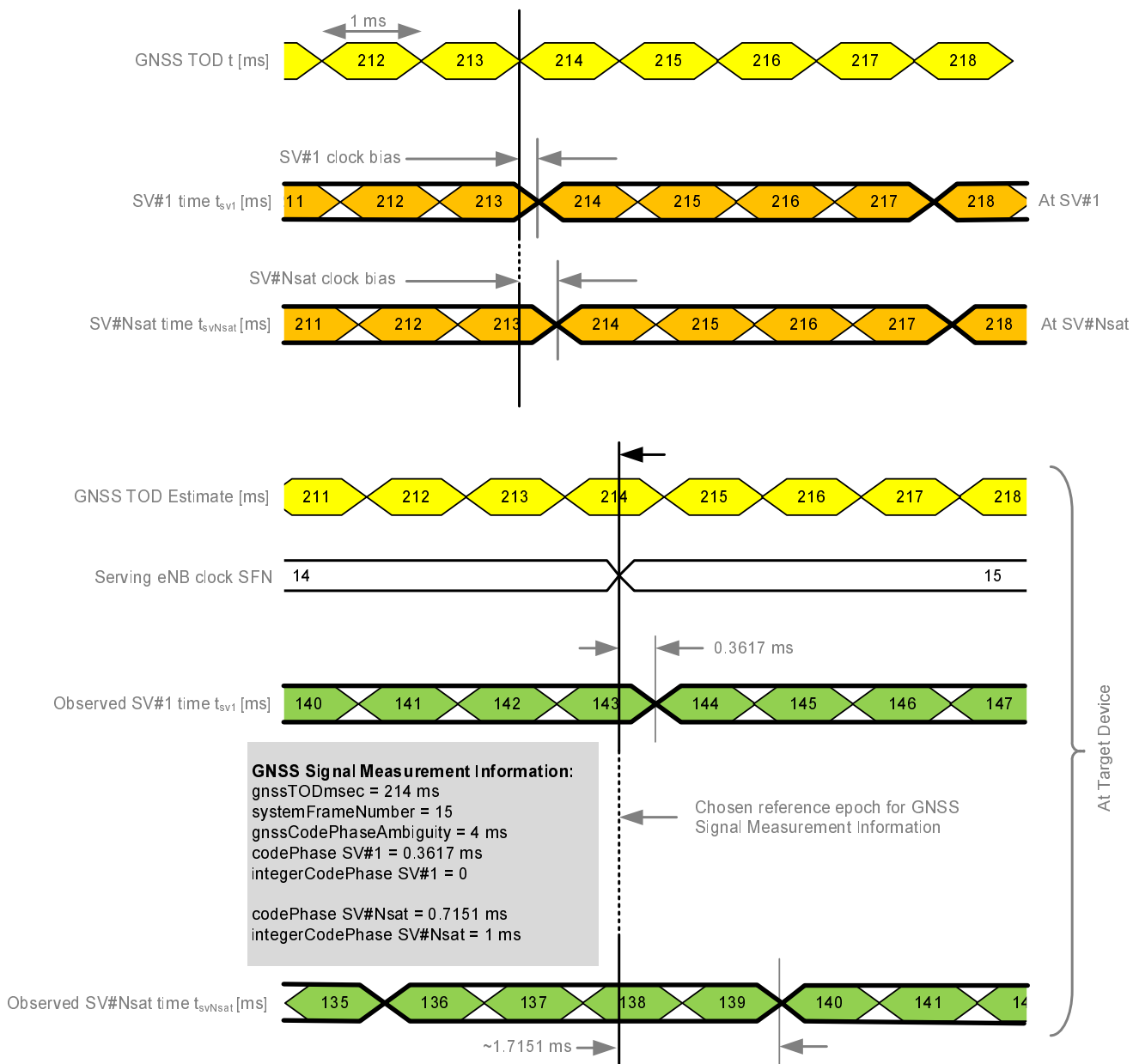

Figure 6.5.2.6-1: Exemplary calculation of some GNSS Signal Measurement Information fields.

GNSS-LocationInformation

The IE *GNSS-LocationInformation* is included by the target device when location and optionally velocity information derived using GNSS or hybrid GNSS and other measurements is provided to the location server.

```

-- ASN1START
GNSS-LocationInformation ::= SEQUENCE {
    measurementReferenceTime      MeasurementReferenceTime,
    agnss-List                    GNSS-ID-Bitmap,
    ...
}
-- ASN1STOP
    
```

GNSS-LocationInformation field descriptions

GNSS-LocationInformation field descriptions
<p>measurementReferenceTime This field specifies the GNSS system time for which the location estimate and optionally velocity are valid. It may also include GNSS-network time relationship, if requested by the location server and supported by the target device.</p>
<p>agnss-List This field provides a list of satellite systems used by the target device to calculate the location estimate and velocity estimate, if included. This is represented by a bit string in <i>GNSS-ID-Bitmap</i>, with a one-value at the bit position means the particular method has been used; a zero-value means not used.</p>

6.5.2.7 GNSS Location Information Request

– A-GNSS-RequestLocationInformation

The IE *A-GNSS-RequestLocationInformation* is used by the location server to request location information from the target device using GNSS.

```
-- ASN1START
A-GNSS-RequestLocationInformation ::= SEQUENCE {
    gnss-PositioningInstructions    GNSS-PositioningInstructions,
    ...
}
-- ASN1STOP
```

6.5.2.8 GNSS Location Information Request Elements

– GNSS-PositioningInstructions

The IE *GNSS-PositioningInstructions* is used to provide GNSS measurement instructions.

```
-- ASN1START
GNSS-PositioningInstructions ::= SEQUENCE {
    gnss-Methods                GNSS-ID-Bitmap,
    fineTimeAssistanceMeasReq   BOOLEAN,
    adrMeasReq                  BOOLEAN,
    multiFreqMeasReq           BOOLEAN,
    assistanceAvailability      BOOLEAN,
    ...
}
-- ASN1STOP
```

GNSS-PositioningInstructions field descriptions
<p>gnssMethods This field indicates the satellite systems allowed by the location server. This is represented by a bit string in <i>GNSS-ID-Bitmap</i>, with a one-value at the bit position means the particular GNSS is allowed; a zero-value means not allowed. The target device shall not request assistance data or report or obtain measurements for systems that are not indicated in this bit map. At least one of the bits in this bit map shall be set to value one.</p>
<p>fineTimeAssistanceMeasReq This field indicates whether the target device is requested to report GNSS-network time association. TRUE means requested.</p>
<p>adrMeasReq This field indicates whether the target device is requested to include ADR measurements in <i>GNSS-MeasurementList</i> IE or not. TRUE means requested.</p>
<p>multiFreqMeasReq This field indicates whether the target device is requested to report measurements on multiple supported GNSS signal types in <i>GNSS-MeasurementList</i> IE or not. TRUE means requested.</p>
<p>assistanceAvailability This field indicates whether the target device may request additional GNSS assistance data from the server. TRUE means allowed and FALSE means not allowed.</p>

6.5.2.9 GNSS Capability Information

– A-GNSS-ProvideCapabilities

The IE *A-GNSS-Provide-Capabilities* is used by the target device to indicate its capability to support A-GNSS and to provide it's A-GNSS location capabilities (e.g., GNSSs and assistance data supported) to the location server.

```
-- ASN1START
A-GNSS-ProvideCapabilities ::= SEQUENCE {
    gnss-SupportList          GNSS-SupportList          OPTIONAL,
    assistanceDataSupportList AssistanceDataSupportList OPTIONAL,
    locationCoordinateTypes   LocationCoordinateTypes   OPTIONAL,
    velocityTypes             VelocityTypes             OPTIONAL,
    ...
}

GNSS-SupportList ::= SEQUENCE (SIZE(1..16)) OF GNSS-SupportElement

GNSS-SupportElement ::= SEQUENCE {
    gnss-ID                GNSS-ID,
    sbas-IDs                SBAS-IDs                OPTIONAL,    -- Cond GNSS-ID-SBAS
    agnss-Modes             PositioningModes,
    gnss-Signals            GNSS-SignalIDs,
    fta-MeasSupport        SEQUENCE {
        cellTime           AccessTypes,
        mode               PositioningModes,
        ...
    } OPTIONAL,    -- Cond fta
    adr-Support            BOOLEAN,
    velocityMeasurementSupport BOOLEAN,
    ...
}

AssistanceDataSupportList ::= SEQUENCE {
    gnss-CommonAssistanceDataSupport GNSS-CommonAssistanceDataSupport,
    gnss-GenericAssistanceDataSupport GNSS-GenericAssistanceDataSupport,
    ...
}

-- ASN1STOP
```

Conditional presence	Explanation
<i>GNSS-ID-SBAS</i>	The field is mandatory present if the <i>GNSS-ID = sbas</i> ; otherwise it is not present.
<i>fta</i>	The field is mandatory present if the target device supports the reporting of fine time assistance measurements; otherwise it is not present.

A-GNSS-ProvideCapabilities field descriptions

<i>gnss-SupportList</i>
This field specifies the list of GNSS supported by the target device and the target device capabilities associated with each of the supported GNSS. This field shall be present if the <i>gnss-SupportListReq</i> in the A-GNSS - <i>RequestCapabilities</i> IE is set to TRUE and if the target device supports the A-GNSS positioning method. If the IE <i>A-GNSS-Provide-Capabilities</i> is provided unsolicited, this field shall be included if the target device supports the assisted GNSS positioning method.
<i>gnss-ID</i>
This field specifies the GNSS supported by the target device for which the capabilities in <i>GNSS-SupportElement</i> are provided.
<i>sbas-IDs</i>
This field specifies the SBAS(s) supported by the target device. This is represented by a bit string, with a one-value at the bit position means the particular SBAS is supported; a zero-value means not supported.
<i>agnss-Modes</i>
This field specifies the GNSS mode(s) supported by the target device for the GNSS indicated by <i>gnss-ID</i> . This is represented by a bit string, with a one-value at the bit position means the particular GNSS mode is supported; a zero-value means not supported.
<i>gnss-Signals</i>
This field specifies the GNSS signal(s) supported by the target device for the GNSS indicated by <i>gnss-ID</i> . This is represented by a bit string, with a one-value at the bit position means the particular GNSS signal type is supported; a zero-value means not supported.

A-GNSS-ProvideCapabilities field descriptions
<p>fta-MeasSupport This field specifies that the target device is capable of performing fine time assistance measurements (i.e., GNSS-cellular time association reporting). The <i>cellTime</i> field specifies for which cellular network(s) this capability is supported. This is represented by a bit string, with a one-value at the bit position means FTA measurements for the specific cellular network time is supported; a zero-value means not supported. The <i>mode</i> field specifies for which GNSS mode(s) FTA measurements are supported by the target device. This is represented by a bit string, with a one-value at the bit position means FTA measurements for the GNSS mode is supported; a zero-value means not supported.</p>
<p>adr-Support This field specifies whether the target device supports ADR measurement reporting. TRUE means supported.</p>
<p>velocityMeasurementSupport This field specifies whether the target device supports measurement reporting related to velocity. TRUE means supported.</p>
<p>assistanceDataSupportList This list defines the assistance data and assistance data choices supported by the target device. This field shall be present if the <i>assistanceDataSupportListReq</i> in the A-GNSS-RequestCapabilities IE is set to TRUE and if the target device supports GNSS assistance data. If the IE A-GNSS-Provide-Capabilities is provided unsolicited, this field shall be included if the target device supports any GNSS assistance data.</p>
<p>locationCoordinateTypes This parameter identifies the geographical location coordinate types that a target device supports for GNSS. TRUE indicates that a location coordinate type is supported and FALSE that it is not. This field shall be present if the <i>locationVelocityTypesReq</i> in the A-GNSS-RequestCapabilities IE is set to TRUE and if the target device supports UE-based or standalone GNSS positioning method. If the IE A-GNSS-Provide-Capabilities is provided unsolicited, this field shall be included if the target device supports UE-based or standalone GNSS positioning method.</p>
<p>velocityTypes This parameter identifies the velocity types that a target device supports for GNSS. TRUE indicates that a velocity type is supported and FALSE that it is not. FALSE for all velocity types indicates that velocity reporting is not supported. This field shall be present if the <i>locationVelocityTypesReq</i> in the A-GNSS-RequestCapabilities IE is set to TRUE and if the target device supports UE-based or standalone GNSS positioning method. If the IE A-GNSS-Provide-Capabilities is provided unsolicited, this field shall be included if the target device supports UE-based or standalone GNSS positioning method.</p>

6.5.2.10 GNSS Capability Information Elements

– GNSS-CommonAssistanceDataSupport

The IE *GNSS-CommonAssistanceDataSupport* is used by the target device to provide information on supported GNSS common assistance data types to the location server.

```

-- ASN1START
GNSS-CommonAssistanceDataSupport ::= SEQUENCE {
    gnss-ReferenceTimeSupport          GNSS-ReferenceTimeSupport
                                     OPTIONAL, -- Cond RefTimeSup
    gnss-ReferenceLocationSupport     GNSS-ReferenceLocationSupport
                                     OPTIONAL, -- Cond RefLocSup
    gnss-IonosphericModelSupport      GNSS-IonosphericModelSupport
                                     OPTIONAL, -- Cond IonoModSup
    gnss-EarthOrientationParametersSupport GNSS-EarthOrientationParametersSupport
                                     OPTIONAL, -- Cond EOPSup
    ...
}
-- ASN1STOP

```

Conditional presence	Explanation
<i>RefTimeSup</i>	The field is mandatory present if the target device supports <i>GNSS-ReferenceTime</i> ; otherwise it is not present.
<i>RefLocSup</i>	This field is mandatory present if the target device supports <i>GNSS-ReferenceLocation</i> ; otherwise it is not present.
<i>IonoModSup</i>	This field is mandatory present if the target device supports <i>GNSS-IonosphericModel</i> ; otherwise it is not present.
<i>EOPSup</i>	This field is mandatory present if the target device supports <i>GNSS-EarthOrientationParameters</i> ; otherwise it is not present.

– GNSS-ReferenceTimeSupport

```
-- ASN1START
GNSS-ReferenceTimeSupport ::= SEQUENCE {
    gnss-SystemTime    GNSS-ID-Bitmap,
    fta-Support        AccessTypes                                OPTIONAL, -- Cond fta
    ...
}
-- ASN1STOP
```

Conditional presence	Explanation
<i>fta</i>	The field is mandatory present if the target device supports fine time assistance in <i>GNSSReferenceTime</i> IE; otherwise it is not present.

GNSS-ReferenceTimeSupport field descriptions

gnss-SystemTime

This field specifies the GNSS system time(s) supported by the target device. This is represented by a bit string in *GNSS-ID-Bitmap*, with a one-value at the bit position means the particular GNSS system time is supported; a zero-value means not supported.

fta-Support

This field specifies that the target device supports fine time assistance (i.e., GNSS-cellular time association) in *GNSS-ReferenceTime* IE. This is represented by a bit string in *AccessTypes*, with a one-value at the bit position means FTA for the specific cellular network time is supported; a zero-value means not supported.

– GNSS-ReferenceLocationSupport

```
-- ASN1START
GNSS-ReferenceLocationSupport ::= SEQUENCE {
    ...
}
-- ASN1STOP
```

– GNSS-IonosphericModelSupport

```
-- ASN1START
GNSS-IonosphericModelSupport ::= SEQUENCE {
    ionoModel          BIT STRING { klobuchar (0),
    ...                neQuick      (1) } (SIZE (1..8)),
    ...
}
-- ASN1STOP
```

GNSS-IonosphericModelSupport field descriptions

ionoModel

This field specifies the ionospheric model(s) supported by the target device. This is represented by a bit string, with a one-value at the bit position means the particular ionospheric model is supported; a zero-value means not supported.

– GNSS-EarthOrientationParametersSupport

```
-- ASN1START
GNSS-EarthOrientationParametersSupport ::= SEQUENCE {
    ...
}
-- ASN1STOP
```

– GNSS-GenericAssistanceDataSupport

The IE *GNSS-GenericAssistanceDataSupport* is used by the target device to provide information on supported GNSS generic assistance data types to the location server for each supported GNSS.

```
-- ASN1START
GNSS-GenericAssistanceDataSupport ::=
    SEQUENCE (SIZE (1..16)) OF GNSS-GenericAssistDataSupportElement
GNSS-GenericAssistDataSupportElement ::= SEQUENCE {
    gnss-ID                GNSS-ID,
    sbas-ID                SBAS-ID                OPTIONAL, -- Cond GNSS-ID-SBAS
    gnss-TimeModelsSupport GNSS-TimeModelListSupport
                                OPTIONAL, -- Cond TimeModSup
    gnss-DifferentialCorrectionsSupport GNSS-DifferentialCorrectionsSupport
                                OPTIONAL, -- Cond DGNSS-Sup
    gnss-NavigationModelSupport GNSS-NavigationModelSupport
                                OPTIONAL, -- Cond NavModSup
    gnss-RealTimeIntegritySupport GNSS-RealTimeIntegritySupport
                                OPTIONAL, -- Cond RTISup
    gnss-DataBitAssistanceSupport GNSS-DataBitAssistanceSupport
                                OPTIONAL, -- Cond DataBitsSup
    gnss-AcquisitionAssistanceSupport GNSS-AcquisitionAssistanceSupport
                                OPTIONAL, -- Cond AcquAssistSup
    gnss-AlmanacSupport      GNSS-AlmanacSupport
                                OPTIONAL, -- Cond AlmanacSup
    gnss-UTC-ModelSupport    GNSS-UTC-ModelSupport
                                OPTIONAL, -- Cond UTCModSup
    gnss-AuxiliaryInformationSupport GNSS-AuxiliaryInformationSupport
                                OPTIONAL, -- Cond AuxInfoSup
    ...
}
-- ASN1STOP
```

Conditional presence	Explanation
<i>GNSS-ID-SBAS</i>	The field is mandatory present if the <i>GNSS-ID</i> = <i>sbas</i> ; otherwise it is not present.
<i>TimeModSup</i>	The field is mandatory present if the target device supports <i>GNSS-TimeModelList</i> ; otherwise it is not present.
<i>DGNSS-Sup</i>	The field is mandatory present if the target device supports <i>GNSS-DifferentialCorrections</i> ; otherwise it is not present.
<i>NavModSup</i>	The field is mandatory present if the target device supports <i>GNSS-NavigationModel</i> ; otherwise it is not present.
<i>RTISup</i>	The field is mandatory present if the target device supports <i>GNSS-RealTimeIntegrity</i> ; otherwise it is not present.
<i>DataBitsSup</i>	The field is mandatory present if the target device supports <i>GNSS-DataBitAssistance</i> ; otherwise it is not present.
<i>AcquAssistSup</i>	The field is mandatory present if the target device supports <i>GNSS-AcquisitionAssistance</i> ; otherwise it is not present.
<i>AlmanacSup</i>	The field is mandatory present if the target device supports <i>GNSS-Almanac</i> ; otherwise it is not present.
<i>UTCModSup</i>	The field is mandatory present if the target device supports <i>GNSS-UTC-Model</i> ; otherwise it is not present.
<i>AuxInfoSup</i>	The field is mandatory present if the target device supports <i>GNSS-AuxiliaryInformation</i> ; otherwise it is not present.

– GNSS-TimeModelListSupport

```
-- ASN1START
GNSS-TimeModelListSupport ::= SEQUENCE {
    ...
}
-- ASN1STOP
```

– GNSS-DifferentialCorrectionSupport

```
-- ASN1START
GNSS-DifferentialCorrectionsSupport ::= SEQUENCE {
    gnssSignalIDs      GNSS-SignalIDs,
    dgnss-ValidityTimeSup  BOOLEAN,
    ...
}
-- ASN1STOP
```

GNSS-DifferentialCorrectionsSupport field descriptions

gnssSignalIDs

This field specifies the GNSS signal types for which differential corrections are supported by the target device. This is represented by a bit string in *GNSS-SignalIDs*, with a one-value at the bit position means differential corrections for the particular GNSS signal type is supported; a zero-value means not supported.

dgnss-ValidityTimeSup

This field specifies if the target device supports estimation of UDRE based on growth rate and validity time for differential corrections. TRUE means supported.

– GNSS-NavigationModelSupport

```
-- ASN1START
GNSS-NavigationModelSupport ::= SEQUENCE {
    clockModel      BIT STRING {
        model-1      (0),
        model-2      (1),
        model-3      (2),
        model-4      (3),
        model-5      (4) } (SIZE (1..8)) OPTIONAL,
    orbitModel      BIT STRING {
        model-1      (0),
        model-2      (1),
        model-3      (2),
        model-4      (3),
        model-5      (4) } (SIZE (1..8)) OPTIONAL,
    ...
}
-- ASN1STOP
```

GNSS-NavigationModelSupport field descriptions

clockModel

This field specifies the *gnss-ClockModel* choice(s) in *GNSS-NavigationModel* IE supported by the target device for the GNSS indicated by *GNSS-ID*. This is represented by a bit string, with a one-value at the bit position means the particular clock model is supported; a zero-value means not supported.

If the target device supports GPS and *GNSS-NavigationModel* assistance, it shall support *clockModel* Model-2.

If the target device supports SBAS and *GNSS-NavigationModel* assistance, it shall support *clockModel* Model-5.

If the target device supports QZSS and *GNSS-NavigationModel* assistance, it shall support *clockModel* Model-2.

If the target device supports Galileo and *GNSS-NavigationModel* assistance, it shall support *clockModel* Model-1.

If the target device supports GLONASS and *GNSS-NavigationModel* assistance, it shall support *clockModel* Model-4.

If this field is absent, the target device supports the mandatory (native) *clockModel* choice only as listed above for the GNSS indicated by *GNSS-ID*.

orbitModel

This field specifies the *gnss-OrbitModel* choice(s) in *GNSS-NavigationModel* IE supported by the target device for the GNSS indicated by *GNSS-ID*. This is represented by a bit string, with a one-value at the bit position means the particular orbit model is supported; a zero-value means not supported.

If the target device supports GPS and *GNSS-NavigationModel* assistance, it shall support *orbitModel* Model-2.

If the target device supports SBAS and *GNSS-NavigationModel* assistance, it shall support *orbitModel* Model-5.

If the target device supports QZSS and *GNSS-NavigationModel* assistance, it shall support *orbitModel* Model-2.

If the target device supports Galileo and *GNSS-NavigationModel* assistance, it shall support *orbitModel* Model-1.

If the target device supports GLONASS and *GNSS-NavigationModel* assistance, it shall support *orbitModel* Model-4.

If this field is absent, the target device supports the mandatory (native) *orbitModel* choice only as listed above for the GNSS indicated by *GNSS-ID*.

– GNSS-RealTimeIntegritySupport

```
-- ASN1START
GNSS-RealTimeIntegritySupport ::= SEQUENCE {
    ...
}
-- ASN1STOP
```

– GNSS-DataBitAssistanceSupport

```
-- ASN1START
GNSS-DataBitAssistanceSupport ::= SEQUENCE {
    ...
}
-- ASN1STOP
```

– GNSS-AcquisitionAssistanceSupport

```
-- ASN1START
GNSS-AcquisitionAssistanceSupport ::= SEQUENCE {
    ...
    confidenceSupport-r10          ENUMERATED { true }      OPTIONAL,
    dopplerUncertaintyExtSupport-r10  ENUMERATED { true }      OPTIONAL
}
-- ASN1STOP
```

GNSS-AcquisitionAssistanceSupport field descriptions

confidenceSupport

If this field is present, the target device supports the *confidence* field in *GNSS-AcquisitionAssistance*.

dopplerUncertaintyExtSupport

If this field is present, the target device supports the *dopplerUncertaintyExt* field in *GNSS-AcquisitionAssistance*.

– GNSS-AlmanacSupport

```
-- ASN1START
GNSS-AlmanacSupport ::= SEQUENCE {
    almanacModel BIT STRING {
        model-1 (0),
        model-2 (1),
        model-3 (2),
        model-4 (3),
        model-5 (4),
        model-6 (5) } (SIZE (1..8)) OPTIONAL,
    ...
}
-- ASN1STOP
```

GNSS-AlmanacSupport field descriptions

GNSS-AlmanacSupport field descriptions***almanacModel***

This field specifies the *almanacModel* choice(s) in *GNSS-Almanac* IE supported by the target device for the GNSS indicated by *GNSS-ID*. This is represented by a bit string, with a one-value at the bit position means the particular almanac model is supported; a zero-value means not supported.

If the target device supports GPS and *GNSS-Almanac* assistance, it shall support Model-2.

If the target device supports SBAS and *GNSS-Almanac* assistance, it shall support Model-6.

If the target device supports QZSS and *GNSS-Almanac* assistance, it shall support Model-2.

If the target device supports Galileo and *GNSS-Almanac* assistance, it shall support Model-1.

If the target device supports GLONASS and *GNSS-Almanac* assistance, it shall support Model-5.

If this field is absent, the target device supports the mandatory (native) *almanacModel* choice only as listed above for the GNSS indicated by *GNSS-ID*.

GNSS-UTC-ModelSupport

```
-- ASN1START
GNSS-UTC-ModelSupport ::= SEQUENCE {
    utc-Model      BIT STRING {
        model-1    (0),
        model-2    (1),
        model-3    (2),
        model-4    (3) } (SIZE (1..8))    OPTIONAL,
    ...
}
-- ASN1STOP
```

GNSS-UTC-ModelSupport field descriptions***utc-Model***

This field specifies the *GNSS-UTC-Model* choice(s) in *GNSS-UTC-Model* IE supported by the target device for the GNSS indicated by *GNSS-ID*. This is represented by a bit string, with a one-value at the bit position means the particular UTC model is supported; a zero-value means not supported.

If the target device supports GPS and *GNSS-UTC-Model* assistance, it shall support Model-1.

If the target device supports SBAS and *GNSS-UTC-Model* assistance, it shall support Model-4.

If the target device supports QZSS and *GNSS-UTC-Model* assistance, it shall support Model-1.

If the target device supports Galileo and *GNSS-UTC-Model* assistance, it shall support Model-1.

If the target device supports GLONASS and *GNSS-UTC-Model* assistance, it shall support Model-3.

If this field is absent, the target device supports the mandatory (native) *utc-Model* choice only as listed above for the GNSS indicated by *GNSS-ID*.

GNSS-AuxiliaryInformationSupport

```
-- ASN1START
GNSS-AuxiliaryInformationSupport ::= SEQUENCE {
    ...
}
-- ASN1STOP
```

6.5.2.11 GNSS Capability Information Request**A-GNSS-RequestCapabilities**

The IE *A-GNSS-Request-Capabilities* is used by the location server to request A-GNSS location capabilities (e.g., GNSSs and assistance data supported) from the target device.

```
-- ASN1START
A-GNSS-RequestCapabilities ::= SEQUENCE {
    gnss-SupportListReq      BOOLEAN,
    assistanceDataSupportListReq  BOOLEAN,
    locationVelocityTypesReq  BOOLEAN,
    ...
}
```

```
}
-- ASN1STOP
```

A-GNSS-RequestCapabilities field descriptions

gnss-SupportListReq

This field specifies whether the target device is requested to include the *gnss-SupportList* field in the *A-GNSS-ProvideCapabilities* IE or not. TRUE means requested.

assistanceDataSupportListReq

This field specifies whether the target device is requested to include the *assistanceDataSupportList* field in the *A-GNSS-ProvideCapabilities* IE or not. TRUE means requested.

locationVelocityTypesReq

This field specifies whether the target device is requested to include the *locationCoordinateTypes* field and *velocityTypes* field in the *A-GNSS-ProvideCapabilities* IE or not. TRUE means requested.

6.5.2.12 GNSS Error Elements

– A-GNSS-Error

The IE *A-GNSS-Error* is used by the location server or target device to provide GNSS error reasons.

```
-- ASN1START
A-GNSS-Error ::= CHOICE {
    locationServerErrorCauses      GNSS-LocationServerErrorCauses,
    targetDeviceErrorCauses       GNSS-TargetDeviceErrorCauses,
    ...
}
-- ASN1STOP
```

– GNSS-LocationServerErrorCauses

The IE *GNSS-LocationServerErrorCauses* is used by the location server to provide GNSS error reasons to the target device.

```
-- ASN1START
GNSS-LocationServerErrorCauses ::= SEQUENCE {
    cause      ENUMERATED {
        undefined,
        undeliveredAssistanceDataIsNotSupportedByServer,
        undeliveredAssistanceDataIsSupportedButCurrentlyNotAvailableByServer,
        undeliveredAssistanceDataIsPartlyNotSupportedAndPartlyNotAvailableByServer,
        ...
    },
    ...
}
-- ASN1STOP
```

– GNSS-TargetDeviceErrorCauses

The IE *GNSS-TargetDeviceErrorCauses* is used by the target device to provide GNSS error reasons to the location server.

```
-- ASN1START
GNSS-TargetDeviceErrorCauses ::= SEQUENCE {
    cause      ENUMERATED {
        undefined,
        thereWereNotEnoughSatellitesReceived,
        assistanceDataMissing,
        notAllRequestedMeasurementsPossible,
        ...
    },
    fineTimeAssistanceMeasurementsNotPossible    NULL    OPTIONAL,
}
-- ASN1STOP
```

```

    adrMeasurementsNotPossible          NULL          OPTIONAL,
    multiFrequencyMeasurementsNotPossible  NULL          OPTIONAL,
    ...
}
-- ASN1STOP

```

GNSS-TargetDeviceErrorCauses field descriptions

cause

This field provides a GNSS specific error cause. If the cause value is "*notAllRequestedMeasurementsPossible*", the target device was not able to provide all requested GNSS measurements (but may be able to report a location estimate or location measurements). In this case, the target device should include any of the "*fineTimeAssistanceMeasurementsNotPossible*", "*adrMeasurementsNotPossible*", or "*multiFrequencyMeasurementsNotPossible*" fields, as applicable.

6.5.2.13 Common GNSS Information Elements

– GNSS-ID

The IE *GNSS-ID* is used to indicate a specific GNSS.

```

-- ASN1START
GNSS-ID ::= SEQUENCE {
    gnss-id          ENUMERATED{ gps, sbas, qzss, galileo, glonass, ...},
    ...
}
-- ASN1STOP

```

– GNSS-ID-Bitmap

The IE *GNSS-ID-Bitmap* is used to indicate several GNSSs using a bit map.

```

-- ASN1START
GNSS-ID-Bitmap ::= SEQUENCE {
    gnss-ids          BIT STRING {
        gps           (0),
        sbas          (1),
        qzss          (2),
        galileo       (3),
        glonass       (4) } (SIZE (1..16)),
    ...
}
-- ASN1STOP

```

GNSS-ID-Bitmap field descriptions

gnss-ids

This field specifies the GNSS(s). This is represented by a bit string, with a one-value at the bit position means the particular GNSS is addressed; a zero-value means not addressed.

– GNSS-SignalID

The IE *GNSS-SignalID* is used to indicate a specific GNSS signal type. The interpretation of *GNSS-SignalID* depends on the *GNSS-ID*.

```

-- ASN1START
GNSS-SignalID ::= SEQUENCE {
    gnss-SignalID    INTEGER (0 .. 7),
    ...
}

```

-- ASN1STOP

GNSS-SignalID field descriptions

gnss-SignalID

This field specifies a particular GNSS signal. The interpretation of *gnss-SignalID* depends on the *GNSS-ID* and is as shown in the table System to Value & Explanation relation below.

System to Value & Explanation relation

System	Value	Explanation
GPS	0	GPS L1 C/A
	1	GPS L1C
	2	GPS L2C
	3	GPS L5
	4-7	Reserved
SBAS	0	L1
	1-7	Reserved
QZSS	0	QZS-L1
	1	QZS-L1C
	2	QZS-L2C
	3	QZS-L5
	4-7	Reserved
GLONASS	0	GLONASS G1
	1	GLONASS G2
	2	GLONASS G3
	3-7	Reserved
Galileo	0	Galileo E1
	1	Galileo E5A
	2	Galileo E5B
	3	Galileo E6
	4	Galileo E5A + E5B
	5-7	Reserved

GNSS-SignalIDs

The IE *GNSSSignal-IDs* is used to indicate several GNSS signals using a bit map. The interpretation of *GNSSSignal-IDs* depends on the *GNSS-ID*.

```
-- ASN1START
GNSS-SignalIDs ::= SEQUENCE {
    gnss-SignalIDs    BIT STRING (SIZE(8)),
    ...
}
-- ASN1STOP
```

GNSS-SignalIDs field descriptions

gnss-SignalIDs

This field specifies one or several GNSS signals using a bit map. A one-value at the bit position means the particular signal is addressed; a zero-value at the particular bit position means the signal is not addressed. The interpretation of the bit map in *gnssSignalIDs* depends on the *GNSS-ID* and is shown in the table below.

Unfilled table entries indicate no assignment and shall be set to zero.

interpretation of the bit map in *gnssSignalIDs*

GNSS	Bit 1 (MSB)	Bit 2	Bit 3	Bit 4	Bit 5	Bit 6	Bit 7	Bit 8 (LSB)
GPS	L1 C/A	L1C	L2C	L5				
SBAS	L1							
QZSS	QZS-L1	QZS-L1C	QZS-L2C	QZS-L5				
GLONASS	G1	G2	G3					
Galileo	E1	E5a	E5b	E6	E5a+E5b			

– SBAS-ID

The IE *SBAS-ID* is used to indicate a specific SBAS.

```
-- ASN1START
SBAS-ID ::= SEQUENCE {
    sbas-id          ENUMERATED { waas, egnos, msas, gagan, ... },
    ...
}
-- ASN1STOP
```

– SBAS-IDs

The IE *SBAS-IDs* is used to indicate several SBASs using a bit map.

```
-- ASN1START
SBAS-IDs ::= SEQUENCE {
    sbas-IDs        BIT STRING {
        waas          (0),
        egnos         (1),
        msas          (2),
        gagan         (3) } (SIZE (1..8)),
    ...
}
-- ASN1STOP
```

SBAS-IDs field descriptions

sbas-IDs

This field specifies one or several SBAS(s) using a bit map. A one-value at the bit position means the particular SBAS is addressed; a zero-value at the particular bit position means the SBAS is not addressed.

– SV-ID

The IE *SV-ID* is used to indicate a specific GNSS satellite. The interpretation of *SV-ID* depends on the *GNSS-ID*.

```
-- ASN1START
SV-ID ::= SEQUENCE {
    satellite-id    INTEGER(0..63),
    ...
}
-- ASN1STOP
```

SV-ID field descriptions

satellite-id

This field specifies a particular satellite within a specific GNSS. The interpretation of *satellite-id* depends on the *GNSS-ID* see the table below.

interpretation of *satellite-id*

System	Value of <i>satellite-id</i>	Interpretation of <i>satellite-id</i>
GPS	"0" – "62" "63"	Satellite PRN Signal No. 1 to 63 Reserved
SBAS	"0" – "38" "39" – "63"	Satellite PRN Signal No. 120 to 158 Reserved
QZSS	"0" – "4" "5" – "63"	Satellite PRN Signal No. 193 to 197 Reserved
GLONASS	"0" – "23" "24" – "63"	Slot Number 1 to 24 Reserved
Galileo	TBD	TBD

6.5.3 Enhanced Cell ID Positioning

6.5.3.1 E-CID Location Information

– ECID-ProvideLocationInformation

The IE *ECID-ProvideLocationInformation* is used by the target device to provide E-CID location measurements to the location server. It may also be used to provide ECID positioning specific error reason.

```
-- ASN1START
ECID-ProvideLocationInformation ::= SEQUENCE {
    ecid-SignalMeasurementInformation  ECID-SignalMeasurementInformation  OPTIONAL,
    ecid-Error                          ECID-Error                          OPTIONAL,
    ...
}
-- ASN1STOP
```

6.5.3.2 E-CID Location Information Elements

– ECID-SignalMeasurementInformation

The IE *ECID-SignalMeasurementInformation* is used by the target device to provide various UE-measurements to the location server.

```
-- ASN1START
ECID-SignalMeasurementInformation ::= SEQUENCE {
    primaryCellMeasuredResults  MeasuredResultsElement  OPTIONAL,
    measuredResultsList         MeasuredResultsList,
    ...
}
MeasuredResultsList ::= SEQUENCE (SIZE(1..32)) OF MeasuredResultsElement
MeasuredResultsElement ::= SEQUENCE {
    physCellId      INTEGER (0..503),
    cellGlobalId    CellGlobalIdEUTRA-AndUTRA          OPTIONAL,
    arfcnEUTRA      ARFCN-ValueEUTRA,
    systemFrameNumber
    BIT STRING (SIZE (10))                               OPTIONAL,
    rsrp-Result     INTEGER (0..97)                     OPTIONAL,
    rsrq-Result     INTEGER (0..34)                     OPTIONAL,
    ue-RxTxTimeDiff INTEGER (0..4095)                   OPTIONAL,
    ...
    [[ arfcnEUTRA-v9a0  ARFCN-ValueEUTRA-v9a0          OPTIONAL      -- Cond EARFCN-max
    ]]
}
-- ASN1STOP
```

Conditional presence	Explanation
<i>EARFCN-max</i>	The field is mandatory present if the corresponding <i>arfcnEUTRA</i> (i.e. without suffix) is set to <i>maxEARFCN</i> . Otherwise the field is not present.

<i>ECID-SignalMeasurementInformation</i> field descriptions
<p><i>primaryCellMeasuredResults</i> This field contains measurements for the primary cell, when the target device reports measurements for both primary cell and neighbour cells. This field shall be omitted when the target device reports measurements for the primary cell only, in which case the measurements the primary cell is reported in the <i>measuredResultsList</i>.</p>
<p><i>measuredResultsList</i> This list contains the E-CID measurements for up to 32 cells.</p>
<p><i>physCellId</i> This field specifies the physical cell identity of the measured cell.</p>
<p><i>cellGlobalId</i> This field specifies cell global ID of the measured cell. The target device shall provide this field if it was able to determine the ECGI of the measured cell at the time of measurement.</p>
<p><i>arfcnEUTRA</i> This field specifies the ARFCN of the measured E-UTRA carrier frequency, as defined in [12]. In case the target device includes <i>arfcnEUTRA-v9a0</i>, the target device shall set the corresponding <i>arfcnEUTRA</i> (i.e. without suffix) to <i>maxEARFCN</i>.</p>
<p><i>systemFrameNumber</i> This field specifies the system frame number of the measured cell during which the measurements have been performed. The target device shall include this field if it was able to determine the SFN of the cell at the time of measurement.</p>
<p><i>rsrp-Result</i> This field specifies the reference signal received power (RSRP) measurement, as defined in [12],[17].</p>
<p><i>rsrq-Result</i> This field specifies the reference signal received quality (RSRQ) measurement, as defined in [12],[17].</p>
<p><i>ue-RxTxTimeDiff</i> This field specifies the UE Rx-Tx time difference measurement, as defined in [17]. It is provided only for measurements on the UE's primary cell. Measurement report mapping is according to 3GPP TS 36.133 [18].</p>

6.5.3.3 E-CID Location Information Request

– ECID-RequestLocationInformation

The IE *ECID-RequestLocationInformation* is used by the location server to request E-CID location measurements from a target device.

```
-- ASN1START
ECID-RequestLocationInformation ::= SEQUENCE {
    requestedMeasurements    BIT STRING {
        rsrpReq      (0),
        rsrqReq      (1),
        ueRxTxReq    (2) } (SIZE(1..8)),
    ...
}
-- ASN1STOP
```

<i>ECID-RequestLocationInformation</i> field descriptions
<p><i>requestedMeasurements</i> This field specifies the E-CID measurements requested. This is represented by a bit string, with a one-value at the bit position means the particular measurement is requested; a zero-value means not requested.</p>

6.5.3.4 E-CID Capability Information

– ECID-ProvideCapabilities

The IE *ECID-ProvideCapabilities* is used by the target device to indicate its capability to support E-CID and to provide its E-CID location capabilities to the location server.

```

-- ASN1START
ECID-ProvideCapabilities ::= SEQUENCE {
    ecid-MeasSupported BIT STRING {
        rsrpSup      (0),
        rsrqSup      (1),
        ueRxTxSup    (2) } (SIZE(1..8)),
    ...
}
-- ASN1STOP

```

ECID-Provide-Capabilities field descriptions

ecid-MeasSupported

This field specifies the E-CID measurements supported by the target device. This is represented by a bit string, with a one-value at the bit position means the particular measurement is supported; a zero-value means not supported. A zero-value in all bit positions in the bit string means only the basic Cell ID positioning method is supported by the target device.

If the UE Rx-Tx time difference measurement is supported by the target device (i.e., *ueRxTxSup* field is set to one), it means that the UE supports the UE Rx-Tx time difference measurement reporting via both LPP signaling and RRC signalling.

If a target device doesn't support LPP, the E-SMLC may assume the target device can not report the UE Rx-Tx time difference measurement results via RRC signalling.

6.5.3.5 E-CID Capability Information Request

– ECID-RequestCapabilities

The IE *ECID-RequestCapabilities* is used by the location server to request E-CID positioning capabilities from a target device.

```

-- ASN1START
ECID-RequestCapabilities ::= SEQUENCE {
    ...
}
-- ASN1STOP

```

6.5.3.6 E-CID Error Elements

– ECID-Error

The IE *ECID-Error* is used by the location server or target device to provide E-CID error reasons to the target device or location server, respectively.

```

-- ASN1START
ECID-Error ::= CHOICE {
    locationServerErrorCauses ECID-LocationServerErrorCauses,
    targetDeviceErrorCauses ECID-TargetDeviceErrorCauses,
    ...
}
-- ASN1STOP

```

– ECID-LocationServerErrorCauses

The IE *ECID-LocationServerErrorCauses* is used by the location server to provide E-CID error reasons to the target device.

```

-- ASN1START
ECID-LocationServerErrorCauses ::= SEQUENCE {
    cause ENUMERATED { undefined,

```

```

    ...
  },
  ...
}
-- ASN1STOP

```

– ECID-TargetDeviceErrorCauses

The IE *ECID-TargetDeviceErrorCauses* is used by the target device to provide E-CID error reasons to the location server.

```

-- ASN1START
ECID-TargetDeviceErrorCauses ::= SEQUENCE {
  cause          ENUMERATED {
    undefined,
    requestedMeasurementNotAvailable,
    notAllrequestedMeasurementsPossible,
    ...
  },
  rsrpMeasurementNotPossible           NULL          OPTIONAL,
  rsrqMeasurementNotPossible           NULL          OPTIONAL,
  ueRxTxMeasurementNotPossible         NULL          OPTIONAL,
  ...
}
-- ASN1STOP

```

***ECID-TargetDeviceErrorCauses* field descriptions**

cause

This field provides a ECID specific error cause. If the cause value is "*notAllRequestedMeasurementsPossible*", the target device was not able to provide all requested ECID measurements (but may be able to provide some measurements). In this case, the target device should include any of the "*rsrpMeasurementNotPossible*", "*rsrqMeasurementNotPossible*", or "*ueRxTxMeasurementNotPossible*" fields, as applicable.

– End of LPP-PDU-Definitions

```

-- ASN1START
END
-- ASN1STOP

```

Annex A (informative): Change History

Change history							
Date	TSG #	TSG Doc.	CR	Rev	Subject/Comment	Old	New
2009-10	RAN2 #67bis	R2-096252			RAN2 agreed TS 36.355 v0.1.0	-	0.1.0
2009-11	RAN2 #68	R2-097492			RAN2 agreed TS 36.355 v2.0.0	0.1.0	2.0.0
2009-12	RP-46	RP-091208			RAN #46 approval of TS 36.355	2.0.0	9.0.0
2010-03	RP-47	RP-100304	0001	-	Clarification on Position location	9.0.0	9.1.0
	RP-47	RP-100304	0002	-	Clarification on UE Rx-Tx time difference supporting capability	9.0.0	9.1.0
	RP-47	RP-100304	0003	2	Completion of LPP common material	9.0.0	9.1.0
	RP-47	RP-100304	0004	5	Completion of OTDOA in LPP	9.0.0	9.1.0
	RP-47	RP-100304	0006	-	Provision of Frame Drift Information in Network Time	9.0.0	9.1.0
	RP-47	RP-100304	0007	-	Clarification of measurement reference point	9.0.0	9.1.0
	RP-47	RP-100304	0010	-	GNSS-DifferentialCorrectionsSupport	9.0.0	9.1.0
	RP-47	RP-100304	0011	-	BSAlign Indication in GNSS Reference Time	9.0.0	9.1.0
	RP-47	RP-100304	0012	1	Changes to reflect LPP ASN.1 review	9.0.0	9.1.0
	RP-47	RP-100304	0013	1	Introduction of LPP reliability sublayer	9.0.0	9.1.0
	RP-47	RP-100304	0015	-	LPP error procedures and conditions	9.0.0	9.1.0
	RP-47	RP-100304	0016	-	Triggered Location Information Transfer due to Cell Change	9.0.0	9.1.0
2010-06	RP-48	RP-100558	0018	2	Addition of need codes to optional LPP information elements	9.1.0	9.2.0
	RP-48	RP-100558	0019	1	Miscellaneous corrections to LPP stage 3	9.1.0	9.2.0
	RP-48	RP-100558	0020	1	Small corrections to LPP specification	9.1.0	9.2.0
	RP-48	RP-100558	0021	-	Clarifications of OTDOA parameters	9.1.0	9.2.0
	RP-48	RP-100558	0022	1	Signalling support for PRS muting in OTDOA	9.1.0	9.2.0
	-	-	-	-	Two times capital R replaced by lower case r in "MeasuredResultsElement" (undoing not intended change)	9.2.0	9.2.1
2010-09	RP-49	RP-100852	0024	-	Addition of an EPDU to an LPP Error and LPP Abort	9.2.1	9.3.0
	RP-49	RP-100852	0026	-	Division of LPP into Separate ASN.1 Modules with a Global Identifier	9.2.1	9.3.0
	RP-49	RP-100852	0028	-	Proposed Corrections to LPP Reliable Transport	9.2.1	9.3.0
	RP-49	RP-100852	0029	-	Proposed Corrections to the PeriodicalReportingCriteria in LPP	9.2.1	9.3.0
	RP-49	RP-100852	0030	1	Various corrections and clarifications to LPP	9.2.1	9.3.0
	RP-49	RP-100852	0031	-	Support of functional components for LPP reliable transport	9.2.1	9.3.0
	RP-49	RP-100852	0032	1	Introduction of EPDU ID requested by OMA LOC	9.2.1	9.3.0
	RP-49	RP-100852	0035	1	Several corrections in LPP	9.2.1	9.3.0
	RP-49	RP-100852	0036	-	Clarification to Assistance Data Transfer Procedure	9.2.1	9.3.0
2010-12	RP-50	RP-101207	0037	-	Correction of reliable transport terminology in description of LPP-Message	9.3.0	9.4.0
	RP-50	RP-101207	0038	-	One cell with known SFN in OTDOA assistance data	9.3.0	9.4.0
	RP-50	RP-101207	0039	1	UE frequency capability for LPP	9.3.0	9.4.0
	RP-50	RP-101207	0041	-	Correction to LPP reliable transport	9.3.0	9.4.0
	RP-50	RP-101207	0042	-	Correction to LPP Error procedure	9.3.0	9.4.0
	RP-50	RP-101207	0043	-	Addition of missing reference to LPPe	9.3.0	9.4.0
	RP-50	RP-101207	0044	2	Correction to the OTDOA assistance data	9.3.0	9.4.0
	RP-50	RP-101226	0040	-	Update of 'serving cell' terminology in 36.355	9.3.0	10.0.0
2011-03	RP-51	RP-110269	0046	-	Editorial corrections to 36.355	10.0.0	10.1.0
	RP-51	RP-110269	0048	-	Removal of FFS for retransmission timer in LPP	10.0.0	10.1.0
	RP-51	RP-110269	0050	-	Correction to code phase encoding in GNSS acquisition assistance	10.0.0	10.1.0
	RP-51	RP-110269	0052	1	Clarification on SFN provided with OTDOA measurement	10.0.0	10.1.0
	RP-51	RP-110269	0053	1	Introduction of OTDOA inter-freq RSTD measurement indication procedure	10.0.0	10.1.0
	RP-51	RP-110269	0057	-	Small corrections in 36.355	10.0.0	10.1.0
	RP-51	RP-110269	0058	3	Further corrections to the OTDOA assistance data	10.0.0	10.1.0
2011-06	RP-52	RP-110830	0060	-	Clarifications to description of OTDOA positioning fields	10.1.0	10.2.0
2011-09	RP-53	RP-111279	0062	1	Various corrections to LPP	10.2.0	10.3.0
	RP-53	RP-111279	0064	-	Mandatory support of PRS for OTDOA measurements	10.2.0	10.3.0
2011-12	RP-54	RP-111709	0066	-	Clarification of packed encoding rules of LPP	10.3.0	10.4.0
	RP-54	RP-111709	0068	-	Clarification of first bit in BIT STRING definitions	10.3.0	10.4.0
2012-06	RP-56	RP-120808	0071	-	Usage of additionalInformation IE	10.4.0	10.5.0

2012-09	RP-57	RP-121424	0074	2	Corrections to GNSS Acquisition Assistance Data	10.5.0	10.6.0
	RP-57	-	-	-	Upgrade to the Release 11 - no technical change	10.6.0	11.0.0
2012-12	RP-58	RP-121931	0077	-	Correcting the referencing of QoS parameters	11.0.0	11.1.0
	RP-58	RP-121931	0080	-	Correction to missing field description in GNSS-AcquisitionAssistance IE	11.0.0	11.1.0
2013-03	RP-59	RP-130237	0083	1	Extending E-UTRA Frequency Band and EARFCN value range	11.1.0	11.2.0
	RP-59	RP-130230	0086	-	Correction to PRS Muting Configuration	11.1.0	11.2.0
2013-06	RP-60	RP-130803	0088	-	Correction for ASN.1 errors from CR0083r1	11.2.0	11.3.0
	RP-60	RP-130803	0091	-	Correction to integer code phase field description in GNSS Acquisition Assistance	11.2.0	11.3.0
	RP-60	RP-130803	0093	-	Correction to serving cell terminology	11.2.0	11.3.0
	RP-60	RP-130803	0094	-	Encoding of LPP IEs	11.2.0	11.3.0
2013-09	RP-61	RP-131314	0098	-	Correction on svReqList	11.3.0	11.4.0

History

Document history		
V11.0.0	October 2012	Publication
V11.1.0	February 2013	Publication
V11.2.0	April 2013	Publication
V11.3.0	July 2013	Publication
V11.4.0	September 2013	Publication