

ETSI TS 136 443 V11.0.0 (2012-11)



**LTE;
Evolved Universal Terrestrial Radio
Access Network (E-UTRAN);
M2 Application Protocol (M2AP)
(3GPP TS 36.443 version 11.0.0 Release 11)**



Reference

RTS/TSGR-0336443vb00

Keywords

LTE

ETSI

650 Route des Lucioles
F-06921 Sophia Antipolis Cedex - FRANCE

Tel.: +33 4 92 94 42 00 Fax: +33 4 93 65 47 16

Siret N° 348 623 562 00017 - NAF 742 C
Association à but non lucratif enregistrée à la
Sous-Préfecture de Grasse (06) N° 7803/88

Important notice

Individual copies of the present document can be downloaded from:

<http://www.etsi.org>

The present document may be made available in more than one electronic version or in print. In any case of existing or perceived difference in contents between such versions, the reference version is the Portable Document Format (PDF). In case of dispute, the reference shall be the printing on ETSI printers of the PDF version kept on a specific network drive within ETSI Secretariat.

Users of the present document should be aware that the document may be subject to revision or change of status.

Information on the current status of this and other ETSI documents is available at

<http://portal.etsi.org/tb/status/status.asp>

If you find errors in the present document, please send your comment to one of the following services:

http://portal.etsi.org/chaicor/ETSI_support.asp

Copyright Notification

No part may be reproduced except as authorized by written permission.
The copyright and the foregoing restriction extend to reproduction in all media.

© European Telecommunications Standards Institute 2012.
All rights reserved.

DECTTM, PLUGTESTSTM, UMTSTM and the ETSI logo are Trade Marks of ETSI registered for the benefit of its Members.
3GPPTM and LTETM are Trade Marks of ETSI registered for the benefit of its Members and
of the 3GPP Organizational Partners.
GSM[®] and the GSM logo are Trade Marks registered and owned by the GSM Association.

Intellectual Property Rights

IPRs essential or potentially essential to the present document may have been declared to ETSI. The information pertaining to these essential IPRs, if any, is publicly available for **ETSI members and non-members**, and can be found in ETSI SR 000 314: *"Intellectual Property Rights (IPRs); Essential, or potentially Essential, IPRs notified to ETSI in respect of ETSI standards"*, which is available from the ETSI Secretariat. Latest updates are available on the ETSI Web server (<http://ipr.etsi.org>).

Pursuant to the ETSI IPR Policy, no investigation, including IPR searches, has been carried out by ETSI. No guarantee can be given as to the existence of other IPRs not referenced in ETSI SR 000 314 (or the updates on the ETSI Web server) which are, or may be, or may become, essential to the present document.

Foreword

This Technical Specification (TS) has been produced by ETSI 3rd Generation Partnership Project (3GPP).

The present document may refer to technical specifications or reports using their 3GPP identities, UMTS identities or GSM identities. These should be interpreted as being references to the corresponding ETSI deliverables.

The cross reference between GSM, UMTS, 3GPP and ETSI identities can be found under <http://webapp.etsi.org/key/queryform.asp>.

Contents

Intellectual Property Rights	2
Foreword.....	2
Foreword.....	6
1 Scope	7
2 References	7
3 Definitions, symbols and abbreviations	8
3.1 Definitions	8
3.2 Abbreviations	9
4 General	9
4.1 Procedure Specification Principles	9
4.2 Forwards and Backwards Compatibility	9
4.3 Specification Notations	9
5 M2AP Services	11
5.1 M2AP procedure modules	11
5.2 Parallel transactions	11
6 Services Expected from Signalling Transport	12
7 Functions of M2AP	13
8 M2AP Procedures	14
8.1 List of M2AP Elementary procedures	14
8.2 MBMS Session Start	14
8.2.1 General	14
8.2.2 Successful Operation	15
8.2.3 Unsuccessful Operation	15
8.2.4 Abnormal Conditions	15
8.3 MBMS Session Stop	15
8.3.1 General	15
8.3.2 Successful Operation	16
8.3.3 Abnormal Conditions	16
8.4 MBMS Scheduling Information	16
8.4.1 General	16
8.4.2 Successful Operation	16
8.4.3 Abnormal Conditions	17
8.5 Reset	17
8.5.1 General	17
8.5.2 Successful Operation	17
8.5.2.1 Reset Procedure Initiated from the MCE	17
8.5.2.2 Reset Procedure Initiated from the eNB	18
8.5.3 Abnormal Conditions	19
8.5.3.1 Abnormal Condition at the MCE	19
8.5.3.2 Abnormal Condition at the eNB	19
8.5.3.3 Crossing of Reset Messages	19
8.6 M2 Setup	19
8.6.1 General	19
8.6.2 Successful Operation	20
8.6.3 Unsuccessful Operation	20
8.6.4 Abnormal Conditions	21
8.7 eNB Configuration Update	21
8.7.1 General	21
8.7.2 Successful Operation	21
8.7.3 Unsuccessful Operation	22
8.7.4 Abnormal Conditions	22

8.8	MCE Configuration Update	23
8.8.1	General.....	23
8.8.2	Successful Operation	23
8.8.3	Unsuccessful Operation	24
8.8.4	Abnormal Conditions.....	24
8.9	Error Indication	24
8.9.1	General.....	24
8.9.2	Successful Operation	25
8.9.3	Abnormal Conditions.....	25
8.10	MBMS Session Update	25
8.10.1	General.....	25
8.10.2	Successful Operation	26
8.10.3	Unsuccessful Operation	26
8.10.4	Abnormal Conditions.....	26
8.11	MBMS Service Counting	26
8.11.1	General.....	26
8.11.2	Successful Operation	27
8.11.3	Unsuccessful Operation	27
8.11.4	Abnormal Conditions.....	27
8.12	MBMS Service Counting Results Report.....	27
8.12.1	General.....	27
8.12.2	Successful Operation	28
8.12.3	Abnormal Conditions.....	28
9	Elements for M2AP Communication	29
9.1	Message Functional Definition and Content	29
9.1.1	General.....	29
9.1.1	Message Contents	29
9.1.1.1	Presence	29
9.1.1.2	Criticality	29
9.1.1.3	Range	29
9.1.1.4	Assigned Criticality.....	29
9.1.2	MBMS SESSION START REQUEST.....	30
9.1.3	MBMS SESSION START RESPONSE.....	30
9.1.4	MBMS SESSION START FAILURE.....	30
9.1.5	MBMS SESSION STOP REQUEST.....	30
9.1.6	MBMS SESSION STOP RESPONSE.....	31
9.1.7	MBMS SCHEDULING INFORMATION	31
9.1.8	MBMS SCHEDULING INFORMATION RESPONSE	32
9.1.9	RESET	32
9.1.10	RESET ACKNOWLEDGE	33
9.1.11	M2 SETUP REQUEST.....	33
9.1.12	M2 SETUP RESPONSE.....	34
9.1.13	M2 SETUP FAILURE.....	34
9.1.14	ENB CONFIGURATION UPDATE	35
9.1.15	ENB CONFIGURATION UPDATE ACKNOWLEDGE	35
9.1.16	ENB CONFIGURATION UPDATE FAILURE	36
9.1.17	MCE CONFIGURATION UPDATE	36
9.1.18	MCE CONFIGURATION UPDATE ACKNOWLEDGE	36
9.1.19	MCE CONFIGURATION UPDATE FAILURE.....	36
9.1.20	ERROR INDICATION.....	37
9.1.21	MBMS SESSION UPDATE REQUEST.....	37
9.1.22	MBMS SESSION UPDATE RESPONSE.....	37
9.1.23	MBMS SESSION UPDATE FAILURE.....	38
9.1.24	MBMS SERVICE COUNTING REQUEST	38
9.1.25	MBMS SERVICE COUNTING RESPONSE	38
9.1.26	MBMS SERVICE COUNTING FAILURE	38
9.1.27	MBMS SERVICE COUNTING RESULTS REPORT.....	39
9.2	Information Element Definitions.....	39
9.2.1	Radio Network Layer Related IEs	39
9.2.1.1	Message Type	39
9.2.1.2	Cause.....	40

9.2.1.3	Void.....	41
9.2.1.4	Void.....	41
9.2.1.5	Void.....	41
9.2.1.6	Void.....	42
9.2.1.7	Criticality Diagnostics.....	42
9.2.1.8	PMCH Configuration.....	42
9.2.1.9	MBMS Session List per PMCH.....	43
9.2.1.10	Global eNB ID.....	43
9.2.1.11	E-UTRAN CGI.....	43
9.2.1.12	eNB MBMS Configuration data Item.....	44
9.2.1.13	MCCH related BCCH Configuration Item.....	44
9.2.1.14	MBSFN Area Id.....	45
9.2.1.15	Time to Wait.....	45
9.2.1.16	Global MCE ID.....	45
9.2.1.17	MBSFN Subframe Configuration.....	45
9.2.1.18	Common Subframe Allocation Period.....	46
9.2.1.19	MCCH Update Time.....	46
9.2.1.20	MBSFN Synchronisation Area Id.....	46
9.2.1.21	Counting Result.....	46
9.2.2	Transport Network Layer Related IEs.....	47
9.2.2.1	IP Address.....	47
9.2.2.2	GTP-TEID.....	47
9.2.3	NAS Related IEs.....	47
9.2.3.1	MCE MBMS M2AP ID.....	47
9.2.3.2	eNB MBMS M2AP ID.....	47
9.2.3.3	TMGI.....	47
9.2.3.4	MBMS Session Identity.....	48
9.2.3.5	Void.....	48
9.2.3.6	MBMS Service Area.....	48
9.2.3.7	PLMN Identity.....	48
9.3	Message and Information Element Abstract Syntax (with ASN.1).....	49
9.3.1	General.....	49
9.3.2	Usage of Private Message Mechanism for Non-standard Use.....	49
9.3.3	Elementary Procedure Definitions.....	49
9.3.4	PDU Definitions.....	54
9.3.5	Information Element definitions.....	68
9.3.6	Common definitions.....	75
9.3.7	Constant definitions.....	76
9.3.8	Container definitions.....	77
9.4	Message Transfer Syntax.....	82
9.5	Timers.....	82
10	Handling of Unknown, Unforeseen and Erroneous Protocol Data.....	83
Annex A (informative): Change history		84
History		85

Foreword

This Technical Specification has been produced by the 3rd Generation Partnership Project (3GPP).

The contents of the present document are subject to continuing work within the TSG and may change following formal TSG approval. Should the TSG modify the contents of the present document, it will be re-released by the TSG with an identifying change of release date and an increase in version number as follows:

Version x.y.z

where:

- x the first digit:
 - 1 presented to TSG for information;
 - 2 presented to TSG for approval;
 - 3 or greater indicates TSG approved document under change control.
- y the second digit is incremented for all changes of substance, i.e. technical enhancements, corrections, updates, etc.
- z the third digit is incremented when editorial only changes have been incorporated in the document.

1 Scope

The present document specifies the E-UTRAN radio network layer signalling protocol for the M2 interface. The M2 Application Protocol (M2AP) supports the functions of the M2 interface by signalling procedures defined in this document. M2AP is developed in accordance to the general principles stated in TS 36.401 [2] and TS 36.300 [3].

2 References

The following documents contain provisions which, through reference in this text, constitute provisions of the present document.

- References are either specific (identified by date of publication, edition number, version number, etc.) or non-specific.
- For a specific reference, subsequent revisions do not apply.
- For a non-specific reference, the latest version applies. In the case of a reference to a 3GPP document (including a GSM document), a non-specific reference implicitly refers to the latest version of that document *in the same Release as the present document*.

- [1] 3GPP TR 21.905: "Vocabulary for 3GPP Specifications".
- [2] 3GPP TS 36.401: "E-UTRAN Architecture Description".
- [3] 3GPP TS 36.300: "Evolved Universal Terrestrial Radio Access (E-UTRA) and Evolved Universal Terrestrial Radio Access Network (E-UTRAN); Overall description; Stage 2".
- [4] 3GPP TS 36.413: " Evolved Universal Terrestrial Radio Access Network (E-UTRAN); S1 Application Protocol (S1AP)".
- [5] ITU-T Recommendation X.691 (07/2002): "Information technology - ASN.1 encoding rules - Specification of Packed Encoding Rules (PER) ".
- [6] ITU-T Recommendation X.680 (07/2002): "Information technology - Abstract Syntax Notation One (ASN.1): Specification of basic notation".
- [7] Void
- [8] 3GPP TS 23.246: "Multimedia Broadcast/Multicast Service (MBMS); Architecture and functional description".
- [9] 3GPP TS 29.061 "Interworking between the Public Land Mobile Network (PLMN) supporting packet based services and Packet Data Networks (PDN)".
- [10] Void
- [11] 3GPP TS 36.331: "Evolved Universal Terrestrial Radio Access (E-UTRAN); Radio Resource Control (RRC) Protocol Specification".
- [12] 3GPP TS 36.211: "Evolved Universal Terrestrial Radio Access (E-UTRAN); Physical Channels and Modulation".
- [13] 3GPP TS 36.445: "Evolved Universal Terrestrial Radio Access Network (E-UTRAN); M1 Data Transport".
- [14] 3GPP TS 29.281: "General Packet Radio Service (GPRS); Tunnelling Protocol User Plane (GTPv1-U)".

3 Definitions, symbols and abbreviations

3.1 Definitions

For the purposes of the present document, the terms and definitions given in TR 21.905 [1] and the following apply. A term defined in the present document takes precedence over the definition of the same term, if any, in TR 21.905 [1].

Elementary Procedure: M2AP consists of Elementary Procedures (EPs). An Elementary Procedure is a unit of interaction between eNBs and the MCE. These Elementary Procedures are defined separately and are intended to be used to build up complete sequences in a flexible manner. If the independence between some EPs is restricted, it is described under the relevant EP description. Unless otherwise stated by the restrictions, the EPs may be invoked independently of each other as stand alone procedures, which can be active in parallel. The usage of several M2AP EPs together or together with EPs from other interfaces is specified in stage 2 specifications (e.g. TS 36.300 [3] and TS 23.246 [8]).

An EP consists of an initiating message and possibly a response message. Two kinds of EPs are used:

- **Class 1:** Elementary Procedures with response (success and/or failure).
- **Class 2:** Elementary Procedures without response.

For Class 1 EPs, the types of responses can be as follows:

Successful:

- A signalling message explicitly indicates that the elementary procedure successfully completed with the receipt of the response.

Unsuccessful:

- A signalling message explicitly indicates that the EP failed.
- On time supervision expiry (i.e. absence of expected response).

Successful and Unsuccessful:

- One signalling message reports both successful and unsuccessful outcome for the different included requests. The response message used is the one defined for successful outcome.

Class 2 EPs are considered always successful.

eNB MBMS M2AP ID: Unique identity, referencing the MBMS-service-associated logical M2-connection within an eNB.

MCE MBMS M2AP ID: Unique identity, referencing the MBMS-service-associated logical M2-connection within an MCE.

MBMS E-RAB: denotes both, the data bearer established between the eNB and the UE(s) to transport MBMS data and the MBMS M1 data bearer.

MBMS-service-associated signalling: When M2AP messages associated to one MBMS service uses the MBMS-service-associated logical M2-connection for association of the message to the respective MBMS service in eNB and EPC.

MBMS-service-associated logical M2-connection: The MBMS-service-associated logical M2-connection uses the identities *eNB MBMS M2AP ID* and *MCE MBMS M2AP ID*. For a received M2AP message the MCE identifies the associated MBMS E-RAB based on the *MCE MBMS M2AP ID* IE and the eNB identifies the associated MBMS-RAB based on the *eNB MBMS M2AP ID* IE.

3.2 Abbreviations

For the purposes of the present document, the abbreviations given in TR 21.905 [1] and the following apply. An abbreviation defined in the present document takes precedence over the definition of the same abbreviation, if any, in TR 21.905 [1].

MCCH	Multicast Control CHannel
PMCH	Physical Multicast CHannel

4 General

4.1 Procedure Specification Principles

The principle for specifying the procedure logic is to specify the functional behaviour of the terminating node exactly and completely. Any rule that specifies the behaviour of the originating node shall be possible to be verified with information that is visible within the system.

The following specification principles have been applied for the procedure text in clause 8:

- The procedure text discriminates between:

- 1) Functionality which "shall" be executed

The procedure text indicates that the receiving node "shall" perform a certain function Y under a certain condition. If the receiving node supports procedure X but cannot perform functionality Y requested in the REQUEST message of a Class 1 EP, the receiving node shall respond with the message used to report unsuccessful outcome for this procedure, containing an appropriate cause value.

- 2) Functionality which "shall, if supported" be executed

The procedure text indicates that the receiving node "shall, if supported," perform a certain function Y under a certain condition. If the receiving node supports procedure X, but does not support functionality Y, the receiving node shall proceed with the execution of the EP, possibly informing the requesting node about the not supported functionality.

- Any required inclusion of an optional IE in a response message is explicitly indicated in the procedure text. If the procedure text does not explicitly indicate that an optional IE shall be included in a response message, the optional IE shall not be included. For requirements on including *Criticality Diagnostics* IE, see section 10 in TS 36.413 [4].

4.2 Forwards and Backwards Compatibility

The forwards and backwards compatibility of the protocol is assured by mechanism where all current and future messages, and IEs or groups of related IEs, include ID and criticality fields that are coded in a standard format that will not be changed in the future. These parts can always be decoded regardless of the standard version.

4.3 Specification Notations

For the purposes of the present document, the following notations apply:

Procedure	When referring to an elementary procedure in the specification the Procedure Name is written with the first letters in each word in upper case characters followed by the word "procedure", e.g. E-RAB procedure.
Message	When referring to a message in the specification the MESSAGE NAME is written with all letters in upper case characters followed by the word "message", e.g. MESSAGE NAME message.
IE	When referring to an information element (IE) in the specification the <i>Information Element Name</i> is written with the first letters in each word in upper case characters and all letters in <i>Italic font</i> followed by the abbreviation "IE", e.g. <i>Information Element</i> IE.

Value of an IE When referring to the value of an information element (IE) in the specification the "Value" is written as it is specified in subclause 9.2 enclosed by quotation marks, e.g. "Value".

5 M2AP Services

The present clause describes the services an eNB offers to its associated MCE.

5.1 M2AP procedure modules

The M2 interface M2AP procedures may be sub-divided as follows:

1. M2AP MBMS session control procedures;
2. M2AP global procedures;

The M2AP session control procedures are related to MBMS services.

The Global Procedures module contains procedures that are not related to a specific MBMS service.

5.2 Parallel transactions

Unless explicitly indicated in the procedure specification, at any instance in time one protocol peer shall have a maximum of one ongoing M2AP procedure related to a certain MBMS service.

6 Services Expected from Signalling Transport

The signalling connection shall provide in sequence delivery of M2AP messages. M2AP shall be notified if the signalling connection breaks.

7 Functions of M2AP

The M2AP protocol provides the following functions:

- MBMS Session Handling. This function supports start, stop and modify of an MBMS session, as well as configuration and modification of basic radio transmission parameters related to that service.
- MBMS Scheduling Information. This function provides MCCH related information to the eNB.
- Reporting of General Error Situations. This function allows reporting of general error situations, for which function specific error messages have not been defined.
- Resetting the M2. This function is used to reset the M2 interface.
- Setting up the M2. This function is used to exchange necessary data for the eNB for setup the M2 interface, provides basic configuration of radio parameters for transmission of MBMS data and implicitly perform an M2 Reset.
- eNB and MCE Configuration Update functions are to update configuration data exchanged during setup of M2.
- MBMS Service Counting. This function enables the MCE to perform counting and to receive the counting results for the MBMS service(s) per MBSFN area.

The mapping between the above functions and M2 EPs is shown in the table below.

Table 1: Mapping between M2AP functions and M2AP EPs

Function	Elementary Procedure(s)
MBMS Session Handling	a) MBMS Session Start b) MBMS Session Stop c) MBMS Session Update
MBMS Scheduling Information	MBMS Scheduling Information
Reporting of General Error Situations	Error Indication
Resetting the M2	Reset
Setting up the M2	M2 Setup
Configuration Update	a) eNB Configuration Update b) MCE Configuration Update
MBMS Service Counting	a) MBMS Service Counting b) MBMS Service Counting Results Report

8 M2AP Procedures

8.1 List of M2AP Elementary procedures

In the following tables, all EPs are divided into Class 1 and Class 2 EPs (see subclause 3.1 for explanation of the different classes):

Table 2: Class 1 procedures

Elementary Procedure	Initiating Message	Successful Outcome	Unsuccessful Outcome
		Response message	Response message
MBMS Session Start	MBMS SESSION START REQUEST	MBMS SESSION START RESPONSE	MBMS SESSION START FAILURE
MBMS Session Stop	MBMS SESSION STOP REQUEST	MBMS SESSION STOP RESPONSE	
MBMS Session Update	MBMS SESSION UPDATE REQUEST	MBMS SESSION UPDATE RESPONSE	MBMS SESSION UPDATE FAILURE
MBMS Scheduling Information	MBMS SCHEDULING INFORMATION	MBMS SCHEDULING INFORMATION RESPONSE	
Reset	RESET	RESET ACKNOWLEDGE	
M2 Setup	M2 SETUP REQUEST	M2 SETUP RESPONSE	M2 SETUP FAILURE
eNB Configuration Update	ENB CONFIGURATION UPDATE	ENB CONFIGURATION UPDATE ACKNOWLEDGE	ENB CONFIGURATION UPDATE FAILURE
MCE Configuration Update	MCE CONFIGURATION UPDATE	MCE CONFIGURATION UPDATE ACKNOWLEDGE	MCE CONFIGURATION UPDATE FAILURE
MBMS Service Counting	MBMS SERVICE COUNTING REQUEST	MBMS SERVICE COUNTING RESPONSE	MBMS SERVICE COUNTING FAILURE

Table 3: Class 2 procedures

Elementary Procedure	Message
Error Indication	ERROR INDICATION
MBMS Service Counting Results Report	MBMS SERVICE COUNTING RESULTS REPORT

The following applies concerning interference between Elementary Procedures:

- The Reset procedure takes precedence over all other EPs.

8.2 MBMS Session Start

8.2.1 General

The purpose of the MBMS Session Start procedure is to request the eNB to notify UEs about an upcoming MBMS Session of a given MBMS Bearer Service and to establish an MBMS E-RAB and an MBMS-service-associated logical M2-connection. The MBMS Session Start procedure is triggered by the MCE.

The procedure uses MBMS-Service-associated signalling.

8.2.2 Successful Operation

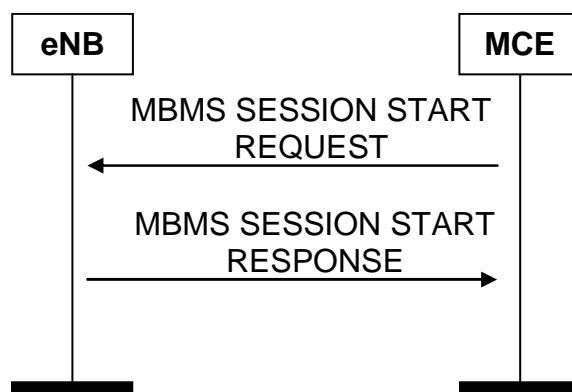

Figure 8.2.2-1. MBMS Session Start procedure. Successful operation.

The MCE initiates the procedure by sending an MBMS SESSION START REQUEST message. If the eNB accepts the MBMS session start request, the eNB responds with the MBMS SESSION START RESPONSE message. The eNB shall join the transport network IP multicast address (including the IP address of the multicast source) as described by the *TNL Information* IE to enable the reception of MBMS data.

If the MBMS SESSION START REQUEST message contains the *MBMS Session Identity* IE, the eNB shall use it for broadcast of the MBMS Session Identity on the air interface.

8.2.3 Unsuccessful Operation

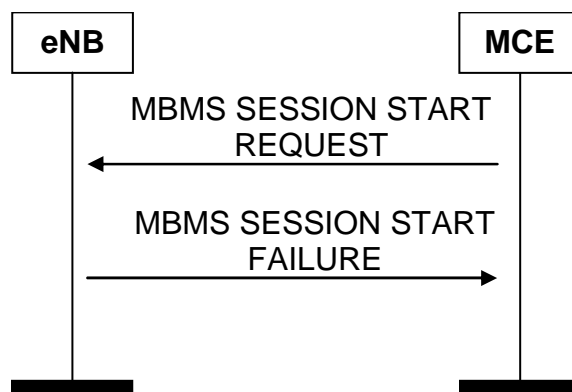

Figure 8.2.3-1. MBMS Session Start procedure. Unsuccessful operation.

If the eNB is not capable of correctly processing the request (e.g. the MBMS resources could not be established at all in any cell), the MCE shall be informed by the MBMS SESSION START FAILURE message.

8.2.4 Abnormal Conditions

Void.

8.3 MBMS Session Stop

8.3.1 General

The purpose of the MBMS Session Stop procedure is to release the corresponding MBMS E-RAB and the MBMS-service-associated logical M2-connection. The MBMS Session Stop procedure is triggered by the MCE.

The procedure uses MBMS-Service-associated signalling.

8.3.2 Successful Operation

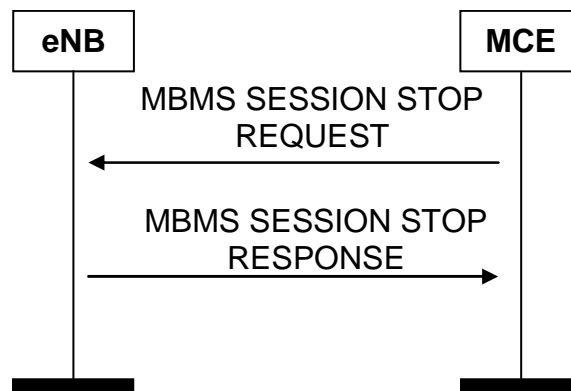

Figure 8.3.2-1. MBMS Session Stop procedure. Successful operation.

The MCE initiates the procedure by sending a MBMS SESSION STOP REQUEST message. Upon receipt of the MBMS SESSION STOP REQUEST message, the eNB shall respond with the MBMS SESSION STOP RESPONSE message. The eNB shall disable the reception from the IP backbone of the particular MBMS bearer service, release the affected resources and remove the MBMS bearer context.

8.3.3 Abnormal Conditions

Void.

8.4 MBMS Scheduling Information

8.4.1 General

The purpose of the MBMS Scheduling Information Procedure is to provide MCCH related information to the eNB.

The procedure uses non MBMS-Service-associated signalling.

8.4.2 Successful Operation

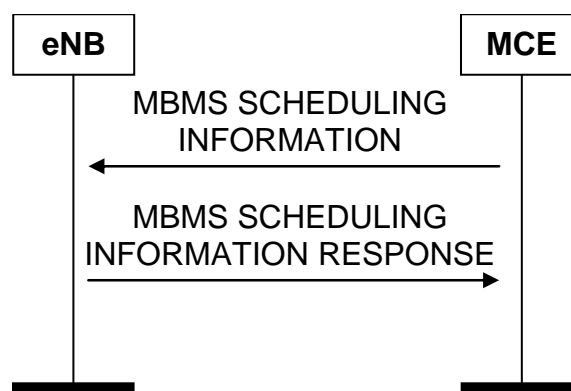

Figure 8.4.2-1. MBMS Scheduling Information procedure. Successful operation.

The MCE initiates the procedure by sending the MBMS SCHEDULING INFORMATION message to the eNB. If PMCH configuration information is contained in this message, the eNB shall do PMCH transmission according to the PMCH configuration information. If PMCH configuration information for an existing PMCH is not contained in this message, the eNB should stop PMCH transmission for the PMCH. The eNB shall store the *MBSFN Area Configuration Item* IE, and apply the MCCH update from the modification period defined in the *MCCH Update Time* IE. The eNB shall schedule the MBMS services in the MCCH according to the order defined in the *MBMS Session List per PMCH* IE.

8.4.3 Abnormal Conditions

Void.

8.5 Reset

8.5.1 General

The purpose of the Reset procedure is to initialise or re-initialise the eNB or part of eNB M2AP MBMS-service-related contexts, in the event of a failure in the MCE or vice versa. This procedure doesn't affect the application level configuration data exchanged during, e.g., the M2 Setup procedure.

The procedure uses non MBMS-service-associated signalling.

8.5.2 Successful Operation

8.5.2.1 Reset Procedure Initiated from the MCE

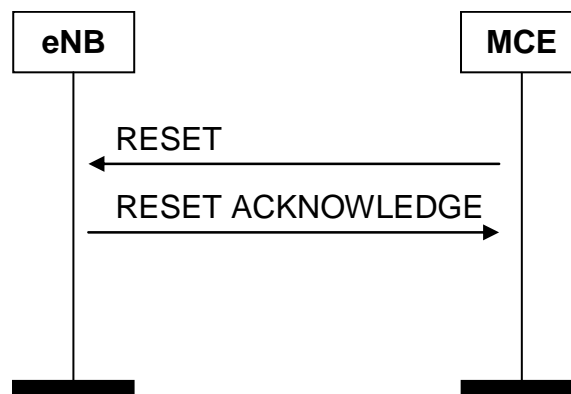

Figure 8.5.2.1-1. Reset procedure initiated from the MCE. Successful operation.

In the event of a failure at the MCE, which has resulted in the loss of some or all transaction reference information, a RESET message shall be sent to the eNB.

At reception of RESET message the eNB shall release all allocated resources on M2 and M1/Uu related to MBMS-service association(s) indicated explicitly or implicitly in the RESET message and remove the indicated MBMS-service contexts including MBMS M2AP IDs.

After the eNB has released all assigned M2 and M1 resources and MBMS-service contexts for all indicated MBMS-service association(s), the eNB shall respond with the RESET ACKNOWLEDGE message. The eNB does not need to wait for the release of radio resources to be completed before returning the RESET ACKNOWLEDGE message.

If the RESET message contains the *MBMS-Service-associated logical M2-connection list* IE, then:

- The eNB shall use the *MCE MBMS M2AP ID* IE and/or the *eNB MBMS M2AP ID* IE to explicitly identify the MBMS service association(s) to be reset.
- The eNB shall in the RESET ACKNOWLEDGE message include, for each MBMS service association to be reset, the *MBMS-Service-associated logical M2-connection Item* IE in the *MBMS-Service-associated logical M2-connection list* IE. The *MBMS-Service-associated logical M2-connection Item* IEs shall be in the same order as received in the RESET message and shall include also unknown MBMS-Service-associated logical M2-connections. Empty *MBMS-Service-associated logical M2-connection Item* IEs, received in the RESET message, may be omitted in the RESET ACKNOWLEDGE message.
- If the *MCE MBMS M2AP ID* IE is included in the *MBMS-Service-associated logical M2-connection Item* IE for an MBMS service association, the eNB shall include the *MCE MBMS M2AP ID* IE in the corresponding *MBMS-Service-associated logical M2-connection Item* IE in the RESET ACKNOWLEDGE message.

- If the *eNB MBMS M2AP ID IE* is included in an *MBMS-Service-associated logical M2-connection Item IE* for an MBMS service association, the eNB shall include the *eNB MBMS M2AP ID IE* in the corresponding *MBMS-Service-associated logical M2-connection Item IE* in the RESET ACKNOWLEDGE message.

Interactions with other procedures:

If the RESET message is received, any other ongoing procedure (except another Reset procedure) on the same M2 interface related to a MBMS service association, indicated explicitly or implicitly in the RESET message, shall be aborted.

8.5.2.2 Reset Procedure Initiated from the eNB

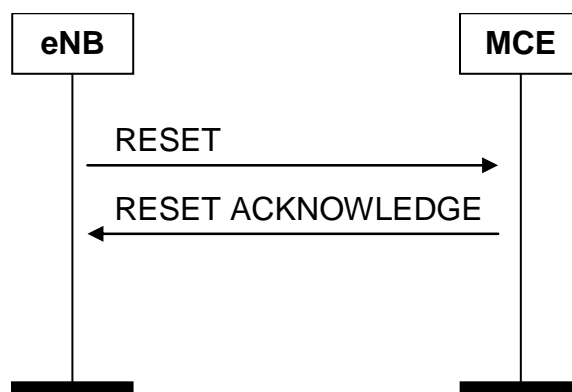

Figure 8.5.2.2-1. Reset procedure initiated from the eNB. Successful operation.

In the event of a failure at the eNB, which has resulted in the loss of some or all transaction reference information, a RESET message shall be sent to the MCE.

At reception of RESET message the MCE shall release all allocated resources on M2 related to MBMS-service association(s) indicated explicitly or implicitly in the RESET message and the indicated MBMS-service contexts on M2 for the eNB.

After the MCE has released all assigned M2 resources and MBMS-service contexts for all the eNB indicated MBMS-service association(s), the MCE shall respond with the RESET ACKNOWLEDGE message.

If the RESET message contains the *MBMS-Service-associated logical M2-connection list IE*, then:

- The MCE shall use the *MCE MBMS M2AP ID IE* and/or the *eNB MBMS M2AP ID IE* to explicitly identify the MBMS service association(s) to be reset.
- The MCE shall in the RESET ACKNOWLEDGE message include, for each MBMS service association to be reset, the *MBMS-Service-associated logical M2-connection Item IE* in the *MBMS-Service-associated logical M2-connection list IE*. The *MBMS-Service-associated logical M2-connection Item IE*s shall be in the same order as received in the RESET message and shall include also unknown MBMS-Service-associated logical M2-connections. Empty *MBMS-Service-associated logical M2-connection Item IE*s, received in the RESET message, may be omitted in the RESET ACKNOWLEDGE message.
- If the *MCE MBMS M2AP ID IE* is included in the *MBMS-Service-associated logical M2-connection Item IE* for an MBMS service association, the MCE shall include the *MCE MBMS M2AP ID IE* in the corresponding *MBMS-Service-associated logical M2-connection Item IE* in the RESET ACKNOWLEDGE message.
- If the *eNB MBMS M2AP ID IE* is included in an *MBMS-Service-associated logical M2-connection Item IE* for an MBMS service association, the MCE shall include the *eNB MBMS M2AP ID IE* in the corresponding *MBMS-Service-associated logical M2-connection Item IE* in the RESET ACKNOWLEDGE message.

Interactions with other procedures:

If the RESET message is received, any other ongoing procedure (except another Reset procedure) on same M2 interface related to a MBMS service association, indicated explicitly or implicitly in the RESET message, shall be aborted.

8.5.3 Abnormal Conditions

8.5.3.1 Abnormal Condition at the MCE

If the RESET message includes the *MBMS-Service-associated logical M2-connection list* IE, but neither the *MCE MBMS M2AP ID* IE nor the *eNB MBMS M2AP ID* IE is present for a *MBMS-Service-associated logical M2-connection Item* IE, then the MCE shall ignore the *MBMS-Service-associated logical M2-connection Item* IE. The MCE may return the empty *MBMS-Service-associated logical M2-connection Item* IE in the *MBMS-Service-associated logical M2-connection list* IE in the RESET ACKNOWLEDGE message.

8.5.3.2 Abnormal Condition at the eNB

If the RESET message includes the *MBMS-Service-associated logical M2-connection list* IE, but neither the *MCE MBMS M2AP ID* IE nor the *eNB MBMS M2AP ID* IE is present for a *MBMS-Service-associated logical M2-connection Item* IE, then the eNB shall ignore the *MBMS-Service-associated logical M2-connection Item* IE. The eNB may return the empty *MBMS-Service-associated logical M2-connection Item* IE in the *MBMS-Service-associated logical M2-connection list* IE in the RESET ACKNOWLEDGE message.

8.5.3.3 Crossing of Reset Messages

If Reset procedure is ongoing in eNB and the eNB receives a RESET message from the peer entity on the same M2 interface related to one or several MBMS service associations previously requested to be reset, indicated explicitly or implicitly in the received RESET message, the eNB shall respond with RESET ACKNOWLEDGE message as described in 8.5.2.1.

If Reset procedure is ongoing in MCE and the MCE receives a RESET message from the peer entity on the same M2 interface related to one or several MBMS service associations previously requested to be reset, indicated explicitly or implicitly in the received RESET message, the MCE shall respond with RESET ACKNOWLEDGE message as described in 8.5.2.2.

8.6 M2 Setup

8.6.1 General

The purpose of the M2 Setup procedure is to exchange application level data needed for the eNB and MCE to interoperate correctly on the M2 interface and to configure MCCH related content on the BCCH for each of the cells controlled by the eNB which is foreseen to participate in MBMS service data transmission. This procedure shall be the first M2AP procedure triggered after the TNL association has become operational. The procedure uses non MBMS-service-associated signalling.

This procedure erases any existing application level configuration data in the eNB and the MCE and MCCH related BCCH data in all cells served by the eNB. This procedure also re-initialises the E-UTRAN M2AP MBMS service related contexts (if any) and erases all related signalling connections in the two nodes like a Reset procedure would do.

8.6.2 Successful Operation

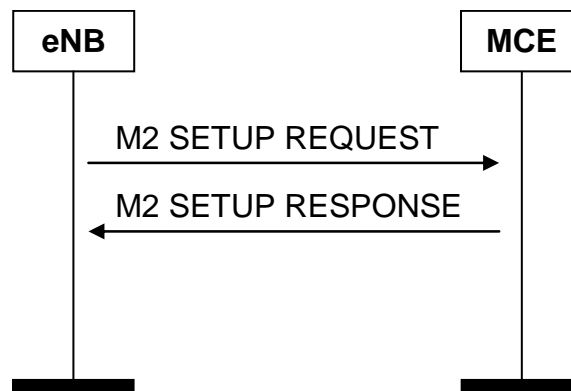

Figure 8.6.2-1. M2 Setup procedure. Successful operation.

The eNB initiates the procedure by sending a M2 SETUP REQUEST message including the appropriate data to the MCE. The eNB shall include in the M2 SETUP REQUEST message the cell(s) which is(are) foreseen to participate in MBMS service data transmission.

The MCE responds with M2 SETUP RESPONSE message including the appropriate data. The MCE shall provide the MCCH related BCCH configuration for all cells indicated in the M2 SETUP REQUEST message.

The exchanged data shall be stored in the respective node, MCCH related BCCH configuration broadcasted as provided by the MCE in the respective cell(s), and used for the duration of the TNL association or until any further configuration update procedure is performed..

When this procedure is finished the M2 interface is operational, all affected cells are ready for MBMS service data transmission and other M2 messages can be exchanged.

If the M2 SETUP REQUEST message contains the *eNB Name* IE the MCE may use this IE as a human readable name of the eNB.

If the M2 SETUP RESPONSE message contains the *MCE Name* IE the eNB may use this IE as a human readable name of the MCE.

The eNB shall broadcast the MCCH related BCCH configuration only in those cells indicated in the *Cell Information List* IE contained in the M2 SETUP RESPONSE message for which the *Cell Reservation Info* IE within the *MCCH related BCCH Configuration Item* IE is not set to "reserved Cell".

8.6.3 Unsuccessful Operation

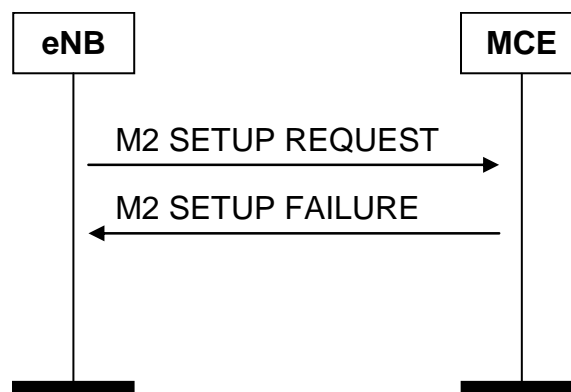

Figure 8.6.2-1. M2 Setup procedure. Unsuccessful operation.

If the MCE can not accept the setup it should respond with a M2 SETUP FAILURE message and appropriate cause value.

If the M2 SETUP FAILURE messages includes the *Time To Wait* IE the eNB shall wait at least for the indicated time before reinitiating the M2 setup towards the same MCE.

8.6.4 Abnormal Conditions

Void.

8.7 eNB Configuration Update

8.7.1 General

The purpose of the eNB Configuration Update procedure is to update application level configuration data needed for the eNB and MCE to interoperate correctly on the M2 interface. This procedure does not affect existing MBMS-service-related contexts, if any.

The procedure uses non MBMS-service-associated signalling.

8.7.2 Successful Operation

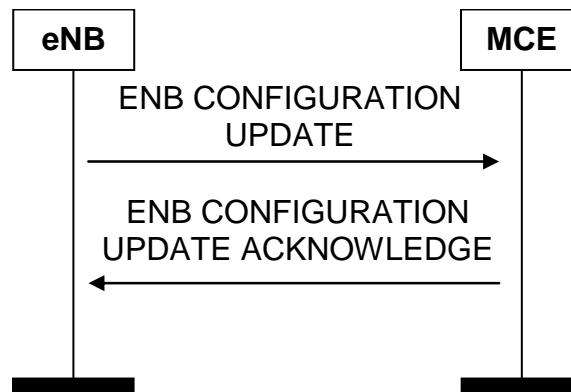

Figure 8.7.2-1. eNB Configuration Update procedure. Successful operation.

The eNB initiates the procedure by sending an ENB CONFIGURATION UPDATE message to the MCE including an appropriate set of updated configuration data that it has just taken into operational use. The eNB CONFIGURATION UPDATE message may contain:

- the *Global eNB ID* IE,
- the *eNB Name* IE,
- the *eNB MBMS Configuration data per cell* IE.

If the *Global eNB ID* IE is not included in the ENB CONFIGURATION UPDATE message, the MCE shall interpret that the existing eNB ID is not changed.

If the *eNB Name* IE is not included in the ENB CONFIGURATION UPDATE message, the MCE shall interpret that the existing eNB name, if any, is not changed.

The MCE responds with the ENB CONFIGURATION UPDATE ACKNOWLEDGE message to acknowledge that it successfully updated the configuration data. If the ENB CONFIGURATION UPDATE message does not contain the information for an existing cell, the MCE shall interpret that the corresponding configuration data for that cell is not changed and shall continue to operate the M2 with the existing related configuration data for that cell.

If the ENB CONFIGURATION UPDATE ACKNOWLEDGE message contains the *Cell Information List* IE within the *MCCH related BCCH Configuration Item* IE, the eNB shall broadcast that MCCH related BCCH configuration only in those cells indicated in the IE for which the *Cell Reservation Info* IE is not set to "reservedCell". If the ENB CONFIGURATION UPDATE ACKNOWLEDGE message does not contain the *Cell Information List* IE within the *MCCH related BCCH Configuration Item* IE, the eNB shall not broadcast that MCCH related BCCH configuration in

any cell. If the ENB CONFIGURATION UPDATE ACKNOWLEDGE message does not contain the *MCCH related BCCH Configuration Item* IE for an existing MBSFN area, the eNB shall interpret that the corresponding configuration data for that MBSFN area is not changed and shall continue to operate the M2 with the existing related configuration data for that MBSFN area.

The eNB may update the configured MBMS Services Areas and the MBSFN Synchronisation Area per cell:

- If the eNB includes the *E-UTRAN CGI* IE for a cell within the ENB CONFIGURATION UPDATE message, the MCE shall assume that the eNB does neither broadcast MCCH related configuration in the BCCH nor any MBMS service data in that cell any more.
- If the eNB includes the *eNB MBMS Configuration data Item* IE for a cell within the ENB CONFIGURATION UPDATE message, the MCE may decide to include in the ENB CONFIGURATION UPDATE ACKNOWLEDGE message the MCCH related BCCH configuration for the related MBSFN area(s).

If the eNB CONFIGURATION UPDATE message contains the *eNB Name* IE, the MCE may use this IE as a human readable name of the eNB.

The updated configuration data shall be stored in both eNB and MCE and used for the duration of the TNL association or until any further update is triggered by the eNB or the MCE.

The eNB may initiate a further eNB Configuration Update procedure only after a previous eNB Configuration Update procedure has been completed.

8.7.3 Unsuccessful Operation

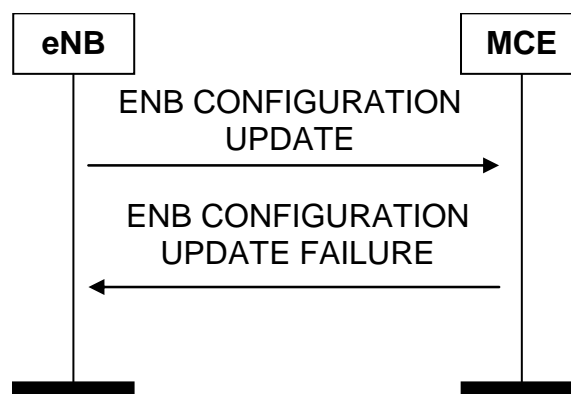

Figure 8.7.3-1. eNB Configuration Update procedure. Unsuccessful operation.

If the MCE can not accept the update it shall respond with an ENB CONFIGURATION UPDATE FAILURE message and appropriate cause value.

If the ENB CONFIGURATION UPDATE FAILURE message includes the *Time To Wait* IE the eNB shall wait at least for the indicated time before reinitiating the ENB Configuration Update procedure towards the MCE. Both nodes shall continue to operate the M2 interface with their respective configuration data.

8.7.4 Abnormal Conditions

If the eNB after initiating eNB Configuration Update procedure receives neither an ENB CONFIGURATION UPDATE ACKNOWLEDGE nor an ENB CONFIGURATION UPDATE FAILURE message, the eNB may reinitiate a further eNB Configuration Update procedure towards the same MCE, provided that the content of the new ENB CONFIGURATION UPDATE message is identical to the content of the previously unacknowledged ENB CONFIGURATION UPDATE message.

8.8 MCE Configuration Update

8.8.1 General

The purpose of the MCE Configuration Update procedure is to update application level configuration data needed for the eNB and MCE to interoperate correctly on the M2 interface and to re-configure MCCH related content on the BCCH for the MBSFN areas contributed by the eNB which is foreseen to participate in MBMS service data transmission. The procedure uses non MBMS-service-associated signalling. This procedure does not affect existing MBMS-service-related contexts, if any.

8.8.2 Successful Operation

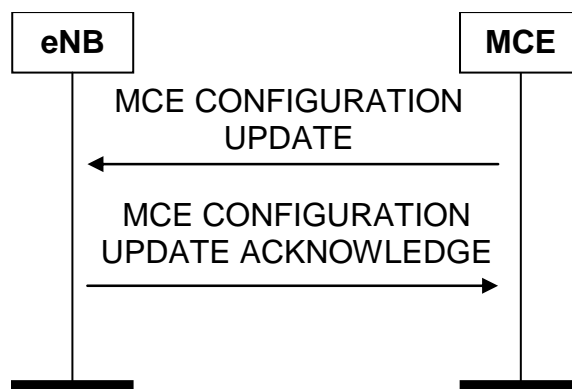

Figure 8.8.2-1. MCE Configuration Update procedure. Successful operation.

The MCE initiates the procedure by sending an MCE CONFIGURATION UPDATE message to the eNB including an appropriate set of updated configuration data. The MCE CONFIGURATION UPDATE message may contain:

- the *Global MCE ID IE*,
- the *MCE Name IE*,
- the *MCCH related BCCH Configuration data per MBSFN area IE*.

If the *Global MCE ID IE* is not included in the MCE CONFIGURATION UPDATE message, the eNB shall interpret that the existing MCE ID is not changed.

If the *MCE Name IE* is not included in the MCE CONFIGURATION UPDATE message, the eNB shall interpret that the existing MCE name, if any, is not changed.

The eNB responds with the MCE CONFIGURATION UPDATE ACKNOWLEDGE message to acknowledge that it successfully updated the configuration data.

If the MCE CONFIGURATION UPDATE message contains the *Cell Information List IE* within the *MCCH related BCCH Configuration Item IE*, the eNB shall broadcast that MCCH related BCCH configuration only in those cells indicated in the IE for which the Cell Reservation Info IE is not set to 'reservedCell'. If the MCE CONFIGURATION UPDATE message does not contain the *Cell Information List IE* within the *MCCH related BCCH Configuration Item IE*, the eNB shall not broadcast that MCCH related BCCH configuration in any cell. If the MCE CONFIGURATION UPDATE message does not contain the *MCCH related BCCH Configuration Item IE* for an existing MBSFN area, the eNB shall interpret that the corresponding configuration data for that MBSFN area is not changed and shall continue to operate the M2 with the existing related configuration data for that MBSFN area.

If the MCE CONFIGURATION UPDATE message contains the *MCE Name IE*, the eNB may use this IE as a human readable name of the MCE.

The updated configuration data shall be stored in both eNB and MCE and used for the duration of the TNL association or until any further update is triggered by the MCE or the eNB.

The MCE may initiate a further MCE Configuration Update procedure only after a previous MCE Configuration Update procedure has been completed.

8.8.3 Unsuccessful Operation

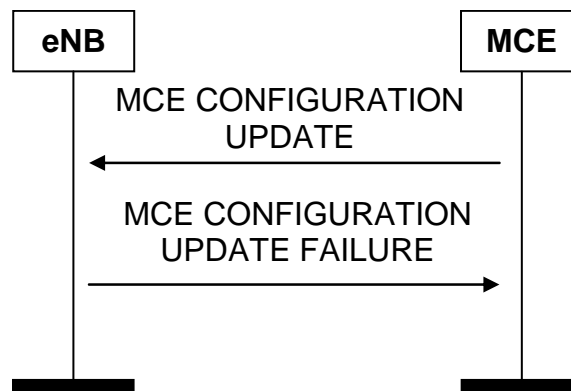

Figure 8.78.3-1. MCE Configuration Update procedure. Unsuccessful operation.

If the eNB can not accept the update it shall respond with an MCE CONFIGURATION UPDATE FAILURE message and appropriate cause value.

If the MCE CONFIGURATION UPDATE FAILURE message includes the *Time To Wait* IE the MCE shall wait at least for the indicated time before reinitiating the MCE Configuration Update procedure towards the eNB. Both nodes shall continue to operate the M2 interface with their respective configuration data.

8.8.4 Abnormal Conditions

If the MCE neither receives an MCE CONFIGURATION UPDATE ACKNOWLEDGE nor an MCE CONFIGURATION UPDATE FAILURE message, the MCE may reinitiate MCE Configuration Update procedure towards the same eNB provided that the content of the new MCE CONFIGURATION UPDATE message is identical to the content of the previously unacknowledged MCE CONFIGURATION UPDATE message.

8.9 Error Indication

8.9.1 General

The Error Indication procedure is initiated by a node to report detected errors in one incoming message, provided they cannot be reported by an appropriate failure message.

If the error situation arises due to reception of a message utilising MBMS-service-associated signalling, then the Error Indication procedure uses MBMS-service-associated signalling. Otherwise the procedure uses non MBMS-service-associated signalling.

8.9.2 Successful Operation

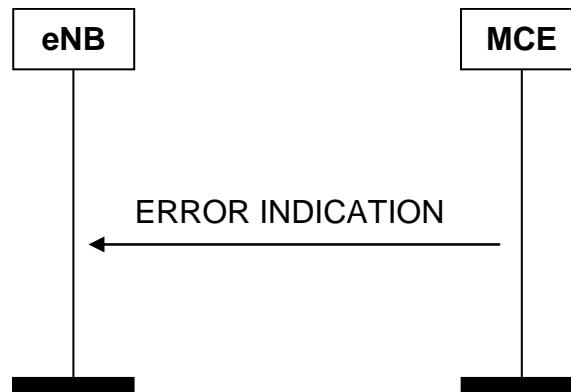

Figure 8.9.2-1. Error Indication procedure, MCE originated. Successful operation.

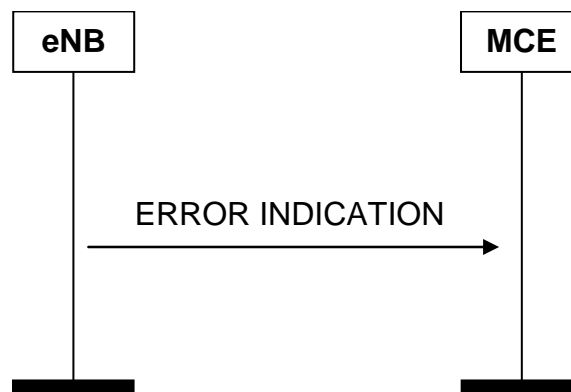

Figure 8.9.2.1-2. Error Indication procedure, eNB originated. Successful operation.

When the conditions defined in clause 10 are fulfilled, the Error Indication procedure is initiated by an ERROR INDICATION message sent from the receiving node.

The ERROR INDICATION message shall contain at least either the *Cause* IE or the *Criticality Diagnostics* IE.

In case the Error Indication procedure is triggered by utilising MBMS-service-associated signalling the *MCE MBMS M2AP ID* IE and the *eNB MBMS M2AP ID* IE shall be included in the ERROR INDICATION message. If one or both of *MCE MBMS M2AP ID* IE and the *eNB MBMS M2AP ID* IE are not correct, the cause shall be set to appropriate value e.g. "Unknown or already allocated MCE MBMS M2AP ID", "Unknown or already allocated eNB MBMS M2AP ID" or "Unknown or inconsistent pair of MBMS M2AP ID".

8.9.3 Abnormal Conditions

Void.

8.10 MBMS Session Update

8.10.1 General

The purpose of the MBMS Session Update procedure is to inform the eNB about changing characteristics of the MBMS session e.g. change in the service area.

The procedure uses MBMS-Service-associated signalling.

8.10.2 Successful Operation

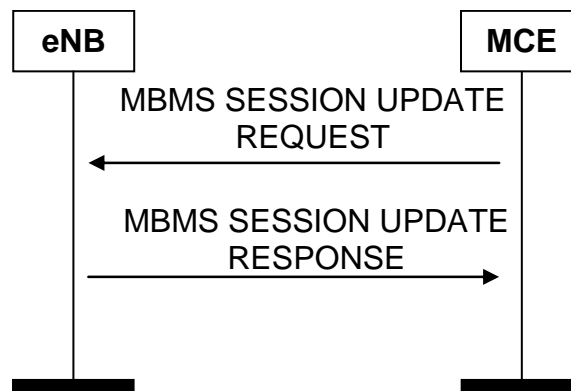

Figure 8.10.2-1. MBMS Session Update procedure. Successful operation.

The MCE initiates the procedure by sending a MBMS SESSION UPDATE REQUEST message.

If the *MBMS Service Area* IE is included in the MBMS SESSION UPDATE REQUEST message, the eNB shall check the involvement of its cells in the new service area, update correspondingly the MBMS context and resources, join or leave the IP multicast if needed and send the MBMS SESSION UPDATE RESPONSE message.

If the *TNL Information* IE is included in the MBMS SESSION UPDATE REQUEST message, the eNB shall use the contained information to join the IP multicast when needed.

If the MBMS SESSION UPDATE REQUEST message contains the *MBMS Session Identity* IE for an MBMS service, the eNB shall use it for broadcast of the MBMS Session Identity on air interface.

8.10.3 Unsuccessful Operation

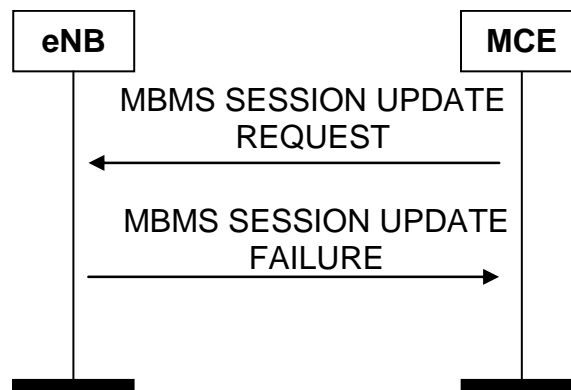

Figure 8.10.3-1. MBMS Session Update procedure. Unsuccessful operation.

If the eNB fails to update the MBMS session, it shall return a MBMS SESSION UPDATE FAILURE message.

8.10.4 Abnormal Conditions

Void.

8.11 MBMS Service Counting

8.11.1 General

The purpose of the MBMS Service Counting procedure is to request the eNB to report the number of connected mode UEs that either are receiving the MBMS service(s) or are interested in the reception of the MBMS service(s).

The procedure uses non MBMS-Service-associated signalling.

8.11.2 Successful Operation

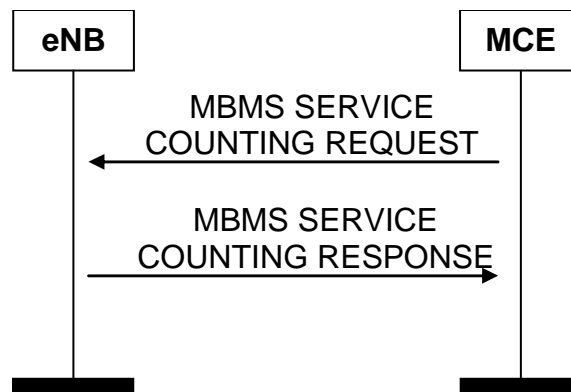

Figure 8.11.2-1. MBMS Service Counting procedure. Successful operation.

The MCE initiates the procedure by sending the MBMS SERVICE COUNTING REQUEST message to the eNB.

After receiving the MBMS SERVICE COUNTING REQUEST message successfully, the eNB shall respond the MCE with the MBMS SERVICE COUNTING RESPONSE message.

8.11.3 Unsuccessful Operation

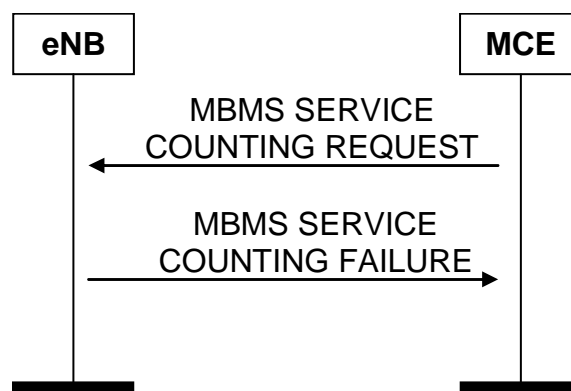

Figure 8.11.3-1. MBMS Service Counting procedure. Unsuccessful operation.

If the eNB is not capable of correctly processing the request, it shall return a MBMS SERVICE COUNTING FAILURE message.

8.11.4 Abnormal Conditions

If the eNB has received a MBMS SERVICE COUNTING REQUEST message for a MBSFN Area ID and MCCH Update Time pair, the eNB shall ignore subsequent MBMS SERVICE COUNTING REQUEST messages containing the same MBSFN Area ID and MCCH Update Time, and a different *MBMS Counting Request Session IE*.

8.12 MBMS Service Counting Results Report

8.12.1 General

The purpose of the MBMS Service Counting Results Report procedure is for the eNB to provide the counting results to the MCE.

The procedure uses non MBMS-Service-associated signalling.

8.12.2 Successful Operation

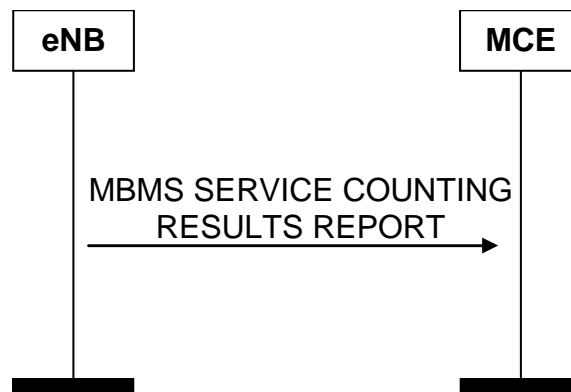

Figure 8.12.2-1. MBMS Service Counting Results Report procedure. Successful operation.

The eNB initiates the procedure by sending an MBMS SERVICE COUNTING RESULTS REPORT message.

The MBMS SERVICE COUNTING RESULTS REPORT message contains the counting results according to the counting configuration in the respective MBMS SERVICE COUNTING REQUEST message.

8.12.3 Abnormal Conditions

If, for a given MBSFN area, the MBMS SERVICE COUNTING RESULTS REPORT message contains one or more TMGIs corresponding to the configuration of one MBMS SERVICE COUNTING REQUEST message and some other TMGIs not part of this configuration, the MCE shall ignore the result corresponding to those other TMGIs.

9 Elements for M2AP Communication

9.1 Message Functional Definition and Content

9.1.1 General

Sub clauses 9.1 and 9.2 describe the structure of the messages and information elements required for the M2AP protocol in tabular format. Sub clause 9.3 provides the corresponding ASN.1 definition.

The following attributes are used for the tabular description of the messages and information elements: Presence, Range Criticality and Assigned Criticality.

9.1.1.1 Message Contents

9.1.1.1.1 Presence

All information elements in the message descriptions below are marked mandatory, optional or conditional according to table 4.

Table 4. Meaning of abbreviations used in M2AP messages

Abbreviation	Meaning
M	IEs marked as Mandatory (M) shall always be included in the message.
O	IEs marked as Optional (O) may or may not be included in the message.
C	IEs marked as Conditional (C) shall be included in a message only if the condition is satisfied. Otherwise the IE shall not be included.

9.1.1.1.2 Criticality

Each Information Element or Group of Information Elements may have criticality information applied to it. Following cases are possible:

Table 5. Meaning of content within "Criticality" column

Abbreviation	Meaning
–	No criticality information is applied explicitly.
YES	Criticality information is applied. This is usable only for non-repeatable IEs
GLOBAL	The IE and all its repetitions together have one common criticality information. This is usable only for repeatable IEs.
EACH	Each repetition of the IE has its own criticality information. It is not allowed to assign different criticality values to the repetitions. This is usable only for repeatable IEs.

9.1.1.1.3 Range

The Range column indicates the allowed number of copies of repetitive IEs/IE groups.

9.1.1.1.4 Assigned Criticality

This column provides the actual criticality information as defined in subclause 10.3.2 in TS 36.413 [4], if applicable.

9.1.2 MBMS SESSION START REQUEST

This message is sent by the MCE to establish an MBMS-service-associated logical M2-connection.

Direction: MCE → eNB.

IE/Group Name	Presence	Range	IE type and reference	Semantics description	Criticality	Assigned Criticality
Message Type	M		9.2.1.1		YES	reject
MCE MBMS M2AP ID	M		9.2.3.1		YES	reject
TMGI	M		9.2.3.3		YES	reject
MBMS Session Identity	O		9.2.3.4		YES	ignore
MBMS Service Area	M		9.2.3.6		YES	reject
TNL Information		1			YES	reject
>IP Multicast Address	M		IP Address 9.2.2.1		-	
>IP Source Address	M		IP Address 9.2.2.1		-	
>GTP DL TEID	M		GTP-TEID 9.2.2.2		-	

9.1.3 MBMS SESSION START RESPONSE

This message is sent by the eNB to report the successful outcome of the request from the MBMS SESSION START REQUEST message.

Direction: eNB → MCE.

IE/Group Name	Presence	Range	IE type and reference	Semantics description	Criticality	Assigned Criticality
Message Type	M		9.2.1.1		YES	reject
MCE MBMS M2AP ID	M		9.2.3.1		YES	ignore
eNB MBMS M2AP ID	M		9.2.3.2		YES	ignore
Criticality Diagnostics	O		9.2.1.7		YES	ignore

9.1.4 MBMS SESSION START FAILURE

This message is sent by the eNB to report the unsuccessful outcome of the request from the MBMS SESSION START REQUEST message.

Direction: eNB → MCE.

IE/Group Name	Presence	Range	IE type and reference	Semantics description	Criticality	Assigned Criticality
Message Type	M		9.2.1.1		YES	reject
MCE MBMS M2AP ID	M		9.2.3.1		YES	ignore
Cause	M		9.2.1.2		YES	ignore
Criticality Diagnostics	O		9.2.1.7		YES	ignore

9.1.5 MBMS SESSION STOP REQUEST

This message is sent by the MCE to release the corresponding MBMS E-RAB and the MBMS-service-associated logical M2-connection.

Direction: MCE → eNB.

IE/Group Name	Presence	Range	IE type and reference	Semantics description	Criticality	Assigned Criticality
Message Type	M		9.2.1.1		YES	reject
MCE MBMS M2AP ID	M		9.2.3.1		YES	reject
eNB MBMS M2AP ID	M		9.2.3.2		YES	reject

9.1.6 MBMS SESSION STOP RESPONSE

This message is sent by the eNB to acknowledge the MBMS SESSION STOP message.

Direction: eNB → MCE.

IE/Group Name	Presence	Range	IE type and reference	Semantics description	Criticality	Assigned Criticality
Message Type	M		9.2.1.1		YES	reject
MCE MBMS M2AP ID	M		9.2.3.1		YES	ignore
eNB MBMS M2AP ID	M		9.2.3.2		YES	ignore
Criticality Diagnostics	O		9.2.1.7		YES	ignore

9.1.7 MBMS SCHEDULING INFORMATION

This message is sent by the MCE to provide MCCH related information to the eNB.

Direction: MCE → eNB.

IE/Group Name	Presence	Range	IE type and reference	Semantics description	Criticality	Assigned Criticality
Message Type	M		9.2.1.1		YES	reject
MCCH Update Time	M		9.2.1.19		YES	reject
MBSFN Area Configuration List		1			YES	reject
> MBSFN Area Configuration Item IEs		1 to <maxnoofMBSFNareas>			EACH	reject
>> PMCH Configuration List		1			YES	reject
>>> PMCH Configuration Item IEs		0 to <maxnoofPMCHsperMBSFNarea>			EACH	reject
>>>>PMCH Configuration	M		9.2.1.8		-	
>>>>MBMS Session List per PMCH	M		9.2.1.9		-	
>> Subframes Configuration List		1			YES	reject
>>> Subframes Configuration Item IEs		1 to <maxnoofMBSFNallocations>			EACH	reject
>>>>MBSFN Subframe Configuration	M		9.2.1.17		-	
>>Common Subframe Allocation Period	M		9.2.1.18		YES	reject
>>MBSFN Area ID	M		9.2.1.14		YES	reject

Range bound	Explanation
maxnoofMBSFNareas	Maximum no. of MBSFN areas served by a single eNB. The value for maxnoofMBSFNareas is 256.
maxnoofPMCHsperMBSFNarea	Maximum no. of PMCHs possible per MBSFN. The value for maxnoofPMCHsperMBSFNarea is 15.
maxnoofMBSFNallocations	Maximum no. of MBSFN frame allocations with different offset. The value for maxnoofMBSFNallocations is 8.

9.1.8 MBMS SCHEDULING INFORMATION RESPONSE

This message is sent by the eNB to acknowledge the MBMS SCHEDULING INFORMATION message.

Direction: eNB → MCE.

IE/Group Name	Presence	Range	IE type and reference	Semantics description	Criticality	Assigned Criticality
Message Type	M		9.2.1.1		YES	reject
Criticality Diagnostics	O		9.2.1.7		YES	ignore

9.1.9 RESET

This message is either sent by the eNB or the MCE and is used to request the M2 interface or part of M2 interface to be reset.

Direction: eNB → MCE, MCE → eNB

IE/Group Name	Presence	Range	IE type and reference	Semantics description	Criticality	Assigned Criticality
Message Type	M		9.2.1.1		YES	reject
Cause	M		9.2.1.2		YES	ignore
CHOICE <i>Reset Type</i>	M				YES	reject
> <i>M2 interface</i>						
>>Reset All	M		ENUMERATED (Reset all, ...)		–	–
> <i>Part of M2 interface</i>						
>>MBMS-Service-associated logical M2-connection list		1			–	–
>>>MBMS-Service - associated logical M2-connection Item		1 to < <i>maxNrOfIndividualM2ConnectionsToReset</i> >			EACH	reject
>>>>eNB MBMS M2AP ID	O		9.2.3.2		–	–
>>>>MCE MBMS M2AP ID	O		9.2.3.1		–	–

Range bound	Explanation
maxNrOfIndividualM2ConnectionsToReset	Maximum no. of MBMS-Service-associated logical M2-connections allowed to reset in one message. Value is 256.

9.1.10 RESET ACKNOWLEDGE

This message is sent as a response to the RESET message.

Direction: MCE → eNB, eNB → MCE.

IE/Group Name	Presence	Range	IE type and reference	Semantics description	Criticality	Assigned Criticality
Message Type	M		9.2.1.1		YES	reject
MBMS-Service-associated logical M2-connection list		0..1			YES	ignore
>MBMS-Service - associated logical M2-connection Item		1 to < <i>maxNrOfIndividualM2ConnectionsToReset</i> >			EACH	ignore
>>eNB MBMS M2AP ID	O		9.2.3.2		–	–
>>MCE MBMS M2AP ID	O		9.2.3.1		–	–
Criticality Diagnostics	O		9.2.1.7		YES	ignore

Range bound	Explanation
maxNrOfIndividualM2ConnectionsToReset	Maximum no. of MBMS-Service-associated logical M2-connections allowed to reset in one message. Value is 256.

9.1.11 M2 SETUP REQUEST

This message is sent by the eNB to initiate the M2 interface instance.

Direction: eNB → MCE.

IE/Group Name	Presence	Range	IE type and reference	Semantics description	Criticality	Assigned Criticality
Message Type	M		9.2.1.1		YES	reject
Global eNB ID	M		9.2.1.10		YES	reject
eNB Name	O		Printable String (1..150,...)		YES	ignore
eNB MBMS Configuration data per cell		1			YES	reject
>eNB MBMS Configuration data Item IEs		1 to <maxnoofCells>			EACH	reject
>>eNB MBMS Configuration data Item	M		9.2.1.12		-	

Range bound	Explanation
maxnoofCells	Maximum no. of cells that may be served by an eNB. The value for maxnoofCells is 256.

9.1.12 M2 SETUP RESPONSE

This message is sent by the MCE to complete the initiation of an M2 interface instance, providing MCCH related BCCH information.

Direction: MCE → eNB.

IE/Group Name	Presence	Range	IE type and reference	Semantics description	Criticality	Assigned Criticality
Message Type	M		9.2.1.1		YES	reject
Global MCE ID	M		9.2.1.16		YES	reject
MCE Name	O		Printable String (1..150,...)		YES	ignore
MCCH related BCCH Configuration data per MBSFN area		1			YES	reject
>MCCH related BCCH Configuration data Item IEs		1 to <maxnoofMBSFNareas>			EACH	reject
>> MCCH related BCCH Configuration Item	M		9.2.1.13		-	
Criticality Diagnostics	O		9.2.1.7		YES	ignore

Range bound	Explanation
maxnoofMBSFNareas	Maximum no. of MBSFN areas served by a single eNB. The value for maxnoofMBSFNareas is 256.

9.1.13 M2 SETUP FAILURE

This message is sent by the MCE to indicate non acceptance of the M2 Setup Request.

Direction: MCE → eNB.

IE/Group Name	Presence	Range	IE type and reference	Semantics description	Criticality	Assigned Criticality
Message Type	M		9.2.1.1		YES	reject
Cause	M		9.2.1.2		YES	ignore
Time To Wait	O		9.2.1.15		YES	ignore
Criticality Diagnostics	O		9.2.1.7		YES	ignore

9.1.14 ENB CONFIGURATION UPDATE

This message is sent by the eNB to indicate that application level configuration data has changed in the eNB.

Direction: eNB → MCE.

IE/Group Name	Presence	Range	IE type and reference	Semantics description	Criticality	Assigned Criticality
Message Type	M		9.2.1.1		YES	reject
Global eNB ID	O		9.2.1.10		YES	reject
eNB Name	O		Printable String (1..150,...)		YES	ignore
eNB MBMS Configuration data per cell		0..1			YES	reject
>eNB MBMS Configuration data per cell Item IEs		1 to <maxnoofCells>			EACH	reject
>>CHOICE MBMS Configuration Update	M					
>>>Configuration Data						
>>>>eNB MBMS Configuration data Item			9.2.1.12			
>>>E-CGI						
>>>>E-UTRAN CGI			9.2.1.11			

Range bound	Explanation
maxnoofCells	Maximum no. of cells that may be served by an eNB. The value for maxnoofCells is 256.

9.1.15 ENB CONFIGURATION UPDATE ACKNOWLEDGE

This message acknowledges the ENB CONFIGURATION UPDATE message.

Direction: MCE → eNB.

IE/Group Name	Presence	Range	IE type and reference	Semantics description	Criticality	Assigned Criticality
Message Type	M		9.2.1.1		YES	reject
MCCH related BCCH Configuration data per MBSFN area		0..1			YES	reject
>MCCH related BCCH Configuration data Item IEs		1 to <maxnoofMBSFNareas>			EACH	reject
>>MCCH related BCCH Configuration Item	M		9.2.1.13		-	
Criticality Diagnostics	O		9.2.1.7		YES	ignore

Range bound	Explanation
maxnoofMBSFNareas	Maximum no. of MBSFN areas served by a single eNB. The value for maxnoofMBSFNareas is 256.

9.1.16 ENB CONFIGURATION UPDATE FAILURE

This message is sent by the MCE to indicate non acceptance of the eNB Configuration Update.

Direction: MCE → eNB.

IE/Group Name	Presence	Range	IE type and reference	Semantics description	Criticality	Assigned Criticality
Message Type	M		9.2.1.1		YES	reject
Cause	M		9.2.1.2		YES	ignore
Time To Wait	O		9.2.1.15		YES	ignore
Criticality Diagnostics	O		9.2.1.7		YES	ignore

9.1.17 MCE CONFIGURATION UPDATE

This message is sent by the MCE to indicate that application level configuration data has changed in the MCE.

Direction: MCE → eNB.

IE/Group Name	Presence	Range	IE type and reference	Semantics description	Criticality	Assigned Criticality
Message Type	M		9.2.1.1		YES	reject
Global MCE ID	O		9.2.1.16		YES	reject
MCE Name	O		Printable String (1..150,...)		YES	ignore
MCCH related BCCH Configuration data per MBSFN area		0..1			YES	reject
>MCCH related BCCH Configuration data Item IEs		1 to <maxnoofMBSFNareas>			EACH	reject
>>MCCH related BCCH Configuration Item	M		9.2.1.13		-	

Range bound	Explanation
maxnoofMBSFNareas	Maximum no. of MBSFN areas served by a single eNB. The value for maxnoofMBSFNareas is 256.

9.1.18 MCE CONFIGURATION UPDATE ACKNOWLEDGE

This message acknowledges the MCE CONFIGURATION UPDATE message.

Direction: eNB → MCE.

IE/Group Name	Presence	Range	IE type and reference	Semantics description	Criticality	Assigned Criticality
Message Type	M		9.2.1.1		YES	reject
Criticality Diagnostics	O		9.2.1.7		YES	ignore

9.1.19 MCE CONFIGURATION UPDATE FAILURE

This message is sent by the eNB to indicate non acceptance of the MCE Configuration Update.

Direction: eNB → MCE.

IE/Group Name	Presence	Range	IE type and reference	Semantics description	Criticality	Assigned Criticality
Message Type	M		9.2.1.1		YES	reject
Cause	M		9.2.1.2		YES	ignore
Time To Wait	O		9.2.1.15		YES	ignore
Criticality Diagnostics	O		9.2.1.7		YES	ignore

9.1.20 ERROR INDICATION

This message is sent by both the MCE and the eNB and is used to indicate that some error has been detected in the node.

Direction: MCE → eNB and eNB → MCE.

IE/Group Name	Presence	Range	IE type and reference	Semantics description	Criticality	Assigned Criticality
Message Type	M		9.2.1.1		YES	ignore
MCE MBMS M2AP ID	O		9.2.3.1		YES	ignore
eNB MBMS M2AP ID	O		9.2.3.2		YES	ignore
Cause	O		9.2.1.2		YES	ignore
Criticality Diagnostics	O		9.2.1.7		YES	ignore

9.1.21 MBMS SESSION UPDATE REQUEST

This message is sent by the MCE to the eNB in order to inform of the change of session characteristics e.g. service area of one MBMS service session.

Direction: MCE → eNB.

IE/Group Name	Presence	Range	IE type and reference	Semantics description	Criticality	Assigned Criticality
Message Type	M		9.2.1.1		YES	reject
MCE MBMS M2AP ID	M		9.2.3.1		YES	reject
eNB MBMS M2AP ID	M		9.2.3.2		YES	reject
TMGI	M		9.2.3.3		YES	reject
MBMS Session Identity	O		9.2.3.4		YES	ignore
MBMS Service Area	O		9.2.3.6		YES	ignore
TNL Information	O				YES	reject
>IP Multicast Address	M		9.2.2.1		-	
>IP Source Address	M		IP Address 9.2.2.1		-	
>GTP DL TEID	M		GTP-TEID 9.2.2.2		-	

9.1.22 MBMS SESSION UPDATE RESPONSE

This message is sent by the eNB to report the successful outcome of the request from the MBMS SESSION UPDATE REQUEST message.

Direction: eNB → MCE.

IE/Group Name	Presence	Range	IE type and reference	Semantics description	Criticality	Assigned Criticality
Message Type	M		9.2.1.1		YES	reject
MCE MBMS M2AP ID	M		9.2.3.1		YES	ignore
eNB MBMS M2AP ID	M		9.2.3.2		YES	ignore
Criticality Diagnostics	O		9.2.1.7		YES	ignore

9.1.23 MBMS SESSION UPDATE FAILURE

This message is sent by the eNB to report the unsuccessful outcome of the request from the MBMS SESSION UPDATE REQUEST message.

Direction: eNB → MCE.

IE/Group Name	Presence	Range	IE type and reference	Semantics description	Criticality	Assigned Criticality
Message Type	M		9.2.1.1		YES	reject
MCE MBMS M2AP ID	M		9.2.3.1		YES	ignore
eNB MBMS M2AP ID	M		9.2.3.2		YES	ignore
Cause	M		9.2.1.2		YES	ignore
Criticality Diagnostics	O		9.2.1.7		YES	ignore

9.1.24 MBMS SERVICE COUNTING REQUEST

This message is sent by the MCE to request the eNB to report the number of connected mode UEs that are receiving or interested in the MBMS service(s).

Direction: MCE → eNB.

IE/Group Name	Presence	Range	IE type and reference	Semantics description	Criticality	Assigned Criticality
Message Type	M		9.2.1.1		YES	reject
MCCH Update Time	M		9.2.1.19		YES	reject
MBSFN Area ID	M		9.2.1.14		YES	reject
MBMS Counting Request Session	M				YES	reject
>MBMS Counting Request Session Item		1 to <maxnoofcounting service>			EACH	reject
>>TMGI	M		9.2.3.3		-	-

Range bound	Explanation
maxnoofcountingservice	Maximum no. of the services that are counted by RAN. The value for maxnoofcountingservice is 16.

9.1.25 MBMS SERVICE COUNTING RESPONSE

This message is sent by the eNB to acknowledge the MBMS SERVICE COUNTING REQUEST message.

Direction: eNB→MCE.

IE/Group Name	Presence	Range	IE type and reference	Semantics description	Criticality	Assigned Criticality
Message Type	M		9.2.1.1		YES	reject
Criticality Diagnostics	O		9.2.1.7		YES	ignore

9.1.26 MBMS SERVICE COUNTING FAILURE

This message is sent by the eNB to report the unsuccessful outcome of the request from the MBMS SERVICE COUNTING REQUEST message.

Direction: eNB → MCE.

IE/Group Name	Presence	Range	IE type and reference	Semantics description	Criticality	Assigned Criticality
Message Type	M		9.2.1.1		YES	reject
Cause	M		9.2.1.2		YES	ignore
Criticality Diagnostics	O		9.2.1.7		YES	ignore

9.1.27 MBMS SERVICE COUNTING RESULTS REPORT

This message is sent by the eNB to report the number of connected mode UEs that are receiving or interested in the MBMS service(s) as indicated in the MBMS SERVICE COUNTING REQUEST message.

Direction: eNB→MCE.

IE/Group Name	Presence	Range	IE type and reference	Semantics description	Criticality	Assigned Criticality
Message Type	M		9.2.1.1		YES	reject
MBSFN Area ID	M		9.2.1.14		YES	reject
MBMS Counting Result List	M				YES	reject
>MBMS Counting Result Item		1 to <maxnoofcounting service>			EACH	reject
>>TMGI	M		9.2.3.3		-	
>>Counting Result	M		9.2.1.21		-	

Range bound	Explanation
Maxnoofcountingservice	Maximum no. of the services that are counted by RAN. The value for maxnoofcountingservice is 16.

9.2 Information Element Definitions

9.2.1 Radio Network Layer Related IEs

9.2.1.1 Message Type

The *Message Type* IE uniquely identifies the message being sent. It is mandatory for all messages.

IE/Group Name	Presence	Range	IE type and reference	Semantics description
Message Type				Assumed max no of messages is 256.
>Procedure Code	M		(Session Start, Session Stop, MBMS Scheduling Information, Reset, M2 Setup, eNB Configuration Update, MCE Configuration Update, Error Indication, Session Update, MBMS Service Counting, MBMS Service Counting Results Report, ...)	
>Type of Message	M		CHOICE (Initiating Message, Successful Outcome, Unsuccessful Outcome, ...)	

9.2.1.2 Cause

The purpose of the *Cause* IE is to indicate the reason for a particular event for the M2AP protocol.

IE/Group Name	Presence	Range	IE Type and Reference	Semantics Description
CHOICE <i>Cause Group</i>	M			
> <i>Radio Network Layer</i>				
>>Radio Network Layer Cause	M		ENUMERATED (Unknown or already allocated MCE MBMS M2AP ID, Unknown or already allocated eNB MBMS M2AP ID, Unknown or inconsistent pair of MBMS M2AP IDs, Radio resources not available, Interaction with other procedure, Unspecified, ...)	
> <i>Transport Layer</i>				
>>Transport Layer Cause	M		ENUMERATED (Transport Resource Unavailable, Unspecified, ...)	
> <i>NAS</i>				
>>NAS Cause	M		ENUMERATED (Unspecified, ...)	
> <i>Protocol</i>				
>>Protocol Cause	M		ENUMERATED (Transfer Syntax Error, Abstract Syntax Error (Reject), Abstract Syntax Error (Ignore and Notify), Message not Compatible with Receiver State, Semantic Error, Abstract Syntax Error (Falsely Constructed Message), Unspecified, ...)	
> <i>Misc</i>				
>>Miscellaneous Cause	M		ENUMERATED (Control Processing Overload, Hardware Failure, O&M Intervention, Unspecified, ...)	

The meaning of the different cause values is described in the following table. In general, "not supported" cause values indicate that the related capability is missing. On the other hand, "not available" cause values indicate that the related capability is present, but insufficient resources were available to perform the requested action.

Radio Network Layer cause	Meaning
Unknown or already allocated MCE MBMS M2AP ID	The action failed because the MCE MBMS M2AP ID is either unknown, or (for a first message received at the eNB) is known and already allocated to an existing MBMS service related context.
Unknown or already allocated eNB MBMS M2AP ID	The action failed because the eNB MBMS M2AP ID is either unknown, or (for a first message received at the MCE) is known and already allocated to an existing context.
Unknown or inconsistent pair of MBMS M2AP IDs	The action failed because both MBMS M2AP IDs are unknown, or are known but do not define a single MBMS context.
Radio resources not available	No requested radio resources are available
Interaction with other procedure	The action is due to an ongoing interaction with another procedure
Unspecified	Sent for radio network layer cause when none of the specified cause values applies

Transport Layer cause	Meaning
Transport Resource Unavailable	The required transport resources are not available
Unspecified	Sent for transport network layer cause when none of the specified cause values applies.

NAS cause	Meaning
Unspecified	Sent for NAS cause when none of the specified cause values applies.

Protocol cause	Meaning
Transfer Syntax Error	The received message included a transfer syntax error.
Abstract Syntax Error (Reject)	The received message included an abstract syntax error and the concerning criticality indicated "reject".
Abstract Syntax Error (Ignore And Notify)	The received message included an abstract syntax error and the concerning criticality indicated "ignore and notify".
Message Not Compatible With Receiver State	The received message was not compatible with the receiver state.
Semantic Error	The received message included a semantic error.
Abstract Syntax Error (Falsely Constructed Message)	The received message contained IEs or IE groups in wrong order or with too many occurrences.
Unspecified	Sent for protocol cause when none of the specified cause values applies.

Miscellaneous cause	Meaning
Control Processing Overload	Control processing overload
Hardware Failure	Action related to hardware failure
O&M Intervention	The action is due to O&M intervention.
Unspecified	Sent when none of the above cause values applies and the cause is not related to any of the categories Radio Network Layer, Transport Network Layer, NAS or Protocol.

9.2.1.3 Void

9.2.1.4 Void

9.2.1.5 Void

9.2.1.6 Void

9.2.1.7 Criticality Diagnostics

The *Criticality Diagnostics* IE is sent by the eNB or the MCE when parts of a received message have not been comprehended or were missing, or if the message contained logical errors. When applicable, it contains information about which IEs were not comprehended or were missing.

For further details on how to use the *Criticality Diagnostics* IE, (see section 10 in TS 36.413 [4]).

IE/Group Name	Presence	Range	IE type and reference	Semantics description
Procedure Code	O		INTEGER (0..255)	Procedure Code is to be used if Criticality Diagnostics is part of Error Indication procedure, and not within the response message of the same procedure that caused the error
Triggering Message	O		ENUMERATED (initiating message, successful outcome, unsuccessful outcome)	The Triggering Message is used only if the Criticality Diagnostics is part of Error Indication procedure.
Procedure Criticality	O		ENUMERATED (reject, ignore, notify)	This Procedure Criticality is used for reporting the Criticality of the Triggering message (Procedure).
Information Element Criticality Diagnostics		<i>0 to <maxnoof errors></i>		
>IE Criticality	M		ENUMERATED (reject, ignore, notify)	The IE Criticality is used for reporting the criticality of the triggering IE. The value 'ignore' shall not be used.
>IE ID	M		INTEGER (0..65535)	The IE ID of the not understood or missing IE
>Type of Error	M		ENUMERATED (not understood, missing, ...)	

Range bound	Explanation
maxnooferrors	Maximum no. of IE errors allowed to be reported with a single message. The value for maxnooferrors is 256.

9.2.1.8 PMCH Configuration

This information element provided PMCH configuration related content for MCCH.

IE/Group Name	Presence	Range	IE type and reference	Semantics description
Allocated Subframes End	M		INTEGER (0..1535)	Encoded as the <i>sf-AllocEnd</i> IE in TS 36.331 [11]
Modulation and Coding Scheme	M		INTEGER (0..28)	Encoded as the <i>dataMCS</i> IE in TS 36.331 [11]
MCH Scheduling Period	M		ENUMERATED (rf8, rf16, rf32, rf64, rf128, rf256, rf512, rf1024)	Encoded as the <i>mch-SchedulingPeriod</i> IE in TS 36.331 [11]

9.2.1.9 MBMS Session List per PMCH

This information element provided PMCH configuration related content for MCCH.

IE/Group Name	Presence	Range	IE type and reference	Semantics description
MBMS Session List per PMCH Item IEs		<i>1 to <maxnoofSessionsPerPMCH></i>		
>MBMS Service Identity	M		TMGI 9.2.3.3	
>LCID	M		INTEGER (0..28)	Logical Channel Identity

Range bound	Explanation
maxnoofSessionsPerPMCH	Maximum no. of Sessions per PMCH. The value for maxnoofSessionsPerPMCH is 29.

9.2.1.10 Global eNB ID

This information element is used to globally identify an eNB (see TS 36.401 [2]).

IE/Group Name	Presence	Range	IE type and reference	Semantics description
PLMN Identity	M		9.2.3.7	
CHOICE <i>eNB ID</i>	M			
> <i>eNB ID</i>				
>>Macro eNB ID			BIT STRING (20)	Equal to the 20 leftmost bits of the Cell Identity IE contained in the E-UTRAN CGI IE (see section 9.2.1.11) of each cell served by the eNB.

9.2.1.11 E-UTRAN CGI

This information element is used to globally identify a cell (see TS 36.401 [2]).

IE/Group Name	Presence	Range	IE type and reference	Semantics description
PLMN Identity	M		9.2.3.7	
Cell Identity	M		BIT STRING (28)	The 20 leftmost bits of the Cell Identity correspond to the eNB ID (<i>Global eNB ID</i> IE defined in section 9.2.1.10).

9.2.1.12 eNB MBMS Configuration data Item

This information element provides MBMS related configuration information from the eNB.

IE/Group Name	Presence	Range	IE type and reference	Semantics description
E-UTRAN CGI	M		9.2.1.11	
MBSFN Synchronisation Area Id	M		9.2.1.20	
MBMS Service Area List		1		
>MBMS Service Area Item		1 to <maxnoofMBMSServiceAreasPerCell>		
>>MBMS Service Area	M		9.2.3.6	

Range bound	Explanation
maxnoofMBMSServiceAreasPerCell	Maximum no. of Service Areas per cell. The value for maxnoofMBMSServiceAreasPerCell is 256.

9.2.1.13 MCCH related BCCH Configuration Item

This information element provides MCCH related BCCH configuration information to the eNB.

IE/Group Name	Presence	Range	IE type and reference	Semantics description
MBSFN Area Id	M		9.2.1.14	
PDCCH Length	M		ENUMERATED (s1, s2,...)	This IE is encoded along the number of OFDM symbols for PDCCH as of table 6.7-1. in TS 36.211 [12].
Repetition Period	M		ENUMERATED (rf32, rf64, rf128, rf256)	The same encoding as the <i>mcch-RepetitionPeriod</i> IE in the <i>mcch-Config</i> IE as specified in TS 36.331 [11]
Offset	M		INTEGER (0..10)	The same encoding as the <i>mcch-Offset</i> in <i>mcch-Config</i> IE as specified in TS 36.331 [11]
Modification Period	M		ENUMERATED (rf512, rf1024)	The same encoding as the <i>mcch-ModificationPeriod</i> IE in the <i>mcch-Config</i> IE as specified in TS 36.331 [11]
Subframe Allocation Info	M		BIT STRING (SIZE(6))	The same encoding as the <i>sf-AllocInfo</i> IE specified in TS 36.331 [11]
Modulation and Coding Scheme	M		ENUMERATED (n2, n7, n13, n19)	The same encoding as the <i>signallingMCS</i> IE specified in TS 36.331 [11]
Cell Information List		0..1		
>Cell Information		1 to <maxnoofCells>		
>>E-UTRAN CGI	M		9.2.1.11	
>>Cell Reservation Info	M		ENUMERATED (reservedCell, nonReservedCell, ...)	

Range bound	Explanation
maxnoofCells	Maximum no. of cells that may be served by an eNB. The value for maxnoofCells is 256.

9.2.1.14 MBSFN Area Id

This IE defines the MBSFN Area Id.

IE/Group Name	Presence	Range	IE type and reference	Semantics description
MBSFN Area Id	M		INTEGER (0..255)	The same encoding as the <i>mbsfn-AreaId</i> IE specified in TS 36.331 [11].

9.2.1.15 Time to Wait

This IE defines the minimum allowed waiting time.

IE/Group Name	Presence	Range	IE type and reference	Semantics description
Time to Wait	M		ENUMERATED (1s, 2s, 5s, 10s, 20s, 60s,...)	

9.2.1.16 Global MCE ID

This IE is used to globally identify an MCE.

IE/Group Name	Presence	Range	IE type and reference	Semantics description
PLMN Identity	M		9.2.3.8	
MCE ID	M		OCTET STRING (SIZE(2))	

9.2.1.17 MBSFN Subframe Configuration

This IE indicates the MBSFN Subframe Configuration, as defined in TS 36.331 [11].

IE/Group Name	Presence	Range	IE type and reference	Semantics description
Radio Frame Allocation Period	M		ENUMERATED (n1, n2, n4, n8, n16, n32)	Semantics along the IE definition in TS 36.331 [11]
Radio Frame Allocation Offset	M		INTEGER (0..7)	Semantics along the IE definition in TS 36.331 [11]
CHOICE <i>Subframe Allocation</i>	M			
> <i>One Frame</i>				
>>One Frame Item	M		BIT STRING (SIZE(6))	Semantics along the IE definition in TS 36.331 [11]
> <i>Four Frames</i>				
>>Four Frame Item	M		BIT STRING (SIZE(24))	Semantics along the IE definition in TS 36.331 [11]

9.2.1.18 Common Subframe Allocation Period

This IE defines the period during which allocated subframes are divided between PMCHs configured for the MBSFN area, see TS 36.331 [11].

IE/Group Name	Presence	Range	IE type and reference	Semantics description
Common Subframe Allocation Period	M		ENUMERATED (rf4, rf8, rf16, rf32, rf64, rf128, rf256)	The same encoding as the <i>commonSF-AllocPeriod</i> IE as specified in TS 36.331 [11]

9.2.1.19 MCCH Update Time

This IE indicates the time at which the eNB shall apply the update of the MCCH as specified in TS 36.300 [3].

IE/Group Name	Presence	Range	IE type and reference	Semantics description
MCCH Update Time	M		INTEGER (0..255)	This IE indicates the modification period, as an absolute value, from when the MCCH update should be applied. Note: The duration of the modification period is configured in eNB and MCE:

9.2.1.20 MBSFN Synchronisation Area Id

This IE defines the MBSFN Synchronisation Area Identity as specified in TS 36.300 [3].

IE/Group Name	Presence	Range	IE type and reference	Semantics description
MBSFN Synchronisation Area Id	M		INTEGER (0..65535)	The MBSFN Synchronisation Area is defined in TS 36.300 [3]

9.2.1.21 Counting Result

This IE defines the number of connected mode UEs that are receiving or interested in a MBMS service.

IE/Group Name	Presence	Range	IE type and reference	Semantics description
Counting Result	M		INTEGER(0..1023)	This IE indicates the number of connected mode UEs that are receiving or interested in a MBMS service. The value 1023 is used if the UE number is equal to or more than 1023.

9.2.2 Transport Network Layer Related IEs

9.2.2.1 IP Address

This information element is an IP address.

IE/Group Name	Presence	Range	IE type and reference	Semantics description
IP Address	M		OCTET STRING (4..16)	The Radio Network Layer is not supposed to interpret the address information. It should pass it to the transport layer for interpretation. For details on the IP Address, see ref. TS 36.445 [13].

9.2.2.2 GTP-TEID

This information element is the GTP Tunnel Endpoint Identifier to be used for the user plane transport between eNB and the MBMS-GW.

IE/Group Name	Presence	Range	IE type and reference	Semantics description
GTP TEID	M		OCTET STRING (4)	For details and range, see TS 29.281 [14]

9.2.3 NAS Related IEs

9.2.3.1 MCE MBMS M2AP ID

The MCE MBMS M2AP ID uniquely identifies the MBMS Service association over the M2 interface within the MCE.

IE/Group Name	Presence	Range	IE type and reference	Semantics description
MCE MBMS M2AP ID	M		INTEGER (0 .. $2^{24}-1$)	

9.2.3.2 eNB MBMS M2AP ID

The eNB MBMS M2AP ID uniquely identifies the MBMS Service association over the M2 interface within the eNB.

IE/Group Name	Presence	Range	IE type and reference	Semantics description
eNB MBMS M2AP ID	M		INTEGER (0 .. 65535)	

9.2.3.3 TMGI

The TMGI uniquely identifies the MBMS Bearer Service.

IE/Group Name	Presence	Range	IE type and reference	Semantics description
TMGI				
>PLMN identity	M		9.2.3.7	
>Service ID	M		OCTET STRING (SIZE (3))	

9.2.3.4 MBMS Session Identity

The MBMS Session Identity identifies the session of an MBMS Bearer Service in E-UTRAN and is used by the UE to recognise repetitions of the session.

This IE is transparent to RAN.

IE/Group Name	Presence	Range	IE type and reference	Semantics description
MBMS Session Identity	M		OCTET STRING (SIZE (1))	Coded same way as the MBMS Session Identity IE as defined in TS 29.061 [9].

9.2.3.5 Void

9.2.3.6 MBMS Service Area

The MBMS Service Area IE consists of a list of one or several MBMS Service Area Identities where each MBMS Service Area Identity is frequency agnostic and can be mapped onto one or more cells.

IE/Group Name	Presence	Range	IE type and reference	Semantics description
MBMS Service Area	M		OCTET STRING	Value part coded per MBMS Service Area AVP as defined in TS 29.061 [9].

9.2.3.7 PLMN Identity

This information element indicates the PLMN Identity.

IE/Group Name	Presence	Range	IE type and reference	Semantics description
PLMN identity	M		OCTET STRING (SIZE (3))	<ul style="list-style-type: none"> - digits 0 to 9, encoded 0000 to 1001, - 1111 used as filler digit, two digits per octet, - bits 4 to 1 of octet n encoding digit 2n-1 - bits 8 to 5 of octet n encoding digit 2n <p>-The Selected PLMN identity consists of 3 digits from MCC followed by either</p> <ul style="list-style-type: none"> -a filler digit plus 2 digits from MNC (in case of 2 digit MNC) or -3 digits from MNC (in case of a 3 digit MNC).

9.3 Message and Information Element Abstract Syntax (with ASN.1)

9.3.1 General

M2AP ASN.1 definition conforms with ITU-T Rec. X.691 [5] and ITU-T Rec. X.680 [6].

Sub clause 9.3 presents the Abstract Syntax of the M2AP protocol with ASN.1. In case there is contradiction between the ASN.1 definition in this sub clause and the tabular format in sub clause 9.1 and 9.2, the ASN.1 shall take precedence, except for the definition of conditions for the presence of conditional elements, in which the tabular format shall take precedence.

The ASN.1 definition specifies the structure and content of M2AP messages. M2AP messages can contain any IEs specified in the object set definitions for that message without the order or number of occurrence being restricted by ASN.1. However, for this version of the standard, a sending entity shall construct an M2AP message according to the PDU definitions module and with the following additional rules (Note that in the following IE means an IE in the object set with an explicit id. If one IE needed to appear more than once in one object set, then the different occurrences have different IE ids):

- IEs shall be ordered (in an IE container) in the order they appear in object set definitions.
- Object set definitions specify how many times IEs may appear. An IE shall appear exactly once if the presence field in an object has value "mandatory". An IE may appear at most once if the presence field in an object has value "optional" or "conditional". If in a tabular format there is multiplicity specified for an IE (i.e. an IE list) then in the corresponding ASN.1 definition the list definition is separated into two parts. The first part defines an IE container list in which the list elements reside. The second part defines list elements. The IE container list appears as an IE of its own. For this version of the standard an IE container list may contain only one kind of list elements.

If an M2AP message that is not constructed as defined above is received, this shall be considered as Abstract Syntax Error, and the message shall be handled as defined for Abstract Syntax Error in clause 10.

9.3.2 Usage of Private Message Mechanism for Non-standard Use

The private message mechanism for non-standard use may be used:

- for special operator (and/or vendor) specific features considered not to be part of the basic functionality, i.e. the functionality required for a complete and high-quality specification in order to guarantee multivendor inter-operability.
- by vendors for research purposes, e.g. to implement and evaluate new algorithms/features before such features are proposed for standardisation.

The private message mechanism shall not be used for basic functionality. Such functionality shall be standardised.

9.3.3 Elementary Procedure Definitions

```
-- *****  
--  
-- Elementary Procedure definitions  
--  
-- *****
```



```
M2AP-PDU-Descriptions {  
itu-t (0) identified-organization (4) etsi (0) mobileDomain (0)  
eps-Access (21) modules (3) m2ap (4) version1 (1) m2ap-PDU-Descriptions (0) }
```

```
DEFINITIONS AUTOMATIC TAGS ::=
```

```
BEGIN
```

```
-- *****  
--  
-- IE parameter types from other modules.  
--  
-- *****
```

```
IMPORTS
```

```
    Criticality,  
    ProcedureCode
```

```
FROM M2AP-CommonDataTypes
```

```
    SessionStartRequest,  
    SessionStartResponse,  
    SessionStartFailure,  
    SessionStopRequest,  
    SessionStopResponse,  
    SessionUpdateRequest,  
    SessionUpdateResponse,  
    SessionUpdateFailure,  
    MbmsSchedulingInformation,  
    MbmsSchedulingInformationResponse,  
    ErrorIndication,  
    Reset,  
    ResetAcknowledge,  
    M2SetupRequest,  
    M2SetupResponse,  
    M2SetupFailure,  
    ENBConfigurationUpdate,  
    ENBConfigurationUpdateAcknowledge,  
    ENBConfigurationUpdateFailure,  
    MCEConfigurationUpdate,  
    MCEConfigurationUpdateAcknowledge,  
    MCEConfigurationUpdateFailure,  
    MbmsServiceCountingRequest,  
    MbmsServiceCountingResponse,  
    MbmsServiceCountingFailure,  
    MbmsServiceCountingResultsReport,  
    PrivateMessage
```

```
FROM M2AP-PDU-Contents
```

```
    id-sessionStart,  
    id-sessionStop,  
    id-sessionUpdate,  
    id-mbmsServiceCounting,
```



```

    id-mbmsServiceCountingResultsReport,
    id-mbmsSchedulingInformation,
    id-errorIndication,
    id-reset,
    id-m2Setup,
    id-eNBConfigurationUpdate,
    id-mCEConfigurationUpdate,
    id-privateMessage
FROM M2AP-Constants;

-- *****
--
-- Interface Elementary Procedure Class
--
-- *****

M2AP-ELEMENTARY-PROCEDURE ::= CLASS {
    &InitiatingMessage
    &SuccessfulOutcome          OPTIONAL,
    &UnsuccessfulOutcome        OPTIONAL,
    &procedureCode              ProcedureCode    UNIQUE,
    &criticality                 Criticality      DEFAULT ignore
}
WITH SYNTAX {
    INITIATING MESSAGE      &InitiatingMessage
    [SUCCESSFUL OUTCOME     &SuccessfulOutcome]
    [UNSUCCESSFUL OUTCOME   &UnsuccessfulOutcome]
    PROCEDURE CODE          &procedureCode
    [CRITICALITY            &criticality]
}

-- *****
--
-- Interface PDU Definition
--
-- *****

M2AP-PDU ::= CHOICE {
    initiatingMessage      InitiatingMessage,
    successfulOutcome       SuccessfulOutcome,
    unsuccessfulOutcome     UnsuccessfulOutcome,
    ...
}

InitiatingMessage ::= SEQUENCE {
    procedureCode      M2AP-ELEMENTARY-PROCEDURE.&procedureCode      ({M2AP-ELEMENTARY-PROCEDURES}),
    criticality        M2AP-ELEMENTARY-PROCEDURE.&criticality          ({M2AP-ELEMENTARY-PROCEDURES}{@procedureCode}),
    value              M2AP-ELEMENTARY-PROCEDURE.&InitiatingMessage    ({M2AP-ELEMENTARY-PROCEDURES}{@procedureCode})
}

SuccessfulOutcome ::= SEQUENCE {
    procedureCode      M2AP-ELEMENTARY-PROCEDURE.&procedureCode      ({M2AP-ELEMENTARY-PROCEDURES}),
    criticality        M2AP-ELEMENTARY-PROCEDURE.&criticality          ({M2AP-ELEMENTARY-PROCEDURES}{@procedureCode}),

```



```

    value          M2AP-ELEMENTARY-PROCEDURE.&SuccessfulOutcome  ({M2AP-ELEMENTARY-PROCEDURES}{@procedureCode})
  }

UnsuccessfulOutcome ::= SEQUENCE {
    procedureCode  M2AP-ELEMENTARY-PROCEDURE.&procedureCode      ({M2AP-ELEMENTARY-PROCEDURES}),
    criticality    M2AP-ELEMENTARY-PROCEDURE.&criticality         ({M2AP-ELEMENTARY-PROCEDURES}{@procedureCode}),
    value          M2AP-ELEMENTARY-PROCEDURE.&UnsuccessfulOutcome ({M2AP-ELEMENTARY-PROCEDURES}{@procedureCode})
}

-- *****
--
-- Interface Elementary Procedure List
--
-- *****

M2AP-ELEMENTARY-PROCEDURES M2AP-ELEMENTARY-PROCEDURE ::= {
    M2AP-ELEMENTARY-PROCEDURES-CLASS-1      |
    M2AP-ELEMENTARY-PROCEDURES-CLASS-2      ,
    ...
}

M2AP-ELEMENTARY-PROCEDURES-CLASS-1 M2AP-ELEMENTARY-PROCEDURE ::= {
    sessionStart
    sessionStop
    sessionUpdate
    mbmsSchedulingInformation
    reset
    m2Setup
    eNBConfigurationUpdate
    mCEConfigurationUpdate
    mbmsServiceCounting
    mbmsServiceCountingResultsReport
    ...
}

M2AP-ELEMENTARY-PROCEDURES-CLASS-2 M2AP-ELEMENTARY-PROCEDURE ::= {
    errorIndication
    privateMessage
    ...
}

-- *****
--
-- Interface Elementary Procedures
--
-- *****

sessionStart M2AP-ELEMENTARY-PROCEDURE ::= {
    INITIATING MESSAGE      SessionStartRequest
    SUCCESSFUL OUTCOME      SessionStartResponse
    UNSUCCESSFUL OUTCOME    SessionStartFailure
}

```



```

        PROCEDURE CODE      id-sessionStart
        CRITICALITY         reject
    }

    sessionStop M2AP-ELEMENTARY-PROCEDURE ::= {
        INITIATING MESSAGE    SessionStopRequest
        SUCCESSFUL OUTCOME    SessionStopResponse
        PROCEDURE CODE        id-sessionStop
        CRITICALITY           reject
    }

    sessionUpdate M2AP-ELEMENTARY-PROCEDURE ::= {
        INITIATING MESSAGE    SessionUpdateRequest
        SUCCESSFUL OUTCOME    SessionUpdateResponse
        UNSUCCESSFUL OUTCOME SessionUpdateFailure
        PROCEDURE CODE        id-sessionUpdate
        CRITICALITY           reject
    }

    mbmsSchedulingInformation M2AP-ELEMENTARY-PROCEDURE ::= {
        INITIATING MESSAGE    MbmsSchedulingInformation
        SUCCESSFUL OUTCOME    MbmsSchedulingInformationResponse
        PROCEDURE CODE        id-mbmsSchedulingInformation
        CRITICALITY           reject
    }

    errorIndication M2AP-ELEMENTARY-PROCEDURE ::= {
        INITIATING MESSAGE    ErrorIndication
        PROCEDURE CODE        id-errorIndication
        CRITICALITY           ignore
    }

    reset M2AP-ELEMENTARY-PROCEDURE ::= {
        INITIATING MESSAGE    Reset
        SUCCESSFUL OUTCOME    ResetAcknowledge
        PROCEDURE CODE        id-reset
        CRITICALITY           reject
    }

    m2Setup M2AP-ELEMENTARY-PROCEDURE ::= {
        INITIATING MESSAGE    M2SetupRequest
        SUCCESSFUL OUTCOME    M2SetupResponse
        UNSUCCESSFUL OUTCOME M2SetupFailure
        PROCEDURE CODE        id-m2Setup
        CRITICALITY           reject
    }

    eNBConfigurationUpdate M2AP-ELEMENTARY-PROCEDURE ::= {
        INITIATING MESSAGE    ENBConfigurationUpdate
        SUCCESSFUL OUTCOME    ENBConfigurationUpdateAcknowledge
        UNSUCCESSFUL OUTCOME ENBConfigurationUpdateFailure
        PROCEDURE CODE        id-eNBConfigurationUpdate
        CRITICALITY           reject
    }

```



```

mCEConfigurationUpdate      M2AP-ELEMENTARY-PROCEDURE ::= {
    INITIATING MESSAGE      MCEConfigurationUpdate
    SUCCESSFUL OUTCOME      MCEConfigurationUpdateAcknowledge
    UNSUCCESSFUL OUTCOME    MCEConfigurationUpdateFailure
    PROCEDURE CODE          id-mCEConfigurationUpdate
    CRITICALITY              reject
}

mbmsServiceCounting          M2AP-ELEMENTARY-PROCEDURE ::= {
    INITIATING MESSAGE      MbmsServiceCountingRequest
    SUCCESSFUL OUTCOME      MbmsServiceCountingResponse
    UNSUCCESSFUL OUTCOME    MbmsServiceCountingFailure
    PROCEDURE CODE          id-mbmsServiceCounting
    CRITICALITY              reject
}

mbmsServiceCountingResultsReport M2AP-ELEMENTARY-PROCEDURE ::= {
    INITIATING MESSAGE      MbmsServiceCountingResultsReport
    PROCEDURE CODE          id-mbmsServiceCountingResultsReport
    CRITICALITY              reject
}

privateMessage               M2AP-ELEMENTARY-PROCEDURE ::= {
    INITIATING MESSAGE      PrivateMessage
    PROCEDURE CODE          id-privateMessage
    CRITICALITY              ignore
}

END

```

9.3.4 PDU Definitions

```

-- *****
--
-- PDU definitions for M2AP.
--
-- *****

M2AP-PDU-Contents {
    itu-t (0) identified-organization (4) etsi (0) mobileDomain (0)
    eps-Access (21) modules (3) m2ap (4) version1 (1) m2ap-PDU-Contents (1) }

DEFINITIONS AUTOMATIC TAGS ::=

BEGIN

-- *****
--
-- IE parameter types from other modules.
--
-- *****

```

IMPORTS

Cause,
CriticalityDiagnostics,
ENB-MBMS-Configuration-data-Item,
ENB-MBMS-Configuration-data-ConfigUpdate-Item,
ENB-MBMS-M2AP-ID,
ENBname,
GlobalENB-ID,
GlobalMCE-ID,
MBSFN-Area-ID,
MBMS-Service-Area,
MBMS-Session-ID,
MBMSsessionListPerPMCH-Item,
MBMS-Service-associatedLogicalM2-ConnectionItem,
MBSFN-Subframe-Configuration,
MCCH-Update-Time,
MCCHrelatedBCCH-ConfigPerMBSFNArea-Item,
MCE-MBMS-M2AP-ID,
MCENAME,
PMCH-Configuration,
Common-Subframe-Allocation-Period,
TimeToWait,
TMGI,
TNL-Information

FROM M2AP-IES

PrivateIE-Container{},
ProtocolExtensionContainer{},
ProtocolIE-Container{},
ProtocolIE-ContainerList{},
ProtocolIE-ContainerPair{},
ProtocolIE-ContainerPairList{},
ProtocolIE-Single-Container{},
M2AP-PRIVATE-IES,
M2AP-PROTOCOL-EXTENSION,
M2AP-PROTOCOL-IES,
M2AP-PROTOCOL-IES-PAIR

FROM M2AP-Containers

id-MCE-MBMS-M2AP-ID,
id-ENB-MBMS-M2AP-ID,
id-TMGI,
id-MBMS-Session-ID,
id-MBMS-Service-Area,
id-TNL-Information,
id-CriticalityDiagnostics,
id-Cause,
id-MBSFN-Area-Configuration-List,
id-MBSFN-Subframe-Configuration-Item,
id-MBSFN-Subframe-Configuration-List,
id-MCCH-Update-Time,
id-PMCH-Configuration-List,

```

id-PMCH-Configuration-Item,
id-Common-Subframe-Allocation-Period,
id-GlobalENB-ID,
id-ENBname,
id-ENB-MBMS-Configuration-data-List,
id-ENB-MBMS-Configuration-data-Item,
id-GlobalMCE-ID,
id-MCENAME,
id-MCCHrelatedBCCH-ConfigPerMBSFNArea,
id-MCCHrelatedBCCH-ConfigPerMBSFNArea-Item,
id-TimeToWait,
id-ENB-MBMS-Configuration-data-List-ConfigUpdate,
id-ENB-MBMS-Configuration-data-ConfigUpdate-Item,
id-MBSFN-Area-ID,
id-ResetType,
id-MBMS-Service-associatedLogicalM2-ConnectionItem,
id-MBMS-Service-associatedLogicalM2-ConnectionListResAck,
id-MBMS-Counting-Request-Session,
id-MBMS-Counting-Request-Session-Item,
id-MBMS-Counting-Result-List,
id-MBMS-Counting-Result-Item,
maxnoofMBSFN-Allocations,
maxnoofMBSFNAreas,
maxnoofPMCHsperMBSFNArea,
maxnoofCells,
maxnoofMBMSServiceAreasPerCell,
maxnoofSessionsPerPMCH,
maxnooferrors,
maxNrOfIndividualM2ConnectionsToReset,
maxnoofCountingService

FROM M2AP-Constants;

-- *****
--
-- SESSION START REQUEST
--
-- *****

SessionStartRequest ::= SEQUENCE {
    protocolIEs          ProtocolIE-Container    {{SessionStartRequest-IEs}},
    ...
}

SessionStartRequest-IEs M2AP-PROTOCOL-IES ::= {
    { ID id-MCE-MBMS-M2AP-ID          CRITICALITY reject TYPE MCE-MBMS-M2AP-ID PRESENCE mandatory } |
    { ID id-TMGI                      CRITICALITY reject TYPE TMGI PRESENCE mandatory } |
    { ID id-MBMS-Session-ID           CRITICALITY ignore TYPE MBMS-Session-ID PRESENCE optional } |
    { ID id-MBMS-Service-Area          CRITICALITY reject TYPE MBMS-Service-Area PRESENCE mandatory } |
    { ID id-TNL-Information            CRITICALITY reject TYPE TNL-Information PRESENCE mandatory } ,
    ...
}

-- *****

```



```

--
-- SESSION START RESPONSE
--
-- *****

SessionStartResponse ::= SEQUENCE {
    protocolIEs          ProtocolIE-Container    {{ SessionStartResponse-IEs}},
    ...
}

SessionStartResponse-IEs M2AP-PROTOCOL-IES ::= {
    { ID id-MCE-MBMS-M2AP-ID          CRITICALITY ignore TYPE MCE-MBMS-M2AP-ID          PRESENCE mandatory } |
    { ID id-ENB-MBMS-M2AP-ID          CRITICALITY ignore TYPE ENB-MBMS-M2AP-ID          PRESENCE mandatory } |
    { ID id-CriticalityDiagnostics     CRITICALITY ignore TYPE CriticalityDiagnostics    PRESENCE optional  },
    ...
}

-- *****
--
-- SESSION START FAILURE
--
-- *****

SessionStartFailure ::= SEQUENCE {
    protocolIEs          ProtocolIE-Container    {{ SessionStartFailure-IEs}},
    ...
}

SessionStartFailure-IEs M2AP-PROTOCOL-IES ::= {
    { ID id-MCE-MBMS-M2AP-ID          CRITICALITY ignore TYPE MCE-MBMS-M2AP-ID          PRESENCE mandatory } |
    { ID id-Cause                     CRITICALITY ignore TYPE Cause                     PRESENCE mandatory } |
    { ID id-CriticalityDiagnostics     CRITICALITY ignore TYPE CriticalityDiagnostics    PRESENCE optional  },
    ...
}

-- *****
--
-- SESSION STOP REQUEST
--
-- *****

SessionStopRequest ::= SEQUENCE {
    protocolIEs          ProtocolIE-Container    {{SessionStopRequest-IEs}},
    ...
}

SessionStopRequest-IEs M2AP-PROTOCOL-IES ::= {
    { ID id-MCE-MBMS-M2AP-ID          CRITICALITY reject TYPE MCE-MBMS-M2AP-ID          PRESENCE mandatory } |
    { ID id-ENB-MBMS-M2AP-ID          CRITICALITY reject TYPE ENB-MBMS-M2AP-ID          PRESENCE mandatory } ,
    ...
}

```



```

-- *****
--
-- SESSION STOP RESPONSE
--
-- *****

SessionStopResponse ::= SEQUENCE {
    protocolIEs          ProtocolIE-Container    {{ SessionStopResponse-IEs}},
    ...
}

SessionStopResponse-IEs M2AP-PROTOCOL-IES ::= {
    { ID id-MCE-MBMS-M2AP-ID          CRITICALITY ignore TYPE MCE-MBMS-M2AP-ID          PRESENCE mandatory } |
    { ID id-ENB-MBMS-M2AP-ID          CRITICALITY ignore TYPE ENB-MBMS-M2AP-ID          PRESENCE mandatory } |
    { ID id-CriticalityDiagnostics     CRITICALITY ignore TYPE CriticalityDiagnostics     PRESENCE optional  } ,
    ...
}

-- *****
--
-- SESSION UPDATE REQUEST
--
-- *****

SessionUpdateRequest ::= SEQUENCE {
    protocolIEs          ProtocolIE-Container    {{SessionUpdateRequest-IEs}},
    ...
}

SessionUpdateRequest-IEs M2AP-PROTOCOL-IES ::= {
    { ID id-MCE-MBMS-M2AP-ID          CRITICALITY reject TYPE MCE-MBMS-M2AP-ID          PRESENCE mandatory } |
    { ID id-ENB-MBMS-M2AP-ID          CRITICALITY reject TYPE ENB-MBMS-M2AP-ID          PRESENCE mandatory } |
    { ID id-TMGI                      CRITICALITY reject TYPE TMGI                      PRESENCE mandatory } |
    { ID id-MBMS-Session-ID           CRITICALITY ignore TYPE MBMS-Session-ID           PRESENCE optional  } |
    { ID id-MBMS-Service-Area          CRITICALITY ignore TYPE MBMS-Service-Area          PRESENCE optional  } |
    { ID id-TNL-Information            CRITICALITY reject TYPE TNL-Information            PRESENCE optional  } ,
    ...
}

-- *****
--
-- SESSION UPDATE RESPONSE
--
-- *****

SessionUpdateResponse ::= SEQUENCE {
    protocolIEs          ProtocolIE-Container    {{ SessionUpdateResponse-IEs}},
    ...
}

SessionUpdateResponse-IEs M2AP-PROTOCOL-IES ::= {
    { ID id-MCE-MBMS-M2AP-ID          CRITICALITY ignore TYPE MCE-MBMS-M2AP-ID          PRESENCE mandatory } |
    { ID id-ENB-MBMS-M2AP-ID          CRITICALITY ignore TYPE ENB-MBMS-M2AP-ID          PRESENCE mandatory } |
    { ID id-CriticalityDiagnostics     CRITICALITY ignore TYPE CriticalityDiagnostics     PRESENCE optional  } ,

```



```

    ...
}
-- *****
--
-- SESSION UPDATE FAILURE
--
-- *****

SessionUpdateFailure ::= SEQUENCE {
    protocolIEs          ProtocolIE-Container    {{ SessionUpdateFailure-IEs}},
    ...
}

SessionUpdateFailure-IEs M2AP-PROTOCOL-IES ::= {
    { ID id-MCE-MBMS-M2AP-ID          CRITICALITY ignore TYPE MCE-MBMS-M2AP-ID          PRESENCE mandatory } |
    { ID id-ENB-MBMS-M2AP-ID          CRITICALITY ignore TYPE ENB-MBMS-M2AP-ID          PRESENCE mandatory } |
    { ID id-Cause                      CRITICALITY ignore TYPE Cause                    PRESENCE mandatory } |
    { ID id-CriticalityDiagnostics      CRITICALITY ignore TYPE CriticalityDiagnostics    PRESENCE optional   },
    ...
}

-- *****
--
-- MBMS SCHEDULING INFORMATION
--
-- *****

MbmsSchedulingInformation ::= SEQUENCE {
    protocolIEs          ProtocolIE-Container    {{ MbmsSchedulingInformation-IEs}},
    ...
}

MbmsSchedulingInformation-IEs M2AP-PROTOCOL-IES ::= {
    { ID id-MCCH-Update-Time          CRITICALITY reject TYPE MCCH-Update-Time          PRESENCE mandatory } |
    { ID id-MBSFN-Area-Configuration-List CRITICALITY reject TYPE MBSFN-Area-Configuration-List PRESENCE mandatory } ,
    ...
}

MBSFN-Area-Configuration-List ::= SEQUENCE (SIZE(1.. maxnoofMBSFNareas)) OF ProtocolIE-Container { { MBSFN-Area-Configuration-Item } }

MBSFN-Area-Configuration-Item M2AP-PROTOCOL-IES ::= {
    { ID id-PMCH-Configuration-List    CRITICALITY reject TYPE PMCH-Configuration-List    PRESENCE mandatory } |
    { ID id-MBSFN-Subframe-Configuration-List CRITICALITY reject TYPE MBSFN-Subframe-ConfigurationList PRESENCE mandatory } |
    { ID id-Common-Subframe-Allocation-Period CRITICALITY reject TYPE Common-Subframe-Allocation-Period PRESENCE mandatory } |
    { ID id-MBSFN-Area-ID              CRITICALITY reject TYPE MBSFN-Area-ID              PRESENCE mandatory },
    ...
}

PMCH-Configuration-List ::= SEQUENCE (SIZE(0.. maxnoofPMCHsperMBSFNarea)) OF ProtocolIE-Single-Container { { PMCH-Configuration-ItemIEs } }

PMCH-Configuration-ItemIEs M2AP-PROTOCOL-IES ::= {
    { ID id-PMCH-Configuration-Item    CRITICALITY reject TYPE PMCH-Configuration-Item    PRESENCE mandatory },
    ...
}

```



```

PMCH-Configuration-Item ::= SEQUENCE {
    pmch-Configuration          PMCH-Configuration,
    mbms-Session-List          MBMSsessionListPerPMCH-Item,
    iE-Extensions              ProtocolExtensionContainer { { PMCH-Configuration-ItemExtIEs } } OPTIONAL,
    ...
}

PMCH-Configuration-ItemExtIEs M2AP-PROTOCOL-EXTENSION ::= {
    ...
}

MBSFN-Subframe-ConfigurationList ::= SEQUENCE (SIZE(1.. maxnoofMBSFN-Allocations)) OF ProtocolIE-Single-Container { { MBSFN-Subframe-
ConfigurationItem } }

MBSFN-Subframe-ConfigurationItem M2AP-PROTOCOL-IES ::= {
    { ID id-MBSFN-Subframe-Configuration-Item          CRITICALITY reject          TYPE MBSFN-Subframe-Configuration          PRESENCE mandatory },
    ...
}

-- *****
--
-- MBMS SCHEDULING INFORMATION RESPONSE
--
-- *****

MbmsSchedulingInformationResponse ::= SEQUENCE {
    protocolIEs          ProtocolIE-Container          {{ MbmsSchedulingInformationResponse-IEs}},
    ...
}

MbmsSchedulingInformationResponse-IEs M2AP-PROTOCOL-IES ::= {
    { ID id-CriticalityDiagnostics          CRITICALITY ignore          TYPE CriticalityDiagnostics PRESENCE optional },
    ...
}

-- *****
--
-- M2 SETUP REQUEST
--
-- *****

M2SetupRequest ::= SEQUENCE {
    protocolIEs          ProtocolIE-Container          {{M2SetupRequest-IEs}},
    ...
}

M2SetupRequest-IEs M2AP-PROTOCOL-IES ::= {
    { ID id-GlobalENB-ID          CRITICALITY reject          TYPE GlobalENB-ID          PRESENCE mandatory } |
    { ID id-ENBname          CRITICALITY ignore          TYPE ENBname          PRESENCE optional } |
    { ID id-ENB-MBMS-Configuration-data-List          CRITICALITY reject          TYPE ENB-MBMS-Configuration-data-List          PRESENCE mandatory } ,
    ...
}

```



```

}

ENB-MBMS-Configuration-data-List ::= SEQUENCE (SIZE(1.. maxnoofCells)) OF ProtocolIE-Single-Container { { ENB-MBMS-Configuration-data-ItemIEs } }

ENB-MBMS-Configuration-data-ItemIEs M2AP-PROTOCOL-IES ::= {
  { ID id-ENB-MBMS-Configuration-data-Item CRITICALITY reject TYPE ENB-MBMS-Configuration-data-Item PRESENCE mandatory },
  ...
}

-- *****
--
-- M2 SETUP RESPONSE
--
-- *****

M2SetupResponse ::= SEQUENCE {
  protocolIEs ProtocolIE-Container {{ M2SetupResponse-IEs}},
  ...
}

M2SetupResponse-IEs M2AP-PROTOCOL-IES ::= {
  { ID id-GlobalMCE-ID CRITICALITY reject TYPE GlobalMCE-ID PRESENCE mandatory } |
  { ID id-MCName CRITICALITY ignore TYPE MCName PRESENCE optional } |
  { ID id-MCCHrelatedBCCH-ConfigPerMBSFNArea CRITICALITY reject TYPE MCCHrelatedBCCH-ConfigPerMBSFNArea PRESENCE mandatory } |
  { ID id-CriticalityDiagnostics CRITICALITY ignore TYPE CriticalityDiagnostics PRESENCE optional } ,
  ...
}

MCCHrelatedBCCH-ConfigPerMBSFNArea ::= SEQUENCE (SIZE(1.. maxnoofMBSFNAreas)) OF ProtocolIE-Single-Container { { MCCHrelatedBCCH-
ConfigPerMBSFNArea-ItemIEs } }

MCCHrelatedBCCH-ConfigPerMBSFNArea-ItemIEs M2AP-PROTOCOL-IES ::= {
  { ID id-MCCHrelatedBCCH-ConfigPerMBSFNArea-Item CRITICALITY reject TYPE MCCHrelatedBCCH-ConfigPerMBSFNArea-Item PRESENCE mandatory },
  ...
}

-- *****
--
-- M2 SETUP FAILURE
--
-- *****

M2SetupFailure ::= SEQUENCE {
  protocolIEs ProtocolIE-Container {{ M2SetupFailure-IEs}},
  ...
}

M2SetupFailure-IEs M2AP-PROTOCOL-IES ::= {
  { ID id-Cause CRITICALITY ignore TYPE Cause PRESENCE mandatory } |
  { ID id-TimeToWait CRITICALITY ignore TYPE TimeToWait PRESENCE optional } |
  { ID id-CriticalityDiagnostics CRITICALITY ignore TYPE CriticalityDiagnostics PRESENCE optional } ,
  ...
}

```



```

}

-- *****
--
-- ENB CONFIGURATION UPDATE
--
-- *****

ENBConfigurationUpdate ::= SEQUENCE {
    protocolIEs          ProtocolIE-Container    {{ENBConfigurationUpdate-IEs}},
    ...
}

ENBConfigurationUpdate-IEs M2AP-PROTOCOL-IES ::= {
    { ID id-GlobalENB-ID          CRITICALITY reject TYPE GlobalENB-ID          PRESENCE optional } |
    { ID id-ENBname               CRITICALITY ignore TYPE ENBname               PRESENCE optional } |
    { ID id-ENB-MBMS-Configuration-data-List-ConfigUpdate CRITICALITY reject TYPE ENB-MBMS-Configuration-data-List-ConfigUpdate PRESENCE optional } ,
    ...
}

ENB-MBMS-Configuration-data-List-ConfigUpdate ::= SEQUENCE (SIZE(1.. maxnoofCells)) OF ProtocolIE-Single-Container { { ENB-MBMS-Configuration-data-ConfigUpdate-ItemIEs } }

ENB-MBMS-Configuration-data-ConfigUpdate-ItemIEs M2AP-PROTOCOL-IES ::= {
    { ID id-ENB-MBMS-Configuration-data-ConfigUpdate-Item CRITICALITY reject TYPE ENB-MBMS-Configuration-data-ConfigUpdate-Item PRESENCE mandatory } ,
    ...
}

-- *****
--
-- ENB CONFIGURATION UPDATE ACKNOWLEDGE
--
-- *****

ENBConfigurationUpdateAcknowledge ::= SEQUENCE {
    protocolIEs          ProtocolIE-Container    {{ ENBConfigurationUpdateAcknowledge-IEs}},
    ...
}

ENBConfigurationUpdateAcknowledge-IEs M2AP-PROTOCOL-IES ::= {
    { ID id-MCCHrelatedBCCH-ConfigPerMBSFNArea          CRITICALITY reject TYPE MCCHrelatedBCCH-ConfigPerMBSFNArea PRESENCE optional } |
    { ID id-CriticalityDiagnostics                      CRITICALITY ignore TYPE CriticalityDiagnostics PRESENCE optional } ,
    ...
}

-- *****
--
-- ENB CONFIGURATION UPDATE FAILURE
--
-- *****

ENBConfigurationUpdateFailure ::= SEQUENCE {

```



```

    protocolIEs                ProtocolIE-Container    {{ ENBConfigurationUpdateFailure-IEs}},
  }

ENBConfigurationUpdateFailure-IEs M2AP-PROTOCOL-IES ::= {
  { ID id-Cause                CRITICALITY ignore    TYPE Cause                PRESENCE mandatory } |
  { ID id-TimeToWait           CRITICALITY ignore    TYPE TimeToWait          PRESENCE optional } |
  { ID id-CriticalityDiagnostics CRITICALITY ignore    TYPE CriticalityDiagnostics PRESENCE optional },
  ...
}

-- *****
--
-- MCE CONFIGURATION UPDATE
--
-- *****

MCEConfigurationUpdate ::= SEQUENCE {
  protocolIEs                ProtocolIE-Container    {{MCEConfigurationUpdate-IEs}},
  ...
}

MCEConfigurationUpdate-IEs M2AP-PROTOCOL-IES ::= {
  { ID id-GlobalMCE-ID         CRITICALITY reject    TYPE GlobalMCE-ID        PRESENCE optional } |
  { ID id-MCENAME              CRITICALITY ignore    TYPE MCENAME             PRESENCE optional } |
  { ID id-MCCHrelatedBCCH-ConfigPerMBSFNArea CRITICALITY reject    TYPE MCCHrelatedBCCH-ConfigPerMBSFNArea PRESENCE optional },
  ...
}

-- *****
--
-- MCE CONFIGURATION UPDATE ACKNOWLEDGE
--
-- *****

MCEConfigurationUpdateAcknowledge ::= SEQUENCE {
  protocolIEs                ProtocolIE-Container    {{ MCEConfigurationUpdateAcknowledge-IEs}},
  ...
}

MCEConfigurationUpdateAcknowledge-IEs M2AP-PROTOCOL-IES ::= {
  { ID id-CriticalityDiagnostics CRITICALITY ignore    TYPE CriticalityDiagnostics PRESENCE optional },
  ...
}

-- *****
--
-- MCE CONFIGURATION UPDATE FAILURE
--
-- *****

```



```

MCEConfigurationUpdateFailure ::= SEQUENCE {
    protocolIEs          ProtocolIE-Container    {{ MCEConfigurationUpdateFailure-IEs}},
    ...
}

MCEConfigurationUpdateFailure-IEs M2AP-PROTOCOL-IES ::= {
    { ID id-Cause          CRITICALITY ignore  TYPE Cause          PRESENCE mandatory } |
    { ID id-TimeToWait     CRITICALITY ignore  TYPE TimeToWait      PRESENCE optional  } |
    { ID id-CriticalityDiagnostics CRITICALITY ignore  TYPE CriticalityDiagnostics PRESENCE optional },
    ...
}

-- *****
--
-- ERROR INDICATION
--
-- *****

ErrorIndication ::= SEQUENCE {
    protocolIEs          ProtocolIE-Container    {{ErrorIndication-IEs}},
    ...
}

ErrorIndication-IEs M2AP-PROTOCOL-IES ::= {
    { ID id-MCE-MBMS-M2AP-ID          CRITICALITY ignore  TYPE MCE-MBMS-M2AP-ID          PRESENCE optional } |
    { ID id-ENB-MBMS-M2AP-ID          CRITICALITY ignore  TYPE ENB-MBMS-M2AP-ID          PRESENCE optional } |
    { ID id-Cause                      CRITICALITY ignore  TYPE Cause                      PRESENCE optional } |
    { ID id-CriticalityDiagnostics      CRITICALITY ignore  TYPE CriticalityDiagnostics    PRESENCE optional },
    ...
}

-- *****
--
-- RESET
--
-- *****

Reset ::= SEQUENCE {
    protocolIEs          ProtocolIE-Container    {{Reset-IEs}},
    ...
}

Reset-IEs M2AP-PROTOCOL-IES ::= {
    { ID id-Cause          CRITICALITY ignore  TYPE Cause          PRESENCE mandatory } |
    { ID id-ResetType      CRITICALITY reject  TYPE ResetType      PRESENCE mandatory },
    ...
}

ResetType ::= CHOICE {
    m2-Interface          ResetAll,
    partOfM2-Interface    MBMS-Service-associatedLogicalM2-ConnectionListRes,
    ...
}

```



```

}

ResetAll ::= ENUMERATED {
    reset-all,
    ...
}

MBMS-Service-associatedLogicalM2-ConnectionListRes ::= SEQUENCE (SIZE(1.. maxNrOfIndividualM2ConnectionsToReset)) OF ProtocolIE-Single-Container {
    { MBMS-Service-associatedLogicalM2-ConnectionItemRes } }

MBMS-Service-associatedLogicalM2-ConnectionItemRes M2AP-PROTOCOL-IES ::= {
    { ID id-MBMS-Service-associatedLogicalM2-ConnectionItem CRITICALITY reject TYPE MBMS-Service-associatedLogicalM2-ConnectionItem PRESENCE
mandatory },
    ...
}

-- *****
--
-- RESET ACKNOWLEDGE
--
-- *****

ResetAcknowledge ::= SEQUENCE {
    protocolIEs ProtocolIE-Container {{ResetAcknowledge-IEs}},
    ...
}

ResetAcknowledge-IEs M2AP-PROTOCOL-IES ::= {
    { ID id-MBMS-Service-associatedLogicalM2-ConnectionListResAck CRITICALITY ignore TYPE MBMS-Service-associatedLogicalM2-
ConnectionListResAck PRESENCE optional }|
    { ID id-CriticalityDiagnostics CRITICALITY ignore TYPE CriticalityDiagnostics PRESENCE optional },
    ...
}

MBMS-Service-associatedLogicalM2-ConnectionListResAck ::= SEQUENCE (SIZE(1.. maxNrOfIndividualM2ConnectionsToReset)) OF ProtocolIE-Single-Container
{ { MBMS-Service-associatedLogicalM2-ConnectionItemResAck } }

MBMS-Service-associatedLogicalM2-ConnectionItemResAck M2AP-PROTOCOL-IES ::= {
    { ID id-MBMS-Service-associatedLogicalM2-ConnectionItem CRITICALITY ignore TYPE MBMS-Service-associatedLogicalM2-ConnectionItem PRESENCE
mandatory },
    ...
}

-- *****
--
-- PRIVATE MESSAGE
--
-- *****

PrivateMessage ::= SEQUENCE {
    privateIEs PrivateIE-Container {{PrivateMessage-IEs}},
    ...
}

```



```

PrivateMessage-IEs M2AP-PRIVATE-IES ::= {
    ...
}

-- *****
--
-- MBMS SERVICE COUNTING REQUEST
--
-- *****

MbmsServiceCountingRequest ::= SEQUENCE {
    protocolIEs          ProtocolIE-Container    {{MbmsServiceCountingRequest-IEs}},
    ...
}

MbmsServiceCountingRequest-IEs M2AP-PROTOCOL-IES ::= {
    { ID id-MCCH-Update-Time          CRITICALITY reject  TYPE MCCH-Update-Time          PRESENCE mandatory } |
    { ID id-MBSFN-Area-ID              CRITICALITY reject  TYPE MBSFN-Area-ID              PRESENCE mandatory } |
    { ID id-MBMS-Counting-Request-Session CRITICALITY reject  TYPE MBMS-Counting-Request-Session PRESENCE mandatory } ,
    ...
}

MBMS-Counting-Request-Session ::= SEQUENCE (SIZE(1.. maxnoofCountingService)) OF ProtocolIE-Container { { MBMS-Counting-Request-Session-Item } }

MBMS-Counting-Request-Session-Item M2AP-PROTOCOL-IES ::= {
    { ID id-MBMS-Counting-Request-Session-Item CRITICALITY reject  TYPE MBMS-Counting-Request-SessionIE PRESENCE mandatory } ,
    ...
}

MBMS-Counting-Request-SessionIE ::= SEQUENCE{
    tmgi          TMGI,
    iE-Extensions ProtocolExtensionContainer { { MBMS-Counting-Request-SessionIE-ExtIEs } } OPTIONAL,
    ...
}

MBMS-Counting-Request-SessionIE-ExtIEs M2AP-PROTOCOL-EXTENSION ::= {
    ...
}

-- *****
--
-- MBMS SERVICE COUNTING RESPONSE
--
-- *****

MbmsServiceCountingResponse ::= SEQUENCE {
    protocolIEs          ProtocolIE-Container    {{MbmsServiceCountingResponse-IEs}},
    ...
}

MbmsServiceCountingResponse-IEs M2AP-PROTOCOL-IES ::= {

```



```

    { ID id-CriticalityDiagnostics      CRITICALITY ignore  TYPE CriticalityDiagnostics      PRESENCE optional },
    ...
}

-- *****
--
-- MBMS SERVICE COUNTING FAILURE
--
-- *****

MbmsServiceCountingFailure ::= SEQUENCE {
    protocolIEs      ProtocolIE-Container      {{ MbmsServiceCountingFailure-IEs}},
    ...
}

MbmsServiceCountingFailure-IEs M2AP-PROTOCOL-IES ::= {
    { ID id-Cause                        CRITICALITY ignore  TYPE Cause                        PRESENCE mandatory} |
    { ID id-CriticalityDiagnostics      CRITICALITY ignore  TYPE CriticalityDiagnostics      PRESENCE optional},
    ...
}

-- *****
--
-- MBMS SERVICE COUNTING RESULTS REPORT
--
-- *****

MbmsServiceCountingResultsReport ::= SEQUENCE {
    protocolIEs      ProtocolIE-Container      {{ MbmsServiceCountingResultsReport-IEs}},
    ...
}

MbmsServiceCountingResultsReport-IEs M2AP-PROTOCOL-IES ::= {
    { ID id-MBSFN-Area-ID                CRITICALITY reject  TYPE MBSFN-Area-ID                PRESENCE mandatory } |
    { ID id-MBMS-Counting-Result-List    CRITICALITY reject  TYPE MBMS-Counting-Result-List    PRESENCE mandatory } ,
    ...
}

MBMS-Counting-Result-List ::= SEQUENCE (SIZE(1.. maxnoofCountingService)) OF ProtocolIE-Container { { MBMS-Counting-Result-Item } }

MBMS-Counting-Result-Item M2AP-PROTOCOL-IES ::= {
    { ID id-MBMS-Counting-Result-Item    CRITICALITY reject  TYPE MBMS-Counting-Result        PRESENCE mandatory } ,
    ...
}

MBMS-Counting-Result ::= SEQUENCE{
    tmgi                TMGI,
    countingResult       CountingResult,
    iE-Extensions       ProtocolExtensionContainer { { MBMS-Counting-Result-ExtIEs} } OPTIONAL,
    ...
}

```



```
MBMS-Counting-Result-ExtIEs M2AP-PROTOCOL-EXTENSION ::= {
    ...
}
```

```
CountingResult ::= INTEGER (0..1023)
```

```
END
```

9.3.5 Information Element definitions

```
-- *****
--
-- Information Element Definitions
--
-- *****
```

```
M2AP-IEs {
    itu-t (0) identified-organization (4) etsi (0) mobileDomain (0)
    eps-Access (21) modules (3) m2ap (4) version1 (1) m2ap-IEs (2) }
```

```
DEFINITIONS AUTOMATIC TAGS ::=
```

```
BEGIN
```

```
IMPORTS
```

```
    maxnoofMBSFNareas,
    maxnoofPMCHsperMBSFNarea,
    maxnoofCells,
    maxnoofMBMSServiceAreasPerCell,
    maxnoofSessionsPerPMCH,
    maxnooferrors
```

```
FROM M2AP-Constants
```

```
    Criticality,
    ProcedureCode,
    ProtocolIE-ID,
    TriggeringMessage
```

```
FROM M2AP-CommonDataTypes
```

```
    ProtocolExtensionContainer{},
    ProtocolIE-Single-Container{},
    M2AP-PROTOCOL-EXTENSION,
    M2AP-PROTOCOL-IES
```

```
FROM M2AP-Containers;
```

```
-- A
```

```
AllocatedSubframesEnd ::= INTEGER (0..1535)
```



```
-- B

-- C

Cause ::= CHOICE {
    radioNetwork      CauseRadioNetwork,
    transport         CauseTransport,
    nAS               CauseNAS,
    protocol          CauseProtocol,
    misc              CauseMisc,
    ...
}

CauseMisc ::= ENUMERATED {
    control-processing-overload,
    hardware-failure,
    om-intervention,
    unspecified,
    ...
}

CauseNAS ::= ENUMERATED {
    unspecified,
    ...
}

CauseProtocol ::= ENUMERATED {
    transfer-syntax-error,
    abstract-syntax-error-reject,
    abstract-syntax-error-ignore-and-notify,
    message-not-compatible-with-receiver-state,
    semantic-error,
    abstract-syntax-error-falsely-constructed-message,
    unspecified,
    ...
}

CauseRadioNetwork ::= ENUMERATED {
    unknown-or-already-allocated-MCE-MBMS-M2AP-ID,
    unknown-or-already-allocated-eNB-MBMS-M2AP-ID,
    unknown-or-inconsistent-pair-of-MBMS-M2AP-IDs,
    radio-resources-not-available,
    interaction-with-other-procedure,
    unspecified,
    ...
}

CauseTransport ::= ENUMERATED {
    transport-resource-unavailable,
    unspecified,
    ...
}
```



```

Cell-Information      ::= SEQUENCE {
    eCGI                ECGI,
    cellReservationInfo  ENUMERATED {reservedCell, nonReservedCell, ...},
    iE-Extensions        ProtocolExtensionContainer { { Cell-Information-ExtIEs } } OPTIONAL,
    ...
}

Cell-Information-ExtIEs M2AP-PROTOCOL-EXTENSION ::= {
    ...
}

Cell-Information-List  ::= SEQUENCE (SIZE(1..maxnoofCells)) OF Cell-Information

CriticalityDiagnostics ::= SEQUENCE {
    procedureCode          ProcedureCode          OPTIONAL,
    triggeringMessage       TriggeringMessage       OPTIONAL,
    procedureCriticality    Criticality             OPTIONAL,
    iEsCriticalityDiagnostics CriticalityDiagnostics-IE-List OPTIONAL,
    iE-Extensions          ProtocolExtensionContainer { {CriticalityDiagnostics-ExtIEs} } OPTIONAL,
    ...
}

CriticalityDiagnostics-ExtIEs M2AP-PROTOCOL-EXTENSION ::= {
    ...
}

CriticalityDiagnostics-IE-List ::= SEQUENCE (SIZE (1..maxnooferrors)) OF
    SEQUENCE {
        iECriticality          Criticality,
        iE-ID                  ProtocolIE-ID,
        typeOfError            TypeOfError,
        iE-Extensions          ProtocolExtensionContainer { {CriticalityDiagnostics-IE-List-ExtIEs} } OPTIONAL,
        ...
    }

CriticalityDiagnostics-IE-List-ExtIEs M2AP-PROTOCOL-EXTENSION ::= {
    ...
}

-- D
-- E

ECGI ::= SEQUENCE {
    pLMN-Identity          PLMN-Identity,
    eUTRANcellIdentifier    EUTRANCellIdentifier,
    iE-Extensions          ProtocolExtensionContainer { {ECGI-ExtIEs} } OPTIONAL,
    ...
}

ECGI-ExtIEs M2AP-PROTOCOL-EXTENSION ::= {
    ...
}

```



```

}

ENB-ID ::= CHOICE {
    macro-eNB-ID    BIT STRING (SIZE (20)),
    ...
}

ENB-MBMS-Configuration-data-Item ::= SEQUENCE {
    eCGI
    mbsfnSynchronisationArea    MBSFN-SynchronisationArea-ID,
    mbmsServiceAreaList         MBMS-Service-Area-ID-List,
    iE-Extensions                ProtocolExtensionContainer { { ENB-MBMS-Configuration-data-Item-ExtIEs } } OPTIONAL,
    ...
}

ENB-MBMS-Configuration-data-Item-ExtIEs M2AP-PROTOCOL-EXTENSION ::= {
    ...
}

ENB-MBMS-Configuration-data-ConfigUpdate-Item ::= CHOICE {
    mBMSCfgData            ENB-MBMS-Configuration-data-Item,
    eCGI                    ECGI,
    ...
}

ENB-MBMS-M2AP-ID ::= INTEGER (0..65535)

ENBname ::= PrintableString (SIZE (1..150,...))

EUTRANCellIdentifier ::= BIT STRING (SIZE (28))

-- F
-- G

GlobalENB-ID ::= SEQUENCE {
    pLMN-Identity    PLMN-Identity,
    eNB-ID            ENB-ID,
    iE-Extensions     ProtocolExtensionContainer { {GlobalENB-ID-ExtIEs} } OPTIONAL,
    ...
}

GlobalENB-ID-ExtIEs M2AP-PROTOCOL-EXTENSION ::= {
    ...
}

GlobalMCE-ID ::= SEQUENCE {
    pLMN-Identity    PLMN-Identity,
    mCE-ID            MCE-ID,
    iE-Extensions     ProtocolExtensionContainer { {GlobalMCE-ID-ExtIEs} } OPTIONAL,
    ...
}

```



```

GlobalMCE-ID-ExtIEs M2AP-PROTOCOL-EXTENSION ::= {
    ...
}

GTP-TEID                ::= OCTET STRING (SIZE (4))

-- H
-- I

IPAddress                ::= OCTET STRING (SIZE(4..16))

-- J
-- K
-- L

LCID                    ::= INTEGER (0..28)

-- M

MBMS-Service-associatedLogicalM2-ConnectionItem ::= SEQUENCE {
    eNB-MBMS-M2AP-ID          ENB-MBMS-M2AP-ID OPTIONAL,
    mCE-MBMS-M2AP-ID          MCE-MBMS-M2AP-ID OPTIONAL,
    iE-Extensions              ProtocolExtensionContainer { { MBMS-Service-associatedLogicalM2-ConnectionItemExtIEs} } OPTIONAL,
    ...
}

MBMS-Service-associatedLogicalM2-ConnectionItemExtIEs M2AP-PROTOCOL-EXTENSION ::= {
    ...
}

MBMS-Service-Area                ::= OCTET STRING

MBMS-Service-Area-ID-List        ::= SEQUENCE (SIZE(1..maxnoofMBMSServiceAreasPerCell)) OF MBMS-Service-Area

MBMS-Session-ID ::= OCTET STRING (SIZE (1))

MBMSSessionListPerPMCH-Item ::= SEQUENCE (SIZE(1..maxnoofSessionsPerPMCH)) OF SEQUENCE {
    tmgi                      TMGI,
    lcId                      LCID,
    iE-Extensions              ProtocolExtensionContainer { { MBMSSessionListPerPMCH-Item-ExtIEs} } OPTIONAL,
    ...
}

MBMSSessionListPerPMCH-Item-ExtIEs M2AP-PROTOCOL-EXTENSION ::= {
    ...
}

MBSFN-Area-ID                ::= INTEGER (0..255)

MBSFN-SynchronisationArea-ID ::= INTEGER (0..65535)

MBSFN-Subframe-Configuration ::= SEQUENCE {
    radioframeAllocationPeriod    ENUMERATED {n1, n2, n4, n8, n16, n32},

```



```

    radioframeAllocationOffset    INTEGER (0..7),
    subframeAllocation            CHOICE {
        oneFrame                  BIT STRING (SIZE (6) ),
        fourFrames                BIT STRING (SIZE (24) ) },
    iE-Extensions                 ProtocolExtensionContainer { { MBSFN-Subframe-Configuration-ExtIEs } } OPTIONAL,
    ...
}

MBSFN-Subframe-Configuration-ExtIEs M2AP-PROTOCOL-EXTENSION ::= {
    ...
}

MCCH-Update-Time                ::= INTEGER (0..255)

MCCHrelatedBCCH-ConfigPerMBSFNArea-Item ::= SEQUENCE {
    mbsfnArea                     MBSFN-Area-ID,
    pdcchLength                   ENUMERATED {s1, s2, ...},
    repetitionPeriod              ENUMERATED {rf32, rf64, rf128, rf256},
    offset                        INTEGER (0..10),
    modificationPeriod            ENUMERATED {rf512, rf1024},
    subframeAllocationInfo        BIT STRING (SIZE(6)),
    modulationAndCodingScheme     ENUMERATED {n2, n7, n13, n19},
    cellInformationList            Cell-Information-List OPTIONAL,
    iE-Extensions                 ProtocolExtensionContainer { { MCCHrelatedBCCH-ConfigPerMBSFNArea-Item-ExtIEs } } OPTIONAL,
    ...
}

MCCHrelatedBCCH-ConfigPerMBSFNArea-Item-ExtIEs M2AP-PROTOCOL-EXTENSION ::= {
    ...
}

MCE-ID                           ::= OCTET STRING (SIZE(2))

MCE-MBMS-M2AP-ID                 ::= INTEGER (0.. 16777215)

MCENAME ::= PrintableString (SIZE (1..150,...))

MCH-Scheduling-Period             ::= ENUMERATED {rf8, rf16, rf32, rf64, rf128, rf256, rf512, rf1024}
-- N
-- O
-- P

PLMN-Identity ::= OCTET STRING (SIZE(3))

PMCH-Configuration                ::= SEQUENCE {
    allocatedSubframesEnd         AllocatedSubframesEnd,
    dataMCS                       INTEGER (0..28),
    mchSchedulingPeriod           MCH-Scheduling-Period,
    iE-Extensions                 ProtocolExtensionContainer { { PMCH-Configuration-ExtIEs } } OPTIONAL,
    ...
}

PMCH-Configuration-ExtIEs M2AP-PROTOCOL-EXTENSION ::= {

```



```
    ...
}

Common-Subframe-Allocation-Period ::= ENUMERATED {rf4, rf8, rf16, rf32, rf64, rf128, rf256}

PriorityLevel ::= INTEGER { spare (0), highest (1), lowest (14), no-priority (15) } (0..15)

-- Q
-- R
-- S
-- T

TimeToWait ::= ENUMERATED {v1s, v2s, v5s, v10s, v20s, v60s, ...}

TMGI ::= SEQUENCE {
    plmnIdentity          PLMN-Identity,
    serviceID             OCTET STRING (SIZE (3)),
    iE-Extensions         ProtocolExtensionContainer { {TMGI-ExtIEs} } OPTIONAL,
    ...
}

TMGI-ExtIEs M2AP-PROTOCOL-EXTENSION ::= {
    ...
}

TNL-Information ::= SEQUENCE {
    ipMCAddress           IPAddress,
    ipSourceAddress        IPAddress,
    gTP-TEID              GTP-TEID,
    iE-Extensions         ProtocolExtensionContainer { {TNL-Information-ExtIEs} } OPTIONAL,
    ...
}

TNL-Information-ExtIEs M2AP-PROTOCOL-EXTENSION ::= {
    ...
}

TypeOfError ::= ENUMERATED {
    not-understood,
    missing,
    ...
}

-- U
-- V
-- W
-- X
-- Y
-- Z

END
```

9.3.6 Common definitions

```
-- *****
--
-- Common definitions
--
-- *****

M2AP-CommonDataTypes {
itu-t (0) identified-organization (4) etsi (0) mobileDomain (0)
eps-Access (21) modules (3) m2ap (4) version1 (1) m2ap-CommonDataTypes (3) }

DEFINITIONS AUTOMATIC TAGS ::=

BEGIN

-- *****
--
-- Extension constants
--
-- *****

maxPrivateIEs                INTEGER ::= 65535
maxProtocolExtensions        INTEGER ::= 65535
maxProtocolIEs               INTEGER ::= 65535

-- *****
--
-- Common Data Types
--
-- *****

Criticality      ::= ENUMERATED { reject, ignore, notify }

Presence         ::= ENUMERATED { optional, conditional, mandatory }

PrivateIE-ID     ::= CHOICE {
    local          INTEGER (0.. maxPrivateIEs),
    global         OBJECT IDENTIFIER
}

ProcedureCode    ::= INTEGER (0..255)

ProtocolIE-ID    ::= INTEGER (0..maxProtocolIEs)

TriggeringMessage ::= ENUMERATED { initiating-message, successful-outcome, unsuccessful-outcome}

END
```

9.3.7 Constant definitions

```
-- *****
--
-- Constant definitions
--
-- *****

M2AP-Constants {
itu-t (0) identified-organization (4) etsi (0) mobileDomain (0)
eps-Access (21) modules (3) m2ap (4) version1 (1) m2ap-Constants (4) }

DEFINITIONS AUTOMATIC TAGS ::=

BEGIN

IMPORTS
    ProcedureCode,
    ProtocolIE-ID
FROM M2AP-CommonDataTypes;

-- *****
--
-- Elementary Procedures
--
-- *****

id-sessionStart                ProcedureCode ::= 0
id-sessionStop                 ProcedureCode ::= 1
id-mbmsSchedulingInformation    ProcedureCode ::= 2
id-errorIndication              ProcedureCode ::= 3
id-reset                       ProcedureCode ::= 4
id-m2Setup                     ProcedureCode ::= 5
id-eNBConfigurationUpdate       ProcedureCode ::= 6
id-mCEConfigurationUpdate       ProcedureCode ::= 7
id-privateMessage               ProcedureCode ::= 8
id-sessionUpdate                ProcedureCode ::= 9
id-mbmsServiceCounting          ProcedureCode ::= 10
id-mbmsServiceCountingResultsReport ProcedureCode ::= 11

-- *****
--
-- Lists
--
-- *****

maxnoofMBSFNareas              INTEGER ::= 256
maxnoofMBSFN-Allocations        INTEGER ::= 8
maxnoofPMCHsperMBSFNarea        INTEGER ::= 15
maxnoofCells                    INTEGER ::= 256
maxnoofMBMSServiceAreasPerCell  INTEGER ::= 256
maxnoofSessionsPerPMCH          INTEGER ::= 29
maxnooferrors                    INTEGER ::= 256
```



```

maxNrOfIndividualM2ConnectionsToReset    INTEGER ::= 256
maxnoofCountingService                   INTEGER ::= 16

-- *****
--
-- IEs
--
-- *****

id-MCE-MBMS-M2AP-ID                      ProtocolIE-ID ::= 0
id-ENB-MBMS-M2AP-ID                      ProtocolIE-ID ::= 1
id-TMGI                                  ProtocolIE-ID ::= 2
id-MBMS-Session-ID                       ProtocolIE-ID ::= 3
id-MBMS-Service-Area                     ProtocolIE-ID ::= 6
id-TNL-Information                       ProtocolIE-ID ::= 7
id-CriticalityDiagnostics                 ProtocolIE-ID ::= 8
id-Cause                                 ProtocolIE-ID ::= 9
id-MBSFN-Area-Configuration-List          ProtocolIE-ID ::= 10
id-PMCH-Configuration-List               ProtocolIE-ID ::= 11
id-PMCH-Configuration-Item               ProtocolIE-ID ::= 12
id-GlobalENB-ID                          ProtocolIE-ID ::= 13
id-ENBname                               ProtocolIE-ID ::= 14
id-ENB-MBMS-Configuration-data-List       ProtocolIE-ID ::= 15
id-ENB-MBMS-Configuration-data-Item      ProtocolIE-ID ::= 16
id-GlobalMCE-ID                          ProtocolIE-ID ::= 17
id-MCENAME                               ProtocolIE-ID ::= 18
id-MCCHrelatedBCCH-ConfigPerMBSFNArea    ProtocolIE-ID ::= 19
id-MCCHrelatedBCCH-ConfigPerMBSFNArea-Item ProtocolIE-ID ::= 20
id-TimeToWait                             ProtocolIE-ID ::= 21
id-MBSFN-Subframe-Configuration-List      ProtocolIE-ID ::= 22
id-MBSFN-Subframe-Configuration-Item      ProtocolIE-ID ::= 23
id-Common-Subframe-Allocation-Period      ProtocolIE-ID ::= 24
id-MCCH-Update-Time                       ProtocolIE-ID ::= 25
id-ENB-MBMS-Configuration-data-List-ConfigUpdate ProtocolIE-ID ::= 26
id-ENB-MBMS-Configuration-data-ConfigUpdate-Item ProtocolIE-ID ::= 27
id-MBMS-Service-associatedLogicalM2-ConnectionItem ProtocolIE-ID ::= 28
id-MBSFN-Area-ID                          ProtocolIE-ID ::= 29
id-ResetType                             ProtocolIE-ID ::= 30
id-MBMS-Service-associatedLogicalM2-ConnectionListResAck ProtocolIE-ID ::= 31
id-MBMS-Counting-Request-Session           ProtocolIE-ID ::= 32
id-MBMS-Counting-Request-Session-Item      ProtocolIE-ID ::= 33
id-MBMS-Counting-Result-List               ProtocolIE-ID ::= 34
id-MBMS-Counting-Result-Item               ProtocolIE-ID ::= 35

END

```

9.3.8 Container definitions

```

-- *****
--
-- Container definitions

```



```
--
-- *****

M2AP-Containers {
itu-t (0) identified-organization (4) etsi (0) mobileDomain (0)
eps-Access (21) modules (3) m2ap (4) version1 (1) m2ap-Containers (5) }

DEFINITIONS AUTOMATIC TAGS ::=

BEGIN

-- *****
--
-- IE parameter types from other modules.
--
-- *****

IMPORTS
    maxPrivateIEs,
    maxProtocolExtensions,
    maxProtocolIEs,
    Criticality,
    Presence,
    PrivateIE-ID,
    ProtocolIE-ID
FROM M2AP-CommonDataTypes;

-- *****
--
-- Class Definition for Protocol IEs
--
-- *****

M2AP-PROTOCOL-IES ::= CLASS {
    &id          ProtocolIE-ID          UNIQUE,
    &criticality Criticality,
    &Value,
    &presence    Presence
}
WITH SYNTAX {
    ID          &id
    CRITICALITY &criticality
    TYPE        &Value
    PRESENCE    &presence
}

-- *****
--
-- Class Definition for Protocol IEs
--
-- *****

M2AP-PROTOCOL-IES-PAIR ::= CLASS {
    &id          ProtocolIE-ID          UNIQUE,
```



```

        &firstCriticality      Criticality,
        &FirstValue,
        &secondCriticality     Criticality,
        &SecondValue,
        &presence              Presence
    }
    WITH SYNTAX {
        ID                      &id
        FIRST CRITICALITY      &firstCriticality
        FIRST TYPE              &FirstValue
        SECOND CRITICALITY     &secondCriticality
        SECOND TYPE             &SecondValue
        PRESENCE                &presence
    }

-- *****
--
-- Class Definition for Protocol Extensions
--
-- *****

M2AP-PROTOCOL-EXTENSION ::= CLASS {
    &id                      ProtocolIE-ID          UNIQUE,
    &criticality              Criticality,
    &Extension,
    &presence                 Presence
}
WITH SYNTAX {
    ID                      &id
    CRITICALITY             &criticality
    EXTENSION               &Extension
    PRESENCE                &presence
}

-- *****
--
-- Class Definition for Private IEs
--
-- *****

M2AP-PRIVATE-IES ::= CLASS {
    &id                      PrivateIE-ID,
    &criticality              Criticality,
    &Value,
    &presence                 Presence
}
WITH SYNTAX {
    ID                      &id
    CRITICALITY             &criticality
    TYPE                    &Value
    PRESENCE                &presence
}

-- *****

```



```

--
-- Container for Protocol IEs
--
-- *****

ProtocolIE-Container {M2AP-PROTOCOL-IES : IEsSetParam} ::=
    SEQUENCE (SIZE (0..maxProtocolIEs)) OF
        ProtocolIE-Field {{IEsSetParam}}

ProtocolIE-Single-Container {M2AP-PROTOCOL-IES : IEsSetParam} ::=
    ProtocolIE-Field {{IEsSetParam}}

ProtocolIE-Field {M2AP-PROTOCOL-IES : IEsSetParam} ::= SEQUENCE {
    id                M2AP-PROTOCOL-IES.&id                ({IEsSetParam}),
    criticality       M2AP-PROTOCOL-IES.&criticality        ({IEsSetParam}{@id}),
    value             M2AP-PROTOCOL-IES.&Value              ({IEsSetParam}{@id})
}

-- *****
--
-- Container for Protocol IE Pairs
--
-- *****

ProtocolIE-ContainerPair {M2AP-PROTOCOL-IES-PAIR : IEsSetParam} ::=
    SEQUENCE (SIZE (0..maxProtocolIEs)) OF
        ProtocolIE-FieldPair {{IEsSetParam}}

ProtocolIE-FieldPair {M2AP-PROTOCOL-IES-PAIR : IEsSetParam} ::= SEQUENCE {
    id                M2AP-PROTOCOL-IES-PAIR.&id            ({IEsSetParam}),
    firstCriticality  M2AP-PROTOCOL-IES-PAIR.&firstCriticality ({IEsSetParam}{@id}),
    firstValue       M2AP-PROTOCOL-IES-PAIR.&FirstValue      ({IEsSetParam}{@id}),
    secondCriticality M2AP-PROTOCOL-IES-PAIR.&secondCriticality ({IEsSetParam}{@id}),
    secondValue      M2AP-PROTOCOL-IES-PAIR.&SecondValue     ({IEsSetParam}{@id})
}

-- *****
--
-- Container Lists for Protocol IE Containers
--
-- *****

ProtocolIE-ContainerList {INTEGER : lowerBound, INTEGER : upperBound, M2AP-PROTOCOL-IES : IEsSetParam} ::=
    SEQUENCE (SIZE (lowerBound..upperBound)) OF
        ProtocolIE-Container {{IEsSetParam}}

ProtocolIE-ContainerPairList {INTEGER : lowerBound, INTEGER : upperBound, M2AP-PROTOCOL-IES-PAIR : IEsSetParam} ::=
    SEQUENCE (SIZE (lowerBound..upperBound)) OF
        ProtocolIE-ContainerPair {{IEsSetParam}}

-- *****
--
-- Container for Protocol Extensions
--

```



```
-- *****

ProtocolExtensionContainer {M2AP-PROTOCOL-EXTENSION : ExtensionSetParam} ::=
    SEQUENCE (SIZE (1..maxProtocolExtensions)) OF
    ProtocolExtensionField {{ExtensionSetParam}}

ProtocolExtensionField {M2AP-PROTOCOL-EXTENSION : ExtensionSetParam} ::= SEQUENCE {
    id                M2AP-PROTOCOL-EXTENSION.&id                ({ExtensionSetParam}),
    criticality        M2AP-PROTOCOL-EXTENSION.&criticality        ({ExtensionSetParam}{@id}),
    extensionValue      M2AP-PROTOCOL-EXTENSION.&Extension        ({ExtensionSetParam}{@id})
}

-- *****
--
-- Container for Private IEs
--
-- *****

PrivateIE-Container {M2AP-PRIVATE-IES : IEsSetParam} ::=
    SEQUENCE (SIZE (1..maxPrivateIEs)) OF
    PrivateIE-Field {{IEsSetParam}}

PrivateIE-Field {M2AP-PRIVATE-IES : IEsSetParam} ::= SEQUENCE {
    id                M2AP-PRIVATE-IES.&id                ({IEsSetParam}),
    criticality        M2AP-PRIVATE-IES.&criticality        ({IEsSetParam}{@id}),
    value              M2AP-PRIVATE-IES.&Value              ({IEsSetParam}{@id})
}

END
```

9.4 Message Transfer Syntax

M2AP shall use the ASN.1 Basic Packed Encoding Rules (BASIC-PER) Aligned Variant as transfer syntax as specified in ref. ITU-T Rec. X.691 [5].

9.5 Timers

10 Handling of Unknown, Unforeseen and Erroneous Protocol Data

Section 10 of TS 36.413 [4] is applicable for the purposes of the present document.

Annex A (informative): Change history

TSG #	TSG Doc.	CR	Rev	Subject/Comment	New
2008-02				First draft	0.0.0
2009-10				Second draft	0.0.1
2009-10				Draft with first content	0.0.2
2009-10				Including comments from RAN3#65bis	0.0.3
2009-10				Preparing RAN3#66	0.0.4
2009-10				Submission to RAN3#66, based on received comments	0.0.5
2009-11				Update following discussions at RAN3#66	0.0.6
2009-11				further revisions along RAN2 agreements, step to v100	1.0.0
2009-11				incorporating comments along email discussions before RAN#46	1.1.0
2009-12				stepping the version to 2.0.0 for approval at RAN#46	2.0.0
46	RP-091200			Approved at RAN#46	9.0.0
47	RP-100226	0001	1	Some minor description corrections for M2AP	9.1.0
47	RP-100226	0002	1	Removal of QoS information in MBMS Session Start message	9.1.0
47	RP-100226	0003		Clarification of MCCH Update Time	9.1.0
47	RP-100226	0004		Correct the descripton of Error Indication and misspelt of BIT STRING	9.1.0
47	RP-100227	0005	1	Some corrections to TS36.443	9.1.0
47	RP-100226	0006	1	MBSFN subframe configuration	9.1.0
47	RP-100227	0008	2	MBSFN Area Configuration	9.1.0
47	RP-100227	0009	1	Miscellaneous corrections to TS36.443	9.1.0
47	RP-100227	0010	2	Optional MBMS Session ID	9.1.0
47	RP-100227	0013	3	Remove the MBMS Session Duration IE from the MBMS Session Start Request message	9.1.0
47	RP-100227	0015	3	Misc corrections	9.1.0
47	RP-100227	0016	2	Introduction of MBMS Session Update in M2AP	9.1.0
47	RP-100227	0019	3	Rapporteur's update for M2AP protocol	9.1.0
49	RP-100906	0027		Alignment of tabulars to agreed notation for TS36.413 and TS36.423	9.2.0
2010-12				Created Rel-10 version based on v. 9.2.0	10.0.0
SP-49	SP-100629			Clarification on the use of References (TS 21.801 CR#0030)	10.1.0
51	RP-110240	0033	2	Introduction of MBMS counting procedure	10.1.0
51	RP-110221	0037		Addition of Criticality Diagnostics IE in the M2 Setup Response message	10.1.0
51	RP-110223	0040	1	Correction on MBMS Reset procedure	10.1.0
51	RP-110222	0042	1	Correction of M2 Setup	10.1.0
51	RP-110226	0043	1	Clarification on TEID value range	10.1.0
52	RP-110692	0044	1	Completion of MBMS new functions	10.2.0
52	RP-110692	0045	1	Mismatch in Counting Report	10.2.0
52	RP-110686	0047	1	Removal of unused references and text clean-up for Rel-10	10.2.0
53	RP-111197	0050	2	Clarification on the M2 Reset Procedure	10.3.0
53	RP-111196	0053	1	Correction to the eNB Configuration Update procedure, and the MCE Configuration Update procedure	10.3.0
53	RP-111195	0054	1	Abnormal condition UE Counting Request	10.3.0
54	RP-111648	0060		Correction of Counting Request	10.4.0
54	RP-111651	0061	1	Correction to the eNB Configuration Update procedure, and the MCE Configuration Update procedure	10.4.0
55	RP-120234	0062		Correct of reset	10.5.0
2012-06				Created Rel-11 version based on v. 10.5.0	
56	RP-120752	0063	2	Correction on MBMS Session Start and Stop procedures in M2 interface	11.0.0

History

Document history		
V11.0.0	November 2012	Publication