

ETSI TS 136 523-1 V8.2.1 (2009-08)

Technical Specification

**LTE;
Evolved Universal Terrestrial Radio Access (E-UTRA) and
Evolved Packet Core (EPC);
User Equipment (UE) conformance specification;
Part 1: Protocol conformance specification
(3GPP TS 36.523-1 version 8.2.1 Release 8)**



Reference

RTS/TSGR-0536523-1v821

Keywords

LTE

ETSI

650 Route des Lucioles
F-06921 Sophia Antipolis Cedex - FRANCE

Tel.: +33 4 92 94 42 00 Fax: +33 4 93 65 47 16

Siret N° 348 623 562 00017 - NAF 742 C
Association à but non lucratif enregistrée à la
Sous-Préfecture de Grasse (06) N° 7803/88

Important notice

Individual copies of the present document can be downloaded from:

<http://www.etsi.org>

The present document may be made available in more than one electronic version or in print. In any case of existing or perceived difference in contents between such versions, the reference version is the Portable Document Format (PDF). In case of dispute, the reference shall be the printing on ETSI printers of the PDF version kept on a specific network drive within ETSI Secretariat.

Users of the present document should be aware that the document may be subject to revision or change of status. Information on the current status of this and other ETSI documents is available at

<http://portal.etsi.org/tb/status/status.asp>

If you find errors in the present document, please send your comment to one of the following services:

http://portal.etsi.org/chaicor/ETSI_support.asp

Copyright Notification

No part may be reproduced except as authorized by written permission.
The copyright and the foregoing restriction extend to reproduction in all media.

© European Telecommunications Standards Institute 2009.
All rights reserved.

DECT[™], **PLUGTESTS**[™], **UMTS**[™], **TIPHON**[™], the TIPHON logo and the ETSI logo are Trade Marks of ETSI registered for the benefit of its Members.

3GPP[™] is a Trade Mark of ETSI registered for the benefit of its Members and of the 3GPP Organizational Partners.

LTE[™] is a Trade Mark of ETSI currently being registered

for the benefit of its Members and of the 3GPP Organizational Partners.

GSM[®] and the GSM logo are Trade Marks registered and owned by the GSM Association.

Intellectual Property Rights

IPRs essential or potentially essential to the present document may have been declared to ETSI. The information pertaining to these essential IPRs, if any, is publicly available for **ETSI members and non-members**, and can be found in ETSI SR 000 314: "*Intellectual Property Rights (IPRs); Essential, or potentially Essential, IPRs notified to ETSI in respect of ETSI standards*", which is available from the ETSI Secretariat. Latest updates are available on the ETSI Web server (<http://www.etsi.org/legal/home.htm>).

Pursuant to the ETSI IPR Policy, no investigation, including IPR searches, has been carried out by ETSI. No guarantee can be given as to the existence of other IPRs not referenced in ETSI SR 000 314 (or the updates on the ETSI Web server) which are, or may be, or may become, essential to the present document.

Foreword

This Technical Specification (TS) has been produced by the ETSI 3rd Generation Partnership Project (3GPP).

The present document may refer to technical specifications or reports using their 3GPP identities, UMTS identities or GSM identities. These should be interpreted as being references to the corresponding ETSI deliverables.

The cross reference between GSM, UMTS, 3GPP and ETSI identities can be found under <http://webapp.etsi.org/key/queryform.asp>.

Contents

Intellectual Property Rights	2
Foreword.....	2
Foreword.....	10
Introduction	10
1 Scope	11
2 References	11
3 Definitions, symbols and abbreviations	13
3.1 Definitions	13
3.2 Abbreviations	13
4 Overview	13
4.1 Test Methodology.....	13
4.1.1 Testing of optional functions and procedures	13
4.1.2 Test interfaces and facilities.....	13
4.2 Implicit Testing	13
5 Reference Conditions	13
5.1 Generic setup procedures	13
6 Idle Mode Operations.....	14
6.0 Introduction	14
6.0.1 PLMN and TAC	14
6.0.2 Other	14
6.1 In a pure E-UTRAN environment	15
6.1.1 PLMN Selection	15
6.1.1.1 PLMN selection of RPLMN, HPLMN/EHPLMN, UPLMN and OPLMN; Automatic mode.....	15
6.1.2 Cell Selection and Reselection.....	19
6.1.2.2 Cell selection, $Q_{rxlevmin}$	19
6.1.2.3 Cell selection / intra E-UTRAN / serving cell becomes non-suitable ($S_{<0}$, barred) (intra frequency)	22
6.1.2.4 Cell reselection.....	27
6.1.2.5 Cell reselection for inter-band operation.....	29
6.1.2.6 Cell reselection using Q_{hyst} , Q_{offset} and $T_{reselection}$	32
6.1.2.7 Cell reselection: Equivalent PLMN	38
6.1.2.8 Cell reselection using cell status and cell reservations (access control class 0-9).....	41
6.1.2.9 Cell reselection using cell status and cell reservations (access control class 11-15).....	46
6.1.2.11 Inter-frequency cell reselection.....	49
6.1.2.15 Inter-frequency cell reselection according to cell reselection priority provided by SIBs.....	51
6.2.2.1 Inter-RAT cell Selection / from E-UTRA RRC_IDLE to UTRA_Idle, serving cell becomes non-suitable ($S_{ServingCell}<0$,barred).....	56
6.2.2.2 Inter-RAT cell Selection / from E-UTRA RRC_IDLE to GSM_Idle/GPRS Packet_idle, serving cell becomes non-suitable ($S_{ServingCell}<0$,barred).....	60
6.2.2.3 Inter-RAT Cell selection / from E-UTRA RRC_IDLE to HRPD Idle, when the serving cell becomes non-suitable ($S_{ServingCell}<0$).....	65
6.2.3.1 Inter-RAT Cell Reselection / from E-UTRA RRC_IDLE to GSM_Idle/GPRS Packet_Idle.....	68
6.2.3.2 Inter-RAT Cell Reselection / from GSM_Idle/GPRS Packet_Idle to E-UTRA.....	74
6.2.3.5 Inter-RAT Cell Reselection / from E-UTRA RRC_IDLE to UTRA_Idle	76
6.2.3.7 Inter-RAT Cell Reselection: from E-UTRA RRC_IDLE to HRPD Idle – When HRPD cell is higher reselection priority than E-UTRA.....	79
6.2.3.8 Inter-RAT Cell Reselection: from E-UTRA RRC_IDLE to HRPD Idle – When HRPD is lower reselection priority than E-UTRA	83
6.3 Closed Subscriber Group cells	87
6.3.6 Ignoring CSG cells in cell selection/reselection when Allowed CSG list is empty or not supported.....	87
7 Layer 2.....	92

7.1	MAC.....	92
7.1.1	Mapping between logical channels and transport channels	92
7.1.1.1	CCCH mapped to UL SCH/ DL-SCH / Reserved LCID (Logical Channel ID)	92
7.1.1.2	DTCH or DCCH mapped to UL SCH/ DL-SCH / Reserved LCID (Logical Channel ID)	95
7.1.2	RACH	98
7.1.2.1	Correct Selection of RACH parameters / Random Access Preamble and PRACH resource explicitly signalled to the UE by RRC [Non Contention Based Random Access Procedure].....	98
7.1.2.2	Correct Selection of RACH parameters / Random Access Preamble and PRACH resource explicitly signalled to the UE in PDCCH Order [Non Contention Based Random Access Procedure]	100
7.1.2.3	Correct Selection of RACH parameters, selected by MAC itself [Contention Based Random Access Procedure].....	103
7.1.2.4	Random Access Procedure: Successful.....	107
7.1.2.5	Random Access Procedure: MAC PDU containing Multiple RAR's	112
7.1.2.6	Maintenance of Uplink Time Alignment	115
7.1.2.7	MAC-Contention Resolution [Temporary C-RNTI].....	118
7.1.2.8	MAC-Contention Resolution [C-RNTI]	121
7.1.2.9	MAC-Backoff Indicator	124
7.1.3	DL-SCH Data transfer	127
7.1.3.1	Correct handling of DL assignment / dynamic case.....	127
7.1.3.2	Correct handling of DL assignment: semi persistent case.....	128
7.1.3.3	MAC PDU header handling	133
7.1.3.4	Correct HARQ process handling[DCCH /DTCH]	138
7.1.3.5	Correct HARQ process handling [CCCH]	140
7.1.3.6	Correct HARQ process handling [BCCH]	144
7.1.3.7	MAC-Padding	147
7.1.3.9	MAC reset-DL	149
7.1.4	UL-SCH Data Transfer	152
7.1.4.1	Correct handling of UL assignment / dynamic case.....	152
7.1.4.2	Correct handling of UL assignment / semi persistent case.....	154
7.1.4.3	Logical channel prioritization handling	160
7.1.4.4	Correct Handling of MAC control information [Scheduling Requests/ PUCCH]	162
7.1.4.5	Correct Handling of MAC control information [Scheduling Requests/Random Access Procedure]	164
7.1.4.6	Correct Handling of MAC control information [Buffer Status/ UL data arrives in the UE Tx buffer and retransmission of BSR / Regular BSR].....	166
7.1.4.7	Correct Handling of MAC control information [Buffer Status/ UL resources are allocated/ Padding BSR].....	171
7.1.4.8	Correct Handling of MAC control information [Buffer Status/ Periodic BSR Timer expires].....	176
7.1.4.10	MAC-Padding	180
7.1.4.11	Correct HARQ process handling.....	183
7.1.4.12	MAC reset-UL	189
7.1.4.13	MAC PDU header handling	193
7.1.4.14	Correct HARQ process handling: TTI Bundling.....	198
7.1.4.15	UE Power Headroom Reporting [Periodic reporting]	204
7.1.4.16	UE Power Headroom Reporting [DL_Pathloss change reporting].....	207
7.1.6	DRX operation.....	211
7.1.6.1	DRX Operation / (short cycle not configured) /Parameters configured by RRC (radio resource configuration).....	211
7.1.6.2	DRX Operation / Parameters (short cycle not configured) / DRX command MAC control element reception	216
7.1.7	Transport Block Size selection	220
7.1.7.1	DL-SCH Transport Block Size selection	220
7.1.7.1.1	DL-SCH Transport Block Size selection / DCI format 1 / RA type 0.....	220
7.1.7.1.2	DL-SCH Transport Block Size selection / DCI format 1 / RA type 1	231
7.1.7.1.3	DL-SCH Transport Block Size selection / DCI format 1A / RA type 2 / Localised VRB	242
7.1.7.1.4	DL-SCH Transport Block Size selection / DCI format 1A / RA type 2 / Distributed VRB	254
7.1.7.2	UL-SCH Transport Block Size support.....	266
7.1.7.2.1	UL-SCH Transport Block Size selection / DCI format 0	266
7.2	RLC.....	277
7.2.1	General.....	277
7.2.2	Unacknowledged Mode	277

7.2.2.1	UM RLC / Segmentation and Reassembly / 5-bit SN / "Framing Info Field"	277
7.2.2.2	UM RLC / Segmentation and Reassembly / 10-bit SN / "Framing Info Field"	279
7.2.2.3	UM RLC / Reassembly / 5-bit SN / LI value > PDU size.....	280
7.2.2.4	UM RLC/ Reassembly / 10-bit SN / LI value > PDU size.....	282
7.2.2.5	UM RLC / Correct use of Sequence Numbering.....	283
7.2.2.5.1	UM RLC / 5-bit SN / Correct use of Sequence Numbering	283
7.2.2.5.2	UM RLC / 10-bit SN / Correct use of Sequence Numbering	286
7.2.2.6	UM RLC / Concatenation, Segmentation and Reassembly.....	289
7.2.2.7	UM RLC / In sequence delivery of upper layers PDUs without residual loss of RLC PDUs / Maximum re-ordering delay below <i>t-Reordering</i>	294
7.2.2.8	UM RLC / In sequence delivery of upper layers PDUs without residual loss of RLC PDUs / Maximum re-ordering delay exceeds <i>t-Reordering</i>	296
7.2.2.9	UM RLC / In sequence delivery of upper layers PDUs with residual loss of RLC PDUs / Maximum re-ordering delay exceeds <i>t-Reordering</i>	299
7.2.2.10	UM RLC / Duplicated detection of RLC PDUs.....	301
7.2.2.11	UM RLC / RLC re-establishment procedure	303
7.2.3	Acknowledged Mode.....	306
7.2.3.1	AM RLC / Concatenation and Reassembly	306
7.2.3.2	AM RLC / Segmentation and Reassembly / No PDU segmentation.....	309
7.2.3.3	AM RLC / Segmentation and Reassembly / "Framing Info Field"	311
7.2.3.4	AM RLC / Segmentation and Reassembly / Different numbers of Length Indicators.....	313
7.2.3.5	AM RLC / Reassembly / LI value > PDU size	316
7.2.3.6	AM RLC / Correct use of Sequence Numbering.....	317
7.2.3.7	AM RLC / Control of Transmit Window	320
7.2.3.8	AM RLC / Control of Receive Window	323
7.2.3.9	AM RLC / Polling for status	325
7.2.3.10	AM RLC / Receiver Status Triggers	328
7.2.3.11	Void.....	332
7.2.3.12	Void.....	332
7.2.3.13	AM RLC / Reconfiguration of RLC parameters by upper layers.....	332
7.2.3.14	AM RLC / In sequence delivery of upper layers PDUs	336
7.2.3.15	AM RLC / Re-ordering of RLC PDU segments	338
7.2.3.16	AM RLC / Re-transmission of RLC PDU without re-segmentation.....	342
7.2.3.17	AM RLC / Re-segmentation RLC PDU / SO, FI, LSF	344
7.2.3.18	AM RLC / Reassembly / AMD PDU reassembly from AMD PDU segments; Segmentation Offset and Last Segment Flag fields	348
7.2.3.19	Void.....	353
7.2.3.20	AM RLC / Duplicate detection of RLC PDUs.....	353
7.2.3.21	AM RLC / RLC re-establishment at RRC Connection reconfiguration including <i>mobilityControlInfo</i> IE.....	354
7.3	PDCP.....	357
7.3.1	Maintenance of PDCP sequence numbers for radio bearers.....	357
7.3.1.1	Maintenance of PDCP sequence numbers (user plane, RLC AM).....	357
7.3.1.2	Maintenance of PDCP sequence numbers (user plane, RLC UM, short PDCP SN (7 bits))	360
7.3.1.3	Maintenance of PDCP sequence numbers (user plane, RLC UM, long PDCP SN (12 bits))	362
7.3.3	PDCP Ciphering and deciphering	364
7.3.3.1	Ciphering and Deciphering: Correct functionality of EPS AS encryption algorithms (SNOW 3G)....	364
7.3.3.2	Ciphering and Deciphering: Correct functionality of EPS UP encryption algorithms (SNOW 3G)....	366
7.3.3.3	Ciphering and Deciphering: Correct functionality of EPS AS encryption algorithms (AES).....	367
7.3.3.4	Ciphering and Deciphering: Correct functionality of EPS UP encryption algorithms (AES).....	368
7.3.4	PDCP Integrity Protection	369
7.3.4.1	Integrity protection: Correct functionality of EPS AS integrity algorithms (SNOW3G).....	369
7.3.4.2	Integrity protection: Correct functionality of EPS AS integrity algorithms (AES).....	371
7.3.5	PDCP – Handover.....	372
7.3.5.1	Void.....	372
7.3.5.2	PDCP handover / Lossless handover / PDCP Sequence Number maintenance	372
7.3.5.3	PDCP handover/Non-lossless handover / PDCP Sequence Number maintenance.....	375
7.3.5.4	PDCP handover / Lossless handover / PDCP status report to convey the information on missing or acknowledged PDCP SDUs at handover	377
7.3.5.5	PDCP handover / In-order delivery and duplicate elimination in the downlink	380
7.3.6	Others.....	383
7.3.6.1	PDCP Discard	383

8	Radio Resource Control RRC	385
8.1	RRC Connection management procedures.....	385
8.1.1	Paging	385
8.1.1.1	RRC / Paging for Connection in idle mode.....	385
8.1.1.2	RRC / Paging for notification of BCCH modification in idle mode	388
8.1.1.3	RRC / Paging for Connection in idle mode (multiple paging records)	391
8.1.1.4	RRC / Paging for Connection in idle mode (Shared Network environment)	395
8.1.2	RRC Connection Establishment	398
8.1.2.1	RRC Connection Establishment: Success	398
8.1.2.2	RRC Connection Establishment / Reject with wait time.....	400
8.1.2.3	RRC Connection Establishment in RRC_IDLE state: return to idle state after T300 timeout.....	403
8.1.2.5	RRC Connection Establishment: 0% access probability for MO calls, no restriction for MO signalling.....	404
8.1.2.7	RRC Connection Establishment: 0% access probability for AC 0..9, AC 10 is barred, AC 11..15 are not barred, access for UE with the access class is in the range 11..15 is allowed.	409
8.1.2.8	RRC Connection Establishment: range of access barring time	414
8.1.2.10	RRC Connection Establishment during Cell reselection: Failure	418
8.1.3	RRC Connection Release.....	420
8.1.3.1	RRC Connection Release: Success	420
8.1.3.3	RRC Connection Release: UE stays on same cell.....	421
8.1.3.4	RRC Connection Release: redirection to another E-UTRAN frequency	423
8.1.3.5	RRC Connection Release: success (with priority information).....	426
8.1.3.6	RRC Connection Release: redirection from E-UTRAN to UTRAN	430
8.1.3.8	RRC Connection Release: redirection from E-UTRAN to GERAN.....	432
8.1.3.9	RRC Connection Release: redirection from E-UTRAN to CDMA2000-HRPD.....	435
8.1.3.10	RRC Connection Release: redirection from E-UTRAN to CDMA2000-1XRTT	437
8.2	RRC Connection Reconfiguration.....	439
8.2.1	Radio Bearer Establishment.....	439
8.2.1.1	RRC Connection Reconfiguration / Radio Bearer Establishment for transition from RRC_IDLE to RRC_CONNECTED: Success (Default bearer, early bearer establishment).....	439
8.2.1.2	RRC Connection Reconfiguration / Radio Bearer Establishment for transition from RRC_IDLE to RRC_CONNECTED: Failure (Default bearer).....	442
8.2.1.3	RRC Connection Reconfiguration / Radio Bearer Establishment: Success (Dedicated bearer).....	445
8.2.1.4	RRC Connection Reconfiguration / Radio Bearer Establishment: Failure (Dedicated bearer).....	447
8.2.1.7	RRC Connection Reconfiguration / Radio Bearer Establishment: Success (SRB2)	451
8.2.2	Radio Resource Reconfiguration	453
8.2.2.1	RRC Connection Reconfiguration / Radio Resource Reconfiguration: Success.....	453
8.2.2.2	RRC Connection Reconfiguration / SRB/DRB Reconfiguration: Success	458
8.2.3	Radio Bearer Release.....	461
8.2.3.1	RRC Connection Reconfiguration / Radio Bearer Release: Success	461
8.2.4	Handover	463
8.2.4.1	RRC Connection Reconfiguration / Handover: Success (Dedicated preamble).....	463
8.2.4.2	RRC Connection Reconfiguration / Handover: Success (Common preamble).....	472
8.2.4.3	RRC Connection Reconfiguration / Handover: success (intra-cell, security reconfiguration).....	476
8.2.4.5	RRC Connection Reconfiguration / Handover (all parameters included)	480
8.2.4.6	RRC Connection Reconfiguration / Handover: Success (inter-frequency)	485
8.2.4.7	RRC Connection Reconfiguration / Handover: Failure (Re-establishment successful).....	490
8.2.4.8	RRC Connection Reconfiguration / Handover: Failure (re-establishment failure)	504
8.2.4.9	RRC Connection Reconfiguration / Handover (Inter band blind handover): Success	512
8.3	Measurement Configuration Control and Reporting	516
8.3.1	Intra E-UTRAN measurements.....	516
8.3.1.1	Measurement configuration control and reporting / intra E-UTRAN measurements: event A1	516
8.3.1.2	Measurement configuration control and reporting / intra E-UTRAN measurements: event A2.....	521
8.3.1.3	Measurement configuration control and reporting / intra E-UTRAN measurements: 2 simultaneous events A3 (intra and inter frequency measurements)	526
8.3.1.4	Measurement configuration control and reporting / intra E-UTRAN measurements: Periodic reporting (intra and inter frequency measurements)	533
8.3.1.5	Measurement configuration control and reporting / intra E-UTRAN measurements: 2 simultaneous event A3 (intra frequency measurements).....	545
8.3.1.6	Measurement configuration control and reporting / intra E-UTRAN measurements: 2 simultaneous events A2 and A3 (Inter frequency measurements)	552
8.3.1.7	Measurement configuration control and reporting/ intra E-UTRAN measurements: blacklisting	557

8.3.1.8	Measurement configuration control and reporting / intra E-UTRAN measurements: handover (IE measurement configuration present)	563
8.3.1.9	Measurement configuration control and reporting / intra E-UTRAN measurements: intra-frequency handover (IE measurement configuration not present)	569
8.3.1.10	Measurement configuration control and reporting / intra E-UTRAN measurements: inter-frequency handover (IE measurement configuration not present)	576
8.3.2	Inter RAT measurements	582
8.3.2.1	Measurement configuration control and reporting / inter RAT measurements: event B2 (measurement of GERAN cells)	582
8.3.2.3	Measurement configuration control and reporting / inter RAT measurements: event B2 (measurement of UTRAN cells)	589
8.3.2.4	Measurement configuration control and reporting / inter RAT measurements: Periodic reporting (measurement of UTRAN cells)	597
8.3.2.6	Measurement configuration control and reporting / inter RAT measurements: Simultaneous A2 and two B2 (measurements of E-UTRAN, UTRAN and GERAN cells).....	606
8.3.2.7	Measurement configuration control and reporting / inter-RAT measurements: event B2 (measurement HRPD cells).....	613
8.3.2.8	Measurement configuration control and reporting / inter RAT measurements: Periodic reporting (measurement of HRPD cells).....	620
8.3.2.9	Measurement configuration control and reporting / inter RAT measurements: event B2 (measurement of 1xRTT cells).....	628
8.3.3	Measurements for Self Optimized Networks	635
8.3.3.1	Measurement configuration control and reporting / SON / ANR: CGI reporting of LTE cell.....	635
8.4	Inter RAT Handover.....	645
8.4.1.8	CS fallback caused by addition of CS service / from E-UTRA(Data) to UTRA(PS+CS)	645
8.5	RRC Others	648
8.5.1	Radio Link Failure	648
8.5.1.1	RRC Connection Re-establishment: Success (after Radio Link Failure).....	648
8.5.1.2	RRC Connection Re-establishment: End of procedure after T301 expiry (after Radio Link Failure).....	651
8.5.1.3	RRC Connection Re-establishment; Failure: T311 Expiry (after Radio Link Failure).....	653
8.5.1.4	RRC Connection Re-establishment; Failure: Reject (after Radio Link Failure).....	655
8.5.1.5	Radio Link Recovery while T310 is running	656
8.5.4	UE capability transfer	657
8.5.4.1	UE capability transfer / Success.....	657
9	EPS Mobility Management	664
9.1	EMM common procedures	664
9.1.1	GUTI reallocation procedures.....	664
9.1.1.1	GUTI reallocation procedure	664
9.1.1.2	GUTI reallocation procedure, no TAI list	666
9.1.2	Authentication procedure.....	669
9.1.2.1	Authentication accepted	669
9.1.2.2	Authentication not accepted by the network, GUTI used, identification procedure and authentication restart	671
9.1.2.3	Authentication not accepted by the network, GUTI used, authentication reject and re-authentication	672
9.1.2.4	Authentication not accepted by the UE, MAC code failure	675
9.1.2.5	Authentication not accepted by the UE, SQN failure.....	677
9.1.3	Security mode control procedure	680
9.1.3.1	NAS security mode command accepted by the UE.....	680
9.1.3.2	NAS security mode command not accepted by the UE.....	683
9.1.4	Identification procedure	686
9.1.4.1	Void.....	686
9.2	EMM specific procedures	686
9.2.1	Attach procedure.....	686
9.2.1.1	Attach procedure for EPS services.....	686
9.2.1.1.1	Attach Procedure / Success (valid GUTI)	686
9.2.1.1.1a	Attach Procedure / Success (last visited TAI, TAI list and equivalent PLMN list handling).....	694
9.2.1.1.2	Attach Procedure / Success / With IMSI, GUTI reallocation.....	701
9.2.1.1.5	Attach procedure / Success / ATTACH ACCEPT message includes the PDN address assigned to the UE.....	703

9.2.1.1.7	Attach Procedure / Success / list of equivalent PLMNs in the ATTACH ACCEPT message.....	709
9.2.1.1.9	Attach / rejected / IMSI invalid	711
9.2.1.1.10	Attach / rejected / illegal ME.....	714
9.2.1.1.11	Attach / rejected / GPRS services and non-GPRS services not allowed.....	714
9.2.1.1.12	Attach / rejected / GPRS services not allowed	715
9.2.1.1.13	Attach / rejected / PLMN not allowed	718
9.2.1.1.14	Attach / rejected / tracking area not allowed	723
9.2.1.1.15	Attach / rejected / roaming not allowed in this tracking area	727
9.2.1.1.17	Attach / rejected / no suitable cells in tracking area	733
9.2.1.1.19	Attach / Abnormal case / Failure due to non integrity protection.....	738
9.2.1.1.20	Attach / Abnormal case / Access barred because of access class barring or NAS signalling connection establishment rejected by the network	743
9.2.1.1.25	Attach / Abnormal case / Mobile originated detach required	746
9.2.1.2	Combined attach procedure for EPS services and non-EPS services.....	747
9.2.1.2.1	Combined attach procedure / Success /EPS and non-EPS services.....	747
9.2.1.2.2	Combined attach procedure / Success / EPS services only / IMSI unknown in HSS	750
9.2.1.2.3	Successful combined attach procedure, EPS service only / MSC temporarily not reachable.....	754
9.2.1.2.4	Successful combined attach procedure, EPS service only / CS domain not available.....	761
9.2.1.2.6	Combined attach / rejected / Illegal ME.....	766
9.2.1.2.8	Combined attach / rejected / EPS services not allowed	768
9.2.1.2.9	Combined attach / rejected / PLMN not allowed	769
9.2.1.2.10	Combined attach / rejected / Tracking area not allowed.....	773
9.2.2	Detach procedure	776
9.2.2.1	UE initiated detach procedure	776
9.2.2.1.1	UE initiated detach / UE switched off	776
9.2.2.1.2	UE initiated detach / USIM removed from the UE.....	777
9.2.2.1.6	UE initiated detach / Abnormal case / local detach after 5 attempts due to no network response	779
9.2.2.2	Network initiated detach procedure	780
9.2.2.2.1	NW initiated detach / re-attach required.....	780
9.2.2.2.2	NW initiated detach / IMSI detach	782
9.2.2.2.4	Void	784
9.2.2.2.6	Void	784
9.2.2.2.7	Void	784
9.2.2.2.8	Void	785
9.2.3	Tracking area updating procedure (S1 mode only).....	785
9.2.3.1	Normal and periodic tracking area updating	785
9.2.3.1.1	Normal tracking area update / accepted.....	785
9.2.3.1.2	Normal tracking area update / accepted / "Active" flag set	788
9.2.3.1.4	Normal tracking area update / list of equivalent PLMNs in the TRACKING AREA UPDATE ACCEPT message	792
9.2.3.1.5	Periodic tracking area update / accepted.....	795
9.2.3.1.8	UE receives an indication that the RRC connection was released with cause "load balancing TAU required"	800
9.2.3.1.10	Normal tracking area update / rejected / IMSI invalid	802
9.2.3.1.11	Normal tracking area update / rejected / illegal ME	805
9.2.3.1.12	Normal tracking area update / rejected / EPS service not allowed	806
9.2.3.1.13	Normal tracking area update / rejected / UE identity cannot be derived by the network	809
9.2.3.1.14	Normal tracking area update / rejected / UE implicitly detached.....	811
9.2.3.1.15	Normal tracking area update / rejected / PLMN not allowed	813
9.2.3.1.16	Normal tracking area update / rejected / Tracking area not allowed	817
9.2.3.2	Combined tracking area updating	822
9.2.3.2.1	Combined tracking area update / successful.....	822
9.2.3.2.3	Combined tracking area update / successful for EPS services only / MSC temporarily not reachable.....	829
9.2.3.2.6	Combined tracking area update / rejected / Illegal ME	832
9.2.3.2.10	Combined tracking area update / rejected / UE implicitly detached.....	834
9.2.3.2.12	Combined tracking area update / rejected / Tracking area not allowed.....	836
9.2.3.2.15	Combined tracking area update / rejected / No suitable cells in tracking area	840
9.2.3.3.1	First Iu mode to S1 mode intersystem change after attach; go to E-UTRAN RRC idle; RAU to UTRAN	842
9.2.3.4.1	TAU/RAU procedure for inter-system cell re-selection between A/Gb and S1 modes.....	847

9.3	EMM connection management procedures (S1 mode only)	858
9.3.1	Service Request Procedure	858
9.3.1.1	Service Request initiated by UE for user data	858
9.3.1.2	Service Request initiated by UE for uplink signalling	860
9.3.1.3	Service Request / Mobile originating CS fallback	862
9.3.1.4	Service Request / Rejected / IMSI invalid	864
9.3.1.7a	Service Request / Rejected / UE implicitly detached	866
9.3.2	Paging procedure	868
9.3.2.1	Paging procedure	868
9.3.2.2	Paging for CS fallback / Idle mode	869
9.4	NAS Security	871
9.4.1	Integrity protection: Correct functionality of EPS NAS integrity algorithm (SNOW3G)	871
9.4.2	Integrity protection: Correct functionality of EPS NAS integrity algorithm (AES)	874
9.4.3	Ciphering and Deciphering: Correct functionality of EPS NAS encryption algorithm (SNOW3G)	874
9.4.4	Ciphering and Deciphering: Correct functionality of EPS NAS encryption algorithm (AES)	877
10	EPS Session Management	878
10.2.1	Dedicated EPS bearer context activation / Success	878
10.3	EPS bearer context modification	880
10.3.1	EPS bearer context modification / Success	880
10.4	EPS bearer context deactivation	881
10.4.1	EPS bearer context deactivation / Success	881
10.5	UE requested PDN connectivity	890
10.5.1	UE requested PDN connectivity accepted by the network	890
10.5.2	UE requested PDN connectivity accepted by the network / no PDN address allocated	896
10.5.3	UE requested PDN connectivity not accepted	902
10.6	UE requested PDN disconnect	905
10.6.1	UE requested PDN disconnect procedure accepted by the network	905
10.6.2	UE requested PDN disconnect procedure not accepted by the network	908
10.7.1	UE requested bearer resource modification accepted by the network / new EPS bearer context	911
11	General Tests	913
12	E-UTRA Radio Bearer Tests	914
12.1	Generic E-UTRA radio bearer test procedure	914
12.1.1	Generic E-UTRA radio bearer test procedure – one layer of spatial multiplexing layer	914
12.2	Data transfer of E-UTRA radio bearer combinations – one layer DL spatial multiplexing	915
	Annex A (informative): Change history	917
	History	926

Foreword

This Technical Specification has been produced by the 3rd Generation Partnership Project (3GPP).

The contents of the present document are subject to continuing work within the TSG and may change following formal TSG approval. Should the TSG modify the contents of the present document, it will be re-released by the TSG with an identifying change of release date and an increase in version number as follows:

Version x.y.z

where:

- x the first digit:
 - 1 presented to TSG for information;
 - 2 presented to TSG for approval;
 - 3 or greater indicates TSG approved document under change control.
- y the second digit is incremented for all changes of substance, i.e. technical enhancements, corrections, updates, etc.
- z the third digit is incremented when editorial only changes have been incorporated in the document.

Introduction

The present document is the first part of a multi-part conformance specification valid for 3GPP Release 8. 3GPP TS 36.523-2 [18] contains a pro-forma for the Implementation Conformance Statement (ICS) and an applicability table, indicating the release from which each test case is applicable. 3GPP TS 36.523-3 [19] contains a detailed and executable description of the test cases written in a standard testing language, TTCN, as defined in ISO/IEC 9646.

For at least a minimum set of services, the prose descriptions of test cases will have a matching detailed test case implemented in TTCN [19].

The present document may contain descriptions of tests for additional services, but these tests may not have matching TTCN test cases.

The present document will not contain any tests on the USIM, or the interface between the UE and the USIM. These tests are documented elsewhere.

1 Scope

The present document specifies the protocol conformance testing for the 3rd Generation E-UTRAN User Equipment (UE).

This is the first part of a multi-part test specification. The following information can be found in this part:

- the overall test structure;
- the test configurations;
- the conformance requirement and reference to the core specifications;
- the test purposes; and
- a brief description of the test procedure, the specific test requirements and short message exchange table.

The following information relevant to testing could be found in accompanying specifications:

- the default setting of the test parameters [18];
- the applicability of each test case [19].

A detailed description of the expected sequence of messages could be found in the 3rd part of this test specification.

The Implementation Conformance Statement (ICS) pro-forma could be found in the 2nd part of the present document.

The present document is valid for UE implemented according to 3GPP Release 8.

2 References

The following documents contain provisions which, through reference in this text, constitute provisions of the present document.

- References are either specific (identified by date of publication, edition number, version number, etc.) or non-specific.
- For a specific reference, subsequent revisions do not apply.
- For a non-specific reference, the latest version applies. In the case of a reference to a 3GPP document (including a GSM document), a non-specific reference implicitly refers to the latest version of that document in the same Release as the present document.
 - For a Release 8 UE, references to 3GPP documents are to version 8.x.y, when available.

- [1] 3GPP TR 21.905: "Vocabulary for 3GPP Specifications".
- [2] 3GPP TS 23.003: "Numbering, Addressing and Identification".
- [3] 3GPP TS 23.122: "Non-Access-Stratum functions related to Mobile Station (MS) in idle mode".
- [4] 3GPP TS 24.008: "Mobile Radio Interface Layer 3 specification; Core Network Protocols; Stage 3".
- [5] 3GPP TS 34.108: "Common Test Environments for User Equipment (UE) Conformance Testing".
- [6] 3GPP TS 34.109: "Terminal logical test interface; Special conformance testing functions".
- [7] 3GPP TS 34.123-1: "User Equipment (UE) conformance specification; Part 1: Protocol conformance specification".
- [8] 3GPP TS 34.123-2: "User Equipment (UE) conformance specification; Part 2: Implementation Conformance Statement (ICS) proforma specification".

- [9] 3GPP TS 34.123-3: "User Equipment (UE) conformance specification; Part 3: Abstract Test Suites (ATS)".
- [10] 3GPP TS 36.300: "Evolved Universal Terrestrial Radio Access (E-UTRA) and Evolved Universal Terrestrial Radio Access Network (E-UTRAN); Overall description; Stage 2".
- [11] 3GPP TS 36.302: "Services provided by the physical layer for E-UTRA".
- [12] 3GPP TS 36.304: "Evolved Universal Terrestrial Radio Access (E-UTRA) User Equipment (UE) Procedures in idle mode".
- [13] 3GPP TS 36.306: "Evolved Universal Terrestrial Radio Access (E-UTRA) User Equipment (UE) Radio Access capabilities".
- [14] 3GPP TS 36.321: "Evolved Universal Terrestrial Radio Access (E-UTRA) Medium Access Control (MAC) protocol specification".
- [15] 3GPP TS 36.322: "Evolved Universal Terrestrial Radio Access (E-UTRA) Radio Link Control (RLC) protocol specification".
- [16] 3GPP TS 36.323: "Evolved Universal Terrestrial Radio Access (E-UTRA) Packet Data Convergence Protocol (PDCP) specification".
- [17] 3GPP TS 36.331: "Evolved Universal Terrestrial Radio Access (E-UTRA) Radio Resource Control (RRC) Protocol Specification".
- [18] 3GPP TS 36.508: "Evolved Universal Terrestrial Radio Access (E-UTRA) and Evolved Universal Terrestrial Radio Access (E-UTRAN); Common Test Environments for User Equipment (UE) Conformance Testing".
- [19] 3GPP TS 36.523-2: "Evolved Universal Terrestrial Radio Access (E-UTRA) and Evolved Universal Terrestrial Radio Access (E-UTRAN); User Equipment (UE) conformance specification; Part 2: Implementation Conformance Statement (ICS) proforma specification".
- [20] 3GPP TS 36.523-3: "Evolved Universal Terrestrial Radio Access (E-UTRA) and Evolved Universal Terrestrial Radio Access (E-UTRAN); User Equipment (UE) conformance specification; Part 3: Abstract Test Suites (ATS)".
- [21] 3GPP TR 24.801: "3GPP System Architecture Evolution; CT WG1 Aspects".
- [22] 3GPP TS 23.401: "3GPP System Architecture Evolution; GPRS enhancements for E-UTRAN access".
- [23] 3GPP TS 51.010-1: "Mobile Station (MS) conformance specification; Part 1: Conformance specification".
- [24] ISO/IEC 9646 (all parts): "Information technology - Open Systems Interconnection - Conformance testing methodology and framework".
- [25] 3GPP TS 36.509: "Evolved Universal Terrestrial Radio Access (E-UTRA) and Evolved Universal Terrestrial Radio Access Network (E-UTRAN); Special conformance testing functions for User Equipment (UE)".
- [26] 3GPP TS 33.102: "3G Security; Security architecture".
- [27] 3GPP TS 33.401: "3GPP System Architecture Evolution (SAE); Security architecture".
- [28] 3GPP TS 24.301: "Non-Access-Stratum (NAS) protocol for Evolved Packet System (EPS); Stage 3".
- [29] 3GPP TS 36.212: "Evolved Universal Terrestrial Radio Access (E-UTRA); Multiplexing and channel coding".
- [30] 3GPP TS 36.213: "Evolved Universal Terrestrial Radio Access (E-UTRA); Physical layer procedures".

3 Definitions, symbols and abbreviations

3.1 Definitions

For the purposes of the present document, the terms and definitions given in TR 21.905 [1] and the following apply. A term defined in the present document takes precedence over the definition of the same term, if any, in TR 21.905 [1].

example: text used to clarify abstract rules by applying them literally.

Floor: Floor(x) is the largest integer smaller than or equal to x.

Ceil: Ceil (x) is the smallest integer larger than or equal to x.

3.2 Abbreviations

For the purposes of the present document, the abbreviations given in TR 21.905 [1] and the following apply. An abbreviation defined in the present document takes precedence over the definition of the same abbreviation, if any, in TR 21.905 [1].

ENB	Evolved Node B
FDD	Frequency Division Duplex
FFS	For Further Study
ICS	Implementation Conformance Statement
ROHC	RObust Header Compression

4 Overview

4.1 Test Methodology

4.1.1 Testing of optional functions and procedures

Any function or procedure which is optional, as indicated in the present document, may be subject to a conformance test if it is implemented in the UE.

A declaration by the apparatus supplier (ICS) is used to determine whether an optional function/procedure has been implemented.

4.1.2 Test interfaces and facilities

Detailed descriptions of the UE test interfaces and special facilities for testing will be provided in [6 or FFS].

4.2 Implicit Testing

For some 3GPP signalling and protocol features conformance is not verified explicitly in the present document. This does not imply that correct functioning of these features is not essential, but that these are implicitly tested to a sufficient degree in other tests.

5 Reference Conditions

The reference environments used by all signalling and protocol tests will be specified in TS 36.508 [18]. Where a test requires an environment that is different, this will be specified in the test itself.

5.1 Generic setup procedures

A set of basic generic procedures for radio resource signalling, and generic setup procedures for layer 3 NAS signalling will be described in TS 36.508 [18]. These procedures will be used in numerous test cases throughout the present document.

6 Idle Mode Operations

6.0 Introduction

6.0.1 PLMN and TAC

The PLMN numbers indicated in Table 6.0.1-1 are used in test cases to associate a cell with an MCC and MNC for that cell. If no PLMN is explicitly specified, the default value is PLMN 1.

Table 6.0.1-1: Tracking Area Identity (TAI) in System Information Block Type 1 broadcast on the BCCH (E-UTRAN)

PLMN	MCC1	MCC2	MCC3	MNC1	MNC2	MNC3	TAC
1	0	0	1	0	1	Not present	See Table 6.0.1-2
2	0	0	2	1	1	Not present	
3	0	0	3	2	1	Not present	
4	0	0	4	3	1	Not present	
5	0	0	5	4	1	Not present	
6	0	0	6	5	1	Not present	
7	0	0	7	6	1	Not present	
8	0	0	8	7	1	Not present	
9	0	0	9	0	2	Not present	
10	0	1	0	1	2	Not present	
11	0	1	1	2	2	Not present	
12	0	1	2	3	2	Not present	

NOTE: The Location Area Information (LAI) for UTRA and GSM could be re-used from TS 34.123-1 clause 6.

If no TAC for E-UTRAN cell is explicitly specified in the test case description, the TACs for E-UTRAN cells indicated in Table 6.0.1-2 are used in the test case.

Table 6.0.1-2: Tracking Area Code (TAC) for E-UTRAN cells

cell ID	TAC
Cell 1	1
Cell 2	2
Cell 3	3
Cell 4	4
Cell 6	6
Cell 10	10
Cell 11	11
Cell 12	12
Cell 13	13
Cell 14	14

If no RAI for UTRAN cell is explicitly specified in the test case description, the RAI for UTRAN cells indicated in Table 4.4.4-2 in [18] are used in the test case.

6.0.2 Other

Editor's note: Other generic [FFS] information for idle mode testing to be added in this clause is as follows:

- Default values of the system information fields for different methods and IEs specific to idle mode;
- Requirements for FDD and TDD cells (check TS 36.331) in order for the UE to be able to identify a new detectable cell and camp on it (minimum channel power levels);
- Generic test behaviour in case of combined E-UTRA/UTRA/GSM/HRPD/1xRTT tests: indication of access technology;

- Test channel numbers used in test cases to associate a cell with a frequency for that cell. If no channel is explicitly specified, the default value is Test Channel 1. The frequencies and RF signal levels for UTRA and GSM could be re-used from TS 34.123-1 clause 6. The frequencies and RF signal levels for E-UTRA test channels shall be based on TS 36.508 clauses 4.3.1.1, 4.3.1.2 and 4.3.4.

6.1 In a pure E-UTRAN environment

6.1.1 PLMN Selection

6.1.1.1 PLMN selection of RPLMN, HPLMN/EHPLMN, UPLMN and OPLMN; Automatic mode

6.1.1.1.1 Test Purpose (TP)

(1)

```
with { UE in Automatic network selection mode and RPLMN, HPLMN, UPLMN and OPLMN E-UTRAN cells
available and UE is fitted with a USIM indicating RPLMN should be selected }
ensure that {
  when { UE is switched on or return to coverage }
    then { UE selects a cell of the RPLMN and UE attempts a location registration on the selected
cell and when successfully registered indicates the selected PLMN to the user. }
}
```

(2)

```
with { UE camped on an E-UTRAN VPLMN cell and cells of a higher priority E-UTRAN PLMN available }
ensure that {
  when { higher priority PLMN search timer T expires }
    then { UE selects and camps on a cell of the highest priority PLMN and UE attempts a location
registration on the selected cell and when successfully registered indicates the selected PLMN to
the user. }
}
```

(3)

```
with { UE in Automatic network selection mode and HPLMN, UPLMN and OPLMN E-UTRAN cells available and
UE is fitted with a USIM with Access Technology data files for each PLMN and there are no equivalent
HPLMNs defined}
ensure that {
  when { UE is switched on or return to coverage }
    then { UE selects a cell of the highest priority PLMN and UE attempts a location registration on
the selected cell and when successfully registered indicates the selected PLMN to the user. }
}
```

6.1.1.1.2 Conformance requirements

References: The conformance requirements covered in the present TC are specified in: TS 23.122 clauses 4.4.3.1, 4.4.3.1.1 and 4.4.3.3.

[TS 23.122, clause 4.4.3.1]

At switch on, or following recovery from lack of coverage, the MS selects the registered PLMN or equivalent PLMN (if it is available) using all access technologies that the MS is capable of and if necessary (in the case of recovery from lack of coverage, see clause 4.5.2) attempts to perform a Location Registration.

...

If successful registration is achieved, the MS indicates the selected PLMN.

If there is no registered PLMN, or if registration is not possible due to the PLMN being unavailable or registration failure, the MS follows one of the following two procedures depending on its PLMN selection operating mode. At switch on, if the MS provides the optional feature of user preferred PLMN selection operating mode at switch on then this operating mode shall be used.

...

NOTE 1: If successful registration is achieved, then the current serving PLMN becomes the registered PLMN and the MS does not store the previous registered PLMN for later use.

...

NOTE2: ...

[TS 23.122, clause 4.4.3.1.1]

The MS selects and attempts registration on other PLMN/access technology combinations, if available and allowable, in the following order:

- i) either the HPLMN (if the EHPLMN list is not present or is empty) or the highest priority EHPLMN that is available (if the EHPLMN list is present) ;
- ii) each PLMN/access technology combination in the "User Controlled PLMN Selector with Access Technology" data file in the SIM (in priority order);
- iii) each PLMN/access technology combination in the "Operator Controlled PLMN Selector with Access Technology" data file in the SIM (in priority order);
- iv) ...
- v) ...

When following the above procedure the following requirements apply:

- a) ...
- b) ...
- c) In ii and iii, the MS should limit its search for the PLMN to the access technology or access technologies associated with the PLMN in the appropriate PLMN Selector with Access Technology list (User Controlled or Operator Controlled selector list). An MS using a SIM without access technology information storage (i.e. the "User Controlled PLMN Selector with Access Technology" and the "Operator Controlled PLMN Selector with Access Technology" data files are not present) shall instead use the "PLMN Selector" data file, for each PLMN in the "PLMN Selector" data file, the MS shall search for all access technologies it is capable of and shall assume GSM access technology as the highest priority radio access technology.
- d) ...
- e) ...
- f) In i, the MS shall search for all access technologies it is capable of. No priority is defined for the preferred access technology and the priority is an implementation issue, but "HPLMN Selector with Access Technology" data file on the SIM may be used to optimise the procedure.
- g) ...
- h) ...

NOTE 1: ...

NOTE 2: ...

NOTE 3: High quality signal is defined in the appropriate AS specification.

If successful registration is achieved, the MS indicates the selected PLMN.

...

[TS 23.122, clause 4.4.3.3]

If the MS is in a VPLMN, the MS shall periodically attempt to obtain service on its HPLMN (if the EHPLMN list is not present or is empty) or one of its EHPLMNs (if the EHPLMN list is present) or a higher priority PLMN/access technology combinations listed in "user controlled PLMN selector" or "operator controlled PLMN selector" by scanning in accordance with the requirements that are applicable to i), ii) and iii) as defined in the Automatic Network Selection Mode in clause 4.4.3.1.1. In the case that the mobile has a stored "Equivalent PLMNs" list the mobile shall only select a PLMN if it is of a higher priority than those of the same country as the current serving PLMN which are stored in the "Equivalent PLMNs" list. For this purpose, a value T minutes may be stored in the SIM, T is either in the range 6 minutes to 8 hours in 6 minute steps or it indicates that no periodic attempts shall be made. If no value is stored in the SIM, a default value of 60 minutes is used.

The attempts to access the HPLMN or an EHPLMN or higher priority PLMN shall be as specified below:

- a) The periodic attempts shall only be performed in automatic mode when the MS is roaming;
- b) After switch on a period of at least 2 minutes and at most T minutes shall elapse before the first attempt is made;
- c) The MS shall make the following attempts if the MS is on the VPLMN at time T after the last attempt;
- d) Periodic attempts shall only be performed by the MS while in idle mode;
- e) If the HPLMN (if the EHPLMN list is not present or is empty) or a EHPLMN (if the list is present) or a higher priority PLMN is not found, the MS shall remain on the VPLMN.
- f) In steps i), ii) and iii) of subclause 4.4.3.1.1 the MS shall limit its attempts to access higher priority PLMN/access technology combinations to PLMN/access technology combinations of the same country as the current serving VPLMN, as defined in Annex B.
- g) ...
- h) If the PLMN of the highest priority PLMN/access technology combination available is the current VPLMN, or one of the PLMNs in the "Equivalent PLMNs" list, the MS shall remain on the current PLMN/access technology combination.

6.1.1.1.3 Test description

6.1.1.1.3.1 Pre-test conditions

System Simulator

- Four inter-frequency multi-PLMN cells as specified in TS36.508 clause 4.4.1.2 are configured broadcasting default PLMNs as indicated in TS 36.508 Table 4.4.2-2 except that all MCC values are the same as for Cell 1.
- The PLMNs are identified in the test by the identifiers in Table 6.1.1.1.3.1-1.

Table 6.1.1.1.3.1–1: PLMN identifiers

Cell	PLMN name
1	PLMN4
12	PLMN1
13	PLMN2
14	PLMN3

UE

- The UE is in Automatic PLMN selection mode.
- The UE is equipped with a USIM containing default values (as per TS 36.508) except for those listed in Table 6.1.1.1.3.1-2.

Table 6.1.1.1.3.1–2: USIM configuration

USIM field	Priority	Value	Access Technology Identifier
EF _{LOCI}		PLMN1 (See preamble)	
EF _{IMSI}		The HPLMN (MCC+MNC) of the IMSI is set to PLMN4.	
EF _{PLMNwAcT}	1 2 3	Default PLMN3 PLMN2 Remaining mandatory entries use default values	Default All specified E-UTRAN
EF _{OPLMNwAcT}	1	PLMN1 Remaining defined entries use default values	All specified
EF _{HPLMNwAcT}	1	PLMN4	UTRAN & E-UTRAN
EF _{UST}		Services 20, 42, 43 and 74 are supported. Service 71 is not supported (there is no EHPLMN list).	
EF _{HPPLMN}		1 (6 minutes)	

Preamble

- The UE is in state Switched OFF (State 1).

6.1.1.1.3.2 Test procedure sequence

Table 6.1.1.1.3.2 – 1 shows the cell configurations used during the test. The configuration T0 indicates the initial conditions. Subsequent configurations marked “T1”, “T2” etc are applied at the points indicated in the Main behaviour description in Table 6.1.1.1.3.2-2. Cell powers are chosen for a serving cell and a non-suitable “Off” cell as defined in TS36.508 Table 6.2.2.1-1.

Table 6.1.1.1.3.2-1: Cell configuration changes over time

	Parameter	Unit	Cell 1	Cell 12	Cell 13	Cell 14	Remarks
T0	RS EPRE	dBm/15kHz	“Off”	-85	“Off”	“Off”	Power level “Off” is defined in TS36.508 Table 6.2.2.1-1
T1	RS EPRE	dBm/15kHz	[-85]	[-85]	[-85]	[-85]	
T2	RS EPRE	dBm/15kHz	“Off”	[-85]	[-85]	“Off”	Power level “Off” is defined in TS36.508 Table 6.2.2.1-1
T3	RS EPRE	dBm/15kHz	“Off”	[-85]	[-85]	[-85]	Power level “Off” is defined in TS36.508 Table 6.2.2.1-1

Table 6.1.1.1.3.2-2: Main behaviour

St	Procedure	Message Sequence		TP	Verdict
		U - S	Message		
1	SS adjusts cell levels according to row T1 of table 6.1.1.1.3.2-1	-	-	-	-
2	Power on the UE.	-	-	-	-
3	Check: Does the UE initiate a random access on Cell 1?	-	-	1	P
4	The UE performs the registration procedure described in TS 36.508 table 4.5.2.3-1	-	-	-	-
5	Check: Is PLMN1 indicated by the UE?	-	-	1	P
6	Check: Does the UE initiate a random access on Cell 1 after 120 seconds, but before 360 seconds from power on?	-	-	2	P
7	Check: Is PLMN4 indicated by the UE?	-	-	2	P
8	Check: Does the UE initiate a random access within [720 seconds]?	-	-	2	F
9	SS adjusts cell levels according to row T2 of table 6.1.1.1.3.2-1	-	-	-	-
10	Check: Does the UE initiate a random access on Cell 13?	-	-	3	P
11	Check: Is PLMN2 indicated by the UE?	-	-	3	P
12	SS adjusts cell levels according to row T3 of table 6.1.1.1.3.2-1	-	-	-	-
13	Check: Does the UE initiate a random access on Cell 14 after 360 seconds after step 8?	-	-	2	P
14	Check: Is PLMN3 indicated by the UE?	-	-	2	P
15	Check: Does the UE initiate a random access within [720 seconds]?	-	-	2	F

Note 1: Timers in Steps 5, 7, 12 and 14 are derived from the high priority PLMN search timer T defined by EF_{HPPLMN}

6.1.1.1.3.3 Specific message contents

None

6.1.2 Cell Selection and Reselection

6.1.2.2 Cell selection, Qrxlevmin

6.1.2.2.1 Test Purpose (TP)

(1)

```
with { UE in E-UTRA RRC_IDLE state }
ensure that {
  when { a cell fulfils all requirements for a suitable cell except the cell selection criteria
which are not fulfilled (S<0)}
  then { the UE does not consider the cell suitable and no camping on this cell can take place }
}
```

(2)

```
with { UE in E-UTRA RRC_IDLE state }
ensure that {
  when { a cell fulfils all requirements for a suitable cell including the cell selection criteria
for a cell which are also fulfilled (S>0)}
  then { the UE considers the cell suitable and camps on it }
}
```

6.1.2.2.2 Conformance requirements

References: The conformance requirements covered in the current TC are specified in: TS36.300, clause 10.1.1.1 and TS 36.304, clause 4.1, 5.1.2.2, 5.2.3.1, 5.2.3.2 and 5.2.8.

[TS 36.300, clause 10.1.1.1]

...

Cell selection:

- The UE NAS identifies a selected PLMN and equivalent PLMNs;
- The UE searches the E-UTRA frequency bands and for each carrier frequency identifies the strongest cell. It reads cell system information broadcast to identify its PLMN(s):
 - The UE may search each carrier in turn ("initial cell selection") or make use of stored information to shorten the search ("stored information cell selection").
- The UE seeks to identify a suitable cell; if it is not able to identify a suitable cell it seeks to identify an acceptable cell. When a suitable cell is found or if only an acceptable cell is found it camps on that cell and commence the cell reselection procedure:
 - A suitable cell is one for which the measured cell attributes satisfy the cell selection criteria; the cell PLMN is the selected PLMN, registered or an equivalent PLMN; the cell is not barred or reserved and the cell is not part of a tracking area which is in the list of "forbidden tracking areas for roaming";
 - An acceptable cell is one for which the measured cell attributes satisfy the cell selection criteria and the cell is not barred;

...

[TS 36.304, clause 4.1]

...

When a UE is switched on, a public land mobile network (PLMN) is selected by NAS. For the selected PLMN, associated RAT(s) may be set [5]. The NAS shall provide a list of equivalent PLMNs, if available, that the AS shall use for cell selection and cell reselection.

With the cell selection, the UE searches for a suitable cell of the selected PLMN and chooses that cell to provide available services, further the UE shall tune to its control channel. This choosing is known as "camping on the cell".

The UE will, if necessary, then register its presence, by means of a NAS registration procedure, in the tracking area of the chosen cell and as outcome of a successful Location Registration the selected PLMN becomes the registered PLMN [5].

...

[TS 36.304, clause 5.1.2.2]

The UE shall scan all RF channels in the E-UTRA bands according to its capabilities to find available PLMNs. On each carrier, the UE shall search for the strongest cell and read its system information, in order to find out which PLMN(s) the cell belongs to. If the UE can read one or several PLMN identities in the strongest cell, each found PLMN (see the PLMN reading in [3]) shall be reported to the NAS as a high quality PLMN (but without the [quality measure TBD]), provided that the following high quality criterion is fulfilled:

1. For an E-UTRAN cell, the measured RSRP value shall be greater than or equal to -110 dBm.

Found PLMNs that do not satisfy the high quality criterion, but for which the UE has been able to read the PLMN identities are reported to the NAS together with the RSRP value. The quality measure reported by the UE to NAS shall be the same for each PLMN found in one cell.

...

Once the UE has selected a PLMN, the cell selection procedure shall be performed in order to select a suitable cell of that PLMN to camp on.

[TS 36.304, clause 5.2.3.1]

The UE shall use one of the following two cell selection procedures:

- a) Initial Cell Selection

This procedure requires no prior knowledge of which RF channels are E-UTRA carriers. The UE shall scan all RF channels in the E-UTRA bands according to its capabilities to find a suitable cell. On each carrier frequency, the UE need only search for the strongest cell. Once a suitable cell is found this cell shall be selected.

...

[TS 36.304, clause 5.2.3.2]

The cell selection criterion S is fulfilled when:

$$S_{rxlev} > 0$$

Where:

$$S_{rxlev} = Q_{rxlevmeas} - (Q_{rxlevmin} + Q_{rxlevminoffset}) - P_{compensation}$$

Where:

the signalled value $Q_{rxlevminOffset}$ is only applied when a cell is evaluated for cell selection as a result of a periodic search for a higher priority PLMN while camped normally in a VPLMN [5]. During this periodic search for higher priority PLMN the UE may check the S criteria of a cell using parameter values stored from a different cell of this higher priority PLMN.

S_{rxlev}	Cell Selection RX level value (dB)
$Q_{rxlevmeas}$	Measured cell RX level value (RSRP).
$Q_{rxlevmin}$	Minimum required RX level in the cell (dBm)
$Q_{rxlevminoffset}$	Offset to the signalled $Q_{rxlevmin}$ taken into account in the S_{rxlev} evaluation as a result of a periodic search for a higher priority PLMN while camped normally in a VPLMN [5]
$P_{compensation}$	$\max(P_{EMAX} - P_{UMAX}, 0)$ (dB)
P_{EMAX}	Maximum TX power level an UE may use when transmitting on the uplink in the cell (dBm) defined as P_{EMAX} in [TS 36.101]
P_{UMAX}	Maximum RF output power of the UE (dBm) according to the UE power class as defined in [TS 36.101]

[TS 36.304, clause 5.2.8]

In this state, the UE shall attempt to find an acceptable cell of any PLMN to camp on, trying all RATs that are supported by the UE and searching first for a high quality cell, as defined in subclause 5.1.2.2.

The UE, which is not camped on any cell, shall stay in this state until an acceptable cell is found.

6.1.2.2.3 Test description

6.1.2.2.3.1 Pre-test conditions

System Simulator:

- Cell 1
- Cell 1 is a cell with TAI1 (PLMN1 + TAC1)
- Cell 1 is not a CSG cell, $S_{rxlev_{Cell 1}} < 0$

UE:

USIM contains a valid TAI1..

Preamble:

- The UE is in state Switched OFF (state 1) according to [18].

6.1.2.2.3.2 Test procedure sequence

Table 6.1.2.2.3.2-1 illustrates the downlink power levels and other changing parameters to be applied for the cells at various time instants of the test execution. Row marked "T0" denotes the conditions after the preamble, while row marked "T1" is to be applied subsequently. The exact instants on which these values shall be applied are described in the texts in this clause.

Table 6.1.2.2.3.2-1: Time instances of cell power level and parameter changes

	Parameter	Unit	Cell 1	Remark
T0	Cell-specific RS EPRE	dBm/15kHz	-95	The power level value is such to satisfy $S_{rxlevCell\ 1} < 0$ but the UE is able to read the PLMN identity
	Qrxlevmin	dBm	-84	
	Qrxlevminoffset	dB	0	
	Pcompensation	dB	0	
T1	Cell-specific RS EPRE	dBm/15kHz	-75	The power level is such that $S_{rxlevCell\ 1} > 0$

Note: The downlink signal level uncertainty is specified in TS 36.508 section 4.3.4.1

Table 6.1.2.2.3.2-2: Main behaviour

St	Procedure	Message Sequence		TP	Verdict
		U - S	Message		
1	The UE is switched on.	-	-	-	-
2	Check: Is there any random access request from the UE on Cell 1 within the next 60 s?	-	-	1	F
3	SS re-adjusts the cell-specific reference signal level of Cell 1 level according to row "T1" in table 6.1.2.2.3.2-1.	-	-	-	-
4	Check: Is there any random access request from the UE on Cell1?	-	-	2	P

6.1.2.2.3.3 Specific message or IE contents

Table 6.1.2.2.3.3-1: SystemInformationBlockType1 for cell 1 (preamble)

Derivation Path: 36.508 clause 4.4.3.2			
Information Element	Value/Remark	Comment	Condition
SystemInformationBlockType1 ::= SEQUENCE { cellSelectionInfo SEQUENCE { q-RxLevMin } schedulingInfoList ::= SEQUENCE (SIZE (1..maxSI-Message)) OF SEQUENCE {} }	-42 (-84 dBm) Combination 1 in TS 36.508 section 4.4.3.1.1	Only SIB2 and SIB3 are transmitted	

6.1.2.3 Cell selection / intra E-UTRAN / serving cell becomes non-suitable ($S < 0$, barred) (intra frequency)

6.1.2.3.1 Test Purpose (TP)

(1)

```
with { UE in E-UTRA RRC_IDLE state }
ensure that {
  when { the serving cell becomes non-suitable ( $S < 0$ ) and there is a suitable neighbour cell ( $S > 0$ ) }
  then { UE selects the suitable neighbour cell }
```

(2)

```

with { UE in E-UTRA RRC_IDLE state }
ensure that {
  when { the serving cell becomes barred and there is a suitable neighbour cell }
  then { UE selects the suitable neighbour cell }
}

```

6.1.2.3.2 Conformance requirements

References: The conformance requirements covered in the current TC are specified in: TS36.300, clause 10.1.1.1 and TS 36.304, clause 4.1, 5.2.1, 5.2.3.2, 5.2.4.6 and 5.3.1.

[TS 36.300, clause 10.1.1.1]

...

Cell selection:

- The UE NAS identifies a selected PLMN and equivalent PLMNs;
- The UE searches the E-UTRA frequency bands and for each carrier frequency identifies the strongest cell. It reads cell system information broadcast to identify its PLMN(s):
 - The UE may search each carrier in turn ("initial cell selection") or make use of stored information to shorten the search ("stored information cell selection").
- The UE seeks to identify a suitable cell; if it is not able to identify a suitable cell it seeks to identify an acceptable cell. When a suitable cell is found or if only an acceptable cell is found it camps on that cell and commence the cell reselection procedure:
 - A suitable cell is one for which the measured cell attributes satisfy the cell selection criteria; the cell PLMN is the selected PLMN, registered or an equivalent PLMN; the cell is not barred or reserved and the cell is not part of a tracking area which is in the list of "forbidden tracking areas for roaming";
 - An acceptable cell is one for which the measured cell attributes satisfy the cell selection criteria and the cell is not barred;

...

[TS 36.304, clause 4.1]

...

With the cell selection, the UE searches for a suitable cell of the selected PLMN and chooses that cell to provide available services, further the UE shall tune to its control channel. This choosing is known as "camping on the cell".

The UE will, if necessary, then register its presence, by means of a NAS registration procedure, in the tracking area of the chosen cell and as outcome of a successful Location Registration the selected PLMN becomes the registered PLMN [5].

If the UE finds a more suitable cell, according to the cell reselection criteria, it reselects onto that cell and camps on it. If the new cell does not belong to at least one tracking area to which the UE is registered, location registration is performed.

...

[TS 36.304, clause 5.2.1]

...

When camped on a cell, the UE shall regularly search for a better cell according to the cell reselection criteria. If a better cell is found, that cell is selected.

...

[TS 36.304, clause 5.2.3.2]

The cell selection criterion S is fulfilled when:

$$S_{rxlev} > 0$$

Where:

$$S_{rxlev} = Q_{rxlevmeas} - (Q_{rxlevmin} - Q_{rxlevminoffset}) - P_{compensation}$$

Where:

the signalled value $Q_{rxlevminOffset}$ is only applied when a cell is evaluated for cell selection as a result of a periodic search for a higher priority PLMN while camped normally in a VPLMN [5]. During this periodic search for higher priority PLMN the UE may check the S criteria of a cell using parameter values stored from a different cell of this higher priority PLMN.

S_{rxlev}	Cell Selection RX level value (dB)
$Q_{rxlevmeas}$	Measured cell RX level value (RSRP).
$Q_{rxlevmin}$	Minimum required RX level in the cell (dBm)
$Q_{rxlevminoffset}$	Offset to the signalled $Q_{rxlevmin}$ taken into account in the S_{rxlev} evaluation as a result of a periodic search for a higher priority PLMN while camped normally in a VPLMN [5]
$P_{compensation}$	$\max(P_{EMAX} - P_{UMAX}, 0)$ (dB)
P_{EMAX}	Maximum TX power level an UE may use when transmitting on the uplink in the cell (dBm) defined as P_{EMAX} in [TS 36.101]
P_{UMAX}	Maximum RF output power of the UE (dBm) according to the UE power class as defined in [TS 36.101]

[TS 36.304, clause 5.2.4.6]

...

In all cases, the UE shall reselect the new cell, only if the following conditions are met:

- the new cell is better ranked than the serving cell during a time interval $T_{reselection_{RAT}}$;
- more than 1 second has elapsed since the UE camped on the current serving cell.

[TS 36.304, clause 5.3.1]

Cell status and cell reservations are indicated in the *SystemInformationBlockType1* [3] by means of two Information Elements:

- cellBarred (IE type: "barred" or "not barred")
In case of multiple PLMNs indicated in SIB1 sharing, this IE is common for all PLMNs

...

When cell status is indicated as "not barred" and "not reserved" for operator use,

- All UEs shall treat this cell as candidate during the cell selection and cell re-selection procedures.

...

When cell status "barred" is indicated or to be treated as if the cell status is "barred",

- The UE is not permitted to select/re-select this cell, not even for emergency calls.
- The UE shall select another cell according to the following rule:
 - If the cell is a CSG cell:
 - the UE may select another cell on the same frequency if the selection/reselection criteria are fulfilled.

- else
 - If the IE *intraFreqReselection* in IE *cellAccessRelatedInfo* in *SystemInformationBlockType1* is set to "allowed", the UE may select another cell on the same frequency if re-selection criteria are fulfilled.
 - The UE shall exclude the barred cell as a candidate for cell selection/reselection for 300 seconds.
 - If the IE *intraFreqReselection* in IE *cellAccessRelatedInfo* in *SystemInformationBlockType1* is set to "not allowed" the UE shall not re-select a cell on the same frequency as the barred cell.
 - The UE shall exclude the barred cell as a candidate for cell selection/reselection for 300 seconds.

...

6.1.2.3.3 Test description

6.1.2.3.3.1 Pre-test conditions

System Simulator:

- Cell 1 and Cell 2
- Cell 1 and Cell 2 are high quality cells on the same E-UTRA frequency and different tracking areas:
 - Cell 1 serving cell, $Srxlev_{Cell\ 1} > 0$
 - Cell 2 $Srxlev_{Cell\ 2} > 0$
 - $Treselection_{Cell\ 1} = Treselection_{Cell\ 2} > 1$ second

UE:

None.

Preamble:

- UE is in state Registered, Idle Mode (state 2) according to [18].

6.1.2.3.3.2 Test procedure sequence

Table 6.1.2.3.3.2-1 illustrates the downlink power levels and other changing parameters to be applied for the cells at various time instants of the test execution. Row marked "T0" denotes the conditions after the preamble, while rows marked "T1" and "T2" are to be applied subsequently. The exact instants on which these values shall be applied are described in the texts in this clause.

Table 6.1.2.3.3.2-1: Time instances of cell power level and parameter changes

	Parameter	Unit	Cell 1	Cell 2	Remark
T0	Cell-specific RS EPRE	dBm/ 15kHz Z	-60	-80	$Srxlev_{Cell\ 1} > Srxlev_{Cell\ 2}$, such that camping on Cell 1 is guaranteed
	Qrxlevmin	dBm	-110	-110	
	Qrxlevminoffset	dB	0	0	
	Qhyst	dB	0	0	
	Treselection	s	7	7	Cell reselection timer values for EUTRA cells
	Srxlev*	dB	50	30	Cell 1 is the strongest cell
T1	Cell-specific RS EPRE	dBm/ 15kHz Z	-120	-80	$Srxlev_{Cell\ 1} < 0$
	Srxlev*	dB	-10	30	Cell 2 becomes the strongest cell
T2	Cell-specific RS EPRE	dBm/ 15kHz Z	-100	-80	$Srxlev_{Cell\ 2} > Srxlev_{Cell\ 1} > 0$
	Srxlev*	dB	10	30	Cell 1 becomes suitable
	cellBarred	-	notBarred	barred	Serving cell becomes barred

Table 6.1.2.3.3.2-2: Main behaviour

St	Procedure	Message Sequence		TP	Verdict
		U - S	Message		
1	SS re-adjusts the cell-specific reference signal level of Cell 1 according to row "T1" in table 6.1.2.3.3.2-1.	-	-	-	-
2	Check: Is there any random access requests from the UE on Cell 2.	-	-	1	P
3	SS changes serving cell signal level and SIB1 IE <i>cellBarred</i> according to row "T2" in table 6.1.2.3.3.2-1 and transmits a <i>Paging</i> message including <i>systemInfoModification</i>	<--	<i>Paging</i>	-	-
4	Check: Is there any random access request from the UE on Cell 1?	-	-	2	P

6.1.2.3.3.3 Specific message or IE contents

Table 6.1.2.3.3.3-1: Conditions for tables 6.1.2.3.3.3-2, 6.1.2.3.3.3-3 and 6.1.2.3.3.3-4

Condition descriptions
Cell 1 This condition applies to system information transmitted on Cell 1.
Cell 2 This condition applies to system information transmitted on Cell 2.

Table 6.1.2.3.3.3-2: SystemInformationBlockType1 for cells 1 and 2 (preamble and all steps, Table 6.1.2.3.3.2-1)

Derivation Path: 36.508 clause 4.4.3.2			
Information Element	Value/remark	Comment	Condition
SystemInformationBlockType1 ::= SEQUENCE {			
cellSelectionInfo SEQUENCE {			
q-RxLevMin	-55 (-110 dBm)		
}			
schedulingInformation ::= SEQUENCE (SIZE (1..maxSI-Message)) OF SEQUENCE {	Combination 1 in TS 36.508 section 4.4.3.1.1	Only SIB2 and SIB3 are transmitted	
}			
}			

Table 6.1.2.3.3.3-3: SystemInformationBlockType3 for cells 1 and 2 (Preamble and all steps, table 6.1.2.3.3.2-1)

Derivation Path: 36.508 clause 4.4.3.3, Table 4.4.3.3-2			
Information Element	Value/remark	Comment	Condition
SystemInformationBlockType3 ::= SEQUENCE {			
cellReselectionInfoCommon SEQUENCE {			
q-Hyst	dB0		
}			
intraFreqCellReselectionInfo SEQUENCE {			
q-RxLevMin	-55 (-110 dBm)		
t-ReselectionEUTRA	7		Cell 1
}	7		Cell 2
}			

Table 6.1.2.3.3-4: SystemInformationBlockType1 for cell 2 (step 3, Table 6.1.2.3.3-1)

Derivation Path: 36.508 clause 4.4.3.2			
Information Element	Value/remark	Comment	Condition
SystemInformationBlockType1 ::= SEQUENCE {			
cellAccessRelatedInfo SEQUENCE {			
cellBarred	barred		Cell 2
intraFreqReselection	allowed		Cell 2
}			
}			

6.1.2.4 Cell reselection

6.1.2.4.1 Test Purpose (TP)

(1)

```
with { UE in E-UTRA RRC_IDLE state }
ensure that {
  when { UE detects the cell ranked as the best cell }
  then { UE reselects the new cell }
}
```

6.1.2.4.2 Conformance requirements

References: The conformance requirements covered in the present TC are specified in: TS 36.304, clause 5.2.4.2 and 5.2.4.6.

[TS 36.304, clause 5.2.4.2]

When evaluating for reselection purposes cell selection criterion or $S_{\text{nonServingCell},x}$, the UE shall use parameters provided by the serving cell.

Following rules are used by the UE to limit needed measurements:

- If $S_{\text{intrasearch}}$ is sent in the serving cell and $S_{\text{ServingCell}} > S_{\text{intrasearch}}$, UE may choose to not perform intra-frequency measurements.
- If $S_{\text{ServingCell}} \leq S_{\text{intrasearch}}$, or $S_{\text{intrasearch}}$ is not sent in the serving cell UE shall perform intra-frequency measurements.
- The UE shall apply the following rules for E-UTRAN inter-frequencies and inter-RAT frequencies which are indicated in system information and for which the UE has priority provided as defined in 5.2.4.1:
 - For an E-UTRAN inter-frequency or inter-RAT frequency with a reselection priority higher than the reselection priority of the current E-UTRA frequency the UE shall perform measurements of higher priority E-UTRAN inter-frequency inter-RAT frequencies according to [10].
 - For an E-UTRAN inter-frequency with an equal or lower reselection priority than the reselection priority of the current E-UTRA frequency and for inter-RAT frequency with lower reselection priority than the reselection priority of the current E-UTRAN frequency:
 - If $S_{\text{nonintrasearch}}$ is sent in the serving cell and $S_{\text{ServingCell}} > S_{\text{nonintrasearch}}$ UE may choose not to perform measurements of E-UTRAN inter-frequencies or inter-RAT frequency cells of equal or lower priority.
 - If $S_{\text{ServingCell}} \leq S_{\text{nonintrasearch}}$ or $S_{\text{nonintrasearch}}$ is not sent in the serving cell the UE shall perform measurements of E-UTRAN inter-frequencies or inter-RAT frequency cells of equal or lower priority according to [10].

Where $S_{\text{ServingCell}}$ is the S_{rxlev} -value of the serving cell.

[TS 36.304, clause 5.2.4.6]

The cell-ranking criterion R_s for serving cell and R_n for neighbouring cells is defined by:

$R_s = Q_{meas,s} + Q_{hyst_s}$ $R_n = Q_{meas,n} - Q_{offset}$

where:

Q_{meas}	RSRP measurement quantity used in cell reselections.
Q_{offset}	For intra-frequency: Equals to $Q_{offsets,n}$, if $Q_{offsets,n}$ is valid, otherwise this equals to zero. For inter-frequency: Equals to $Q_{offsets,n}$ plus $Q_{offset_{frequency}}$, if $Q_{offset_{s,n}}$ is valid, otherwise this equals to $Q_{offset_{frequency}}$.

The UE shall perform ranking of all cells that fulfill the cell selection criterion S, which is defined in 5.2.3.2, but may exclude all CSG cells that are known by the UE to be not allowed.

The cells shall be ranked according to the R criteria specified above, deriving $Q_{meas,n}$ and $Q_{meas,s}$ and calculating the R values using averaged RSRP results.

If a cell is ranked as the best cell the UE shall perform cell re-selection to that cell. If this cell is found to be not-suitable, the UE shall behave according to subclause 5.2.4.4.

In all cases, the UE shall reselect the new cell, only if the following conditions are met:

- the new cell is better ranked than the serving cell during a time interval $T_{reselection_{RAT}}$
- more than 1 second has elapsed since the UE camped on the current serving cell.

6.1.2.4.3 Test description

6.1.2.4.3.1 Pre-test conditions

System Simulator:

- Cell 1 and Cell 2.

UE:

None.

Preamble:

- The UE is in state Registered, Idle mode (state 2) on Cell 1 according to [18].

6.1.2.4.3.2 Test procedure sequence

Table 6.1.2.4.3.2-1 illustrates the downlink power levels and other changing parameters to be applied for the cells at various time instants of the test execution. Row marked "T0" denotes the conditions after the preamble, while columns marked "T1" is to be applied subsequently. The exact instants on which these values shall be applied are described in the texts in this clause.

Table 6.1.2.4.3.2-1: Time instances of cell power level and parameter changes

	Parameter	Unit	Cell 1	Cell 2	Remark
T0	Cell-specific RS EPRE	dBm/15kHz	[-80]	[-95]	The power level values are assigned to satisfy $Srxlev_{Cell\ 1} > Srxlev_{Cell\ 2}$, such that camping on Cell 1 is guaranteed
T1	Cell-specific RS EPRE	dBm/15kHz	[-95]	[-75]	The power level values are assigned to satisfy $R_{Cell\ 1} < R_{Cell\ 2}$.

Editor's note: The limitations on power level settings for multiple cells need to be taken into account

Table 6.1.2.4.3.2-2: Main behaviour

St	Procedure	Message Sequence		TP	Verdict
		U - S	Message		
1	The SS changes Cell 1 and Cell 2 level according to the row "T1" in table 6.1.2.4.3.2-1.	-	-	-	-
2	Check: Is there any random access requests from the UE on Cell 2.	-	-	1	P

6.1.2.4.3.3 Specific message contents

Table 6.1.2.4.3.3-1: SystemInformationBlockType3 for Cell 1 (pre-test conditions)

Derivation path: 36.508 table 4.4.3.3-2			
Information Element	Value/Remark	Comment	Condition
SystemInformationBlockType3 ::= SEQUENCE { cellReselectionInfoCommon SEQUENCE { q-Hyst } }	dB0		

6.1.2.5 Cell reselection for inter-band operation

6.1.2.5.1 Test Purpose (TP)

(1)

```
with { UE in E-UTRA RRC_IDLE state }
ensure that {
  when { UE detects the cell re-selection criteria are met for the cell on the different frequency band }
  then { UE reselects the new cell }
}
```

6.1.2.5.2 Conformance requirements

References: The conformance requirements covered in the present TC are specified in: TS 36.304, clause 5.2.4.1, 5.2.4.2 and 5.2.4.5.

[TS 36.304, clause 5.2.4.1]

Absolute priorities of different E-UTRAN frequencies or inter-RAT frequencies may be provided to the UE in the system information, in the *RRCConnectionRelease* message, or by inheriting from another RAT at inter-RAT cell (re)selection. In the case of system information, an E-UTRAN frequency or inter-RAT frequency may be listed without providing a priority (i.e. the field *cellReselectionPriority* is absent for that frequency). If priorities are provided in dedicated signalling, the UE shall ignore all the priorities provided in system information. If UE is in *camped on any cell* state, UE shall only apply the priorities provided by system information from current cell, and the UE preserves priorities provided by dedicated signalling unless specified otherwise. When the UE in *camped normally* state, has only dedicated priorities other than for the current frequency, the UE shall consider the current frequency to be the lowest priority frequency (i.e. lower than the eight network configured values). The UE shall delete priorities provided by dedicated signalling when:

- the UE enters RRC_CONNECTED state; or
- the optional validity time of dedicated priorities (T320) expires; or
- a PLMN selection is performed on request by NAS [5].

NOTE: Equal priorities between RATs are not supported.

The UE shall only perform cell reselection evaluation for E-UTRAN frequencies and inter-RAT frequencies that are given in system information and for which the UE has a priority provided.

The UE shall not consider any black listed cells as candidate for cell reselection.

The UE shall inherit the priorities provided by dedicated signalling and the remaining validity time (i.e., T320 in E-UTRA, T322 in UTRA and [T3230, FFS] in GERAN), if configured, at inter-RAT cell (re)selection.

NOTE: The network may assign dedicated cell reselection priorities for frequencies not configured by system information.

[TS 36.304, clause 5.2.4.2]

When evaluating for reselection purposes cell selection criterion or $S_{\text{nonServingCell},x}$, the UE shall use parameters provided by the serving cell.

Following rules are used by the UE to limit needed measurements:

- If $S_{\text{intrasearch}}$ is sent in the serving cell and $S_{\text{ServingCell}} > S_{\text{intrasearch}}$, UE may choose to not perform intra-frequency measurements.
- If $S_{\text{ServingCell}} \leq S_{\text{intrasearch}}$, or $S_{\text{intrasearch}}$ is not sent in the serving cell UE shall perform intra-frequency measurements.
- The UE shall apply the following rules for E-UTRAN inter-frequencies and inter-RAT frequencies which are indicated in system information and for which the UE has priority provided as defined in 5.2.4.1:
 - For an E-UTRAN inter-frequency or inter-RAT frequency with a reselection priority higher than the reselection priority of the current E-UTRA frequency the UE shall perform measurements of higher priority E-UTRAN inter-frequency or inter-RAT frequencies according to [10].
 - For an E-UTRAN inter-frequency with an equal or lower reselection priority than the reselection priority of the current E-UTRA frequency and for inter-RAT frequency with lower reselection priority than the reselection priority of the current E-UTRAN frequency:
 - If $S_{\text{nonintrasearch}}$ is sent in the serving cell and $S_{\text{ServingCell}} > S_{\text{nonintrasearch}}$ UE may choose not to perform measurements of E-UTRAN inter-frequencies or inter-RAT frequency cells of equal or lower priority.
 - If $S_{\text{ServingCell}} \leq S_{\text{nonintrasearch}}$ or $S_{\text{nonintrasearch}}$ is not sent in the serving cell the UE shall perform measurements of E-UTRAN inter-frequencies or inter-RAT frequency cells of equal or lower priority according to [10].

Where $S_{\text{ServingCell}}$ is the S_{rxlev} -value of the serving cell.

[TS 36.304, clause 5.2.4.5]

Criteria 1: the $S_{\text{nonServingCell},x}$ of a cell on evaluated frequency is greater than $\text{Thresh}_{x, \text{high}}$ during a time interval $\text{Treselection}_{\text{RAT}}$;

Cell reselection to a cell on a higher priority E-UTRAN frequency or inter-RAT frequency than serving frequency shall be performed if:

- A cell of a higher priority E-UTRAN frequency or inter-RAT frequency fulfils criteria 1; and
- more than 1 second has elapsed since the UE camped on the current serving cell.

Cell reselection to a cell on a lower priority E-UTRAN frequency or inter-RAT frequency than serving frequency shall be performed if:

- No cell on serving frequency or on an equal priority E-UTRAN frequency or on a higher priority E-UTRAN frequency or inter-RAT frequency than serving frequency fulfills the criteria 1; and
- $S_{\text{ServingCell}} < \text{Thresh}_{\text{Serving}, \text{low}}$ and the $S_{\text{nonServingCell},x}$ of a cell of a lower priority E-UTRAN frequency or inter-RAT frequency is greater than $\text{Thresh}_{x, \text{low}}$ during a time interval $\text{Treselection}_{\text{RAT}}$; and
- more than 1 second has elapsed since the UE camped on the current serving cell

or if:

- there are no candidate cells for reselection on serving frequency according to 5.2.4.4 or 5.3.1.

Cell reselection to a cell on an equal priority E-UTRAN frequency shall be based on ranking for Intra-frequency cell reselection as defined in sub-clause 5.2.4.6.

For GERAN, UTRAN, and E-UTRAN, $S_{\text{nonServingCell},x}$ is the S_{rxlev} -value of an evaluated cell. For UTRAN FDD, S_{qual} is higher than 0, as defined in [8]. For cdma2000 RATs, $S_{\text{nonServingCell},x}$ is equal to $\text{FLOOR}(-2 \times 10 \times \log_{10} E_c/I_o)$ in units of 0.5 dB, as defined in [18], with E_c/I_o referring to the value measured from the evaluated cell.

In all the above criteria the value of $T_{\text{reselection,RAT}}$ is scaled when the UE is in the medium or high mobility state as defined in subclause 5.2.4.3.1. If more than one cell meets the above criteria, the UE shall reselect a cell ranked as the best cell among the cells meeting the criteria on the highest priority frequencies or the highest priority RAT if the highest priority RAT is E-UTRA according to criteria defined in 5.2.4.6.

6.1.2.5.3 Test description

6.1.2.5.3.1 Pre-test conditions

System Simulator:

- Cell 1, Cell 3 and Cell 10.

UE:

None.

Preamble:

- The UE is in state Registered, Idle mode (state 2) on Cell 1 according to [18].

6.1.2.5.3.2 Test procedure sequence

Table 6.1.2.5.3.2-1 illustrates the downlink power levels and other changing parameters to be applied for the cells at various time instants of the test execution. Row marked "T0" denotes the conditions after the preamble, while columns marked "T1" is to be applied subsequently. The exact instants on which these values shall be applied are described in the texts in this clause.

Table 6.1.2.5.3.2-1: Time instances of cell power level and parameter changes

	Parameter	Unit	Cell 1	Cell 3	Cell 10	Remark
T0	Cell-specific RS EPRE	dBm/ 15kHz z	[-56]	[-76]	[-96]	The power level values are assigned to satisfy $S_{\text{rxlev}_{\text{Cell 1}}} > S_{\text{rxlev}_{\text{Cell 3}}}$ and $S_{\text{rxlev}_{\text{Cell 1}}} > S_{\text{rxlev}_{\text{Cell 10}}}$, such that camping on Cell 1 is guaranteed.
T1	Cell-specific RS EPRE	dBm/ 15kHz z	[-56]	[-56]	[-56]	Cell 3 and Cell 10 become stronger than $\text{Thresh}_{x, \text{high}}$.

Table 6.1.2.5.3.2-2: Main behaviour

St	Procedure	Message Sequence		TP	Verdict
		U - S	Message		
1	The SS changes Cell 1, Cell 3 and Cell 10 level according to the row "T1" in table 6.1.2.5.3.2-1.	-	-	-	-
2	Check: Is there any random access requests from the UE on Cell 10?	-	-	1	P

6.1.2.5.3.3 Specific message contents

Table 6.1.2.5.3.3-1: SystemInformationBlockType3 for Cell 1 (pre-test conditions)

Derivation path: 36.508 table 4.4.3.3-2			
Information Element	Value/Remark	Comment	Condition
SystemInformationBlockType3 ::= SEQUENCE { cellReselectionServingFreqInfo SEQUENCE { cellReselectionPriority } }	1		

Table 6.1.2.5.3.3-2: SystemInformationBlockType5 for Cell 1 (pre-test conditions)

Derivation path: 36.508 table 4.4.3.3-4			
Information Element	Value/Remark	Comment	Condition
SystemInformationBlockType5 ::= SEQUENCE { interFreqCarrierFreqList SEQUENCE (SIZE (1..maxFreq)) OF SEQUENCE { dl-CarrierFreq[1] threshX-High[1] cellReselectionPriority[1] dl-CarrierFreq[2] threshX-High[2] cellReselectionPriority[2] } }	2 entries Same downlink EARFCN as used for Cell 3 20 3 Same downlink EARFCN as used for Cell 10 20 5		

6.1.2.6 Cell reselection using Qhyst, Qoffset and Treselection

6.1.2.6.1 Test Purpose (TP)

(1)

```
with { UE in E-UTRA RRC_IDLE state, and the UE is not in high mobility state }
ensure that {
  when { Qhyst is non-zero or its value changes in system information }
    then { UE reselects the highest ranked cell taking the actual Qhyst value into account }
}
```

(2)

```
with { UE in E-UTRA RRC_IDLE state, and the UE is not in high mobility state }
ensure that {
  when { cell reselection criteria are fulfilled during a time interval Treselection }
    then { UE reselects the highest ranked cell }
}
```

(3)

```
with { UE in E-UTRA RRC_IDLE state, and the UE is not in high mobility state }
ensure that {
  when { Qoffset is non-zero or its value changes in system information }
    then { UE reselects the highest ranked cell taking the actual Qoffset value into account }
}
```

6.1.2.6.2 Conformance requirements

References: The conformance requirements covered in the current TC are specified in: TS36.300, clause 10.1.1.2 and TS 36.304, clauses 5.2.1 and 5.2.4.6 and TS 36.331 clause 6.3.1.

[TS 36.300, clause 10.1.1.2]

UE in RRC_IDLE performs cell reselection. The principles of the procedure are the following:

- The UE makes measurements of attributes of the serving and neighbour cells to enable the reselection process:
 - There is no need to indicate neighbouring cell in the serving cell system information to enable the UE to search and measure a cell i.e. E-UTRAN relies on the UE to detect the neighbouring cells;
 - For the search and measurement of inter-frequency neighbouring cells, only the carrier frequencies need to be indicated;
 - Measurements may be omitted if the serving cell attribute fulfils particular search or measurement criteria.
- Cell reselection identifies the cell that the UE should camp on. It is based on cell reselection criteria which involves measurements of the serving and neighbour cells:
 - Intra-frequency reselection is based on ranking of cells;
 - ...
 - Cell reselection parameters are applicable for all UEs in a cell, ...

...

[TS 36.304, clause 5.2.1]

...

When camped on a cell, the UE shall regularly search for a better cell according to the cell reselection criteria. If a better cell is found, that cell is selected.

...

[TS 36.304, clause 5.2.4.6]

The cell-ranking criterion R_s for serving cell and R_n for neighbouring cells is defined by:

$$R_s = Q_{meas,s} + Q_{Hyst}$$

$$R_n = Q_{meas,n} - Q_{offset}$$

where:

Q_{meas}	RSRP measurement quantity used in cell reselections.
Qoffset	For intra-frequency: Equals to $Q_{offset_{s,n}}$, if $Q_{offset_{s,n}}$ is valid, otherwise this equals to zero. For inter-frequency: Equals to $Q_{offset_{s,n}}$ plus $Q_{offset_{frequency}}$, if $Q_{offset_{s,n}}$ is valid, otherwise this equals to $Q_{offset_{frequency}}$.

The UE shall perform ranking of all cells that fulfill the cell selection criterion S, which is defined in 5.2.3.2, but may exclude all CSG cells that are known by the UE to be not allowed.

The cells shall be ranked according to the R criteria specified above, deriving $Q_{meas,n}$ and $Q_{meas,s}$ and calculating the R values using averaged RSRP results.

If a cell is ranked as the best cell the UE shall perform cell re-selection to that cell.

...

In all cases, the UE shall reselect the new cell, only if the following conditions are met:

- the new cell is better ranked than the serving cell during a time interval $T_{reselection_{RAT}}$,
- more than 1 second has elapsed since the UE camped on the current serving cell.

[TS 36.331, clause 6.3.1]

The IE *SystemInformationBlockType4* contains neighbouring cell related information relevant only for intra-frequency cell re-selection. The IE includes cells with specific re-selection parameters as well as blacklisted cells.

...

6.1.2.6.3 Test description

6.1.2.6.3.1 Pre-test conditions

System Simulator:

- Cell 1 and Cell 2
- Cell 1 and Cell 2 are high quality cells on the same E-UTRA frequency and different tracking areas:
 - Cell 1 serving cell, $Srxlev_{Cell\ 1} > 0$
 - Cell 2 intra-frequency cell $Srxlev_{Cell\ 2} > 0$
 - All cells broadcast system information. Serving cell does not continuously page UE. Normal response to *RRCCConnectionRequest* so Attach can be done

UE:

None.

Preamble:

- The UE is in state Registered, Idle mode (state 2) according to [18].

6.1.2.6.3.2 Test procedure sequence

Table 6.1.2.6.3.2-1 illustrates the downlink power levels and other changing parameters to be applied for the cells at various time instants of the test execution. Rows marked "T0" denote the conditions after the preamble, while rows marked "T1", "T2", "T3", "T4", "T5", "T6" and "T7" are to be applied subsequently. The exact instants on which these values shall be applied are described in the texts in this clause.

Table 6.1.2.6.3.2-1: Time instances of cell power level and parameter change

Ti	Parameter	Unit	Cell 1	Cell 2	Remark
T0	Cell-specific RS EPRE	dBm/ 15kHz z	-85	-97	The assigned values ensure $Srxlev_{Cell1} > Srxlev_{Cell2}$ such that camping on Cell 1 is guaranteed
	Qhyst _s	dB	24	0	
	Qoffset _{s,n}	dB	0	0	
	TreselectionEUTRAN	s	0	0	
T1	Cell-specific RS EPRE	dBm/ 15kHz z	-97	-85	Cell 2 becomes stronger than Cell 1 but Cell 1 remains the highest ranked one due to Qhyst _{sCell1}
T2	Qhyst _s	dB	0	0	Qhyst _{sCell1} change causes Cell 2 to become highest ranked cell
T3	Cell-specific RS EPRE	dBm/ 15kHz z	-85	-97	Cell 1 becomes the strongest and highest ranked one due to
	Qoffset _{s,n}	dB	24	0	Qoffset _{s,nCell2} remains zero
T4	Cell-specific RS EPRE	dBm/ 15kHz z	-97	-85	Cell 1 becomes weaker but it remains the highest ranked one due to Qoffset _{s,nCell1}
T5	Qoffset _{s,n}	dB	0	0	Cell 2 becomes the highest ranked one due to Qoffset _{s,nCell1} change
T6	Cell-specific RS EPRE	dBm/ 15kHz z	-85	-97	Cell 1 becomes the highest ranked one
	TreselectionEUTRAN	s	7	0	
T7	Cell-specific RS EPRE	dBm/ 15kHz z	-97	-85	Cell 2 becomes the highest ranked cell
Note:	The total test tolerance used is the sum of downlink signal level uncertainty (TS 36.508 clause 6.2.2.1) and relative UE measurement accuracy of RSRP (TS 36.133 clause 9.1.2.2).				

Table 6.1.2.6.3.2-2: Main behaviour

St	Procedure	Message Sequence		TP	Verdict
		U - S	Message		
1	SS re-adjusts the cell-specific reference signal levels according to row "T1" in table 6.1.2.6.3.2-1.	-	-	-	-
2	Check: If there is any random access request from the UE on Cell 2 within the next [10s].	-	-	1	F
3	SS resets $Q_{hyst_{s,Cell1}}$ according to row "T2" in table 6.1.2.6.3.2-1. and notifies UE of the system information change.	<--	<i>Paging</i>	-	-
4	Check: If there is any random access request from the UE on Cell 2.	-	-	1	P
5	SS changes $Q_{offset_{s,nCell1}}$ and re-adjusts cell-specific reference signal levels according to rows "T3" in table 6.1.2.6.3.2-1.	-	-	-	-
6	Wait until there is any random access requests from the UE on Cell 1	-	-	-	-
7	SS re-adjusts cell-specific reference signal levels according to row "T4" in table 6.1.2.6.3.2-1.	-	-	-	-
8	Check: If there is any random access request from the UE on Cell 2 within the next [10s]?	-	-	3	F
9	SS resets $Q_{offset_{s,nCell1}}$ according to row "T5" in table 6.1.2.6.3.2-1 and notifies UE of the system information change.	<--	<i>Paging</i>	-	-
10	Check: Is there any random access request from the UE on Cell 2?	-	-	3	P
11	SS changes $T_{reselectionEUTRAN_{Cell1}}$ and re-adjusts cell-specific reference signal levels according to rows "T6" in table 6.1.2.6.3.2-1.	-	-	-	-
12	Wait until there is any random access requests from the UE on Cell 1	-	-	-	-
13	SS re-adjusts cell-specific reference signal levels according to rows "T7" in table 6.1.2.6.3.2-1.	-	-	-	-
14	Check: Is there any random access requests from the UE on Cell 2 within the next 6s?	-	-	2	F
15	Check: Is there any random access requests from the UE on Cell 2 within the next 12s?	-	-	2	P

NOTE: The wait time in step 14 is selected to cover time interval $T_{reselectionEUTRAN_{Cell1}}$. The time interval in step 15 is set to cover $T_{evaluateFDD,intra}$ (TS 36.133 clause 4.2.2.3) + 1280 ms for DRX cycle + 1280 ms for system information block type scheduling. The timer tolerances are taken into account according to [18].

6.1.2.6.3.3 Specific message contents

Table 6.1.2.6.3.3-1: Conditions for tables 6.1.2.6.3.3-2 and 6.1.2.6.3.3-3

Condition descriptions
Cell 1 This condition applies to system information transmitted on Cell 1.
Cell 2 This condition applies to system information transmitted on Cell 2.

Table 6.1.2.6.3.3-2: SystemInformationBlockType1 for cells 1 and 2 (preamble and all steps, Table 6.1.2.6.3.2-1)

Derivation Path: 36.508 table 4.4.3.2-3			
Information Element	Value/remark	Comment	Condition
SystemInformationBlockType1 ::= SEQUENCE {			
schedulingInformation ::= SEQUENCE (SIZE (1..maxSI-Message)) OF SEQUENCE {	Combination 2 in TS 36.508 section 4.4.3.1	SIB2, SIB3 and SIB4 are transmitted	Cell 1 Cell 2
}			

Table 6.1.2.6.3.3-3: SystemInformationBlockType3 for cells 1 and 2 (preamble and table 6.1.2.6.3.2-1)

Derivation Path: 36.508 table 4.4.3.3-2			
Information Element	Value/remark	Comment	Condition
SystemInformationBlockType3 ::= SEQUENCE {			
cellReselectionInfoCommon SEQUENCE {			
q-Hyst	dB24 dB0	Qhyst _{sCell1} Qhyst _{sCell2}	Cell 1 Cell 2
}			
}			

Table 6.1.2.6.3.3-4: SystemInformationBlockType3 for cells 1 and 2 (step 3 and table 6.1.2.6.3.2-1)

Derivation Path: 36.508 table 4.4.3.3-2			
Information Element	Value/remark	Comment	Condition
SystemInformationBlockType3 ::= SEQUENCE {			
cellReselectionInfoCommon SEQUENCE {			
q-Hyst	dB0 dB0	Qhyst _{sCell1} Qhyst _{sCell2}	Cell 1 Cell 2
}			
}			

Table 6.1.2.6.3.3-5: SystemInformationBlockType3 for cells 1 and 2 (step 11 and table 6.1.2.6.3.2-1)

Derivation Path: 36.508 table 4.4.3.3-2			
Information Element	Value/remark	Comment	Condition
SystemInformationBlockType3 ::= SEQUENCE {			
cellReselectionInfoCommon SEQUENCE {			
q-Hyst	dB0 dB0	Qhyst _{sCell1} Qhyst _{sCell2}	Cell 1 Cell 2
}			
intraFreqCellReselectionInfo SEQUENCE {			
t-ReselectionEUTRA	7 0	seconds seconds	Cell 1 Cell 2
}			
}			

Table 6.1.2.6.3.3-6: SystemInformationBlockType4 for cell 1 (step 5 and table 6.1.2.6.3.2-1)

Derivation Path: 36.508 table 4.4.3.3-3			
Information Element	Value/remark	Comment	Condition
SystemInformationBlockType4 ::= SEQUENCE {			
intraFreqNeighCellList SEQUENCE (SIZE (1..maxCellIntra)) OF SEQUENCE {			
physCellId [1]	Physical cell identity of Cell 2		Cell 1
q-OffsetCell [1]	dB24	Qoffset _{s,nCell 1}	Cell 1
}			
}			

Table 6.1.2.6.3.3-7: *SystemInformationBlockType4* for cell 1 (step 9 and table 6.1.2.6.3.2-1)

Derivation Path: 36.508 table 4.4.3.3-3			
Information Element	Value/remark	Comment	Condition
SystemInformationBlockType4 ::= SEQUENCE {			
intraFreqNeighCellList SEQUENCE (SIZE (1..maxCellIntra)) OF SEQUENCE {			
phyCellId [1]	Physical cell identity of Cell 2		Cell 1
q-OffsetCell [1]	dB0	Qoffset _{s,nCell 1}	Cell 1
}			
}			

6.1.2.7 Cell reselection: Equivalent PLMN

6.1.2.7.1 Test Purpose (TP)

(1)

```
with { UE camped normally on a cell and network has downloaded a list of equivalent PLMNs during the
Location Registration procedure }
ensure that {
  when { a suitable neighbour cell on an equivalent PLMN becomes better ranked than the suitable
Serving cell }
    then { UE reselects to this equivalent PLMN cell. }
}
```

(2)

```
with { UE camped normally on a cell and network has downloaded a list of equivalent PLMNs during the
Location Registration procedure }
ensure that {
  when { the Serving cell becomes unsuitable due to S<0 and a suitable cell exists on an equivalent
PLMN }
    then { UE reselects to this equivalent PLMN cell. }
}
```

(3)

```
with { UE camped normally on a cell and network has downloaded a list of equivalent PLMNs during the
Location Registration procedure }
ensure that {
  when { the Serving cell becomes unsuitable due to cell barring and a suitable cell exists on an
equivalent PLMN }
    then { UE reselects to this equivalent PLMN cell. }
}
```

(4)

```
with { UE camped normally on a cell and network has downloaded a list of equivalent PLMNs during the
Location Registration procedure }
ensure that {
  when { the UE evaluates cells for reselection }
    then { UE ignores suitable cells for which the UE has no reselection priority provided. }
}
```

6.1.2.7.2 Conformance requirements

References: The conformance requirements covered in the present TC are specified in: TS 36.304 clause 5.2.4.1, TS 23.122 clause 4.4.3.

[TS 36.304, clause 5.2.4.1]

...

UE shall only perform reselection evaluation for E-UTRAN frequencies and inter-RAT frequencies that are given in system information and for which the UE has a priority provided.

...

[TS 23.122, clause 4.4.3]

...

The Mobile Equipment stores a list of "equivalent PLMNs". This list is replaced or deleted at the end of each location update procedure, routing area update procedure and GPRS attach procedure. The stored list consists of a list of equivalent PLMNs as downloaded by the network plus the PLMN code of the registered PLMN that downloaded the list. All PLMNs in the stored list, in all access technologies supported by the PLMN, are regarded as equivalent to each other for PLMN selection, cell selection/re-selection and handover.

...

6.1.2.7.3 Test description

6.1.2.7.3.1 Pre-test conditions

System Simulator

- Three inter-frequency multi-PLMN cells as specified in TS36.508 clause 4.4.1.2 are configured broadcasting default NAS parameters as indicated in TS 36.508 Table 4.4.2-2.
- The PLMNs are identified in the test by the identifiers in Table 6.1.2.7.3.1-1.

Table 6.1.2.7.3.1-1: PLMN identifiers

Cell	PLMN name
1	PLMN1
12	PLMN2
13	PLMN3

- All cells are high quality.
- All cells are suitable cells.

UE

- The UE is in Automatic PLMN selection mode.
- The UE is equipped with a USIM containing default values (as per TS 36.508) except for those listed in Table 6.1.2.7.3.1-2.

Table 6.1.2.7.3.1-2: USIM configuration

USIM field	Priority	Value	Access Technology Identifier
EF _{LOCI}		PLMN1 (See pre-amble)	
EF _{UST}		Service 74 is supported. Service 71 is not supported (there is no EHPLMN list).	

Preamble

- The UE is registered on PLMN1 (Cell 1) using the procedure described in TS 36.508 clause 4.5.2.3 except that the ATTACH ACCEPT message indicates PLMN3 in the Equivalent PLMN list as described in Table 6.1.2.7.3.3-1.
- The UE is in state Registered, Idle Mode (State 2) on Cell 1 according to [18].

6.1.2.7.3.2 Test procedure sequence

Table 6.1.2.7.3.2-1 shows the cell configurations used during the test. The configuration T0 indicates the initial conditions. Subsequent configurations marked "T1" and "T2" are applied at the points indicated in the Main behaviour description in Table 6.1.2.7.3.2-2. Cell powers are chosen for a serving cell and a non-suitable cell as defined in TS 36.508 Table 6.2.2.1-1.

Table 6.1.2.7.3.2-1: Cell configuration changes over time

	Parameter	Unit	Cell 1	Cell 12	Cell 13	Remarks
T0	RS EPRE	dBm/15kHz	-67	-82	-97	All cells S>0
	Cell status	N/A	cellBarred= notBarred	cellBarred= notBarred	cellBarred= notBarred	No cells are barred
T1	RS EPRE	dBm/15kHz	-115	-82	-97	Cell 1 S < 0 as described in TS 36.508 clause 6.2.2.1
	Cell status	N/A	cellBarred= notBarred	cellBarred= notBarred	cellBarred= notBarred	No cells are barred
T2	RS EPRE	dBm/15kHz	-67	-82	-97	All cells S>0
	Cell status	N/A	cellBarred= notBarred	cellBarred= barred	cellBarred= notBarred	The Serving cell, Cell 12, becomes barred

Note 1: The default values (including "not present") for all other parameters influencing cell reselection are suitable for this test. The values are defined in TS 36.508 clauses 4.4.3.2 and 4.4.3.3.

Table 6.1.2.7.3.2-2: Main behaviour

St	Procedure	Message Sequence		TP	Verdict
		U - S	Message		
1	Check: Does the UE initiate a random access within the next [100 seconds]?	-	-	1	F
2	SS adjusts cell levels and cell status according to row T1 of table 6.1.2.7.3.2-1.	-	-	-	-
3	Check: Does the UE initiate a random access on Cell 13? Location Registration is accepted with PLMN1 and PLMN2 listed as an Equivalent PLMN.	-	-	2	P
4	Check: Is PLMN3 indicated by the UE?	-	-	2	P
5	Check: Does the UE initiate a random access on Cell 12? Location Registration is accepted with PLMN1 and PLMN3 listed as an Equivalent PLMN.	-	-	1	P
6	Check: Is PLMN2 indicated by the UE?	-	-	1	P
7	SS adjusts cell levels and cell status according to row T0 of table 6.1.2.7.3.2-1.	-	-	-	-
8	Check: Does the UE initiate a random access within the next [100 seconds]?	-	-	1,4	F
9	SS adjusts cell levels and cell status according to row T2 of table 6.1.2.7.3.2-1.	-	-	-	-
10	Notify UE of change of System Information.	<--	<i>Paging</i>	-	-
11	Check: Does the UE initiate a random access on Cell 13? Location Registration is accepted with PLMN1 and PLMN2 listed as an Equivalent PLMN.	-	-	3,4	P
12	Check: Is PLMN3 indicated by the UE?	-	-	3,4	P
13	Check: Does the UE initiate a random access on Cell 1? Location Registration is accepted with PLMN3 listed as an Equivalent PLMN.	-	-	1	P
14	Check: Is PLMN1 indicated by the UE?	-	-	1	P

Note 1: In Steps 1 and 8, a wait time long enough to ensure that the UE has detected, measured and evaluated the neighbour inter-frequency cells is provided, see 36.133 clause 4.2.2.4.

Note 2: In Steps 3, 5, 11 and 13 the TAU ACCEPT message includes an Equivalent PLMN list as described in Table 6.1.2.7.3.3-2.

Note 3: In Step 11, the UE moves to Cell 13 because no reselection priority is defined for Cell 1, see Table 6.1.2.7.3.3-5.

6.1.2.7.3.3 Specific message contents

Table 6.1.2.7.3.3-1: ATTACH ACCEPT for Cell 1 (preamble)

Derivation path: 36.508 Table 4.7.2-1			
Information Element	Value/Remark	Comment	Condition
Equivalent PLMNs	PLMN3		Cell 1

Table 6.1.2.7.3.3-2: TRACKING AREA UPDATE ACCEPT for Cells 1, 12 and 13 (steps 3, 5, 11 & 13, Table 6.1.2.7.3.2-2)

Derivation path: 36.508 Table 4.7.2-24			
Information Element	Value/Remark	Comment	Condition
Equivalent PLMNs	PLMN3		Cell 1
	PLMN1, 3		Cell 12
	PLMN1, 2		Cell 13

Table 6.1.2.7.3.3-3: SystemInformationBlockType1 for Cell 12 (step 9, Table 6.1.2.7.3.2-2)

Derivation path: 36.508 Table 4.4.3.2-3			
Information Element	Value/Remark	Comment	Condition
SystemInformationBlockType1 ::= SEQUENCE {			
cellAccessRelatedInformation SEQUENCE {			
cellBarred	barred		Cell 12
}			
}			

Table 6.1.2.7.3.3-4: Paging (step 10, Table 6.1.2.7.3.2-2)

Derivation path: 36.508 Table 4.6.1-7			
Information Element	Value/Remark	Comment	Condition
Paging ::= SEQUENCE {			
pagingRecordList	Not present		
systemInfoModification	true		
etws-PrimaryNotificationIndication	Not present		
nonCriticalExtension SEQUENCE {}	Not present		
}			

Table 6.1.2.7.3.3-5: SystemInformationBlockType5 for Cell 12 (preamble and all steps, Table 6.1.2.7.3.2-2)

Derivation path: 36.508 Table 4.4.3.3-4			
Information Element	Value/Remark	Comment	Condition
SystemInformationBlockType5 ::= SEQUENCE {			
interFreqCarrierFreqList SEQUENCE (SIZE (1..maxFreq)) OF SEQUENCE {	The same number of entries as the configured inter-freq carriers		
cellReselectionPriority	Not present for Cell 1 frequency. Default for Cell 13 frequency.	UE does not have a priority for frequency of Cell 1	Cell 12
}			
}			

6.1.2.8 Cell reselection using cell status and cell reservations (access control class 0-9)

6.1.2.8.1 Test Purpose (TP)

(1)

with { UE camped normally in state E-UTRA RRC_IDLE and UE fitted with a USIM with access class 0..9}
 ensure that {

```

when { a higher ranked cell is found with cell status "Barred" }
  then { UE does not attempt to reselect to the higher ranked cell }
}

```

(2)

```

with { UE camped normally in state E-UTRA RRC_IDLE and UE fitted with a USIM with access class 0..9}
ensure that {
  when { a higher ranked cell is found "reserved" for Operator use" }
    then { UE does not attempt to reselect to the higher ranked cell }
}

```

6.1.2.8.2 Conformance requirements

References: The conformance requirements covered in the present TC are specified in: TS 36.304, clauses 5.2.4.4 and 5.3.1.

[TS 36.304, clause 5.2.4.4]

For the highest ranked cell (including serving cell) according to cell reselection criteria specified in subclause 5.2.4.6, the UE shall check if the access is restricted according to the rules in subclause 5.3.1.

If that cell and other cells have to be excluded from the candidate list, as stated in subclause 5.3.1, the UE shall not consider these as candidates for cell reselection. This limitation shall be removed when the highest ranked cell changes.

...

[TS 36.304, clause 5.3.1]

Cell status and cell reservations are indicated in the *SystemInformationBlockType1* [3] by means of two Information Elements:

- *cellBarred* (IE type: "barred" or "not barred")
- ...
- *cellReservedForOperatorUse* (IE type: "reserved" or "not reserved")
- ...

When cell status is indicated as "not barred" and "not reserved" for operator use,

- All UEs shall treat this cell as candidate during the cell selection and cell re-selection procedures.

When cell status is indicated as "not barred" and "reserved" for operator use for any PLMN,

- ...
- UEs assigned to an Access Class in the range of 0 to 9, 12 to 14 and UEs with AC 11 or 15 not operating in their HPLMN/EHPLMN shall behave as if the cell status is "barred" in case the cell is "reserved for operator use" for the PLMN the UE is currently registered with.

NOTE 1: ...

When cell status "barred" is indicated or to be treated as if the cell status is "barred",

- The UE is not permitted to select/re-select this cell, not even for emergency calls.
- The UE shall select another cell according to the following rule:
 - If the cell is a CSG cell:
 - ...
 - else
 - If the IE *intraFrequencyReselection* in IE *cellAccessRelatedInfo* in *SystemInformationBlockType1* is set to "allowed", the UE may select another cell on the same frequency if re-selection criteria are fulfilled.
 - The UE shall exclude the barred cell as a candidate for cell selection/reselection for 300 seconds.

- If the IE *intraFreqReselection* in IE *cellAccessRelatedInfo* in *SystemInformationBlockType1* is set to "not allowed" the UE shall not re-select a cell on the same frequency as the barred cell.
- The UE shall exclude the barred cell as a candidate for cell selection/reselection for 300 seconds.

...

6.1.2.8.3 Test description

6.1.2.8.3.1 Pre-test conditions

System Simulator

- Three inter-frequency cells as specified in TS36.508 clause 4.4.1.2 are configured broadcasting default NAS parameters as indicated in TS 36.508 Table 4.4.2-2, except that TAC values use the codes in Table 6.1.2.8.3.1-1.
- SIB 1 of Cell 3 and Cell 6 indicate cellBarred=barred.
- Each cell has only a single PLMN identity.
- All cells are high quality.-
- The cell power levels are configured as shown in Table 6.1.2.8.3.1-1.

Table 6.1.2.8.3.1–1: Cell power configuration

Parameter	Unit	Cell 1	Cell 3	Cell 6	Remarks
RS EPRE	dBm/15kHz	[-97]	[-82]	[-67]	S>0 for all cells
Note 1: The default values (including "not present") for all other parameters influencing cell reselection are suitable for this test. The values are defined in TS36.508 clauses 4.4.3.2 and 4.4.3.3					

UE

- The UE is in Automatic PLMN selection mode.
- The UE is equipped with a USIM containing default values (as per TS 36.508) except for those shown in Table 6.1.2.8.3.1-2.

Table 6.1.2.8.3.1–2: USIM Configuration

USIM field	Value
EF _{ACC}	Type "A" as defined in TS34.108 clause 8.3.2.15

Preamble

- The UE is in state Registered, Idle Mode (State 2) on Cell 1 according to [18].

6.1.2.8.3.2 Test procedure sequence

Table 6.1.2.8.3.2-1: Main behaviour

St	Procedure	Message Sequence		TP	Verdict
		U - S	Message		
1	SS adjusts SIB1 of Cell 3 to indicate cellBarred=notBarred	-	-	-	-
2	Check: Does the UE initiate a random access on Cell 3?	-	-	1	P
3	SS adjusts SIB1 of Cell 3 to indicate cellBarred=barred. (Cell 3 and Cell 6 are now both barred)	-	-	-	-
4	Notify UE of change of System Information	<--	<i>Paging</i>	-	-
5	Check: Does the UE initiate a random access on Cell 1?	-	-	1	P
6	SS adjusts SIB1 of both Cell 3 and Cell 6: Cell 3 indicates cellBarred=notBarred; Cell 6 indicates cellBarred=notBarred and cellReservedForOperatorUse = reserved.	-	-	-	-
7	Check: Does the UE initiate a random access on Cell 3?	-	-	2	P
8	SS adjusts SIB1 of both Cell 3 and Cell 6 to indicate cellReservedForOperatorUse = reserved.	-	-	-	-
9	Notify UE of change of System Information	<--	<i>Paging</i>	-	-
10	Check: Does the UE initiate a random access on Cell 1?	-	-	2	P

6.1.2.8.3.3 Specific message contents

Table 6.1.2.8.3.3-1: SystemInformationBlockType1 for Cell 3 and Cell 6 (pre-test conditions and step 3, Table 6.1.2.8.3.2-1)

Derivation Path: 36.508 clause 4.4.3.2			
Information Element	Value/remark	Comment	Condition
SystemInformationBlockType1 ::= SEQUENCE {			
cellAccessRelatedInformation SEQUENCE {			
plmn-IdentityList SEQUENCE (SIZE (1..6))	1 entry		
OF SEQUENCE {			
cellReservedForOperatorUse	<i>notReserved</i>		Cell 3 Cell 6
}			
cellBarred	<i>barred</i>		Cell 3 Cell 6
}			
}			

Table 6.1.2.8.3.3-2: SystemInformationBlockType1 for Cell 3 and Cell 6 (step 1, Table 6.1.2.8.3.2-1)

Derivation Path: 36.508 clause 4.4.3.2			
Information Element	Value/remark	Comment	Condition
SystemInformationBlockType1 ::= SEQUENCE {			
cellAccessRelatedInformation SEQUENCE {			
plmn-IdentityList SEQUENCE (SIZE (1..6)) OF SEQUENCE {	1 entry		
cellReservedForOperatorUse	notReserved		Cell 3 Cell 6
}			
cellBarred	notBarred		Cell 3
	barred		Cell 6
}			
}			

Table 6.1.2.8.3.3-6: Paging (steps 4 & 9, Table 6.1.2.8.3.2-1)

Derivation Path: 36.508 Table 4.6.1-7			
Information Element	Value/remark	Comment	Condition
Paging ::= SEQUENCE {			
pagingRecordList	Not present		
systemInfoModification	true		
etws-PrimaryNotificationIndication	Not present		
nonCriticalExtension SEQUENCE {}	Not present		
}			

Table 6.1.2.8.3.3-4: SystemInformationBlockType1 for Cell 3 and Cell 6 (step 6, Table 6.1.2.8.3.2-1)

Derivation Path: 36.508 clause 4.4.3.2			
Information Element	Value/remark	Comment	Condition
SystemInformationBlockType1 ::= SEQUENCE {			
cellAccessRelatedInformation SEQUENCE {			
plmn-IdentityList SEQUENCE (SIZE (1..6)) OF SEQUENCE {	1 entry		
cellReservedForOperatorUse	notReserved		Cell 3
	reserved		Cell 6
}			
cellBarred	notBarred		Cell 3 Cell 6
}			
}			

Table 6.1.2.8.3.3-5: SystemInformationBlockType1 for Cell 3 and Cell 6 (step 8, Table 6.1.2.8.3.2-1)

Derivation Path: 36.508 clause 4.4.3.2			
Information Element	Value/remark	Comment	Condition
SystemInformationBlockType1 ::= SEQUENCE {			
cellAccessRelatedInformation SEQUENCE {			
plmn-IdentityList SEQUENCE (SIZE (1..6)) OF SEQUENCE {	1 entry		
cellReservedForOperatorUse	reserved		Cell 3 Cell 6
}			
cellBarred	notBarred		Cell 3 Cell 6
}			
}			

6.1.2.9 Cell reselection using cell status and cell reservations (access control class 11-15)

6.1.2.9.1 Test Purpose (TP)

(1)

```
with { UE camped normally in state E-UTRA RRC_IDLE and UE fitted with a USIM with access class 0..9
and access classes 11..15 inclusive }
ensure that {
  when { a higher ranked cell is found with cell status "Barred" }
  then { UE does not attempt to reselect to the higher ranked cell }
}
```

(2)

```
with { UE camped normally in state E-UTRA RRC_IDLE and UE fitted with a USIM with access class 0..9
and access classes 11..15 inclusive }
ensure that {
  when { a higher ranked cell is found "reserved" for Operator use" }
  then { UE re-selects to the higher ranked cell }
}
```

6.1.2.9.2 Conformance requirements

References: The conformance requirements covered in the present TC are specified in: TS 36.304, clauses 5.2.4.4 and 5.3.1.

[TS 36.304, clause 5.2.4.4]

For the highest ranked cell (including serving cell) according to cell reselection criteria specified in subclause 5.2.4.6, the UE shall check if the access is restricted according to the rules in subclause 5.3.1.

If that cell and other cells have to be excluded from the candidate list, as stated in subclause 5.3.1, the UE shall not consider these as candidates for cell reselection. This limitation shall be removed when the highest ranked cell changes.

...

[TS 36.304, clause 5.3.1]

Cell status and cell reservations are indicated in the *SystemInformationBlockType1* [3] by means of two Information Elements:

- *cellBarred* (IE type: "barred" or "not barred")
- ...
- *cellReservedForOperatorUse* (IE type: "reserved" or "not reserved")
- ...

When cell status is indicated as "not barred" and "not reserved" for operator use,

- All UEs shall treat this cell as candidate during the cell selection and cell re-selection procedures.

When cell status is indicated as "not barred" and "reserved" for operator use for any PLMN,

- UEs assigned to Access Class 11 or 15 operating in their HPLMN/EHPLMN shall treat this cell as candidate during the cell selection and reselection procedures if the IE *cellReservedForOperatorUse* for that PLMN set to "reserved".
- UEs assigned to an Access Class in the range of 0 to 9, 12 to 14 and UEs with AC 11 or 15 not operating in their HPLMN/EHPLMN shall behave as if the cell status is "barred" in case the cell is "reserved for operator use" for the PLMN the UE is currently registered with.

NOTE 1: ...

When cell status "barred" is indicated or to be treated as if the cell status is "barred",

- The UE is not permitted to select/re-select this cell, not even for emergency calls.

- The UE shall select another cell according to the following rule:
 - If the cell is a CSG cell:
 - ...
 - else
 - If the IE *intraFrequencyReselection* in IE *cellAccessRelatedInfo* in *SystemInformationBlockType1* is set to "allowed", the UE may select another cell on the same frequency if selection/re-selection criteria are fulfilled.
 - The UE shall exclude the barred cell as a candidate for cell selection/reselection for 300 seconds.- If the IE *intraFreqReselection* in IE *cellAccessRelatedInfo* in *SystemInformationBlockType1* is set to "not allowed" the UE shall not re-select a cell on the same frequency as the barred cell.
 - The UE shall exclude the barred cell as a candidate for cell selection/reselection for 300 seconds.

...

6.1.2.9.3 Test description

6.1.2.9.3.1 Pre-test conditions

System Simulator

- Three inter-frequency cells as specified in TS36.508 clause 4.4.1.2 are configured broadcasting default NAS parameters- as indicated in TS 36.508 Table 4.4.2-2, except that TAC values use the codes in Table 6.0.4-2.
- SIB 1 of Cell 3 and Cell 6 indicate cellBarred=barred
- Each cell has only a single PLMN identity.
- All cells are high quality.
- The cell power levels are configured as shown in Table 6.1.2.9.3.1-1.

Table 6.1.2.9.3.1–1: Cell power configuration

Parameter	Unit	Cell 1	Cell 3	Cell 6	Remarks
RS EPRE	dBm/15kHz	[-97]	[-82]	[-67]	S>0 for all cells
Note 1: The default values (including "not present") for all other parameters influencing cell reselection are suitable for this test. The values are defined in TS36.508 clauses 4.4.3.2 and 4.4.3.3					

UE

- The UE is in Automatic PLMN selection mode.
- The UE is equipped with a USIM containing default values (as per TS 36.508) except for those shown in Table 6.1.2.9.3.1-2.

Table 6.1.2.9.3.1–2: USIM Configuration

USIM field	Value
EF _{ACC}	Type "B" as defined in TS34.108 clause 8.3.2.15

Preamble

- The UE is in state Registered, Idle Mode (State 2) on Cell 1 according to [18].

6.1.2.9.3.2 Test procedure sequence

Table 6.1.2.9.3.2-1: Main behaviour

St	Procedure	Message Sequence		TP	Verdict
		U - S	Message		
1	SS adjusts SIB1 of Cell 3 to indicate cellBarred=notBarred	-	-	-	-
2	Check: Does the UE initiate a random access on Cell 3?	-	-	1	P
3	SS adjusts SIB1 of Cell 3 to indicate cellBarred=barred. (Cell 3 and Cell 6 are now both barred)	-	-	-	-
4	Notify UE of change of System Information	<--	<i>Paging</i>	-	-
5	Check: Does the UE initiate a random access on Cell 1?	-	-	1	P
6	SS adjusts SIB1 of both Cell 3 and Cell 6: Cell 3 indicates cellBarred=notBarred; Cell 6 indicates cellBarred=notBarred and cellReservedForOperatorUse = reserved	-	-	-	-
7	Check: Does the UE initiate a random access on Cell 6?	-	-	2	P

6.1.2.9.3.3 Specific message contents

Table 6.1.2.9.3.3-1: SystemInformationBlockType1 for Cell 3 and Cell 6 (pre-test conditions and step 3, Table 6.1.2.9.3.2-1)

Derivation Path: 36.508 clause 4.4.3.2			
Information Element	Value/remark	Comment	Condition
SystemInformationBlockType1 ::= SEQUENCE {			
cellAccessRelatedInformation SEQUENCE {			
plmn-IdentityList SEQUENCE (SIZE (1..6))	1 entry		
OF SEQUENCE {			
cellReservedForOperatorUse	notReserved		Cell 3 Cell 6
}			
cellBarred	<i>notBarred, Barred</i>		As conditions in Table 6.1.2.9.3.3-1
}			
}			

Table 6.1.2.9.3.3-2: SystemInformationBlockType1 for Cell 3 and Cell 6 (step 1, Table 6.1.2.9.3.2-1)

Derivation Path: 36.508 clause 4.4.3.2			
Information Element	Value/remark	Comment	Condition
SystemInformationBlockType1 ::= SEQUENCE {			
cellAccessRelatedInformation SEQUENCE {			
plmn-IdentityList SEQUENCE (SIZE (1..6))	1 entry		
OF SEQUENCE {			
cellReservedForOperatorUse	notReserved		Cell 3 Cell 6
}			
cellBarred	notBarred barred		Cell 3 Cell 6
}			
}			

Table 6.1.2.9.3.3-4: Paging (step 4, Table 6.1.2.9.3.2-1)

Derivation Path: 36.508 Table 4.6.1-7			
Information Element	Value/remark	Comment	Condition
Paging ::= SEQUENCE {			
pagingRecordList	Not present		
systemInfoModification	true		
etws-PrimaryNotificationIndication	Not present		
nonCriticalExtension SEQUENCE {}	Not present		
}			

Table 6.1.2.9.3.3-5: SystemInformationBlockType1 for Cell 3 and Cell 6 (step 6, Table 6.1.2.9.3.2-1)

Derivation Path: 36.508 clause 4.4.3.2			
Information Element	Value/remark	Comment	Condition
SystemInformationBlockType1 ::= SEQUENCE {			
cellAccessRelatedInformation SEQUENCE {			
plmn-IdentityList SEQUENCE (SIZE (1..6)) OF SEQUENCE {	1 entry		
cellReservedForOperatorUse	notReserved		Cell 3
	reserved		Cell 6
}			
cellBarred	notBarred		Cell 3 Cell 6
}			
}			

6.1.2.11 Inter-frequency cell reselection

6.1.2.11.1 Test Purpose (TP)

(1)

```
with { UE in E-UTRA RRC_IDLE state }
ensure that {
  when { UE detects both intra-frequency and equal priority inter-frequency neighbour cells and the
inter-frequency cell is the highest ranked cell }
  then { UE reselects the inter-frequency cell }
}
```

6.1.2.11.2 Conformance requirements

References: The conformance requirements covered in the present TC are specified in: TS 36.304, clause 5.2.4.5 and 5.2.4.6.

[TS 36.304, clause 5.2.4.5]

...

Cell reselection to a cell on an equal priority E-UTRAN frequency shall be based on ranking for Intra-frequency cell reselection as defined in sub-clause 5.2.4.6.

...

[TS 36.304, clause 5.2.4.6]

The cell-ranking criterion R_s for serving cell and R_n for neighbouring cells is defined by:

$$R_s = Q_{\text{meas},s} + Q_{\text{Hyst}}$$

$$R_n = Q_{\text{meas},n} - Q_{\text{offset}}$$

where:

Q_{meas}	RSRP measurement quantity used in cell reselections.
Qoffset	For intra-frequency: Equals to $Q_{offset_{s,n}}$, if $Q_{offset_{s,n}}$ is valid, otherwise this equals to zero. For inter-frequency: Equals to $Q_{offset_{s,n}}$ plus $Q_{offset_{frequency}}$, if $Q_{offset_{s,n}}$ is valid, otherwise this equals to $Q_{offset_{frequency}}$.

The UE shall perform ranking of all cells that fulfil the cell selection criterion S, which is defined in 5.2.3.2, but may exclude all CSG cells that are known by the UE to be not allowed.

The cells shall be ranked according to the R criteria specified above, deriving $Q_{meas,n}$ and $Q_{meas,s}$ and calculating the R values using averaged RSRP results.

If a cell is ranked as the best cell the UE shall perform cell reselection to that cell. If this cell is found to be not-suitable, the UE shall behave according to subclause 5.2.4.4.

In all cases, the UE shall reselect the new cell, only if the following conditions are met:

- the new cell is better ranked than the serving cell during a time interval $T_{reselection_{RAT}}$;
- more than 1 second has elapsed since the UE camped on the current serving cell.

6.1.2.11.3 Test description

6.1.2.11.3.1 Pre-test conditions

System Simulator:

- 3 E-UTRA cells:
 - Cell 1 E-UTRA serving cell
 - Cell 2 E-UTRA intra-frequency cell
 - Cell 3 E-UTRA inter-frequency cell
- The parameters settings and power levels for Cell 1, Cell 2 and Cell 3 are selected according to [18] so that camping on Cell 1 is guaranteed (inter-frequency priority is equal to serving priority).

UE:

None.

Preamble:

- The UE is in state Registered, Idle mode (state 2) on Cell 1 according to [18].

6.1.2.11.3.2 Test procedure sequence

Table 6.1.2.11.3.2-1 illustrates the downlink power levels and other changing parameters to be applied for the cells at various time instants of the test execution. Row marked "T0" denotes the conditions after the preamble, while row marked "T1" is to be applied subsequently. The exact instants on which these values shall be applied are described in the texts in this clause.

Table 6.1.2.11.3.2-1: Time instances of cell power level and parameter changes

	Parameter	Unit	Cell 1	Cell 2	Cell 3	Remark
T0	Cell-specific RS EPRE	dBm/15kHz	[-85]	[-95]	[-95]	The power level values are such that $Srxlev_{Cell\ 1} > Srxlev_{Cell\ 2} = Srxlev_{Cell\ 3}$ so that camping on Cell 1 is guaranteed
T1	Cell-specific RS EPRE	dBm/15kHz	[-85]	[-95]	[-75]	The power level values are set so that $R_{Cell\ 2} < R_{Cell\ 1} < R_{Cell\ 3}$.

Table 6.1.2.11.3.2-2: Main behaviour

St	Procedure	Message Sequence		TP	Verdict
		U - S	Message		
1	The SS changes Cell 3 level according to the row "T1" in table 6.1.2.11.3.2-1.	-	-	-	-
2	Check: Is there any random access requests from the UE on Cell 3?	-	-	1	P

6.1.2.11.3.3 Specific message contents

Table 6.1.2.11.3.3-1: Conditions for specific message contents in Tables 6.1.2.11.3.3-2, 6.1.2.11.3.3-3 and 6.1.2.11.3.3-4

Condition descriptions
Cell 1 This condition applies to system information transmitted on Cell 1.
Cell 2 This condition applies to system information transmitted on Cell 2.
Cell 3 This condition applies to system information transmitted on Cell 3.

Table 6.1.2.11.3.3-2: SystemInformationBlockType1 for Cell 1 and Cell 3 (preamble and all steps, Table 6.1.2.11.3.2-2)

Derivation Path: 36.508 table 4.4.3.2-3			
Information Element	Value/remark	Comment	Condition
SystemInformationBlockType1 ::= SEQUENCE { schedulingInfoList ::= SEQUENCE (SIZE (1..maxSI-Message)) OF SEQUENCE {	Combination 3 in TS 36.508 section 4.4.3.1	SIB2, SIB3 and SIB5 are transmitted	Cell 1 Cell 3
}			

Table 6.1.2.11.3.3-3: SystemInformationBlockType5 for Cell 1 and Cell 3 (preamble and all steps, Table 6.1.2.11.3.2-2)

Derivation path: 36.508 table 4.4.3.3-4			
Information Element	Value/Remark	Comment	Condition
SystemInformationBlockType5 ::= SEQUENCE { interFreqCarrierFreqList SEQUENCE (SIZE (1..maxFreq)) OF SEQUENCE { dl-CarrierFreq[1]	1 entry		
}	EARFCN of Cell 3 EARFCN of Cell 1		Cell 1 Cell 3
}			

6.1.2.15 Inter-frequency cell reselection according to cell reselection priority provided by SIBs

6.1.2.15.1 Test Purpose (TP)

(1)

```
with { UE in E-UTRA RRC_IDLE state }
ensure that {
  when { UE detects the cell re-selection criteria are met for the cell which belongs to the equal priority frequency }
  then { UE reselects the cell which belongs to the equal priority frequency }
}
```

(2)

```
with { UE in E-UTRA RRC_IDLE state }
ensure that {
```

```

when { UE detects the cell re-selection criteria are met for the cell which belongs to the higher
priority frequency }
  then { UE reselects the cell which belongs to the higher priority frequency }
}

```

(3)

```

with { UE in E-UTRA RRC_IDLE state }
ensure that {
  when { UE detects the cell re-selection criteria are met for the cell which belongs to the lower
priority frequency }
    then { UE reselects the cell which belongs to the lower priority frequency }
}

```

6.1.2.15.2 Conformance requirements

References: The conformance requirements covered in the present TC are specified in: TS 36.304, clause 5.2.4.1, 5.2.4.2, 5.2.4.5 and 5.2.4.6.

[TS 36.304, clause 5.2.4.1]

Absolute priorities of different E-UTRAN frequencies or inter-RAT frequencies may be provided to the UE in the system information, in the *RRCCConnectionRelease* message, or by inheriting from another RAT at inter-RAT cell (re)selection. In the case of system information, an E-UTRAN frequency or inter-RAT frequency may be listed without providing a priority (i.e. the field *cellReselectionPriority* is absent for that frequency). If priorities are provided in dedicated signalling, the UE shall ignore all the priorities provided in system information. If UE is in *camped on any cell* state, UE shall only apply the priorities provided by system information from current cell, and the UE preserves priorities provided by dedicated signalling unless specified otherwise. When the UE in *camped normally* state, has only dedicated priorities other than for the current frequency, the UE shall consider the current frequency to be the lowest priority frequency (i.e. lower than the eight network configured values). The UE shall delete priorities provided by dedicated signalling when:

- the UE enters RRC_CONNECTED state; or
- the optional validity time of dedicated priorities (T320) expires; or
- a PLMN selection is performed on request by NAS [5].

NOTE: Equal priorities between RATs are not supported.

The UE shall only perform cell reselection evaluation for E-UTRAN frequencies and inter-RAT frequencies that are given in system information and for which the UE has a priority provided.

The UE shall not consider any black listed cells as candidate for cell reselection.

The UE shall inherit the priorities provided by dedicated signalling and the remaining validity time (i.e., T320 in E-UTRA, T322 in UTRA and [T3230, FFS] in GERAN), if configured, at inter-RAT cell (re)selection.

NOTE: The network may assign dedicated cell reselection priorities for frequencies not configured by system information.

[TS 36.304, clause 5.2.4.2]

When evaluating for reselection purposes cell selection criterion or $S_{\text{nonServingCell},x}$, the UE shall use parameters provided by the serving cell.

Following rules are used by the UE to limit needed measurements:

- If $S_{\text{intraSearch}}$ is sent in the serving cell and $S_{\text{ServingCell}} > S_{\text{intraSearch}}$, UE may choose to not perform intra-frequency measurements.
- If $S_{\text{ServingCell}} \leq S_{\text{intraSearch}}$, or $S_{\text{intraSearch}}$ is not sent in the serving cell UE shall perform intra-frequency measurements.
- The UE shall apply the following rules for E-UTRAN inter-frequencies and inter-RAT frequencies which are indicated in system information and for which the UE has priority provided as defined in 5.2.4.1:

- For an E-UTRAN inter-frequency or inter-RAT frequency with a reselection priority higher than the reselection priority of the current E-UTRA frequency the UE shall perform measurements of higher priority E-UTRAN inter-frequency or inter-RAT frequencies according to [10].
- For an E-UTRAN inter-frequency with an equal or lower reselection priority than the reselection priority of the current E-UTRA frequency and for inter-RAT frequency with lower reselection priority than the reselection priority of the current E-UTRAN frequency:
 - If $S_{\text{nonintrasearch}}$ is sent in the serving cell and $S_{\text{ServingCell}} > S_{\text{nonintrasearch}}$ UE may choose not to perform measurements of E-UTRAN inter-frequencies or inter-RAT frequency cells of equal or lower priority.
 - If $S_{\text{ServingCell}} \leq S_{\text{nonintrasearch}}$ or $S_{\text{nonintrasearch}}$ is not sent in the serving cell the UE shall perform measurements of E-UTRAN inter-frequencies or inter-RAT frequency cells of equal or lower priority according to [10].

Where $S_{\text{ServingCell}}$ is the S_{rxlev} -value of the serving cell.

[TS 36.304, clause 5.2.4.5]

Criteria 1: the $S_{\text{nonServingCell},x}$ of a cell on evaluated frequency is greater than $\text{Thresh}_{x, \text{high}}$ during a time interval $\text{Treselection}_{\text{RAT}}$;

Cell reselection to a cell on a higher priority E-UTRAN frequency or inter-RAT frequency than serving frequency shall be performed if:

- A cell of a higher priority E-UTRAN frequency or inter-RAT frequency fulfils criteria 1; and
- more than 1 second has elapsed since the UE camped on the current serving cell.

Cell reselection to a cell on a lower priority E-UTRAN frequency or inter-RAT frequency than serving frequency shall be performed if:

- No cell on serving frequency or on an equal priority E-UTRAN frequency or on a higher priority E-UTRAN frequency or inter-RAT frequency than serving frequency fulfills the criteria 1; and
- $S_{\text{ServingCell}} < \text{Thresh}_{\text{erving, low}}$ and the $S_{\text{nonServingCell},x}$ of a cell of a lower priority E-UTRAN frequency or inter-RAT frequency is greater than $\text{Thresh}_{x, \text{low}}$ during a time interval $\text{Treselection}_{\text{RAT}}$; and
- more than 1 second has elapsed since the UE camped on the current serving cell.

or if:

- there are no candidate cells for reselection on serving frequency according to 5.2.4.4 or 5.3.1.

Cell reselection to a cell on an equal priority E-UTRAN frequency shall be based on ranking for Intra-frequency cell reselection as defined in sub-clause 5.2.4.6.

For GERAN, UTRAN, and E-UTRAN, $S_{\text{nonServingCell},x}$ is the S_{rxlev} -value of an evaluated cell. For UTRAN FDD, S_{qual} is higher than 0, as defined in [8]. For cdma2000 RATs, $S_{\text{nonServingCell},x}$ is equal to $\text{FLOOR}(-2 \times 10 \times \log_{10} E_c/I_o)$ in units of 0.5 dB, as defined in [18], with E_c/I_o referring to the value measured from the evaluated cell.

In all the above criteria the value of $\text{Treselection}_{\text{RAT}}$ is scaled when the UE is in the medium or high mobility state as defined in subclause 5.2.4.3.1. If more than one cell meets the above criteria, the UE shall reselect a cell ranked as the best cell among the cells meeting the criteria on the highest priority frequencies or the highest priority RAT if the highest priority RAT is E-UTRA according to criteria defined in 5.2.4.6.

[TS 36.304, clause 5.2.4.6]

The cell-ranking criterion R_s for serving cell and R_n for neighbouring cells is defined by:

$$R_s = Q_{\text{meas},s} + Q_{\text{hyst},s}$$

$$R_n = Q_{\text{meas},n} - Q_{\text{offset}}$$

where:

Q_{meas}	RSRP measurement quantity used in cell reselections.
Q_{offset}	For intra-frequency: Equals to $Q_{\text{offset},n}$, if $Q_{\text{offset},n}$ is valid, otherwise this equals to zero. For inter-frequency: Equals to $Q_{\text{offset},s,n}$ plus $Q_{\text{offset},\text{frequency}}$, if $Q_{\text{offset},s,n}$ is valid, otherwise this equals to $Q_{\text{offset},\text{frequency}}$.

The UE shall perform ranking of all cells that fulfil the cell selection criterion S, which is defined in 5.2.3.2, but may exclude all CSG cells that are known by the UE to be not allowed.

The cells shall be ranked according to the R criteria specified above, deriving $Q_{\text{meas},n}$ and $Q_{\text{meas},s}$ and calculating the R values using averaged RSRP results.

If a cell is ranked as the best cell the UE shall perform cell re-selection to that cell. If this cell is found to be not-suitable, the UE shall behave according to subclause 5.2.4.4.

In all cases, the UE shall reselect the new cell, only if the following conditions are met:

- the new cell is better ranked than the serving cell during a time interval $T_{\text{reselection,RAT}}$;
- more than 1 second has elapsed since the UE camped on the current serving cell.

6.1.2.15.3 Test description

6.1.2.15.3.1 Pre-test conditions

System Simulator:

- Cell 1, Cell 3 and Cell 6.

UE:

None.

Preamble:

- The UE is in state Registered, Idle mode (state 2) on Cell 1 according to [18].

6.1.2.15.3.2 Test procedure sequence

Table 6.1.2.15.3.2-1 illustrates the downlink power levels and other changing parameters to be applied for the cells at various time instants of the test execution. Row marked "T0" denotes the conditions after the preamble, while columns marked "T1", "T2" and "T3" are to be applied subsequently. The exact instants on which these values shall be applied are described in the texts in this clause.

Table 6.1.2.15.3.2-1: Time instances of cell power level and parameter changes

	Parameter	Unit	Cell 1	Cell 3	Cell 6	Remark
T0	Cell-specific RS EPRE	dBm/15kHz	[-90]	"off"	"off"	The power level values are assigned to satisfy $Srxlev_{Cell\ 1} > 0$, $Srxlev_{Cell\ 3} \leq 0$ and $Srxlev_{Cell\ 6} < Thresh_{Cell\ 1,high}$ such that camping on Cell 1 is guaranteed. (NOTE 1).
T1	Cell-specific RS EPRE	dBm/15kHz	[-90]	[-75]	"off"	The power level values are assigned to satisfy $R_{Cell\ 1} < R_{Cell\ 3}$. (NOTE 1).
T2	Cell-specific RS EPRE	dBm/15kHz	"off"	[-75]	[-75]	The power level values are assigned to satisfy $Srxlev_{Cell\ 1} < 0$ and $Srxlev_{Cell\ 6} > Thresh_{Cell\ 3,high}$. (NOTE 1).
T3	Cell-specific RS EPRE	dBm/15kHz	"off"	[-75]	[-95]	The power level values are assigned to satisfy $Srxlev_{Cell\ 6} < Thresh_{serving,low}$ and $Srxlev_{Cell\ 3} > Thresh_{Cell\ 6,low}$, $Srxlev_{Cell\ 1} < 0$. (NOTE 1).
NOTE 1: Power level "Off" is defined in TS36.508 Table 6.2.2.1-1.						

Table 6.1.2.15.3.2-2: Main behaviour

St	Procedure	Message Sequence		TP	Verdict
		U - S	Message		
1	The SS changes Cell 3 and Cell 6 level according to the row "T1" in table 6.1.2.15.3.2-1.	-	-	-	-
2	Check: Is there any random access requests from the UE on Cell 3?	-	-	1	P
3	The SS changes Cell 1 and Cell 6 level according to the row "T2" in table 6.1.2.15.3.2-1.	-	-	-	-
4	Check: Is there any random access requests from the UE on Cell 6?	-	-	2	P
5	The SS changes Cell 6 level according to the row "T3" in table 6.1.2.15.3.2-1.	-	-	-	-
6	Check: Is there any random access requests from the UE on Cell 3?	-	-	3	P

6.1.2.15.3.3 Specific message contents

Table 6.1.2.15.3.3-1: Conditions for specific message contents in Tables 6.1.2.15.3.3-2 and 6.1.2.15.3.3-3

Condition	Explanation
Cell 1	This condition applies to system information transmitted on Cell 1.
Cell 3	This condition applies to system information transmitted on Cell 3.
Cell 6	This condition applies to system information transmitted on Cell 6.

Table 6.1.2.15.3.3-2: SystemInformationBlockType1 for Cell 1, Cell 3 and Cell 6 (preamble and all steps, Table 6.1.2.15.3.2-2)

Derivation Path: 36.508 table 4.4.3.2-3			
Information Element	Value/remark	Comment	Condition
SystemInformationBlockType1 ::= SEQUENCE { SchedulingInfoList SEQUENCE (SIZE (1..maxSI-Message)) OF SEQUENCE {	Combination 3 in TS 36.508 section 4.4.3.1	SIB2, SIB3 and SIB5 are transmitted	Cell 1 Cell 3 Cell 6
}			

Table 6.1.2.15.3.3-3: SystemInformationBlockType3 for Cell 6 (preamble and all steps, Table 6.1.2.15.3.2-2)

Derivation path: 36.508 table 4.4.3.3-2			
Information Element	Value/Remark	Comment	Condition
SystemInformationBlockType3 ::= SEQUENCE { cellReselectionServingFreqInfo SEQUENCE { threshServingLow cellReselectionPriority } }	10 5	20 dB	

Table 6.1.2.15.3.3-4: SystemInformationBlockType5 for Cell 1, Cell 3 and Cell 6 (preamble and all steps, Table 6.1.2.15.3.2-2)

Derivation path: 36.508 table 4.4.3.3-4			
Information Element	Value/Remark	Comment	Condition
SystemInformationBlockType5 ::= SEQUENCE { interFreqCarrierFreqList SEQUENCE (SIZE (1..maxFreq)) OF SEQUENCE { dl-CarrierFreq[1] dl-CarrierFreq[2] threshX-High[2] cellReselectionPriority[2] } }	2 entries EARFCN of Cell 3 EARFCN of Cell 1 EARFCN of Cell 6 EARFCN of Cell 3 10 5	20 dB	Cell 1 Cell 3, Cell 6 Cell 1, Cell 3 Cell 6 Cell 1, Cell 3 Cell 1, Cell 3

6.2.2.1 Inter-RAT cell Selection / from E-UTRA RRC_IDLE to UTRA_Idle, serving cell becomes non-suitable (SServingCell<0,barred)

6.2.2.1.1 Test Purpose (TP)

(1)

```
with { UE in E-UTRA RRC_IDLE state }
ensure that {
  when { the serving cell becomes non-suitable and there is a suitable UTRA neighbour cell }
  then { UE selects the suitable UTRA neighbour cell }
```

(2)

```
with { UE in E-UTRA RRC_IDLE state }
ensure that {
  when { the serving cell becomes barred and there is a suitable UTRA neighbour cell }
  then { UE selects the suitable UTRA neighbour cell }
}
```

6.2.2.1.2 Conformance requirements

References: The conformance requirements covered in the current TC are specified in: TS 36.304, clause 4.1, 4.3, 5.2.1, 5.2.3.2 and 5.3.1. TS 25.304, clause 5.2.3.2.

[TS 36.304, clause 4.1]

With the cell selection, the UE searches for a suitable cell of the selected PLMN and chooses that cell to provide available services, further the UE shall tune to its control channel. This choosing is known as "camping on the cell".

The UE shall, if necessary, then register its presence, by means of a NAS registration procedure, in the tracking area of the chosen cell and as outcome of a successful Location Registration the selected PLMN becomes the registered PLMN [5].

If the UE finds a more suitable cell, according to the cell reselection criteria, it reselects onto that cell and camps on it. If the new cell does not belong to at least one tracking area to which the UE is registered, location registration is performed.

[TS 36.304, clause 4.3]

suitable cell:

A "suitable cell" is a cell on which the UE may camp on to obtain normal service. Such a cell shall fulfil all the following requirements.

- The cell is part of either:
 - the selected PLMN, or
 - the registered PLMN, or
 - a PLMN of the Equivalent PLMN list
 according to the latest information provided by NAS:
- The cell is not barred, see subclause 5.3.1;
- The cell is part of at least one TA that is not part of the list of "forbidden tracking areas for roaming" [4], which belongs to a PLMN that fulfils the first bullet above;
- The cell selection criteria are fulfilled, see subclause 5.2.3.2;
- For a CSG cell, the CSG ID is part of the allowed CSG list of the UE.

If more than one PLMN identity is broadcast in the cell, the cell is considered to be part of all TAs with TAIs constructed from the PLMN identities and the TAC broadcast in the cell.

barred cell:

A cell is barred if it is so indicated in the system information [3].

[TS 36.304, clause 5.2.1]

When camped on a cell, the UE shall regularly search for a better cell according to the cell reselection criteria. If a better cell is found, that cell is selected.

[TS 36.304, clause 5.2.3.2]

The cell selection criterion S is fulfilled when:

$$S_{rxlev} > 0$$

Where:

$$S_{rxlev} = Q_{rxlevmeas} - (Q_{rxlevmin} + Q_{rxlevminoffset}) - P_{compensation}$$

Where:

the signalled value $Q_{rxlevminOffset}$ is only applied when a cell is evaluated for cell selection as a result of a periodic search for a higher priority PLMN while camped normally in a VPLMN [5]. During this periodic search for higher priority PLMN the UE may check the S criteria of a cell using parameter values stored from a different cell of this higher priority PLMN.

Srxlev	Cell Selection RX level value (dB)
Qrxlevmeas	Measured cell RX level value (RSRP).
Qrxlevmin	Minimum required RX level in the cell (dBm)
Qrxlevminoffset	Offset to the signalled Q _{rxlevmin} taken into account in the Srxlev evaluation as a result of a periodic search for a higher priority PLMN while camped normally in a VPLMN [5]
Pcompensation	$\max(P_{EMAX} - P_{UMAX}, 0)$ (dB)
P _{EMAX}	Maximum TX power level an UE may use when transmitting on the uplink in the cell (dBm) defined as P _{EMAX} in [TS 36.101]
P _{UMAX}	Maximum RF output power of the UE (dBm) according to the UE power class as defined in [TS 36.101]

[TS 36.304, clause 5.3.1]

Cell status and cell reservations are indicated in the *SystemInformationBlockType1* [3] by means of two Information Elements:

- *cellBarred* (IE type: "barred" or "not barred")
In case of multiple PLMNs indicated in SIB1, this IE is common for all PLMNs

...

When cell status is indicated as "not barred" and "not reserved" for operator use,

- All UEs shall treat this cell as candidate during the cell selection and cell re-selection procedures.

...

When cell status "barred" is indicated or to be treated as if the cell status is "barred",

- The UE is not permitted to select/re-select this cell, not even for emergency calls.
- The UE shall select another cell according to the following rule:
 - If the cell is a CSG cell:
 - the UE may select another cell on the same frequency if the selection/reselection criteria are fulfilled.
 - else
 - If the IE *intraFreqReselection* in IE *cellAccessRelatedInfo* in *SystemInformationBlockType1* is set to "allowed", the UE may select another cell on the same frequency if re-selection criteria are fulfilled.
 - The UE shall exclude the barred cell as a candidate for cell selection/reselection for 300 seconds.
 - If the IE *intraFreqReselection* in IE *cellAccessRelatedInfo* in *SystemInformationBlockType1* is set to "not allowed" the UE shall not re-select a cell on the same frequency as the barred cell.
 - The UE shall exclude the barred cell as a candidate for cell selection/reselection for 300 seconds.

The cell selection of another cell may also include a change of RAT.

[TS 25.304, clause 5.2.3.2]

The cell selection criterion S is fulfilled when:

for FDD cells:	$Srxlev > 0$ AND $Squal > 0$
for TDD cells:	$Srxlev > 0$

Where:

$$Squal = Q_{qualmeas} - Q_{qualmin}$$

$$Srxlev = Q_{rxlevmeas} - Q_{rxlevmin} - P_{compensation}$$

Squal	Cell Selection quality value (dB) Applicable only for FDD cells.
Srxlev	Cell Selection RX level value (dB)
$Q_{qualmeas}$	Measured cell quality value. The quality of the received signal expressed in CPICH E_c/N_0 (dB) for FDD cells. CPICH E_c/N_0 shall be averaged as specified in [10]. Applicable only for FDD cells.
$Q_{rxlevmeas}$	Measured cell RX level value. This is received signal, CPICH RSCP for FDD cells (dBm) and P-CCPCH RSCP for TDD cells (dBm).
Qqualmin	Minimum required quality level in the cell (dB). Applicable only for FDD cells.
Qrxlevmin	Minimum required RX level in the cell (dBm)
Pcompensation	$\max(UE_TXPWR_MAX_RACH - P_MAX, 0)$ (dB)
UE_TXPWR_MAX_RACH	Maximum TX power level an UE may use when accessing the cell on RACH (read in system information) (dBm)
P_MAX	Maximum RF output power of the UE (dBm)

6.2.2.1.3 Test description

6.2.2.1.3.1 Pre-test conditions

System Simulator:

- Cell 1 and Cell 5

UE:

None.

Preamble:

- UE is in state Registered, Idle Mode (state 2) according to [18] in cell 1.

6.2.2.1.3.2 Test procedure sequence

Tables 6.2.2.1.3.2-1 & 6.2.2.1.3.2-2 illustrates the downlink power levels and other changing parameters to be applied for the cells at various time instants of the test execution. Row marked "T0" denotes the initial conditions, while rows marked "T1" or "T2" are to be applied subsequently. The exact instants on which these values shall be applied are described in the texts in this clause.

Table 6.2.2.1.3.2-1: Time instances of cell power level and parameter changes

	Parameter	Unit	Cell 1	Remark
T0	Cell-specific RS EPRE	dBm	-60	
	Qrxlevmin	dBm	-110	Default value
	Qrxlevminoffset	dB	0	Default value
	Qhyst	dB	0	Default value
	Treselection	s	7	Cell reselection timer values for EUTRA cells
	Srxlev*	dB	50	Cell 1 is the strongest cell
T1	Cell-specific RS EPRE	dBm	-120	$Srxlev_{Cell 1} < 0$
	Srxlev*	dB	-10	Cell 5 becomes the strongest cell
T2	Cell-specific RS EPRE	dBm	-60	$Srxlev_{Cell 1} > Srxlev_{Cell 5} > 0$
	Srxlev*	dB	50	
	cellBarred	-	Barred	Serving cell becomes barred

Note: Srxlev is calculated in the UE

Table 6.2.2.1.3.2-2: Time instances of cell power level and parameter changes

	Parameter	Unit	Cell 5	Remark
T0	CPICH_Ec	dBm/3.84 MHz	OFF	Camping on Cell 1 is guaranteed
	Qrxlevmin	dBm	-110	
	Srxlev*	dB	N/A	
T1	CPICH_Ec	dBm/3.84 MHz	-70	Srxlev _{Cell 5} > 0
	Srxlev*	dB	40	Cell 5 becomes the strongest cell

Note: Srxlev is calculated in the UE

Table 6.2.2.1.3.2-3: Main behaviour

St	Procedure	Message Sequence		TP	Verdict
		U - S	Message		
1	SS re-adjusts the cell-specific reference signal level of Cell 1 according to row "T1" in table 6.1.2.3.3.2-1 & cell 5 power level is set according to row "T1" in table 6.1.2.3.3.2-2.	-	-	-	-
2	Check: Does the UE initiate a random access on Cell 5?	-	-	1	P
3	UE is switched off (performs DETACH at switch off) and SS re-adjusts the cell-specific reference signal level of Cell 1 according to row "T0" in table 6.1.2.3.3.2-1 & cell 5 power level is set according to row "T0" in table 6.1.2.3.3.2-2.	-	-	-	-
4	UE is switched on	-	-	-	-
5	UE performs registration in cell 1	-	-	-	-
6	SS changes serving cell signal level and SIB1 IE <i>cellBarred</i> according to row "T2" in table 6.1.2.3.3.2-1 and transmits a <i>Paging</i> message including <i>systemInfoModification</i> & cell 5 power level is set according to row "T1" in table 6.1.2.3.3.2-2.	-	-	-	-
7	Check: Does the UE initiate a random access on Cell 5?	-	-	2	P

Table 6.2.2.1.3.3-4: SystemInformationBlockType1 for cells 1 (preamble and all steps, Table 6.2.2.1.3.2-1)

Derivation Path: 36.508 clause 4.4.3.2			
Information Element	Value/remark	Comment	Condition
SystemInformationBlockType1 ::= SEQUENCE {			
cellSelectionInfo SEQUENCE {			
q-Rxlevmin	-55 (-110 dBm)		
q-Rxlevminoffset	Not present		
}			
schedulingInformation ::= SEQUENCE (SIZE (1..maxSI-Message)) OF SEQUENCE {	Combination 1 in TS 36.508 section 4.4.3.1.1	Only SIB2 and SIB3 are transmitted	
}			

6.2.2.2 Inter-RAT cell Selection / from E-UTRA RRC_IDLE to GSM_Idle/GPRS Packet_idle, serving cell becomes non-suitable (SServingCell<0,barred)

6.2.2.2.1 Test Purpose (TP)

(1)

```
with { UE in E-UTRA RRC_IDLE state }
ensure that {
  when { the serving cell becomes non-suitable and there is a suitable GSM neighbour cell }
  then { UE selects the suitable GSM neighbour cell }
```

(2)

```

with { UE in E-UTRA RRC_IDLE state }
ensure that {
  when { the serving cell becomes barred and there is a suitable GSM neighbour cell }
  then { UE selects the suitable GSM neighbour cell }
}

```

6.2.2.2.2 Conformance requirements

References: The conformance requirements covered in the current TC are specified in: TS 36.304, clause 4.1, 4.3,5.2.1, 5.2.3.2, 5.3.1, 43.022, clause 3.6 and TS 45.008, clause 6.4.

[TS 36.304, clause 4.1]

With the cell selection, the UE searches for a suitable cell of the selected PLMN and chooses that cell to provide available services, further the UE shall tune to its control channel. This choosing is known as "camping on the cell".

The UE shall, if necessary, then register its presence, by means of a NAS registration procedure, in the tracking area of the chosen cell and as outcome of a successful Location Registration the selected PLMN becomes the registered PLMN [5].

If the UE finds a more suitable cell, according to the cell reselection criteria, it reselects onto that cell and camps on it. If the new cell does not belong to at least one tracking area to which the UE is registered, location registration is performed.

[TS 36.304, clause 4.3]

suitable cell:

A "suitable cell" is a cell on which the UE may camp on to obtain normal service. Such a cell shall fulfil all the following requirements.

- The cell is part of either:
 - the selected PLMN, or:
 - the registered PLMN, or:
 - a PLMN of the Equivalent PLMN list
 according to the latest information provided by NAS:
- The cell is not barred, see subclause 5.3.1;
- The cell is part of at least one TA that is not part of the list of "forbidden tracking areas for roaming" [4], which belongs to a PLMN that fulfils the first bullet above;
- The cell selection criteria are fulfilled, see subclause 5.2.3.2;
- For a CSG cell, the CSG ID is part of the allowed CSG list of the UE.

If more than one PLMN identity is broadcast in the cell, the cell is considered to be part of all TAs with TAIs constructed from the PLMN identities and the TAC broadcast in the cell.

barred cell:

A cell is barred if it is so indicated in the system information [3].

[TS 36.304, clause 5.2.1]

When camped on a cell, the UE shall regularly search for a better cell according to the cell reselection criteria. If a better cell is found, that cell is selected.

[TS 36.304, clause 5.2.3.2]

The cell selection criterion S is fulfilled when:

$$S_{rxlev} > 0$$

Where:

$$S_{rxlev} = Q_{rxlevmeas} - (Q_{rxlevmin} + Q_{rxlevminoffset}) - P_{compensation}$$

Where:

the signalled value $Q_{rxlevminOffset}$ is only applied when a cell is evaluated for cell selection as a result of a periodic search for a higher priority PLMN while camped normally in a VPLMN [5]. During this periodic search for higher priority PLMN the UE may check the S criteria of a cell using parameter values stored from a different cell of this higher priority PLMN.

S_{rxlev}	Cell Selection RX level value (dB)
$Q_{rxlevmeas}$	Measured cell RX level value (RSRP).
$Q_{rxlevmin}$	Minimum required RX level in the cell (dBm)
$Q_{rxlevminoffset}$	Offset to the signalled $Q_{rxlevmin}$ taken into account in the S_{rxlev} evaluation as a result of a periodic search for a higher priority PLMN while camped normally in a VPLMN [5]
$P_{compensation}$	$\max(P_{EMAX} - P_{UMAX}, 0)$ (dB)
P_{EMAX}	Maximum TX power level an UE may use when transmitting on the uplink in the cell (dBm) defined as P_{EMAX} in [TS 36.101]
P_{UMAX}	Maximum RF output power of the UE (dBm) according to the UE power class as defined in [TS 36.101]

[TS 36.304, clause 5.3.1]

Cell status and cell reservations are indicated in the *SystemInformationBlockType1* [3] by means of two Information Elements:

- *cellBarred* (IE type: "barred" or "not barred")
In case of multiple PLMNs indicated in SIB1, this IE is common for all PLMNs

...

When cell status is indicated as "not barred" and "not reserved" for operator use,

- All UEs shall treat this cell as candidate during the cell selection and cell re-selection procedures.

...

When cell status "barred" is indicated or to be treated as if the cell status is "barred",

- The UE is not permitted to select/re-select this cell, not even for emergency calls.
- The UE shall select another cell according to the following rule:
 - If the cell is a CSG cell:
 - the UE may select another cell on the same frequency if the selection/reselection criteria are fulfilled.
 - else
 - If the IE *intraFreqReselection* in IE *cellAccessRelatedInfo* in *SystemInformationBlockType1* is set to "allowed", the UE may select another cell on the same frequency if re-selection criteria are fulfilled.
 - The UE shall exclude the barred cell as a candidate for cell selection/reselection for 300 seconds.
 - If the IE *intraFreqReselection* in IE *cellAccessRelatedInfo* in *SystemInformationBlockType1* is set to "not allowed" the UE shall not re-select a cell on the same frequency as the barred cell.
 - The UE shall exclude the barred cell as a candidate for cell selection/reselection for 300 seconds.

The cell selection of another cell may also include a change of RAT.

[TS 43.022, clause 3.6]

The MS uses a "path loss criterion" parameter C1 to determine whether a cell is suitable to camp on. C1 depends on 4 parameters:

- i) The received signal level (suitably averaged);
- ii) The parameter RXLEV_ACCESS_MIN, which is broadcast as system information, and is related to the minimum signal that the operator wants the network to receive when being initially accessed by an MS;
- iii) The parameter MS_TXPWR_MAX_CCH, which is also broadcast as system information, and is the maximum power that an MS may use when initially accessing the network;
- iv) The maximum power of the MS.

The formula for determining C1 is given in 3GPP TS 45.008.

Use of the parameter C1 enables the MS to determine whether communication is possible with the network in the absence of interference. However because of the possibility of interference degrading the communications, an additional safeguard is used. This is to monitor the success rate of the MS in decoding signalling blocks of the paging subchannel. If there is a downlink signalling failure, i.e. the success rate drops too low, this indicates probable interference on the downlink, and the MS attempts to find another suitable cell. Downlink signalling failure monitoring is specified in 3GPP TS 45.008.

In order to optimize cell reselection, additional cell reselection parameters can be broadcast as system information of each cell. The cell reselection process employs a parameter C2 which depends on these parameters.

The parameters used to calculate C2 are as follows:

- i) CELL_RESELECT_OFFSET (see subclause 3.5.2.2);
- ii) PENALTY_TIME;

When the MS places the cell on the list of the strongest carriers as specified in 3GPP TS 45.008, it starts a timer which expires after the PENALTY_TIME. This timer will be reset when the cell is taken off the list. For the duration of this timer, C2 is given a negative offset. This will tend to prevent fast moving MSs from selecting the cell.

- iii) TEMPORARY_OFFSET;

This is the amount of the negative offset described in (ii) above. An infinite value can be applied, but a number of finite values are also possible.

The permitted values of these parameters and the way in which they are combined to calculate C2 are defined in 3GPP TS 45.008.

Instead of the parameter C2, a GPRS MS applies the corresponding GPRS parameter if provided.

[TS 45.008, clause 6.4]

The path loss criterion parameter C1 used for cell selection and reselection is defined by:

$$C1 = (A - \text{Max}(B,0))$$

where

$$\begin{aligned} A &= RLA_C - RXLEV_ACCESS_MIN \\ B &= MS_TXPWR_MAX_CCH - P \end{aligned}$$

except for the class 3 DCS 1 800 MS where:

$$\begin{aligned} B &= MS_TXPWR_MAX_CCH + \text{POWER OFFSET} - P \\ RXLEV_ACCESS_MIN &= \text{Minimum received signal level at the MS required for access to the system.} \end{aligned}$$

- MS_TXPWR_MAX_CCH = Maximum TX power level an MS may use when accessing the system until otherwise commanded.
- POWER OFFSET = The power offset to be used in conjunction with the MS TXPWR MAX CCH parameter by the class 3 DCS 1 800 MS.
- P = Maximum RF output power of the MS.

All values are expressed in dBm.

The path loss criterion (3GPP TS 43.022) is satisfied if $C1 > 0$.

6.2.2.2.3 Test description

6.2.2.2.3.1 Pre-test conditions

System Simulator:

- Cell 1 and Cell 24

UE:

None.

Preamble:

- UE is in state Registered, Idle Mode (state 2) according to [18] in cell 1.

6.2.2.2.3.2 Test procedure sequence

Tables 6.2.2.2.3.2-1 & 6.2.2.2.3.2-2 illustrates the downlink power levels and other changing parameters to be applied for the cells at various time instants of the test execution. Row marked "T0" denotes the initial conditions, while rows marked "T1" or "T2" are to be applied subsequently. The exact instants on which these values shall be applied are described in the texts in this clause.

Table 6.2.2.2.3.2-1: Time instances of cell power level and parameter changes

	Parameter	Unit	Cell 1	Remark
T0	Cell-specific RS EPRE	dBm	-60	
	Qrxlevmin	dBm	-110	Default value
	Qrxlevminoffset	dB	0	Default value
	Qhyst	dB	0	Default value
	Treselection	s	7	Cell reselection timer values for EUTRA cells
	Srxlev*	dB	50	Cell 1 is the strongest cell
T1	Cell-specific RS EPRE	dBm	-120	$Srxlev_{Cell\ 1} < 0$
	Srxlev*	dB	-10	Cell 5 becomes the strongest cell
T2	Cell-specific RS EPRE	dBm	-60	$Srxlev_{Cell\ 1} > Srxlev_{Cell\ 24} > 0$
	Srxlev*	dB	50	
	cellBarred	-	Barred	Serving cell becomes barred

Note: Srxlev is calculated in the UE

Table 6.2.2.2.3.2-2: Time instances of cell power level and parameter changes

	Parameter	Unit	Cell 24	Remark
T0	RF Signal Level	dBm	OFF	Camping on Cell 1 is guaranteed
	RXLEV_ACCESS_MIN	dBm	-100	
	C1*	dB	N/A	
T1	RF Signal Level	dBm	-80	$Srxlev_{Cell\ 24} > 0$
	C1*	dB	20	Cell [23] becomes the strongest cell

Note: Srxlev is calculated in the UE

Table 6.2.2.3.2-3: Main behaviour

St	Procedure	Message Sequence		TP	Verdict
		U - S	Message		
1	SS re-adjusts the cell-specific reference signal level of Cell 1 according to row "T1" in table 6.1.2.3.3.2-1 & cell 24] power level is set according to row "T1" in table 6.1.2.3.3.2-2.	-	-	-	-
2	Check: Does the UE initiate a random access on Cell 24?	-	-	1	P
3	UE is switched off (performs DETACH at switch off) and SS re-adjusts the cell-specific reference signal level of Cell 1 according to row "T0" in table 6.1.2.3.3.2-1 & Cell 24 power level is set according to row "T0" in table 6.1.2.3.3.2-2.	-	-	-	-
4	UE is switched on	-	-	-	-
5	UE performs registration on cell 1	-	-	-	-
6	SS changes serving cell signal level and SIB1 IE <i>cellBarred</i> according to row "T2" in table 6.1.2.3.3.2-1 and transmits a <i>Paging</i> message including <i>systemInfoModification</i> & Cell 24 power level is set according to row "T1" in table 6.1.2.3.3.2-2.	-	-	-	-
7	Check: Does the UE initiate a random access on Cell 24?	-	-	2	P

Table 6.2.2.3.3-4: *SystemInformationBlockType1* for cells 1 (preamble and all steps, Table 6.2.2.3.2-1)

Derivation Path: 36.508 clause 4.4.3.2			
Information Element	Value/remark	Comment	Condition
SystemInformationBlockType1 ::= SEQUENCE {			
cellSelectionInfo SEQUENCE {			
q-Rxlevmin	-55 (-110 dBm)		
q-Rxlevminoffset	Not present		
}			
schedulingInformation ::= SEQUENCE (SIZE (1..maxSI-Message)) OF SEQUENCE {	Combination 1 in TS 36.508 section 4.4.3.1.1	Only SIB2 and SIB3 are transmitted	
}			

6.2.2.3 Inter-RAT Cell selection / from E-UTRA RRC_IDLE to HRPD Idle, when the serving cell becomes non-suitable ($S_{\text{ServingCell}} < 0$)

6.2.2.3.1 Test Purpose (TP)

(1)

```

with { UE in E-UTRA RRC_IDLE state }
ensure that {
  when { the serving cell becomes non-suitable ( $S_{\text{ServingCell}} < 0$ ) and there is a suitable neighbour HRPD cell ( $S > 0$ ) }
  then { UE selects the suitable neighbour HRPD cell }
}

```

6.2.2.3.2 Conformance requirements

References: The conformance requirements covered in the current TC are specified in: TS36.300, clause 10.1.1.1 and TS 36.304, clause 4.1, 5.2.1, and 5.2.3.2.

[TS 36.300, clause 10.1.1.1]

...

Cell selection:

- The UE NAS identifies a selected PLMN and equivalent PLMNs;
- The UE searches the E-UTRA frequency bands and for each carrier frequency identifies the strongest cell. It reads cell system information broadcast to identify its PLMN(s):
 - The UE may search each carrier in turn ("initial cell selection") or make use of stored information to shorten the search ("stored information cell selection").
- The UE seeks to identify a suitable cell; if it is not able to identify a suitable cell it seeks to identify an acceptable cell. When a suitable cell is found or if only an acceptable cell is found it camps on that cell and commence the cell reselection procedure:
 - A suitable cell is one for which the measured cell attributes satisfy the cell selection criteria; the cell PLMN is the selected PLMN, registered or an equivalent PLMN; the cell is not barred or reserved and the cell is not part of a tracking area which is in the list of "forbidden tracking areas for roaming";
 - An acceptable cell is one for which the measured cell attributes satisfy the cell selection criteria and the cell is not barred;

...

[TS 36.304, clause 4.1]

...

With the cell selection, the UE searches for a suitable cell of the selected PLMN and chooses that cell to provide available services, further the UE shall tune to its control channel. This choosing is known as "camping on the cell".

The UE will, if necessary, then register its presence, by means of a NAS registration procedure, in the tracking area of the chosen cell and as outcome of a successful Location Registration the selected PLMN becomes the registered PLMN [5].

If the UE finds a more suitable cell, according to the cell reselection criteria, it reselects onto that cell and camps on it. If the new cell does not belong to at least one tracking area to which the UE is registered, location registration is performed.

...

[TS 36.304, clause 5.2.1]

...

When camped on a cell, the UE shall regularly search for a better cell according to the cell reselection criteria. If a better cell is found, that cell is selected.

[TS 36.304, clause 5.2.3.2]

The cell selection criterion S is fulfilled when:

$$S_{rxlev} > 0$$

Where:

$$S_{rxlev} = Q_{rxlevmeas} - (Q_{rxlevmin} - Q_{rxlevminoffset}) - P_{compensation}$$

Where:

the signalled value $Q_{rxlevminOffset}$ is only applied when a cell is evaluated for cell selection as a result of a periodic search for a higher priority PLMN while camped normally in a VPLMN [5]. During this periodic search for higher priority PLMN the UE may check the S criteria of a cell using parameter values stored from a different cell of this higher priority PLMN.

Srxlev	Cell Selection RX level value (dB)
Qrxlevmeas	Measured cell RX level value (RSRP).
Qrxlevmin	Minimum required RX level in the cell (dBm)
Qrxlevminoffset	Offset to the signalled Qrxlevmin taken into account in the Srxlev evaluation as a result of a periodic search for a higher priority PLMN while camped normally in a VPLMN [5]
Pcompensation	[FFS]

6.2.2.3.3 Test description

6.2.2.3.3.1 Pre-test conditions

System Simulator:

- Cell 1 is high quality cell on E-UTRA
- Cell 15 is high quality cell on HRPD

UE:

None

Preamble:

- UE is in state Registered, Idle Mode (state 2) according to [18].

6.2.2.3.3.2 Test procedure sequence

Table 6.2.2.3.3.2-1 illustrates the downlink power levels and other changing parameters to be applied for the cells at various time instants of the test execution. Row marked "T0" denotes the initial conditions, while rows marked "T1" and "T2" are to be applied subsequently. The exact instants on which these values shall be applied are described in the texts in this clause.

Table 6.2.2.3.3.2-1: Time instances of cell power level and parameter changes

	Parameter	Unit	Cell 1	Cell 15	Remark
T0	Cell-specific RS EPRE	dBm	-60	-	Srxlev _{Cell 1} > 0 and Cell 15 is off such that camping on Cell 1 is guaranteed
	Srxlev*	dB	50		
T1	FLOOR(-2 x 10 x log ₁₀ Ec/Io)	dB	-	[FFS]	Cell 15 is on
T2	Cell-specific RS EPRE	dBm	120	-	Srxlev _{Cell 1} < 0 and Cell 15 becomes the strongest cell
	Srxlev*	dB	-10		

Table 6.2.2.3.3.2-2: Main behaviour

St	Procedure	Message Sequence		TP	Verdict
		U - S	Message		
1	SS re-adjusts the cell-specific reference signal level of Cell 1 according to "T2" in 6.2.2.3.3.2.	-	-	-	-
2	Check: Does the UE transmit an Access Probe on Cell 15?	-->	Access Probe	1	P

6.2.2.3.3.3 Specific message contents

Table 6.2.2.3.3.3-1 *SystemInformationBlockType1 to Cell 1* (Preamble and all steps, table 6.2.2.3.3.2-1)

Derivation path: 36.508 table clause 4.4.3.2			
Information Element	Value/Remark	Comment	Condition
SystemInformationBlockType1 ::= SEQUENCE { cellSelectionInfo SEQUENCE { q-Rxlevmin q-Rxlevminoffset } schedulingInformation ::= SEQUENCE (SIZE (1..maxSI-Message)) OF SEQUENCE {} }	-55 (-110 dBm) Not present Combination 6 in TS 36.508 section 4.4.3.1.1		

Table 6.2.2.3.3.3-2: SystemInformationBlockType8 to Cell 1 (Preamble and all steps, table 6.2.2.3.3.2-1)

Derivation path: 36.508 table 4.4.3.3			
Information Element	Value/Remark	Comment	Condition
SystemInformationBlockType8 ::= SEQUENCE { cdma2000-SystemTimeInfo SEQUENCE { cdma-EUTRA-Synchronisation cdma-SystemTime CHOICE { cdma-SynchronousSystemTime } } searchWindowSize hrpd-Parameters SEQUENCE { hrpd-CellReselectionParameters SEQUENCE { hrpd-BandClassList SEQUENCE (SIZE (1..maxCDMA -BandClass)) OF SEQUENCE { hrpd-BandClass hrpd-CellReselectionPriority threshX-High threshX-Low } t-ReselectionCDMA-HRPD } }	TRUE A valid value as per TS 36.331 and calculated by the SS 5 The same number of entries as the configured HRPD carriers Band Class of frequency under test 5 FFS FFS [7]	 [Set according to specific test case] [3 is applicable when HRPD is lower priority than E-UTRA. 5 is applicable when HRPD is higher priority than E- UTRA] INTEGER (0..63) INTEGER (0..63) INTEGER (0..7)	HRPD

6.2.3.1 Inter-RAT Cell Reselection / from E-UTRA RRC_IDLE to GSM_Idle/GPRS Packet_Idle

6.2.3.1.1 Test Purpose (TP)

(1)

```
with { UE in E-UTRA RRC_IDLE state }
ensure that {
  when { UE detects the cell re-selection criteria are met for the cell which belongs to the higher
priority inter-RAT(GERAN) frequency for TreselectionRAT }
  then { UE reselects the cell which belongs to the higher priority inter-RAT(GERAN) frequency }
}
```

(2)

```
with { UE in E-UTRA RRC_IDLE state }
ensure that {
  when { UE detects the cell re-selection criteria are met for the cell which belongs to the lower
priority inter-RAT(GERAN) frequency for TreselectionRAT }
```

```

then { UE reselects the cell which belongs to the lower priority inter-RAT (GERAN) frequency }
}

```

6.2.3.1.2 Conformance requirements

References: The conformance requirements covered in the present TC are specified in: TS 36.304, clause 5.2.4.1, 5.2.4.2 and 5.2.4.5.

[TS 36.304, clause 5.2.4.1]

Absolute priorities of different E-UTRAN frequencies or inter-RAT frequencies may be provided to the UE in the system information, in the *RRCConnectionRelease* message, or by inheriting from another RAT at inter-RAT cell (re)selection. In the case of system information, an E-UTRAN frequency or inter-RAT frequency may be listed without providing a priority (i.e. the field *cellReselectionPriority* is absent for that frequency). If priorities are provided in dedicated signalling, the UE shall ignore all the priorities provided in system information. If UE is in *camped on any cell* state, UE shall only apply the priorities provided by system information from current cell, and the UE preserves priorities provided by dedicated signalling unless specified otherwise. When the UE in *camped normally* state, has only dedicated priorities other than for the current frequency, the UE shall consider the current frequency to be the lowest priority frequency (i.e. lower than the eight network configured values). The UE shall delete priorities provided by dedicated signalling when:

- the UE enters RRC_CONNECTED state; or
- the optional validity time of dedicated priorities (T320) expires; or
- a PLMN selection is performed on request by NAS [5].

NOTE: Equal priorities between RATs are not supported.

The UE shall only perform cell reselection evaluation for E-UTRAN frequencies and inter-RAT frequencies that are given in system information and for which the UE has a priority provided.

The UE shall not consider any black listed cells as candidate for cell reselection.

The UE shall inherit the priorities provided by dedicated signalling and the remaining validity time (i.e., T320 in E-UTRA, T322 in UTRA and [T3230, FFS] in GERAN), if configured, at inter-RAT cell (re)selection.

NOTE: The network may assign dedicated cell reselection priorities for frequencies not configured by system information.

[TS 36.304, clause 5.2.4.2]

When evaluating for reselection purposes cell selection criterion or $S_{\text{nonServingCell},x}$, the UE shall use parameters provided by the serving cell.

Following rules are used by the UE to limit needed measurements:

- If $S_{\text{intraSearch}}$ is sent in the serving cell and $S_{\text{ServingCell}} > S_{\text{intraSearch}}$, UE may choose to not perform intra-frequency measurements.
- If $S_{\text{ServingCell}} \leq S_{\text{intraSearch}}$, or $S_{\text{intraSearch}}$ is not sent in the serving cell UE shall perform intra-frequency measurements.
- The UE shall apply the following rules for E-UTRAN inter-frequencies and inter-RAT frequencies which are indicated in system information and for which the UE has priority provided as defined in 5.2.4.1:
 - For an E-UTRAN inter-frequency or inter-RAT frequency with a reselection priority higher than the reselection priority of the current E-UTRA frequency the UE shall perform measurements of higher priority E-UTRAN inter-frequency or inter-RAT frequencies according to [10].
 - For an E-UTRAN inter-frequency with an equal or lower reselection priority than the reselection priority of the current E-UTRA frequency and for inter-RAT frequency with lower reselection priority than the reselection priority of the current E-UTRAN frequency:
 - If $S_{\text{nonIntraSearch}}$ is sent in the serving cell and $S_{\text{ServingCell}} > S_{\text{nonIntraSearch}}$ UE may choose not to perform measurements of E-UTRAN inter-frequencies or inter-RAT frequency cells of equal or lower priority.

- If $S_{\text{ServingCell}} \leq S_{\text{nonintrasearch}}$ or $S_{\text{nonintrasearch}}$ is not sent in the serving cell the UE shall perform measurements of E-UTRAN inter-frequencies or inter-RAT frequency cells of equal or lower priority according to [10].

Where $S_{\text{ServingCell}}$ is the S_{rxlev} -value of the serving cell.

[TS 36.304, clause 5.2.4.5]

Criteria 1: the $S_{\text{nonServingCell},x}$ of a cell on evaluated frequency is greater than $\text{Thresh}_{x, \text{high}}$ during a time interval $\text{Treselection}_{\text{RAT}}$;

Cell reselection to a cell on a higher priority E-UTRAN frequency or inter-RAT frequency than serving frequency shall be performed if:

- A cell of a higher priority E-UTRAN frequency or inter-RAT frequency fulfils criteria 1; and
- more than 1 second has elapsed since the UE camped on the current serving cell.

Cell reselection to a cell on a lower priority E-UTRAN frequency or inter-RAT frequency than serving frequency shall be performed if:

- No cell on serving frequency or on an equal priority E-UTRAN frequency or on a higher priority E-UTRAN frequency or inter-RAT frequency than serving frequency fulfills the criteria 1; and
- $S_{\text{ServingCell}} < \text{Thresh}_{\text{serv}, \text{low}}$ and the $S_{\text{nonServingCell},x}$ of a cell of a lower priority E-UTRAN frequency or inter-RAT frequency is greater than $\text{Thresh}_{x, \text{low}}$ during a time interval $\text{Treselection}_{\text{RAT}}$; and
- more than 1 second has elapsed since the UE camped on the current serving cell.

or if:

- there are no candidate cells for reselection on serving frequency according to 5.2.4.4 or 5.3.1.

Cell reselection to a cell on an equal priority E-UTRAN frequency shall be based on ranking for Intra-frequency cell reselection as defined in sub-clause 5.2.4.6.

For GERAN, UTRAN, and E-UTRAN, $S_{\text{nonServingCell},x}$ is the S_{rxlev} -value of an evaluated cell. For UTRAN FDD, S_{qual} is higher than 0, as defined in [8]. For cdma2000 RATs, $S_{\text{nonServingCell},x}$ is equal to $\text{FLOOR}(-2 \times 10 \times \log_{10} E_c/I_o)$ in units of 0.5 dB, as defined in [18], with E_c/I_o referring to the value measured from the evaluated cell.

6.2.3.1.3 Test description

6.2.3.1.3.1 Pre-test conditions

System Simulator:

- Cell 1 Cell 24 and Cell 25.

UE:

None.

Preamble:

- The UE is in state Registered, Idle mode (state 2) on Cell 1 according to [18].

6.2.3.1.3.2 Test procedure sequence

Tables 6.2.3.1.3.2-1 & 6.2.3.1.3.2-2 illustrates the downlink power levels and other changing parameters to be applied for the cells at various time instants of the test execution. Row marked "T0" denotes the initial conditions, while rows marked "T1" or "T2" are to be applied subsequently. The exact instants on which these values shall be applied are described in the texts in this clause.

Table 6.2.3.1.3.2-1: Time instances of cell power level and parameter changes for E-UTRA cells

	Parameter	Unit	Cell 1	Remark
T0	Cell-specific RS EPRE	dBm/15kHz	-60	
	Qrxlevmin	dBm	-106	Default value
	Qrxlevminoffset	dB	0	Default value
	Qhyst	dB	0	Default value
	Srxlev*	dB	46	Cell 1 is the strongest cell
	s-NonIntraSearch	dB	N/A	Not transmitted Default value
T1	Cell-specific RS EPRE	dBm/15kHz	-70	$Srxlev_{Cell\ 1} > 0$
	Srxlev*	dB	36	$Srxlev_{Cell\ 1} > Srxlev_{Cell\ 24} > 0$
T2	Cell-specific RS EPRE	dBm/15kHz	-100	$Srxlev_{Cell\ 1} < 20$ [threshServingLow]
	Srxlev*	dB	6	

Note: Srxlev is calculated in the UE

Table 6.2.3.1.3.2-2: Time instances of cell power level and parameter changes for GERAN cells

	Parameter	Unit	Cell 24	Cell 25	Remark
T0	RF Signal Level	dBm	OFF	OFF	Camping on Cell 1 is guaranteed
	RXLEV_ACCESS_MIN	dBm	-101	-101	
	C1*	dB	N/A	N/A	
T1	RF Signal Level	dBm	-80	OFF	$Srxlev_{Cell\ 24} > 4$ [threshX-High]
	C1*	dB	21	N/A	
T2	RF Signal Level	dBm	OFF	-80	
	C1*	dB	N/A	21	$Srxlev_{Cell\ 25} > 4$ [threshX-Low]

Note: C1 is calculated in the UE

Table 6.2.3.1.3.2-3: Main behaviour

St	Procedure	Message Sequence		TP	Verdict
		U - S	Message		
1	The SS changes Cell 1 according to the row "T1" in table 6.2.3.1.3.2-1 and Cell 24 level according to the row "T1" in table 6.2.3.1.3.2-2.	-	-	-	-
2	Check: For 5 seconds, is there any random access requests from the UE on Cell 24?	-	-	1	F
3	Check: Does the UE initiate a random access on Cell 24?	-	-	1	P
4	Wait for [5 s].	-	-	-	-
5	The SS changes Cell 1 according to the row "T0" in table 6.2.3.1.3.2-1 and Cell 24 level according to the row "T0" in table 6.2.3.1.3.2-2	-	-	-	-
6	UE reselects Cell 1 and completes tracking area update procedure.	-	-	-	-
7	Wait for [5s].	-	-	-	-
8	The SS changes Cell 1 according to the row "T2" in table 6.2.3.1.3.2-1 and Cell 25 level according to the row "T2" in table 6.2.3.1.3.2-2.	-	-	-	-
9	Check: : For 5 seconds, does the UE initiate a random access on Cell 25?	-	-	2	F
10	Check: Does the UE initiate a random access on Cell 25?	-	-	2	P

6.2.3.1.3.3 Specific message contents

Table 6.2.3.1.3.3-1: Table 4.4.3.3-2: SystemInformationBlockType3 cell 1[preamble]

Derivation Path: 36.508 table 4.4.3.3-2			
Information Element	Value/remark	Comment	Condition
SystemInformationBlockType3 ::= SEQUENCE {			
cellReselectionServingFreqInfo SEQUENCE {			
s-NonIntraSearch	Not present		
threshServingLow	10	Actual value =20 dB	
cellReselectionPriority	4	A middle value in the range has been selected.	
}			
}			

Table 6.2.3.1.3.3-2: SystemInformationBlockType7 cell 1[preamble]

Derivation Path: 36.508 table 4.4.3.3-6			
Information Element	Value/remark	Comment	Condition
SystemInformationBlockType7 ::= SEQUENCE {			
t-ReselectionGERAN	7	INTEGER (0..7)	
speedDependentScalingParameters SEQUENCE {	Not present		
}			
carrierFreqsInfoList SEQUENCE (SIZE (1..maxGNFG)) OF SEQUENCE {	2 elements		
CarrierFreqsGERAN SEQUENCE {			
startingARFCN	Same as cell 24		
bandIndicator	Same as cell 24		
followingARFCNs CHOICE {			
equallySpacedARFCNs SEQUENCE {			
arfcn-Spacing	Same as cell 24		
numberOfFollowingARFCNs	Same as cell 24		
}			
}			
}			
commonInfo SEQUENCE {			
geran-CellReselectionPriority	5	Greater than EUTRA Freq	
ncc-Permitted	'11111111'B		
q-RxLevMin	2	The actual value of $Q_{rxlevmin}$ in dBm = (IE value * 2) - 115.	
threshX-High	2	Actual value =4 dB	
threshX-Low	2	Actual value =4 dB	
}			
CarrierFreqsGERAN SEQUENCE {			
startingARFCN	Same as cell 25		
bandIndicator	Same as cell 25		
followingARFCNs CHOICE {			
equallySpacedARFCNs SEQUENCE {			
arfcn-Spacing	Same as cell 25		
numberOfFollowingARFCNs	Same as cell 25		
}			
}			
}			
commonInfo SEQUENCE {			
geran-CellReselectionPriority	3	Less than EUTRA Freq	
ncc-Permitted	'11111111'B		
q-RxLevMin	2	The actual value of $Q_{rxlevmin}$ in dBm = (IE value * 2) - 115.	
threshX-High	2	Actual value =4 dB	
threshX-Low	2	Actual value =4 dB	
}			
}			
}			
}			

6.2.3.2 Inter-RAT Cell Reselection / from GSM_Idle/GPRS Packet_Idle to E-UTRA

6.2.3.2.1 Test Purpose (TP)

(1)

```
with { UE in GSM/GPRS Registered state and no RR connection }
ensure that {
  when { UE detects the cell re-selection criteria are met for the cell which belongs to the higher
priority inter-RAT E-UTRA cell}
  then { UE reselects the cell which belongs to the higher priority inter-RAT E-UTRA cell }
}
```

6.2.3.2.2 Conformance requirements

References: The conformance requirements covered in the present TC are specified in: TS 45.008, clause 10.1.3.3 & TS 44.018, clause 3.4.1.2.1.1a.

[TS 45.008, clause 10.1.3.3]

The algorithm in this subclause shall be used for inter-RAT cell reselection if priority information is available to the MS and threshold information is provided by the network. The network shall provide priority information if E-UTRAN frequencies are included in the neighbour cell list. The mobile station may apply either priorities broadcast in system information or individual priorities received through dedicated signalling. The rules regarding which set of priorities shall apply are defined in 3GPP TS 44.018 and 3GPP TS 44.060.

NOTE: Throughout the specification, the phrase “neighbour cell list” will include also the E-UTRAN Neighbour Cell list and/or the GPRS E-UTRAN Neighbour Cell list where appropriate.

If the GPRS 3G Cell Reselection list or the GPRS E-UTRAN Neighbour Cell list include frequencies of other radio access technologies, the MS shall, at least every 5 seconds update the value RLA_P for the serving cell and each of the at least 6 strongest non serving GSM cells.

The MS shall then reselect a suitable (see 3GPP TS 25.304 for UTRAN and 3GPP TS 36.304 for E-UTRAN) cell of another radio access technology if the criteria below are satisfied. $S_{\text{non-serving_XXX}}$ is the measurement quantity of a non-serving inter-RAT cell and XXX indicates the other radio access technology/mode. $S_{\text{non-serving_XXX}}$ is defined in subclause 6.6.6.

Cell reselection to a cell of another inter-RAT frequency shall be performed if any of the conditions below (to be evaluated in the order shown) is satisfied:

- The $S_{\text{non-serving_XXX}}$ of one or more cells of a higher priority inter-RAT frequency is greater than THRESH_XXX_high during a time interval $T_{\text{reselection}}$; in that case, the mobile station shall consider the cells for reselection in decreasing order of priority and, for cells of the same inter-RAT frequency, in decreasing order of $S_{\text{non-serving_XXX}}$, and reselect the first cell that satisfies the conditions above;
- The value of S_{serving} is lower than $\text{THRESH_serving_low}$ for the serving cell and all measured GSM cells; in this case, the mobile station shall consider for reselection the inter-RAT cells in the following order, and reselect the first one that satisfies the following criteria:
 - cells of a lower priority inter-RAT frequency whose $S_{\text{non-serving_XXX}}$ is greater than THRESH_XXX_low during a time interval $T_{\text{reselection}}$; these cells shall be considered in decreasing order of priority and, for cells of the same RAT, in decreasing order of $S_{\text{non-serving_XXX}}$;
 - if no cells satisfy the criterion above, inter-RAT cells for which, during a time interval $T_{\text{reselection}}$, $S_{\text{non-serving_XXX}}$ is higher than S_{serving} by at least a specific hysteresis H_{PRIO} ; these cells shall be considered in decreasing order of $S_{\text{non-serving_XXX}}$.

A UTRAN FDD cell shall only be reselected if, in addition to the criteria above, its measured E_c/N_0 value is equal to or greater than $\text{FDD_Qmin} - \text{FDD_Qmin_Offset}$.

Cell reselection to a cell of another radio access technology (e.g. UTRAN or E-UTRAN) shall not occur within [5] seconds after the MS has reselected a GSM cell from an inter-RAT cell if a suitable GSM cell can be found.

If the mobile station applies individual priorities received through dedicated signalling and priority information is available only for some inter-RAT frequencies, cells belonging to frequencies for which no individual priority is

available or no threshold is broadcast in system information shall not be considered for measurement and for cell re-selection.

If a mobile station in *camped normally* state (see 3GPP TS 43.022) applies individual priorities received through dedicated signalling and no priority is available for the serving cell, the mobile station shall consider any GSM cell (including the serving cell) to have lowest priority (i.e. lower than the eight network configured values).

A mobile station in *camped on any cell* state (see 3GPP TS 43.022) shall ignore individual priorities received through dedicated signalling and shall apply priorities received from the system information of the serving cell while attempting to find a suitable cell. If the mobile station supports CS voice services, the MS shall avoid reselecting acceptable (but not suitable) E-UTRA cells regardless of the priorities provided in system information.

NOTE: If the MS is camping on an acceptable cell, individual priorities are not discarded until an event leading to their deletion occurs.

In case of a reselection attempt towards a barred UTRAN cell, the MS shall abandon further reselection attempts towards this UTRAN cell as defined by the T_{barred} value on the barred UTRAN cell (see 3GPP TS 25.331).

NOTE: It is FFS whether a similar requirement should be added in case of a reselection attempt towards a barred E-UTRAN cell.

NOTE: Requirements for cells belonging to “forbidden LAs for roaming” should be included here.

[TS 44.018, clause 3.4.1.2.1.1a]

This applies only to a multi-RAT MS supporting E-UTRAN. One or more instances of the Measurement Information message or SI2quater message may provide E-UTRAN Neighbour Cell Description information in one or more instances of the Repeated E-UTRAN Neighbour Cells IE. This is used to build the E-UTRAN Neighbour Cell list. The E-UTRAN Neighbour Cell list may contain up to 8 E-UTRAN frequencies. For each E-UTRAN frequency, zero or more E-UTRAN neighbour cells may be specified that are not allowed for cell reselection. The list of not allowed cells is defined in the Not Allowed Cells IEs.

Each EARFCN in each instance of the Repeated E-UTRAN Neighbour Cells IE is added to the E-UTRAN Neighbour Cell list in the order in which it is received.

6.2.3.2.3 Test description

6.2.3.2.3.1 Pre-test conditions

System Simulator:

- Cell 1 and Cell 24.

UE:

None.

Preamble:

- The UE is in state Registered, Idle mode (state 2) on Cell 24 according to [18].

6.2.3.2.3.2 Test procedure sequence

Tables 6.2.3.2.3.2-1 & 6.2.3.2.3.2-2 illustrates the downlink power levels and other changing parameters to be applied for the cells at various time instants of the test execution. Row marked "T0" denotes the initial conditions, while rows marked "T1" are to be applied subsequently. The exact instants on which these values shall be applied are described in the texts in this clause.

Table 6.2.3.2.3.2-1: Time instances of cell power level and parameter changes for E-UTRA cell

	Parameter	Unit	Cell 1	Remark
T0	Cell-specific RS EPRE	dBm/15kHz	OFF	
	Qrxlevmin	dBm	-110	Default value
	Srxlev*	dB	N/A	
T1	Cell-specific RS EPRE	dBm/15kHz	-70	
	Srxlev*	dB	30	Srxlev _{Cell 1} >THRESH_E-UTRAN_high

Note: Srxlev is calculated in the UE

Table 6.2.3.2.3.2-2: Time instances of cell power level and parameter changes for GERAN cells

	Parameter	Unit	Cell 24	Remark
T0	RF Signal Level	dBm	-80	Camping on Cell 24 is guaranteed
	RXLEV_ACCESS_MIN	dBm	-101	
	C1*	dB	21	

Note: C1 is calculated in the UE

Table 6.2.3.2.3.2-3: Main behaviour

St	Procedure	Message Sequence		TP	Verdict
		U - S	Message		
1	The SS changes Cell 1 according to the row "T1" in table 6.2.3.2.3.2-1.	-	-	-	-
2	Check: Does the UE initiate a random access on Cell 1?	-	-	1	P

Note: GERAN cell priority is not allocated, hence it will be considered as the less than all allowed values of 1 to 8.

6.2.3.2.3.3 Specific message contents

Table 6.2.3.2.3.3-1 Repeated E-UTRAN Neighbour Cells struct of SI2Quarter for Cell 24[Preamble]

Derivation Path: 36.508 table FFS			
Information Element	Value/remark	Comment	Condition
Repeated E-UTRAN Neighbour Cells ::= SEQUENCE {			
EARFCN	Same as cell 1	This field specifies the E-UTRA Absolute Radio Frequency Channel Number as defined in 3GPP TS 36.104.	
Measurement Bandwidth	Same as cell 1		
E-UTRAN_PRIORITY	'100'B	Same as cell 1	
THRESH_E-UTRAN_high	'00010'B	Actual value =4 dB	
THRESH_E-UTRAN_low	'00010'B	Actual value =4 dB	
E-UTRAN_QRXLEVMIN	FFS		
}			

6.2.3.5 Inter-RAT Cell Reselection / from E-UTRA RRC_IDLE to UTRA_Idle

6.2.3.5.1 Test Purpose (TP)

(1)

```

with { UE in E-UTRA RRC_IDLE state }
ensure that {
  when { UE detects the cell re-selection criteria are met for the neighbour cell which belongs to the higher priority UTRAN frequency }
  then { UE reselects the UTRA cell }
}
    
```

6.2.3.5.2 Conformance requirements

References: The conformance requirements covered in the present TC are specified in: TS 36.304, clause 5.2.4.5.

[TS 36.304, clause 5.2.4.5]

Criteria 1: the $S_{\text{nonServingCell},x}$ of a cell on evaluated frequency is greater than $\text{Thresh}_{x,\text{high}}$ during a time interval $\text{Treselection}_{\text{RAT}}$;

Cell reselection to a cell on a higher priority E-UTRAN frequency or inter-RAT frequency than serving frequency shall be performed if:

- A cell of a higher priority E-UTRAN frequency or inter-RAT frequency fulfils criteria 1; and
- more than 1 second has elapsed since the UE camped on the current serving cell.

...

For GERAN, UTRAN, and E-UTRAN, $S_{\text{nonServingCell},x}$ is the S_{rxlev} -value of an evaluated cell. ...

...

6.2.3.5.3 Test description

6.2.3.5.3.1 Pre-test conditions

System Simulator:

- 2 cells, one E-UTRA and one UTRA cell and different location areas:
 - Cell 1 E-UTRA serving cell
 - Cell 5 suitable neighbour UTRA cell
- The parameters settings and power levels for Cell 1 and Cell 5 are selected according to [18], [5] so that camping on Cell 1 is guaranteed (utra priority is higher than serving and $S_{\text{nonServingCell}, \text{Cell}5} < \text{Thresh}_{\text{Cell}5,\text{low}}$).

UE:

None.

Preamble:

- The UE is in state Registered, Idle mode (state 2) on Cell 1 according to [18].

6.2.3.5.3.2 Test procedure sequence

Table 6.2.3.5.3.2-1 illustrates the downlink power levels and other changing parameters to be applied for the cells at various time instants of the test execution. Row marked "T0" denotes the conditions after the preamble, while row marked "T1" is to be applied subsequently. The exact instants on which these values shall be applied are described in the texts in this clause.

Table 6.2.3.5.3.2-1: Time instances of cell power level and parameter changes

	Parameter	Unit	Cell 1	Cell 5	Remark
T0	Cell-specific RS EPRE	dBm/15kHz	-85	-	The power levels are such that camping on Cell 1 is guaranteed.
	CPICH_Ec	dBm/3.84 MHz	-	[-89]	$S_{nonServingCell, Cell5} < Thresh_{Cell 5,low}$
T1	Cell-specific RS EPRE	dBm/15kHz	-85	-	
	CPICH_Ec	dBm/3.84 MHz	-	[-65]	$S_{nonServingCell, Cell5} > Thresh_{Cell 5,high}$

Table 6.2.3.5.3.2-2: Main behaviour

St	Procedure	Message Sequence		TP	Verdict
		U - S	Message		
1	The SS changes Cell 1 and Cell 5 levels according to the row "T1" in table 6.2.3.5.3.2-1.	-	-	-	-
2	Check: Is there any random access requests from the UE on Cell 5?	-	-	1	P

6.2.3.5.3.3 Specific message contents

Table 6.2.3.5.3.3-1: Conditions for specific message contents in Tables 6.2.3.5.3.3-2, 6.2.3.5.3.3-3 and 6.2.3.5.3.3-4

Condition descriptions
Cell 1 This condition applies to system information transmitted on Cell 1.
Cell 5 This condition applies to system information transmitted on Cell 5.

Table 6.2.3.5.3.3-2: SystemInformationBlockType1 for Cell 1 (preamble and all steps, Table 6.2.3.5.3.2-2)

Derivation Path: 36.508 table 4.4.3.2-3			
Information Element	Value/remark	Comment	Condition
SystemInformationBlockType1 ::= SEQUENCE {			
schedulingInfoList ::= SEQUENCE (SIZE (1..maxSI-Message)) OF SEQUENCE {	Combination 4 in TS 36.508 section 4.4.3.1	SIB2, SIB3 and SIB6 are transmitted	
}			

Table 6.2.3.5.3.3-3: SystemInformationBlockType6 for Cell 1 (preamble and all steps, Table 6.2.3.5.3.2-2)

Derivation Path: 36.508 table 4.4.3.3-5			
Information Element	Value/remark	Comment	Condition
SystemInformationBlockType6 ::= SEQUENCE {			
carrierFreqListUTRA-FDD SEQUENCE (SIZE (1..maxUTRA-FDD-Carrier)) OF SEQUENCE {	1 entry		UTRA-FDD
cellReselectionPriority	5	Higher priority than E-UTRA	
}			
carrierFreqListUTRA-TDD SEQUENCE (SIZE (1..maxUTRA-TDD-Carrier)) OF SEQUENCE {	1 entry		UTRA-TDD
cellReselectionPriority	5	Higher priority than E-UTRA	
}			
}			

6.2.3.7 Inter-RAT Cell Reselection: from E-UTRA RRC_IDLE to HRPD Idle – When HRPD cell is higher reselection priority than E-UTRA

6.2.3.7.1 Test Purpose (TP)

(1)

```
with { UE in E-UTRA RRC_IDLE state and UE detects the cell re-selection criteria that HRPD cell is
higher reselection priority than E-UTRAN serving cell }
ensure that { UE searches for and measures HRPD cell at least every  $T_{higher\_priority\_search}$ 
  when {  $S_{nonServingCell, HRPD} > Thresh_{HRPD, high}$  }
    then { UE reselects the HRPD cell }
  }
```

6.2.3.7.2 Conformance requirements

References: The conformance requirements covered in the present TC are specified in: TS 36.304, clause 5.2.4.1, 5.2.4.2 and 5.2.4.5 and TS 36.133, clause 4.2.2.5 and 4.2.2.5.4.

[TS 36.304, clause 5.2.4.1]

Absolute priorities of different E-UTRAN frequencies or inter-RAT frequencies may be provided to the UE in the system information or in the RRC message releasing the RRC connection. If priorities are assigned via dedicated signalling, the UE shall ignore all the priorities provided in system information. The UE shall delete priorities provided by dedicated signalling when:

- the UE enters RRC_CONNECTED state; or
- the optional validity time of dedicated priorities (T_{320}) expires; or
- a PLMN selection is performed on request by NAS [5].

NOTE: Equal priorities between RATs are not supported.

UE shall only perform reselection evaluation for E-UTRAN frequencies and inter-RAT frequencies that are given in system information and for which the UE has a priority provided.

[TS 36.304, clause 5.2.4.2]

Following rules are used by the UE to limit needed measurements:

- If $S_{ServingCell} > S_{intraSearch}$, UE may choose to not perform intra-frequency measurements.
- If $S_{ServingCell} \leq S_{intraSearch}$, UE shall perform intra-frequency measurements.
- The UE shall apply the following rules for E-UTRAN inter-frequencies and inter-RAT frequencies which are indicated in system information and for which the UE has priority provided as defined in 5.2.4.1:
 - o For an E-UTRAN inter-frequency or inter-RAT frequency with a reselection priority higher than the reselection priority of the current E-UTRA frequency the UE shall perform measurements of higher priority E-UTRAN inter-frequency or inter-RAT frequencies according to [10].
 - o For an E-UTRAN inter-frequency with a equal or lower reselection priority than the reselection priority of the current E-UTRA frequency and for inter-RAT frequency with lower reselection priority than the reselection priority of the current E-UTRAN frequency:
 - If $S_{ServingCell} > S_{nonintraSearch}$ UE may choose not to perform measurements of E-UTRAN inter-frequencies or inter-RAT frequencies of equal or lower priority.
 - If $S_{ServingCell} \leq S_{nonintraSearch}$ the UE shall perform measurements of E-UTRAN inter-frequencies or inter-RAT frequencies cells of equal or lower priority according to [10].

Where $S_{ServingCell}$ is the S_{rxlev} -value of the serving cell.

[TS 36.304, clause 5.2.4.5]

Criteria 1: the $S_{nonServingCell,x}$ of a cell on evaluated frequency is greater than $Thresh_{x, high}$ during a time interval $T_{reselection_{RAT}}$;

Cell reselection to a cell on a higher priority E-UTRAN frequency or inter-RAT frequency than serving frequency shall be performed if:

- A cell of a higher priority E-UTRAN frequency or inter-RAT frequency fulfils criteria 1; and
- more than 1 second has elapsed since the UE camped on the current serving cell.

Cell reselection to a cell on a lower priority E-UTRAN frequency or inter-RAT frequency than serving frequency shall be performed if:

- No cell on serving frequency or on a higher priority E-UTRAN frequency or inter-RAT frequency than serving frequency fulfills the criteria 1; and
- $S_{ServingCell} < Thresh_{serving, low}$ and the $S_{nonServingCell,x}$ of a cell of a lower priority E-UTRAN frequency or inter-RAT frequency is greater than $Thresh_{x, low}$ during a time interval $T_{reselectionRAT}$; and
- more than 1 second has elapsed since the UE camped on the current serving cell.

Cell reselection to a cell on an equal priority E-UTRAN frequency shall be based on ranking for Intra-frequency Cell Reselection as defined in sub-clause 5.2.4.6.

For GERAN, UTRAN, and E-UTRAN, $S_{nonServingCell,x}$ is the S_{rxlev} -value of an evaluated cell. For cdma2000 RATs, $S_{nonServingCell,x}$ is equal to $FLOOR(-2 \times 10 \times \log_{10} E_c/I_o)$ in units of 0.5 db, as defined in [18], with E_c/I_o referring to the value measured from the evaluated cell.

In all the above criteria the value of $T_{reselectionRAT}$ is scaled when the UE is in the medium or high mobility state as defined in subclause 5.2.4.3.1. If more than one cell meets the above criteria, the UE shall reselect a cell ranked as the best cell among the cells meeting the criteria on the highest priority frequencies or the highest priority RAT if the highest priority RAT is E-UTRA according to criteria defined in 5.2.4.6.

[TS 36.133, clause 4.2.2.5]

If the $S_{ServingCell}$ of the E-UTRA serving cell (or other cells on the same frequency layer) is greater than $S_{nonintraSearch}$, then

- the UE may not search for, or measure inter-RAT layers of equal or lower priority.
- the UE shall search for inter-RAT layers of higher priority at least every $T_{higher_priority_search}$ where $T_{higher_priority_search}$ is described in section 4.2.2.

If the $S_{ServingCell}$ of the E-UTRA serving cell is less than or equal to $S_{nonintraSearch}$, then the UE shall search for and measure inter-RAT layers of higher, equal or lower priority in preparation for possible reselection. In this scenario, the minimum rate at which the UE is required to search for and measure such layers is not reduced and shall be the same as that defined below for lower priority RATs.

[TS 36.133, clause 4.2.2.5.4]

In order to perform measurement and cell reselection to HRPD cell, the UE shall acquire the timing of HRPD cells.

When the measurement rules indicate that HRPD cells are to be measured, the UE shall measure CDMA2000 HRPD Pilot Strength of HRPD cells in the neighbour cell list at the minimum measurement rate specified in this section.

The parameter 'Number of HRPD Neighbor Frequency', which is transmitted on E-UTRAN BCCH, is the number of carriers used for all HRPD cells in the neighbour cell list.

When the RSRP of the E-UTRA serving cell (or other cells on the same frequency layer) is lower than 'HRPD Start Measuring E-UTRAN Rx Power Strength Threshold' and HRPD is of lower priority than the currently selected E-UTRAN frequency layer, the UE shall measure CDMA2000 HRPD Pilot Strength of the HRPD cells at least every $(\text{Number of HRPD Neighbor Frequency}) \times T_{measureHRPD}$. In case HRPD is of higher priority than the currently selected E-UTRAN frequency layer the UE shall measure HRPD cells at least every $(\text{Number of HRPD Neighbor Frequency}) \times T_{higher_priority_search}$. The parameter $T_{higher_priority_search}$ is defined in section 4.2.2.

The UE shall be capable of evaluating that the HRPD cell has met cell reselection criterion defined in [1] within $T_{evaluateHRPD}$.

Table 4.2.2.5.4-1 gives values of $T_{measureHRPD}$ and $T_{evaluateHRPD}$.

Table 4.2.2.5.4-1: $T_{\text{measureHRPD}}$ and $T_{\text{evaluateHRPD}}$

DRX cycle length [s]	$T_{\text{measureHRPD}}$ [s] (number of DRX cycles)	$T_{\text{evaluateHRPD}}$ [s] (number of DRX cycles)
0.32	5.12 (16)	15.36 (48)
0.64	5.12 (8)	15.36 (24)
1.28	6.4 (5)	19.2 (15)
2.56	7.68 (3)	23.04 (9)

6.2.3.7.3 Test description

6.2.3.7.3.1 Pre-test conditions

System Simulator:

- Cell 1 for E-UTRAN
- Cell 15 for HRPD with higher reselection priority than Cell 1

UE:

None.

Preamble:

- The UE is in state Registered, Idle mode (state 2) on Cell 1 according to [18].

6.2.3.7.3.2 Test procedure sequence

Table 6.2.3.7.3.2-1 illustrates the downlink power levels and other changing parameters to be applied for the cells at various time instants of the test execution. Row marked "T0" denotes the initial conditions, while rows marked "T1" and "T2" are to be applied subsequently. The exact instants on which these values shall be applied are described in the texts in this clause.

Table 6.2.3.7.3.2-1: Time instances of cell power level and parameter changes

	Parameter	Unit	Cell 1	Cell 15	Remark
T0	Cell-specific RS EPRE	dBm	-60	-	Srxlev _{Cell 1} > 0 and Cell 15 is off such that camping on Cell 1 is guaranteed
	Srxlev*	dB	50		
T1	FLOOR(-2 x 10 x log ₁₀ Ec/Io)	dB	-	[FFS] <= Thresh _{HRP} _{D, high}	Cell 15 is on
T2	FLOOR(-2 x 10 x log ₁₀ Ec/Io)	dB	-	[FFS] > Thresh _{HRP} _{D, high}	Increase pilot power of HRPD cell such that S _{nonServingCell, HRPD} of Cell 15 > Thresh _{HRPD, high}

Table 6.2.3.7.3.2-2: Main behaviour

St	Procedure	Message Sequence		TP	Verdict
		U - S	Message		
1	SS adjust the serving cell signal level to make sure UE is camping on Cell 1, according to "T0" in 6.2.3.7.3.2	-	-	-	-
2	Cell 15 is on and it has higher reselection priority than Cell1, according to "T1" in 6.2.3.7.3.2	-	-	-	-
3	UE performs measurement for Cell 15 at every $T_{higher_priority_search}$	-	-	-	-
4	Check: Does the UE transmit an Access Probe on Cell 15 within the next [60s]?	-->	Access Probe	1	F
5	SS adjust HRPD cell signal level to make sure $S_{nonServingCell,HRPD}$ of Cell 15 > $Thresh_{HRPD, high}$, according to "T2" in 6.2.3.7.3.2	-	-	-	-
6	Check: Does the UE transmit an Access Probe on Cell 15?	-->	Access Probe	1	P

6.2.3.7.3.3 Specific message contents

Table 6.2.3.7.3.3-1: SystemInformationBlockType1 to Cell 1 (Preamble and all steps, table 6.2.3.7.3.2-1)

Derivation path: 36.508 table clause 4.4.3.2			
Information Element	Value/Remark	Comment	Condition
SystemInformationBlockType1 ::= SEQUENCE { cellSelectionInfo SEQUENCE { q-Rxlevmin q-Rxlevminoffset } schedulingInformation ::= SEQUENCE (SIZE (1..maxSI-Message)) OF SEQUENCE {} }	-55 (-110 dBm) Not present Combination 6 in TS 36.508 section 4.4.3.1.1		

Table 6.2.3.7.3.3-2: SystemInformationBlockType8 to Cell 1 (Preamble and all steps, table 6.2.3.7.3.2-1)

Derivation path: 36.508 table 4.4.3.3			
Information Element	Value/Remark	Comment	Condition
SystemInformationBlockType8 ::= SEQUENCE { Cdma2000-SystemTimeInfo SEQUENCE { cdma-EUTRA-Synchronisation cdma-SystemTime CHOICE { cdma-SynchronousSystemTime } } searchWindowSize hrpd-Parameters SEQUENCE { Hrpd-CellReselectionParameters SEQUENCE { hrpd-BandClassList SEQUENCE (SIZE (1..maxCDMA -BandClass)) OF SEQUENCE { hrpd-BandClass hrpd-CellReselectionPriority } } } threshX-High threshX-Low } t-ReselectionCDMA-HRPD }	TRUE A valid value as per TS 36.331 and calculated by the SS 5 The same number of entries as the configured HRPD carriers Band Class of frequency under test 5 FFS FFS [7]	 [Set according to specific test case] [3 is applicable when HRPD is lower priority than E-UTRA. 5 is applicable when HRPD is higher priority than E-UTRA] INTEGER (0..63) INTEGER (0..63) INTEGER (0..7)	HRPD

6.2.3.8 Inter-RAT Cell Reselection: from E-UTRA RRC_IDLE to HRPD Idle – When HRPD is lower reselection priority than E-UTRA

6.2.3.8.1 Test Purpose (TP)

(1)

```
with { UE in E-UTRA RRC_IDLE state and UE detects the cell re-selection criteria that HRPD cell is equal to or lower reselection priority than E-UTRAN serving cell }
ensure that {
  When{ SServingCell <= Snonintrasearch }
  then { UE searches for and measures HRPD cell at least every Thigher_priority_search }
  when { SnonServingCell,HRPD > ThreshHRPD, low }
  then { UE reselects the HRPD cell }
}
```

6.2.3.8.2 Conformance requirements

References: The conformance requirements covered in the present TC are specified in: TS 36.304, clause 5.2.4.1, 5.2.4.2 and 5.2.4.5 and TS 36.133, clause 4.2.2.5 and 4.2.2.5.4.

[TS 36.304, clause 5.2.4.1]

Absolute priorities of different E-UTRAN frequencies or inter-RAT frequencies may be provided to the UE in the system information or in the RRC message releasing the RRC connection. If priorities are assigned via dedicated signalling, the UE shall ignore all the priorities provided in system information. The UE shall delete priorities provided by dedicated signalling when:

- the UE enters RRC_CONNECTED state; or

- the optional validity time of dedicated priorities (T320) expires; or
- a PLMN selection is performed on request by NAS [5].

NOTE: Equal priorities between RATs are not supported.

UE shall only perform reselection evaluation for E-UTRAN frequencies and inter-RAT frequencies that are given in system information and for which the UE has a priority provided.

[TS 36.304, clause 5.2.4.2]

Following rules are used by the UE to limit needed measurements:

- If $S_{ServingCell} > S_{intrasearch}$, UE may choose to not perform intra-frequency measurements.
- If $S_{ServingCell} \leq S_{intrasearch}$, UE shall perform intra-frequency measurements.
- The UE shall apply the following rules for E-UTRAN inter-frequencies and inter-RAT frequencies which are indicated in system information and for which the UE has priority provided as defined in 5.2.4.1:
 - o For an E-UTRAN inter-frequency or inter-RAT frequency with a reselection priority higher than the reselection priority of the current E-UTRA frequency the UE shall perform measurements of higher priority E-UTRAN inter-frequency or inter-RAT frequencies according to [10].
 - o For an E-UTRAN inter-frequency with a equal or lower reselection priority than the reselection priority of the current E-UTRA frequency and for inter-RAT frequency with lower reselection priority than the reselection priority of the current E-UTRAN frequency:
 - If $S_{ServingCell} > S_{nonintrasearch}$ UE may choose not to perform measurements of E-UTRAN inter-frequencies or inter-RAT frequencies of equal or lower priority.
 - If $S_{ServingCell} \leq S_{nonintrasearch}$ the UE shall perform measurements of E-UTRAN inter-frequencies or inter-RAT frequencies cells of equal or lower priority according to [10].

Where $S_{ServingCell}$ is the S_{rxlev} -value of the serving cell.

[TS 36.304, clause 5.2.4.5]

Criteria 1: the $S_{nonServingCell,x}$ of a cell on evaluated frequency is greater than $Thresh_{x, high}$ during a time interval $T_{reselectionRAT}$;

Cell reselection to a cell on a higher priority E-UTRAN frequency or inter-RAT frequency than serving frequency shall be performed if:

- A cell of a higher priority E-UTRAN frequency or inter-RAT frequency fulfils criteria 1; and
- more than 1 second has elapsed since the UE camped on the current serving cell.

Cell reselection to a cell on a lower priority E-UTRAN frequency or inter-RAT frequency than serving frequency shall be performed if:

- No cell on serving frequency or on a higher priority E-UTRAN frequency or inter-RAT frequency than serving frequency fulfils the criteria 1; and
- $S_{ServingCell} < Thresh_{serving, low}$ and the $S_{nonServingCell,x}$ of a cell of a lower priority E-UTRAN frequency or inter-RAT frequency is greater than $Thresh_{x, low}$ during a time interval $T_{reselectionRAT}$; and
- more than 1 second has elapsed since the UE camped on the current serving cell.

Cell reselection to a cell on an equal priority E-UTRAN frequency shall be based on ranking for Intra-frequency Cell Reselection as defined in sub-clause 5.2.4.6.

For GERAN, UTRAN, and E-UTRAN, $S_{nonServingCell,x}$ is the S_{rxlev} -value of an evaluated cell. For cdma2000 RATs, $S_{nonServingCell,x}$ is equal to $FLOOR(-2 \times 10 \times \log_{10} E_c/I_o)$ in units of 0.5 db, as defined in [18], with E_c/I_o referring to the value measured from the evaluated cell.

In all the above criteria the value of $T_{\text{reselectionRAT}}$ is scaled when the UE is in the medium or high mobility state as defined in subclause 5.2.4.3.1. If more than one cell meets the above criteria, the UE shall reselect a cell ranked as the best cell among the cells meeting the criteria on the highest priority frequencies or the highest priority RAT if the highest priority RAT is E-UTRA according to criteria defined in 5.2.4.6.

[TS 36.133, clause 4.2.2.5]

If the $S_{\text{ServingCell}}$ of the E-UTRA serving cell (or other cells on the same frequency layer) is greater than $S_{\text{nonintrasearch}}$, then

- the UE may not search for, or measure inter-RAT layers of equal or lower priority.
- the UE shall search for inter-RAT layers of higher priority at least every $T_{\text{higher_priority_search}}$ where $T_{\text{higher_priority_search}}$ is described in section 4.2.2.

If the $S_{\text{ServingCell}}$ of the E-UTRA serving cell is less than or equal to $S_{\text{nonintrasearch}}$, then the UE shall search for and measure inter-RAT layers of higher, equal or lower priority in preparation for possible reselection. In this scenario, the minimum rate at which the UE is required to search for and measure such layers is not reduced and shall be the same as that defined below for lower priority RATs.

[TS 36.133, clause 4.2.2.5.4]

In order to perform measurement and cell reselection to HRPD cell, the UE shall acquire the timing of HRPD cells.

When the measurement rules indicate that HRPD cells are to be measured, the UE shall measure CDMA2000 HRPD Pilot Strength of HRPD cells in the neighbour cell list at the minimum measurement rate specified in this section.

The parameter 'Number of HRPD Neighbor Frequency', which is transmitted on E-UTRAN BCCH, is the number of carriers used for all HRPD cells in the neighbour cell list.

When the RSRP of the E-UTRA serving cell (or other cells on the same frequency layer) is lower than 'HRPD Start Measuring E-UTRAN Rx Power Strength Threshold' and HRPD is of lower priority than the currently selected E-UTRAN frequency layer, the UE shall measure CDMA2000 HRPD Pilot Strength of the HRPD cells at least every $(\text{Number of HRPD Neighbor Frequency}) \cdot T_{\text{measureHRPD}}$. In case HRPD is of higher priority than the currently selected E-UTRAN frequency layer the UE shall measure HRPD cells at least every $(\text{Number of HRPD Neighbor Frequency}) \cdot T_{\text{higher_priority_search}}$. The parameter $T_{\text{higher_priority_search}}$ is defined in section 4.2.2.

The UE shall be capable of evaluating that the HRPD cell has met cell reselection criterion defined in [1] within $T_{\text{evaluateHRPD}}$.

Table 4.2.2.5.4-1 gives values of $T_{\text{measureHRPD}}$ and $T_{\text{evaluateHRPD}}$.

Table 4.2.2.5.4-1: $T_{\text{measureHRPD}}$ and $T_{\text{evaluateHRPD}}$

DRX cycle length [s]	$T_{\text{measureHRPD}}$ [s] (number of DRX cycles)	$T_{\text{evaluateHRPD}}$ [s] (number of DRX cycles)
0.32	5.12 (16)	15.36 (48)
0.64	5.12 (8)	15.36 (24)
1.28	6.4 (5)	19.2 (15)
2.56	7.68 (3)	23.04 (9)

6.2.3.8.3 Test description

6.2.3.8.3.1 Pre-test conditions

System Simulator:

- Cell 1 for E-UTRAN
- Cell 15 for HRPD with lower reselection priority than Cell 1

UE:

None.

Preamble:

- The UE is in state Registered, Idle mode (state 2) on Cell 1 according to [18].

6.2.3.8.3.2 Test procedure sequence

Table 6.2.3.8.3.2-1 illustrates the downlink power levels and other changing parameters to be applied for the cells at various time instants of the test execution. Row marked "T0" denotes the initial conditions, while rows marked "T1" and "T2" are to be applied subsequently. The exact instants on which these values shall be applied are described in the texts in this clause.

Table 6.2.3.8.3.2-1: Time instances of cell power level and parameter changes

	Parameter	Unit	Cell 1	Cell 15	Remark
T0	Cell-specific RS EPRE	dBm	-60	-	S _{rxlev} _{Cell 1} > 0 and Cell 15 is off such that camping on Cell 1 is guaranteed
	S _{rxlev} *	dB	50		
T1	FLOOR(-2 x 10 x log ₁₀ E _c /I _o)	dB	-	[FFS] <= Thresh _{HRPD, low}	Cell 15 is on
	Cell-specific RS EPRE	dBm	[FFS]	-	S _{ServingCell} of the E-UTRA <= S _{nonIntraSearch}
	S _{rxlev} *	dB	[FFS]		
T2	FLOOR(-2 x 10 x log ₁₀ E _c /I _o)	dB	-	[FFS] > Thresh _{HRPD, low}	Increase pilot power of HRPD cell such that S _{nonServingCell, HRPD} of Cell 15 > Thresh _{x, low}

Table 6.2.3.8.3.2-2: Main behaviour

St	Procedure	Message Sequence		TP	Verdict
		U - S	Message		
1	SS adjust the serving cell signal level to make sure UE is camping on Cell 1, according to "T0" in 6.2.3.8.3.2	-	-	-	-
2	Cell 15 is on and it has lowerer reselection priority than Cell 1, according to "T1" in 6.2.3.8.3.2	-	-	-	-
3	SS adjust the serving cell signal level so that S _{ServingCell} of the E-UTRA <= S _{nonIntraSearch}	-	-		
4	UE performs measurement for Cell 15 at every T _{higher priority search}	-	-		
5	Check: Does the UE transmit an Access Probe on Cell 15 within the next [60s]?	-->	Access Probe	1	F
6	SS adjust HRPD cell signal level to make sure S _{nonServingCell, HRPD} of Cell 15 > Thresh _{HRPD, low}				
7	Check: Does the UE transmit an Access Probe on Cell 15?	-->	Access Probe	1	P

6.2.3.8.3.3 Specific message contents

Table 6.2.3.8.3.3-1: SystemInformationBlockType1 to Cell 1 (Preamble and all steps, table 6.2.3.8.3.2-1)

Derivation path: 36.508 table 4.4.3.2			
Information Element	Value/Remark	Comment	Condition
SystemInformationBlockType1 ::= SEQUENCE { cellSelectionInfo SEQUENCE { q-Rxlevmin q-Rxlevminoffset } schedulingInformation ::= SEQUENCE (SIZE (1..maxSI-Message)) OF SEQUENCE {} }	-55 (-110 dBm) Not present Combination 6 in TS 36.508 section 4.4.3.1.1		

Table 6.2.3.8.3.3-2: SystemInformationBlockType8 to Cell 1 (Preamble and all steps, table 6.2.3.8.3.2-1)

Derivation path: 36.508 table 4.4.3.3			
Information Element	Value/Remark	Comment	Condition
SystemInformationBlockType8 ::= SEQUENCE { cdma2000-SystemTimeInfo SEQUENCE { cdma-EUTRA-Synchronisation cdma-SystemTime CHOICE { cdma-SynchronousSystemTime } } searchWindowSize hrpd-Parameters SEQUENCE { hrpd-CellReselectionParameters SEQUENCE { hrpd-BandClassList SEQUENCE (SIZE (1..maxCDMA -BandClass)) OF SEQUENCE { hrpd-BandClass hrpd-CellReselectionPriority } threshX-High threshX-Low } t-ReselectionCDMA-HRPD }	TRUE A valid value as per TS 36.331 and calculated by the SS 5 The same number of entries as the configured HRPD carriers Band Class of frequency under test 3 FFS FFS [7]	 [Set according to specific test case] [3 is applicable when HRPD is lower priority than E-UTRA. 5 is applicable when HRPD is higher priority than E-UTRA] INTEGER (0..63) INTEGER (0..63) INTEGER (0..7)	HRPD

6.3 Closed Subscriber Group cells

6.3.6 Ignoring CSG cells in cell selection/reselection when Allowed CSG list is empty or not supported

6.3.6.1 Test Purpose (TP)

(1)

```
with { UE in E-UTRA RRC_IDLE state and UE does not support Allowed CSG list or UE's Allowed CSG list is empty }
ensure that {
  when { Srvlev < 0 for non-CSG cell and Srxlev > 0 for intra-frequency CSG cell and Srxlev > 0 for inter-frequency CSG cell }
  then { UE does not select the intra-freq CSG cell nor the inter-frequency CSG cell }
}
```

(2)

```
with { UE in E-UTRA RRC_IDLE state and UE does not support Allowed CSG list or UE's Allowed CSG list is empty }
ensure that {
  when { Srvlev > 0 for non-CSG cell and Srxlev of non-CSG cell < Srxlev of intra-frequency CSG cell and Srxlev of non-CSG cell < Srxlev of inter-frequency CSG cell }
  then { UE selects the non-CSG cell }
}
```

(3)

```
with { UE in E-UTRA RRC_IDLE state and UE does not support Allowed CSG list or UE's Allowed CSG list is empty }
```



```

ensure that {
  when { UE detects an intra-frequency CSG cell with  $R_n$  higher than  $R_s$  }
  then { UE does not reselect to the intra-frequency CSG cell }
}

```

(4)

```

with { UE in E-UTRA RRC_IDLE state and UE does not support Allowed CSG list or UE's Allowed CSG list is empty }
ensure that {
  when { UE detects an inter-frequency CSG cell with  $R_n$  higher than  $R_s$  }
  then { UE does not reselect to the inter-frequency CSG cell }
}

```

6.3.6.2 Conformance requirements

References: The conformance requirements covered in the present TC are specified in: TS 36.304, clause 5.2.3.2, 5.2.4.6 and TS 36.331, clause B.2.

[TS 36.304, clause 5.2.3.2]

The cell selection criterion S is fulfilled when:

$$S_{rxlev} > 0$$

Where:

$$S_{rxlev} = Q_{rxlevmeas} - (Q_{rxlevmin} + Q_{rxlevminoffset}) - P_{compensation}$$

Where:

the signalled value $Q_{rxlevminOffset}$ is only applied when a cell is evaluated for cell selection as a result of a periodic search for a higher priority PLMN while camped normally in a VPLMN [3]. During this periodic search for higher priority PLMN the UE may check the S criteria of a cell using parameter values stored from a different cell of this higher priority PLMN.

S_{rxlev}	Cell Selection RX level value (dB)
$Q_{rxlevmeas}$	Measured cell RX level value (RSRP).
$Q_{rxlevmin}$	Minimum required RX level in the cell (dBm)
$Q_{rxlevminoffset}$	Offset to the signalled $Q_{rxlevmin}$ taken into account in the S_{rxlev} evaluation as a result of a periodic search for a higher priority PLMN while camped normally in a VPLMN [5]
$P_{compensation}$	$\max(P_{EMAX} - P_{UMAX}, 0)$ (dB)
P_{EMAX}	Maximum TX power level an UE may use when transmitting on the uplink in the cell (dBm) defined as P_{EMAX} in [TS 36.101]
P_{UMAX}	Maximum RF output power of the UE (dBm) according to the UE power class as defined in [TS 36.101]

[TS 36.304, clause 5.2.4.6]

The cell-ranking criterion R_s for serving cell and R_n for neighbouring cells is defined by:

$$R_s = Q_{meas,s} + Q_{hyst,s}$$

$$R_n = Q_{meas,n} - Q_{offset}$$

where:

Q_{meas}	RSRP measurement quantity used in cell reselections.
Qoffset	For intra-frequency: Equals to $Q_{offsets,n}$, if $Q_{offsets,n}$ is valid, otherwise this equals to zero. For inter-frequency: Equals to $Q_{offsets,n}$ plus $Q_{offset_{frequency}}$, if $Q_{offsets,n}$ is valid, otherwise this equals to $Q_{offset_{frequency}}$.

The UE shall perform ranking of all cells that fulfill the cell selection criterion S , which is defined in 5.2.3.2

The cells shall be ranked according to the R criteria specified above, deriving $Q_{meas,n}$ and $Q_{meas,s}$ and calculating the R values using averaged RSRP results.

If a cell is ranked as the best cell the UE shall perform cell re-selection to that cell. If this cell is found to be not-suitable, the UE shall behave according to subclause 5.2.4.4.

In all cases, the UE shall reselect the new cell, only if the following conditions are met:

- the new cell is better ranked than the serving cell during a time interval $T_{reselection_{RAT}}$;
- more than 1 second has elapsed since the UE camped on the current serving cell.

[TS 36.331, clause B.2]

In this release of the protocol, it is mandatory for the UE to support a minimum set of CSG functionality consisting of:

- Identifying whether a cell is CSG or not;
- Ignoring CSG cells in cell selection/reselection.

6.3.6.3 Test description

6.3.6.3.1 Pre-test conditions

System Simulator:

- Cell 1, Cell 2 and Cell 3.
- Cell 1 is not a CSG cell.
- Cell 2 and Cell 3 are CSG cells.

UE:

- If $pc_Allowed_CSG_list$, the UE's Allowed CSG list is empty.

Preamble:

- The UE is in state Switched OFF (state 1) according to [18].

6.3.6.3.2 Test procedure sequence

Table 6.3.6.3.2-1 illustrates the downlink power levels and other changing parameters to be applied for the cells at various time instants of the test execution. Row marked "T0" denotes the initial conditions, while rows marked "T1", "T2" and "T3" are to be applied subsequently. The exact instants on which these values shall be applied are described in the texts in this clause.

Table 6.3.6.3.2-1: Time instances of cell power level and parameter changes

	Parameter	Unit	Cell 1	Cell 2	Cell 3	Remark
T0	Cell-specific RS EPRE	dBm/15k Hz	-120	-80	-60	$Srxlev_{Cell\ 1} < 0$ and $Srxlev_{Cell\ 3} > Srxlev_{Cell\ 2} > 0$.
	Qrxlevmin	dBm	-110	-110	-110	
	Qhyst	dB	0	0	0	
	Srxlev*	dB	-10	30	50	Cell 3 is the strongest cell
T1	Cell-specific RS EPRE	dBm/15k Hz	-80	-60	-70	$Srxlev_{Cell\ 2} > Srxlev_{Cell\ 3} > Srxlev_{Cell\ 1} > 0$.
	Srxlev*	dB	30	50	40	Cell 2 is the strongest cell
T2	Cell-specific RS EPRE	dBm/15k Hz	[-90]	[-75]	[-120]	The power level values are assigned to satisfy $R_{Cell\ 1} < R_{Cell\ 2}$.
T3	Cell-specific RS EPRE	dBm/15k Hz	[-90]	[-120]	[-75]	The power level values are assigned to satisfy $R_{Cell\ 1} < R_{Cell\ 3}$.

Table 6.3.6.3.2-2: Main behaviour

St	Procedure	Message Sequence		TP	Verdict
		U - S	Message		
1	The UE is switched on.	-	-	-	-
2	Check: Does the UE initiate a random access on Cell 2 or Cell 3 within 60 seconds?	-	-	1	F
3	The SS changes Cell 1, Cell 2 and Cell 3 levels according to row "T1" in table 6.3.6.3.2-1.	-	-	-	-
4	Check: Does the UE initiate a random access on Cell 1?	-	-	2	P
5	The UE performs the registration procedure described in TS 36.508 table 4.5.2.3-1.	-	-	-	-
6	The SS changes Cell 1, Cell 2 and Cell 3 levels according to row "T2" in table 6.3.6.3.2-1.	-	-	-	-
7	Check: Does the UE initiate a random access on Cell 2 within 60 seconds?	-	-	3	F
8	The SS changes Cell 1, Cell 2 and Cell 3 levels according to row "T3" in table 6.3.6.3.2-1.	-	-	-	-
9	Check: Does the UE initiate a random access on Cell 3 within 60 seconds?	-	-	4	F

6.3.6.3.3 Specific message contents

Table 6.3.6.3.3-1: Conditions for tables 6.3.6.3.3-2 and 6.3.6.3.3-3

Condition descriptions
Cell 1 This condition applies to system information transmitted on Cell 1.
Cell 2 This condition applies to system information transmitted on Cell 2.
Cell 3 This condition applies to system information transmitted on Cell 3.

Table 6.3.6.3.3-2: SystemInformationBlockType1 for Cell 1, 2 and 3 (Pre-test conditions and all steps, Table 6.3.6.3.2-2)

Derivation Path: 36.508 clause 4.4.3.2			
Information Element	Value/remark	Comment	Condition
SystemInformationBlockType1 ::= SEQUENCE {			
cellAccessRelatedInfo SEQUENCE {			
csg-Indication	FALSE		Cell 1
	TRUE		Cell 2 Cell 3
csg-Identity	Not present		Cell 1
	'000 0000 0000 0000 0000 0000 0010'B		Cell 2
	'000 0000 0000 0000 0000 0000 0011'B		Cell 3
}			
cellSelectionInfo SEQUENCE {			
q-RxLevMin	-55 (-110 dBm)		
}			
schedulingInfo ::= SEQUENCE (SIZE (1..maxSI-Message)) OF SEQUENCE {}	Combination 1 in TS 36.508 section 4.4.3.1.1	Only SIB2 and SIB3 are transmitted	Cell 1
schedulingInfo ::= SEQUENCE (SIZE (1..maxSI-Message)) OF SEQUENCE {}	Combination 2 in TS 36.508 section 4.4.3.1.1	Only SIB2, SIB3 and SIB4 are transmitted	Cell 2 Cell 3
}			
}			

Table 6.3.6.3.3-3: SystemInformationBlockType3 for Cell 1, 2 and 3 (Pre-test conditions and all steps, table 6.3.6.3.2-2)

Derivation Path: 36.508 clause 4.4.3.3, Table 4.4.3.3-2			
Information Element	Value/remark	Comment	Condition
SystemInformationBlockType3 ::= SEQUENCE {			
cellReselectionInfoCommon SEQUENCE {			
q-Hyst	dB0		
}			
}			

Table 6.3.6.3.3-4: SystemInformationBlockType4 for Cell 2 and 3 (Pre-test conditions and all steps, table 6.3.6.3.2-2)

Derivation Path: 36.508 clause 4.4.3.3, Table 4.4.3.3-3			
Information Element	Value/remark	Comment	Condition
SystemInformationBlockType4 ::= SEQUENCE {			
csg-PhysCellIdRange ::= SEQUENCE {			
Start	2	Cell 2	
Start	3	Cell 3	
Range	Not present	The UE shall apply value 1 in case the field is absent, in which case only the physical cell identity value indicated by start applies.	
}			
}			

7 Layer 2

7.1 MAC

7.1.1 Mapping between logical channels and transport channels

7.1.1.1 CCCH mapped to UL SCH/ DL-SCH / Reserved LCID (Logical Channel ID)

7.1.1.1.1 Test Purpose (TP)

(1)

```
with { UE in E-UTRA RRC_IDLE state and after transmitting a RRCConnectionRequest message}
ensure that {
  when { UE receives a MAC PDU on DL SCH and addressed to its T-CRNTI but including a reserved value
for LCID }
  then { UE discards the MAC PDU }
}
```

(2)

```
with { UE in E-UTRA RRC_IDLE state and after transmitting a RRCConnectionRequest message}
ensure that {
  when { UE receives a MAC PDU on DL SCH and addressed to its T-CRNTI with value '00000'B as LCID }
  then { UE forwards to upper layers the disassembled and demultiplexed SDU on logical channel
CCCH }
}
```

7.1.1.1.2 Conformance requirements

References: The conformance requirements covered in the current TC are specified in: TS 36.321, clause 5.11, 6.2.1, 5.3.3 and 6.1.2.

[TS 36.321, clause 5.11]

When a MAC entity receives a MAC PDU for the UE's C-RNTI or Semi-Persistent Scheduling C-RNTI, containing reserved or invalid values, the MAC entity shall:

- discard the received PDU.

[TS 36.321, clause 6.2.1]

The MAC header is of variable size and consists of the following fields:

- LCID: The Logical Channel ID field identifies the logical channel instance of the corresponding MAC SDU or the type of the corresponding MAC control element or padding as described in tables 6.2.1-1 and 6.2.1-2 for the DL and UL-SCH respectively. There is one LCID field for each MAC SDU, MAC control element or padding included in the MAC PDU. The LCID field size is 5 bits;

...

Table 6.2.1-1: Values of LCID for DL-SCH

Index	LCID values
00000	CCCH
00001-01010	Identity of the logical channel
01011-11011	Reserved
11100	UE Contention Resolution Identity
11101	Timing Advance
11110	DRX Command
11111	Padding

[TS 36.321, clause 5.3.3]

The UE shall disassemble and demultiplex a MAC PDU as defined in subclause 6.1.2.

[TS 36.321, clause 6.1.2]

A MAC PDU consists of a MAC header, zero or more MAC Service Data Units (MAC SDU), zero, or more MAC control elements, and optionally padding; as described in Figure 6.1.2-3.

Both the MAC header and the MAC SDUs are of variable sizes.

A MAC PDU header consists of one or more MAC PDU sub-headers; each subheader corresponds to either a MAC SDU, a MAC control element or padding.

A MAC PDU subheader consists of the six header fields R/R/E/LCID/F/L but for the last subheader in the MAC PDU and for fixed sized MAC control elements. The last subheader in the MAC PDU and sub-headers for fixed sized MAC control elements consist solely of the four header fields R/R/E/LCID. A MAC PDU subheader corresponding to padding consists of the four header fields R/R/E/LCID.

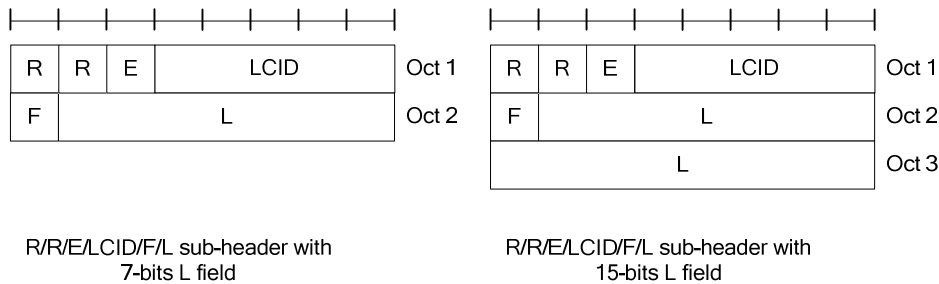

Figure 6.1.2-1: R/R/E/LCID/F/L MAC subheader

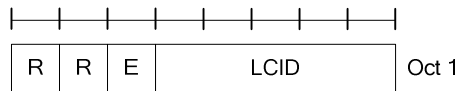

Figure 6.1.2-2: R/R/E/LCID MAC subheader

MAC PDU sub-headers have the same order as the corresponding MAC SDUs, MAC control elements and padding.

MAC control elements, are always placed before any MAC SDU.

Padding occurs at the end of the MAC PDU, except when single-byte or two-byte padding is required. Padding may have any value and the UE shall ignore it.

When single-byte or two-byte padding is required, one or two MAC PDU sub-headers corresponding to padding are placed at the beginning of the MAC PDU before any other MAC PDU subheader.

A maximum of one MAC PDU can be transmitted per TB per UE.

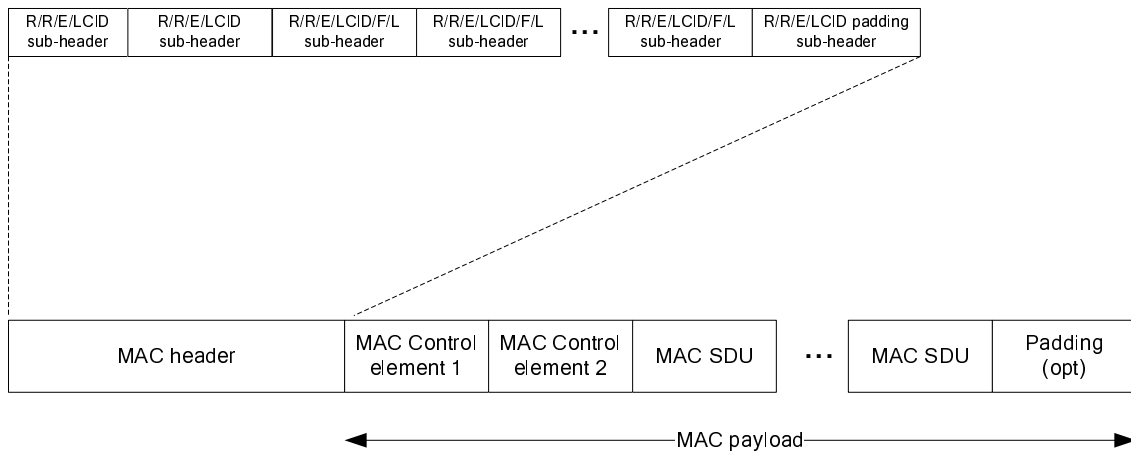

Figure 6.1.2-3: Example of MAC PDU consisting of MAC header, MAC control elements, MAC SDUs and padding

- 7.1.1.1.3 Test description
- 7.1.1.1.3.1 Pre-test conditions

System Simulator:

- Cell 1

UE:

None.

Preamble:

- The UE is in state Registered, Idle mode (state 2) according to [18].

7.1.1.1.3.2 Test procedure sequence

Table 7.1.1.1.3.2-1: Main behaviour

St	Procedure	Message Sequence		TP	Verdict
		U - S	Message		
	EXCEPTION: Steps 1 to 4 shall be repeated for decreasing reserved LCID values from 01011 to 11011.				
1	The SS transmits a <i>Paging</i> message including a matched identity.	-	-	-	-
2	The UE transmits an <i>RRCCConnectionRequest</i> message.	-	-	-	-
3	The SS Transmits a valid MAC PDU containing <i>RRCCConnectionSetup</i> , and Contention Resolution Identity MAC Control Element except for LCID in MAC Header set to reserved value 11011 or lower (depending on iteration number).	<--	MAC PDU	-	-
	EXCEPTION: In parallel with step 4, UE may execute parallel behaviour defined in table 7.1.1.1.3.2-2				
4	Check: For 5 seconds after Step3, does the UE transmit <i>RRCCConnectionSetupComplete</i> message?	-	-	1	F
5	The SS transmits a <i>Paging</i> message including a matched identity.	-	-	-	-
6	The UE transmits an <i>RRCCConnectionRequest</i> message.	-	-	-	-
7	The SS transmits a valid MAC PDU containing <i>RRCCConnectionSetup</i> , and Contention Resolution Identity MAC Control Element and LCID in MAC Header set correctly to CCCH 00000	<--	MAC PDU	-	-
8	Check: does the UE transmit an <i>RRCCConnectionSetupComplete</i> message?	-	-	2	P

Table 7.1.1.1.3.2-2: Parallel behaviour

St	Procedure	Message Sequence		TP	Verdict
		U - S	Message		
1	The UE transmits an <i>RRCCConnectionRequest</i> message.	-	-	-	-

7.1.1.1.3.3 Specific message contents

None.

7.1.1.2 DTCH or DCCH mapped to UL SCH/ DL-SCH / Reserved LCID (Logical Channel ID)

7.1.1.2.1 Test Purpose (TP)

(1)

```

with { UE in E-UTRA RRC_Connected state with DRB [Logical channel ID 3] established}
ensure that {
  when { UE receives a MAC PDU on DL SCH and addressed to its CRNTI but including a reserved value
for LCID }
  then { UE shall not forward the disassembled and demultiplexed SDU on the configured logical
channels }
}

```

(2)

```

with { UE in E-UTRA RRC_IDLE state and after transmitting a RRCCConnectionRequest message}
ensure that {

```



```

when { UE receives a MAC PDU on DL SCH and addressed to its CRNTI with value '00011'B as LCID }
  then { UE shall forward the disassembled and demultiplexed SDU on the corresponding logical
channel }
    }
    
```

7.1.1.2.2 Conformance requirements

References: The conformance requirements covered in the current TC are specified in: TS 36.321, clause 6.2.1, 5.3.3 and 6.1.2.

[TS 36.321, clause 6.2.1]

The MAC header is of variable size and consists of the following fields:

- LCID: The Logical Channel ID field identifies the logical channel instance of the corresponding MAC SDU or the type of the corresponding MAC control element or padding as described in tables 6.2.1-1 and 6.2.1-2 for the DL and UL-SCH respectively. There is one LCID field for each MAC SDU, MAC control element or padding included in the MAC PDU. The LCID field size is 5 bits;

...

Table 6.2.1-1: Values of LCID for DL-SCH

Index	LCID values
00000	CCCH
00001-01010	Identity of the logical channel
01011-11011	Reserved
11100	UE Contention Resolution Identity
11101	Timing Advance
11110	DRX Command
11111	Padding

[TS 36.321, clause 5.3.3]

The UE shall disassemble and demultiplex a MAC PDU as defined in subclause 6.1.2.

[TS 36.321, clause 6.1.2]

A MAC PDU consists of a MAC header, zero or more MAC Service Data Units (MAC SDU), zero, or more MAC control elements, and optionally padding; as described in Figure 6.1.2-3.

Both the MAC header and the MAC SDUs are of variable sizes.

A MAC PDU header consists of one or more MAC PDU sub-headers; each subheader corresponds to either a MAC SDU, a MAC control element or padding.

A MAC PDU subheader consists of the six header fields R/R/E/LCID/F/L but for the last subheader in the MAC PDU and for fixed sized MAC control elements. The last subheader in the MAC PDU and sub-headers for fixed sized MAC control elements consist solely of the four header fields R/R/E/LCID. A MAC PDU subheader corresponding to padding consists of the four header fields R/R/E/LCID.

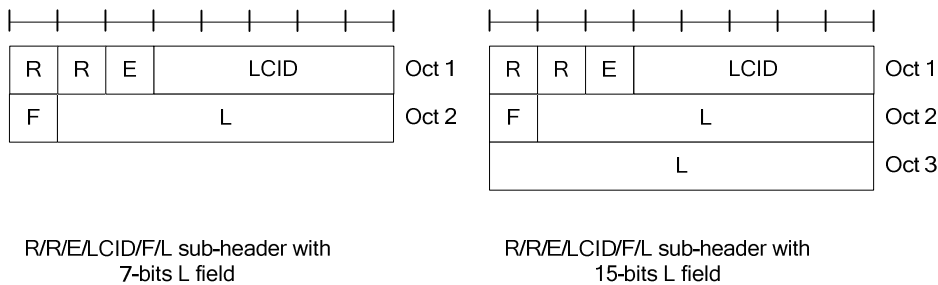

Figure 6.1.2-1: R/R/E/LCID/F/L MAC subheader

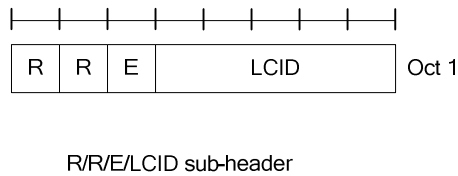

Figure 6.1.2-2: R/R/E/LCID MAC subheader

MAC PDU sub-headers have the same order as the corresponding MAC SDUs, MAC control elements and padding.

MAC control elements, are always placed before any MAC SDU.

Padding occurs at the end of the MAC PDU, except when single-byte or two-byte padding is required. Padding may have any value and the UE shall ignore it.

When single-byte or two-byte padding is required, one or two MAC PDU sub-headers corresponding to padding are placed at the beginning of the MAC PDU before any other MAC PDU subheader.

A maximum of one MAC PDU can be transmitted per TB per UE.

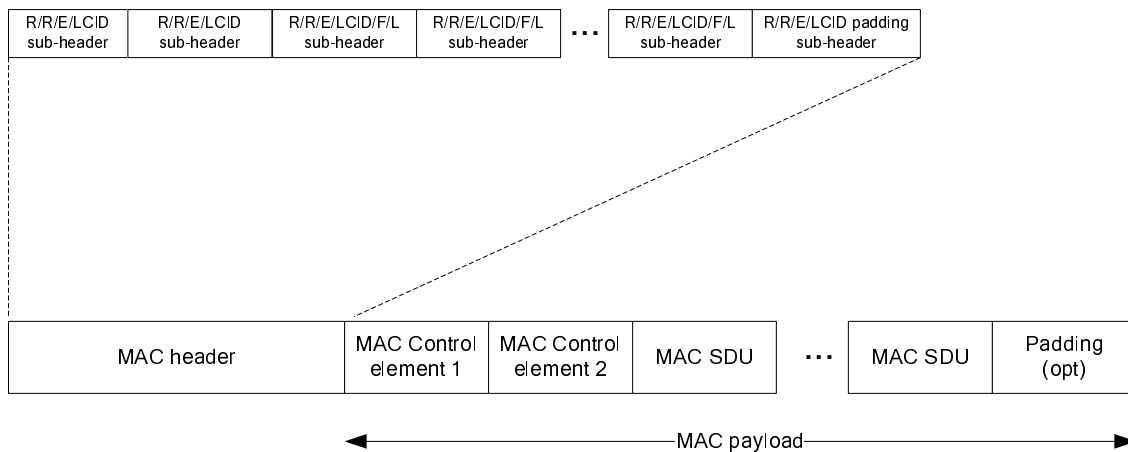

Figure 6.1.2-3: Example of MAC PDU consisting of MAC header, MAC control elements, MAC SDUs and padding

7.1.1.2.3 Test description

7.1.1.2.3.1 Pre-test conditions

System Simulator:

- Cell 1

UE:

None.

Preamble:

- The UE is in state Loopback Activated (state 4) according to [18].

NOTE: In the following, the established DRB is assumed to have Logical channel ID 3

7.1.1.2.3.2 Test procedure sequence

Table 7.1.1.2.3.2-1: Main behaviour

St	Procedure	Message Sequence		TP	Verdict
		U - S	Message		
	EXCEPTION: the steps 1 and 2 are repeated for decreasing reserved LCID values from 01011 to 11011	-	-	-	-
1	The SS transmits a valid MAC PDU containing a RLC PDU except for LCID in MAC Header set to reserved value 11011.	<--	MAC PDU	-	-
2	Check: does the UE transmit a Scheduling Request on PUCCH within 5 seconds after step 1?	-->	(SR)	1	F
3	The SS Transmits a valid MAC PDU containing RLC PDU with LCID in MAC Header set correctly to DRB 00011.	<--	MAC PDU	-	-
4	Check: does the UE transmits a Scheduling Request on PUCCH?	-->	(SR)	2	P
5	The SS sends an UL grant suitable for the loop back PDU to transmitted	<--	(UL Grant)	-	-
6	Check: does the UE transmit a MAC PDU with LCID set to DRB 00011?	->	MAC PDU	2	P

7.1.1.2.3.3 Specific message contents

None.

7.1.2 RACH

7.1.2.1 Correct Selection of RACH parameters / Random Access Preamble and PRACH resource explicitly signalled to the UE by RRC [Non Contention Based Random Access Procedure]

7.1.2.1.1 Test Purpose (TP)

(1)

```

with { UE in E-UTRA RRC_CONNECTED state }
ensure that {
  when { SS sends an RRCConnectionReconfiguration message including RACH-ConfigDedicated information element }
  then { UE sends a prach preamble given in the RACH-ConfigDedicated on the target cell }
}

```

7.1.2.1.2 Conformance requirements

References: The conformance requirements covered in the current TC are specified in: TS 36.321, clauses 5.1.2 and 5.1.4.

[TS 36.321, clause 5.1.2]

The Random Access Resource selection procedure shall be performed as follows:

- If *ra-PreambleIndex* (Random Access Preamble) and *ra-PRACH-MaskIndex* (PRACH Mask Index) have been explicitly signalled and *ra-PreambleIndex* is not 000000:
- the Random Access Preamble and the PRACH Mask Index are those explicitly signalled.

[TS 36.321, clause 5.1.4]

Once the Random Access Preamble is transmitted and regardless of the possible occurrence of a measurement gap, the UE shall monitor the PDCCH for Random Access Response(s) identified by the RA-RNTI defined below, in the RA Response window which starts at the subframe that contains the end of the preamble transmission [7] plus three

subframes and has length $ra\text{-ResponseWindowSize}$ subframes. The RA-RNTI associated with the PRACH in which the Random Access Preamble is transmitted, is computed as:

$$RA\text{-RNTI} = 1 + t_id + 10 * f_id$$

Where t_id is the index of the first subframe of the specified PRACH ($0 \leq t_id < 10$), and f_id is the index of the specified PRACH within that subframe, in ascending order of frequency domain ($0 \leq f_id < 6$). The UE may stop monitoring for Random Access Response(s) after successful reception of a Random Access Response containing Random Access Preamble identifiers that matches the transmitted Random Access Preamble.

- If a downlink assignment for this RA Response has been received on the PDCCH for the RA-RNTI and the received TB is successfully decoded, the UE shall regardless of the possible occurrence of a measurement gap:

...

- if the Random Access Response contains a Random Access Preamble identifier corresponding to the transmitted Random Access Preamble (see subclause 5.1.3), the UE shall:
 - consider this Random Access Response reception successful;
 - process the received Timing Advance Command (see subclause 5.2);
 - indicate the *preambleInitialReceivedTargetPower* and the amount of power ramping applied to the latest preamble transmission to lower layers (i.e., $(\text{PREAMBLE_TRANSMISSION_COUNTER} - 1) * \text{powerRampingStep}$);
 - process the received UL grant value and indicate it to the lower layers;
 - if *ra-PreambleIndex* was explicitly signalled and it was not 000000 (i.e., not selected by MAC):
 - consider the Random Access procedure successfully completed.

7.1.2.1.3 Test description

7.1.2.1.3.1 Pre-test conditions

System Simulator:

- Cell 1 and Cell 2.

UE:

None.

Preamble:

- UE is in state Generic RB Established (state 3) according to [18] in cell 1.

7.1.2.1.3.2 Test procedure sequence

Table 7.1.2.1.3.2-1: Main behaviour

St	Procedure	Message Sequence		TP	Verdict
		U - S	Message		
1	The SS transmits an <i>RRCConnectionReconfiguration</i> message to order the UE to perform intra frequency handover to Cell 2, including explicit Random Access Preamble.	-	-	-	-
2	Check: does the UE transmit Preamble on PRACH corresponding to <i>ra-PreambleIndex</i> in step 1?	-->	(PRACH Preamble)	1	P
3	The SS transmits Random Access Response on cell 2, with RAPID corresponding to <i>ra-PreambleIndex</i> in step 1	<--	Random Access Response	-	-
4	Check: Does the UE sends on cell 2, a MAC PDU containing <i>RRCConnectionReconfigurationComplete</i> ?	-->	MAC PDU	1	P
5	Check: does the test result of CALL generic procedure indicates that UE is in E-UTRA RRC_CONNECTED state in cell 2?	-	-	-	-

7.1.2.1.3.3 Specific message contents

Table 7.1.2.1.3.3-1: *RRCConnectionReconfiguration* (step 1, table 7.1.2.1.3.2-1)

Derivation Path: 36.508, Table 4.6.1-6, condition RBC-HO			
Information Element	Value/Remark	Comment	Condition
<i>RRCConnectionReconfiguration</i> ::= SEQUENCE { criticalExtensions CHOICE { c1 CHOICE { <i>rrcConnectionReconfiguration-r8</i> SEQUENCE { mobilityControllInformation SEQUENCE { targetCellIdentity eutra-CarrierFreq rach-ConfigDedicated SEQUENCE { <i>ra-PreambleIndex</i> <i>ra-PreambleIndex</i> <i>ra-PRACH-MaskIndex</i> } } } } }	MobilityControllInformation-HO PhysicalCellIdentity of Cell 2 (see 36.508 clause 4.4.4.2) Not present 52 (see TS 36.211 Table 5.7.1-2) 52 (see TS 36.211 Table 5.7.1-3) 0	All	FDD TDD

7.1.2.2 Correct Selection of RACH parameters / Random Access Preamble and PRACH resource explicitly signalled to the UE in PDCCH Order [Non Contention Based Random Access Procedure]

7.1.2.2.1 Test Purpose (TP)

(1)

```
with { UE in E-UTRA RRC_CONNECTED state }
ensure that {
  when { PDCCH control command is received providing Random Access Preamble }
  then { UE sends a prach preamble given in the PDCCH Order }
}
```

(2)

```

with { UE in E-UTRA RRC_CONNECTED state and transmitted PRACH Preamble, after reception of PDCCH
order }
ensure that {
  when { UE does not receive a matching Random Access response in ra-ResponseWindowSize (hence
considers RACH attempt as failed) and PREAMBLE_TRANSMISSION_COUNTER is less than PREAMBLE_TRANS_MAX
}
  then { UE retransmits the Preamble given in the PDCCH Order }
}

```

7.1.2.2.2 Conformance requirements

References: The conformance requirements covered in the current TC are specified in: TS 36.321, clauses 5.1.2 and 5.1.24.

[TS 36.321, clause 5.1.2]

The Random Access Resource selection procedure shall be performed as follows:

- If *ra-PreambleIndex* (Random Access Preamble) and *ra-PRACH-MaskIndex* (PRACH Mask Index) have been explicitly signalled and *ra-PreambleIndex* is not 000000:
 - the Random Access Preamble and the PRACH Mask Index are those explicitly signalled.

[TS 36.321, clause 5.1.4]

Once the Random Access Preamble is transmitted and regardless of the possible occurrence of a measurement gap, the UE shall monitor the PDCCH for Random Access Response(s) identified by the RA-RNTI defined below, in the window which starts at the subframe that contains the end of the preamble transmission [7] plus three subframes and has length *ra-ResponseWindowSize* subframes. The RA-RNTI associated with the PRACH in which the Random Access Preamble is transmitted, is computed as:

$$\text{RA-RNTI} = 1 + t_id + 10 * f_id$$

Where *t_id* is the index of the first subframe of the specified PRACH ($0 \leq t_id < 10$), and *f_id* is the index of the specified PRACH within that subframe, in ascending order of frequency domain ($0 \leq f_id < 6$). The UE may stop monitoring for Random Access Response(s) after successful reception of a Random Access Response corresponding to the Random Access Preamble identifiers that matches the transmitted Random Access Preamble.

- If a downlink assignment for this TTI has been received on the PDCCH for the RA-RNTI and the received TB is successfully decoded, the UE shall regardless of the possible occurrence of a measurement gap:

...

- if the Random Access Response contains a Random Access Preamble identifier corresponding to the transmitted Random Access Preamble (see subclause 5.1.3), the UE shall:
 - consider this Random Access Response reception successful;
 - process the received Timing Advance Command (see subclause 5.2);
 - indicate the *preambleInitialReceivedTargetPower* and the amount of power ramping applied to the latest preamble transmission to lower layers (i.e., $(\text{PREAMBLE_TRANSMISSION_COUNTER} - 1) * \text{powerRampingStep}$);
 - process the received UL grant value and indicate it to the lower layers;
 - if *ra-PreambleIndex* was explicitly signalled and it was not 000000 (i.e., not selected by MAC):
 - consider the Random Access procedure successfully completed.

...

If no Random Access Response is received within the RA Response window, or if none of all received Random Access Responses contains a Random Access Preamble identifier corresponding to the transmitted Random Access Preamble, the Random Access Response reception is considered not successful and the UE shall:

- increment *PREAMBLE_TRANSMISSION_COUNTER* by 1;

- If PREAMBLE_TRANSMISSION_COUNTER = $preambleTransMax + 1$:
 - indicate a Random Access problem to upper layers
 - if in this Random Access procedure:
 - the Random Access Preamble was selected by MAC:
 - based on the backoff parameter in the UE, select a random backoff time according to a uniform distribution between 0 and the Backoff Parameter Value;
 - delay the subsequent Random Access transmission by the backoff time;
 - proceed to the selection of a Random Access Resource (see subclause 5.1.2).

7.1.2.2.3 Test description

7.1.2.2.3.1 Pre-test conditions

System Simulator:

- Cell 1

UE:

None.

Preamble:

- The UE is in state Generic RB Established (state 3) according to [18] in cell 1

7.1.2.2.3.2 Test procedure sequence

Table 7.1.2.2.3.2-1: Main behaviour

St	Procedure	Message Sequence		TP	Verdict
		U - S	Message		
1	The SS transmits a PDCCH order providing Random Access Preamble.	<--	(PDCCH Order)	-	-
2	Check: does the UE transmit a preamble on PRACH using the same preamble index as given in step 1?	-->	(PRACH Preamble)	1	P
3	Check: does the UE transmit a preamble on PRACH after <i>ra-ResponseWindowSize</i> using the same preamble index as given in step 1?	-->	(PRACH Preamble)	2	P
4	Check: does the UE transmit a preamble on PRACH after <i>ra-ResponseWindowSize</i> using the same preamble index as given in step 1?	-->	(PRACH Preamble)	2	P
5	Check: does the UE transmit a preamble on PRACH after <i>ra-ResponseWindowSize</i> using the same preamble index as given in step 1?	-->	(PRACH Preamble)	2	P
6	The SS transmits Random Access Response with RAPID corresponding to Preamble in step 1.	<--	Random Access Response	-	-
7	Check: does the test result of CALL generic procedure indicate that UE is in E-UTRA RRC_CONNECTED state?	-	-	-	-

7.1.2.2.3.3 Specific message contents

Table 7.1.2.2.3.3-1: SystemInformationBlockType2 (all steps, table 7.1.2.2.3.2-1)

Derivation Path: 36.508 clause 4.4.3.3, Table Nr. 4.4.3.3.-1			
Information Element	Value/Remark	Comment	Condition
SystemInformationBlockType2 ::= SEQUENCE { radioResourceConfigCommon SEQUENCE { rach-Configuration SEQUENCE { ra-SupervisionInformation SEQUENCE { preambleTransMax } } } } } } } }	N4	PREAMBLE_TRANS_MAX	

7.1.2.3 Correct Selection of RACH parameters, selected by MAC itself [Contention Based Random Access Procedure]

7.1.2.3.1 Test Purpose (TP)

(1)

```
with { UE in E-UTRA RRC_IDLE state }
ensure that {
  when { SS sends a Paging message to the UE and MAC PDU Size carrying CCCH PDU is less than
messageSizeGroupA }
  then { UE transmits a random access preamble using a preamble in group A of random access
preambles indicated in SIB2 }
}
```

(2)

```
with { UE in E-UTRA RRC_IDLE state and has transmitted Msg3 }
ensure that {
  when { SS does not respond before contention resolution timer expiry }
  then { UE transmits a random access preamble using a preamble in the same group of random access
preambles as used for the first transmission of Msg3 }
}
```

(3)

```

with { UE in E-UTRA RRC_IDLE state and Random access procedure initiated by MAC }
ensure that {
  when { SS does not respond before contention resolution timer expiry after more than
PREAMBLE_TRANS_MAX transmissions from UE }
  then { UE transmits a random access preamble using a preamble in the same group of random access
preambles as used for the first transmission of Msg3 }
}

```

(4)

```

with { UE in E-UTRA RRC_IDLE state }
ensure that {
  when { UE has data available for transmission and the MAC PDU Size carrying this data is
greater than messageSizeGroupA }
  then { UE transmits a random access preamble using a preamble in group B of random access
preambles indicated in SIB2 }
}

```

7.1.2.3.2 Conformance requirements

References: The conformance requirements covered in the current TC are specified in: TS 36.321, clause 5.1.2 and 5.1.5.

[TS 36.321, clause 5.1.2]

The Random Access Resource selection procedure shall be performed as follows:

- If *ra-PreambleIndex* (Random Access Preamble) and *ra-PRACH-MaskIndex* (PRACH Mask Index) have been explicitly signalled and *ra-PreambleIndex* is not 000000:
 - ...
- else the Random Access Preamble shall be selected by the UE as follows:
 - If *Msg3* has not yet been transmitted, the UE shall:
 - if Random Access Preambles group B exists and if the potential message size (data available for transmission plus MAC header and, where required, MAC control elements) is greater than *messageSizeGroupA* and if the pathloss is less than $P_{\text{CMAX}} - \text{preambleInitialReceivedTargetPower} - \text{deltaPreambleMsg3} - \text{messagePowerOffsetGroupB}$, then:
 - select the Random Access Preambles group B;
 - else:
 - select the Random Access Preambles group A.
 - else, if *Msg3* is being retransmitted, the UE shall, the UE shall:
 - select the same group of Random Access Preambles as was used for the preamble transmission attempt corresponding to the first transmission of *Msg3*.
 - randomly select a Random Access Preamble within the selected group. The random function shall be such that each of the allowed selections can be chosen with equal probability;
 - set PRACH Mask Index to 0.
 - determine the next available subframe containing PRACH permitted by the restrictions given by the *prach-ConfigurationIndex* and PRACH Mask Index (see subclause 7.3) (a UE may take into account the possible occurrence of measurement gaps when determining the next available PRACH subframe);
 - if the transmission mode is TDD and the PRACH Mask Index is equal to zero:
 - if *ra-PreambleIndex* was explicitly signalled and the signalled random access preamble ID was not 000000 (i.e., not selected by MAC):

- randomly select, with equal probability, one PRACH from the PRACHs available in the determined subframe.
- else:
 - randomly select, with equal probability, one PRACH from the PRACHs available in the determined subframe and the next two consecutive subframes.
- else:
 - determine a PRACH within the determined subframe in accordance with the requirements of the PRACH Mask Index.
- proceed to the transmission of the Random Access Preamble (see subclause 5.1.3).

[TS 36.321, clause 5.1.5]

Contention Resolution is based on either C-RNTI on PDCCH or UE Contention Resolution Identity on DL-SCH..

Once Msg3 is transmitted, the UE shall:

- start *mac-ContentionResolutionTimer* and restart *mac-ContentionResolutionTimer* at each HARQ retransmission;
- regardless of the possible occurrence of a measurement gap, monitor the PDCCH until *mac-ContentionResolutionTimer* expires or is stopped;
- ...
- if *mac-ContentionResolutionTimer* expires:
 - discard the Temporary C-RNTI;
 - consider the Contention Resolution not successful.
- if the Contention Resolution is considered not successful the UE shall:
 - flush the HARQ buffer used for transmission of the MAC PDU in the Msg3 buffer;
 - increment PREAMBLE_TRANSMISSION_COUNTER by 1;
 - If PREAMBLE_TRANSMISSION_COUNTER = *preambleTransMax* + 1:
 - indicate a Random Access problem to upper layers.
 - ...
 - proceed to the selection of a Random Access Resource (see subclause 5.1.2).

7.1.2.3.3 Test description

7.1.2.3.3.1 Pre-test conditions

System Simulator:

- Cell 1.
- System information set using parameters as specified in Table 7.1.2.3.3.3-1.

UE:

None.

Preamble:

- The UE is in state Registered, Idle mode (state 2) according to [18].

7.1.2.3.3.2 Test procedure sequence

Table 7.1.2.3.3.2-1: Main behaviour

St	Procedure	Message Sequence		TP	Verdict
		U - S	Message		
1	The SS transmits a Paging message including a matched identity.	-	-	-	-
2	Check: Does the UE transmit preamble on PRACH using a preamble in group A defined in SIB2 (<i>numberOfRA-Preambles</i> and <i>sizeOfRA-PreamblesGroupA</i>)?	-->	PRACH Preamble	1	P
3	Check: Does the UE transmit preamble on PRACH using a preamble in group A defined in SIB2 (<i>numberOfRA-Preambles</i> and <i>sizeOfRA-PreamblesGroupA</i>)?	-->	PRACH Preamble	1	P
4	Check: Does the UE transmit preamble on PRACH using a preamble in group A defined in SIB2 (<i>numberOfRA-Preambles</i> and <i>sizeOfRA-PreamblesGroupA</i>)?	-->	PRACH Preamble	1	P
5	The SS transmits Random Access Response with RAPID corresponding to the transmitted Preamble in step 4, including T-CRNTI and not including Backoff Indicator sub header.	<--	Random Access Response	2	-
6	The UE transmits an <i>RRConnectionRequest</i> message.	-->	MAC PDU	2	-
7	Check: Does the UE transmit preamble on PRACH using a preamble belonging to group A.	-->	PRACH Preamble	2	P
8	Check: Does the UE continue to repeatedly transmit for 2s after step 2 a preamble belonging to group A. Note: 2s is the value of T302.	-->	PRACH Preamble	2, 3	P
9	The UE is in state Loopback Activated (state 4) according to [18]	-	-		
10	The SS transmits a MAC PDU containing a PDCP SDU of size 320 bits[>208].	<--	MAC PDU		
	Exception: step 11 and 12 will be repeated <i>dsr-TransMax</i> times.	-	-	-	-
11	UE transmits a Scheduling Request.	-->	Scheduling Request		
12	The SS does not allocate UL grant for the scheduling request in step 11.			-	-
13	Check: does the UE transmit preamble on PRACH using a preamble in group B defined in SIB2 (<i>numberOfRA-Preambles</i> and <i>sizeOfRA-PreamblesGroupA</i>)?	-->	PRACH Preamble	4	P
14	Check: does the UE transmit preamble on PRACH using a preamble in group B defined in SIB2 (<i>numberOfRA-Preambles</i> and <i>sizeOfRA-PreamblesGroupA</i>)?	-->	PRACH Preamble	4	P
15	Check: does the UE transmit preamble on PRACH using a preamble in group B defined in SIB2 (<i>numberOfRA-Preambles</i> and <i>sizeOfRA-PreamblesGroupA</i>)?	-->	PRACH Preamble	4	P
16	The SS transmits Random Access Response with RAPID corresponding to the transmitted Preamble in step 1, including T-CRNTI and not including Backoff Indicator sub header.	<--	Random Access Response	2	-
17	The UE transmits a MAC PDU with C-RNTI containing loop backed PDCP SDU	->	MAC PDU	2	-
18	The SS ignores the UL MAC PDU and does not allocate UL grant for the C-RNTI in step 17.			-	-
19	Check: does the UE transmit preamble on PRACH using a preamble belonging to group B?.	-->	PRACH Preamble	2	P
20	The SS transmits Random Access Response	<--	Random Access Response	2	-

	with RAPID corresponding to the transmitted Preamble in step 19				
21	The UE transmits a MAC PDU containing loop backed PDCP SDU	->	MAC PDU	-	-
22	SS sends PDCCH transmission for UE C-RNTI	-	-	-	-
Note: Size of RRCConnectionRequest message is 45 bits, octet aligned =48 bits.. With 8 bits of MAC Header the minimum size of MAC PDU carrying RRCConnectionRequest is 56 bits.					

7.1.2.3.3.3 Specific message contents

Table 7.1.2.3.3.3-1: SystemInformationBlockType2 (all steps, table 7.1.2.3.3.2-1)

Derivation path: 36.508 clause 4.4.3.3, Table 4.4.3.3.-1			
Information Element	Value/Remark	Comment	Condition
SystemInformationBlockType2 ::= SEQUENCE { radioResourceConfigCommon SEQUENCE { rach-Configuration SEQUENCE { preambleInformation SEQUENCE { numberOfRA-Preambles preamblesGroupAConfig := {SEQUENCE { sizeOfRA-PreamblesGroupA messageSizeGroupA messagePowerOffsetGroupB } } ra-SupervisionInformation SEQUENCE { preambleTransMax } } } } ue-TimersAndConstants SEQUENCE { t300 } radioResourceConfigDedicated SEQUENCE { PhysicalConfigDedicated SEQUENCE { schedulingRequestConfig SEQUENCE { dsr-TransMax } } } } }	n64 n28 b208 minusinfinity n3 ms2000 n16	PREAMBLE_TRANS_MAX T300	

7.1.2.4 Random Access Procedure: Successful

7.1.2.4.1 Test Purpose (TP)

(1)

```
with { UE in E-UTRA RRC_IDLE state }
ensure that {
  when { The SS pages the UE with a matching identity }
  then { UE transmits a random access preamble in the next available Random Access occasion }
}
```

(2)

```
with { UE in E-UTRA RRC_IDLE state after transmission of a PRACH preamble }
ensure that {
  when { SS does not answer with a matching Random Access Response within ra-ResponseWindowSize }
  then { UE retransmits a PRACH preamble }
}
```

7.1.2.4.2 Conformance requirements

References: The conformance requirements covered in the current TC are specified in: TS 36.321, clause 5.1.2, 5.1.3 & 5.1.4.

[TS 36.321, clause 5.1.2]

The Random Access Resource selection procedure shall be performed as follows:

- If *ra-PreambleIndex* (Random Access Preamble) and *ra-PRACH-MaskIndex* (PRACH Mask Index) have been explicitly signalled and *ra-PreambleIndex* is not 000000:
 - the Random Access Preamble and the PRACH Mask Index are those explicitly signalled.
- else the Random Access Preamble shall be selected by the UE as follows:
 - If Msg3 has not yet been transmitted, the UE shall:
 - if Random Access Preambles group B exists and if the potential message size (data available for transmission plus MAC header and, where required, MAC control elements) is greater than *messageSizeGroupA* and if the pathloss is less than $P_{\text{CMAX}} - \text{preambleInitialReceivedTargetPower} - \text{deltaPreambleMsg3} - \text{messagePowerOffsetGroupB}$, then:
 - select the Random Access Preambles group B;
 - else:
 - select the Random Access Preambles group A.
 - else, if Msg3 is being retransmitted, the UE shall:
 - select the same group of Random Access Preambles as was used for the preamble transmission attempt corresponding to the first transmission of Msg3.
 - randomly select a Random Access Preamble within the selected group. The random function shall be such that each of the allowed selections can be chosen with equal probability;
 - set PRACH Mask Index to 0.
 - determine the next available subframe containing PRACH permitted by the restrictions given by the *prach-ConfigurationIndex* and the PRACH Mask Index (see subclause 7.3) (a UE may take into account the possible occurrence of measurement gaps when determining the next available PRACH subframe);
 - if the transmission mode is TDD and the PRACH Mask Index is equal to zero:
 - if *ra-PreambleIndex* was explicitly signalled and it was not 000000 (i.e., not selected by MAC):
 - randomly select, with equal probability, one PRACH from the PRACHs available in the determined subframe.
 - else:
 - randomly select, with equal probability, one PRACH from the PRACHs available in the determined subframe and the next two consecutive subframes.
 - else:
 - determine a PRACH within the determined subframe in accordance with the requirements of the PRACH Mask Index.
 - proceed to the transmission of the Random Access Preamble (see subclause 5.1.3).

[TS 36.321, clause 5.1.3]

The random-access procedure shall be performed as follows:

- set `PREAMBLE_RECEIVED_TARGET_POWER` to $\text{preambleInitialReceivedTargetPower} + \text{DELTA_PREAMBLE} + (\text{PREAMBLE_TRANSMISSION_COUNTER} - 1) * \text{powerRampingStep}$;

- instruct the physical layer to transmit a preamble using the selected PRACH, corresponding RA-RNTI, preamble index and PREAMBLE_RECEIVED_TARGET_POWER.

[TS 36.321, clause 5.1.4]

Once the Random Access Preamble is transmitted and regardless of the possible occurrence of a measurement gap, the UE shall monitor the PDCCH for Random Access Response(s) identified by the RA-RNTI defined below, in the RA Response window which starts at the subframe that contains the end of the preamble transmission [7] plus three subframes and has length *ra-ResponseWindowSize* subframes. The RA-RNTI associated with the PRACH in which the Random Access Preamble is transmitted, is computed as:

$$\text{RA-RNTI} = t_{\text{id}} + 10 * f_{\text{id}}$$

Where t_{id} is the index of the first subframe of the specified PRACH ($0 \leq t_{\text{id}} < 10$), and f_{id} is the index of the specified PRACH within that subframe, in ascending order of frequency domain ($0 \leq f_{\text{id}} < 6$). The UE may stop monitoring for Random Access Response(s) after successful reception of a Random Access Response containing Random Access Preamble identifiers that matches the transmitted Random Access Preamble.

- If a downlink assignment for this TTI has been received on the PDCCH for the RA-RNTI and the received TB is successfully decoded, the UE shall regardless of the possible occurrence of a measurement gap:
 - if the Random Access Response contains a Backoff Indicator sub header:
 - set the backoff parameter value in the UE as indicated by the BI field of the Backoff Indicator sub header and Table 7.2-1.
 - else, set the backoff parameter value in the UE to 0 ms.
 - if the Random Access Response contains a Random Access Preamble identifier corresponding to the transmitted Random Access Preamble (see subclause 5.1.3), the UE shall:
 - consider this Random Access Response reception successful;
 - process the received Timing Advance Command (see subclause 5.2);
 - indicate the *preambleInitialReceivedTargetPower* and the amount of power ramping applied to the latest preamble transmission to lower layers (i.e., $(\text{PREAMBLE_TRANSMISSION_COUNTER} - 1) * \text{powerRampingStep}$);
 - process the received UL grant value and indicate it to the lower layers;
 - if *ra-PreambleIndex* was explicitly signalled and it was not 000000 (i.e., not selected by MAC):
 - consider the Random Access procedure successfully completed.
 - else, if the Random Access Preamble was selected by UE MAC:
 - set the Temporary C-RNTI to the value received in the Random Access Response message no later than at the time of the first transmission corresponding to the UL grant provided in the Random Access Response message;
 - if this is the first successfully received Random Access Response within this Random Access procedure:
 - if the transmission is not being made for the CCCH logical channel, indicate to the Multiplexing and assembly entity to include a C-RNTI MAC control element in the subsequent uplink transmission;
 - obtain the MAC PDU to transmit from the "Multiplexing and assembly" entity and store it in the Msg3 buffer.

NOTE: When an uplink transmission is required, e.g., for contention resolution, the eNB should not provide a grant smaller than 56 bits in the Random Access Response.

NOTE: If within a Random Access procedure, an uplink grant provided in the Random Access Response for the same group of Random Access Preambles has a different size than the first uplink grant allocated during that Random Access procedure, the UE behaviour is not defined.

If no Random Access Response is received within the RA Response window, or if none of all received Random Access Responses contains a Random Access Preamble identifier corresponding to the transmitted Random Access Preamble, the Random Access Response reception is considered not successful and the UE shall:

- increment `PREAMBLE_TRANSMISSION_COUNTER` by 1;
- If `PREAMBLE_TRANSMISSION_COUNTER = preambleTransMax + 1`:
 - indicate a Random Access problem to upper layers.

...

- proceed to the selection of a Random Access Resource (see subclause 5.1.2).

7.1.2.4.3 Test description

7.1.2.4.3.1 Pre-test conditions

System Simulator:

- Cell 1
- System information are set according to table 7.1.2.4.3.3-1

UE:

None.

Preamble:

- The UE is in state Registered, Idle mode (state 2) according to [18].

7.1.2.4.3.2 Test procedure sequence

Table 7.1.2.4.3.2-1: Main behaviour

St	Procedure	Message Sequence		TP	Verdict
		U - S	Message		
1	The SS transmits a Paging message including a matched identity.	-	-	-	-
-					
2	Check: does the UE transmit a preamble on PRACH, in an even frame number X, subframe number 4(FDD)/3(TDD)?	-->	PRACH Preamble	1	P
3	Check: does the UE transmit a preamble on PRACH, in an even frame number X+2, subframe number 4(FDD)/3(TDD)?	-->	PRACH Preamble	1,2	P
4	Check: does the UE transmit a preamble on PRACH, in an even frame number X+4, subframe number 4(FDD)/3(TDD)?	-->	PRACH Preamble	1,2	P
5	The SS transmits a Random Access Response with not-matching RA-Id, including T-CRNTI and not including Backoff Indicator sub header.	<--	Random Access Response	-	-
6	Check: does the UE transmit a preamble on PRACH in an even frame number X+6, subframe number 4(FDD)/3(TDD)?	-->	PRACH Preamble	1,2	P
7	Wait for 2s. Note: the UE may transmit additional RACH preambles	-->	PRACH Preamble	-	-
8	The SS transmits a Paging message including a matched identity.	-	-	-	-
9	Check: does the UE transmit a preamble on PRACH, in an even frame number, subframe number 4(FDD)/3(TDD)?	-->	PRACH Preamble	1	P
10	The SS transmits Random Access Response with RAPID corresponding to the transmitted Preamble in step 9, including T-CRNTI and not including Backoff Indicator sub header.	<--	Random Access Response	-	-
11	The UE transmits an <i>RRCCoalitionRequest</i> message.	-	-	-	-
12	The SS Transmits a valid MAC PDU containing <i>RRCCoalitionSetup</i> , and including 'UE Contention Resolution Identity' MAC control element with matching 'Contention Resolution Identity'	<--	MAC PDU	-	-
13	The UE transmits an <i>RRCCoalitionSetupComplete</i> message.	-	-	-	-

7.1.2.4.3.3 Specific message contents

Table 7.1.2.4.3.3-1: SystemInformationBlockType2 (all steps, table 7.1.2.4.3.2-1)

Derivation path: 36.508 table 4.4.3.3.-1			
Information Element	Value/Remark	Comment	Condition
SystemInformationBlockType2 ::= SEQUENCE { radioResourceConfigCommon SEQUENCE { rach-Configuration SEQUENCE { ra-SupervisionInformation SEQUENCE { preambleTransMax } } prach-Configuration SEQUENCE { prach-ConfigInfo SEQUENCE { prach-ConfigurationIndex prach-ConfigurationIndex } } ue-TimersAndConstants SEQUENCE { t300 }	n3 1 0 ms2000	PREAMBLE_TRANS_MAX As per table 5.7.1-2 of 36.211, this results in PRACH preamble transmission start in even frame numbers and sub-frame number 4 As per table 5.7.1-4 of 36.211, this results in PRACH preamble transmission with frequency resource index=0; occurring in even radio frames; resource is located in first half frame and sub frame number 3 Note 1 T300	 FDD TDD
Note 1: 36.508, Table 4.4.3.2-3 specifies tdd-Configuration-> subframeAssignment as sa1.			

7.1.2.5 Random Access Procedure: MAC PDU containing Multiple RAR's

7.1.2.5.1 Test Purpose (TP)

(1)

```
with { UE in E-UTRA RRC_IDLE state and transmitted PRACH preamble }
ensure that {
  when { UE receives during TTI window [RA_WINDOW_BEGIN-RA_WINDOW_END] MAC PDU containing multiple
RAR's but with none of the subheaders contains a RAPID corresponding to the UE }
  then { UE transmits a random access preamble in the next available Random Access occasion }
}
```

(2)

```
with { UE in E-UTRA RRC_IDLE state and transmitted PRACH preamble }
ensure that {
  when { UE receives during TTI window [RA_WINDOW_BEGIN-RA_WINDOW_END] MAC PDU containing multiple
RAR's and one of the subheaders contains a RAPID corresponding to the UE }
  then { UE transmits MAC PDU containing RRCConnectionRequest }
}
```

7.1.2.5.2 Conformance requirements

References: The conformance requirements covered in the current TC are specified in: TS 36.321, clause 5.1.3 and 5.1.4.

[TS 36.321, clause 5.1.3]

The random-access procedure shall be performed as follows:

- set PREAMBLE_RECEIVED_TARGET_POWER to $preambleInitialReceivedTargetPower + DELTA_PREAMBLE + (PREAMBLE_TRANSMISSION_COUNTER - 1) * powerRampingStep$;
- instruct the physical layer to transmit a preamble using the selected PRACH resource, corresponding RA-RNTI, preamble index and PREAMBLE_RECEIVED_TARGET_POWER.

[TS 36.321, clause 5.1.4]

Once the Random Access Preamble is transmitted and regardless of the possible occurrence of a measurement gap, the UE shall monitor the PDCCH for Random Access Response(s) identified by the RA-RNTI defined below, in the RA Response window which starts at the subframe that contains the end of the preamble transmission [7] plus three subframes and has length *ra-ResponseWindowSize* subframes. The RA-RNTI associated with the PRACH in which the Random Access Preamble is transmitted, is computed as:

$$RA-RNTI = 1 + t_id + 10 * f_id$$

Where *t_id* is the index of the first subframe of the specified PRACH ($0 \leq t_id < 10$), and *f_id* is the index of the specified PRACH within that subframe, in ascending order of frequency domain ($0 \leq f_id < 6$). The UE may stop monitoring for Random Access Response(s) after successful reception of a Random Access Response containing the Random Access Preamble identifiers that matches the transmitted Random Access Preamble.

- If a downlink assignment for this TTI has been received on the PDCCH for the RA-RNTI and the received TB is successfully decoded, the UE shall regardless of the possible occurrence of a measurement gap:
 - if the Random Access Response contains a Backoff Indicator sub header:
 - set the backoff parameter value in the UE as indicated by the BI field of the Backoff Indicator sub header and Table 7.2-1.
 - else, set the backoff parameter value in the UE to 0 ms.
- if the Random Access Response contains a Random Access Preamble identifier corresponding to the transmitted Random Access Preamble (see subclause 5.1.3), the UE shall:
 - consider this Random Access Response reception successful;
 - process the received Timing Advance Command (see subclause 5.2);
 - indicate the *preambleInitialReceivedTargetPower* and the amount of power ramping applied to the latest preamble transmission to lower layers (i.e., $(PREAMBLE_TRANSMISSION_COUNTER - 1) * powerRampingStep$);
 - process the received UL grant value and indicate it to the lower layers;
 - if *ra-PreambleIndex* was explicitly signalled and it was not 000000 (i.e., not selected by MAC):
 - consider the Random Access procedure successfully completed.
 - else, if the Random Access Preamble was selected by UE MAC:
 - set the Temporary C-RNTI to the value received in the Random Access Response message no later than at the time of the first transmission corresponding to the UL grant provided in the Random Access Response message;
 - if this is the first successfully received Random Access Response within this Random Access procedure:

- if the transmission is not being made for the CCCH logical channel, indicate to the Multiplexing and assembly entity to include a C-RNTI MAC control element in the subsequent uplink transmission;
- obtain the MAC PDU to transmit from the "Multiplexing and assembly" entity and store it in the Msg3 buffer.

NOTE: When an uplink transmission is required, e.g., for contention resolution, the eNB should not provide a grant smaller than 56 bits in the Random Access Response.

NOTE: If within a Random Access procedure, an uplink grant provided in the Random Access Response for the same group of Random Access Preambles has a different size than the first uplink grant allocated during that Random Access procedure, the UE behaviour is not defined.

If no Random Access Response is received within the RA Response window, or if none of all received Random Access Responses contains a Random Access Preamble identifier corresponding to the transmitted Random Access Preamble, the Random Access Response reception is considered not successful and the UE shall:

- increment PREAMBLE_TRANSMISSION_COUNTER by 1;
- If $PREAMBLE_TRANSMISSION_COUNTER = preambleTransMax + 1$:
 - indicate a Random Access problem to upper layers.

...

- proceed to the selection of a Random Access Resource (see subclause 5.1.2).

7.1.2.5.3 Test description

7.1.2.5.3.1 Pre-test conditions

System Simulator:

- Cell 1
- System information are set according to table 7.1.2.4.3.3-1

UE:

None.

Preamble:

- The UE is in state Registered, Idle mode (state 2) according to [18].

7.1.2.5.3.2 Test procedure sequence

Table 7.1.2.5.3.2-1: Main behaviour

St	Procedure	Message Sequence		TP	Verdict
		U - S	Message		
1	The SS transmits a Paging message including a matched identity.	-	-	-	-
2	Check: does the UE transmit a preamble on PRACH	-->	PRACH Preamble	1	P
3	The SS transmits a MAC PDU addressed to UE RA-RNTI, containing multiple RAR's but none of the MAC sub headers contains a matching RAPID	<--	Random Access Response	-	-
-	EXCEPTION: In parallel with step 4, parallel behaviour defined in table 7.1.2.5.3.2-3 is executed	-	-	-	-
4	Check: does the UE re-transmit a preamble on PRACH	-->	PRACH Preamble	1	P
5	The SS transmits a MAC PDU addressed to UE RA-RNTI, containing multiple RAR's one of the MAC sub headers contains a matching RAPID	<--	Random Access Response	-	-
6	The UE transmits an RRCConnectionRequest message.	-	MAC PDU	2	-
7	The SS sends a MAC PDU containing matching Contention Resolution Identity MAC control element	<--	MAC Control PDU	-	-

Table 7.1.2.5.3.2-2: Parallel behaviour

St	Procedure	Message Sequence		TP	Verdict
		U - S	Message		
1	The UE transmits an RRCConnectionRequest message.	-	MAC PDU	1	F

7.1.2.5.3.3 Specific message contents

None.

7.1.2.6 Maintenance of Uplink Time Alignment

7.1.2.6.1 Test Purpose (TP)

(1)

```
with (UE in E-UTRA RRC_IDLE state and having initiated a random access procedure)
  ensure that {
    when { The SS transmits a Timing Alignment Command in a Random Access Response message}
      then {the UE applies the received Timing Advance value in the next transmitted MAC PDU}
  }
```

(2)

```
with (UE in E-UTRA RRC_CONNECTED state)
  ensure that {
    when { Timing Advanced MAC control Element is received and UE has pending data during the period
the Time Alignment timer is running}
      then { UE does not send any Random Access Preamble, but Scheduling Requests to request
transmission of data while Time Alignment timer is running}
  }
```

(3)

```
with (UE in E-UTRA RRC_CONNECTED state)
  ensure that {
    when{(Timing Alignment timer has expired or is not running and UL transmission is required)}
      then {UE triggers a RA Procedure}
  }
```

7.1.2.6.2 Conformance requirements

References: The conformance requirements covered in the current TC are specified in: TS 36.321 clause 5.2.

[TS 36.321 clause 5.2]

The UE has a configurable Time Alignment Timer. The Time Alignment Timer is valid only in the cell for which it was configured and started.

If the Time Alignment Timer has been configured, the UE shall:

- when a Timing Advance MAC control element is received:
 - apply the Timing Advance Command;
 - start the Time Alignment Timer (if not running) or restart the Time Alignment Timer (if already running).
- when a Time Alignment Command is received in a Random Access Response message:
 - if the Random Access Preamble and PRACH resource were explicitly signalled:
 - apply the Time Alignment Command;
 - start the Time Alignment Timer (if not running) or restart the Time Alignment Timer (if already running).
 - else, if the Time Alignment Timer is not running or has expired:
 - apply the Time Alignment Command;
 - start the Time Alignment Timer;
 - when the contention resolution is considered not successful as described in subclause 5.1.5, stop the Time Alignment Timer.
 - else:
 - ignore the received Time Alignment Command.
- when the Time Alignment Timer has expired or is not running:
 - prior to any uplink transmission, use the Random Access procedure (see subclause 5.1) in order to obtain uplink Time Alignment.
- when the Time Alignment Timer expires:
 - flush all HARQ buffers and consider the next transmission for each process as the very first transmission;
 - release all PUCCH resources;
 - release any assigned SRS resources.

7.1.2.6.3 Test description

7.1.2.6.3.1 Pre-test condition

System Simulator

- Cell 1

UE

None.

Preamble

- The generic procedure to get UE in state Idle mode (state 2) Loopback Activated (State 4) according to TS 36.508 clause 4.5 is executed.

7.1.2.6.3.2 Test procedure sequence

Table 7.1.2.6.3.2-1: Main behaviour

St	Procedure	Message Sequence		TP	Verdict
		U – S	Message		
1	SS pages the UE	-	-	-	-
2	SS respond to UE Random Access request by a Random Access Response with TA field within message set to 600 (Note 2).	<--	MAC PDU(Random Access Response (TA=600))	-	-
3	Check: Does UE send an <i>RRCConectionRequest</i> message in the first scheduled UL transmission using the Timing Advance value sent by the SS in step 2?	-->	MAC PDU (<i>RRCConectionRequest</i>)	1	P
4	RA Procedure considered a success.	<--	MAC PDU (UE Contention Resolution Identity)	-	-
5	The SS sends an <i>RRCConectionSetup</i> message.	<--	MAC PDU (<i>RRCConectionSetup</i>)	-	-
6	Check: does the UE transmit an <i>RRCConectionSetupComplete</i> ?	-->	MAC PDU (<i>RRCConectionSetupComplete</i>)	1	P
7	The generic procedure to get UE in test state Loopback Activated (State 4) according to TS 36.508 clause 4.5 is executed with UL SDU size set to '0' (no data returned in uplink)	-	-	-	-
8	SS transmits Timing Advance command. SS does not send any subsequent alignments. SS Starts Timer_1 = 0.8 * Time Alignment Timer	<--	MAC PDU (Timing Advance MAC Control Element)	-	-
9	SS sends a MAC PDU containing a RLC PDU with SN=0 and poll bit set to trigger UE to transmit a status report in uplink. SS does not respond to any scheduling requests or Random Access Preambles from the UE.	<--	MAC PDU (RLC PDU)	-	-
10	Check: Does UE transmit Scheduling Requests, but no Random Access Preamble message while Timer_1 is running? (Note 1)	-->	(SR)	2	P
11	SS waits 0.2* Time Alignment Timer	-	-	-	-
12	Check: UE transmits a Random Access Preamble	-->	Random Access Preamble	3	P
13	SS responds with a valid Random Access Response	<--	MAC PDU (Random Access Response (C-RNTI))	-	-
14	Check: The UE successfully transmits an RLC STATUS PDU for the acknowledgement of the DL Data with the Temporary C-RNTI set to the value of C-RNTI received in the Random Access Response message	-->	MAC PDU(RLC STATUS PDU (ACK_SN =1))	3	P
15	The SS Transmits a valid MAC PDU including 'UE Contention Resolution Identity' MAC control element with matching 'Contention Resolution Identity'	<--	MAC PDU(Matching UE Contention Resolution Identity)	-	-
Note 1	A conformant UE correctly applies Timing Advance MAC Control and restarts the Timing Alignment timer, causing the uplink to stay in sync for a period equal to the received Time Alignment Value.				
Note 2	TA value of 600 has been chosen arbitrary in the middle of the range 0 to 1282 and corresponds to 0.3125 ms (timing advance in ms = 1000 x NTA x TS where NTA = TA x 16 and TS = 1 / (15000x2048) according to TS 36.213 and TS 36.211).				

7.1.2.6.3.3 Specific Message Contents

None.

7.1.2.7 MAC-Contention Resolution [Temporary C-RNTI]

7.1.2.7.1 Test Purpose (TP)

(1)

```
with { UE in E-UTRA RRC_IDLE state and after transmitting a RRCConnectionRequest message}
ensure that {
  when { SS does not send any MAC PDU including 'UE Contention Resolution Identity' MAC control
  element before contention resolution timer expires }
  then { UE re-transmits RRCConnectionRequest }
}
```

(2)

```
with { UE in E-UTRA RRC_IDLE state and after transmitting a RRCConnectionRequest message}
ensure that {
  when { SS transmits a valid MAC PDU containing RRCConnectionSetup, but not including 'UE
  Contention Resolution Identity' MAC control element }
  then { UE re-transmits RRCConnectionRequest }
}
```

(3)

```
with { UE in E-UTRA RRC_IDLE state and after transmitting a RRCConnectionRequest message}
ensure that {
  when { SS transmits a valid MAC PDU containing RRCConnectionSetup, including 'UE Contention
  Resolution Identity' MAC control element but with un-matched 'Contention Resolution Identity' }
  then { UE re-transmits RRCConnectionRequest }
}
```

(4)

```
with { UE in E-UTRA RRC_IDLE state and after transmitting a RRCConnectionRequest message}
ensure that {
  when { SS transmits a valid MAC PDU containing a RRCConnectionSetup, including 'UE Contention
  Resolution Identity' MAC control element and matching 'Contention Resolution Identity' }
  then { UE transmits a RRCConnectionSetupComplete message}
}
```

7.1.2.7.2 Conformance requirements

References: The conformance requirements covered in the current TC are specified in: TS 36.321, clause 5.1.5.

[TS 36.321, clause 5.1.5]

Contention Resolution is based on either C-RNTI on PDCCH or UE Contention Resolution Identity on DL-SCH..

Once Msg3 is transmitted, the UE shall:

- start *mac-ContentionResolutionTimer* and restart *mac-ContentionResolutionTimer* at each HARQ retransmission;
- regardless of the possible occurrence of a measurement gap, monitor the PDCCH until *mac-ContentionResolutionTimer* expires or is stopped;
- if notification of a reception of a PDCCH transmission is received from lower layers, the UE shall:

...

- else if the CCCH SDU was included in Msg3 and the PDCCH transmission is addressed to its Temporary C-RNTI:
 - if the MAC PDU is successfully decoded:
 - stop *mac-ContentionResolutionTimer*;
 - if the MAC PDU contains a UE Contention Resolution Identity MAC control element; and
 - if the UE Contention Resolution Identity included in the MAC control element matches the CCCH SDU transmitted in Msg3:

- consider this Contention Resolution successful and finish the disassembly and demultiplexing of the MAC PDU;
- set the C-RNTI to the value of the Temporary C-RNTI;
- discard the Temporary C-RNTI;
- consider this Random Access procedure successfully completed.
- else
 - discard the Temporary C-RNTI;
 - consider this Contention Resolution not successful and discard the successfully decoded MAC PDU.
- if *mac-ContentionResolutionTimer* expires:
 - discard the Temporary C-RNTI;
 - consider the Contention Resolution not successful.
- if the Contention Resolution is considered not successful the UE shall:
 - flush the HARQ buffer used for transmission of the MAC PDU in the Msg3 buffer;
 - increment PREAMBLE_TRANSMISSION_COUNTER by 1;
 - If PREAMBLE_TRANSMISSION_COUNTER = *preambleTransMax* + 1:
 - indicate a Random Access problem to upper layers.
 - based on the backoff parameter in the UE, select a random backoff time according to a uniform distribution between 0 and the Backoff Parameter Value;
 - delay the subsequent Random Access transmission by the backoff time;
 - proceed to the selection of a Random Access Resource (see subclause 5.1.2).

7.1.2.7.3 Test description

7.1.2.7.3.1 Pre-test conditions

System Simulator:

- Cell 1

UE:

None.

Preamble:

- The UE is in state Registered, Idle mode (state 2) according to [18].

7.1.2.7.3.2 Test procedure sequence

Table 7.1.2.7.3.2-1: Main behaviour

St	Procedure	Message Sequence		TP	Verdict
		U - S	Message		
1	The SS transmits a Paging message including a matched identity.	-	-	1	-
2	The UE transmits a MAC PDU containing an <i>RRCCConnectionRequest</i> message.	-->	MAC PDU	1	-
3	Check: For time equal to 'Contention Resolution Timer', does UE send a PRACH preamble?		PRACH preamble	1	F
4	Check: does the UE transmit a MAC PDU containing an <i>RRCCConnectionRequest</i> message?	-->	MAC PDU	1	P
-	EXCEPTION: In parallel with steps 5 to 8, the parallel behaviour in table 7.1.2.7.3.2-2 is running.	-	-	-	-
5	The SS Transmits a valid MAC PDU containing <i>RRCCConnectionSetup</i> , but not including 'UE Contention Resolution Identity' MAC control element	<--	MAC PDU	2	-
6	Check: does the UE transmit a MAC PDU containing an <i>RRCCConnectionRequest</i> message?	-->	MAC PDU	2	P
7	The SS Transmits a valid MAC PDU containing <i>RRCCConnectionSetup</i> , and including 'UE Contention Resolution Identity' MAC control element but with un matched 'Contention Resolution Identity'	<--	MAC PDU	3	-
8	Check: does the UE transmit a MAC PDU containing an <i>RRCCConnectionRequest</i> message?	-->	MAC PDU	3	P
9	The SS Transmits a valid MAC PDU containing <i>RRCCConnectionSetup</i> , and including 'UE Contention Resolution Identity' MAC control element with matching 'Contention Resolution Identity'	<--	MAC PDU	4	-
10	Check: does the UE transmit a MAC PDU containing an <i>RRCCConnectionSetupComplete</i> message?	-->	MAC PDU	4	P

Table 7.1.2.7.3.2-2: Parallel behaviour

St	Procedure	Message Sequence		TP	Verdict
		U - S	Message		
1	Check: UE transmits a MAC PDU containing an <i>RRCCConnectionSetupComplete</i> message indicating acceptance of <i>RRCCConnectionSetup</i> message	-->	MAC PDU	2,3	F

7.1.2.7.3.3 Specific message contents

7.1.2.7.3.3-1: SystemInformationBlockType2 (all steps, table 7.1.2.7.3.2-1)

Derivation path: 36.508 table 4.4.3.3-1			
Information Element	Value/Remark	Comment	Condition
SystemInformationBlockType2 ::= SEQUENCE { radioResourceConfigCommon SEQUENCE { rach-Configuration SEQUENCE { ra-SupervisionInformation SEQUENCE { preambleTransMax mac-ContentionResolutionTimer } } } }	N10 sf64	Max value Max value	

7.1.2.8 MAC-Contention Resolution [C-RNTI]

7.1.2.8.1 Test Purpose (TP)

(1)

```
with { UE in E-UTRA RRC_CONNECTED state and after transmitting a
RRCCONNECTIONRECONFIGURATIONCOMPLETE message for a handover without dedicated preamble}
ensure that {
  when { The SS does not schedule any PDCCH transmission addressed to UE C-RNTI before Contention
resolution timer expiry}
  then { The UE retransmits the RRCCONNECTIONRECONFIGURATIONCOMPLETE message}
}
```

(2)

```
with { UE in E-UTRA RRC_CONNECTED state and after transmitting a
RRCCONNECTIONRECONFIGURATIONCOMPLETE message for a handover without dedicated preamble }
ensure that {
  when { UE receive PDCCH transmission addressed to its C-RNTI before Contention resolution timer
expiry }
  then { The UE does not retransmit the RRCCONNECTIONRECONFIGURATIONCOMPLETE message }
}
```

7.1.2.8.2 Conformance requirements

References: The conformance requirements covered in the current TC are specified in: TS 36.321, clause 5.1.5.

[TS 36.321, clause 5.1.5]

Contention Resolution is based on either C-RNTI on PDCCH or UE Contention Resolution Identity on DL-SCH..

Once Msg3 is transmitted, the UE shall:

- start *mac-ContentionResolutionTimer* and restart *mac-ContentionResolutionTimer* at each HARQ retransmission;
- regardless of the possible occurrence of a measurement gap, monitor the PDCCH until *mac-ContentionResolutionTimer* expires or is stopped;
- if notification of a reception of a PDCCH transmission is received from lower layers, the UE shall:
 - if the C-RNTI MAC control element was included in Msg3:
 - if the Random Access procedure was initiated by the MAC sublayer itself and the PDCCH transmission is addressed to the C-RNTI and contains an UL grant for a new transmission; or
 - if the Random Access procedure was initiated by a PDCCH order and the PDCCH transmission is addressed to the C-RNTI:
 - consider this Contention Resolution successful;
 - stop *mac-ContentionResolutionTimer*;

- discard the Temporary C-RNTI;
- consider this Random Access procedure successfully completed.

...

- else
 - discard the Temporary C-RNTI;
 - consider this Contention Resolution not successful and discard the successfully decoded MAC PDU.
- if *mac-ContentionResolutionTimer* expires:
 - discard the Temporary C-RNTI;
 - consider the Contention Resolution not successful.
- if the Contention Resolution is considered not successful the UE shall:
 - flush the HARQ buffer used for transmission of the MAC PDU in the Msg3 buffer;
 - increment PREAMBLE_TRANSMISSION_COUNTER by 1;
 - If PREAMBLE_TRANSMISSION_COUNTER = *preambleTransMax* + 1:
 - indicate a Random Access problem to upper layers.
 - based on the backoff parameter in the UE, select a random backoff time according to a uniform distribution between 0 and the Backoff Parameter Value;
 - delay the subsequent Random Access transmission by the backoff time;
 - proceed to the selection of a Random Access Resource (see subclause 5.1.2).

7.1.2.8.3 Test description

7.1.2.8.3.1 Pre-test conditions

System Simulator:

- Cell 1 and Cell 2
- System information as in table 7.1.2.8.3.3-1.

UE:

None.

Preamble:

- The UE is in state Generic RB Established (state 3) according to [18] on cell 1.

7.1.2.8.3.2 Test procedure sequence

Table 7.1.2.8.3.2-1: Main behaviour

St	Procedure	Message Sequence		TP	Verdict
		U - S	Message		
1	The SS transmits a MAC PDU containing an <i>RRCCONNECTIONRECONFIGURATION</i> message to order the UE to perform intra frequency handover to Cell 2, not including explicit Random Access Preamble.	<--	MAC PDU	-	-
2	The UE transmits on cell 2 a MAC PDU containing <i>RRCCONNECTIONRECONFIGURATIONCOMPLETE</i> , including C-RNTI MAC control element	-->	MAC PDU	-	-
3	SS Does not schedule any PDCCH transmission for UE C-RNTI	-	-	-	-
4	Check: does the UE transmit a PRACH preamble within time equal to 'Contention Resolution Timer'?	-->	(PRACH preamble)	1	F
5	Check: does the UE transmit on cell 2 a MAC PDU containing <i>RRCCONNECTIONRECONFIGURATIONCOMPLETE</i> , including C-RNTI MAC control element?	-->	MAC PDU	1	P
6	SS sends PDCCH transmission for UE C-RNTI	-	-	-	-
7	Check: does the UE transmit MAC PDU containing <i>RRCCONNECTIONRECONFIGURATIONCOMPLETE</i> within the next 2s?	-->	MAC PDU	2	F
8	Check: does the test result of CALL generic procedure indicate that the UE is in E-UTRA RRC_CONNECTED state on Cell 2?	-			-

7.1.2.8.3.3 Specific message contents

Table 7.1.2.8.3.3-1: SystemInformationBlockType2 (all steps, Table 7.1.2.8.3.2-1)

Derivation path: 36.508 table 4.4.3.3-1			
Information Element	Value/Remark	Comment	Condition
SystemInformationBlockType2 ::= SEQUENCE { radioResourceConfigCommon SEQUENCE { rach-Configuration SEQUENCE { ra-SupervisionInformation SEQUENCE { preambleTransMax mac-ContentionResolutionTimer } } } } }	N10 sf64	Max value Max value	

Table 7.1.2.8.3.3-2: *RRCConnectionReconfiguration* (step 1, Table 7.1.2.8.3.2-1)

Derivation path: 36.508 table 4.6.1-6, condition RBC-HO			
Information Element	Value/Remark	Comment	Condition
<pre> RRCConnectionReconfiguration ::= SEQUENCE { criticalExtensions CHOICE { c1 CHOICE{ rrcConnectionReconfiguration-r8 SEQUENCE { mobilityControllInformation SEQUENCE { targetCellIdentity eutra-CarrierFreq } } } } } </pre>	<p>MobilityControllInformation-HO PhysicalCellIdentity of Cell 2 (see 36.508 clause 4.4.4.2) Not present</p>		

7.1.2.9 MAC-Backoff Indicator

7.1.2.9.1 Test Purpose (TP)

(1)

```

with (UE in E-UTRA RRC_IDLE state and having initiated a random access procedure)
  ensure that{
    when { SS sends a Random Access Response including a Backoff Indicator and the Random Access Preamble identifier is different from the value received from the UE }
      then{ UE triggers RA preamble after a random time between 0 and the indicated Backoff parameter }
  }

```

(2)

```

with (UE in E-UTRA RRC_IDLE state and having initiated a random access procedure)
  ensure that {
    when { { SS sends a Random Access Response containing Backoff Indicator and a Random Access Preamble identifier with the same value as received from the UE }
      then{ UE stores Backoff Indicator and sends a RRC connection request in the first scheduled UL transmission }
    }

```

(3)

```

with (UE in E-UTRA RRC_IDLE state and having initiated a random access procedure)
  ensure that {
    when { UE receives a Contention Resolution failure }
      then {UE triggers RA preamble after random time between 0 and the UE stored Backoff parameter}
    }

```

7.1.2.9.2 Conformance requirements

References: The conformance requirements covered in the current TC are specified in: TS 36.321, clauses 5.1.4, 5.1.5 and 7.2.

[TS 36.321 clause 5.1.4]

- If a downlink assignment for this TTI has been received on the PDCCH for the RA-RNTI and the received TB is successfully decoded, the UE shall regardless of the possible occurrence of a measurement gap:
 - if the Random Access Response contains a Backoff Indicator sub header:
 - set the backoff parameter value in the UE as indicated by the BI field of the Backoff Indicator sub header and Table 7.2-1.
 - else, set the backoff parameter value in the UE to 0 ms.

...

If no Random Access Response is received within the TTI window [RA_WINDOW_BEGIN—RA_WINDOW_END], or if all received Random Access Responses contain Random Access Preamble identifiers that do not match the transmitted Random Access Preamble, the Random Access Response reception is considered not successful and the UE shall:

...

- if in this Random Access procedure, the Random Access Preamble was selected by MAC:
 - based on the backoff parameter in the UE, select a random backoff time according to a uniform distribution between 0 and the Backoff Parameter Value;
 - delay the subsequent Random Access transmission by the backoff time;

[TS 36.321 clause 5.1.5]

- if the Contention Resolution is considered not successful the UE shall:
 - if the Random Access procedure was initiated by the MAC sublayer itself; or
 - if the Random Access procedure was initiated by a PDCCH order and the PREAMBLE_TRANSMISSION_COUNTER is less than PREAMBLE_TRANS_MAX:
 - increment PREAMBLE_TRANSMISSION_COUNTER by 1;
 - If PREAMBLE_TRANSMISSION_COUNTER = PREAMBLE_TRANS_MAX + 1:
 - indicate a Random Access problem to upper layers.
 - based on the backoff parameter in the UE, select a random backoff time according to a uniform distribution between 0 and the Backoff Parameter Value;
 - delay the subsequent Random Access transmission by the backoff time;
 - proceed to the selection of a Random Access Resource (see subclause 5.1.2).

[TS 36.321 clause 7.2]

Backoff Parameter values are presented in Table 7.2-1.

Table 7.2-1: Backoff Parameter values.

Index	Backoff Parameter value (ms)
0	0
1	10
2	20
3	30
4	40
5	60
6	80
7	120
8	160
9	240
10	320
11	480
12	960

7.1.2.9.3 Test description

7.1.2.9.3.1 Pre-test conditions

System Simulator

- Cell 1

UE:

None.

Preamble

- The UE is in state Registered, Idle Mode (state 2) according to [18].

Table 7.1.2.9.3.1-1: (Void)

7.1.2.9.3.2 Test procedure sequence

Table 7.1.2.9.3.2-1: Backoff Parameter values.

x: Index	Y: Backoff Parameter value (ms)
1	10
2	20
3	30
4	40
5	60
6	80
7	120
8	160
9	240
10	320
11	480
12	960

Table 7.1.2.9.3.2-2: Main behaviour

St	Procedure	Message Sequence		TP	Verdict
		U - S	Message		
	EXCEPTION: Steps 1 to 5 are repeated for values of 'x' and 'y' according to table 7.1.2.9.3.2-1	-	-	-	-
1	SS pages the UE	-	-	-	-
2	UE sends a Random Access Preamble	-->	Random Access Preamble	-	-
3	SS sends a Random Access Response with the backoff parameter set to value Index field 'x' and with the Random Access Preamble identifier different from the value received from the UE in the Random Access Preamble. The SS sets Timer_T1 to the Backoff value 'y' associated with the Index value 'x' and starts Timer_T1.	<--	Random Access Response(BI, RAPID)	-	-
4	Check: Does UE send a Random Access Preamble while Timer_T1 is running?	-->	Random Access Preamble	1	P
5	SS stops Timer_T1. SS waits 5 seconds to allow T300 to expire. During this time the SS ignores and RA preambles.	-	-	-	-
	EXCEPTION: Steps 6 to 12 are repeated for values of 'x' and 'y' according to table 7.1.2.9.3.2-1	-	-	-	-
6	SS pages the UE	-	-	-	-
7	UE sends a Random Access Preamble	-->	Random Access Preamble	-	-
8	SS sends Random Access Response with a backoff parameter set to value Index field 'x' and the Random Access Preamble identifier value set to the same value as received from the UE in the Random Access Preamble.	<--	Random Access Response(BI, RAPID)	-	-
9	Check: Does UE sends an <i>RRCConnectionRequest</i> in the grant associated to the Random Access Response	-->	MAC PDU (<i>RRCConnectionRequest</i>)	2	P

	received in step 8?				
10	The SS sends a Contention Resolution Failure. The SS sets Timer_T1 to the Backoff value 'y' associated with the Index value 'x' and starts Timer_T1.	<--	MAC Control PDU (Unmatching UE Contention Resolution Identity)	-	-
11	Check: Does UE send a Random Access Preamble while Timer_T1 is running?	-->	Random Access Preamble	3	P
12	SS stops Timer_T1. SS waits 5 seconds to allow T300 to expiry. During this time the SS ignores and RA preambles.	-	-	3	P

7.1.2.9.3.3 Specific Message Contents

None

7.1.3 DL-SCH Data transfer

7.1.3.1 Correct handling of DL assignment / dynamic case

7.1.3.1.1 Test Purpose (TP)

(1)

```
with { UE in E-UTRA RRC_CONNECTED state }
ensure that {
  when { UE receives downlink assignment on the PDCCH for the UE's C-RNTI and receives data in the
associated subframe and UE performs HARQ operation }
  then { UE sends a HARQ feedback on the HARQ process }
}
```

(2)

```
with { UE in E-UTRA RRC_CONNECTED state }
ensure that {
  when { UE receives downlink assignment on the PDCCH with a C-RNTI unknown by the UE and data is
available in the associated subframe }
  then { UE does not send any HARQ feedback on the HARQ process }
}
```

7.1.3.1.2 Conformance requirements

References: The conformance requirements covered in the present TC are specified in: 3GPP TS 36.321 clause 5.3.1

[TS 36.321, clause 5.3.1]

Downlink assignments transmitted on the PDCCH indicate if there is a transmission on the DL-SCH for a particular UE and provide the relevant HARQ information.

When the UE has a C-RNTI, Semi-Persistent Scheduling C-RNTI, or Temporary C-RNTI, the UE shall for each TTI during which it monitors PDCCH:

- if a downlink assignment for this TTI has been received on the PDCCH for the UE's C-RNTI, or Temporary C-RNTI:
 - if this is the first downlink assignment for this Temporary C-RNTI:
 - consider the NDI to have been toggled.
 - if the downlink assignment is for UE's C-RNTI and if either a downlink assignment has been received for the UE's Semi-Persistent Scheduling C-RNTI or a configured downlink assignment has been indicated to the HARQ entity since the previous received downlink assignment for the UE's C-RNTI for the same HARQ process:
 - consider the NDI to have been toggled regardless of the value of the NDI.
- indicate the presence of a downlink assignment and deliver the associated HARQ information to the HARQ entity for this TTI.

...

7.1.3.1.3 Test description

7.1.3.1.3.1 Pre-test conditions

System Simulator

- Cell 1

UE:

None.

Preamble

- The generic procedure to get UE in test state Loopback Activated (State 4) according to TS 36.508 clause 4.5 is executed, with all the parameters as specified in the procedure except that the RLC SDU size is set to return no data in uplink.

7.1.3.1.3.2 Test procedure sequence

Table 7.1.3.1.3.2-1: Main behaviour

St	Procedure	Message Sequence		TP	Verdict
		U - S	Message		
1	SS transmits a downlink assignment including the C-RNTI assigned to the UE	<--	(PDCCH (C-RNTI))	-	-
2	SS transmits in the indicated downlink assignment a RLC PDU in a MAC PDU.	<--	MAC PDU	-	-
3	Check: Does the UE transmit an HARQ ACK on PUCCH?	-->	HARQ ACK	1	P
4	SS transmits a downlink assignment to including a C-RNTI different from the assigned to the UE	<--	(PDCCH (unknown C-RNTI))	-	-
5	SS transmits in the indicated downlink assignment a RLC PDU in a MAC PDU.	<--	MAC PDU	-	-
6	Check: Does the UE send any HARQ ACK on PUCCH?	-->	HARQ ACK	2	F

Note 1: For TDD, the timing of ACK/NACK is not constant as FDD, see Table 10.1-1 of TS 36.213.

7.1.3.1.3.3 Specific Message Contents

None.

7.1.3.2 Correct handling of DL assignment: semi persistent case

7.1.3.2.1 Test Purpose (TP)

(1)

```
with { UE in E-UTRA RRC_Connected state with DRB established and sps-Configuration in UL is enabled
}
ensure that {
  when { UE receives a DL assignment addressed to its stored SPS-CRNTI in SF-Num y and with NDI set
as 0 }
  then { UE starts receiving DL MAC PDU in SF-Nums y+n*[semiPersistSchedIntervalDL] where 'n' is
positive integer starting at zero}
}
```

(2)

```
with { UE in E-UTRA RRC_Connected state with DRB established and stored DL SPS assignment to receive
MAC PDU at SF-Num y+n*[semiPersistSchedIntervalDL] }
ensure that {
  when { UE receives a DL assignment addressed to its SPS-CRNTI in SF-Num p and with NDI set as 0,
where p!= y+n*[semiPersistSchedIntervalDL] }
```

then { UE starts receiving DL MAC PDU in SF-Nums $p+n \cdot [\text{semiPersistSchedIntervalDL}]$ and stops receiving DL MAC PDU at SF-Nums $y+n \cdot [\text{semiPersistSchedIntervalDL}]$ where 'n' is positive integer starting at zero }

(3)

with { UE in E-UTRA RRC_Connected state with DRB established and stored DL SPS assignment to receive MAC PDU at SF-Num $p+n \cdot [\text{semiPersistSchedIntervalDL}]$ }

ensure that {
when { UE receives a DL assignment [for retransmission] addressed to its SPS-CRNTI in SF-Num z and with NDI set as 1, where $z \neq p+n \cdot [\text{semiPersistSchedIntervalDL}]$ }
then { UE receives MAC PDU in SF-Num z as per the new grant for SPS-CRNTI }

(4)

with { UE in E-UTRA RRC_Connected state with DRB established and stored DL SPS assignment to receive MAC PDU at SF-Num $z+n \cdot [\text{semiPersistSchedIntervalDL}]$ }

ensure that {
when { UE receives a DL assignment addressed to its CRNTI in SF-Num p, such that $p = z+n \cdot [\text{semiPersistSchedIntervalDL}]$ }
then { UE receives MAC PDU in SF-Num p as per assignment addressed to its C-RNTI }

(5)

with { UE in E-UTRA RRC_Connected state with DRB established and stored DL SPS grant to receive MAC PDU at SF-Num $z+n \cdot [\text{semiPersistSchedIntervalDL}]$ }

ensure that {
when { UE receives a RRCConnectionReconfiguration including sps-Configuration with sps-ConfigurationDL set as 'disable' and hence resulting in DL SPS grant deactivation }
then { UE deletes the stored sps-Configuration DL parameters and stops receiving DL MAC PDU's as per stored SPS assignment in SF-Num $z+n \cdot [\text{semiPersistSchedIntervalDL}]$ }
}

7.1.3.2.2 Conformance requirements

References: The conformance requirements covered in the current TC are specified in: TS 36.321 clause 5.3.1 and 36.331 clause 5.3.10.5.

[TS 36.321, clause 5.3.1, 5.10, 5.10.1]

Downlink assignments transmitted on the PDCCH indicate if there is a transmission on the DL-SCH for a particular UE and provide the relevant HARQ information.

When the UE has a C-RNTI, Semi-Persistent Scheduling C-RNTI, or Temporary C-RNTI, the UE shall for each TTI during which it monitors PDCCH:

- if a downlink assignment for this TTI has been received on the PDCCH for the UE's C-RNTI, or Temporary C-RNTI:
 - if this is the first downlink assignment for this Temporary C-RNTI:
 - consider the NDI to have been toggled.
 - if either a downlink assignment has been received for the UE's Semi-Persistent Scheduling C-RNTI or a configured downlink assignment has occurred since the previous received downlink assignment for the UE's C-RNTI for the same HARQ process:
 - consider the NDI to have been toggled regardless of the value of the NDI.
 - indicate the presence of a downlink assignment and deliver the associated HARQ information to the HARQ entity for this TTI.
- else, if a downlink assignment for this TTI has been received on the PDCCH for the UE's Semi-Persistent Scheduling C-RNTI:
 - if the NDI in the received HARQ information is 1:
 - consider the NDI not to have been toggled;

- indicate the presence of a downlink assignment and deliver the associated HARQ information to the HARQ entity for this TTI.
- else, if the NDI in the received HARQ information is 0:
 - if PDCCH contents indicate SPS release:
 - clear the configured downlink assignment (if any);
 - instruct the physical layer to transmit a positive acknowledgement.
 - else:
 - store the downlink assignment and the associated HARQ information as configured downlink assignment;
 - initialise (if not active) or re-initialise (if already active) the configured downlink assignment to start in this TTI and to recur according to rules in subclause 5.10.1;
 - set the HARQ Process ID to the HARQ Process ID associated with this TTI;
 - consider the NDI bit to have been toggled;
 - indicate the presence of a configured downlink assignment and deliver the stored HARQ information to the HARQ entity for this TTI.
- else, if a downlink assignment for this TTI has been configured and there is no measurement gap in this TTI:
 - instruct the physical layer to receive, in this TTI, transport(s) block on the DL-SCH according to the configured downlink assignment and to deliver it to the HARQ entity;
 - set the HARQ Process ID to the HARQ Process ID associated with this TTI;
 - consider the NDI bit to have been toggled;
 - indicate the presence of a configured downlink assignment and deliver the stored HARQ information to the HARQ entity for this TTI.

[TS 36.321, clause 5.10]

When Semi-Persistent Scheduling is enabled by upper layer, the following information is provided:

- Semi-Persistent Scheduling C-RNTI;
- Uplink Semi-Persistent Scheduling Interval, if Semi-Persistent Scheduling is enabled for the uplink;
- Whether [two-intervals-Semi-Persistent Scheduling] is enabled or disabled for uplink, only for TDD;
- Downlink Semi-Persistent Scheduling Interval, if Semi-Persistent Scheduling is enabled for the downlink;

When Semi-Persistent Scheduling for uplink or downlink is disabled by RRC, the corresponding configured grant or configured assignment shall be discarded.

[TS 36.321, clause 5.10.1]

After a Semi-Persistent downlink assignment is configured, the UE shall consider that the assignment recurs in each subframe for which:

- $(10 * SFN + \text{subframe}) = [(10 * SFN_{\text{start time}} + \text{subframe}_{\text{start time}}) + N * (\text{Downlink Semi-Persistent Scheduling Interval})] \text{ modulo } 10240$, for all $N > 0$.

Where $SFN_{\text{start time}}$ and $\text{subframe}_{\text{start time}}$ are the SFN and subframe, respectively, at the time the configured downlink assignment were (re-)initialised.

[TS 36.331, clause 5.3.10.5]

The UE shall:

- 1> if the received *radioResourceConfiguration* includes *sps-Configuration*:

2> if *sps-Configuration* includes *sps-ConfigurationDL* and the configuration is set to 'disable':

3> deactivate any downlink semi-persistent scheduling resources, if active;

3> release the downlink semi-persistent scheduling configuration.

2> if *sps-Configuration* includes *sps-ConfigurationUL* and the configuration is set to 'disable':

3> deactivate any uplink semi-persistent scheduling resources, if active;

3> release the uplink semi-persistent scheduling configuration.

7.1. 3.2.3 Test description

7.1.3.2.3.1 Pre-test conditions

System Simulator:

- Cell 1

UE:

None.

Preamble:

- The UE is in state Loopback Activated (state 4) according to [18].
- The loop back size is set in such a way that one RLC SDU in DL shall result in 1 RLC SDU's in UL of same size.

7.1.3.2.3.2 Test procedure sequence

Table 7.1.3.2.3.2-1: Main behaviour

St	Procedure	Message Sequence		TP	Verdict
		U - S	Message		
1	The SS Transmits a DL assignment using UE's SPS C-RNTI in SF-Num 'Y', NDI=0	<--	(DL SPS Grant)	-	-
2	The SS transmits in SF-Num 'Y', DL MAC PDU containing a RLC PDU (DL-SQN=0)on DRB	<-	MAC PDU	-	-
3	Check: Does the UE transmit a HARQ ACK?	-->	HARQ ACK	1	P
4	The SS transmits in SF-Num 'Y+X(semiPersistSchedIntervalDL)', DL MAC PDU containing a RLC PDU (DL-SQN=1)on DRB	<-	MAC PDU	-	-
5	Check: Does the UE transmit a HARQ ACK?	-->	HARQ ACK	1	P
6	The SS Transmits a DL assignment using UE's SPS C-RNTI in SF-Num 'P', NDI=0; (Where $Y+X < P < Y+2X$)	<--	(DL SPS Grant)	-	-
7	The SS transmits in SF-Num 'P', DL MAC PDU containing a RLC PDU (DL-SQN=2)on DRB	<-	MAC PDU	-	-
8	Check: Does the UE transmit a HARQ ACK?	-->	HARQ ACK	2	P
9	The SS transmits in SF-Num 'Y+2X', DL MAC PDU containing a RLC PDU (DL-SQN=3)on DRB	<-	MAC PDU	-	-
10	Check: Does the UE transmit a HARQ Feedback?	-->	HARQ ACK/NACK	2	F
11	The SS transmits in SF-Num 'P+4+X(semiPersistSchedIntervalDL)', DL MAC PDU containing a RLC PDU (DL-SQN=3)on DRB; CRC is calculated in such a way will result in CRC error in UE.	<-	MAC PDU	-	-
12	Check: Does the UE transmit a HARQ NACK?	-->	HARQ NACK	2,3	P
13	The SS Transmits a DL assignment using UE's SPS C-RNTI in SF-Num 'Z', NDI=1; Where ($P < Z < P+1X$); The DL HARQ process is same as in step 11	<--	(DL SPS Grant)	-	-
14	The SS re-transmits in SF-Num 'Z', DL MAC PDU containing a RLC PDU (DL-SQN=3)on DRB;	<-	MAC PDU	-	-
15	Check: Does the UE transmit a HARQ ACK?	-->	HARQ ACK	3	P
16	The SS transmits in SF-Num 'P+2X(semiPersistSchedIntervalDL)', DL MAC PDU containing a RLC PDU (DL-SQN=4)on DRB	<-	MAC PDU	-	-
17	Check: Does the UE transmit a HARQ ACK?	-->	HARQ ACK	1	P
18	The SS Transmits a DL assignment using UE's C-RNTI in SF-Num 'P+3X(semiPersistSchedIntervalDL)'	<--	(DL Grant)	-	-
19	The SS transmits in SF-Num 'P+3X(semiPersistSchedIntervalDL)', DL MAC PDU containing 1 RLC PDU's (DL-SQN=4)on DRB;Note 1	<-	MAC PDU	-	-
20	Check: Does the UE transmit a HARQ ACK ?	-->	HARQ ACK	4	P
21	SS transmits an UL Grant sufficient for transmitting loop back PDU's corresponding to DL RLC PDU's with SQN's 0 to 4	<--	(UL Grant)		
22	The UE MAC PDU transmits loop back SDU's corresponding to DL RLC PDU's with SQN 0 to 4.	->	MAC PDU		
23	SS Transmits RRCConnectionReconfiguration to disable SPS-ConfigurationUL			-	-
24	The UE transmits RRCConnectionReconfigurationComplete			-	-

25	The SS transmits in SF-Num 'Y+nX(semiPersistSchedIntervalDL)', DL MAC PDU containing 1 RLC PDU's (DL-SQN=5) on DRB; (n>4)	<-	MAC PDU	-	-
26	Check: The UE transmits a HARQ Feedback	-->	HARQ ACK/NACK	5	F
Note 1: The DL assignment for C-RNTI and hence the size of MAC PDU is different in size than stored SPS C-RNTI DL assignment in step 6. This assures UE is reciving DSCH data as per DL assignment for C-RNTI and not as per stored grant for SPS C-RNTI.					

NOTE 1: Steps 21 and 22 are executed to bring UE in stable state.

NOTE 2: For TDD, the subframe number for 'Y', 'P', and 'Z' should be selected from {'0', '4', '5'} respectively based on TDD configuration 1.

7.1.3.2.3.3 Specific message contents

Table 7.1.3.2.3.3-1: RRCConnectionReconfiguration. RadioResourceConfigDedicated (Preamble)

Derivation path: 36.508 table 4.6.3-16				
Information Element	Value/remark	Comment	Condition	
RadioResourceConfigDedicated ::= SEQUENCE {				
sps-Configuration ::= SEQUENCE {				
semiPersistSchedC-RNTI	'FFF0'H			
sps-ConfigurationDL ::= CHOICE {				
enable SEQUENCE {				
semiPersistSchedIntervalDL	sf160	160 Subframe		
numberOfConfSPS-Processes	8		FDD	
numberOfConfSPS-Processes	7	Max DL HARQ processes is 7 considering TDD configuration 1.	TDD	
n1Pucch-AN-Persistent	0			
}				
}				
sps-ConfigurationUL	Not Present			
}				
}				

Table 7.1.3.2.3.3-1: RRCConnectionReconfiguration. RadioResourceConfigDedicated (step 23 of table 7.1.3.2.3.2-1)

Derivation path: 36.508 table 4.6.3-16				
Information Element	Value/remark	Comment	Condition	
RadioResourceConfigDedicated ::= SEQUENCE {				
sps-Configuration ::= SEQUENCE {				
semiPersistSchedC-RNTI	Not Present			
sps-ConfigurationDL ::= CHOICE {				
disable	NULL			
}				
sps-ConfigurationUL	Not Present			
}				
}				

7.1.3.3 MAC PDU header handling

7.1.3.3.1 Test Purpose (TP)

(1)

```
with { UE in E-UTRA RRC_CONNECTED state }
ensure that {
  when { UE receives a MAC PDU containing an AMD PDU that is larger than 128 bytes with padding at the end }
  then { UE successfully decodes the MAC PDU and forward to higher layer }
```

}

(2)

```
with { UE in E-UTRA RRC_CONNECTED state }
ensure that {
  when { UE receives a MAC PDU containing an AMD PDU that is smaller than 128 bytes with padding at the end }
  then { UE successfully decodes the MAC PDU and forward to higher layer }
}
```

(3)

```
with { UE in E-UTRA RRC_CONNECTED state }
ensure that {
  when { UE receives a MAC PDU containing an single AMD PDU with no padding }
  then { UE successfully decodes the MAC PDU and forward to higher layer }
}
```

(4)

```
with { UE in E-UTRA RRC_CONNECTED state }
ensure that {
  when { UE receives a MAC PDU containing multiple MAC SDUs each containg an AMD PDU and no padding }
  then { UE successfully decodes the MAC PDU and forward the AMD PDUs to higher layer }
}
```

7.1.3.3.2 Conformance requirements

References: The conformance requirements covered in the present TC are specified in: 3GPP TS 36.321 clauses 6.1.2 and 6.2.1.

[TS 36.321, clause 6.1.2]

A MAC PDU consists of a MAC header, zero or more MAC Service Data Units (MAC SDU), zero, or more MAC control elements, and optionally padding; as described in Figure 6.1.2-3.

Both the MAC header and the MAC SDUs are of variable sizes.

A MAC PDU header consists of one or more MAC PDU sub-headers; each sub header corresponding to either a MAC SDU, a MAC control element or padding.

A MAC PDU sub header consists of the six header fields R/R/E/LCID/F/L but for the last sub header in the MAC PDU and for fixed sized MAC control elements. The last sub header in the MAC PDU and sub-headers for fixed sized MAC control elements consist solely of the four header fields R/R/E/LCID. It follows that a MAC PDU sub header corresponding to padding consists of the four header fields R/R/E/LCID.

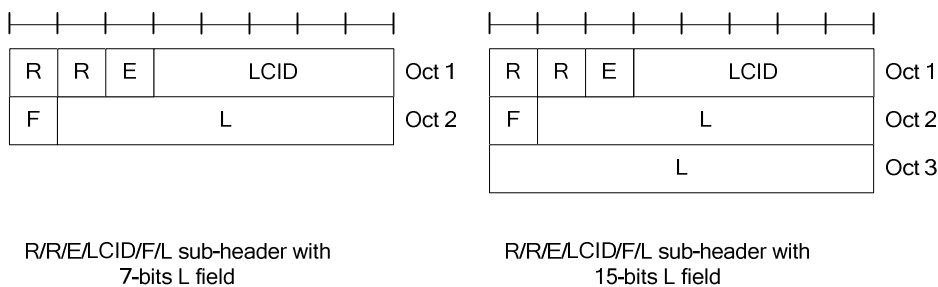

Figure 6.1.2-1: R/R/E/LCID/F/L MAC sub header

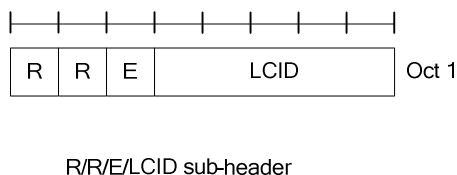

Figure 6.1.2-2: R/R/E/LCID MAC sub header

MAC PDU sub-headers have the same order as the corresponding MAC SDUs, MAC control elements and padding.

MAC control elements, are always placed before any MAC SDU.

Padding occurs at the end of the MAC PDU, except when single-byte or two-byte padding is required but cannot be achieved by padding at the end of the MAC PDU. Padding may have any value and the UE shall ignore it.

When single-byte or two-byte padding is required but cannot be achieved by padding at the end of the MAC PDU, one or two MAC PDU sub-headers corresponding to padding are inserted before the first MAC PDU sub header corresponding to a MAC SDU; or if such sub header is not present, before the last MAC PDU sub header corresponding to a MAC control element.

A maximum of one MAC PDU can be transmitted per TB per UE.

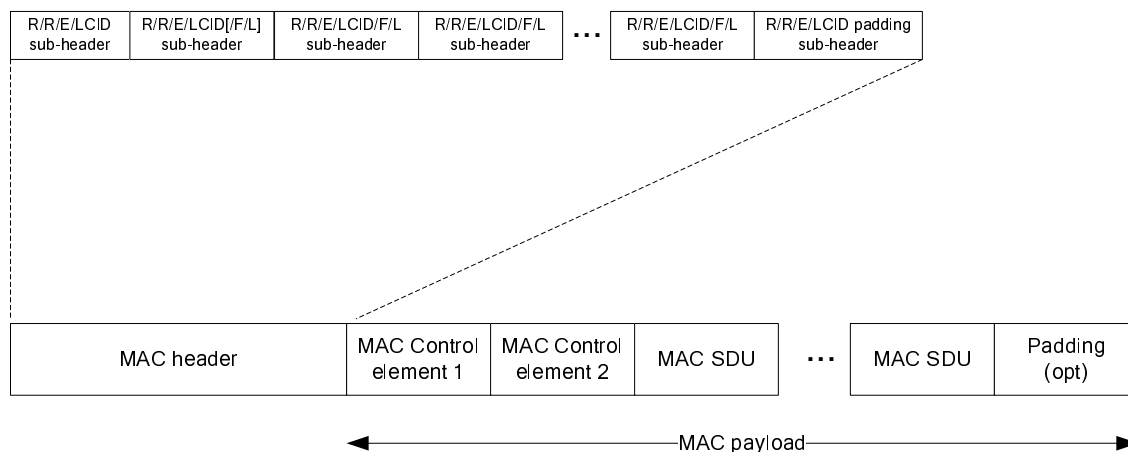

Figure 6.1.2-3: Example of MAC PDU consisting of MAC header, MAC control elements, MAC SDUs and padding

[TS 36.321, clause 6.2.1]

The MAC header is of variable size and consists of the following fields:

- LCID: The Logical Channel ID field identifies the logical channel instance of the corresponding MAC SDU or the type of the corresponding MAC control element or padding as described in tables 6.2.1-1 and 6.2.1-2 for the DL and UL-SCH respectively. There is one LCID field for each MAC SDU, MAC control element or padding included in the MAC PDU. In addition to that, one or two additional LCID fields are included in the MAC PDU, when single-byte or two-byte padding is required but cannot be achieved by padding at the end of the MAC PDU. The LCID field size is 5 bits;
- L: The Length field indicates the length of the corresponding MAC SDU or MAC control element in bytes. There is one L field per MAC PDU sub header except for the last sub header and sub-headers corresponding to fixed-sized MAC control elements. The size of the L field is indicated by the F field;
- F: The Format field indicates the size of the Length field as indicated in table 6.2.1-3. There is one F field per MAC PDU sub header except for the last sub header and sub-headers corresponding to fixed-sized MAC control elements. The size of the F field is 1 bit. If the size of the MAC SDU or MAC control element is less than 128 bytes, the UE shall set the value of the F field to 0, otherwise the UE shall set it to 1;
- E: The Extension field is a flag indicating if more fields are present in the MAC header or not. The E field is set to "1" to indicate another set of at least R/R/E/LCID fields. The E field is set to "0" to indicate that either a MAC SDU, a MAC control element or padding starts at the next byte;
- R: Reserved bits, set to "0".

The MAC header and sub-headers are octet aligned.

Table 6.2.1-1: Values of LCID for DL-SCH

Index	LCID values
00000	CCCH
00001-01010	Identity of the logical channel
01011-11011	Reserved
11100	UE Contention Resolution Identity
11101	Timing Advance Command
11110	DRX Command
11111	Padding

Table 6.2.1-2: Values of LCID for UL-SCH

Index	LCID values
00000	CCCH
00001-01010	Identity of the logical channel
01011-11001	Reserved
11010	Power Headroom Report
11011	C-RNTI
11100	Truncated BSR
11101	Short BSR
11110	Long BSR
11111	Padding

Table 6.2.1-3: Values of F field:

Index	Size of Length field (in bits)
0	7
1	15

7.1.3.3.3 Test description

7.1.3.3.3.1 Pre-test conditions

System Simulator

- Cell 1

UE:

None.

Preamble

- The UE is in state Loopback Activated (state 4) according to [18].
- The UL RLC SDU size is set to not return any data.

7.1.3.3.3.2 Test procedure sequence

Table 7.1.3.3.3.2-1: Main behaviour

St	Procedure	Message Sequence		TP	Verdict
		U - S	Message		
1	The SS transmits a MAC PDU containing a RLC SDU of 130 bytes in an AMD PDU (SN=0) with polling field 'P' set to '1' and 5 bytes of padding. The MAC header contains two MAC sub-headers where the first MAC sub-header is a 3-byte R/R/E/LCID/F/L MAC sub-header with 'E' field set to '1', the 'F' set to '1', the 'LCID' field set to '00011' and the 'L' field set to '132' bytes. The second MAC sub-header is a padding control 1byte R/R/E/LCID MAC sub-header with 'E' field set to '0' and 'LCID' field set to '11111'.	<--	MAC PDU (R/R/E/LCID/F/L MAC sub-header (E='1', LCID='00011', F='1', L='132'), MAC R/R/E/LCID MAC sub-header (E='0', LCID='11111'), 132 bytes MAC SDU and 5 bytes padding)	-	-
2	Check: Does the UE transmit a MAC PDU containing an RLC STATUS PDU acknowledging the reception of the AMD PDU in step 1?	-->	MAC PDU (RLC STATUS PDU (ACK_SN '1'))	1	P
3	The SS transmits a MAC PDU containing a RLC SDU of 40 bytes in an AMD PDU(SN=1) with polling field 'P' set to '1'and 5 bytes of padding. The MAC header contains two MAC sub-headers where the first MAC sub-header is a 2-byte R/R/E/LCID/F/L MAC sub-header with 'E' field set to '1', the 'F' set to '0', the 'LCID' field set to '00011' and the 'L' field set to '42' bytes. The second MAC sub-header is a padding control 1byte R/R/E/LCID MAC sub-header with 'E' field set to '0' and 'LCID' field set to '11111'.	<--	MAC PDU (R/R/E/LCID/F/L MAC sub-header (E='1', LCID='00011', F='0', L='42'), R/R/E/LCID MAC sub-header (E='0', LCID='11111'), 42 bytes MAC SDU and 5 bytes padding)	-	-
4	Check: Does the UE transmit a MAC PDU containing an RLC STATUS PDU acknowledging the reception of the AMD PDU in step 3?	-->	MAC PDU (RLC STATUS PDU (ACK_SN '2'))	2	P
5	The SS transmits a MAC PDU containing a MAC SDU with a RLC SDU of 130 bytes in an AMD PDU(SN=2) with polling field 'P' set to '1'. The MAC header contains one R/R/E/LCID MAC sub-header with 'E' field set to '0' and the 'LCID' field set to '00011'.	<--	MAC PDU (R/R/E/LCID MAC sub-header (E='0', LCID='00011'), 132 bytes MAC SDU)	-	-
6	Check: Does the UE transmit a MAC PDU containing an RLC STATUS PDU acknowledging the reception of the AMD PDU in step 5?	-->	MAC PDU (RLC STATUS PDU (ACK_SN '3'))	3	P
7	The SS transmits a MAC PDU containing one MAC SDU containing a RLC SDU of size 127 bytes in an AMD PDU (SN=3) and five MAC SDUs each containing a RLC SDU of 41 bytes in an AMD PDU (SN=4 to 8) in an AMD PDU with the polling field 'P' set to '1' in the last AMD PDU. The MAC header contains six MAC sub-headers where the first The MAC sub-header contains a 3 byte R/R/E/LCID/F/L MAC sub-header with 'E' field set to '1', 'LCID' field set to '00011', 'F' field set to '1' and the 'L' field set to '129'. The second to fifth MAC sub-header are two byte R/R/E/LCID/F/L MAC sub-headers with 'E' field set to '1', 'LCID' field set to '00011', 'F' field set to '0' and the 'L' field set to '43' bytes. The sixth MAC sub-header is a one byte R/R/E/LCID MAC sub-header with 'E' field set to '0' and the 'LCID' field set to '00011'.	<--	MAC PDU (R/R/E/LCID/L MAC sub-header (E='1', LCID='00011', F='1', L='129'), 4 x R/R/E/LCID/L MAC sub-header (E='1', LCID='00011', F='0', L='43'), R/R/E/LCID MAC sub-header (E='0', LCID='00011'), 129 bytes MAC SDU, 5 x 43 bytes MAC SDUs)	4	-

8	Check: Does the UE transmit a MAC PDU containing an RLC STATUS PDU acknowledging the reception of the AMD PDUs in step 7?	-->	MAC PDU (RLC STATUS PDU (ACK_SN '9'))	4	P
---	---	-----	---------------------------------------	---	---

7.1.3.3.3.3 Specific Message Contents

None

7.1.3.4 Correct HARQ process handling[DCCH /DTCH]

7.1.3.4.1 Test Purpose (TP)

(1)

```
with { UE in E-UTRA RRC_ CONNECTED state with DRB established}
ensure that {
  when { the UE receives a MAC PDU for DRB and CRC fails}
  then { the UE transmits a NACK for the corresponding HARQ process}
}
```

(2)

```
with { UE in E-UTRA RRC_ CONNECTED state with DRB established}
ensure that {
  when { the UE receives a MAC PDU retransmission for DRB, and results in CRC pass on combined data}
  then { the UE transmits an ACK for the corresponding HARQ process and delivers data to upper layers}
}
```

7.1.3.4.2 Conformance requirements

References: The conformance requirements covered in the current TC are specified in: TS 36.321, clause 5.3.2.1 & 5.3.2.2.

[TS 36.321, clause 5.3.2.1]

There is one HARQ entity at the UE which maintains a number of parallel HARQ processes. Each HARQ process is associated with a HARQ process identifier. The HARQ entity directs HARQ information and associated TBs received on the DL-SCH to the corresponding HARQ processes (see subclause 5.3.2.2).

The number of DL HARQ processes is specified in [2], clause 7.

When the physical layer is configured for spatial multiplexing [2], one or two TBs are expected per subframe and they are associated with the same HARQ process. Otherwise, one TB is expected per subframe.

The UE shall:

- If a downlink assignment has been indicated for this TTI:
 - allocate the TBs received from the physical layer and the associated HARQ information to the HARQ process indicated by the associated HARQ information.
- If a downlink assignment has been indicated for the broadcast HARQ process:
 - allocate the received TB to the broadcast HARQ process.

NOTE: In case of BCCH a dedicated broadcast HARQ process is used.

[TS 36.321, clause 5.3.2.2]

For each subframe where a transmission takes place for the HARQ process, one or two (in case of spatial multiplexing) TBs and the associated HARQ information are received from the HARQ entity.

For each received TB and associated HARQ information, the HARQ process shall:

- if the NDI, when provided, has been toggled compared to the value of the previous received transmission corresponding to this TB; or

- if the HARQ process is equal to the broadcast process and if this is the first received transmission for the TB according to the system information schedule indicated by RRC; or
- if this is the very first received transmission for this TB (i.e. there is no previous NDI for this TB):
 - consider this transmission to be a new transmission.
- else:
 - consider this transmission to be a retransmission.

The UE then shall:

- if this is a new transmission
 - replace the data currently in the soft buffer for this TB with the received data.
- else if this is a retransmission:
 - if the data has not yet been successfully decoded:
 - combine the received data with the data currently in the soft buffer for this TB.
 - if the TB size is different from the last valid TB size signalled for this TB:
 - the UE may replace the data currently in the soft buffer for this TB with the received data.
- attempt to decode the data in the soft buffer for this TB;
- if the data in the soft buffer was successfully decoded for this TB:
 - if the HARQ process is equal to the broadcast process, deliver the decoded MAC PDU to upper layers.
 - else, deliver the decoded MAC PDU to the disassembly and demultiplexing entity.
 - generate a positive acknowledgement (ACK) of the data in this TB.
- else:
 - generate a negative acknowledgement (NACK) of the data in this TB.
- if the HARQ process is associated with a transmission indicated with a Temporary C-RNTI and the Contention Resolution is not successful (see subclause 5.1.5); or
- if the HARQ process is equal to the broadcast process; or
- if *timeAlignmentTimer* is stopped or expired:
 - do not indicate the generated positive or negative acknowledgement to the physical layer.
- else:
 - indicate the generated positive or negative acknowledgement for this TB to the physical layer.

The UE shall ignore NDI received in all downlink assignments on PDCCH for its Temporary C-RNTI when determining if NDI on PDCCH for its C-RNTI has been toggled compared to the value in the previous transmission.

7.1.3.4.3 Test description

7.1.3.4.3.1 Pre-test conditions

System Simulator:

- Cell 1

UE:

None.

Preamble:

- The UE is in state Loopback Activated (state 4) according to [18].

7.1.3.4.3.2 Test procedure sequence

Table 7.1.3.4.3.2-1: Main behaviour

St	Procedure	Message Sequence		TP	Verdict
		U - S	Message		
	EXCEPTION: Steps 1 to 7 are run 8[FDD]/7[TDD] times using test parameter values as given for each iteration in table 7.1.3.4.3.2.-2.				
1	The SS indicates a new transmission on PDCCH and transmits a MAC PDU (containing an RLC PDU) on HARQ process X, but the CRC is calculated in such a way that it will result in CRC error on UE side. The AMD PDU contains a full RLC SDU.	<--	MAC PDU	1	-
2	Check: Does the UE transmit a HARQ NACK?	-->	HARQ NACK	1	P
3	The SS indicates a retransmission on PDCCH and transmits the same MAC PDU like step 1, with CRC is calculated in such a way that it will result in CRC pass on UE side.	<--	MAC PDU	-	-
4	Check: Does the UE send a HARQ ACK?	-->	HARQ ACK	2	P
5	UE transmit a Scheduling Request on PUCCH	-->	(SR)	-	-
6	The SS sends an UL grant suitable for the loop back PDU to transmitted	<--	(UL Grant)	-	-
7	The UE transmit a MAC PDU containing the loop back PDU corresponding to step 1 and 3	->	MAC PDU	-	-

Table 7.1.3.4.3.2-2: Test Parameters

Iteration	DL HARQ process (X)
1	0
2	1
3	2
4	3
5	4
6	5
7	6
8	7[only for FDD]
Note: The maximum DL HARQ process is 7 for TDD configuration 1.	

7.1.3.4.3.3 Specific message contents

None.

7.1.3.5 Correct HARQ process handling [CCCH]

7.1.3.5.1 Test Purpose (TP)

(1)

```
with { UE in E-UTRA RRC_IDLE state with RRC connection establishment procedure initiated}
ensure that {
  when { UE receives a MAC PDU addressed to RA-RNTI }
  then { UE does not transmit ACK/NACK for the corresponding HARQ process}
}
```

(2)

```
with { UE in E-UTRA RRC_IDLE state with RRC connection establishment procedure initiated }
```

```

ensure that {
  when { UE receives a MAC PDU addressed to T-CRNTI without UE Contention Resolution Identity
  matching the one included in the RRCConnectionRequest message }
  then { UE does not transmit a ACK/NACK for the corresponding HARQ process }
}

```

(3)

```

with { UE in E-UTRA RRC_IDLE state with RRC connection establishment procedure initiated }
ensure that {
  when { UE receives a MAC PDU addressed to T-CRNTI and cannot decode properly }
  then { UE does not transmits a NACK for the corresponding HARQ }
}

```

(4)

```

with { UE in E-UTRA RRC_IDLE state with RRC connection establishment procedure initiated }
ensure that {
  when { UE receives a MAC PDU addressed to T-CRNTI with UE Contention Resolution Identity matching
  the one included in the RRCConnectionRequest message }
  then { UE transmits an ACK for the corresponding HARQ process and delivers data to upper layers}
}

```

7.1.3.5.2 Conformance requirements

References: The conformance requirements covered in the current TC are specified in: TS 36.321, clause 5.3.2.1 and 5.3.2.2.

[TS 36.321, clause 5.3.2.1]

There is one HARQ entity at the UE which maintains a number of parallel HARQ processes. Each HARQ process is associated with a HARQ process identifier. The HARQ entity directs HARQ information and associated TBs received on the DL-SCH to the corresponding HARQ processes (see subclause 5.3.2.2).

The number of DL HARQ processes is specified in [2], clause 7.

When the physical layer is configured for spatial multiplexing [2], one or two TBs are expected per subframe and they are associated with the same HARQ process. Otherwise, one TB is expected per subframe.

The UE shall:

- If a downlink assignment has been indicated for this TTI:
 - allocate the TBs received from the physical layer and the associated HARQ information to the HARQ process indicated by the associated HARQ information.
- If a downlink assignment has been indicated for the broadcast HARQ process:
 - allocate the received TB to the broadcast HARQ process.

NOTE: In case of BCCH a dedicated broadcast HARQ process is used.

[TS 36.321, clause 5.3.2.2]

For each subframe where a transmission takes place for the HARQ process, one or two (in case of spatial multiplexing) TBs and the associated HARQ information are received from the HARQ entity.

For each received TB and associated HARQ information, the HARQ process shall:

- if the NDI, when provided, has been toggled compared to the value of the previous received transmission corresponding to this TB; or
- if the HARQ process is equal to the broadcast process and if this is the first received transmission for the TB according to the system information schedule indicated by RRC; or
- if this is the very first received transmission for this TB (i.e. there is no previous NDI for this TB):
 - consider this transmission to be a new transmission.
- else:
 - consider this transmission to be a retransmission.

The UE then shall:

- if this is a new transmission
 - replace the data currently in the soft buffer for this TB with the received data.
- if a retransmission is indicated for this TB:
 - if the data has not yet been successfully decoded:
 - combine the received data with the data currently in the soft buffer for this TB.
 - if the TB size is different from the last valid TB size signalled for this TB:
 - the UE may replace the data currently in the soft buffer for this TB with the received data.
- attempt to decode the data in the soft buffer for this TB;
- if the data in the soft buffer was successfully decoded for this TB:
 - if the HARQ process is equal to the broadcast process:
 - deliver the decoded MAC PDU to upper layers.
 - else:
 - deliver the decoded MAC PDU to the disassembly and demultiplexing entity.
 - generate a positive acknowledgement (ACK) of the data in this TB.
- else:
 - generate a negative acknowledgement (NACK) of the data in this TB.
- if the HARQ process is associated with a transmission indicated with a Temporary C-RNTI and a UE the Contention Resolution Identity match is not indicated successful (see subclause 5.1.5); or
- if the HARQ process is equal to the broadcast process; or
- - if *timeAlignmentTimer* is stopped or expired:
 - do not indicate the generated positive or negative acknowledgement to the physical layer.
- else:
 - indicate the generated positive or negative acknowledgement for this TB to the physical layer.

The UE shall ignore NDI received in all downlink assignments on PDCCH for its Temporary C-RNTI when determining if NDI on PDCCH for its C-RNTI has been toggled compared to the value in the previous transmission.

7.1.3.5.3 Test description

7.1.3.5.3.1 Pre-test conditions

System Simulator:

- Cell 1
- System information taking into account parameters in table 7.1.3.5.3.3-1

UE:

None.

Preamble:

- The UE is in state Registered, Idle mode state (state 2) according to [18].

7.1.3.5.3.2 Test procedure sequence

Table 7.1.3.5.3.2-1: Main behaviour

St	Procedure	Message Sequence		TP	Verdict
		U - S	Message		
1	The SS transmits a Paging message including a matched identity.	-		-	-
2	The UE transmits Preamble on PRACH	-->	PRACH Preamble	-	-
3	The SS transmits Random Access Response with matching RA-Id and including T-CRNTI. The CRC is calculated in such a way, it will result in CRC error on UE side	<--	Random Access Response	-	-
4	Check: does the UE transmit a HARQ ACK/NACK?	-->	HARQ ACK/NACK	1	F
5	The UE transmits Preamble on PRACH	-->	PRACH Preamble	-	-
6	The SS transmits Random Access Response with matching RA-Id and including T-CRNTI. The CRC is calculated in such a way, it will result in CRC pass on UE side.	<--	Random Access Response	-	-
7	Check: does the UE transmit a HARQ ACK/NACK?	-->	HARQ ACK/NACK	1	F
8	The UE transmits a MAC PDU containing an <i>RRCCoNNECTIONRequest</i> message.	-->	MAC PDU	-	-
9	The SS transmits a valid MAC PDU containing <i>RRCCoNNECTIONSetup</i> , and including 'UE Contention Resolution Identity' MAC control element with not matching 'Contention Resolution Identity'.	<--	MAC PDU	-	-
10	Check: does the UE transmit a HARQ ACK/NACK?	-->	HARQ ACK/NACK	2	F
11	The UE transmits Preamble on PRACH	-->	PRACH Preamble	-	-
12	The SS transmits Random Access Response with matching RA-Id and including T-CRNTI.	<--	Random Access Response	-	-
13	The UE transmits a MAC PDU containing an <i>RRCCoNNECTIONRequest</i> message.	-->	MAC PDU	-	-
14	The SS transmits a valid MAC PDU containing <i>RRCCoNNECTIONSetup</i> , and including 'UE Contention Resolution Identity' MAC control element with matching 'Contention Resolution Identity'. The CRC is calculated in such a way that it will result in CRC error on UE side	<--	MAC PDU	-	-
15	Check: Does UE transmit a HARQ NACK?	-->	HARQ NACK	3	F
16	The UE transmits Preamble on PRACH	-->	PRACH Preamble	-	-
17	The SS transmits Random Access Response with matching RA-Id and including T-CRNTI.	<--	Random Access Response	-	-
18	The UE transmits a MAC PDU containing an <i>RRCCoNNECTIONRequest</i> message.	-->	MAC PDU	-	-
19	The SS transmits the same MAC PDU like in step 14, but the CRC is calculated in such a way that it will result in CRC pass on UE side	<--	MAC PDU	-	-
20	Check: does the UE transmit a HARQ ACK?	-->	HARQ ACK	4	P
21	The UE transmits a MAC PDU containing an <i>RRCCoNNECTIONSetupComplete</i> message indicating acceptance of <i>RRCCoNNECTIONSetup</i> message	-->	MAC PDU	-	-

7.1.3.5.3.3 Specific message contents

Table 7.1.3.5.3.3-1: SystemInformationBlockType2 (all steps, table 7.1.3.5.3.2-1)

Derivation path: 36.508 table 4.4.3.3-1			
Information Element	Value/Remark	Comment	Condition
SystemInformationBlockType2 ::= SEQUENCE { radioResourceConfigCommon SEQUENCE { rach-Configuration SEQUENCE { ra-SupervisionInformation SEQUENCE { preambleTransMax mac-ContentionResolutionTimer } } prach-Configuration SEQUENCE { prach-ConfigInfo SEQUENCE { prach-ConfigurationIndex	n8 sf64	Max Value	
prach-ConfigurationIndex	1	As per table 5.7.1-2 of 36.211, this results in PRACH preamble transmission start in even frame numbers and sub-frame number 4	FDD
	0	As per table 5.7.1-4 of 36.211, this results in PRACH preamble transmission with frequency resource index=0; occurring in even radio frames; resource is located in first half frame and sub frame number 3 Note 1	TDD
ue-TimersAndConstants SEQUENCE{ t300 }	ms2000	T300	

7.1.3.6 Correct HARQ process handling [BCCH]

7.1.3.6.1 Test Purpose (TP)

(1)

```
with { UE in E-UTRA RRC_Idle state}
ensure that {
  when { UE receives a MAC PDU addressed to S-RNTI}
  then { UE does not send any ACK/NACK for the corresponding dedicated HARQ process}
}
```

7.1.3.6.2 Conformance requirements

References: The conformance requirements covered in the current TC are specified in: TS 36.321, clause 5.3.2.1 & 5.3.2.2.

[TS 36.321, clause 5.3.2.1]

There is one HARQ entity at the UE which maintains a number of parallel HARQ processes. Each HARQ process is associated with a HARQ process identifier. The HARQ entity directs HARQ information and associated TBs received on the DL-SCH to the corresponding HARQ processes (see subclause 5.3.2.2).

The number of DL HARQ processes is specified in [2], clause 7.

When the physical layer is configured for spatial multiplexing [2], one or two TBs are expected per subframe and they are associated with the same HARQ process. Otherwise, one TB is expected per subframe.

The UE shall:

- If a downlink assignment has been indicated for this TTI:
 - allocate the TBs received from the physical layer and the associated HARQ information to the HARQ process indicated by the associated HARQ information.
- If a downlink assignment has been indicated for the broadcast HARQ process:
 - allocate the received TB to the broadcast HARQ process.

NOTE: In case of BCCH a dedicated broadcast HARQ process is used.

[TS 36.321, clause 5.3.2.2]

For each subframe where a transmission takes place for the HARQ process, one or two (in case of spatial multiplexing) TBs and the associated HARQ information are received from the HARQ entity.

For each received TB and associated HARQ information, the HARQ process shall:

- if the NDI, when provided, has been toggled compared to the value of the previous received transmission corresponding to this TB; or
- if the HARQ process is equal to the broadcast process and the physical layer indicates a new transmission; or
- if this is the very first received transmission for this TB:
 - consider this transmission to be a new transmission.
- else:
 - consider this transmission to be a retransmission.

The UE then shall:

- if this is a new transmission:
 - replace the data currently in the soft buffer for this TB with the received data.
- else if this is a retransmission:
 - if the data has not yet been successfully decoded:
 - combine the received data with the data currently in the soft buffer for this TB.
 - if the TB size is different from the last valid TB size signalled for this TB:
 - the UE may replace the data currently in the soft buffer for this TB with the received data.
- attempt to decode the data in the soft buffer for this TB;
- if the data in the soft buffer was successfully decoded for this TB:
 - if the HARQ process is equal to the broadcast process, deliver the decoded MAC PDU to upper layers.
 - else, deliver the decoded MAC PDU to the disassembly and demultiplexing entity.
 - generate a positive acknowledgement (ACK) of the data in this TB.

- else:
 - generate a negative acknowledgement (NACK) of the data in this TB.
- if the HARQ process is associated with a transmission indicated with a Temporary C-RNTI and a UE the Contention Resolution Identity match is not indicated successful (see subclause 5.1.5); or
- if the HARQ process is equal to the broadcast process; or
- if there is a measurement gap at the time of the transmission of the HARQ feedback:
 - do not indicate the generated positive or negative acknowledgement to the physical layer.
- else:
 - indicate the generated positive or negative acknowledgement for this TB to the physical layer.

The UE shall ignore NDI received in all downlink assignments on PDCCH for its Temporary C-RNTI when determining if NDI on PDCCH for its C-RNTI has been incremented compared to the value in the previous transmission.

7.1.3.6.3 Test description

7.1.3.6.3.1 Pre-test conditions

System Simulator:

- Cell 1

UE:

None.

Preamble:

- The UE is in state Registered, Idle mode (state 2) according to [18].

7.1.3.6.3.2 Test procedure sequence

Table 7.1.3.6.3.2-1: Main behaviour

St	Procedure	Message Sequence		TP	Verdict
		U - S	Message		
1	The SS transmits an updated system information with S-RNTI addressed in L1/L2 header. CRC is calculated in such a way, it will result in CRC fail on UE side. Dedicated HARQ process for broadcast is used.	-	-	-	-
2	Check: Does the UE transmit a HARQ NACK ?	->	HARQ NACK	1	F
3	Wait for 10 seconds for UE to attempt to read the modified system information.	-	-	-	-
4	The SS transmits a <i>Paging</i> message including a matched identity.	<--	-		
45	Check: does the UE transmits a MAC PDU containing an <i>RRCCoNNECTIONRequest</i> message?	-->	MAC PDU	1	P
6	The SS transmits an updated system information with S-RNTI addressed in L1/L2 header. CRC is calculated in such a way, it will result in CRC fail on UE side. Dedicated HARQ process for broadcast is used.				
7	Check: does the UE transmit an ACK?	->	HARQ ACK	1	F
8	Wait for 10 seconds for UE to read the modified system information.	-	-	-	-
9	The SS transmits a <i>Paging</i> message including a matched identity.	<--	-	-	-
10	Check: does the UE transmit a MAC PDU containing an <i>RRCCoNNECTIONRequest</i> message, using PRACH resources as in new SI.	-->	MAC PDU	1	P

7.1.3.6.3.3 Specific message contents

Table 7.1.3.6.3.3-1: SystemInformationBlockType2 (steps 1 and 6 of table 7.1.3.6.3.2-1)

Derivation path: 36.508 table 4.4.3.3-1			
Information Element	Value/Remark	Comment	Condition
SystemInformationBlockType2 ::= SEQUENCE { radioResourceConfigCommon SEQUENCE { prach-Configuration SEQUENCE { rootSequenceIndex	20 (<i>u</i> = 2, Value different than default in TS 36.508)		FDD
rootSequenceIndex	2 (<i>u</i> = 2, Value different than default in TS 36.508)	rootSequenceIndex should take value from table of 5.7.2-5 in TS 36.211 since, the PRACH format 4 is used as default for testing for TDD.	TDD
}			
}			
}			

7.1.3.7 MAC-Padding

7.1.3.7.1 Test Purpose (TP)

(1)

```
with (UE in E-UTRA RRC_CONNECTED state)
ensure that {
```

```

when{ UE is receiving RLC PDUs in MAC PDUs with padding greater than 2 bytes }
  then { UE acknowledge reception of the RLC PDUs }
}
    
```

(2)

```

with (UE in E-UTRA RRC_CONNECTED state)
  ensure that {
    when { UE is receiving RLC PDUs in MAC PDUs with padding less than 2 bytes }
      then { UE acknowledge reception of the RLC PDUs }
  }
    
```

(3)

```

with (UE in E-UTRA RRC_CONNECTED state)
  ensure that {
    when { SS is transmitting a MAC control Timing Advance PDU with padding less than 2 bytes and no
    Data MAC PDU sub-headers followed by transmitting a RLC PDU using the new Timing Advance value }
      then { UE acknowledge reception of the RLC PDU }
  }
    
```

7.1.3.7.2 Conformance requirements

References: The conformance requirements covered in the current TC are specified in: TS 36.321, clause 6.1.2.

[TS 36.321 clause 6.1.2]

...

Padding occurs at the end of the MAC PDU, except when single-byte or two-byte padding is required but cannot be achieved by padding at the end of the MAC PDU.

When single-byte or two-byte padding is required but cannot be achieved by padding at the end of the MAC PDU, one or two MAC PDU sub-headers corresponding to padding are inserted before the first MAC PDU sub header corresponding to a MAC SDU; or if such sub header is not present, before the last MAC PDU sub header corresponding to a MAC control element.

A maximum of one MAC PDU can be transmitted per TB per UE.

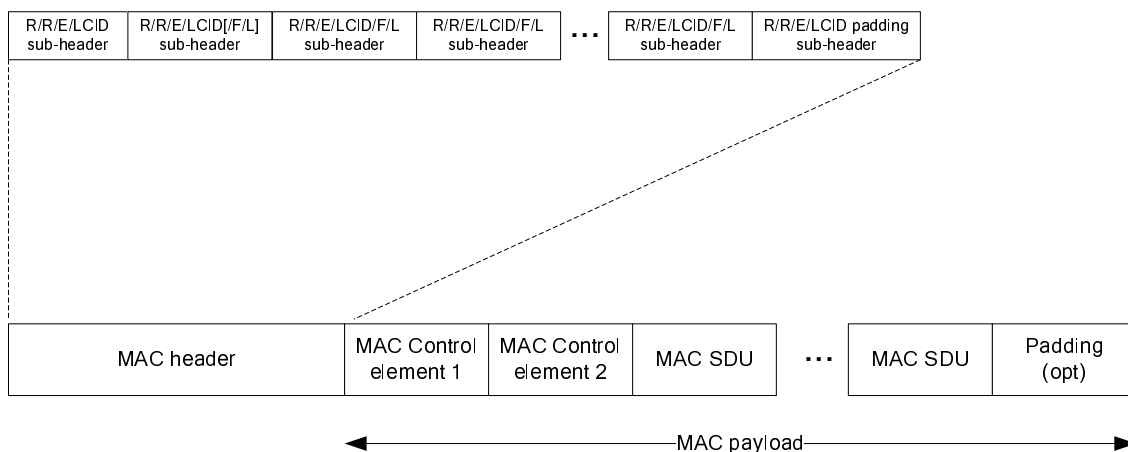

Figure 6.1.2-3: MAC PDU consisting of MAC header, MAC control elements, MAC SDUs and padding

7.1.3.7.3 Test description

7.1.3.7.3.1 Pre-test conditions

System Simulator

- Cell 1

UE:

None.

Preamble

- The UE is in state Loopback Activated (state 4) according to [18].
- The UL RLC SDU size is set to not return any data.

7.1.3.7.3.2 Test procedure sequence

Table 7.1.3.7.3.2-1: Main behaviour

St	Procedure	Message Sequence		TP	Verdict
		U - S	Message		
1	The SS transmits a MAC PDU containing a RLC SDU in an AMD PDU with polling field 'P' set to '1'. The MAC SDU payload is set 10-bytes smaller than the TB size allocated in the DL Assignment minus AMD PDU and MAC headers.	<--	MAC PDU(AMD PDU, padding)	-	-
2	Check: Does the UE transmit an RLC STATUS PDU with ACK_SN field equal to 1?	-->	RLC STATUS PDU (ACK_SN 'n')	1	P
3	The SS transmits a MAC PDU containing a RLC SDU in an AMD PDU. The MAC SDU payload is set to 1-byte smaller than the TB size allocated in the DL Assignment minus AMD PDU and MAC headers. SS adds a 1 byte padding by inserting a MAC PDU sub-header before first Data MAC PDU sub-header.	<--	MACPDU(AMD PDU, one byte padding)	-	-
4	Check: does the UE transmit an RLC STATUS PDU with ACK_SN field equal to 2?	-->	MAC PDU(RLC STATUS PDU (ACK_SN =2))	2	P
5	The SS sets the downlink assignment for TBS of '16-bits'	-	-	-	-
6	The SS transmits a Timing Advance without any additional padding. Start Timer_1 = Time Alignment timer value.	<--	MAC Control PDU(Timing Advance)	-	-
7	The SS sets the downlink assignment for TBS of '24-bits'	-	-	-	-
8	The SS waits a time period equal to 0.5 of Timer_1 value and configures a MAC PDU that consists of only a Control MAC PDU sub header (8-bits). Transmit another Timing Advance MAC PDU (8-bits) which leaves 1-byte padding. The SS does not transmit any subsequent timing alignment. Restart Timer_1 = Time Alignment timer value	<--	MAC Control(Timing Advance) + 1-byte padding	-	-
9	The SS waits a time period equal to 0.7 of Timer_1 and then transmits MAC PDU containing one RLC SDU in an AMD PDU with polling field 'P' set to '1'.	<--	MAC PDU(AMD PDU (SN=2, P=1))	-	-
10	Check: does the UE transmit an RLC STATUS PDU acknowledging the reception of the RLC PDU in step 9?	-->	MAC PDU(RLC STATUS PDU (ACK_SN =3))	3	P

7.1.3.7.3.3 Specific Message Contents

None.

7.1.3.9 MAC reset-DL

7.1.3.9.1 Test Purpose (TP)

(1)

```
with (UE in E-UTRA RRC_CONNECTED state)
ensure that {
```

```

when{ UE MAC is reset, due to handover to a new cell}
  then { UE flushes DL HARQ buffer}
}

```

(2)

```

with (UE in E-UTRA RRC_CONNECTED state)
  ensure that {
    when{ UE MAC is reset, due to handover to a new cell}
      then { UE Considers the next transmission for each DL HARQ process as very first }
  }

```

7.1.3.9.2 Conformance requirements

References: The conformance requirements covered in the current TC are specified in: TS 36.321, clause 5.9.

[TS 36.321 clause 5.9]

If a reset of the MAC entity is requested by upper layers, the UE shall:

- initialize Bj for each logical channel to zero;
- stop and reset all timers, if running;
- consider the Time Alignment Timer as expired and perform the corresponding actions in 5.2;
- stop, if any, ongoing RACH procedure;
- flush Msg3 buffer;
- cancel, if any, triggered Scheduling Request procedure;
- cancel, if any, triggered Buffer Status Reporting procedure;
- cancel, if any, triggered Power Headroom Reporting procedure;
- flush all UL HARQ buffers;
- flush all DL HARQ buffers;.
- for UL, consider the next transmission for each process as very first;
- for DL, consider the next received TB for each process as very first;
- release, if any, configured downlink assignment;
- release, if any, configured uplink grant;
- release, if any, Temporary C-RNTI.

7.1.3.9.3 Test description

7.1.3.9.3.1 Pre-test conditions

System Simulator

- Cell 1 and Cell 2

UE:

None.

Preamble:

- The UE is in state Loopback Activated (state 4) in cell 1 according to [18], with the DRB for the default EPS bearer context configured with RLC in UM mode.

7.1.3.9.3.2 Test procedure sequence

Table 7.1.3.9.3.2-1 illustrates the downlink power levels and other changing parameters to be applied for the cells at various time instants of the test execution. Row marked "T0" denotes the initial conditions, while columns marked "T1" is to be applied subsequently. The exact instants on which these values shall be applied are described in the texts in this clause.

Table 7.1.3.9.3.2-1: Time instances of cell power level and parameter changes

	Parameter	Unit	Cell 1	Cell 2	Remark
T0	Cell-specific RS EPRE	dBm/15Khz	-90	Off	
T1	Cell-specific RS EPRE	dBm/15Khz	-90	-80	

Table 7.1.3.9.3.2-2: Main behaviour

St	Procedure	Message Sequence		TP	Verdict
		U - S	Message		
1	The SS ignores scheduling requests and does not allocate any uplink grant.	-	-	-	-
2	The SS transmits a MAC PDU containing one RLC SDU on LC 3, but the CRC is calculated in such a way that it will result in CRC error on UE side.	<--	MAC PDU (1 RLC SDU of 40 bytes on DRB)	-	-
3	The UE transmit a HARQ NACK	-->	HARQ NACK	-	-
4	The SS changes Cell 2 level according to the row "T1" in table 7.1.4.12.3.2-1	-	-	-	-
5	The SS transmits an <i>RRCCONNECTIONRECONFIGURATION</i> message to order the UE to perform intra frequency handover to Cell 2, including explicit Random Access Preamble.			-	-
6	The UE transmits on cell 2, <i>RRCCONNECTIONRECONFIGURATIONCOMPLETE</i>			-	-
7	Check: For 100 ms, does UE transmits any HARQ NACK?	-->	HARQ NACK	1	F
8	The SS transmits a MAC PDU containing RLC SDU on LC 3. The NDI on PDCCH is same as in step 2	<--	MAC PDU (1 RLC SDU of 40 bytes on DRB)	-	-
9	Check: Does the UE transmit a scheduling request?	-->	(SR)	2	P
10	The SS allocate UL Grant sufficient for one RLC SDU to be loop backed in a TTI, and NDI indicates new transmission	<--	Uplink Grant	-	-
11	The UE transmits a MAC PDU including one RLC SDU	-->	MAC PDU	-	-

7.1.3.9.3.3 Specific Message Contents

Table 7.1. 3.9.3.3-1: MAC-MainConfiguration {RRCCONNECTIONRECONFIGURATION (preamble)}

Derivation path: 36.508 table 4.8.2.1.5-1			
Information Element	Value/remark	Comment	Condition
MAC-MainConfiguration-RBC ::= SEQUENCE { ul-SCH-Configuration SEQUENCE { maxHARQ-Tx } }	n28		

Table 7.1.3.9.3.3-2: *RRCConnectionReconfiguration* (step 5, table 7.1.3.9.3.2-2)

Derivation Path: 36.508, Table 4.6.1-6, condition RBC-HO			
Information Element	Value/Remark	Comment	Condition
<pre> RRCConnectionReconfiguration ::= SEQUENCE { criticalExtensions CHOICE { c1 CHOICE{ rrcConnectionReconfiguration-r8 SEQUENCE { mobilityControllInformation SEQUENCE { targetCellIdentity eutra-CarrierFreq } } } } } </pre>	<p>MobilityControllInformation-HO PhysicalCellIdentity of Cell 2 (see 36.508 clause 4.4.4.2) Not present</p>		

7.1.4 UL-SCH Data Transfer

7.1.4.1 Correct handling of UL assignment / dynamic case

7.1.4.1.1 Test Purpose (TP)

(1)

```

with { UE in E-UTRA RRC_CONNECTED state }
ensure that {
  when { UE receives for a TTI an uplink grant with valid C-RNTI }
  then { UE transmits data and associated HARQ information to the HARQ entity for this TTI }
}

```

7.1.4.1.2 Conformance requirements

References: The conformance requirements covered in the present TC are specified in: 3GPP TS 36.321 clause 5.4.1.

[TS 36.321, clause 5.4.1]

In order to transmit on the UL-SCH the UE must have a valid uplink grant (except for non-adaptive HARQ retransmissions) which it may receive dynamically on the PDCCH or in a Random Access Response or which may be configured semi-persistently. To perform requested transmissions, the MAC layer receives HARQ information from lower layers.

When *timeAlignmentTimer* is running and the UE has a C-RNTI, Semi-Persistent Scheduling C-RNTI, or Temporary C-RNTI, the UE shall for each TTI :

- if an uplink grant for this TTI has been received in a Random Access Response:
 - set NDI to the value 0 and consider the NDI to have been toggled.
 - if an uplink grant for this TTI has been received on the PDCCH for the UE's C-RNTI or Temporary C-RNTI; or
- if an uplink grant for this TTI has been received in a Random Access Response:
 - if the uplink grant is for UE's C-RNTI and if either an uplink grant has been received for the UE's Semi-Persistent Scheduling C-RNTI or a configured uplink grant has occurred since the previous received uplink grant for the UE's C-RNTI for the same HARQ process:
- consider the NDI to have been toggled regardless of the value of the NDI.
- deliver the uplink grant and the associated HARQ information to the HARQ entity for this TTI.
- else, if an uplink grant for this TTI has been received on the PDCCH for the UE's Semi-Persistent C-RNTI:

- if the NDI in the received HARQ information is 1:
 - consider the NDI not to have been toggled;
 - indicate a valid uplink grant and the associated HARQ information to the HARQ entity for this TTI.

...

NOTE 1: The period of configured uplink grants is expressed in TTIs.

NOTE 2: If the UE receives both a grant for its RA-RNTI and a grant for its C-RNTI or Semi persistent scheduling C-RNTI, the UE may choose to continue with either the grant for its RA-RNTI or the grant for its C-RNTI or Semi persistent scheduling C-RNTI.

NOTE 3: When a configured uplink grant is indicated during a measurement gap and indicates an UL-SCH transmission during a measurement gap, the UE processes the grant but does not transmit on UL-SCH.

7.1.4.1.3 Test description

7.1.4.1.3.1 Pre-test conditions

System Simulator

- Cell 1

UE:

None.

Preamble:

- The UE is in state Loopback Activated (state 4) according to [18].

7.1.4.1.3.2 Test procedure sequence

Table 7.1.4.1.3.2-1: Main behaviour

St	Procedure	Message Sequence		TP	Verdict
		U - S	Message		
1	The SS ignores scheduling requests and does not allocate any uplink grant.	-	-	-	-
2	SS transmits a MAC PDU including a RLC SDU	<--	MAC PDU	1	-
3	UE transmits a Scheduling Request	→	(SR)	-	-
	EXCEPTION: Step 4 runs in parallel with behaviour in table 7.1.4.1.3.2-2				
4	For 40 ms SS transmits an UL Grant, allowing the UE to return the RLC SDU as received in step 2, on PDCCH, but with the C-RNTI different from the C-RNTI assigned to the UE. Note 1:	<--	(UL Grant (unknown C-RNTI))	-	-
5	Check: Does the UE transmit a MAC PDU corresponding to grant in step 3?	-->	MAC PDU	1	F
6	SS transmits an UL Grant, allowing the UE to return the RLC SDU as received in step 2, on PDCCH with the C-RNTI assigned to the UE.	<--	(UL Grant (C-RNTI))	-	-
7	Check: Does the UE transmit a MAC PDU corresponding to grant in step 6?	-	-	1	F
Note 1: Note 40 ms corresponding to 4 frames is selected to be sufficiently large than loop back delay and small than the dsr-TransMax[64 sub frames].					

Table 7.1.4.1.3.2-2: Parallel behaviour

St	Procedure	Message Sequence		TP	Verdict
		U - S	Message		
1	UE transmits a Scheduling Request.	-->	(SR)	-	-

7.1.4.1.3.3 Specific message contents.

Table 7.1.4.1.3.3-1: SchedulingRequest-Configuration to be used in RRCConnectionReconfiguration in preamble

Derivation Path: 36.508 clause 4.6.3-20			
Information Element	Value/remark	Comment	Condition
SchedulingRequest-Configuration ::= CHOICE {			
enable SEQUENCE {			
dsr-TransMax	n64	Max value allowed	
}			
}			

7.1.4.2 Correct handling of UL assignment / semi persistent case

7.1.4.2.1 Test Purpose (TP)

(1)

```

with { UE in E-UTRA RRC_Connected state with DRB established and sps-Configuration in UL is enabled
}
ensure that {
  when { UE receives a UL grant addressed to its stored SPS-CRNTI in SF-Num y and with NDI set as 0
  }
  then { UE starts transmitting UL MAC PDU in SF-Num y+k+n*[semiPersistSchedIntervalUL] where 'n'
is an integer [≥0], k is with a constant value of 4 for FDD, and k varies depending on UL/DL
configuration and subframe number for TDD, see Table 8-2 in TS 36.213.}
  }
}

```

(2)

```

with { UE in E-UTRA RRC_Connected state with DRB established and stored UL SPS grant to transmit MAC
PDU at SF-Num y+k+n*[semiPersistSchedIntervalUL]
}
ensure that {
  when { UE receives a UL grant addressed to its SPS-CRNTI in SF-Num-frame P and with NDI set as 0,
where p!= y+n*[semiPersistSchedIntervalUL]
  }
  then { UE starts transmitting UL MAC PDU in SF-Num p+k+n*[semiPersistSchedIntervalUL] and stops
transmitting UL MAC PDU at SF-Num y+k+n*[semiPersistSchedIntervalUL] where 'n' is an integer [≥0]
  }
}

```

(3)

```

with { UE in E-UTRA RRC_Connected state with DRB established and stored UL SPS grant to transmit MAC
PDU at SF-Num y+k+n*[semiPersistSchedIntervalUL]
}
ensure that {
  when { UE receives a UL grant [for retransmission] addressed to its SPS-CRNTI in SF-Num z and with
NDI set as 1, for the corresponding HARQ Process, where z!= y+n*[semiPersistSchedIntervalUL]
  }
  then { UE re-transmits MAC PDU in SF-Num z+k as per the new grant for SPS-CRNTI
  }
}

```

(4)

```

with { UE in E-UTRA RRC_Connected state with DRB established and stored UL SPS grant to receive MAC
PDU at SF-Num z+k+n*[semiPersistSchedIntervalUL]
}
ensure that {
  when { UE receives a UL grant addressed to its CRNTI in SF-Num p, such that in SF-Num p+k=
z+k+n*[semiPersistSchedIntervalUL]
  }
  then { UE transmits MAC PDU in SF-Num p+k as per grant addressed to its C-RNTI
  }
}

```

(5)

```

with { UE in E-UTRA RRC_Connected state with DRB established and stored UL SPS grant to receive MAC
PDU at SF-Num z+k+n*[semiPersistSchedIntervalUL]
}
ensure that {
  when { UE receives a RRCConnectionReconfiguration including sps-Configuration with sps-
ConfigurationUL set as 'disable' and hence resulting in UL SPS grant deactivation
  }
  then { UE deletes the stored sps-Configuration UL parameters and stops transmitting UL MAC
PDU's as per stored SPS grant in SF-Num z+k+n*[semiPersistSchedIntervalUL]
  }
}

```

(6)

```

with { UE in E-UTRA RRC_Connected state with DRB established and configured UL SPS grant
}
ensure that {
  when { UE transmits 'implicitReleaseAfter' MAC PDU's on SPS-Grant containing zero MAC SDU
  }
  then { UE clears configured SPS grant
  }
}

```

Note: $SF\text{-Num} = [10 * SFN + \text{subframe}] \text{ modulo } 10240$.

7.1.4.2.2 Conformance requirements

References: The conformance requirements covered in the current TC are specified in: TS 36.321 clause 5.4.1, 5.10, 5.10.2 and 36.331 clause 5.3.10.5.

[TS 36.321, clause 5.4.1]

In order to transmit on the UL-SCH the UE must have a valid uplink grant (except for non-adaptive HARQ retransmissions) which it may receive dynamically on the PDCCH or in a Random Access Response or which may be configured semi-persistently. To perform requested transmissions, the MAC layer receives HARQ information from lower layers.

When the UE has a C-RNTI, Semi-Persistent Scheduling C-RNTI, or Temporary C-RNTI, the UE shall for each TTI during which it monitors PDCCH:

- if an uplink grant for this TTI has been received on the PDCCH for the UE's C-RNTI or Temporary C-RNTI; or
- if an uplink grant for this TTI has been received in a Random Access Response:
 - if either an uplink grant has been received for the UE's Semi-Persistent Scheduling C-RNTI or a configured uplink grant has occurred since the previous received uplink grant for the UE's C-RNTI for the same HARQ process:
 - consider the NDI to have been toggled regardless of the value of the NDI.
 - deliver the uplink grant and the associated HARQ information to the HARQ entity for this TTI.
 - else, if an uplink grant for this TTI has been received on the PDCCH for the UE's Semi-Persistent C-RNTI:
 - if the NDI in the received HARQ information is 1:
 - consider the NDI not to have been toggled;
 - deliver the uplink grant and the associated HARQ information to the HARQ entity for this TTI.
 - else if the NDI in the received HARQ information is 0:
 - if PDCCH contents indicate SPS release:
 - clear the configured uplink grant (if any).
 - else:
 - store the uplink grant and the associated HARQ information as configured uplink grant;
 - initialise (if not active) or re-initialise (if already active) the configured uplink grant to start in this TTI and to recur according to rules in subclause 5.10.2;
 - consider the NDI bit to have been toggled;
 - deliver the configured uplink grant and the associated HARQ information to the HARQ entity for this TTI.
 - else, if an uplink grant for this TTI has been configured:
 - consider the NDI bit to have been toggled;
 - deliver the configured uplink grant, and the associated HARQ information to the HARQ entity for this TTI.

NOTE: The period of configured uplink grants is expressed in TTIs.

NOTE: If the UE receives both a grant for its RA-RNTI and a grant for its C-RNTI or Semi persistent scheduling C-RNTI, the UE may choose to continue with either the grant for its RA-RNTI or the grant for its C-RNTI or Semi persistent scheduling C-RNTI.

NOTE: When a configured uplink grant is indicated during a measurement gap and indicates an UL-SCH transmission during a measurement gap, the UE processes the grant but does not transmit on UL-SCH.

[TS 36.331, clause 5.3.10.5]

When Semi-Persistent Scheduling is enabled by upper layer, the following information is provided:

- Semi-Persistent Scheduling C-RNTI;
- Uplink Semi-Persistent Scheduling Interval, if Semi-Persistent Scheduling is enabled for the uplink;
- Whether [two-intervals-Semi-Persistent Scheduling] is enabled or disabled for uplink, only for TDD;
- Downlink Semi-Persistent Scheduling Interval, if Semi-Persistent Scheduling is enabled for the downlink;

When Semi-Persistent Scheduling for uplink or downlink is disabled by RRC, the corresponding configured grant or configured assignment shall be discarded.

[TS 36.321, clause 5.10.2]

After a Semi-Persistent Scheduling uplink grant is configured, the UE shall:

- if [two-intervals-Semi-Persistent Scheduling] is enabled by upper layer;
 - set the Subframe_Offset according to Table 7.4-1.
- else:
 - set Subframe_Offset to 0.
- consider that the grant recurs in each subframe for which:
 - $(10 * SFN + \text{subframe}) = [(10 * SFN_{\text{start time}} + \text{subframe}_{\text{start time}}) + N * (\text{Uplink Semi-Persistent Scheduling Interval}) + \text{Subframe_Offset} * (N \text{ modulo } 2)] \text{ modulo } 10240$, for all $N > 0$.

Where $SFN_{\text{start time}}$ and $\text{subframe}_{\text{start time}}$ are the SFN and subframe, respectively, at the time the configured uplink grant were (re-)initialised.

The UE shall clear the configured uplink grant immediately after transmitting the number of consecutive new uplink transmissions on the Semi-Persistent Scheduling resource, configured by RRC, each containing zero MAC SDU.

The UE shall:

- 1> if the received *radioResourceConfiguration* includes *sps-Configuration*:
 - 2> if *sps-Configuration* includes *sps-ConfigurationDL* and the configuration is set to 'disable':
 - 3> deactivate any downlink semi-persistent scheduling resources, if active;
 - 3> release the downlink semi-persistent scheduling configuration.
 - 2> if *sps-Configuration* includes *sps-ConfigurationUL* and the configuration is set to 'disable':
 - 3> deactivate any uplink semi-persistent scheduling resources, if active;
 - 3> release the uplink semi-persistent scheduling configuration.

7.1. 4.2.3 Test description

7.1.4.2.3.1 Pre-test conditions

System Simulator:

- Cell 1

UE:

None.

Preamble:

- The UE is in state Loopback Activated (state 4) according to [18].
- The loop back size is set in such a way that one RLC SDU in DL shall result in 1 RLC SDU's in UL of same size.

7.1.4.2.3.2 Test procedure sequence

Table 7.1.4.2.3.2-1: Main behaviour

St	Procedure	Message Sequence		TP	Verdict
		U - S	Message		
1	The SS transmits a DL MAC PDU containing 9 RLC SDU's	<--	MAC PDU	-	-
2	The UE transmits a Scheduling Request, indicating that loop back PDUs are ready for transmission in UL RLC	-->	(SR)	-	-
3	The SS transmits an UL Grant using UE's SPS C-RNTI in SF-Num 'Y', NDI=0, allowing the UE to transmit one loop back PDU per MAC PDU.	<--	(UL SPS Grant)	-	-
4	Check: Does the UE transmit a MAC PDU in SF-Num 'Y+k'?	-->	MAC PDU	1	P
5	The SS transmits a HARQ ACK	<--	HARQ ACK	-	-
6	Check: does The UE transmit a MAC PDU in SF-Num 'Y+k+X semiPersistSchedIntervalUL'?	-->	MAC PDU	1	P
7	The SS transmits a HARQ ACK	<--	HARQ ACK	-	-
8	The SS Transmits an UL Grant using UE's SPS C-RNTI in SF-Num 'P', NDI=0, where $Y+X < P < Y+2X$, and allowing the UE to transmit two loop back PDUs per MAC PDU.	<--	(UL SPS Grant)	-	-
9	Check: Does the UE transmit a MAC PDU in SF-Num 'P+k' as per grant in step 8?	-->	MAC PDU	2	P
10	The SS transmits a HARQ ACK	<--	HARQ ACK	-	-
11	Check: does the UE transmit a MAC PDU in SF-Num 'Y+k+2X'?	-->	MAC PDU	2	F
12	Check: Does the UE transmit a MAC PDU in SF-Num 'P+k+X semiPersistSchedIntervalUL' as per grant in step 8?	-->	MAC PDU	2,3	P
13	The SS transmits a HARQ ACK	<--	HARQ ACK	-	-
14	The SS Transmits an UL Grant using UE's SPS C-RNTI in SF-Num 'Z', NDI=1, where $P < Z < P+1X$; the UL HARQ process is the same as in step 12	<--	(UL SPS Grant)	-	-
15	Check: Does the UE transmit in SF-Num 'Z+k' a MAC PDU as in step 12?	-->	MAC PDU	3	P
16	The SS transmits a HARQ ACK	<--	HARQ ACK	3	-
17	Check: Does the UE transmit a MAC PDU in SF-Num 'P+k+2X semiPersistSchedIntervalUL' as per grant in step 8?	-->	MAC PDU	1	P
18	The SS transmits a HARQ ACK	<--	HARQ ACK	-	-
19	The SS Transmits a UL Grant using UE's C-RNTI in SF-Num 'P+3X semiPersistSchedIntervalUL'; allowing UE to transmit MAC PDU containing two RLC SDU	<--	(UL Grant)	-	-
20	Check: Does the UE transmit a MAC PDU in SF-Num 'P+k+3X semiPersistSchedIntervalUL' as per grant in step 19?	-->	MAC PDU	4	P
21	The SS transmits a HARQ ACK	<--	HARQ ACK	-	-
22	Check: Does the UE transmit a MAC PDU in SF-Num 'P+k+4X semiPersistSchedIntervalUL' containing zero MAC SDU	-->	MAC PDU	1	P
23	The SS transmits a HARQ ACK	<--	HARQ ACK	-	-
24	Check: Does the UE transmit a MAC PDU in SF-Num 'P+k+5X semiPersistSchedIntervalUL' containing zero MAC SDU	-->	MAC PDU	1	P
25	The SS transmits a HARQ ACK	<--	HARQ ACK	-	-
26	Check: Does the UE transmit a MAC PDU in SF-Num 'P+k+6X semiPersistSchedIntervalUL'	-->	MAC PDU	6	F
27	The SS Transmits an UL Grant using UE's SPS C-RNTI in SF-Num 'Q', NDI=0, transmit one loop back PDUs per MAC PDU.	<--	(UL SPS Grant)	-	-
28	Check: Does the UE transmit a MAC PDU in	-->	MAC PDU	1	P

	SF-Num 'Q+k' containing zero MAC SDU				
29	SS Transmits <i>RRConnectionReconfiguration</i> to disable SPS-ConfigurationUL.	-	-	-	-
30	The UE transmits <i>RRConnectionReconfigurationComplete</i>	-	-	-	-
31	The SS transmits DL MAC PDU containing 1 RLC SDU's	<--	MAC PDU	-	-
32	The UE transmits Scheduling request, indicating loop back PDU's ready for transmission in UL RLC	-->	(SR)	-	-
33	Check :does the UE transmit a MAC PDU in SF-Num 'Y+k+nX semiPersistSchedIntervalUL' as per grant in step 8?	-->	MAC PDU	5	F
34	SS transmits an UL Grant	<--	(UL Grant)	-	-
35	The UE transmits MAC PDU as per grant in step 34.	-->	MAC PDU	-	-

NOTE 1: For TDD, the subframe number for 'Y', 'P', and 'Z' should be selected from {'1', '4', '6'} respectively based on TDD configuration 1.

Table 7.1.4.2.3.2-2: k value for TDD configuration 1 given UL grant in certain DL subframe

TDD UL/DL Configuration	DL subframe number <i>n</i>									
	0	1	2	3	4	5	6	7	8	9
1		6			4		6			4

NOTE 1: For the k value for all configurations see Table 8-2 in TS 36.213. The table here only provide k value for TDD configuration 1.

7.1.4.2.3.3 Specific message contents

Table 7.1.3.2.4.3-1: *RRConnectionReconfiguration*. RadioResourceConfigDedicated (Preamble)

Derivation path: 36.508 table 4.6.3-16			
Information Element	Value/remark	Comment	Condition
RadioResourceConfigDedicated ::= SEQUENCE {			
sps-Configuration ::= SEQUENCE {			
semiPersistSchedC-RNTI	'FFF0'H		
sps-ConfigurationDL	Not Present		
sps-ConfigurationUL ::= CHOICE {			
enable SEQUENCE {			
semiPersistSchedIntervalUL	sf160	160 Subframe	
implicitReleaseAfter	e2		
p0-Persistent	Not Present		
}			
}			
}			
}			

Table 7.1.3.2.4.3-1: RRCConnectionReconfiguration. RadioResourceConfigDedicated (step 29 of table 7.1.3.2.3.2-1)

Derivation path: 36.508 table 4.6.3-16			
Information Element	Value/remark	Comment	Condition
RadioResourceConfigDedicated ::= SEQUENCE {			
sps-Configuration ::= SEQUENCE {			
semiPersistSchedC-RNTI	Not Present		
sps-ConfigurationDL	Not Present		
sps-ConfigurationUL ::= CHOICE {			
disable	NULL		
}			
}			
}			

7.1.4.3 Logical channel prioritization handling

7.1.4.3.1 Test Purpose (TP)

(1)

```
with {UE in E-UTRA RRC_CONNECTED state}
ensure that {
  when { sending data on the uplink }
  then { UE serves the logical channels according to their priority and configured PBR }
}
```

7.1.4.3.2 Conformance requirements

References: The conformance requirements covered in the present TC are specified in: 3GPP TS 36.321 clauses 5.4.3.1.

[TS 36.321, clause 5.4.3.1]

The Logical Channel Prioritization procedure is applied when a new transmission is performed.

RRC can control the scheduling of uplink data by giving each logical channel a priority where increasing priority values indicate lower priority levels. In addition, each logical channel is given a Prioritized Bit Rate (PBR).

The UE shall maintain a variable B_j for each logical channel j . B_j shall be initialized to zero, and incremented by PBR of the logical channel j for each TTI. However, the value of B_j can never exceed the bucket size and if the value of B_j is larger than the bucket size of logical channel j , it shall be set to the bucket size.

The UE shall perform the following Logical Channel Prioritization procedure when a new transmission is performed:

- The UE shall allocate resources to the logical channels in the following steps:
 - Step 1: All the logical channels with $B_j > 0$ are allocated resources in a decreasing priority order. If the PBR of a radio bearer is set to “infinity”, the UE shall allocate resources for all the data that is available for transmission on the radio bearer before meeting the PBR of the lower priority radio bearer(s);
 - Step 2: the UE shall decrement B_j by the amount of data served to logical channel j in Step 1

NOTE: The value of B_j can be negative.

- Step 3: if any resources remain, all the logical channels are served in a strict decreasing priority order (regardless of the value of B_j) until either the data for that logical channel or the UL grant is exhausted, whichever comes first.
- The UE shall also follow the rules below during the scheduling procedures above:
 - the UE should not segment an RLC SDU (or partially transmitted SDU or retransmitted RLC PDU) if the whole SDU (or partially transmitted SDU or retransmitted RLC PDU) fits into the remaining resources;
 - if the UE segments an RLC SDU from the logical channel, it shall maximize the size of the segment to fill the grant as much as possible;

- UE should maximise the transmission of data.

Logical channels configured with the same priority shall be served equally the by UE.

MAC control elements for BSR, with exception of Padding BSR, have higher priority than U-plane Logical Channels.

At serving cell change, the first UL-DCCH MAC SDU to be transmitted in the new cell has higher priority than MAC control elements for BSR.

7.1.4.3.3 Test description

7.1.4.3.3.1 Pre-test conditions

System Simulator:

- Cell 1

UE:

None

Preamble:

- The UE is in state Loopback Activated (state 4) according to [18].
- 3 DRBs are configured according to table 7.1.4.3.3.1-1.

Table 7.1.4.3.3.1-1: Priority, PBR and Bucket Delay settings

DRB	priority	prioritizedBitRate (kbytes/s)	bucketSizeDuration (ms)
DRB1	6	8	100
DRB2	7	16	100
DRB3	8	32	100

7.1.4.3.3.2 Test procedure sequence

Table 7.1.4.3.3.2-1: Main behaviour

St	Procedure	Message Sequence		TP	Verdict
		U - S	Message		
1	The SS transmits N1 320-octet RLC SDUs on DRB1, N2 320-octet RLC SDUs on DRB2, and N3 320-octet RLC SDUs on DRB3.	<--	(RLC SDUs)	-	-
	EXCEPTION: the steps 2 to 4 are run 4 times using the parameters specified for each run in table 7.1.4.3.3.2-3. In addition, for each run, step 2 is run in parallel with the behaviour specified in table 7.1.4.3.3.2-2.				
2	For a duration of T2, the SS transmits an UL grant of D octets every T1.	<--	(UL grants)	-	-
3	Check: are the total number of octets of the UL RLC SDUs received at the SS for each DRB as follows?: - the total number of octets received for DRB1 is D1 octets +/- 10% - the total number of octets received for DRB2 is D2 octets +/- 10% - the total number of octets received for DRB3 is D3 octets +/- 10%	-	-	1	P
4	The SS re-establish the RLC for each RB at the UE.	-	-	-	-

Table 7.1.4.3.3.2-2: Parallel behaviour

St	Procedure	Message Sequence		TP	Verdict
		U - S	Message		
1	The UE sends the RLC SDUs back to the SS.	-->	-	-	-

Table 7.1.4.3.3.2-3: Test parameter values

Parameter	First run	Second run	Third run	Fourth run
N1 (SDUs)	13	13	7	104
N2 (SDUs)	25	25	50	25
N3 (SDUs)	50	50	50	50
D (octets)	1143	573	1143	2292
T1 (ms)	20	20	20	20
T2 (ms)	500	500	500	500
D1 (octets)	4160	4160	2240	33280
D2 (octets)	8000	7680	10975	8000
D3 (octets)	16000	2485	15360	16000

Editor's note: the numbers above and the test procedure assume that the UE has a loopback buffer of at least 57280 octets.

7.1.4.3.3.3 Specific message contents

None.

7.1.4.4 Correct Handling of MAC control information [Scheduling Requests/ PUCCH]

7.1.4.4.1 Test Purpose (TP)

(1)

```
with (UE in E-UTRA RRC_CONNECTED state)
  ensure that {
    when { PUCCH Configured and UE has UL data in transmission buffer and UE has no UL-SCH resources
available and SR_COUNTER is less than SR_TRANS_MAX}
      then { the UE transmits a SR on PUCCH at every TTI until resources are granted }
  }
```

7.1.4.4.2 Conformance requirements

References: The conformance requirements covered in the current TC are specified in: TS 36.321, clause 5.4.4.

[TS 36.321 clause 5.4.4]

The Scheduling Request (SR) is used for requesting UL-SCH resources for new transmission.

When an SR is triggered, it shall be considered as pending until it is cancelled.

If an SR is triggered and there is no other SR pending, the UE shall set the SR_COUNTER to 0.

As long as one SR is pending, the UE shall for each TTI:

- if no UL-SCH resources are available for a transmission in this TTI:
 - if the UE has no valid PUCCH resource for SR configured in any TTI: initiate a Random Access procedure (see subclause 5.1) and cancel all pending SRs;
 - else if the UE has a valid PUCCH resource for SR configured for this TTI and if this TTI is not part of a measurement gap:
 - if SR_COUNTER < *dss-TransMax*:
 - increment SR_COUNTER by 1;

- instruct the physical layer to signal the SR on PUCCH;
- else:
 - notify RRC to release PUCCH/SRS;
 - clear any configured downlink assignments and uplink grants;
 - initiate a Random Access procedure (see subclause 5.1) and cancel all pending SRs.
- else if UL-SCH resources for new transmission are granted in this TTI, cancel all pending SR(s).

7.1.4.4.3.1 Pre-test conditions

System Simulator

- Cell 1

UE:

None.

Preamble

- The UE is in state Loopback Activated (state 4) according to [18].

7.1.4.4.3.2 Test procedure sequence

Table 7.1.4.4.3.2-1: Main behaviour

St	Procedure	Message Sequence		TP	Verdict
		U - S	Message		
1	The SS transmits a MAC PDU containing 10 MAC SDUs each containing a RLC SDU	<--	MAC PDU (containing 10 MAC SDUs)		
-	EXCEPTION: Step 2 shall be repeated for N TTIs. Step 2 runs in parallel with behaviour in table 7.1.4.4.3.2-2. (Note 1)	-	-	-	-
2	Check: does the UE transmit a Scheduling Request on PUCCH at this TTI? (Note 2)	-->	(SR)	1	P
3	The SS transmits UL grant to allocate UL-SCH resources that are enough to transmit MAC PDU containing 10 MAC SDUs	<--	(UL Grant)	-	-
4	Check: Does the UE transmit a MAC PDU containing 10 RLC PDUs?	-->	MAC PDU (containing 10 MAC SDUs)	1	P
Note 1: The value of N shall be between 30 to 40. The reason for not specifying an explicit value is to avoid unnecessary complexity of the test case implementation covering the FDD and TDD case. Note 2: The UE repeats the scheduling requests as long as SR_COUNTER < SR_TRANS_MAX and there is data in the transmission buffer and there are no resources available to transmit it.					

Table 7.1.4.4.3.2-2: Parallel behaviour

St	Procedure	Message Sequence		TP	Verdict
		U - S	Message		
1	Check: Does the UE transmit a MAC PDU?	-->	MAC PDU	1	F

7.1.4.4.3.3 Specific Message Contents

Table 7.1.4.4.3.3-1: SchedulingRequest-Configuration to be used in RRCConnectionReconfiguration in preamble

Derivation Path: 36.508 clause 4.6.3-20			
Information Element	Value/remark	Comment	Condition
SchedulingRequest-Configuration ::= CHOICE {			
enable SEQUENCE {			
dsr-TransMax	n64		
}			
}			

7.1.4.5 Correct Handling of MAC control information [Scheduling Requests/Random Access Procedure]

7.1.4.5.1 Test Purpose (TP)

(1)

```
with { UE is in E-UTRA RRC_CONNECTED state, no PUCCH for SR is configured }
  ensure that {
    when { UE receives a MAC PDU with a Timing Advance control element and UL data in transmission
buffer and no UL-SCH resources available }
      then { the UE initiates the random access procedure }
  }
```

(2)

```
with (UE in E-UTRA RRC_CONNECTED state)
  ensure that {
    when { PUCCH Configured and UE has UL data in transmission buffer and UE has no UL-SCH resources
available and SR_COUNTER becomes equal to SR_TRANS_MAX }
      then { the UE transmits a PRACH Preamble to initiate a Random Access procedure }
  }
```

7.1.4.5.2 Conformance requirements

References: The conformance requirements covered in the current TC are specified in: TS 36.321 , clause 5.4.4.

[TS 36.321 clause 5.4.4]

The Scheduling Request (SR) is used for requesting UL-SCH resources for new transmission.

When an SR is triggered, it shall be considered as pending until it is cancelled.

If an SR is triggered and there is no other SR pending, the UE shall set the SR_COUNTER to 0.

As long as one SR is pending, the UE shall for each TTI:

- if no UL-SCH resources are available for a transmission in this TTI:
 - if the UE has no valid PUCCH resource for SR configured in any TTI: initiate a Random Access procedure (see subclause 5.1) and cancel all pending SRs;
 - else if the UE has a valid PUCCH resource for SR configured for this TTI and if this TTI is not part of a measurement gap:
 - if SR_COUNTER < dsr-TransMax:
 - increment SR_COUNTER by 1;
 - instruct the physical layer to signal the SR on PUCCH;
 - else:
 - notify RRC to release PUCCH/SRS;

- clear any configured downlink assignments and uplink grants;
- initiate a Random Access procedure (see subclause 5.1) and cancel all pending SRs.
- else if UL-SCH resources for new transmission are granted in this TTI, cancel all pending SR(s).

7.1.4.5.3.1 Pre-test conditions

System Simulator

- Cell 1

UE

None.

Preamble

- The UE is in state Loopback Activated (state 4) according to [18].

7.1.4.5.3.2 Test procedure sequence

Table 7.1.4.5.3.2-1: Main behaviour

St	Procedure	Message Sequence		TP	Verdict
		U - S	Message		
1	The SS transmits a MAC PDU containing a MAC SDU and a Timing Advance MAC Control Element, but do not send any subsequent alignments.	<--	MAC PDU (Timing Advance Command, MAC SDU)	-	-
-	EXCEPTION: Step 2 runs in parallel with behaviour in table 7.1.4.4.3.2-2	-	-	-	-
2	Check: does the UE transmit a preamble on PRACH? (Note 1)	-->	(PRACH Preamble)	1	P
3	The SS transmits a Random Access Response including an UL grant to enable UE to transmit C-RNTI MAC Control Element and the RLC SDU as received in step 1.	<--	Random Access Response	-	-
4	Check: does the UE transmit a MAC PDU including a C-RNTI MAC Control Element and a MAC SDU? (Note 2)	-->	MAC PDU (C-RNTI control element, MAC SDU)	1	P
5	The UE transmits a MAC PDU including a UE Contention Resolution control element)	<--	MAC PDU (UE Contention Resolution Identity)	-	-
6	The SS ignores any Scheduling Requests from the UE.	-	-	-	-
7	The SS transmits a MAC PDU containing one MAC SDU containing a RLC SDU	<--	MAC PDU (MAC SDU)	-	-
-	EXCEPTION: Step 8 shall be repeated for 64 TTIs. Step 8 runs in parallel with behaviour in table 7.1.4.5.3.2-2.	-	-	-	-
8	UE transmit a Scheduling Request on PUCCH (Note 3)	-->	(SR)	-	-
9	Check: does the UE transmit a preamble on PRACH? (Note 4)	-->	(PRACH Preamble)	2	P
Note 1	When UL time alignment timer expires in the UE then "UL synchronization" is lost and the UE initiates a Random Access Procedure.				
Note 2	The UE transmission of the MAC PDU ensures that the random access procedure was successful.				
Note 3:	The UE repeats the scheduling requests as long as SR_COUNTER < SR_TRANS_MAX and there is data in the transmission buffer and there are no resources available to transmit it.				
Note 4:	Reception of PRACH Preamble by the SS verifies that UE has initiated a Random Access procedure triggered by SR_COUNTER having reached SR_TRANS_MAX.				

Table 7.1.4.5.3.2-2: Parallel behaviour

St	Procedure	Message Sequence		TP	Verdict
		U - S	Message		
1	UE may transmit a Scheduling Request before timing alignment timer expires. SS shall not respond to the Scheduling Grant.	-->	(SR)	-	-

Table 7.1.4.5.3.2-2: Parallel behaviour

St	Procedure	Message Sequence		TP	Verdict
		U - S	Message		
1	Check: Does the UE transmit a MAC PDU?	-->	MAC PDU	1	F

7.1.4.5.3.3 Specific Message Contents

Table 7.1.4.5.3.3-1: SchedulingRequest-Configuration to be used in RRCConnectionReconfiguration in preamble

Derivation Path: 36.508 clause 4.6.3-20			
Information Element	Value/remark	Comment	Condition
SchedulingRequest-Configuration ::= CHOICE {			
enable SEQUENCE {			
dsr-TransMax	n64		
}			
}			

7.1.4.6 Correct Handling of MAC control information [Buffer Status/ UL data arrives in the UE Tx buffer and retransmission of BSR / Regular BSR]

7.1.4.6.1 Test Purpose (TP)

(1)

```
with (UE in E-UTRA RRC_CONNECTED state)
  ensure that {
    when{ UL data arrives in the UE transmission buffer and the data belongs to a logical channel
with higher priority than those for which data is already available for transmission and the new
logical channel and the existing logical channels belongs to the different LCG}
    then { UE Reports a Long Buffer Status Reporting (BSR)}
  }
```

(2)

```
with (UE in E-UTRA RRC_CONNECTED state)
  ensure that {
    when{ UL data arrives in the UE transmission buffer and there is no data available for
transmission for any of the logical channels which belong to a LCG}
    then { UE Reports a Short Buffer Status Reporting (BSR)}
  }
```

(3)

```
with (UE in E-UTRA RRC_CONNECTED state)
  ensure that {
    when{ UL data arrives in the UE transmission buffer and the data belongs to a logical channel
with higher priority than those for which data is already available for transmission and the new
logical channel and existing logical channels belong to the same LCG}
    then { UE Reports a Short Buffer Status Reporting (BSR)}
  }
```

(4)

```
with (UE in E-UTRA RRC_CONNECTED state)
  ensure that {
    when{ RETX_BSR_TIMER expires and only one LCG has data available for transmission }
    then { UE triggers a regular BSR and Reports a Short Buffer Status Reporting (BSR)}
  }
```

(5)

```

with (UE in E-UTRA RRC_CONNECTED state)
  ensure that {
    when { a Regular BSR has been triggered and UE has pending data for transmission and UE has only
resources to send either BSR report or data}
      then { UE transmits the BSR report}
    }

```

(6)

```

with (UE in E-UTRA RRC_CONNECTED state)
  ensure that {
    when{ UE determines that a BSR has been triggered since the last transmission of a BSR and UE has
no UL resources allocated for new transmission for this TTI}
      then { UE transmits a scheduling request}
    }

```

7.1.4.6.2 Conformance requirements

References: The conformance requirements covered in the current TC are specified in: TS 36.321, clause 5.4.3.1, 5.4.5, 6.1.2, 6.1.3.1 and 6.2.1 and in TS 36.323 clause 4.5.

[TS 36.321 clause 5.4.3.1]

For the Logical Channel Prioritization procedure, the UE shall take into account the following relative priority in decreasing order:

- MAC control element for C-RNTI or data from UL-CCCH;
- MAC control element for BSR, with exception of BSR included for padding;
- MAC control element for PHR;
- data from any Logical Channel, except data from UL-CCCH;
- MAC control element for BSR included for padding.

[TS 36.321 clause 5.4.4]

The Scheduling Request (SR) is used for requesting UL-SCH resources for new transmission.

[TS 36.321 clause 5.4.5]

The Buffer Status reporting procedure is used to provide the serving eNB with information about the amount of data available for transmission in the UL buffers of the UE. RRC controls BSR reporting by configuring the two timers *periodicBSR-Timer* and *retxBSR-Timer* and by, for each logical channel, optionally signalling *logicalChannelGroup* which allocates the logical channel to an LCG [8].

For the Buffer Status reporting procedure, the UE shall consider all radio bearers which are not suspended and may consider radio bearers which are suspended.

A Buffer Status Report (BSR) shall be triggered if any of the following events occur:

- UL data, for a logical channel which belongs to a LCG, becomes available for transmission in the RLC entity or in the PDCP entity (the definition of what data shall be considered as available for transmission is specified in [3] and [4] respectively) and either the data belongs to a logical channel with higher priority than the priorities of the logical channels which belong to any LCG and for which data is already available for transmission, or there is no data available for transmission for any of the logical channels which belong to a LCG, in which case the BSR is referred below to as "Regular BSR";
- UL resources are allocated and number of padding bits is equal to or larger than the size of the Buffer Status Report MAC control element plus its subheader, in which case the BSR is referred below to as "Padding BSR";
- *retxBSR-Timer* expires and the UE has data available for transmission for any of the logical channels which belong to a LCG, in which case the BSR is referred below to as "Regular BSR";
- *periodicBSR-Timer* expires, in which case the BSR is referred below to as "Periodic BSR".

For Regular and Periodic BSR:

- if more than one LCG has data available for transmission in the TTI where the BSR is transmitted: report Long BSR;
- else report Short BSR.

For Padding BSR:

- if the number of padding bits is equal to or larger than the size of the Short BSR plus its subheader but smaller than the size of the Long BSR plus its subheader:
 - if more than one LCG has data available for transmission in the TTI where the BSR is transmitted: report Truncated BSR of the LCG with the highest priority logical channel with data available for transmission;
 - else report Short BSR.
- else if the number of padding bits is equal to or larger than the size of the Long BSR plus its subheader, report Long BSR.

If the Buffer Status reporting procedure determines that at least one BSR has been triggered since the last transmission of a BSR or if this is the first time that at least one BSR is triggered:

- if the UE has UL resources allocated for new transmission for this TTI:
 - instruct the Multiplexing and Assembly procedure to generate a BSR MAC control element;
 - start or restart *periodicBSR-Timer* except when the BSR is a Truncated BSR;
 - start or restart *retxBSR-Timer*.
- else if a Regular BSR has been triggered:
 - a Scheduling Request shall be triggered.

A MAC PDU shall contain at most one MAC BSR control element, even when multiple events trigger a BSR by the time a BSR can be transmitted in which case the Regular BSR and the Periodic BSR shall have precedence over the padding BSR.

The UE shall restart *retxBSR-Timer* upon reception of a grant for transmission of new data on UL-SCH.

All triggered BSRs shall be cancelled in case the UL grant can accommodate all pending data available for transmission but is not sufficient to additionally accommodate the BSR MAC control element plus its subheader. All triggered BSRs shall be cancelled when a BSR is included in a MAC PDU for transmission.

[TS 36.321 clause 6.1.2]

MAC control elements are always placed before any MAC SDU.

[TS 36.321 clause 6.1.3.1]

Buffer Status Report (BSR) MAC control elements consist of either:

- Short BSR and Truncated BSR format: one LCG ID field and one corresponding Buffer Size field (figure 6.1.3.1-1); or
- Long BSR format: four Buffer Size fields, corresponding to LCG IDs #0 through #3 (figure 6.1.3.1-2).

The BSR formats are identified by MAC PDU subheaders with LCIDs as specified in table 6.2.1.-1.

The fields LCG ID and Buffer Size are defined as follow:

- LCG ID: The Logical Channel Group ID field identifies the group of logical channel(s) which buffer status is being reported. The length of the field is 2 bits;
- Buffer Size: The Buffer Size field identifies the total amount of data available across all logical channels of a logical channel group after the MAC PDU has been built. The amount of data is indicated in number of bytes. It shall include all data that is available for transmission in the RLC layer and in the PDCP layer; the definition of

what data shall be considered as available for transmission is specified in [3] and [4] respectively. The size of the RLC and MAC headers are not considered in the buffer size computation. The length of this field is 6 bits. The values taken by the Buffer Size field are shown in Table 6.1.3.1-1.

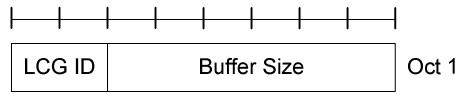

Figure 6.1.3.1-1: Short BSR and Truncated BSR MAC control element

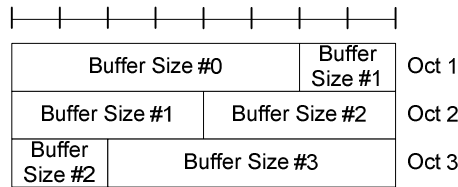

Figure 6.1.3.1-2: Long BSR MAC control element

Table 6.1.3.1-1: Buffer size levels for BSR

Index	Buffer Size (BS) value [bytes]	Index	Buffer Size (BS) value [bytes]
0	BS = 0	32	1132 < BS <= 1326
1	0 < BS <= 10	33	1326 < BS <= 1552
2	10 < BS <= 12	34	1552 < BS <= 1817
3	12 < BS <= 14	35	1817 < BS <= 2127
4	14 < BS <= 17	36	2127 < BS <= 2490
5	17 < BS <= 19	37	2490 < BS <= 2915
6	19 < BS <= 22	38	2915 < BS <= 3413
7	22 < BS <= 26	39	3413 < BS <= 3995
8	26 < BS <= 31	40	3995 < BS <= 4677
9	31 < BS <= 36	41	4677 < BS <= 5476
10	36 < BS <= 42	42	5476 < BS <= 6411
11	42 < BS <= 49	43	6411 < BS <= 7505
12	49 < BS <= 57	44	7505 < BS <= 8787
13	57 < BS <= 67	45	8787 < BS <= 10287
14	67 < BS <= 78	46	10287 < BS <= 12043
15	78 < BS <= 91	47	12043 < BS <= 14099
16	91 < BS <= 107	48	14099 < BS <= 16507
17	107 < BS <= 125	49	16507 < BS <= 19325
18	125 < BS <= 146	50	19325 < BS <= 22624
19	146 < BS <= 171	51	22624 < BS <= 26487
20	171 < BS <= 200	52	26487 < BS <= 31009
21	200 < BS <= 234	53	31009 < BS <= 36304
22	234 < BS <= 274	54	36304 < BS <= 42502
23	274 < BS <= 321	55	42502 < BS <= 49759
24	321 < BS <= 376	56	49759 < BS <= 58255
25	376 < BS <= 440	57	58255 < BS <= 68201
26	440 < BS <= 515	58	68201 < BS <= 79846
27	515 < BS <= 603	59	79846 < BS <= 93479
28	603 < BS <= 706	60	93479 < BS <= 109439
29	706 < BS <= 826	61	109439 < BS <= 128125
30	826 < BS <= 967	62	128125 < BS <= 150000
31	967 < BS <= 1132	63	BS > 150000

[TS 36.321 clause 6.2.1]

Table 6.2.1-2: Values of LCID for UL-SCH

Index	LCID values
00000	CCCH
00001-01010	Identity of the logical channel
01011-11001	Reserved
11010	Power Headroom Report
11011	C-RNTI
11100	Truncated BSR
11101	Short BSR
11110	Long BSR
11111	Padding

[TS 36.323 clause 4.5]

For the purpose of MAC buffer status reporting, the UE shall consider the following as data available for transmission in the PDCP layer:

For SDUs for which no PDU has been submitted to lower layers:

- the SDU itself, if the SDU has not yet been processed by PDCP, or
- the PDU (control or data) if the SDU has been processed by PDCP.

7.1.4.6.3 Test description

7.1.4.6.3.1 Pre-test conditions

System Simulator :

- Cell 1

UE:

None.

Preamble :

- The UE is in state Loopback Activated (state 4) according to [18].
- 3 AM DRBS are configured with the following parameters:

Table 7.1.4.6.3.1-1: Logical Channel Configuration Settings

Parameter	Value DRB1	Value DRB1	Value DRB1
LogicalChannel-Identity	3	4	5
Priority	8	7	6
prioritizedBitRate	0 kB/s	0 kB/s	0 kB/s
logicalChannelGroup	2 (LCG ID#3)	2 (LCG ID#3)	1 (LCG ID#2)
retr_BSR_Timer	320 SF		

7.1.4.6.3.2 Test procedure sequence

Table 7.1.4.6.3.2-1: Main behaviour

St	Procedure	Message Sequence		TP	Verdict
		U - S	Message		
1	The SS ignores scheduling requests and does not allocate any uplink grant.	-	-	-	-
2	The SS transmits a MAC PDU containing two RLC SDUs of size 10 bytes on LC 3	<--	MAC PDU (2 RLC SDUs on LC 3)	-	-
3	SS allocates an UL Grant of 32 bits. (Note 1)	<--	(UL Grant, 32 bits)	-	-
4	Check: Does the UE transmit a Short BSR with 'LCG ID' field set to '3' and 'Buffer size' field set to value '6' or bigger? (Note 2)	-->	MAC PDU (MAC Short BSR (LCG ID='3', Buffer Size='6' or bigger))	2,5	P
5	Wait for Retr-BSR-Timer expire on UE side.	-	-	-	-
6	Check: Does the UE transmit a scheduling request?	-->	(SR)	6	P
7	SS respond to the scheduling request in step 6 by an UL Grant of 32 bits. (Note 1)	<--	(UL Grant, 32 bits)	-	-
8	Check: Does the UE transmit a Short BSR with 'LCG ID' field set to '3' and 'Buffer size' field set to value '6' or bigger? (Note 2)	-->	MAC PDU (MAC Short BSR (LCG ID='3', Buffer Size='6' or bigger))	4,5	P
9	The SS transmits a MAC PDU containing one RLC SDUs of size 10 bytes on LC 4	<--	MAC PDU (1 RLC SDUs on LC 4)	-	-
10	Check: Does the UE transmit a scheduling request?	-->	(SR)	6	P
11	SS respond to the scheduling request in step 10 by an UL Grant of 32 bits. (Note 1)	<--	(UL Grant, 32 bits)	-	-
12	Check: Does the UE transmit a Short BSR with 'LCG ID' field set to '3' and 'Buffer size#1' field set to value '8' or bigger? (Note 2)	-->	MAC PDU (MAC Short BSR (LCG ID='3', Buffer Size='8' or bigger))	3,5	P
13	The SS transmits a MAC PDU containing two RLC SDUs of size 2 bytes on LC 5	<--	MAC PDU (2 RLC SDUs on LC 5)	-	-
14	Check: Does the UE transmit a scheduling request?	-->	(SR)	6	P
15	SS respond to the scheduling request in step 14 by one UL Grant of 32 bits. (Note 2)	<--	(UL Grant, 32 bits)	-	-
16	Check: Does the UE transmit a Long BSR with 'Buffer size#2' field set to value '1', 'Buffer size#3' field set to value '8' or bigger? (Note 2)	-->	MAC PDU (MAC Long BSR (Buffer size#2='1' or bigger, Buffer size#3='8' or bigger))	1,5	P
Note 1	32 bits enables UE to transmit a MAC PDU with a MAC BSR header and a Short BSR (1 bytes) or a Long BSR (3 byte).				
Note 2	UE triggers a Short BSR of type "Regular BSR" to report buffer status for one LCG for that TTI. The UE should not send any of the received RLC SDUs (segmented) due to Regular BSR has higher priority than U-plane logical channels.				
Note 3	UE triggers and transmit a Long BSR of type "Regular BSR". The UL grant would be enough for UE to transmit one RLC SDU as received in step 8, but Regular BSR has higher priority than U-plane logical channels.				

7.1.4.6.3.3 Specific Message Contents

None.

7.1.4.7 Correct Handling of MAC control information [Buffer Status/ UL resources are allocated/ Padding BSR]

7.1.4.7.1 Test Purpose (TP)

(1)

```

with (UE in E-UTRA RRC_CONNECTED state =
ensure that {
  when { UE transmits a MAC PDU and the number of padding bits are larger than the Size of a Short
BSR plus its subheader, but less than the size of a Long BSR plus its subheader and the UE has
buffered data from more than one LCG in the TTI where the BSR is transmitted }

```

```

    then { UE Reports a Truncated BSR with LCG containing highest LC priority }
  }

```

(2)

```

with (UE in E-UTRA RRC_CONNECTED state)
ensure that {
  when { UE transmits a MAC PDU and the number of padding bits are larger than the Size of a Short
BSR plus its subheader, but less than the size of a Long BSR plus its subheader and the UE has
buffered data for only one LCG in the TTI where the BSR is transmitted }
  then { UE Reports a Short BSR indicating the LCG with buffered data }
}

```

(3)

```

with (UE in E-UTRA RRC_CONNECTED state )
ensure that {
  when{ UE transmits a MAC PDU and the number of padding bits are larger than the Size of a Long BSR
plus its subheader }
  then { UE Reports a long BSR }
}

```

7.1.4.7.2 Conformance requirements

References: The conformance requirements covered in the current TC are specified in: TS 36.321, clause 5.4.5, 6.1.2, 6.1.3.1 and 6.2.1 and in TS 36.323 V8.2.1 clause 4.5.

[[TS 36.321 clause 5.4.3.1]

...

For the Logical Channel Prioritization procedure, the UE shall take into account the following relative priority in decreasing order:

- MAC control element for C-RNTI or data from UL-CCCH;
- MAC control element for BSR, with exception of BSR included for padding;
- MAC control element for PHR;
- data from any Logical Channel, except data from UL-CCCH;
- MAC control element for BSR included for padding.

TS 36.321 clause 5.4.5]

The Buffer Status reporting procedure is used to provide the serving eNB with information about the amount of data available for transmission in the UL buffers of the UE.

For the Buffer Status reporting procedure, the UE shall consider all radio bearers which are not suspended and may consider radio bearers which are suspended. RRC controls BSR reporting by configuring the two timers *periodicBSR-Timer* and *retxBSR-Timer* and by, for each logical channel, optionally signalling *logicalChannelGroup* which allocates the logical channel to an LCG [8].

A Buffer Status Report (BSR) shall be triggered if any of the following events occur:

...

- UL resources are allocated and number of padding bits is equal to or larger than the size of the Buffer Status Report MAC control element plus its subheader, in which case the BSR is referred below to as "Padding BSR";

...

For padding BSR:

- if the number of padding bits is equal to or larger than the size of the Short BSR plus its sub header but smaller than the size of the Long BSR plus its sub header:
- if more than one LCG has data available for transmission in the TTI where the BSR is transmitted: report Truncated BSR of the LCG with the highest priority logical channel with data available for transmission;

- else report Short BSR.
- else if the number of padding bits is equal to or larger than the size of the Long BSR plus its sub header, report Long BSR.

If the Buffer Status reporting procedure determines that at least one BSR has been triggered since the last transmission of a BSR or this is the first time that at least one BSR is triggered:

- if the UE has UL resources allocated for new transmission for this TTI:
 - instruct the Multiplexing and Assembly procedure to generate a BSR MAC control element;
 - start or restart the PERIODIC BSR TIMER except when the BSR is a Truncated BSR;
 - start or restart *retxBSR-Timer*.
- else if a Regular BSR has been triggered:
 - a Scheduling Request shall be triggered.

A MAC PDU shall contain at most one MAC BSR control element, even when multiple events trigger a BSR by the time a BSR can be transmitted in which case the Regular BSR and the Periodic BSR shall have precedence over the padding BSR.

The UE shall restart *retxBSR-Timer* upon reception of a grant for transmission of new data on UL-SCH.

All triggered BSRs shall be cancelled in case the UL grant can accommodate all pending data available for transmission but is not sufficient to additionally accommodate the BSR MAC control element plus its subheader. All triggered BSRs shall be cancelled when a BSR is included in a MAC PDU for transmission.

[TS 36.321 clause 6.1.2]

MAC control elements are always placed before any MAC SDU.

[TS 36.321 clause 6.1.3.1]

Buffer Status Report (BSR) MAC control elements consist of either:

- Short BSR and Truncated BSR format: one LCG ID field and one corresponding Buffer Size field (figure 6.1.3.1-1); or
- Long BSR format: four Buffer Size fields, corresponding to LCG IDs #0 through #3 (figure 6.1.3.1-2).

The BSR formats are identified by MAC PDU sub headers with LCIDs as specified in table 6.2.1.-1.

The fields LCG ID and BS are defined as follow:

- LCG ID: The Logical Channel Group ID field identifies the group of logical channel(s) which buffer status is being reported. The length of the field is 2 bits;
- Buffer Size: The Buffer Size field identifies the total amount of data available across all logical channels of a logical channel group after the MAC PDU has been built. The amount of data is indicated in number of bytes. It shall include all data that is available for transmission in the RLC layer and in the PDCP layer; the definition of what data shall be considered as available for transmission is specified in [3] and [4] respectively. The size of the RLC and MAC headers are not considered in the buffer size computation. The length of this field is 6 bits. The values taken by the Buffer Size field are shown in Table 6.1.3.1-1.

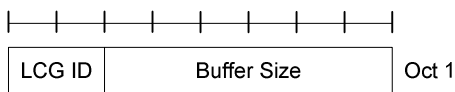

Figure 6.1.3.1-1: Short BSR and Truncated BSR MAC control element

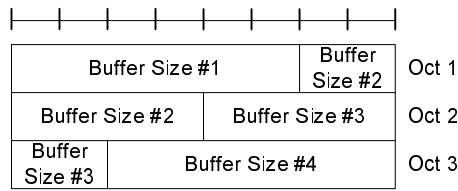

Figure 6.1.3.1-2: Long BSR MAC control element

[TS 36.321 clause 6.2.1]

Table 6.2.1-2: Values of LCID for UL-SCH

Index	LCID values
00000	CCCH
00001-01010	Identity of the logical channel
01011-11001	Reserved
11010	Power Headroom Report
11011	C-RNTI
11100	Truncated BSR
11101	Short BSR
11110	Long BSR
11111	Padding

[TS 36.323 clause 4.5]

For the purpose of MAC buffer status reporting, the UE shall consider the following as data available for transmission in the PDCP layer:

For SDUs for which no PDU has been submitted to lower layers:

- the SDU itself, if the SDU has not yet been processed by PDCP, or
- the PDU (control or data) if the SDU has been processed by PDCP.

7.1.4.7.3 Test description

7.1.4.7.3.1 Pre-test conditions

System Simulator

- Cell 1

UE

None.

Preamble

- The UE is in state Loopback Activated (state 4) according to [18].
- 3 AM DRBS are configured with the parameters specified in table 7.1.4.7.1-1.

Table 7.1.4.7.1-1: Logical Channel Configuration Settings

Parameter	DRB1	DRB2
LogicalChannel-Identity	3	4
Priority	7	6
prioritizedBitRate	0kbs	0kbs
logicalChannelGroup	2 (LCG ID#3)	1 (LCG ID#2)
periodicBSR-Timer	infinity	

7.1.4.7.3.2 Test procedure sequence

Table 7.1.4.7.3.2-1: Main behaviour

St	Procedure	Message Sequence		TP	Verdict
		U - S	Message		
1	The SS ignores scheduling requests and does not allocate any uplink grant.	-	-	-	-
-	EXCEPTION: Step 2 shall be repeated for 2 times	-	-	-	-
2	The SS transmits a MAC PDU including an RLC SDU of size 12 bytes on logical channel 4.	<--	MAC PDU (RLC SDU on LC 4)	-	-
3	The SS transmits a MAC PDU including an RLC SDU of size 12 bytes on logical channel 3.	<--	MAC PDU (RLC SDU on LC 3)	-	-
4	SS waits until UE transmits a Scheduling Request on PUCCH.	-->	(SR)	-	-
5	The SS sends an uplink grant of size 32 bits. (Note 1)	<--	(UL grant)	-	-
6	The UE transmit a Long BSR report	-->	MAC PDU (Long BSR header (LCID='11110'), Long BSR)	-	-
7	The SS sends an uplink grant of size 136 bits. (Note 2)	<--	(UL grant)	-	-
8	Check: Does UE transmit a MAC PDU containing a RLC SDU and a Truncated BSR indicating pending data ('Buffer size' field > '0') for logicalChannelGroup 1 ('LCG ID' field set to '01')?	-->	MAC PDU (Truncated BSR header (LCID='11100'), Short BSR(LCG ID = '01', Buffer size>'0'), RLC SDU)	1	P
9	SS waits until UE transmits a Scheduling Request on PUCCH.	-->	(SR)	-	-
10	The SS sends an uplink grant of size 136 bits (Note 2)	<--	(UL grant)	-	-
11	Check: Does UE transmit a MAC PDU containing a RLC SDU and with a Short BSR indicating pending data ('Buffer size' field > '0') for logicalChannelGroup 2 ('LCG ID' field = '10')?	-->	MAC PDU (Short BSR header(LCID='11101'), Short BSR(LCG ID = '10', Buffer size>'0'), RLC SDU)	2	P
12	The SS transmits a MAC PDU including a RLC SDU of size 12 bytes on logical channel 3.	<--	MAC PDU (RLC SDU on LC 3)	-	-
13	SS waits until UE transmits a Scheduling Request on PUCCH.	-->	(SR)	-	-
14	The SS sends an uplink grant of size 152 bits. (Note 3)	<--	(UL grant)	-	-
15	Check: Does UE transmit a MAC PDU containing a RLC SDU and a Long?	-->	MAC PDU (Long BSR header (LCID='11110'), Long BSR), RLC SDU)	3	P
Note 1:	SS transmit an UL grant of 32 bits ($I_{TBS}=0$, $N_{PRB}=2$, TS 36.213 Table 7.1.7.2.1-1) to allow UE to transmit a Regular BSR triggered by the new data received logicalChannelGroup 2 and 1 in steps 2 and 3. This to enable testing of Padding BSR which has lower priority than Regular BSR.				
Note 2:	UL grant of 136 bits ($I_{TBS}=9$, $N_{PRB}=1$, TS 36.213 Table 7.1.7.2.1-1) is chosen such that the MAC PDU padding bits will be equal to or larger than the size of Short/Truncated BSR and smaller than Long BSR. RLC SDU size is 12 bytes, size of AMD PDU header is 2 bytes, size of MAC header is 2 bytes (1 byte for MAC SDU sub-header using R/R/E/LCID for last sub header and 1 byte for BSR sub-header) and size of Short BSR/Truncated BSR is one byte, i.e. setting UL grant to 17 bytes (136 bits) enable UE to include Short/Truncated BSR.				
Note 3:	UL grant of 152 bits ($I_{TBS}=9$, $N_{PRB}=1$, TS 36.213 Table 7.1.7.2.1-1) is chosen such that the MAC PDU padding bits will be equal to or larger than the size of Long BSR. RLC SDU size is 12 bytes, size of AMD PDU header is 2 bytes, size of MAC header is 2 bytes (1 byte for MAC SDU sub-header using R/R/E/LCID for last sub header and 1 byte for BSR sub-header) and size of Long BSR is 3 bytes, i.e. setting UL grant to 19 bytes (152 bits) enable UE to include padding Long BSR.				

7.1.4.7.3.3 Specific Message Contents

None.

7.1.4.8 Correct Handling of MAC control information [Buffer Status/ Periodic BSR Timer expires]

7.1.4.8.1 Test Purpose (TP)

(1)

```
with { UE in E-UTRA RRC_CONNECTED state }
  ensure that {
    when { PERIODIC BSR TIMER expires and more than one LCG has buffered data in a TTI }
      then { UE reports Long BSR }
  }
```

(2)

```
with { UE in E-UTRA RRC_CONNECTED state }
  ensure that {
    when { PERIODIC BSR TIMER expires and one LCG has buffered data in a TTI }
      then { UE reports Short BSR }
  }
```

7.1.4.8.2 Conformance requirements

References: The conformance requirements covered in the current TC are specified in: TS 36.321, clause 5.4.5, 6.1.2, 6.1.3.1 and 6.2.1; TS 36.323 clause 4.5.

[TS 36.321 clause 5.4.5]

The Buffer Status reporting procedure is used to provide the serving eNB with information about the amount of data available for transmission in the UL buffers of the UE. RRC controls BSR reporting by configuring the two timers *periodicBSR-Timer* and *retxBSR-Timer* and by, for each logical channel, optionally signalling *logicalChannelGroup* which allocates the logical channel to an LCG [8].

For the Buffer Status reporting procedure, the UE shall consider all radio bearers which are not suspended and may consider radio bearers which are suspended.

A Buffer Status Report (BSR) shall be triggered if any of the following events occur:

...

- *periodicBSR-Timer* expires, in which case the BSR is referred below to as "Periodic BSR".

For Regular and Periodic BSR:

- if more than one LCG has data available for transmission in the TTI where the BSR is transmitted: report Long BSR;
- else report Short BSR.

...

If the Buffer Status reporting procedure determines that at least one BSR has been triggered since the last transmission of a BSR or this is the first time that at least one BSR is triggered:

- if the UE has UL resources allocated for new transmission for this TTI:
 - instruct the Multiplexing and Assembly procedure to generate a BSR MAC control element;
 - start or restart the PERIODIC BSR TIME except when the BSR is a Truncated BSR;
- start or restart *retxBSR-Timer*.R...

A MAC PDU shall contain at most one MAC BSR control element, even when multiple events trigger a BSR by the time a BSR can be transmitted in which case the Regular BSR and the Periodic BSR shall have precedence over the padding BSR.

The UE shall restart *retxBSR-Timer* upon reception of a grant for transmission of new data on UL-SCH.

All triggered BSRs shall be cancelled in case the UL grant can accommodate all pending data available for transmission but is not sufficient to additionally accommodate the BSR MAC control element. All triggered BSRs shall be cancelled when a BSR is included in a MAC PDU for transmission.

[TS 36.321 clause 6.1.2]

MAC control elements are always placed before any MAC SDU.

[TS 36.321 clause 6.1.3.1]

Buffer Status Report (BSR) MAC control elements consist of either:

- Short BSR and Truncated BSR format: one LCG ID field and one corresponding Buffer Size field (figure 6.1.3.1-1); or
- Long BSR format: four Buffer Size fields, corresponding to LCG IDs #0 through #3 (figure 6.1.3.1-2).

The BSR formats are identified by MAC PDU sub headers with LCIDs as specified in table 6.2.1.-1.

The fields LCG ID and Buffer Size are defined as follow:

- LCG ID: The Logical Channel Group ID field identifies the group of logical channel(s) which buffer status is being reported. The length of the field is 2 bits;
- Buffer Size: The Buffer Size field identifies the total amount of data available across all logical channels of a logical channel group after the MAC PDU has been built. The amount of data is indicated in number of bytes. It shall include all data that is available for transmission in the RLC layer and in the PDCP layer; the definition of what data shall be considered as available for transmission is specified in [3] and [4] respectively. The size of the RLC and MAC headers are not considered in the buffer size computation. The length of this field is 6 bits. The values taken by the Buffer Size field are shown in Table 6.1.3.1-1.

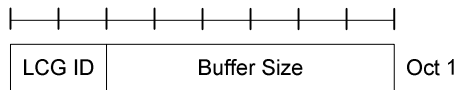

Figure 6.1.3.1-1: Short BSR and Truncated BSR MAC control element

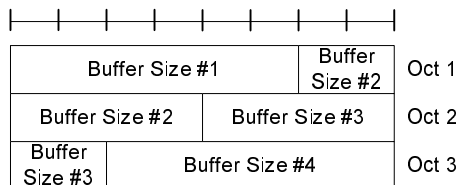

Figure 6.1.3.1-2: Long BSR MAC control element

[TS 36.321 clause 6.2.1]

Table: 6.2.1-2 Values of LCID for UL-SCH

Index	LCID values
00000	CCCH
00001-01010	Identity of the logical channel
01011-11001	Reserved
11010	Power Headroom Report
11011	C-RNTI
11100	Truncated BSR
11101	Short BSR
11110	Long BSR
11111	Padding

[TS 36.323 clause 4.5]

For the purpose of MAC buffer status reporting, the UE shall consider the following as data available for transmission in the PDCP layer:

For SDUs for which no PDU has been submitted to lower layers:

- the SDU itself, if the SDU has not yet been processed by PDCP, or
- the PDU (control or data) if the SDU has been processed by PDCP.

7.1.4.8.3 Test description

7.1.4.8.3.1 Pre-test conditions

System Simulator

- Cell 1

UE

None.

Preamble

- The UE is in state Loopback Activated (state 4) according to [18].
- 2 AM DRBS are configured with the parameters specified in table 7.1.4.8.1-1.

Table 7.1.4.8.1-1: Logical Channel Configuration Settings

Parameter	DRB1	DRB2
LogicalChannel-Identity	3	4
priority	7	6
prioritizedBitRate	0kbs	0kbs
logicalChannelGroup	2	1
periodicBSR-Timer	10 SF	

7.1.4.8.3.2 Test procedure sequence

Table 7.1.4.8.3.2-1: Main behaviour

St	Procedure	Message Sequence		TP	Verdict
		U - S	Message		
1	The SS ignores scheduling requests and does not allocate any uplink grant.	-	-	-	-
-	EXCEPTION: Step 2 shall be repeated for 50 times	-	-	-	-
2	The SS transmits a MAC PDU containing an RLC PDU on logical channel 4 (LCG ID 1), which contains an RLC SDU of size 14 bytes.	<--	MAC PDU (RLC SDU)		
3	The SS sends an uplink grant of size 32 bits. (Note 3)	<--	(UL grant)	-	-
4	The UE transmit a Long BSR report	-->	MAC PDU (Long BSR)		
5	The SS responds to any scheduling grants by sending UL Grants of 136 bits. (Note 1)	-	-	-	-
-	EXCEPTION: In parallel to the events described in step 4, step 1 specified in Table 7.1.4.4.3.5.2-2 should take place.	-	-	-	-
-	EXCEPTION: Step 6 shall be repeated twice	-	-	-	-
6	Check: Does UE transmit a MAC PDU containing a Short BSR with 'LCG ID' field set to '01' (logicalChannelGroup 1) and Buffer Size Index > 0?	-->	MAC PDU (LCID='11101', LCG ID='01', Buffer Size index > 0)	2	P
7	The SS ignores scheduling requests and does not allocate any uplink grant.	-	-	-	-
-	EXCEPTION: Step 8 shall be repeated for 30 times	-	-	-	-
8	The SS transmits a MAC PDU containing an RLC PDU on logical channel 3 (LCG ID 2), which contains an RLC SDU of size 14 bytes.	<--	MAC PDU (RLC SDU)	-	-
9	The SS responds to any scheduling grants by sending UL Grants of 136 bits. (Note 1)	-	-	-	-
-	EXCEPTION: In parallel to the events described in step 4, step 1 specified in Table 7.1.4.4.3.5.2-2 should take place.	-	-	-	-
-	EXCEPTION: Step 10 shall be repeated twice.	-	-	-	-
10	Check: Does UE transmit a MAC PDU containing a Long BSR with 'Buffer size#2' (LCG ID=1) and 'Buffer size#3' (LCG ID=2) fields set to value > '0'? (Note 2)	-->	MAC PDU (LCID='11110', Buffer size#2 index > 0, Buffer size#3 index > 0)	1	P
11	The UE transmits MAC PDUs containing the remaining RLC SDUs as sent by the SS in steps 2 and 6.	-->	MAC PDU (complete RLC SDU or RLC SDU segment)	-	-
<p>Note 1. UL grant of 136 bits ($I_{TBS}=9$, $N_{PRB}=1$, TS 36.213 Table 7.1.7.2.1-1) is chosen such that the UE can return one RLC SDU without padding. RLC SDU size is 14 bytes, size of AMD PDU header is 2 bytes, size of MAC header is 1 byte (1 byte for MAC SDU sub-header using last R/R/E/LCID sub-header), i.e. setting UL grant to 17 bytes (136 bits) enable UE to either to send a complete RLC SDU or a Short or Long BSR when BSR is triggered.</p> <p>Note 2. Buffer size fields in Long BSR are number #1 to #4 in 36.321 (Clause 6.1.3.1) which maps to LCG ID values 0 to 3, i.e. LCG ID=1 associates with Buffer size#2 field, and LCG ID=2 associates with Buffer size#3, in the Long BSR MAC control element.</p> <p>Note 3: SS transmit an UL grant of 32 bits ($I_{TBS}=0$, $N_{PRB}=2$, TS 36.213 Table 7.1.7.2.1-1) to allow UE to transmit a Regular BSR triggered by the new data received logicalChannelGroup 2 and 1 in steps 2 and 3. This to enable testing of Padding BSR which has lower priority than Regular BSR.</p>					

Table 7.1.4.8.3.2-2: Parallel behaviour

St	Procedure	Message Sequence		TP	Verdict
		U - S	Message		
1	The UE transmits a MAC PDU containing a complete RLC SDU, RLC SDU segments or BSR and RLC SDU segments.	-->	MAC PDU	-	-

7.1.4.8.3.3 Specific Message Contents

None.

7.1.4.10 MAC-Padding

7.1.4.10.1 Test Purpose (TP)

(1)

```
with { UE in E-UTRA RRC_CONNECTED state }
  ensure that {
    when { UE is to transmit a MAC PDU with padding exceeding 2 bytes }
      then { Padding goes to the end of the MAC PDU }
  }
```

(2)

```
with { UE in E-UTRA RRC_CONNECTED state }
  ensure that {
    when { UE is to transmit a MAC PDU with with single-byte padding and there is a data MAC PDU
subheader present }
      then { UE is insering padding MAC PDU subheader before the first Data MAC PDU subheader }
  }
```

(3)

```
with { UE in E-UTRA RRC_CONNECTED state }
  ensure that {
    when { UE is to transmit a MAC PDU with with two-byte padding and there is a data MAC PDU
subheader }
      then { UE is inserting two padding MAC PDU subheaders before the first data MAC PDU subheader }
  }
```

(4)

```
with { UE in E-UTRA RRC_CONNECTED state }
  ensure that {
    when { UE is to transmit a MAC PDU with single-byte padding and there is no data MAC PDU
subheader but a MAC Control element is present }
      then { UE is inserting a padding MAC PDU subheader before the last Control MAC PDU
subheader }
  }
```

7.1.4.10.2 Conformance requirements

References: The conformance requirements covered in the current TC are specified in: TS 36.321 , clause 6.1.2.

[TS 36.321 clause 6.1.2]

...

Padding occurs at the end of the MAC PDU, except when single-byte or two-byte padding is required. Padding may have any value and the UE shall ignore it.

When single-byte or two-byte padding is required, one or two MAC PDU subheaders corresponding to padding are placed at the beginning of the MAC PDU before any other MAC PDU subheader.

A maximum of one MAC PDU can be transmitted per TB per UE..

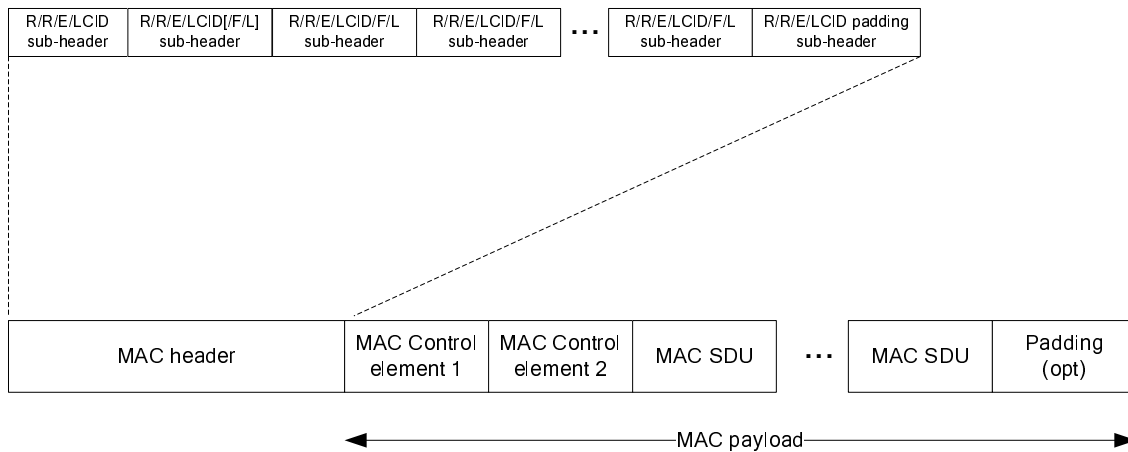

Figure 6.1.2-3: Example of MAC PDU consisting of MAC header, MAC control elements, MAC SDUs and padding

- 7.1.4.10.3 Test description
- 7.1.4.10.3.1 Pre-test conditions

System Simulator:

- Cell 1

UE:

None.

Preamble

- The UE is in state Loopback Activated (state 4) according to [18].
- MAC configuration setting are as specified in table 7.1.4.10.3.1-1.

Table 7.1.4.10.3.1-1: MAC Configuration Settings

Parameter	Value
periodicBSR-Timer	Infinity

7.1.4.10.3.1 Test procedure sequence

Table 7.1.4.10.3.3.2-1: Main behaviour

St	Procedure	Message Sequence		TP	Verdict
		U - S	Message		
1	The SS ignores scheduling requests and does not allocate any uplink grant.	-	-	-	-
2	The SS transmits a MAC PDU containing an RLC AMD PDU of size 8 bytes.	<--	MAC PDU(AMD PDU)	-	-
3	The SS waits [10 TTIs]. (Note 5)	-	-	-	-
4	The SS transmits an uplink grant of size 152 bits. (Note 1)	<--	(UL grant)	-	-
5	Check: Does the UE transmit a MAC PDU with a MAC SDU of length 8 bytes and where the last MAC sub-header has the Extension field 'E' set to '0' and the Logical Channel ID field 'LCID' set to '11111'?	-->	MAC PDU (MAC SDU sub-header (L=8 bytes), Padding MAC sub-header (E='0', LCID='11111'), BSR, MAC SDU, padding)	1	P
6	The SS transmits a MAC PDU containing an RLC AMD PDU of size 10 bytes.	<--	MAC PDU(AMD PDU)	-	-
7	The SS waits [10 TTIs]. (Note 5)	-	-	-	-
8	The SS transmits an uplink grant of size 120 bits. (Note 2)	<--	(UL grant)	-	-
9	Check: Does the UE transmit a MAC PDU with a MAC SDU of length 10 bytes and with a padding MAC sub-header, with Extension field 'E' is set to '1' and the Logical Channel ID field 'LCID' is set to '11111', inserted before the MAC SDU sub-header?	-->	MAC PDU (Padding MAC-sub-header (E='1', LCID='11111'), MAC SDU sub-header (L=10 bytes), MAC SDU)	2	P
10	The SS transmits a MAC PDU containing an RLC AMD PDU of size 5 bytes.	<--	MAC PDU (AMD PDU)	-	-
11	The SS waits [10 TTIs]. (Note 5)	-	-	-	-
12	The SS transmits an uplink grant of size 120 bits. (Note 3)	<--	(UL grant)	-	-
13	Check: Does the UE transmit a MAC PDU with two padding MAC sub-header, with Extension field 'E' is set to '1' and the Logical Channel ID field 'LCID' is set to '11111', inserted after the BSR sub-header, but before the MAC SDU sub-header?	-->	MAC PDU (BSR sub-header, Padding MAC-sub-header#1 (E='1', LCID='11111'), Padding MAC-sub-header#2 (E='1', LCID='11111'), MAC SDU sub-header (L=5 bytes), BSR, MAC-SDU)	3	P
14	The SS transmits a Timing Advance command and does not send any subsequent timing alignments. Start Timer_T1 = Time Alignment timer value on SS.	<--	MAC PDU (Timing Advance Command)	-	-
15	The SS waits until Timer_T1 expires and then transmits a MAC PDU containing an RLC AMD PDU with polling enabled.	<--	MAC PDU (AMD PDU (P=1))	-	-
16	The UE transmits a preamble on PRACH.	-->	(PRACH preamble)	-	-
17	The SS transmits a Random Access Response, with an UL Grant of 32-bits. (Note 4)	<--	Random Access Response		
18	Check: Does the UE transmit a MAC PDU with a padding MAC sub header with Extension field 'E' is set to '1' and 'LCID' field set to '11111' (8-bits) inserted before a Control sub-header (8-bits) and a C-RNTI MAC Control Element (16-bits)?	-->	MAC PDU (Padding MAC-sub-header#1 (E='1', LCID='11111'), MAC Control sub-header, C-RNTI control element)	4	P
19	The SS transmits a MAC PDU with a UE Contention Resolution Identity Control Element.	<--	MAC PDU (UE Contention Resolution Identity)	-	-

20	The SS transmits an uplink grant enabling UE to transmit a RLC STATUS PDU.	<--	(UL grant)	-	-
21	The UE transmits an RLC STATUS PDU.	-->	MAC PDU(RLC STATUS PDU)	4	P
Note 1:	UL grant of 152 bits ($I_{TBS}=0$, $N_{PRB}=6$, see TS 36.213 Table 7.1.7.2.1-1) is chosen such that the MAC PDU padding will be larger than 2 bytes. RLC SDU size is 8 bytes, size of AMD PDU header is 2 bytes, size of MAC header is 3 bytes (2 bytes for MAC SDU sub-header using 7-bit LI and 1 byte for BSR sub-header) and size of Short BSR is 1 byte, equals to 112 bits (14 bytes) and resulting into 40 bits padding.				
Note 2:	UL grant of 120 bits ($I_{TBS}=0$, $N_{PRB}=5$, see TS 36.213 Table 7.1.7.2.1-1) is chosen such that the MAC PDU padding will be a single byte. RLC SDU size is 10 bytes, size of AMD PDU header is 2 bytes and size of MAC header is 2 bytes for MAC SDU sub-header (using 7-bit LI), equals to 112 bits (14 bytes) and resulting into 1 single byte padding.				
Note 3:	UL grant of 120 bits ($I_{TBS}=0$, $N_{PRB}=5$, see TS 36.213 Table 7.1.7.2.1-1) is chosen such that the MAC PDU padding will be equal to 2 bytes. RLC SDU size is 5 bytes, size of AMD PDU header is 2 bytes, size of MAC header is 3 bytes (2 bytes for MAC SDU sub-header using 7-bit LI and 1 byte for BSR sub-header) and size of Long BSR is 3 bytes, equals to 104 bits (13 bytes) and resulting into two-bytes padding.				
Note 4:	UL grant of 32 bits ($I_{TBS}=0$, $N_{PRB}=2$, see TS 36.213 Table 7.1.7.2.1-1) is chosen such that the MAC PDU padding will be equal a single byte.				
Note 5:	The wait time is specified to ensure that the UE is ready to loop back the data when the grant is received.				

7.1.4.10.3.3 Specific Message Contents

None.

7.1.4.11 Correct HARQ process handling

7.1.4.11.1 Test Purpose (TP)

(1)

```
with { UE in E-UTRA RRC_CONNECTED state with DRB established }
ensure that {
  when { UE receives an UL Grant with incremented NDI and has data is available for transmission }
  then { UE transmits a new MAC PDU using redundancy version 0 }
}
```

(2)

```
with { UE in E-UTRA RRC_CONNECTED state with DRB established and having transmitted a MAC PDU less
than maxHARQ-Tx times }
ensure that {
  when { UE receives a NACK and no uplink grant is included for the next TTI corresponding to the
HARQ process }
  then { UE performs non adaptive retransmission of the MAC PDU with redundancy version incremented
by one of the last (re)transmission [0,2,3,1 order]}
}
```

(3)

```
with { UE in E-UTRA RRC_CONNECTED state with DRB established and having transmitted a MAC PDU less
than maxHARQ-Tx times }
ensure that {
  when { UE receives a uplink grant on PDCCH for the next TTI corresponding to the HARQ process with
old NDI [not incremented], irrespective of ACK/NACK is received for previous (re)transmission}
  then { UE performs an adaptive retransmission of the MAC PDU with redundancy version as received
on PDCCH}
}
```

(4)

```
with { UE in E-UTRA RRC_CONNECTED state with DRB established and having transmitted a MAC PDU less
than maxHARQ-Tx times }
ensure that {
  when { UE receives a ACK and no uplink grant is included for the next TTI corresponding to the
HARQ process }
  then { UE does not retransmit the MAC PDU}
}
```

(5)

```
with { UE in E-UTRA RRC_CONNECTED state with DRB established and having transmitted a MAC PDU
maxHARQ-Tx times }
```



```

ensure that {
  when { UE receives an uplink grant on PDCCH for the next TTI corresponding to the HARQ process
with not incremented NDI }
  then { UE flushes the HARQ buffer and does not retransmit the MAC PDU}
}

```

(6)

```

with { UE in E-UTRA RRC_CONNECTED state with DRB established and having transmitted a MAC PDU less
than maxHARQ-Tx times }
ensure that {
  when { UE receives an uplink grant on PDCCH for the next TTI corresponding to the HARQ process
with incremented NDI, and data are not available for transmission}
  then { UE flushes the HARQ buffer and does not transmit any MAC PDU}
}

```

(7)

```

with { UE in E-UTRA RRC_CONNECTED state with DRB established and having transmitted a MAC PDU
maxHARQ-Tx times }
ensure that {
  when { UE receives a NACK and no uplink grant is included for the next TTI corresponding to the
HARQ process}
  then { UE does not transmit any MAC PDU }
}

```

7.1.4.11.2 Conformance requirements

References: The conformance requirements covered in the current TC are specified in: TS 36.321, clause 5.4.2.1 & 5.4.2.2.

[TS 36.321, clause 5.4.2.1]

There is one HARQ entity at the UE, which maintains a number of parallel HARQ processes allowing transmissions to take place continuously while waiting for the feedback on the successful or unsuccessful reception of previous transmissions.

The number of parallel HARQ processes is specified in [2], clause 8.

At a given TTI, if an uplink grant is indicated for the TTI, the HARQ entity identifies the HARQ process for which a transmission should take place. It also routes the received feedback (ACK/NACK information), MCS and resource, relayed by the physical layer, to the appropriate HARQ process.

If TTI bundling is configured, the parameter TTI_BUNDLE_SIZE provides the number of TTIs of a TTI bundle. Within a bundle HARQ retransmissions are non-adaptive and shall be performed without waiting for feedback from previous transmissions according to TTI_BUNDLE_SIZE. The feedback for a bundle is only received for the TTI corresponding to TTI_BUNDLE_SIZE. A retransmission of a TTI bundle is also a TTI bundle.

For transmission of an uplink message containing the C-RNTI MAC control element or an uplink message including a CCCH SDU during Random Access (see section 5.1.5) TTI bundling does not apply.

For each TTI, the HARQ entity shall:

- identify the HARQ process associated with this TTI;
- if an uplink grant has been indicated for this TTI:
 - if the received grant was not addressed to a Temporary C-RNTI on PDCCH and if the NDI provided in the associated HARQ information has been toggled compared to the value in the previous transmission of this HARQ process; or
 - if this is the very first transmission for this HARQ process (i.e., no previous NDI is available); or
 - if the uplink grant was received in a Random Access Response:
 - if there is a MAC PDU in the Msg3 buffer and the uplink grant was received in a Random Access Response:
 - obtain the MAC PDU to transmit from the Msg3 buffer.
 - else:

- obtain the MAC PDU to transmit from the "Multiplexing and assembly" entity;
- deliver the MAC PDU and the uplink grant and the HARQ information to the identified HARQ process;
- instruct the identified HARQ process to trigger a new transmission.
- else:
 - deliver the uplink grant and the HARQ information (redundancy version) to the identified HARQ process;
 - instruct the identified HARQ process to generate an adaptive retransmission.
- else, if the HARQ buffer of the HARQ process corresponding to this TTI is not empty:
 - instruct the identified HARQ process to generate a non-adaptive retransmission.

When determining if NDI has been incremented compared to the value in the previous transmission UE shall ignore NDI received in all uplink grants on PDCCH for its Temporary C-RNTI.

NOTE: A retransmission triggered by the HARQ entity should be cancelled by the corresponding HARQ process if it collides with a measurement gap or if a non-adaptive retransmission is not allowed.

[TS 36.321, clause 5.4.2.2]

Each HARQ process is associated with a HARQ buffer.

Each HARQ process shall maintain a state variable CURRENT_TX_NB, which indicates the number of transmissions that have taken place for the MAC PDU currently in the buffer, and a state variable HARQ_FEEDBACK, which indicates the HARQ feedback for the MAC PDU currently in the buffer. When the HARQ process is established, CURRENT_TX_NB shall be initialized to 0.

The sequence of redundancy versions is 0, 2, 3, 1. The variable CURRENT_IRV is an index into the sequence of redundancy versions. This variable is up-dated modulo 4.

New transmissions and adaptive retransmissions are performed on the resource and with the MCS indicated on PDCCH, except for new transmissions of Msg3 which are performed according to UL grant in Random Access Response. Non-adaptive retransmission is performed on the same resource and with the same MCS as was used for the last made transmission attempt,

The UE is configured with a Maximum number of HARQ transmissions and a Maximum number of Msg3 HARQ transmissions by RRC. For transmissions on all HARQ processes and all logical channels except for transmission of a MAC PDU stored in the Msg3 buffer, maximum number of transmissions shall be set to Maximum number of HARQ transmissions. For transmission of a MAC PDU stored in the Msg3 buffer, maximum number of transmissions shall be set to Maximum number of Msg3 HARQ transmissions.

When the HARQ feedback is received for this HARQ process:

- set HARQ_FEEDBACK to the received value.

If the HARQ entity requests a new transmission, the HARQ process shall:

- set CURRENT_TX_NB to 0;
- set CURRENT_IRV to 0;
- store the MAC PDU in the associated HARQ buffer;
- store the uplink grant received from the HARQ entity;
- set HARQ_FEEDBACK to NACK;
- generate a transmission as described below.

If the HARQ entity requests a retransmission, the HARQ process shall:

- increment CURRENT_TX_NB by 1;

- if the HARQ entity requests an adaptive retransmission:
 - store the uplink grant received from the HARQ entity;
 - set CURRENT_IRV to the index corresponding to the redundancy version value provided in the HARQ information;
- set HARQ_FEEDBACK to NACK;
 - generate a transmission as described below.
- else if the HARQ entity requests a non-adaptive retransmission:
 - if HARQ_FEEDBACK = NACK; or
 - if TTI bundling is configured and CURRENT_TX_NB is less than TTI_BUNDLE_SIZE:
 - generate a transmission as described below.

NOTE: When receiving a HARQ ACK alone, the UE keeps the data in the HARQ buffer.

NOTE: When no UL-SCH transmission can be made due to the occurrence of a measurement gap, no HARQ feedback can be received and a non-adaptive retransmission follows.

To generate a transmission, the HARQ process shall:

- if there is no measurement gap at the time of the transmission or if the MAC PDU was obtained from the Msg3 buffer:
- instruct the physical layer to generate a transmission according to the stored uplink grant with the redundancy version corresponding to the CURRENT_IRV value;
- increment CURRENT_IRV by 1;
- if there is a measurement gap at the time of the feedback reception for this transmission and if the MAC PDU was not obtained from the Msg3 buffer:
 - set HARQ_FEEDBACK to ACK.

The HARQ process shall:

- if CURRENT_TX_NB = maximum number of transmissions - 1:
 - flush the HARQ buffer;

The HARQ process may:

- if CURRENT_TX_NB = maximum number of transmissions - 1; and
- if the last feedback received (i.e., the feedback received for the last transmission of this process) is a HARQ NACK except for the transmission of a MAC PDU stored in the [Msg3] buffer:
 - notify the relevant ARQ entities in the upper layer that the transmission of the corresponding RLC PDUs failed.

7.1.4.11.3 Test description

7.1.4.11.3.1 Pre-test conditions

System Simulator:

- Cell 1
- System information take into account the parameters in table 7.1.2.11.3.1-1.

UE:

None.

Preamble:

- The UE is in state Loopback Activated (state 4) according to [18], with the DRB for the default EPS bearer context configured with RLC in UM mode.
- The loop back size is set in such a way that one RLC SDU in DL shall result in 1 RLC SDU's in UL.
- No UL Grant is allocated, PUCCH is in synchronised state for sending Scheduling Requests.

Table 7.1.2.11.3.1-1: RACH Parameters

Parameter	Value
maxHARQ-Tx	n8

7.1.4.11.3.2 Test procedure sequence

Table 7.1.4.11.3.2-1: Main behaviour

St	Procedure	Message Sequence		TP	Verdict
		U - S	Message		
1	The SS Transmits a valid MAC PDU containing RLC PDU	<--	MAC PDU	-	-
2	Check: Does the UE transmit a Scheduling Request?	-->	Scheduling Request	-	-
3	The SS allocate UL Grant for one HARQ process X, sufficient for one RLC SDU to be loop backed in a TTI, and NDI indicates new transmission	<--	Uplink Grant	-	-
4	Check: Does the UE transmit a MAC PDU including one RLC SDU, in HARQ process X, redundancy version 0?	-->	MAC PDU	1	P
5	The SS transmits a NACK	<--	HARQ NACK	-	-
6	Check: Does the UE transmit a MAC PDU for HARQ process X, redundancy version 2?	-->	MAC PDU	2	P
7	The SS transmits a NACK	<--	HARQ NACK	-	-
8	Check: Does the UE transmit a MAC PDU for HARQ process X, redundancy version 3?	-->	MAC PDU	2	P
9	The SS transmits a NACK	<--	HARQ NACK	-	-
10	Check: Does the UE transmit a MAC PDU for HARQ process X, redundancy version 1?	-->	MAC PDU	2	P
11	The SS transmits a NACK	<--	HARQ NACK	-	-
12	Check: Does the UE transmit a MAC PDU for HARQ process X, redundancy version 0?	-->	MAC PDU	2	P
13	The SS transmits a NACK	<--	HARQ NACK	-	-
14	Check: Does the UE transmit a MAC PDU for HARQ process X, redundancy version 2?	-->	MAC PDU	2	P
15	The SS transmits an ACK	<--	HARQ ACK	-	-
16	Check: Does the UE transmit a MAC PDU for HARQ process X?	-->	MAC PDU	4	F
17	The SS transmits an UL grant corresponding to TTI for HARQ process X, with NDI not incremented and redundancy version to be used as '1'	<--	Uplink Grant	-	-
18	Check: Does the UE transmit a MAC PDU in for HARQ process X, using redundancy version 1?	-->	MAC PDU	3	P
19	The SS transmits a NACK	<--	HARQ NACK	-	-
20	The SS transmits an UL grant corresponding to next TTI for HARQ process X, with NDI not incremented and redundancy version to be used as '3'	<--	Uplink Grant	-	-
21	Check: Does the UE transmit a MAC PDU for HARQ process X, using next redundancy version 3?	-->	MAC PDU	3	P
22	The SS transmits a NACK	<--	HARQ NACK	-	-
23	Check: Does the UE transmit a MAC PDU in the next TTIs corresponding to HARQ process X?	-->	MAC PDU	7	F
24	The SS transmits an UL grant corresponding to TTI for HARQ process X, with NDI not incremented	<--	Uplink Grant	-	-
25	Check: Does the UE transmit a MAC PDU in the next TTIs corresponding to HARQ process X?	-->	MAC PDU	5	F
26	The SS Transmits a valid MAC PDU containing RLC PDU	<--	MAC PDU	-	-
27	The UE transmits a Scheduling Request	-->	Scheduling Request	-	-
28	The SS allocates UL Grant for one HARQ process Y, sufficient for one RLC SDU to be loop backed in a TTI, and NDI indicates new transmission	<--	Uplink Grant	-	-

29	Check: Does the UE transmit a MAC PDU including one RLC SDU, in HARQ process Y, redundancy version 0?	-->	MAC PDU	1	P
30	The SS allocates UL Grant for one HARQ process Y, sufficient for one RLC SDU to be loop backed in a TTI, and NDI indicates new transmission	<--	Uplink Grant	-	-
31	Check: Does the UE transmit a MAC PDU in the next TTIs corresponding to HARQ process Y?	-->	MAC PDU	6	F

7.1.4.11.3.3 Specific message contents

None.

7.1.4.12 MAC reset-UL

7.1.4.12.1 Test Purpose (TP)

(1)

```
with (UE in E-UTRA RRC_CONNECTED state, with Scheduling Request procedure triggered)
  ensure that {
    when{ UE MAC is reset, due to handover to a new cell}
      then { UE cancels Scheduling Request procedure}
  }
```

(2)

```
with (UE in E-UTRA RRC_CONNECTED state)
  ensure that {
    when{ UE MAC is reset, due to handover to a new cell}
      then { UE flushes UL HARQ buffer}
  }
```

(3)

```
with (UE in E-UTRA RRC_CONNECTED state)
  ensure that {
    when{ UE MAC is reset, due to handover to a new cell}
      then { UE Considers the next transmission for each UL HARQ process as very first }
  }
```

7.1.4.12.2 Conformance requirements

References: The conformance requirements covered in the current TC are specified in: TS 36.321, clause 5.9.

[TS 36.321 clause 5.9]

If a reset of the MAC entity is requested by upper layers, the UE shall:

- initialize B_j for each logical channel to zero;
- stop (if running) all timers;
- consider *timeAlignmentTimer* as expired and perform the corresponding actions in subclause 5.2;
- stop, if any, ongoing RACH procedure;
- discard explicitly signalled *ra-PreambleIndex* and *ra-PRACH-MaskIndex*, if any;
- flush Msg3 buffer;
- cancel, if any, triggered Scheduling Request procedure;
- cancel, if any, triggered Buffer Status Reporting procedure;
- cancel, if any, triggered Power Headroom Reporting procedure;
- flush the soft buffers for all DL HARQ processes;

- for each DL HARQ process, consider the next received transmission for a TB as the very first transmission;
- release, if any, Temporary C-RNTI.

7.1.4.12.3 Test description

7.1.4.12.3.1 Pre-test conditions

System Simulator

- Cell 1 and Cell 2

UE:

None.

Preamble:

- The UE is in state Loopback Activated (state 4) in Cell 1 according to [18], with the DRB for the default EPS bearer context configured with RLC in UM mode.

7.1.4.12.3.2 Test procedure sequence

Table 7.1.4.12.3.2-1 illustrates the downlink power levels and other changing parameters to be applied for the cells at various time instants of the test execution. Row marked "T0" denotes the initial conditions, while columns marked "T1" is to be applied subsequently. The exact instants on which these values shall be applied are described in the texts in this clause.

Table 7.1.4.12.3.2-1: Time instances of cell power level and parameter changes

	Parameter	Unit	Cell 1	Cell 2	Remark
T0	Cell-specific RS EPRE	dBm/15Khz	-90	Off	
T1	Cell-specific RS EPRE	dBm/15Khz	-90	-80	

Table 7.1.4.12.3.2-2: Main behaviour

St	Procedure	Message Sequence		TP	Verdict
		U - S	Message		
1	The SS ignores scheduling requests and does not allocate any uplink grant.	-	-	-	-
2	The SS transmits a MAC PDU containing one RLC SDU on LC 3	<--	MAC PDU (1 RLC SDU of 40 bytes on DRB)	-	-
3	The UE transmit a scheduling request	-->	(SR)	-	-
4	Wait for 50ms [Discard timer] to expire at UE.	-	-	-	-
5	The SS changes Cell 2 level according to the row "T1" in table 7.1.4.12.3.2-1	-	-	-	-
6	The SS transmits an <i>RRCCONNECTIONRECONFIGURATION</i> message to order the UE to perform intra frequency handover to Cell 2, including explicit Random Access Preamble.			-	-
7	The UE transmits on cell 2, <i>RRCCONNECTIONRECONFIGURATIONCOMPLETE</i>			-	-
8	Check: For 2 seconds, if UE transmits a scheduling request?	-->	(SR)	1	F
9	The SS transmits a MAC PDU containing RLC SDU on LC 3	<--	MAC PDU (1 RLC SDU of 40 bytes on DRB)	-	-
10	The UE transmit a scheduling request	-->	(SR)	-	-
11	The SS allocate UL Grant sufficient for one RLC SDU to be loop backed in a TTI, and NDI indicates new transmission	<--	Uplink Grant	-	-
12	The UE transmit a MAC PDU including one RLC SDU	-->	MAC PDU	-	-
13	The SS transmits a NACK	<--	HARQ NACK	-	-
14	The SS transmits an <i>RRCCONNECTIONRECONFIGURATION</i> message to order the UE to perform intra frequency handover to Cell 1			-	-
15	The UE transmits on cell 1, <i>RRCCONNECTIONRECONFIGURATIONCOMPLETE</i>			-	-
16	Check: For 2 seconds, does UE transmit MAC PDU containing Loop Back PDU?	-->	MAC PDU (1 RLC SDU of 40 bytes on DRB)	2	F
17	The SS transmits a MAC PDU containing RLC SDU on LC 3	<--	MAC PDU (1 RLC SDU of 40 bytes on DRB)	-	-
18	The UE transmit a scheduling request	-->	(SR)	-	-
19	The SS allocate UL Grant sufficient for one RLC SDU to be loop backed in a TTI, and NDI indicates new transmission	<--	Uplink Grant	-	-
20	Check: Does UE transmit a MAC PDU including one RLC SDU?	-->	MAC PDU	3	P

7.1.4.12.3.3 Specific Message Contents

Table 7.1. 4.12.3.3-1: MAC-MainConfiguration {RRCCONNECTIONRECONFIGURATION (preamble)}

Derivation path: 36.508 table 4.8.2.1.5-1			
Information Element	Value/remark	Comment	Condition
MAC-MainConfiguration-RBC ::= SEQUENCE {			
ul-SCH-Configuration SEQUENCE {			
maxHARQ-Tx	n28		
}			
}			

Table 7.1.4.12.3.3-2: PDCP-Configuration-DRB-UM {RRCConnectionReconfiguration (preamble)}

Derivation Path: 36.508 clause 4.8.2.1.2.1-1			
Information Element	Value/remark	Comment	Condition
PDCP-Configuration-DRB-UM ::= SEQUENCE {			
discardTimer	ms50	Lowest value	
}			

Table 7.1.4.12.3.3-3: SchedulingRequest-Configuration {RRCConnectionReconfiguration (preamble)}

Derivation Path: 36.508 clause 4.6.3-20			
Information Element	Value/remark	Comment	Condition
SchedulingRequest-Configuration ::= CHOICE {			
enable SEQUENCE {			
dsr-TransMax	n64	Max value allowed	
}			
}			

Table 7.1.4.12.3.3-4: RRCConnectionReconfiguration (step 6, table 7.1.4.12.3.2-2)

Derivation Path: 36.508, Table 4.6.1-6, condition RBC-HO			
Information Element	Value/Remark	Comment	Condition
RRCConnectionReconfiguration ::= SEQUENCE {			
criticalExtensions CHOICE {			
c1 CHOICE{			
rrcConnectionReconfiguration-r8 SEQUENCE {			
mobilityControllInformation SEQUENCE {			
targetCellIdentity	MobilityControllInformation-HO		
	PhysicalCellIdentity of Cell 2 (see 36.508 clause 4.4.4.2)		
eutra-CarrierFreq	Not present		
}			
}			
}			
}			

Table 7.1.4.12.3.3-5: RRCConnectionReconfiguration (step 14, table 7.1.4.12.3.2-2)

Derivation Path: 36.508, Table 4.6.1-6, condition RBC-HO			
Information Element	Value/Remark	Comment	Condition
RRCConnectionReconfiguration ::= SEQUENCE {			
criticalExtensions CHOICE {			
c1 CHOICE{			
rrcConnectionReconfiguration-r8 SEQUENCE {			
mobilityControllInformation SEQUENCE {			
targetCellIdentity	MobilityControllInformation-HO		
	PhysicalCellIdentity of Cell 1 (see 36.508 clause 4.4.4.2)		
eutra-CarrierFreq	Not present		
}			
}			
}			
}			

7.1.4.13 MAC PDU header handling

7.1.4.13.1 Test Purpose (TP)

(1)

```
with { UE in E-UTRA RRC_CONNECTED state }
ensure that {
  when { UE has a MAC SDU to be transmitted that is less smaller 128 bytes }
  then { UE sets F field to 0 }
}
```

(2)

```
with { UE in E-UTRA RRC_CONNECTED state }
ensure that {
  when { UE has a MAC SDU to be transmitted that is larger than 128 bytes }
  then { UE sets F field to 1 }
}
```

(3)

```
with { UE in E-UTRA RRC_CONNECTED state }
ensure that {
  when { UE inserts a R/R/E/LCID field in the MAC header and there is a subsequent R/R/E/LCID field
to be inserted }
  then { UE sets E field to 1 }
}
```

(4)

```
with { UE in E-UTRA RRC_CONNECTED state }
ensure that {
  when { UE inserts a R/R/E/LCID field in the MAC header and a MAC SDU or a MAC control element
starts at the next byte }
  then { UE sets E field to 0 }
}
```

(5)

```
with { UE in E-UTRA RRC_CONNECTED state }
ensure that {
  when { UE inserts the last MAC sub-header in the MAC PDU }
  then { UE inserts a MAC sub-header consist solely of the four header fields R/R/E/LCID }
}
```

(6)

```
with { UE in E-UTRA RRC_CONNECTED state }
ensure that {
  when { UE inserts padding at the end of a MAC PDU }
  then { UE inserts the last MAC sub-header as a padding MAC subheader consisting solely of the
four header fields R/R/E/LCID with LCID set to Padding }
}
```

7.1.4.13.2 Conformance requirements

References: The conformance requirements covered in the present TC are specified in: 3GPP TS 36.321 clause 6.1.2 and 6.2.1.

[TS 36.321, clause 6.1.2]

A MAC PDU consists of a MAC header, zero or more MAC Service Data Units (MAC SDU), zero, or more MAC control elements, and optionally padding; as described in Figure 6.1.2-3.

Both the MAC header and the MAC SDUs are of variable sizes.

A MAC PDU header consists of one or more MAC PDU sub-headers; each sub header corresponding to either a MAC SDU, a MAC control element or padding.

A MAC PDU sub header consists of the six header fields R/R/E/LCID/F/L but for the last sub header in the MAC PDU and for fixed sized MAC control elements. The last sub header in the MAC PDU and sub-headers for fixed sized MAC

control elements consist solely of the four header fields R/R/E/LCID. A MAC PDU subheader corresponding to padding consists of the four header fields R/R/E/LCID.

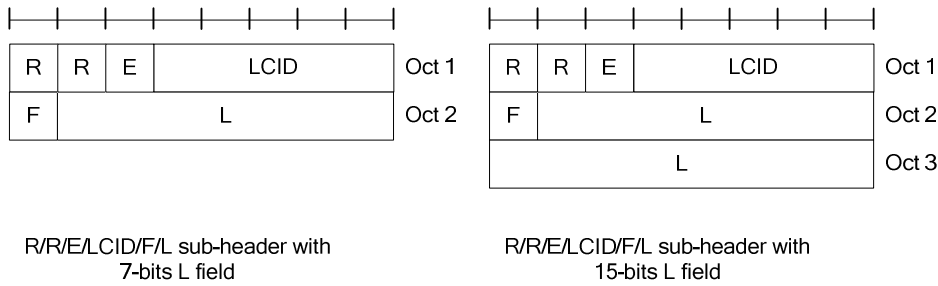

Figure 6.1.2-1: R/R/E/LCID/F/L MAC sub header

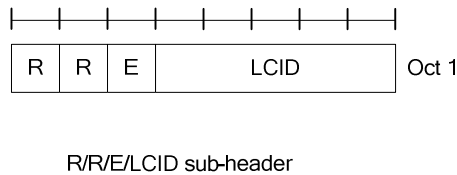

Figure 6.1.2-2: R/R/E/LCID MAC sub header

MAC PDU sub-headers have the same order as the corresponding MAC SDUs, MAC control elements and padding.

MAC control elements are always placed before any MAC SDU.

Padding occurs at the end of the MAC PDU, except when single-byte or two-byte padding is required. Padding may have any value and the UE shall ignore it.

When single-byte or two-byte padding is required, one or two MAC PDU subheaders corresponding to padding are placed at the beginning of the MAC PDU before any other MAC PDU subheader.

A maximum of one MAC PDU can be transmitted per TB per UE.

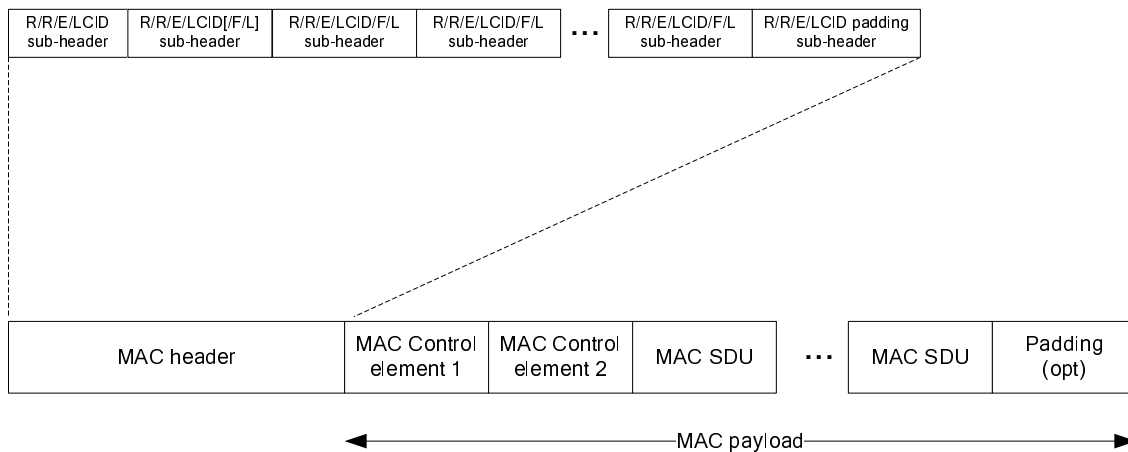

Figure 6.1.2-3: Example of MAC PDU consisting of MAC header, MAC control elements, MAC SDUs and padding

[TS 36.321, clause 6.2.1]

The MAC header is of variable size and consists of the following fields:

- LCID: The Logical Channel ID field identifies the logical channel instance of the corresponding MAC SDU or the type of the corresponding MAC control element or padding as described in tables 6.2.1-1 and 6.2.1-2 for the DL and UL-SCH respectively. There is one LCID field for each MAC SDU, MAC control element or padding included in the MAC PDU. In addition to that, one or two additional LCID fields are included in the MAC PDU,

when single-byte or two-byte padding is required but cannot be achieved by padding at the end of the MAC PDU. The LCID field size is 5 bits;

- L: The Length field indicates the length of the corresponding MAC SDU or MAC control element in bytes. There is one L field per MAC PDU sub header except for the last sub header and sub-headers corresponding to fixed-sized MAC control elements. The size of the L field is indicated by the F field;
- F: The Format field indicates the size of the Length field as indicated in table 6.2.1-3. There is one F field per MAC PDU sub header except for the last sub header and sub-headers corresponding to fixed-sized MAC control elements. The size of the F field is 1 bit. If the size of the MAC SDU or MAC control element is less than 128 bytes, the UE shall set the value of the F field to 0, otherwise the UE shall set it to 1;
- E: The Extension field is a flag indicating if more fields are present in the MAC header or not. The E field is set to "1" to indicate another set of at least R/R/E/LCID fields. The E field is set to "0" to indicate that either a MAC SDU, a MAC control element or padding starts at the next byte;
- R: Reserved bits, set to "0".

The MAC header and sub-headers are octet aligned.

...

Table 6.2.1-2: Values of LCID for UL-SCH

Index	LCID values
00000	CCCH
00001-01010	Identity of the logical channel
01011-11001	Reserved
11010	Power Headroom Report
11011	C-RNTI
11100	Truncated BSR
11101	Short BSR
11110	Long BSR
11111	Padding

....

Table 6.2.1-3: Values of F field:

Index	Size of Length field (in bits)
0	7
1	15

7.1.4.13.3 Test description

7.1.4.13.3.1 Pre-test conditions

System Simulator

- Cell 1

UE

None.

Preamble

- The UE is in state Loopback Activated (state 4) according to [18].
- 2 AM DRBs are configured with the parameters specified in table 7.1.4.13.3.1-1.

Table 7.1.4.13.3.1-1: Logical Channel Configuration Settings

Parameter	DRB1	DRB2
LogicalChannel-Identity	3	4
Priority	7	6
prioritizedBitRate	0kbs	0kbs
logicalChannelGroup	2	1
periodicBSR-Timer	infinity	

7.1.4.13.3.2 Test procedure sequence

Table 7.1.4.13.3.2-1: Main behaviour

St	Procedure	Message Sequence		TP	Verdict
		U - S	Message		
1	The SS ignores scheduling requests and does not allocate any uplink grant.	-	-	-	-
2	The SS transmits a MAC PDU containing a MAC SDU of size 127 bytes (RLC SDU of size 125 bytes + AMD PDU header 2 bytes with the Logical Channel ID field 'LCID' set to '00011', Format field 'F' set to '0' and Length field 'L' set to '127' in the associated MAC SDU sub-header.	<--	MAC PDU (MAC sub-header (LCID='00011', F='0', L='127'), AMD PDU)	-	-
3	The SS waits [10 TTIs]. (Note 5)	-	-	-	-
4	The SS transmits an uplink grant of size 1064 bits. (Note 1)	<--	(UL grant)	-	-
5	Check: does the UE transmit a MAC PDU with a MAC SDU sub-header with Logical Channel ID field 'LCID' set to '00011', Format field 'F' set to '0' and Length field 'L' set to '127'?	-->	MAC PDU (MAC sub-header (LCID='00011', F='0', L='127' bytes), AMD PDU)	1	P
6	The SS transmits a MAC PDU containing a MAC SDU of size 129 bytes RLC SDU of 127 bytes + AMD PDU header 2 bytes) with the Logical Channel ID field 'LCID' set to '00011', Format field 'F' set to '1' and Length field 'L' set to '129' in the associated MAC SDU sub-header.	<--	MAC PDU (MAC sub-header (LCID='00011', F='1', L='129'), AMD PDU)	-	-
7	The SS waits [10 TTIs]. (Note 5)	-	-	-	-
8	The SS transmits an uplink grant of size 1064 bits. (Note 2)	<--	(UL grant)	-	-
9	Check: Does the UE transmit a MAC PDU with a MAC SDU sub-header with Format field 'F' set to '1' and Logical Channel ID field 'LCID' set to '00011'?	-->	MAC PDU (MAC sub-header (LCID='00011', F='1', L='129'), AMD PDU)	2	P
10	The SS transmits an RLC STATUS PDU to acknowledge correctly received data	<--	RLC STATUS PDU (ACK_SN=2)	-	-
11	The SS transmits a MAC PDU containing two MAC SDUs, the first containing a 11 byte RLC SDU with LCID set to '00011' and the second containing a 10 byte RLC SDU with LCID set to '00100'.	<--	MAC PDU (MAC sub-header (E='1', LCID='00011', F='0', L='11'), MAC sub-header (E='0', LCID='00100', F='0'), AMD PDU, AMD PDU)	-	-
12	The SS waits [10 TTIs]. (Note 5)	-	-	-	-
13	The SS transmits an uplink grant of size 176 bits. (Note 3)	<--	(UL grant)	-	-
14	Check: Does the UE return a MAC PDU of length 176 bits containing two MAC sub-headers where the first MAC sub-header has the Expansion bit 'E' set to '1' and including a LCID field set to '00011' and a Length field set to '11'; or including a LCID set to '00100' and a Length field set to '10' bytes; and the second MAC sub-header has the Expansion bit 'E' set to '0' and not including any Length field?	-->	MAC PDU (MAC sub-header (E='1', (LCID='00011', L='11') or (LCID='00100', L='10'), MAC sub-header (E='0', no Length field present), AMD PDU, AMD PDU)	3,4, 5	P
15	SS transmits an RLC STATUS PDU to acknowledge correctly received data	<--	RLC STATUS PDU (ACK_SN=4)	-	-
16	The SS transmits a MAC PDU containing two MAC SDUs, the first containing a 10 byte RLC SDU with LCID set to '00011' and the second containing a 9 byte RLC SDU with LCID set to '00100'.	<--	MAC PDU (MAC sub-header (E='1', LCID='00011', F='0', L='10'), MAC sub-header (E='1', LCID='00100', F='0', L='9'), padding MAC sub-header (E='0', LCID='11111'), AMD PDU, AMD PDU, padding)	-	-
17	SS waits [10 TTIs]. (Note 5)	-	-	-	-
18	The SS transmits an uplink grant of size 224 bits. (Note 4)	<--	(UL grant)	-	-
19	Check: Does the UE return a MAC PDU of	-->	MAC PDU (MAC sub-header	3,4,	P

	length 224 bits containing four MAC sub-headers where the first two MAC sub-header have the Expansion bit 'E' set to '1' and the last MAC sub-header has the Expansion bit 'E' set to '0' and the LCID field set to '11111'?		(E='1', F='0'), MAC sub-header (E='1', F='0'), Long BSR MAC sub-header (E='1', LCID='11110', F='0'), padding MAC sub-header (E='0', LCID='11111'), AMD PDU, AMD PDU, Long BSR, padding)	6	
Note 1.	UL grant of 1064 bits ($I_{TBS}=17$, $N_{PRB}=3$, TS 36.213 Table 7.1.7.2.1-1) is chosen to enable UE to transmit a MAC SDU of size 127 bytes in a MAC PDU (125 bytes RLC SDU size + 2 bytes AMD PDU header + 2 bytes MAC header (7 bit LI) = 129 bytes = 1032 bits < 1064 bits)				
Note 2.	UL grant of 1096 bits ($I_{TBS}=17$, $N_{PRB}=3$, TS 36.213 Table 7.1.7.2.1-1) is chosen to enable UE to transmit a MAC SDU of size 129 bytes in a MAC PDU (127 bytes RLC SDU size + 2 bytes AMD PDU header + 3 bytes MAC header (15 bit LI) = 132 bytes = 1056 bits < 1064 bits)				
Note 3.	UL grant of 176 bits ($I_{TBS}=1$, $N_{PRB}=5$, TS 36.213 Table 7.1.7.2.1-1) is chosen to enable UE to transmit two MAC SDUs, one of size 11 and one of size 10 bytes, in a MAC PDU (9 bytes RLC SDU + 2 bytes AMD PDU header + 8 bytes RLC SDU + 2 bytes MAC sub-header (7 bit LI) + one byte MAC sub-header (R/R/E/LCID) = 22 bytes = 176 bits)				
Note 4.	UL grant of 224 bits ($I_{TBS}=5$, $N_{PRB}=5$, TS 36.213 Table 7.1.7.2.1-1) is chosen to enable UE to transmit two MAC SDUs of size 10 and 9 bytes in a MAC PDU (8 bytes RLC SDU + 2 bytes AMD PDU header + 7 bytes RLC SDU + 2 byte padding + 3 byte Long BSR + 2 x 2 bytes MAC sub-header (7 bit LI) + one byte BSR header + one byte padding MAC sub-header (R/R/E/LCID) = 28 bytes = 224 bits)				
Note 5:	The wait time is specified to ensure that the UE is ready to loop back the data when the grant is received.				

7.1.4.13.3.3 Specific Message Contents

None.

7.1.4.14 Correct HARQ process handling: TTI Bundling

7.1.4.14.1 Test Purpose (TP)

(1)

```
with { UE in E-UTRA RRC_CONNECTED state with DRB established and TTI bundling configured}
ensure that {
  when { UE receives an UL Grant with toggled NDI and has data available for transmission}
  then { UE transmits a new MAC PDU and non-adaptive retransmissions for 3 additional consecutive
UL subframes }
}
```

(2)

```
with { UE in E-UTRA RRC_CONNECTED state with DRB established, TTI bundling configured and having
transmitted a MAC PDU less than maxHARQ-Tx times }
ensure that {
  when { UE receives a NACK and no uplink grant is included for the next TTI corresponding to the
bundled HARQ process }
  then { UE performs non adaptive retransmission of the MAC PDU for 4 consecutive UL subframes }
}
```

(3)

```
with { UE in E-UTRA RRC_CONNECTED state with DRB established, TTI bundling configured and having
transmitted a MAC PDU less than maxHARQ-Tx times }
ensure that {
  when { UE receives an uplink grant on PDCCH for the next TTI corresponding to the HARQ process with
old NDI, irrespective of ACK/NACK is received for previous (re)transmission}
  then { UE performs an adaptive retransmission of the MAC PDU with redundancy version as received
on PDCCH in first UL subframe and non-adaptive retransmissions in 3 additional consecutive UL
subframes }
}
```

(4)

```
with { UE in E-UTRA RRC_CONNECTED state with DRB established and having transmitted a MAC PDU less
than maxHARQ-Tx times }
ensure that {
  when { UE receives a ACK and no uplink grant is included for the next TTI corresponding to the
HARQ process }
  then { UE does not retransmit the TTI Bundle}
}
```

7.1.4.14.2 Conformance requirements

References: The conformance requirements covered in the current TC are specified in: TS 36.321, clause 5.4.2.1, 5.4.2.2 & 7.5, TS 36.213 clause 8, 8.3 & 8.6.1.

[TS 36.321, clause 5.4.2.1]

There is one HARQ entity at the UE, which maintains a number of parallel HARQ processes allowing transmissions to take place continuously while waiting for HARQ the feedback on the successful or unsuccessful reception of previous transmissions.

The number of parallel HARQ processes is specified in [2], clause 8.

At a given TTI, if an uplink grant is indicated for the TTI, the HARQ entity identifies the HARQ process for which a transmission should take place. It also routes the received HARQ feedback (ACK/NACK information), MCS and resource, relayed by the physical layer, to the appropriate HARQ process.

When TTI bundling is configured, the parameter TTI_BUNDLE_SIZE provides the number of TTIs of a TTI bundle. TTI bundling operation relies on the HARQ entity for invoking the same HARQ process for each transmission that is part of the same bundle. Within a bundle HARQ retransmissions are non-adaptive and triggered without waiting for feedback from previous transmissions according to TTI_BUNDLE_SIZE. The HARQ feedback of a bundle is only received for the last TTI of the bundle (i.e the TTI corresponding to TTI_BUNDLE_SIZE), regardless of whether a transmission in that TTI takes place or not (e.g. when a measurement gap occurs). A retransmission of a TTI bundle is also a TTI bundle.

For transmission of Msg3 during Random Access (see section 5.1.5) TTI bundling does not apply.

For each TTI, the HARQ entity shall:

- identify the HARQ process associated with this TTI;
- if an uplink grant has been indicated for this TTI:
 - if the received grant was not addressed to a Temporary C-RNTI on PDCCH and if the NDI provided in the associated HARQ information has been toggled compared to the value in the previous transmission of this HARQ process; or
 - if this is the very first transmission for this HARQ process (i.e. , no previous NDI is available); or
 - if the uplink grant was received on PDCCH for the C-RNTI and the HARQ buffer of the identified process is empty; or
 - if the uplink grant was received in a Random Access Response:
 - if there is a MAC PDU in the Msg3 buffer and the uplink grant was received in a Random Access Response:
 - obtain the MAC PDU to transmit from the Msg3 buffer.
 - else:
 - obtain the MAC PDU to transmit from the "Multiplexing and assembly" entity;
 - deliver the MAC PDU and the uplink grant and the HARQ information to the identified HARQ process;
 - instruct the identified HARQ process to trigger a new transmission.
 - else:
 - deliver the uplink grant and the HARQ information (redundancy version) to the identified HARQ process;
 - instruct the identified HARQ process to generate an adaptive retransmission.
- else, if the HARQ buffer of the HARQ process corresponding to this TTI is not empty:
 - instruct the identified HARQ process to generate a non-adaptive retransmission.

When determining if NDI has been toggled compared to the value in the previous transmission UE shall ignore NDI received in all uplink grants on PDCCH for its Temporary C-RNTI.

NOTE: A retransmission triggered by the HARQ entity should be cancelled by the corresponding HARQ process if it collides with a measurement gap or if a non-adaptive retransmission is not allowed.

[TS 36.321, clause 5.4.2.2]

Each HARQ process is associated with a HARQ buffer.

Each HARQ process shall maintain a state variable `CURRENT_TX_NB`, which indicates the number of transmissions that have taken place for the MAC PDU currently in the buffer, and a state variable `HARQ_FEEDBACK`, which indicates the HARQ feedback for the MAC PDU currently in the buffer. When the HARQ process is established, `CURRENT_TX_NB` shall be initialized to 0.

The sequence of redundancy versions is 0, 2, 3, 1. The variable `CURRENT_IRV` is an index into the sequence of redundancy versions. This variable is up-dated modulo 4.

New transmissions and adaptive retransmissions are performed on the resource and with the MCS indicated on PDCCH, except for new transmissions of Msg3 which are performed according to UL grant in Random Access Response. Non-adaptive retransmission is performed on the same resource and with the same MCS as was used for the last made transmission attempt,

The UE is configured with a Maximum number of HARQ transmissions and a Maximum number of Msg3 HARQ transmissions by RRC: *maxHARQ-Tx* and *maxHARQ-Msg3Tx* respectively. For transmissions on all HARQ processes and all logical channels except for transmission of a MAC PDU stored in the Msg3 buffer, the maximum number of transmissions shall be set to *maxHARQ-Tx*. For transmission of a MAC PDU stored in the Msg3 buffer, the maximum number of transmissions shall be set to *maxHARQ-Msg3Tx*.

When the HARQ feedback is received for this TB, the HARQ process shall:

- set `HARQ_FEEDBACK` to the received value.

If the HARQ entity requests a new transmission, the HARQ process shall:

- set `CURRENT_TX_NB` to 0;
- set `CURRENT_IRV` to 0;
- store the MAC PDU in the associated HARQ buffer;
- store the uplink grant received from the HARQ entity;
- set `HARQ_FEEDBACK` to NACK;
- generate a transmission as described below.

If the HARQ entity requests a retransmission, the HARQ process shall:

- increment `CURRENT_TX_NB` by 1;
- if the HARQ entity requests an adaptive retransmission:
 - store the uplink grant received from the HARQ entity;
 - set `CURRENT_IRV` to the index corresponding to the redundancy version value provided in the HARQ information;
 - set `HARQ_FEEDBACK` to NACK;
 - generate a transmission as described below.
- else if the HARQ entity requests a non-adaptive retransmission:
 - if `HARQ_FEEDBACK = NACK`:
 - generate a transmission as described below.

NOTE 1: When receiving a HARQ ACK alone, the UE keeps the data in the HARQ buffer.

NOTE 2: When no UL-SCH transmission can be made due to the occurrence of a measurement gap, no HARQ feedback can be received and a non-adaptive retransmission follows.

To generate a transmission, the HARQ process shall:

- if the MAC PDU was obtained from the Msg3 buffer; or
- if there is no measurement gap at the time of the transmission and, in case of retransmission, the retransmission does not collide with a transmission for a MAC PDU obtained from the Msg3 buffer in this TTI:
 - instruct the physical layer to generate a transmission according to the stored uplink grant with the redundancy version corresponding to the CURRENT_IRV value;
 - increment CURRENT_IRV by 1;
 - if there is a measurement gap at the time of the HARQ feedback reception for this transmission and if the MAC PDU was not obtained from the Msg3 buffer:
 - set HARQ_FEEDBACK to ACK at the time of the HARQ feedback reception for this transmission.

After performing above actions, the HARQ process then shall:

- if CURRENT_TX_NB = maximum number of transmissions – 1:
 - flush the HARQ buffer;

[TS 36.321, clause 7.5]

The parameter TTI_BUNDLE_SIZE is 4.

[TS 36.213, clause 8]

In subframe bundling operation, a bundle of PUSCH transmissions consists of four consecutive uplink subframes in both FDD and TDD.

...

For FDD and subframe bundling operation, the UE shall upon detection of a PDCCH with DCI format 0 in subframe n intended for the UE, and/or a PHICH transmission in subframe $n-5$ intended for the UE, adjust the corresponding first PUSCH transmission in the bundle in subframe $n+4$ according to the PDCCH and PHICH information.

...

For TDD UL/DL configurations 1 and 6 and subframe bundling operation, the UE shall upon detection of a PDCCH with DCI format 0 in subframe n intended for the UE, and/or a PHICH transmission intended for the UE in subframe $n-l$ with l given in Table 8-2a, adjust the corresponding first PUSCH transmission in the bundle in subframe $n+k$, with k given in Table 8-2, according to the PDCCH and PHICH information.

...

Table 8-2: k for TDD configurations 0-6

TDD UL/DL Configuration	DL subframe number n									
	0	1	2	3	4	5	6	7	8	9
0	4	6				4	6			
1		6			4		6			4
2				4						4
3	4								4	4
4									4	4
5									4	
6	7	7				7	7			5

Table 8-2a: l for TDD configurations 0, 1 and 6

TDD UL/DL Configuration	DL subframe number n									
	0	1	2	3	4	5	6	7	8	9
0	9	6				9	6			
1		2			3		2			3
6	5	5				6	6			8

[TS 36.213, clause 8.3]

For Frame Structure type 1, an ACK/NACK received on the PHICH assigned to a UE in subframe i is associated with the PUSCH transmission in subframe $i-4$.

For Frame Structure type 2 UL/DL configuration 1-6, an ACK/NACK received on the PHICH assigned to a UE in subframe i is associated with the PUSCH transmission in the subframe $i-k$ as indicated by the following table 8.3-1.

...

Table 8.3-1 k for TDD configurations 0-6

TDD UL/DL Configuration	DL subframe number i									
	0	1	2	3	4	5	6	7	8	9
0	7	4				7	4			
1		4			6		4			6
2				6					6	
3	6								6	6
4									6	6
5									6	
6	6	4				7	4			6

[TS 36.213, clause 8.6.1]

For $0 \leq I_{\text{MCS}} \leq 28$, the modulation order (Q_m) is determined as follows:

...

- If the UE is to transmit the PUSCH in bundled mode, the resource allocation size is restricted to $N_{\text{PRB}} \leq 3$ and the modulation order is set to $Q_m = 2$.

7.1.4.14.3 Test description

7.1.4.14.3.1 Pre-test conditions

System Simulator:

- Cell 1

UE:

None.

Preamble:

- The UE is in state Loopback Activated (state 4) according to [18], with the DRB for the default EPS bearer context configured with RLC in UM mode.
- No UL Grant is allocated; PUCCH is in synchronised state for sending Scheduling Requests.

7.1.4.14.3.2 Test procedure sequence

Table 7.1.4.14.3.2-1: Main behaviour

St	Procedure	Message Sequence		TP	Verdict
		U - S	Message		
1	The SS Transmits a valid MAC PDU containing RLC PDU of size 312 bits	<--	MAC PDU	-	-
2	The UE transmit a Scheduling Request	-->	Scheduling Request	-	-
3	The SS allocate UL Grant of 328 bits with NDI indicating new transmission (i.e. Nprb=3 and Imcs=7)	<--	Uplink Grant	-	-
4	Check: Does the UE transmit a MAC PDU including one RLC SDU, with redundancy version 0, 'k' sub frame after step 3?	-->	MAC PDU	1	P
5	Check: Does UE repeats non adaptive retransmission of MAC PDU in step 4, for 3 consecutive UL sub-frames?	-->	MAC PDU	1	P
6	The SS transmits a NACK, 'kk' sub frame after last transmission in step 5.	<--	HARQ NACK	-	-
7	Check: Does the UE makes a non adaptive retransmission of the MAC PDU 'k+l' subframes after NACK in step 6, for 4 consecutive UL sub frames?	-->	MAC PDU	2	P
8	The SS transmits an ACK, 'kk' sub frame after last transmission in step 7.	<--	HARQ ACK	-	-
9	The SS allocate UL Grant with NDI indicating re transmission, start redundancy version =2[i.e. Nprb=3 and Imcs=30], 'l' sub frames after ACK in step 8.	<--	Uplink Grant	-	-
10	Check: Does the UE performs adaptive retransmission of the MAC PDU 'k' sub frames after grant in step 9, using redundancy version 2?	-->	MAC PDU	3	P
11	Check: Does UE repeats non adaptive retransmission of MAC PDU in step 10, for 3 consecutive UL sub-frames?	-->	MAC PDU	3	P
12	The SS transmits an ACK, 'kk' sub frame after last transmission in step 11.	<--	HARQ ACK	-	-
13	Check: Does the UE makes any retransmission of the MAC PDU 'k+l' subframes after ACK in step 12, for 4 consecutive UL sub frames?	-->	MAC PDU	4	F

Note: For FDD value of 'k', 'kk' is 4 and 'l' is 5.
For TDD UL/DL configuration 1, values of 'k', 'l' and 'kk' are given in table 7.1.4.14.3.2-2

Table 7.1.4.14.3.2-2: Values for parameter 'k', 'l' and 'kk' in Main behavior.

Parameter	DL sub-frame number <i>n</i>									
	0	1	2	3	4	5	6	7	8	9
k		6			4		6			4
l		2			3		2			3
kk		4			6		4			6

7.1.4.14.3.3 Specific message contents

Table 7.1.4.14.3.3-1: MAC-MainConfiguration in *RRCConnectionReconfiguration*(preamble)

Derivation Path: 36.508 table 4.8.2.1.5-1			
Information Element	Value/remark	Comment	Condition
MAC-MainConfiguration ::= SEQUENCE {			
ul-SCH-Configuration SEQUENCE {			
maxHARQ-Tx	n28	Max value allowed	
periodicBSR-Timer	sf20	Default value	
retxBSR-Timer	sf1280	Default value	
ttiBundling	TRUE		
}			
}			

7.1.4.15 UE Power Headroom Reporting [Periodic reporting]

7.1.4.15.1 Test Purpose (TP)

(1)

```
with { UE in E-UTRA RRC_Connected state with DRB established, periodic power headroom reporting
configured}
ensure that {
  when { PERIODIC PHR TIMER is configured in RRCConnectionReconfiguration procedure }
    then { UE transmits a MAC PDU containing Power Headroom MAC Control Element }
}
```

(2)

```
with { UE in E-UTRA RRC_Connected state with DRB established, periodic power headroom reporting
configured}
ensure that {
  when { PERIODIC PHR TIMER expires and UL resources allocated for new transmission }
    then { UE transmits a MAC PDU containing Power Headroom MAC Control Element }
}
```

(3)

```
with { UE in E-UTRA RRC_Connected state with DRB established}
ensure that {
  when { power headroom reporting is disabled }
    then { UE stops transmitting Power Headroom MAC Control Element }
}
```

7.1.4.15.2 Conformance requirements

References: The conformance requirements covered in the current TC are specified in: TS 36.321 clause 5.4.6 and 6.1.3.6, 36.331 clause 5.3.10.4.

[TS 36.321, clause 5.4.6]

The Power Headroom reporting procedure is used to provide the serving eNB with information about the difference between the nominal UE maximum transmit power and the estimated power for UL-SCH transmission. The reporting period, delay and mapping of Power Headroom are defined in subclause 9.1.8 of 3GPP TS 36.133 [9].

A Power Headroom Report (PHR) shall be triggered if any of the following events occur:

- the PROHIBIT_PHR_TIMER expires or has expired and the path loss has changed more than DL_PathlossChange dB since the last power headroom report when UE has UL resources for new transmission;
- the PERIODIC PHR TIMER expires, in which case the PHR is referred below to as "Periodic PHR";
- upon configuration and reconfiguration of a Periodic PHR.

If the UE has UL resources allocated for new transmission for this TTI:

- if the Power Headroom reporting procedure determines that a PHR has been triggered since the last transmission of a PHR:

- obtain the value of the power headroom from the physical layer;
- instruct the Multiplexing and Assembly procedure to generate a PHR MAC control element based on the value reported by the physical layer;
- if a "Periodic PHR" has been triggered since the last transmission of a PHR, start or restart the PERIODIC PHR TIMER;
- restart the PROHIBIT_PHR_TIMER.

NOTE: Even if multiple events occur by the time a PHR can be transmitted, only one PHR is included in the MAC PDU.

[TS 36.321, clause 6.1.3.6]

The Power Headroom MAC control element is identified by a MAC PDU sub header with LCID as specified in table 6.2.1-1. It has a fixed size and consists of a single octet defined as follows (figure 6.1.3.6-1):

- R: reserved bit, set to "0";
- Power Headroom(PH): this field indicates the power headroom level. The length of the field is 6 bits. The reported PH and the corresponding power headroom levels are shown in Table 6.1.3.6.1-1 below (the corresponding measured values in dB can be found in subclause 9.1.8.4 of [17])

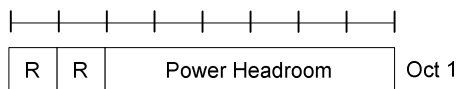

Figure 6.1.3.6-1: Power Headroom MAC control element

Table 6.1.3.6-1: Power Headroom levels for PHR

PH	Power Headroom Level
0	POWER_HEADROOM_0
1	POWER_HEADROOM_1
2	POWER_HEADROOM_2
3	POWER_HEADROOM_3
...	...
60	POWER_HEADROOM_60
61	POWER_HEADROOM_61
62	POWER_HEADROOM_62
63	POWER_HEADROOM_63

[TS 36.331, clause 5.3.10.4]

The UE shall:

- 1> if the received *radioResourceConfiguration* includes the IE *MAC-MainConfigurationmac-MainConfig*:
 - ...
- 2> else:
 - ...
- 3> if the *mac-MainConfig* includes *phr-Configuration*:
 - 4> if the *phr-Configuration* is set to 'disable':
 - 5> disable the power headroom reporting functionality;

7.1.4.15.3 Test description

7.1.4.15.3.1 Pre-test conditions

System Simulator:

- Cell 1

UE:

None.

Preamble:

- The UE is in state Generic RB Established (state 3) on Cell 1 according to [18].

7.1.4.15.3.2 Test procedure sequence

Table 7.1.4.15.3.2-1: Main behaviour

St	Procedure	Message Sequence		TP	Verdict
		U - S	Message		
1	The SS transmits UL grant for the UE at every TTI for FDD, and only at DL subframes for TDD.				
2	The SS transmits an <i>RRCCONNECTIONRECONFIGURATION</i> message to provide Power Headroom parameters	-	-	-	-
3	Check: does the UE transmit a MAC PDU containing Power Headroom MAC Control Element	-->	MAC PDU	1	P
4	The UE transmits an <i>RRCCONNECTIONRECONFIGURATIONCOMPLETE</i> message to confirm the setup of Power Headroom parameters.	-	-	-	-
5	Check: does the UE transmit a MAC PDU containing Power Headroom MAC Control Element 200ms after step 3?	-->	MAC PDU	2	P
6	The SS transmits an <i>RRCCONNECTIONRECONFIGURATION</i> message to disable Power Headroom reporting	-	-	-	-
7	The UE transmits an <i>RRCCONNECTIONRECONFIGURATIONCOMPLETE</i> message to confirm the disabling of Power Headroom parameters	-	-	-	-
8	Check: for 2 seconds, does the UE transmit a MAC PDU containing Power Headroom MAC Control Element	-->	MAC PDU	3	P

Note: Steps 3 and 4 can happen in 2 MAC PDU's, or may be combined in one MAC PDU.

7.1.4.15.3.3 Specific message contents

Table 7.1.4.15.3.3-1: RRCConnectionReconfiguration (step 1, Table 8.2.4.6.3.2-2)

Derivation path: 36.508 table xxx			
Information Element	Value/Remark	Comment	Condition
<pre> RRCConnectionReconfiguration ::= SEQUENCE { criticalExtensions CHOICE { c1 CHOICE{ rrcConnectionReconfiguration-r8 SEQUENCE { RadioResourceConfigDedicated SEQUENCE { mac-MainConfig CHOICE { explicit SEQUENCE { phr-Configuration CHOICE { enable SEQUENCE { periodicPHR-Timer prohibitPHR-Timer dl-PathlossChange } } } } } } } } } </pre>	<p>sf200 sf1000 infinity</p>		

Table 7.1.4.15.3.3-2: RRCConnectionReconfiguration (step 6, Table 8.2.4.6.3.2-2)

Derivation path: 36.508 table xxx			
Information Element	Value/Remark	Comment	Condition
<pre> RRCConnectionReconfiguration ::= SEQUENCE { criticalExtensions CHOICE { c1 CHOICE{ rrcConnectionReconfiguration-r8 SEQUENCE { RadioResourceConfigDedicated SEQUENCE { mac-MainConfig CHOICE { explicit SEQUENCE { phr-Configuration CHOICE { disable } } } } } } } } </pre>	<p>NULL</p>		

7.1.4.16 UE Power Headroom Reporting [DL_Pathloss change reporting]

7.1.4.16.1 Test Purpose (TP)

(1)

```

with { UE in E-UTRA RRC_Connected state with DRB established, Power headroom reporting for
DL_Pathloss change configured}
ensure that {
  when { the DL Pathloss changes and prohibitPHR-Timer is running }
  then { UE does not transmits a MAC PDU containing Power Headroom MAC Control Element }
}
                    
```

(2)

```

with { UE in E-UTRA RRC_Connected state with DRB established, periodic power headroom reporting
configured}
ensure that {
                    
```



```

when { prohibitPHR-Timer expires and power headroom report is triggered due to DL Pathloss change
}
  then { UE transmits a MAC PDU containing Power Headroom MAC Control Element }
  }
    
```

7.1.4.16.2 Conformance requirements

References: The conformance requirements covered in the current TC are specified in: TS 36.321 clause 5.4.6 and 6.1.3.6

[TS 36.321, clause 5.4.6]

The Power Headroom reporting procedure is used to provide the serving eNB with information about the difference between the nominal UE maximum transmit power and the estimated power for UL-SCH transmission. The reporting period, delay and mapping of Power Headroom are defined in subclause 9.1.8 of 3GPP TS 36.133 [9].

A Power Headroom Report (PHR) shall be triggered if any of the following events occur:

- the PROHIBIT_PHR_TIMER expires or has expired and the path loss has changed more than *DL_PathlossChange* dB since the last power headroom report when UE has UL resources for new transmission;
- the PERIODIC PHR TIMER expires, in which case the PHR is referred below to as "Periodic PHR";
- upon configuration and reconfiguration of a Periodic PHR.

If the UE has UL resources allocated for new transmission for this TTI:

- if the Power Headroom reporting procedure determines that a PHR has been triggered since the last transmission of a PHR:
 - obtain the value of the power headroom from the physical layer;
 - instruct the Multiplexing and Assembly procedure to generate a PHR MAC control element based on the value reported by the physical layer;
 - if a "Periodic PHR" has been triggered since the last transmission of a PHR, start or restart the PERIODIC PHR TIMER;
 - restart the PROHIBIT_PHR_TIMER.

NOTE: Even if multiple events occur by the time a PHR can be transmitted, only one PHR is included in the MAC PDU.

[TS 36.321, clause 6.1.3.6]

The Power Headroom MAC control element is identified by a MAC PDU sub header with LCID as specified in table 6.2.1-1. It has a fixed size and consists of a single octet defined as follows (figure 6.1.3.6-1):

- R: reserved bit, set to "0";
- Power Headroom (PH): this field indicates the power headroom level. The length of the field is 6 bits. The reported PH and the corresponding power headroom levels are shown in Table 6.1.3.6.1-1 below (the corresponding measured values in dB can be found in subclause 9.1.8.4 of [17]).

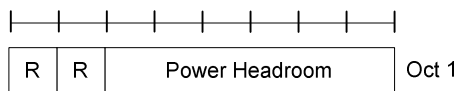

Figure 6.1.3.6-1: Power Headroom MAC control element

Table 6.1.3.6-1: Power Headroom levels for PHR

PH	Power Headroom Level
0	POWER_HEADROOM_0
1	POWER_HEADROOM_1
2	POWER_HEADROOM_2
3	POWER_HEADROOM_3
...	...
60	POWER_HEADROOM_60
61	POWER_HEADROOM_61
62	POWER_HEADROOM_62
63	POWER_HEADROOM_63

7.1. 4.15.3 Test description

7.1.4.16.3.1 Pre-test conditions

System Simulator:

- Cell 1

UE:

None.

Preamble:

- The UE is in state Generic RB Established (state 3) on Cell 1 according to [18].

7.1.4.16.3.2 Test procedure sequence

Table 7.1.4.16.3.2-1: Main behaviour

St	Procedure	Message Sequence		TP	Verdict
		U - S	Message		
1	Exception: SS is configured to transmit UL grant for UE at every TTI for FDD, and only at DL subframes for TDD.				
2	SS transmits an <i>RRCCONNECTIONRECONFIGURATION</i> message to provide Power Headroom parameters	<--	<i>RRCCONNECTIONRECONFIGURATION</i>	-	-
3	The UE transmit a MAC PDU containing Power Headroom MAC Control Element.	-->	MAC PDU	-	-
4	The UE transmits an <i>RRCCONNECTIONRECONFIGURATIONCOMPLETE</i> message to confirm the setup of Power Headroom parameters.	-->	<i>RRCCONNECTIONRECONFIGURATIONCOMPLETE</i>	-	-
5	Wait for $T1 = 10\%$ of <i>prohibitPHR-Timer</i> .				
6	Reduce SS power level so as to cause a DL_Pathloss change at UE by 5dB.				
7	Check : for 80% of <i>prohibitPHR-Timer</i> since step 6, if the UE transmit a MAC PDU containing Power Headroom MAC Control Element	-->	MAC PDU	1	F
8	Check: after <i>prohibitPHR-Timer</i> after step 4, does the UE transmit a MAC PDU containing Power Headroom MAC Control Element	-->	MAC PDU	2	P
9	Increase SS power level so as to cause a DL_Pathloss change at UE by 5dB.				
10	Check : for 80% of <i>prohibitPHR-Timer</i> since step 6, if the UE transmit a MAC PDU containing Power Headroom MAC Control Element	-->	MAC PDU	1	F
11	Check: after <i>prohibitPHR-Timer</i> after step 8, does the UE transmit a MAC PDU containing Power Headroom MAC Control Element	-->	MAC PDU	2	P

Note: Steps 3 and 4 can happen in in 2 MAC PDU's, or may be combined in one MAC PDU.

7.1.4.16.3.3 Specific message contents

Table 7.1. 4.15.3.3-1: RRCCONNECTIONRECONFIGURATION (step 1, Table 8.2.4.6.3.2-2)

Derivation path: 36.508 table xxx			
Information Element	Value/Remark	Comment	Condition
<pre> RRCCONNECTIONRECONFIGURATION ::= SEQUENCE { criticalExtensions CHOICE { c1 CHOICE{ rrcConnectionReconfiguration-r8 SEQUENCE { RadioResourceConfigDedicated SEQUENCE { mac-MainConfig CHOICE { explicit SEQUENCE { phr-Configuration CHOICE { enable SEQUENCE { periodicPHR-Timer prohibitPHR-Timer dl-PathlossChange } } } } } } } } } } </pre>	<p>infinity sf1000 dB3</p>		

7.1.6 DRX operation

7.1.6.1 DRX Operation / (short cycle not configured) /Parameters configured by RRC (radio resource configuration)

7.1.6.1.1 Test Purpose (TP)

(1)

```
with { UE in CONNECTED mode }
ensure that {
  when { long DRX cycle is configured and [(SFN * 10) + subframe number] modulo (LongDRX-Cycle) =
drxStartOffset }
    then { UE starts the OnDurationTimer and monitors the PDCCH for OnDurationTimer PDCCH-subframes}
```

(2)

```
with { UE in CONNECTED mode }
ensure that {
  when { long DRX cycle is configured and a new DL transmission is indicated on the PDCCH during
Active Time }
    then { UE monitors the PDCCH for Drx-InactivityTimer PDCCH sub-frames starting from the next
PDCCH sub-frame of the PDCCH sub-frame where the DL new transmission was indicated }
}
```

(3)

```
with { UE in CONNECTED mode }
ensure that {
  when { long DRX cycle is configured and if a HARQ RTT Timer expires in this subframe and the data
in the soft buffer of the corresponding HARQ process was not successfully decoded}
    then { UE starts the drx-RetransmissionTimer for the corresponding HARQ process and monitors the
PDCCH for drx-RetransmissionTimer consecutive PDCCH-subframes}
```

(4)

```
with { UE in CONNECTED mode }
ensure that {
  when { long DRX cycle is configured and an uplink grant for a pending HARQ retransmission can
occur in this subframe }
    then { UE monitors the PDCCH in this subframe }
```

7.1.6.1.2 Conformance requirements

References: The conformance requirements covered in the current TC are specified in: TS 36.321, clauses 3.1 and 5.7.

[TS 36.321, clause 3.1]

Active Time: Time related to DRX operation, as defined in subclause 5.7, during which the UE monitors the PDCCH in PDCCH-subframes.

...

DRX Cycle: Specifies the periodic repetition of the On Duration followed by a possible period of inactivity (see figure 3.1-1 below).

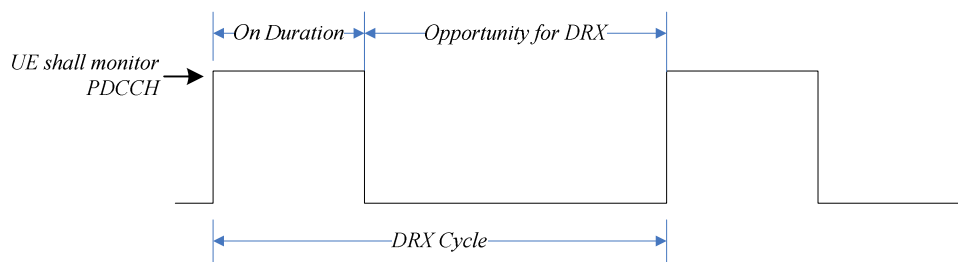

Figure 3.1-1: DRX Cycle

drx-InactivityTimer: Specifies the number of consecutive PDCCH-subframe(s) after successfully decoding a PDCCH indicating an initial UL or DL user data transmission for this UE.

drx-RetransmissionTimer: Specifies the maximum number of consecutive PDCCH-subframe(s) for as soon as a DL retransmission is expected by the UE.

drxShortCycleTimer: Specifies the number of consecutive subframe(s) the UE shall follow the short DRX cycle.

drxStartOffset: Specifies the subframe where the DRX Cycle starts.

...

HARQ RTT Timer: This parameter specifies the minimum amount of subframe(s) before a DL HARQ retransmission is expected by the UE.

...

onDurationTimer: Specifies the number of consecutive PDCCH-subframe(s) at the beginning of a DRX Cycle.

PDCCH-subframe: For FDD UE operation, this represents any subframe; for TDD, only downlink subframes and subframes including DwPTS.

[TS 36.321, clause 5.7]

The UE may be configured by RRC with a DRX functionality that controls the UE's PDCCH monitoring activity for the UE's C-RNTI, TPC-PUCCH-RNTI, TPC-PUSCH-RNTI and Semi-Persistent Scheduling C-RNTI (if configured). When in RRC_CONNECTED, if DRX is configured, the UE is allowed to monitor the PDCCH discontinuously using the DRX operation specified in this subclause; otherwise the UE monitors the PDCCH continuously. When using DRX operation, the UE shall also monitor PDCCH according to requirements found in other subclauses of this specification. RRC controls DRX operation by configuring the timers *onDurationTimer*, *drx-InactivityTimer*, *drx-RetransmissionTimer* (one per DL HARQ process except for the broadcast process), the *longDRX-Cycle*, the value of the *drxStartOffset* and optionally the *drxShortCycleTimer* and *shortDRX-Cycle*. A HARQ RTT timer per DL HARQ process (except for the broadcast process) is also defined (see subclause 7.7).

When a DRX cycle is configured, the Active Time includes the time while:

- *onDurationTimer* or *drx-InactivityTimer* or *drx-RetransmissionTimer* or *mac-ContentionResolutionTimer* (as described in subclause 5.1.5) is running; or
- a Scheduling Request sent on PUCCH is pending (as described in subclause 5.4.4); or
- an uplink grant for a pending HARQ retransmission can occur and there is data in the corresponding HARQ buffer; or
- a PDCCH indicating a new transmission addressed to the C-RNTI of the UE has not been received after successful reception of a Random Access Response for the explicitly signaled preamble (as described in subclause 5.1.4).

When DRX is configured, the UE shall for each subframe:

- If the Short DRX Cycle is used and $[(SFN * 10) + \text{subframe number}] \bmod (shortDRX-Cycle) = (drxStartOffset) \bmod (shortDRX-Cycle)$; or
- if the Long DRX Cycle is used and $[(SFN * 10) + \text{subframe number}] \bmod (LongDRX-Cycle) = drxStartOffset$:
 - start *onDurationTimer*.
- if a HARQ RTT Timer expires in this subframe and the data in the soft buffer of the corresponding HARQ process was not successfully decoded:
 - start the *drx-RetransmissionTimer* for the corresponding HARQ process.
- if a DRX Command MAC control element is received:
 - stop *onDurationTimer*;

- stop *drx-InactivityTimer*.
- if *drx-InactivityTimer* expires or a DRX Command MAC control element is received in this subframe:
 - if the short DRX cycle is configured:
 - start or restart *drxShortCycleTimer*;
 - use the Short DRX Cycle.
 - else:
 - use the Long DRX cycle.
- if *drxShortCycleTimer* expires in this subframe:
 - use the long DRX cycle.
- during the Active Time, for a PDCCH-subframe except if the subframe is required for uplink transmission for half-duplex FDD UE operation and except if the subframe is part of a configured measurement gap:
 - monitor the PDCCH;
 - if the PDCCH indicates a DL transmission or if a DL assignment has been configured for this subframe:
 - start the HARQ RTT Timer for the corresponding HARQ process;
 - stop the *drx-RetransmissionTimer* for the corresponding HARQ process.
 - if the PDCCH indicates a new transmission (DL or UL):
 - start or restart *drx-InactivityTimer*.
- when not in Active Time, CQI/PMI/RI on PUCCH and SRS shall not be reported.

Regardless of whether the UE is monitoring PDCCH or not the UE receives and transmits HARQ feedback when such is expected.

NOTE: A UE may optionally choose to not send CQI/PMI/RI reports on PUCCH and/or SRS transmissions for up to 4 subframes following a PDCCH indicating a new transmission (UL or DL) received in the last subframe of active time. The choice not to send CQI/PMI/RI reports on PUCCH and/or SRS transmissions is not applicable for subframes where *onDurationTimer* is running.

7.1.6.1.3 Test description

7.1.6.1.3.1 Pre-test conditions

System Simulator:

- Cell 1

UE:

None.

Preamble:

- The UE is in state Loopback Activated (state 4) according to [18] configured to return no data in UL.

7.1.6.1.3.2 Test procedure sequence

Table 7.1.6.1.3.2-1: Main Behaviour

St	Procedure	Message Sequence		TP	Verdict
		U - S	Message		
1	In the first PDCCH sub frame when the OnDurationTimer is running(For FDD only $[(SFN * 10) + \text{subframe number}] \bmod (LongDRX-Cycle) = \text{drxStartOffset}$ the SS indicates the transmission of a DL MAC PDU on the PDCCH.	<-	MAC PDU		
2	Check: Does the UE transmit a HARQ ACK for the DL MAC PDU in Step 1?	->	HARQ ACK	1,	P
3	At least drx-InactivityTimer PDCCH-sub frames after the transmission of the MAC PDU in Step 1 has been indicated(This means the next DRX cycle or later after Step 1) in the last PDCCH sub frame while the onDurationTimer is still running(For FDD only $[(SFN * 10) + \text{subframe number}] \bmod (LongDRX-Cycle) = \text{drxStartOffset} + \text{onDurationTimer} - 1$) the SS indicates the transmission a DL MAC PDU on the PDDCH. (Note 4)	<-	MAC PDU		
4	Check: Does the UE transmit a HARQ ACK for the DL MAC PDU in Step 3?	->	HARQ ACK	1	P
5	drx-InactivityTimer PDCCH-subframes after the transmission of the MAC PDU transmitted in step 3 was indicated on the PDCCH (For FDD only $[(SFN * 10) + \text{subframe number}] \bmod (LongDRX-Cycle) = \text{drxStartOffset} + \text{onDurationTimer} + \text{drx-InactivityTimer} - 1$) the SS indicates the transmission of a DL MAC PDU on the PDCCH. (Note 4)	<-	MAC PDU		
6	Check: Does the UE transmit a HARQ ACK for the DL MAC PDU in Step 5?	->	HARQ ACK	2	P
7	At least drx-InactivityTimer PDCCH sub frames after the transmission of the MAC PDU in Step 5 has been indicated (This means the next DRX cycle or later after Step 3) and 1 PDCCH sub-frame before the OnDurationTimer expires(For FDD only $[(SFN * 10) + \text{subframe number}] \bmod (LongDRX-Cycle) = \text{drxStartOffset} + \text{onDurationTimer} - 2$) the SS indicates the transmission of a DL MAC PDU on the PDDCH. The DL MAC PDU transmitted is invalid. (Note 1, Note 4)	<-	Invalid MAC PDU		
8	Check: Does the UE transmit a HARQ NACK for the DL MAC PDU in Step 7?	->	HARQ NACK	1	P
9	In the first PDCCH sub frame when the Drx-RetransmissionTimer for the MAC PDU in Step 7 is started (For FDD only $LongDRX-Cycle) = \text{drxStartOffset} + \text{onDurationTimer} - 2 + \text{HARQ RTT timer}$) the SS indicates the transmission of a DL MAC PDU on the PDCCH.		MAC PDU		
10	Check: Does the UE transmit a HARQ ACK for the DL MAC PDU in Step 9?	->	HARQ ACK	3	P
11	At least drx-InactivityTimer PDCCH sub frames after the transmission of the DL MAC PDU in Step 9 has been indicated (This means the next DRX cycle or later after Step 5) and 1 PDCCH sub-frame before the OnDurationTimer expires(For FDD only $[(SFN * 10) + \text{subframe number}] \bmod (LongDRX-Cycle) = \text{drxStartOffset} + \text{onDurationTimer} - 2$) the SS indicates the transmission of DL MAC PDU on the PDCCH. The DL MAC PDU transmitted is invalid(Note 1, Note 4)	<-	Invalid MAC PDU		

12	Check: Does the UE transmit a HARQ NACK for the DL MAC PDU in Step 11?	->	HARQ NACK	1	P
13	In the last PDCCH sub frame when the drx-RetransmissionTimer for MAC PDU in Step 11 is still running (For FDD only <i>LongDRX-Cycle</i>) = $drxStartOffset + onDurationTimer - 2 + HARQ\ RTT\ timer + drx-RetransmissionTimer - 1$ the SS indicates the transmission of a DL MAC PDU on the PDCCH.	<-	MAC PDU		
14	Check: Does the UE transmit a HARQ ACK for the DL MAC PDU in Step 13?	->	HARQ ACK	3	P
15	At least drx-InactivityTimer PDCCH sub frames after the transmission of the DL MAC PDU in Step 13 has been indicated in the last sub-frame when the onDurationTimer is still running (This means the next DRX cycle or later after Step 7) (For FDD only <i>LongDRX-Cycle</i>) = $drxStartOffset + onDurationTimer - 1$ the SS indicates an UL grant to the UE on the PDCCH. (Note 4)	<-	UL grant on PDCCH		
16	Check: Does the UE transmit a Buffer Status Report on the UL indicating an empty buffer?	->	Buffer Status Report MAC control element		
17	X sub frames after the sub frame in which the UL grant was indicated on the PDCCH for the UL MAC PDU sent in the previous step the SS indicates the transmission of a DL MAC PDU on the PDCCH. <i>X is the number of sub frames required to do a retransmission of the UL MAC PDU transmitted in the previous Step maxHARQ-Tx - 1 times (for FDD this is 8x maxHARQ-Tx sub frames).</i>	<-	MAC PDU		
18	Check: Does the UE transmit a HARQ ACK for the DL MAC PDU in Step 17?	->	HARQ ACK	4	P
<p>Note 1: Invalid MAC PDU is a MAC PDU that fails the CRC check.</p> <p>Note 2: All the DL MAC PDU are transmitted with the NDI set on the PDCCH.</p> <p>Note 3: Timer tolerances for the MAC DRX related timers measured in subframes or PDCCH subframes is 0. These timers are: drx-InactivityTimer, drx-RetransmissionTimer, HARQ RTT Timer.</p> <p>Note 4: The drx-InactivityTimer is started in the next PDCCH sub-frame of the PDCCH sub-frame where DL new transmission is indicated</p>					

7.1.6.1.3.3 Specific message contents

Table 7.1.6.1.3.3-1: specific Parameters in RRCConnectionSetup in the preamble

Derivation Path: 36.331 clause 6.3.2			
Information Element	Value/remark	Comment	Condition
MAC-MainConfig-RBC ::= SEQUENCE {			
ul-SCH-Config SEQUENCE {			
maxHARQ-Tx	n5		
periodicBSR-Timer	infinity		
retxBSR-Timer	sf10240		
ttiBundling	FALSE		
}			
drx-Config CHOICE {			
setup SEQUENCE {			
onDurationTimer	psf20		
drx-InactivityTimer	psf6		
drx-RetransmissionTimer	psf6		
longDRX-CycleStartOffset CHOICE {			
sf640	1		
}			
shortDRX	Not present		
}			
}			

7.1.6.2 DRX Operation / Parameters (short cycle not configured) / DRX command MAC control element reception

7.1.6.2.1 Test Purpose (TP)

(1)

```
with { UE in CONNECTED mode }
ensure that {
  if { long DRX cycle is configured and a DRX Command MAC control element is received }
  then { UE successfully decodes the MAC control PDU }
}
```

(2)

```
with { UE in CONNECTED mode }
ensure that {
  if { long DRX cycle is configured and the HARQ RTT Timer is running and a DRX Command MAC control
  element is received }
  then { UE continues running the HARQ RTT timer }
}
```

(3)

```
with { UE in CONNECTED mode }
ensure that {
  if { long DRX cycle is configured and the drx-RetransmissionTimer is running and a DRX Command MAC
  control element is received }
  then { UE continues running the drx-RetransmissionTimer and monitors the PDCCH }
}
```

7.1.6.2.2 Conformance requirements

References: The conformance requirements covered in the current TC are specified in: TS 36.321, clauses 3.1 and 5.7.

[TS 36.321, clause 3.1]

Active Time: Time related to DRX operation, as defined in subclause 5.7, during which the UE monitors the PDCCH in PDCCH-subframes.

...

DRX Cycle: Specifies the periodic repetition of the On Duration followed by a possible period of inactivity (see figure 3.1-1 below).

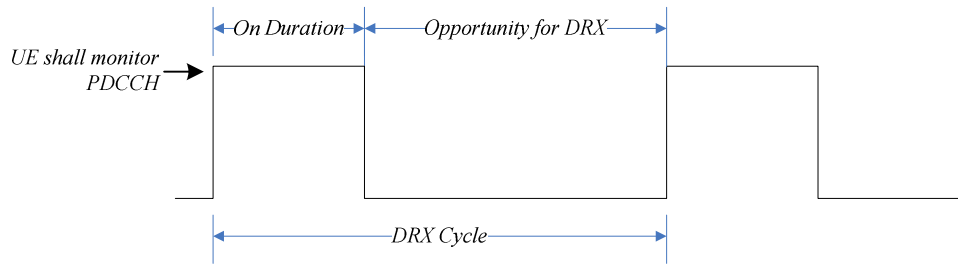

Figure 3.1-1: DRX Cycle

drx-InactivityTimer: Specifies the number of consecutive PDCCH-subframe(s) after successfully decoding a PDCCH indicating an initial UL or DL user data transmission for this UE.

drx-RetransmissionTimer: Specifies the maximum number of consecutive PDCCH-subframe(s) for as soon as a DL retransmission is expected by the UE.

drxShortCycleTimer: Specifies the number of consecutive subframe(s) the UE shall follow the short DRX cycle.

drxStartOffset: Specifies the subframe where the DRX Cycle starts.

...

HARQ RTT Timer: This parameter specifies the minimum amount of subframe(s) before a DL HARQ retransmission is expected by the UE.

...

onDurationTimer: Specifies the number of consecutive PDCCH-subframe(s) at the beginning of a DRX Cycle.

PDCCH-subframe: For FDD UE operation, this represents any subframe; for TDD, only downlink subframes and subframes including DwPTS.

[TS 36.321, clause 5.7]

- if a HARQ RTT Timer expires in this subframe and the data in the soft buffer of the corresponding HARQ process was not successfully decoded:
 - start the *drx-RetransmissionTimer* for the corresponding HARQ process.
- if a DRX Command MAC control element is received:
 - stop *onDurationTimer*;
 - stop *drx-InactivityTimer*.
- if *drx-InactivityTimer* expires or a DRX Command MAC control element is received in this subframe:
 - if the short DRX cycle is configured:
 - start or restart *drxShortCycleTimer*;
 - use the Short DRX Cycle.
 - else:
 - use the Long DRX cycle.
- if *drxShortCycleTimer* expires in this subframe:
 - use the long DRX cycle.
- during the Active Time, for a PDCCH-subframe except if the subframe is required for uplink transmission for half-duplex FDD UE operation and except if the subframe is part of a configured measurement gap:
 - monitor the PDCCH;

- if the PDCCH indicates a DL transmission or if a DL assignment has been configured for this subframe:
 - start the HARQ RTT Timer for the corresponding HARQ process;
 - stop the *drx-RetransmissionTimer* for the corresponding HARQ process.
- if the PDCCH indicates a new transmission (DL or UL):
 - start or restart *drx-InactivityTimer*.
- when not in Active Time, CQI/PMI/RI on PUCCH and SRS shall not be reported.

Regardless of whether the UE is monitoring PDCCH or not the UE receives and transmits HARQ feedback when such is expected.

7.1.6.2.3 Test description

7.1.6.2.3.1 Pre-test conditions

System Simulator:

- Cell 1

UE:

None.

Preamble:

- The UE is in state Loopback Activated (state 4) according to [18] configured to return no data in UL.

7.1.6.2.3.2 Test procedure sequence

Table 7.1.6.2.3.2-1: Main Behavior

St	Procedure	Message Sequence		TP	Verdict
		U - S	Message		
1	In a PDCCH sub frame which is X sub frames before the PDCCH sub-frame in which the onDurationTimer expires, with $\text{drx-InactivityTimer} < X < \text{HARQ RTT timer}$, (For FDD only $[(\text{SFN} * 10) + \text{subframe number}] \bmod (\text{Long DRX Cycle}) = \text{drxStartOffset} + \text{onDurationTimer} - 1 - X$) the SS indicates the transmission of a DL MAC PDU on the PDCCH. The SS transmits an invalid MAC PDU.(Note 1)	<-	MAC PDU		
2	Check: Does the UE transmit a HARQ NACK for the DL MAC PDU in Step 1?	->	HARQ NACK		
3	In a PDCCH sub frames before the onDurationTimer expires(For FDD $[(\text{SFN} * 10) + \text{subframe number}] \bmod (\text{Long DRX Cycle}) = \text{drxStartOffset} + \text{onDurationTimer} - 1 - X + Y$ where $0 < Y < X$) the SS indicates the transmission of a DL MAC PDU on the PDCCH. The SS transmits a DL MAC PDU with DRX MAC Control element. UE successfully decodes the MAC PDU	<-	MAC PDU(DRX MAC Control element)		
4	Check: Does the UE transmit a HARQ ACK for the DL MAC PDU in Step 3?	->	HARQ ACK	1	P
5	In the PDCCH sub frame when the drx-RetransmissionTimer for the MAC PDU indicated in Step 1 on the PDCCH (For FDD only $[(\text{SFN} * 10) + \text{subframe number}] \bmod (\text{Long DRX Cycle}) = \text{drxStartOffset} + \text{onDurationTimer} - 1 - X + \text{HARQ RTT Timer}$) is started the SS indicates the transmission of a DL MAC PDU. The SS transmits an invalid MAC PDU.(Note 1)	<-	MAC PDU		
6	Check: Does the UE transmit a HARQ NACK for the DL MAC PDU in Step 5?	->	HARQ NACK	2,3	P
7	Z PDCCH sub frames, where $Z > \text{drx-InactivityTimer}$, before the PDCCH sub-frame in which the drx-RetransmissionTimer for the DL MAC PDU in Step 5 expires (For FDD only $[(\text{SFN} * 10) + \text{subframe number}] \bmod (\text{Long DRX Cycle}) = \text{drxStartOffset} + \text{onDurationTimer} - 1 - X + \text{HARQ RTT} + \text{drx-RetransmissionTimer} - Z$ where $1 < Z < \text{drx-RetransmissionTimer}$) the SS indicates the transmission of a DL MAC PDU. The SS transmits a DL MAC PDU with DRX MAC Control element.	<-	MAC PDU(DRX MAC Control element)		
8	Check: Does the UE transmit a HARQ ACK for the DL MAC PDU in Step 7?	->	HARQ ACK	2,3,1	P
9	In the last sub frame when the Drx-RetransmissionTimer for the DL MAC PDU indicated on the PDCCH in Step 5 is still running(For FDD $[(\text{SFN} * 10) + \text{subframe number}] \bmod (\text{Long DRX Cycle}) = \text{drxStartOffset} + \text{onDurationTimer} - 1 - X + \text{HARQ RTT} + \text{drx-RetransmissionTimer} - 1$) the SS indicates the transmission of a DL MAC PDU.	<-	MAC PDU		
10	Check: Does the UE transmit a HARQ ACK for the DL MAC PDU in Step 9?	->	HARQ ACK	2,3	P

Note 1: Invalid MAC PDU is a MAC PDU that fails the CRC check.

Note 2: All DL MAC PDUs are transmitted with the NDI set on the PDCCH.
 Note 3: Timer tolerances for the MAC DRX related timers measured in subframes or PDCCH subframes is 0. These timers are: drx-InactivityTimer, drx-RetransmissionTimer, HARQ RTT Timer.

7.1.6.2.3.3 Specific message contents

Table 7.1.6.2.3.3-1: specific Parameters in RRCConnectionSetup in the preamble

Derivation Path: 36.331 clause 6.3.2			
Information Element	Value/remark	Comment	Condition
MAC-MainConfig-RBC ::= SEQUENCE {			
ul-SCH-Config SEQUENCE {			
maxHARQ-Tx	n5		
periodicBSR-Timer	infinity		
retxBSR-Timer	sf10240		
ttiBundling	FALSE		
}			
drx-Config CHOICE {			
setup SEQUENCE {			
onDurationTimer	psf20		
drx-InactivityTimer	psf1		
drx-RetransmissionTimer	psf6		
longDRX-CycleStartOffset CHOICE {			
sf640	0		
}			
shortDRX	Not present		
}			
}			
}			

7.1.7 Transport Block Size selection

7.1.7.1 DL-SCH Transport Block Size selection

Editor's note: It is for FFS if there is a need to split into separate test case for each UE category.

7.1.7.1.1 DL-SCH Transport Block Size selection / DCI format 1 / RA type 0

Editor's note: There is a need to update test procedure to exclude test points resulting in an effective channel code rate higher than 0.930 (ref TS 36.213 clause 7.1.7).

7.1.7.1.1.1 Test Purpose (TP)

(1)

```
with { UE in E-UTRA RRC_CONNECTED state }
ensure that {
  when { UE on PDCCH receives DCI format 1 indicating Resource Allocation Type 0, a Resource block
assignment correspondent to  $N_{PRB}$  physical resource blocks and a Modulation and Coding scheme  $I_{MCS}$  }
    then { UE decodes the received transport block of size correspondent to the read  $N_{PRB}$  and
 $I_{MCS}$  and forward it to higher layers }
}
```

7.1.7.1.1.2 Conformance requirements

References: The conformance requirements covered in the current TC are specified in: TS 36.212, clause 5.3.3.1.2; TS 36.213, clauses 7.1.6.1, 7.1.7, 7.1.7.1, 7.1.7.2 and 7.1.7.2.1; and TS 36.306 clause 4.1.

[TS 36.212 clause 5.3.3.1.2]

DCI format 1 is used for the scheduling of one PDSCH codeword.

The following information is transmitted by means of the DCI format 1:

- Resource allocation header (resource allocation type 0 / type 1) – 1 bit as defined in section 7.1.6 of [3]

If downlink bandwidth is less than or equal to 10 PRBs, there is no resource allocation header and resource allocation type 0 is assumed.

- Resource block assignment:

- For resource allocation type 0 as defined in section 7.1.6.1 of [3]:

- $\lceil N_{RB}^{DL} / P \rceil$ bits provide the resource allocation

...

where the value of P depends on the number of DL resource blocks as indicated in section 7.1.6 of [3]

- Modulation and coding scheme – 5 bits as defined in section 7.1.7 of [3]

...

[TS 36.213 clause 7.1.6.1]

In resource allocations of type 0, resource block assignment information includes a bitmap indicating the resource block groups (RBGs) that are allocated to the scheduled UE where a RBG is a set of consecutive physical resource blocks (PRBs). Resource block group size (P) is a function of the system bandwidth as shown in Table 7.1.6.1-1. The total number of RBGs (N_{RBG}) for downlink system bandwidth of N_{RB}^{DL} PRBs is given by $N_{RBG} = \lceil N_{RB}^{DL} / P \rceil$ where $\lfloor N_{RB}^{DL} / P \rfloor$ of the RBGs are of size P and if $N_{RB}^{DL} \bmod P > 0$ then one of the RBGs is of size $N_{RB}^{DL} - P \cdot \lfloor N_{RB}^{DL} / P \rfloor$. The bitmap is of size N_{RBG} bits with one bitmap bit per RBG such that each RBG is addressable. The RBGs shall be indexed in the order of increasing frequency and non-increasing RBG sizes starting at the lowest frequency. The order of RBG to bitmap bit mapping is in such way that RBG 0 to RBG $N_{RBG} - 1$ are mapped to MSB to LSB of the bitmap. The RBG is allocated to the UE if the corresponding bit value in the bitmap is 1, the RBG is not allocated to the UE otherwise.

Table 7.1.6.1-1: Type 0 Resource Allocation RBG Size vs. Downlink System Bandwidth

System Bandwidth N_{RB}^{DL}	RBG Size (P)
≤ 10	1
11 – 26	2
27 – 63	3
64 – 110	4

[TS 36.213 clause 7.1.7]

To determine the modulation order and transport block size(s) in the physical downlink shared channel, the UE shall first

– read the 5-bit “modulation and coding scheme” field (I_{MCS}) in the DCI

and second if the DCI CRC is scrambled by P-RNTI, RA-RNTI, or SI-RNTI then

...

else

– set the Table 7.1.7.2.1-1 column indicator N'_{PRB} to the total number of allocated PRBs based on the procedure defined in Section 7.1.6.

if the transport block is transmitted in DwPTS of the special subframe in frame structure type 2, then

set the Table 7.1.7.2.1-1 column indicator $N_{PRB} = \max \left\{ \left\lfloor N'_{PRB} \times 0.75 \right\rfloor, 1 \right\}$,

else, set the Table 7.1.7.2.1-1 column indicator $N_{PRB} = N'_{PRB}$.

The UE may skip decoding a transport block in an initial transmission if the effective channel code rate is higher than 0.930, where the effective channel code rate is defined as the number of downlink information bits (including CRC bits) divided by the number of physical channel bits on PDSCH. If the UE skips decoding, the physical layer indicates to higher layer that the transport block is not successfully decoded. For the special subframe configurations 0 and 5 with normal CP or configurations 0 and 4 with extended CP, shown in table 4.2-1 [3], there shall be no PDSCH transmission in DwPTS of the special subframe.

...

[TS 36.213 clause 7.1.7.1]

The UE shall use $Q_m = 2$ if the DCI CRC is scrambled by P-RNTI, RA-RNTI, or SI-RNTI, otherwise, the UE shall use I_{MCS} and Table 7.1.7.1-1 to determine the modulation order (Q_m) used in the physical downlink shared channel.

Table 7.1.7.1-1: Modulation and TBS index table for PDSCH

MCS Index I_{MCS}	Modulation Order Q_m	TBS Index I_{TBS}
0	2	0
1	2	1
2	2	2
3	2	3
4	2	4
5	2	5
6	2	6
7	2	7
8	2	8
9	2	9
10	4	9
11	4	10
12	4	11
13	4	12
14	4	13
15	4	14
16	4	15
17	6	15
18	6	16
19	6	17
20	6	18
21	6	19
22	6	20
23	6	21
24	6	22
25	6	23
26	6	24
27	6	25
28	6	26
29	2	reserved
30	4	
31	6	

[TS 36.213 clause 7.1.7.2]

If the DCI CRC is scrambled by P-RNTI, RA-RNTI, or SI-RNTI then

- for DCI format 1A:
 - the UE shall set the TBS index (I_{TBS}) equal to I_{MCS} and determine its TBS by the procedure in Section 7.1.7.2.1.

...

else

- for $0 \leq I_{MCS} \leq 28$, the UE shall first determine the TBS index (I_{TBS}) using I_{MCS} and Table 7.1.7.1-1 except if the transport block is disabled in DCI formats 2 and 2A as specified below. For a transport block that is not mapped to two-layer spatial multiplexing, the TBS is determined by the procedure in Section 7.1.7.2.1. For a transport block that is mapped to two-layer spatial multiplexing, the TBS is determined by the procedure in Section 7.1.7.2.2.
- for $29 \leq I_{MCS} \leq 31$, the TBS is assumed to be as determined from DCI transported in the latest PDCCH for the same transport block using $0 \leq I_{MCS} \leq 28$.
- In DCI formats 2 and 2A a transport block is disabled if $I_{MCS} = 0$ and if $rv_{idx} = 1$ otherwise the transport block is enabled.

The NDI and HARQ process ID, as signalled on PDCCH, and the TBS, as determined above, shall be delivered to higher layers.

[TS 36.213 clause 7.1.7.2.1]

For $1 \leq N_{PRB} \leq 110$, the TBS is given by the (I_{TBS}, N_{PRB}) entry of Table 7.1.7.2.1-1.

Table 7.1.7.2.1-1: Transport block size table (dimension 27x110)

I_{TBS}	N_{PRB}									
	1	2	3	4	5	6	7	8	9	10
0	16	32	56	88	120	152	176	208	224	256
1	24	56	88	144	176	208	224	256	328	344
2	32	72	144	176	208	256	296	328	376	424
3	40	104	176	208	256	328	392	440	504	568
4	56	120	208	256	328	408	488	552	632	696
5	72	144	224	328	424	504	600	680	776	872
6	328	176	256	392	504	600	712	808	936	1032
7	104	224	328	472	584	712	840	968	1096	1224
8	120	256	392	536	680	808	968	1096	1256	1384
9	136	296	456	616	776	936	1096	1256	1416	1544
10	144	328	504	680	872	1032	1224	1384	1544	1736
11	176	376	584	776	1000	1192	1384	1608	1800	2024
12	208	440	680	904	1128	1352	1608	1800	2024	2280
13	224	488	744	1000	1256	1544	1800	2024	2280	2536
14	256	552	840	1128	1416	1736	1992	2280	2600	2856
15	280	600	904	1224	1544	1800	2152	2472	2728	3112
16	328	632	968	1288	1608	1928	2280	2600	2984	3240
17	336	696	1064	1416	1800	2152	2536	2856	3240	3624
18	376	776	1160	1544	1992	2344	2792	3112	3624	4008
19	408	840	1288	1736	2152	2600	2984	3496	3880	4264
20	440	904	1384	1864	2344	2792	3240	3752	4136	4584
21	488	1000	1480	1992	2472	2984	3496	4008	4584	4968
22	520	1064	1608	2152	2664	3240	3752	4264	4776	5352
23	552	1128	1736	2280	2856	3496	4008	4584	5160	5736
24	584	1192	1800	2408	2984	3624	4264	4968	5544	5992
25	616	1256	1864	2536	3112	3752	4392	5160	5736	6200
26	712	1480	2216	2984	3752	4392	5160	5992	6712	7480
I_{TBS}	N_{PRB}									
	11	12	13	14	15	16	17	18	19	20
0	288	328	344	376	392	424	456	488	504	536
1	376	424	456	488	520	568	600	632	680	712
2	472	520	568	616	648	696	744	776	840	872
3	616	680	744	808	872	904	968	1032	1096	1160
4	776	840	904	1000	1064	1128	1192	1288	1352	1416
5	968	1032	1128	1224	1320	1384	1480	1544	1672	1736
6	1128	1224	1352	1480	1544	1672	1736	1864	1992	2088
7	1320	1480	1608	1672	1800	1928	2088	2216	2344	2472
8	1544	1672	1800	1928	2088	2216	2344	2536	2664	2792
9	1736	1864	2024	2216	2344	2536	2664	2856	2984	3112
10	1928	2088	2280	2472	2664	2792	2984	3112	3368	3496
11	2216	2408	2600	2792	2984	3240	3496	3624	3880	4008
12	2472	2728	2984	3240	3368	3624	3880	4136	4392	4584
13	2856	3112	3368	3624	3880	4136	4392	4584	4968	5160
14	3112	3496	3752	4008	4264	4584	4968	5160	5544	5736
15	3368	3624	4008	4264	4584	4968	5160	5544	5736	6200
16	3624	3880	4264	4584	4968	5160	5544	5992	6200	6456
17	4008	4392	4776	5160	5352	5736	6200	6456	6712	7224
18	4392	4776	5160	5544	5992	6200	6712	7224	7480	7992
19	4776	5160	5544	5992	6456	6968	7224	7736	8248	8504
20	5160	5544	5992	6456	6968	7480	7992	8248	8760	9144
21	5544	5992	6456	6968	7480	7992	8504	9144	9528	9912
22	5992	6456	6968	7480	7992	8504	9144	9528	10296	10680
23	6200	6968	7480	7992	8504	9144	9912	10296	11064	11448
24	6712	7224	7992	8504	9144	9912	10296	11064	11448	12216
25	6968	7480	8248	8760	9528	10296	10680	11448	12216	12576
26	8248	8760	9528	10296	11064	11832	12576	13536	14112	14688
I_{TBS}	N_{PRB}									
	21	22	23	24	25	26	27	28	29	30
0	568	600	616	648	680	712	744	776	776	808
1	744	776	808	872	904	936	968	1000	1032	1064

2	936	968	1000	1064	1096	1160	1192	1256	1288	1320
3	1224	1256	1320	1384	1416	1480	1544	1608	1672	1736
4	1480	1544	1608	1736	1800	1864	1928	1992	2088	2152
5	1864	1928	2024	2088	2216	2280	2344	2472	2536	2664
6	2216	2280	2408	2472	2600	2728	2792	2984	2984	3112
7	2536	2664	2792	2984	3112	3240	3368	3368	3496	3624
8	2984	3112	3240	3368	3496	3624	3752	3880	4008	4264
9	3368	3496	3624	3752	4008	4136	4264	4392	4584	4776
10	3752	3880	4008	4264	4392	4584	4776	4968	5160	5352
11	4264	4392	4584	4776	4968	5352	5544	5736	5992	5992
12	4776	4968	5352	5544	5736	5992	6200	6456	6712	6712
13	5352	5736	5992	6200	6456	6712	6968	7224	7480	7736
14	5992	6200	6456	6968	7224	7480	7736	7992	8248	8504
15	6456	6712	6968	7224	7736	7992	8248	8504	8760	9144
16	6712	7224	7480	7736	7992	8504	8760	9144	9528	9912
17	7480	7992	8248	8760	9144	9528	9912	10296	10296	10680
18	8248	8760	9144	9528	9912	10296	10680	11064	11448	11832
19	9144	9528	9912	10296	10680	11064	11448	12216	12576	12960
20	9912	10296	10680	11064	11448	12216	12576	12960	13536	14112
21	10680	11064	11448	12216	12576	12960	13536	14112	14688	15264
22	11448	11832	12576	12960	13536	14112	14688	15264	15840	16416
23	12216	12576	12960	13536	14112	14688	15264	15840	16416	16992
24	12960	13536	14112	14688	15264	15840	16416	16992	17568	18336
25	13536	14112	14688	15264	15840	16416	16992	17568	18336	19080
26	15264	16416	16992	17568	18336	19080	19848	20616	21384	22152
I_{TBS}	N_{PRB}									
	31	32	33	34	35	36	37	38	39	40
0	840	872	904	936	968	1000	1032	1032	1064	1096
1	1128	1160	1192	1224	1256	1288	1352	1384	1416	1416
2	1384	1416	1480	1544	1544	1608	1672	1672	1736	1800
3	1800	1864	1928	1992	2024	2088	2152	2216	2280	2344
4	2216	2280	2344	2408	2472	2600	2664	2728	2792	2856
5	2728	2792	2856	2984	3112	3112	3240	3368	3496	3496
6	3240	3368	3496	3496	3624	3752	3880	4008	4136	4136
7	3752	3880	4008	4136	4264	4392	4584	4584	4776	4968
8	4392	4584	4584	4776	4968	4968	5160	5352	5544	5544
9	4968	5160	5160	5352	5544	5736	5736	5992	6200	6200
10	5544	5736	5736	5992	6200	6200	6456	6712	6712	6968
11	6200	6456	6712	6968	6968	7224	7480	7736	7736	7992
12	6968	7224	7480	7736	7992	8248	8504	8760	8760	9144
13	7992	8248	8504	8760	9144	9144	9528	9912	9912	10296
14	8760	9144	9528	9912	9912	10296	10680	11064	11064	11448
15	9528	9912	10296	10296	10680	11064	11448	11832	11832	12216
16	9912	10296	10680	11064	11448	11832	12216	12216	12576	12960
17	11064	11448	11832	12216	12576	12960	13536	13536	14112	14688
18	12216	12576	12960	13536	14112	14112	14688	15264	15264	15840
19	13536	13536	14112	14688	15264	15264	15840	16416	16992	16992
20	14688	14688	15264	15840	16416	16992	16992	17568	18336	18336
21	15840	15840	16416	16992	17568	18336	18336	19080	19848	19848
22	16992	16992	17568	18336	19080	19080	19848	20616	21384	21384
23	17568	18336	19080	19848	19848	20616	21384	22152	22152	22920
24	19080	19848	19848	20616	21384	22152	22920	22920	23688	24496
25	19848	20616	20616	21384	22152	22920	23688	24496	24496	25456
26	22920	23688	24496	25456	25456	26416	27376	28336	29296	29296
I_{TBS}	N_{PRB}									
	41	42	43	44	45	46	47	48	49	50
0	1128	1160	1192	1224	1256	1256	1288	1320	1352	1384
1	1480	1544	1544	1608	1608	1672	1736	1736	1800	1800
2	1800	1864	1928	1992	2024	2088	2088	2152	2216	2216
3	2408	2472	2536	2536	2600	2664	2728	2792	2856	2856
4	2984	2984	3112	3112	3240	3240	3368	3496	3496	3624
5	3624	3752	3752	3880	4008	4008	4136	4264	4392	4392
6	4264	4392	4584	4584	4776	4776	4968	4968	5160	5160
7	4968	5160	5352	5352	5544	5736	5736	5992	5992	6200

8	5736	5992	5992	6200	6200	6456	6456	6712	6968	6968
9	6456	6712	6712	6968	6968	7224	7480	7480	7736	7992
10	7224	7480	7480	7736	7992	7992	8248	8504	8504	8760
11	8248	8504	8760	8760	9144	9144	9528	9528	9912	9912
12	9528	9528	9912	9912	10296	10680	10680	11064	11064	11448
13	10680	10680	11064	11448	11448	11832	12216	12216	12576	12960
14	11832	12216	12216	12576	12960	12960	13536	13536	14112	14112
15	12576	12960	12960	13536	13536	14112	14688	14688	15264	15264
16	13536	13536	14112	14112	14688	14688	15264	15840	15840	16416
17	14688	15264	15264	15840	16416	16416	16992	17568	17568	18336
18	16416	16416	16992	17568	17568	18336	18336	19080	19080	19848
19	17568	18336	18336	19080	19080	19848	20616	20616	21384	21384
20	19080	19848	19848	20616	20616	21384	22152	22152	22920	22920
21	20616	21384	21384	22152	22920	22920	23688	24496	24496	25456
22	22152	22920	22920	23688	24496	24496	25456	25456	26416	27376
23	23688	24496	24496	25456	25456	26416	27376	27376	28336	28336
24	25456	25456	26416	26416	27376	28336	28336	29296	29296	30576
25	26416	26416	27376	28336	28336	29296	29296	30576	31704	31704
26	30576	30576	31704	32856	32856	34008	35160	35160	36696	36696
I_{TBS}	N_{PRB}									
	51	52	53	54	55	56	57	58	59	60
0	1416	1416	1480	1480	1544	1544	1608	1608	1608	1672
1	1864	1864	1928	1992	1992	2024	2088	2088	2152	2152
2	2280	2344	2344	2408	2472	2536	2536	2600	2664	2664
3	2984	2984	3112	3112	3240	3240	3368	3368	3496	3496
4	3624	3752	3752	3880	4008	4008	4136	4136	4264	4264
5	4584	4584	4776	4776	4776	4968	4968	5160	5160	5352
6	5352	5352	5544	5736	5736	5992	5992	5992	6200	6200
7	6200	6456	6456	6712	6712	6712	6968	6968	7224	7224
8	7224	7224	7480	7480	7736	7736	7992	7992	8248	8504
9	7992	8248	8248	8504	8760	8760	9144	9144	9144	9528
10	9144	9144	9144	9528	9528	9912	9912	10296	10296	10680
11	10296	10680	10680	11064	11064	11448	11448	11832	11832	12216
12	11832	11832	12216	12216	12576	12576	12960	12960	13536	13536
13	12960	13536	13536	14112	14112	14688	14688	14688	15264	15264
14	14688	14688	15264	15264	15840	15840	16416	16416	16992	16992
15	15840	15840	16416	16416	16992	16992	17568	17568	18336	18336
16	16416	16992	16992	17568	17568	18336	18336	19080	19080	19848
17	18336	19080	19080	19848	19848	20616	20616	20616	21384	21384
18	19848	20616	21384	21384	22152	22152	22920	22920	23688	23688
19	22152	22152	22920	22920	23688	24496	24496	25456	25456	25456
20	23688	24496	24496	25456	25456	26416	26416	27376	27376	28336
21	25456	26416	26416	27376	27376	28336	28336	29296	29296	30576
22	27376	28336	28336	29296	29296	30576	30576	31704	31704	32856
23	29296	29296	30576	30576	31704	31704	32856	32856	34008	34008
24	31704	31704	32856	32856	34008	34008	35160	35160	36696	36696
25	32856	32856	34008	34008	35160	35160	36696	36696	37888	37888
26	37888	37888	39232	40576	40576	40576	42368	42368	43816	43816
I_{TBS}	N_{PRB}									
	61	62	63	64	65	66	67	68	69	70
0	1672	1736	1736	1800	1800	1800	1864	1864	1928	1928
1	2216	2280	2280	2344	2344	2408	2472	2472	2536	2536
2	2728	2792	2856	2856	2856	2984	2984	3112	3112	3112
3	3624	3624	3624	3752	3752	3880	3880	4008	4008	4136
4	4392	4392	4584	4584	4584	4776	4776	4968	4968	4968
5	5352	5544	5544	5736	5736	5736	5992	5992	5992	6200
6	6456	6456	6456	6712	6712	6968	6968	6968	7224	7224
7	7480	7480	7736	7736	7992	7992	8248	8248	8504	8504
8	8504	8760	8760	9144	9144	9144	9528	9528	9528	9912
9	9528	9912	9912	10296	10296	10296	10680	10680	11064	11064
10	10680	11064	11064	11448	11448	11448	11832	11832	12216	12216
11	12216	12576	12576	12960	12960	13536	13536	13536	14112	14112
12	14112	14112	14112	14688	14688	15264	15264	15264	15840	15840
13	15840	15840	16416	16416	16992	16992	16992	17568	17568	18336

14	17568	17568	18336	18336	18336	19080	19080	19848	19848	19848
15	18336	19080	19080	19848	19848	20616	20616	20616	21384	21384
16	19848	19848	20616	20616	21384	21384	22152	22152	22152	22920
17	22152	22152	22920	22920	23688	23688	24496	24496	24496	25456
18	24496	24496	24496	25456	25456	26416	26416	27376	27376	27376
19	26416	26416	27376	27376	28336	28336	29296	29296	29296	30576
20	28336	29296	29296	29296	30576	30576	31704	31704	31704	32856
21	30576	31704	31704	31704	32856	32856	34008	34008	35160	35160
22	32856	34008	34008	34008	35160	35160	36696	36696	36696	37888
23	35160	35160	36696	36696	37888	37888	37888	39232	39232	40576
24	36696	37888	37888	39232	39232	40576	40576	42368	42368	42368
25	39232	39232	40576	40576	40576	42368	42368	43816	43816	43816
26	45352	45352	46888	46888	48936	48936	48936	51024	51024	52752
I_{TBS}	N_{PRB}									
	71	72	73	74	75	76	77	78	79	80
0	1992	1992	2024	2088	2088	2088	2152	2152	2216	2216
1	2600	2600	2664	2728	2728	2792	2792	2856	2856	2856
2	3240	3240	3240	3368	3368	3368	3496	3496	3496	3624
3	4136	4264	4264	4392	4392	4392	4584	4584	4584	4776
4	5160	5160	5160	5352	5352	5544	5544	5544	5736	5736
5	6200	6200	6456	6456	6712	6712	6712	6968	6968	6968
6	7480	7480	7736	7736	7736	7992	7992	8248	8248	8248
7	8760	8760	8760	9144	9144	9144	9528	9528	9528	9912
8	9912	9912	10296	10296	10680	10680	10680	11064	11064	11064
9	11064	11448	11448	11832	11832	11832	12216	12216	12576	12576
10	12576	12576	12960	12960	12960	13536	13536	13536	14112	14112
11	14112	14688	14688	14688	15264	15264	15840	15840	15840	16416
12	16416	16416	16416	16992	16992	17568	17568	17568	18336	18336
13	18336	18336	19080	19080	19080	19848	19848	19848	20616	20616
14	20616	20616	20616	21384	21384	22152	22152	22152	22920	22920
15	22152	22152	22152	22920	22920	23688	23688	23688	24496	24496
16	22920	23688	23688	24496	24496	24496	25456	25456	25456	26416
17	25456	26416	26416	26416	27376	27376	27376	28336	28336	29296
18	28336	28336	29296	29296	29296	30576	30576	30576	31704	31704
19	30576	30576	31704	31704	32856	32856	32856	34008	34008	34008
20	32856	34008	34008	34008	35160	35160	35160	36696	36696	36696
21	35160	36696	36696	36696	37888	37888	39232	39232	39232	40576
22	37888	39232	39232	40576	40576	40576	42368	42368	42368	43816
23	40576	40576	42368	42368	43816	43816	43816	45352	45352	45352
24	43816	43816	45352	45352	45352	46888	46888	46888	48936	48936
25	45352	45352	46888	46888	46888	48936	48936	48936	51024	51024
26	52752	52752	55056	55056	55056	55056	57336	57336	57336	59256
I_{TBS}	N_{PRB}									
	81	82	83	84	85	86	87	88	89	90
0	2280	2280	2280	2344	2344	2408	2408	2472	2472	2536
1	2984	2984	2984	3112	3112	3112	3240	3240	3240	3240
2	3624	3624	3752	3752	3880	3880	3880	4008	4008	4008
3	4776	4776	4776	4968	4968	4968	5160	5160	5160	5352
4	5736	5992	5992	5992	5992	6200	6200	6200	6456	6456
5	7224	7224	7224	7480	7480	7480	7736	7736	7736	7992
6	8504	8504	8760	8760	8760	9144	9144	9144	9144	9528
7	9912	9912	10296	10296	10296	10680	10680	10680	11064	11064
8	11448	11448	11448	11832	11832	12216	12216	12216	12576	12576
9	12960	12960	12960	13536	13536	13536	13536	14112	14112	14112
10	14112	14688	14688	14688	14688	15264	15264	15264	15840	15840
11	16416	16416	16992	16992	16992	17568	17568	17568	18336	18336
12	18336	19080	19080	19080	19080	19848	19848	19848	20616	20616
13	20616	21384	21384	21384	21384	22152	22152	22152	22920	22920
14	22920	23688	23688	24496	24496	24496	25456	25456	25456	25456
15	24496	25456	25456	25456	26416	26416	26416	27376	27376	27376
16	26416	26416	27376	27376	27376	28336	28336	28336	29296	29296
17	29296	29296	30576	30576	30576	30576	31704	31704	31704	32856
18	31704	32856	32856	32856	34008	34008	34008	35160	35160	35160
19	35160	35160	35160	36696	36696	36696	37888	37888	37888	39232

20	37888	37888	39232	39232	39232	40576	40576	40576	42368	42368
21	40576	40576	42368	42368	42368	43816	43816	43816	45352	45352
22	43816	43816	45352	45352	45352	46888	46888	46888	48936	48936
23	46888	46888	46888	48936	48936	48936	51024	51024	51024	51024
24	48936	51024	51024	51024	52752	52752	52752	52752	55056	55056
25	51024	52752	52752	52752	55056	55056	55056	55056	57336	57336
26	59256	59256	61664	61664	61664	63776	63776	63776	66592	66592
I_{TBS}	N_{PRB}									
	91	92	93	94	95	96	97	98	99	100
0	2536	2536	2600	2600	2664	2664	2728	2728	2728	2792
1	3368	3368	3368	3496	3496	3496	3496	3624	3624	3624
2	4136	4136	4136	4264	4264	4264	4392	4392	4392	4584
3	5352	5352	5352	5544	5544	5544	5736	5736	5736	5736
4	6456	6456	6712	6712	6712	6968	6968	6968	6968	7224
5	7992	7992	8248	8248	8248	8504	8504	8760	8760	8760
6	9528	9528	9528	9912	9912	9912	10296	10296	10296	10296
7	11064	11448	11448	11448	11448	11832	11832	11832	12216	12216
8	12576	12960	12960	12960	13536	13536	13536	13536	14112	14112
9	14112	14688	14688	14688	15264	15264	15264	15264	15840	15840
10	15840	16416	16416	16416	16992	16992	16992	16992	17568	17568
11	18336	18336	19080	19080	19080	19080	19848	19848	19848	19848
12	20616	21384	21384	21384	21384	22152	22152	22152	22920	22920
13	23688	23688	23688	24496	24496	24496	25456	25456	25456	25456
14	26416	26416	26416	27376	27376	27376	28336	28336	28336	28336
15	28336	28336	28336	29296	29296	29296	29296	30576	30576	30576
16	29296	30576	30576	30576	30576	31704	31704	31704	31704	32856
17	32856	32856	34008	34008	34008	35160	35160	35160	35160	36696
18	36696	36696	36696	37888	37888	37888	37888	39232	39232	39232
19	39232	39232	40576	40576	40576	40576	42368	42368	42368	43816
20	42368	42368	43816	43816	43816	45352	45352	45352	46888	46888
21	45352	46888	46888	46888	46888	48936	48936	48936	48936	51024
22	48936	48936	51024	51024	51024	51024	52752	52752	52752	55056
23	52752	52752	52752	55056	55056	55056	55056	57336	57336	57336
24	55056	57336	57336	57336	57336	59256	59256	59256	61664	61664
25	57336	59256	59256	59256	61664	61664	61664	61664	63776	63776
26	66592	68808	68808	68808	71112	71112	71112	73712	73712	75376
I_{TBS}	N_{PRB}									
	101	102	103	104	105	106	107	108	109	110
0	2792	2856	2856	2856	2984	2984	2984	2984	2984	3112
1	3752	3752	3752	3752	3880	3880	3880	4008	4008	4008
2	4584	4584	4584	4584	4776	4776	4776	4776	4968	4968
3	5992	5992	5992	5992	6200	6200	6200	6200	6456	6456
4	7224	7224	7480	7480	7480	7480	7736	7736	7736	7992
5	8760	9144	9144	9144	9144	9528	9528	9528	9528	9528
6	10680	10680	10680	10680	11064	11064	11064	11448	11448	11448
7	12216	12576	12576	12576	12960	12960	12960	12960	13536	13536
8	14112	14112	14688	14688	14688	14688	15264	15264	15264	15264
9	15840	16416	16416	16416	16416	16992	16992	16992	17568	17568
10	17568	18336	18336	18336	18336	18336	19080	19080	19080	19080
11	20616	20616	20616	21384	21384	21384	21384	22152	22152	22152
12	22920	23688	23688	23688	23688	24496	24496	24496	24496	25456
13	26416	26416	26416	26416	27376	27376	27376	27376	28336	28336
14	29296	29296	29296	29296	30576	30576	30576	30576	31704	31704
15	30576	31704	31704	31704	31704	32856	32856	32856	34008	34008
16	32856	32856	34008	34008	34008	34008	35160	35160	35160	35160
17	36696	36696	36696	37888	37888	37888	39232	39232	39232	39232
18	40576	40576	40576	40576	42368	42368	42368	42368	43816	43816
19	43816	43816	43816	45352	45352	45352	46888	46888	46888	46888
20	46888	46888	48936	48936	48936	48936	48936	51024	51024	51024
21	51024	51024	51024	52752	52752	52752	52752	55056	55056	55056
22	55056	55056	55056	57336	57336	57336	57336	59256	59256	59256
23	57336	59256	59256	59256	59256	61664	61664	61664	61664	63776
24	61664	61664	63776	63776	63776	63776	66592	66592	66592	66592
25	63776	63776	66592	66592	66592	66592	68808	68808	68808	71112

26	75376	75376	75376	75376	75376	75376	75376	75376	75376	75376
----	-------	-------	-------	-------	-------	-------	-------	-------	-------	-------

[TS 36.306 clause 4.1]

The UE Category parameter defines a combined uplink and downlink capability. The parameters set by the UE Category are defined in subclause 4.2. Tables 4.1-1 and 4.1-2 define the downlink and, respectively, uplink physical layer parameter values for each UE Category.

Table 4.1-1: Downlink physical layer parameter values set by UE Category

UE Category	Maximum number of DL-SCH transport block bits received within a TTI	Maximum number of bits of a DL-SCH transport block received within a TTI	Total number of soft channel bits	Maximum number of supported layers for spatial multiplexing in DL
Category 1	10296	10296	250368	1
Category 2	51024	51024	1237248	2
Category 3	102048	75376	1237248	2
Category 4	150752	75376	1827072	2
Category 5	302752	151376	3667200	4

Table 4.1-2: Uplink physical layer parameter values set by UE Category

UE Category	Maximum number of bits of an UL-SCH transport block transmitted within a TTI	Support for 64QAM in UL
Category 1	5160	No
Category 2	25456	No
Category 3	51024	No
Category 4	51024	No
Category 5	75376	Yes

7.1.7.1.1.3 Test description

7.1.7.1.1.3.1 Pre-test conditions

System Simulator

- Cell 1.
- Uplink and downlink bandwidth set to 20 MHz (to enable testing of N_{PRB} up to maximum value).

UE:

None.

Preamble

- The UE is in state Loopback Activated (state 4) according to [18].

7.1.7.1.1.3.2 Test procedure sequence

Table 7.1.7.1.1.3.2-1: Maximum TB_{size} for different UE categories

UE Category	Maximum number of DL-SCH transport block bits received within a TTI
Category 1	10296
Category 2	51024
Category 3	102048
Category 4	150752
Category 5	302752

Table 7.1.7.1.1.3.2-2: Number of downlink PDCP SDUs and PDCP SDU size used as test data

TB_{size} [bits]	Number of PDCP SDUs	PDCP SDU size of each PDCP SDU [bits] See note 1
$TB_{size} \leq 12000$	1	[FFS]
$12001 \leq TB_{size} \leq 24000$	2	[FFS]
$24001 \leq TB_{size} \leq 36000$	3	[FFS]
$36001 \leq TB_{size} \leq 48000$	4	[FFS]
$48001 \leq TB_{size} \leq 60000$	5	[FFS]
$60001 \leq TB_{size} \leq 72000$	6	[FFS]
$TB_{size} \geq 72001$	7	[FFS]

Note 1. Each PDCP SDU is limited to [TBD] octets (keep below maximum SDU size of ESM as specified in TS 24.301 clause 9.9.4.12).

Table 7.1.7.1.1.3.2-3: Main behaviour

St	Procedure	Message Sequence		TP	Verdict
		U – S	Message		
-	EXCEPTION: Steps 1 to 4 are repeated for values of N_{PRB} from 1 to 110 and I_{MCS} from 0 to 28.	-	-	-	-
1	SS looks up I_{TBS} in table 7.1.7.1-1 in TS 36.213 based on the value of I_{MCS} . SS looks up TB_{size} in table 7.1.7.2.1-1 in TS 36.213 based on values of N_{PRB} and I_{TBS} .	-	-	-	-
-	EXCEPTION: Steps 2 to 4 are performed if TB_{size} is less or equal to UE capability "Maximum number of DL-SCH transport block bits received within a TTI" as specified in Table 7.1.7.1.1.3.2-1.	-	-	-	-
2	SS creates one or more PDCP SDUs, depending on TB_{size} , in accordance with Table 7.1.7.1.1.3.2-2.	-	-	-	-
3	SS transmits the PDCP SDUs concatenated into a MAC PDU and indicates on PDSCH DCI	<--	MAC PDU (NxPDCP SDUs) DCI: (DCI Format 1, RA	-	-

	Format 1 with RA type 0 and a Resource block assignment (RBA) correspondent to N_{PRB} as specified in 7.1.6.1 in TS 36.213 and Modulation and coding scheme I_{MCS} .		type 0, $\text{RBA}(N_{\text{PRB}}), I_{\text{MCS}}$		
4	CHECK: Does UE return the same number of PDCP SDUs with same content as transmitted by the SS in step 3?	-->	(NxPDCP SDUs)	1	P

7.1.7.1.1.3.3 Specific Message Contents

None

7.1.7.1.2 DL-SCH Transport Block Size selection / DCI format 1 / RA type 1

Editor's note: There is a need to update test procedure to exclude test points resulting in an effective channel code rate higher than 0.930 (ref TS 36.213 clause 7.1.7).

7.1.7.1.2.1 Test Purpose (TP)

(1)

```
with { UE in E-UTRA RRC_CONNECTED state }
ensure that {
  when { UE on PDCCH receives DCI format 1 indicating Resource Allocation Type 1, a Resource block
assignment correspondent to  $N_{\text{PRB}}$  physical resource blocks and a Modulation and Coding scheme  $I_{\text{MCS}}$  }
    then { UE decodes the received transport block of size correspondent to the read  $N_{\text{PRB}}$  and
 $I_{\text{MCS}}$  and forward it to higher layers }
}
```

7.1.7.1.2.2 Conformance requirements

References: The conformance requirements covered in the current TC are specified in: TS 36.212, clause 5.3.3.1.2; TS 36.213, clauses 7.1.6.2, 7.1.7, 7.1.7.1, 7.1.7.2 and 7.1.7.2.1; and TS 36.306 clause 4.1.

[TS 36.212 clause 5.3.3.1.2]

DCI format 1 is used for the scheduling of one PDSCH codeword.

The following information is transmitted by means of the DCI format 1:

- Resource allocation header (resource allocation type 0 / type 1) – 1 bit as defined in section 7.1.6 of [3]

If downlink bandwidth is less than or equal to 10 PRBs, there is no resource allocation header and resource allocation type 0 is assumed.

- Resource block assignment:

...

- For resource allocation type 1 as defined in section 7.1.6.2 of [3]:

- $\lceil \log_2(P) \rceil$ bits of this field are used as a header specific to this resource allocation type to indicate the selected resource blocks subset

- 1 bit indicates a shift of the resource allocation span

- $\left(\left\lceil N_{\text{RB}}^{\text{DL}} / P \right\rceil - \lceil \log_2(P) \rceil - 1 \right)$ bits provide the resource allocation

where the value of P depends on the number of DL resource blocks as indicated in section 7.1.6 of [3]

- Modulation and coding scheme – 5 bits as defined in section 7.1.7 of [3]

...

[TS 36.213 clause 7.1.6.2]

In resource allocations of type 1, a resource block assignment information of size N_{RBG} indicates to a scheduled UE the PRBs from the set of PRBs from one of P RBG subsets. Also P is the RBG size associated with the system bandwidth as shown in Table 7.1.6.1-1. A RBG subset p , where $0 \leq p < P$, consists of every P th RBG starting from RBG p . The resource block assignment information consists of three fields [4].

The first field with $\lceil \log_2(P) \rceil$ bits is used to indicate the selected RBG subset among P RBG subsets.

The second field with one bit is used to indicate a shift of the resource allocation span within a subset. A bit value of 1 indicates shift is triggered. Shift is not triggered otherwise.

The third field includes a bitmap, where each bit of the bitmap addresses a single PRB in the selected RBG subset in such a way that MSB to LSB of the bitmap are mapped to the PRBs in the increasing frequency order. The PRB is allocated to the UE if the corresponding bit value in the bit field is 1, the PRB is not allocated to the UE otherwise. The portion of the bitmap used to address PRBs in a selected RBG subset has size $N_{\text{RB}}^{\text{TYPE1}}$ and is defined as

$$N_{\text{RB}}^{\text{TYPE1}} = \left\lceil \frac{N_{\text{RB}}^{\text{DL}}}{P} \right\rceil - \lceil \log_2(P) \rceil - 1$$

The addressable PRB numbers of a selected RBG subset start from an offset, $\Delta_{\text{shift}}(p)$ to the smallest PRB number within the selected RBG subset, which is mapped to the MSB of the bitmap. The offset is in terms of the number of PRBs and is done within the selected RBG subset. If the value of the bit in the second field for shift of the resource allocation span is set to 0, the offset for RBG subset p is given by $\Delta_{\text{shift}}(p) = 0$. Otherwise, the offset for RBG subset p is given by $\Delta_{\text{shift}}(p) = N_{\text{RB}}^{\text{RBG subset}}(p) - N_{\text{RB}}^{\text{TYPE1}}$, where the LSB of the bitmap is justified with the highest PRB number within the selected RBG subset. $N_{\text{RB}}^{\text{RBG subset}}(p)$ is the number of PRBs in RBG subset p and can be calculated by the following equation,

$$N_{\text{RB}}^{\text{RBG subset}}(p) = \begin{cases} \left\lfloor \frac{N_{\text{RB}}^{\text{DL}} - 1}{P^2} \right\rfloor \cdot P + P & , p < \left\lfloor \frac{N_{\text{RB}}^{\text{DL}} - 1}{P} \right\rfloor \bmod P \\ \left\lfloor \frac{N_{\text{RB}}^{\text{DL}} - 1}{P^2} \right\rfloor \cdot P + (N_{\text{RB}}^{\text{DL}} - 1) \bmod P + 1 & , p = \left\lfloor \frac{N_{\text{RB}}^{\text{DL}} - 1}{P} \right\rfloor \bmod P \\ \left\lfloor \frac{N_{\text{RB}}^{\text{DL}} - 1}{P^2} \right\rfloor \cdot P & , p > \left\lfloor \frac{N_{\text{RB}}^{\text{DL}} - 1}{P} \right\rfloor \bmod P \end{cases}$$

Consequently, when RBG subset p is indicated, bit i for $i = 0, 1, \dots, N_{\text{RB}}^{\text{TYPE1}} - 1$ in the bitmap field indicates PRB number,

$$n_{\text{PRB}}^{\text{RBG subset}}(p) = \left\lfloor \frac{i + \Delta_{\text{shift}}(p)}{P} \right\rfloor P^2 + p \cdot P + (i + \Delta_{\text{shift}}(p)) \bmod P$$

[TS 36.213 clause 7.1.7]

To determine the modulation order and transport block size(s) in the physical downlink shared channel, the UE shall first

– read the 5-bit “modulation and coding scheme” field (I_{MCS}) in the DCI

and second if the DCI CRC is scrambled by P-RNTI, RA-RNTI, or SI-RNTI then

...

else

- set the Table 7.1.7.2.1-1 column indicator N'_{PRB} to the total number of allocated PRBs based on the procedure defined in Section 7.1.6.

if the transport block is transmitted in DwPTS of the special subframe in frame structure type 2, then

$$\text{set the Table 7.1.7.2.1-1 column indicator } N_{PRB} = \max \left\{ \left\lfloor N'_{PRB} \times 0.75 \right\rfloor, 1 \right\},$$

else, set the Table 7.1.7.2.1-1 column indicator $N_{PRB} = N'_{PRB}$.

The UE may skip decoding a transport block in an initial transmission if the effective channel code rate is higher than 0.930, where the effective channel code rate is defined as the number of downlink information bits (including CRC bits) divided by the number of physical channel bits on PDSCH. If the UE skips decoding, the physical layer indicates to higher layer that the transport block is not successfully decoded. For the special subframe configurations 0 and 5 with normal CP or configurations 0 and 4 with extended CP, shown in table 4.2-1 [3], there shall be no PDSCH transmission in DwPTS of the special subframe.

...

[TS 36.213 clause 7.1.7.1]

The UE shall use $Q_m = 2$ if the DCI CRC is scrambled by P-RNTI, RA-RNTI, or SI-RNTI, otherwise, the UE shall use I_{MCS} and Table 7.1.7.1-1 to determine the modulation order (Q_m) used in the physical downlink shared channel.

Table 7.1.7.1-1: Modulation and TBS index table for PDSCH

MCS Index I_{MCS}	Modulation Order Q_m	TBS Index I_{TBS}
0	2	0
1	2	1
2	2	2
3	2	3
4	2	4
5	2	5
6	2	6
7	2	7
8	2	8
9	2	9
10	4	9
11	4	10
12	4	11
13	4	12
14	4	13
15	4	14
16	4	15
17	6	15
18	6	16
19	6	17
20	6	18
21	6	19
22	6	20
23	6	21
24	6	22
25	6	23
26	6	24
27	6	25
28	6	26
29	2	reserved
30	4	
31	6	

[TS 36.213 clause 7.1.7.2]

If the DCI CRC is scrambled by P-RNTI, RA-RNTI, or SI-RNTI then

- for DCI format 1A:
 - the UE shall set the TBS index (I_{TBS}) equal to I_{MCS} and determine its TBS by the procedure in Section 7.1.7.2.1.

...

else

- for $0 \leq I_{\text{MCS}} \leq 28$, the UE shall first determine the TBS index (I_{TBS}) using I_{MCS} and Table 7.1.7.1-1 except if the transport block is disabled in DCI formats 2 and 2A as specified below. For a transport block that is not mapped to two-layer spatial multiplexing, the TBS is determined by the procedure in Section 7.1.7.2.1. For a transport block that is mapped to two-layer spatial multiplexing, the TBS is determined by the procedure in Section 7.1.7.2.2.
- for $29 \leq I_{\text{MCS}} \leq 31$, the TBS is assumed to be as determined from DCI transported in the latest PDCCH for the same transport block using $0 \leq I_{\text{MCS}} \leq 28$.
- In DCI formats 2 and 2A a transport block is disabled if $I_{\text{MCS}} = 0$ and if $rv_{idx} = 1$ otherwise the transport block is enabled.

The NDI and HARQ process ID, as signalled on PDCCH, and the TBS, as determined above, shall be delivered to higher layers.

[TS 36.213 clause 7.1.7.2.1]

For $1 \leq N_{\text{PRB}} \leq 110$, the TBS is given by the ($I_{\text{TBS}}, N_{\text{PRB}}$) entry of Table 7.1.7.2.1-1.

Table 7.1.7.2.1-1: Transport block size table (dimension 27x110)

I_{TBS}	N_{PRB}									
	1	2	3	4	5	6	7	8	9	10
0	16	32	56	88	120	152	176	208	224	256
1	24	56	88	144	176	208	224	256	328	344
2	32	72	144	176	208	256	296	328	376	424
3	40	104	176	208	256	328	392	440	504	568
4	56	120	208	256	328	408	488	552	632	696
5	72	144	224	328	424	504	600	680	776	872
6	328	176	256	392	504	600	712	808	936	1032
7	104	224	328	472	584	712	840	968	1096	1224
8	120	256	392	536	680	808	968	1096	1256	1384
9	136	296	456	616	776	936	1096	1256	1416	1544
10	144	328	504	680	872	1032	1224	1384	1544	1736
11	176	376	584	776	1000	1192	1384	1608	1800	2024
12	208	440	680	904	1128	1352	1608	1800	2024	2280
13	224	488	744	1000	1256	1544	1800	2024	2280	2536
14	256	552	840	1128	1416	1736	1992	2280	2600	2856
15	280	600	904	1224	1544	1800	2152	2472	2728	3112
16	328	632	968	1288	1608	1928	2280	2600	2984	3240
17	336	696	1064	1416	1800	2152	2536	2856	3240	3624
18	376	776	1160	1544	1992	2344	2792	3112	3624	4008
19	408	840	1288	1736	2152	2600	2984	3496	3880	4264
20	440	904	1384	1864	2344	2792	3240	3752	4136	4584
21	488	1000	1480	1992	2472	2984	3496	4008	4584	4968
22	520	1064	1608	2152	2664	3240	3752	4264	4776	5352
23	552	1128	1736	2280	2856	3496	4008	4584	5160	5736
24	584	1192	1800	2408	2984	3624	4264	4968	5544	5992
25	616	1256	1864	2536	3112	3752	4392	5160	5736	6200
26	712	1480	2216	2984	3752	4392	5160	5992	6712	7480

I_{TBS}	N_{PRB}									
	11	12	13	14	15	16	17	18	19	20
0	288	328	344	376	392	424	456	488	504	536
1	376	424	456	488	520	568	600	632	680	712
2	472	520	568	616	648	696	744	776	840	872
3	616	680	744	808	872	904	968	1032	1096	1160
4	776	840	904	1000	1064	1128	1192	1288	1352	1416
5	968	1032	1128	1224	1320	1384	1480	1544	1672	1736
6	1128	1224	1352	1480	1544	1672	1736	1864	1992	2088
7	1320	1480	1608	1672	1800	1928	2088	2216	2344	2472
8	1544	1672	1800	1928	2088	2216	2344	2536	2664	2792
9	1736	1864	2024	2216	2344	2536	2664	2856	2984	3112
10	1928	2088	2280	2472	2664	2792	2984	3112	3368	3496
11	2216	2408	2600	2792	2984	3240	3496	3624	3880	4008
12	2472	2728	2984	3240	3368	3624	3880	4136	4392	4584
13	2856	3112	3368	3624	3880	4136	4392	4584	4968	5160
14	3112	3496	3752	4008	4264	4584	4968	5160	5544	5736
15	3368	3624	4008	4264	4584	4968	5160	5544	5736	6200
16	3624	3880	4264	4584	4968	5160	5544	5992	6200	6456
17	4008	4392	4776	5160	5352	5736	6200	6456	6712	7224
18	4392	4776	5160	5544	5992	6200	6712	7224	7480	7992
19	4776	5160	5544	5992	6456	6968	7224	7736	8248	8504
20	5160	5544	5992	6456	6968	7480	7992	8248	8760	9144
21	5544	5992	6456	6968	7480	7992	8504	9144	9528	9912
22	5992	6456	6968	7480	7992	8504	9144	9528	10296	10680
23	6200	6968	7480	7992	8504	9144	9912	10296	11064	11448
24	6712	7224	7992	8504	9144	9912	10296	11064	11448	12216
25	6968	7480	8248	8760	9528	10296	10680	11448	12216	12576
26	8248	8760	9528	10296	11064	11832	12576	13536	14112	14688

I_{TBS}	N_{PRB}									
	21	22	23	24	25	26	27	28	29	30

0	568	600	616	648	680	712	744	776	776	808
1	744	776	808	872	904	936	968	1000	1032	1064
2	936	968	1000	1064	1096	1160	1192	1256	1288	1320
3	1224	1256	1320	1384	1416	1480	1544	1608	1672	1736
4	1480	1544	1608	1736	1800	1864	1928	1992	2088	2152
5	1864	1928	2024	2088	2216	2280	2344	2472	2536	2664
6	2216	2280	2408	2472	2600	2728	2792	2984	2984	3112
7	2536	2664	2792	2984	3112	3240	3368	3368	3496	3624
8	2984	3112	3240	3368	3496	3624	3752	3880	4008	4264
9	3368	3496	3624	3752	4008	4136	4264	4392	4584	4776
10	3752	3880	4008	4264	4392	4584	4776	4968	5160	5352
11	4264	4392	4584	4776	4968	5352	5544	5736	5992	5992
12	4776	4968	5352	5544	5736	5992	6200	6456	6712	6712
13	5352	5736	5992	6200	6456	6712	6968	7224	7480	7736
14	5992	6200	6456	6968	7224	7480	7736	7992	8248	8504
15	6456	6712	6968	7224	7736	7992	8248	8504	8760	9144
16	6712	7224	7480	7736	7992	8504	8760	9144	9528	9912
17	7480	7992	8248	8760	9144	9528	9912	10296	10296	10680
18	8248	8760	9144	9528	9912	10296	10680	11064	11448	11832
19	9144	9528	9912	10296	10680	11064	11448	12216	12576	12960
20	9912	10296	10680	11064	11448	12216	12576	12960	13536	14112
21	10680	11064	11448	12216	12576	12960	13536	14112	14688	15264
22	11448	11832	12576	12960	13536	14112	14688	15264	15840	16416
23	12216	12576	12960	13536	14112	14688	15264	15840	16416	16992
24	12960	13536	14112	14688	15264	15840	16416	16992	17568	18336
25	13536	14112	14688	15264	15840	16416	16992	17568	18336	19080
26	15264	16416	16992	17568	18336	19080	19848	20616	21384	22152

I_{TBS}	N_{PRB}									
	31	32	33	34	35	36	37	38	39	40
0	840	872	904	936	968	1000	1032	1032	1064	1096
1	1128	1160	1192	1224	1256	1288	1352	1384	1416	1416
2	1384	1416	1480	1544	1544	1608	1672	1672	1736	1800
3	1800	1864	1928	1992	2024	2088	2152	2216	2280	2344
4	2216	2280	2344	2408	2472	2600	2664	2728	2792	2856
5	2728	2792	2856	2984	3112	3112	3240	3368	3496	3496
6	3240	3368	3496	3496	3624	3752	3880	4008	4136	4136
7	3752	3880	4008	4136	4264	4392	4584	4584	4776	4968
8	4392	4584	4584	4776	4968	4968	5160	5352	5544	5544
9	4968	5160	5160	5352	5544	5736	5736	5992	6200	6200
10	5544	5736	5736	5992	6200	6200	6456	6712	6712	6968
11	6200	6456	6712	6968	6968	7224	7480	7736	7736	7992
12	6968	7224	7480	7736	7992	8248	8504	8760	8760	9144
13	7992	8248	8504	8760	9144	9144	9528	9912	9912	10296
14	8760	9144	9528	9912	9912	10296	10680	11064	11064	11448
15	9528	9912	10296	10296	10680	11064	11448	11832	11832	12216
16	9912	10296	10680	11064	11448	11832	12216	12216	12576	12960
17	11064	11448	11832	12216	12576	12960	13536	13536	14112	14688
18	12216	12576	12960	13536	14112	14112	14688	15264	15264	15840
19	13536	13536	14112	14688	15264	15264	15840	16416	16992	16992
20	14688	14688	15264	15840	16416	16992	16992	17568	18336	18336
21	15840	15840	16416	16992	17568	18336	18336	19080	19848	19848
22	16992	16992	17568	18336	19080	19080	19848	20616	21384	21384
23	17568	18336	19080	19848	19848	20616	21384	22152	22152	22920
24	19080	19848	19848	20616	21384	22152	22920	22920	23688	24496
25	19848	20616	20616	21384	22152	22920	23688	24496	24496	25456
26	22920	23688	24496	25456	25456	26416	27376	28336	29296	29296

I_{TBS}	N_{PRB}									
	41	42	43	44	45	46	47	48	49	50
0	1128	1160	1192	1224	1256	1256	1288	1320	1352	1384
1	1480	1544	1544	1608	1608	1672	1736	1736	1800	1800
2	1800	1864	1928	1992	2024	2088	2088	2152	2216	2216
3	2408	2472	2536	2536	2600	2664	2728	2792	2856	2856
4	2984	2984	3112	3112	3240	3240	3368	3496	3496	3624

5	3624	3752	3752	3880	4008	4008	4136	4264	4392	4392
6	4264	4392	4584	4584	4776	4776	4968	4968	5160	5160
7	4968	5160	5352	5352	5544	5736	5736	5992	5992	6200
8	5736	5992	5992	6200	6200	6456	6456	6712	6968	6968
9	6456	6712	6712	6968	6968	7224	7480	7480	7736	7992
10	7224	7480	7480	7736	7992	7992	8248	8504	8504	8760
11	8248	8504	8760	8760	9144	9144	9528	9528	9912	9912
12	9528	9528	9912	9912	10296	10680	10680	11064	11064	11448
13	10680	10680	11064	11448	11448	11832	12216	12216	12576	12960
14	11832	12216	12216	12576	12960	12960	13536	13536	14112	14112
15	12576	12960	12960	13536	13536	14112	14688	14688	15264	15264
16	13536	13536	14112	14112	14688	14688	15264	15840	15840	16416
17	14688	15264	15264	15840	16416	16416	16992	17568	17568	18336
18	16416	16416	16992	17568	17568	18336	18336	19080	19080	19848
19	17568	18336	18336	19080	19080	19848	20616	20616	21384	21384
20	19080	19848	19848	20616	20616	21384	22152	22152	22920	22920
21	20616	21384	21384	22152	22920	22920	23688	24496	24496	25456
22	22152	22920	22920	23688	24496	24496	25456	25456	26416	27376
23	23688	24496	24496	25456	25456	26416	27376	27376	28336	28336
24	25456	25456	26416	26416	27376	28336	28336	29296	29296	30576
25	26416	26416	27376	28336	28336	29296	29296	30576	31704	31704
26	30576	30576	31704	32856	32856	34008	35160	35160	36696	36696

I_{TBS}	N_{PRB}									
	51	52	53	54	55	56	57	58	59	60
0	1416	1416	1480	1480	1544	1544	1608	1608	1608	1672
1	1864	1864	1928	1992	1992	2024	2088	2088	2152	2152
2	2280	2344	2344	2408	2472	2536	2536	2600	2664	2664
3	2984	2984	3112	3112	3240	3240	3368	3368	3496	3496
4	3624	3752	3752	3880	4008	4008	4136	4136	4264	4264
5	4584	4584	4776	4776	4776	4968	4968	5160	5160	5352
6	5352	5352	5544	5736	5736	5992	5992	5992	6200	6200
7	6200	6456	6456	6712	6712	6712	6968	6968	7224	7224
8	7224	7224	7480	7480	7736	7736	7992	7992	8248	8504
9	7992	8248	8248	8504	8760	8760	9144	9144	9144	9528
10	9144	9144	9144	9528	9528	9912	9912	10296	10296	10680
11	10296	10680	10680	11064	11064	11448	11448	11832	11832	12216
12	11832	11832	12216	12216	12576	12576	12960	12960	13536	13536
13	12960	13536	13536	14112	14112	14688	14688	14688	15264	15264
14	14688	14688	15264	15264	15840	15840	16416	16416	16992	16992
15	15840	15840	16416	16416	16992	16992	17568	17568	18336	18336
16	16416	16992	16992	17568	17568	18336	18336	19080	19080	19848
17	18336	19080	19080	19848	19848	20616	20616	20616	21384	21384
18	19848	20616	21384	21384	22152	22152	22920	22920	23688	23688
19	22152	22152	22920	22920	23688	24496	24496	25456	25456	25456
20	23688	24496	24496	25456	25456	26416	26416	27376	27376	28336
21	25456	26416	26416	27376	27376	28336	28336	29296	29296	30576
22	27376	28336	28336	29296	29296	30576	30576	31704	31704	32856
23	29296	29296	30576	30576	31704	31704	32856	32856	34008	34008
24	31704	31704	32856	32856	34008	34008	35160	35160	36696	36696
25	32856	32856	34008	34008	35160	35160	36696	36696	37888	37888
26	37888	37888	39232	40576	40576	40576	42368	42368	43816	43816

I_{TBS}	N_{PRB}									
	61	62	63	64	65	66	67	68	69	70
0	1672	1736	1736	1800	1800	1800	1864	1864	1928	1928
1	2216	2280	2280	2344	2344	2408	2472	2472	2536	2536
2	2728	2792	2856	2856	2856	2984	2984	3112	3112	3112
3	3624	3624	3624	3752	3752	3880	3880	4008	4008	4136
4	4392	4392	4584	4584	4584	4776	4776	4968	4968	4968
5	5352	5544	5544	5736	5736	5736	5992	5992	5992	6200
6	6456	6456	6456	6712	6712	6968	6968	6968	7224	7224
7	7480	7480	7736	7736	7992	7992	8248	8248	8504	8504
8	8504	8760	8760	9144	9144	9144	9528	9528	9528	9912
9	9528	9912	9912	10296	10296	10296	10680	10680	11064	11064

10	10680	11064	11064	11448	11448	11448	11832	11832	12216	12216
11	12216	12576	12576	12960	12960	13536	13536	13536	14112	14112
12	14112	14112	14112	14688	14688	15264	15264	15264	15840	15840
13	15840	15840	16416	16416	16992	16992	16992	17568	17568	18336
14	17568	17568	18336	18336	18336	19080	19080	19848	19848	19848
15	18336	19080	19080	19848	19848	20616	20616	20616	21384	21384
16	19848	19848	20616	20616	21384	21384	22152	22152	22152	22920
17	22152	22152	22920	22920	23688	23688	24496	24496	24496	25456
18	24496	24496	24496	25456	25456	26416	26416	27376	27376	27376
19	26416	26416	27376	27376	28336	28336	29296	29296	29296	30576
20	28336	29296	29296	29296	30576	30576	31704	31704	31704	32856
21	30576	31704	31704	31704	32856	32856	34008	34008	35160	35160
22	32856	34008	34008	34008	35160	35160	36696	36696	36696	37888
23	35160	35160	36696	36696	37888	37888	37888	39232	39232	40576
24	36696	37888	37888	39232	39232	40576	40576	42368	42368	42368
25	39232	39232	40576	40576	40576	42368	42368	43816	43816	43816
26	45352	45352	46888	46888	48936	48936	48936	51024	51024	52752

I_{TBS}	N_{PRB}									
	71	72	73	74	75	76	77	78	79	80
0	1992	1992	2024	2088	2088	2088	2152	2152	2216	2216
1	2600	2600	2664	2728	2728	2792	2792	2856	2856	2856
2	3240	3240	3240	3368	3368	3368	3496	3496	3496	3624
3	4136	4264	4264	4392	4392	4392	4584	4584	4584	4776
4	5160	5160	5160	5352	5352	5544	5544	5544	5736	5736
5	6200	6200	6456	6456	6712	6712	6712	6968	6968	6968
6	7480	7480	7736	7736	7736	7992	7992	8248	8248	8248
7	8760	8760	8760	9144	9144	9144	9528	9528	9528	9912
8	9912	9912	10296	10296	10680	10680	10680	11064	11064	11064
9	11064	11448	11448	11832	11832	11832	12216	12216	12576	12576
10	12576	12576	12960	12960	12960	13536	13536	13536	14112	14112
11	14112	14688	14688	14688	15264	15264	15840	15840	15840	16416
12	16416	16416	16416	16992	16992	17568	17568	17568	18336	18336
13	18336	18336	19080	19080	19080	19848	19848	19848	20616	20616
14	20616	20616	20616	21384	21384	22152	22152	22152	22920	22920
15	22152	22152	22152	22920	22920	23688	23688	23688	24496	24496
16	22920	23688	23688	24496	24496	24496	25456	25456	25456	26416
17	25456	26416	26416	26416	27376	27376	27376	28336	28336	29296
18	28336	28336	29296	29296	29296	30576	30576	30576	31704	31704
19	30576	30576	31704	31704	32856	32856	32856	34008	34008	34008
20	32856	34008	34008	34008	35160	35160	35160	36696	36696	36696
21	35160	36696	36696	36696	37888	37888	39232	39232	39232	40576
22	37888	39232	39232	40576	40576	40576	42368	42368	42368	43816
23	40576	40576	42368	42368	43816	43816	43816	45352	45352	45352
24	43816	43816	45352	45352	45352	46888	46888	46888	48936	48936
25	45352	45352	46888	46888	46888	48936	48936	48936	51024	51024
26	52752	52752	55056	55056	55056	55056	57336	57336	57336	59256

I_{TBS}	N_{PRB}									
	81	82	83	84	85	86	87	88	89	90
0	2280	2280	2280	2344	2344	2408	2408	2472	2472	2536
1	2984	2984	2984	3112	3112	3112	3240	3240	3240	3240
2	3624	3624	3752	3752	3880	3880	3880	4008	4008	4008
3	4776	4776	4776	4968	4968	4968	5160	5160	5160	5352
4	5736	5992	5992	5992	5992	6200	6200	6200	6456	6456
5	7224	7224	7224	7480	7480	7480	7736	7736	7736	7992
6	8504	8504	8760	8760	8760	9144	9144	9144	9144	9528
7	9912	9912	10296	10296	10296	10680	10680	10680	11064	11064
8	11448	11448	11448	11832	11832	12216	12216	12216	12576	12576
9	12960	12960	12960	13536	13536	13536	13536	14112	14112	14112
10	14112	14688	14688	14688	14688	15264	15264	15264	15840	15840
11	16416	16416	16992	16992	16992	17568	17568	17568	18336	18336
12	18336	19080	19080	19080	19080	19848	19848	19848	20616	20616
13	20616	21384	21384	21384	22152	22152	22152	22920	22920	22920
14	22920	23688	23688	24496	24496	24496	25456	25456	25456	25456

15	24496	25456	25456	25456	26416	26416	26416	27376	27376	27376
16	26416	26416	27376	27376	27376	28336	28336	28336	29296	29296
17	29296	29296	30576	30576	30576	30576	31704	31704	31704	32856
18	31704	32856	32856	32856	34008	34008	34008	35160	35160	35160
19	35160	35160	35160	36696	36696	36696	37888	37888	37888	39232
20	37888	37888	39232	39232	39232	40576	40576	40576	42368	42368
21	40576	40576	42368	42368	42368	43816	43816	43816	45352	45352
22	43816	43816	45352	45352	45352	46888	46888	46888	48936	48936
23	46888	46888	46888	48936	48936	48936	51024	51024	51024	51024
24	48936	51024	51024	51024	52752	52752	52752	52752	55056	55056
25	51024	52752	52752	52752	55056	55056	55056	55056	57336	57336
26	59256	59256	61664	61664	61664	63776	63776	63776	66592	66592

I_{TBS}	N_{PRB}									
	91	92	93	94	95	96	97	98	99	100
0	2536	2536	2600	2600	2664	2664	2728	2728	2728	2792
1	3368	3368	3368	3496	3496	3496	3496	3624	3624	3624
2	4136	4136	4136	4264	4264	4264	4392	4392	4392	4584
3	5352	5352	5352	5544	5544	5544	5736	5736	5736	5736
4	6456	6456	6712	6712	6712	6968	6968	6968	6968	7224
5	7992	7992	8248	8248	8248	8504	8504	8760	8760	8760
6	9528	9528	9528	9912	9912	9912	10296	10296	10296	10296
7	11064	11448	11448	11448	11448	11832	11832	11832	12216	12216
8	12576	12960	12960	12960	13536	13536	13536	13536	14112	14112
9	14112	14688	14688	14688	15264	15264	15264	15264	15840	15840
10	15840	16416	16416	16416	16992	16992	16992	16992	17568	17568
11	18336	18336	19080	19080	19080	19080	19848	19848	19848	19848
12	20616	21384	21384	21384	21384	22152	22152	22152	22920	22920
13	23688	23688	23688	24496	24496	24496	25456	25456	25456	25456
14	26416	26416	26416	27376	27376	27376	28336	28336	28336	28336
15	28336	28336	28336	29296	29296	29296	29296	30576	30576	30576
16	29296	30576	30576	30576	30576	31704	31704	31704	31704	32856
17	32856	32856	34008	34008	34008	35160	35160	35160	35160	36696
18	36696	36696	36696	37888	37888	37888	37888	39232	39232	39232
19	39232	39232	40576	40576	40576	40576	42368	42368	42368	43816
20	42368	42368	43816	43816	43816	45352	45352	45352	46888	46888
21	45352	46888	46888	46888	46888	48936	48936	48936	48936	51024
22	48936	48936	51024	51024	51024	51024	52752	52752	52752	55056
23	52752	52752	52752	55056	55056	55056	55056	57336	57336	57336
24	55056	57336	57336	57336	57336	59256	59256	59256	61664	61664
25	57336	59256	59256	59256	61664	61664	61664	61664	63776	63776
26	66592	68808	68808	68808	71112	71112	71112	73712	73712	75376

I_{TBS}	N_{PRB}									
	101	102	103	104	105	106	107	108	109	110
0	2792	2856	2856	2856	2984	2984	2984	2984	2984	3112
1	3752	3752	3752	3752	3880	3880	3880	4008	4008	4008
2	4584	4584	4584	4584	4776	4776	4776	4776	4968	4968
3	5992	5992	5992	5992	6200	6200	6200	6200	6456	6456
4	7224	7224	7480	7480	7480	7480	7736	7736	7736	7992
5	8760	9144	9144	9144	9144	9528	9528	9528	9528	9528
6	10680	10680	10680	10680	11064	11064	11064	11448	11448	11448
7	12216	12576	12576	12576	12960	12960	12960	12960	13536	13536
8	14112	14112	14688	14688	14688	14688	15264	15264	15264	15264
9	15840	16416	16416	16416	16416	16992	16992	16992	16992	17568
10	17568	18336	18336	18336	18336	18336	19080	19080	19080	19080
11	20616	20616	20616	21384	21384	21384	21384	22152	22152	22152
12	22920	23688	23688	23688	23688	24496	24496	24496	24496	25456
13	26416	26416	26416	26416	27376	27376	27376	27376	28336	28336
14	29296	29296	29296	29296	30576	30576	30576	30576	31704	31704
15	30576	31704	31704	31704	31704	32856	32856	32856	34008	34008
16	32856	32856	34008	34008	34008	34008	35160	35160	35160	35160
17	36696	36696	36696	37888	37888	37888	39232	39232	39232	39232
18	40576	40576	40576	40576	42368	42368	42368	42368	43816	43816
19	43816	43816	43816	45352	45352	45352	46888	46888	46888	46888

20	46888	46888	48936	48936	48936	48936	48936	51024	51024	51024
21	51024	51024	51024	52752	52752	52752	52752	55056	55056	55056
22	55056	55056	55056	57336	57336	57336	57336	59256	59256	59256
23	57336	59256	59256	59256	59256	61664	61664	61664	61664	63776
24	61664	61664	63776	63776	63776	63776	66592	66592	66592	66592
25	63776	63776	66592	66592	66592	66592	68808	68808	68808	71112
26	75376	75376	75376	75376	75376	75376	75376	75376	75376	75376

[TS 36.306 clause 4.1]

The UE Category parameter defines a combined uplink and downlink capability. The parameters set by the UE Category are defined in subclause 4.2. Tables 4.1-1 and 4.1-2 define the downlink and, respectively, uplink physical layer parameter values for each UE Category.

Table 4.1-1: Downlink physical layer parameter values set by UE Category

UE Category	Maximum number of DL-SCH transport block bits received within a TTI	Maximum number of bits of a DL-SCH transport block received within a TTI	Total number of soft channel bits	Maximum number of supported layers for spatial multiplexing in DL
Category 1	10296	10296	250368	1
Category 2	51024	51024	1237248	2
Category 3	102048	75376	1237248	2
Category 4	150752	75376	1827072	2
Category 5	302752	151376	3667200	4

Table 4.1-2: Uplink physical layer parameter values set by UE Category

UE Category	Maximum number of bits of an UL-SCH transport block transmitted within a TTI	Support for 64QAM in UL
Category 1	5160	No
Category 2	25456	No
Category 3	51024	No
Category 4	51024	No
Category 5	75376	Yes

7.1.7.1.2.3 Test description

7.1.7.1.2.3.1 Pre-test conditions

System Simulator

- Cell 1.
- Uplink and downlink bandwidth set to 20 MHz (to enable testing of N_{PRB} up to maximum value).

UE:

None.

Preamble

- The UE is in state Loopback Activated (state 4) according to [18].

7.1.7.1.2.3.2 Test procedure sequence

Table 7.1.7.1.2.3.2-1: Maximum TB_{size} for different UE categories

UE Category	Maximum number of DL-SCH transport block bits received within a TTI
Category 1	10296
Category 2	51024
Category 3	102048
Category 4	150752
Category 5	302752

Table 7.1.7.1.2.3.2-2: Number of downlink PDCP SDUs and PDCP SDU size used as test data

TB_{size} [bits]	Number of PDCP SDUs	PDCP SDU size of each PDCP SDU [bits] See note 1
$TB_{size} \leq 12000$	1	[FFS]
$12001 \leq TB_{size} \leq 24000$	2	[FFS]
$24001 \leq TB_{size} \leq 36000$	3	[FFS]
$36001 \leq TB_{size} \leq 48000$	4	[FFS]
$48001 \leq TB_{size} \leq 60000$	5	[FFS]
$60001 \leq TB_{size} \leq 72000$	6	[FFS]
$TB_{size} \geq 72001$	7	[FFS]

Note 1: Each PDCP SDU is limited to [TBD] octets (keep below maximum SDU size of ESM as specified in TS 24.301 clause 9.9.4.12).

Table 7.1.7.1.2.3.2-3: Main behaviour

St	Procedure	Message Sequence		TP	Verdict
		U – S	Message		
-	EXCEPTION: Steps 1 to 4 are repeated for values of N_{PRB} from 1 to 110 and I_{MCS} from 0 to 28.	-	-	-	-
1	SS looks up I_{TBS} in table 7.1.7.1-1 in TS 36.213 based on the value of I_{MCS} . SS looks up TB_{size} in table 7.1.7.2.1-1 in TS 36.213 based on values of N_{PRB} and I_{TBS} .	-	-	-	-
-	EXCEPTION: Steps 2 to 4 are performed if TB_{size} is less or equal to UE capability "Maximum number of DL-SCH transport block bits received within a TTI" as specified in Table 7.1.7.1.2.3.2-1.	-	-	-	-
2	SS creates one or more PDCP SDUs, depending on TB_{size} , in accordance with Table 7.1.7.1.2.3.2-2.	-	-	-	-
3	SS transmits the PDCP SDUs concatenated into a MAC PDU and indicates on PDSCH DCI	<--	MAC PDU (NxPDCP SDUs) DCI: (DCI Format 1, RA	-	-

	Format 1 with RA type 1 and a Resource block assignment (RBA) correspondent to N_{PRB} as specified in 7.1.6.2 in TS 36.213 and Modulation and coding scheme I_{MCS} .		type 1, $\text{RBA}(N_{\text{PRB}}), I_{\text{MCS}}$		
4	CHECK: Does UE return the same number of PDCP SDUs with same content as transmitted by the SS in step 3?	-->	(NxPDCP SDUs)	1	P

7.1.7.1.2.3.3 Specific Message Contents

None

7.1.7.1.3 DL-SCH Transport Block Size selection / DCI format 1A / RA type 2 / Localised VRB

Editor's note; There is a need to update test procedure to exclude test points resulting in an effective channel code rate higher than 0.930 (ref TS 36.213 clause 7.1.7).

7.1.7.1.3.1 Test Purpose (TP)

(1)

```
with { UE in E-UTRA RRC_CONNECTED state }
ensure that {
  when { UE on PDCCH receives DCI format 1A indicating Resource Allocation Type 2 with Localised
VRB, a Resource block assignment correspondent to  $N_{\text{PRB}}$  physical resource blocks and a Modulation
and Coding scheme  $I_{\text{MCS}}$  }
  then { UE decodes the received transport block of size correspondent to the read  $N_{\text{PRB}}$  and
 $I_{\text{MCS}}$  and forward it to higher layers }
}
```

7.1.7.1.3.2 Conformance requirements

References: The conformance requirements covered in the current TC are specified in: TS 36.212, clause 5.3.3.1.3; TS 36.213, clauses 7.1.6.3, 7.1.7, 7.1.7.1, 7.1.7.2 and 7.1.7.2.1; and TS 36.306 clause 4.1.

[TS 36.212 clause 5.3.3.1.3]

DCI format 1A is used for the compact scheduling of one PDSCH codeword and random access procedure initiated by a PDCCH order.

The following information is transmitted by means of the DCI format 1A:

- Flag for format0/format1A differentiation – 1 bit, where value 0 indicates format 0 and value 1 indicates format 1A

...

Otherwise,

- Localized/Distributed VRB assignment flag – 1 bit as defined in 7.1.6.3 of [3]

- Resource block assignment – $\lceil \log_2(N_{\text{RB}}^{\text{DL}}(N_{\text{RB}}^{\text{DL}} + 1)/2) \rceil$ bits as defined in section 7.1.6.3 of [3]:

- For localized VRB:

$\lceil \log_2(N_{\text{RB}}^{\text{DL}}(N_{\text{RB}}^{\text{DL}} + 1)/2) \rceil$ bits provide the resource allocation

- For distributed VRB:

- If $N_{RB}^{DL} < 50$ or if the format 1A CRC is scrambled by RA-RNTI, P-RNTI, or SI-RNTI

- $\lceil \log_2(N_{RB}^{DL}(N_{RB}^{DL} + 1)/2) \rceil$ bits provide the resource allocation

- Else

- 1 bit, the MSB indicates the gap value, where value 0 indicates $N_{gap} = N_{gap,1}$ and value 1 indicates $N_{gap} = N_{gap,2}$

- $(\lceil \log_2(N_{RB}^{DL}(N_{RB}^{DL} + 1)/2) \rceil - 1)$ bits provide the resource allocation

- Modulation and coding scheme – 5bits as defined in section 7.1.7 of [3]

...

[TS 36.213 clause 7.1.6.3]

In resource allocations of type 2, the resource block assignment information indicates to a scheduled UE a set of contiguously allocated localized virtual resource blocks or distributed virtual resource blocks. In case of resource allocation signalled with PDCCH DCI format 1A, 1B or 1D, one bit flag indicates whether localized virtual resource blocks or distributed virtual resource blocks are assigned (value 0 indicates Localized and value 1 indicates Distributed VRB assignment) while distributed virtual resource blocks are always assigned in case of resource allocation signalled with PDCCH DCI format 1C. Localized VRB allocations for a UE vary from a single VRB up to a maximum number of VRBs spanning the system bandwidth. For DCI format 1A the distributed VRB allocations for a UE vary from a single VRB up to N_{VRB}^{DL} VRBs, where N_{VRB}^{DL} is defined in [3], if the DCI CRC is scrambled by P-RNTI, RA-RNTI, or SI-RNTI. With PDCCH DCI format 1B, 1D, or 1A with a CRC scrambled with C-RNTI, distributed VRB allocations for a UE vary from a single VRB up to N_{VRB}^{DL} VRBs if N_{RB}^{DL} is 6-49 and vary from a single VRB up to 16 if N_{RB}^{DL} is 50-110. With PDCCH DCI format 1C, distributed VRB allocations for a UE vary from N_{RB}^{step} VRB(s) up to $\lfloor N_{VRB}^{DL} / N_{RB}^{step} \rfloor \cdot N_{RB}^{step}$ VRBs with an increment step of N_{RB}^{step} , where N_{RB}^{step} value is determined depending on the downlink system bandwidth as shown in Table 7.1.6.3-1.

Table 7.1.6.3-1: N_{RB}^{step} values vs. Downlink System Bandwidth

System BW (N_{RB}^{DL})	N_{RB}^{step}
	DCI format 1C
6-49	2
50-110	4

For PDCCH DCI format 1A, 1B or 1D, a type 2 resource allocation field consists of a resource indication value (RIV) corresponding to a starting resource block (RB_{start}) and a length in terms of virtually contiguously allocated resource blocks L_{CRBs} . The resource indication value is defined by

if $(L_{CRBs} - 1) \leq \lfloor N_{RB}^{DL} / 2 \rfloor$ then

$$RIV = N_{RB}^{DL} (L_{CRBs} - 1) + RB_{start}$$

else

$$RIV = N_{RB}^{DL} (N_{RB}^{DL} - L_{CRBs} + 1) + (N_{RB}^{DL} - 1 - RB_{start})$$

where $L_{CRBs} \geq 1$ and shall not exceed $N_{VRB}^{DL} - RB_{start}$.

For PDCCH DCI format 1C, a type 2 resource block assignment field consists of a resource indication value (RIV) corresponding to a starting resource block ($RB_{start} = 0, N_{RB}^{step}, 2N_{RB}^{step}, \dots, (\lfloor N_{VRB}^{DL} / N_{RB}^{step} \rfloor - 1)N_{RB}^{step}$) and a length in terms

of virtually contiguously allocated resource blocks ($L_{CRBs} = N_{RB}^{step}, 2N_{RB}^{step}, \dots, \lfloor N_{VRB}^{DL} / N_{RB}^{step} \rfloor \cdot N_{RB}^{step}$). The resource indication value is defined by

if $(L'_{CRBs} - 1) \leq \lfloor N_{VRB}^{DL} / 2 \rfloor$ then

$$RIV = N_{VRB}^{DL} (L'_{CRBs} - 1) + RB'_{start}$$

else

$$RIV = N_{VRB}^{DL} (N_{VRB}^{DL} - L'_{CRBs} + 1) + (N_{VRB}^{DL} - 1 - RB'_{start})$$

where $L'_{CRBs} = L_{CRBs} / N_{RB}^{step}$, $RB'_{start} = RB_{start} / N_{RB}^{step}$ and $N_{VRB}^{DL} = \lfloor N_{VRB}^{DL} / N_{RB}^{step} \rfloor$. Here,

$L'_{CRBs} \geq 1$ and shall not exceed $N_{VRB}^{DL} - RB'_{start}$.

[TS 36.213 clause 7.1.7]

To determine the modulation order and transport block size(s) in the physical downlink shared channel, the UE shall first

- read the 5-bit “modulation and coding scheme” field (I_{MCS}) in the DCI

and second if the DCI CRC is scrambled by P-RNTI, RA-RNTI, or SI-RNTI then

...

else

- set the Table 7.1.7.2.1-1 column indicator N'_{PRB} to the total number of allocated PRBs based on the procedure defined in Section 7.1.6.

if the transport block is transmitted in DwPTS of the special subframe in frame structure type 2, then

$$\text{set the Table 7.1.7.2.1-1 column indicator } N_{PRB} = \max \left\{ \left\lfloor N'_{PRB} \times 0.75 \right\rfloor, 1 \right\},$$

else, set the Table 7.1.7.2.1-1 column indicator $N_{PRB} = N'_{PRB}$.

The UE may skip decoding a transport block in an initial transmission if the effective channel code rate is higher than 0.930, where the effective channel code rate is defined as the number of downlink information bits (including CRC bits) divided by the number of physical channel bits on PDSCH. If the UE skips decoding, the physical layer indicates to higher layer that the transport block is not successfully decoded. For the special subframe configurations 0 and 5 with normal CP or configurations 0 and 4 with extended CP, shown in table 4.2-1 [3], there shall be no PDSCH transmission in DwPTS of the special subframe.

...

[TS 36.213 clause 7.1.7.1]

The UE shall use $Q_m = 2$ if the DCI CRC is scrambled by P-RNTI, RA-RNTI, or SI-RNTI, otherwise, the UE shall use I_{MCS} and Table 7.1.7.1-1 to determine the modulation order (Q_m) used in the physical downlink shared channel.

Table 7.1.7.1-1: Modulation and TBS index table for PDSCH

MCS Index I_{MCS}	Modulation Order Q_m	TBS Index I_{TBS}
0	2	0
1	2	1
2	2	2
3	2	3
4	2	4
5	2	5
6	2	6
7	2	7
8	2	8
9	2	9
10	4	9
11	4	10
12	4	11
13	4	12
14	4	13
15	4	14
16	4	15
17	6	15
18	6	16
19	6	17
20	6	18
21	6	19
22	6	20
23	6	21
24	6	22
25	6	23
26	6	24
27	6	25
28	6	26
29	2	reserved
30	4	
31	6	

[TS 36.213 clause 7.1.7.2]

If the DCI CRC is scrambled by P-RNTI, RA-RNTI, or SI-RNTI then

- for DCI format 1A:
 - the UE shall set the TBS index (I_{TBS}) equal to I_{MCS} and determine its TBS by the procedure in Section 7.1.7.2.1.

...

else

- for $0 \leq I_{MCS} \leq 28$, the UE shall first determine the TBS index (I_{TBS}) using I_{MCS} and Table 7.1.7.1-1 except if the transport block is disabled in DCI formats 2 and 2A as specified below. For a transport block that is not mapped to two-layer spatial multiplexing, the TBS is determined by the procedure in Section 7.1.7.2.1. For a transport block that is mapped to two-layer spatial multiplexing, the TBS is determined by the procedure in Section 7.1.7.2.2.
- for $29 \leq I_{MCS} \leq 31$, the TBS is assumed to be as determined from DCI transported in the latest PDCCH for the same transport block using $0 \leq I_{MCS} \leq 28$.
- In DCI formats 2 and 2A a transport block is disabled if $I_{MCS} = 0$ and if $rv_{idx} = 1$ otherwise the transport block is enabled.

The NDI and HARQ process ID, as signalled on PDCCH, and the TBS, as determined above, shall be delivered to higher layers.

[TS 36.213 clause 7.1.7.2.1]

For $1 \leq N_{\text{PRB}} \leq 110$, the TBS is given by the $(I_{\text{TBS}}, N_{\text{PRB}})$ entry of Table 7.1.7.2.1-1.

Table 7.1.7.2.1-1: Transport block size table (dimension 27x110)

I_{TBS}	N_{PRB}									
	1	2	3	4	5	6	7	8	9	10
0	16	32	56	88	120	152	176	208	224	256
1	24	56	88	144	176	208	224	256	328	344
2	32	72	144	176	208	256	296	328	376	424
3	40	104	176	208	256	328	392	440	504	568
4	56	120	208	256	328	408	488	552	632	696
5	72	144	224	328	424	504	600	680	776	872
6	328	176	256	392	504	600	712	808	936	1032
7	104	224	328	472	584	712	840	968	1096	1224
8	120	256	392	536	680	808	968	1096	1256	1384
9	136	296	456	616	776	936	1096	1256	1416	1544
10	144	328	504	680	872	1032	1224	1384	1544	1736
11	176	376	584	776	1000	1192	1384	1608	1800	2024
12	208	440	680	904	1128	1352	1608	1800	2024	2280
13	224	488	744	1000	1256	1544	1800	2024	2280	2536
14	256	552	840	1128	1416	1736	1992	2280	2600	2856
15	280	600	904	1224	1544	1800	2152	2472	2728	3112
16	328	632	968	1288	1608	1928	2280	2600	2984	3240
17	336	696	1064	1416	1800	2152	2536	2856	3240	3624
18	376	776	1160	1544	1992	2344	2792	3112	3624	4008
19	408	840	1288	1736	2152	2600	2984	3496	3880	4264
20	440	904	1384	1864	2344	2792	3240	3752	4136	4584
21	488	1000	1480	1992	2472	2984	3496	4008	4584	4968
22	520	1064	1608	2152	2664	3240	3752	4264	4776	5352
23	552	1128	1736	2280	2856	3496	4008	4584	5160	5736
24	584	1192	1800	2408	2984	3624	4264	4968	5544	5992
25	616	1256	1864	2536	3112	3752	4392	5160	5736	6200
26	712	1480	2216	2984	3752	4392	5160	5992	6712	7480

I_{TBS}	N_{PRB}									
	11	12	13	14	15	16	17	18	19	20
0	288	328	344	376	392	424	456	488	504	536
1	376	424	456	488	520	568	600	632	680	712
2	472	520	568	616	648	696	744	776	840	872
3	616	680	744	808	872	904	968	1032	1096	1160
4	776	840	904	1000	1064	1128	1192	1288	1352	1416
5	968	1032	1128	1224	1320	1384	1480	1544	1672	1736
6	1128	1224	1352	1480	1544	1672	1736	1864	1992	2088
7	1320	1480	1608	1672	1800	1928	2088	2216	2344	2472
8	1544	1672	1800	1928	2088	2216	2344	2536	2664	2792
9	1736	1864	2024	2216	2344	2536	2664	2856	2984	3112
10	1928	2088	2280	2472	2664	2792	2984	3112	3368	3496
11	2216	2408	2600	2792	2984	3240	3496	3624	3880	4008
12	2472	2728	2984	3240	3368	3624	3880	4136	4392	4584
13	2856	3112	3368	3624	3880	4136	4392	4584	4968	5160
14	3112	3496	3752	4008	4264	4584	4968	5160	5544	5736
15	3368	3624	4008	4264	4584	4968	5160	5544	5736	6200
16	3624	3880	4264	4584	4968	5160	5544	5992	6200	6456
17	4008	4392	4776	5160	5352	5736	6200	6456	6712	7224
18	4392	4776	5160	5544	5992	6200	6712	7224	7480	7992
19	4776	5160	5544	5992	6456	6968	7224	7736	8248	8504
20	5160	5544	5992	6456	6968	7480	7992	8248	8760	9144
21	5544	5992	6456	6968	7480	7992	8504	9144	9528	9912
22	5992	6456	6968	7480	7992	8504	9144	9528	10296	10680
23	6200	6968	7480	7992	8504	9144	9912	10296	11064	11448
24	6712	7224	7992	8504	9144	9912	10296	11064	11448	12216
25	6968	7480	8248	8760	9528	10296	10680	11448	12216	12576
26	8248	8760	9528	10296	11064	11832	12576	13536	14112	14688

I_{TBS}	N_{PRB}									
	21	22	23	24	25	26	27	28	29	30

0	568	600	616	648	680	712	744	776	776	808
1	744	776	808	872	904	936	968	1000	1032	1064
2	936	968	1000	1064	1096	1160	1192	1256	1288	1320
3	1224	1256	1320	1384	1416	1480	1544	1608	1672	1736
4	1480	1544	1608	1736	1800	1864	1928	1992	2088	2152
5	1864	1928	2024	2088	2216	2280	2344	2472	2536	2664
6	2216	2280	2408	2472	2600	2728	2792	2984	2984	3112
7	2536	2664	2792	2984	3112	3240	3368	3368	3496	3624
8	2984	3112	3240	3368	3496	3624	3752	3880	4008	4264
9	3368	3496	3624	3752	4008	4136	4264	4392	4584	4776
10	3752	3880	4008	4264	4392	4584	4776	4968	5160	5352
11	4264	4392	4584	4776	4968	5352	5544	5736	5992	5992
12	4776	4968	5352	5544	5736	5992	6200	6456	6712	6712
13	5352	5736	5992	6200	6456	6712	6968	7224	7480	7736
14	5992	6200	6456	6968	7224	7480	7736	7992	8248	8504
15	6456	6712	6968	7224	7736	7992	8248	8504	8760	9144
16	6712	7224	7480	7736	7992	8504	8760	9144	9528	9912
17	7480	7992	8248	8760	9144	9528	9912	10296	10296	10680
18	8248	8760	9144	9528	9912	10296	10680	11064	11448	11832
19	9144	9528	9912	10296	10680	11064	11448	12216	12576	12960
20	9912	10296	10680	11064	11448	12216	12576	12960	13536	14112
21	10680	11064	11448	12216	12576	12960	13536	14112	14688	15264
22	11448	11832	12576	12960	13536	14112	14688	15264	15840	16416
23	12216	12576	12960	13536	14112	14688	15264	15840	16416	16992
24	12960	13536	14112	14688	15264	15840	16416	16992	17568	18336
25	13536	14112	14688	15264	15840	16416	16992	17568	18336	19080
26	15264	16416	16992	17568	18336	19080	19848	20616	21384	22152

I_{TBS}	N_{PRB}									
	31	32	33	34	35	36	37	38	39	40
0	840	872	904	936	968	1000	1032	1032	1064	1096
1	1128	1160	1192	1224	1256	1288	1352	1384	1416	1416
2	1384	1416	1480	1544	1544	1608	1672	1672	1736	1800
3	1800	1864	1928	1992	2024	2088	2152	2216	2280	2344
4	2216	2280	2344	2408	2472	2600	2664	2728	2792	2856
5	2728	2792	2856	2984	3112	3112	3240	3368	3496	3496
6	3240	3368	3496	3496	3624	3752	3880	4008	4136	4136
7	3752	3880	4008	4136	4264	4392	4584	4584	4776	4968
8	4392	4584	4584	4776	4968	4968	5160	5352	5544	5544
9	4968	5160	5160	5352	5544	5736	5736	5992	6200	6200
10	5544	5736	5736	5992	6200	6200	6456	6712	6712	6968
11	6200	6456	6712	6968	6968	7224	7480	7736	7736	7992
12	6968	7224	7480	7736	7992	8248	8504	8760	8760	9144
13	7992	8248	8504	8760	9144	9144	9528	9912	9912	10296
14	8760	9144	9528	9912	9912	10296	10680	11064	11064	11448
15	9528	9912	10296	10296	10680	11064	11448	11832	11832	12216
16	9912	10296	10680	11064	11448	11832	12216	12216	12576	12960
17	11064	11448	11832	12216	12576	12960	13536	13536	14112	14688
18	12216	12576	12960	13536	14112	14112	14688	15264	15264	15840
19	13536	13536	14112	14688	15264	15264	15840	16416	16992	16992
20	14688	14688	15264	15840	16416	16992	16992	17568	18336	18336
21	15840	15840	16416	16992	17568	18336	18336	19080	19848	19848
22	16992	16992	17568	18336	19080	19080	19848	20616	21384	21384
23	17568	18336	19080	19848	19848	20616	21384	22152	22152	22920
24	19080	19848	19848	20616	21384	22152	22920	22920	23688	24496
25	19848	20616	20616	21384	22152	22920	23688	24496	24496	25456
26	22920	23688	24496	25456	25456	26416	27376	28336	29296	29296

I_{TBS}	N_{PRB}									
	41	42	43	44	45	46	47	48	49	50
0	1128	1160	1192	1224	1256	1256	1288	1320	1352	1384
1	1480	1544	1544	1608	1608	1672	1736	1736	1800	1800
2	1800	1864	1928	1992	2024	2088	2088	2152	2216	2216
3	2408	2472	2536	2536	2600	2664	2728	2792	2856	2856
4	2984	2984	3112	3112	3240	3240	3368	3496	3496	3624

5	3624	3752	3752	3880	4008	4008	4136	4264	4392	4392
6	4264	4392	4584	4584	4776	4776	4968	4968	5160	5160
7	4968	5160	5352	5352	5544	5736	5736	5992	5992	6200
8	5736	5992	5992	6200	6200	6456	6456	6712	6968	6968
9	6456	6712	6712	6968	6968	7224	7480	7480	7736	7992
10	7224	7480	7480	7736	7992	7992	8248	8504	8504	8760
11	8248	8504	8760	8760	9144	9144	9528	9528	9912	9912
12	9528	9528	9912	9912	10296	10680	10680	11064	11064	11448
13	10680	10680	11064	11448	11448	11832	12216	12216	12576	12960
14	11832	12216	12216	12576	12960	12960	13536	13536	14112	14112
15	12576	12960	12960	13536	13536	14112	14688	14688	15264	15264
16	13536	13536	14112	14112	14688	14688	15264	15840	15840	16416
17	14688	15264	15264	15840	16416	16416	16992	17568	17568	18336
18	16416	16416	16992	17568	17568	18336	18336	19080	19080	19848
19	17568	18336	18336	19080	19080	19848	20616	20616	21384	21384
20	19080	19848	19848	20616	20616	21384	22152	22152	22920	22920
21	20616	21384	21384	22152	22920	22920	23688	24496	24496	25456
22	22152	22920	22920	23688	24496	24496	25456	25456	26416	27376
23	23688	24496	24496	25456	25456	26416	27376	27376	28336	28336
24	25456	25456	26416	26416	27376	28336	28336	29296	29296	30576
25	26416	26416	27376	28336	28336	29296	29296	30576	31704	31704
26	30576	30576	31704	32856	32856	34008	35160	35160	36696	36696

I_{TBS}	N_{PRB}									
	51	52	53	54	55	56	57	58	59	60
0	1416	1416	1480	1480	1544	1544	1608	1608	1608	1672
1	1864	1864	1928	1992	1992	2024	2088	2088	2152	2152
2	2280	2344	2344	2408	2472	2536	2536	2600	2664	2664
3	2984	2984	3112	3112	3240	3240	3368	3368	3496	3496
4	3624	3752	3752	3880	4008	4008	4136	4136	4264	4264
5	4584	4584	4776	4776	4776	4968	4968	5160	5160	5352
6	5352	5352	5544	5736	5736	5992	5992	5992	6200	6200
7	6200	6456	6456	6712	6712	6712	6968	6968	7224	7224
8	7224	7224	7480	7480	7736	7736	7992	7992	8248	8504
9	7992	8248	8248	8504	8760	8760	9144	9144	9144	9528
10	9144	9144	9144	9528	9528	9912	9912	10296	10296	10680
11	10296	10680	10680	11064	11064	11448	11448	11832	11832	12216
12	11832	11832	12216	12216	12576	12576	12960	12960	13536	13536
13	12960	13536	13536	14112	14112	14688	14688	14688	15264	15264
14	14688	14688	15264	15264	15840	15840	16416	16416	16992	16992
15	15840	15840	16416	16416	16992	16992	17568	17568	18336	18336
16	16416	16992	16992	17568	17568	18336	18336	19080	19080	19848
17	18336	19080	19080	19848	19848	20616	20616	20616	21384	21384
18	19848	20616	21384	21384	22152	22152	22920	22920	23688	23688
19	22152	22152	22920	22920	23688	24496	24496	25456	25456	25456
20	23688	24496	24496	25456	25456	26416	26416	27376	27376	28336
21	25456	26416	26416	27376	27376	28336	28336	29296	29296	30576
22	27376	28336	28336	29296	29296	30576	30576	31704	31704	32856
23	29296	29296	30576	30576	31704	31704	32856	32856	34008	34008
24	31704	31704	32856	32856	34008	34008	35160	35160	36696	36696
25	32856	32856	34008	34008	35160	35160	36696	36696	37888	37888
26	37888	37888	39232	40576	40576	40576	42368	42368	43816	43816

I_{TBS}	N_{PRB}									
	61	62	63	64	65	66	67	68	69	70
0	1672	1736	1736	1800	1800	1800	1864	1864	1928	1928
1	2216	2280	2280	2344	2344	2408	2472	2472	2536	2536
2	2728	2792	2856	2856	2856	2984	2984	3112	3112	3112
3	3624	3624	3624	3752	3752	3880	3880	4008	4008	4136
4	4392	4392	4584	4584	4584	4776	4776	4968	4968	4968
5	5352	5544	5544	5736	5736	5736	5992	5992	5992	6200
6	6456	6456	6456	6712	6712	6968	6968	6968	7224	7224
7	7480	7480	7736	7736	7992	7992	8248	8248	8504	8504
8	8504	8760	8760	9144	9144	9144	9528	9528	9528	9912
9	9528	9912	9912	10296	10296	10296	10680	10680	11064	11064

10	10680	11064	11064	11448	11448	11448	11832	11832	12216	12216
11	12216	12576	12576	12960	12960	13536	13536	13536	14112	14112
12	14112	14112	14112	14688	14688	15264	15264	15264	15840	15840
13	15840	15840	16416	16416	16992	16992	16992	17568	17568	18336
14	17568	17568	18336	18336	18336	19080	19080	19848	19848	19848
15	18336	19080	19080	19848	19848	20616	20616	20616	21384	21384
16	19848	19848	20616	20616	21384	21384	22152	22152	22152	22920
17	22152	22152	22920	22920	23688	23688	24496	24496	24496	25456
18	24496	24496	24496	25456	25456	26416	26416	27376	27376	27376
19	26416	26416	27376	27376	28336	28336	29296	29296	29296	30576
20	28336	29296	29296	29296	30576	30576	31704	31704	31704	32856
21	30576	31704	31704	31704	32856	32856	34008	34008	35160	35160
22	32856	34008	34008	34008	35160	35160	36696	36696	36696	37888
23	35160	35160	36696	36696	37888	37888	37888	39232	39232	40576
24	36696	37888	37888	39232	39232	40576	40576	42368	42368	42368
25	39232	39232	40576	40576	40576	42368	42368	43816	43816	43816
26	45352	45352	46888	46888	48936	48936	48936	51024	51024	52752

I_{TBS}	N_{PRB}									
	71	72	73	74	75	76	77	78	79	80
0	1992	1992	2024	2088	2088	2088	2152	2152	2216	2216
1	2600	2600	2664	2728	2728	2792	2792	2856	2856	2856
2	3240	3240	3240	3368	3368	3368	3496	3496	3496	3624
3	4136	4264	4264	4392	4392	4392	4584	4584	4584	4776
4	5160	5160	5160	5352	5352	5544	5544	5544	5736	5736
5	6200	6200	6456	6456	6712	6712	6712	6968	6968	6968
6	7480	7480	7736	7736	7736	7992	7992	8248	8248	8248
7	8760	8760	8760	9144	9144	9144	9528	9528	9528	9912
8	9912	9912	10296	10296	10680	10680	10680	11064	11064	11064
9	11064	11448	11448	11832	11832	11832	12216	12216	12576	12576
10	12576	12576	12960	12960	12960	13536	13536	13536	14112	14112
11	14112	14688	14688	14688	15264	15264	15840	15840	15840	16416
12	16416	16416	16416	16992	16992	17568	17568	17568	18336	18336
13	18336	18336	19080	19080	19080	19848	19848	19848	20616	20616
14	20616	20616	20616	21384	21384	22152	22152	22152	22920	22920
15	22152	22152	22152	22920	22920	23688	23688	23688	24496	24496
16	22920	23688	23688	24496	24496	24496	25456	25456	25456	26416
17	25456	26416	26416	26416	27376	27376	27376	28336	28336	29296
18	28336	28336	29296	29296	29296	30576	30576	30576	31704	31704
19	30576	30576	31704	31704	32856	32856	32856	34008	34008	34008
20	32856	34008	34008	34008	35160	35160	35160	36696	36696	36696
21	35160	36696	36696	36696	37888	37888	39232	39232	39232	40576
22	37888	39232	39232	40576	40576	40576	42368	42368	42368	43816
23	40576	40576	42368	42368	43816	43816	43816	45352	45352	45352
24	43816	43816	45352	45352	45352	46888	46888	46888	48936	48936
25	45352	45352	46888	46888	46888	48936	48936	48936	51024	51024
26	52752	52752	55056	55056	55056	55056	57336	57336	57336	59256

I_{TBS}	N_{PRB}									
	81	82	83	84	85	86	87	88	89	90
0	2280	2280	2280	2344	2344	2408	2408	2472	2472	2536
1	2984	2984	2984	3112	3112	3112	3240	3240	3240	3240
2	3624	3624	3752	3752	3880	3880	3880	4008	4008	4008
3	4776	4776	4776	4968	4968	4968	5160	5160	5160	5352
4	5736	5992	5992	5992	5992	6200	6200	6200	6456	6456
5	7224	7224	7224	7480	7480	7480	7736	7736	7736	7992
6	8504	8504	8760	8760	8760	9144	9144	9144	9144	9528
7	9912	9912	10296	10296	10296	10680	10680	10680	11064	11064
8	11448	11448	11448	11832	11832	12216	12216	12216	12576	12576
9	12960	12960	12960	13536	13536	13536	13536	14112	14112	14112
10	14112	14688	14688	14688	14688	15264	15264	15264	15840	15840
11	16416	16416	16992	16992	16992	17568	17568	17568	18336	18336
12	18336	19080	19080	19080	19080	19848	19848	19848	20616	20616
13	20616	21384	21384	21384	22152	22152	22152	22920	22920	22920
14	22920	23688	23688	24496	24496	24496	25456	25456	25456	25456

15	24496	25456	25456	25456	26416	26416	26416	27376	27376	27376
16	26416	26416	27376	27376	27376	28336	28336	28336	29296	29296
17	29296	29296	30576	30576	30576	30576	31704	31704	31704	32856
18	31704	32856	32856	32856	34008	34008	34008	35160	35160	35160
19	35160	35160	35160	36696	36696	36696	37888	37888	37888	39232
20	37888	37888	39232	39232	39232	40576	40576	40576	42368	42368
21	40576	40576	42368	42368	42368	43816	43816	43816	45352	45352
22	43816	43816	45352	45352	45352	46888	46888	46888	48936	48936
23	46888	46888	46888	48936	48936	48936	51024	51024	51024	51024
24	48936	51024	51024	51024	52752	52752	52752	52752	55056	55056
25	51024	52752	52752	52752	55056	55056	55056	55056	57336	57336
26	59256	59256	61664	61664	61664	63776	63776	63776	66592	66592

I_{TBS}	N_{PRB}									
	91	92	93	94	95	96	97	98	99	100
0	2536	2536	2600	2600	2664	2664	2728	2728	2728	2792
1	3368	3368	3368	3496	3496	3496	3496	3624	3624	3624
2	4136	4136	4136	4264	4264	4264	4392	4392	4392	4584
3	5352	5352	5352	5544	5544	5544	5736	5736	5736	5736
4	6456	6456	6712	6712	6712	6968	6968	6968	6968	7224
5	7992	7992	8248	8248	8248	8504	8504	8760	8760	8760
6	9528	9528	9528	9912	9912	9912	10296	10296	10296	10296
7	11064	11448	11448	11448	11448	11832	11832	11832	12216	12216
8	12576	12960	12960	12960	13536	13536	13536	13536	14112	14112
9	14112	14688	14688	14688	15264	15264	15264	15264	15840	15840
10	15840	16416	16416	16416	16992	16992	16992	16992	17568	17568
11	18336	18336	19080	19080	19080	19080	19848	19848	19848	19848
12	20616	21384	21384	21384	21384	22152	22152	22152	22920	22920
13	23688	23688	23688	24496	24496	24496	25456	25456	25456	25456
14	26416	26416	26416	27376	27376	27376	28336	28336	28336	28336
15	28336	28336	28336	29296	29296	29296	29296	30576	30576	30576
16	29296	30576	30576	30576	30576	31704	31704	31704	31704	32856
17	32856	32856	34008	34008	34008	35160	35160	35160	35160	36696
18	36696	36696	36696	37888	37888	37888	37888	39232	39232	39232
19	39232	39232	40576	40576	40576	40576	42368	42368	42368	43816
20	42368	42368	43816	43816	43816	45352	45352	45352	46888	46888
21	45352	46888	46888	46888	46888	48936	48936	48936	48936	51024
22	48936	48936	51024	51024	51024	51024	52752	52752	52752	55056
23	52752	52752	52752	55056	55056	55056	55056	57336	57336	57336
24	55056	57336	57336	57336	57336	59256	59256	59256	61664	61664
25	57336	59256	59256	59256	61664	61664	61664	61664	63776	63776
26	66592	68808	68808	68808	71112	71112	71112	73712	73712	75376

I_{TBS}	N_{PRB}									
	101	102	103	104	105	106	107	108	109	110
0	2792	2856	2856	2856	2984	2984	2984	2984	2984	3112
1	3752	3752	3752	3752	3880	3880	3880	4008	4008	4008
2	4584	4584	4584	4584	4776	4776	4776	4776	4968	4968
3	5992	5992	5992	5992	6200	6200	6200	6200	6456	6456
4	7224	7224	7480	7480	7480	7480	7736	7736	7736	7992
5	8760	9144	9144	9144	9144	9528	9528	9528	9528	9528
6	10680	10680	10680	10680	11064	11064	11064	11448	11448	11448
7	12216	12576	12576	12576	12960	12960	12960	12960	13536	13536
8	14112	14112	14688	14688	14688	14688	15264	15264	15264	15264
9	15840	16416	16416	16416	16416	16992	16992	16992	16992	17568
10	17568	18336	18336	18336	18336	18336	19080	19080	19080	19080
11	20616	20616	20616	21384	21384	21384	21384	22152	22152	22152
12	22920	23688	23688	23688	23688	24496	24496	24496	24496	25456
13	26416	26416	26416	26416	27376	27376	27376	27376	28336	28336
14	29296	29296	29296	29296	30576	30576	30576	30576	31704	31704
15	30576	31704	31704	31704	31704	32856	32856	32856	34008	34008
16	32856	32856	34008	34008	34008	34008	35160	35160	35160	35160
17	36696	36696	36696	37888	37888	37888	39232	39232	39232	39232
18	40576	40576	40576	40576	42368	42368	42368	42368	43816	43816
19	43816	43816	43816	45352	45352	45352	46888	46888	46888	46888

20	46888	46888	48936	48936	48936	48936	48936	51024	51024	51024
21	51024	51024	51024	52752	52752	52752	52752	55056	55056	55056
22	55056	55056	55056	57336	57336	57336	57336	59256	59256	59256
23	57336	59256	59256	59256	59256	61664	61664	61664	61664	63776
24	61664	61664	63776	63776	63776	63776	66592	66592	66592	66592
25	63776	63776	66592	66592	66592	66592	68808	68808	68808	71112
26	75376	75376	75376	75376	75376	75376	75376	75376	75376	75376

[TS 36.306 clause 4.1]

The UE Category parameter defines a combined uplink and downlink capability. The parameters set by the UE Category are defined in subclause 4.2. Tables 4.1-1 and 4.1-2 define the downlink and, respectively, uplink physical layer parameter values for each UE Category.

Table 4.1-1: Downlink physical layer parameter values set by UE Category

UE Category	Maximum number of DL-SCH transport block bits received within a TTI	Maximum number of bits of a DL-SCH transport block received within a TTI	Total number of soft channel bits	Maximum number of supported layers for spatial multiplexing in DL
Category 1	10296	10296	250368	1
Category 2	51024	51024	1237248	2
Category 3	102048	75376	1237248	2
Category 4	150752	75376	1827072	2
Category 5	302752	151376	3667200	4

Table 4.1-2: Uplink physical layer parameter values set by UE Category

UE Category	Maximum number of bits of an UL-SCH transport block transmitted within a TTI	Support for 64QAM in UL
Category 1	5160	No
Category 2	25456	No
Category 3	51024	No
Category 4	51024	No
Category 5	75376	Yes

7.1.7.1.3.3 Test description

7.1.7.1.3.3.1 Pre-test conditions

System Simulator

- Cell 1.
- Uplink and downlink bandwidth set to 20 MHz (to enable testing of N_{PRB} up to maximum value).

UE:

None.

Preamble

- The UE is in state Loopback Activated (state 4) according to [18].

7.1.7.1.3.3.2 Test procedure sequence

Table 7.1.7.1.3.3.2-1: Maximum TB_{size} for different UE categories

UE Category	Maximum number of DL-SCH transport block bits received within a TTI
Category 1	10296
Category 2	51024
Category 3	102048
Category 4	150752
Category 5	302752

Table 7.1.7.1.3.3.2-2: Number of downlink PDCP SDUs and PDCP SDU size used as test data

TB_{size} [bits]	Number of PDCP SDUs	PDCP SDU size of each PDCP SDU [bits] See note 1
$TB_{size} \leq 12000$	1	[FFS]
$12001 \leq TB_{size} \leq 24000$	2	[FFS]
$24001 \leq TB_{size} \leq 36000$	3	[FFS]
$36001 \leq TB_{size} \leq 48000$	4	[FFS]
$48001 \leq TB_{size} \leq 60000$	5	[FFS]
$60001 \leq TB_{size} \leq 72000$	6	[FFS]
$TB_{size} \geq 72001$	7	[FFS]

Note 1. Each PDCP SDU is limited to [TBD] octets (keep below maximum SDU size of ESM as specified in TS 24.301 clause 9.9.4.12).

Table 7.1.7.1.3.3.2-3: Main behaviour

St	Procedure	Message Sequence		TP	Verdict
		U – S	Message		
-	EXCEPTION: Steps 1 to 4 are repeated for values of N_{PRB} from 1 to 110 and I_{MCS} from 0 to 28.	-	-	-	-
1	SS looks up I_{TBS} in table 7.1.7.1-1 in TS 36.213 based on the value of I_{MCS} . SS looks up TB_{size} in table 7.1.7.2.1-1 in TS 36.213 based on values of N_{PRB} and I_{TBS} .	-	-	-	-
-	EXCEPTION: Steps 2 to 4 are performed if TB_{size} is less or equal to UE capability "Maximum number of DL-SCH transport block bits received within a TTI" as specified in Table 7.1.7.1.4.3.2-1.	-	-	-	-
2	SS creates one or more PDCP SDUs, depending on TB_{size} , in accordance with Table 7.1.7.1.4.3.2-2.	-	-	-	-
3	SS transmits the PDCP SDUs concatenated into a MAC PDU and indicates on PDSCH DCI	<--	MAC PDU (NxPDCP SDUs) DCI: (DCI Format 1A, RA	-	-

	Format 1A with RA type 2 using Distributed VRB and a Resource block assignment (RBA) correspondent to N_{PRB} as specified in 7.1.6.3 in TS 36.213 and Modulation and coding scheme I_{MCS} .		type 2, Localized/Distributed VRB assignment flag = '1', RBA(N_{PRB}), I_{MCS})		
4	CHECK: Does UE return the same number of PDCP SDUs with same content as transmitted by the SS in step 3?	-->	(NxPDCP SDUs)	1	P

7.1.7.1.3.3.3 Specific Message Contents

None

7.1.7.1.4 DL-SCH Transport Block Size selection / DCI format 1A / RA type 2 / Distributed VRB

Editor's note: There is a need to update test procedure to exclude test points resulting in an effective channel code rate higher than 0.930 (ref TS 36.213 clause 7.1.7).

7.1.7.1.4.1 Test Purpose (TP)

(1)

```
with { UE in E-UTRA RRC_CONNECTED state }
ensure that {
  when { UE on PDCCH receives DCI format 1A indicating Resource Allocation Type 2 with Distributed
VRB, a Resource block assignment correspondent to  $N_{PRB}$  physical resource blocks and a Modulation
and Coding scheme  $I_{MCS}$  }
  then { UE decodes the received transport block of size correspondent to the read  $N_{PRB}$  and
 $I_{MCS}$  and forward it to higher layers }
}
```

7.1.7.1.4.2 Conformance requirements

References: The conformance requirements covered in the current TC are specified in: TS 36.212, clause 5.3.3.1.3; TS 36.213, clauses 7.1.6.3, 7.1.7, 7.1.7.1, 7.1.7.2 and 7.1.7.2.1; and TS 36.306 clause 4.1.

[TS 36.212 clause 5.3.3.1.3]

DCI format 1A is used for the compact scheduling of one PDSCH codeword and random access procedure initiated by a PDCCH order.

The following information is transmitted by means of the DCI format 1A:

- Flag for format0/format1A differentiation – 1 bit, where value 0 indicates format 0 and value 1 indicates format 1A

...

Otherwise,

- Localized/Distributed VRB assignment flag – 1 bit as defined in 7.1.6.3 of [3]

- Resource block assignment – $\lceil \log_2(N_{RB}^{DL}(N_{RB}^{DL} + 1)/2) \rceil$ bits as defined in section 7.1.6.3 of [3]:

- For localized VRB:

$\lceil \log_2(N_{RB}^{DL}(N_{RB}^{DL} + 1)/2) \rceil$ bits provide the resource allocation

- For distributed VRB:

- If $N_{RB}^{DL} < 50$ or if the format 1A CRC is scrambled by RA-RNTI, P-RNTI, or SI-RNTI

- $\lceil \log_2(N_{RB}^{DL}(N_{RB}^{DL} + 1)/2) \rceil$ bits provide the resource allocation

- Else

- 1 bit, the MSB indicates the gap value, where value 0 indicates $N_{gap} = N_{gap,1}$ and value 1 indicates $N_{gap} = N_{gap,2}$

- $(\lceil \log_2(N_{RB}^{DL}(N_{RB}^{DL} + 1)/2) \rceil - 1)$ bits provide the resource allocation

- Modulation and coding scheme – 5bits as defined in section 7.1.7 of [3]

...

[TS 36.213 clause 7.1.6.3]

In resource allocations of type 2, the resource block assignment information indicates to a scheduled UE a set of contiguously allocated localized virtual resource blocks or distributed virtual resource blocks. In case of resource allocation signalled with PDCCH DCI format 1A, 1B or 1D, one bit flag indicates whether localized virtual resource blocks or distributed virtual resource blocks are assigned (value 0 indicates Localized and value 1 indicates Distributed VRB assignment) while distributed virtual resource blocks are always assigned in case of resource allocation signalled with PDCCH DCI format 1C. Localized VRB allocations for a UE vary from a single VRB up to a maximum number of VRBs spanning the system bandwidth. For DCI format 1A the distributed VRB allocations for a UE vary from a single VRB up to N_{VRB}^{DL} VRBs, where N_{VRB}^{DL} is defined in [3], if the DCI CRC is scrambled by P-RNTI, RA-RNTI, or SI-RNTI. With PDCCH DCI format 1B, 1D, or 1A with a CRC scrambled with C-RNTI, distributed VRB allocations for a UE vary from a single VRB up to N_{VRB}^{DL} VRBs if N_{RB}^{DL} is 6-49 and vary from a single VRB up to 16 if N_{RB}^{DL} is 50-110. With PDCCH DCI format 1C, distributed VRB allocations for a UE vary from N_{RB}^{step} VRB(s) up to $\lfloor N_{VRB}^{DL} / N_{RB}^{step} \rfloor \cdot N_{RB}^{step}$ VRBs with an increment step of N_{RB}^{step} , where N_{RB}^{step} value is determined depending on the downlink system bandwidth as shown in Table 7.1.6.3-1.

Table 7.1.6.3-1: N_{RB}^{step} values vs. Downlink System Bandwidth

System BW (N_{RB}^{DL})	N_{RB}^{step}
	DCI format 1C
6-49	2
50-110	4

For PDCCH DCI format 1A, 1B or 1D, a type 2 resource allocation field consists of a resource indication value (RIV) corresponding to a starting resource block (RB_{start}) and a length in terms of virtually contiguously allocated resource blocks L_{CRBs} . The resource indication value is defined by

if $(L_{CRBs} - 1) \leq \lfloor N_{RB}^{DL} / 2 \rfloor$ then

$$RIV = N_{RB}^{DL} (L_{CRBs} - 1) + RB_{start}$$

else

$$RIV = N_{RB}^{DL} (N_{RB}^{DL} - L_{CRBs} + 1) + (N_{RB}^{DL} - 1 - RB_{start})$$

where $L_{CRBs} \geq 1$ and shall not exceed $N_{VRB}^{DL} - RB_{start}$.

For PDCCH DCI format 1C, a type 2 resource block assignment field consists of a resource indication value (RIV) corresponding to a starting resource block ($RB_{start} = 0, N_{RB}^{step}, 2N_{RB}^{step}, \dots, (\lfloor N_{VRB}^{DL} / N_{RB}^{step} \rfloor - 1)N_{RB}^{step}$) and a length in terms of virtually contiguously allocated resource blocks ($L_{CRBs} = N_{RB}^{step}, 2N_{RB}^{step}, \dots, \lfloor N_{VRB}^{DL} / N_{RB}^{step} \rfloor \cdot N_{RB}^{step}$). The resource indication value is defined by

if $(L'_{CRBs} - 1) \leq \lfloor N_{VRB}^{DL} / 2 \rfloor$ then

$$RIV = N_{VRB}^{DL} (L'_{CRBs} - 1) + RB'_{start}$$

else

$$RIV = N_{VRB}^{DL} (N_{VRB}^{DL} - L'_{CRBs} + 1) + (N_{VRB}^{DL} - 1 - RB'_{start})$$

where $L'_{CRBs} = L_{CRBs} / N_{RB}^{step}$, $RB'_{start} = RB_{start} / N_{RB}^{step}$ and $N_{VRB}^{DL} = \lfloor N_{VRB}^{DL} / N_{RB}^{step} \rfloor$. Here,

$$L'_{CRBs} \geq 1 \text{ and shall not exceed } N_{VRB}^{DL} - RB'_{start}.$$

[TS 36.213 clause 7.1.7]

To determine the modulation order and transport block size(s) in the physical downlink shared channel, the UE shall first

- read the 5-bit “modulation and coding scheme” field (I_{MCS}) in the DCI

and second if the DCI CRC is scrambled by P-RNTI, RA-RNTI, or SI-RNTI then

...

else

- set the Table 7.1.7.2.1-1 column indicator N'_{PRB} to the total number of allocated PRBs based on the procedure defined in Section 7.1.6.

if the transport block is transmitted in DwPTS of the special subframe in frame structure type 2, then

$$\text{set the Table 7.1.7.2.1-1 column indicator } N_{PRB} = \max \left\{ \left\lfloor N'_{PRB} \times 0.75 \right\rfloor, 1 \right\},$$

else, set the Table 7.1.7.2.1-1 column indicator $N_{PRB} = N'_{PRB}$.

The UE may skip decoding a transport block in an initial transmission if the effective channel code rate is higher than 0.930, where the effective channel code rate is defined as the number of downlink information bits (including CRC bits) divided by the number of physical channel bits on PDSCH. If the UE skips decoding, the physical layer indicates to higher layer that the transport block is not successfully decoded. For the special subframe configurations 0 and 5 with normal CP or configurations 0 and 4 with extended CP, shown in table 4.2-1 [3], there shall be no PDSCH transmission in DwPTS of the special subframe.

...

[TS 36.213 clause 7.1.7.1]

The UE shall use $Q_m = 2$ if the DCI CRC is scrambled by P-RNTI, RA-RNTI, or SI-RNTI, otherwise, the UE shall use I_{MCS} and Table 7.1.7.1-1 to determine the modulation order (Q_m) used in the physical downlink shared channel.

Table 7.1.7.1-1: Modulation and TBS index table for PDSCH

MCS Index I_{MCS}	Modulation Order Q_m	TBS Index I_{TBS}
0	2	0
1	2	1
2	2	2
3	2	3
4	2	4
5	2	5
6	2	6
7	2	7
8	2	8
9	2	9
10	4	9
11	4	10
12	4	11
13	4	12
14	4	13
15	4	14
16	4	15
17	6	15
18	6	16
19	6	17
20	6	18
21	6	19
22	6	20
23	6	21
24	6	22
25	6	23
26	6	24
27	6	25
28	6	26
29	2	reserved
30	4	
31	6	

[TS 36.213 clause 7.1.7.2]

If the DCI CRC is scrambled by P-RNTI, RA-RNTI, or SI-RNTI then

- for DCI format 1A:
 - the UE shall set the TBS index (I_{TBS}) equal to I_{MCS} and determine its TBS by the procedure in Section 7.1.7.2.1.

...

else

- for $0 \leq I_{MCS} \leq 28$, the UE shall first determine the TBS index (I_{TBS}) using I_{MCS} and Table 7.1.7.1-1 except if the transport block is disabled in DCI formats 2 and 2A as specified below. For a transport block that is not mapped to two-layer spatial multiplexing, the TBS is determined by the procedure in Section 7.1.7.2.1. For a transport block that is mapped to two-layer spatial multiplexing, the TBS is determined by the procedure in Section 7.1.7.2.2.
- for $29 \leq I_{MCS} \leq 31$, the TBS is assumed to be as determined from DCI transported in the latest PDCCH for the same transport block using $0 \leq I_{MCS} \leq 28$.
- In DCI formats 2 and 2A a transport block is disabled if $I_{MCS} = 0$ and if $rv_{idx} = 1$ otherwise the transport block is enabled.

The NDI and HARQ process ID, as signalled on PDCCH, and the TBS, as determined above, shall be delivered to higher layers.

[TS 36.213 clause 7.1.7.2.1]

For $1 \leq N_{\text{PRB}} \leq 110$, the TBS is given by the $(I_{\text{TBS}}, N_{\text{PRB}})$ entry of Table 7.1.7.2.1-1.

Table 7.1.7.2.1-1: Transport block size table (dimension 27x110)

I_{TBS}	N_{PRB}									
	1	2	3	4	5	6	7	8	9	10
0	16	32	56	88	120	152	176	208	224	256
1	24	56	88	144	176	208	224	256	328	344
2	32	72	144	176	208	256	296	328	376	424
3	40	104	176	208	256	328	392	440	504	568
4	56	120	208	256	328	408	488	552	632	696
5	72	144	224	328	424	504	600	680	776	872
6	328	176	256	392	504	600	712	808	936	1032
7	104	224	328	472	584	712	840	968	1096	1224
8	120	256	392	536	680	808	968	1096	1256	1384
9	136	296	456	616	776	936	1096	1256	1416	1544
10	144	328	504	680	872	1032	1224	1384	1544	1736
11	176	376	584	776	1000	1192	1384	1608	1800	2024
12	208	440	680	904	1128	1352	1608	1800	2024	2280
13	224	488	744	1000	1256	1544	1800	2024	2280	2536
14	256	552	840	1128	1416	1736	1992	2280	2600	2856
15	280	600	904	1224	1544	1800	2152	2472	2728	3112
16	328	632	968	1288	1608	1928	2280	2600	2984	3240
17	336	696	1064	1416	1800	2152	2536	2856	3240	3624
18	376	776	1160	1544	1992	2344	2792	3112	3624	4008
19	408	840	1288	1736	2152	2600	2984	3496	3880	4264
20	440	904	1384	1864	2344	2792	3240	3752	4136	4584
21	488	1000	1480	1992	2472	2984	3496	4008	4584	4968
22	520	1064	1608	2152	2664	3240	3752	4264	4776	5352
23	552	1128	1736	2280	2856	3496	4008	4584	5160	5736
24	584	1192	1800	2408	2984	3624	4264	4968	5544	5992
25	616	1256	1864	2536	3112	3752	4392	5160	5736	6200
26	712	1480	2216	2984	3752	4392	5160	5992	6712	7480

I_{TBS}	N_{PRB}									
	11	12	13	14	15	16	17	18	19	20
0	288	328	344	376	392	424	456	488	504	536
1	376	424	456	488	520	568	600	632	680	712
2	472	520	568	616	648	696	744	776	840	872
3	616	680	744	808	872	904	968	1032	1096	1160
4	776	840	904	1000	1064	1128	1192	1288	1352	1416
5	968	1032	1128	1224	1320	1384	1480	1544	1672	1736
6	1128	1224	1352	1480	1544	1672	1736	1864	1992	2088
7	1320	1480	1608	1672	1800	1928	2088	2216	2344	2472
8	1544	1672	1800	1928	2088	2216	2344	2536	2664	2792
9	1736	1864	2024	2216	2344	2536	2664	2856	2984	3112
10	1928	2088	2280	2472	2664	2792	2984	3112	3368	3496
11	2216	2408	2600	2792	2984	3240	3496	3624	3880	4008
12	2472	2728	2984	3240	3368	3624	3880	4136	4392	4584
13	2856	3112	3368	3624	3880	4136	4392	4584	4968	5160
14	3112	3496	3752	4008	4264	4584	4968	5160	5544	5736
15	3368	3624	4008	4264	4584	4968	5160	5544	5736	6200
16	3624	3880	4264	4584	4968	5160	5544	5992	6200	6456
17	4008	4392	4776	5160	5352	5736	6200	6456	6712	7224
18	4392	4776	5160	5544	5992	6200	6712	7224	7480	7992
19	4776	5160	5544	5992	6456	6968	7224	7736	8248	8504
20	5160	5544	5992	6456	6968	7480	7992	8248	8760	9144
21	5544	5992	6456	6968	7480	7992	8504	9144	9528	9912
22	5992	6456	6968	7480	7992	8504	9144	9528	10296	10680
23	6200	6968	7480	7992	8504	9144	9912	10296	11064	11448
24	6712	7224	7992	8504	9144	9912	10296	11064	11448	12216
25	6968	7480	8248	8760	9528	10296	10680	11448	12216	12576
26	8248	8760	9528	10296	11064	11832	12576	13536	14112	14688

I_{TBS}	N_{PRB}									
	21	22	23	24	25	26	27	28	29	30

0	568	600	616	648	680	712	744	776	776	808
1	744	776	808	872	904	936	968	1000	1032	1064
2	936	968	1000	1064	1096	1160	1192	1256	1288	1320
3	1224	1256	1320	1384	1416	1480	1544	1608	1672	1736
4	1480	1544	1608	1736	1800	1864	1928	1992	2088	2152
5	1864	1928	2024	2088	2216	2280	2344	2472	2536	2664
6	2216	2280	2408	2472	2600	2728	2792	2984	2984	3112
7	2536	2664	2792	2984	3112	3240	3368	3368	3496	3624
8	2984	3112	3240	3368	3496	3624	3752	3880	4008	4264
9	3368	3496	3624	3752	4008	4136	4264	4392	4584	4776
10	3752	3880	4008	4264	4392	4584	4776	4968	5160	5352
11	4264	4392	4584	4776	4968	5352	5544	5736	5992	5992
12	4776	4968	5352	5544	5736	5992	6200	6456	6712	6712
13	5352	5736	5992	6200	6456	6712	6968	7224	7480	7736
14	5992	6200	6456	6968	7224	7480	7736	7992	8248	8504
15	6456	6712	6968	7224	7736	7992	8248	8504	8760	9144
16	6712	7224	7480	7736	7992	8504	8760	9144	9528	9912
17	7480	7992	8248	8760	9144	9528	9912	10296	10296	10680
18	8248	8760	9144	9528	9912	10296	10680	11064	11448	11832
19	9144	9528	9912	10296	10680	11064	11448	12216	12576	12960
20	9912	10296	10680	11064	11448	12216	12576	12960	13536	14112
21	10680	11064	11448	12216	12576	12960	13536	14112	14688	15264
22	11448	11832	12576	12960	13536	14112	14688	15264	15840	16416
23	12216	12576	12960	13536	14112	14688	15264	15840	16416	16992
24	12960	13536	14112	14688	15264	15840	16416	16992	17568	18336
25	13536	14112	14688	15264	15840	16416	16992	17568	18336	19080
26	15264	16416	16992	17568	18336	19080	19848	20616	21384	22152

I_{TBS}	N_{PRB}									
	31	32	33	34	35	36	37	38	39	40
0	840	872	904	936	968	1000	1032	1032	1064	1096
1	1128	1160	1192	1224	1256	1288	1352	1384	1416	1416
2	1384	1416	1480	1544	1544	1608	1672	1672	1736	1800
3	1800	1864	1928	1992	2024	2088	2152	2216	2280	2344
4	2216	2280	2344	2408	2472	2600	2664	2728	2792	2856
5	2728	2792	2856	2984	3112	3112	3240	3368	3496	3496
6	3240	3368	3496	3496	3624	3752	3880	4008	4136	4136
7	3752	3880	4008	4136	4264	4392	4584	4584	4776	4968
8	4392	4584	4584	4776	4968	4968	5160	5352	5544	5544
9	4968	5160	5160	5352	5544	5736	5736	5992	6200	6200
10	5544	5736	5736	5992	6200	6200	6456	6712	6712	6968
11	6200	6456	6712	6968	6968	7224	7480	7736	7736	7992
12	6968	7224	7480	7736	7992	8248	8504	8760	8760	9144
13	7992	8248	8504	8760	9144	9144	9528	9912	9912	10296
14	8760	9144	9528	9912	9912	10296	10680	11064	11064	11448
15	9528	9912	10296	10296	10680	11064	11448	11832	11832	12216
16	9912	10296	10680	11064	11448	11832	12216	12216	12576	12960
17	11064	11448	11832	12216	12576	12960	13536	13536	14112	14688
18	12216	12576	12960	13536	14112	14112	14688	15264	15264	15840
19	13536	13536	14112	14688	15264	15264	15840	16416	16992	16992
20	14688	14688	15264	15840	16416	16992	16992	17568	18336	18336
21	15840	15840	16416	16992	17568	18336	18336	19080	19848	19848
22	16992	16992	17568	18336	19080	19080	19848	20616	21384	21384
23	17568	18336	19080	19848	19848	20616	21384	22152	22152	22920
24	19080	19848	19848	20616	21384	22152	22920	22920	23688	24496
25	19848	20616	20616	21384	22152	22920	23688	24496	24496	25456
26	22920	23688	24496	25456	25456	26416	27376	28336	29296	29296

I_{TBS}	N_{PRB}									
	41	42	43	44	45	46	47	48	49	50
0	1128	1160	1192	1224	1256	1256	1288	1320	1352	1384
1	1480	1544	1544	1608	1608	1672	1736	1736	1800	1800
2	1800	1864	1928	1992	2024	2088	2088	2152	2216	2216
3	2408	2472	2536	2536	2600	2664	2728	2792	2856	2856
4	2984	2984	3112	3112	3240	3240	3368	3496	3496	3624

5	3624	3752	3752	3880	4008	4008	4136	4264	4392	4392
6	4264	4392	4584	4584	4776	4776	4968	4968	5160	5160
7	4968	5160	5352	5352	5544	5736	5736	5992	5992	6200
8	5736	5992	5992	6200	6200	6456	6456	6712	6968	6968
9	6456	6712	6712	6968	6968	7224	7480	7480	7736	7992
10	7224	7480	7480	7736	7992	7992	8248	8504	8504	8760
11	8248	8504	8760	8760	9144	9144	9528	9528	9912	9912
12	9528	9528	9912	9912	10296	10680	10680	11064	11064	11448
13	10680	10680	11064	11448	11448	11832	12216	12216	12576	12960
14	11832	12216	12216	12576	12960	12960	13536	13536	14112	14112
15	12576	12960	12960	13536	13536	14112	14688	14688	15264	15264
16	13536	13536	14112	14112	14688	14688	15264	15840	15840	16416
17	14688	15264	15264	15840	16416	16416	16992	17568	17568	18336
18	16416	16416	16992	17568	17568	18336	18336	19080	19080	19848
19	17568	18336	18336	19080	19080	19848	20616	20616	21384	21384
20	19080	19848	19848	20616	20616	21384	22152	22152	22920	22920
21	20616	21384	21384	22152	22920	22920	23688	24496	24496	25456
22	22152	22920	22920	23688	24496	24496	25456	25456	26416	27376
23	23688	24496	24496	25456	25456	26416	27376	27376	28336	28336
24	25456	25456	26416	26416	27376	28336	28336	29296	29296	30576
25	26416	26416	27376	28336	28336	29296	29296	30576	31704	31704
26	30576	30576	31704	32856	32856	34008	35160	35160	36696	36696

I_{TBS}	N_{PRB}									
	51	52	53	54	55	56	57	58	59	60
0	1416	1416	1480	1480	1544	1544	1608	1608	1608	1672
1	1864	1864	1928	1992	1992	2024	2088	2088	2152	2152
2	2280	2344	2344	2408	2472	2536	2536	2600	2664	2664
3	2984	2984	3112	3112	3240	3240	3368	3368	3496	3496
4	3624	3752	3752	3880	4008	4008	4136	4136	4264	4264
5	4584	4584	4776	4776	4776	4968	4968	5160	5160	5352
6	5352	5352	5544	5736	5736	5992	5992	5992	6200	6200
7	6200	6456	6456	6712	6712	6712	6968	6968	7224	7224
8	7224	7224	7480	7480	7736	7736	7992	7992	8248	8504
9	7992	8248	8248	8504	8760	8760	9144	9144	9144	9528
10	9144	9144	9144	9528	9528	9912	9912	10296	10296	10680
11	10296	10680	10680	11064	11064	11448	11448	11832	11832	12216
12	11832	11832	12216	12216	12576	12576	12960	12960	13536	13536
13	12960	13536	13536	14112	14112	14688	14688	14688	15264	15264
14	14688	14688	15264	15264	15840	15840	16416	16416	16992	16992
15	15840	15840	16416	16416	16992	16992	17568	17568	18336	18336
16	16416	16992	16992	17568	17568	18336	18336	19080	19080	19848
17	18336	19080	19080	19848	19848	20616	20616	20616	21384	21384
18	19848	20616	21384	21384	22152	22152	22920	22920	23688	23688
19	22152	22152	22920	22920	23688	24496	24496	25456	25456	25456
20	23688	24496	24496	25456	25456	26416	26416	27376	27376	28336
21	25456	26416	26416	27376	27376	28336	28336	29296	29296	30576
22	27376	28336	28336	29296	29296	30576	30576	31704	31704	32856
23	29296	29296	30576	30576	31704	31704	32856	32856	34008	34008
24	31704	31704	32856	32856	34008	34008	35160	35160	36696	36696
25	32856	32856	34008	34008	35160	35160	36696	36696	37888	37888
26	37888	37888	39232	40576	40576	40576	42368	42368	43816	43816

I_{TBS}	N_{PRB}									
	61	62	63	64	65	66	67	68	69	70
0	1672	1736	1736	1800	1800	1800	1864	1864	1928	1928
1	2216	2280	2280	2344	2344	2408	2472	2472	2536	2536
2	2728	2792	2856	2856	2856	2984	2984	3112	3112	3112
3	3624	3624	3624	3752	3752	3880	3880	4008	4008	4136
4	4392	4392	4584	4584	4584	4776	4776	4968	4968	4968
5	5352	5544	5544	5736	5736	5736	5992	5992	5992	6200
6	6456	6456	6456	6712	6712	6968	6968	6968	7224	7224
7	7480	7480	7736	7736	7992	7992	8248	8248	8504	8504
8	8504	8760	8760	9144	9144	9144	9528	9528	9528	9912
9	9528	9912	9912	10296	10296	10296	10680	10680	11064	11064

10	10680	11064	11064	11448	11448	11448	11832	11832	12216	12216
11	12216	12576	12576	12960	12960	13536	13536	13536	14112	14112
12	14112	14112	14112	14688	14688	15264	15264	15264	15840	15840
13	15840	15840	16416	16416	16992	16992	16992	17568	17568	18336
14	17568	17568	18336	18336	18336	19080	19080	19848	19848	19848
15	18336	19080	19080	19848	19848	20616	20616	20616	21384	21384
16	19848	19848	20616	20616	21384	21384	22152	22152	22152	22920
17	22152	22152	22920	22920	23688	23688	24496	24496	24496	25456
18	24496	24496	24496	25456	25456	26416	26416	27376	27376	27376
19	26416	26416	27376	27376	28336	28336	29296	29296	29296	30576
20	28336	29296	29296	29296	30576	30576	31704	31704	31704	32856
21	30576	31704	31704	31704	32856	32856	34008	34008	35160	35160
22	32856	34008	34008	34008	35160	35160	36696	36696	36696	37888
23	35160	35160	36696	36696	37888	37888	37888	39232	39232	40576
24	36696	37888	37888	39232	39232	40576	40576	42368	42368	42368
25	39232	39232	40576	40576	40576	42368	42368	43816	43816	43816
26	45352	45352	46888	46888	48936	48936	48936	51024	51024	52752

I_{TBS}	N_{PRB}									
	71	72	73	74	75	76	77	78	79	80
0	1992	1992	2024	2088	2088	2088	2152	2152	2216	2216
1	2600	2600	2664	2728	2728	2792	2792	2856	2856	2856
2	3240	3240	3240	3368	3368	3368	3496	3496	3496	3624
3	4136	4264	4264	4392	4392	4392	4584	4584	4584	4776
4	5160	5160	5160	5352	5352	5544	5544	5544	5736	5736
5	6200	6200	6456	6456	6712	6712	6712	6968	6968	6968
6	7480	7480	7736	7736	7736	7992	7992	8248	8248	8248
7	8760	8760	8760	9144	9144	9144	9528	9528	9528	9912
8	9912	9912	10296	10296	10680	10680	10680	11064	11064	11064
9	11064	11448	11448	11832	11832	11832	12216	12216	12576	12576
10	12576	12576	12960	12960	12960	13536	13536	13536	14112	14112
11	14112	14688	14688	14688	15264	15264	15840	15840	15840	16416
12	16416	16416	16416	16992	16992	17568	17568	17568	18336	18336
13	18336	18336	19080	19080	19080	19848	19848	19848	20616	20616
14	20616	20616	20616	21384	21384	22152	22152	22152	22920	22920
15	22152	22152	22152	22920	22920	23688	23688	23688	24496	24496
16	22920	23688	23688	24496	24496	24496	25456	25456	25456	26416
17	25456	26416	26416	26416	27376	27376	27376	28336	28336	29296
18	28336	28336	29296	29296	29296	30576	30576	30576	31704	31704
19	30576	30576	31704	31704	32856	32856	32856	34008	34008	34008
20	32856	34008	34008	34008	35160	35160	35160	36696	36696	36696
21	35160	36696	36696	36696	37888	37888	39232	39232	39232	40576
22	37888	39232	39232	40576	40576	40576	42368	42368	42368	43816
23	40576	40576	42368	42368	43816	43816	43816	45352	45352	45352
24	43816	43816	45352	45352	45352	46888	46888	46888	48936	48936
25	45352	45352	46888	46888	46888	48936	48936	48936	51024	51024
26	52752	52752	55056	55056	55056	55056	57336	57336	57336	59256

I_{TBS}	N_{PRB}									
	81	82	83	84	85	86	87	88	89	90
0	2280	2280	2280	2344	2344	2408	2408	2472	2472	2536
1	2984	2984	2984	3112	3112	3112	3240	3240	3240	3240
2	3624	3624	3752	3752	3880	3880	3880	4008	4008	4008
3	4776	4776	4776	4968	4968	4968	5160	5160	5160	5352
4	5736	5992	5992	5992	5992	6200	6200	6200	6456	6456
5	7224	7224	7224	7480	7480	7480	7736	7736	7736	7992
6	8504	8504	8760	8760	8760	9144	9144	9144	9144	9528
7	9912	9912	10296	10296	10296	10680	10680	10680	11064	11064
8	11448	11448	11448	11832	11832	12216	12216	12216	12576	12576
9	12960	12960	12960	13536	13536	13536	13536	14112	14112	14112
10	14112	14688	14688	14688	14688	15264	15264	15264	15840	15840
11	16416	16416	16992	16992	16992	17568	17568	17568	18336	18336
12	18336	19080	19080	19080	19080	19848	19848	19848	20616	20616
13	20616	21384	21384	21384	22152	22152	22152	22920	22920	22920
14	22920	23688	23688	24496	24496	24496	25456	25456	25456	25456

15	24496	25456	25456	25456	26416	26416	26416	27376	27376	27376
16	26416	26416	27376	27376	27376	28336	28336	28336	29296	29296
17	29296	29296	30576	30576	30576	30576	31704	31704	31704	32856
18	31704	32856	32856	32856	34008	34008	34008	35160	35160	35160
19	35160	35160	35160	36696	36696	36696	37888	37888	37888	39232
20	37888	37888	39232	39232	39232	40576	40576	40576	42368	42368
21	40576	40576	42368	42368	42368	43816	43816	43816	45352	45352
22	43816	43816	45352	45352	45352	46888	46888	46888	48936	48936
23	46888	46888	46888	48936	48936	48936	51024	51024	51024	51024
24	48936	51024	51024	51024	52752	52752	52752	52752	55056	55056
25	51024	52752	52752	52752	55056	55056	55056	55056	57336	57336
26	59256	59256	61664	61664	61664	63776	63776	63776	66592	66592

I_{TBS}	N_{PRB}									
	91	92	93	94	95	96	97	98	99	100
0	2536	2536	2600	2600	2664	2664	2728	2728	2728	2792
1	3368	3368	3368	3496	3496	3496	3496	3624	3624	3624
2	4136	4136	4136	4264	4264	4264	4392	4392	4392	4584
3	5352	5352	5352	5544	5544	5544	5736	5736	5736	5736
4	6456	6456	6712	6712	6712	6968	6968	6968	6968	7224
5	7992	7992	8248	8248	8248	8504	8504	8760	8760	8760
6	9528	9528	9528	9912	9912	9912	10296	10296	10296	10296
7	11064	11448	11448	11448	11448	11832	11832	11832	12216	12216
8	12576	12960	12960	12960	13536	13536	13536	13536	14112	14112
9	14112	14688	14688	14688	15264	15264	15264	15264	15840	15840
10	15840	16416	16416	16416	16992	16992	16992	16992	17568	17568
11	18336	18336	19080	19080	19080	19080	19848	19848	19848	19848
12	20616	21384	21384	21384	21384	22152	22152	22152	22920	22920
13	23688	23688	23688	24496	24496	24496	25456	25456	25456	25456
14	26416	26416	26416	27376	27376	27376	28336	28336	28336	28336
15	28336	28336	28336	29296	29296	29296	29296	30576	30576	30576
16	29296	30576	30576	30576	30576	31704	31704	31704	31704	32856
17	32856	32856	34008	34008	34008	35160	35160	35160	35160	36696
18	36696	36696	36696	37888	37888	37888	37888	39232	39232	39232
19	39232	39232	40576	40576	40576	40576	42368	42368	42368	43816
20	42368	42368	43816	43816	43816	45352	45352	45352	46888	46888
21	45352	46888	46888	46888	46888	48936	48936	48936	48936	51024
22	48936	48936	51024	51024	51024	51024	52752	52752	52752	55056
23	52752	52752	52752	55056	55056	55056	55056	57336	57336	57336
24	55056	57336	57336	57336	57336	59256	59256	59256	61664	61664
25	57336	59256	59256	59256	61664	61664	61664	61664	63776	63776
26	66592	68808	68808	68808	71112	71112	71112	73712	73712	75376

I_{TBS}	N_{PRB}									
	101	102	103	104	105	106	107	108	109	110
0	2792	2856	2856	2856	2984	2984	2984	2984	2984	3112
1	3752	3752	3752	3752	3880	3880	3880	4008	4008	4008
2	4584	4584	4584	4584	4776	4776	4776	4776	4968	4968
3	5992	5992	5992	5992	6200	6200	6200	6200	6456	6456
4	7224	7224	7480	7480	7480	7480	7736	7736	7736	7992
5	8760	9144	9144	9144	9144	9528	9528	9528	9528	9528
6	10680	10680	10680	10680	11064	11064	11064	11448	11448	11448
7	12216	12576	12576	12576	12960	12960	12960	12960	13536	13536
8	14112	14112	14688	14688	14688	14688	15264	15264	15264	15264
9	15840	16416	16416	16416	16416	16992	16992	16992	16992	17568
10	17568	18336	18336	18336	18336	18336	19080	19080	19080	19080
11	20616	20616	20616	21384	21384	21384	21384	22152	22152	22152
12	22920	23688	23688	23688	23688	24496	24496	24496	24496	25456
13	26416	26416	26416	26416	27376	27376	27376	27376	28336	28336
14	29296	29296	29296	29296	30576	30576	30576	30576	31704	31704
15	30576	31704	31704	31704	31704	32856	32856	32856	34008	34008
16	32856	32856	34008	34008	34008	34008	35160	35160	35160	35160
17	36696	36696	36696	37888	37888	37888	39232	39232	39232	39232
18	40576	40576	40576	40576	42368	42368	42368	42368	43816	43816
19	43816	43816	43816	45352	45352	45352	46888	46888	46888	46888

20	46888	46888	48936	48936	48936	48936	48936	51024	51024	51024
21	51024	51024	51024	52752	52752	52752	52752	55056	55056	55056
22	55056	55056	55056	57336	57336	57336	57336	59256	59256	59256
23	57336	59256	59256	59256	59256	61664	61664	61664	61664	63776
24	61664	61664	63776	63776	63776	63776	66592	66592	66592	66592
25	63776	63776	66592	66592	66592	66592	68808	68808	68808	71112
26	75376	75376	75376	75376	75376	75376	75376	75376	75376	75376

[TS 36.306 clause 4.1]

The UE Category parameter defines a combined uplink and downlink capability. The parameters set by the UE Category are defined in subclause 4.2. Tables 4.1-1 and 4.1-2 define the downlink and, respectively, uplink physical layer parameter values for each UE Category.

Table 4.1-1: Downlink physical layer parameter values set by UE Category

UE Category	Maximum number of DL-SCH transport block bits received within a TTI	Maximum number of bits of a DL-SCH transport block received within a TTI	Total number of soft channel bits	Maximum number of supported layers for spatial multiplexing in DL
Category 1	10296	10296	250368	1
Category 2	51024	51024	1237248	2
Category 3	102048	75376	1237248	2
Category 4	150752	75376	1827072	2
Category 5	302752	151376	3667200	4

Table 4.1-2: Uplink physical layer parameter values set by UE Category

UE Category	Maximum number of bits of an UL-SCH transport block transmitted within a TTI	Support for 64QAM in UL
Category 1	5160	No
Category 2	25456	No
Category 3	51024	No
Category 4	51024	No
Category 5	75376	Yes

7.1.7.1.4.3 Test description

7.1.7.1.4.3.1 Pre-test conditions

System Simulator

- Cell 1.
- Uplink and downlink bandwidth set to 20 MHz (to enable testing of N_{PRB} up to maximum value).
- DCI format 1C shall be used for BCCH, PCH and RAR (note).

UE:

None.

Preamble

- The UE is in state Loopback Activated (state 4) according to [18].

NOTE: To maximize resources for DL-SCH TB size testing for DCI format 1A/RA type 2/Distributed VRB then the SS need to use DCI Format 1C for BCCH, PCH and RAR

7.1.7.1.4.3.2 Test procedure sequence

Table 7.1.7.1.4.3.2-1: Maximum TB_{size} for different UE categories

UE Category	Maximum number of DL-SCH transport block bits received within a TTI
Category 1	10296
Category 2	51024
Category 3	102048
Category 4	150752
Category 5	302752

Table 7.1.7.1.4.3.2-2: Number of downlink PDCP SDUs and PDCP SDU size used as test data

TB_{size} [bits]	Number of PDCP SDUs	PDCP SDU size of each PDCP SDU [bits] See note 1
$TB_{size} \leq 12000$	1	[FFS]
$12001 \leq TB_{size} \leq 24000$	2	[FFS]
$24001 \leq TB_{size} \leq 36000$	3	[FFS]
$36001 \leq TB_{size} \leq 48000$	4	[FFS]
$48001 \leq TB_{size} \leq 60000$	5	[FFS]
$60001 \leq TB_{size} \leq 72000$	6	[FFS]
$TB_{size} \geq 72001$	7	[FFS]

Note 1. Each PDCP SDU is limited to [TBD] octets (keep below maximum SDU size of ESM as specified in TS 24.301 clause 9.9.4.12).

Table 7.1.7.1.4.3.2-3: Main behaviour

St	Procedure	Message Sequence		TP	Verdict
		U – S	Message		
-	EXCEPTION: Steps 1 to 4 are repeated for values of N_{PRB} from 1 to 110 and I_{MCS} from 0 to 28.	-	-	-	-
1	SS looks up I_{TBS} in table 7.1.7.1-1 in TS 36.213 based on the value of I_{MCS} . SS looks up TB_{size} in table 7.1.7.2.1-1 in TS 36.213 based on values of N_{PRB} and I_{TBS} .	-	-	-	-
-	EXCEPTION: Steps 2 to 4 are performed if TB_{size} is less or equal to UE capability "Maximum number of DL-SCH transport block bits received within a TTI" as specified in Table 7.1.7.1.3.3.2-1.	-	-	-	-
2	SS creates one or more PDCP SDUs, depending on TB_{size} , in accordance with Table 7.1.7.1.3.3.2-2.	-	-	-	-
3	SS transmits the PDCP SDUs concatenated into a MAC PDU and indicates on PDSCH DCI	<--	MAC PDU (NxPDCP SDUs) DCI: (DCI Format 1A, RA	-	-

	Format 1A with RA type 2 using Localised VRB and a Resource block assignment (RBA) correspondent to N_{PRB} as specified in 7.1.6.3 in TS 36.213 and Modulation and coding scheme I_{MCS} .		type 2, Localized/Distributed VRB assignment flag = '0', RBA(N_{PRB}), I_{MCS})		
4	CHECK: Does UE return the same number of PDCP SDUs with same content as transmitted by the SS in step 3?	-->	(NxPDCP SDUs)	1	P

7.1.7.1.4.3.3 Specific Message Contents

None

7.1.7.2 UL-SCH Transport Block Size support

Editor's note: It is for FFS if there is a need to split into separate test case for each UE category.

Editor's note: It is FFS if there is a need for a specific test case for retransmission using I_{MCS} value 29, 30 and 31 or this will be implicitly tested by RF/RRM test cases.

7.1.7.2.1 UL-SCH Transport Block Size selection / DCI format 0

7.1.7.2.1.1 Test Purpose (TP)

(1)

```
with { UE in E-UTRA RRC_CONNECTED state }
ensure that {
  when { UE has pending data for transmission and receives a Resource Block Assignment correspondent
to  $N_{PRB}$  physical resource blocks and a Modulation and Coding scheme  $I_{MCS}$  for PUSCH scheduling }
  then { UE transmits MAC PDU on PUSCH on the granted resources using a transport block size
correspondent to the read  $N_{PRB}$  and  $I_{MCS}$  }
}
```

7.1.7.2.1.2 Conformance requirements

References: The conformance requirements covered in the current TC are specified in: TS 36.212, clause 5.3.3.1.1; TS 36.213, clauses 8.1, 8.6, 8.6.1, 8.6.2 and 7.1.7.2.1; and TS 36.306 clause 4.1.

[TS 36.212 clause 5.3.3.1.1]

DCI format 0 is used for the scheduling of PUSCH.

The following information is transmitted by means of the DCI format 0:

- Flag for format0/format1A differentiation – 1 bit, where value 0 indicates format 0 and value 1 indicates format 1A
- Hopping flag – 1 bit as defined in section 8.4 of [3]
- Resource block assignment and hopping resource allocation – $\left\lceil \log_2(N_{RB}^{UL}(N_{RB}^{UL} + 1)/2) \right\rceil$ bits
- For PUSCH hopping:
- N_{UL_hop} MSB bits are used to obtain the value of $\tilde{n}_{PRB}(i)$ as indicated in subclause [8.4] of [3]
- $\left(\left\lceil \log_2(N_{RB}^{UL}(N_{RB}^{UL} + 1)/2) \right\rceil - N_{UL_hop} \right)$ bits provide the resource allocation of the first slot in the UL subframe

- For non-hopping PUSCH:
 - $\left(\left\lceil \log_2(N_{RB}^{UL}(N_{RB}^{UL} + 1)/2) \right\rceil \right)$ bits provide the resource allocation in the UL subframe as defined in section 8.1 of [3]
 - Modulation and coding scheme and redundancy version – 5 bits as defined in section 8.6 of [3]

....

[TS 36.213 clause 8.1]

The resource allocation information indicates to a scheduled UE a set of contiguously allocated virtual resource block indices denoted by n_{VRB} . A resource allocation field in the scheduling grant consists of a resource indication value (RIV) corresponding to a starting resource block (RB_{START}) and a length in terms of contiguously allocated resource blocks ($L_{CRBs} \geq 1$). The resource indication value is defined by

if $(L_{CRBs} - 1) \leq \lfloor N_{RB}^{UL} / 2 \rfloor$ then

$$RIV = N_{RB}^{UL}(L_{CRBs} - 1) + RB_{START}$$

else

$$RIV = N_{RB}^{UL}(N_{RB}^{UL} - L_{CRBs} + 1) + (N_{RB}^{UL} - 1 - RB_{START})$$

A UE shall discard PUSCH resource allocation in the corresponding PDCCH with DCI format 0 if consistent control information is not detected.

[TS 36.213 clause 8.6]

To determine the modulation order, redundancy version and transport block size for the physical uplink shared channel, the UE shall first

- read the 5-bit “modulation and coding scheme and redundancy version” field (I_{MCS}) in the DCI, and
- check the “CQI request” bit in DCI, and
- compute the total number of allocated PRBs (N_{PRB}) based on the procedure defined in Section 8.1, and
- compute the number of coded symbols for control information..

[TS 36.213 clause 8.6.1]

For $0 \leq I_{MCS} \leq 28$, the modulation order (Q_m) is determined as follows:

- If the UE is capable of supporting 64QAM in PUSCH and has not been configured by higher layers to transmit only QPSK and 16QAM, the modulation order is given by Q_m' in Table 8.6.1-1.
- If the UE is not capable of supporting 64QAM in PUSCH or has been configured by higher layers to transmit only QPSK and 16QAM, Q_m' is first read from Table 8.6.1-1. The modulation order is set to $Q_m = \min(4, Q_m')$.
- If the parameter *ttiBundling* provided by higher layers is set to *TRUE*, then the resource allocation size is restricted to $N_{PRB} \leq 3$ and the modulation order is set to $Q_m = 2$.

For $29 \leq I_{MCS} \leq 31$, the modulation order is assumed to be as determined from DCI transported in the most recent PDCCH for the same transport block using $0 \leq I_{MCS} \leq 28$ except for the following case. If $I_{MCS} = 29$, the “CQI request” bit in DCI format 0 is set to 1 and $N_{PRB} \leq 4$, the modulation order is set to $Q_m = 2$.

The UE shall use I_{MCS} and Table 8.6.1-1 to determine the redundancy version (rv_{idx}) to use in the physical uplink shared channel.

Table 8.6.1-1: Modulation, TBS index and redundancy version table for PUSCH

MCS Index I_{MCS}	Modulation Order Q_m'	TBS Index I_{TBS}	Redundancy Version rv_{idx}
0	2	0	0
1	2	1	0
2	2	2	0
3	2	3	0
4	2	4	0
5	2	5	0
6	2	6	0
7	2	7	0
8	2	8	0
9	2	9	0
10	2	10	0
11	4	10	0
12	4	11	0
13	4	12	0
14	4	13	0
15	4	14	0
16	4	15	0
17	4	16	0
18	4	17	0
19	4	18	0
20	4	19	0
21	6	19	0
22	6	20	0
23	6	21	0
24	6	22	0
25	6	23	0
26	6	24	0
27	6	25	0
28	6	26	0
29	reserved		1
30			2
31			3

[TS 36.213 clause 8.6.2]

For $0 \leq I_{\text{MCS}} \leq 28$, the UE shall first determine the TBS index (I_{TBS}) using I_{MCS} and Table 8.6.1-1. The UE shall then follow the procedure in Section 7.1.7.2.1 to determine the transport block size.

For $29 \leq I_{\text{MCS}} \leq 31$, the transport block size is assumed to be as determined from DCI transported in the initial PDCCH for the same transport block using $0 \leq I_{\text{MCS}} \leq 28$ except for the following case. If $I_{\text{MCS}} = 29$, the ‘‘CQI request’’ bit in DCI format 0 is set to 1 and $N_{\text{PRB}} \leq 4$, then there is no transport block for the UL-SCH and only the control information feedback for the current PUSCH reporting mode is transmitted by the UE.

[TS 36.213 clause 7.1.7.2.1]

For $1 \leq N_{\text{PRB}} \leq 110$, the TBS is given by the ($I_{\text{TBS}}, N_{\text{PRB}}$) entry of Table 7.1.7.2.1-1.

Table 7.1.7.2.1-1: Transport block size table (dimension 27x110)

I_{TBS}	N_{PRB}									
	1	2	3	4	5	6	7	8	9	10
0	16	32	56	88	120	152	176	208	224	256
1	24	56	88	144	176	208	224	256	328	344
2	32	72	144	176	208	256	296	328	376	424
3	40	104	176	208	256	328	392	440	504	568
4	56	120	208	256	328	408	488	552	632	696
5	72	144	224	328	424	504	600	680	776	872
6	328	176	256	392	504	600	712	808	936	1032
7	104	224	328	472	584	712	840	968	1096	1224
8	120	256	392	536	680	808	968	1096	1256	1384
9	136	296	456	616	776	936	1096	1256	1416	1544
10	144	328	504	680	872	1032	1224	1384	1544	1736
11	176	376	584	776	1000	1192	1384	1608	1800	2024
12	208	440	680	904	1128	1352	1608	1800	2024	2280
13	224	488	744	1000	1256	1544	1800	2024	2280	2536
14	256	552	840	1128	1416	1736	1992	2280	2600	2856
15	280	600	904	1224	1544	1800	2152	2472	2728	3112
16	328	632	968	1288	1608	1928	2280	2600	2984	3240
17	336	696	1064	1416	1800	2152	2536	2856	3240	3624
18	376	776	1160	1544	1992	2344	2792	3112	3624	4008
19	408	840	1288	1736	2152	2600	2984	3496	3880	4264
20	440	904	1384	1864	2344	2792	3240	3752	4136	4584
21	488	1000	1480	1992	2472	2984	3496	4008	4584	4968
22	520	1064	1608	2152	2664	3240	3752	4264	4776	5352
23	552	1128	1736	2280	2856	3496	4008	4584	5160	5736
24	584	1192	1800	2408	2984	3624	4264	4968	5544	5992
25	616	1256	1864	2536	3112	3752	4392	5160	5736	6200
26	712	1480	2216	2984	3752	4392	5160	5992	6712	7480

I_{TBS}	N_{PRB}									
	11	12	13	14	15	16	17	18	19	20
0	288	328	344	376	392	424	456	488	504	536
1	376	424	456	488	520	568	600	632	680	712
2	472	520	568	616	648	696	744	776	840	872
3	616	680	744	808	872	904	968	1032	1096	1160
4	776	840	904	1000	1064	1128	1192	1288	1352	1416
5	968	1032	1128	1224	1320	1384	1480	1544	1672	1736
6	1128	1224	1352	1480	1544	1672	1736	1864	1992	2088
7	1320	1480	1608	1672	1800	1928	2088	2216	2344	2472
8	1544	1672	1800	1928	2088	2216	2344	2536	2664	2792
9	1736	1864	2024	2216	2344	2536	2664	2856	2984	3112
10	1928	2088	2280	2472	2664	2792	2984	3112	3368	3496
11	2216	2408	2600	2792	2984	3240	3496	3624	3880	4008
12	2472	2728	2984	3240	3368	3624	3880	4136	4392	4584
13	2856	3112	3368	3624	3880	4136	4392	4584	4968	5160
14	3112	3496	3752	4008	4264	4584	4968	5160	5544	5736
15	3368	3624	4008	4264	4584	4968	5160	5544	5736	6200
16	3624	3880	4264	4584	4968	5160	5544	5992	6200	6456
17	4008	4392	4776	5160	5352	5736	6200	6456	6712	7224
18	4392	4776	5160	5544	5992	6200	6712	7224	7480	7992
19	4776	5160	5544	5992	6456	6968	7224	7736	8248	8504
20	5160	5544	5992	6456	6968	7480	7992	8248	8760	9144
21	5544	5992	6456	6968	7480	7992	8504	9144	9528	9912
22	5992	6456	6968	7480	7992	8504	9144	9528	10296	10680
23	6200	6968	7480	7992	8504	9144	9912	10296	11064	11448
24	6712	7224	7992	8504	9144	9912	10296	11064	11448	12216
25	6968	7480	8248	8760	9528	10296	10680	11448	12216	12576
26	8248	8760	9528	10296	11064	11832	12576	13536	14112	14688

I_{TBS}	N_{PRB}									
	21	22	23	24	25	26	27	28	29	30

0	568	600	616	648	680	712	744	776	776	808
1	744	776	808	872	904	936	968	1000	1032	1064
2	936	968	1000	1064	1096	1160	1192	1256	1288	1320
3	1224	1256	1320	1384	1416	1480	1544	1608	1672	1736
4	1480	1544	1608	1736	1800	1864	1928	1992	2088	2152
5	1864	1928	2024	2088	2216	2280	2344	2472	2536	2664
6	2216	2280	2408	2472	2600	2728	2792	2984	2984	3112
7	2536	2664	2792	2984	3112	3240	3368	3368	3496	3624
8	2984	3112	3240	3368	3496	3624	3752	3880	4008	4264
9	3368	3496	3624	3752	4008	4136	4264	4392	4584	4776
10	3752	3880	4008	4264	4392	4584	4776	4968	5160	5352
11	4264	4392	4584	4776	4968	5352	5544	5736	5992	5992
12	4776	4968	5352	5544	5736	5992	6200	6456	6712	6712
13	5352	5736	5992	6200	6456	6712	6968	7224	7480	7736
14	5992	6200	6456	6968	7224	7480	7736	7992	8248	8504
15	6456	6712	6968	7224	7736	7992	8248	8504	8760	9144
16	6712	7224	7480	7736	7992	8504	8760	9144	9528	9912
17	7480	7992	8248	8760	9144	9528	9912	10296	10296	10680
18	8248	8760	9144	9528	9912	10296	10680	11064	11448	11832
19	9144	9528	9912	10296	10680	11064	11448	12216	12576	12960
20	9912	10296	10680	11064	11448	12216	12576	12960	13536	14112
21	10680	11064	11448	12216	12576	12960	13536	14112	14688	15264
22	11448	11832	12576	12960	13536	14112	14688	15264	15840	16416
23	12216	12576	12960	13536	14112	14688	15264	15840	16416	16992
24	12960	13536	14112	14688	15264	15840	16416	16992	17568	18336
25	13536	14112	14688	15264	15840	16416	16992	17568	18336	19080
26	15264	16416	16992	17568	18336	19080	19848	20616	21384	22152

I_{TBS}	N_{PRB}									
	31	32	33	34	35	36	37	38	39	40
0	840	872	904	936	968	1000	1032	1032	1064	1096
1	1128	1160	1192	1224	1256	1288	1352	1384	1416	1416
2	1384	1416	1480	1544	1544	1608	1672	1672	1736	1800
3	1800	1864	1928	1992	2024	2088	2152	2216	2280	2344
4	2216	2280	2344	2408	2472	2600	2664	2728	2792	2856
5	2728	2792	2856	2984	3112	3112	3240	3368	3496	3496
6	3240	3368	3496	3496	3624	3752	3880	4008	4136	4136
7	3752	3880	4008	4136	4264	4392	4584	4584	4776	4968
8	4392	4584	4584	4776	4968	4968	5160	5352	5544	5544
9	4968	5160	5160	5352	5544	5736	5736	5992	6200	6200
10	5544	5736	5736	5992	6200	6200	6456	6712	6712	6968
11	6200	6456	6712	6968	6968	7224	7480	7736	7736	7992
12	6968	7224	7480	7736	7992	8248	8504	8760	8760	9144
13	7992	8248	8504	8760	9144	9144	9528	9912	9912	10296
14	8760	9144	9528	9912	9912	10296	10680	11064	11064	11448
15	9528	9912	10296	10296	10680	11064	11448	11832	11832	12216
16	9912	10296	10680	11064	11448	11832	12216	12216	12576	12960
17	11064	11448	11832	12216	12576	12960	13536	13536	14112	14688
18	12216	12576	12960	13536	14112	14112	14688	15264	15264	15840
19	13536	13536	14112	14688	15264	15264	15840	16416	16992	16992
20	14688	14688	15264	15840	16416	16992	16992	17568	18336	18336
21	15840	15840	16416	16992	17568	18336	18336	19080	19848	19848
22	16992	16992	17568	18336	19080	19080	19848	20616	21384	21384
23	17568	18336	19080	19848	19848	20616	21384	22152	22152	22920
24	19080	19848	19848	20616	21384	22152	22920	22920	23688	24496
25	19848	20616	20616	21384	22152	22920	23688	24496	24496	25456
26	22920	23688	24496	25456	25456	26416	27376	28336	29296	29296

I_{TBS}	N_{PRB}									
	41	42	43	44	45	46	47	48	49	50
0	1128	1160	1192	1224	1256	1256	1288	1320	1352	1384
1	1480	1544	1544	1608	1608	1672	1736	1736	1800	1800
2	1800	1864	1928	1992	2024	2088	2088	2152	2216	2216
3	2408	2472	2536	2536	2600	2664	2728	2792	2856	2856
4	2984	2984	3112	3112	3240	3240	3368	3496	3496	3624

5	3624	3752	3752	3880	4008	4008	4136	4264	4392	4392
6	4264	4392	4584	4584	4776	4776	4968	4968	5160	5160
7	4968	5160	5352	5352	5544	5736	5736	5992	5992	6200
8	5736	5992	5992	6200	6200	6456	6456	6712	6968	6968
9	6456	6712	6712	6968	6968	7224	7480	7480	7736	7992
10	7224	7480	7480	7736	7992	7992	8248	8504	8504	8760
11	8248	8504	8760	8760	9144	9144	9528	9528	9912	9912
12	9528	9528	9912	9912	10296	10680	10680	11064	11064	11448
13	10680	10680	11064	11448	11448	11832	12216	12216	12576	12960
14	11832	12216	12216	12576	12960	12960	13536	13536	14112	14112
15	12576	12960	12960	13536	13536	14112	14688	14688	15264	15264
16	13536	13536	14112	14112	14688	14688	15264	15840	15840	16416
17	14688	15264	15264	15840	16416	16416	16992	17568	17568	18336
18	16416	16416	16992	17568	17568	18336	18336	19080	19080	19848
19	17568	18336	18336	19080	19080	19848	20616	20616	21384	21384
20	19080	19848	19848	20616	20616	21384	22152	22152	22920	22920
21	20616	21384	21384	22152	22920	22920	23688	24496	24496	25456
22	22152	22920	22920	23688	24496	24496	25456	25456	26416	27376
23	23688	24496	24496	25456	25456	26416	27376	27376	28336	28336
24	25456	25456	26416	26416	27376	28336	28336	29296	29296	30576
25	26416	26416	27376	28336	28336	29296	29296	30576	31704	31704
26	30576	30576	31704	32856	32856	34008	35160	35160	36696	36696

I_{TBS}	N_{PRB}									
	51	52	53	54	55	56	57	58	59	60
0	1416	1416	1480	1480	1544	1544	1608	1608	1608	1672
1	1864	1864	1928	1992	1992	2024	2088	2088	2152	2152
2	2280	2344	2344	2408	2472	2536	2536	2600	2664	2664
3	2984	2984	3112	3112	3240	3240	3368	3368	3496	3496
4	3624	3752	3752	3880	4008	4008	4136	4136	4264	4264
5	4584	4584	4776	4776	4776	4968	4968	5160	5160	5352
6	5352	5352	5544	5736	5736	5992	5992	5992	6200	6200
7	6200	6456	6456	6712	6712	6712	6968	6968	7224	7224
8	7224	7224	7480	7480	7736	7736	7992	7992	8248	8504
9	7992	8248	8248	8504	8760	8760	9144	9144	9144	9528
10	9144	9144	9144	9528	9528	9912	9912	10296	10296	10680
11	10296	10680	10680	11064	11064	11448	11448	11832	11832	12216
12	11832	11832	12216	12216	12576	12576	12960	12960	13536	13536
13	12960	13536	13536	14112	14112	14688	14688	14688	15264	15264
14	14688	14688	15264	15264	15840	15840	16416	16416	16992	16992
15	15840	15840	16416	16416	16992	16992	17568	17568	18336	18336
16	16416	16992	16992	17568	17568	18336	18336	19080	19080	19848
17	18336	19080	19080	19848	19848	20616	20616	20616	21384	21384
18	19848	20616	21384	21384	22152	22152	22920	22920	23688	23688
19	22152	22152	22920	22920	23688	24496	24496	25456	25456	25456
20	23688	24496	24496	25456	25456	26416	26416	27376	27376	28336
21	25456	26416	26416	27376	27376	28336	28336	29296	29296	30576
22	27376	28336	28336	29296	29296	30576	30576	31704	31704	32856
23	29296	29296	30576	30576	31704	31704	32856	32856	34008	34008
24	31704	31704	32856	32856	34008	34008	35160	35160	36696	36696
25	32856	32856	34008	34008	35160	35160	36696	36696	37888	37888
26	37888	37888	39232	40576	40576	40576	42368	42368	43816	43816

I_{TBS}	N_{PRB}									
	61	62	63	64	65	66	67	68	69	70
0	1672	1736	1736	1800	1800	1800	1864	1864	1928	1928
1	2216	2280	2280	2344	2344	2408	2472	2472	2536	2536
2	2728	2792	2856	2856	2856	2984	2984	3112	3112	3112
3	3624	3624	3624	3752	3752	3880	3880	4008	4008	4136
4	4392	4392	4584	4584	4584	4776	4776	4968	4968	4968
5	5352	5544	5544	5736	5736	5736	5992	5992	5992	6200
6	6456	6456	6456	6712	6712	6968	6968	6968	7224	7224
7	7480	7480	7736	7736	7992	7992	8248	8248	8504	8504
8	8504	8760	8760	9144	9144	9144	9528	9528	9528	9912
9	9528	9912	9912	10296	10296	10296	10680	10680	11064	11064

10	10680	11064	11064	11448	11448	11448	11832	11832	12216	12216
11	12216	12576	12576	12960	12960	13536	13536	13536	14112	14112
12	14112	14112	14112	14688	14688	15264	15264	15264	15840	15840
13	15840	15840	16416	16416	16992	16992	16992	17568	17568	18336
14	17568	17568	18336	18336	18336	19080	19080	19848	19848	19848
15	18336	19080	19080	19848	19848	20616	20616	20616	21384	21384
16	19848	19848	20616	20616	21384	21384	22152	22152	22152	22920
17	22152	22152	22920	22920	23688	23688	24496	24496	24496	25456
18	24496	24496	24496	25456	25456	26416	26416	27376	27376	27376
19	26416	26416	27376	27376	28336	28336	29296	29296	29296	30576
20	28336	29296	29296	29296	30576	30576	31704	31704	31704	32856
21	30576	31704	31704	31704	32856	32856	34008	34008	35160	35160
22	32856	34008	34008	34008	35160	35160	36696	36696	36696	37888
23	35160	35160	36696	36696	37888	37888	37888	39232	39232	40576
24	36696	37888	37888	39232	39232	40576	40576	42368	42368	42368
25	39232	39232	40576	40576	40576	42368	42368	43816	43816	43816
26	45352	45352	46888	46888	48936	48936	48936	51024	51024	52752

I_{TBS}	N_{PRB}									
	71	72	73	74	75	76	77	78	79	80
0	1992	1992	2024	2088	2088	2088	2152	2152	2216	2216
1	2600	2600	2664	2728	2728	2792	2792	2856	2856	2856
2	3240	3240	3240	3368	3368	3368	3496	3496	3496	3624
3	4136	4264	4264	4392	4392	4392	4584	4584	4584	4776
4	5160	5160	5160	5352	5352	5544	5544	5544	5736	5736
5	6200	6200	6456	6456	6712	6712	6712	6968	6968	6968
6	7480	7480	7736	7736	7736	7992	7992	8248	8248	8248
7	8760	8760	8760	9144	9144	9144	9528	9528	9528	9912
8	9912	9912	10296	10296	10680	10680	10680	11064	11064	11064
9	11064	11448	11448	11832	11832	11832	12216	12216	12576	12576
10	12576	12576	12960	12960	12960	13536	13536	13536	14112	14112
11	14112	14688	14688	14688	15264	15264	15840	15840	15840	16416
12	16416	16416	16416	16992	16992	17568	17568	17568	18336	18336
13	18336	18336	19080	19080	19080	19848	19848	19848	20616	20616
14	20616	20616	20616	21384	21384	22152	22152	22152	22920	22920
15	22152	22152	22152	22920	22920	23688	23688	23688	24496	24496
16	22920	23688	23688	24496	24496	24496	25456	25456	25456	26416
17	25456	26416	26416	26416	27376	27376	27376	28336	28336	29296
18	28336	28336	29296	29296	29296	30576	30576	30576	31704	31704
19	30576	30576	31704	31704	32856	32856	32856	34008	34008	34008
20	32856	34008	34008	34008	35160	35160	35160	36696	36696	36696
21	35160	36696	36696	36696	37888	37888	39232	39232	39232	40576
22	37888	39232	39232	40576	40576	40576	42368	42368	42368	43816
23	40576	40576	42368	42368	43816	43816	43816	45352	45352	45352
24	43816	43816	45352	45352	45352	46888	46888	46888	48936	48936
25	45352	45352	46888	46888	46888	48936	48936	48936	51024	51024
26	52752	52752	55056	55056	55056	55056	57336	57336	57336	59256

I_{TBS}	N_{PRB}									
	81	82	83	84	85	86	87	88	89	90
0	2280	2280	2280	2344	2344	2408	2408	2472	2472	2536
1	2984	2984	2984	3112	3112	3112	3240	3240	3240	3240
2	3624	3624	3752	3752	3880	3880	3880	4008	4008	4008
3	4776	4776	4776	4968	4968	4968	5160	5160	5160	5352
4	5736	5992	5992	5992	5992	6200	6200	6200	6456	6456
5	7224	7224	7224	7480	7480	7480	7736	7736	7736	7992
6	8504	8504	8760	8760	8760	9144	9144	9144	9144	9528
7	9912	9912	10296	10296	10296	10680	10680	10680	11064	11064
8	11448	11448	11448	11832	11832	12216	12216	12216	12576	12576
9	12960	12960	12960	13536	13536	13536	13536	14112	14112	14112
10	14112	14688	14688	14688	14688	15264	15264	15264	15840	15840
11	16416	16416	16992	16992	16992	17568	17568	17568	18336	18336
12	18336	19080	19080	19080	19080	19848	19848	19848	20616	20616
13	20616	21384	21384	21384	22152	22152	22152	22920	22920	22920
14	22920	23688	23688	24496	24496	24496	25456	25456	25456	25456

15	24496	25456	25456	25456	26416	26416	26416	27376	27376	27376
16	26416	26416	27376	27376	27376	28336	28336	28336	29296	29296
17	29296	29296	30576	30576	30576	30576	31704	31704	31704	32856
18	31704	32856	32856	32856	34008	34008	34008	35160	35160	35160
19	35160	35160	35160	36696	36696	36696	37888	37888	37888	39232
20	37888	37888	39232	39232	39232	40576	40576	40576	42368	42368
21	40576	40576	42368	42368	42368	43816	43816	43816	45352	45352
22	43816	43816	45352	45352	45352	46888	46888	46888	48936	48936
23	46888	46888	46888	48936	48936	48936	51024	51024	51024	51024
24	48936	51024	51024	51024	52752	52752	52752	52752	55056	55056
25	51024	52752	52752	52752	55056	55056	55056	55056	57336	57336
26	59256	59256	61664	61664	61664	63776	63776	63776	66592	66592

I_{TBS}	N_{PRB}									
	91	92	93	94	95	96	97	98	99	100
0	2536	2536	2600	2600	2664	2664	2728	2728	2728	2792
1	3368	3368	3368	3496	3496	3496	3496	3624	3624	3624
2	4136	4136	4136	4264	4264	4264	4392	4392	4392	4584
3	5352	5352	5352	5544	5544	5544	5736	5736	5736	5736
4	6456	6456	6712	6712	6712	6968	6968	6968	6968	7224
5	7992	7992	8248	8248	8248	8504	8504	8760	8760	8760
6	9528	9528	9528	9912	9912	9912	10296	10296	10296	10296
7	11064	11448	11448	11448	11448	11832	11832	11832	12216	12216
8	12576	12960	12960	12960	13536	13536	13536	13536	14112	14112
9	14112	14688	14688	14688	15264	15264	15264	15264	15840	15840
10	15840	16416	16416	16416	16992	16992	16992	16992	17568	17568
11	18336	18336	19080	19080	19080	19080	19848	19848	19848	19848
12	20616	21384	21384	21384	21384	22152	22152	22152	22920	22920
13	23688	23688	23688	24496	24496	24496	25456	25456	25456	25456
14	26416	26416	26416	27376	27376	27376	28336	28336	28336	28336
15	28336	28336	28336	29296	29296	29296	29296	30576	30576	30576
16	29296	30576	30576	30576	30576	31704	31704	31704	31704	32856
17	32856	32856	34008	34008	34008	35160	35160	35160	35160	36696
18	36696	36696	36696	37888	37888	37888	37888	39232	39232	39232
19	39232	39232	40576	40576	40576	40576	42368	42368	42368	43816
20	42368	42368	43816	43816	43816	45352	45352	45352	46888	46888
21	45352	46888	46888	46888	46888	48936	48936	48936	48936	51024
22	48936	48936	51024	51024	51024	51024	52752	52752	52752	55056
23	52752	52752	52752	55056	55056	55056	55056	57336	57336	57336
24	55056	57336	57336	57336	57336	59256	59256	59256	61664	61664
25	57336	59256	59256	59256	61664	61664	61664	61664	63776	63776
26	66592	68808	68808	68808	71112	71112	71112	73712	73712	75376

I_{TBS}	N_{PRB}									
	101	102	103	104	105	106	107	108	109	110
0	2792	2856	2856	2856	2984	2984	2984	2984	2984	3112
1	3752	3752	3752	3752	3880	3880	3880	4008	4008	4008
2	4584	4584	4584	4584	4776	4776	4776	4776	4968	4968
3	5992	5992	5992	5992	6200	6200	6200	6200	6456	6456
4	7224	7224	7480	7480	7480	7480	7736	7736	7736	7992
5	8760	9144	9144	9144	9144	9528	9528	9528	9528	9528
6	10680	10680	10680	10680	11064	11064	11064	11448	11448	11448
7	12216	12576	12576	12576	12960	12960	12960	12960	13536	13536
8	14112	14112	14688	14688	14688	14688	15264	15264	15264	15264
9	15840	16416	16416	16416	16416	16992	16992	16992	16992	17568
10	17568	18336	18336	18336	18336	18336	19080	19080	19080	19080
11	20616	20616	20616	21384	21384	21384	21384	22152	22152	22152
12	22920	23688	23688	23688	23688	24496	24496	24496	24496	25456
13	26416	26416	26416	26416	27376	27376	27376	27376	28336	28336
14	29296	29296	29296	29296	30576	30576	30576	30576	31704	31704
15	30576	31704	31704	31704	31704	32856	32856	32856	34008	34008
16	32856	32856	34008	34008	34008	34008	35160	35160	35160	35160
17	36696	36696	36696	37888	37888	37888	39232	39232	39232	39232
18	40576	40576	40576	40576	42368	42368	42368	42368	43816	43816
19	43816	43816	43816	45352	45352	45352	46888	46888	46888	46888

20	46888	46888	48936	48936	48936	48936	48936	51024	51024	51024
21	51024	51024	51024	52752	52752	52752	52752	55056	55056	55056
22	55056	55056	55056	57336	57336	57336	57336	59256	59256	59256
23	57336	59256	59256	59256	59256	61664	61664	61664	61664	63776
24	61664	61664	63776	63776	63776	63776	66592	66592	66592	66592
25	63776	63776	66592	66592	66592	66592	68808	68808	68808	71112
26	75376	75376	75376	75376	75376	75376	75376	75376	75376	75376

[TS 36.306 clause 4.1]

The UE Category parameter defines a combined uplink and downlink capability. The parameters set by the UE Category are defined in subclause 4.2. Tables 4.1-1 and 4.1-2 define the downlink and, respectively, uplink physical layer parameter values for each UE Category.

Table 4.1-1: Downlink physical layer parameter values set by UE Category

UE Category	Maximum number of DL-SCH transport block bits received within a TTI	Maximum number of bits of a DL-SCH transport block received within a TTI	Total number of soft channel bits	Maximum number of supported layers for spatial multiplexing in DL
Category 1	10296	10296	250368	1
Category 2	51024	51024	1237248	2
Category 3	102048	75376	1237248	2
Category 4	150752	75376	1827072	2
Category 5	302752	151376	3667200	4

Table 4.1-2: Uplink physical layer parameter values set by UE Category

UE Category	Maximum number of bits of an UL-SCH transport block transmitted within a TTI	Support for 64QAM in UL
Category 1	5160	No
Category 2	25456	No
Category 3	51024	No
Category 4	51024	No
Category 5	75376	Yes

7.1.7.2.1.3 Test description

7.1.7.2.1.3.1 Pre-test conditions

System Simulator

- Cell 1.
- Uplink and downlink bandwidth set to 20 MHz (to enable testing of N_{PRB} up to maximum value).

UE:

None.

Preamble

- The UE is in state Loopback Activated (state 4) according to [18].

7.1.7.2.1.3.2 Test procedure sequence

Table 7.1.7.2.1.3.2-1: Maximum TB_{size} for different UE categories

UE Category	Maximum number of bits of an UL-SCH transport block transmitted within a TTI
Category 1	5160
Category 2	25456
Category 3	51024
Category 4	51024
Category 5	75376

Table 7.1.7.2.1.3.2-2: Number of downlink PDCP SDUs and PDCP SDU size used as test data

TB_{size} [bits]	Number of PDCP SDUs, N_{SDUs}	PDCP SDU size of each PDCP SDU [bits] See note 1
$TB_{size} \leq 12000$	1	[FFS]
$12001 \leq TB_{size} \leq 24000$	2	[FFS]
$24001 \leq TB_{size} \leq 36000$	3	[FFS]
$36001 \leq TB_{size} \leq 48000$	4	[FFS]
$48001 \leq TB_{size} \leq 60000$	5	[FFS]
$60001 \leq TB_{size} \leq 72000$	6	[FFS]
$TB_{size} \geq 72001$	7	[FFS]

Note 1: Each PDCP SDU is limited to [TBD] octets (keep below maximum SDU size of ESM as specified in TS 24.301 clause 9.9.4.12).

Table 7.1.7.2.1.3.2-3: Main behaviour

St	Procedure	Message Sequence		TP	Verdict
		U – S	Message		
1	The SS ignores scheduling requests and does not allocate any uplink grant.	-	-	-	-
-	EXCEPTION: Steps 2 to 7 are repeated for values of N_{PRB} from 1 to 110 and I_{MCS} from 0 to 28, where N_{PRB} satisfies values equal to $2^{\alpha_2} \cdot 3^{\alpha_3} \cdot 5^{\alpha_5} \leq N_{RB}^{UL}$ and where $\alpha_2, \alpha_3, \alpha_5$ is a set of non-negative integers.	-	-	-	-
2	SS looks up I_{TBS} in table 8.6.1-1 in TS 36.213 based on the value of I_{MCS} . SS looks up TB_{size} in table 7.1.7.2.1-1 in TS 36.213 based on values of N_{PRB} and I_{TBS} .	-	-	-	-
-	EXCEPTION: Steps 3 to 7 are performed if TB_{size} is less or equal to UE capability "Maximum	-	-	-	-

	number of UL-SCH transport block bits received within a TTI" as specified in Table 7.1.7.2.1.3.2-1.				
3	SS creates one or more PDCP SDUs, depending on TB_{size} , in accordance with Table 7.1.7.2.1.3.2-2.	-	-	-	-
4	SS transmits all PDCP SDUs (N_{SDUs}) as created in step 3 in a MAC PDU.	<--	MAC PDU ($N_{SDUs} \times$ PDCP SDU)	-	-
5	The SS responds to any scheduling requests by a PUSCH scheduling indicating DCI Format 0 with a RVI correspondent to N_{PRB} as specified in 8.1 in TS 36.213 and Modulation and coding scheme I_{MCS} as specified in Table 8.6.1-1 in TS 36.213.	<--	(UL Grant) DCI: (DCI Format 0, RVI (N_{PRB}), I_{MCS})	-	-
6	The SS ignores scheduling requests and does not allocate any uplink grant.	-	-	-	-
7	CHECK: Does UE return the same number of PDCP SDUs with same content as transmitted by the UE using the Resource Block Assignment and Modulation and coding scheme as configured by the SS in step 5?	-->	MAC PDU ($N_{SDUs} \times$ PDCP SDU)	1	P

7.1.7.2.1.3.3 Specific Message Contents

None

7.2 RLC

7.2.1 General

For UM tests, the UM test DRB is set up using the Generic Procedure described in clause 4.5 of [18], with the parameters described in clause 4.8.2.1.3.1 of [18], except for the tests that explicitly specify a different DRB configuration.

For AM tests, the AM test DRB is set up using the Generic Procedure described in clause 4.5 of [18], with the parameters described in clause 4.8.2.1.3.2 of [18], except for the tests that explicitly specify a different DRB configuration.

7.2.2 Unacknowledged Mode

7.2.2.1 UM RLC / Segmentation and Reassembly / 5-bit SN / "Framing Info Field"

7.2.2.1.1 Test Purpose (TP)

(1)

```
with { UE in E-UTRA RRC_CONNECTED state }
ensure that {
  when { UE receives a 5 bit SN configured UMD PDU containing a FI field set to 00 }
  then { UE correctly decodes the received UMD PDU }
}
```

(2)

```
with { UE in E-UTRA RRC_CONNECTED state }
ensure that {
  when { UE receives a 5 bit SN configured UMD PDU containing a FI field set to 01 }
  then { UE correctly decodes the received UMD PDU }
}
```

(3)

```
with { UE in E-UTRA RRC_CONNECTED state }
ensure that {
  when { UE receives a 5 bit SN configured UMD PDU containing a FI field set to 11 }
  then { UE correctly decodes the received UMD PDU }
}
```

(4)

```
with { UE in E-UTRA RRC_CONNECTED state }
ensure that {
  when { UE receives a 5 bit SN configured UMD PDU containing a FI field set to 10 }
  then { UE correctly decodes the received UMD PDU }
}
```

7.2.2.1.2 Conformance requirements

References: The conformance requirements covered in the present TC are specified in: TS 36.322, clause 6.2.1.3 and 6.2.2.6.

[TS 36.322, clause 6.2.1.3]

...

An UM RLC entity is configured by RRC to use either a 5 bit SN or a 10 bit SN. When the 5 bit SN is configured, the length of the fixed part of the UMD PDU header is one byte. When the 10 bit SN is configured, the fixed part of the UMD PDU header is identical to the fixed part of the AMD PDU header, except for D/C, RF and P fields all being replaced with R1 fields. The extension part of the UMD PDU header is identical to the extension part of the AMD PDU header (regardless of the configured SN size).

...

[TS 36.322, clause 6.2.2.6]

Length: 2 bits.

The FI field indicates whether a RLC SDU is segmented at the beginning and/or at the end of the Data field. Specifically, the FI field indicates whether the first byte of the Data field corresponds to the first byte of a RLC SDU, and whether the last byte of the Data field corresponds to the last byte of a RLC SDU. The interpretation of the FI field is provided in Table 6.2.2.6-1.

Table 6.2.2.6-1: FI field interpretation

Value	Description
00	First byte of the Data field corresponds to the first byte of a RLC SDU. Last byte of the Data field corresponds to the last byte of a RLC SDU.
01	First byte of the Data field corresponds to the first byte of a RLC SDU. Last byte of the Data field does not correspond to the last byte of a RLC SDU.
10	First byte of the Data field does not correspond to the first byte of a RLC SDU. Last byte of the Data field corresponds to the last byte of a RLC SDU.
11	First byte of the Data field does not correspond to the first byte of a RLC SDU. Last byte of the Data field does not correspond to the last byte of a RLC SDU.

7.2.2.1.3 Test description

7.2.2.1.3.1 Pre-test conditions

System Simulator:

- Cell 1.

UE:

None.

Preamble:

- The UE is in state Loopback Activated (state 4) according to [18] with the exceptions listed in table 7.2.2.1.3.1-1.

Table 7.2.2.1.3.1-1: RLC parameters

Uplink RLC sn-FieldLength	size5
Downlink RLC sn-FieldLength	size5

7.2.2.1.3.2 Test procedure sequence

Table 7.2.2.1.3.2-1: Main behaviour

St	Procedure	Message Sequence		TP	Verdict
		U - S	Message		
1	The SS transmits UMD PDU#1 containing a complete RLC SDU#1 (FI field = 00).	<--	UMD PDU#1	-	-
2	Check: Does the UE transmit RLC SDU#1?	-->	(RLC SDU#1)	1	P
3	The SS transmits UMD PDU#2 containing the first segment of RLC SDU#2 (FI field = 01).	<--	UMD PDU#2	-	-
4	The SS transmits UMD PDU#3 containing the second segment of RLC SDU#2 (FI field = 11).	<--	UMD PDU#3	-	-
5	The SS transmits UMD PDU#4 containing the last segment of RLC SDU#2 (FI field = 10).	<--	UMD PDU#4	-	-
6	Check: Does the UE transmit RLC SDU#2?	-->	(RLC SDU#2)	2,3, 4	P

7.2.2.1.3.3 Specific message contents

None.

7.2.2.2 UM RLC / Segmentation and Reassembly / 10-bit SN / "Framing Info Field"

7.2.2.2.1 Test Purpose (TP)

(1)

```
with { UE in E-UTRA RRC_CONNECTED state }
ensure that {
  when { UE receives a 10 bit SN configured UMD PDU containing a FI field set to 00 }
  then { UE correctly decodes the received UMD PDU }
}
```

(2)

```
with { UE in E-UTRA RRC_CONNECTED state }
ensure that {
  when { UE receives a 10 bit SN configured UMD PDU containing a FI field set to 01 }
  then { UE correctly decodes the received UMD PDU }
}
```

(3)

```
with { UE in E-UTRA RRC_CONNECTED state }
ensure that {
  when { UE receives a 10 bit SN configured UMD PDU containing a FI field set to 11 }
  then { UE correctly decodes the received UMD PDU }
}
```

(4)

```
with { UE in E-UTRA RRC_CONNECTED state }
ensure that {
  when { UE receives a 10 bit SN configured UMD PDU containing a FI field set to 10 }
  then { UE correctly decodes the received UMD PDU }
}
```

7.2.2.2.2 Conformance requirements

References: The conformance requirements covered in the present TC are specified in: TS 36.322, clause 6.2.1.3 and 6.2.2.6.

[TS 36.322, clause 6.2.1.3]

...

An UM RLC entity is configured by RRC to use either a 5 bit SN or a 10 bit SN. When the 5 bit SN is configured, the length of the fixed part of the UMD PDU header is one byte. When the 10 bit SN is configured, the fixed part of the UMD PDU header is identical to the fixed part of the AMD PDU header, except for D/C, RF and P fields all being replaced with R1 fields. The extension part of the UMD PDU header is identical to the extension part of the AMD PDU header (regardless of the configured SN size).

...

[TS 36.322, clause 6.2.2.6]

Length: 2 bits.

The FI field indicates whether a RLC SDU is segmented at the beginning and/or at the end of the Data field. Specifically, the FI field indicates whether the first byte of the Data field corresponds to the first byte of a RLC SDU, and whether the last byte of the Data field corresponds to the last byte of a RLC SDU. The interpretation of the FI field is provided in Table 6.2.2.6-1.

Table 6.2.2.6-1: FI field interpretation

Value	Description
00	First byte of the Data field corresponds to the first byte of a RLC SDU. Last byte of the Data field corresponds to the last byte of a RLC SDU.
01	First byte of the Data field corresponds to the first byte of a RLC SDU. Last byte of the Data field does not correspond to the last byte of a RLC SDU.
10	First byte of the Data field does not correspond to the first byte of a RLC SDU. Last byte of the Data field corresponds to the last byte of a RLC SDU.
11	First byte of the Data field does not correspond to the first byte of a RLC SDU. Last byte of the Data field does not correspond to the last byte of a RLC SDU.

7.2.2.2.3 Test description

7.2.2.2.3.1 Pre-test conditions

System Simulator:

- Cell 1.

UE:

None.

Preamble:

- The UE is in state Loopback Activated (state 4) according to [18].

7.2.2.2.3.2 Test procedure sequence

Table 7.2.2.2.3.2-1: Main behaviour

St	Procedure	Message Sequence		TP	Verdict
		U - S	Message		
1	The SS transmits UMD PDU#1 containing a complete RLC SDU#1 (FI field = 00).	<--	UMD PDU#1	-	-
2	Check: Does the UE transmit RLC SDU#1?	-->	(RLC SDU#1)	1	P
3	The SS transmits UMD PDU#2 containing the first segment of RLC SDU#2 (FI field = 01).	<--	UMD PDU#2	-	-
4	The SS transmits UMD PDU#3 containing the second segment of RLC SDU#2 (FI field = 11).	<--	UMD PDU#3	-	-
5	The SS transmits UMD PDU#4 containing the last segment of RLC SDU#2 (FI field = 10).	<--	UMD PDU#4	-	-
6	Check: Does the UE transmit RLC SDU#2?	-->	(RLC SDU#2)	2, 3, 4	P

7.2.2.2.3.3 Specific message contents

None.

7.2.2.3 UM RLC / Reassembly / 5-bit SN / LI value > PDU size

7.2.2.3.1 Test Purpose (TP)

(1)

```

with { UE in E-UTRA RRC_CONNECTED state }
ensure that {
  when { UE receives a 5 bit SN configured RLC PDU with Length Indicator value larger than RLC PDU size }
  then { UE discards the RLC PDU }
}

```

7.2.2.3.2 Conformance requirements

See TS 36.322 clauses 6.2.2.5 and 5.5.1

References: The conformance requirements covered in the present TC are specified in: TS 36.322, clause 5.5.1 and 6.2.2.5.

[TS 36.322, clause 5.5.1]

When an RLC entity receives an RLC PDU that contains reserved or invalid values, the RLC entity shall:

- discard the received PDU.

[TS 36.322, clause 6.2.2.5]

Length: 11 bits.

The LI field indicates the length in bytes of the corresponding Data field element present in the RLC data PDU delivered/received by an UM or an AM RLC entity. The first LI present in the RLC data PDU header corresponds to the first Data field element present in the Data field of the RLC data PDU, the second LI present in the RLC data PDU header corresponds to the second Data field element present in the Data field of the RLC data PDU, and so on. The value 0 is reserved.

7.2.2.3.3 Test description

7.2.2.3.3.1 Pre-test conditions

System Simulator:

- Cell 1.

UE:

None.

Preamble:

- The UE is in state Loopback Activated (state 4) according to [18] with the exceptions listed in table 7.2.2.3.3.1-1.

Table 7.2.2.3.3.1-1: RLC parameters

Uplink RLC sn-FieldLength	size5
Downlink RLC sn-FieldLength	size5

7.2.2.3.3.2 Test procedure sequence

Table 7.2.2.3.3.2-1: Main behaviour

St	Procedure	Message Sequence		TP	Verdict
		U - S	Message		
-	EXCEPTION: the behaviour described in table 7.2.2.3.3.2-2 runs in parallel with steps 1 to 5 below.	-	-	-	-
1	The SS transmits UMD PDU#1 containing first segment of RLC SDU#1.	<--	UMD PDU#1	-	-
2	The SS transmits UMD PDU#2 containing last segment of RLC SDU#1 and first segment of RLC SDU#2.	<--	UMD PDU#2	-	-
3	The SS transmits UMD PDU#3 containing last segment of RLC SDU#2, first segment of RLC SDU#3 and with Length Indicator that points beyond the end of the UMD PDU#3.	<--	UMD PDU#3	-	-
4	The SS transmits UMD PDU#4 containing last segment of RLC SDU#3.	<--	UMD PDU#4	-	-
5	The SS transmits UMD PDU#5 containing RLC SDU#4.	<--	UMD PDU#5	-	-

Table 7.2.2.3.3.2-2: Parallel behaviour

St	Procedure	Message Sequence		TP	Verdict
		U - S	Message		
1	Check: Does the UE send RLC SDU#1?	-->	(RLC SDU#1)	-	-
2	Check: Does the UE send RLC SDU#2?	-->	(RLC SDU#2)	1	F
3	Check: Does the UE send RLC SDU#3?	-->	(RLC SDU#3)	1	F
4	Check: Does the UE send RLC SDU#4?	-->	(RLC SDU#4)	1	P

7.2.2.3.3.3 Specific message contents

None.

7.2.2.4 UM RLC/ Reassembly / 10-bit SN / LI value > PDU size

7.2.2.4.1 Test Purpose (TP)

(1)

```
with { UE in E-UTRA RRC_CONNECTED state }
ensure that {
  when { UE receives an RLC PDU with Length Indicator value larger than RLC PDU size }
  then { UE discards the RLC PDU }
}
```

7.2.2.4.2 Conformance requirements

References: The conformance requirements covered in the present TC are specified in: TS 36.322, clause 5.5.1.

[TS 36.322, clause 5.5.1]

When an RLC entity receives an RLC PDU that contains reserved or invalid values, the RLC entity shall:

- discard the received PDU.

7.2.2.4.3 Test description

7.2.2.4.3.1 Pre-test conditions

System Simulator:

- Cell 1.

UE:

None.

Preamble:

- The UE is in state Loopback Activated (state 4) according to [18].

7.2.2.4.3.2 Test procedure sequence

Table 7.2.2.4.3.2-1: Main behaviour

St	Procedure	Message Sequence		TP	Verdict
		U - S	Message		
-	EXCEPTION: The behaviour described in table 7.2.2.4.3.2-2 runs in parallel with steps 1 to 5 below.	-	-	-	-
1	The SS transmits UMD PDU#1 containing first segment of RLC SDU#1.	<--	UMD PDU#1	-	-
2	The SS transmits UMD PDU#2 containing last segment of RLC SDU#1 and first segment of RLC SDU#2.	<--	UMD PDU#2	-	-
3	The SS transmits UMD PDU#3 containing last segment of RLC SDU#2, first segment of RLC SDU#3 and with Length Indicator that points beyond the end of the RLC PDU#3.	<--	UMD PDU#3	-	-
4	The SS transmits UMD PDU#4 containing last segment of RLC SDU#3.	<--	UMD PDU#4	-	-
5	The SS transmits UMD PDU#5 containing RLC SDU#4.	<--	UMD PDU#5	-	-

Table 7.2.2.4.3.2-2: Parallel behaviour

St	Procedure	Message Sequence		TP	Verdict
		U - S	Message		
1	Check: Does the UE send RLC SDU#1.	-->	(RLC SDU#1)	1	P
2	Check: Does the UE send RLC SDU#2.	-->	(RLC SDU#2)	1	F
3	Check: Does the UE send RLC SDU#3.	-->	(RLC SDU#3)	1	F
4	Check: Does the UE send RLC SDU#4.	-->	(RLC SDU#4)	1	P

7.2.2.4.3.3 Specific message contents

None.

7.2.2.5 UM RLC / Correct use of Sequence Numbering

7.2.2.5.1 UM RLC / 5-bit SN / Correct use of Sequence Numbering

7.2.2.5.1.1 Test Purpose (TP)

(1)

```
with { UE in E-UTRA RRC_CONNECTED state }
ensure that {
  when { UE transmits the first PDU }
  then { UE sets the Sequence Number field equal to 0 }
}
```

(2)

```
with { UE in E-UTRA RRC_CONNECTED state }
ensure that {
  when { UE transmits subsequent PDUs }
  then { SN incremented by 1 for each PDU transmitted }
}
```

(3)

```
with { UE in E-UTRA RRC_CONNECTED state and an UM RLC DRB is configured using 5 bit SN }
ensure that {
  when { UE transmits more than 32 PDUs }
  then { UE wraps the Sequence Number after transmitting the 32 PDU }
}
```

(4)

```
with { UE in E-UTRA RRC_CONNECTED state and an UM RLC DRB is configured using 5 bit SN }
```

```

ensure that {
  when { more than 32 PDUs are sent to UE }
    then { UE accepts PDUs with SNs that wrap around every 32 PDU }
}

```

7.2.2.5.1.2 Conformance requirements

References: The conformance requirements covered in the present TC are specified in: 3GPP TS 36.322, clause 5.1.2.1.1, 5.1.2.2, 6.2.1.3, 6.2.2.3 and 7.1.

[TS 36.322, clause 5.1.2.1.1]

When delivering a new UMD PDU to lower layer, the transmitting UM RLC entity shall:

- set the SN of the UMD PDU to VT(US), and then increment VT(US) by one.

[TS 36.322, clause 5.1.2.2]

The receiving UM RLC entity shall maintain a reordering window according to state variable VR(UH) as follows:

- a SN falls within the reordering window if $(VR(UH) - UM_Window_Size) \leq SN < VR(UH)$;
- a SN falls outside of the reordering window otherwise.

When receiving an UMD PDU from lower layer, the receiving UM RLC entity shall:

- either discard the received UMD PDU or place it in the reception buffer (see sub clause 5.1.2.2.2);
- if the received UMD PDU was placed in the reception buffer:
 - update state variables, reassemble and deliver RLC SDUs to upper layer and start/stop *t-Reordering* as needed (see sub clause 5.1.2.2.3);

...

When an UMD PDU with SN = x is received from lower layer, the receiving UM RLC entity shall:

- if $VR(UR) < x < VR(UH)$ and the UMD PDU with SN = x has been received before; or
- if $(VR(UH) - UM_Window_Size) \leq x < VR(UR)$:
 - discard the received UMD PDU;
- else:
 - place the received UMD PDU in the reception buffer.

...

When an UMD PDU with SN = x is placed in the reception buffer, the receiving UM RLC entity shall:

- if x falls outside of the reordering window:
 - update VR(UH) to x + 1;
 - reassemble RLC SDUs from any UMD PDUs with SN that falls outside of the reordering window, remove RLC headers when doing so and deliver the reassembled RLC SDUs to upper layer in sequence if not delivered before;
 - if VR(UR) falls outside of the reordering window:
 - set VR(UR) to $(VR(UH) - UM_Window_Size)$;
- if the reception buffer contains an UMD PDU with SN = VR(UR):
 - update VR(UR) to the SN of the first UMD PDU with SN > current VR(UR) that has not been received;
 - reassemble RLC SDUs from any UMD PDUs with SN < updated VR(UR), remove RLC headers when doing so and deliver the reassembled RLC SDUs to upper layer in sequence if not delivered before;

...

[TS 36.322, clause 6.2.1.3]

...

An UM RLC entity is configured by RRC to use either a 5 bit SN or a 10 bit SN. When the 5 bit SN is configured, the length of the fixed part of the UMD PDU header is one byte. When the 10 bit SN is configured, the fixed part of the UMD PDU header is identical to the fixed part of the AMD PDU header, except for D/C, RF and P fields all being replaced with R1 fields. The extension part of the UMD PDU header is identical to the extension part of the AMD PDU header (regardless of the configured SN size).

...

[TS 36.322, clause 6.2.2.3]

Length: 5 bits or 10 bits (configurable) for UMD PDU.

The SN field indicates the sequence number of the corresponding UMD... The sequence number is incremented by one for every UMD...

[TS 36.322, clause 7.1]

All state variables and all counters are non-negative integers.

...

All state variables related to UM data transfer can take values from 0 to $[2^{\text{sn-FieldLength}} - 1]$. All arithmetic operations contained in the present document on state variables related to UM data transfer are affected by the UM modulus (i.e. final value = [value from arithmetic operation] modulo $2^{\text{sn-FieldLength}}$).

...

When performing arithmetic comparisons of state variables or SN values, a modulus base shall be used.

...

$\text{VR(UH)} - \text{UM_Window_Size}$ shall be assumed as the modulus base at the receiving side of an UM RLC entity. This modulus base is subtracted from all the values involved, and then an absolute comparison is performed (e.g. $(\text{VR(UH)} - \text{UM_Window_Size}) \leq \text{SN} < \text{VR(UH)}$ is evaluated as $[(\text{VR(UH)} - \text{UM_Window_Size}) - (\text{VR(UH)} - \text{UM_Window_Size})] \bmod 2^{\text{sn-FieldLength}} \leq [\text{SN} - (\text{VR(UH)} - \text{UM_Window_Size})] \bmod 2^{\text{sn-FieldLength}} < [\text{VR(UH)} - (\text{VR(UH)} - \text{UM_Window_Size})] \bmod 2^{\text{sn-FieldLength}}$).

...

Each transmitting UM RLC entity shall maintain the following state variables:

a) VT(US)

This state variable holds the value of the SN to be assigned for the next newly generated UMD PDU. It is initially set to 0, and is updated whenever the UM RLC entity delivers an UMD PDU with $\text{SN} = \text{VT(US)}$.

Each receiving UM RLC entity shall maintain the following state variables:

a) VR(UR) – UM receive state variable

This state variable holds the value of the SN of the earliest UMD PDU that is still considered for reordering. It is initially set to 0.

b) VR(UX) – UM *t-Reordering* state variable

This state variable holds the value of the SN following the SN of the UMD PDU which triggered *t-Reordering*.

c) VR(UH) – UM highest received state variable

This state variable holds the value of the SN following the SN of the UMD PDU with the highest SN among received UMD PDUs, and it serves as the higher edge of the reordering window. It is initially set to 0.

7.2.2.5.1.3 Test description

7.2.2.5.1.3.1 Pre-test conditions

System Simulator:

- Cell 1.

UE:

None.

Preamble:

- UE is in state Loopback Activated (state 4) according to [18] with the exceptions listed in table 7.2.2.5.1.3.1-1.

Table 7.2.2.5.1.3.1-1: RLC parameters

Uplink RLC sn-FieldLength	size5
Downlink RLC sn-FieldLength	size5

7.2.2.5.1.3.2 Test procedure sequence

Table 7.2.2.5.1.3.2-1: Main behaviour

St	Procedure	Message Sequence		TP	Verdict
		U - S	Message/PDU/SDU		
-	EXCEPTION: Step 3 to 4 is executed 31 times.	-	-	-	-
1	The SS transmits an UMD PDU. SN equals 0.	<--	UMD PDU	-	-
2	Check: Does the UE transmit an UMD PDU with SN = 0?	-->	UMD PDU	1	P
3	The SS transmits an UMD PDU. SN equals 1 and is incremented for each PDU transmitted.	<--	UMD PDU	-	-
4	Check: Does the UE transmit an UMD PDU with SN increased by 1 compared with the previous one?	-->	UMD PDU	2	P
5	The SS transmits an UMD PDU. SN equals 0.	<--	UMD PDU	-	-
6	Check: Does the UE transmit an UMD PDU with SN=0?	-->	UMD PDU	3, 4	P

7.2.2.5.1.3.3 Specific message contents

None.

7.2.2.5.2 UM RLC / 10-bit SN / Correct use of Sequence Numbering

7.2.2.5.2.1 Test Purpose (TP)

(1)

```
with { UE in E-UTRA RRC_CONNECTED state }
ensure that {
  when { UE transmits the first PDU }
  then { UE sets the Sequence Number field equal to 0 }
}
```

(2)

```
with { UE in E-UTRA RRC_CONNECTED state }
ensure that {
  when { UE transmits subsequent PDUs }
  then { SN incremented by 1 for each PDU transmitted }
}
```

(3)

```
with { UE in E-UTRA RRC_CONNECTED state and an UM RLC DRB is configured using 10 bit SN }
ensure that {
  when { UE transmits more than 1024 PDUs }
  then { UE wraps the Sequence Number after transmitting the 1024 PDU }
}
```

(4)

```
with { UE in E-UTRA RRC_CONNECTED state and an UM RLC DRB is configured using 10 bit SN }
ensure that {
  when { more than 1024 PDUs are sent to UE }
  then { UE accepts PDUs with SNs that wrap around every 1024 PDU }
}
```

7.2.2.5.2.2 Conformance requirements

References: The conformance requirements covered in the present TC are specified in: 3GPP TS 36.322, clause 5.1.2.1.1, 5.1.2.2, 6.2.1.3, 6.2.2.3 and 7.1.

[TS 36.322, clause 5.1.2.1.1]

When delivering a new UMD PDU to lower layer, the transmitting UM RLC entity shall:

- set the SN of the UMD PDU to VT(US), and then increment VT(US) by one.

[TS 36.322, clause 5.1.2.2]

The receiving UM RLC entity shall maintain a reordering window according to state variable VR(UH) as follows:

- a SN falls within the reordering window if $(VR(UH) - UM_Window_Size) \leq SN < VR(UH)$;
- a SN falls outside of the reordering window otherwise.

When receiving an UMD PDU from lower layer, the receiving UM RLC entity shall:

- either discard the received UMD PDU or place it in the reception buffer (see sub clause 5.1.2.2.2);
- if the received UMD PDU was placed in the reception buffer:
 - update state variables, reassemble and deliver RLC SDUs to upper layer and start/stop T_reordering as needed (see sub clause 5.1.2.2.3);

...

When an UMD PDU with SN = x is received from lower layer, the receiving UM RLC entity shall:

- if $VR(UR) < x < VR(UH)$ and the UMD PDU with SN = x has been received before; or
- if $(VR(UH) - UM_Window_Size) \leq x < VR(UR)$:
 - discard the received UMD PDU;
- else:
 - place the received UMD PDU in the reception buffer.

...

When an UMD PDU with SN = x is placed in the reception buffer, the receiving UM RLC entity shall:

- if x falls outside of the reordering window:
 - update VR(UH) to x + 1;
 - reassemble RLC SDUs from any UMD PDUs with SN that falls outside of the reordering window, remove RLC headers when doing so and deliver the reassembled RLC SDUs to upper layer in sequence if not delivered before;
- if VR(UR) falls outside of the reordering window:

- set VR(UR) to (VR(UH) – UM_Window_Size);
- if the reception buffer contains an UMD PDU with SN = VR(UR):
 - update VR(UR) to the SN of the first UMD PDU with SN > current VR(UR) that has not been received;
 - reassemble RLC SDUs from any UMD PDUs with SN < updated VR(UR), remove RLC headers when doing so and deliver the reassembled RLC SDUs to upper layer in sequence if not delivered before;

...

[TS 36.322, clause 6.2.1.3]

...

An UM RLC entity is configured by RRC to use either a 5 bit SN or a 10 bit SN. When the 5 bit SN is configured, the length of the fixed part of the UMD PDU header is one byte. When the 10 bit SN is configured, the fixed part of the UMD PDU header is identical to the fixed part of the AMD PDU header, except for D/C, RF and P fields all being replaced with R1 fields. The extension part of the UMD PDU header is identical to the extension part of the AMD PDU header (regardless of the configured SN size).

...

[TS 36.322, clause 6.2.2.3]

Length: 5 bits or 10 bits (configurable) for UMD PDU.

The SN field indicates the sequence number of the corresponding UMD... The sequence number is incremented by one for every UMD...

[TS 36.322, clause 7.1]

...

All state variables and all counters are non-negative integers.

...

All state variables related to UM data transfer can take values from 0 to $2^{[sn-FieldLength]} - 1$. All arithmetic operations contained in the present document on state variables related to UM data transfer are affected by the UM modulus (i.e. final value = [value from arithmetic operation] modulo $2^{[sn-FieldLength]}$).

...

When performing arithmetic comparisons of state variables or SN values, a modulus base shall be used.

...

VR(UH) – UM_Window_Size shall be assumed as the modulus base at the receiving side of an UM RLC entity. This modulus base is subtracted from all the values involved, and then an absolute comparison is performed (e.g. $(VR(UH) - UM_Window_Size) \leq SN < VR(UH)$ is evaluated as $[(VR(UH) - UM_Window_Size) - (VR(UH) - UM_Window_Size)] \text{ modulo } 2^{[sn-FieldLength]} \leq [SN - (VR(UH) - UM_Window_Size)] \text{ modulo } 2^{[sn-FieldLength]} < [VR(UH) - (VR(UH) - UM_Window_Size)] \text{ modulo } 2^{[sn-FieldLength]}$).

...

Each transmitting UM RLC entity shall maintain the following state variables:

a) VT(US)

This state variable holds the value of the SN to be assigned for the next newly generated UMD PDU. It is initially set to 0, and is updated whenever the UM RLC entity delivers an UMD PDU with SN = VT(US).

Each receiving UM RLC entity shall maintain the following state variables:

a) VR(UR) – UM receive state variable

This state variable holds the value of the SN of the earliest UMD PDU that is still considered for reordering. It is initially set to 0.

b) VR(UX) – UM T_reordering state variable

This state variable holds the value of the SN following the SN of the UMD PDU which triggered *t-Reordering*.

c) VR(UH) – UM highest received state variable

This state variable holds the value of the SN following the SN of the UMD PDU with the highest SN among received UMD PDUs, and it serves as the higher edge of the reordering window. It is initially set to 0.

7.2.2.5.2.3 Test description

7.2.2.5.2.3.1 Pre-test conditions

System Simulator:

- Cell 1.

UE:

None.

Preamble:

- UE is in state Loopback Activated (state 4) according to [18].

7.2.2.5.2.3.2 Test procedure sequence

Table 7.2.2.5.2.3.2-1: Main behaviour

St	Procedure	Message Sequence		TP	Verdict
		U - S	Message/PDU/SDU		
-	EXCEPTION: Step 3 to 4 is executed 1023 times.	-	-	-	-
1	The SS transmits an UMD PDU. SN equals 0.	<--	UMD PDU	-	-
2	Check: Does the UE transmit an UMD PDU with SN = 0?	-->	UMD PDU	1	P
3	The SS transmits an UMD PDU. SN equals 1 and is incremented for each PDU transmitted.	<--	UMD PDU	-	-
4	Check: Does the UE transmit an UMD PDU with SN increased by 1 compared with the previous one?	-->	UMD PDU	2	P
5	The SS transmits an UMD PDU. SN equals 0.	<--	UMD PDU	-	-
6	Check: Does the UE transmit an UMD PDU with SN=0?	-->	UMD PDU	3, 4	P

7.2.2.5.2.3.3 Specific message contents

None.

7.2.2.6 UM RLC / Concatenation, Segmentation and Reassembly

7.2.2.6.1 Test Purpose (TP)

(1)

```

with { UE in E-UTRA RRC_CONNECTED state }
ensure that {
  when { The UE has multiple RLC SDUs in the transmission buffer that fits into the available UMD
PDU size }
  then { The UE concatenates the RLC SDUs in the transmission buffer into one UMD PDU and
transmits it}
}

```

(2)

```

with { UE in E-UTRA RRC_CONNECTED state }
ensure that {
  when { The UE receives UMD PDUs containing concatenated RLC SDUs }
  then { The UE reassembles the RLC SDUs in accordance with the Framing Info and Length Indicators
indicated in UMD PDUs }
}

```

(3)

```

with { UE in E-UTRA RRC_CONNECTED state }
ensure that {
  when { The UE has RLC SDU in the transmission buffer that does not fit into the available UMD PDU
size }
  then { The UE segments the RLC SDU in accordance with the Framing Info and Length Indicators
indicated in UMD PDUs }
}

```

7.2.2.6.2 Conformance requirements

References: The conformance requirements covered in the present TC are specified in: 3GPP TS 36.322, clause 4.2.1.2.2, 4.2.1.2.3, 4.4, 6.2.1.3 and 6.2.2.6.

[TS 36.322, clause 4.2.1.2.2]

When a transmitting UM RLC entity forms UMD PDUs from RLC SDUs, it shall:

- segment and/or concatenate the RLC SDUs so that the UMD PDUs fit within the total size of RLC PDU(s) indicated by lower layer at the particular transmission opportunity notified by lower layer;
- include relevant RLC headers in the UMD PDU.

[TS 36.322, clause 4.2.1.2.3]

When a receiving UM RLC entity receives UMD PDUs, it shall:

...

- reassemble RLC SDUs from the reordered UMD PDUs (not accounting for RLC PDUs for which losses have been detected) and deliver the RLC SDUs to upper layer in ascending order of the RLC SN;

...

[TS 36.322, clause 4.4]

The following functions are supported by the RLC sub layer:

...

- concatenation, segmentation and reassembly of RLC SDUs (only for UM and AM data transfer);

...

[TS 36.322, clause 6.2.1.3]

UMD PDU consists of a Data field and an UMD PDU header.

UMD PDU header consists of a fixed part (fields that are present for every UMD PDU) and an extension part (fields that are present for an UMD PDU when necessary). The fixed part of the UMD PDU header itself is byte aligned and consists of a FI, an E and a SN. The extension part of the UMD PDU header itself is byte aligned and consists of E(s) and LI(s).

An UM RLC entity is configured by RRC to use either a 5 bit SN or a 10 bit SN. When the 5 bit SN is configured, the length of the fixed part of the UMD PDU header is one byte. When the 10 bit SN is configured, the fixed part of the UMD PDU header is identical to the fixed part of the AMD PDU header, except for D/C, RF and P fields all being replaced with R1 fields. The extension part of the UMD PDU header is identical to the extension part of the AMD PDU header (regardless of the configured SN size).

An UMD PDU header consists of an extension part only when more than one Data field elements are present in the UMD PDU, in which case an E and a LI are present for every Data field element except the last. Furthermore, when an UMD PDU header consists of an odd number of LI(s), four padding bits follow after the last LI.

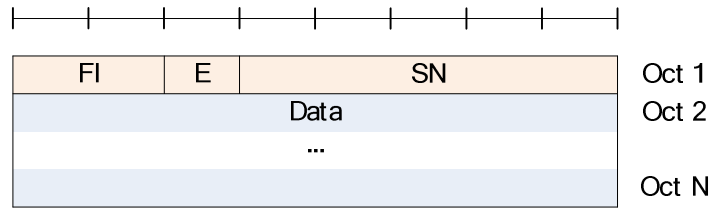

Figure 6.2.1.3-1: UMD PDU with 5 bit SN (No LI)

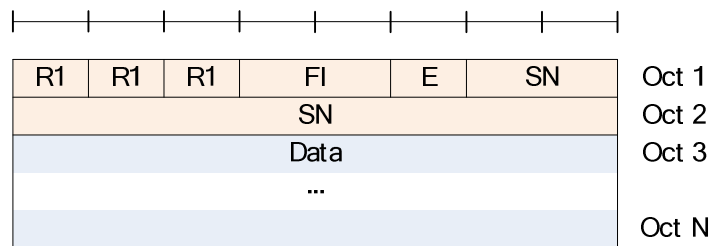

Figure 6.2.1.3-2: UMD PDU with 10 bit SN (No LI)

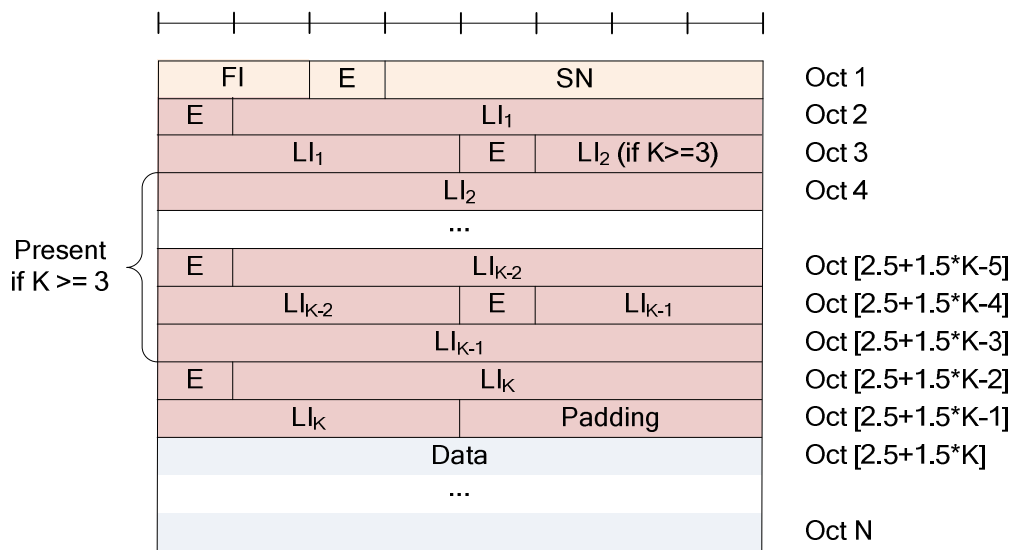

Figure 6.2.1.3-3: UMD PDU with 5 bit SN (Odd number of LIs, i.e. K = 1, 3, 5, ...)

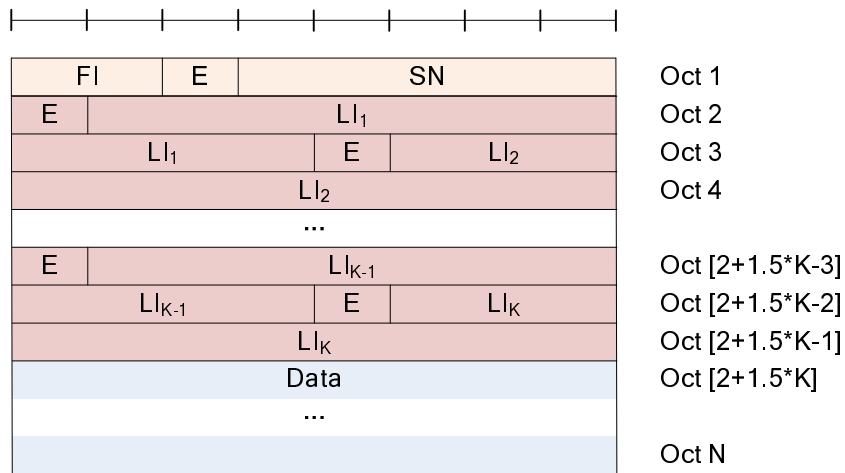

Figure 6.2.1.3-4: UMD PDU with 5 bit SN (Even number of LIs, i.e. K = 2, 4, 6, ...)

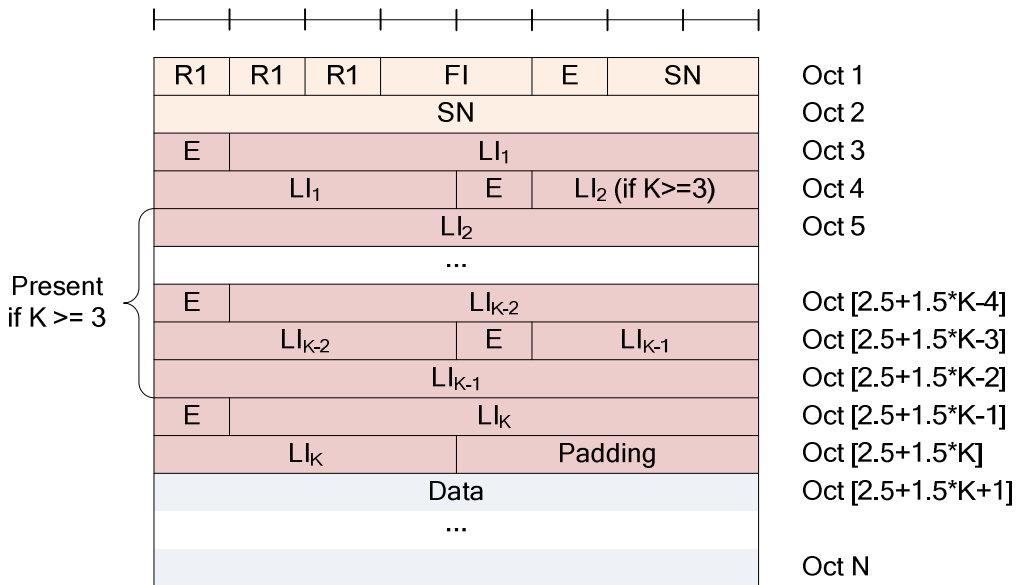

Figure 6.2.1.3-5: UMD PDU with 10 bit SN (Odd number of LIs, i.e. K = 1, 3, 5, ...)

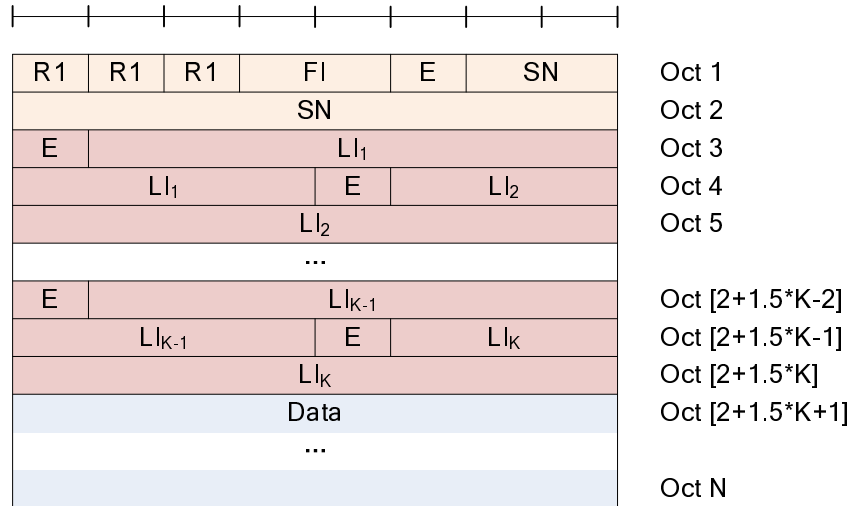

Figure 6.2.1.3-6: UMD PDU with 10 bit SN (Even number of LIs, i.e. K = 2, 4, 6, ...)

[TS 36.322, clause 6.2.2.6]

Length: 2 bits.

The FI field indicates whether a RLC SDU is segmented at the beginning and/or at the end of the Data field. Specifically, the FI field indicates whether the first byte of the Data field corresponds to the first byte of a RLC SDU, and whether the last byte of the Data field corresponds to the last byte of a RLC SDU. The interpretation of the FI field is provided in Table 6.2.2.6-1.

Table 6.2.2.6-1: FI field interpretation

Value	Description
00	First byte of the Data field corresponds to the first byte of a RLC SDU. Last byte of the Data field corresponds to the last byte of a RLC SDU.
01	First byte of the Data field corresponds to the first byte of a RLC SDU. Last byte of the Data field does not correspond to the last byte of a RLC SDU.
10	First byte of the Data field does not correspond to the first byte of a RLC SDU. Last byte of the Data field corresponds to the last byte of a RLC SDU.
11	First byte of the Data field does not correspond to the first byte of a RLC SDU. Last byte of the Data field does not correspond to the last byte of a RLC SDU.

7.2.2.6.3 Test description

7.2.2.6.3.1 Pre-test conditions

System Simulator:

- Cell 1.

UE:

None.

Preamble:

- The UE is in state Loopback Activated (state 4) according to [18].

7.2.2.6.3.2 Test procedure sequence

Table 7.2.2.6.3.2-1: Main behaviour

St	Procedure	Message Sequence		TP	Verdict
		U - S	Message		
1	The SS ignores scheduling requests and does not allocate any uplink grant.	-	-	-	-
2	The SS transmits UMD PDU#1. This PDU carries SDU#1 with size of 50 bytes.	<--	UMD PDU#1 (RLC SDU#1)	-	-
3	The SS transmits UMD PDU#2. This PDU carries SDU#2 with size of 50 bytes.	<--	UMD PDU#2 (RLC SDU#2)	-	-
4	SS transmits UL grants to enable UE to return RLC SDU#1 and RLC SDU#2 both in one UMD PDU.	<--	(UL grants)	-	-
5	Check: Does UE transmit RLC SDU#1 and RLC SDU#2 within UMD PDU with FI field set to '00', E field in the fixed part set to '1', first E field in the extension part set to '0' and first LI field set to 50 bytes?	-->	UMD PDU#1 (RLC SDU#1 and RLC SDU#2)	1	P
6	SS transmits an UMD PDU#3 including RLC SDU#3 and RLC SDU#4 each with size of 50 bytes. Header of UMD PDU#3 contains FI='00', E='1', SN=2, E ₁ ='0', LI ₁ ='50'.	<--	UMD PDU#3 (RLC SDU#3 and RLC SDU#4)	-	-
7	SS transmits UL grants to enable UE to return each RLC SDU in one UMD PDU.	<--	(UL grants)	-	-
8	Check: Does UE transmit RLC SDU#3 within an UMD PDU with FI field set to '00' and E field in the fixed part set to '0'?	-->	UMD PDU#3 (RLC SDU#3)	2	P
9	Check: Does UE transmit RLC SDU#4 within an UMD PDU with FI field set to '00' and E field in the fixed part set to '0'?	-->	UMD PDU#4 (RLC SDU#4)	2	P
10	The SS transmits UMD PDU#4. This PDU carries SDU#5 with size of 50 bytes.	<--	UMD PDU#4 (RLC SDU#5)	-	-
11	SS transmits UL grants to enable UE to return RLC SDU#5 in two UMD PDUs.	<--	(UL grants)	-	-
12	Check: Does UE transmit 1 st part of RLC SDU#5 within UMD PDU#5 with FI field set to '01' and E field in the fixed part set to '0'?	-->	UMD PDU#5	3	P
13	Check: Does UE transmit last part of RLC SDU#5 within an UMD PDU#6 with FI field set to '10' and E field in the fixed part set to '0'?	-->	UMD PDU#6	3	P

7.2.2.6.3.3 Specific message contents

None.

7.2.2.7 UM RLC / In sequence delivery of upper layers PDUs without residual loss of RLC PDUs / Maximum re-ordering delay below *t-Reordering*

7.2.2.7.1 Test Purpose (TP)

(1)

```

with { UE in E-UTRAN RRC_CONNECTED state }
ensure that {
  when { UE receives missing PDUs within a SN gap before t-Reordering has expired }
  then { RLC reassembles and reorders the UMD PDUs and delivers them to the upper layer in
sequence }
}

```

7.2.2.7.2 Conformance requirements

References: The conformance requirements covered in the present TC are specified in: 3GPP TS 36.322, clause 5.1.2.2.

[TS 36.322, clause 5.1.2.2]

The receiving UM RLC entity shall maintain a reordering window according to state variable VR(UH) as follows:

- a SN falls within the reordering window if $(VR(UH) - UM_Window_Size) \leq SN < VR(UH)$;
- a SN falls outside of the reordering window otherwise.

When receiving an UMD PDU from lower layer, the receiving UM RLC entity shall:

- either discard the received UMD PDU or place it in the reception buffer (see sub clause 5.1.2.2.2);
- if the received UMD PDU was placed in the reception buffer:
 - update state variables, reassemble and deliver RLC SDUs to upper layer and start/stop *t-Reordering* as needed (see sub clause 5.1.2.2.3);

...

When an UMD PDU with SN = x is received from lower layer, the receiving UM RLC entity shall:

- if $VR(UR) < x < VR(UH)$ and the UMD PDU with SN = x has been received before; or
- if $(VR(UH) - UM_Window_Size) \leq x < VR(UR)$:
 - discard the received UMD PDU;
- else:
 - place the received UMD PDU in the reception buffer.

...

When an UMD PDU with SN = x is placed in the reception buffer, the receiving UM RLC entity shall:

- if x falls outside of the reordering window:
 - update VR(UH) to x + 1;
 - reassemble RLC SDUs from any UMD PDUs with SN that falls outside of the reordering window, remove RLC headers when doing so and deliver the reassembled RLC SDUs to upper layer in sequence if not delivered before;
 - if VR(UR) falls outside of the reordering window:
 - set VR(UR) to $(VR(UH) - UM_Window_Size)$;
- if the reception buffer contains an UMD PDU with SN = VR(UR):
 - update VR(UR) to the SN of the first UMD PDU with SN > current VR(UR) that has not been received;
 - reassemble RLC SDUs from any UMD PDUs with SN < updated VR(UR), remove RLC headers when doing so and deliver the reassembled RLC SDUs to upper layer in sequence if not delivered before;
- if *t-Reordering* is running:
 - if $VR(UX) \leq VR(UR)$; or
 - if VR(UX) falls outside of the reordering window and VR(UX) is not equal to VR(UH)::
 - stop and reset *t-Reordering*;
- if *t-Reordering* is not running (includes the case when *t-Reordering* is stopped due to actions above):
 - if $VR(UH) > VR(UR)$:
 - start *t-Reordering*;
 - set VR(UX) to VR(UH).

7.2.2.7.3 Test description

7.2.2.7.3.1 Pre-test conditions

System Simulator:

- Cell 1.

UE:

None.

Preamble

- UE is in state Loopback Activated (state 4) according to [18] with the exceptions listed in table 7.2.2.7.3.1-1.

Table 7.2.2.7.3.1-1: RLC parameters

Downlink RLC <i>t-Reordering</i>	ms200
-------------------------------------	-------

7.2.2.7.3.2 Test procedure sequence

Table 7.2.2.7.3.2-1: Main behaviour

St	Procedure	Message Sequence		TP	Verdict
		U - S	Message		
1	The SS transmits an UMD PDU. This PDU carries SDU#1. SN equals 0.	<--	UMD PDU#1		
2	Check: Does the UE transmit RLC SDU#1?	-->	(RLC SDU#1)	-	-
3	The SS transmits an UMD PDU. This PDU contains the last part of SDU#4. SN equals 3. The UE starts <i>t-Reordering</i> .	<--	UMD PDU#4	-	-
4	The SS transmits an UMD PDU. This PDU contains the last part of SDU#3, and the 1 st part of SDU#4. SN equals 2.	<--	UMD PDU#3	-	-
5	The SS transmits an UMD PDU. This PDU carries SDU#2 and the 1 st part of SDU#3. SN equals 1. (Note)	<--	UMD PDU#2	-	-
6	Check: Does the UE transmit RLC SDU#2?	-->	(RLC SDU#2)	1	P
7	Check: Does the UE transmit RLC SDU#3?	-->	(RLC SDU#3)	1	P
8	Check: Does the UE transmit RLC SDU#4?	-->	(RLC SDU#4)	1	P
Note:	The UE stops <i>t-Reordering</i> , reassembles UMD PDUs and delivers RLC SDU#2, RLC SDU#3 and RLC SDU#4 to the upper layer in sequence.				

7.2.2.7.3.3 Specific message contents

None.

7.2.2.8 UM RLC / In sequence delivery of upper layers PDUs without residual loss of RLC PDUs / Maximum re-ordering delay exceeds *t-Reordering*

7.2.2.8.1 Test Purpose (TP)

(1)

```
with { UE in E-UTRA RRC_CONNECTED state }
ensure that {
  when { a PDU is received out of order after t-Reordering has expired }
  then { UE discards the corresponding PDU and delivers all correctly received RLC SDUs to upper
layer in the correct order }
}
```

7.2.2.8.2 Conformance requirements

References: The conformance requirements covered in the present TC are specified in: TS 36.322, clause 5.1.2.2.2, 5.1.2.2.3 and 5.1.2.2.4.

[TS 36.322, clause 5.1.2.2.2]

When an UMD PDU with SN = x is received from lower layer, the receiving UM RLC entity shall:

- if $VR(UR) < x < VR(UH)$ and the UMD PDU with SN = x has been received before; or
- if $(VR(UH) - UM_Window_Size) \leq x < VR(UR)$:
 - discard the received UMD PDU;
- else:
 - place the received UMD PDU in the reception buffer.

[TS 36.322, clause 5.1.2.2.3]

When an UMD PDU with SN = x is placed in the reception buffer, the receiving UM RLC entity shall:

- if x falls outside of the reordering window:
 - update $VR(UH)$ to $x + 1$;
 - reassemble RLC SDUs from any UMD PDUs with SN that falls outside of the reordering window, remove RLC headers when doing so and deliver the reassembled RLC SDUs to upper layer in ascending order of the RLC SN if not delivered before;
 - if $VR(UR)$ falls outside of the reordering window:
 - set $VR(UR)$ to $(VR(UH) - UM_Window_Size)$;
- if the reception buffer contains an UMD PDU with SN = $VR(UR)$:
 - update $VR(UR)$ to the SN of the first UMD PDU with SN > current $VR(UR)$ that has not been received;
 - reassemble RLC SDUs from any UMD PDUs with SN < updated $VR(UR)$, remove RLC headers when doing so and deliver the reassembled RLC SDUs to upper layer in ascending order of the RLC SN if not delivered before;
- if *t-Reordering* is running:
 - if $VR(UX) \leq VR(UR)$; or
 - if $VR(UX)$ falls outside of the reordering window and $VR(UX)$ is not equal to $VR(UH)$:
 - stop and reset *t-Reordering*;
- if *t-Reordering* is not running (includes the case when *t-Reordering* is stopped due to actions above):
 - if $VR(UH) > VR(UR)$:
 - start *t-Reordering*;
 - set $VR(UX)$ to $VR(UH)$.

[TS 36.322, clause 5.1.2.2.4]

When *t-Reordering* expires, the receiving UM RLC entity shall:

- update $VR(UR)$ to the SN of the first UMD PDU with SN $\geq VR(UX)$ that has not been received;
- reassemble RLC SDUs from any UMD PDUs with SN < updated $VR(UR)$, remove RLC headers when doing so and deliver the reassembled RLC SDUs to upper layer in ascending order of the RLC SN if not delivered before;

- if VR(UH) > VR(UR):
 - start *t-Reordering*;
 - set VR(UX) to VR(UH).

7.2.2.8.3 Test description

7.2.2.8.3.1 Pre-test conditions

System Simulator:

- Cell 1.

UE:

None.

Preamble:

- The UE is in state Loopback Activated (state 4) according to [18] with the exceptions listed in table 7.2.2.8.3.1-1.

Table 7.2.2.8.3.1-1: RLC parameters

Downlink RLC t-Reordering (ms)	ms200
-----------------------------------	-------

7.2.2.8.3.2 Test procedure sequence

Table 7.2.2.8.3.2-1: Main behaviour

St	Procedure	Message Sequence		TP	Verdict
		U - S	Message		
-	EXCEPTION: The behaviour described in table 7.2.2.8.3.2-2 runs in parallel with steps 1 to 4 below.	-	-	-	-
1	The SS transmits RLC PDU#1 containing first segment of RLC SDU#1.	<--	UMD PDU#1	-	-
2	The SS does not transmit RLC PDU#2 containing last segment of RLC SDU#1.	-	-	-	-
3	The SS transmits RLC PDU#3 containing RLC SDU#2.	<--	UMD PDU#3	-	-
4	300ms (1.5 * <i>t-Reordering</i>) after Step 3, the SS transmit RLC PDU#2 containing last segment of RLC SDU#1.	<--	UMD PDU#2	-	-

Table 7.2.2.8.3.2-2: Parallel behaviour

St	Procedure	Message Sequence		TP	Verdict
		U - S	Message		
1	Check: Does the UE send back the RLC SDU#2?	-->	(RLC SDU#2)	1	P

7.2.2.8.3.3 Specific message contents

None.

7.2.2.9 UM RLC / In sequence delivery of upper layers PDUs with residual loss of RLC PDUs / Maximum re-ordering delay exceeds *t-Reordering*

7.2.2.9.1 Test Purpose (TP)

(1)

```
with { UE in E-UTRA RRC_CONNECTED state }
ensure that {
  when { UE detects that RLC PDUs constructing different RLC SDUs are lost }
  then { UE delivers all received RLC SDUs to upper layer in the correct order }
}
```

7.2.2.9.2 Conformance requirements

References: The conformance requirements covered in the present TC are specified in: TS 36.322, clause 5.1.2.2.2, 5.1.2.2.3 and 5.1.2.2.4.

[TS 36.322, clause 5.1.2.2.2]

When an UMD PDU with SN = x is received from lower layer, the receiving UM RLC entity shall:

- if $VR(UR) < x < VR(UH)$ and the UMD PDU with SN = x has been received before; or
- if $(VR(UH) - UM_Window_Size) \leq x < VR(UR)$:
 - discard the received UMD PDU;
- else:
 - place the received UMD PDU in the reception buffer.

[TS 36.322, clause 5.1.2.2.3]

When an UMD PDU with SN = x is placed in the reception buffer, the receiving UM RLC entity shall:

- if x falls outside of the reordering window:
 - update $VR(UH)$ to $x + 1$;
 - reassemble RLC SDUs from any UMD PDUs with SN that falls outside of the reordering window, remove RLC headers when doing so and deliver the reassembled RLC SDUs to upper layer in ascending order of the RLC SN if not delivered before;
- if $VR(UR)$ falls outside of the reordering window:
 - set $VR(UR)$ to $(VR(UH) - UM_Window_Size)$;
- if the reception buffer contains an UMD PDU with SN = $VR(UR)$:
 - update $VR(UR)$ to the SN of the first UMD PDU with SN > current $VR(UR)$ that has not been received;
 - reassemble RLC SDUs from any UMD PDUs with SN < updated $VR(UR)$, remove RLC headers when doing so and deliver the reassembled RLC SDUs to upper layer in ascending order of the RLC SN if not delivered before;
- if *t-Reordering* is running:
 - if $VR(UX) \leq VR(UR)$; or
 - if $VR(UX)$ falls outside of the reordering window and $VR(UX)$ is not equal to $VR(UH)$:
 - stop and reset *t-Reordering*;
- if *t-Reordering* is not running (includes the case when *t-Reordering* is stopped due to actions above):
 - if $VR(UH) > VR(UR)$:

- start *t-Reordering*;
- set VR(UX) to VR(UH).

[TS 36.322, clause 5.1.2.2.4]

When *t-Reordering* expires, the receiving UM RLC entity shall:

- update VR(UR) to the SN of the first UMD PDU with SN \geq VR(UX) that has not been received;
- reassemble RLC SDUs from any UMD PDUs with SN $<$ updated VR(UR), remove RLC headers when doing so and deliver the reassembled RLC SDUs to upper layer in ascending order of the RLC SN if not delivered before;
- if VR(UH) $>$ VR(UR):
 - start *t-Reordering*;
 - set VR(UX) to VR(UH).

7.2.2.9.3 Test description

7.2.2.9.3.1 Pre-test conditions

System Simulator:

- Cell 1.

UE:

None.

Preamble:

- UE is in state Loopback Activated (state 4) according to [18] with the exceptions listed in table 7.2.2.9.3.1-1.

Table 7.2.2.9.3.1-1: RLC parameters

Downlink RLC <i>t-Reordering</i> (ms)	ms200
--	-------

7.2.2.9.3.2 Test procedure sequence

Table 7.2.2.9.3.2-1: Main behaviour

St	Procedure	Message Sequence		TP	Verdict
		U - S	Message		
1	The SS transmits UMD PDU#1 containing first segment of RLC SDU#1.	<--	UMD PDU#1	-	-
2	The SS does not transmit UMD PDU#2 containing last segment of RLC SDU#1.	-		-	-
3	The SS transmits UMD PDU#3 containing first segment of RLC SDU#2.	<--	UMD PDU#3	-	-
4	The SS transmits UMD PDU#4 containing last segment of RLC SDU#2.	<--	UMD PDU#4	-	-
5	The SS transmits UMD PDU#5 containing first segment of RLC SDU#3.	<--	UMD PDU#5	-	-
6	The SS does not transmit UMD PDU#6 containing last segment of RLC SDU#3.	-		-	-
7	The SS transmits RLC UMD #7 containing first segment of RLC SDU#4.	<--	UMD PDU#7	-	-
8	The SS transmits RLC UMD #8 containing last segment of RLC SDU#4.	<--	UMD PDU#8	-	-
9	Wait for 200 ms to ensure that <i>t-Reordering</i> for the UMD PDU#2 expires.	-	-	-	-
10	Check: Does the UE loop back the RLC SDU#2.	-->	(RLC SDU#2)	1	P
11	Wait for 200 ms to ensure that <i>t-Reordering</i> for the UMD PDU#6 expires.	-	-	-	-
12	Check: Does the UE loop back the RLC SDU#4.	-->	(RLC SDU#4)	1	P

7.2.2.9.3.3 Specific message contents

None.

7.2.2.10 UM RLC / Duplicated detection of RLC PDUs

7.2.2.10.1 Test Purpose (TP)

(1)

```
with { UE in E-UTRAN RRC_CONNECTED state }
ensure that {
  when { UE receives duplicate UMD PDUs }
  then { UE discards the duplicate UMD PDUs }
}
```

(2)

```
with { UE in E-UTRAN RRC_CONNECTED state }
ensure that {
  when { UE receives UMD PDUs with SN gap and duplicate UMD PDUs }
  then { UE discards the duplicate UMD PDUs }
}
```

7.2.2.10.2 Conformance requirements

References: The conformance requirements covered in the present TC are specified in: 3GPP TS 36.322, clause 4.2.1.2.3 and 5.1.2.2.2.

[TS 36.322, clause 4.2.1.2.3]

When a receiving UM RLC entity receives UMD PDUs, it shall:

- detect whether or not the UMD PDUs have been received in duplication, and discard duplicated UMD PDUs;
- reorder the UMD PDUs if they are received out of sequence;

- detect the loss of UMD PDUs at lower layers and avoid excessive reordering delays;
- reassemble RLC SDUs from the reordered UMD PDUs (not accounting for RLC PDUs for which losses have been detected) and deliver the RLC SDUs to upper layer in ascending order of the RLC SN

...;

[TS 36.322, clause 5.1.2.2.2]

When an UMD PDU with SN = x is received from lower layer, the receiving UM RLC entity shall:

- if $VR(UR) < x < VR(UH)$ and the UMD PDU with SN = x has been received before; or
- if $(VR(UH) - UM_Window_Size) \leq x < VR(UR)$:
 - discard the received UMD PDU

...;

7.2.2.10.3 Test description

7.2.2.10.3.1 Pre-test conditions

System Simulator:

- Cell .1

UE:

None.

Preamble:

- UE is in state Loopback Activated (state 4) according to [18].

7.2.2.10.3.2 Test procedure sequence

Table 7.2.2.10.3.2-1: Main behaviour

St	Procedure	Message Sequence		TP	Verdict
		U - S	Message		
1	The SS transmits an UMD PDU. This PDU carries SDU#1. SN equals 0.	<--	UMD PDU#1	-	-
2	The UE transmits RLC SDU#1.	-->	(RLC SDU#1)	-	-
3	The SS transmits an UMD PDU. This PDU carries SDU#1. SN equals 0.	<--	UMD PDU#1	-	-
4	Check: Does the UE transmit RLC SDU#1?	-->	(RLC SDU#1)	1	F
5	The SS transmits an UMD PDU. This PDU contains SDU#2 and the 1 st part of SDU# 3. SN equals 1.	<--	UMD PDU#2	-	-
6	The UE transmit RLC SDU#2.	-->	(RLC SDU#2)	-	-
7	The SS transmits an UMD PDU. This PDU contains SDU#2 and the 1 st part of SDU#3. SN equals 1.	<--	UMD PDU#2	-	-
8	Check: Does the UE transmit RLC SDU#2?	-->	(RLC SDU#2)	1	F
9	The SS transmits an UMD PDU. This PDU contains the last part of SDU#3. SN equals 2.	<--	UMD PDU#3	-	-
10	The UE transmits RLC SDU#3.	-->	(RLC SDU#3)	-	-
11	The SS transmits an UMD PDU. This PDU carries SDU#5. SN equals 4.	<--	UMD PDU#5	-	-
12	The SS transmits an UMD PDU. This PDU carries SDU#6. SN equals 5.	<--	UMD PDU#6	-	-
13	The SS transmits an UMD PDU. This PDU contains the last part of SDU#3. SN equals 2.	<--	UMD PDU#3	-	-
14	Check: Does the UE transmit RLC SDU#3?	-->	(RLC SDU#3)	2	F
15	The SS transmits an UMD PDU. This PDU carries SDU#4. SN equals 3.	<--	UMD PDU#4	-	-
16	The UE transmits RLC SDU#4.	-->	(RLC SDU#4)	-	-
17	The UE transmits RLC SDU#5.	-->	(RLC SDU#5)	-	-
18	The UE transmits RLC SDU#6.	-->	(RLC SDU#6)	-	-

7.2.2.10.3.3 Specific message contents

None.

7.2.2.11 UM RLC / RLC re-establishment procedure

7.2.2.11.1 Test Purpose (TP)

(1)

```
with { UE in E-UTRA RRC_CONNECTED state }
ensure that {
  when { RLC re-establishment is performed upon request by RRC }
  then { The UE discards all UMD PDUs where no RLC SDUs can be reassembled }
}
```

(2)

```
with { UE in E-UTRA RRC_CONNECTED state }
ensure that {
  when { RLC re-establishment is performed upon request by RRC }
  then { The UE resets variable VT(US), VR(UH) and VR(UR) to its initial value }
}
```

7.2.2.11.2 Conformance requirements

References: The conformance requirements covered in the present TC are specified in: 3GPP TS 36.322, clause 4.2.1.2.3 and 5.4.

[TS 36.322, clause 4.2.1.2.3]

At the time of RLC re-establishment, the receiving UM RLC entity shall:

- if possible, reassemble RLC SDUs from the UMD PDUs that are received out of sequence and deliver them to upper layer;
- discard any remaining UMD PDUs that could not be reassembled into RLC SDUs;
- initialize relevant state variables and stop relevant timers.

[TS 36.322, clause 5.4]

RLC re-establishment is performed upon request by RRC, and the function is applicable for AM, UM and TM RLC entities.

When RRC indicates that an RLC entity should be re-established, the RLC entity shall:

- ...
- if it is a receiving UM RLC entity:
 - when possible, reassemble RLC SDUs from UMD PDUs with SN < VR(UH), remove RLC headers when doing so and deliver all reassembled RLC SDUs to upper layer in sequence, if not delivered before;
 - discard all remaining UMD PDUs;
- ...
- reset all state variables to their initial values.

7.2.2.11.3 Test description

7.2.2.11.3.1 Pre-test conditions

System Simulator:

- Cell 1

UE:

None.

Preamble:

- UE is in Loopback Activated state (state 4) according to TS 36.508 clause 4.5 [18] with the exceptions listed in table 7.2.2.11.3.1-1.

Table 7.2.2.11.3.1-1: RLC parameters

Downlink RLC t-Reordering	ms200
------------------------------	-------

7.2.2.11.3.2 Test procedure sequence

Table 7.2.2.11.3.2-1: Main behaviour

St	Procedure	Message Sequence		TP	Verdict
		U - S	Message		
1	The SS transmits UMD PDU#1. Header of UMD PDU#1 contains SN=0. This PDU carries RLC SDU#1.	<--	UMD PDU#1	-	-
2	The UE transmits RLC SDU#1.	-->	(RLC SDU#1)	-	-
3	The SS transmits UMD PDU#2. Header of UMD PDU#2 contains SN=1. This PDU carries the 1 st segment of SDU#2.	<--	UMD PDU#2	-	-
4	SS performs a RRC Connection Reconfiguration procedure including the mobilityControllInformation IE in <i>RRCCConnectionReconfiguration</i> triggering RLC-reestablishment.	-	-	-	-
5	The SS transmits UMD PDU#3. Header of UMD PDU#3 contains SN=2. This PDU carries the last segment of RLC SDU#2. The UE starts T_reordering.	<--	UMD PDU#3	-	-
6	Check: Does the UE transmit RLC SDU#2?	-->	(RLC SDU#2)	1	F
7	300ms (1.5 * T_reordering) after step 5 the SS transmits UMD PDU#4. Header of UMD PDU#4 contains SN=3. This PDU carries RLC SDU#3.	<--	UMD PDU#4	-	-
8	The UE transmit RLC SDU#3. Header of UMD PDU carrying RLC SDU#3 contains SN=0.	-->	(RLC SDU#3)	-	-
9	The SS transmits UMD PDU#5. Header of UMD PDU#5 contains SN=4. This PDU carries RLC SDU#4.	<--	UMD PDU#5	-	-
10	The UE transmits RLC SDU#4. Header of UMD PDU carrying RLC SDU#4 contains SN=1.	-->	(RLC SDU#4)	-	-
11	SS performs a RRC Connection Reconfiguration procedure including the mobilityControllInformation IE in <i>RRCCConnectionReconfiguration</i> triggering RLC-reestablishment.	-	-	-	-
12	The SS transmits UMD PDU#6. Header of UMD PDU#6 contains SN=0. This PDU carries RLC SDU#5.	<--	UMD PDU#6	-	-
13	Check: Does the UE transmit RLC SDU#5? Check: Does header of UMD PDU carrying RLC SDU#5 contains SN=0?	-->	(RLC SDU#5)	2	P

7.2.2.11.3.3 Specific message contents

Table 7.2.2.11.3.3-1: *RRCCConnectionReconfiguration* (step 4 and step 11)

Derivation Path: 36.508 table 4.6.1-8: <i>RRCCConnectionReconfiguration</i> , condition HO			
Information Element	Value/remark	Comment	Condition
<i>RRCCConnectionReconfiguration</i> ::= SEQUENCE {			
criticalExtensions CHOICE {			
c1 CHOICE{			
rrcConnectionReconfiguration-r8 SEQUENCE {			
mobilityControllInformation SEQUENCE {			
targetCellIdentity	Set to the physical cell identity of cell 1		
Eutra-CarrierFreq	Not present		
}			
radioResourceConfiguration	Not present		
}			
}			
}			

}		
---	--	--

7.2.3 Acknowledged Mode

7.2.3.1 AM RLC / Concatenation and Reassembly

7.2.3.1.1 Test Purpose (TP)

(1)

```
with { UE in E-UTRA RRC_CONNECTED state }
ensure that {
  when { The UE has multiple RLC SDUs in the transmission buffer that fits into the available AMD
PDU size }
  then { The UE concatenates the RLC SDUs in the transmission buffer into an AMD PDU and transmits
it}
}
```

(2)

```
with { UE in E-UTRA RRC_CONNECTED state }
ensure that {
  when { The UE receives an AMD PDUs containing concatenated RLC }
  then { The UE reassembles the RLC SDUs in accordance with the Framing Info and Length Indicators
indicated in AMD PDUs }
}
```

7.2.3.1.2 Conformance requirements

References: The conformance requirements covered in the current TC are specified in: TS 36.322, clauses 4.2.1.3.2 , 4.2.1.3.3, 6.2.1.4 and 6.2.2.6.

[TS 36.322, clause 4.2.1.3.2]

When the transmitting side of an AM RLC entity forms AMD PDUs from RLC SDUs, it shall:

- segment and/or concatenate the RLC SDUs so that the AMD PDUs fit within the total size of RLC PDU(s) indicated by lower layer at the particular transmission opportunity notified by lower layer.

...

[TS 36.322, clause 4.2.1.3.3]

When the receiving side of an AM RLC entity receives RLC data PDUs, it shall:

....

- reassemble RLC SDUs from the reordered RLC data PDUs and deliver the RLC SDUs to upper layer in sequence.

...

[TS 36.322, clause 6.2.1.4]

AMD PDU consists of a Data field and an AMD PDU header.

AMD PDU header consists of a fixed part (fields that are present for every AMD PDU) and an extension part (fields that are present for an AMD PDU when necessary). The fixed part of the AMD PDU header itself is byte aligned and consists of a D/C, a RF, a P, a FI, an E and a SN. The extension part of the AMD PDU header itself is byte aligned and consists of E(s) and LI(s).

An AMD PDU header consists of an extension part only when more than one Data field elements are present in the AMD PDU, in which case an E and a LI are present for every Data field element except the last. Furthermore, when an AMD PDU header consists of an odd number of LI(s), four padding bits follow after the last LI.

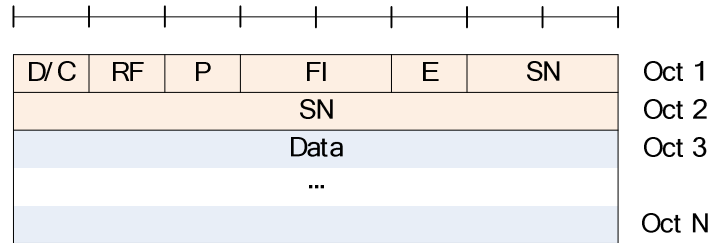

Figure 6.2.1.4-1: AMD PDU (No LI)

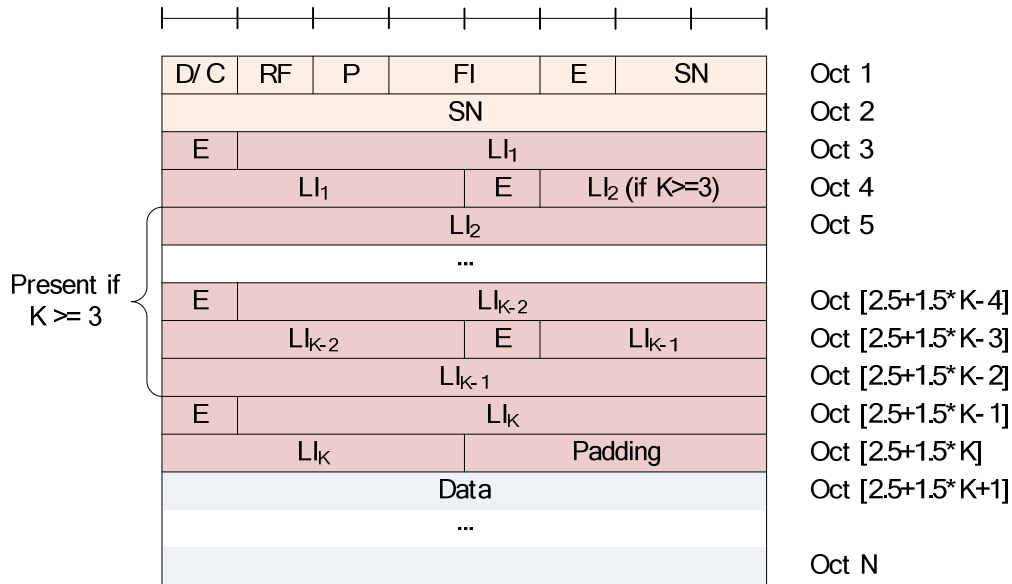

Figure 6.2.1.4-2: AMD PDU (Odd number of LIs, i.e. K = 1, 3, 5, ...)

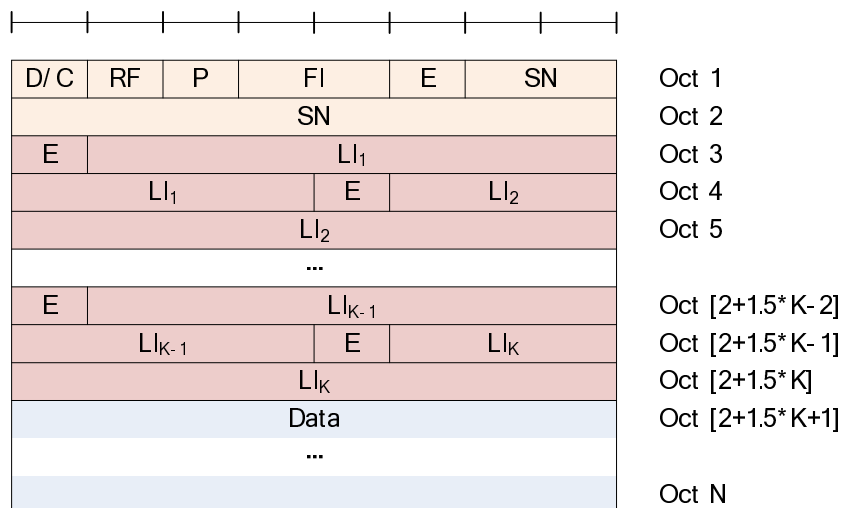

Figure 6.2.1.4-3: AMD PDU (Even number of LIs, i.e. K = 2, 4, 6, ...)

[TS 36.322, clause 6.2.2.6]

The FI field indicates whether a RLC SDU is segmented at the beginning and/or at the end of the Data field. Specifically, the FI field indicates whether the first byte of the Data field corresponds to the first byte of a RLC SDU,

and whether the last byte of the Data field corresponds to the last byte of a RLC SDU. The interpretation of the FI field is provided in Table 6.2.2.6-1.

Table 6.2.2.6-1: FI field interpretation

Value	Description
00	First byte of the Data field corresponds to the first byte of a RLC SDU. Last byte of the Data field corresponds to the last byte of a RLC SDU.
01	First byte of the Data field corresponds to the first byte of a RLC SDU. Last byte of the Data field does not correspond to the last byte of a RLC SDU.
10	First byte of the Data field does not correspond to the first byte of a RLC SDU. Last byte of the Data field corresponds to the last byte of a RLC SDU.
11	First byte of the Data field does not correspond to the first byte of a RLC SDU. Last byte of the Data field does not correspond to the last byte of a RLC SDU.

7.2.3.1.3 Test description

7.2.3.1.3.1 Pre-test conditions

System Simulator:

- Cell 1.

UE:

None.

Preamble:

- The UE is in state Loopback Activated (state 4) according to [18] with the exceptions listed in table 7.2.3.1.3.1-1.

Table 7.2.3.1.3.1-1: RLC settings

Parameter	Value
t-StatusProhibit	500 ms

7.2.3.1.3.2 Test procedure sequence

Table 7.2.3.1.3.2-1: Main behaviour

St	Procedure	Message Sequence		TP	Verdict
		U - S	Message		
1	The SS ignores scheduling requests and does not allocate any uplink grant	-	-	-	-
2	SS transmits an AMD PDU including two RLC SDUs of size 40 bytes each with poll bit set to '1'.	<--	AMD PDU(AMD PDU header(D/C='1', RF='0', P='1', FI='00', E='1', SN='0', E ₁ '=0', LI ₁ '=40' bytes), 2 RLC SDUs of 40 bytes)	-	-
3	SS responds to any scheduling requests from the UE by transmitting UL grants of size 776 bits (Note 1).	<--	(UL grants, 776 bits)	-	-
4	Check: Does UE transmit a STATUS PDU with positive acknowledgement?	-->	STATUS PDU (ACK SN=1)	2	P
5	Check: Does UE transmit two RLC SDUs within an AMD PDU with FI field set to '00', first E field in the fixed part set to '1', first E field in the extension part set to '0', first LI field set to 40 bytes?	-->	AMD PDU(AMD PDU header(P='1', FI='00', E='1', SN=0, E ₁ '=0', LI ₁ '=40') , two RLC SDUs of size 40 bytes)	1, 2	P
6	The SS ignores scheduling requests and does not allocate any uplink grant.	-	-	-	-
7	SS transmits an AMD PDU including three RLC SDU of size 40 bytes with P field set to "1".	<--	AMD PDU(AMD PDU header(D/C='1', RF='0', P='1', FI='00', E='1', SN='1', E ₁ '=1', LI ₁ '=40' bytes, E ₂ '=0', LI ₂ '=40' bytes), three RLC SDUs of size 40 bytes)	-	-
8	SS responds to any scheduling requests from the UE by transmitting an UL grant of size 1096 bits. (Note 2)	<--	(UL grants, 1096 bits)	-	-
9	Check: Does UE transmit a STATUS PDU with positive acknowledgement?	-->	STATUS PDU (ACK SN=2)	2	P
10	Check: Does UE transmit three RLC SDUs within an AMD PDU with FI field set to "00", first E field in the fixed part set to '1', first E field in the extension part set to '1', first LI field set to 40 bytes, second E field in the extension part set to '0', second LI field set to 40 bytes and P field set to "1"?	-->	AMD PDU(AMD PDU header(P='1', FI='00', SN=1, E ₁ '=1', LI ₁ '=40', E ₂ '=0', LI ₂ '=40'), three RLC SDUs of size 40 bytes)	1, 2	P
Note 1	UL grant of 776 bits ($I_{TBS}=11$, $N_{PRB}=4$, see TS 36.213 Table 7.1.7.2.1-1) is chosen such that UE will fit two RLC SDUs of 40 bytes within one AMD PDU. MAC PDU of 776 bits=97 bytes fits an AMD PDU payload of 80 bytes (two 40 byte RLC SDUs) + 2 byte AMD PDU header + 15 bytes spare for MAC header and possible RLC STATUS PDU and BSR report.				
Note 2	UL grant of 1096 bits ($I_{TBS}=9$, $N_{PRB}=7$, see TS 36.213 Table 7.1.7.2.1-1) is chosen such that UE will fit three RLC SDUs of 40 bytes within one AMD PDU. MAC PDU of 1096 bits=137 bytes fits an AMD PDU payload of 120 bytes (three 40 byte RLC SDUs) + 2 byte AMD PDU header + 15 bytes spare for MAC header and possible RLC STATUS PDU and BSR report.				

7.2.3.1.3.3 Specific message contents

None.

7.2.3.2 AM RLC / Segmentation and Reassembly / No PDU segmentation

7.2.3.2.1 Test Purpose (TP)

(1)

```

with { UE in E-UTRA RRC_CONNECTED state }
  ensure that {
    when { the UE has a RLC SDU with larger size than available AMD PDU size in the transmission
buffer }
      then { the UE segments the RLC SDU in accordance with the available AMD PDU size }
  }

```

(2)

```

with { UE in E-UTRA RRC_CONNECTED state }
ensure that {
  when { the UE receives AMD PDUs containing a segmented RLC SDU }
  then { the UE reassembles the RLC SDUs in accordance with the Framing Info and Length Indicators
indicated in the AMD PDUs }
}

```

7.2.3.2.2 Conformance requirements

References: The conformance requirements covered in the current TC are specified in: TS 36.322, clauses 4.2.1.3.2, 4.2.1.3.3 and 6.2.2.6.

[TS 36.322, clause 4.2.1.3.2]

When the transmitting side of an AM RLC entity forms AMD PDUs from RLC SDUs, it shall:

- segment and/or concatenate the RLC SDUs so that the AMD PDUs fit within the total size of RLC PDU(s) indicated by lower layer at the particular transmission opportunity notified by lower layer.

...

[TS 36.322, clause 4.2.1.3.3]

When the receiving side of an AM RLC entity receives RLC data PDUs, it shall:

....

- reassemble RLC SDUs from the reordered RLC data PDUs and deliver the RLC SDUs to upper layer in sequence.

...

[TS 36.322, clause 6.2.2.6]

...

The FI field indicates whether a RLC SDU is segmented at the beginning and/or at the end of the Data field. Specifically, the FI field indicates whether the first byte of the Data field corresponds to the first byte of a RLC SDU, and whether the last byte of the Data field corresponds to the last byte of a RLC SDU. The interpretation of the FI field is provided in Table 6.2.2.6-1.

Table 6.2.2.6-1: FI field interpretation

Value	Description
00	First byte of the Data field corresponds to the first byte of a RLC SDU. Last byte of the Data field corresponds to the last byte of a RLC SDU.
01	First byte of the Data field corresponds to the first byte of a RLC SDU. Last byte of the Data field does not correspond to the last byte of a RLC SDU.
10	First byte of the Data field does not correspond to the first byte of a RLC SDU. Last byte of the Data field corresponds to the last byte of a RLC SDU.
11	First byte of the Data field does not correspond to the first byte of a RLC SDU. Last byte of the Data field does not correspond to the last byte of a RLC SDU.

7.2.3.2.3 Test description

7.2.3.2.3.1 Pre-test conditions

System Simulator:

- Cell 1.

UE:

None.

Preamble:

- The UE is in state Loopback Activated (state 4) according to [18].

7.2.3.2.3.2 Test procedure sequence

Table 7.2.3.2.3.2-1: Main behaviour

St	Procedure	Message Sequence		TP	Verdict
		U - S	Message/PDU/SDU		
1	The SS ignores scheduling requests and does not allocate any uplink grant.				
2	The SS transmits a RLC SDU of size 80 bytes segmented into two AMD PDUs. The two AMD PDUs are transmitted in separate TTIs.	<--	(RLC SDU#1) AMD PDU#1(FI='01',SN=0) AMD PDU#2(FI='10',SN=1)	-	-
3	The SS responds to any scheduling requests from the UE by transmitting an UL grant of size 392 bits. (Note 1).	<--	(UL grants)	-	-
4	Check: Does the UE return a RLC SDU with equal content as sent in downlink in step 2 segmented into two AMD PDUs and received in different TTIs?	-->	(RLC SDU#1) AMD PDU#1 AMD PDU#2	1,2	P
5	The SS ignores scheduling requests and does not allocate any uplink grant.	-	-	-	-
6	The SS sends a RLC SDU of size 120 bytes octets segmented into three AMD PDUs.	<--	(RLC SDU#2) AMD PDU#1(FI='01',SN=2) AMD PDU#2(FI='11',SN=3) AMD PDU#3(FI='10',SN=4)	-	-
7	The SS responds to any scheduling requests from the UE by transmitting an UL grant of size 392 bits. (Note 1).	<--	(UL grants)	-	-
8	Check: Does the UE return a RLC SDU with equal content as sent in downlink in step 6 segmented into three AMD PDUs where each AMD PDU is received in different TTI?	-->	(RLC SDU#2) AMD PDU#1 AMD PDU#2 AMD PDU#3	1,2	P
Note 1	UL grant of 392 bits ($I_{TBS}=8$, $N_{PRB}=3$, see TS 36.213 Table 7.1.7.2.1-1) is chosen to force the UE to segment the returned UL RLC SDU into multiple AMD PDUs. An UL grant of 392 bits=49 bytes allows the UE to transmit one AMD PDU of maximum 46 bytes (49 bytes – 2 byte AMD PDU header - minimum 1 byte MAC header).				

7.2.3.2.3.3 Specific message contents

None.

7.2.3.3 AM RLC / Segmentation and Reassembly / "Framing Info Field"

7.2.3.3.1 Test Purpose (TP)

(1)

```
with { UE in E-UTRA RRC_CONNECTED state }
ensure that {
  when { UE receives an AMD PDU or an AMD PDU segment containing a FI field set to 00 }
  then { UE correctly decodes the received AMD PDU or AMD PDU segment }
}
```

(2)

```
with { UE in E-UTRA RRC_CONNECTED state }
ensure that {
  when { UE receives an AMD PDU or an AMD PDU segment containing a FI field set to 01 }
  then { UE correctly decodes the received AMD PDU or AMD PDU segment }
}
```

(3)

```
with { UE in E-UTRA RRC_CONNECTED state }
ensure that {
  when { UE receives an AMD PDU or an AMD PDU segment containing a FI field set to 11 }
  then { UE correctly decodes the received AMD PDU or AMD PDU segment }
}
```



```
    }
```

(4)

```
with { UE in E-UTRA RRC_CONNECTED state }
ensure that {
  when { UE receives an AMD PDU or an AMD PDU segment containing a FI field set to 10 }
  then { UE correctly decodes the received AMD PDU or AMD PDU segment }
}
```

7.2.3.3.2 Conformance requirements

References: The conformance requirements covered in the present TC are specified in: TS 36.322, clause 6.2.2.6.

[TS 36.322, clause 6.2.2.6]

Length: 2 bits.

The FI field indicates whether a RLC SDU is segmented at the beginning and/or at the end of the Data field. Specifically, the FI field indicates whether the first byte of the Data field corresponds to the first byte of a RLC SDU, and whether the last byte of the Data field corresponds to the last byte of a RLC SDU. The interpretation of the FI field is provided in Table 6.2.2.6-1.

Table 6.2.2.6-1: FI field interpretation

Value	Description
00	First byte of the Data field corresponds to the first byte of a RLC SDU. Last byte of the Data field corresponds to the last byte of a RLC SDU.
01	First byte of the Data field corresponds to the first byte of a RLC SDU. Last byte of the Data field does not correspond to the last byte of a RLC SDU.
10	First byte of the Data field does not correspond to the first byte of a RLC SDU. Last byte of the Data field corresponds to the last byte of a RLC SDU.
11	First byte of the Data field does not correspond to the first byte of a RLC SDU. Last byte of the Data field does not correspond to the last byte of a RLC SDU.

7.2.3.3.3 Test description

7.2.3.3.3.1 Pre-test conditions

System Simulator:

- Cell 1.

UE:

None.

Preamble:

- The UE is in state Loopback Activated (state 4) according to [18].

7.2.3.3.3.2 Test procedure sequence

Table 7.2.3.3.3.2-1: Main behaviour

St	Procedure	Message Sequence		TP	Verdict
		U - S	Message		
1	The SS transmits AMD PDU#1 containing a complete RLC SDU#1 (FI field = 00).	<--	AMD PDU#1	-	-
2	Check: Does the UE transmit RLC SDU#1?	-->	(RLC SDU#1)	1	P
3	The SS transmits AMD PDU#2 containing the first segment of RLC SDU#2 (FI field = 01).	<--	AMD PDU#2	-	-
4	The SS transmits AMD PDU#3 containing the second segment of RLC SDU#2 (FI field = 11).	<--	AMD PDU#3	-	-
5	The SS transmits AMD PDU#4 containing the last segment of RLC SDU#2 (FI field = 10).	<--	AMD PDU#4	-	-
6	Check: Does the UE transmit RLC SDU#2?	-->	(RLC SDU#2)	2,3, 4	P
7	The <i>t-PollRetransmit</i> timer for RLC PDU#5 expires and SS assumes that the transmission of AMD PDU#5 containing a complete RLC SDU#3 and a complete RLC SDU#4 is failed and consider RLC PDU#5 for re-transmission	-	-	-	-
8	The SS transmits AMD PDU segment containing a complete RLC SDU#3 (FI field = 00).	<--	AMD PDU segment	-	-
9	Check: Does the UE transmit RLC SDU#3?	-->	(RLC SDU#3)	1	P
10	The SS transmits AMD PDU segment containing the first segment of RLC SDU#4 (FI field = 01).	<--	AMD PDU segment	-	-
11	The SS transmits AMD PDU segment containing the second segment of RLC SDU#4 (FI field = 11).	<--	AMD PDU segment	-	-
12	The SS transmits AMD PDU segment containing the last segment of RLC SDU#4 (FI field = 10).	<--	AMD PDU segment	-	-
13	Check: Does the UE transmit RLC SDU#4?	-->	(RLC SDU#4)	2,3, 4	P

7.2.3.3.3.3 Specific message contents

None.

7.2.3.4 AM RLC / Segmentation and Reassembly / Different numbers of Length Indicators

7.2.3.4.1 Test Purpose (TP)

(1)

```
with { UE in E-UTRA RRC_CONNECTED state }
ensure that {
  when { UE receives an AMD PDU or an AMD PDU segment without no LI field }
  then { UE correctly decodes the received AMD PDU or AMD PDU segment }
}
```

(2)

```
with { UE in E-UTRA RRC_CONNECTED state }
ensure that {
  when { UE receives an AMD PDU or an AMD PDU segment with one LI field }
  then { UE correctly decodes the received AMD PDU or AMD PDU segment }
}
```

(3)

```
with { UE in E-UTRA RRC_CONNECTED state }
ensure that {
  when { UE receives an AMD PDU or an AMD PDU segment with two LI fields }
  then { UE correctly decodes the received AMD PDU or AMD PDU segment }
}
```

}

7.2.3.4.2 Conformance requirements

References: The conformance requirements covered in the present TC are specified in: TS 36.322, clause 6.2.2.5.

[TS 36.322, clause 6.2.2.5]

Length: 11 bits.

The LI field indicates the length in bytes of the corresponding Data field element present in the RLC data PDU delivered/received by an UM or an AM RLC entity. The first LI present in the RLC DATA PDU header corresponds to the first Data field element present in the Data field of the RLC DATA PDU, the second LI present in the RLC DATA PDU header corresponds to the second Data field element present in the Data field of the RLC DATA PDU, and so on. The value 0 is reserved.

7.2.3.4.3 Test description

7.2.3.4.3.1 Pre-test conditions

System Simulator:

- Cell 1.

UE:

None.

Preamble:

- The UE is in state Loopback Activated (state 4) according to [18].

7.2.3.4.3.2 Test procedure sequence

Table 7.2.3.4.3.2-1: Main behaviour

St	Procedure	Message Sequence		TP	Verdict
		U - S	Message		
1	The SS transmits AMD PDU#1 containing a complete RLC SDU#1 without LI field.	<--	AMD PDU#1	1	-
2	The SS transmits an uplink grant allowing the UE to transmit 1 RLC SDU.	<--	(UL grant)	1	-
3	Check: Does the UE transmit RLC SDU#1?	-->	(RLC SDU#1)	1	P
4	The SS transmits AMD PDU#2 containing a complete RLC SDU#2 and a complete RLC SDU#3 with one LI field.	<--	AMD PDU#2	2	-
5	The SS transmits two uplink grants allowing the UE to transmit 2 RLC SDUs.	<--	(UL grant)	2	-
6	Check: Does the UE transmit RLC SDU#2?	-->	(RLC SDU#2)	2	P
7	Check: Does the UE transmit RLC SDU#3?	-->	(RLC SDU#3)	2	P
8	The SS transmits AMD PDU#3 containing a complete RLC SDU#4, a complete RLC SDU#5 and a complete RLC SDU#6 with two LI fields.	<--	AMD PDU#3	3	-
9	The SS transmits three uplink grants allowing the UE to transmit 3 RLC SDUs.	<--	(UL grant)	3	-
10	Check: Does the UE transmit RLC SDU#4?	-->	(RLC SDU#4)	3	P
11	Check: Does the UE transmit RLC SDU#5?	-->	(RLC SDU#5)	3	P
12	Check: Does the UE transmit RLC SDU#6?	-->	(RLC SDU#6)	3	P
13	The <i>t-PollRetransmit</i> timer for AMD PDU#4 expires and SS assumes that the transmission of AMD PDU#4 containing a complete RLC SDU#7, a complete RLC SDU#8, a complete RLC SDU#9, a complete RLC SDU#10, a complete RLC SDU#11 and a complete RLC SDU#12 is failed and consider AMD PDU#4 for re-transmission.	-	-	-	-
14	The SS transmits AMD PDU segment containing a complete RLC SDU#7 without LI field.	<--	AMD PDU segment	1	-
15	The SS transmits an uplink grant allowing the UE to transmit 1 RLC SDU.	<--	(UL grant)	1	-
16	Check: Does the UE transmit RLC SDU#7?	-->	(RLC SDU#7)	1	P
17	The SS transmits AMD PDU segment containing a complete RLC SDU#8 and a complete RLC SDU#9 with one LI field.	<--	AMD PDU segment	2	-
18	The SS transmits two uplink grants allowing the UE to transmit 2 RLC SDUs.	<--	(UL grant)	2	-
19	Check: Does the UE transmit RLC SDU#8?	-->	(RLC SDU#8)	2	P
20	Check: Does the UE transmit RLC SDU#9?	-->	(RLC SDU#9)	2	P
21	The SS transmits AMD PDU segment containing a complete RLC SDU#10, a complete RLC SDU#11 and a complete RLC SDU#12 with two LI fields.	<--	AMD PDU segment	3	-
22	The SS transmits three uplink grants allowing the UE to transmit 3 RLC SDUs.	<--	(UL grant)	3	-
23	Check: Does the UE transmit RLC SDU#10?	-->	(RLC SDU#10)	3	P
24	Check: Does the UE transmit RLC SDU#11?	-->	(RLC SDU#11)	3	P
25	Check: Does the UE transmit RLC SDU#12?	-->	(RLC SDU#12)	3	P

7.2.3.4.3.3 Specific message contents

None.

7.2.3.5 AM RLC / Reassembly / LI value > PDU size

7.2.3.5.1 Test Purpose (TP)

(1)

```
with { UE in E-UTRA RRC_CONNECTED state }
ensure that {
  when { UE receives PDU with "Length Indicators" that point beyond the end of the PDU }
  then { UE discards PDU }
}
```

7.2.3.5.2 Conformance requirements

References: The conformance requirements covered in the present TC are specified in: 3GPP TS 36.322 clauses 5.5.1 and 6.2.2.5.

[TS 36.322, clause 5.5.1]

When an RLC entity receives an RLC PDU that contains reserved or invalid values, the RLC entity shall:

- discard the received PDU.

[TS 36.322, clause 6.2.2.5]

Length: 11 bits.

The LI field indicates the length in bytes of the corresponding Data field element present in the AMD PDU. The first LI present in the AMD PDU header corresponds to the first Data field element present in the Data field of the AMD PDU, the second LI present in the AMD PDU header corresponds to the second Data field element present in the Data of the AMD PDU, and so on. The value 0 is reserved.

7.2.3.5.3 Test description

7.2.3.5.3.1 Pre-test conditions

System Simulator:

- Cell 1.

UE:

None.

Preamble:

- The UE is in state Loopback Activated (state 4) according to [18] with the loopback size set to 102 bytes.

7.2.3.5.3.2 Test procedure sequence

Table 7.2.3.5.3.2-1: Main behaviour

St	Procedure	Message Sequence		TP	Verdict
		U - S	Message/PDU/SDU		
1	The SS transmits an AMD PDU of 50 data bytes to the UE. This PDU is the 1 st part of SDU#1.	<--	AMD PDU#1(SN = 0)	-	-
2	The SS transmits an AMD PDU of 100 data bytes to the UE. This PDU contains the last part of SDU#1, and the 1 st part of SDU#2. LI associated with PDU#2 has a value > PDU size, i.e. > 100.	<--	AMD PDU#2(SN=1)	-	-
3	The SS transmits an AMD PDU of 100 data bytes to the UE. This PDU contains the last part of SDU 2, and the 1 st part of SDU#3.	<--	AMD PDU#3(SN=2)	-	-
4	The SS transmits an AMD PDU of 50 data bytes to the UE. This PDU contains the last part of SDU#3.	<--	AMD PDU#4(SN=3)	-	-
5	Check: Does the UE transmit a STATUS PDU with NACK_SN field set to 1?	-->	STATUS PDU	1	P
6	The SS transmits an AMD PDU of 100 data bytes to the UE. This PDU contains the last part of SDU#1, and the 1st part of SDU#2. The LI is correct.	<--	AMD PDU#2 (SN=1)	-	-
7	Check: Does the UE transmit RLC SDU#1?	-->	(RLC SDU#1)	1	P
8	Check: Does the UE transmit RLC SDU#2?	-->	(RLC SDU#2)	1	P
9	Check: Does the UE transmit RLC SDU#3?	-->	(RLC SDU#3)	1	P

7.2.3.5.3.3 Specific message contents

None.

7.2.3.6 AM RLC / Correct use of Sequence Numbering

7.2.3.6.1 Test Purpose (TP)

(1)

```
with { UE in E-UTRA RRC_CONNECTED state }
ensure that {
  when { UE transmits the first PDU }
  then { UE sets the Sequence Number field equal to 0 }
}
```

(2)

```
with { UE in E-UTRA RRC_CONNECTED state }
ensure that {
  when { UE transmits subsequent PDUs }
  then { SN incremented by 1 for each PDU transmitted }
}
```

(3)

```
with { UE in E-UTRA RRC_CONNECTED state }
ensure that {
  when { UE transmits more than 1024 PDUs }
  then { UE wraps the Sequence Number after transmitting the 1024 PDU }
}
```

(4)

```
with { UE in E-UTRA RRC_CONNECTED state }
ensure that {
  when { more than 1024 PDUs are sent to UE }
  then { UE accepts PDUs with SNs that wrap around every 1024 PDU }
}
```

7.2.3.6.2 Conformance requirements

References: The conformance requirements covered in the present TC are specified in: 3GPP TS 36.322 clauses 5.1.3.1.1, 6.2.2.3 and 7.1.

[TS 36.322, clause 5.1.3.1.1]

The transmitting side of an AM RLC entity shall prioritize transmission of RLC control PDUs over RLC data PDUs. The transmitting side of an AM RLC entity shall prioritize retransmission of RLC data PDUs over transmission of new AMD PDUs.

The transmitting side of an AM RLC entity shall maintain a transmitting window according to state variables VT(A) and VT(MS) as follows:

- a SN falls within the transmitting window if $VT(A) \leq SN < VT(MS)$;
- a SN falls outside of the transmitting window otherwise.

The transmitting side of an AM RLC entity shall not deliver to lower layer any RLC data PDU whose SN falls outside of the transmitting window.

When delivering a new AMD PDU to lower layer, the transmitting side of an AM RLC entity shall:

- set the SN of the AMD PDU to VT(S), and then increment VT(S) by one.

The transmitting side of an AM RLC entity can receive a positive acknowledgement (confirmation of successful reception by its peer AM RLC entity) for a RLC data PDU by the following:

- STATUS PDU from its peer AM RLC entity.

When receiving a positive acknowledgement for an AMD PDU with $SN = VT(A)$, the transmitting side of an AM RLC entity shall:

- set VT(A) equal to the SN of the AMD PDU with the smallest SN, whose SN falls within the range $VT(A) \leq SN \leq VT(S)$ and for which a positive acknowledgment has not been received yet.
- if positive acknowledgements have been received for all AMD PDUs associated with a transmitted RLC SDU :

[TS 36.322, clause 6.2.2.3]

Length: 10bits for AMD PDU, AMD PDU segments and STATUS PDUs. ...

The SN field indicates the sequence number of the corresponding ... AMD PDU. For an AMD PDU segment, the SN field indicates the sequence number of the original AMD PDU from which the AMD PDU segment was constructed from. The sequence number is incremented by one for every ... AMD PDU.

[TS 36.322, clause 7.1]

...

All state variables and all counters are non-negative integers.

All state variables related to AM data transfer can take values from 0 to 1023. All arithmetic operations contained in the present document on state variables related to AM data transfer are affected by the AM modulus (i.e. final value = [value from arithmetic operation] modulo 1024).

AMD PDUs ... are numbered integer sequence numbers (SN) cycling through the field: 0 to 1023 for AMD PDU ...

...

c) VT(S) – Send state variable

This state variable holds the value of the SN to be assigned for the next newly generated AMD PDU. It is initially set to 0, and is updated whenever the AM RLC entity delivers an AMD PDU with $SN = VT(S)$.

...

7.2.3.6.3 Test description

7.2.3.6.3.1 Pre-test conditions

System Simulator:

- Cell 1.

UE:

None.

Preamble:

- The UE is in state Loopback Activated (state 4) according to [18].

7.2.3.6.3.2 Test procedure sequence

Table 7.2.3.6.3.2-1: Main behaviour

St	Procedure	Message Sequence		TP	Verdict
		U - S	Message/PDU/SDU		
-	EXCEPTION: Step 1 to 2 are executed 1024 times.	-	-	-	-
-	EXCEPTION: In parallel to step 1, the behaviour described in table 7.2.3.6.3.2-2 is running.	-	-	-	-
1	The SS transmits an AMD PDU to the UE. SN equals 0 and is incremented for each PDU transmitted. Polling bit enabled for every 128th AMD PDU transmitted.	<--	AMD PDU	-	-
2	The UE transmits a STATUS PDU with ACK_SN field which is smaller or equal to last SN transmitted from the SS and greater than 128 resp multiples of 128.	-->	STATUS PDU	-	-
3	The SS transmits an AMD PDU to the UE. SN equals 0. The polling bit is enabled.	<--	AMD PDU	-	-
4	Check: Does the UE transmit a STATUS PDU with ACK_SN = 1?	-->	STATUS PDU	4	P
5	Check: Does the UE transmit an AMD PDU with SN=0?	-->	AMD PDU	3	P
6	The SS transmits a STATUS PDU with ACK_SN = 1.	<--	STATUS PDU	-	-

Table 7.2.3.6.3.2-2: Parallel behaviour

St	Procedure	Message Sequence		TP	Verdict
		U - S	Message		
1	Check: Does the UE transmit an AMD PDU with SN = 0?	-->	AMD PDU	1	P
-	EXCEPTION: Steps 2-3 are executed 1023 times.	-	-	-	-
2	Check: Does the UE transmit an AMD PDU with SN increased by 1 compared with the previous one?	-->	AMD PDU	2	P
3	IF the AMD PDU received in step 2 contains a polling bit THEN the SS transmits a STATUS PDU with ACK_SN acknowledging all the AMD PDUs received.	<--	STATUS PDU	-	-

7.2.3.6.3.3 Specific message contents

None.

7.2.3.7 AM RLC / Control of Transmit Window

7.2.3.7.1 Test Purpose (TP)

(1)

```
with { UE in E-UTRA RRC_CONNECTED state with DRB established and pending uplink data for
transmission }
ensure that {
  when { AMD PDUs in transmission buffer fall outside VT(A) <= SN < VT(MS) }
  then { UE does not transmit these AMD PDUs }
}
```

(2)

```
with { UE in E-UTRA RRC_CONNECTED state with DRB established and pending uplink data for
transmission }
ensure that {
  when { receiving a STATUS PDU where ACK_SN acknowledges at least one AMD PDU not yet acknowledged }
  then { UE transmits AMD PDUs within updated window range }
}
```

7.2.3.7.2 Conformance requirements

References: The conformance requirements covered in the present TC are specified in: 3GPP TS 36.322 clauses 5.1.3.1.1, 7.1 7.2.

[TS 36.322, clause 5.1.3.1.1]

...

The transmitting side of an AM RLC entity shall maintain a transmitting window according to state variables VT(A) and VT(MS) as follows:

- a SN falls within the transmitting window if $VT(A) \leq SN < VT(MS)$;
- a SN falls outside of the transmitting window otherwise.

The transmitting side of an AM RLC entity shall not deliver to lower layer any RLC data PDU whose SN falls outside of the transmitting window.

When delivering a new AMD PDU to lower layer, the transmitting side of an AM RLC entity shall:

- set the SN of the AMD PDU to VT(S), and then increment VT(S) by one.

The transmitting side of an AM RLC entity can receive a positive acknowledgement (confirmation of successful reception by its peer AM RLC entity) for a RLC data PDU by the following:

- STATUS PDU from its peer AM RLC entity.

When receiving a positive acknowledgement for an AMD PDU with $SN = VT(A)$, the transmitting side of an AM RLC entity shall:

- set VT(A) equal to the SN of the AMD PDU with the smallest SN, whose SN falls within the range $VT(A) \leq SN \leq VT(S)$ and for which a positive acknowledgment has not been received yet.
- if positive acknowledgements have been received for all AMD PDUs associated with a transmitted RLC SDU :
 - send an indication to the upper layers of successful delivery of the RLC SDU.

[TS 36.322, clause 7.2]

a) AM_Window_Size

This constant is used by both the transmitting side and the receiving side of each AM RLC entity to calculate VT(MS) from VT(A), and VR(MR) from VR(R). $AM_Window_Size = 512$.

...

[TS 36.322, clause 7.1]

...

a) VT(A) – Acknowledgement state variable

This state variable holds the value of the SN of the next AMD PDU for which a positive acknowledgment is to be received in-sequence, and it serves as the lower edge of the transmitting window). It is initially set to 0, and is updated whenever the AM RLC entity receives a positive acknowledgment for an AMD PDU with $SN = VT(A)$.

b) VT(MS) – Maximum send state variable

This state variable equals $VT(A) + AM_Window_Size$, and it serves as the higher edge of the transmitting window.

...

7.2.3.7.3 Test description

7.2.3.7.3.1 Pre-test conditions

System Simulator:

- Cell 1.

UE:

None.

Preamble:

- The UE is in state Loopback Activated (state 4) according to [18] with the loopback size set to 100 bytes.
- UE support for either RLC SDU Buffering OR RLC SDU Discard. This is to be indicated in the PIXIT.

7.2.3.7.3.2 Test procedure sequence

Table 7.2.3.7.3.2-1: Main behaviour

St	Procedure	Message Sequence		TP	Verdict
		U - S	Message		
-	EXCEPTION: Step 1 is repeated $W+1$ times, where $W = AM_Window_Size$.	-	-	-	-
-	EXCEPTION: In parallel to step 1, the behaviour described in table 7.2.3.7.3.2-2 is running.	-	-	-	-
1	The SS transmits an AMD PDU containing a SDU to the UE	<--	AMD PDU		
2	Check: Does the UE transmit an AMD PDU within $t_PollRetransmit/2$?	-->	AMD PDU	1	F
3	The SS transmits a STATUS PDU to acknowledge the W uplink AMD PDUs with $SN=0$ to $SN=W-1$. $ACK_SN = W$.	<--	STATUS PDU		
-	EXCEPTION: Step 4 is repeated $W+1$ times.	-	-	-	-
-	EXCEPTION: IF UE buffers RLC SDUs in parallel to the events described in Step 4 the steps specified in table 7.2.3.7.3.2-3 shall take place; IF UE discards RLC SDUs in parallel to the events described in Step 4 the steps specified in table 7.2.3.7.3.2-4 shall take place.	-	-	-	-
4	The SS transmits an AMD PDU containing a SDU to the UE	<--	AMD PDU	-	-
5	Check: Does the UE transmit an AMD PDU within $t_PollRetransmit/2$?	-->	AMD PDU	1	F
6	The SS transmits a STATUS PDU to acknowledge W uplink RLC PDUs	<--	STATUS PDU	-	-
7a	IF UE buffers RLC SDUs THEN Check: does the UE transmit the same PDU content as received in the corresponding downlink PDU ($2W+1$) of the SDU?	-->	AMD PDU $2W+1(SN=0)$	2	P
7b1	IF UE discards RLC SDUs THEN The SS transmits an AMD PDU containing an SDU to the UE	-->	AMD PDU $W+2$, Poll	-	-
7b2	Check: Does the UE transmit the same AMD PDU content as received in the corresponding downlink AMD PDU ($2W+3$) of the SDU?	-->	AMD PDU $2W+3$, ($SN = 0$)	2	P
Note: SDUs are numbered 1,2, ..., $2W+3$					

Table 7.2.3.7.3.2-2: Parallel behaviour

St	Procedure	Message Sequence		TP	Verdict
		U - S	Message		
-	EXCEPTION: Step 1 is repeated $W-1$ times.	-	-	-	-
1	The UE transmit an AMD PDU with the same data as received in the corresponding DL AMD PDU.	-->	AMD PDU	-	-
2	Check: Does the UE transmit an AMD PDU with the Poll bit set and with the contents of the SDU?	-->	AMD PDU($SN=W-1$), Poll	1	P

Table 7.2.3.7.3.2-3: Parallel behaviour

St	Procedure	Message Sequence		TP	Verdict
		U - S	Message		
-	EXCEPTION: Step 1 is repeated W-1 times.	-	-	-	-
1	The UE transmit an AMD PDU with the same data as received in the corresponding DL AMD PDU.	-->	AMD PDU	-	-
2	The UE transmit an AMD PDU with the Poll bit set and contents of the (2W)th SDU. The contents is that of the (2W)th SDU.	-->	AMD PDU(SN=2W-1), Poll	-	-

Table 7.2.3.7.3.2-4: Parallel behaviour

St	Procedure	Message Sequence		TP	Verdict
		U - S	Message/PDU/SDU		
-	EXCEPTION: Step 1 is repeated W-1 times.	-	-	-	-
1	The UE transmits an AMD PDU with the same data as received in the corresponding DL AMD PDU.	-->	AMD PDU W		
2	The UE transmit an AMD PDU with the Poll bit set. The contents is that of the (2W+1)th SDU.	-->	AMD PDU(SN=2W-1), Poll	-	-

7.2.3.7.3.3 Specific message contents

None.

7.2.3.8 AM RLC / Control of Receive Window

7.2.3.8.1 Test Purpose (TP)

(1)

```
with { UE in E-UTRA RRC_CONNECTED state }
ensure that {
  when { the UE receives AMD PDUs with SN outside the upper boundary of the receive window }
  then { the UE discards these AMD PDUs }
}
```

(2)

```
with { UE in E-UTRA RRC_CONNECTED state }
ensure that {
  when { the receive window has been moved }
  then { UE continues accepting AMD PDUs within updated window range }
}
```

7.2.3.8.2 Conformance requirements

References: The conformance requirements covered in the present TC are specified in: 3GPP TS 36.322 clauses 5.1.3.2.1 and 7.2.

[TS 36.322, clause 5.1.3.2.1]

The receiving side of an AM RLC entity shall maintain a receiving window according to state variables VR(R) and VR(MR) as follows:

- a SN falls within the receiving window if $VR(R) \leq SN < VR(MR)$;
- a SN falls outside of the receiving window otherwise.

When receiving a RLC data PDU from lower layer, the receiving side of an AM RLC entity shall:

- either discard the received RLC data PDU or place it in the reception buffer (see sub clause 5.1.3.2.2);
- if the received RLC data PDU was placed in the reception buffer:

- update state variables, reassemble and deliver RLC SDUs to upper layer and start/stop *t-Reordering* as needed (see sub clause 5.1.3.2.3).

When *t-Reordering* expires, the receiving side of an AM RLC entity shall:

- update state variables and start *t-Reordering* as needed (see sub clause 5.1.3.2.4).

[TS 36.322, clause 7.2]

a) AM_Window_Size

This constant is used by both the transmitting side and the receiving side of each AM RLC entity to calculate VT(MS) from VT(A), and VR(MR) from VR(R). AM_Window_Size = 512.

...

7.2.3.8.3 Test description

7.2.3.8.3.1 Pre-test conditions

System Simulator:

- Cell 1.

UE:

None.

Preamble:

- The UE is in state Loopback Activated (state 4) according to [18] with a loopback size of 0 byte.

7.2.3.8.3.2 Test procedure sequence

Table 7.2.3.8.3.2-1: Main behaviour

St	Procedure	Message Sequence		TP	Verdict
		U - S	Message/PDU/SDU		
-	EXCEPTION: Step 1 shall be repeated W times, where W is AM_Window_Size. Polling bit enabled for the Wth RLC PDU transmitted. The SS shall set the Sequence Number field for the first AMD PDU to 0 and increment it by 1 for every execution of Step 1.	-	-	-	-
1	The SS transmits an AMD PDU to the UE	<--	AMD PDU		
2	Check: Does the UE transmit a STATUS PDU acknowledging W PDUs? (ACK_SN = W)	-->	STATUS PDU	1	P
3	The SS transmits the (W+1)th AMD PDU to the UE with the Sequence Number field set to ((2W mod 1024) = 0) and the Polling bit set	<--	AMD PDU		
4	Check: does the UE transmit a STATUS PDU acknowledging W PDUs? (ACK_SN = W) (Note 1)	-->	STATUS PDU	1	P
5	The SS transmits the (W+2)th AMD PDU to the UE with the Sequence Number field set to W and the Polling bit set.	<--	AMD PDU		
6	Check: Does the UE transmit a STATUS PDU acknowledging W +1 PDUs? (ACK_SN field = W+1) (Note 2)	-->	STATUS PDU	2	P

Note 1: This shows that the UE has discarded the (W+1)th PDU.

Note 2: This shows that the UE did not discard the (W+2)th PDU and has updated the Receive Window correctly

7.2.3.8.3.3 Specific message contents

None.

7.2.3.9 AM RLC / Polling for status

7.2.3.9.1 Test Purpose (TP)

(1)

```
with { UE in E-UTRA RRC_CONNECTED state and using AM RLC }
ensure that {
  when { last data in the buffer was transmitted }
  then { UE transmits a Poll }
}
```

(2)

```
with { UE in E-UTRA RRC_CONNECTED state and using AM RLC }
ensure that {
  when { the t-PollRetransmit timer expires }
  then { UE transmits a Poll }
}
```

(3)

```
with { UE in E-UTRA RRC_CONNECTED state and using AM RLC }
ensure that {
  when { PDU_WITHOUT_POLL=pollPDU }
  then { UE transmits a Poll }
}
```

(4)

```
with { UE in E-UTRA RRC_CONNECTED state and using AM RLC }
ensure that {
  when { BYTE_WITHOUT_POLL=pollByte }
  then { UE transmits a Poll }
}
```

7.2.3.9.2 Conformance requirements

References: The conformance requirements covered in the present TC are specified in: 3GPP TS 36.322 clauses 5.2.2.

[TS 36.322, clause 5.2.2]

...

Upon assembly of a new AMD PDU, the transmitting side of an AM RLC entity shall:

- increment PDU_WITHOUT_POLL by one;
- increment BYTE_WITHOUT_POLL by every new byte of Data field element that it maps to the Data field of the RLC data PDU;
- if PDU_WITHOUT_POLL \geq pollPDU; or
- if BYTE_WITHOUT_POLL \geq pollByte;
 - include a poll in the RLC data PDU as described below.

Upon assembly of an AMD PDU or AMD PDU segment, the transmitting side of an AM RLC entity shall:

- if both the transmission buffer and the retransmission buffer becomes empty (excluding transmitted RLC data PDU awaiting for acknowledgements) after the transmission of the RLC data PDU; or
- if no further RLC data PDU can be transmitted after the transmission of the RLC data PDU (e.g. due to window stalling);
 - include a poll in the RLC data PDU as described below.

To include a poll in a RLC data PDU, the transmitting side of an AM RLC entity shall:

- set the P field of the RLC data PDU to "1";

- set PDU_WITHOUT_POLL to 0;
- set BYTE_WITHOUT_POLL to 0;

After delivering a RLC data PDU including a poll to lower layer and after incrementing of VT(S) if necessary, the transmitting side of an AM RLC entity shall:

- set POLL_SN to VT(S) – 1;
- if *t-PollRetransmit* is not running:
 - start *t-PollRetransmit*;
- else:
 - restart *t-PollRetransmit*;

[TS 36.322, clause 5.2.2.3]

Upon expiry of *t-PollRetransmit*, the transmitting side of an AM RLC entity shall:

- if both the transmission buffer and the retransmission buffer are empty (excluding transmitted RLC data PDU awaiting for acknowledgements); or
- if no new RLC data PDU can be transmitted (e.g. due to window stalling):
 - consider the AMD PDU with SN = VT(S) – 1 for retransmission;
 - consider any AMD PDU which has not been positively acknowledged for retransmission;
- include a poll in a RLC data PDU as described in section 5.2.2.1.

7.2.3.9.3 Test description

7.2.3.9.3.1 Pre-test conditions

System Simulator:

- Cell 1.

UE:

None.

Preamble:

- UE is in state Loopback Activated (state 4) according to [18] with the exceptions listed in table 7.2.3.9.3.1-1.

Table 7.2.3.9.3.1-1: RLC Settings

Parameter	Value
pollPDU	p256
pollByte	kB25
t-PollRetransmit	ms400

NOTE: these settings assume a 2-octet RLC header and 2-octets MAC header for non-segmented RLC SDUs.

7.2.3.9.3.2 Test procedure sequence

Table 7.2.3.9.3.2-1: Main behaviour

St	Procedure	Message Sequence		TP	Verdict
		U - S	Message		
-	During the whole test sequence, the size of the UL grants allocated by the SS shall be 12 576 bits. (Note 1)	-	-	-	
-	EXCEPTION: In parallel to the events described in step 1, the steps specified in Table 7.2.3.9.3.2-2 should take place	-	-	-	-
1	The SS transmits 4 AMD PDUs, each containing an RLC SDU of size 12 544 bits.	<--	AMD PDU(SN=0) AMD PDU(SN=1) AMD PDU(SN=2) AMD PDU(SN=3)	-	-
2	Check1: Does the UE transmit an AMD PDU with SN=3 and P=1?	-->	AMD PDU	2	P
3	Upon receiving the Poll, the SS sends an RLC Status Report.	<--	STATUS PDU	-	-
4	Check: Does the UE retransmit an AMD PDU within $t\text{-PollRetransmit}$ ms?	-->	AMD PDU	2	F
5	SS performs a RRC Connection Reconfiguration procedure triggering an RLC-reestablishment of the RLC entity and sets $pollPDU$ to 4.	-	-	-	-
-	EXCEPTION: In parallel to the events described in step 6, the steps specified in Table 7.2.3.9.3.2-3 should take place	-	-	-	-
6	The SS transmits 8 AMD PDUs, each containing an RLC SDU of 12 544 bits.	<--	AMD PDU(SN=0) AMD PDU(SN=1) ... AMD PDU(SN=7)	-	-
7	The SS sends a Status Report with NACK_SN=0, NACK_SN=1, NACK_SN=2 and NACK_SN=4.	<--	STATUS PDU	-	-
8	Check: Does the UE transmit AMD PDUs with the following SN and P values? AMD PDU, SN=0, P=0 AMD PDU, SN=1, P=0 AMD PDU, SN=2, P=0 AMD PDU, SN=4, P=0	-->	AMD PDU(SN=0, P=0) AMD PDU(SN=1, P=0) AMD PDU(SN=2, P=0) AMD PDU(SN=4, P=0)	3	P
9	SS performs a RRC Connection Reconfiguration procedure triggering an RLC-reestablishment of the RLC entity and sets $pollPDU$ to 256.	-	-	-	-
-	EXCEPTION: In parallel to the events described in step 10, the steps specified in Table 7.2.3.9.3.2-4 should take place	-	-	-	-
12	The SS transmits 34 AMD PDUs, each containing an RLC SDU of size 12 544 bits.	<--	AMD PDU(SN=0) AMD PDU(SN=1) ... AMD PDU(SN=33)	-	-
Note 1	UL grant of 12 576 bits ($I_{TBS}=25$, $N_{PRB}=20$, see TS 36.213 Table 7.1.7.2.1-1) is chosen to allow the UE to loop back one SDU of size 12 544 bits into each AMD PDU sent in the uplink (12 576 bits - 16 bit AMD PDU header - 16 bit MAC SDU header).				

Table 7.2.3.9.3.2-2: Parallel behaviour

St	Procedure	Message Sequence		TP	Verdict
		U - S	Message		
1	Check: Does the UE transmit 4 AMD PDUs, with only the last one having the poll bit set? Record time T_A when the PDU with the poll bit set is received at SS.	-->	AMD PDUs	1	P

Table 7.2.3.9.3.2-3: Parallel behaviour

St	Procedure	Message Sequence		TP	Verdict
		U - S	Message		
1	Check: Does the UE transmit 8 AMD PDUs, with the poll bit set only in the 4 th and the 8 th PDUs?	-->	AMD PDUs	3	P

Table 7.2.3.9.3.2-4: Parallel behaviour

St	Procedure	Message Sequence		TP	Verdict
		U - S	Message		
1	Check: Does the UE transmit 34 AMD PDUs, with the poll bit set only in the 16 th one, the 32 nd one and the last one?	-->	AMD PDUs	4	P

7.2.3.9.3.3 Specific message contents

None.

7.2.3.10 AM RLC / Receiver Status Triggers

7.2.3.10.1 Test Purpose (TP)

(1)

```
with { UE in E-UTRA RRC_CONNECTED state and using AM RLC }
ensure that {
  when { Reception failure of an RLC data PDU is detected }
  then { UE initiates Status Reporting when t-Reordering expires }
}
```

(2)

```
with { UE in E-UTRA RRC_CONNECTED state and using AM RLC }
ensure that {
  when { Status Reporting is triggered and t-StatusProhibit is running }
  then { UE wait until t-StatusProhibit has expired to send Status Report }
}
```

(3)

```
with { UE in E-UTRA RRC_CONNECTED state and using AM RLC }
ensure that {
  when { Polling from peer AM RLC entity is detected and the sequence number of the PDU that carries
the Poll is less than VR(MS) }
  then { UE initiates Status Reporting }
}
```

(4)

```
with { UE in E-UTRA RRC_CONNECTED state and using AM RLC }
ensure that {
  when { Polling from peer AM RLC entity is detected and the sequence number of the PDU that carries
the Poll is greater than or equal to VR(MS) }
  then { UE waits until VR(MS) becomes greater than the sequence number of the PDU with the Poll
before initiating Status Reporting }
}
```

(5)

```
with { UE in E-UTRA RRC_CONNECTED state and using AM RLC }
ensure that {
  when { the UE needs to send a Status Report and the UL grant is not large enough to accommodate
the whole report }
  then { UE includes as many NACK SNs in the Status Report as allowed by the UL grant }
}
```

7.2.3.10.2 Conformance requirements

References: The conformance requirements covered in the present TC are specified in: 3GPP TS 36.322 clause 5.2.3.
[TS 36.322, clause 5.2.3]

An AM RLC entity sends STATUS PDUs to its peer AM RLC entity in order to provide positive and/or negative acknowledgements of RLC PDUs (or portions of them).

RRC configures whether or not the status prohibit function is to be used an AM RLC entity.

Triggers to initiate STATUS reporting include:

- Polling from its peer AM RLC entity:
 - When a RLC data PDU with SN = x and the P field set to "1" is received from lower layer, the receiving side of an AM RLC entity shall:
 - if the PDU is to be discarded as specified in subclause 5.1.3.2.2; or
 - if $x < VR(MS)$ or $x \geq VR(MR)$:
 - trigger a STATUS report;
 - else:
 - delay triggering the STATUS report until $x < VR(MS)$ or $x \geq VR(MR)$.

NOTE: This ensures that the RLC Status report is transmitted after HARQ reordering.

- Detection of reception failure of an RLC data PDU:
 - The receiving side of an AM RLC entity shall trigger a STATUS report when *t-Reordering* expires.

NOTE: The expiry of *T_reordering* triggers both *VR(MS)* to be updated and a STATUS report to be triggered, but the STATUS report shall be triggered after *VR(MS)* is updated.

When STATUS reporting has been triggered, the receiving side of an AM RLC entity shall:

- if *t-StatusProhibit* is not running:
 - at the first transmission opportunity indicated by lower layer, construct a STATUS PDU and deliver it to lower layer;
- else:
 - at the first transmission opportunity indicated by lower layer after *t-StatusProhibit* expires, construct a single STATUS PDU even if status reporting was triggered several times while *t-StatusProhibit* was running and deliver it to lower layer;

When a STATUS PDU has been delivered to lower layer, the receiving side of an AM RLC entity shall:

- start *t-StatusProhibit*.

When constructing a STATUS PDU, the AM RLC entity shall:

- for the AMD PDUs with SN such that $VR(R) \leq SN < VR(MS)$ that has not been completely received yet, in increasing SN order of PDUs and increasing byte segment order within PDUs, starting with SN = *VR(R)* up to the SN for which the resulting STATUS PDU still fits to the total size of RLC PDU(s) indicated by lower layer:
 - if no byte segments have been received yet for an AMD PDU:
 - include in the STATUS PDU a *NACK_SN* which is set to the SN of the AMD PDU;
- for a continuous sequence of byte segments of a partly received AMD PDU that have not been received yet :
 - include in the STATUS PDU a set of *NACK_SN*, *SOstart* and *SOend*

- set the ACK_SN to the SN of the next not received RLC Data PDU which is not indicated as missing in the resulting STATUS PDU.

7.2.3.10.3 Test description

7.2.3.10.3.1 Pre-test conditions

System Simulator:

- Cell 1.

UE:

None.

Preamble

- The UE is in state Loopback Activated (state 4) according to [18] with the exceptions listed in table 7.2.3.10.3.1-1.

Table 7.2.3.10.3.1-1: RLC settings

Parameter	Value
t-Reordering	ms200
t-StatusProhibit	ms300
t-PollRetransmit	ms500

7.2.3.10.3.2 Test procedure sequence

Table 7.2.3.10.3.2-1: Main behaviour

St	Procedure	Message Sequence		TP	Verdict
		U - S	Message		
-	EXCEPTION: In parallel to the events described in steps 1 to 23, the UE performs the parallel behaviour specified in Table 7.2.3.10.3.2-2	-	-	-	-
1	The SS transmits 4 AMD PDUs with SN=0, 1, 2, and 4. The SS sets the P field of all the AMD PDUs to 0. Record time T_A when the AMD PDU with SN=4 is sent.	<--	AMD PDU (SN=0, P=0) AMD PDU (SN=1, P=0) AMD PDU (SN=2, P=0) AMD PDU (SN=4, P=0)	-	-
2	Check 1: Does the UE transmit a Status Report with NACK_SN=3 and ACK_SN=5? Record time T_B Check 2: $(T_B - T_A) = t\text{-Reordering}$	-->	STATUS PDU	1	P
3	Within 50 ms after the Status Report is received at Step 2, the SS transmits 4 AMD PDUs with SN=5, 6, 8 and 9. The SS sets the P field of all the AMD PDUs to 0.	<--	AMD PDU (SN=5, P=0) AMD PDU (SN=6, P=0) AMD PDU (SN=8, P=0) AMD PDU (SN=9, P=0)	-	-
4	Check 1: Does the UE transmit a Status Report with NACK_SN=3, NACK_SN=7 and ACK_SN=10? Record time T_C Check 2: $(T_C - T_B) = t\text{-StatusProhibit}$	-->	STATUS PDU	2	P
5	The SS waits for <i>t-StatusProhibit</i> .	-	-	-	-
6	The SS transmits 3 AMD PDUs with SN=3, SN=7, and SN=9. The SS sets the P field of all the AMD PDUs to 0 except for that of the AMD PDU with SN=9.	<--	AMD PDU (SN=3, P=0) AMD PDU (SN=7, P=0) AMD PDU (SN=9, P=1)	-	-
7	Check: Does the UE transmit a Status Report with no NACK_SN and ACK_SN = 10?	-->	STATUS PDU	3	P
8	The SS waits for <i>t-StatusProhibit</i> .	-	-	-	-
9	The SS transmits an AMD PDU with SN=10 and P=0, and an AMD PDU with SN=12 and P=1.	<--	AMD PDU (SN=10, P=0) AMD PDU (SN=12, P=1)	-	-
10	Within <i>t-Reordering</i> (/ 2) ms after Step 9, the SS transmits an AMD PDU with SN=11 and P=0.	<--	AMD PDU (SN=11, P=0)	-	-
11	Check: Does the UE transmit a Status Report with no NACK_SN and ACK_SN=13?	-->	STATUS PDU	4	P
12	The SS ignores scheduling requests and does not allocate any uplink grant.	-	-	-	-
13	The SS waits for <i>t-StatusProhibit</i> .	-	-	-	-
14	The SS transmits an AMD PDU with SN=13 and P=0, and an AMD PDU with SN=19 and P=1.	<--	AMD PDU (SN=13, P=0) AMD PDU (SN=19, P=1)	-	-
15	The SS waits for <i>t-Reordering</i> .	-	-	-	-
16	Check: Does the UE transmit a scheduling request?	-->	(SR)		
17	The SS responds to the scheduling request received at Step 16 with an UL grant of size 72 bits. (Note 1)	<--	(UL Grant)	-	-
18	Check: Does the UE transmit a Status Report with ACK_SN=16 and 2 NACK_SNs: 14 and 15?	-->	STATUS PDU	5	P
19	The SS ignores scheduling requests and does not allocate any uplink grant.	-	-	-	-
20	The SS waits for <i>t-StatusProhibit</i> .	-	-	-	-
21	The SS transmits an AMD PDU with SN=14 and P=1.	<--	AMD PDU (SN=14, P=1)	-	-
22	The SS transmits an UL grant of size 72 bits. (Note 2)	<--	(UL Grant)	-	-
23	Check: Does the UE transmit a Status Report	-->	STATUS PDU	5	P

	with ACK_SN=20 and 4 NACK_SNs: 15, 16, 17 and 18?				
Note 1	UL grant of 72 bits ($I_{TBS}=2$, $N_{PRB}=2$, see TS 36.213 Table 7.1.7.2.1-1) is chosen to allow the UE to transmit a 2 byte regular BSR and a Status Report with ACK_SN and 2 NACK_SNs (8-bit MAC PDU subheader + 4-bit D/C/CPT + 10-bit ACK_SN + 1-bit E1 + 2 x (12-bit NACK_SN/E1/E2)).				
Note 2	UL grant of 72 bits ($I_{TBS}=2$, $N_{PRB}=2$, see TS 36.213 Table 7.1.7.2.1-1) is chosen to allow the UE to transmit a Status Report with ACK_SN and 4 NACK_SNs (8-bit MAC PDU subheader + 4-bit D/C/CPT + 10-bit ACK_SN + 1-bit E1 + 4 x (12-bit NACK_SN/E1/E2)).				

Table 7.2.3.10.3.2-2: Parallel behaviour

St	Procedure	Message Sequence		TP	Verdict
		U - S	Message		
1	UE transmits AMD PDUs to loop back the data received in the downlink	-->	AMD PDUs	-	-

7.2.3.10.3.3 Specific message contents

None.

7.2.3.11 Void

7.2.3.12 Void

7.2.3.13 AM RLC / Reconfiguration of RLC parameters by upper layers

7.2.3.13.1 Test Purpose (TP)

(1)

```
with { UE in E-UTRA RRC_CONNECTED state and using AM RLC }
ensure that {
  when { t-PollRetransmit expires }
  then { UE transmits a Poll }
}
```

(2)

```
with { UE in E-UTRA RRC_CONNECTED state and using AM RLC }
ensure that {
  when { loss of an RLC data PDU is detected }
  then { UE initiates Status Reporting }
}
```

(3)

```
with { UE in E-UTRA RRC_CONNECTED state and using AM RLC }
ensure that {
  when { Status Reporting is triggered and t-StatusProhibit is running }
  then { UE transmits a status report at t-StatusProhibit expiry }
}
```

7.2.3.13.2 Conformance requirements

References: The conformance requirements covered in the present TC are specified in: 3GPP TS 36.322 clause 5.2.2, 5.2.2.1, 5.2.2.2, 5.2.2.3 and 5.2.3.

[TS 36.322, clause 5.2.2]

An AM RLC entity can poll its peer AM RLC entity in order to trigger STATUS reporting at the peer AM RLC entity.

[TS 36.322, clause 5.2.2.1]

Upon assembly of a new AMD PDU, the transmitting side of an AM RLC entity shall:

- increment PDU_WITHOUT_POLL by one;
- increment BYTE_WITHOUT_POLL by every new byte of Data field element that it maps to the Data field of the RLC data PDU;
- if PDU_WITHOUT_POLL \geq *pollPDU*; or
- if BYTE_WITHOUT_POLL \geq *pollByte*;
 - include a poll in the RLC data PDU as described below.

Upon assembly of a AMD PDU or AMD PDU segment, the transmitting side of an AM RLC entity shall:

- if both the transmission buffer and the retransmission buffer becomes empty (excluding transmitted RLC data PDU awaiting for acknowledgements) after the transmission of the RLC data PDU; or
- if no new RLC data PDU can be transmitted after the transmission of the RLC data PDU (e.g. due to window stalling);
 - include a poll in the RLC data PDU as described below.

To include a poll in a RLC data PDU, the transmitting side of an AM RLC entity shall:

- set the P field of the RLC data PDU to "1";
- set PDU_WITHOUT_POLL to 0;
- set BYTE_WITHOUT_POLL to 0;

After delivering a RLC data PDU including a poll to lower layer and after incrementing of VT(S) if necessary, the transmitting side of an AM RLC entity shall:

- set POLL_SN to VT(S) – 1;
- if *t-PollRetransmit* is not running:
 - start *t-PollRetransmit*;
- else:
 - restart *t-PollRetransmit*;

[TS 36.322, clause 5.2.2.2]

Upon reception of a STATUS report from the receiving RLC AM entity the transmitting side of an AM RLC entity shall:

- if the STATUS report comprises a positive or negative acknowledgement for the RLC data PDU with sequence number equal to POLL_SN:
 - if the *t-PollRetransmit* is running:
 - stop *t-PollRetransmit*.

[TS 36.322, clause 5.2.2.3]

Upon expiry of *t-PollRetransmit*, the transmitting side of an AM RLC entity shall:

- if both the transmission buffer and the retransmission buffer are empty (excluding transmitted RLC data PDU awaiting for acknowledgements); or
- if no new RLC data PDU can be transmitted (e.g. due to window stalling):
 - consider the AMD PDU with SN = VT(S) – 1 for retransmission; or
 - consider any AMD PDU which has not been positively acknowledged for retransmission;

- include a poll in a RLC data PDU as described in section 5.2.2.1.

[TS 36.322, clause 5.2.3]

An AM RLC entity sends STATUS PDUs to its peer AM RLC entity in order to provide positive and/or negative acknowledgements of RLC PDUs (or portions of them).

RRC configures whether or not the status prohibit function is to be used for an AM RLC entity.

Triggers to initiate STATUS reporting include:

- Polling from its peer AM RLC entity:
 - When a RLC data PDU with SN = x and the P field set to "1" is received from lower layer, the receiving side of an AM RLC entity shall:
 - if the PDU is to be discarded as specified in subclause 5.1.3.2.2; or
 - if $x < VR(MS)$ or $x \geq VR(MR)$:
 - trigger a STATUS report;
 - else:
 - delay triggering the STATUS report until $x < VR(MS)$ or $x \geq VR(MR)$.

NOTE: This ensures that the RLC Status report is transmitted after HARQ reordering.

- Detection of reception failure of an RLC data PDU:
 - The receiving side of an AM RLC entity shall trigger a STATUS report when *t-Reordering* expires.

NOTE: The expiry of *T_reordering* triggers both *VR(MS)* to be updated and a STATUS report to be triggered, but the STATUS report shall be triggered after *VR(MS)* is updated.

When STATUS reporting has been triggered, the receiving side of an AM RLC entity shall:

- if *t-StatusProhibit* is not running:
 - at the first transmission opportunity indicated by lower layer, construct a STATUS PDU and deliver it to lower layer;
- else:
 - at the first transmission opportunity indicated by lower layer after *t-StatusProhibit* expires, construct a single STATUS PDU even if status reporting was triggered several times while *T_status_prohibit* was running and deliver it to lower layer;

When a STATUS PDU has been delivered to lower layer, the receiving side of an AM RLC entity shall:

- start *t-StatusProhibit*.

When constructing a STATUS PDU, the AM RLC entity shall:

- for the AMD PDUs with SN such that $VR(R) \leq SN < VR(MS)$ that has not been completely received yet, in increasing SN order of PDUs and increasing byte segment order within PDUs, starting with SN = *VR(R)* up to the point where the resulting STATUS PDU still fits to the total size of RLC PDU(s) indicated by lower layer:
 - for an AMD PDU for which no byte segments have been received yet :
 - include in the STATUS PDU a *NACK_SN* which is set to the SN of the AMD PDU;
 - for a continuous sequence of byte segments of a partly received AMD PDU that have not been received yet
 - include in the STATUS PDU a set of *NACK_SN*, *SOstart* and *SOend*
- set the *ACK_SN* to the SN of the next not received RLC Data PDU which is not indicated as missing in the resulting STATUS PDU.

7.2.3.13.3 Test description

7.2.3.13.3.1 Pre-test conditions

System Simulator:

- Cell 1.

UE:

None.

Preamble:

- The UE is in state Loopback Activated (state 4) according to [18].

7.2.3.13.3.2 Test procedure sequence

Table 7.2.3.13.3.2-1: Main behaviour

St	Procedure	Message Sequence		TP	Verdict
		U - S	Message/PDU/SDU		
1	The SS reconfigures RLC in the UE and sets - <i>t-Reordering</i> to 50 ms, - <i>t-StatusProhibit</i> to 150 ms, - <i>t-PollRetransmit</i> to 200 ms, - <i>pollPDU</i> to Infinity, - <i>pollByte</i> to Infinity. See Note 1	-	-	-	-
-	EXCEPTION: In parallel to steps 2-8, the behaviour described in table 7.2.3.13.3.2-2 is running.	-	-	-	-
2	The SS transmits 4 AMD PDUs with P=0 and SN=0, 1, 2 and 4. The SS record time T_A when AMD PDU 5 (with SN=4) is sent.	<--	AMD PDU#1 (SN=0, P=0) AMD PDU#2 (SN=1, P=0) AMD PDU#3 (SN=2, P=0) AMD PDU#4 (SN=4, P=0)	-	-
3	Check 1: Does the UE transmit a STATUS PDU with NACK_SN=3 and ACK_SN=5 ? Record time T_B . Check 2: Is $(T_B - T_A) = t-Reordering?$	-->	STATUS PDU	3	P
4	The SS sends 4 AMD PDUs with SN=5, 6, 8 and 9 within $(t-StatusProhibit / 2)$ ms reception of the STATUS PDU in step 3 above.	<--	AMD PDU#6 (SN=5, P=0) AMD PDU#7 (SN=6, P=0) AMD PDU#9 (SN=8, P=0) AMD PDU#10 (SN=9, P=0)	-	-
5	Check 1: Does the UE transmit a STATUS PDU with NACK_SN=3, NACK_SN=7 and ACK_SN=10 ? Record time T_C . Check 2: Is $(T_C - T_B) = t-StatusProhibit?$	-->	STATUS PDU	3	P
6	The SS waits for <i>t-StatusProhibit/2</i> .	-	-	-	-
7	The SS transmits 3 AMD PDUs with SN=3, 7, 9	<--	AMD PDU#4 (SN=3, P=0) AMD PDU#8 (SN=7, P=0) AMD PDU#10 (SN=9, P=1)	-	-
8	The UE transmits a Status Report with no NACK_SN and ACK_SN = 10.	-->	STATUS PDU	-	-
9	The SS transmits an AMD PDU to the UE	<--	AMD PDU#11 (SN=10, P=0)		
10	The UE transmits an AMD PDU with the same data as received in the corresponding DL AMD PDU.	-->	AMD PDU#11 (SN=10, P=1)		
11	The UE sets the poll bit as both the transmission and retransmission buffers become empty.	-->	AMD PDU#11 (SN=10, P=1)	1	P
Note 1 The RRC Connection Reconfiguration procedure is performed.					

Table 7.2.3.13.3.2-2: Parallel behaviour

St	Procedure	Message Sequence		TP	Verdict
		U - S	Message		
1	Check : Does the UE send AMD PDUs corresponding to the received AMD PDUs ?	-->	AMD PDU	-	-

7.2.3.13.3.3 Specific message contents

None.

7.2.3.14 AM RLC / In sequence delivery of upper layers PDUs

7.2.3.14.1 Test Purpose (TP)

(1)

```
with { UE in E-UTRAN RRC_CONNECTED state }
ensure that {
  when { UE receives duplicate AMD PDUs }
  then { UE discards the duplicate AMD PDUs }
}
```

(2)

```
with { UE in E-UTRAN RRC_CONNECTED state }
ensure that {
  when { UE receives an AMD PDU with a SN gap }
  then { UE sends STATUS PDU to request retransmissions of PDUs in the SN gap }
}
```

(3)

```
with { UE in E-UTRAN RRC_CONNECTED state }
ensure that {
  when { UE receives PDUs within a SN gap }
  then { RLC reassembles and reorders the AMD PDUs and deliver them to the upper layer in sequence }
}
```

7.2.3.14.2 Conformance requirements

References: The conformance requirements covered in the present TC are specified in: 3GPP TS 36.322 clause 4.2.1.3.3.

[TS 36.322, clause 4.2.1.3.3]

When the receiving side of an AM RLC entity receives RLC data PDUs, it shall:

- detect whether or not the RLC data PDUs have been received in duplication, and discard duplicated RLC data PDUs;
- reorder the RLC data PDUs if they are received out of sequence;
- detect the loss of RLC data PDUs at lower layers and request retransmissions to its peer AM RLC entity;
- reassemble RLC SDUs from the reordered RLC data PDUs and deliver the RLC SDUs to upper layer in sequence.

...

7.2.3.14.3 Test description

7.2.3.14.3.1 Pre-test conditions

System Simulator:

- Cell 1.

UE:

None.

Preamble:

- The UE is in state Loopback Activated (state 4) according to [18].

7.2.3.14.3.2 Test procedure sequence

Table 7.2.3.14.3.2-1: Main behaviour

St	Procedure	Message Sequence		TP	Verdict
		U - S	Message		
1	The SS transmits an AMD PDU to the UE. This PDU carries SDU#1.	<--	AMD PDU#1		
2	The SS transmits an AMD PDU to the UE. This PDU carries SDU#1.	<--	AMD PDU#1	-	-
3	Check: Does the UE transmit RLC SDU#1?	-->	(RLC SDU#1)	1	P
4	The SS transmits an AMD PDU to the UE. This PDU contains SDU#2, and the 1 st part of SDU#3.	<--	AMD PDU#2	-	-
5	Check: Does the UE transmit RLC SDU#2?	-->	(RLC SDU#2)	1	P
6	The SS transmits an AMD PDU to the UE. This PDU contains SDU#2, and the 1 st part of SDU#3.	<--	AMD PDU#2	-	-
7	Check: Does the UE transmit RLC SDU#2?	-->	(RLC SDU#2)	1	F
8	The SS transmits an AMD PDU to the UE. This PDU contains the 2 nd part of SDU#3.	<--	AMD PDU#3	-	-
9	Check: Does the UE transmit RLC SDU#3?	-->	(RLC SDU#3)	1	P
10	The SS transmits an AMD PDU to the UE. This PDU contains the last part of SDU#6.	<--	AMD PDU#6	-	-
11	The SS transmits an AMD PDU to the UE. This PDU contains SDU#5, and the 1 st part of SDU#6.	<--	AMD PDU#5	-	-
12	The SS transmits an AMD PDU to the UE. This PDU carries SDU#4 and the 1 st part of SDU#5.	<--	AMD PDU#4	-	-
13	Check: Does the UE transmit RLC SDU#4?	-->	(RLC SDU#4)	3	P
14	Check: does the UE transmit RLC SDU#5?	-->	(RLC SDU#5)	3	P
15	Check: does the UE transmit RLC SDU#6?	-->	(RLC SDU#6)	3	P
16	The SS transmits an AMD RLC PDU [FFS] bytes to the UE. This PDU contains the last part of SDU#9.	<--	AMD PDU#9	-	-
17	Check: does the UE transmit a STATUS PDU NACK_SN/E1/E2 fields set correctly to inform SS of missing PDUs #7, #8, (ACK_SN =10, NACK_SN = 7, NACK_SN = 8).?	-->	STATUS PDU	2	P
18	The SS transmits an AMD PDU to the UE. This PDU contains SDU#8, and the 1 st part of SDU#9.	<--	AMD PDU#8	-	-
19	The SS transmits an AMD PDU to the UE. This PDU carries SDDU#7.	<--	AM PDU#7	-	-
20	Check: does the UE transmit RLC SDU#7?	-->	AMD PDU#7	3	P
21	Check: does the UE transmit RLC SDU#8?	-->	AMD PDU#8	3	P
22	Check: does the UE transmit RLC SDU#9?	-->	AMD PDU#9	3	P

7.2.3.14.3.3 Specific message contents

None.

7.2.3.15 AM RLC / Re-ordering of RLC PDU segments

7.2.3.15.1 Test Purpose (TP)

(1)

```
with { UE in E-UTRAN RRC_CONNECTED state }
ensure that {
  when { UE receives RLC AM PDU segments }
  then { UE reorders RLC AMD PDU segments received out of sequence }
}
```

(2)

```
with { UE in E-UTRAN RRC_CONNECTED state }
ensure that {
  when { t-Reordering expires }
  then { Set VR(MS) to SN of the first AMD PDU with SN >= VR(X) for which not all byte segments
have been received }
}
```

7.2.3.15.2 Conformance requirements

References: The conformance requirements covered in the present TC are specified in: 3GPP TS 36.322 clauses 4.2.1.3.3, 5.1.3.2.1, 5.1.3.2.2, 5.1.2.3.3 and 5.1.2.3.4.

[TS 36.322, clause 4.2.1.3.3]

When the receiving side of an AM RLC entity receives RLC data PDUs, it shall:

...

- detect the loss of RLC data PDUs at lower layers and request retransmissions to its peer AM RLC entity;
- reassemble RLC SDUs from the reordered RLC data PDUs and deliver the RLC SDUs to upper layer in sequence.

...

[TS 36.322, clause 5.1.3.2.1]

The receiving side of an AM RLC entity shall maintain a receiving window according to state variables VR(R) and VR(MR) as follows:

- a SN falls within the receiving window if $VR(R) \leq SN < VR(MR)$;
- a SN falls outside of the receiving window otherwise.

When receiving a RLC data PDU from lower layer, the receiving side of an AM RLC entity shall:

- either discard the received RLC data PDU or place it in the reception buffer (see sub clause 5.1.3.2.2);
- if the received RLC data PDU was placed in the reception buffer:
 - update state variables, reassemble and deliver RLC SDUs to upper layer and start/stop T_reordering as needed (see sub clause 5.1.3.2.3).

When *t-Reordering* expires, the receiving side of an AM RLC entity shall:

- update state variables and start *t-Reordering* as needed (see sub clause 5.1.3.2.4).

[TS 36.322, clause 5.1.3.2.2]

When a RLC data PDU is received from lower layer, where the RLC data PDU contains byte segment numbers y to z of an AMD PDU with SN = x, the receiving side of an AM RLC entity shall:

- if x falls outside of the receiving window; or
- if byte segment numbers y to z of the AMD PDU with SN = x have been received before:

- discard the received RLC data PDU;
- else:
 - place the received RLC data PDU in the reception buffer;
 - if some byte segments of the AMD PDU contained in the RLC data PDU have been received before:
 - discard the duplicate byte segments.

[TS 36.322, clause 5.1.3.2.3]

When a RLC data PDU with SN = x is placed in the reception buffer, the receiving side of an AM RLC entity shall:

- if all byte segments of the AMD PDU with SN = VR(MS) are received:
 - update VR(MS) to the SN of the first AMD PDU with SN > current VR(MS) for which not all byte segments have been received;
- if x = VR(R):
 - if all byte segments of the AMD PDU with SN = VR(R) are received:
 - update VR(R) to the SN of the first AMD PDU with SN > current VR(R) for which not all byte segments have been received;
 - update VR(MR) to the updated VR(R) + AM_Window_Size;
 - reassemble RLC SDUs from any byte segments of AMD PDUs with SN that falls outside of the receiving window and in-sequence byte segments of the AMD PDU with SN = VR(R), remove RLC headers when doing so and deliver the reassembled RLC SDUs to upper layer in sequence if not delivered before;
- if x >= VR(H)
 - update VR(H) to x+ 1;
- if *t-Reordering* is running:
 - if VR(X) = VR(R); or
 - if VR(X) falls outside of the receiving window:
 - stop and reset *t-Reordering*;
- if *t-Reordering* is not running (includes the case *t-Reordering* is stopped due to actions above):
 - if the VR (H) > VR(R):
 - start *t-Reordering*;
 - set VR(X) to VR(H).

[TS 36.322, clause 5.1.3.2.4]

When *t-Reordering* expires, the receiving side of an AM RLC entity shall:

- update VR(MS) to the SN of the first AMD PDU with SN >= VR(X) for which not all byte segments have been received;
- if VR(H) > VR(MS):
 - start *t-Reordering*;
 - set VR(X) to VR(H).

7.2.3.15.3 Test description

7.2.3.15.3.1 Pre-test conditions

System Simulator:

- Cell 1.

UE:

None.

Preamble:

- The UE is in state Loopback Activated (state 4) according to [18] with a loop back size of 102 bytes.

7.2.3.15.3.2 Test procedure sequence

Table 7.2.3.15.3.2-1: Main behaviour

St	Procedure	Message Sequence		TP	Verdict
		U - S	Message/PDU/SDU		
1	The SS transmits 1 RLC PDU of 100 data bytes to the UE. SN=7 indicates the loss of 7 PDUs.	<--	AMD PDU#8	-	-
2	The SS transmits one AMD PDU segment of 50 data bytes to the UE. This PDU carries part 1 of PDU#1. SO=0 and LSF=0.	<--	AMD PDU#1 segment 1	-	-
3	The SS transmits one AMD PDU segment of 50 data bytes to the UE. This PDU carries part 2 of PDU#2. SO=50 and LSF=1.	<--	AMD PDU#2 segment 2	-	-
4	The SS transmits one AMD PDU segment of 50 data bytes to the UE. This PDU carries part 1 of PDU#3. SO=0 and LSF=0.	<--	AMD PDU#3 segment 1	-	-
5	The SS transmits one AMD PDU segment of 50 data bytes to the UE. This PDU carries part 2 of PDU#4. SO=50 and LSF=1.	<--	AMD PDU#4 segment 2	-	-
6	The SS transmits one AMD PDU segment of 50 data bytes to the UE. This PDU carries part 1 of PDU#4. SO=0 and LSF=0.	<--	AMD PDU#4 segment 1	-	-
7	The SS transmits one AMD PDU segment of 50 data bytes to the UE. This PDU carries part 2 of PDU#1. SO=50 and LSF=1.	<--	AMD PDU#1 segment 2	-	-
8	Check: Does the UE transmit an RLC SDU with same data contents as received in the corresponding DL PDU segments?	-->	(RLC SDU#1)	1	P
9	The SS transmits one RLC PDU of 50 data bytes to the UE. This PDU carries part 1 of PDU#2. SO=0 and LSF=0.	<--	AMD PDU#2 segment 1	-	-
10	Check: Does the UE transmit an RLC SDU with the same data contents as received in the corresponding DL PDU segments?	-->	(RLC SDU#2)	1	P
11	The SS transmits one RLC PDU of 50 data bytes to the UE. This PDU carries part 2 of PDU#3. SO=50 and LSF=1.	<--	AMD PDU#3 segment 2		
12	Check: Does the UE transmit an RLC SDU with same data contents as received in the corresponding DL PDU segments?	-->	(RLC SDU#3)	1	P
13	Check: Does the UE transmit an RLC SDU with same data contents as received in the corresponding DL PDU segments?	-->	(RLC SDU#4)	1	P
14	The SS transmits an RLC STATUS PDU to the UE. This PDU acks PDUs up to those including SDU#4. ACK_SN=4.	<--	STATUS PDU		
15	The SS transmits one RLC PDU of 50 data bytes to the UE. This PDU carries segment 1 of PDU 7. SO=0 and LSF=0.	<--	AMD PDU#7 segment 1		
16	The SS transmits one RLC PDU of 50 data bytes to the UE. This PDU carries segment 2 of PDU 6. SO=50 and LSF=1.	<--	AMD PDU#6 segment 2		
17	Wait for <i>t-Reordering</i> to run out at the UE side	-			
18	Check: Does the UE transmit a Status Report with NACK_SN=4, NACK_SN=5 with SOStart=0 and SOEnd=49, and NACK_SN=6 with SOStart=50 and SOEnd=special value, and ACK_SN=8?	-->	STATUS PDU	2	P
19	The SS transmits one RLC PDU of 50 data bytes to the UE. This PDU carries part 2 of PDU#7. SO=50 and LSF=1.	<--	AMD PDU#7 segment 2		
20	The SS transmits one RLC PDU of 50 data bytes to the UE. This PDU carries part 1 of PDU#6. SO=0 and LSF=0.	<--	AMD PDU#6 segment 1		
21	The SS transmits one RLC PDU of 50 data	<--	AMD PDU#5		

	bytes to the UE. This PDU carries part 1 of PDU#5. SO=0 and LSF=0.		segment 1		
22	Wait for <i>t-Reordering</i> to run out at the UE side	-			
23	Check: Does the UE transmit a Status Report with NACK_SN=4 with SOStart=0 and SOEnd=49, and ACK_SN=8?	-->	STATUS PDU	2	P
24	The SS transmits one RLC PDU of 50 data bytes to the UE. This PDU carries part 2 of PDU#5. SO=50 and LSF=1.	<--	AMD PDU#5 segment 2		
25	Check: Does the UE transmit an RLC SDU with same data contents as received in the corresponding DL PDU segments?	-->	(RLC SDU#5)	1	P
26	Check: Does the UE transmit an RLC SDU with same data contents as received in the corresponding DL PDU segments?	-->	(RLC SDU#6)	1	P
27	Check: Does the UE transmit an RLC SDU with same data contents as received in the corresponding DL PDU segments?	-->	(RLC SDU#7)	1	P
28	Check: Does the UE transmit an RLC SDU with same data contents as received in the corresponding DL PDU segments?	-->	(RLC SDU#8)	1	P
29	The SS transmits an RLC STATUS PDU to the UE. This PDU acks PDUs up to those including SDU#7.. ACK_SN=8.	<--	STATUS PDU	-	-

7.2.3.15.3.3 Specific message contents

None.

7.2.3.16 AM RLC / Re-transmission of RLC PDU without re-segmentation

7.2.3.16.1 Test Purpose (TP)

(1)

```
with { UE in E-UTRA RRC_CONNECTED state }
ensure that {
  when { UE receives a STATUS PDU including a NACK_SN for missing AMD PDUs and missing AMD PDUs can
fit into within the total size of RLC PDU(s) indicated by lower layer at the particular transmission
opportunity}
then { UE successfully retransmits missing AMD PDUs without re-segmentation}
}
```

(2)

```
with { UE in E-UTRA RRC_CONNECTED state }
ensure that {
  when { NACK received for missing AMD PDUs and RETX_COUNT < maxRetxThreshold }
then { UE retransmits AMD PDUs }
}
```

(3)

```
with { UE in E-UTRA RRC_CONNECTED state }
ensure that {
  when { an AMD PDU or a portion of an AMD PDU is considered for retransmission and if RETX_COUNT =
maxRetxThreshold }
then { UE indicates to upper layers that max retransmission has been reached }
}
```

7.2.3.16.2 Conformance requirements

References: The conformance requirements covered in the present TC are specified in: 3GPP TS 36.322 clause 5.2.1.

[TS 36.322 clause 5.2.1]

The transmitting side of an AM RLC entity can receive a negative acknowledgement (notification of reception failure by its peer AM RLC entity) for an AMD PDU or a portion of an AMD PDU by the following:

- STATUS PDU from its peer AM RLC entity.

When receiving a negative acknowledgement for an AMD PDU or a portion of an AMD PDU by a STATUS PDU from its peer AM RLC entity, the transmitting side of the AM RLC entity shall:

- if the SN of the corresponding AMD PDU falls within the range $VT(A) \leq SN < VT(S)$:
 - consider the AMD PDU or the portion of the AMD PDU for which a negative acknowledgement was received for retransmission.

When an AMD PDU or a portion of an AMD PDU is considered for retransmission, the transmitting side of the AM RLC entity shall:

- if the AMD PDU is considered for retransmission for the first time:
 - set the RETX_COUNT associated with the AMD PDU to zero;
- else, if it (the AMD or the portion of the AMD PDU that is considered for retransmission) or a portion of it is not pending for retransmission already:
 - increment the RETX_COUNT;
- if $RETX_COUNT = maxRetxThreshold$:
 - indicate to upper layers that max retransmission has been reached.

When retransmitting an AMD PDU, the transmitting side of an AM RLC entity shall:

- if the AMD PDU can entirely fit within the total size of RLC PDU(s) indicated by lower layer at the particular transmission opportunity:
 - deliver the AMD PDU as it is except for the P field (the P field should be set according to sub clause 5.2.2) to lower layer;
- otherwise:
 - segment the AMD PDU and form a new AMD PDU segment which will fit within the total size of RLC PDU(s) indicated by lower layer at the particular transmission opportunity and deliver the new AMD PDU segment to lower layer.

When retransmitting a portion of an AMD PDU, the transmitting side of an AM RLC entity shall:

- segment the portion of the AMD PDU as necessary, form a new AMD PDU segment which will fit within the total size of RLC PDU(s) indicated by lower layer at the particular transmission opportunity and deliver the new AMD PDU segment to lower layer.

When forming a new AMD PDU segment, the transmitting side of an AM RLC entity shall:

- only map the Data field of the original AMD PDU to the Data field of the new AMD PDU segment;
- set the header of the new AMD PDU segment in accordance with the description in sub clause 6.;
- set the P field according to sub clause 5.2.2.

7.2.3.16.3 Test description

7.2.3.16.3.1 Pre-test conditions

System Simulator:

- Cell 1.

UE:

None.

Preamble:

- The UE is in state Loopback Activated (state 4) according to [18] with a loopback size of 102 bytes.

7.2.3.16.3.2 Test procedure sequence

Table 7.2.3.16.3.2-1: Main behaviour

St	Procedure	Message Sequence		TP	Verdict
		U - S	Message		
1	The SS transmits one RLC PDU of 100 data bytes. The PDU carries SDU#1.	<--	AMD PDU#1	-	-?
2	Check: Does the UE transmit one RLC PDU which carries SDU#1?	-->	AMD PDU#1 (SN=0)	-	-
3	The SS transmits an RLC STATUS PDU. ACK_SNSN_ACK=1, NACK_SN=0.	<--	STATUS PDU		
4	Check: Does the UE transmit a RLC PDU not yet acknowledged?	-->	AMD PDU#1 (SN=0)	1	P
5	The SS transmits an RLC STATUS PDU. ACK_SN=1.		STATUS PDU		
6	The SS transmits one RLC PDU of 100 data bytes. The PDU carries SDU#2		AMD PDU#2		
7	The UE transmits an RLC PDU which carries SDU#2		AMD PDU#2 (SN=1)		
-	EXCEPTION: Step 10 to 12 shall be repeated <i>maxRetxThreshold</i> times	-	-	-	-
8	The SS transmits an RLC STATUS PDU. ACK_SN =2 and NACK_SN =1.	<--	STATUS PDU		
9	Check: Does the UE retransmit the RLC PDU not yet acknowledged?	-->	AMD PDU#2 (SN=1)	2	P
10	The SS transmits an RLC STATUS PDU. ACK_SN =2 and NACK_SN =1.		STATUS PDU		
11	Check: Does the UE transmit an RRC Connection Re-establishment Request? Note 1		-	3	P
Note 1 The RRC Connection Re-establishment procedure is initiated. See 36.331 cl. 5.3.7.2 and 5.3.11.3.					

7.2.3.16.3.3 Specific message contents

None.

7.2.3.17 AM RLC / Re-segmentation RLC PDU / SO, FI, LSF

7.2.3.17.1 Test Purpose (TP)

(1)

```
with { UE in E-UTRA RRC_CONNECTED state }
ensure that {
  when { AMD PDU to be retransmitted does not fit in new allocated TBS }
then { UE segments AMD PDU into AMD PDU segments }
}
```

(2)

```
with { UE in E-UTRA RRC_CONNECTED state }
ensure that {
  when { AMD PDU segment to be retransmitted does not fit in new allocated TBS }
then { UE resegments AMD PDU segment to fit TBS }
}
```

7.2.3.17.2 Conformance requirements

References: The conformance requirements covered in the present TC are specified in: 3GPP TS 36.322 clauses 4.2.1.3.2, 5.2.1, 6.2.1.4 and 6.2.1.5.

[TS 36.322, clause 4.2.1.3.2]

When the transmitting side of an AM RLC entity forms AMD PDUs from RLC SDUs, it shall:

- segment and/or concatenate the RLC SDUs so that the AMD PDUs fit within the total size of RLC PDU(s) indicated by lower layer at the particular transmission opportunity notified by lower layer.

The transmitting side of an AM RLC entity supports retransmission of RLC data PDUs (ARQ):

- if the RLC data PDU to be retransmitted does not fit within the total size of RLC PDU(s) indicated by lower layer at the particular transmission opportunity notified by lower layer, the AM RLC entity can re-segment the RLC data PDU into AMD PDU segments;
- the number of re-segmentation is not limited.

When the transmitting side of an AM RLC entity forms AMD PDUs from RLC SDUs received from upper layer or AMD PDU segments from RLC data PDUs to be retransmitted, it shall:

- include relevant RLC headers in the RLC data PDU.

[TS 36.322 clause 5.2.1]

...

When retransmitting an AMD PDU, the transmitting side of an AM RLC entity shall:

- if the AMD PDU can entirely fit within the total size of RLC PDU(s) indicated by lower layer at the particular transmission opportunity:
 - deliver the AMD PDU as it is except for the P field (the P field should be set according to sub clause 5.2.2);
- otherwise:
 - segment the AMD PDU and form a new AMD PDU segment which will fit within the total size of RLC PDU(s) indicated by lower layer at the particular transmission opportunity and deliver the new AMD PDU segment to lower layer.

When retransmitting a portion of an AMD PDU, the transmitting side of an AM RLC entity shall:

- segment the portion of the AMD PDU as necessary and form a new AMD PDU segment which will fit within the total size of RLC PDU(s) indicated by lower layer at the particular transmission opportunity and deliver the new AMD PDU segment to lower layer.

When forming a new AMD PDU segment, the transmitting side of an AM RLC entity shall:

- only map the Data field of the original AMD PDU to the Data field of the new AMD PDU segment;
- set the header of the new AMD PDU segment in accordance with the description in sub clause 6.;
- set the P field according to sub clause 5.2.2.

[TS 36.322, clause 6.2.1.4]

AMD PDU consists of a Data field and an AMD PDU header.

AMD PDU header consists of a fixed part (fields that are present for every AMD PDU) and an extension part (fields that are present for an AMD PDU when necessary). The fixed part of the AMD PDU header itself is byte aligned and consists of a D/C, a RF, a P, a FI, an E and a SN. The extension part of the AMD PDU header itself is byte aligned and consists of E(s) and LI(s).

An AMD PDU header consists of an extension part only when more than one Data field elements are present in the AMD PDU, in which case an E and a LI are present for every Data field element except the last. Furthermore, when an AMD PDU header consists of an odd number of LI(s), four padding bits follow after the last LI

....

[TS 36.322, clause 6.2.1.5]

AMD PDU segment consists of a Data field and an AMD PDU segment header.

AMD PDU segment header consists of a fixed part (fields that are present for every AMD PDU segment) and an extension part (fields that are present for an AMD PDU segment when necessary). The fixed part of the AMD PDU segment header itself is byte aligned and consists of a D/C, a RF, a P, a FI, an E, a SN, a LSF and a SO. The extension part of the AMD PDU segment header itself is byte aligned and consists of E(s) and LI(s).

An AMD PDU segment header consists of an extension part only when more than one Data field elements are present in the AMD PDU segment, in which case an E and a LI are present for every Data field element except the last. Furthermore, when an AMD PDU segment header consists of an odd number of LI(s), four padding bits follow after the last LI.

...

7.2.3.17.3 Test description

7.2.3.17.3.1 Pre-test conditions

System Simulator:

- Cell 1.

UE:

None.

Preamble:

- The UE is in state Loopback Activated (state 4) according to [18] with a loop back size of 102 bytes.

7.2.3.17.3.2 Test procedure sequence

Table 7.2.3.17.3.2-1: Main behaviour

St	Procedure	Message Sequence		TP	Verdict
		U - S	Message/PDU/SDU		
1	The SS transmits one AMD PDU of 100 data bytes. This PDU carries SDU#1.	<--	AMD PDU#1		
2	Check: Does the UE transmit an AMD PDU with the same data contents as received in the corresponding part of DL PDU#1?	-->	AMD PDU#1 (SN=0)		
3	The SS transmits one AMD PDU of 100 data bytes. This PDU carries SDU#2.	<--	AMD PDU#2		
4	Check: Does the UE transmit an AMD PDU with the same data contents as received in the corresponding part of DL PDU#2?	-->	AMD PDU#2 (SN=1)		
5	SS responds to any scheduling requests from the UE by transmitting UL grants of size 472 bits (Note 1).	<--	(UL grants, 472 bits)	-	-
6	The SS transmits a STATUS PDU. This PDU nacks the AMD PDU with SN=0. NACK_SN=0 and ACK_SN=2.	<--	STATUS PDU		
7	Check: Does the UE transmit an AMD PDU segment with SO=0, LSF=0 and the same data contents at the received positions as in the original AMD PDU?	-->	AMD PDU#1 segment 1 (SN=0)	1	P
8	Check: Does the UE transmit an AMD PDU segment with SO=<x>, LSF=1 and the same data contents at the received positions as in the original AMD PDU? (Note 3)	-->	AMD PDU#1 segment 2 (SN=0)	1	P
9	SS responds to any scheduling requests from the UE by transmitting UL grants of size 328 bits (Note 2).	<--	(UL grants, 328 bits)	-	-
10	The SS transmits a STATUS PDU. This PDU nacks the AMD PDU with SN=0. NACK_SN=0, SOStart=0, SOEnd=<x-1> and ACK_SN =2. (Note 3)	<--	STATUS PDU	-	-
11	Check: Does the UE transmit an AMD PDU segment with SO=0, LSF=0 and the same data contents at the received positions as in the original AMD PDU?	-->	AMD PDU#1 segment 1, 1 st part (SN=0)	2	P
12	Check: Does the UE transmit an AMD PDU segment with SO=<y>, LSF=0 and the same data contents at the received positions as in the original AMD PDU? (Note 3)	-->	AMD PDU#1 segment 2, 2 nd part (SN=0)	2	P
13	The SS transmits a STATUS PDU. This PDU acks the AMD PDUs with SN=0 and SN=1. ACK_SN=2.	<--	STATUS PDU	-	-
Note 1	UL grant of 472 bits ($I_{TBS}=7$, $N_{PRB}=4$, see TS 36.213 Table 7.1.7.2.1-1) is chosen such that UE will segment into 2 AMD PDUs. MAC PDU of 472 bits=59 bytes fits an AMD PDU payload of ≥ 50 bytes + 2 bytes AMD PDU header + 2 bytes of segment header + ? bytes spare for MAC header and possible RLC STATUS PDU and BSR report.				
Note 2	UL grant of 328 bits ($I_{TBS}=5$, $N_{PRB}=4$, see TS 36.213 Table 7.1.7.2.1-1) is chosen such that UE will segment into 2 AMD PDUs. MAC PDU of 328 bits=41 bytes fits an AMD PDU payload of ≥ 25 bytes + 2 bytes AMD PDU header + 2 bytes of segment header + ? bytes spare for MAC header and possible RLC STATUS PDU and BSR report.				
Note 3	The values x and y depend upon the need of the UE to add RLC STATUS PDU and BSR report. The TBS has been chosen to ensure that the PDUs to be resegmented can be carried in 2 segments.				

7.2.3.17.3.3 Specific message contents

None.

7.2.3.18 AM RLC / Reassembly / AMD PDU reassembly from AMD PDU segments; Segmentation Offset and Last Segment Flag fields

7.2.3.18.1 Test Purpose (TP)

(1)

```
with { UE in E-UTRAN RRC_CONNECTED state }
ensure that {
  when { UE receives AM PDU segments }
  then { UE delivers reassembled RLC SDU to upper layer }
}
```

(2)

```
with { UE in E-UTRAN RRC_CONNECTED state }
ensure that {
  when { UE receives RLC AM PDU segments without segment header extension part }
  then { UE correctly reassembles RLC AMD PDU segments into RLC AMD PDUs }
}
```

(3)

```
with { UE in E-UTRAN RRC_CONNECTED state }
ensure that {
  when { UE receives RLC AM PDU segments with segment header extension part }
  then { UE correctly reassembles RLC AMD PDU segments into RLC AMD PDUs }
}
```

(4)

```
with { UE in E-UTRAN RRC_CONNECTED state }
ensure that {
  when { UE receives duplicate RLC AM PDU segments }
  then { UE discards duplicate RLC AMD PDU segments }
}
```

(5)

```
with { UE in E-UTRA RRC_CONNECTED state }
ensure that {
  when { UE receives RLC AM PDU segments out of sequence }
  then { UE delivers reassembled RLC SDU to upper layer }
}
```

(6)

```
with { UE in E-UTRAN RRC_CONNECTED state }
ensure that {
  when { UE receives RLC AMD PDU segments with segments lost }
  then { UE transmits STATUS PDU to request retransmission of missing segments }
}
```

(7)

```
with { UE in E-UTRAN RRC_CONNECTED state }
ensure that {
  when { UE receives overlapping RLC AMD PDU segments }
  then { UE discards duplicate RLC AMD PDU byte segments }
}
```

7.2.3.18.2 Conformance requirements

References: The conformance requirements covered in the present TC are specified in: 3GPP TS 36.322 clauses 4.2.1.3.3, 5.1.3.2.2, 6.2.1.4 and 6.2.1.5.

[TS 36.322, clause 4.2.1.3.3]

When the receiving side of an AM RLC entity receives RLC data PDUs, it shall:

- detect whether or not the RLC data PDUs have been received in duplication, and discard duplicated RLC data PDUs;
- reorder the RLC data PDUs if they are received out of sequence;

- detect the loss of RLC data PDUs at lower layers and request retransmissions to its peer AM RLC entity;
- reassemble RLC SDUs from the reordered RLC data PDUs and deliver the RLC SDUs to upper layer in sequence.

...

[TS 36.322, clause 5.1.3.2.2]

When a RLC data PDU is received from lower layer, where the RLC data PDU contains byte segment numbers y to z of an AMD PDU with SN = x , the receiving side of an AM RLC entity shall:

- if x falls outside of the receiving window; or
- if byte segment numbers y to z of the AMD PDU with SN = x have been received before:
 - discard the received RLC data PDU;
- else:
 - place the received RLC data PDU in the reception buffer;
 - if some byte segments of the AMD PDU contained in the RLC data PDU have been received before:
 - discard the duplicate byte segments.

[TS 36.322, clause 6.2.1.4]

AMD PDU consists of a Data field and an AMD PDU header.

AMD PDU header consists of a fixed part (fields that are present for every AMD PDU) and an extension part (fields that are present for an AMD PDU when necessary). The fixed part of the AMD PDU header itself is byte aligned and consists of a D/C, a RF, a P, a FI, an E and a SN. The extension part of the AMD PDU header itself is byte aligned and consists of E(s) and LI(s).

An AMD PDU header consists of an extension part only when more than one Data field elements are present in the AMD PDU, in which case an E and a LI are present for every Data field element except the last. Furthermore, when an AMD PDU header consists of an odd number of LI(s), four padding bits follow after the last LI.

[TS 36.322, clause 6.2.1.5]

AMD PDU segment consists of a Data field and an AMD PDU segment header.

AMD PDU segment header consists of a fixed part (fields that are present for every AMD PDU segment) and an extension part (fields that are present for an AMD PDU segment when necessary). The fixed part of the AMD PDU segment header itself is byte aligned and consists of a D/C, a RF, a P, a FI, an E, a SN, a LSF and a SO. The extension part of the AMD PDU segment header itself is byte aligned and consists of E(s) and LI(s).

An AMD PDU segment header consists of an extension part only when more than one Data field elements are present in the AMD PDU segment, in which case an E and a LI are present for every Data field element except the last. Furthermore, when an AMD PDU segment header consists of an odd number of LI(s), four padding bits follow after the last LI.

...

7.2.3.18.3 Test description

7.2.3.18.3.1 Pre-test conditions

System Simulator:

- Cell 1.

UE:

None.

Preamble:

- The UE is in state Loopback Activated (state 4) according to [18] with a loop back size of 98 bytes.

7.2.3.18.3.2 Test procedure sequence

Table 7.2.3.18.3.2-1: Main behaviour

St	Procedure	Message Sequence		TP	Verdict
		U - S	Message/PDU/SDU		
1	The SS transmits an AMD PDU of size 50 data bytes. This PDU carries the 1 st part of SDU#1. This PDU is in error (SN falls outside of the receiving window) and is to be discarded by the UE.	<--	AMD PDU#1	-	-
2	The SS transmits an AMD PDU of size 100 data bytes with the P-bit set. This PDU carries SDU#2.	<--	AMD PDU#2	-	-
3	The UE transmits a STATUS PDU NACK_SN field indicating missing PDU#1. ACK_SN=2, NACK_SN=0.	-->	STATUS PDU	-	-
4	The SS transmits a 50 data byte segment of AMD PDU#1 (AMD PDU#1 carries SDU#1). SO=0 and LSF=0. No header extension part is provided.	<--	AMD PDU#1 segment 1	-	-
5	The SS transmits a 50 data byte segment of AMD PDU#1 (AMD PDU#1 carries SDU#1) with the P-bit set. SO=50 and LSF=1. No header extension part is provided.	<--	AMD PDU #1 segment 2	-	-
6	Check: Does the UE transmit a STATUS PDU with ACK_SN=2, thus acknowledging the reception of PDUs with SN=0 and SN=1, and no NACK_SN provided?	-->	STATUS PDU	2	P
7	Check: Does the UE transmit RLC SDU#1?	-->	(RLC SDU#1)	1	P
8	The UE transmits RLC SDU#2.	-->	(RLC SDU#2)	-	-
9	The SS transmits a 50 data byte segment of AMD PDU#3 (AMD PDU#3 carries SDU#3 and SDU#4) with the P-bit set. This PDU segment carries the last part of SDU#4. FI=10, SO=150 and LSF=1. No header extension part is provided.	<--	AMD PDU#3 segment 2	-	-
10	The UE transmits a STATUS PDU NACK_SN field for receipt of PDU#3. ACK_SN=3, NACK_SN=2, SOStart=0/SOEnd=149.	-->	STATUS PDU	-	-
11	The SS transmits a 150 data byte segment of AMD PDU#3 (AMD PDU#3 carries SDU#3 and SDU#4) with the P-bit set. This PDU segment carries SDU#3 and the first part of SDU#4. FI=01, SO=0 and LSF=0. Header extension part present: E in fixed part header=1, E in extension part header=0, LI=100.	<--	AMD PDU#3 segment 1	-	-
12	Check: Does the UE transmit a STATUS PDU with ACK_SN=3?	-->	STATUS PDU	3	P
13	The UE transmits RLC SDU#3.	-->	RLC SDU#3	-	-
14	Check: Does the UE transmit RLC SDU#4?	-->	RLC SDU#4	1,5	P
15	The SS transmits a 50 data byte segment of AMD PDU#4 (AMD PDU#4 carries SDU#5). This PDU segment carries the first segment of PDU#4. SO=0 and LSF=0. No header extension part is provided.	<--	AMD PDU#4 segment 1	-	-
16	The SS transmits a 50 data byte segment of AMD PDU#4 (AMD PDU#4 carries SDU#5). This PDU segment carries the first segment of PDU#4. SO=0 and LSF=0. No header extension part is provided.	<--	AMD PDU#4 segment 1	-	-
17	The SS transmits a 50 data byte segment of AMD PDU#4 (AMD PDU#4 carries SDU#5) with the P-bit set. This PDU segment carries the second segment of PDU#4. SO=50 and LSF=1. No header extension part is provided.	<--	AMD PDU#4 segment 2	-	-
18	Check: Does the UE transmit a STATUS PDU with ACK_SN=4, thus acknowledging the	-->	STATUS PDU	4	P

	reception of PDUs with SN=0 to SN=3, and no NACK_SN provided?				
19	Check: Does the UE transmit RLC SDU#5?	-->	RLC SDU#5	1	P
20	The SS transmits a 50 data byte segment of AMD PDU#6 (AMD PDU#6 carries SDU#7) with the P-bit set. This PDU segment is sent with SN 5 and carries the second segment of PDU#6. SO=50 and LSF=1. No header extension part is provided.	<--	AMD PDU#6 segment 2	-	-
21	Check: Does the UE transmit a STATUS PDU with ACK_SN=6, thus acknowledging the reception of PDUs with SN=0 to SN=5, and NACK_SN=4, E1/E2 field for receipt of PDU#5 and NACK_SN=5, SOStart=0/SOEnd=49 for segment 1 of PDU#6?	-->	STATUS PDU	6	P
22	The SS transmits a 50 data byte segment of AMD PDU#6 (AMD PDU#6 carries SDU#7). This PDU segment carries the first segment of PDU#6. SO=0 and LSF=0. No header extension part is provided.	<--	AMD PDU#6 segment 1	-	-
23	The SS transmits one AMD PDU of size 100 data bytes with the P-bit set. This PDU carries PDU#5. PDU#5 carries SDU#6.	<--	AMD PDU#5	-	-
24	The UE transmits a STATUS PDU with ACK_SN=6, thus acknowledging the reception of PDUs with SN=0 to SN=5, and no NACK_SN provided.	-->	STATUS PDU	-	-
25	The UE transmits RLC SDU#6.	-->	(RLC SDU#6)	-	-
26	Check: Does the UE transmit RLC SDU#7?	-->	(RLC SDU#7)	2,5	P
27	The SS transmits a 120 data byte segment of AMD PDU#7 (AMD PDU#7 carries SDU#8, SDU#9 and SDU#10) with the P-bit set. This PDU segment carries the last part of SDU#9 and SDU#10. FI=10, SO=180 and LSF=1. Header extension part present: E in fixed part header=1, E in extension part header=0, LI=20.	<--	AMD PDU#7 segment 3	-	-
28	The UE transmits a STATUS PDU NACK_SN field for receipt of PDU#7. ACK_SN=7, NACK_SN=6, SOStart=0/SOEnd=179.	-->	STATUS PDU	-	-
29	The SS transmits a 120 data byte segment of AMD PDU#7 (AMD PDU#7 carries SDU#8, SDU#9 and SDU#10) with the P-bit set. This PDU segment carries the last part of SDU#8 and SDU#9, and overlaps with the PDU segment sent at Step 27. FI=10, SO=80 and LSF=0. Header extension part present: E in fixed part header=1, E in extension part header=0, LI=20.	<--	AMD PDU#7 segment 2	-	-
30	The UE transmits a STATUS PDU NACK_SN field for receipt of PDU#7. ACK_SN=7, NACK_SN=6, SOStart=0/SOEnd=79.	-->	STATUS PDU	7	P
31	The SS transmits a 80 data byte segment of AMD PDU#7 (AMD PDU#7 carries SDU#8, SDU#9 and SDU#10) with the P-bit set. This PDU segment carries the first part of SDU#8. SO=0 and LSF=0. No header extension part is provided.	<--	AMD PDU#7 segment 1	-	-
32	Check: Does the UE transmit a STATUS PDU with ACK_SN=7, thus acknowledging the reception of PDUs with SN=0 to SN=6, and no NACK_SN provided?	-->	STATUS PDU	7	P
33	Check: Does the UE transmit RLC SDU#8?	-->	RLC SDU#8	7	P
34	Check: Does the UE transmit RLC SDU#9?	-->	RLC SDU#9	7	P
35	Check: Does the UE transmit RLC SDU#10?	-->	RLC SDU#10	7	P

7.2.3.18.3.3 Specific message contents

None.

7.2.3.19 Void

7.2.3.20 AM RLC / Duplicate detection of RLC PDUs

7.2.3.20.1 Test Purpose (TP)

(1)

```
with { UE in E-UTRA RRC_CONNECTED state }  
ensure that {  
  when { UE is in AM mode and receives duplicated RLC data PDUs having the same sequence number }  
  then { UE discards the duplicated RLC data PDUs }  
}
```

7.2.3.20.2 Conformance requirements

References: The conformance requirements covered in the current TC are specified in: TS 36.322, clause 4.2.1.3.3.

[TS 36.322, clause 4.2.1.3.3]

When the receiving side of an AM RLC entity receives RLC data PDUs, it shall:

- detect whether or not the RLC data PDUs have been received in duplication, and discard duplicated RLC data PDUs;

...

7.2.3.20.3 Test description

7.2.3.20.3.1 Pre-test conditions

System Simulator:

- Cell 1.

UE:

None.

Preamble:

- The UE is in state Loopback Activated (state 4) according to [18].

7.2.3.20.3.2 Test procedure sequence

Table 7.2.3.20.3.2-1: Main behaviour

St	Procedure	Message Sequence		TP	Verdict
		U - S	Message		
1	SS creates 3 RLC SDUs of size 40 bytes segmented into two AMD PDUs each. AMD PDU#1 and AMD PDU#2 belongs to RLC SDU#1, AMD PDU#3 and #4 belongs to RLC SDU#2 and AMD PDU#5 and #6 belongs to RLC SDU#3. SS transmits AMD PDU#1 with SN=0, AMD PDU#2 with SN=1 and AMD PDU#3 twice with SN=2.	<--	RLC AMD PDU#1 (SN=0) RLC AMD PDU#2 (SN=1) RLC AMD PDU#3 (SN=2) RLC AMD PDU#3 (SN=2)	1	-
2	Check: Does the UE transmit RLC SDU#1? (Note 1)	-->	(RLC SDU#1)	1	P
3	SS transmits AMD PDU#4 with SN=3.	<--	RLC AMD PDU#4 (SN=3)	1	-
4	Check: Does the UE transmit RLC SDU#2?	-->	(RLC SDU#2)	1	P
5	SS transmits AMD PDU#6 twice with SN=5.	<--	RLC AMD PDU#6 (SN=5) RLC AMD PDU#6 (SN=5)	1	-
6	SS transmits AMD PDU#5 twice with SN=4.	<--	RLC AMD PDU#5 (SN=4) RLC AMD PDU#5 (SN=4)	1	-
7	Check: Does the UE transmit RLC SDU#3 once? (Note 2)	-->	(RLC SDU#3)	1	P
Note 1	The duplicated AMD PDU#3 have been discarded by the conformant UE in step 1.				
Note 2	The duplicated AMD PDU#5 and AMD PDU#6 have been discarded by the conformant UE in steps 5 and 6.				

7.2.3.20.3.3 Specific message content

None.

7.2.3.21 AM RLC / RLC re-establishment at RRC Connection reconfiguration including *mobilityControlInfo* IE

7.2.3.21.1 Test Purpose (TP)

(1)

```

with { UE in E-UTRA RRC_CONNECTED state }
ensure that {
  when { UE is requested to perform a RRC Connection reconfiguration including mobilityControlInfo IE }
  then { the UE discards the remaining AMD PDUs; and discards all RLC SDUs in the transmitting side; and reset all state variables to their initial values. }
}

```

7.2.3.21.2 Conformance requirements

References: The conformance requirements covered in the current TC are specified in: TS 36.322, clause 5.4 and TS 36.331 clause 5.3.5.4.

[TS 36.322, clause 5.4]

RLC re-establishment is performed upon request by RRC, and the function is applicable for AM, UM and TM RLC entities.

When RRC indicates that an RLC entity should be re-established, the RLC entity shall:

...

- if it is an AM RLC entity:

- when possible, reassemble RLC SDUs from any byte segments of AMD PDUs with SN < VR(MR) in the receiving side, remove RLC headers when doing so and deliver all reassembled RLC SDUs to upper layer in sequence, if not delivered before;
- discard the remaining AMD PDUs and byte segments of AMD PDUs in the receiving side;
- discard all RLC SDUs and AMD PDUs in the transmitting side;
- discard all RLC control PDUs.
- stop and reset all timers;
- reset all state variables to their initial values.

[TS 36.331, clause 5.3.5.4]

If the *RRConnectionReconfiguration* message includes the *mobilityControlInfo* and the UE is able to comply with the configuration included in this message, the UE shall:

....

- 1> re-establish RLC for all RBs that are established;

7.2.3.21.3 Test description

7.2.3.21.3.1 Pre-test conditions

System Simulator:

- Cell 1.

UE:

None.

Preamble:

- The UE is in state Loopback Activated (state 4) according to [18].

7.2.3.21.3.2 Test procedure sequence

Table 7.2.3.21.3.2-1: Main behaviour

St	Procedure	Message Sequence		TP	Verdict
		U - S	Message		
1	SS creates 3 RLC SDUs of size 40 bytes segmented into two AMD PDUs each. AMD PDU#1 and AMD PDU#2 belong to RLC SDU#1, AMD PDU#3 and #4 belongs to RLC SDU#2 and AMD PDU#5 and #6 belongs to RLC SDU#3. SS transmits AMD PDU#1 (SN=0), AMD PDU#2 (SN=1) and AMD PDU#4 (SN=3).	<--	AMD PDU#1 AMD PDU#2 AMD PDU#4	-	-
2	Check: Does the UE return RLC SDU#1?	-->	(RLC SDU#1)	1	P
3	SS does not acknowledge the reception of RLC SDU#1.	-	-	-	-
4	SS performs a RRC Connection Reconfiguration procedure including the <i>mobilityControlInfo</i> IE triggering RLC-reestablishment. (Note 1)	-	-	-	-
5	SS transmits AMD PDU#5 with SN=0 and the P field set to "1"	<--	AMD PDU#5	-	-
6	Check: Does the UE transmit a RLC STATUS PDU report indicating that the AMD PDU with SN=2 is missing? (Note 2)	-->	RLC STATUS PDU	1	F
7	SS transmits AMD PDU#6 with SN=Receiving_AM_Window_Size+2	<--	AMD PDU#6	1	-
8	Check: Does the UE return RLC SDU#3 within 1s? See Note 3.	-->	(RLC SDU#3)	1	F
9	SS transmits AMD PDU#6 with SN=2	<--	AMD PDU#6	1	-
10	Check: Does the UE return RLC SDU#3 with its first AMD PDU set to SN=0?	-->	(RLC SDU#3)	1	P
Note 1	Upon a RLC re-establishment a conformant UE discards any remaining AMD PDUs in the receiver and transmitter side, stops and resets all timers and resets all state variables to their initial values.				
Note 2	AMD PDU#4 is discarded by a conformant UE in step 4.				
Note 3	AMD PDU#6 is discarded by a conformant UE due to being outside the receiving window size.				

7.2.3.21.3.3 Specific message contents

Table 7.2.3.21.3.3-1: *RRCConnectionReconfiguration* (step 4)

Derivation Path: 36.508 table 4.6.1-8: <i>RRCConnectionReconfiguration</i> , condition HO			
Information Element	Value/remark	Comment	Condition
<i>RRCConnectionReconfiguration</i> ::= SEQUENCE {			
criticalExtensions CHOICE {			
c1 CHOICE{			
rrcConnectionReconfiguration-r8 SEQUENCE {			
mobilityControlInfo SEQUENCE {			
targetPhysCellId	Set to the physical cell identity of cell 1		
carrierFreq	Not present		
}			
radioResourceConfigCommon	Not present		
}			
}			
}			
}			

7.3 PDCP

7.3.1 Maintenance of PDCP sequence numbers for radio bearers

7.3.1.1 Maintenance of PDCP sequence numbers (user plane, RLC AM)

7.3.1.1.1 Test Purpose (TP)

(1)

```
with { UE in E-UTRA RRC_CONNECTED state }
ensure that {
  when { UE transmits a PDCP Data SDU on a DRB mapped on AM RLC }
  then { UE increments SN with 1 for each transmitted PDU for SN=0 to Maximum_PDCP_SN }
}
```

(2)

```
with { UE in E-UTRA RRC_CONNECTED state }
ensure that {
  when { UE transmits a PDCP Data SDU on a DRB mapped on AM RLC and Next_PDCP_TX_SN reach the
Maximum_PDCP_SN limit }
  then { UE sets SN to 0 in the next transmitted PDCP SDU}
}
```

7.3.1.1.2 Conformance requirements

References: The conformance requirements covered in the present TC are specified in: 3GPP TS 36.323 clause 5.1.1, 5.1.2.2 and 6.2.3.

[TS 36.323, clause 5.1.1]

At reception of a PDCP SDU from upper layers, the UE shall:

- start the Discard_Timer associated with this PDCP SDU (if configured);

For a PDCP SDU received from upper layers, the UE shall:

- associate the PDCP SN corresponding to Next_PDCP_TX_SN to this PDCP SDU;
- perform header compression of the PDCP SDU (if configured) as specified in the subclause 5.5.4;
- perform integrity protection (if applicable), and ciphering (if applicable) using COUNT based on TX_HFN and the PDCP SN associated with this PDCP SDU as specified in the subclause 5.7 and 5.6, respectively;
- increment Next_PDCP_TX_SN by one;
- if Next_PDCP_TX_SN > Maximum_PDCP_SN:
 - set Next_PDCP_TX_SN to 0;
 - increment TX_HFN by one;
- submit the resulting PDCP Data PDU to lower layer.

[TS 36.323, clause 5.1.2.1.2]

For DRBs mapped on RLC AM, at reception of a PDCP Data PDU from lower layers, the UE shall:

- if received PDCP SN – Last_Submitted_PDCP_RX_SN > Reordering_Window or 0 <= Last_Submitted_PDCP_RX_SN – received PDCP SN < Reordering_Window:
- if received PDCP SN > Next_PDCP_RX_SN:
 - decipher the PDCP PDU as specified in the subclause 5.6, using COUNT based on RX_HFN - 1 and the received PDCP SN;
- else:

- decipher the PDCP PDU as specified in the subclause 5.6, using COUNT based on RX_HFN and the received PDCP SN;
- perform header decompression (if configured) as specified in the subclause 5.5.5;
- discard this PDCP SDU;
- else if $\text{Next_PDCP_RX_SN} - \text{received PDCP SN} > \text{Reordering_Window}$:
 - increment RX_HFN by one;
 - use COUNT based on RX_HFN and the received PDCP SN for deciphering the PDCP PDU;
 - set Next_PDCP_RX_SN to the received PDCP SN + 1;
- else if $\text{received PDCP SN} - \text{Next_PDCP_RX_SN} > \text{Reordering_Window}$:
 - use COUNT based on $\text{RX_HFN} - 1$ and the received PDCP SN for deciphering the PDCP PDU;
- else if $\text{received PDCP SN} \geq \text{Next_PDCP_RX_SN}$:
 - use COUNT based on RX_HFN and the received PDCP SN for deciphering the PDCP PDU;
 - set Next_PDCP_RX_SN to the received PDCP SN + 1;
- if Next_PDCP_RX_SN is larger than Maximum_PDCP_SN:
 - set Next_PDCP_RX_SN to 0;
 - increment RX_HFN by one;
- else if $\text{received PDCP SN} < \text{Next_PDCP_RX_SN}$:
 - use COUNT based on RX_HFN and the received PDCP SN for deciphering the PDCP PDU;
- if the PDCP PDU has not been discarded in the above:
 - perform deciphering and header decompression (if configured) for the PDCP PDU as specified in the subclauses 5.6 and 5.5.5, respectively;
- if a PDCP SDU with the same PDCP SN is stored:
 - discard this PDCP SDU;
- else:
 - store the PDCP SDU;
- if the PDCP PDU received by PDCP is not due to the re-establishment of lower layers:
 - deliver to upper layers in ascending order of the associated COUNT value:
 - all stored PDCP SDU(s) with an associated COUNT value less than the COUNT value associated with the received PDCP SDU;
 - all stored PDCP SDU(s) with consecutively associated COUNT value(s) starting from the COUNT value associated with the received PDCP SDU;
 - set Last_Submitted_PDCP_RX_SN to the PDCP SN of the last PDCP SDU delivered to upper layers;
- else if $\text{received PDCP SN} = \text{Last_Submitted_PDCP_RX_SN} + 1$:
 - deliver to upper layers in ascending order of the associated COUNT value:
 - all stored PDCP SDU(s) with consecutively associated COUNT value(s) starting from the COUNT value associated with the received PDCP SDU;
 - set Last_Submitted_PDCP_RX_SN to the PDCP SN of the last PDCP SDU delivered to upper layers.

[TS 36.323, clause 6.2.3]

Figure 6.2.3.1 shows the format of the PDCP Data PDU when a 12 bit SN length is used. This format is applicable for PDCP Data PDUs carrying data from DRBs mapped on RLC AM or RLC UM.

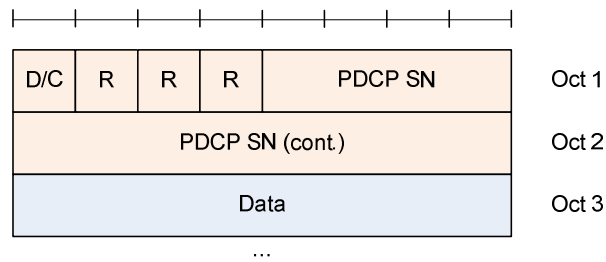

Figure 6.2.3.1: PDCP Data PDU format for DRBs using a 12 bit SN

7.3.1.1.3 Test description

7.3.1.1.3.1 Pre-test conditions

System Simulator

- Cell 1
- SS PDCP set to Transparent Mode

UE:

None.

Preamble

- The UE is in state Loopback Activated (state 4) according to [18].

7.3.1.1.3.2 Test procedure sequence

Table 7.3.1.1.3.2-1: Main behaviour

St	Procedure	Message Sequence		TP	Verdict
		U - S	Message		
-	EXCEPTION: Steps 1 and 2 shall be repeated for k=0 to Maximum_PDCP_SN (increment=1).				
1	SS transmits a PDCP Data PDU on DRB1 containing one IP packet without header compression.	<--	PDCP Data PDU (SN = k)		
2	CHECK: Does UE transmit a PDCP Data PDU with SN=0 for the first iteration and then incremented by 1 at each iteration?	-->	PDCP Data PDU (SN = k)	1	P
3	SS transmits a PDCP Data PDU on DRB1 containing one IP packet without header compression.	<--	PDCP Data PDU (SN = 0)		
4	CHECK: Does UE transmit a PDCP Data PDU with SN=0?	-->	PDCP Data PDU (SN = 0)	2	P
5	SS sends a PDCP Data PDU on DRB1 containing one IP packet without header compression.	<--	PDCP Data PDU (SN = 1)		
6	CHECK: Does UE transmit a PDCP Data PDU with SN=1?	-->	PDCP Data PDU (SN = 1)	1	P

7.3.1.1.3.3 Specific message contents

None

7.3.1.2 Maintenance of PDCP sequence numbers (user plane, RLC UM, short PDCP SN (7 bits))

7.3.1.2.1 Test Purpose (TP)

(1)

```
with { UE in E-UTRA RRC_CONNECTED state }
ensure that {
  when { UE transmits a PDCP Data SDU on a DRB mapped on UM RLC and configured for short PDCP SN
size (7 bits) }
  then { UE increments SN with 1 for each transmitted PDU for SN=0 to Maximum_PDCP_SN }
}
```

(2)

```
with { UE in E-UTRA RRC_CONNECTED state }
ensure that {
  when { UE transmits a PDCP Data SDU on a DRB mapped on UM RLC and configured for short PDCP SN
size (7 bits); and Next_PDCP_TX_SN reach the Maximum_PDCP_SN limit }
  then { UE sets SN to 0 in the next transmitted PDCP SDU}
}
```

7.3.1.2.2 Conformance requirements

References: The conformance requirements covered in the present TC are specified in: 3GPP TS 36.323 clause 5.1.1 , 5.1.2.1.3 and 6.2.4.

[TS 36.323, clause 5.1.1]

At reception of a PDCP SDU from upper layers, the UE shall:

- start the Discard_Timer associated with this PDCP SDU (if configured);

For a PDCP SDU received from upper layers, the UE shall:

- associate the PDCP SN corresponding to Next_PDCP_TX_SN to this PDCP SDU;
- perform header compression of the PDCP SDU (if configured) as specified in the subclause 5.5.4;
- perform integrity protection (if applicable), and ciphering (if applicable) using COUNT based on TX_HFN and the PDCP SN associated with this PDCP SDU as specified in the subclause 5.7 and 5.6, respectively;
- increment Next_PDCP_TX_SN by one;
- if Next_PDCP_TX_SN > Maximum_PDCP_SN:
 - set Next_PDCP_TX_SN to 0;
 - increment TX_HFN by one;
- submit the resulting PDCP Data PDU to lower layer.

[TS 36.323, clause 5.1.2.1.3]

For DRBs mapped on RLC UM, at reception of a PDCP Data PDU from lower layers, the UE shall:

- if received PDCP SN < Next_PDCP_RX_SN:
 - increment RX_HFN by one;
- decipher the PDCP Data PDU using COUNT based on RX_HFN and the received PDCP SN as specified in the subclause 5.6;
- set Next_PDCP_RX_SN to the received PDCP SN + 1;

- if Next_PDCP_RX_SN > Maximum_PDCP_SN:
 - set Next_PDCP_RX_SN to 0;
 - increment RX_HFN by one;
- perform header decompression (if configured) of the deciphered PDCP Data PDU as specified in the subclause 5.5.5;
- deliver the resulting PDCP SDU to upper layer.

[TS 36.323, clause 6.2.4]

Figure 6.2.4.1 shows the format of the PDCP Data PDU when a 7 bit SN length is used. This format is applicable for PDCP Data PDUs carrying data from DRBs mapped on RLC UM.

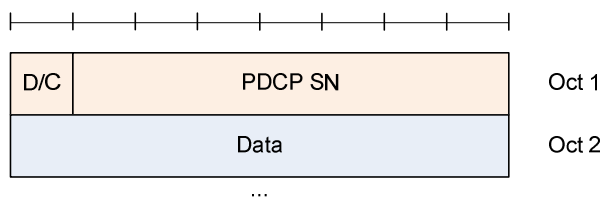

Figure 6.2.4.1: PDCP Data PDU format for DRBs using 7 bit SN

7.3.1.2.3 Test description

7.3.1.2.3.1 Pre-test conditions

System Simulator

- Cell 1
- SS PDCP set to Transparent Mode

UE:

None.

Preamble

- The UE is in state Loopback Activated (state 4) according to [18] with a RLC UM bearer.

7.3.1.2.3.2 Test procedure sequence

Table 7.3.1.2.3.2-1: Main behaviour

St	Procedure	Message Sequence		TP	Verdict
		U - S	Message		
-	EXCEPTION: Steps 1 and 2 shall be repeated for k=0 to Maximum_PDCP_SN (increment=1).				
1	SS transmits a PDCP Data PDU on DRB1 containing one IP packet without header compression.	<--	PDCP Data PDU (SN = k)		
2	CHECK: Does UE transmit a PDCP Data PDU with SN=0 for the first iteration and then incremented by 1 at each iteration?	-->	PDCP Data PDU (SN = k)	1	P
3	SS transmits a PDCP Data PDU on DRB1 containing one IP packet without header compression.	<--	PDCP Data PDU (SN = 0)		
4	CHECK: Does UE transmit a PDCP Data PDU with SN=0?	-->	PDCP Data PDU (SN = 0)	2	P
5	SS sends a PDCP Data PDU on DRB1	<--	PDCP Data PDU (SN = 1)		

	containing one IP packet without header compression.				
6	CHECK: Does UE transmit a PDCP Data PDU with SN=1?	-->	PDCP Data PDU (SN = 1)	1	P

7.3.1.2.3.3 Specific message contents

None

7.3.1.3 Maintenance of PDCP sequence numbers (user plane, RLC UM, long PDCP SN (12 bits))

7.3.1.3.1 Test Purpose (TP)

(1)

```
with { UE in E-UTRA RRC_CONNECTED state }
ensure that {
  when { UE transmits a PDCP Data SDU on a DRB mapped on UM RLC and configured for long PDCP SN size (12 bits) }
  then { UE increments SN with 1 for each transmitted PDU for SN=0 to Maximum_PDCP_SN }
}
```

(2)

```
with { UE in E-UTRA RRC_CONNECTED state }
ensure that {
  when { UE transmits a PDCP Data SDU on a DRB mapped on UM RLC and configured for long PDCP SN size (12 bits); and Next_PDCP_TX_SN reach the Maximum_PDCP_SN limit }
  then { UE sets SN to 0 in the next transmitted PDCP SDU }
}
```

7.3.1.3.2 Conformance requirements

References: The conformance requirements covered in the present TC are specified in: 3GPP TS 36.323 clause 5.1.1 , 5.1.2.1.3 and 6.2.3.

[TS 36.323, clause 5.1.1]

At reception of a PDCP SDU from upper layers, the UE shall:

- start the Discard_Timer associated with this PDCP SDU (if configured);

For a PDCP SDU received from upper layers, the UE shall:

- associate the PDCP SN corresponding to Next_PDCP_TX_SN to this PDCP SDU;
- perform header compression of the PDCP SDU (if configured) as specified in the subclause 5.5.4;
- perform integrity protection (if applicable), and ciphering (if applicable) using COUNT based on TX_HFN and the PDCP SN associated with this PDCP SDU as specified in the subclause 5.7 and 5.6, respectively;
- increment Next_PDCP_TX_SN by one;
- if Next_PDCP_TX_SN > Maximum_PDCP_SN:
 - set Next_PDCP_TX_SN to 0;
 - increment TX_HFN by one;
- submit the resulting PDCP Data PDU to lower layer.

[TS 36.323, clause 5.1.2.1.3]

For DRBs mapped on RLC UM, at reception of a PDCP Data PDU from lower layers, the UE shall:

- if received PDCP SN < Next_PDCP_RX_SN:
 - increment RX_HFN by one;

- decipher the PDCP Data PDU using COUNT based on RX_HFN and the received PDCP SN as specified in the subclause 5.6;
- set Next_PDCP_RX_SN to the received PDCP SN + 1;
- if Next_PDCP_RX_SN > Maximum_PDCP_SN:
 - set Next_PDCP_RX_SN to 0;
 - increment RX_HFN by one;
- perform header decompression (if configured) of the deciphered PDCP Data PDU as specified in the subclause 5.5.5;
- deliver the resulting PDCP SDU to upper layer.

[TS 36.323, clause 6.2.3]

Figure 6.2.3.1 shows the format of the PDCP Data PDU when a 12 bit SN length is used. This format is applicable for PDCP Data PDUs carrying data from DRBs mapped on RLC AM or RLC UM.

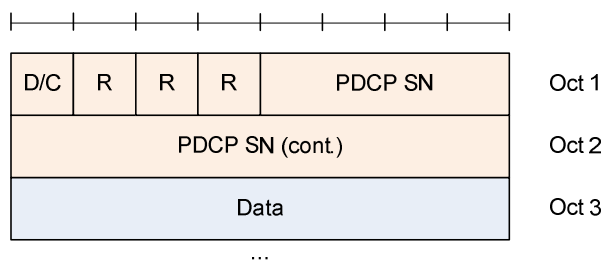

Figure 6.2.3.1: PDCP Data PDU format for DRBs using a 12 bit SN

7.3.1.3.3 Test description

7.3.1.3.3.1 Pre-test conditions

System Simulator

- Cell 1
- SS PDCP set to Transparent Mode

UE:

None.

Preamble

- The UE is in state Loopback Activated (state 4) according to [18] with a RLC UM bearer and configured for long PDCP SN size (12 bits).

7.3.1.3.3.2 Test procedure sequence

Table 7.3.1.3.3.2-1: Main behaviour

St	Procedure	Message Sequence		TP	Verdict
		U - S	Message		
-	EXCEPTION: Steps 1 and 2 shall be repeated for k=0 to Maximum_PDCP_SN (increment=1).				
1	SS transmits a PDCP Data PDU on DRB1 containing one IP packet without header	<--	PDCP Data PDU (SN = k)		

	compression.				
2	CHECK: Does UE transmit a PDCP Data PDU with SN=0 for the first iteration and then incremented by 1 at each iteration?	-->	PDCP Data PDU (SN = k)	1	P
3	SS transmits a PDCP Data PDU on DRB1 containing one IP packet without header compression.	<--	PDCP Data PDU (SN = 0)		
4	CHECK: Does UE transmit a PDCP Data PDU with SN=0?	-->	PDCP Data PDU (SN = 0)	2	P
5	SS sends a PDCP Data PDU on DRB1 containing one IP packet without header compression.	<--	PDCP Data PDU (SN = 1)		
6	CHECK: Does UE transmit a PDCP Data PDU with SN=1?	-->	PDCP Data PDU (SN = 1)	1	P

7.3.1.3.3.3 Specific message contents

None

7.3.3 PDCP Ciphering and deciphering

7.3.3.1 Ciphering and Deciphering: Correct functionality of EPS AS encryption algorithms (SNOW 3G)

7.3.3.1.1 Test Purpose (TP)

(1)

```
with { UE in E-UTRA RRC_CONNECTED state }
ensure that {
  when { UE is requested to achieve functionality of EPS AS encryption algorithms with SNOW 3G }
  then { UE performs correct AS ciphering function in PDCP entities associated with SRBs. }
}
```

7.3.3.1.2 Conformance requirements

References: The conformance requirements covered in the present TC are specified in: TS 36.323, clause 5.6.

[TS 36.323, clause 5.6]

The ciphering function includes both ciphering and deciphering and is performed in PDCP. For the control plane, the data unit that is ciphered is the data part of the PDCP PDU (see subclause 6.3.3) and the MAC-I (see subclause 6.3.4). For the user plane, the data unit that is ciphered is the data part of the PDCP PDU (see subclause 6.3.3); ciphering is not applicable to PDCP Control PDUs.

The ciphering algorithm and key to be used by the PDCP entity are configured by upper layers [3] and the ciphering method shall be applied as specified in [6].

The ciphering function is activated by upper layers [3]. After security activation, the ciphering function shall be applied to all PDCP PDUs indicated by upper layers [3] for the downlink and the uplink, respectively.

The parameters that are required by PDCP for ciphering are defined in [6] and are input to the ciphering algorithm. The required inputs to the ciphering function include the COUNT value, and DIRECTION (direction of the transmission: 0 for uplink, 1 for downlink). The parameters required by PDCP which are provided by upper layers [3] are listed below:

- BEARER (defined as the radio bearer identifier in [6]. It will use the value RB identity -1 as in [3]);
- KEY (the ciphering keys for the control plane and for the user plane are K_{RRCenc} and K_{UPenc} , respectively).

7.3.3.1.3 Test description

7.3.3.1.3.1 Pre-test conditions

System Simulator:

- Cell 1.

UE:

- None.

Preamble:

- The UE shall be in Registered Idle Mode (State 2) according to [18].

7.3.3.1.3.2 Test procedure sequence

Table 7.3.3.1.3.2-1: Main Behaviour

St	Procedure	Message Sequence		TP	Verdict
		U - S	Message		
1	The SS sends a <i>Paging</i> message to the UE on the appropriate paging block, and including the UE identity in one entry of the IE <i>pagingRecordLists</i> .	<--	Paging (PCCH)	-	-
2	The UE transmits an <i>RRCCONNECTIONREQUEST</i> message. This message related PDCP Data PDU should not be integrity protected and ciphered.	-->	RRCCONNECTIONREQUEST	-	-
3	The SS transmits an <i>RRCCONNECTIONSETUP</i> message. This message related PDCP Data PDU should not be integrity protected and ciphered.	<--	RRCCONNECTIONSETUP	-	-
4	The UE transmits an <i>RRCCONNECTIONSETUPCOMPLETE</i> message to confirm the successful completion of the connection establishment and to initiate the session management procedure by including the SERVICE REQUEST message. (State3) This message related PDCP Data PDU should not be integrity protected and ciphered.	-->	RRCCONNECTIONSETUPCOMPLETE	-	-
5	The SS transmits a <i>SECURITYMODECOMMAND</i> message to activate EPS AS encryption algorithm security. The message related PDCP Data PDU should be integrity protected but not ciphered.	<--	SECURITYMODECOMMAND	-	-
6	The UE transmits a <i>SECURITYMODECOMPLETE</i> message and establishes the initial security configuration. The message related PDCP Data PDU should be integrity protected but not ciphered.	-->	SECURITYMODECOMPLETE	-	-
7	The SS configures a new data radio bearer, associated with the default EPS bearer context. This message related PDCP Data PDU should be integrity protected and ciphered. The COUNT of this message related PDCP Data PDU can be used for deciphering.	<--	RRCCONNECTIONRECONFIGURATION	-	-
8	The UE transmits a <i>RRCCONNECTIONRECONFIGURATIONCOMPLETE</i> message to confirm the establishment of the new data radio bearer, associated with the default EPS bearer context. This message related PDCP Data PDU should be integrity protected and ciphered. The COUNT of this message related PDCP Data PDU can be used for deciphering.	-->	RRCCONNECTIONRECONFIGURATIONCOMPLETE	1	P

7.3.3.1.3.3 Specific message contents

Table 7.3.3.1.3.3-1 SecurityModeCommand (step 6, Table 7.3.3.1.3.2-1)

Derivation Path: TS36.508 clause 4.6.1 table 4.6.1-19			
Information Element	Value/remark	Comment	Condition
SecurityModeCommand ::= SEQUENCE {			
criticalExtensions CHOICE {			
c1 CHOICE{			
securityModeCommand-r8 SEQUENCE {			
securityConfiguration SEQUENCE {			
cipheringAlgorithm	eea1		
nextHopChainingCount	Not present		
}			
nonCriticalExtension SEQUENCE {}	Not present		
}			
}			
}			
}			
}			

7.3.3.2 Ciphering and Deciphering: Correct functionality of EPS UP encryption algorithms (SNOW 3G)

7.3.3.2.1 Test Purpose (TP)

(1)

```

with { UE in E-UTRA RRC_CONNECTED state }
ensure that {
  when { UE is requested to achieve functionality of EPS UP encryption algorithms with SNOW 3G }
  then { UE performs correct UP ciphering function in PDCP entities associated with DRBs. }
}

```

7.3.3.2.2 Conformance requirements

References: The conformance requirements covered in the present TC are specified in: TS 36.323, clause 5.6.

[TS 36.323, clause 5.6]

The ciphering function includes both ciphering and deciphering and is performed in PDCP. For the control plane, the data unit that is ciphered is the data part of the PDCP PDU (see subclause 6.3.3) and the MAC-I (see subclause 6.3.4). For the user plane, the data unit that is ciphered is the data part of the PDCP PDU (see subclause 6.3.3); ciphering is not applicable to PDCP Control PDUs.

The ciphering algorithm and key to be used by the PDCP entity are configured by upper layers [3] and the ciphering method shall be applied as specified in [6].

The ciphering function is activated by upper layers [3]. After security activation, the ciphering function shall be applied to all PDCP PDUs indicated by upper layers [3] for the downlink and the uplink, respectively.

The parameters that are required by PDCP for ciphering are defined in [6] and are input to the ciphering algorithm. The required inputs to the ciphering function include the COUNT value, and DIRECTION (direction of the transmission: 0 for uplink, 1 for downlink). The parameters required by PDCP which are provided by upper layers [3] are listed below:

- BEARER (defined as the radio bearer identifier in [6]. It will use the value RB identity –1 as in [3]);
- KEY (the ciphering keys for the control plane and for the user plane are K_{RRCenc} and K_{UPenc} , respectively).

7.3.3.2.3 Test description

7.3.3.2.3.1 Pre-test conditions

System Simulator:

- Cell 1.

UE:

- None.

Preamble

- The UE shall be in Loopback Activation state (State 4) according to TS36.508.

7.3.3.2.3.2 Test procedure sequence

Table 7.3.3.2.3.2-1: Main Behavior

St	Procedure	Message Sequence		TP	Verdict
		U - S	Message		
1	SS Transmits PDCP PDU on DRB ciphered.	<--	PDCP PDU	-	-
2	Check: Does the UE transmit loop backed PDCP PDU ciphered.	-->	PDCP PDU	1	P

7.3.3.2.3.3 Specific message contents

Table 7.3.3.2.3.3-1 SecurityModeCommand (in the preamble)

Derivation Path: TS36.508 clause 4.6.1 table 4.6.1-19			
Information Element	Value/remark	Comment	Condition
SecurityModeCommand ::= SEQUENCE {			
criticalExtensions CHOICE {			
c1 CHOICE{			
securityModeCommand-r8 SEQUENCE {			
securityConfiguration SEQUENCE {			
cipheringAlgorithm	eea1		
nextHopChainingCount	Not present		
}			
nonCriticalExtension SEQUENCE {}	Not present		
}			
}			
}			

7.3.3.3 Cipherring and Decipherring: Correct functionality of EPS AS encryption algorithms (AES)

7.3.3.3.1 Test Purpose (TP)

(1)

```
with { UE in E-UTRA RRC_CONNECTED state }
ensure that {
  when { UE is requested to achieve functionality of EPS AS encryption algorithms with AES }
  then { UE performs correct AS cipherring function in PDCP entities associated with SRBs. }
}
```

7.3.3.3.2 Conformance requirements

Same Conformance requirements as in clause 7.3.3.1.2

7.3.3.3.3 Test description

7.3.3.3.3.1 Pre-test conditions

Same Pre-test conditions as in clause 7.3.3.1.3.1.

7.3.3.3.3.2 Test procedure sequence

Same Test procedure sequence as in Table 7.3.3.1.3.2.

7.3.3.3.3.3 Specific message contents

Table 7.3.3.3.3-1 SecurityModeCommand (step 6)

Derivation Path: TS36.508 clause 4.6.1 table 4.6.1-19			
Information Element	Value/remark	Comment	Condition
SecurityModeCommand ::= SEQUENCE {			
criticalExtensions CHOICE {			
c1 CHOICE{			
securityModeCommand-r8 SEQUENCE {			
securityConfiguration SEQUENCE {			
cipheringAlgorithm	eea2		
nextHopChainingCount	Not present		
}			
nonCriticalExtension SEQUENCE {}	Not present		
}			
}			
}			
}			

7.3.3.4 Cipherng and Decipherng: Correct functionality of EPS UP encryption algorithms (AES)

7.3.3.4.1 Test Purpose (TP)

(1)

```
with { UE in E-UTRA RRC_CONNECTED state }
ensure that {
  when { UE is requested to achieve functionality of EPS UP encryption algorithms with AES }
  then { UE performs correct UP ciphering function in PDCP entities associated with DRBs. }
}
```

7.3.3.4.2 Conformance requirements

Same Conformance requirements as in clause 7.3.3.2.2.

7.3.3.4.3 Test description

7.3.3.4.3.1 Pre-test conditions

Same Pre-test conditions as in clause 7.3.3.2.3.1.

7.3.3.4.3.2 Test procedure sequence

Same Test procedure sequence as in Table 7.3.3.2.3.2.

7.3.3.4.3.3 Specific message contents

Table 7.3.3.4.3.3-1 SecurityModeCommand (in the preamble)

Derivation Path: TS36.508 clause 4.6.1 table 4.6.1-19			
Information Element	Value/remark	Comment	Condition
SecurityModeCommand ::= SEQUENCE {			
criticalExtensions CHOICE {			
c1 CHOICE{			
securityModeCommand-r8 SEQUENCE {			
securityConfiguration SEQUENCE {			
cipheringAlgorithm	eea2		
nextHopChainingCount	Not present		
}			
nonCriticalExtension SEQUENCE {}	Not present		
}			
}			
}			
}			
}			

7.3.4 PDCP Integrity Protection

7.3.4.1 Integrity protection: Correct functionality of EPS AS integrity algorithms (SNOW3G)

7.3.4.1.1 Test Purpose (TP)

(1)

```

with { UE in E-UTRA RRC_CONNECTED state }
ensure that {
  when { UE is requested to achieve functionality of EPS AS integrity algorithms with SNOW3G }
  then { UE performs the integrity protection function in PDCP entities associated with SRBs. }
}

```

7.3.4.1.2 Conformance requirements

References: The conformance requirements covered in the present TC are specified in: 3GPP TS 36.323 clauses 5.7

[TS 36.323, clause 5.7]

The integrity protection function includes both integrity protection and integrity verification and is performed in PDCP for PDCP entities associated with SRBs. The data unit that is integrity protected is the PDU header and the data part of the PDU before ciphering.

The integrity protection algorithm and key to be used by the PDCP entities are configured by upper layers [3] and the integrity protection method shall be applied as specified in [6].

The integrity protection function is activated by upper layers [3]. After security activation, the integrity protection function shall be applied to all PDUs including and subsequent to the PDU indicated by upper layers [3] for the downlink and the uplink, respectively.

NOTE: As the RRC message which activates the integrity protection function is itself integrity protected with the configuration included in this RRC message, this message needs first be decoded by RRC before the integrity protection verification could be performed for the PDU in which the message was received.

The parameters that are required by PDCP for integrity protection are defined in [6] and are input to the integrity protection algorithm. The required inputs to the integrity protection function include the COUNT value, and DIRECTION (direction of the transmission: set as specification in [6]). The parameters required by PDCP which are provided by upper layers [3] are listed below:

- BEARER (defined as the radio bearer identifier in [6]. It will use the value RB identity –1 as in [3]);
- KEY (K_{RRCint}).

At transmission, the UE computes the value of the MAC-I field and at reception it verifies the integrity of the PDCP PDU by calculating the X-MAC based on the input parameters as specified above. If the calculated X-MAC corresponds to the received MAC-I, integrity protection is verified successfully.

7.3.4.1.3 Test description

7.3.4.1.3.1 Pre-test conditions

System Simulator:

- Cell 1

UE:

None.

Preamble:

- The UE is in state Registered, Idle Mode (State 2) according to [18].

7.3.4.1.3.2 Test procedure sequence

Table 7.3.4.1.3.2-1: Main behaviour

St	Procedure	Message Sequence		TP	Verdict
		U - S	Message		
1	The SS sends a Paging message to the UE on the appropriate paging block, and including the UE identity in one entry of the IE <i>pagingRecordLists</i> .	-	<i>Paging</i>	-	-
2	The UE transmits an <i>RRConnectionRequest</i> message. This message related PDCP Data PDU is not integrity protected.	-->	<i>RRConnectionRequest</i>	-	-
3	The SS transmits an <i>RRConnectionSetup</i> message. The message related PDCP Data PDU is not integrity protected.	<--	<i>RRConnectionSetup</i>	-	-
4	The UE transmits an <i>RRConnectionSetupComplete</i> message to confirm the successful completion of the connection establishment and to initiate the session management procedure by including the SERVICE REQUEST message. The message related PDCP Data PDU is not integrity protected.	-->	<i>RRConnectionSetupComplete</i>	-	-
5	The SS transmits a <i>SecurityModeCommand</i> message to activate AS security with SNOW3G integrity algorithms protected.	<--	<i>SecurityModeCommand</i>	-	-
6	Check: Does the UE transmit a <i>SecurityModeComplete</i> message with SNOW3G integrity algorithms and RRC integrity key protected and establish the initial security configuration.	-->	<i>SecurityModeComplete</i>	1	P
7	Check: Does the <i>SecurityModeComplete</i> message from the UE pass the SS' integrity protection check.	-	-	1	P

7.3.4.1.3.3 Specific message contents

Table 7.3.43.3.1.4-1: SecurityModeCommand message (step 5, Table 7.3.4.1.3.2-1)

Derivation Path: 36.508 Table 4.6.1-19			
Information Element	Value/remark	Comment	Condition
SecurityModeCommand ::= SEQUENCE {			
rrc-TransactionIdentifier	RRC-TransactionIdentifier-DL		
criticalExtensions CHOICE {			
c1 CHOICE {			
securityModeCommand-r8 SEQUENCE {			
securityConfigSMC SEQUENCE {			
securityAlgorithmConfig SEQUENCE {			
integrityProtAlgorithm	eia1	128-EIA1 SNOW 3G	
}			
}			
}			
}			
}			
}			

7.3.4.2 Integrity protection: Correct functionality of EPS AS integrity algorithms (AES)

7.3.4.2.1 Test Purpose (TP)

(1)

```

with { UE in E-UTRA RRC_CONNECTED state }
ensure that {
  when { UE is requested to achieve functionality of EPS AS integrity algorithms with AES }
  then { UE performs the integrity protection function in PDCP entities associated with SRBs. }
}

```

7.3.4.2.2 Conformance requirements

Same Conformance requirements as in clause 7.3.4.1.2

7.3.4.2.3 Test description

7.3.4.2.3.1 Pre-test conditions

Same Pre-test conditions as in clause 7.3.4.1.3.1.

7.3.4.2.3.2 Test procedure sequence

Same Test procedure sequence as in table 7.3.4.1.3.2-1, except the integrity protection algorithm is AES.

7.3.4.2.3.3 Specific message contents

Table 7.3.4.2.3.3-1: SecurityModeCommand message (step 5, Table 7.3.4.1.3.2-1)

Derivation Path: 36.508 Table 4.6.1-19			
Information Element	Value/remark	Comment	Condition
SecurityModeCommand ::= SEQUENCE {			
rrc-TransactionIdentifier	RRC-TransactionIdentifier-DL		
criticalExtensions CHOICE {			
c1 CHOICE {			
securityModeCommand-r8 SEQUENCE {			
securityConfigSMC SEQUENCE {			
securityAlgorithmConfig SEQUENCE {			
integrityProtAlgorithm	eia2	128-EIA2 AES	
}			
}			
}			
}			
}			
}			

7.3.5 PDCP – Handover

7.3.5.1 Void

7.3.5.2 PDCP handover / Lossless handover / PDCP Sequence Number maintenance

7.3.5.2.1 Test Purpose (TP)

(1)

```

with {UE in E-UTRA RRC_CONNECTED state with default RB using RLC-AM}
ensure that {
  when { UE is requested to make a lossless handover by SS }
  then { UE retransmits the unacknowledged data }
}

```

7.3.5.2.2 Conformance requirements

References: The conformance requirements covered in the present TC are specified in: 3GPP TS 36.323 clause 5.2.1.1.

[TS 36.323, clause 5.2.1.1]

When upper layers request a PDCP re-establishment, the UE shall:

- reset the header compression protocol for uplink (if configured);
- apply the ciphering algorithm and key provided by upper layers during the re-establishment procedure;
- from the first PDCP SDU for which the successful delivery of the corresponding PDCP PDU has not been confirmed by lower layers, perform retransmission or transmission of all the PDCP SDUs already associated with PDCP SNs in ascending order of the COUNT values associated to the PDCP SDU prior to the PDCP re-establishment as specified below:
- perform header compression of the PDCP SDU (if configured) as specified in the subclause 5.5.4;
- perform ciphering of the PDCP SDU using the COUNT value associated with this PDCP SDU as specified in the subclause 5.6;
- submit the resulting PDCP Data PDU to lower layer

7.3.5.2.3 Test description

7.3.5.2.3.1 Pre-test conditions

System Simulator:

- Cell 1 and Cell 2

UE:

None.

Preamble:

- The UE is in state Loopback Activated (state 4) according to [18].

7.3.5.2.3.2 Test procedure sequence

Table 7.3.5.2.3.2-1: Main behaviour

St	Procedure	Message Sequence		TP	Verdict
		U - S	Message		
1	The SS creates 5 PDCP Data PDUs and the Next_PDCP_TX_SN is set to "0".	-	-	-	-
-	EXCEPTION: Step 2 and 3 shall be repeated for k=0 to 1(increment=1).	-	-	-	-
2	The SS sends the PDCP Data PDU#k via RLC-AM RB with the following content to the UE: D/C field = 1 (PDCP Data PDU) and PDCP SN = k. After having sent a PDU, the SS set Next_PDCP_TX_SN= k+1.	<--	PDCP PDU DATA □k	-	-
3	The UE sends the PDCP Data PDU#k via RLC-AM RB with the following content to the UE: D/C field = 1 (PDCP Data PDU) and PDCP SN = k. Data is previously received data from PDU #k. The SS acknowledges the received data.	-->	PDCP PDU DATA □k	-	-
4	Configure SS not to allocate UL grant to the UE in Cell 1.	-	-	-	-
-	EXCEPTION: Step 5 shall be repeated for m=2 to 4 (increment=1).	-	-	-	-
5	The SS sends the PDCP Data PDU #m via RLC-AM RB with the following content to the UE: D/C field = 1 (PDCP Data PDU) and PDCP SN =m. After having sent a PDU, the SS set Next_PDCP_TX_SN = m+1.	<--	PDCP PDU DATA □m	-	-
6	The SS requests UE to make a handover to Cell2 with the RRCConnectionReconfiguration message sent on Cell 1.	<--	<i>RRCCConnectionReconfiguration</i>	-	-
7	Configure SS to allocate UL grant to the UE in Cell 2	-	-	-	-
-	EXCEPTION:Either steps 8a1 to 8a2 OR steps 8b1 to 8b2 can happen in the specified order.	-	-	-	-
8a1	The UE on Cell 2 transmits a RRCConnectionReconfigurationComplete message.	-->	<i>RRCCConnectionReconfigurationComplete</i>	-	-
-	EXCEPTION: Step 8a2 shall be repeated for m=2 to 4 (increment=1).	-	-	-	-
8a2	Check: Does the UE send the PDCP Data PDU #m via RLC-AM RB with the following content to the SS: D/C field = 1 (PDCP Data PDU) and PDCP SN = m? Data is previously received data from PDU #m.	-->	PDCP PDU DATA #m	1	P
-	EXCEPTION: Steps 8b1 shall be repeated for m=2 to 4 (increment=1).	-	-	-	-
8b1	Check: Does the UE send the PDCP Data PDU #m via RLC-AM RB with the following content to the SS: D/C field = 1 (PDCP Data PDU) and PDCP SN = m? Data is the previously received data from PDU #m	-->	PDCP PDU DATA #m	1	P
8b2	The UE on Cell 2 transmits a RRCConnectionReconfigurationComplete message.	-->	<i>RRCCConnectionReconfigurationComplete</i>	-	-

7.3.5.2.3.3 Specific message contents

Table 7.3.5.2.3.3-1: RRCConnectionReconfiguration (step 6, Table 7.3.5.2.3.2-1)

Derivation Path: 36.508, Table 4.6.1-8, condition HO			
Information Element	Value/remark	Comment	Condition
RRCConnectionReconfiguration ::= SEQUENCE {			
criticalExtensions CHOICE {			
c1 CHOICE{			
rrcConnectionReconfiguration-r8 SEQUENCE {			
mobilityControlInfo SEQUENCE {		MobilityControlInfo -HO	
targetPhysCellId	PhysicalCellIdentity of Cell 2		
}			
}			
}			
}			
}			

7.3.5.3 PDCP handover/Non-lossless handover PDCP Sequence Number maintenance

7.3.5.3.1 Test Purpose (TP)

(1)

```

with {UE in E-UTRA RRC_CONNECTED state with default bearer using RLC-UM}
ensure that {
  when {UE is requested to make a non-lossless handover by SS}
  then {UE transmits next PDCP Data PDU with SN value 0 }
}

```

7.3.5.3.2 Conformance requirements

References: The conformance requirements covered in the present TC are specified in: 3GPP TS 36.323 clauses 5.2.1.2.

[TS 36.323, clause 5.2.1.2]

When upper layers request a PDCP re-establishment, the UE shall:

- reset the header compression protocol for uplink (if configured);
- set Next_PDCP_TX_SN, and TX_HFN to 0;
- apply the ciphering algorithm and key provided by upper layers during the re-establishment procedure;
- for each PDCP SDU already associated with a PDCP SN but for which a corresponding PDU has not previously been submitted to lower layers:
- consider the PDCP SDUs as received from upper layer;
- perform transmission of the PDCP SDUs in ascending order of the COUNT value associated to the PDCP SDU prior to the PDCP re-establishment, as specified in the subclause 5.1.1 without restarting the *discard-Timer*.

7.3.5.3.3 Test description

7.3.5.3.3.1 Pre-test conditions

System Simulator:

- Cell 1 and Cell 2

UE:

None.

Preamble:

- The UE is in state Loopback Activated (state 4) according to [18].

7.3.5.3.3.2 Test procedure sequence

Table 7.3.5.3.3.2-1: Main behaviour

St	Procedure	Message Sequence		TP	Verdict
		U - S	Message		
1	The SS creates 3 PDCP Data PDUs and the Next_PDCP_TX_SN is set to "0".	-	-	-	-
	EXCEPTION: Step 2 and 3 shall be repeated for k=0 to 1 (increment=1).				
2	The SS sends the PDCP Data PDU #k via RLC-UM RB with the following content to the UE: D/C field = 1 (PDCP Data PDU) and PDCP SN = k. After having sent a PDU, the SS set Next_PDCP_TX_SN= k+1.	<--	PDCP PDU DATA □k	-	-
3	The UE sends the PDCP Data PDU #k via RLC-UM RB with the following content to the SS: D/C field = 1 (PDCP Data PDU) and PDCP SN = k. Data is previously received data PDU #k The SS acknowledges the received data.	-->	PDCP PDU DATA □k		
4	The SS requests UE to make a handover to Cell 2 with the <i>RRCCConnectionReconfiguration</i> message.	<--	<i>RRCCConnectionReconfiguration</i>		
5	The UE transmits a <i>RRCCConnectionReconfigurationComplete</i> message.	-->	<i>RRCCConnectionReconfigurationComplete</i>	-	
6	The SS sends the PDCP Data PDU #2 via RLC-UM RB with the following content to the UE: D/C field = 1 (PDCP Data PDU) and PDCP SN = 2. After having sent a PDU, the SS set Next_PDCP_TX_SN= k+1.	<--	PDCP PDU DATA □2		
7	Check: Does the UE send the PDCP Data PDU #2 via RLC-UM RB with the following content back to the SS: D/C field = 1 (PDCP Data PDU) and PDCP SN = 0. Data is previously received data PDU #2.	-->	PDCP PDU DATA □2	1	P

7.3.5.3.3 Specific message contents

Table 7.3.5.3.3-1: RRCConnectionReconfiguration (step 4, 7.3.5.3.3.2-1)

Derivation Path: 36.508, Table 4.6.1-8, condition HO			
Information Element	Value/remark	Comment	Condition
RRCConnectionReconfiguration ::= SEQUENCE {			
criticalExtensions CHOICE {			
c1 CHOICE{			
rrcConnectionReconfiguration-r8 SEQUENCE {			
mobilityControlInfo SEQUENCE {		MobilityControlInfo -HO	
targetPhysCellId	PhysicalCellIdentity of Cell 2		
}			
}			
}			
}			
}			

7.3.5.4 PDCP handover / Lossless handover / PDCP status report to convey the information on missing or acknowledged PDCP SDUs at handover

7.3.5.4.1 Test Purpose (TP)

(1)

```
with { UE in E-UTRA RRC_CONNECTED state with default RB used RLC-AM mode }
ensure that {
  when { UE is requested to make a handover by SS }
  then { UE creates a PDCP status report to SS}}
```

(2)

```
with { UE in E-UTRA RRC_CONNECTED state with default RB used RLC-AM mode }
ensure that {
  when { UE is requested to make a handover by SS }
  then { UE discards the corresponding PDCP PDU and PDCP SDU according to the PDCP status report
from SS }}
```

7.3.5.4.2 Conformance requirements

References: The conformance requirements covered in the present TC are specified in: 3GPP TS 36.323 clauses 5.3 and 5.4

[TS 36.323, clause 5.3.1]

When upper layers request a PDCP re-establishment, for radio bearers that are mapped on RLC AM, the UE shall:

- if the radio bearer is configured by upper layers to send a PDCP status report in the uplink, compile a status report as indicated below after processing the PDCP Data PDUs that are received from lower layers due to the re-establishment of the lower layers as specified in the subclause 5.2.2.1, and submit it to lower layers as the first PDCP PDU for the transmission, by:
 - setting the FMS field to the PDCP SN of the first missing PDCP SDU;
 - if there is at least one out-of-sequence PDCP SDU stored, allocating a Bitmap field of length in bits equal to the number of PDCP SNs from and not including the first missing PDCP SDU up to and including the last out-of-sequence PDCP SDUs, rounded up to the next multiple of 8;
 - setting as '0' in the corresponding position in the bitmap field for all PDCP SDUs that have not been received as indicated by lower layers, and optionally PDCP SDUs for which decompression have failed;
 - indicating in the bitmap field as '1' for all other PDCP SDUs.

[TS 36.323, clause 5.3.2]

When a PDCP status report is received in the downlink, for radio bearers that are mapped on RLC AM:

- for each PDCP SDU, if any, with the bit in the bitmap set to '1', or with the associated COUNT value less than the COUNT value of the PDCP SDU identified by the FMS field, the successful delivery of the corresponding PDCP SDU is confirmed, and the UE shall process the PDCP SDU as specified in the subclause 5.4.

[TS 36.323, clause 5.4]

When the Discard_Timer expires for a PDCP SDU, or the successful delivery of a PDCP SDU is confirmed by PDCP status report, the UE shall discard the PDCP SDU along with the corresponding PDCP PDU. If the corresponding PDCP PDU has already been submitted to lower layers the discard is indicated to lower layers.

7.3.5.4.3 Test description

TC is applicable to:

- All UEs supporting E-UTRA.

7.3.5.4.3.1 Pre-test conditions

System Simulator:

- Cell 1 and Cell 2 (FDD for Cell 1 and Cell 2, or TDD for Cell 1 and Cell 2).
- ROHC is not used for headerCompression settings.

UE:

- UE in UE Loopback Activated test state (state 4) with default RB using RLC-AM in Cell 1.

7.3.5.4.3.2 Test procedure sequence

Table 7.3.5.4.3.2: Main Behaviour

St	Procedure	Message Sequence		TP	Verdict
		U - S	Message		
1	The SS creates 5 PDCP Data PDUs and the Next_PDCP_TX_SN is set to "0".		-	-	-
	EXCEPTION: Step 2 and 3 shall be repeated for k=0 to 1 (increment=1).				
2	The SS sends the PDCP Data PDU #k via RLC-AM RB with the following content to the UE: D/C field = 1 (PDCP Data PDU) and PDCP SN = k. After having sent a PDU, the SS set Next_PDCP_TX_SN = k + 1.	<--	PDCP PDU DATA □k	-	-
3	The UE sends a PDCP Data PDU #k via RLC-AM RB with the following content back to the SS: D/C field = 1 (PDCP Data PDU) and PDCP SN = k data: previously received packet.	-->	PDCP PDU DATA □k	-	-
4	The SS requests UE to make a handover to Cell2 with the <i>RRConnectionReconfiguration</i> message sent on Cell1.	<--	<i>RRConnectionReconfiguration</i> message.	-	-
5	The UE transmits a <i>RRConnectionReconfigurationComplete</i> message on Cell2.	-->	<i>RRConnectionReconfigurationC</i> omplete message.	-	-
6	Check:Does The UE sends PDCP Control PDUs via RLC-AM RB with the following content to the SS: D/C field = 0 (PDCP control PDU) and PDU Type =000, FMS field = 2.	-->	PDCP status report	1	P
7	Configure SS to not allocate UL grant to the UE in Cell 2.			-	-
	EXCEPTION: Step 8 shall be repeated for k=2 to 4 (increment=1).				
8	The SS sends the PDCP Data PDU #k via RLC-AM RB with the following content to the UE: D/C field = 1 (PDCP Data PDU) and PDCP SN = k. After having sent a PDU, the SS set Next_PDCP_TX_SN = k + 1.	<--	PDCP PDU DATA □k	-	-
9	The SS generates a PDCP status report message and sends it to UE: D/C field = 0 (PDCP control PDU) and PDU Type =000, FMS field = 3 and the Bitmap1=01111111.	<--	PDCP status report	-	-
10	Configure SS to allocate UL grant to the UE in Cell 2.			-	-
11	Check:Does the UE sends a PDCP Data PDU#2 via RLC-AM RB with the following content back to the SS: D/C field = 1 (PDCP Data PDU) and PDCP SN =2 data: previously received packet.	-->	PDCP PDU DATA □2	2	F
12	Check:Does the UE sends a PDCP Data PDU#3 via RLC-AM RB with the following content back to the SS: D/C field = 1 (PDCP Data PDU) and PDCP SN = 3 data: previously received packet.	-->	PDCP PDU DATA □3	2	P
13	Check:Does the UE sends a PDCP Data PDU#4 via RLC-AM RB with the following content back to the SS: D/C field = 1 (PDCP Data PDU) and PDCP SN = 4 data: previously received packet.	-->	PDCP PDU DATA □4	2	P

7.3.5.4.3.3 Specific message contents

Table 7.3.5.4.3.3-1: RRCConnectionReconfiguration (Step 4, table 7.3.5.4.3.2-1)

Derivation Path: 36.508 Table 4.6.1-8			
Information Element	Value/remark	Comment	Condition
RRCConnectionReconfiguration ::= SEQUENCE {			
criticalExtensions CHOICE {			
c1 CHOICE{			
rrcConnectionReconfiguration-r8 SEQUENCE {			
RadioResourceConfigDedicated-HO {			
drb-ToAddModifyList {			
PDCP-Configuration-DRB-AM {			
discardTimer	infinity		
rlc-AM SEQUENCE {			
statusReportRequired	TRUE		
}			
}			
}			
}			
}			
}			
}			

7.3.5.5 PDCP handover / In-order delivery and duplicate elimination in the downlink

7.3.5.5.1 Test Purpose (TP)

(1)

```

with { UE in E-UTRA RRC_CONNECTED state with default RB using RLC-AM }
ensure that {
  when { UE is requested to make a handover by SS }
  then { UE achieves in-order delivery and duplicate elimination in the downlink }
}

```

7.3.5.5.2 Conformance requirements

References: The conformance requirements covered in the present TC are specified in: 3GPP TS 36.323 clauses 5.1.2.1.

[TS 36.323, clause 5.1.2.1]

For DRBs mapped on RLC AM, at reception of a PDCP Data PDU from lower layers, the UE shall:

- if received PDCP SN – Last_Submitted_PDCP_RX_SN > Reordering_Window or 0 <= Last_Submitted_PDCP_RX_SN – received PDCP SN < Reordering_Window:
 - if received PDCP SN > Next_PDCP_RX_SN:
 - decipher the PDCP PDU as specified in the subclause 5.6, using COUNT based on RX_HFN - 1 and the received PDCP SN;
 - else:
 - decipher the PDCP PDU as specified in the subclause 5.6, using COUNT based on RX_HFN and the received PDCP SN;
 - perform header decompression (if configured) as specified in the subclause 5.5.5;
 - discard this PDCP SDU;
- else if Next_PDCP_RX_SN – received PDCP SN > Reordering_Window:
 - increment RX_HFN by one;

- use COUNT based on RX_HFN and the received PDCP SN for deciphering the PDCP PDU;
- set Next_PDCP_RX_SN to the received PDCP SN + 1;
- else if received PDCP SN – Next_PDCP_RX_SN >= Reordering_Window:
 - use COUNT based on RX_HFN – 1 and the received PDCP SN for deciphering the PDCP PDU;
- else if received PDCP SN >= Next_PDCP_RX_SN:
 - use COUNT based on RX_HFN and the received PDCP SN for deciphering the PDCP PDU;
 - set Next_PDCP_RX_SN to the received PDCP SN + 1;
 - if Next_PDCP_RX_SN is larger than Maximum_PDCP_SN:
 - set Next_PDCP_RX_SN to 0;
 - increment RX_HFN by one;
- else if received PDCP SN < Next_PDCP_RX_SN:
 - use COUNT based on RX_HFN and the received PDCP SN for deciphering the PDCP PDU;
- if the PDCP PDU has not been discarded in the above:
 - perform deciphering and header decompression (if configured) for the PDCP PDU as specified in the subclauses 5.6 and 5.5.5, respectively;
 - if a PDCP SDU with the same PDCP SN is stored:
 - discard this PDCP SDU;
 - else:
 - store the PDCP SDU;
 - if the PDCP PDU received by PDCP is not due to the re-establishment of lower layers:
 - deliver to upper layers in ascending order of the associated COUNT value:
 - all stored PDCP SDU(s) with an associated COUNT value less than the COUNT value associated with the received PDCP SDU;
 - all stored PDCP SDU(s) with consecutively associated COUNT value(s) starting from the COUNT value associated with the received PDCP SDU;
 - set Last_Submitted_PDCP_RX_SN to the PDCP SN of the last PDCP SDU delivered to upper layers;
 - else if received PDCP SN = Last_Submitted_PDCP_RX_SN + 1:
 - deliver to upper layers in ascending order of the associated COUNT value:
 - all stored PDCP SDU(s) with consecutively associated COUNT value(s) starting from the COUNT value associated with the received PDCP SDU;
- set Last_Submitted_PDCP_RX_SN to the PDCP SN of the last PDCP SDU delivered to upper layers.

7.3.5.5.3 Test description

7.3.5.5.3.1 Pre-test conditions

System Simulator:

- Cell 1 and Cell 2

UE:

None.

Preamble:

- The UE is in state Loopback Activated (state 4) according to [18].

7.3.5.5.3.2 Test procedure sequence

Table 7.3.5.5.3.2-1: Main behaviour

St	Procedure	Message Sequence		TP	Verdict
		U - S	Message		
1	The SS creates a PDCP Data PDU#0. The Next_PDCP_TX_SN is set to "0".	-	-	-	-
2	The SS sends the PDCP Data PDU#0 via RLC-AM RB with the following content to the UE: D/C field = 1 (PDCP Data PDU) and PDCP SN=0 After having sent a PDU, the SS sets its counter value Next_PDCP_TX_SN to "1".	<--	PDCP DATA PDU#0	-	-
3	The UE transmit a PDCP Data PDU via RLC-AM RB with the following content back to the SS D/C field = 1 (PDCP Data PDU) and PDCP SN=0 data: previously received packet in PDCP DATA#0 The SS acknowledges the received data.	-->	PDCP DATA PDU #0		
4	The SS requests UE to make a handover to Cell 2 with the <i>RRConnectionReconfiguration</i> message.	<---	<i>RRConnectionReconfiguration</i>	-	-
5	The UE transmits a <i>RRConnectionReconfigurationComplete</i> message in the new cell.	-->	<i>RRConnectionReconfigurationC</i> omplete	-	-
6	The SS creates a PDCP Data PDU#1. The Next_PDCP_TX_SN is set to "2".	-	-	-	-
7	The SS sends the PDCP Data PDU#1 via RLC-AM RB with the following content to the UE: D/C field = 1 (PDCP Data PDU) and PDCP SN=2	<--	PDCP DATA PDU #1	-	-
8	Check: Does the UE transmit a PDCP DATA PDU#1?	-->	PDCP DATA PDU#1	1	F
9	The SS creates a PDCP Data PDU#2. The Next_PDCP_TX_SN is set to "1".	-	-	-	-
10	The SS sends the PDCP Data PDU#2 via RLC-AM RB with the following content to the UE: D/C field = 1 (PDCP Data PDU) and PDCP SN=1 After having sent a PDU, the SS sets its counter value Next_PDCP_TX_SN to "2".	<--	PDCP DATA PDU #2	-	-
11	Check: does the UE transmit a PDCP Data PDU via RLC-AM RB with the following content back to the SS? D/C field = 1 (PDCP Data PDU) and PDCP SN=1 data: previously received packet in PDCP DATA#2	-->	PDCP DATA PDU #2	1	P
12	Check: does the UE transmit PDCP Data PDU via RLC-AM RB with the following content back to the SS? D/C field = 1 (PDCP Data PDU) and PDCP SN=2 data: previously received packet in PDCP DATA#1	-->	PDCP DATA PDU #1	1	P

7.3.5.5.3.3 Specific message contents

Table 7.3.5.5.3.3-1: RRCConnectionReconfiguration (Step 4, Table 7.3.5.5.3.2-1)

Derivation Path: 36.508, Table 4.6.1-6			
Information Element	Value/Remark	Comment	Condition
<pre> RRCConnectionReconfiguration ::= SEQUENCE { criticalExtensions CHOICE { c1 CHOICE{ rrcConnectionReconfiguration-r8 SEQUENCE { mobilityControlInfo SEQUENCE { targetPhysCellId } radioResourceConfigDedicated { RadioResourceConfigDedicated-HO{ drb_ToAddModList{ pdcp-Config{ discardTimer } } } } } } } } </pre>	<p>PhysicalCellIdentity of Cell 2</p> <p>infinity</p>	MobilityControlInfo-HO	

7.3.6 Others

7.3.6.1 PDCP Discard

7.3.6.1.1 Test Purpose (TP)

(1)

```

with { UE in E-UTRA RRC_CONNECTED state }
ensure that {
  when { the Discard Timer for a PDCP SDU expires }
  then { UE discards the corresponding PDCP SDU }
}
                    
```

7.3.6.1.2 Conformance requirements

References: The conformance requirements covered in the present TC are specified in: 3GPP TS 36.323 clause 5.9.

[TS 36.323, clause 5.4]

When the Discard_Timer expires for a PDCP SDU, or the successful delivery of a PDCP SDU is confirmed by PDCP status report, the UE shall discard the PDCP SDU along with the corresponding PDCP PDU. If the corresponding PDCP PDU has already been submitted to lower layers the discard is indicated to lower layers.

7.3.6.1.3 Test description

7.3.6.1.3.1 Pre-test conditions

System Simulator:

- Cell 1

UE:

None.

Preamble

- The UE is in state Loopback Activated (state 4) according to [18], with the DRB for the default EPS bearer context configured with RLC in UM mode and the exceptions as specified in table 7.3.6.1.3.1-1.

Table 7.3.6.1.3.1-1: PDCP Settings

Parameter	Value
Discard_Timer	500ms

7.3.6.1.3.2 Test procedure sequence

Table 7.3.6.1.3.2-1: Main behaviour

St	Procedure	Message Sequence		TP	Verdict
		U - S	Message		
1	The SS creates 5 PDCP Data PDUs and the Next_PDCP_TX_SN is set to "0".	-		-	-
2	The SS ignores scheduling requests and does not allocate any uplink grant.	-	-	-	-
	EXCEPTION: Step 3 shall be repeated for k=0 to 2 (increment=1).				
3	The SS sends a PDCP Data PDU via RLC-UM RB with the following content to the UE: D/C field = 1 (PDCP Data PDU) and PDCP SN = k After having sent a PDU, the SS sets Next_PDCP_TX_SN = k+1.	<--	PDCP PDU DATA (SN=k)	-	-
	Wait for Discard_Timer + 10 TTI.	-	-	-	-
	EXCEPTION: Step 5 shall be repeated for k=3 to 4 (increment=1).				
5	The SS sends a PDCP Data PDU via RLC-UM RB with the following content to the UE: D/C field = 1 (PDCP Data PDU) and PDCP SN = k After having sent a PDU, the SS set Next_PDCP_TX_SN = k+1.	<--	PDCP PDU DATA (SN=k)	-	-
6	The SS resumes normal UL grant allocation.	-		-	-
7	Check: Does UE transmit a PDCP Data PDU with PDCP SN = 3?	-->	PDCP Data PDU (SN = 3)	1	P
8	Check: Does UE transmit a PDCP Data PDU with PDCP SN = 4?	-->	PDCP Data PDU (SN = 4)	1	P

7.3.6.1.3.3 Specific message contents

None.

8 Radio Resource Control RRC

8.1 RRC Connection management procedures

8.1.1 Paging

8.1.1.1 RRC / Paging for Connection in idle mode

8.1.1.1.1 Test Purpose (TP)

(1)

```
with { UE in E-UTRA RRC_IDLE state }
ensure that {
  when { UE receives a Paging message including an ue-Identity set an unmatched S-TMSI i.e. other
than the one allocated to the UE at the UE registration procedure }
  then { UE does not establish an RRC connection }
}
```

(2)

```
with { UE in E-UTRA RRC_IDLE state }
ensure that {
  when { UE receives a Paging message including an ue-Identity set to the S-TMSI which was allocated
to the UE at the UE registration procedure }
  then { UE establishes an RRC connection }
}
```

8.1.1.1.2 Conformance requirements

References: The conformance requirements covered in the present TC are specified in: TS 36.331, clause 5.3.2.3, 5.3.3.2, 5.3.3.3 and 5.3.3.4.

[TS 36.331, clause 5.3.2.3]

Upon receiving the *Paging* message, the UE shall:

- 1> if in RRC_IDLE, for each of the *PagingRecord*, if any, included in the *Paging* message:
 - 2> if the *ue-Identity* included in the *PagingRecord* matches one of the UE identities allocated by upper layers:
 - 3> forward the *ue-Identity*, and the *cn-Domain* to the upper layers.

...

[TS 36.331, clause 5.3.3.2]

The UE initiates the procedure when upper layers request establishment of an RRC connection while the UE is in RRC_IDLE.

Upon initiation of the procedure, the UE shall:

...

- 1> if access to the cell, as specified above, is not barred:
 - 2> apply the default physical channel configuration as specified in 9.2.4;
 - 2> apply the default semi-persistent scheduling configuration as specified in 9.2.3;
 - 2> apply the default MAC main configuration as specified in 9.2.2;
 - 2> apply the CCCH configuration as specified in 9.1.1.2;
 - 2> apply the *timeAlignmentTimerCommon* included in *SystemInfoBlockType2*;

2> start timer T300;

2> initiate transmission of the *RRCCConnectionRequest* message in accordance with 5.3.3.3;

NOTE 2: Upon initiating the connection establishment procedure, the UE is not required to ensure it maintains up to date system information applicable only for UEs in RRC_IDLE state. However, the UE needs to perform system information acquisition upon cell re-selection.

...

[TS 36.331, clause 5.3.3.3]

The UE shall set the contents of *RRCCConnectionRequest* message as follows:

1> set the *ue-Identity* as follows:

2> if upper layers provide an S-TMSI:

3> set the *ue-Identity* to the value received from upper layers;

2> else:

3> draw a random value in the range $0 \dots 2^{40}-1$ and set the *ue-Identity* to this value;

NOTE 1: Upper layers provide the S-TMSI if the UE is registered in the TA of the current cell.

1> set the *establishmentCause* in accordance with the information received from upper layers;

The UE shall submit the *RRCCConnectionRequest* message to lower layers for transmission.

The UE shall continue cell re-selection related measurements as well as cell re-selection evaluation. If the conditions for cell re-selection are fulfilled, the UE shall perform cell re-selection as specified in 5.3.3.5.

[TS 36.331, clause 5.3.3.4]

NOTE: Prior to this, lower layer signalling is used to allocate a C-RNTI. For further details see TS 36.321 [6];

The UE shall:

1> perform the radio resource configuration procedure in accordance with the received *radioResourceConfigDedicated* and as specified in 5.3.10;

1> if stored, discard the cell reselection priority information provided by the *idleModeMobilityControlInfo* or inherited from another RAT;

1> stop timer T300;

1> stop timer T302, if running;

1> stop timer T303, if running;

1> stop timer T305, if running;

1> perform the actions as specified in 5.3.3.7;

1> stop timer T320, if running;

1> enter RRC_CONNECTED;

1> stop the cell re-selection procedure;

1> set the content of *RRCCConnectionSetupComplete* message as follows:

2> set the *selectedPLMN-Identity* to the PLMN selected by upper layers (see TS 23.122 [11], TS 24.301 [35]) from the PLMN(s) included in the *plmn-IdentityList* in *SystemInformationBlockType1*;

2> if upper layers provide the 'Registered MME', include and set the *registeredMME* as follows:

3> if the PLMN identity of the 'Registered MME' is different from the PLMN selected by the upper layers:

4> include the *plmnIdentity* in the *registeredMME* and set it to the value of the PLMN identity in the 'Registered MME' received from upper layers;

3> set the *mmegi* and the *mmec* to the value received from upper layers;

2> set the *dedicatedInfoNAS* to include the information received from upper layers;

2> submit the *RRCConnectionSetupComplete* message to lower layers for transmission, upon which the procedure ends.

8.1.1.1.3 Test description

8.1.1.1.3.1 Pre-test conditions

System Simulator:

- Cell 1.

UE:

None.

Preamble:

- The UE is in state Registered, Idle mode (state 2) according to [18].

8.1.1.1.3.2 Test procedure sequence

Table 8.1.1.1.3.2-1: Main behaviour

St	Procedure	Message Sequence		TP	Verdict
		U - S	Message		
1	The SS transmits a <i>Paging</i> message including an unmatched identity (incorrect S-TMSI).	<--	<i>Paging</i>	-	-
2	Check: Does the UE transmit an <i>RRCConnectionRequest</i> message within 5 s?	-->	<i>RRCConnectionRequest</i>	1	F
3	The SS transmits a <i>Paging</i> message including a matched identity.	<--	<i>Paging</i>	-	-
4	Check: Does the UE transmit an <i>RRCConnectionRequest</i> message?	-->	<i>RRCConnectionRequest</i>	2	P
5	The SS transmits an <i>RRCConnectionSetup</i> message.	<--	<i>RRCConnectionSetup</i>	-	-
6	Check: Does the UE transmit an <i>RRCConnectionSetupComplete</i> message to confirm the successful completion of the connection establishment?	-->	<i>RRCConnectionSetupComplete</i>	2	P
7	Check: Does the test result of CALL generic procedure indicate that the UE is in E-UTRA RRC_CONNECTED state?	-	-	1, 2	-

8.1.1.1.3.3 Specific message contents

Table 8.1.1.1.3.3-1: Paging (step 1, Table 8.1.1.1.3.2-1)

Derivation Path: 36.508 Table 4.6.1-7			
Information Element	Value/remark	Comment	Condition
Paging ::= SEQUENCE {			
pagingRecordList SEQUENCE (SIZE (1..maxPageRec)) OF SEQUENCE {	1 entry		
ue-Identity[1] CHOICE {			
s-TMSI SEQUENCE {			
mmec	Set to the different value from the S-TMSI of the UE		
m-TMSI	Set to the different value from the S-TMSI of the UE		
}			
}			
}			
}			

Table 8.1.1.1.3.3-2: RRCConnectionRequest (step 4, Table 8.1.1.1.3.2-1)

Derivation Path: 36.508 Table 4.6.1-16			
Information Element	Value/remark	Comment	Condition
RRCConnectionRequest ::= SEQUENCE {			
criticalExtensions CHOICE {			
rrcConnectionRequest-r8 SEQUENCE {			
establishmentCause	mt-Access		
}			
}			
}			

8.1.1.2 RRC / Paging for notification of BCCH modification in idle mode

Editor's Note: This section is based on 36.331 v8.3.0 i.e. after RAN#41.

Editor's Note: The test procedure sequence should be modified because the UE can not answer to paging while T302 is running, so a conformant UE can not pass the test case as it is now. An alternative testing method could be that the SS does not answer for T300 (range is 100ms to 2s), so that the UE resumes acting on paging messages.

8.1.1.2.1 Test Purpose (TP)

(1)

```
with { UE in E-UTRA RRC_IDLE state }
ensure that {
  when { UE receives a Paging message including an IE systemInfoModification }
  then { UE re-acquires and applies the new system information }
}
```

8.1.1.2.2 Conformance requirements

References: The conformance requirements covered in the current TC are specified in: TS 36.331, clause 5.3.2.3, 5.2.2.3, and 5.2.2.4.

[TS 36.331, clause 5.3.2.3]

Upon receiving the *Paging* message, the UE shall:

- 1> If in RRC_IDLE, for each of the Paging records included in the *Paging* message:

2> If the *ue-identity* included in the *pagingRecordList* matches one of the UE identities allocated by upper layers:

3> forward the *ue-Identity*, the *cn-Domain* and the *pagingCause* to the upper layers.

1> If the *systemInfoModification* is included:

2> re-acquire the required system information using the system information acquisition procedure as specified in 5.2.2.

[TS 36.331, clause 5.2.2.3]

The UE shall

1> ensure having a valid version, as defined below, of (at least) the following system information, also referred to as the 'required' System Information:

2> if in RRC_IDLE:

3> the *MasterInformationBlock* and *SystemInformationBlockType1* messages as well as *SystemInformationBlockType2* through *SystemInformationBlockType8*, depending on support of the concerned RATs, and *SystemInformationBlockType9*;

...

[TS 36.331, clause 5.2.2.4]

The UE shall

1> if the procedure is triggered by a system information change notification:

2> start acquiring the required system information, as defined in 5.2.2.3, from the beginning of the modification period following the one in which the change notification was received;

...

The UE may apply the received SIBs immediately i.e. the UE does not need to delay using a SIB until all SI messages have been received.

8.1.1.2.3 Test description

8.1.1.2.3.1 Pre-test conditions

System Simulator:

- Cell 1

UE:

None.

Preamble:

- The UE is in state Registered, Idle mode state (state 2) according to [18].

8.1.1.2.3.2 Test procedure sequence

Table 8.1.1.2.3.2-1: Main behaviour

St	Procedure	Message Sequence		TP	Verdict
		U - S	Message		
1	The SS transmits a <i>Paging</i> message including matched identity.	<--	<i>Paging</i>	-	-
2	Check: Does the UE transmit an <i>RRCCConnectionRequest</i> message?	-->	<i>RRCCConnectionRequest</i>	1	P
3	The SS transmit an <i>RRCCConnectionReject</i> message.	<--	<i>RRCCConnectionReject</i>	-	-
4	The SS changes the <i>prach-ConfigurationIndex</i> in the system information	-	-	-	-
5	The SS transmits a <i>Paging</i> message including <i>systemInfoModification</i> .	<--	<i>Paging</i>	-	-
6	Wait for [X] ms for UE to receive system information.	-	-	-	-
7	The SS transmits a <i>Paging</i> message including matched identity.	<--	<i>Paging</i>	-	-
8	Check: Does the UE transmit an <i>RRCCConnectionRequest</i> message?	-->	<i>RRCCConnectionRequest</i>	1	P
9	The SS transmit an <i>RRCCConnectionReject</i> message.	<--	<i>RRCCConnectionReject</i>	-	-
10	Check: the test result of CALL generic procedure indicates that the UE is in E-UTRA RRC_IDLE state on Cell 1. NOTE: T302 (Reception of <i>RRCCConnectionReject</i> including the IE wait Time) should be long enough so that this should be executed before the expiry of T302	-	-	1	-

8.1.1.2.3.3 Specific message contents

Table 8.1.1.2.3.3-1: RRCCConnectionRequest (step 2 and step 8, Table 8.1.1.2.3.2-1)

Derivation Path: 36.508 Table 4.6.1-15			
Information Element	Value/remark	Comment	Condition
RRCCConnectionRequest ::= SEQUENCE {			
criticalExtensions CHOICE {			
rrcConnectionRequest-r8 SEQUENCE {			
establishmentCause	mt-Access		
}			
}			
}			

Table 8.1.1.2.3.3-2: Paging (step 5, Table 8.1.1.2.3.2-1)

Derivation Path: 36.508 Table 4.6.1-5			
Information Element	Value/remark	Comment	Condition
Paging ::= SEQUENCE {			
pagingRecordList	Not present		
systemInfoModification	true		
}			

Table 8.1.1.2.3.3-3: SystemInformationBlockType2 (step 6, Table 8.1.1.2.3.2-1)

Derivation Path: 36.508 Table 4.4.3.3-1			
Information Element	Value/remark	Comment	Condition
SystemInformationBlockType2 ::= SEQUENCE {			
radioResourceConfigCommon SEQUENCE {			
prach-Configuration SEQUENCE {			
prach-ConfigurationIndex	FFS	Set to index which denote subframe numbers different from the default one.	FDD
prach-ConfigurationIndex	FFS	Set to index which denote subframe numbers different from the default one.	TDD
}			
}			
}			

Condition	Explanation
FDD	FDD cell environment
TDD	TDD cell environment

8.1.1.3 RRC / Paging for Connection in idle mode (multiple paging records)

Editor's Note: This section is based on 36.331 v8.3.0 i.e. after RAN#41.

8.1.1.3.1 Test Purpose (TP)

(1)

```
with { UE in E-UTRA RRC_IDLE state }
ensure that {
  when { UE receives a Paging message including only unmatched identities }
  then { UE does not establish any RRC connection }
}
```

(2)

```
with { UE in E-UTRA RRC_IDLE state }
ensure that {
  when { UE receives a Paging message including any matched identity }
  then { UE establishes an RRC connection }
}
```

8.1.1.3.2 Conformance requirements

References: The conformance requirements covered in the current TC are specified in: TS 36.331, clause 5.3.2.3, 5.3.3.2, 5.3.3.3 and 5.3.3.4.

[TS 36.331, clause 5.3.2.3]

Upon receiving the *Paging* message, the UE shall

- 1> If in RRC_IDLE, for each of the *Paging* records included in the *Paging* message:
 - 2> If the *ue-identity* included in the *pagingRecordList* matches one of the UE identities allocated by upper layers:
 - 3> forward the *ue-Identity*, the *cn-Domain* and the *pagingCause* to the upper layers.

...

[TS 36.331, clause 5.3.3.2]

The UE initiates the procedure when upper layers request establishment of an RRC connection while the UE is in RRC_IDLE state.

Upon initiation of the procedure, the UE shall:

...

- 1> If access to the cell, as specified above, is not barred:
 - 2> apply the default configuration applicable for the *antennaInformation* as specified in 9.2.3, until explicitly receiving a configuration;
 - 2> start timer T300;
 - 2> initiate transmission of the *RRCConnectionRequest* message in accordance with 5.3.3.3;

NOTE 2: Upon initiating the connection establishment procedure, the UE is not required to ensure it maintains up to date system information applicable only for UEs in RRC_IDLE state. However, the UE needs to perform system information acquisition upon re-selection.

...

[TS 36.331, clause 5.3.3.3]

The UE shall set the contents of *RRCConnectionRequest* message as follows:

- 1> set the IE *ue-Identity* as follows:
 - 2> if upper layers provide an S-TMSI:
 - 3> set the *ue-Identity* to the value received from upper layers;
 - 2> else
 - 3> draw a random value and set the *ue-Identity* to this value;

NOTE 1 Upper layers provide the S-TMSI if the UE is registered in the TA of the current cell.

- 1> Set the *establishmentCause* in accordance with the information received from upper layers;

The UE shall submit the *RRCConnectionRequest* message to lower layers for transmission.

The UE shall continue cell re-selection related measurements as well as cell re-selection evaluation. If the conditions for cell re-selection are fulfilled, the UE shall perform cell re-selection as specified in 5.3.3.5.

[TS 36.331, clause 5.3.3.4]

NOTE: Prior to this, lower layers allocate a C-RNTI. For further details see TS 36.321 [6];

The UE shall:

- 1> establish SRB1 in accordance with the received *radioResourceConfiguration* and as specified in 5.3.10;
- 1> If stored, discard the Inter-frequency priority information and the Inter-RAT priority information provided via dedicated signalling using the IE *idleModeMobilityControlInfo*;
- 1> stop timer T300;
- 1> stop timer T302, if running;
- 1> stop timer T303, if running;
- 1> stop timer T305, if running;
- 1> stop timer T320, if running;
- 1> enter RRC_CONNECTED state;

- 1> stop the cell re-selection procedure;
- 1> set the content of *RRCCONNECTIONSETUPCOMPLETE* message as follows:
- 2> set the *selectedPLMN-Identity* to the PLMN selected by upper layers [TS 23.122, TS 24.008] from the PLMN(s) included in the *plmn-IdentityList* broadcast, within *SystemInformationBlockType1*, in the cell where the RRC connection was established;
- 2> if upper layers provide the 'Registered MME', set the *registeredMME* as follows:
- 3> if the PLMN identity of the 'Registered MME' is different from the PLMN selected by the upper layers, set the IE *plmnIdentity* to the value received from upper layers;
- 3> set the IEs *mmegi* and *mmec* to the value received from upper layers;
- 2> set the *nas-DedicatedInformation* to include the information received from upper layers;
- 2> submit the *RRCCONNECTIONSETUPCOMPLETE* message to lower layers for transmission, upon which the procedure ends.

8.1.1.3.3 Test description

8.1.1.3.3.1 Pre-test conditions

System Simulator:

- Cell 1

UE:

None.

Preamble:

- The UE is in state Registered, Idle mode (state 2) according to [18].

8.1.1.3.3.2 Test procedure sequence

Table 8.1.1.3.3.2-1: Main behaviour

St	Procedure	Message Sequence		TP	Verdict
		U - S	Message		
1	The SS transmits a <i>Paging</i> message including only unmatched identities (incorrect IMSI).	<--	<i>Paging</i>	1	-
2	Check: Does the UE transmit an <i>RRCCONNECTIONREQUEST</i> message for [X]s.	-->	<i>RRCCONNECTIONREQUEST</i>	1	F
3	The SS transmits a <i>Paging</i> message including two unmatched identities and a matched identity.	<--	<i>Paging</i>	2	-
4	Check: Does the UE transmit an <i>RRCCONNECTIONREQUEST</i> message.	-->	<i>RRCCONNECTIONREQUEST</i>	2	P
5	The SS transmits an <i>RRCCONNECTIONSETUP</i> message.	<--	<i>RRCCONNECTIONSETUP</i>	-	-
6	The UE transmits an <i>RRCCONNECTIONSETUPCOMPLETE</i> message to confirm the successful completion of the connection establishment.	-->	<i>RRCCONNECTIONSETUPCOMPLETE</i>	-	-
7	Check: Does the test result of CALL generic procedure indicate that the UE is in E-UTRA RRC_CONNECTED state.	-	-	1,2	P

8.1.1.3.3.3 Specific message contents

Table 8.1.1.3.3.3-1: Paging (step 1, Table 8.1.1.3.3.2-1)

Derivation Path: 36.508 Table 4.6.1-5			
Information Element	Value/remark	Comment	Condition
Paging ::= SEQUENCE {			
pagingRecordList SEQUENCE (SIZE (1..maxPageRec)) OF SEQUENCE {	3 entries		
ue-Identity[1] CHOICE {			
imsi	Set to the different value from the IMSI of the UE		
}			
pagingCause[1]	FFS		
ue-Identity[2] CHOICE {			
imsi	Set to the different value from the IMSI of the UE		
}			
pagingCause[2]	FFS		
ue-Identity[3] CHOICE {			
imsi	Set to the different value from the IMSI of the UE		
}			
pagingCause[3]	FFS		
}			
}			

Table 8.1.1.3.3.3-2: Paging (step 3, Table 8.1.1.3.3.2-1)

Derivation Path: 36.508 Table 4.6.1-5			
Information Element	Value/remark	Comment	Condition
Paging ::= SEQUENCE {			
pagingRecordList SEQUENCE (SIZE (1..maxPageRec)) OF SEQUENCE {	3 entries		
ue-Identity[1] CHOICE {			
imsi	Set to the different value from the IMSI of the UE		
}			
pagingCause[1]	FFS		
ue-Identity[2] CHOICE {			
imsi	Set to the different value from the IMSI of the UE		
}			
pagingCause[2]	FFS		
ue-Identity[3] CHOICE {			
imsi	Set to the value of the IMSI of the UE		
}			
pagingCause[3]	FFS		
}			
}			

Table 8.1.1.3.3.3-3: *RRCConnectionRequest* (step 4, Table 8.1.1.3.3.2-1)

Derivation Path: 36.508 Table 4.6.1-15			
Information Element	Value/remark	Comment	Condition
<i>RRCConnectionRequest</i> ::= SEQUENCE {			
<i>criticalExtensions</i> CHOICE {			
<i>rrcConnectionRequest-r8</i> SEQUENCE {			
<i>establishmentCause</i>	mt-Access		
}			
}			
}			

8.1.1.4 RRC / Paging for Connection in idle mode (Shared Network environment)

Editor's Note: This section is based on 36.331 v8.3.0 i.e. after RAN#41.

8.1.1.4.1 Test Purpose (TP)

(1)

```
with { UE in E-UTRA RRC_IDLE state having been registered in the TA of the current cell which has
broadcasted a SystemInformationBlockType1 message including multiple PLMN identities }
ensure that {
  when { UE receives a Paging message including an IE ue-Identity set to the S-TMSI which was
allocated to the UE at the UE registration procedure }
  then { UE establishes an RRC connection }
}
```

8.1.1.4.2 Conformance requirements

References: The conformance requirements covered in the present TC are specified in: TS 36.331, clause 5.3.2.3, 5.3.3.2, 5.3.3.3 and 5.3.3.4.

[TS 36.331, clause 5.3.2.3]

Upon receiving the *Paging* message, the UE shall:

- 1> If in RRC_IDLE, for each of the *Paging* records included in the *Paging* message:
 - 2> If the *ue-identity* included in the *pagingRecordList* matches one of the UE identities allocated by upper layers:
 - 3> forward the *ue-Identity*, the *cn-Domain* and the *pagingCause* to the upper layers.

...

[TS 36.331, clause 5.3.3.2]

The UE initiates the procedure when upper layers request establishment of an RRC connection while the UE is in RRC_IDLE state.

Upon initiation of the procedure, the UE shall:

...

- 1> If access to the cell, as specified above, is not barred:
 - 2> apply the default configuration applicable for the *antennaInformation* as specified in 9.2.3, until explicitly receiving a configuration;
 - 2> start timer T300
 - 2> initiate transmission of the *RRCConnectionRequest* message in accordance with 5.3.3.3;

NOTE 2: Upon initiating the connection establishment procedure, the UE is not required to ensure it maintains up to date system information applicable only for UEs in RRC_IDLE state. However, the UE needs to perform system information acquisition upon re-selection.

...

[TS 36.331, clause 5.3.3.3]

The UE shall set the contents of *RRCCConnectionRequest* message as follows:

- 1> set the IE *ue-Identity* as follows:
 - 2> if upper layers provide an S-TMSI:
 - 3> set the *ue-Identity* to the value received from upper layers;
 - 2> else
 - 3> draw a random value and set the *ue-Identity* to this value;

NOTE 1 Upper layers provide the S-TMSI if the UE is registered in the TA of the current cell.

- 1> Set the *establishmentCause* in accordance with the information received from upper layers;

The UE shall submit the *RRCCConnectionRequest* message to lower layers for transmission.

The UE shall continue cell re-selection related measurements as well as cell re-selection evaluation. If the conditions for cell re-selection are fulfilled, the UE shall perform cell re-selection as specified in 5.3.3.5.

[TS 36.331, clause 5.3.3.4]

NOTE: Prior to this, lower layers allocate a C-RNTI. For further details see TS 36.321 [6];

The UE shall:

- 1> establish SRB1 in accordance with the received *radioResourceConfiguration* and as specified in 5.3.10;
- 1> If stored, discard the Inter-frequency priority information and the Inter-RAT priority information provided via dedicated signalling using the IE *idleModeMobilityControlInfo*;
- 1> stop timer T300;
- 1> stop timer T302, if running;
- 1> stop timer T303, if running;
- 1> stop timer T305, if running;
- 1> stop timer T320, if running;
- 1> enter RRC_CONNECTED state;
- 1> stop the cell re-selection procedure;
- 1> set the content of *RRCCConnectionSetupComplete* message as follows:
 - 2> set the *selectedPLMN-Identity* to the PLMN selected by upper layers [TS 23.122, TS 24.008] from the PLMN(s) included in the *plmn-IdentityList* broadcast, within *SystemInformationBlockType1*, in the cell where the RRC connection was established;
 - 2> if upper layers provide the 'Registered MME', set the *registeredMME* as follows:
 - 3> if the PLMN identity of the 'Registered MME' is different from the PLMN selected by the upper layers, set the IE *plmnIdentity* to the value received from upper layers;
 - 3> set the IEs *mmegi* and *mmec* to the value received from upper layers;
 - 2> set the *nas-DedicatedInformation* to include the information received from upper layers;
 - 2> submit the *RRCCConnectionSetupComplete* message to lower layers for transmission, upon which the procedure ends.

8.1.1.4.3 Test description

8.1.1.4.3.1 Pre-test conditions

System Simulator:

- Cell 1

UE:

None.

Preamble:

- The UE is in state Registered, Idle mode (state 2) according to [18].

8.1.1.4.3.2 Test procedure sequence

Table 8.1.1.4.3.2-1: Main behaviour

St	Procedure	Message Sequence		TP	Verdict
		U - S	Message		
1	The SS transmits a <i>Paging</i> message including a matched identity.	<--	<i>Paging</i>	-	-
2	Check: Does the UE transmit an <i>RRCCoNNECTIONRequest</i> message?	-->	<i>RRCCoNNECTIONRequest</i>	1	P
3	The SS transmit an <i>RRCCoNNECTIONSetup</i> message.	<--	<i>RRCCoNNECTIONSetup</i>	-	-
4	Check: Does the UE transmit an <i>RRCCoNNECTIONSetupComplete</i> message including an IE <i>selectedPLMN-Identity</i> corresponding to the PLMN on which the UE has been registered to confirm the successful completion of the connection establishment?	-->	<i>RRCCoNNECTIONSetupComplete</i>	1	P
5	Check: Does the test result of CALL generic procedure indicates that the UE is in E-UTRA RRC_CONNECTED state?	-	-	1	-

8.1.1.4.3.3 Specific message contents

Editors note:To be updated according to agreed RRC message structure

Table 8.1.1.4.3.3-1: SystemInformationBlockType1 (all steps, Table 8.1.1.4.3.2-1)

Derivation Path: 36.508 Table 4.4.3.2-3			
Information Element	Value/remark	Comment	Condition
SystemInformationBlockType1 ::= SEQUENCE {			
cellAccessRelatedInformation SEQUENCE {			
plmn-IdentityList SEQUENCE (SIZE (1..6)) OF SEQUENCE {	2 entries		
plmn-Identity[1] SEQUENCE {			
mcc	FFS		
mnc	FFS		
}			
cellReservedForOperatorUse[1]	notReserved		
Plmn-Identity[2] SEQUENCE {			
mcc	FFS		
mnc	FFS		
}			
cellReservedForOperatorUse[2]	notReserved		
}			
}			

Table 8.1.1.4.3.3-2: RRCConnectionRequest (step 2, Table 8.1.1.4.3.2-1)

Derivation Path: 36.508 Table 4.6.1-15			
Information Element	Value/remark	Comment	Condition
RRCConnectionRequest ::= SEQUENCE {			
criticalExtensions CHOICE {			
rrcConnectionRequest-r8 SEQUENCE {			
establishmentCause	mt-Access		
}			
}			
}			

Table 8.1.1.4.3.3-3: RRCConnectionSetupComplete (step 4, Table 8.1.1.4.3.2-1)

Derivation Path: 36.508, Table 4.6.1-17			
Information Element	Value/remark	Comment	Condition
RRCConnectionSetupComplete ::= SEQUENCE {			
criticalExtensions CHOICE {			
c1 CHOICE{			
rrcConnectionSetupComplete-r8 SEQUENCE {			
selectedPLMN-Identity	Set to the PLMN selected by upper layers		
}			
}			
}			
}			

8.1.2 RRC Connection Establishment

8.1.2.1 RRC Connection Establishment: Success

8.1.2.1.1 Test Purpose (TP)

(1)

```
with {UE in E-UTRA RRC_IDLE state}
ensure that {
  when { UE is requested to make an outgoing call }
  then { UE establishes an RRC Connection }
}
```

8.1.2.1.2 Conformance requirements

References: The conformance requirements covered in the present TC are specified in: 3GPP TS 36.331 clauses 5.3.3.2, 5.3.3.3 and 5.3.3.4.

[TS 36.331, clause 5.3.3.2]

The UE initiates the procedure when upper layers request establishment of a signalling connection while the UE is in RRC_IDLE state.

Upon initiation of the procedure, the UE shall:

...

- 1> If access to the cell, as specified above, is not barred:
 - 2> apply the default physical channel configuration as specified in 9.2.4;
 - 2> apply the default semi-persistent scheduling configuration as specified in 9.2.3;
 - 2> apply the default MAC main configuration as specified in 9.2.2;
 - 2> apply the CCCH configuration as specified in 9.1.1.2;

- 2> apply the *timeAlignmentTimerCommon* included in *SystemInformationBlockType2*;
- 2> start timer T300;
- 2> initiate transmission of the *RRCCoalitionRequest* message in accordance with 5.3.3.3;

NOTE 2 Upon initiating the connection establishment procedure, the UE is not required to ensure it maintains up to date system information applicable only for UEs in RRC_IDLE state. However, the UE needs to perform system information acquisition upon re-selection.

...

[TS 36.331, clause 5.3.3.3]

The UE shall set the contents of *RRCCoalitionRequest* message as follows:

- 1> set the IE *ue-Identity* as follows:
 - 2> if upper layers provide an S-TMSI:
 - 3> set the *ue-Identity* to the value received from upper layers;
 - 2> else
 - 3> draw a random value in the range $0 \dots 2^{40}-1$ and set the *ue-Identity* to this value;

NOTE 1 Upper layers provide the S-TMSI if the UE is registered in the TA of the current cell.

- 1> Set the *establishmentCause* in accordance with the information received from upper layers;

The UE shall submit the *RRCCoalitionRequest* message to lower layers for transmission.

...

[TS 36.331, clause 5.3.3.4]

...

The UE shall:

- 1> perform the radio resource configuration procedure in accordance with the received *radioResourceConfiguration* and as specified in 5.3.10;
- 1> if stored, discard the cell reselection priority information provided by the *idleModeMobilityControlInfo* or inherited from another RAT;
- 1> stop timer T300;
- 1> stop timer T302, if running;
- 1> stop timer T303, if running;
- 1> stop timer T305, if running;
- 1> perform the actions as specified in 5.3.3.7;
- 1> stop timer T320, if running;
- 1> enter RRC_CONNECTED;
- 1> stop the cell re-selection procedure;
- 1> set the contents of *RRCCoalitionSetupComplete* message as follows:
 - 2> set the *selectedPLMN-Identity* to the PLMN selected by upper layers (see TS 23.122 [11], TS 24.301 [35]) from the PLMNs included in the *plmn-IdentityList* in *SystemInformationBlockType1*;
 - 2> if upper layers provide the 'Registered MME', include and set the *registeredMME* as follows:

3> if the PLMN identity of the 'Registered MME' is different from the PLMN selected by the upper layers:

4> include the *plmnIdentity* in the *registeredMME* and set it to the value of the PLMN identity in the 'Registered MME' received from upper layers;

3> set the *mmegi* and *mmec* to the value received from upper layers;

2> set the *nas-DedicatedInformation* to include the information received from upper layers;

2> submit the *RRCConnectionSetupComplete* message to lower layers for transmission, upon which the procedure ends.

8.1.2.1.3 Test description

8.1.2.1.3.1 Pre-test conditions

System Simulator:

- Cell 1

UE:

None.

Preamble:

- The UE is in state Registered, Idle mode (state 2) according to [18].

8.1.2.1.3 Test procedure sequence

Table 8.1.2.1.3-1: Main behaviour

St	Procedure	Message Sequence		TP	Verdict
		U - S	Message		
1	Make the UE initiate an outgoing call.	-	-	-	-
2	Check: does the UE transmit an <i>RRCConnectionRequest</i> message?	-->	<i>RRCConnectionRequest</i>	1	P
3	The SS transmit a <i>RRCConnectionSetup</i> message with SRB1 configuration.	<--	<i>RRCConnectionSetup</i>	-	-
4	Check: does the UE transmit a <i>RRCConnectionSetupComplete</i> to confirm the successful completion of the connection establishment?	-->	<i>RRCConnectionSetupComplete</i>	1	P
5	Check: does the test result of CALL generic procedure indicates that UE is in E-UTRA RRC_CONNECTED state?	-	-	1	-

8.1.2.1.3.3 Specific message contents

None.

8.1.2.2 RRC Connection Establishment / Reject with wait time

8.1.2.2.1 Test Purpose (TP)

(1)

```
with { UE in E-UTRA RRC_IDLE state and has sent an RRCConnectionRequest message }
ensure that {
  when { UE receives an RRCConnectionReject message including an IE waitTime set to non-zero value }
  then { UE doesn't re-send RRCConnectionRequest before the waitTime is expired }
}
```

8.1.2.2.2 Conformance requirements

References: The conformance requirements covered in the current TC are specified in: TS 36.331, clauses 5.3.3.2, 5.3.3.3 and 5.3.3.8.

[TS 36.331, clause 5.3.3.2]

...

Upon initiation of the procedure, the UE shall:

- 1> if the UE is establishing the RRC connection for mobile terminating calls:
 - 2> if timer T302 is running:
 - 3> consider access to the cell as barred;
 - 2> else:
 - 3> consider access to the cell as not barred;
- 1> else if the UE is establishing the RRC connection for emergency calls:

...

- 1> else if the UE is establishing the RRC connection for mobile originating calls:
 - 2> if timer T302 or T303 is running:
 - 3> consider access to the cell as barred;

...

- 1> If access to the cell, as specified above, is not barred:
 - 2> apply the default physical channel configuration as specified in 9.2.4;
 - 2> apply the default semi-persistent scheduling configuration as specified in 9.2.3;
 - 2> apply the default MAC main configuration as specified in 9.2.2;
 - 2> apply the CCCH configuration as specified in 9.1.1.2;
 - 2> apply the *timeAlignmentTimerCommon* included in *SystemInformationBlockType2*;
 - 2> start timer T300;
 - 2> initiate transmission of the *RRCConnectionRequest* message in accordance with 5.3.3.3;

NOTE 2: Upon initiating the connection establishment procedure, the UE is not required to ensure it maintains up to date system information applicable only for UEs in RRC_IDLE state. However, the UE needs to perform system information acquisition upon re-selection.

...

[TS 36.331, clause 5.3.3.3]

The UE shall set the contents of *RRCConnectionRequest* message as follows:

- 1> set the IE *ue-Identity* as follows:
 - 2> if upper layers provide an S-TMSI:
 - 3> set the *ue-Identity* to the value received from upper layers;
 - 2> else
 - 3> draw a random value in the range $0 \dots 2^{40} - 1$ and set the *ue-Identity* to this value;

NOTE 1 Upper layers provide the S-TMSI if the UE is registered in the TA of the current cell.

- 1> Set the *establishmentCause* in accordance with the information received from upper layers;

The UE shall submit the *RRCConnectionRequest* message to lower layers for transmission.

...

[TS 36.331, clause 5.3.3.8]

The UE shall:

- 1> stop timer T300;
- 1> reset MAC and release the MAC configuration;
- 1> start timer T302, with the timer value set to the *waitTime*;
- 1> inform upper layers about the failure to establish the RRC connection and that access barring for mobile originating calls, mobile originating signalling and mobile terminating access is applicable, upon which the procedure ends.

8.1.2.2.3 Test description

8.1.2.2.3.1 Pre-test conditions

System Simulator:

- Cell 1

UE:

None.

Preamble:

- The UE is in state Registered, Idle mode (state 2) according to [18].

8.1.2.2.3.2 Test procedure sequence

Table 8.1.2.2.3.2-1: Main behaviour

St	Procedure	Message Sequence		TP	Verdict
		U - S	Message		
1	Make the UE attempt an outgoing call	-	-	-	-
2	Check: Does the UE transmit an <i>RRCCConnectionRequest</i> message.	-->	<i>RRCCConnectionRequest</i>	-	-
3	The SS responds with <i>RRCCConnectionReject</i> message with IE <i>waitTime</i> set to 10s.	<--	<i>RRCCConnectionReject</i>	-	-
-	EXCEPTION: the behaviour in table 8.1.2.2.3.2-2 runs in parallel with steps 4 and 5 below.	-	-	-	-
4	Make the UE attempt an outgoing call.	-	-	-	-
5	The SS transmits a Paging message with a matching UE identity.	<--	<i>Paging</i>	-	-
6	Check: Does the test results of CALL generic procedure indicate that the UE is in E-UTRA RRC_IDLE state (see note).	-	-	1	P
NOTE: Test step 6 is always executed 10s after step 3, i.e. when the reject timer is expired in the UE and the UE is allowed to answer paging and initiate calls again. This is because test steps 4 and 5 of the main behaviour run in parallel with test step 1 of the parallel behaviour, which lasts 10s unless the verdict is "Failed".					

Table 8.1.2.2.3.2-2: Parallel behaviour

St	Procedure	Message Sequence		TP	Verdict
		U - S	Message		
1	Check: Does the UE transmit an <i>RRCCConnectionRequest</i> message within 10s.	-->	<i>RRCCConnectionRequest</i>	1	F

8.1.2.2.3.3 Specific message contents

Table 8.1.2.2.3.3-1: RRCConnectionReject (table 8.1.2.2.3.2-1 step 3)

Derivation path: 36.508 table 4.6.1-14			
Information Element	Value/Remark	Comment	Condition
<pre> RRCConnectionReject ::= SEQUENCE { criticalExtensions CHOICE { c1 CHOICE { rrcConnectionReject-r8 SEQUENCE { waitTime } } } } </pre>	10	10 seconds	

8.1.2.3 RRC Connection Establishment in RRC_IDLE state: return to idle state after T300 timeout

8.1.2.3.1 Test Purpose (TP)

(1)

```

with {UE in E-UTRA RRC_IDLE state having sent an RRCConnectionRequest message}
ensure that {
  when { the SS does not answer to the UE during T300}
  then {UE goes to RRC_IDLE}
}
                    
```

8.1.2.3.1 Conformance requirements

References: The conformance requirements covered in the present TC are specified in: 3GPP TS 36.331 clause 5.3.3.6. [TS 36.331, clause 5.3.3.6]

The UE shall:

- 1> if timer T300 expires
 - 2> reset MAC, release the MAC configuration and re-establish RLC for all RBs that are established;
 - 2> inform upper layers about the failure to establish the RRC connection, upon which the procedure ends.

8.1.2.3.3 Test description

8.1.2.3.3.1 Pre-test conditions

System Simulator:

- Cell 1

UE:

None.

Preamble:

- The UE is in state Registered, Idle mode (state 2) according to [18].

8.1.2.3.3.2 Test procedure sequence

Table 8.1.2.3.3-1: Main behaviour

St	Procedure	Message Sequence		TP	Verdict
		U - S	Message		
1	Make the UE attempt an outgoing call	-	-	-	-
2	The UE transmits an <i>RRCCONNECTIONREQUEST</i> message.	-->	<i>RRCCONNECTIONREQUEST</i>	-	-
3	The SS waits for 2s. Note: the UE may transmit one or more <i>RRCCONNECTIONREQUEST</i> messages but the SS does not answer to these messages.	-->	<i>RRCCONNECTIONREQUEST</i>	-	-
4	Check: Does the test result of CALL generic procedure indicate that UE is in E-UTRA RRC_IDLE state.	-	-	1	-

8.1.2.3.3.3 Specific message contents

None.

8.1.2.5 RRC Connection Establishment: 0% access probability for MO calls, no restriction for MO signalling.

8.1.2.5.1 Test Purpose (TP)

(1)

```
with { UE in E-UTRA RRC_IDLE state having received a SystemInformationBlockType2 indicating 0%
access probability for MO calls }
ensure that {
  when { UE is requested to make an outgoing call }
  then { UE does not transmit any RRCCONNECTIONREQUEST message }
}
```

(2)

```
with { UE in E-UTRA RRC_IDLE state }
ensure that {
  when { UE reselects a new cell which belongs to different TA and broadcasts a
SystemInformationBlockType2 indicating no restriction for MO signalling }
  then { UE transmits an RRCCONNECTIONREQUEST message }
}
```

(3)

```
with { UE in E-UTRA RRC_IDLE state having received a SystemInformationBlockType2 with no restriction
}
ensure that {
  when { UE is requested to make an outgoing call }
  then { UE transmits an RRCCONNECTIONREQUEST message }
}
```

8.1.2.5.2 Conformance requirements

References: The conformance requirements covered in the present TC are specified in: TS 36.331, clause 5.3.3.2.

[TS 36.331, clause 5.3.3.2]

The UE initiates the procedure when upper layers request establishment of an RRC connection while the UE is in RRC_IDLE.

Upon initiation of the procedure, the UE shall:

1> if the UE is establishing the RRC connection for mobile terminating calls:

...

1> else if the UE is establishing the RRC connection for emergency calls:

...

- 1> else if the UE is establishing the RRC connection for mobile originating calls:
 - 2> if timer T302 or T303 is running:
 - 3> consider access to the cell as barred;
 - 2> else if *SystemInformationBlockType2* includes the *ac-BarringInfo* and the *ac-BarringForMO-Data* is present:
 - 3> if the UE has one or more Access Classes, as stored on the USIM, with a value in the range 11..15, which is valid for the UE to use according to TS 22.011 [10] and TS 23.122 [11], and
 - 3> for at least one of these Access Classes the corresponding bit in the *ac-BarringForSpecialAC* contained in *ac-BarringForMO-Data* is set to zero:
 - 4> consider access to the cell as not barred;
 - 3> else:
 - 4> draw a random number 'rand' uniformly distributed in the range: $0 \leq \text{rand} < 1$;
 - 4> if 'rand' is lower than the value indicated by *ac-BarringFactor* included in *ac-BarringForMO-Data*:
 - 5> consider access to the cell as not barred;
 - 4> else:
 - 5> consider access to the cell as barred;
 - 2> else:
 - 3> consider access to the cell as not barred;
- 1> else (the UE is establishing the RRC connection for mobile originating signalling):
 - 2> if timer T302 or T305 is running:
 - 3> consider access to the cell as barred;
 - 2> else if *SystemInformationBlockType2* includes the *ac-BarringInfo* and the *ac-BarringForMO-Signalling* is present:
 - 3> if the UE has one or more Access Classes, as stored on the USIM, with a value in the range 11..15, which is valid for the UE to use according to TS 22.011 [10] and TS 23.122 [11], and
 - 3> for at least one of these Access Classes the corresponding bit in the *ac-BarringForSpecialAC* contained in *ac-BarringForMO-Signalling* is set to zero:
 - 4> consider access to the cell as not barred;
 - 3> else:
 - 4> draw a random number 'rand' uniformly distributed in the range: $0 \leq \text{rand} < 1$;
 - 4> if 'rand' is lower than the value indicated by *ac-BarringFactor* included in *ac-BarringForMO-Signalling*:
 - 5> consider access to the cell as not barred;
 - 4> else:
 - 5> consider access to the cell as barred;
 - 2> else:
 - 3> consider access to the cell as not barred;

- 1> if access to the cell, as specified above, is not barred:
 - 2> apply the default physical channel configuration as specified in 9.2.4;
 - 2> apply the default semi-persistent scheduling configuration as specified in 9.2.3;
 - 2> apply the default MAC main configuration as specified in 9.2.2;
 - 2> apply the CCCH configuration as specified in 9.1.1.2;
 - 2> apply the *timeAlignmentTimerCommon* included in *SystemInformationBlockType2*;
 - 2> start timer T300;
 - 2> initiate transmission of the *RRCConnectionRequest* message in accordance with 5.3.3.3;

NOTE 2: Upon initiating the connection establishment procedure, the UE is not required to ensure it maintains up to date system information applicable only for UEs in RRC_IDLE state. However, the UE needs to perform system information acquisition upon cell re-selection.

...

- 8.1.2.5.3 Test description
- 8.1.2.5.3.1 Pre-test conditions

System Simulator:

- Cell 1 and Cell 11 (HPLMN in different TA).

UE:

None.

Preamble:

- The UE is in state Registered, Idle mode (state 2) on Cell 1 according to [18].

8.1.2.5.3.2 Test procedure sequence

Table 8.1.2.5.3.2-1 illustrates the downlink power levels and other changing parameters to be applied for the cells at various time instants of the test execution. Row marked "T0" denotes the initial conditions, while columns marked "T1" is to be applied subsequently. The exact instants on which these values shall be applied are described in the texts in this clause.

Table 8.1.2.5.3.2-1: Time instances of cell power level and parameter changes

	Parameter	Unit	Cell 1	Cell 11	Remark
T0	Cell-specific RS EPRE	dBm/15 kHz	[-70]	[-90]	The power level values are assigned to satisfy $SrxlevCell\ 1 > SrxlevCell\ 11$ such that camping on Cell 1 is guaranteed.
T1	Cell-specific RS EPRE	dBm/15 kHz	[-95]	[-70]	The power level values are assigned to satisfy $RCell\ 1 < RCell\ 11$.

Table 8.1.2.5.3.2-2: Main behaviour

St	Procedure	Message Sequence		TP	Verdict
		U - S	Message		
1	Make the UE initiate an outgoing call.	-	-	-	-
2	Check: Does the UE transmit an <i>RRCCoNNECTIONRequest</i> message on Cell 1 within 5s?	-->	<i>RRCCoNNECTIONRequest</i>	1	F
3	The SS changes Cell 1 and Cell 11 level according to the row "T1" in table 8.1.2.5.3.2-1.	-	-	-	-
4	Check: Does the UE transmit an <i>RRCCoNNECTIONRequest</i> message on Cell 11?	-->	<i>RRCCoNNECTIONRequest</i>	2	P
5	The SS transmits an <i>RRCCoNNECTIONSetup</i> message.	<--	<i>RRCCoNNECTIONSetup</i>	-	-
6	The UE transmits an <i>RRCCoNNECTIONSetupComplete</i> message.	-->	<i>RRCCoNNECTIONSetupComplete</i>	-	-
7	The SS transmits a <i>DLInformationTransfer</i> message.	<--	<i>DLInformationTransfer</i>	-	-
8	The UE transmits an <i>ULInformationTransfer</i> message.	-->	<i>ULInformationTransfer</i>	-	-
9	The SS transmits an <i>RRCCoNNECTIONRelease</i> message to release RRC connection and move to E-UTRA RRC_IDLE state.	<--	<i>RRCCoNNECTIONRelease</i>	-	-
10	Wait for 5 s for the UE to enter E-UTRA RRC_IDLE state.	-	-	-	-
11	The SS transmits a <i>Paging</i> message including <i>systemInfoModification</i> on Cell 11.	<--	<i>Paging</i>	-	-
12	The SS changes <i>SystemInformationBlockType2</i> parameters to default parameters defined in [18].	-	-	-	-
13	Wait for 15 s for the UE to receive system information.	-	-	-	-
14	Make the UE initiate an outgoing call.	-	-	-	-
15	Check: Does the UE transmit an <i>RRCCoNNECTIONRequest</i> message on Cell 11? The UE starts T300. (Note 1)	-->	<i>RRCCoNNECTIONRequest</i>	3	P
16	Wait for 5 s to ensure that T300 expires.	-	-	-	-
17	Check: Does the test result of CALL generic procedure indicate that the UE is in E-UTRA RRC_IDLE state on Cell 11?	-	-	1,2,3	-

Note 1: It is not required to check that the T300 is started.

8.1.2.5.3.3 Specific message contents

Table 8.1.2.5.3.3-1: *SystemInformationBlockType2* for Cell 1 and Cell 11 (preamble and all steps, Table 8.1.2.5.3.2-2)

Derivation Path: 36.508, Table 4.4.3.3-1			
Information Element	Value/remark	Comment	Condition
<i>SystemInformationBlockType2</i> ::= SEQUENCE {			
<i>ac-BarringInfo</i> SEQUENCE {			
<i>ac-BarringForEmergency</i>	FALSE		
<i>ac-BarringForMO-Signalling</i>	Not present		
<i>ac-BarringForMO-Data</i> SEQUENCE {			
<i>ac-BarringFactor</i>	p00		
<i>ac-BarringTime</i>	s4		
<i>ac-BarringForSpecialAC</i>	'00000'B		
}			
}			
}			

Table 8.1.2.5.3.3-2: RRCConnectionRequest (step 4, Table 8.1.2.5.3.2-2)

Derivation Path: 36.508, Table 4.6.1-16			
Information Element	Value/remark	Comment	Condition
RRCConnectionRequest ::= SEQUENCE {			
criticalExtensions CHOICE {			
rrcConnectionRequest-r8 SEQUENCE {			
establishmentCause	mo-Signalling		
}			
}			
}			

Table 8.1.2.5.3.3-3: DLInformationTransfer (step 7, Table 8.1.2.5.3.2-2)

Derivation Path: 36.508, Table 4.6.1-3			
Information Element	Value/remark	Comment	Condition
DLInformationTransfer ::= SEQUENCE {			
criticalExtensions CHOICE {			
c1 CHOICE {			
dlInformationTransfer-r8 SEQUENCE {			
dedicatedInfoType CHOICE {			
dedicatedInfoNAS	TRACKING AREA UPDATE ACCEPT		
}			
}			
}			
}			
}			

Table 8.1.2.5.3.3-4: ULInformationTransfer (step 8, Table 8.1.2.5.3.2-2)

Derivation Path: 36.508, Table 4.6.1-25			
Information Element	Value/remark	Comment	Condition
ULInformationTransfer ::= SEQUENCE {			
criticalExtensions CHOICE {			
c1 CHOICE {			
ulInformationTransfer-r8 SEQUENCE {			
dedicatedInformationType CHOICE {			
dedicatedInfoNAS	TRACKING AREA UPDATE COMPLETE		
}			
}			
}			
}			
}			

Table 8.1.2.5.3.3-5: Paging (step 11, Table 8.1.2.5.3.2-2)

Derivation Path: 36.508, Table 4.6.1-7			
Information Element	Value/remark	Comment	Condition
Paging ::= SEQUENCE {			
pagingRecordList	Not present		
systemInfoModification	true		
}			

Table 8.1.2.5.3.3-6: *RRCConnectionRequest* (step 15, Table 8.1.2.5.3.2-2)

Derivation Path: 36.508, Table 4.6.1-16			
Information Element	Value/remark	Comment	Condition
RRCConnectionRequest ::= SEQUENCE {			
criticalExtensions CHOICE {			
rrcConnectionRequest-r8 SEQUENCE {			
establishmentCause	mo-Data		
}			
}			
}			

8.1.2.7 RRC Connection Establishment: 0% access probability for AC 0..9, AC 10 is barred, AC 11..15 are not barred, access for UE with the access class is in the range 11..15 is allowed.

8.1.2.7.1 Test Purpose (TP)

(1)

```
with { UE in E-UTRA RRC_IDLE state having an Access Class with a value in the range 11..15 and
having received a SystemInformationBlockType2 indicating 0% access probability for AC 0..9 for both
MO call and MO signalling, access restriction for AC 10 and no restriction for AC 11..15 for both MO
call and MO signalling }
ensure that {
  when { UE is requested to make an outgoing call }
    then { UE transmits an RRCConnectionRequest message }
}
```

(2)

```
with { UE in E-UTRA RRC_IDLE state having an Access Class with a value in the range 11..15 }
ensure that {
  when { UE reselects a new cell which belongs to different TA and broadcasts a
SystemInformationBlockType2 indicating 0% access probability for AC 0..9 for both MO call and MO
signalling, access restriction for AC 10 and no restriction for AC 11..15 for both MO call and MO
signalling }
    then { UE transmits an RRCConnectionRequest message }
}
```

(3)

```
with { UE in E-UTRA RRC_IDLE state having an Access Class with a value in the range 11..15 and
having received a SystemInformationBlockType2 indicating 0% access probability for AC 0..9 for both
MO call and MO signalling, access restriction for AC 10 and no restriction for the Access Class
11..15 for both MO call and MO signalling }
ensure that {
  when { UE receives Paging message including a matched identity }
    then { UE transmits an RRCConnectionRequest message }
}
```

(4)

```
with { UE in E-UTRA RRC_IDLE state having received a SystemInformationBlockType2 with no restriction }
ensure that {
  when { UE is requested to make an outgoing call }
    then { UE transmits an RRCConnectionRequest message }
}
```

8.1.2.7.2 Conformance requirements

References: The conformance requirements covered in the present TC are specified in: TS 36.331, clause 5.3.3.2.

[TS 36.331, clause 5.3.3.2]

The UE initiates the procedure when upper layers request establishment of an RRC connection while the UE is in RRC_IDLE.

Upon initiation of the procedure, the UE shall:

- 1> if the UE is establishing the RRC connection for mobile terminating calls:

2> if timer T302 is running:

...

2> else:

3> consider access to the cell as not barred;

1> else if the UE is establishing the RRC connection for emergency calls:

...

1> else if the UE is establishing the RRC connection for mobile originating calls:

2> if timer T302 or T303 is running:

...

2> else if SystemInformationBlockType2 includes the *ac-BarringInfo* and the *ac-BarringForMO-Data* is present:

3> if the UE has one or more Access Classes, as stored on the USIM, with a value in the range 11..15, which is valid for the UE to use according to TS 22.011 [10] and TS 23.122 [11], and

3> for at least one of these Access Classes the corresponding bit in the *ac-BarringForSpecialAC* contained in *ac-BarringForMO-Data* is set to *zero*:

4> consider access to the cell as not barred;

3> else:

...

1> else (the UE is establishing the RRC connection for mobile originating signalling):

2> if timer T302 or T305 is running:

...

2> else if SystemInformationBlockType2 includes the *ac-BarringInfo* and the *ac-BarringForMO-Signalling* is present:

3> if the UE has one or more Access Classes, as stored on the USIM, with a value in the range 11..15, which is valid for the UE to use according to TS 22.011 [10] and TS 23.122 [11], and

3> for at least one of these Access Classes the corresponding bit in the *ac-BarringForSpecialAC* contained in *ac-BarringForMO-Signalling* is set to *zero*:

4> consider access to the cell as not barred;

3> else:

...

1> if access to the cell, as specified above, is not barred:

2> apply the default physical channel configuration as specified in 9.2.4;

2> apply the default semi-persistent scheduling configuration as specified in 9.2.3;

2> apply the default MAC main configuration as specified in 9.2.2;

2> apply the CCCH configuration as specified in 9.1.1.2;

2> apply the *timeAlignmentTimerCommon* included in *SystemInformationBlockType2*;

2> start timer T300;

2> initiate transmission of the *RRCConnectionRequest* message in accordance with 5.3.3.3;

NOTE 2: Upon initiating the connection establishment procedure, the UE is not required to ensure it maintains up to date system information applicable only for UEs in RRC_IDLE state. However, the UE needs to perform system information acquisition upon cell re-selection.

...

8.1.2.7.3 Test description

8.1.2.7.3.1 Pre-test conditions

System Simulator:

- Cell 1 and Cell 11 (HPLMN in different TA).

UE:

- USIM with one or more Access Classes of a value in the range 11..15 is inserted.

Preamble:

- The UE is in state Registered, Idle mode (state 2) on Cell 1 according to [18].

8.1.2.7.3.2 Test procedure sequence

Table 8.1.2.7.3.2-1 illustrates the downlink power levels and other changing parameters to be applied for the cells at various time instants of the test execution. Row marked "T0" denotes the initial conditions, while columns marked "T1" is to be applied subsequently. The exact instants on which these values shall be applied are described in the texts in this clause.

Table 8.1.2.7.3.2-1: Time instances of cell power level and parameter changes

	Parameter	Unit	Cell 1	Cell 11	Remark
T0	Cell-specific RS EPRE	dBm/15 kHz	-70	-90	The power level values are assigned to satisfy $SrxlevCell\ 1 > SrxlevCell\ 11$ such that camping on Cell 1 is guaranteed.
T1	Cell-specific RS EPRE	dBm/15 kHz	-95	-70	The power level values are assigned to satisfy $RCell\ 1 < RCell\ 11$.

Table 8.1.2.7.3.2-2: Main behaviour

St	Procedure	Message Sequence		TP	Verdict
		U - S	Message		
1	Make the UE initiate an outgoing call.	-	-	-	-
2	Check: Does the UE transmit an <i>RRCCoNNECTIONRequest</i> message on the Cell 1? The UE starts T300.(NOTE 1)	-->	<i>RRCCoNNECTIONRequest</i>	1	P
3	Wait for 5 s to ensure that T300 expires.	-	-	-	-
4	The SS changes Cell 1 and Cell 11 level according to the row "T1" in table 8.1.2.7.3.2-1.	-	-	-	-
5	Check: Does the UE transmit an <i>RRCCoNNECTIONRequest</i> message on the Cell 11?	-->	<i>RRCCoNNECTIONRequest</i>	2	P
6	The SS transmits an <i>RRCCoNNECTIONSetup</i> message.	<--	<i>RRCCoNNECTIONSetup</i>	-	-
7	The UE transmits an <i>RRCCoNNECTIONSetupComplete</i> message.	-->	<i>RRCCoNNECTIONSetupComplete</i>	-	-
8	The SS transmits a <i>DLInformationTransfer</i> message.	<--	<i>DLInformationTransfer</i>	-	-
9	The UE transmits an <i>ULInformationTransfer</i> message.	-->	<i>ULInformationTransfer</i>	-	-
10	The SS transmits an <i>RRCCoNNECTIONRelease</i> message to release RRC connection and move to E-UTRA RRC_IDLE state.	<--	<i>RRCCoNNECTIONRelease</i>	-	-
11	Wait for 5 s for the UE to enter E-UTRA RRC_IDLE state.	-	-	-	-
12	The SS transmits a <i>Paging</i> message on the Cell 11 including a matched identity.	<--	<i>Paging</i>	-	-
13	Check: Does the UE transmit an <i>RRCCoNNECTIONRequest</i> message on the Cell 11? The UE starts T300.(NOTE 1)	-->	<i>RRCCoNNECTIONRequest</i>	3	P
14	Wait for 5 s to ensure that T300 expires.	-	-	-	-
15	The SS transmits a <i>Paging</i> message on the Cell 11 including a <i>systemInfoModification</i> .	<--	<i>Paging</i>	-	-
16	The SS changes <i>SystemInformationBlockType2</i> parameters to default parameters defined in [18].	-	-	-	-
17	Wait for 15 s for the UE to receive system information.	-	-	-	-
18	Make the UE initiate an outgoing call.	-	-	-	-
19	Check: Does the UE transmit an <i>RRCCoNNECTIONRequest</i> message on the Cell 11? The UE starts T300.(NOTE 1)	-->	<i>RRCCoNNECTIONRequest</i>	4	P
20	Wait for 5 s to ensure that T300 expires.	-	-	-	-
21	Check: Does the test result of CALL generic procedure indicate that the UE is in E-UTRA RRC_IDLE state on the Cell 11?	-	-	1,2, 3,4	-

NOTE 1: It is not required to check that the T300 is started.

8.1.2.7.3.3 Specific message contents

Table 8.1.2.7.3.3-1: SystemInformationBlockType2 for Cell 1 and Cell 11 (preamble and all steps, Table 8.1.2.7.3.2-2)

Derivation Path: 36.508, Table 4.4.3.3-1			
Information Element	Value/remark	Comment	Condition
SystemInformationBlockType2 ::= SEQUENCE {			
ac-BarringInfo SEQUENCE {			
ac-BarringForEmergency	TRUE		
ac-BarringForMO-Signalling SEQUENCE {			
ac-BarringFactor	p00		
ac-BarringTime	s4		
ac-BarringForSpecialAC	'00000'B		
}			
ac-BarringForMO-Data SEQUENCE {			
ac-BarringFactor	p00		
ac-BarringTime	s4		
ac-BarringForSpecialAC	'00000'B		
}			
}			
}			

Table 8.1.2.7.3.3-2: RRCConnectionRequest (step 2 and 19, Table 8.1.2.7.3.2-2)

Derivation Path: 36.508, Table 4.6.1-16			
Information Element	Value/remark	Comment	Condition
RRCConnectionRequest ::= SEQUENCE {			
criticalExtensions CHOICE {			
rrcConnectionRequest-r8 SEQUENCE {			
establishmentCause	mo-Data		
}			
}			
}			

Table 8.1.2.7.3.3-3: RRCConnectionRequest (step 5, Table 8.1.2.7.3.2-2)

Derivation Path: 36.508, Table 4.6.1-16			
Information Element	Value/remark	Comment	Condition
RRCConnectionRequest ::= SEQUENCE {			
criticalExtensions CHOICE {			
rrcConnectionRequest-r8 SEQUENCE {			
establishmentCause	mo-Signalling		
}			
}			
}			

Table 8.1.2.7.3.3-4: DLInformationTransfer (step 8, Table 8.1.2.7.3.2-2)

Derivation Path: 36.508, Table 4.6.1-3			
Information Element	Value/remark	Comment	Condition
DLInformationTransfer ::= SEQUENCE {			
criticalExtensions CHOICE {			
c1 CHOICE{			
dlInformationTransfer-r8 SEQUENCE {			
dedicatedInfoType CHOICE {			
dedicatedInfoNAS	TRACKING AREA UPDATE ACCEPT		
}			
}			
}			
}			
}			

Table 8.1.2.7.3.3-5: ULInformationTransfer (step 9, Table 8.1.2.7.3.2-2)

Derivation path: 36.508 table 4.6.1-25			
Information Element	Value/Remark	Comment	Condition
ULInformationTransfer ::= SEQUENCE {			
criticalExtensions CHOICE {			
c1 CHOICE {			
ulInformationTransfer-r8 SEQUENCE {			
dedicatedInformationType CHOICE {			
dedicatedInfoNAS	TRACKING AREA UPDATE COMPLETE		
}			
}			
}			
}			
}			

Table 8.1.2.7.3.3-6: RRCConnectionRequest (step 13, Table 8.1.2.7.3.2-2)

Derivation Path: 36.508, Table 4.6.1-16			
Information Element	Value/remark	Comment	Condition
RRCConnectionRequest ::= SEQUENCE {			
criticalExtensions CHOICE {			
rrcConnectionRequest-r8 SEQUENCE {			
establishmentCause	mt-Access		
}			
}			
}			

Table 8.1.2.7.3.3-7: Paging (step 15, Table 8.1.2.7.3.2-2)

Derivation Path: 36.508, Table 4.6.1-7			
Information Element	Value/remark	Comment	Condition
Paging ::= SEQUENCE {			
pagingRecordList	Not present		
systemInfoModification	True		
}			

8.1.2.8 RRC Connection Establishment: range of access barring time

Editor’s Note: This section is based on 36.331 v8.2.0 i.e. after RAN#40 + R2-083795.

8.1.2.8.1 Test Purpose (TP)

(1)

```

with { UE in E-UTRA RRC_IDLE state with T303 running }
ensure that {
  when { UE is requested to make an outgoing call }
  then { UE does not transmit any RRCConnectionRequest message }
}

```

(2)

```

with { UE in E-UTRA RRC_IDLE state having received SystemInformationBlockType2 with no restriction }
ensure that {
  when { UE is requested to make an outgoing call }
  then { UE transmits an RRCConnectionRequest message }
}

```

8.1.2.8.2 Conformance requirements

References: The conformance requirements covered in the present TC are specified in: TS 36.331, clause 5.3.3.2.

[TS 36.331, clause 5.3.3.2]

The UE initiates the procedure when upper layers request establishment of an RRC connection while the UE is in RRC_IDLE state.

Upon initiation of the procedure, the UE shall:

1> if T302 is running and the UE is not establishing the RRC connection for emergency calls:

2> consider access to the cell as barred;

1> else if *SystemInformationBlockType2* includes the *accessBarringInformation*:

2> if the UE is establishing the RRC connection for emergency calls:

...

2> else if the UE is establishing the RRC connection for mobile terminating access:

...

2> else if the UE is establishing the RRC connection for mobile originating signalling:

...

2> else:

3> if the *accessBarringInformation* includes *accessBarringForOriginatingCalls*:

4> if the UE has one or more Access Classes, as stored on the USIM, with a value in the range 11..15, which is valid for the UE to use according to TS 22.011 [10] and TS 23.122 [11], and

4> for at least one of these Access Classes the *accessClassBarring* in the *accessClassBarringList* contained in *accessBarringForOriginatingCalls* is set to FALSE :

5> consider access to the cell as not barred;

4> else:

5> if T303 is running:

6> consider access to the cell as barred;

5> else:

6> draw a random number 'rand' uniformly distributed in the range: $0 \leq \text{rand} < 1$

6> if 'rand' is lower than the value indicated by the *accessProbabilityFactor* included in *accessBarringForOriginatingCalls*:

- 7> consider access to the cell as not barred;
- 6> else:
 - 7> consider access to the cell as barred;
- 3> else:
 - 4> consider access to the cell as not barred;
- 1> else:
 - 2> consider access to the cell as not barred;
- 1> If access to the cell, as specified above, is not barred:
 - 2> stop acting on *Paging* messages;
 - 2> apply the default configuration applicable for the *antennaInformation* as specified in 9.2.3, until explicitly receiving a configuration;
 - 2> start timer T300;
 - 2> initiate transmission of the *RRCConnectionRequest* message in accordance with 5.3.3.3;

NOTE 2: Upon initiating the connection establishment procedure, the UE is not required to ensure it maintains up to date system information applicable only for UEs in RRC_IDLE state. However, the UE needs to perform system information acquisition upon re-selection.

- 1> else:
 - 2> if the UE is not establishing the RRC connection for emergency calls; and
 - 2> if T302 is not running:
 - 3> if the UE is establishing the RRC connection for mobile originating signalling:
 - 4> if T305 is not running:
 - 5> draw a random number 'rand' that is uniformly distributed in the range $0 \leq \text{rand} < 1$;
 - 5> start timer T305 with a timer value calculated as follows, using the *accessBarringTime* included in *accessBarringForSignalling*:

$$T305 = (0.7 + 0.6 * \text{rand}) * \text{accessBarringTime}$$
 - 3> else:
 - 4> if T303 is not running:
 - 5> draw a random number 'rand' that is uniformly distributed in the range $0 \leq \text{rand} < 1$;
 - 5> start timer T303 with a timer value calculated as follows, using the *accessBarringTime* included in *accessBarringForOriginatingCalls*:

$$T303 = (0.7 + 0.6 * \text{rand}) * \text{accessBarringTime}$$
 - 2> inform upper layers about the failure to establish the RRC connection, upon which the procedure ends.

8.1.2.8.3 Test description

8.1.2.8.3.1 Pre-test conditions

System Simulator:

- Cell 1

UE:

None.

Preamble:

- The UE is in Registered, Idle mode state (state 2) according to [18].

8.1.2.8.3.2 Test procedure sequence

Table 8.1.2.8.3.2-1: Main behaviour

St	Procedure	Message Sequence		TP	Verdict
		U - S	Message		
1	The SS transmits a <i>Paging</i> message including <i>systemInfoModification</i> .	<--	<i>Paging</i>	-	-
2	The SS changes <i>SystemInformationBlockType2</i> parameters to 50% access probability for MO calls.	-	-	-	-
3	Wait for [15] s for the UE to receive system information.	-	-	-	-
4	The SS initializes an internal flag F to TRUE.	-	-	-	-
-	EXCEPTION: Step 5 shall be repeated while the flag F is TRUE.	-	-	-	-
5	Make the UE initiate an outgoing call.	-	-	-	-
5a	IF the UE does not transmit any <i>RRCCoalitionRequest</i> message (The UE starts T303) (Note 2) THEN the SS sets the flag F to FALSE.	-	-	1	-
5b	ELSE IF the UE transmits an <i>RRCCoalitionRequest</i> message (The UE starts T300) (Note 1) THEN wait for [5] s to ensure that T300 expires.	-->	<i>RRCCoalitionRequest</i>	-	-
-	EXCEPTION: Step 6 to 7 shall be repeated 35 times (every 10 s).	-	-	-	-
6	Make the UE initiate an outgoing call.	-	-	-	-
7	Check: Does the UE transmit an <i>RRCCoalitionRequest</i> message within 5s?	-->	<i>RRCCoalitionRequest</i>	1	F
8	Wait for 20 s to ensure that T303 expires.	-	-	-	-
9	The SS transmits a <i>Paging</i> message including <i>systemInfoModification</i> .	<--	<i>Paging</i>	-	-
10	The SS changes <i>SystemInformationBlockType2</i> parameters to those used before the step 1.	-	-	-	-
11	Wait for [15] s for the UE to receive system information.	-	-	-	-
12	Make the UE initiate an outgoing call.	-	-	-	-
13	Check: Does the UE transmit an <i>RRCCoalitionRequest</i> message. The UE starts T300.(Note 1)?	-->	<i>RRCCoalitionRequest</i>	2	P
14	Wait for [5] s to ensure that T300 expires.	-	-	-	-
15	Check: Does the test result of CALL generic procedure indicate that the UE is in E-UTRA RRC_IDLE state?	-	-	1,2	-

8.1.2.8.3.3 Specific message contents

Editor's Note: To be updated according to agreed RRC message structure.

Table 8.1.2.8.3.3-1: Paging (step 1, Table 8.1.2.8.3.2-1)

FFS

Table 8.1.2.8.3.3-2: SystemInformationBlockType2 (step 2, Table 8.1.2.8.3.2-1)

FFS

Table 8.1.2.8.3.3-3: RRCConnectionRequest (step 5b, Table 8.1.2.8.3.2-1)

FFS

Table 8.1.2.8.3.3-4: Paging (step 9, Table 8.1.2.8.3.2-1)

FFS

Table 8.1.2.8.3.3-5: RRCConnectionRequest (step 13, Table 8.1.2.8.3.2-1)

FFS

8.1.2.10 RRC Connection Establishment during Cell reselection: Failure

Editor's Note: This section is based on 36.331 v8.3.0 i.e. after RAN#41.

Editor's Note: There are some concerns on the feasibility of this test case, see editor's notes at the end of section 8.1.2.10.3.2.

8.1.2.10.1 Test Purpose (TP)

(1)

```
with { UE in E-UTRA RRC_IDLE state having transmitted an RRCConnectionRequest message }
ensure that {
  when { UE recognises that the current cell conditions change and new cell meets the cell re-
selection criteria }
  then { UE selects the new cell and stops establishment of the RRC connection }
}
```

8.1.2.10.2 Conformance requirements

References: The conformance requirements covered in the present TC are specified in: 3GPP TS 36.331 clauses 5.3.3.5.

[TS 36.331, clause 5.3.3.5]

The UE shall:

- 1> If cell reselection occurs while T300 is running:
 - 2> stop timer T300;
 - 2> stop timer T302, if running;
 - 2> stop timer T303, if running;
 - 2> stop timer T305, if running;
 - 2> reset MAC;
 - 2> inform upper layers about the failure to establish the RRC connection, upon which the procedure ends.

8.1.2.10.3 Test description**8.1.2.10.3.1 Pre-test conditions**

System Simulator:

- 2 cells on same E-UTRA frequency (FDD for both or TDD for both):

- Cell 1: serving cell
- Cell 2: intra-frequency cell

UE:

None.

Preamble:

- UE is brought to state Registered, Idle mode (state 2) on Cell 1 according to [18].

8.1.2.10.3.2 Test procedure sequence

Table 8.1.2.10.3.2-1 illustrates the downlink power levels and other changing parameters to be applied for the cells at various time instants of the test execution. Row marked "T0" denotes the conditions after the preamble, while row marked "T1" is to be applied subsequently. The exact instants on which these values shall be applied are described in the texts in this clause.

Table 8.1.2.10.3.2-1: Time instances of cell power level and parameter changes

	Parameter	Unit	Cell 1	Cell 2	Remark
T0	Cell-specific RS EPRE	dBm/ 15kHz z	P01 (FFS)	P02 (FFS)	Shall be assigned values to satisfy $Srxlev_{Cell\ 1} > Srxlev_{Cell\ 2}$ such that camping on Cell 1 is guaranteed
T1	Cell-specific RS EPRE	dBm/ 15kHz z	P11 (FFS)	P02 (FFS)	Power P11 shall be assigned values to satisfy $RCell\ 1 < RCell\ 2$.

Table 8.1.2.10.3.2-2: Main behaviour

St	Procedure	Message Sequence		TP	Verdict
		U - S	Message		
1	Make UE initiate an outgoing call.	-	-	-	-
2	Check: Does the UE transmit an <i>RRCCONNECTIONREQUEST</i> on Cell 1?	-->	<i>RRCCONNECTIONREQUEST</i>	1	P
3	The SS changes Cell 1 and Cell 2 level according to the row "T1" in table 8.1.2.10.3.2-1.	-	-	-	-
4	Wait for [x]s to ensure that the UE camps on Cell 2.	-	-	1	P
5	Check: Does the test result of CALL generic procedure indicate that UE is in E-UTRA RRC_IDLE state on Cell2.(FFS)?	-	-	1	-

Editor's note: This test case is not really checking the test purpose: the maximum value of T300 is 2, so if waiting for more than 2s as now specified in step 4, normal cell selection after T300 expiry occurs.

Editor's note: It may be possible to check the purpose of this test case using T300=2s and Treselection= 0, assuming the SS can change the power of Cell 1 and Cell 2 within 0.5s after RRCCONNECTIONREQUEST is received in step 2, 1s could be enough for cell reselection (needs checking with 36.133), then paging could be sent within 1.5s-1.6s, so that the RRCCONNECTIONREQUEST on Cell 2 comes before T300 expiry. If any of the above assumption is not true, this test case may not be feasible.

8.1.2.10.3.3 Specific message contents

Table 8.1.2.10.3.3-1: SystemInformationBlockType2 for Cell 1 (pre-test conditions)

Derivation Path: 36.508 Table 4.4.3.3-1			
Information Element	Value/remark	Comment	Condition
SystemInformationBlockType2 ::= SEQUENCE {			
ue-TimersAndConstants SEQUENCE {			
t300	ms2000		
}			
...			
}			

Table 8.1.2.10.3.3-2: SystemInformationBlockType3 for Cell 1 (pre-test conditions)

Derivation Path: 36.508 Table 4.4.3.3-2			
Information Element	Value/remark	Comment	Condition
SystemInformationBlockType3 ::= SEQUENCE {			
cellReselectionInfoCommon SEQUENCE {			
t-ReselectionEUTRAN	0		
}			
...			
}			

Table 8.1.2.10.3.3-3 RRCConnectionRequest (step 2, Table 8.1.2.10.3.2-1)

Derivation Path: 36.508 Table 4.6.1-15			
Information Element	Value/remark	Comment	Condition
RRCConnectionRequest ::= SEQUENCE {			
criticalExtensions CHOICE {			
rrcConnectionRequest-r8 = SEQUENCE {			
establishmentCause	mo-Data		
}			
}			
}			

8.1.3 RRC Connection Release

8.1.3.1 RRC Connection Release: Success

8.1.3.1.1 Test Purpose (TP)

(1)

```

with { UE in RRC_CONNECTED state}
ensure that {
  when { UE receives an RRCConnectionRelease message }
  then { UE releases the signalling connection, the established EPS bearer and all radio resources
and enters in RRC_IDLE state }
}

```

8.1.3.1.2 Conformance requirements

References: The conformance requirements covered in the present TC are specified in: 3GPP TS 36.331 clause 5.3.8.3 and 5.3.12.

[TS 36.331, clause 5.3.8.3]

The UE shall:

- 1> delay the following actions defined in this sub-clause 60ms from the moment the *RRCConnectionRelease* message was received or optionally when lower layers indicate that the receipt of the *RRCConnectionRelease* message has been successfully acknowledged, whichever is earlier;

...

- 1> if the *releaseCause* received in the *RRCConnectionRelease* message indicates ‘*loadBalancingTAURequired*’:
 - 2> perform the actions upon leaving RRC_CONNECTED as specified in 5.3.12, with release cause ‘load balancing TAU required’;
- 1> else:
 - 2> perform the actions upon leaving RRC_CONNECTED as specified in 5.3.12, with release cause ‘other’.

[TS 36.331, clause 5.3.12]

Upon leaving RRC_CONNECTED, the UE shall:

- 1> reset MAC;
- 1> stop all timers that are running except T320;
- 1> release all radio resources, including release of the RLC entity, the MAC configuration and the associated PDCP entity for all established RBs;
- 1> indicate the release of the RRC connection to upper layers together with the release cause;
- 1> if leaving RRC_CONNECTED was not triggered by reception of the *MobilityFromEUTRACommand* message:
 - 2> enter RRC_IDLE by performing cell selection in accordance with the cell selection process, defined for the case of leaving RRC_CONNECTED, as specified in TS 36.304 [4].

8.1.3.1.3 Test description

8.1.3.1.3.1 Pre-test conditions

System Simulator:

- Cell 1

UE:

None.

Preamble:

- The UE is in state Generic RB Established (state 3) according to [18].

8.1.3.1.3.2 Test procedure sequence

Table 8.1.3.1.3.2-1: Main behaviour

St	Procedure	Message Sequence		TP	Verdict
		U - S	Message		
1	SS transmits a <i>RRCConnectionRelease</i> message to release the RRC connection.	<--	<i>RRCConnectionRelease</i>	-	-
2	SS waits for 5s.	-	-	-	-
3	Check: Does the test result of CALL generic procedure indicate that the UE is in E-UTRA RRC_IDLE state.	-	-	-	P

8.1.3.1.3.3 Specific message content

None.

8.1.3.3 RRC Connection Release: UE stays on same cell

8.1.3.3.1 Test Purpose (TP)

(1)

with { UE in E-UTRA RRC_CONNECTED state }

```

ensure that {
  when { UE receives an RRCConnectionRelease message and a cell with higher Srxlev than serving cell exist }
  then { UE enters E-UTRA RRC_IDLE state on the last cell for which UE was in E-UTRA RRC_CONNECTED state }
}

```

8.1.3.3.1 Conformance requirements

References: The conformance requirements covered in the present TC are specified in: 3GPP TS 36.331 clause 5.3.8.3 and 3GPP TS 36.304 clauses 5.2.4.6 and 5.2.7.

[TS 36.331, clause 5.3.8.3]

The UE shall:

- 1> delay the following actions defined in this sub-clause 60ms from the moment the *RRCConnectionRelease* message was received or optionally when lower layers indicate that the receipt of the *RRCConnectionRelease* message has been successfully acknowledged, whichever is earlier;
- 1> perform the actions upon moving from RRC_CONNECTED to RRC_IDLE as specified in 5.3.12.

...

[TS 36.304, clause 5.2.4.6]

In all cases, the UE shall reselect the new cell, only if the following conditions are met:

- the new cell is better ranked than the serving cell during a time interval *T*reselection,

[TS 36.304, clause 5.2.7]

On transition from RRC_CONNECTED to RRC_IDLE, a UE shall attempt to camp on the last cell for which it was in RRC_CONNECTED or any cell on a frequency or frequency of RAT by RRC in the state transition message.

8.1.3.3.3 Test description

8.1.3.3.3.1 Pre-test conditions

System Simulator:

- Cell 1 and Cell 2

UE:

None.

Preamble:

- The UE is in state Generic RB Established (state 3) according to [18].

8.1.3.3.3.2 Test procedure sequence

Table 8.1.3.3.3.2-1 illustrates the downlink power levels and other changing parameters to be applied for the cells at various time instants of the test execution. Row marked "T0" denotes the initial conditions, while columns marked "T1" is to be applied subsequently. The exact instants on which these values shall be applied are described in the texts in this clause.

Table 8.1.3.3.2-1: Time instances of cell power level and parameter changes

	Parameter	Unit	Cell 1	Cell 2	Remark
T0	Ro	dBm	P01 (FFS)	P02 (FFS)	Shall be assigned values to satisfy $Srxlev_{Cell\ 1} > Srxlev_{Cell\ 2}$, such that camping on Cell 1 is guaranteed
T1	Ro	dBm	P01 (FFS)	P12 (FFS)	Power P12 shall be assigned values to satisfy $R_{Cell\ 1} < R_{Cell\ 2}$.

Table 8.1.3.3.3.2-1: Main behaviour

St	Procedure	Message Sequence		TP	Verdict
		U - S	Message		
1	The SS changes Cell 1 and Cell 2 level according to the row "T1" in table 8.1.3.3.3.2-1..	-	-	-	-
2	SS transmits an <i>RRCConnectionRelease</i> message to release the RRC Connection.	<--	<i>RRCConnectionRelease</i>	-	-
3	SS waits for [x1] ms + 5s.	-	-	-	-
4	Make the UE initiate an outgoing call.	-	-	-	-
4	Check: Is there any random access requests from the UE on Cell 1?	-	-	1	P

8.1.3.3.3.3 Specific message contents

Table 8.1.3.3.3.3-1 SystemInformationBlockType3 for Cells 1 and Cell 2 (pre-test conditions)

Derivation Path: 36.508 Table 4.4.3.3-2			
Information Element	Value/remark	Comment	Condition
SystemInformationBlockType3 ::= SEQUENCE {			
cellReselectionInfoCommon SEQUENCE {			
t-ReselectionEUTRAN	7		
}			
...			
}			

8.1.3.4 RRC Connection Release: redirection to another E-UTRAN frequency

8.1.3.4.1 Test Purpose (TP)

(1)

```

with { UE in E-UTRA RRC_CONNECTED state }
ensure that {
  when { UE receives an RRCConnectionRelease message including an IE RedirectionInformation with E-UTRA-CarrierFreq different from the frequency UE was on in RRC_CONNECTED state }
  then { UE enters RRC_IDLE state on new frequency included in IE RedirectionInformation }
}

```

8.1.3.4.2 Conformance requirements

References: The conformance requirements covered in the current TC are specified in: TS 36.331, clauses 5.3.8.3, 5.3.12 and TS 36.304, clauses 5.2.4.1, 5.2.7.

[TS 36.331, clause 5.3.8.3]

The UE shall:

- 1> delay the following actions defined in this sub-clause 60ms from the moment the *RRCConnectionRelease* message was received or optionally when lower layers indicate that the receipt of the *RRCConnectionRelease* message has been successfully acknowledged, whichever is earlier;

1> if the *RRCConnectionRelease* message includes the *idleModeMobilityControlInfo*:

...

1> else:

2> apply the cell reselection priority information broadcast in the system information;

1> if the *releaseCause* received in the *RRCConnectionRelease* message indicates '*loadBalancingTAURequired*':

...

1> else:

2> perform the actions upon leaving RRC_CONNECTED as specified in 5.3.12, with release cause 'other'.

[TS 36.331, clause 5.3.12]

Upon leaving RRC_CONNECTED, the UE shall:

...

1> indicate the release of the RRC connection to upper layers together with the release cause;

1> if leaving RRC_CONNECTED was not triggered by reception of the *MobilityFromEUTRACommand* message:

2> enter RRC_IDLE by performing cell selection in accordance with the cell selection process, defined for the case of leaving RRC_CONNECTED, as specified in TS 36.304 [4].

[TS 36.304, clause 5.2.4.1]

...

UE shall only perform cell reselection evaluation for E-UTRAN frequencies and inter-RAT frequencies that are given in system information and for which the UE has a priority provided.

...

[TS 36.304, clause 5.2.7]

On transition from RRC_CONNECTED to RRC_IDLE, a UE shall attempt to camp on the last cell for which it was in RRC_CONNECTED or any cell on a frequency or frequency of RAT assigned by RRC in the state transition message

...

8.1.3.4.3 Test description

8.1.3.4.3.1 Pre-test conditions

System Simulator:

- 2 cells on different E-UTRA frequencies and different tracking areas:
 - Cell 1 serving cell
 - Cell 23 suitable neighbour inter-frequency cell
 - Cell power levels are selected according to [18] so that camping on Cell 1 is guaranteed

UE:

None.

Preamble:

- The UE is in state Generic RB Established (state 3) according to [18] on cell 1.

8.1.3.4.3.2 Test procedure sequence

Table 8.1.3.4.3.2-1: Main behaviour

St	Procedure	Message Sequence		TP	Verdict
		U - S	Message		
1	SS transmits an <i>RRCCConnectionRelease</i> message (IE <i>redirectionInformation</i> including <i>eutra-CarrierFreq</i> of Cell 23).	<--	<i>RRCCConnectionRelease</i>	-	-
2	Check: Is there is any random access request from the UE on Cell 23?	-	-	1	P

8.1.3.4.3.3 Specific message contents

Table 8.1.3.4.3.3-1: Conditions for tables 8.1.3.4.3.3-2 and 8.1.3.4.3.3-3

Condition descriptions
Cell 1 This condition applies to system information transmitted on Cell 1.
Cell 23 This condition applies to system information transmitted on Cell 23.

Table 8.1.3.4.3.3-2: *SystemInformationBlockType1* for cells 1 and 3 (preamble and all steps, Table 8.1.3.4.3.2-1)

Derivation Path: 36.508 table 4.4.3.2-3			
Information Element	Value/remark	Comment	Condition
<i>SystemInformationBlockType1</i> ::= SEQUENCE { <i>schedulingInfoList</i> ::= SEQUENCE (SIZE (1..maxSI-Message)) OF SEQUENCE {} }	Combination 3 in TS 36.508 section 4.4.3.1	SIB2, SIB3 and SIB5 are transmitted	Cell 1 Cell 23

Table 8.1.3.4.3.3-3: *SystemInformationBlockType5* for cells 1 and 3 (preamble and all steps, Table 8.1.3.4.3.2-1)

Derivation Path: 36.508 table 4.4.3.3-4			
Information Element	Value/remark	Comment	Condition
<i>SystemInformationBlockType5</i> ::= SEQUENCE { <i>interFreqCarrierFreqList</i> SEQUENCE (SIZE (1..maxFreq)) OF SEQUENCE { <i>cellReselectionPriority</i> } }	1 entry Not present		Cell 1 Cell 23

Table 8.1.3.4.3.3-4 *RRCCConnectionRelease* message (step 1, Table 8.1.3.4.3.2-1)

Derivation Path: 36.508 table 4.6.1-15			
Information Element	Value/remark	Comment	Condition
<i>RRCCConnectionRelease</i> ::= SEQUENCE { <i>criticalExtensions</i> CHOICE { c1 CHOICE { <i>rrcConnectionRelease-r8</i> SEQUENCE { <i>redirectedCarrierInfo</i> ::= CHOICE { <i>eutra</i> } } } }	Downlink EARFCN of cell 23		

8.1.3.5 RRC Connection Release: success (with priority information)

8.1.3.5.1 Test Purpose (TP)

(1)

```
with { UE in E-UTRA RRC_IDLE state having received an RRCCConnectionRelease message with the
freqPriorityListEUTRA with higher priority frequency}
ensure that {
  when { UE detects the cell re-selection criteria are met for the cell which belongs to the higher
priority frequency }
  then { UE reselects the cell which belongs to the higher priority frequency }
}
```

8.1.3.5.2 Conformance requirements

References: The conformance requirements covered in the present TC are specified in: TS 36.331, clause 5.3.8.3 and TS 36.304, clause 5.2.4.1, 5.2.4.2 and 5.2.4.5.

[TS 36.331, clause 5.3.8.3]

The UE shall:

1> delay the following actions defined in this sub-clause 60 ms from the moment the *RRCCConnectionRelease* message was received or optionally when lower layers indicate that the receipt of the *RRCCConnectionRelease* message has been successfully acknowledged, whichever is earlier;

1> if the *RRCCConnectionRelease* message includes the *idleModeMobilityControlInfo*:

2> store the cell reselection priority information provided by the *idleModeMobilityControlInfo*;

2> if the *t320* is included:

3> start timer T320, with the timer value set according to the value of *t320*;

1> else:

...

1> if the *releaseCause* received in the *RRCCConnectionRelease* message indicates '*loadBalancingTAURequired*':

2> perform the actions upon leaving RRC_CONNECTED as specified in 5.3.12, with release cause 'load balancing TAU required';

1> else:

2> perform the actions upon leaving RRC_CONNECTED as specified in 5.3.12, with release cause 'other';

[TS 36.304, clause 5.2.4.1]

Absolute priorities of different E-UTRAN frequencies or inter-RAT frequencies may be provided to the UE in the system information, in the *RRCCConnectionRelease* message, or by inheriting from another RAT at inter-RAT cell (re)selection. In the case of system information, an E-UTRAN frequency or inter-RAT frequency may be listed without providing a priority (i.e. the field *cellReselectionPriority* is absent for that frequency). If priorities are provided in dedicated signalling, the UE shall ignore all the priorities provided in system information. If UE is in *camped on any cell* state, UE shall only apply the priorities provided by system information from current cell, and the UE preserves priorities provided by dedicated signalling unless specified otherwise. When the UE in *camped normally* state, has only dedicated priorities other than for the current frequency, the UE shall consider the current frequency to be the lowest priority frequency (i.e. lower than the eight network configured values). The UE shall delete priorities provided by dedicated signalling when:

- the UE enters RRC_CONNECTED state; or
- the optional validity time of dedicated priorities (T320) expires; or
- a PLMN selection is performed on request by NAS [5].

NOTE: Equal priorities between RATs are not supported.

The UE shall only perform cell reselection evaluation for E-UTRAN frequencies and inter-RAT frequencies that are given in system information and for which the UE has a priority provided.

The UE shall not consider any black listed cells as candidate for cell reselection.

The UE shall inherit the priorities provided by dedicated signalling and the remaining validity time (i.e., T320 in E-UTRA, T322 in UTRA and [T3230, FFS] in GERAN), if configured, at inter-RAT cell (re)selection.

NOTE: The network may assign dedicated cell reselection priorities for frequencies not configured by system information.

[TS 36.304, clause 5.2.4.2]

When evaluating for reselection purposes cell selection criterion or $S_{\text{nonServingCell},x}$, the UE shall use parameters provided by the serving cell.

Following rules are used by the UE to limit needed measurements:

- If $S_{\text{intrasearch}}$ is sent in the serving cell and $S_{\text{ServingCell}} > S_{\text{intrasearch}}$, UE may choose to not perform intra-frequency measurements.
- If $S_{\text{ServingCell}} \leq S_{\text{intrasearch}}$, or $S_{\text{intrasearch}}$ is not sent in the serving cell UE shall perform intra-frequency measurements.
- The UE shall apply the following rules for E-UTRAN inter-frequencies and inter-RAT frequencies which are indicated in system information and for which the UE has priority provided as defined in 5.2.4.1:
 - For an E-UTRAN inter-frequency or inter-RAT frequency with a reselection priority higher than the reselection priority of the current E-UTRA frequency the UE shall perform measurements of higher priority E-UTRAN inter-frequency or inter-RAT frequencies according to [10].
 - For an E-UTRAN inter-frequency with an equal or lower reselection priority than the reselection priority of the current E-UTRA frequency and for inter-RAT frequency with lower reselection priority than the reselection priority of the current E-UTRAN frequency:
 - If $S_{\text{nonintrasearch}}$ is sent in the serving cell and $S_{\text{ServingCell}} > S_{\text{nonintrasearch}}$ UE may choose not to perform measurements of E-UTRAN inter-frequencies or inter-RAT frequency cells of equal or lower priority.
 - If $S_{\text{ServingCell}} \leq S_{\text{nonintrasearch}}$ or $S_{\text{nonintrasearch}}$ is not sent in the serving cell the UE shall perform measurements of E-UTRAN inter-frequencies or inter-RAT frequency cells of equal or lower priority according to [10].

Where $S_{\text{ServingCell}}$ is the S_{rxlev} -value of the serving cell.

[TS 36.304, clause 5.2.4.5]

Criteria 1: the $S_{\text{nonServingCell},x}$ of a cell on evaluated frequency is greater than $\text{Thresh}_{x, \text{high}}$ during a time interval $\text{Treselection}_{\text{RAT}}$;

Cell reselection to a cell on a higher priority E-UTRAN frequency or inter-RAT frequency than serving frequency shall be performed if:

- A cell of a higher priority E-UTRAN frequency or inter-RAT frequency fulfils criteria 1; and
- more than 1 second has elapsed since the UE camped on the current serving cell.

Cell reselection to a cell on a lower priority E-UTRAN frequency or inter-RAT frequency than serving frequency shall be performed if:

- No cell on serving frequency or on an equal priority E-UTRAN frequency or on a higher priority E-UTRAN frequency or inter-RAT frequency than serving frequency fulfills the criteria 1; and
- $S_{\text{ServingCell}} < \text{Thresh}_{\text{serv}, \text{low}}$ and the $S_{\text{nonServingCell},x}$ of a cell of a lower priority E-UTRAN frequency or inter-RAT frequency is greater than $\text{Thresh}_{x, \text{low}}$ during a time interval $\text{Treselection}_{\text{RAT}}$; and
- more than 1 second has elapsed since the UE camped on the current serving cell.

or if:

- there are no candidate cells for reselection on serving frequency according to 5.2.4.4 or 5.3.1.

Cell reselection to a cell on an equal priority E-UTRAN frequency shall be based on ranking for Intra-frequency cell reselection as defined in sub-clause 5.2.4.6.

For GERAN, UTRAN, and E-UTRAN, $S_{\text{nonServingCell},x}$ is the S_{rxlev} -value of an evaluated cell. For UTRAN FDD, S_{qual} is higher than 0, as defined in [8]. For cdma2000 RATs, $S_{\text{nonServingCell},x}$ is equal to $\text{FLOOR}(-2 \times 10 \times \log_{10} E_c/I_o)$ in units of 0.5 dB, as defined in [18], with E_c/I_o referring to the value measured from the evaluated cell.

In all the above criteria the value of $T_{\text{reselection,RAT}}$ is scaled when the UE is in the medium or high mobility state as defined in subclause 5.2.4.3.1. If more than one cell meets the above criteria, the UE shall reselect a cell ranked as the best cell among the cells meeting the criteria on the highest priority frequencies or the highest priority RAT if the highest priority RAT is E-UTRA according to criteria defined in 5.2.4.6.

8.1.3.5.3 Test description

8.1.3.5.3.1 Pre-test conditions

System Simulator:

- Cell 1, Cell 3 and Cell 6.

UE:

None.

Preamble:

- The UE is in state Generic RB Established (state 3) on Cell 1 according to [18].

8.1.3.5.3.2 Test procedure sequence

Table 8.1.3.5.3.2-1 illustrates the downlink power levels and other changing parameters to be applied for the cells at various time instants of the test execution. Row marked "T0" denotes the initial conditions, while columns marked "T1" is to be applied subsequently. The exact instants on which these values shall be applied are described in the texts in this clause.

Table 8.1.3.5.3.2-1: Time instances of cell power level and parameter changes

	Parameter	Unit	Cell 1	Cell 3	Cell 6	Remark
T0	Cell-specific RS EPRE	dBm/ 15kHz z	[-74]	[-95]	[-95]	The power level values are assigned to satisfy $S_{\text{rxlevCell } 1} > S_{\text{intrasearch}}$ such that camping on Cell 1 is guaranteed.
T1	Cell-specific RS EPRE	dBm/ 15kHz z	[-74]	[-74]	[-74]	The power level values are assigned to satisfy $\text{Thresh}_{x, \text{high}} < \text{both } S_{\text{rxlevCell } 3} \text{ and } S_{\text{rxlevCell } 6}$.

Table 8.1.3.5.3.2-2: Main behaviour

St	Procedure	Message Sequence		TP	Verdict
		U - S	Message		
1	The SS transmits an <i>RRConnectionRelease</i> message including the <i>freqPriorityListEUTRA</i> on Cell 1.	<--	<i>RRConnectionRelease</i>	-	-
2	Wait for 5 s for the UE to enter E-UTRA RRC_IDLE state on Cell 1.	-	-	-	-
3	The SS changes Cell 1, Cell 3 and Cell 6 level according to the row "T1" in table 8.1.3.5.3.2-1.	-	-	-	-
4	Wait for 5 s for the UE to perform cell reselection procedure.	-	-	-	-
5	Make the UE initiate an outgoing call.	-	-	-	-
6	Check: Is there any random access requests from the UE on Cell 6?	-	-	1	P

8.1.3.5.3.3 Specific message contents

Table 8.1.3.5.3.3-1: *RRConnectionRelease* (step 1, Table 8.1.3.5.3.2-2)

Derivation Path: 36.508 Table 4.6.1-15			
Information Element	Value/remark	Comment	Condition
<i>RRConnectionRelease</i> ::= SEQUENCE {			
criticalExtensions CHOICE {			
c1 CHOICE {			
<i>rrcConnectionRelease-r8</i> SEQUENCE {			
<i>idleModeMobilityControlInfo</i> SEQUENCE {			
<i>freqPriorityListEUTRA</i> SEQUENCE (SIZE (1..maxFreq)) OF SEQUENCE {	3 entries		
<i>carrierFreq</i> [1]	Same downlink EARFCN as used for Cell 1		
<i>cellReselectionPriority</i> [1]	4		
<i>carrierFreq</i> [2]	Same downlink EARFCN as used for Cell 3		
<i>cellReselectionPriority</i> [2]	1		
<i>carrierFreq</i> [3]	Same downlink EARFCN as used for Cell 6		
<i>cellReselectionPriority</i> [3]	5		
}			
<i>freqPriorityListGERAN</i>	Not present		
<i>freqPriorityListUTRA-FDD</i>	Not present		
<i>freqPriorityListUTRA-TDD</i>	Not present		
<i>bandClassPriorityListHRPD</i>	Not present		
<i>bandClassPriorityList1XRTT</i>	Not present		
<i>t320</i>	Not present		
}			
}			
}			
}			

Table 8.1.3.5.3.3-2: SystemInformationBlockType5 for Cell 1 (preamble and all steps, Table 8.1.3.5.3.2-2)

Derivation path: 36.508 table 4.4.3.3-4			
Information Element	Value/Remark	Comment	Condition
SystemInformationBlockType5 ::= SEQUENCE { interFreqCarrierFreqList SEQUENCE (SIZE (1..maxFreq)) OF SEQUENCE { dl-CarrierFreq[1] dl-CarrierFreq[2] threshX-High[2] } }	2 entries Same downlink EARFCN as used for Cell 3 Same downlink EARFCN as used for Cell 6 11		

8.1.3.6 RRC Connection Release: redirection from E-UTRAN to UTRAN

8.1.3.6.1 Test Purpose (TP)

(1)

```
with { UE in E-UTRA RRC_CONNECTED state }
ensure that {
  when { UE receives an RRCConnectionRelease message including an IE redirectionInformation with
    ultra-CarrierFreq UTRA frequency }
  then { UE enters RRC_IDLE state on UTRA frequency included in IE redirectionInformation }
}
```

8.1.3.6.2 Conformance requirements

References: The conformance requirements covered in the current TC are specified in: TS 36.331, clause 5.3.8.3, 5.3.12 and TS 36.304, clause 5.2.7.

[TS 36.331, clause 5.3.8.3]

The UE shall:

1> delay the following actions defined in this sub-clause 60ms from the moment the *RRCConnectionRelease* message was received or optionally when lower layers indicate that the receipt of the *RRCConnectionRelease* message has been successfully acknowledged, whichever is earlier;

1> if the *RRCConnectionRelease* message includes the *idleModeMobilityControlInfo*:

...

1> else:

2> apply the cell reselection priority information broadcast in the system information;

1> if the *releaseCause* received in the *RRCConnectionRelease* message indicates '*loadBalancingTAURequired*':

...

1> else:

2> perform the actions upon leaving RRC_CONNECTED as specified in 5.3.12, with release cause 'other'.

[TS 36.331, clause 5.3.12]

Upon leaving RRC_CONNECTED, the UE shall:

...

1> indicate the release of the RRC connection to upper layers together with the release cause;

1> if leaving RRC_CONNECTED was not triggered by reception of the *MobilityFromEUTRACCommand* message:

2> enter RRC_IDLE by performing cell selection in accordance with the cell selection process, defined for the case of leaving RRC_CONNECTED, as specified in TS 36.304 [4].

[TS 36.304, clause 5.2.7]

On transition from RRC_CONNECTED to RRC_IDLE, a UE shall attempt to camp on the last cell for which it was in RRC_CONNECTED or any cell on a frequency or frequency of RAT assigned by RRC in the state transition message.

...

8.1.3.6.3 Test description

8.1.3.6.3.1 Pre-test conditions

System Simulator:

- 2 cells, one E-UTRA and one UTRA cell and different location areas:
- Cell 1 E-UTRA serving cell
- Cell 5 suitable neighbour UTRA cell
- The parameters settings and power levels for Cell 1 and Cell 5 are selected according to [18], [5] and Table 8.1.3.6.3.2-0 so that camping on Cell 1 is guaranteed and no cell re-selection to Cell 5 can take place (utra priority is lower than serving and $S_{Cell 1} > Thresh_{Cell 1,low}$).

UE:

None.

Preamble:

- The UE is in state Generic RB Established (state 3) on cell 1 according to [18].

8.1.3.6.3.2 Test procedure sequence

Table 8.1.3.6.3.2-0 shows the cell power levels after the preamble.

Table 8.1.3.6.3.2-0: Time instances of cell power level and parameter changes

	Parameter	Unit	Cell 1	Cell 5	Remark
T0	Cell-specific RS EPRE	dBm/15kHz	-75	-	The power levels are such that camping on Cell 1 is guaranteed.
	CPICH_Ec	dBm/3.84 MHz	-	-70	

Table 8.1.3.6.3.2-1: Main behaviour

St	Procedure	Message Sequence		TP	Verdict
		U - S	Message		
1	SS transmits an <i>RRCConnectionRelease</i> message (IE <i>redirectionInformation</i> including <i>UTRA-CarrierFreq</i> of Cell 5).	<--	<i>RRCConnectionRelease</i>	-	-
2	Check: Is there is any random access request from the UE on Cell 5.	-	-	1	P

8.1.3.6.3.3 Specific message or IE contents

Table 8.1.3.6.3.3-1: Conditions for tables 8.1.3.6.3.3-2 and 8.1.3.6.3.3-3

Condition descriptions
Cell 1 This condition applies to system information transmitted on Cell 1.
Cell 5 This condition applies to system information transmitted on Cell 5.

Table 8.1.3.6.3.2-2: SystemInformationBlockType1 for cell 1 (preamble and all steps, Table 8.1.3.6.3.2-1)

Derivation Path: 36.508 table 4.4.3.2-3			
Information Element	Value/remark	Comment	Condition
SystemInformationBlockType1 ::= SEQUENCE { schedulingInfoList ::= SEQUENCE (SIZE (1..maxSI-Message)) OF SEQUENCE { }	Combination 4 in TS 36.508 section 4.4.3.1	SIB2, SIB3 and SIB6 are transmitted	

Table 8.1.3.6.3.3-3: SystemInformationBlockType6 for cell 1 (preamble and all steps, Table 8.1.3.6.3.2-1)

Derivation Path: 36.508 table 4.4.3.3-5			
Information Element	Value/remark	Comment	Condition
SystemInformationBlockType6 ::= SEQUENCE { carrierFreqListUTRA-FDD SEQUENCE (SIZE (1..maxUTRA-FDD-Carrier)) OF SEQUENCE { cellReselectionPriority }	1 entry		UTRA-FDD
cellReselectionPriority	3	Lower priority than E-UTRA	
carrierFreqListUTRA-TDD SEQUENCE (SIZE (1..maxUTRA-TDD-Carrier)) OF SEQUENCE { cellReselectionPriority }	1 entry		UTRA-TDD
cellReselectionPriority	3	Lower priority than E-UTRA	

Table 8.1.3.6.3.3-4 RRCConnectionRelease message (step 1, Table 8.1.3.6.3.2-1)

Derivation Path: 36.508 table 4.6.1.1-15			
Information Element	Value/remark	Comment	Condition
RRCConnectionRelease ::= SEQUENCE { criticalExtensions CHOICE { c1 CHOICE { rrcConnectionRelease-r8 SEQUENCE { redirectedCarrierInfo ::= CHOICE { ultra-FDD ultra-TDD }	Downlink UARFCN of cell 5		UTRA-FDD
ultra-TDD			UTRA-TDD

Editor's note: The need and exact definition of "Priority Info List" for Cell 5 in this test are FFS

8.1.3.8 RRC Connection Release: redirection from E-UTRAN to GERAN

Editor's note: This test case is incomplete. The following aspects are either missing or not yet determined:

The default System Information 2quater is not yet defined. It is assumed, as way forward, that in the System Information 2quater the E-UTRAN priority is lower than GERAN and in SystemInformationBlockType7 the declared priority of GERAN is lower than E-UTRAN.

8.1.3.8.1 Test Purpose (TP)

(1)

```
with { UE in E-UTRA RRC_CONNECTED state }
ensure that {
  when { UE receives an RRCConnectionRelease message including an IE redirectionInformation with
interRAT-target including GERAN-CarrierFreq }
```

```

then { UE enters Idle mode on GERAN Cell included in IE redirectionInformation }
}

```

8.1.3.8.2 Conformance requirements

References: The conformance requirements covered in the current TC are specified in: TS 36.331, clause 5.3.8.3, 5.3.12 and TS 36.304, clause 5.2.7.

[TS 36.331, clause 5.3.8.3]

The UE shall:

1> delay the following actions defined in this sub-clause 60ms from the moment the *RRCConnectionRelease* message was received or optionally when lower layers indicate that the receipt of the *RRCConnectionRelease* message has been successfully acknowledged, whichever is earlier;

1> if the *RRCConnectionRelease* message includes the *idleModeMobilityControlInfo*:

...

1> else:

2> apply the cell reselection priority information broadcast in the system information;

1> if the *releaseCause* received in the *RRCConnectionRelease* message indicates '*loadBalancingTAURequired*':

...

1> else:

2> perform the actions upon leaving RRC_CONNECTED as specified in 5.3.12, with release cause 'other'.

[TS 36.331, clause 5.3.12]

Upon leaving RRC_CONNECTED, the UE shall:

...

1> indicate the release of the RRC connection to upper layers together with the release cause;

1> if leaving RRC_CONNECTED was not triggered by reception of the *MobilityFromEUTRACommand* message:

2> enter RRC_IDLE by performing cell selection in accordance with the cell selection process, defined for the case of leaving RRC_CONNECTED, as specified in TS 36.304 [4].

[TS 36.304, clause 5.2.7]

On transition from RRC_CONNECTED to RRC_IDLE, a UE shall attempt to camp on the last cell for which it was in RRC_CONNECTED or any cell on a frequency or frequency of RAT assigned by RRC in the state transition message.

...

8.1.3.8.3 Test description

8.1.3.8.3.1 Pre-test conditions

System Simulator:

- 2 cells, one E-UTRA and one GERAN cell and different location areas:
 - Cell 1 E-UTRA serving cell
 - Cell 24 GERAN neighbouring cell
- The parameters settings and power levels for Cell 1 and Cell 24 are selected according to [18], [5], [25] and Table 8.1.3.8.3.2-0 so that camping on Cell 1 is guaranteed and no cell re-selection to Cell 24 can take place (GERAN priority is lower than serving and $S_{Cell 1} > Thresh_{Cell 1,low}$)

UE:

None.

Preamble:

- The UE is in state Generic RB Established (state 3) on cell 1 according to [18].

8.1.3.8.3.2 Test procedure sequence

Table 8.1.3.6.3.2-0 shows the cell power levels after the preamble.

Table 8.1.3.8.3.2-0: Time instances of cell power level and parameter changes

	Parameter	Unit	Cell 1	Cell 24	Remark
T0	Cell-specific RS EPRE	dBm/15kHz	-75	-	The power levels are such that camping on Cell 1 is guaranteed.
	GERAN Cell Power	dBm	-	-70	

Table 8.1.3.8.3.2-1: Main behaviour

St	Procedure	Message Sequence		TP	Verdict
		U - S	Message		
1	SS transmits an <i>RRConnectionRelease</i> message (IE <i>redirectionInformation</i> including <i>CarrierFreqsGERAN</i> of Cell 24).	<--	<i>RRConnectionRelease</i>	-	-
2	Check: Is there is any random access request from the UE on Cell 24?	-	-	1	P

8.1.3.8.3.3 Specific message or IE contents

Table 8.1.3.8.3.3-1: Conditions for tables 8.1.3.8.3.3-2 and 8.1.3.8.3.3-3

Condition descriptions
Cell 1 This condition applies to system information transmitted on Cell 1.
Cell 24 This condition applies to system information transmitted on Cell 24.

Table 8.1.3.8.3.3-2: *SystemInformationBlockType1* for cell 1 (preamble and all steps, Table 8.1.3.8.3.2-1)

Derivation Path: 36.508 table 4.4.3.2-3			
Information Element	Value/remark	Comment	Condition
<i>SystemInformationBlockType1</i> ::= SEQUENCE { <i>schedulingInfoList</i> ::= SEQUENCE (SIZE (1..maxSI-Message)) OF SEQUENCE {} }	Combination 5 in TS 36.508 section 4.4.3.1	SIB2, SIB3 and SIB7 are transmitted	

Table 8.1.3.8.3.3-3: *SystemInformationBlockType7* for cell 1 (preamble and all steps, Table 8.1.3.8.3.2-1)

Derivation Path: 36.508 table 4.4.3.3-6			
Information Element	Value/remark	Comment	Condition
<i>SystemInformationBlockType7</i> ::= SEQUENCE { <i>carrierFreqsInfoList</i> SEQUENCE (SIZE (1..maxGNFG)) OF SEQUENCE { <i>commonInfo</i> SEQUENCE { <i>cellReselectionPriority</i> } } }	1 Entry 3		

Table 8.1.3.8.3.3-4: RRCConnectionRelease message (step 1, Table 8.1.3.8.3.2-1)

Derivation Path: 36.508 table 4.6.1-15			
Information Element	Value/remark	Comment	Condition
RRCConnectionRelease ::= SEQUENCE {			
criticalExtensions CHOICE {			
c1 CHOICE {			
rrcConnectionRelease-r8 SEQUENCE {			
redirectedCarrierInfo ::= CHOICE {			
geran			
CarrierFreqsGERAN ::= SEQUENCE {			
startingARFCN	Downlink ARFCN of Cell 24		
bandIndicator	The same band indicator of the Cell 24		
}			
}			
}			
}			
}			
}			

8.1.3.9 RRC Connection Release: redirection from E-UTRAN to CDMA2000-HRPD

8.1.3.9.1 Test Purpose (TP)

(1)

```
with { UE in E-UTRA RRC_CONNECTED state }
ensure that {
  when { UE receives an RRCConnectionRelease message including an IE redirectionInformation with
interRAT-target set to cdma2000-HRPD }
  then { UE enters cdma2000-HRPD mode }
}
```

8.1.3.9.2 Conformance requirements

References: The conformance requirements covered in the current TC are specified in: TS 36.331, clause 5.3.8.3, 5.3.12 and TS 36.304, clause 5.2.7.

[TS 36.331, clause 5.3.8.3]

The UE shall:

1> delay the following actions defined in this sub-clause 60ms from the moment the *RRCConnectionRelease* message was received or optionally when lower layers indicate that the receipt of the *RRCConnectionRelease* message has been successfully acknowledged, whichever is earlier;

1> if the *RRCConnectionRelease* message includes the *idleModeMobilityControlInfo*:

...

1> else:

2> use the idle mobility parameters broadcast in the system information;

1> if the *releaseCause* received in the *RRCConnectionRelease* message indicates '*loadBalancingTAURequired*':

...

1> else:

2> perform the actions upon leaving RRC_CONNECTED as specified in 5.3.12, with release cause 'other'.

[TS 36.331, clause 5.3.12]

Upon leaving RRC_CONNECTED, the UE shall:

...

1> indicate the release of the RRC connection to upper layers together with the release cause;

1> if leaving RRC_CONNECTED was not triggered by reception of the *MobilityFromEUTRACommand* message:

2> enter RRC_IDLE by performing cell selection in accordance with the cell selection process, defined for the case of leaving RRC_CONNECTED, as specified in TS 36.304 [4].

[TS 36.304, clause 5.2.7]

On transition from RRC_CONNECTED to RRC_IDLE, a UE shall attempt to camp on the last cell for which it was in RRC_CONNECTED or any cell on a frequency or frequency of RAT assigned by RRC in the state transition message.

...

8.1.3.9.3 Test description

8.1.3.9.3.1 Pre-test conditions

System Simulator:

- 2 cells, one E-UTRA and one HRPD cell:
 - Cell 1 E-UTRA serving cell
 - Cell 15 suitable neighbour HRPD cell
 - The parameters settings and power levels for Cell 1 and Cell 15 are selected according to [18], [xx] and Table 8.1.3.9.3.2-1 so that camping on Cell 1 is guaranteed and no cell re-selection to Cell 15 can take place (hrpd priority is lower than serving and $S_{Cell 1} > Thresh_{Cell 1,low}$).

UE:

None.

Preamble:

- The UE is in state Generic RB Established (state 3) on Cell 1 according to [18].

Note: UE is not pre-registered in Cell 15.

8.1.3.9.3.2 Test procedure sequence

Table 8.1.3.9.3.2-1 shows the cell power levels after the preamble.

Table 8.1.3.9.3.2-1: Time instances of cell power level and parameter changes

	Parameter	Unit	Cell 1	Cell 15	Remark
T0	Cell-specific RS EPRE	dBm/15kHz	-75	-	The power levels are such that camping on Cell 1 is guaranteed. CDMA2000 HRPD pilot strength as specified in [xx].
	Pilot Strength E_p/I_o	dB	-	[FFS]	

Table 8.1.3.9.3.2-2: Main behaviour

St	Procedure	Message Sequence		TP	Verdict
		U - S	Message		
1	SS transmits an <i>RRCConnectionRelease</i> message (IE <i>redirectionInformation</i> including <i>hrpd-Parameters</i> of Cell 15).	<--	<i>RRCConnectionRelease</i>	-	-
2	Check: Does the UE transmit an Access Probe on Cell 15 to initiate registration?	-->	<i>Access Probe</i>	1	P

8.1.3.9.3.3 Specific message or IE contents

Table 8.1.3.9.3.3-1: SystemInformationBlockType1 for cell 1 (preamble and all steps, Table 8.1.3.9.3.2-2)

Derivation Path: 36.508 table 4.4.3.2-3			
Information Element	Value/remark	Comment	Condition
SystemInformationBlockType1 ::= SEQUENCE {			
schedulingInformation ::= SEQUENCE (SIZE (1..maxSI-Message)) OF SEQUENCE {	Combination 4 in TS 36.508 section 4.4.3.1	SIB2, and SIB3 are transmitted	
}			

Table 8.1.3.9.3.3-2: RRCConnectionRelease message (step 1, Table 8.1.3.9.3.2-2)

Derivation Path: 36.508 table 4.6.1-15			
Information Element	Value/remark	Comment	Condition
RRCConnectionRelease ::= SEQUENCE {			
criticalExtensions CHOICE {			
c1 CHOICE {			
rrcConnectionRelease-r8 SEQUENCE {			
redirectionInformation ::= CHOICE {			
interRAT-target CHOICE {			
cdma2000-HRPD	cdma2000-CarrierInfo for Cell 15		
}			
}			
}			
}			
}			
}			

8.1.3.10 RRC Connection Release: redirection from E-UTRAN to CDMA2000-1XRTT

8.1.3.10.1 Test Purpose (TP)

(1)

```

with { UE in E-UTRA RRC_CONNECTED state }
ensure that {
  when { UE receives an RRCConnectionRelease message including an IE redirectionInformation with
interRAT-target set to cdma2000-1xRTT }
  then { UE enters cdma2000-1xRTT mode }
}

```

8.1.3.10.2 Conformance requirements

References: The conformance requirements covered in the current TC are specified in: TS 36.331, clause 5.3.8.3, 5.3.12 and TS 36.304, clause 5.2.7.

[TS 36.331, clause 5.3.8.3]

The UE shall:

1> delay the following actions defined in this sub-clause 60ms from the moment the *RRCConnectionRelease* message was received or optionally when lower layers indicate that the receipt of the *RRCConnectionRelease* message has been successfully acknowledged, whichever is earlier;

1> if the *RRCConnectionRelease* message includes the *idleModeMobilityControlInfo*:

...

1> else:

2> use the idle mobility parameters broadcast in the system information;

1> if the *releaseCause* received in the *RRCConnectionRelease* message indicates '*loadBalancingTAURequired*':

...

1> else:

2> perform the actions upon leaving *RRC_CONNECTED* as specified in 5.3.12, with release cause 'other'.

[TS 36.331, clause 5.3.12]

Upon leaving *RRC_CONNECTED*, the UE shall:

...

1> indicate the release of the RRC connection to upper layers together with the release cause;

1> if leaving *RRC_CONNECTED* was not triggered by reception of the *MobilityFromEUTRACommand* message:

2> enter *RRC_IDLE* by performing cell selection in accordance with the cell selection process, defined for the case of leaving *RRC_CONNECTED*, as specified in TS 36.304 [4].

[TS 36.304, clause 5.2.7]

On transition from *RRC_CONNECTED* to *RRC_IDLE*, a UE shall attempt to camp on the last cell for which it was in *RRC_CONNECTED* or any cell on a frequency or frequency of RAT assigned by RRC in the state transition message.

...

8.1.3.10.3 Test description

8.1.3.10.3.1 Pre-test conditions

System Simulator:

- 2 cells, one E-UTRA and one 1xRTT cell:
 - Cell 1 E-UTRA serving cell
 - Cell 19 suitable neighbour 1xRTT cell
 - The parameters settings and power levels for Cell 1 and Cell 19 are selected according to [18], [yy] and Table 8.1.3.10.3.2-1 so that camping on Cell 1 is guaranteed and no cell re-selection to Cell 19 can take place (1xRTT priority is lower than serving and $S_{Cell 1} > Thresh_{Cell 1,low}$).

UE:

- UE is not pre-registered in Cell 19.

Preamble:

- The UE is in state Generic RB Established (state 3) on cell 1 according to [18].

8.1.3.10.3.2 Test procedure sequence

Table 8.1.3.10.3.2-1 shows the cell power levels after the preamble.

Table 8.1.3.10.3.2-1: Time instances of cell power level and parameter changes

	Parameter	Unit	Cell 1	Cell 15	Remark
T0	Cell-specific RS EPRE	dBm/15kHz	-75	-	The power levels are such that camping on Cell 1 is guaranteed. CDMA2000 1xRTT pilot strength as specified in [37].
	Pilot Strength	dB	-	[FFS]	

Table 8.1.3.10.3.2-2: Main behaviour

St	Procedure	Message Sequence		TP	Verdict
		U - S	Message		
1	SS transmits an <i>RRConnectionRelease</i> message.	<--	<i>RRConnectionRelease</i>	-	-
2	Check: Does the UE transmit an Access Probe on Cell 19 to initiate registration?	-->	<i>Access Probe</i>	1	P

8.1.3.10.3.3 Specific message or IE contents

Table 8.1.3.10.3.3-1: *SystemInformationBlockType1* for cell 1 (preamble and all steps, Table 8.1.3.10.3.2-1)

Derivation Path: 36.508 table 4.4.3.2-3			
Information Element	Value/remark	Comment	Condition
<i>SystemInformationBlockType1</i> ::= SEQUENCE {			
<i>schedulingInformation</i> ::= SEQUENCE (SIZE (1..maxSI-Message)) OF SEQUENCE {}	Combination 4 in TS 36.508 section 4.4.3.1	SIB2 and SIB3 are transmitted	
}			

Table 8.1.3.10.3.3-4: *RRConnectionRelease* message (step 1, Table 8.1.3.10.3.2-1)

Derivation Path: 36.508 table 4.6.1-15			
Information Element	Value/remark	Comment	Condition
<i>RRConnectionRelease</i> ::= SEQUENCE {			
<i>criticalExtensions</i> CHOICE {			
c1 CHOICE {			
<i>rrcConnectionRelease-r8</i> SEQUENCE {			
<i>redirectionInformation</i> ::= CHOICE {			
interRAT-target CHOICE {			
cdma2000-1xRTT	cdma2000-CarrierInfo for Cell 19		
}			
}			
}			
}			
}			
}			

8.2 RRC Connection Reconfiguration

8.2.1 Radio Bearer Establishment

8.2.1.1 RRC Connection Reconfiguration / Radio Bearer Establishment for transition from RRC_IDLE to RRC_CONNECTED: Success (Default bearer, early bearer establishment)

8.2.1.1.1 Test Purpose (TP)

(1)

```

with { UE having completed the RRC connection establishment procedure }
ensure that {
  when { SS sends in sequence a SecurityModeCommand and an RRConnectionReconfiguration message }
  then { UE establishes the initial security configuration in accordance with the received
securityConfigSMC included in SecurityModeCommand and successfully completes the connection
reconfiguration }
}

```

8.2.1.1.2 Conformance requirements

References: The conformance requirements covered in the present TC are specified in: 3GPP TS 36.331 clauses 5.1.2, 5.3.1.1, 5.3.5.3, 5.3.10.1 and 5.3.10.3. The following represent an extraction of the requirements relevant to the test purpose.

[TS 36.331, clause 5.1.2]

The UE shall:

- 1> process the received messages in order of reception by RRC, i.e. the processing of a message shall be completed before starting the processing of a subsequent message;

NOTE: E-UTRAN may initiate a subsequent procedure prior to receiving the UEs response of a previously initiated procedure.

[TS 36.331, clause 5.3.1.1]

After having initiated the initial security activation procedure, E-UTRAN initiates the establishment of SRB2 and DRBs, i.e. E-UTRAN may do this prior to receiving the confirmation of the initial security activation from the UE. In any case, E-UTRAN will apply both ciphering and integrity protection for the RRC connection reconfiguration messages used to establish SRB2 and DRBs.

[TS 36.331, clause 5.3.5.3]

If the *RRCConnectionReconfiguration* message does not include the *mobilityControlInfo* and the UE is able to comply with the configuration included in this message, the UE shall:

- 1> if this is the first *RRCConnectionReconfiguration* message after successful completion of the RRC Connection Re-establishment procedure:

...

- 1> else:

- 2> If the *RRCConnectionReconfiguration* message includes the *radioResourceConfigDedicated*:

- 3> perform the radio resource configuration procedure as specified in 5.3.10;

NOTE 2: If the *RRCConnectionReconfiguration* message includes the establishment of radio bearers other than SRB1, the UE may start using these radio bearers immediately, i.e. there is no need to wait for an outstanding acknowledgment of the *SecurityModeComplete* message.

...

- 1> submit the *RRCConnectionReconfigurationComplete* message to lower layers for transmission using the new configuration, upon which the procedure ends;

[TS 36.331, clause 5.3.10.1]

The UE shall:

- 1> for each *srb-Identity* value included in the *srb-ToAddModList* that is not part of the current UE configuration (SRB establishment):

- 2> apply the specified configuration defined in 9.1.2 for the corresponding SRB;

- 2> establish a PDCP entity and configure it with the current security configuration, if applicable;

- 2> establish an RLC entity in accordance with the received *rlc-Config*;

- 2> establish a DCCH logical channel in accordance with the received *logicalChannelConfig* and with the logical channel identity set in accordance with 9.1.2

[TS 36.331, clause 5.3.10.3]

The UE shall:

1> for each *drb-Identity* value included in the *drb-ToAddModList* that is not part of the current UE configuration (DRB establishment):

2> establish a PDCP entity and configure it with the current security configuration and in accordance with the received *pdcp-Config*;

2> establish an RLC entity in accordance with the received *rlc-Config*;

2> establish a DTCH logical channel in accordance with the received *logicalChannelIdentity* and the received *logicalChannelConfig*;

1> indicate the establishment of the DRB(s) and the *eps-BearerIdentity* of the established DRB(s) to upper layers;

8.2.1.1.3 Test description

8.2.1.1.3.1 Pre-test conditions

System Simulator:

- Cell 1

UE:

None.

Preamble:

- The UE is in state Registered, Idle mode (state 2) according to [18].

8.2.1.1.3.2 Test procedure sequence

Table 8.2.1.1.3.2-1: Main behaviour

St	Procedure	Message Sequence		TP	Verdict
		U - S	Message		
1	Make UE attempting an outgoing call	-	-	-	-
2	UE transmits an <i>RRCCoNNECTIONRequest</i> message.	-->	<i>RRCCoNNECTIONRequest</i>	-	-
3	SS transmit an <i>RRCCoNNECTIONSetup</i> message	<--	<i>RRCCoNNECTIONSetup</i>	-	-
4	The UE transmits an <i>RRCCoNNECTIONSetupComplete</i> to confirm the successful completion of the connection establishment.	-->	<i>RRCCoNNECTIONSetupComplete</i>	-	-
5	SS transmits a <i>SecurityModeCommand</i> message to activate AS security.	<--	<i>SecurityModeCommand</i>	-	-
6	Before the security activation procedure completes, the SS transmits an <i>RRCCoNNECTIONReconfiguration</i> message to establish a data radio bearer.	<--	<i>RRCCoNNECTIONReconfiguration</i>	-	-
7	Check: Does the UE transmit a <i>SecurityModeComplete</i> message?	-->	<i>SecurityModeComplete</i>	1	P
8	Check: Does the UE transmit an <i>RRCCoNNECTIONReconfigurationComplete</i> message to confirm the establishment of data radio bearer?	-->	<i>RRCCoNNECTIONReconfigurationComplete</i>	1	P
9	Check: Does the test result of CALL generic procedure indicate that UE is in E-UTRA RRC_CONNECTED state?	-	-	1	-

8.2.1.1.3.3 Specific message contents

Table 8.2.1.1.3.3-1: *RRCCConnectionReconfiguration* (step 6, Table 8.2.1.1.3.2-1)

Derivation Path: 36.508 table 4.6.1-8, condition SRB2-DRB(1, 0)

8.2.1.2 RRC Connection Reconfiguration / Radio Bearer Establishment for transition from RRC_IDLE to RRC_CONNECTED: Failure (Default bearer)

Editor's Note: This section is based on 36.331 v8.2.0 i.e. after RAN#40 + R2-083795.

8.2.1.2.1 Test Purpose (TP)

(1)

```
with { UE having completed the initial security activation procedure }
ensure that {
  when { UE is unable to comply with a received RRCCConnectionReconfiguration message }
  then { UE initiates the connection re-establishment procedure }
}
```

8.2.1.2.2 Conformance requirements

References: The conformance requirements covered in the present TC are specified in: TS 36.331, clause 5.3.5.3, 5.3.5.5, 5.3.7.2, 5.3.7.3, 5.3.7.4 and 5.3.7.9.

[TS 36.331, clause 5.3.5.3]

If the *RRCCConnectionReconfiguration* message does not include the *mobilityControlInformation* and the UE is able to comply with the configuration included in this message, the UE shall:

- 1> If the *RRCCConnectionReconfiguration* message includes the *radioResourceConfiguration*:
 - 2> perform the Radio resource configuration procedure as specified in 5.3.10;
- 1> If the *RRCCConnectionReconfiguration* message includes the *ue-RelatedInformation*:
 - 2> set the C-RNTI to the value of the *newUE-Identity*, if received;
- 1> If the *RRCCConnectionReconfiguration* message includes the *nas-DedicatedInformation*:
 - 2> Forward the *nas-DedicatedInformation* to upper layers;
- 1> If the *RRCCConnectionReconfiguration* message includes the *measurementConfiguration*:
 - 2> perform the Measurement configuration procedure as specified in 5.5.2;

NOTE: If the *RRCCConnectionReconfiguration* message includes the establishment of radio bearers others than SRB1, the UE may start using these radio bearers immediately, i.e. there is no need to wait for an outstanding acknowledgment of the *SecurityModeComplete* message.

- 1> submit the *RRCCConnectionReconfigurationComplete* message to lower layers for transmission using the new configuration, upon which the procedure ends;

[TS 36.331, clause 5.3.5.5]

The UE shall:

- 1> If the UE is unable to comply with (part of) the configuration included in the *RRCCConnectionReconfiguration* message:
 - 2> continue using the configuration used prior to the reception of *RRCCConnectionReconfiguration* message;
 - 2> initiate the connection re-establishment procedure as specified in 5.3.7, upon which the connection reconfiguration procedure ends.

NOTE: If the UE is unable to comply with part of the configuration, it does not apply any part of the configuration i.e. there is no partial success/ failure.

[TS 36.331, clause 5.3.7.2]

The UE shall only initiate the procedure when security has been activated. The UE initiates the procedure when one of the following conditions is met:

- 1> after having detected radio link failure, in accordance with 5.3.11; or
- 1> upon handover failure, in accordance with 5.3.5.6; or
- 1> when RLC indicates that the maximum number of retransmissions has been reached, as specified in TS 36.322 [7]; or
- 1> upon an RRC connection reconfiguration failure, in accordance with 5.3.5.5.

Upon initiation of the procedure, the UE shall:

- 1> stop timer T310, if running;
- 1> stop timer T312, if running;
- 1> start timer T311;
- 1> reset MAC and re-establish RLC for all RBs that are established;
- 1> select a suitable cell in accordance with the cell selection process as specified in [4];

[TS 36.331, clause 5.3.7.3]

Upon (re-)entry of service area while T311 is running, the UE shall:

- 1> Upon selecting an E-UTRA cell:
 - 2> stop timer T311;
 - 2> start timer T301;
 - 2> initiate transmission of the *RRCConnectionReestablishmentRequest* message in accordance with 5.3.7.4;

NOTE 1: The criteria for re-entry of service area specified in 5.3.11.4.

NOTE 2: This procedure applies also if the UE returns to the source cell

- 1> Upon selecting an inter-RAT cell:
 - 2> perform the actions upon moving from RRC_CONNECTED to RRC_IDLE as specified in 5.3.12.

[TS 36.331, clause 5.3.7.4]

The UE shall set the contents of *RRCConnectionReestablishmentRequest* message as follows:

- 1> set the IE ue-Identity as follows:
 - 2> set the c-RNTI to the C-RNTI used in the source cell (handover failure case) or used in the cell in which the trigger for the re-establishment occurred (other cases);
 - 2> set the *cellIdentity* to the Physical layer identity of the source cell (handover failure case) or of the cell in which the trigger for the re-establishment occurred (other cases);
 - 2> set the *authenticationCode* to a MAC-I calculated over:
 - 3> the C-RNTI used in the source cell (handover failure case) or used in the cell in which the trigger for the re-establishment occurred (other cases);
 - 3> the Physical layer identity of the source cell (handover failure case) or of the cell in which the trigger for the re-establishment occurred (other cases)
 - 3> the identity of the target cell (details FFS)

1> set the IE *reestablishmentCause* as follows (details FFS):

Editor's note: SA3 indicated that a size of around 16 may be used for the MAC-I i.e. using truncation (see R2-081917).

The UE shall submit the *RRCCONNECTIONREESTABLISHMENTREQUEST* message to lower layers for transmission.

[TS 36.331, clause 5.3.7.9]

Upon receiving the *RRCCONNECTIONREESTABLISHMENTREJECT* message, the UE shall:

1> perform the actions upon moving from RRC_CONNECTED to RRC_IDLE as specified in 5.3.12.

Editor's note: It is up to upper layers to take further action. To facilitate this, the cause of the release may need to be indicated to upper layers.

8.2.1.2.3 Test description

8.2.1.2.3.1 Pre-test conditions

System Simulator:

- Cell 1

UE:

None.

Preamble:

- The UE is in state Registered, Idle mode (state 2) on Cell 1 according to [18].

8.2.1.2.3.2 Test procedure sequence

Table 8.2.1.2.3.2-1: Main behaviour (FFS)

St	Procedure	Message Sequence		TP	Verdict
		U - S	Message		
1	The SS transmits a <i>Paging</i> message including a matched identity.	<--	<i>Paging</i>	-	-
2	The UE transmits an <i>RRCCONNECTIONREQUEST</i> message.	-->	<i>RRCCONNECTIONREQUEST</i>	-	-
3	The SS transmits an <i>RRCCONNECTIONSETUP</i> message.	<--	<i>RRCCONNECTIONSETUP</i>	-	-
4	The UE transmits an <i>RRCCONNECTIONSETUPCOMPLETE</i> message to confirm the successful completion of the connection establishment.	-->	<i>RRCCONNECTIONSETUPCOMPLETE</i>	-	-
5	The SS transmits a <i>SECURITYMODECOMMAND</i> message to activate AS security.	<--	<i>SECURITYMODECOMMAND</i>	-	-
6	The UE transmits a <i>SECURITYMODECOMPLETE</i> message and establishes the initial security configuration.	-->	<i>SECURITYMODECOMPLETE</i>	-	-
7	The SS transmits an <i>RRCCONNECTIONRECONFIGURATION</i> , which lacks the IEs required for the DRB setup.	<--	<i>RRCCONNECTIONRECONFIGURATION</i>	1	-
8	Check: Does the UE transmit an <i>RRCCONNECTIONREESTABLISHMENTREQUEST</i> message.	-->	<i>RRCCONNECTIONREESTABLISHMENTREQUEST</i>	1	P
9	The SS transmits an <i>RRCCONNECTIONREESTABLISHMENTREJECT</i> message to release the RRC connection.	<--	<i>RRCCONNECTIONREESTABLISHMENTREJECT</i>	1	-
10	Check: Does the test result of CALL generic procedure indicate that the UE is in E-UTRA RRC_IDLE state?	-	-	1	-

8.2.1.2.3.3 Specific message contents

Editor's Note: To be updated according to agreed RRC message structure.

Table 8.2.1.2.3.3-1: Paging (step 1, Table 8.2.1.2.3.2-1)

FFS

Table 8.2.1.2.3.3-2: RRCConnectionRequest (step 2, Table 8.2.1.2.3.2-1)

FFS

Table 8.2.1.2.3.3-3: RRCConnectionSetup (step 3, Table 8.2.1.2.3.2-1)

FFS

Table 8.2.1.2.3.3-4: RRCConnectionSetupComplete (step 4, Table 8.2.1.2.3.2-1)

FFS

Table 8.2.1.2.3.3-5: SecurityModeCommand (step 5, Table 8.2.1.2.3.2-1)

FFS

Table 8.2.1.2.3.3-6: SecurityModeComplete (step 6, Table 8.2.1.2.3.2-1)

FFS

Table 8.2.1.2.3.3-7: RRCConnectionReconfiguration (step 7, Table 8.2.1.2.3.2-1)

FFS

Table 8.2.1.2.3.3-8: RRCConnectionReestablishmentRequest (step 8, Table 8.2.1.2.3.2-1)

FFS

Table 8.2.1.2.3.3-9: RRCConnectionReestablishmentReject (step 9, Table 8.2.1.2.3.2-1)

FFS

8.2.1.3 RRC Connection Reconfiguration / Radio Bearer Establishment: Success (Dedicated bearer)

8.2.1.3.1 Test Purpose (TP)

(1)

```
with { UE in E-UTRA RRC_CONNECTED state }
ensure that {
  when { SS sends an RRCConnectionReconfiguration message including a drb-Identity that is not part
of the current UE configuration and a dedicatedInfoNASList }
  then { UE successfully establish the radio bearer according to IE radioResourceConfigDedicated }
}
```

8.2.1.3.2 Conformance requirements

References: The conformance requirements covered in the present TC are specified in: 3GPP TS 36.331 clauses 5.3.5.3 and 5.3.10.3.

The following represent an extraction of the requirements relevant to the test purpose.

[TS 36.331, clause 5.3.5.3]

If the *RRCConnectionReconfiguration* message does not include the *mobilityControlInformation* and the UE is able to comply with the configuration included in this message, the UE shall:

- 1> if this is the first *RRCConnectionReconfiguration* message after successful completion of the RRC Connection Re-establishment procedure:

...

1> else:

2> If the *RRCCConnectionReconfiguration* message includes the *radioResourceConfigDedicated*:

3> perform the radio resource configuration procedure as specified in 5.3.10;

NOTE 2: If the *RRCCConnectionReconfiguration* message includes the establishment of radio bearers other than SRB1, the UE may start using these radio bearers immediately, i.e. there is no need to wait for an outstanding acknowledgment of the *SecurityModeComplete* message.

1> if the *RRCCConnectionReconfiguration* message includes the *dedicatedInfoNASList*:

2> forward each element of the *dedicatedInfoNASList* to upper layers;

...

1> submit the *RRCCConnectionReconfigurationComplete* message to lower layers for transmission using the new configuration, upon which the procedure ends;

[TS 36.331, clause 5.3.10.3]

The UE shall:

1> for each *drb-Identity* value included in the *drb-ToAddModList* that is not part of the current UE configuration (DRB establishment):

2> establish a PDCP entity and configure it with the current security configuration and in accordance with the received *pdcp-Config*;

2> establish an RLC entity in accordance with the received *rlc-Config*;

2> establish a DTCH logical channel in accordance with the received *logicalChannelIdentity* and the received *logicalChannelConfig*;

1> indicate the establishment of the DRB(s) and the *eps-BearerIdentity* of the established DRB(s) to upper layers;

8.2.1.3.3 Test description

8.2.1.3.3.1 Pre-test conditions

System Simulator:

- Cell 1

UE:

None.

Preamble:

- The UE is in state Generic RB Established (state 3) according to [18].

8.2.1.3.3.2 Test procedure sequence

Table 8.2.1.3.3.2-1: Main behaviour

St	Procedure	Message Sequence		TP	Verdict
		U - S	Message		
1	The SS transmits an <i>RRCCONNECTIONRECONFIGURATION</i> message to establish a data radio bearer.	<--	<i>RRCCONNECTIONRECONFIGURATION</i>	-	-
2	Check: Does the UE transmit an <i>RRCCONNECTIONRECONFIGURATIONCOMPLETE</i> message?	-->	<i>RRCCONNECTIONRECONFIGURATIONCOMPLETE</i>	1	P
3	The UE transmits an <i>ULINFORMATIONTRANSFER</i> message.	-->	<i>ULINFORMATIONTRANSFER</i>	-	-
4	Check: Does the test result of CALL generic procedure indicates that UE is in E-UTRA RRC_CONNECTED state?	-	-	1	-

8.2.1.3.3.3 Specific message contents

Table 8.2.1.3.3.3-1: *RRCCONNECTIONRECONFIGURATION* (step 1, Table 8.2.1.3.3.2-1)

Derivation Path: 36.508 table 4.6.1-8, condition DRB(1,0)			
Information Element	Value/remark	Comment	Condition
<i>RRCCONNECTIONRECONFIGURATION</i> ::= SEQUENCE {			
criticalExtensions CHOICE {			
c1 CHOICE{			
rrcConnectionReconfiguration-r8 SEQUENCE {			
dedicatedInfoNASList SEQUENCE	1 entry		
(SIZE(1..maxDRB)) OF			
dedicatedInfoNAS [1]	octet string	ACTIVATE DEDICATED EPS BEARER CONTEXT REQUEST according 36.508 table 4.7.3-3	
}			
}			
}			
}			

8.2.1.4 RRC Connection Reconfiguration / Radio Bearer Establishment: Failure (Dedicated bearer)

Editor's Note: This section is based on 36.331 v8.2.0 i.e. after RAN#40 + R2-083795.

8.2.1.4.1 Test Purpose (TP)

(1)

```

with { UE having completed the radio bearer establishment and initial security activation procedure
}
ensure that {
  when { UE is unable to comply with a received RRCCONNECTIONRECONFIGURATION message }
  then { UE performs the connection re-establishment procedure }
}

```

8.2.1.4.2 Conformance requirements

References: The conformance requirements covered in the present TC are specified in: TS 36.331, clause 5.3.5.3, 5.3.5.5, 5.3.7.2, 5.3.7.3, 5.3.7.4, 5.3.7.5 and 5.3.7.6.

[TS 36.331, clause 5.3.5.3]

If the *RRCConnectionReconfiguration* message does not include the *mobilityControlInformation* and the UE is able to comply with the configuration included in this message, the UE shall:

1> If the *RRCConnectionReconfiguration* message includes the *radioResourceConfiguration*:

2> perform the Radio resource configuration procedure as specified in 5.3.10;

1> If the *RRCConnectionReconfiguration* message includes the *ue-RelatedInformation*:

2> set the C-RNTI to the value of the *newUE-Identity*, if received;

1> If the *RRCConnectionReconfiguration* message includes the *nas-DedicatedInformation*:

2> Forward the *nas-DedicatedInformation* to upper layers;

1> If the *RRCConnectionReconfiguration* message includes the *measurementConfiguration*:

2> perform the Measurement configuration procedure as specified in 5.5.2;

NOTE: If the *RRCConnectionReconfiguration* message includes the establishment of radio bearers others than SRB1, the UE may start using these radio bearers immediately, i.e. there is no need to wait for an outstanding acknowledgment of the *SecurityModeComplete* message.

1> submit the *RRCConnectionReconfigurationComplete* message to lower layers for transmission using the new configuration, upon which the procedure ends;

[TS 36.331, clause 5.3.5.5]

The UE shall:

1> If the UE is unable to comply with (part of) the configuration included in the *RRCConnectionReconfiguration* message:

2> continue using the configuration used prior to the reception of *RRCConnectionReconfiguration* message;

2> initiate the connection re-establishment procedure as specified in 5.3.7, upon which the connection reconfiguration procedure ends.

NOTE: If the UE is unable to comply with part of the configuration, it does not apply any part of the configuration i.e. there is no partial success/ failure.

[TS 36.331, clause 5.3.7.2]

The UE shall only initiate the procedure when security has been activated. The UE initiates the procedure when one of the following conditions is met:

1> after having detected radio link failure, in accordance with 5.3.11; or

1> upon handover failure, in accordance with 5.3.5.6; or

1> when RLC indicates that the maximum number of retransmissions has been reached, as specified in TS 36.322 [7]; or

1> upon an RRC connection reconfiguration failure, in accordance with 5.3.5.5.

Upon initiation of the procedure, the UE shall:

1> stop timer T310, if running;

1> stop timer T312, if running;

1> start timer T311;

1> reset MAC and re-establish RLC for all RBs that are established;

1> select a suitable cell in accordance with the cell selection process as specified in [4];

[TS 36.331, clause 5.3.7.3]

Upon (re-)entry of service area while T311 is running, the UE shall:

- 1> Upon selecting an E-UTRA cell:
 - 2> stop timer T311;
 - 2> start timer T301;
 - 2> initiate transmission of the *RRCConnectionReestablishmentRequest* message in accordance with 5.3.7.4;

NOTE 1: The criteria for re-entry of service area specified in 5.3.11.4.

NOTE 2: This procedure applies also if the UE returns to the source cell

- 1> Upon selecting an inter-RAT cell:
 - 2> perform the actions upon moving from RRC_CONNECTED to RRC_IDLE as specified in 5.3.12.

[TS 36.331, clause 5.3.7.4]

The UE shall set the contents of *RRCConnectionReestablishmentRequest* message as follows:

- 1> set the IE *ue-Identity* as follows:
 - 2> set the *c-RNTI* to the C-RNTI used in the source cell (handover failure case) or used in the cell in which the trigger for the re-establishment occurred (other cases);
 - 2> set the *cellIdentity* to the Physical layer identity of the source cell (handover failure case) or of the cell in which the trigger for the re-establishment occurred (other cases);
 - 2> set the *authenticationCode* to a MAC-I calculated over:
 - 3> the C-RNTI used in the source cell (handover failure case) or used in the cell in which the trigger for the re-establishment occurred (other cases);
 - 3> the Physical layer identity of the source cell (handover failure case) or of the cell in which the trigger for the re-establishment occurred (other cases)
 - 3> the identity of the target cell (details FFS)
- 1> set the IE *reestablishmentCause* as follows (details FFS):

Editor's note: SA3 indicated that a size of around 16 may be used for the MAC-I i.e. using truncation (see R2-081917).

The UE shall submit the *RRCConnectionReestablishmentRequest* message to lower layers for transmission.

[TS 36.331, clause 5.3.7.5]

NOTE: Prior to this, lower layers allocate a C-RNTI. For further details see TS 36.321 [6];

The UE shall:

- 1> Stop timer T301;
- 1> resume SRB1 after reconfiguring it in accordance with the received *radioResourceConfiguration* and as specified in 5.3.10;

Editor's note: It has been agreed that the procedure is the same irrespective of whether the UE returns to the same cell. So, e.g. the UE always derives a new AS base-key (KeNB)

- 1> configure lower layers to re-activate integrity protection using the previously configured algorithm immediately, i.e. integrity protection shall be applied to all subsequent messages received and sent by the UE, including the message used to indicate the successful completion of the procedure;
- 1> configure lower layers to apply ciphering using the previously configured algorithm immediately, i.e. ciphering shall be applied to all subsequent messages received and sent by the UE, including the message used to indicate the successful completion of the procedure;

1> send the *RRConnectionReestablishmentComplete* message as specified in 5.3.7.6;

1> Resume the RRC connection with the restriction that the use of all radio bearers other than SRB1 is suspended until a subsequent *RRConnectionReconfiguration* message is received;

Editor's note: A subsequent RRC connection reconfiguration procedure is used to re-activate the measurements. The concerned *RRConnectionReconfiguration* message can, for the RLC/MAC & measurement configuration, either apply delta or full signalling. In case of 'full signalling' the UE completely deletes the existing configuration and replaces this with the newly received configuration. The use of 'full signalling' for PDCP is FFS, but should be aligned with what is agreed for handover. Upon successful connection re-establishment, the UE applies the same rules to the measurement configuration as defined for the case of handover.

[TS 36.331, clause 5.3.7.6]

The UE shall submit the *RRConnectionReestablishmentComplete* message to lower layers for transmission.

8.2.1.4.3 Test description

8.2.1.4.3.1 Pre-test conditions

System Simulator:

- Cell 1

UE:

None.

Preamble:

- The UE is in state Generic RB Established (state 3) according to [18].

8.2.1.4.3.2 Test procedure sequence

Table 8.2.1.4.3.2-1: Main behaviour (FFS)

St	Procedure	Message Sequence		TP	Verdict
		U - S	Message		
1	The SS transmits an <i>RRConnectionReconfiguration</i> message, which lacks the IEs required for the DRB setup.	<--	<i>RRConnectionReconfiguration</i>	1	-
2	Check: Does the UE transmit an <i>RRConnectionReestablishmentRequest</i> message?	-->	<i>RRConnectionReestablishmentRequest</i>	1	P
3	The SS transmits an <i>RRConnectionReestablishment</i> message.	<--	<i>RRConnectionReestablishment</i>	1	-
4	Check: Does the UE transmit an <i>RRConnectionReestablishmentComplete</i> message.	-->	<i>RRConnectionReestablishmentComplete</i>	1	P
5	Check: Does the test result of CALL generic procedure indicate that the UE is in E-UTRA RRC_CONNECTED state?	-	-	1	

8.2.1.4.3.3 Specific message contents

Editor's Note: To be updated according to agreed RRC message structure.

Table 8.2.1.4.3.3-1: RRCConnectionReconfiguration (step 1, Table 8.2.1.4.3.2-1)

FFS

Table 8.2.1.4.3.3-2: RRCConnectionReestablishmentRequest (step 2, Table 8.2.1.4.3.2-1)

FFS

Table 8.2.1.4.3.3-3: RRCConnectionReestablishment (step 3, Table 8.2.1.4.3.2-1)

FFS

Table 8.2.1.4.3.3-4: RRCConnectionReestablishmentComplete (step 4, Table 8.2.1.4.3.2-1)

FFS

8.2.1.7 RRC Connection Reconfiguration / Radio Bearer Establishment: Success (SRB2)**8.2.1.7.1 Test Purpose (TP)**

```

with { UE in E-UTRA RRC_CONNECTED state without SRB2}
ensure that {
  when { SS sends an RRCConnectionReconfiguration message including SRB2 configuration }
  then { UE successfully establish the signalling radio bearer }
}

```

8.2.1.7.2 Conformance requirements

References: The conformance requirements covered in the present TC are specified in: 3GPP TS 36.331 clauses 5.3.5.3, and 5.3.10.1.

The following represent an extraction of the requirements relevant to the test purpose.

[TS 36.331, clause 5.3.5.3]

If the *RRCConnectionReconfiguration* message does not include the *mobilityControlInformation* and the UE is able to comply with the configuration included in this message, the UE shall:

- 1> If the *RRCConnectionReconfiguration* message includes the *radioResourceConfiguration*:
 - 2> perform the Radio resource configuration procedure as specified in 5.10.10;

...

- 1> submit the *RRCConnectionReconfigurationComplete* message to lower layers for transmission using the new configuration, upon which the procedure ends;

[TS 36.331, clause 5.3.10.1]

The UE shall:

- 1> if the received *radioResourceConfiguration* includes the *srb-ToAddModifyList*:
 - 2> for each *srb-Identity* value included in the *srb-ToAddModifyList* that is not part of the current UE configuration (SRB establishment):
 - 3> if the *rlc-Configuration* is set to 'explicit':
 - 4> establish an RLC entity in accordance with the received *RLC-Configuration* IE;
 - 3> else if the *rlc-Configuration* is set to 'default':
 - 4> establish an RLC entity in accordance with the default configuration applicable for this *srb-identity* as specified in 9.2.1;
 - 3> if the *logicalChannelConfig* is set to 'explicit':

4> establish a DCCH logical channel in accordance with the received *LogicalChannelConfig* IE;

3> else if the *logicalChannelConfig* is set to 'default':

4> establish a DCCH logical channel in accordance with the default configuration applicable for this *srb-identity* as specified in 9.2.1;

8.2.1.7.3 Test description

8.2.1.7.3.1 Pre-test conditions

System Simulator:

- Cell 1

UE:

None.

Preamble:

- The UE is in state Registered, Idle Mode (State 2) according to [18].

8.2.1.7.3.2 Test procedure sequence

Table 8.2.1.7.3.2-1: Main behaviour

St	Procedure	Message Sequence		TP	Verdict
		U - S	Message		
1-7	Generic Radio Bearer Establishment (State 3) step 1 to 7.			-	-
8	The SS transmits an <i>RRCCONNECTIONRECONFIGURATION</i> message to establish SRB2.	<--	<i>RRCCONNECTIONRECONFIGURATION</i>	-	-
9	The UE transmits an <i>RRCCONNECTIONRECONFIGURATIONCOMPLETE</i> message.	-->	<i>RRCCONNECTIONRECONFIGURATIONCOMPLETE</i>	1	P
10	Check: the test result of CALL generic procedure indicates that UE is in E-UTRA RRC_CONNECTED state.	-		1	P

8.2.1.7.3.3 Specific message contents

Table 8.2.1.7.3.3-1: RRCConnectionReconfiguration (step 8)

Derivation Path: 36.508 table 4.6.1-6, condition SRB2-DRB(1, 0)			
Information Element	Value/remark	Comment	Condition
RRCConnectionReconfiguration ::= SEQUENCE {			
criticalExtensions CHOICE {			
C1 CHOICE{			
rrcConnectionReconfiguration-r8 SEQUENCE {			
radioResourceConfiguration SEQUENCE {			
srb-ToAddModifyList SEQUENCE (SIZE (1..2))			
OF SEQUENCE {			
srb-ToAddModify[1] SEQUENCE {			
rlc-Configuration CHOICE {			
explicit	RLC-Configuration-NON-DEFAULT-SRB2		
}			
}			
}			
}			
}			
}			

Table 8.2.1.7.3.3-2: RLC-Configuration-NON-DEFAULT-SRB2 (step 8)

Derivation Path: 36.331 clauses 6.3.2, 9.2.1.2			
Information Element	Value/remark	Comment	Condition
RLC-Configuration-NON-DEFAULT-SRB2 ::= CHOICE {			
am SEQUENCE {			
ul-AM-RLC SEQUENCE {			
t-PollRetransmit	ms100		
pollPDU	p16		
pollByte	kb500		
maxRetxThreshold	t4		
}			
dl-AM-RLC SEQUENCE {			
t-Reordering	ms100		
t-StatusProhibit	ms200		
}			
}			
}			

8.2.2 Radio Resource Reconfiguration

8.2.2.1 RRC Connection Reconfiguration / Radio Resource Reconfiguration: Success

8.2.2.1.1 Test Purpose (TP)

(1)

```

with { UE in E-UTRA RRC_CONNECTED state }
ensure that {
  when { UE receives an RRCConnectionReconfiguration message including a radioResourceConfiguration
with SRB, DRB, transport channel and physical channel reconfiguration }
  then { UE reconfigures the data and signalling radio bearers }
}
    
```

8.2.2.1.2 Conformance requirements

References: The conformance requirements covered in the present TC are specified in: 3GPP TS 36.331 clause 5.3.5.3, 5.3.10.1, 5.3.10.3, 5.3.10.4 and 5.3.10.6.

The following represent an extraction of the requirements relevant to the test purpose.

[TS 36.331, clause 5.3.5.3]

If the *RRCCONNECTIONRECONFIGURATION* message does not include the *mobilityControlInformation* and the UE is able to comply with the configuration included in this message, the UE shall:

- 1> if this is the first *RRCCONNECTIONRECONFIGURATION* message after successful completion of the RRC Connection Re-establishment procedure:

...

- 1> else:

- 2> If the *RRCCONNECTIONRECONFIGURATION* message includes the *radioResourceConfiguration*:

- 3> perform the radio resource configuration procedure as specified in 5.3.10;

...

- 1> submit the *RRCCONNECTIONRECONFIGURATIONCOMPLETE* message to lower layers for transmission using the new configuration, upon which the procedure ends;

[TS 36.331, clause 5.3.10.1]

The UE shall:

- 1> if the received *radioResourceConfiguration* includes the *srb-ToAddModifyList*:

...

- 2> for each *srb-Identity* value included in the *srb-ToAddModifyList* that is part of the current UE configuration (SRB reconfiguration):

- 3> if the *rlc-Configuration* is included and set to 'explicitValue':

- 4> reconfigure the RLC entity in accordance with the received *RLC-Configuration*;

- 3> else if the *rlc-Configuration* is included and set to 'defaultValue':

- 4> reconfigure the RLC entity in accordance with the default configuration applicable for this *srb-Identity* as specified in 9.2.1.1;

- 3> if the *logicalChannelConfig* is included and set to 'explicitValue':

- 4> reconfigure the DCCH logical channel in accordance with the received *LogicalChannelConfig*;

- 3> else if the *logicalChannelConfig* is included and set to 'defaultValue':

- 4> reconfigure the DCCH logical channel in accordance with the default configuration applicable for this *srb-Identity* as specified in 9.2.1;

NOTE 1: 'Infinity' is the only applicable value for the *prioritizedBitRate* for SRB1 and SRB2

NOTE 2: RLC AM is the only applicable RLC mode for SRB1 and SRB2

[TS 36.331, clause 5.3.10.3]

The UE shall:

- 1> if the received *radioResourceConfiguration* includes the *drb-ToAddModifyList*:

...

- 2> indicate the establishment of the DRB(s) and the *eps-BearerIdentity* of the established DRB(s) to upper layers;
- 2> for each *drb-Identity* value included in the *drb-ToAddModifyList* that is part of the current UE configuration (DRB reconfiguration):
 - 3> reconfigure the PDCP entity in accordance with the received *PDCP-Configuration*;
 - 3> reconfigure the RLC entity in accordance with the received *RLC-Configuration*;
 - 3> reconfigure the DTCH logical channel in accordance with the received *LogicalChannelConfig*;

[TS 36.331, clause 5.3.10.4]

The UE shall:

- 1> if the received *radioResourceConfiguration* includes the *mac-MainConfig*:
 - 2> if the *mac-MainConfig* is set to 'explicitValue':
 - 3> if the received *mac-MainConfig* includes the *dl-SCH-Configuration*:
 - 4> reconfigure the DL-SCH transport channel in accordance with the received *dl-SCH-Configuration*;
 - 3> if the received *mac-MainConfig* includes the *ul-SCH-Configuration*:
 - 4> reconfigure the UL-SCH transport channel in accordance with the received *ul-SCH-Configuration*;
 - 3> if the *mac-MainConfig* includes *drx-Configuration*:
 - 4> if the *drx-Configuration* is set to 'disable':
 - 5> disable the DRX functionality;
 - 5> release the DRX configuration.
 - 4> else if the *drx-Configuration* includes *shortDRX* and *shortDRX* is set to 'disable':
 - 5> disable the short DRX functionality;
 - 5> release short DRX configuration;
 - 3> apply the *timeAlignmentTimerDedicated*;
 - 3> if the *mac-MainConfig* includes *phr-Configuration*:
 - 4> if the *phr-Configuration* is set to 'disable':
 - 5> disable the power headroom reporting functionality;
 - 2> else if the *mac-MainConfig* is set to 'defaultValue':
 - 3> reconfigure the *mac-MainConfig* in accordance with the default configuration as specified in 9.2.2.

[TS 36.331, clause 5.3.10.6]

The UE shall:

- 1> if the received *radioResourceConfiguration* includes the *physicalConfigDedicated*:
 - 2> reconfigure the physical channel configuration in accordance with the received *physicalConfigDedicated*;
- 2> if the *antennaInformation* is included and set to 'explicitValue':
 - 3> reconfigure the antenna configuration in accordance with the received *AntennaInformationDedicated*;
- 2> else if the *antennaInformation* is included and set to 'defaultValue':

- 3> reconfigure the antenna configuration in accordance with the default configuration for *AntennaInformationDedicated* as specified in 9.2.4;
- 2> if *physicalConfigDedicated* includes *cqi-Reporting* and *cqi-Reporting* includes *cqi-ReportingPeriodic* and the configuration is set to 'disable':
- 3> deactivate any uplink resources used for periodic CQI reporting, if active;
- 3> release the *cqi-ReportingPeriodic* configuration;
- 2> if *physicalConfigDedicated* includes the *soundingRsUL-Config* and the configuration is set to 'disable':
- 3> deactivate any uplink resources used for sounding if active;
- 3> release the *soundingRsUL-Config* configuration.
- 2> if *physicalConfigDedicated* includes the *schedulingRequestConfig* and the configuration is set to 'disable':
- 3> deactivate any uplink resources used for scheduling request, if active;
- 3> release the *schedulingRequestConfig* configuration.

8.2.2.1.3 Test description

8.2.2.1.3.1 Pre-test conditions

System Simulator:

- Cell 1

UE:

None.

Preamble:

- The UE is in state Generic RB Established (state 3) according to [18].
- The condition SRB2-DRB(1, 1) is used for step 8 in 4.5.3.3 according to [18].

8.2.2.1.3.2 Test procedure sequence

Table 8.2.2.1.3.2-1: Main behaviour

St	Procedure	Message Sequence		TP	Verdict
		U - S	Message		
1	The SS transmits an <i>RRCCONNECTIONRECONFIGURATION</i> containing a <i>RADIORESOURCECONFIGURATION</i> with SRBs, DRB, transport channel and physical channel reconfiguration.	<--	<i>RRCCONNECTIONRECONFIGURATION</i>	-	-
2	Check: does the UE transmit a <i>RRCCONNECTIONRECONFIGURATIONCOMPLETE</i> message to confirm the reconfiguration of the radio resources?	-->	<i>RRCCONNECTIONRECONFIGURATIONCOMPLETE</i>	1	P
3	Check: does the test result of CALL generic procedure indicate that UE is in E-UTRA RRC_CONNECTED state?	-	-	1	-

8.2.2.1.3.3 Specific message contents

Table 8.2.2.1.3.3-1: RRCConnectionReconfiguration (step 1)

Derivation Path: 36.508 table 4.6.1-8: RRCConnectionReconfiguration			
Information Element	Value/remark	Comment	Condition
RRCConnectionReconfiguration ::= SEQUENCE {			
criticalExtensions CHOICE {			
c1 CHOICE{			
rrcConnectionReconfiguration-r8 SEQUENCE {			
radioResourceConfiguration	RadioResourceConfigDe dicated-RECONFIG		
}			
}			
}			
}			

Table 8.2.2.1.3.3-2 RadioResourceConfigDedicated-RECONFIG (step 1)

Derivation Path: 36.331 clause 6.3.2			
Information Element	Value/remark	Comment	Condition
RadioResourceConfigDedicated ::= SEQUENCE {			
srb-ToAddModifyList	SRB-ToAddModifyList- RECONFIG	TS 36.508 Table 4.6.3-22A	
drb-ToAddModifyList	DRB-ToAddModifyList- RECONFIG	TS 36.508 Table 4.6.3-2A	
drb-ToReleaseList	Not present		
mac-MainConfig CHOICE {			
explicitValue	MAC-MainConfiguration- RECONFIG		
}			
sps-Configuration	Not present		
physicalConfigDedicated	PhysicalConfigDedicated -RECONFIG		
}			

Table 8.2.2.1.3.3-3: MAC-MainConfiguration-RECONFIG (step 1)

Derivation Path: 36.508 table 4.8.2.1.5-1: MAC-MainConfiguration-RBC			
Information Element	Value/remark	Comment	Condition
MAC-MainConfiguration ::= SEQUENCE {			
ul-SCH-Configuration SEQUENCE {			
periodicBSR-Timer	sf32		
retxBSR-Timer	sf2560		
}			
drx-Configuration CHOICE {			
enable SEQUENCE {			
onDurationTimer	psf3		
drx-InactivityTimer	psf200		
drx-RetransmissionTimer	sf24		
}			
}			
phr-Configuration CHOICE {			
enable SEQUENCE {			
periodicPHR-Timer	sf1000		
prohibitPHR-Timer	sf500		
}			
}			
}			

Table 8.2.2.1.3.3-4: PhysicalConfigDedicated-RECONFIG (step 1)

Derivation Path: 36.331 clause 6.3.2			
Information Element	Value/remark	Comment	Condition
PhysicalConfigDedicated ::= SEQUENCE {			
pdsch-Configuration	PDSCH-ConfigDedicated-RECONFIG		
pucch-Configuration	Not present		
pusch-Configuration	Not present		
uplinkPowerControl	Not present		
tpc-PDCCH-ConfigPUCCH	Not present		
tpc-PDCCH-ConfigPUSCH	Not present		
cqi-Reporting	Not present		
soundingRsUI-Config	Not present		
antennaInformation CHOICE {			
defaultValue	NULL		
}			
schedulingRequestConfig	Not present		
}			

Table 8.2.2.1.3.3-5: PDSCH-ConfigDedicated-RECONFIG (step 1)

Derivation Path: 36.508 table 4.6.3-6: PDSCH-ConfigDedicated-DEFAULT			
Information Element	Value/remark	Comment	Condition
PDSCH-ConfigDedicated ::= SEQUENCE {			
p-a	dB1		
}			

8.2.2.2 RRC Connection Reconfiguration / SRB/DRB Reconfiguration: Success

8.2.2.2.1 Test Purpose (TP)

(1)

```
with { UE in E-UTRA RRC_CONNECTED state}
ensure that {
  when { UE receives a RRCConnectionReconfiguration message containing a new SRB and DRB
configuration }
  then { UE reconfigures affected SRBs and DRBs according to the contents of the
RRCConnectionReconfiguration message and sends an RRCConnectionReconfigurationComplete message }
}
```

8.2.2.2.2 Conformance requirements

References: The conformance requirements covered in the current TC is specified in: TS 36.331, clauses 5.3.5.3, 5.3.9.1, 5.3.9.3, and 9.2.2.1.

[TS 36.331, clause 5.3.5.3]

If the *RRCConnectionReconfiguration* message does not include the *mobilityControlInformation* and the UE is able to comply with the configuration included in this message, the UE shall:

...

1> else:

2> if the *RRCConnectionReconfiguration* message includes the *radioResourceConfiguration*:

3>perform the Radio resource configuration procedure as specified in 5.3.10;

[TS 36.331, clause 5.3.10.1]

The UE shall:

1> if the received *radioResourceConfiguration* includes the *srb-ToAddModifyList*:

...

- 2> for each *srb-Identity* value included in the *srb-ToAddModifyList* that is part of the current UE configuration (SRB reconfiguration):
 - 3> if the *rlc-Configuration* is set to '*explicitValue*':
 - 4> reconfigure the RLC entity in accordance with the received *RLC-Configuration*;
 - 3> else if the *rlc-Configuration* is set to '*defaultValue*':
 - 4> reconfigure the RLC entity in accordance with the default configuration applicable for this *srb-identity* as specified in 9.2.1;
 - 3> if the *logicalChannelConfig* is set to '*explicitValue*':
 - 4> reconfigure the DCCH logical channel in accordance with the received *LogicalChannelConfig*;
 - 3> else if the *logicalChannelConfig* is set to '*defaultValue*':
 - 4> reconfigure the DCCH logical channel in accordance with the default configuration applicable for this *srb-identity* as specified in 9.2.1;

[TS 36.331, clause 5.3.10.3]

The UE shall:

- 1> if the received *radioResourceConfiguration* includes the *drb-ToAddModifyList*:

...

- 2> for each *drb-Identity* value included in the *drb-ToAddModifyList* that is part of the current UE configuration (DRB reconfiguration):
 - 3> reconfigure the PDCP entity in accordance with the received *PDCP-Configuration*;
 - 3> reconfigure the RLC entity in accordance with the received *RLC-Configuration*;
 - 3> reconfigure the DTCH logical channel in accordance with the received *LogicalChannelConfig*;

8.2.2.2.3 Test Description

8.2.2.2.3.1 Pre-test conditions

System Simulator:

- Cell 1

UE:

None.

Preamble:

- The UE is in state Generic RB Established (state 3) according to [18].
- The condition SRB2-DRB(1, 1) is used for step 8 in 4.5.3.3 according to [18].

8.2.2.2.3.2 Test procedure sequence

Table 8.2.2.2.3.2-1: Main behaviour

St	Procedure	Message Sequence		TP	Verdict
		U - S	Message		
1	SS transmits an <i>RRConnectionReconfiguration</i> message including <i>radioResourceReconfiguration</i> which includes <i>srb-ToAddModifyList</i>	<--	<i>RRConnectionReconfiguration</i>	-	-
2	Check: Does the UE transmit an <i>RRConnectionReconfigurationComplete</i> message?.	-->	<i>RRConnectionReconfigurationComplete</i>	1	P
3	SS transmits <i>RRConnectionReconfiguration</i> message including <i>radioResourceReconfiguration</i> which includes <i>drb-ToAddModifyList</i>	<--	<i>RRConnectionReconfiguration</i>	-	-
4	Check: Does the UE transmit an <i>RRConnectionReconfigurationComplete</i> message?.	-->	<i>RRConnectionReconfigurationComplete</i>	1	P

8.2.2.2.3.3 Specific message or IE contents

Table 8.2.2.2.3.3-1: *RRConnectionReconfiguration* (step 1)

Derivation Path: 36.508 table 4.6.1-8: <i>RRConnectionReconfiguration</i>			
Information Element	Value/remark	Comment	Condition
<i>RRConnectionReconfiguration</i> ::= SEQUENCE {			
criticalExtensions CHOICE {			
c1 CHOICE{			
rrcConnectionReconfiguration-r8 SEQUENCE {			
radioResourceConfiguration	RadioResourceConfigDedicated-SRBRECONFIG		
}			
}			
}			
}			

Table 8.2.2.2.3.3-2: *RadioResourceConfigDedicated-SRBRECONFIG* (step 1)

Derivation Path: 36.331 clause 6.3.2			
Information Element	Value/remark	Comment	Condition
<i>RadioResourceConfigDedicated</i> ::= SEQUENCE {			
srb-ToAddModifyList	SRB-ToAddModifyList-RECONFIG	TS 36.508 Table 4.6.3-22A	
drb-ToAddModifyList	Not present		
drb-ToReleaseList	Not present		
mac-MainConfig	Not present		
sps-Configuration	Not present		
physicalConfigDedicated	Not present		
}			

Table 8.2.2.2.3.3-3: RRCConnectionReconfiguration (step 3, Table 8.2.2.2.3.2-1)

Derivation Path: 36.508 table 4.6.1-8: RRCConnectionReconfiguration			
Information Element	Value/remark	Comment	Condition
RRCConnectionReconfiguration ::= SEQUENCE {			
criticalExtensions CHOICE {			
c1 CHOICE{			
rrcConnectionReconfiguration-r8 SEQUENCE {			
radioResourceConfiguration	RadioResourceConfigDe dicated-DRBRECONFIG		
}			
}			
}			
}			

Table 8.2.2.2.3.3-4: RadioResourceConfigDedicated-DRBRECONFIG (step 1)

Derivation Path: 36.331 clause 6.3.2			
Information Element	Value/remark	Comment	Condition
RadioResourceConfigDedicated ::= SEQUENCE {			
srb-ToAddModifyList	Not present		
drb-ToAddModifyList	DRB-ToAddModifyList- RECONFIG	TS 36.508 Table 4.6.3-2A	
drb-ToReleaseList	Not present		
mac-MainConfig	Not present		
sps-Configuration	Not present		
physicalConfigDedicated	Not present		
}			

Table 8.2.2.2.3.3-5: (Void)**Table 8.2.2.2.3.3-6: (Void)**

8.2.3 Radio Bearer Release

8.2.3.1 RRC Connection Reconfiguration / Radio Bearer Release: Success

8.2.3.1.1 Test Purpose (TP)

(1)

```
with { UE in E-UTRA RRC_CONNECTED state }
ensure that {
  when { UE receives an RRCConnectionReconfiguration message including a drb-ToReleaseList }
  then { for each drb-Identity release the PDCP entity and RLC entity and DTCH logical channel
and indicate release of the DRB(s) to upper layers }
}
```

8.2.3.1.2 Conformance requirements

References: The conformance requirements covered in the present TC are specified in: 3GPP TS 36.331 clause 5.3.5.3 and 5.3.10.2.

[TS 36.331, clause 5.3.5.3]

If the *RRCConnectionReconfiguration* message does not include the *mobilityControlInfo* and the UE is able to comply with the configuration included in this message, the UE shall:

- 2> if this is the first *RRCConnectionReconfiguration* message after successful completion of the RRC Connection Re-establishment procedure:

...

1> else:

2> If the *RRCCConnectionReconfiguration* message includes the *radioResourceConfigDedicated*:

3> perform the radio resource configuration procedure as specified in 5.3.10;

...

1> submit the *RRCCConnectionReconfigurationComplete* message to lower layers for transmission using the new configuration, upon which the procedure ends;

[TS 36.331, clause 5.3.10.2]

The UE shall:

1> for each *drb-Identity* value included in the *drb-ToReleaseList* that is part of the current UE configuration (DRB release):

2> release the PDCP entity;

2> release the RLC entity;

2> release the DTCH logical channel;

1> indicate the release of the DRB(s) and the *eps-BearerIdentity* of the released DRB(s) to upper layers;

8.2.3.1.3 Test description

8.2.3.1.3.1 Pre-test conditions

System Simulator:

- Cell 1

UE:

None.

Preamble:

- The UE is in state Generic RB Established (state 3) according to [18].
- The condition SRB2-DRB(1, 1) is used for step 8 in 4.5.3.3 according to [18].

8.2.3.1.3.2 Test procedure sequence

Table 8.2.3.1.3.2-1: Main behaviour

St	Procedure	Message Sequence		TP	Verdict
		U - S	Message		
1	The SS transmits an <i>RRCCConnectionReconfiguration</i> message with a <i>drb-ToReleaseList</i> .	<--	<i>RRCCConnectionReconfiguration</i>	-	-
2	Check: Does the UE transmit an <i>RRCCConnectionReconfigurationComplete</i> message?	-->	<i>RRCCConnectionReconfigurationComplete</i>	1	P
3	Check: Does the test result of CALL generic procedure indicate that UE is in E-UTRA RRC_CONNECTED state?	-	-	1	-

8.2.3.1.3.3 Specific message contents

Table 8.2.3.1.3.3-1: *RRCConnectionReconfiguration* (step 1)

Derivation Path: 36.508 table 4.6.1-8			
Information Element	Value/remark	Comment	Condition
RRCConnectionReconfiguration ::= SEQUENCE {			
criticalExtensions CHOICE {			
c1 CHOICE{			
rrcConnectionReconfiguration-r8 SEQUENCE {			
radioResourceConfigDedicated	RadioResourceConfigDe dicated-DRB-RELEASE		
}			
}			
}			
}			

Table 8.2.3.1.3.3-2: *RadioResourceConfigDedicated-DRB-RELEASE* (step 1)

Derivation Path: 36.331 clause 6.3.2			
Information Element	Value/remark	Comment	Condition
RadioResourceConfigDedicated ::= SEQUENCE {			
srb-ToAddModList	Not present		
drb-ToAddModList	Not present		
drb-ToReleaseList SEQUENCE (SIZE (1..maxDRB)) OF SEQUENCE {	1 entry		
drb-Identity[1]	1		
}			
mac-MainConfig CHOICE { }	Not present		
sps-Config	Not present		
physicalConfigDedicated	Not present		
}			

8.2.4 Handover

8.2.4.1 RRC Connection Reconfiguration / Handover: Success (Dedicated preamble)

8.2.4.1.1 Test Purpose (TP)

(1)

```
with { UE having completed the radio bearer establishment and initial security activation procedure
and performed the intra frequency measurement }
ensure that {
  when { UE receives an RRCConnectionReconfiguration message including a mobilityControlInfo with a
rach-ConfigDedicated }
    then { UE transmits an RRCConnectionReconfigurationComplete message }
}
```

(2)

```
with { UE having completed the radio bearer establishment and initial security activation procedure
and performed the intra frequency measurement }
ensure that {
  when { UE receives an RRCConnectionReconfiguration message including a nextHopChainingCount which
is different from the NCC associated with the currently active KeNB }
    then { UE derives new KeNB key from the nextHopChainingCount }
}
```

(3)

```
with { UE having completed the radio bearer establishment and initial security activation procedure
and performed the intra frequency measurement }
ensure that {
  when { UE receives an RRCConnectionReconfiguration message including a nextHopChainingCount which
is same as the NCC associated with the currently active KeNB }
    then { UE derives new KeNB key from the currently active KeNB }
}
```

}

8.2.4.1.2 Conformance requirements

References: The conformance requirements covered in the present TC are specified in: TS 36.331, clauses 5.3.5.4, 5.3.10.4 and 5.3.10.6.

[TS 36.331, clause 5.3.5.4]

If the *RRConnectionReconfiguration* message includes the *mobilityControlInfo* and the UE is able to comply with the configuration included in this message, the UE shall:

- 1> stop timer T310, if running;
- 1> start timer T304 with the timer value set to *t304*, as included in the *mobilityControlInfo*;
- 1> if the *carrierFreq* is included:
 - 2> consider the target cell to be one on the frequency indicated by the *carrierFreq* with a physical cell identity indicated by the *targetPhysCellId*;
- 1> else:
 - 2> consider the target cell to be one on the current frequency with a physical cell identity indicated by the *targetPhysCellId*;
- 1> start synchronising to the DL of the target cell;

NOTE 1: The UE should perform the handover as soon as possible following the reception of the RRC message triggering the handover, which could be before confirming successful reception (HARQ and ARQ) of this message.

- 1> reset MAC;
- 1> re-establish PDCP for all RBs that are established;

NOTE 2: The handling of the radio bearers after the successful completion of the PDCP re-establishment, e.g. the re-transmission of unacknowledged PDCP SDUs (as well as the associated status reporting), the handling of the SN and the HFN, is specified in TS 36.323 [8].

- 1> re-establish RLC for all RBs that are established;
- 1> apply the value of the *newUE-Identity* as the C-RNTI;
- 1> configure lower layers in accordance with the received *radioResourceConfigCommon*;
- 1> if the *RRConnectionReconfiguration* message includes the *radioResourceConfigDedicated*:
 - 2> perform the radio resource configuration procedure as specified in 5.3.10;
- 1> if the *keyChangeIndicator* received in the *securityConfigHO* is set to *TRUE*:
 - 2> update the K_{eNB} key based on the K_{ASME} key taken into use with the previous successful NAS SMC procedure, as specified in TS 33.401 [32];
- 1> else:
 - 2> update the K_{eNB} key based on the K_{ASME} key to which the current K_{eNB} is associated, using the *nextHopChainingCount* value indicated in the *securityConfigHO*, as specified in TS 33.401 [32];
- 1> store the *nextHopChainingCount* value;
- 1> if the *securityAlgorithmConfig* is included in the *securityConfigHO*:
 - 2> derive the K_{RRcInt} key associated with the *integrityProtAlgorithm*, as specified in TS 33.401 [32];

- 2> derive the K_{RRCenc} key and the K_{UPenc} key associated with the *cipheringAlgorithm*, as specified in TS 33.401 [32];
- 1> else:
 - 2> derive the K_{RRCint} key associated with the current integrity algorithm, as specified in TS 33.401 [32];
 - 2> derive the K_{RRCenc} key and the K_{UPenc} key associated with the current ciphering algorithm, as specified in TS 33.401 [32];
- 1> configure lower layers to apply the integrity protection algorithm and the K_{RRCint} key, i.e. the integrity protection configuration shall be applied to all subsequent messages received and sent by the UE, including the message used to indicate the successful completion of the procedure;
- 1> configure lower layers to apply the ciphering algorithm, the K_{RRCenc} key and the K_{UPenc} key, i.e. the ciphering configuration shall be applied to all subsequent messages received and sent by the UE, including the message used to indicate the successful completion of the procedure;
- 1> perform the measurement related actions as specified in 5.5.6.1;
- 1> if the *RRCCONNECTIONRECONFIGURATION* message includes the *measConfig*:
 - 2> perform the measurement configuration procedure as specified in 5.5.2;
- 1> submit the *RRCCONNECTIONRECONFIGURATIONCOMPLETE* message to lower layers for transmission;
- 1> if MAC successfully completes the random access procedure:
 - 2> stop timer T304;
 - 2> apply the parts of the configuration that do not require the UE to know the SFN of the target cell;
 - 2> apply the parts of the measurement and the radio resource configuration that require the UE to know the SFN of the target cell (e.g. measurement gaps, periodic CQI reporting, scheduling request configuration, sounding RS configuration), if any, upon acquiring the SFN of the target cell;
 - 2> the procedure ends;

NOTE 3: The UE is not required to determine the SFN of the target cell by acquiring system information from that cell before performing RACH access in the target cell.

[TS 36.331, clause 5.3.10.4]

The UE shall:

- 1> reconfigure the MAC main configuration in accordance with the received *mac-MainConfig*;

[TS 36.331, clause 5.3.10.6]

The UE shall:

- 1> reconfigure the physical channel configuration in accordance with the received *physicalConfigDedicated*;
- 1> if the *antennaInformation* is included and set to 'explicitValue':
 - 2> if the configured *transmissionMode* is not 'tm3' or 'tm4' release *ri-ConfigIndex* in *cqi-ReportPeriodic*, if previously configured;
- 1> else if the *antennaInformation* is included and set to 'defaultValue':
 - 2> release *ri-ConfigIndex* in *cqi-ReportPeriodic*, if previously configured;

8.2.4.1.3 Test description

8.2.4.1.3.1 Pre-test conditions

System Simulator:

- Cell 1, Cell 4 and Cell 11.

UE:

None.

Preamble:

- The UE is in state Generic RB Established (state 3) on Cell 1 according to [18].

8.2.4.1.3.2 Test procedure sequence

Table 8.2.4.1.3.2-1 illustrates the downlink power levels and other changing parameters to be applied for the cells at various time instants of the test execution. Row marked "T0" denotes the initial conditions, while columns marked "T1", "T2", and "T3" are to be applied subsequently. The exact instants on which these values shall be applied are described in the texts in this clause.

Table 8.2.4.1.3.2-1: Time instances of cell power level and parameter changes

	Parameter	Unit	Cell 1	Cell 4	Cell 11	Remark
T0	Cell-specific RS EPRE	dBm/15k Hz	-55	-70	-95	The power level values are such that measurement results for Cell 1 (M1) and Cell 4 (M4) satisfy exit condition for event A3 ($M4 + Hys < M1$).
T1	Cell-specific RS EPRE	dBm/15k Hz	-70	-55	-95	The power level values are such that measurement results for Cell 1 (M1) and Cell 4 (M4) satisfy entry condition for event A3 ($M4 - Hys > M1$).
T2	Cell-specific RS EPRE	dBm/15k Hz	-55	-70	-95	The power level values are such that measurement results for Cell 1 (M1) and Cell 4 (M4) satisfy entry condition for event A3 ($M1 - Hys > M4$).
T3	Cell-specific RS EPRE	dBm/15k Hz	-70	"off"	-55	The power level value shall be such that measurement results for Cell 1 (M1) and Cell 11 (M11) satisfy entry condition for event A3 ($M11 - Hys > M1$)(NOTE 1).
NOTE 1: Power level "Off" is defined in TS36.508 Table 6.2.2.1-1.						

Table 8.2.4.1.3.2-2: Main behaviour

St	Procedure	Message Sequence		TP	Verdict
		U - S	Message		
1	The SS transmits an <i>RRConnectionReconfiguration</i> message to setup intra frequency measurement on Cell 1.	<--	<i>RRConnectionReconfiguration</i>	-	-
2	The UE transmits an <i>RRConnectionReconfigurationComplete</i> message on Cell 1.	-->	<i>RRConnectionReconfigurationComplete</i>	-	-
3	The SS changes Cell 1, Cell 4 and Cell 11 parameters according to the row "T1" in table 8.2.4.1.3.2-1.	-	-	-	-
4	The UE transmits a <i>MeasurementReport</i> message to report event A3 on Cell 1 with the measured RSRP, RSRQ value for Cell 4.	-->	<i>MeasurementReport</i>	-	-
5	The SS transmits an <i>RRConnectionReconfiguration</i> message to order the UE to perform intra frequency handover to Cell 4.	<--	<i>RRConnectionReconfiguration</i>	-	-
6	Check1: Does the UE transmit an <i>RRConnectionReconfigurationComplete</i> message on Cell 4 using dedicated preamble to confirm the successful completion of the intra frequency handover? Check2: Does the UE transmit an <i>RRConnectionReconfigurationComplete</i> using the security key derived from the currently active K_{eNB} ?	-->	<i>RRConnectionReconfigurationComplete</i>	1, 3	P
7	The SS changes Cell 1, Cell 4 and Cell 11 parameters according to the row "T2" in table 8.2.4.1.3.2-1.	-	-	-	-
8	The UE transmits a <i>MeasurementReport</i> message to report event A3 on Cell 4 with the measured RSRP, RSRQ value for Cell 1.	-->	<i>MeasurementReport</i>	-	-
9	The SS transmits an <i>RRConnectionReconfiguration</i> message to order the UE to perform intra frequency handover to Cell 1.	<--	<i>RRConnectionReconfiguration</i>	-	-
10	Check1: Does the UE transmit an <i>RRConnectionReconfigurationComplete</i> message on Cell 1 using dedicated preamble to confirm the successful completion of the intra frequency handover? Check2: Does the UE transmit an <i>RRConnectionReconfigurationComplete</i> using the security key derived from the <i>nextHopChainingCount</i> ?	-->	<i>RRConnectionReconfigurationComplete</i>	1,2	P
11	The SS changes Cell 1 and Cell 11 parameters and switches Cell 4 off according to the row "T3" in table 8.2.4.1.3.2-1.	-	-	-	-
12	The UE transmits a <i>MeasurementReport</i> message to report event A3 on Cell 1 with the measured RSRP, RSRQ value for Cell 11.	-->	<i>MeasurementReport</i>	-	-
13	The SS transmits an <i>RRConnectionReconfiguration</i> message to order the UE to perform intra frequency handover to Cell 11.	<--	<i>RRConnectionReconfiguration</i>	-	-
14	Check1: Does the UE transmit an <i>RRConnectionReconfigurationComplete</i> message on Cell 11 using dedicated preamble to confirm the successful completion of the intra frequency handover? Check2: Does the UE transmit an <i>RRConnectionReconfigurationComplete</i> using the security key derived from the <i>nextHopChainingCount</i> ?	-->	<i>RRConnectionReconfigurationComplete</i>	1,2	P
15	Check: Does the test result of CALL generic	-	-	1	-

	procedure indicate that the UE is in E-UTRA RRC_CONNECTED state on Cell 11?				
--	---	--	--	--	--

8.2.4.1.3.3 Specific message contents

Table 8.2.4.1.3.3-1: RRCConnectionReconfiguration (step 1, Table 8.2.4.1.3.2-2)

Derivation Path: 36.508, Table 4.6.1-8, condition MEAS
--

Table 8.2.4.1.3.3-2: MeasConfig (step 1, Table 8.2.4.1.3.2-2)

Derivation Path: 36.508, Table 4.6.6-1			
Information Element	Value/remark	Comment	Condition
MeasConfig ::= SEQUENCE {			
measObjectToAddModList SEQUENCE (SIZE (1..maxObjectId)) OF SEQUENCE {	1 entry		
measObjectId[1]	IdMeasObject-f1		
measObject[1]	MeasObjectEUTRA-GENERIC(f1)		
}			
reportConfigToAddModList SEQUENCE (SIZE (1..maxReportConfigId)) OF SEQUENCE {	1 entry		
reportConfigId[1]	IdReportConfig-A3		
reportConfig[1]	ReportConfigEUTRA-A3		
}			
measIdToAddModList SEQUENCE (SIZE (1..maxMeasId)) OF SEQUENCE {	1 entry		
measId[1]	1		
measObjectId[1]	IdMeasObject-f1		
reportConfigId[1]	IdReportConfig-A3		
}			
}			

Table 8.2.4.1.3.3-3: MeasurementReport (step 4, Table 8.2.4.1.3.2-2)

Derivation Path: 36.508, Table 4.6.1-5			
Information Element	Value/remark	Comment	Condition
MeasurementReport ::= SEQUENCE {			
criticalExtensions CHOICE {			
c1 CHOICE{			
measurementReport-r8 SEQUENCE {			
measResults SEQUENCE {			
measId	1		
measResultServCell SEQUENCE {			
rsrpResult	(0..97)		
rsrqResult	(0..34)		
}			
measResultNeighCells CHOICE {			
measResultListEUTRA SEQUENCE (SIZE (1..maxCellReport)) OF SEQUENCE {	1 entry		
physCellId[1]	PhysicalCellIdentity of Cell 4		
cgi-Info[1]	Not present		
measResult[1] SEQUENCE {			
rsrpResult	(0..97)		
rsrqResult	(0..34)		
}			
}			
}			
}			
}			
}			
}			

Table 8.2.4.1.3.3-4: RRCConnectionReconfiguration (step 5, Table 8.2.4.1.3.2-2)

Derivation Path: 36.508, Table 4.6.1-8, condition HO
--

Table 8.2.4.1.3.3-5: MobilityControlInfo (step 5, Table 8.2.4.1.3.2-2)

Derivation Path: 36.508, Table 4.6.5-1			
Information Element	Value/remark	Comment	Condition
MobilityControlInfo ::= SEQUENCE {			
targetPhysCellId	PhysicalCellIdentity of Cell 4		
carrierFreq	Not present		
rach-ConfigDedicated SEQUENCE {			
ra-PreambleIndex	63		FDD
ra-PreambleIndex	FFS		TDD
ra-PRACH-MaskIndex	0		
}			
}			

Table 8.2.4.1.3.3-6: MeasurementReport (step 8, Table 8.2.4.1.3.2-2)

Derivation Path: 36.508, Table 4.6.1-5			
Information Element	Value/remark	Comment	Condition
MeasurementReport ::= SEQUENCE {			
criticalExtensions CHOICE {			
c1 CHOICE{			
measurementReport-r8 SEQUENCE {			
measResults SEQUENCE {			
measId	1		
measResultServCell SEQUENCE {			
rsrpResult	(0..97)		
rsrqResult	(0..34)		
}			
measResultNeighCells CHOICE {			
measResultListEUTRA SEQUENCE (SIZE (1..maxCellReport)) OF SEQUENCE {	1 entry		
physCellId[1]	PhysicalCellIdentity of Cell 1		
cgi-Info[1]	Not present		
measResult[1] SEQUENCE {			
rsrpResult	(0..97)		
rsrqResult	(0..34)		
}			
}			
}			
}			
}			
}			
}			

Table 8.2.4.1.3.3-7: RRCConnectionReconfiguration (step 9, Table 8.2.4.1.3.2-2)

Derivation Path: 36.508, Table 4.6.1-8, condition HO
--

Table 8.2.4.1.3.3-8: MobilityControlInfo (step 9, Table 8.2.4.1.3.2-2)

Derivation Path: 36.508, Table 4.6.5-1			
Information Element	Value/remark	Comment	Condition
MobilityControlInfo ::= SEQUENCE {			
targetPhysCellId	PhysicalCellIdentity of Cell 1		
carrierFreq	Not present		
rach-ConfigDedicated SEQUENCE {			
ra-PreambleIndex	63		FDD
ra-PreambleIndex	FFS		TDD
ra-PRACH-MaskIndex	0		
}			
}			

Table 8.2.4.1.3.3-9: SecurityConfigHO (step 9, Table 8.2.4.1.3.2-2)

Derivation Path: 36.508, Table 4.6.4-1			
Information Element	Value/remark	Comment	Condition
SecurityConfigHO ::= SEQUENCE {			
handoverType CHOICE {			
intraLTE SEQUENCE {			
nextHopChainingCount	1		
}			
}			
}			

Table 8.2.4.1.3.3-10: MeasurementReport (step 12, Table 8.2.4.1.3.2-2)

Derivation Path: 36.508, Table 4.6.1-5			
Information Element	Value/remark	Comment	Condition
MeasurementReport ::= SEQUENCE {			
criticalExtensions CHOICE {			
c1 CHOICE{			
measurementReport-r8 SEQUENCE {			
measuredResults SEQUENCE {			
measId	1		
measResultServCell SEQUENCE {			
rsrpResult	(0..97)		
rsrqResult	(0..34)		
}			
measResultNeighCells CHOICE {			
measResultListEUTRA SEQUENCE (SIZE (1..maxCellReport)) OF SEQUENCE {	1 entry		
physCellId[1]	PhysicalCellIdentity of Cell 11		
cgi-Info[1]	Not present		
measResult[1] SEQUENCE {			
rsrpResult	(0..97)		
rsrqResult	(0..34)		
}			
}			
}			
}			
}			
}			

Table 8.2.4.1.3.3-11: RRCConnectionReconfiguration (step 13, Table 8.2.4.1.3.2-2)

Derivation Path: 36.508, Table 4.6.1-8, condition HO

Table 8.2.4.1.3.3-12: MobilityControlInfo (step 13, Table 8.2.4.1.3.2-2)

Derivation Path: 36.508, Table 4.6.5-1			
Information Element	Value/remark	Comment	Condition
MobilityControlInfo ::= SEQUENCE {			
targetPhysCellId	PhysicalCellIdentity of Cell 11		
carrierFreq	Not present		
rach-ConfigDedicated SEQUENCE {			
ra-PreambleIndex	63		FDD
ra-PreambleIndex	FFS		TDD
ra-PRACH-MaskIndex	0		
}			
}			

Condition	Explanation
FDD	FDD cell environment
TDD	TDD cell environment

Table 8.2.4.1.3.3-13: *SecurityConfigHO* (step 13, Table 8.2.4.1.3.2-2)

Derivation Path: 36.508, Table 4.6.4-1			
Information Element	Value/remark	Comment	Condition
SecurityConfigHO ::= SEQUENCE {			
handoverType CHOICE {			
intraLTE SEQUENCE {			
nextHopChainingCount	3		
}			
}			
}			

8.2.4.2 RRC Connection Reconfiguration / Handover: Success (Common preamble)

8.2.4.2.1 Test Purpose (TP)

(1)

```

with { UE having completed the radio bearer establishment and initial security activation procedure
and performed the intra frequency measurement }
ensure that {
  when { UE receives an RRCConnectionReconfiguration message including a mobilityControlInfo without
a rach-ConfigDedicated }
    then { UE transmits an RRCConnectionReconfigurationComplete message }
}

```

8.2.4.2.2 Conformance requirements

References: The conformance requirements covered in the present TC are specified in: TS 36.331, clauses 5.3.5.4, 5.3.10.4 and 5.3.10.6.

[TS 36.331, clause 5.3.5.4]

If the *RRCConnectionReconfiguration* message includes the *mobilityControlInfo* and the UE is able to comply with the configuration included in this message, the UE shall:

- 1> stop timer T310, if running;
- 1> start timer T304 with the timer value set to *t304*, as included in the *mobilityControlInfo*;
- 1> if the *carrierFreq* is included:
 - 2> consider the target cell to be one on the frequency indicated by the *carrierFreq* with a physical cell identity indicated by the *targetPhysCellId*;
- 1> else:
 - 2> consider the target cell to be one on the current frequency with a physical cell identity indicated by the *targetPhysCellId*;
- 1> start synchronising to the DL of the target cell;

NOTE 1: The UE should perform the handover as soon as possible following the reception of the RRC message triggering the handover, which could be before confirming successful reception (HARQ and ARQ) of this message.

- 1> reset MAC;
- 1> re-establish PDCP for all RBs that are established;

NOTE 2: The handling of the radio bearers after the successful completion of the PDCP re-establishment, e.g. the re-transmission of unacknowledged PDCP SDUs (as well as the associated status reporting), the handling of the SN and the HFN, is specified in TS 36.323 [8].

- 1> re-establish RLC for all RBs that are established;
- 1> apply the value of the *newUE-Identity* as the C-RNTI;

- 1> configure lower layers in accordance with the received *radioResourceConfigCommon*;
- 1> if the *RRCConnectionReconfiguration* message includes the *radioResourceConfigDedicated*:
 - 2> perform the radio resource configuration procedure as specified in 5.3.10;
- 1> if the *keyChangeIndicator* received in the *securityConfigHO* is set to *TRUE*:
 - 2> update the K_{eNB} key based on the K_{ASME} key taken into use with the previous successful NAS SMC procedure, as specified in TS 33.401 [32];
- 1> else:
 - 2> update the K_{eNB} key based on the K_{ASME} key to which the current K_{eNB} is associated, using the *nextHopChainingCount* value indicated in the *securityConfigHO*, as specified in TS 33.401 [32];
- 1> store the *nextHopChainingCount* value;
- 1> if the *securityAlgorithmConfig* is included in the *securityConfigHO*:
 - 2> derive the K_{RRcint} key associated with the *integrityProtAlgorithm*, as specified in TS 33.401 [32];
 - 2> derive the K_{RRcenc} key and the K_{UPenc} key associated with the *cipheringAlgorithm*, as specified in TS 33.401 [32];
- 1> else:
 - 2> derive the K_{RRcint} key associated with the current integrity algorithm, as specified in TS 33.401 [32];
 - 2> derive the K_{RRcenc} key and the K_{UPenc} key associated with the current ciphering algorithm, as specified in TS 33.401 [32];
- 1> configure lower layers to apply the integrity protection algorithm and the K_{RRcint} key, i.e. the integrity protection configuration shall be applied to all subsequent messages received and sent by the UE, including the message used to indicate the successful completion of the procedure;
- 1> configure lower layers to apply the ciphering algorithm, the K_{RRcenc} key and the K_{UPenc} key, i.e. the ciphering configuration shall be applied to all subsequent messages received and sent by the UE, including the message used to indicate the successful completion of the procedure;
- 1> perform the measurement related actions as specified in 5.5.6.1;
- 1> if the *RRCConnectionReconfiguration* message includes the *measConfig*:
 - 2> perform the measurement configuration procedure as specified in 5.5.2;
- 1> submit the *RRCConnectionReconfigurationComplete* message to lower layers for transmission;
- 1> if MAC successfully completes the random access procedure:
 - 2> stop timer T304;
 - 2> apply the parts of the configuration that do not require the UE to know the SFN of the target cell;
 - 2> apply the parts of the measurement and the radio resource configuration that require the UE to know the SFN of the target cell (e.g. measurement gaps, periodic CQI reporting, scheduling request configuration, sounding RS configuration), if any, upon acquiring the SFN of the target cell;
- 2> the procedure ends;

...

[TS 36.331, clause 5.3.10.4]

The UE shall:

- 1> reconfigure the MAC main configuration in accordance with the received *mac-MainConfig*;

[TS 36.331, clause 5.3.10.6]

The UE shall:

- 1> reconfigure the physical channel configuration in accordance with the received physicalConfigDedicated;
- 1> if the *antennaInformation* is included and set to 'explicit'-'Value':
 - 2> if the configured *transmissionMode* is not 'tm3' or 'tm4' release *ri-ConfigIndex* in *cqi-ReportPeriodic*, if previously configured;
- 1> else if the *antennaInformation* is included and set to 'default'-'Value':
 - 2> release *ri-ConfigIndex* in *cqi-ReportPeriodic*, if previously configured;

8.2.4.2.3 Test description

8.2.4.2.3.1 Pre-test conditions

System Simulator:

- Cell 1 and Cell 2.

UE:

None.

Preamble:

- The UE is in state Generic RB Established (state 3) on Cell 1 according to [18].

8.2.4.2.3.2 Test procedure sequence

Table 8.2.4.2.3.2-1 illustrates the downlink power levels and other changing parameters to be applied for the cells at various time instants of the test execution. Row marked "T0" denotes the initial conditions, while columns marked "T1" is to be applied subsequently. The exact instants on which these values shall be applied are described in the texts in this clause.

Table 8.2.4.2.3.2-1: Time instances of cell power level and parameter changes

	Parameter	Unit	Cell 1	Cell 2	Remark
T0	Cell-specific RS EPRE	dBm/15k Hz	-70	-90	The power level values are such that measurement results for Cell 1 (M1) and Cell 2 (M2) satisfy exit condition for event A3 ($M2 + Hys < M1$).
T1	Cell-specific RS EPRE	dBm/15k Hz	-95	-70	The power level values are such that measurement results for Cell 1 (M1) and Cell 2 (M2) satisfy entry condition for event A3 ($M2 - Hys > M1$).

Table 8.2.4.2.3.2-2: Main behaviour

St	Procedure	Message Sequence		TP	Verdict
		U - S	Message		
1	The SS transmits an <i>RRConnectionReconfiguration</i> message on Cell 1 to setup intra frequency measurement.	<--	<i>RRConnectionReconfiguration</i>	-	-
2	The UE transmits an <i>RRConnectionReconfigurationComplete</i> message on Cell 1.	-->	<i>RRConnectionReconfigurationComplete</i>	-	-
3	The SS changes Cell 1 and Cell 2 parameters according to the row "T1" in table 8.2.4.2.3.2-1.	-	-	-	-
4	The UE transmits a <i>MeasurementReport</i> message on Cell 1 to report event A3 with the measured RSRP value for Cell 2.	-->	<i>MeasurementReport</i>	-	-
5	The SS transmits an <i>RRConnectionReconfiguration</i> message on Cell 1 to order the UE to perform intra frequency handover to Cell 2.	<--	<i>RRConnectionReconfiguration</i>	-	-
6	Check: Does the UE transmit an <i>RRConnectionReconfigurationComplete</i> message on Cell 2 using common preamble to confirm the successful completion of the intra frequency handover?	-->	<i>RRConnectionReconfigurationComplete</i>	1	P
7	Check: Does the test result of the CALL generic procedure indicate that the UE is in E-UTRA RRC_CONNECTED state on Cell 2?	-	-	1	-

8.2.4.2.3.3 Specific message contents

Table 8.2.4.2.3.3-1: *RRConnectionReconfiguration* (step 1, Table 8.2.4.2.3.2-2)

Derivation Path: 36.508, Table 4.6.1-8, condition MEAS

Table 8.2.4.2.3.3-2: *MeasConfig* (step 1, Table 8.2.4.2.3.2-2)

Derivation Path: 36.508, Table 4.6.6-1			
Information Element	Value/remark	Comment	Condition
MeasConfig SEQUENCE {			
measObjectToAddModList SEQUENCE (SIZE (1..maxObjectId)) OF SEQUENCE {	1 entry		
measObjectId[1]	IdMeasObject-f1		
measObject[1]	MeasObjectEUTRA-GENERIC(f1)		
}			
reportConfigToAddModList SEQUENCE (SIZE (1..maxReportConfigId)) OF SEQUENCE {	1 entry		
reportConfigId[1]	IdReportConfig-A3		
reportConfig[1]	ReportConfigEUTRA-A3		
}			
measIdToAddModList SEQUENCE (SIZE (1..maxMeasId)) OF SEQUENCE {	1 entry		
measId[1]	1		
measObjectId[1]	IdMeasObject-f1		
reportConfigId[1]	IdReportConfig-A3		
}			
}			

Table 8.2.4.2.3.3-3 MeasurementReport (step 4, Table 8.2.4.2.3.2-2)

Derivation Path: 36.508, Table 4.6.1-5			
Information Element	Value/remark	Comment	Condition
MeasurementReport ::= SEQUENCE {			
criticalExtensions CHOICE {			
c1 CHOICE{			
measurementReport-r8 SEQUENCE {			
measResults SEQUENCE {			
measId	1		
measResultServCell SEQUENCE {			
rsrpResult	(0..97)		
rsrqResult	(0..34)		
}			
measResultNeighCells CHOICE {			
measResultListEUTRA SEQUENCE (SIZE (1..maxCellReport)) OF SEQUENCE {	1 entry		
physCellId[1]	PhysicalCellIdentity of Cell 2		
cgi-Info[1]	Not present		
measResult[1] SEQUENCE {			
rsrpResult	(0..97)		
rsrqResult	(0..34)		
}			
}			
}			
}			
}			
}			
}			

Table 8.2.4.2.3.3-4: RRCConnectionReconfiguration (step 5, Table 8.2.4.2.3.2-2)

Derivation Path: 36.508, Table 4.6.1-8, condition HO
--

Table 8.2.4.2.3.3-5: MobilityControlInfo (step 5, Table 8.2.4.2.3.2-2)

Derivation Path: 36.508 clause 4.6.5-1			
Information Element	Value/remark	Comment	Condition
MobilityControlInfo ::= SEQUENCE {			
targetPhysCellId	PhysicalCellIdentity of Cell 2		
carrierFreq	Not present		
}			
}			

8.2.4.3 RRC Connection Reconfiguration / Handover: success (intra-cell, security reconfiguration)

8.2.4.3.1 Test Purpose (TP)

(1)

```
with { UE having completed the radio bearer establishment and initial security activation procedure }
ensure that {
  when { UE receives an RRCConnectionReconfiguration message including a securityConfigHO }
  then { UE transmits an RRCConnectionReconfigurationComplete message }
}
```

8.2.4.3.2 Conformance requirements

References: The conformance requirements covered in the present TC are specified in: TS 36.331, clauses 5.3.5.4.

[TS 36.331, clause 5.3.5.4]

If the *RRConnectionReconfiguration* message includes the *mobilityControlInfo* and the UE is able to comply with the configuration included in this message, the UE shall:

- 1> stop timer T310, if running;
- 1> start timer T304 with the timer value set to *t304*, as included in the *mobilityControlInfo*;
- 1> if the *carrierFreq* is included:
 - 2> consider the target cell to be one on the frequency indicated by the *eutra-CarrierFreq* with a physical cell identity indicated by the *targetPhysCellId*;
- 1> else:
 - 2> consider the target cell to be one on the current frequency with a physical cell identity indicated by the *targetPhysCellId*;
 - 1> start synchronising to the DL of the target cell;

NOTE 1: The UE should perform the handover as soon as possible following the reception of the RRC message triggering the handover, which could be before confirming successful reception (HARQ and ARQ) of this message.

- 1> reset MAC;
- 1> re-establish PDCP for all RBs that are established;

NOTE 2: The handling of the radio bearers after the successful completion of the PDCP re-establishment, e.g. the re-transmission of unacknowledged PDCP SDUs (as well as the associated status reporting), the handling of the SN and the HFN, is specified in TS 36.323 [8].

- 1> re-establish RLC for all RBs that are established;
- 1> apply the value of the *newUE-Identity*; as the C-RNTI
- 1> configure lower layers in accordance with the received *radioResourceConfigCommon*;
- 1> if the *RRConnectionReconfiguration* message includes the *radioResourceConfigDedicated*:
 - 2> perform the radio resource configuration procedure as specified in 5.3.10;
- 1> if the *keyChangeIndicator* received in the *securityConfigHO* is set to *TRUE*:
 - 2> update the K_{eNB} key based on the K_{ASME} key taken into use with the previous successful NAS SMC procedure, as specified in TS 33.401 [32];
- 1> else:
 - 2> update the K_{eNB} key based on the K_{ASME} key to which the current K_{eNB} is associated, using the *nextHopChainingCount* value indicated in the *securityConfigHO*, as specified in TS 33.401 [32];
- 1> store the *nextHopChainingCount* value;
- 1> if the *securityAlgorithmConfig* is included in the *securityConfigHO*:
 - 2> derive the K_{RRcint} key associated with the *integrityProtAlgorithm*, as specified in TS 33.401 [32];
 - 2> derive the K_{RRcenc} key and the K_{UPenc} key associated with the *cipheringAlgorithm*, as specified in TS 33.401 [32];
- 1> else:
 - 2> derive the K_{RRcint} key associated with the current integrity algorithm, as specified in TS 33.401 [32];
 - 2> derive the K_{RRcenc} key and the K_{UPenc} key associated with the current ciphering algorithm, as specified in TS 33.401 [32];

- 1> configure lower layers to apply the integrity protection algorithm and the K_{RRCint} key, i.e. the integrity protection configuration shall be applied to all subsequent messages received and sent by the UE, including the message used to indicate the successful completion of the procedure;
- 1> configure lower layers to apply the ciphering algorithm, the K_{RRCenc} key and the K_{UPenc} key, i.e. the ciphering configuration shall be applied to all subsequent messages received and sent by the UE, including the message used to indicate the successful completion of the procedure;
- 1> perform the measurement related actions as specified in 5.5.6.1;
- 1> if the *RRCCONNECTIONRECONFIGURATION* message includes the *measConfig*:
 - 2> perform the measurement configuration procedure as specified in 5.5.2;
- 1> submit the *RRCCONNECTIONRECONFIGURATIONCOMPLETE* message to lower layers for transmission;
- 1> if MAC successfully completes the random access procedure:
 - 2> stop timer T304;
 - 2> apply the parts of the configuration that do not require the UE to know the SFN of the target cell;
 - 2> apply the parts of the measurement and the radio resource configuration that require the UE to know the SFN of the target cell (e.g. measurement gaps, periodic CQI reporting, scheduling request configuration, sounding RS configuration), if any, upon acquiring the SFN of the target cell;
 - 2> the procedure ends;

...

8.2.4.3.3 Test description

8.2.4.3.3.1 Pre-test conditions

System Simulator:

- Cell 1.

UE:

None.

Preamble:

- The UE is in state Generic RB Established (state 3) on Cell 1 according to [18].

8.2.4.3.3.2 Test procedure sequence

Table 8.2.4.3.3.2-1: Main behaviour

St	Procedure	Message Sequence		TP	Verdict
		U - S	Message		
1	The SS transmits an AUTHENTICATION REQUEST message to initiate the EPS authentication and AKA procedure.	<--	<i>DLInformationTransfer</i>	-	-
2	The UE transmits an AUTHENTICATION RESPONSE message and re-establishes mutual authentication.	-->	<i>ULInformationTransfer</i>	-	-
3	The SS transmits a NAS SECURITY MODE COMMAND message to reactivate NAS security.	<--	<i>DLInformationTransfer</i>	-	-
4	The UE transmits a NAS SECURITY MODE COMPLETE message and re-establishes the security configuration.	-->	<i>ULInformationTransfer</i>	-	-
5	The SS transmits an <i>RRCCoReonfiguration</i> message to perform intra cell handover and security reconfiguration.	<--	<i>RRCCoReonfiguration</i>	-	-
6	Check: Does the UE transmit an <i>RRCCoReonfigurationComplete</i> message using the security key indicated by the <i>keyChangeIndicator</i> and <i>nextHopChainingCount</i> , as well as the indicated algorithms, to confirm the successful completion of the intra cell handover and security reconfiguration?	-->	<i>RRCCoReonfigurationC omplete</i>	1	P
7	Check: Does the test result of CALL generic procedure indicate that the UE is in E-UTRA RRC_CONNECTED state?	-	-	1	-

8.2.4.3.3.3 Specific message contents

Table 8.2.4.3.3.3-1: *RRCCoReonfiguration* (step 5, Table 8.2.4.3.3.2-1)

Derivation Path: 36.508, Table 4.6.1-8, condition HO

Table 8.2.4.3.3.3-2: *MobilityControllInfo* (step 5, Table 8.2.4.3.3.2-1)

Derivation Path: 36.508, Table 4.6.5-1

Information Element	Value/remark	Comment	Condition
<i>MobilityControllInfo</i> ::= SEQUENCE {			
targetPhysCellId	PhysicalCellId of Cell 1		
carrierFreq	Not present		
}			

Table 8.2.4.3.3.3-3: *SecurityConfigHO* (step 5, Table 8.2.4.3.3.2-1)

Derivation Path: 36.508, Table 4.6.4-1

Information Element	Value/remark	Comment	Condition
<i>SecurityConfigHO</i> ::= SEQUENCE {			
handoverType CHOICE {			
intraLTE SEQUENCE {			
keyChangeIndicator	TRUE		
nextHopChainingCount	0		
}			
}			
}			

8.2.4.5 RRC Connection Reconfiguration / Handover (all parameters included)

8.2.4.5.1 Test Purpose (TP)

(1)

```
with { UE having completed the radio bearer establishment and initial security activation procedure
and performed the intra frequency measurement }
ensure that {
  when { UE receives an RRCCONNECTIONRECONFIGURATION message including a mobilityControlInfo will
all parameters included }
  then { UE transmits an RRCCONNECTIONRECONFIGURATIONCOMPLETE message }
}
```

8.2.4.5.2 Conformance requirements

References: The conformance requirements covered in the present TC are specified in: TS 36.331, clauses 5.3.5.4, 5.3.10.4 and 5.3.10.6.

[TS 36.331, clause 5.3.5.4]

If the *RRCCONNECTIONRECONFIGURATION* message includes the *mobilityControlInfo* and the UE is able to comply with the configuration included in this message, the UE shall:

- 1> stop timer T310, if running;
- 1> start timer T304 with the timer value set to *t304*, as included in the *mobilityControlInfo*;
- 1> if the *carrierFreq* is included:
 - 2> consider the target cell to be one on the frequency indicated by the *carrierFreq* with a physical cell identity indicated by the *targetPhysCellId*;
- 1> else:
 - 2> consider the target cell to be one on the current frequency with a physical cell identity indicated by the *targetPhysCellId*;
- 1> start synchronising to the DL of the target cell;

NOTE 1: The UE should perform the handover as soon as possible following the reception of the RRC message triggering the handover, which could be before confirming successful reception (HARQ and ARQ) of this message.

- 1> reset MAC;
- 1> -establish PDCP for all RBs that are established;

NOTE 2: The handling of the radio bearers after the successful completion of the PDCP re-establishment, e.g. the re-transmission of unacknowledged PDCP SDUs (as well as the associated status reporting), the handling of the SN and the HFN, is specified in TS 36.323 [8].

- 1> re-establish RLC for all RBs that are established;
- 1> apply the value of the *newUE-Identity* as the C-RNTI;
- 1> configure lower layers in accordance with the received *radioResourceConfigCommon*;
- 1> if the *RRCCONNECTIONRECONFIGURATION* message includes the *radioResourceConfigDedicated*:
 - 2> perform the radio resource configuration procedure as specified in 5.3.10;
- 1> if the *keyChangeIndicator* received in the *securityConfigHO* is set to *TRUE*:
 - 2> update the K_{eNB} key based on the K_{ASME} key taken into use with the previous successful NAS SMC procedure, as specified in TS 33.401 [32];
- 1> else:

- 2> update the K_{eNB} key based on the K_{ASME} key to which the current K_{eNB} is associated, using the *nextHopChainingCount* value indicated in the *securityConfigHO*, as specified in TS 33.401 [32];
- 1> store the *nextHopChainingCount* value;
- 1> if the *securityAlgorithmConfig* is included in the *securityConfigHO*:
 - 2> derive the K_{RRcint} key associated with the *integrityProtAlgorithm*, as specified in TS 33.401 [32];
 - 2> derive the K_{RRcenc} key and the K_{UPenc} key associated with the *cipheringAlgorithm*, as specified in TS 33.401 [32];
- 1> else:
 - 2> derive the K_{RRcint} key associated with the current integrity algorithm, as specified in TS 33.401 [32];
 - 2> derive the K_{RRcenc} key and the K_{UPenc} key associated with the current ciphering algorithm, as specified in TS 33.401 [32];
- 1> configure lower layers to apply the integrity protection algorithm and the K_{RRcint} key, i.e. the integrity protection configuration shall be applied to all subsequent messages received and sent by the UE, including the message used to indicate the successful completion of the procedure;
- 1> configure lower layers to apply the ciphering algorithm, the K_{RRcenc} key and the K_{UPenc} key, i.e. the ciphering configuration shall be applied to all subsequent messages received and sent by the UE, including the message used to indicate the successful completion of the procedure;
- 1> perform the measurement related actions as specified in 5.5.6.1;
- 1> if the *RRcConnectionReconfiguration* message includes the *measConfig*:
 - 2> perform the measurement configuration procedure as specified in 5.5.2;
- 1> submit the *RRcConnectionReconfigurationComplete* message to lower layers for transmission;
- 1> if MAC successfully completes the random access procedure:
 - 2> stop timer T304;
 - 2> apply the parts of the configuration that do not require the UE to know the SFN of the target cell;
 - 2> apply the parts of the measurement and the radio resource configuration that require the UE to know the SFN of the target cell (e.g. measurement gaps, periodic CQI reporting, scheduling request configuration, sounding RS configuration), if any, upon acquiring the SFN of the target cell;
 - 2> the procedure ends;

...

[TS 36.331, clause 5.3.10.4]

The UE shall:

- 1> reconfigure the MAC main configuration in accordance with the received *mac-MainConfig*;

[TS 36.331, clause 5.3.10.6]

The UE shall:

- 1> reconfigure the physical channel configuration in accordance with the received *physicalConfigDedicated*;
- 1> if the *antennaInformation* is included and set to '*explicitValue*':
 - 2> if the configured *transmissionMode* is not '*tm3*' or '*tm4*' release *ri-ConfigIndex* in *cqi-ReportPeriodic*, if previously configured;
- 1> else if the *antennaInformation* is included and set to '*defaultValue*':

2> release *ri-ConfigIndex* in *cqi-ReportPeriodic*, if previously configured;

8.2.4.5.3 Test description

8.2.4.5.3.1 Pre-test conditions

System Simulator:

- Cell 1 and Cell 2.

UE:

None.

Preamble:

- The UE is in state Generic RB Established (state 3) on Cell 1 according to [18].

8.2.4.5.3.2 Test procedure sequence

Table 8.2.4.5.3.2-1 illustrates the downlink power levels and other changing parameters to be applied for the cells at various time instants of the test execution. Row marked "T0" denotes the initial conditions, while columns marked "T1" is to be applied subsequently. The exact instants on which these values shall be applied are described in the texts in this clause.

Table 8.2.4.5.3.2-1: Time instances of cell power level and parameter changes

	Parameter	Unit	Cell 1	Cell 2	Remark
T0	Cell-specific RS EPRE	dBm/15k Hz	-70	-90	The power level values are such that measurement results for Cell 1 (M1) and Cell 2 (M2) satisfy exit condition for event A3 ($M2 + Hys < M1$).
T1	Cell-specific RS EPRE	dBm/15k Hz	-95	-70	The power level values are such that measurement results for Cell 1 (M1) and Cell 2 (M2) satisfy entry condition for event A3 ($M2 - Hys > M1$).

Table 8.2.4.5.3.2-2: Main behaviour

St	Procedure	Message Sequence		TP	Verdict
		U - S	Message		
1	The SS transmits an <i>RRCCONNECTIONRECONFIGURATION</i> message on Cell 1 to setup intra frequency measurement.	<--	<i>RRCCONNECTIONRECONFIGURATION</i>	-	-
2	The UE transmits an <i>RRCCONNECTIONRECONFIGURATIONCOMPLETE</i> message on Cell 1 to confirm the setup of intra frequency measurement.	-->	<i>RRCCONNECTIONRECONFIGURATIONCOMPLETE</i>	-	-
3	The SS changes Cell 1 and Cell 2 parameters according to the row "T1" in table 8.2.4.5.3.2-1.	-	-	-	-
4	The UE transmits a <i>MEASUREMENTREPORT</i> message on Cell 1 to report event A3 with the measured RSRP value for Cell 2.	-->	<i>MEASUREMENTREPORT</i>	-	-
5	The SS transmits an <i>RRCCONNECTIONRECONFIGURATION</i> message on Cell 1 to order the UE to perform intra frequency handover to Cell 2.	<--	<i>RRCCONNECTIONRECONFIGURATION</i>	-	-
6	Check: Does the UE transmit an <i>RRCCONNECTIONRECONFIGURATIONCOMPLETE</i> message on Cell 2 to confirm the successful completion of the intra frequency handover?	-->	<i>RRCCONNECTIONRECONFIGURATIONCOMPLETE</i>	1	P
7	Check: Does the test result of CALL generic procedure indicates that the UE is in E-UTRA RRC_CONNECTED state on Cell 2?	-	-	1	-

8.2.4.5.3.3 Specific message contents

Table 8.2.4.5.3.3-1: RRCConnectionReconfiguration (step 1, Table 8.2.4.5.3.2-2)

Derivation Path: 36.508, Table 4.6.1-8, condition MEAS

Table 8.2.4.5.3.3-2: MeasConfig (step 1, Table 8.2.4.5.3.2-2)

Derivation Path: 36.508, Table 4.6.6-1			
Information Element	Value/remark	Comment	Condition
MeasConfig SEQUENCE {			
measObjectToAddModList SEQUENCE (SIZE (1..maxObjectId)) OF SEQUENCE {	1 entry		
measObjectId[1]	IdMeasObject-f1		
measObject[1]	MeasObjectEUTRA-GENERIC(f1)		
}			
reportConfigToAddModList SEQUENCE (SIZE (1..maxReportConfigId)) OF SEQUENCE {	1 entry		
reportConfigId[1]	IdReportConfig-A3		
reportConfig[1]	ReportConfigEUTRA-A3		
}			
measIdToAddModList SEQUENCE (SIZE (1..maxMeasId)) OF SEQUENCE {	1 entry		
measId[1]	1		
measObjectId[1]	IdMeasObject-f1		
reportConfigId[1]	IdReportConfig-A3		
}			
}			

Table 8.2.4.5.3.3-3: MeasurementReport (step 4, Table 8.2.4.5.3.2-2)

Derivation Path: 36.508, Table 4.6.1-5			
Information Element	Value/remark	Comment	Condition
MeasurementReport ::= SEQUENCE {			
criticalExtensions CHOICE {			
c1 CHOICE{			
measurementReport-r8 SEQUENCE {			
measResults SEQUENCE {			
measId	1		
measResultServCell SEQUENCE {			
rsrpResult	(0..97)		
rsrqResult	(0..34)		
}			
measResultNeighCells CHOICE {			
measResultListEUTRA SEQUENCE (SIZE (1..maxCellReport)) OF SEQUENCE {	1 entry		
physCellId[1]	PhysicalCellIdentity of Cell 2		
cgi-Info[1]	Not present		
measResult[1] SEQUENCE {			
rsrpResult	(0..97)		
rsrqResult	(0..34)		
}			
}			
}			
}			
}			
}			
}			
}			

Table 8.2.4.5.3.3-4: RRCConnectionReconfiguration (step 5, Table 8.2.4.5.3.2-2)

Derivation Path: 36.508, Table 4.6.1-8, condition HO

Table 8.2.4.5.3.3-5: MobilityControlInfo (step 5, Table 8.2.4.5.3.2-2)

Derivation Path: 36.331 clause 4.6.5-1			
Information Element	Value/remark	Comment	Condition
MobilityControlInfo ::= SEQUENCE {			
targetPhysCellId	PhysicalCellId of Cell 2		
carrierFreq SEQUENCE {			
dl-CarrierFreq	Same downlink EARFCN as used for Cell 1		
ul-CarrierFreq	Same uplink EARFCN as used for Cell 1		FDD
earfcn-UL	Not present		TDD
}			
carrierBandwidth SEQUENCE {			
dl-Bandwidth	Same downlink system bandwidth as used for Cell 1		
ul-Bandwidth	Same uplink system bandwidth as used for Cell 1		FDD
ul-Bandwidth	Not present		TDD
}			
additionalSpectrumEmission	Same additionalSpectrumEmission as used for Cell 1		
t304	ms1000		
newUE-Identity	SS arbitrarily selects a value between '003C'H and 'FFF2'H.		
radioResourceConfigCommon SEQUENCE {			
rach-Config	RACH-ConfigCommon-DEFAULT		
prach-Config	PRACH-Configuration-DEFAULT		
pdsch-ConfigCommon	PDSCH-ConfigCommon-DEFAULT		
pusch-ConfigCommon	PUSCH-ConfigCommon-DEFAULT		
phich-Config	PHICH-Configuration-DEFAULT		
pucch-ConfigCommon	PUCCH-ConfigCommon-DEFAULT		
soundingRSUL-ConfigCommon	SoundingRsUL-ConfigCommon-DEFAULT		
uplinkPowerControlCommon	UplinkPowerControlCommon-DEFAULT		
antennaInfoCommon SEQUENCE {			
antennaPortsCount	an1		
}			
p-Max	Not present		
tdd-Config	Not present		FDD
	TDD-Configuration-DEFAULT		TDD
ul-CyclicPrefixLength	len1		
}			
rach-ConfigDedicated	Not present		
}			

Condition	Explanation
FDD	FDD cell environment
TDD	TDD cell environment

8.2.4.6 RRC Connection Reconfiguration / Handover: Success (inter-frequency)

8.2.4.6.1 Test Purpose (TP)

(1)

```
with { UE having completed the radio bearer establishment and initial security activation procedure
and performed the inter frequency measurement }
ensure that {
  when { UE receives an RRCCONNECTIONRECONFIGURATION message including a MOBILITYCONTROLINFO
indicating a different E-UTRA frequency}
  then { UE transmits an RRCCONNECTIONRECONFIGURATIONCOMPLETE message }
}
```

8.2.4.6.2 Conformance requirements

References: The conformance requirements covered in the present TC are specified in: TS 36.331, clauses 5.3.5.4, 5.3.10.4 and 5.3.10.6.

[TS 36.331, clause 5.3.5.4]

If the *RRCCONNECTIONRECONFIGURATION* message includes the *MOBILITYCONTROLINFO* and the UE is able to comply with the configuration included in this message, the UE shall:

- 1> stop timer T310, if running;
- 1> start timer T304 with the timer value set to *t304*, as included in the *MOBILITYCONTROLINFO*;
- 1> if the *CARRIERFREQ* is included:
 - 2> consider the target cell to be one on the frequency indicated by the *CARRIERFREQ* with a physical cell identity indicated by the *TARGETPHYSCELLID*;
- 1> else:
 - 2> consider the target cell to be one on the current frequency with a physical cell identity indicated by the *TARGETPHYSCELLID*;
- 1> start synchronising to the DL of the target cell;

NOTE 1: The UE should perform the handover as soon as possible following the reception of the RRC message triggering the handover, which could be before confirming successful reception (HARQ and ARQ) of this message.

- 1> reset MAC;
- 1> re-establish PDCP for all RBs that are established;

NOTE 2: The handling of the radio bearers after the successful completion of the PDCP re-establishment, e.g. the re-transmission of unacknowledged PDCP SDUs (as well as the associated status reporting), the handling of the SN and the HFN, is specified in TS 36.323 [8].

- 1> re-establish RLC for all RBs that are established;
- 1> apply the value of the *NEWUE-IDENTITY* as the C-RNTI;
- 1> configure lower layers in accordance with the received *RADIORESOURCECONFIGCOMMON*;
- 1> if the *RRCCONNECTIONRECONFIGURATION* message includes the *RADIORESOURCECONFIGDEDICATED*:
 - 2> perform the radio resource configuration procedure as specified in 5.3.10;
- 1> if the *KEYCHANGEINDICATOR* received in the *SECURITYCONFIGHO* is set to *TRUE*:

- 2> update the K_{eNB} key based on the K_{ASME} key taken into use with the previous successful NAS SMC procedure, as specified in TS 33.401 [32];
- 1> else:
 - 2> update the K_{eNB} key based on the K_{ASME} key to which the current K_{eNB} is associated, using the *nextHopChainingCount* value indicated in the *securityConfigHO*, as specified in TS 33.401 [32];
- 1> store the *nextHopChainingCount* value;
- 1> if the *securityAlgorithmConfig* is included in the *securityConfigHO*:
 - 2> derive the K_{RRcint} key associated with the *integrityProtAlgorithm*, as specified in TS 33.401 [32];
 - 2> derive the K_{RRcenc} key and the K_{UPenc} key associated with the *cipheringAlgorithm*, as specified in TS 33.401 [32];
- 1> else:
 - 2> derive the K_{RRcint} key associated with the current integrity algorithm, as specified in TS 33.401 [32];
 - 2> derive the K_{RRcenc} key and the K_{UPenc} key associated with the current ciphering algorithm, as specified in TS 33.401 [32];
- 1> configure lower layers to apply the integrity protection algorithm and the K_{RRcint} key, i.e. the integrity protection configuration shall be applied to all subsequent messages received and sent by the UE, including the message used to indicate the successful completion of the procedure;
- 1> configure lower layers to apply the ciphering algorithm, the K_{RRcenc} key and the K_{UPenc} key, i.e. the ciphering configuration shall be applied to all subsequent messages received and sent by the UE, including the message used to indicate the successful completion of the procedure;
- 1> perform the measurement related actions as specified in 5.5.6.1;
- 1> if the *RRCCConnectionReconfiguration* message includes the *measConfig*:
 - 2> perform the measurement configuration procedure as specified in 5.5.2;
- 1> submit the *RRCCConnectionReconfigurationComplete* message to lower layers for transmission;
- 1> if MAC successfully completes the random access procedure:
 - 2> stop timer T304;
 - 2> apply the parts of the configuration that do not require the UE to know the SFN of the target cell;
 - 2> apply the parts of the measurement and the radio resource configuration that require the UE to know the SFN of the target cell (e.g. measurement gaps, periodic CQI reporting, scheduling request configuration, sounding RS configuration), if any, upon acquiring the SFN of the target cell;
 - 2> the procedure ends;

...

[TS 36.331, clause 5.3.10.4]

The UE shall:

- 1> reconfigure the MAC main configuration in accordance with the received *mac-MainConfig*;

[TS 36.331, clause 5.3.10.6]

The UE shall:

- 1> if the received *radioResourceConfiguration* includes the *physicalConfigDedicated*:
 - 2> reconfigure the physical channel configuration in accordance with the received *physicalConfigDedicated*;

- 2> if the *antennaInformation* is included and set to 'explicit'-Value':
 - 3> reconfigure the antenna configuration in accordance with the received *AntennaInformationDedicated*;
- 2> else if the *antennaInformation* is included and set to 'default'-Value':
 - 3> reconfigure the antenna configuration in accordance with the default configuration *AntennaInformationDedicated* as specified in 9.2.4;
- 2> if *physicalConfigDedicated* includes IE *cqi-Reporting* and *cqi-Reporting* includes IE *cqi-ReportingPeriodic* and the configuration is set to 'disable':
 - 3> deactivate any uplink resources used for periodic CQI reporting, if active;
 - 3> release the *cqi-ReportingPeriodic* configuration;
- 2> if *physicalConfigDedicated* includes the IE *soundingRsUl-Config* and the configuration is set to 'disable':
 - 3> deactivate any uplink resources used for sounding if active;
 - 3> release the *soundingRsUl-Config* configuration.
- 2> if *physicalConfigDedicated* includes the IE *schedulingRequestConfig* and the configuration is set to 'disable':
 - 3> deactivate any uplink resources used for scheduling request, if active;
 - 3> release the *schedulingRequestConfig* configuration.

8.2.4.6.3 Test description

8.2.4.6.3.1 Pre-test conditions

System Simulator:

- Cell 1 and Cell 3.

UE:

None.

Preamble:

- The UE is in state Generic RB Established (state 3) on Cell 1 according to [18].

8.2.4.6.3.2 Test procedure sequence

Table 8.2.4.6.3.2-1 illustrates the downlink power levels and other changing parameters to be applied for the cells at various time instants of the test execution. Row marked "T0" denotes the initial conditions, while columns marked "T1" is to be applied subsequently. The exact instants on which these values shall be applied are described in the texts in this clause.

Table 8.2.4.6.3.2-1: Time instances of cell power level and parameter changes

	Parameter	Unit	Cell 1	Cell 3	Remark
T0	Cell-specific RS EPRE	dBm/15k Hz	-70	-90	The power level values are such that measurement results for Cell 1 (M1) and Cell 3 (M3) satisfy exit condition for event A3 ($M3 + Hys < M1$).
T1	Cell-specific RS EPRE	dBm/15k Hz	-95	-70	The power level values are such that measurement results for Cell 1 (M1) and Cell 3 (M3) satisfy entry condition for event A3 ($M3 - Hys > M1$).

Table 8.2.4.6.3.2-2: Main behaviour

St	Procedure	Message Sequence		TP	Verdict
		U - S	Message		
1	The SS transmits an <i>RRConnectionReconfiguration</i> message on Cell 1 to setup inter frequency measurement.	<--	<i>RRConnectionReconfiguration</i>	-	-
2	The UE transmits an <i>RRConnectionReconfigurationComplete</i> message on Cell 1.	-->	<i>RRConnectionReconfigurationComplete</i>	-	-
3	The SS changes Cell 1 and Cell 3 parameters according to the row "T1" in table 8.2.4.6.3.2-1.	-	-	-	-
4	The UE transmits a <i>MeasurementReport</i> message on Cell 1 to report event A3 with the measured RSRP value for Cell 3.	-->	<i>MeasurementReport</i>	-	-
5	The SS transmits an <i>RRConnectionReconfiguration</i> message on Cell 1 to order the UE to perform inter frequency handover to Cell 3.	<--	<i>RRConnectionReconfiguration</i>	-	-
6	Check: Does the UE transmit an <i>RRConnectionReconfigurationComplete</i> message on Cell 3 to confirm the successful completion of the inter frequency handover?	-->	<i>RRConnectionReconfigurationComplete</i>	1	P
7	Check: Does the test result of CALL generic procedure indicates that the UE is in E-UTRA RRC_CONNECTED state on Cell 3?	-	-	1	-

8.2.4.6.3.3 Specific message contents

Table 8.2.4.6.3.3-1: *RRConnectionReconfiguration* (step 1, Table 8.2.4.6.3.2-2)

Derivation Path: 36.508, Table 4.6.1-8, condition MEAS

Table 8.2.4.6.3.3-2: *MeasConfig* (step 1, Table 8.2.4.6.3.2-2)

Derivation Path: 36.508, Table 4.6.6-1 condition INTER-FREQ			
Information Element	Value/remark	Comment	Condition
MeasConfig SEQUENCE {			
measObjectToAddModList SEQUENCE (SIZE (1..maxObjectId)) OF SEQUENCE {	1 entry		
measObjectId[1]	IdMeasObject-f1		
measObject[1]	MeasObjectEUTRA-GENERIC(f1)		
}			
reportConfigToAddModList SEQUENCE (SIZE (1..maxReportConfigId)) OF SEQUENCE {	1 entry		
reportConfigId[1]	IdReportConfig-A3		
reportConfig[1]	ReportConfigEUTRA-A3		
}			
measIdToAddModList SEQUENCE (SIZE (1..maxMeasId)) OF SEQUENCE {	1 entry		
measId[1]	1		
measObjectId[1]	IdMeasObject-f1		
reportConfigId[1]	IdReportConfig-A3		
}			
gp1 SEQUENCE {			
}			

Table 8.2.4.6.3.3-3: MeasGapConfig (step 1, Table 8.2.4.6.3.2-2)

Derivation Path: 36.508, Table 4.6.6-1A			
Information Element	Value/remark	Comment	Condition
MeasGapConfig ::= CHOICE {			
setup SEQUENCE {			
gapOffset CHOICE {			
gp0	0		
}			
}			
}			

Table 8.2.4.6.3.3-4: MeasurementReport (step 4, Table 8.2.4.6.3.2-2)

Derivation Path: 36.508, Table 4.6.1-5			
Information Element	Value/remark	Comment	Condition
MeasurementReport ::= SEQUENCE {			
criticalExtensions CHOICE {			
c1 CHOICE{			
measurementReport-r8 SEQUENCE {			
measResults SEQUENCE {			
measId	1		
measResultServCell SEQUENCE {			
rsrpResult	(0..97)		
rsrqResult	(0..34)		
}			
measResultNeighCells CHOICE {			
measResultListEUTRA SEQUENCE (SIZE (1..maxCellReport)) OF SEQUENCE {	1 entry		
physCellId[1]	PhysicalCellIdentity of Cell 3		
cgi-Info[1]	Not present		
measResult[1] SEQUENCE {			
rsrpResult	(0..97)		
rsrqResult	(0..34)		
}			
}			
}			
}			
}			
}			
}			
}			

Table 8.2.4.6.3.3-5: RRCConnectionReconfiguration (step 5, Table 8.2.4.6.3.2-2)

Derivation Path: 36.508, Table 4.6.1-8, condition HO
--

Table 8.2.4.6.3.3-6: MobilityControlInfo (step 5, Table 8.2.4.6.3.2-2)

Derivation Path: 36.508 clause 4.6.5-1			
Information Element	Value/remark	Comment	Condition
MobilityControlInfo ::= SEQUENCE {			
targetPhysCellId	PhysicalCellIdentity of Cell 3		
carrierFreq SEQUENCE {			
dl-CarrierFreq	Same downlink EARFCN as used for Cell 3		
ul-CarrierFreq	Not present		
}			
}			

8.2.4.7 RRC Connection Reconfiguration / Handover: Failure (Re-establishment successful)

8.2.4.7.1 Test Purpose (TP)

(1)

```
with { UE having completed the radio bearer establishment and initial security activation procedure
and after receiving an RRCConnectionReconfiguration message including a mobilityControlInfo
indicating a different E-UTRA cell having attempted intra frequency handover }
ensure that {
  when { UE detects handover failure and the initial cell is selectable }
  then { UE performs an RRC connection re-establishment procedure and remains in the E-UTRA
RRC_CONNECTED state }
}
```

(2)

```
with { UE having transmitted an RRCConnectionReestablishmentRequest message }
ensure that {
  when { UE receives an RRCConnectionReestablishment message with a nextHopChainingCount which is
different from the NCC associated with the currently active KeNB }
  then { UE derives new KeNB from the nextHopChainingCount }
}
```

(3)

```
with { UE having transmitted an RRCConnectionReestablishmentRequest message }
ensure that {
  when { UE receives an RRCConnectionReestablishment message with a nextHopChainingCount which is
same as the NCC associated with the currently active KeNB }
  then { UE derives new KeNB from the currently active KeNB }
}
```

8.2.4.7.2 Conformance requirements

References: The conformance requirements covered in the present TC are specified in: TS 36.331, clauses 5.3.5.4, 5.3.5.6, 5.3.7.2, 5.3.7.4, 5.3.7.5, 5.3.10.4 and 5.3.10.6.

[TS 36.331, clause 5.3.5.4]

If the *RRCConnectionReconfiguration* message includes the *mobilityControlInfo* and the UE is able to comply with the configuration included in this message, the UE shall:

- 1> stop timer T310, if running;
- 1> start timer T304 with the timer value set to *t304*, as included in the *mobilityControlInfo*;
- 1> if the *carrierFreq* is included:
 - 2> consider the target cell to be one on the frequency indicated by the *carrierFreq* with a physical cell identity indicated by the *targetPhysCellId*;
- 1> else:
 - 2> consider the target cell to be one on the current frequency with a physical cell identity indicated by the *targetPhysCellId*;
- 1> start synchronising to the DL of the target cell;

NOTE 1: The UE should perform the handover as soon as possible following the reception of the RRC message triggering the handover, which could be before confirming successful reception (HARQ and ARQ) of this message.

- 1> reset MAC;
- 1> re-establish PDCP for all RBs that are established;

NOTE 2: The handling of the radio bearers after the successful completion of the PDCP re-establishment, e.g. the re-transmission of unacknowledged PDCP SDUs (as well as the associated status reporting), the handling of the SN and the HFN, is specified in TS 36.323 [8].

- 1> re-establish RLC for all RBs that are established;
- 1> apply the value of the *newUE-Identity* as the C-RNTI;
- 1> configure lower layers in accordance with the received *radioResourceConfigCommon*;
- 1> if the *RRCConnectionReconfiguration* message includes the *radioResourceConfigDedicated*:
 - 2> perform the radio resource configuration procedure as specified in 5.3.10;
- 1> if the *keyChangeIndicator* received in the *securityConfigHO* is set to *TRUE*:
 - 2> update the K_{eNB} key based on the K_{ASME} key taken into use with the previous successful NAS SMC procedure, as specified in TS 33.401 [32];
- 1> else:
 - 2> update the K_{eNB} key based on the K_{ASME} key to which the current K_{eNB} is associated, using the *nextHopChainingCount* value indicated in the *securityConfigHO*, as specified in TS 33.401 [32];
- 1> store the *nextHopChainingCount* value;
- 1> if the *securityAlgorithmConfig* is included in the *securityConfigHO*:
 - 2> derive the K_{RRcInt} key associated with the *integrityProtAlgorithm*, as specified in TS 33.401 [32];
 - 2> derive the K_{RRcEnc} key and the K_{UPenc} key associated with the *cipheringAlgorithm*, as specified in TS 33.401 [32];
- 1> else:
 - 2> derive the K_{RRcInt} key associated with the current integrity algorithm, as specified in TS 33.401 [32];
 - 2> derive the K_{RRcEnc} key and the K_{UPenc} key associated with the current ciphering algorithm, as specified in TS 33.401 [32];
- 1> configure lower layers to apply the integrity protection algorithm and the K_{RRcInt} key, i.e. the integrity protection configuration shall be applied to all subsequent messages received and sent by the UE, including the message used to indicate the successful completion of the procedure;
- 1> configure lower layers to apply the ciphering algorithm, the K_{RRcEnc} key and the K_{UPenc} key, i.e. the ciphering configuration shall be applied to all subsequent messages received and sent by the UE, including the message used to indicate the successful completion of the procedure;
- 1> perform the measurement related actions as specified in 5.5.6.1;
- 1> if the *RRCConnectionReconfiguration* message includes the *measConfig*:
 - 2> perform the measurement configuration procedure as specified in 5.5.2;
- 1> submit the *RRCConnectionReconfigurationComplete* message to lower layers for transmission;
- 1> if MAC successfully completes the random access procedure:
 - 2> stop timer T304;
 - 2> apply the parts of the configuration that do not require the UE to know the SFN of the target cell;
 - 2> apply the parts of the measurement and the radio resource configuration that require the UE to know the SFN of the target cell (e.g. measurement gaps, periodic CQI reporting, scheduling request configuration, sounding RS configuration), if any, upon acquiring the SFN of the target cell;
 - 2> the procedure ends;

...

[TS 36.331, clause 5.3.5.6]

The UE shall:

1> if T304 expires (handover failure):

NOTE: Following T304 expiry any dedicated preamble, if provided within the *rach-ConfigDedicated*, is not available for use by the UE anymore.

2> revert back to the configuration used in the source cell, excluding the configuration configured by the *physicalConfigDedicated*, the *mac-MainConfig* and the *sps-Config*;

2> initiate the connection re-establishment procedure as specified in 5.3.7, upon which the RRC connection reconfiguration procedure ends;

[TS 36.331, clause 5.3.7.2]

The UE shall only initiate the procedure when AS security has been activated. The UE initiates the procedure when one of the following conditions is met:

...

1> upon handover failure, in accordance with 5.3.5.6; or

...

Upon initiation of the procedure, the UE shall:

1> stop timer T310, if running;

1> start timer T311;

1> suspend all RBs except SRB0;

1> reset MAC;

1> apply the default physical channel configuration as specified in 9.2.4;

1> apply the default semi-persistent scheduling configuration as specified in 9.2.3;

1> apply the default MAC main configuration as specified in 9.2.2;

1> perform cell selection in accordance with the cell selection process as specified in TS 36.304 [4];

[TS 36.331, clause 5.3.7.4]

The UE shall set the contents of *RRCConnectionReestablishmentRequest* message as follows:

1 >set the *ue-Identity* as follows:

2> set the *c-RNTI* to the C-RNTI used in the source cell (handover and mobility from E-UTRA failure) or used in the cell in which the trigger for the re-establishment occurred (other cases);

2> set the *physCellId* to the physical cell identity of the source cell (handover and mobility from E-UTRA failure) or of the cell in which the trigger for the re-establishment occurred (other cases);

2> set the *shortMAC-I* to the 16 least significant bits of the MAC-I calculated:

3> over the ASN.1 encoded *VarShortMAC-Input*;

3> with the K_{RRInt} key and integrity protection algorithm that was used in the source cell (handover and mobility from E-UTRA failure) or of the cell in which the trigger for the re-establishment occurred (other cases); and

3> with all input bits for COUNT, BEARER and DIRECTION set to binary ones;

1> set the *reestablishmentCause* as follows:

2> if the re-establishment procedure was initiated due to reconfiguration failure as specified in 5.3.5.5 (the UE is unable to comply with the reconfiguration):

3> set the *reestablishmentCause* to the value '*reconfigurationFailure*';

2> else if the re-establishment procedure was initiated due to handover failure as specified in 5.3.5.6 (intra-LTE handover failure) or 5.4.3.5 (inter-RAT mobility from EUTRA failure):

3> set the *reestablishmentCause* to the value '*handoverFailure*';

...

The UE shall submit the *RRCCConnectionReestablishmentRequest* message to lower layers for transmission.

[TS 36.331, clause 5.3.7.5]

NOTE: Prior to this, lower layer signalling is used to allocate a C-RNTI. For further details see TS 36.321 [6];

The UE shall:

1> stop timer T301;

1> re-establish PDCP for SRB1;

1> re-establish RLC for SRB1;

1> perform the radio resource configuration procedure in accordance with the received *radioResourceConfigDedicated* and as specified in 5.3.10;

1> resume SRB1;

1> update the K_{eNB} key based on the K_{ASME} key to which the current K_{eNB} is associated, using the *nextHopChainingCount* value indicated in the *RRCCConnectionReestablishment* message, as specified in TS 33.401 [32];

1> store the *nextHopChainingCount* value;

1> derive the K_{RRCint} key associated with the previously configured integrity algorithm, as specified in TS 33.401 [32];

1> derive the K_{RRCenc} key and the K_{UPenc} key associated with the previously configured ciphering algorithm, as specified in TS 33.401 [32];

1> configure lower layers to activate integrity protection using the previously configured algorithm and the K_{RRCint} key immediately, i.e., integrity protection shall be applied to all subsequent messages received and sent by the UE, including the message used to indicate the successful completion of the procedure;

1> configure lower layers to apply ciphering using the previously configured algorithm, the K_{RRCenc} key and the K_{UPenc} key immediately, i.e., ciphering shall be applied to all subsequent messages received and sent by the UE, including the message used to indicate the successful completion of the procedure;

1> perform the measurement related actions as specified in 5.5.6.1;

1> submit the *RRCCConnectionReestablishmentComplete* message to lower layers for transmission, upon which the procedure ends;

[TS 36.331, clause 5.3.10.4]

The UE shall:

1> reconfigure the MAC main configuration in accordance with the received *mac-MainConfig*;

[TS 36.331, clause 5.3.10.6]

The UE shall:

1> reconfigure the physical channel configuration in accordance with the received `physicalConfigDedicated`;

1> if the `antennaInformation` is included and set to 'explicitValue':

2> if the configured `transmissionMode` is not 'tm3' or 'tm4' release `ri-ConfigIndex` in `cqi-ReportPeriodic`, if previously configured;

1> else if the `antennaInformation` is included and set to 'defaultValue':

2> release `ri-ConfigIndex` in `cqi-ReportPeriodic`, if previously configured;

8.2.4.7.3 Test description

8.2.4.7.3.1 Pre-test conditions

System Simulator:

- Cell 1, Cell 4 and Cell 11.

UE:

None.

Preamble:

- The UE is in state Generic RB Established (state 3) on Cell 1 according to [18].

8.2.4.7.3.2 Test procedure sequence

Table 8.2.4.7.3.2-1 illustrates the downlink power levels and other changing parameters to be applied for the cells at various time instants of the test execution. Row marked "T0" denotes the initial conditions, while columns marked "T1", "T2", "T3", "T4", "T5" and "T6" are to be applied subsequently. The exact instants on which these values shall be applied are described in the texts in this clause.

Table 8.2.4.7.3.2-1: Time instances of cell power level and parameter changes

	Parameter	Unit	Cell 1	Cell 4	Cell 11	Remark
T0	Cell-specific RS EPRE	dBm/15k Hz	-70	-90	-90	The power level values are such that measurement results for Cell 1 (M1) Cell 4 (M4) and Cell 11(M11) satisfy exit condition for event A3 ($M4 + Hys < M1$ and $M11 + Hys < M1$).
T1	Cell-specific RS EPRE	dBm/15k Hz	-77	-55	-95	The power level values are such that measurement results for Cell 1 (M1) and Cell 4 (M4) satisfy entry condition for event A3 ($M4 - Hys > M1$).
T2	Cell-specific RS EPRE	dBm/15k Hz	-115	-90	-115	The power level values are assigned values to satisfy $SrxlevCell\ 1 < 0$ and $SrxlevCell\ 11 < 0$ such that selecting Cell 4 is guaranteed
T3	Cell-specific RS EPRE	dBm/15k Hz	-55	-77	-95	The power level values are such that measurement results for Cell 1 (M1) and Cell 4 (M4) satisfy entry condition for event A3 ($M1 - Hys > M4$).
T4	Cell-specific RS EPRE	dBm/15k Hz	-90	-115	-115	The power level values are assigned values to satisfy $SrxlevCell\ 4 < 0$ and $SrxlevCell\ 11 < 0$ such that selecting Cell 1 is guaranteed.
T5	Cell-specific RS EPRE	dBm/15k Hz	-77	"off"	-55	The power level values are such that measurement results for Cell 1 (M1) and Cell 11 (M11) satisfy entry condition for event A3 ($M11 - Hys > M1$). (NOTE 1).
T6	Cell-specific RS EPRE	dBm/15k Hz	-115	"off"	-90	The power level values are assigned values to satisfy $SrxlevCell\ 1 < 0$ and $SrxlevCell\ 4 < 0$ such that selecting Cell 11 is guaranteed. (NOTE 1).

Table 8.2.4.7.3.2-2: Main behaviour

St	Procedure	Message Sequence		TP	Verdict
		U - S	Message		
1	The SS transmits an <i>RRConnectionReconfiguration</i> message to setup intra frequency measurement on Cell 1.	<--	<i>RRConnectionReconfiguration</i>	-	-
2	The UE transmits an <i>RRConnectionReconfigurationComplete</i> message on Cell 1.	-->	<i>RRConnectionReconfigurationComplete</i>	-	-
3	The SS changes Cell 1, Cell 4 and Cell 11 parameters according to the row "T1" in table 8.2.4.7.3.2-1.	-	-	-	-
4	The UE transmits a <i>MeasurementReport</i> message on Cell 1 to report event A3 with the measured RSRP value for Cell 4.	-->	<i>MeasurementReport</i>	-	-
5	The SS transmits an <i>RRConnectionReconfiguration</i> message on Cell 1 to order the UE to perform intra frequency handover to Cell 4.	<--	<i>RRConnectionReconfiguration</i>	-	-
-	EXCEPTION: In parallel to the events described in step 6 the steps specified in Table 8.2.4.7.3.2-3 should take place.	-	-	-	-
6	The SS changes Cell 1, Cell 4 and Cell 11 parameters according to the row "T2" in table 8.2.4.7.3.2-1.	-	-	-	-
7	Check: Does the UE transmit an <i>RRConnectionReestablishmentRequest</i> message on Cell 4?	-->	<i>RRConnectionReestablishmentRequest</i>	1	P
8	The SS transmits an <i>RRConnectionReestablishment</i> message to resume SRB1 operation and re-activate security on Cell 4.	<--	<i>RRConnectionReestablishment</i>	-	-
9	Check: Does the UE transmit an <i>RRConnectionReestablishmentComplete</i> message using the security key derived from the currently active K_{eNB} on Cell 4?	-->	<i>RRConnectionReestablishmentComplete</i>	3	P
10	The SS transmits an <i>RRConnectionReconfiguration</i> message to resume existing radio bearer on Cell 4.	<--	<i>RRConnectionReconfiguration</i>	-	-
11	The UE transmits an <i>RRConnectionReconfigurationComplete</i> message on Cell 4.	-->	<i>RRConnectionReconfigurationComplete</i>	-	-
12	The SS changes Cell 1, Cell 4 and Cell 11 parameters according to the row "T3" in table 8.2.4.7.3.2-1.	-	-	-	-
13	The UE transmits a <i>MeasurementReport</i> message on Cell 4 to report event A3 with the measured RSRP value for Cell 1.	-->	<i>MeasurementReport</i>	-	-
14	The SS transmits an <i>RRConnectionReconfiguration</i> message on Cell 4 to order the UE to perform intra frequency handover to Cell 1.	<--	<i>RRConnectionReconfiguration</i>	-	-
-	EXCEPTION: In parallel to the events described in step 15 the steps specified in Table 8.2.4.7.3.2-4 should take place.	-	-	-	-
15	The SS changes Cell 1, Cell 4 and Cell 11 parameters according to the row "T4" in table 8.2.4.7.3.2-1.	-	-	-	-
16	The UE transmits an <i>RRConnectionReestablishmentRequest</i> message on Cell 1.	-->	<i>RRConnectionReestablishmentRequest</i>	1	P
17	The SS transmits an <i>RRConnectionReestablishment</i> message to resume SRB1 operation and re-activate security on Cell 1.	<--	<i>RRConnectionReestablishment</i>	-	-
18	Check: Does the UE transmit an	-->	<i>RRConnectionReestablishment</i>	2	P

	<i>RRConnectionReestablishmentComplete</i> message using the security key derived from the <i>nextHopChainingCount</i> on Cell 1?		<i>Complete</i>		
19	The SS transmits an <i>RRConnectionReconfiguration</i> message to resume existing radio bearer on Cell 1.	<--	<i>RRConnectionReconfiguration</i>	-	-
20	The UE transmits an <i>RRConnectionReconfigurationComplete</i> message on Cell 1.	-->	<i>RRConnectionReconfigurationComplete</i>	-	-
21	The SS changes Cell 1 and Cell 11 parameters and switches Cell 4 off according to the row "T5" in table 8.2.4.7.3.2-1.	-	-	-	-
22	The UE transmits a <i>MeasurementReport</i> message on Cell 1 to report event A3 with the measured RSRP value for Cell 11.	-->	<i>MeasurementReport</i>	-	-
23	The SS transmits an <i>RRConnectionReconfiguration</i> message on Cell 1 to order the UE to perform intra frequency handover to Cell 11.	<--	<i>RRConnectionReconfiguration</i>	-	-
-	EXCEPTION: In parallel to the events described in step 24 the steps specified in Table 8.2.4.7.3.2-5 should take place.	-	-	-	-
24	The SS changes Cell 1 and Cell 11 parameters according to the row "T6" in table 8.2.4.7.3.2-1.	-	-	-	-
25	The UE transmits an <i>RRConnectionReestablishmentRequest</i> message on Cell 11.	-->	<i>RRConnectionReestablishmentRequest</i>	1	P
26	The SS transmits an <i>RRConnectionReestablishment</i> message to resume SRB1 operation and re-activate security on Cell 11.	<--	<i>RRConnectionReestablishment</i>	-	-
27	Check: Does the UE transmit an <i>RRConnectionReestablishmentComplete</i> message using the security key derived from the <i>nextHopChainingCount</i> on Cell 11?	-->	<i>RRConnectionReestablishmentComplete</i>	2	P
28	The SS transmits an <i>RRConnectionReconfiguration</i> message to resume existing radio bearer on Cell 11.	<--	<i>RRConnectionReconfiguration</i>	-	-
29	The UE transmits an <i>RRConnectionReconfigurationComplete</i> message on Cell 11.	-->	<i>RRConnectionReconfigurationComplete</i>	-	-
30	Check: Does the test result of CALL generic procedure indicate that the UE is in E-UTRA RRC_CONNECTED state on Cell 11?	-	-	1	-

Table 8.2.4.7.3.2-3: Parallel behaviour

St	Procedure	Message Sequence		TP	Verdict
		U - S	Message		
-	EXCEPTION: The steps 1 and 2 below are repeated for the duration of T304.	-	-	-	-
1	The UE attempts to perform the intra frequency handover using MAC Random Access Preamble on Cell 4.	-	-	-	-
2	The SS does not respond.	-	-	-	-

Table 8.2.4.7.3.2-4: Parallel behaviour

St	Procedure	Message Sequence		TP	Verdict
		U - S	Message		
-	EXCEPTION: The steps 1 and 2 below are repeated for the duration of T304.	-	-	-	-
1	The UE attempts to perform the intra frequency handover using MAC Random Access Preamble on Cell 1.	-	-	-	-
2	The SS does not respond.	-	-	-	-

Table 8.2.4.7.3.2-5: Parallel behaviour

St	Procedure	Message Sequence		TP	Verdict
		U - S	Message		
-	EXCEPTION: The steps 1 and 2 below are repeated for the duration of T304.	-	-	-	-
1	The UE attempts to perform the intra frequency handover using MAC Random Access Preamble on Cell 11.	-	-	-	-
2	The SS does not respond.	-	-	-	-

8.2.4.7.3.3 Specific message contents

Table 8.2.4.7.3.3-1: RRCConnectionReconfiguration (step 1, Table 8.2.4.7.3.2-2)

Derivation Path: 36.508, Table 4.6.1-8, condition MEAS

Table 8.2.4.7.3.3-2: MeasConfig (step 1, Table 8.2.4.7.3.2-2)

Derivation Path: 36.508, Table 4.6.6-1			
Information Element	Value/remark	Comment	Condition
MeasConfig SEQUENCE {			
measObjectToAddModList SEQUENCE (SIZE (1..maxObjectId)) OF SEQUENCE {	1 entry		
measObjectId[1]	IdMeasObject-f1		
measObject[1]	MeasObjectEUTRA-GENERIC(f1)		
}			
reportConfigToAddModList SEQUENCE (SIZE (1..maxReportConfigId)) OF SEQUENCE {	1 entry		
reportConfigId[1]	IdReportConfig-A3		
reportConfig[1]	ReportConfigEUTRA-A3		
}			
measIdToAddModList SEQUENCE (SIZE (1..maxMeasId)) OF SEQUENCE {	1 entry		
measId[1]	1		
measObjectId[1]	IdMeasObject-f1		
reportConfigId[1]	IdReportConfig-A3		
}			
}			

Table 8.2.4.7.3.3-3: MeasurementReport (step 4, Table 8.2.4.7.3.2-2)

Derivation Path: 36.508, Table 4.6.1-5			
Information Element	Value/remark	Comment	Condition
MeasurementReport ::= SEQUENCE {			
criticalExtensions CHOICE {			
c1 CHOICE{			
measurementReport-r8 SEQUENCE {			
measResults SEQUENCE {			
measId	1		
measResultServCell SEQUENCE {			
rsrpResult	(0..97)		
rsrqResult	(0..34)		
}			
measResultNeighCells CHOICE {			
measResultListEUTRA SEQUENCE (SIZE (1..maxCellReport)) OF SEQUENCE {	1 entry		
physCellId[1]	PhysicalCellIdentity of Cell 4		
cgi-Info[1]	Not present		
measResult[1] SEQUENCE {			
rsrpResult	(0..97)		
rsrqResult	(0..34)		
}			
}			
}			
}			
}			
}			

Table 8.2.4.7.3.3-4: RRCConnectionReconfiguration (step 5, Table 8.2.4.7.3.2-2)

Derivation Path: 36.508, Table 4.6.1-8, condition HO
--

Table 8.2.4.7.3.3-5: MobilityControlInfo (step 5, Table 8.2.4.7.3.2-2)

Derivation Path: 36.308, Table 4.6.5-1			
Information Element	Value/remark	Comment	Condition
MobilityControlInfo ::= SEQUENCE {			
targetPhysCellId	PhysicalCellIdentity of Cell 4		
carrierFreq	Not present		
rach-ConfigDedicated SEQUENCE {			
ra-PreambleIndex	63		
ra-PRACH-MaskIndex	0		
}			
}			

Table 8.2.4.7.3.3-6: RRCConnectionReestablishmentRequest (step 7, Table 8.2.4.7.3.2-2)

Derivation Path: 36.508, Table 4.6.1-13			
Information Element	Value/remark	Comment	Condition
RRCConnectionReestablishmentRequest ::= SEQUENCE {			
criticalExtensions CHOICE {			
rrcConnectionReestablishmentRequest-r8			
SEQUENCE {			
ue-Identity SEQUENCE {			
c-RNTI	the value of the C-RNTI of the UE		
physCellId	PhysicalCellIdentity of Cell 1		
shortMAC-I	The same value as the 16 least significant bits of the XMAC-I value calculated by SS.		
}			
reestablishmentCause	handoverFailure		
}			
}			

Table 8.2.4.7.3.3-7: RRCConnectionReestablishment (step 8, Table 8.2.4.7.3.2-2)

Derivation Path: 36.508, Table 4.6.1-10			
Information Element	Value/remark	Comment	Condition
RRCConnectionReestablishment ::= SEQUENCE {			
criticalExtensions CHOICE {			
c1 CHOICE{			
rrcConnectionReestablishment-r8 SEQUENCE {			
nextHopChainingCount	0		
}			
}			
}			
}			

Table 8.2.4.7.3.3-8: RRCConnectionReconfiguration (step 10, step 19 and step 28, Table 8.2.4.7.3.2-2)

Derivation Path: 36.508, Table 4.6.1-8			
Information Element	Value/remark	Comment	Condition
RRCConnectionReconfiguration ::= SEQUENCE {			
criticalExtensions CHOICE {			
c1 CHOICE{			
rrcConnectionReconfiguration-r8 SEQUENCE {			
radioResourceConfigDedicated	RadioResourceConfigDedicated-HO		
}			
}			
}			
}			

Table 8.2.4.7.3.3-9: MeasurementReport (step 13, Table 8.2.4.7.3.2-2)

Derivation Path: 36.508, Table 4.6.1-5			
Information Element	Value/remark	Comment	Condition
MeasurementReport ::= SEQUENCE {			
criticalExtensions CHOICE {			
c1 CHOICE{			
measurementReport-r8 SEQUENCE {			
measResults SEQUENCE {			
measId	1		
measResultServCell SEQUENCE {			
rsrpResult	(0..97)		
rsrqResult	(0..34)		
}			
measResultNeighCells CHOICE {			
measResultListEUTRA SEQUENCE (SIZE (1..maxCellReport)) OF SEQUENCE {	1 entry		
physCellId[1]	PhysicalCellIdentity of Cell 1		
cgi-Info[1]	Not present		
measResult[1] SEQUENCE {			
rsrpResult	(0..97)		
rsrqResult	(0..34)		
}			
}			
}			
}			
}			
}			
}			

Table 8.2.4.7.3.3-10: RRCConnectionReconfiguration (step 14, Table 8.2.4.7.3.2-2)

Derivation Path: 36.508, Table 4.6.1-8, condition HO
--

Table 8.2.4.7.3.3-11: MobilityControlInfo (step 14, Table 8.2.4.7.3.2-2)

Derivation Path: 36.308, Table 4.6.5-1			
Information Element	Value/remark	Comment	Condition
MobilityControlInfo ::= SEQUENCE {			
targetPhysCellId	PhysicalCellIdentity of Cell 1		
carrierFreq	Not present		
rach-ConfigDedicated SEQUENCE {			
ra-PreambleIndex	63		
ra-PRACH-MaskIndex	0		
}			
}			

Table 8.2.4.7.3.3-12: RRCConnectionReestablishmentRequest (step 16, Table 8.2.4.7.3.2-2)

Derivation Path: 36.508, Table 4.6.1-13			
Information Element	Value/remark	Comment	Condition
RRCConnectionReestablishmentRequest ::= SEQUENCE {			
criticalExtensions CHOICE {			
rrcConnectionReestablishmentRequest-r8			
SEQUENCE {			
ue-Identity SEQUENCE {			
c-RNTI	the value of the C-RNTI of the UE		
physCellId	PhysicalCellIdentity of Cell 4		
shortMAC-I	The same value as the 16 least significant bits of the XMAC-I value calculated by SS.		
}			
reestablishmentCause	handoverFailure		
}			
}			

Table 8.2.4.7.3.3-13: RRCConnectionReestablishment (step 17, Table 8.2.4.7.3.2-2)

Derivation Path: 36.508, Table 4.6.1-10			
Information Element	Value/remark	Comment	Condition
RRCConnectionReestablishment ::= SEQUENCE {			
criticalExtensions CHOICE {			
c1 CHOICE{			
rrcConnectionReestablishment-r8 SEQUENCE {			
nextHopChainingCount	1		
}			
}			
}			
}			

Table 8.2.4.7.3.3-14: MeasurementReport (step 22, Table 8.2.4.7.3.2-2)

Derivation Path: 36.508, Table 4.6.1-5			
Information Element	Value/remark	Comment	Condition
MeasurementReport ::= SEQUENCE {			
criticalExtensions CHOICE {			
c1 CHOICE{			
measurementReport-r8 SEQUENCE {			
measResults SEQUENCE {			
measId	1		
measResultServCell SEQUENCE {			
rsrpResult	(0..97)		
rsrqResult	(0..34)		
}			
measResultNeighCells CHOICE {			
measResultListEUTRA SEQUENCE (SIZE (1..maxCellReport)) OF SEQUENCE {	1 entry		
physCellId[1]	PhysicalCellIdentity of Cell 11		
cgi-Info[1]	Not present		
measResult[1] SEQUENCE {			
rsrpResult	(0..97)		
rsrqResult	(0..34)		
}			
}			
}			
}			
}			
}			
}			

Table 8.2.4.7.3.3-15: RRCConnectionReconfiguration (step 23, Table 8.2.4.7.3.2-2)

Derivation Path: 36.508, Table 4.6.1-8, condition HO
--

Table 8.2.4.7.3.3-16: MobilityControlInfo (step 23, Table 8.2.4.7.3.2-2)

Derivation Path: 36.308, Table 4.6.5-1			
Information Element	Value/remark	Comment	Condition
MobilityControlInfo ::= SEQUENCE {			
targetPhysCellId	PhysicalCellIdentity of Cell 11		
carrierFreq	Not present		
rach-ConfigDedicated SEQUENCE {			
ra-PreambleIndex	63		
ra-PRACH-MaskIndex	0		
}			
}			

Table 8.2.4.7.3.3-17: RRCConnectionReestablishmentRequest (step 25, Table 8.2.4.7.3.2-2)

Derivation Path: 36.508, Table 4.6.1-13			
Information Element	Value/remark	Comment	Condition
RRCConnectionReestablishmentRequest ::= SEQUENCE {			
criticalExtensions CHOICE {			
rrcConnectionReestablishmentRequest-r8			
SEQUENCE {			
ue-Identity SEQUENCE {			
c-RNTI	the value of the C-RNTI of the UE		
physCellId	PhysicalCellIdentity of Cell 1		
shortMAC-I	The same value as the 16 least significant bits of the XMAC-I value calculated by SS.		
}			
reestablishmentCause	handoverFailure		
}			
}			

Table 8.2.4.7.3.3-18: RRCConnectionReestablishment (step 26, Table 8.2.4.7.3.2-2)

Derivation Path: 36.508, Table 4.6.1-10			
Information Element	Value/remark	Comment	Condition
RRCConnectionReestablishment ::= SEQUENCE {			
criticalExtensions CHOICE {			
c1 CHOICE{			
rrcConnectionReestablishment-r8 SEQUENCE {			
nextHopChainingCount	3		
}			
}			
}			
}			

8.2.4.8 RRC Connection Reconfiguration / Handover: Failure (re-establishment failure)

Editor's Note: This section is based on 36.331 v8.3.0 i.e. after RAN#41.

8.2.4.8.1 Test Purpose (TP)

(1)

```
with { UE having completed the radio bearer establishment and initial security activation procedure
and after receiving an RRCConnectionReconfiguration message including an IE
mobilityControlInformation indicating a different E-UTRA cell having attempted intra frequency
handover }
ensure that {
  when { UE detects handover failure and fails an RRC connection re-establishment procedure }
  then { UE enters the E-UTRA RRC_IDLE state }
}
```

8.2.4.8.2 Conformance requirements

References: The conformance requirements covered in the present TC are specified in: 3GPP TS 36.331 clauses 5.3.5.4, 5.3.5.6, 5.3.7.2, 5.3.7.3, 5.3.7.4, 5.3.7.7 and 5.3.12.

[TS 36.331, clause 5.3.5.4]

...

If the *RRConnectionReconfiguration* message includes the *mobilityControlInformation* and the UE is able to comply with the configuration included in this message, the UE shall:

- 1> stop timer T310 and T312, if running;
- 1> start timer T304 with the timer value set to t304, as included in the *mobilityControlInformation*;
- 1> request PDCP to initiate the PDCP Re-establishment procedure for all RBs that are established;

NOTE 2: The handling of the radio bearers after the successful completion of the L2 re-establishment, e.g. the re-transmission of unacknowledged PDCP SDUs (as well as the associated status reporting), the handling of the SN and the HFN, is specified in [8].

- 1> reset MAC and re-establish RLC for all RBs that are established;
- 1> If the *RRConnectionReconfiguration* message includes the *radioResourceConfiguration*:
 - 2> perform the Radio resource configuration procedure as specified in 5.3.10;
- 1> set the C-RNTI to the value of the *newUE-Identity*;
- 1> if the *utra-CarrierFreq* is included:
 - 2> consider the target cell to be one on the frequency indicated by the *utra-CarrierFreq* with a physical cell identity indicated by the *targetCellIdentity*;
- 1> else:
 - 2> consider the target cell to be one on the current frequency with a physical cell identity indicated by the *targetCellIdentity*;
- 1> if the *dl-Bandwidth* is included:
 - 2> for the target cell, apply the downlink bandwidth indicated by the *dl-Bandwidth*;
- 1> else:
 - 2> for the target cell, apply the same downlink bandwidth as for the current cell;
- 1> if the *ul-Bandwidth* is included:
 - 2> for the target cell, apply the uplink bandwidth indicated by the *ul-Bandwidth*;
- 1> else:
 - 2> for the target cell, apply the same uplink bandwidth as for the current cell;
- 1> configure lower layers in accordance with the received *radioResourceConfigCommon*;
- 1> If the *RRConnectionReconfiguration* message includes the *securityConfiguration*:
 - 2> apply the AS-derived keys associated with the AS-base key indicated by the *keyIndicator*;
 - 2> configure lower layers to apply the indicated integrity protection algorithm, i.e. the indicated integrity protection configuration shall be applied to all subsequent messages received and sent by the UE in the target cell, including the message used to indicate the successful completion of the procedure;
 - 2> configure lower layers to apply the indicated ciphering algorithm, i.e. the indicated ciphering configuration shall be applied to all subsequent messages received and sent by the UE in the target cell, including the message used to indicate the successful completion of the procedure;
- 1> If the *RRConnectionReconfiguration* message includes the *measurementConfiguration*:
 - 2> perform the Measurement configuration procedure as specified in 5.5.2;
- 1> synchronise to the DL of the target cell;

- 1> submit the *RRCConnectionReconfigurationComplete* message to lower layers for transmission using the new configuration;
- 1> If MAC successfully completes the random access procedure:
 - 2> stop timer T304;
 - 2> If the *physicalConfigDedicated* is included in the *RRCConnectionReconfiguration* message:
 - 3> If the UE needs the SFN of the target cell to apply the PUCCH and Sounding RS configuration:
 - 4> apply the new PUCCH and Sounding RS configuration upon acquiring the SFN of the target cell;
 - 3> else:
 - 4> apply the new PUCCH and Sounding RS configuration;
 - 2> indicate to PDCP to complete the PDCP Re-establishment procedure for all DRBs that are established, if any;
 - 2> the procedure ends.

...

[TS 36.331, clause 5.3.5.6]

The UE shall:

- 1> If T304 expires (handover failure):

NOTE 1: Following T304 expiry dedicated preambles, if provided within the *rach-ConfigDedicated*, are not available for use by the UE anymore.

- 2> revert back to the configuration used in the source cell, excluding the physical layer configuration;

NOTE 2: The UE reverts to the RRC configuration as well as the layer 2 configuration (PDCP/RLC/MAC) used in the source cell.

- 2> initiate the connection re-establishment procedure as specified in 5.3.7, upon which the RRC connection reconfiguration procedure ends.

[TS 36.331, clause 5.3.7.2]

The UE shall only initiate the procedure when security has been activated. The UE initiates the procedure when one of the following conditions is met:

...

- 1> upon handover failure, in accordance with 5.3.5.6; or

...

Upon initiation of the procedure, the UE shall:

...

- 1> start timer T311;

- 1> request PDCP to initiate the PDCP Re-establishment procedure for all RBs that are established;

NOTE 1: The handling of the radio bearers after the successful completion of the L2 re-establishment, e.g. the re-transmission of unacknowledged PDCP SDUs (as well as the associated status reporting), the handling of the SN and the HFN, is specified in [8].

- 1> reset MAC and re-establish RLC for all RBs that are established;

- 1> select a suitable cell in accordance with the cell selection process as specified in [4];

[TS 36.331, clause 5.3.7.3]

...

- 2> initiate transmission of the *RRCCConnectionReestablishmentRequest* message in accordance with 5.3.7.4;

...

[TS 36.331, clause 5.3.7.4]

The UE shall set the contents of *RRCCConnectionReestablishmentRequest* message as follows:

- 1> set the IE *ue-Identity* as follows:

- 2> set the *c-RNTI* to the C-RNTI used in the source cell (handover failure case) or used in the cell in which the trigger for the re-establishment occurred (other cases);
- 2> set the *cellIdentity* to the Physical layer identity of the source cell (handover failure case) or of the cell in which the trigger for the re-establishment occurred (other cases);
- 2> set the *shortMAC-I* to the 16 least significant bits of the MAC-I calculated:
 - 3> over the concatenation of the ASN.1 encoded *CellIdentity* of the current cell, *PhysicalCellIdentity* of the cell the UE was connected to prior to the failure and C-RNTI that the UE had in the cell it was connected to prior to the failure;
 - 3> with the integrity protection key and integrity protection algorithm that was used in the cell the UE was connected to prior to the failure; and
 - 3> with all input bits for COUNT, BEARER and DIRECTION set to binary ones.

- 1> set the IE *reestablishmentCause* as follows:

...

- 2> else if the re-establishment procedure was initiated due to handover failure as specified in 5.3.5.6 (intra-LTE handover failure) or 5.4.3.5 (inter-RAT mobility from EUTRA failure):
 - 3> set the *reestablishmentCause* to the value '*handoverFailure*';

...

The UE shall submit the *RRCCConnectionReestablishmentRequest* message to lower layers for transmission.

[TS 36.331, clause 5.3.7.7]

Upon T311 expiry, the UE shall:

- 1> perform the actions upon moving from RRC_CONNECTED to RRC_IDLE as specified in 5.3.12.

...

[TS 36.331, clause 5.3.12]

Upon moving from RRC_CONNECTED to RRC_IDLE, the UE shall:

- 1> reset MAC and re-establish RLC for all RBs that are established;

...

- 1> stop all timers that are running except T320;
- 1> release all radio resources, including release of the RLC entity and the associated PDCP entity for all established RBs;
- 1> indicate the release of the RRC connection to upper layers;
- 1> enter RRC_IDLE.

8.2.4.8.3 Test description

8.2.4.8.3.1 Pre-test conditions

System Simulator:

- Cell 1 and Cell 2

UE:

- None

Preamble:

- The UE is in state Generic RB Established (state 3) on Cell 1 according to [18].

8.2.4.8.3.2 Test procedure sequence

Table 8.2.4.8.3.2-1 illustrates the downlink power levels and other changing parameters to be applied for the cells at various time instants of the test execution. Row marked "T0" denotes the initial conditions, while columns marked "T1" and "T2" are to be applied subsequently. The exact instants on which these values shall be applied are described in the texts in this clause.

Table 8.2.4.8.3.2-1: Time instances of cell power level and parameter changes

	Parameter	Unit	Cell 1	Cell 2	Remark
T0	Ro	dBm	P01 (FFS)	P02 (FFS)	P01 and P02 shall be such that measurement results for Cell 1 ($M1$) and Cell 2 ($M2$) satisfy exit condition for event A3 ($M2 + Hys < M1$).
T1	Ro	dBm	P11 (FFS)	P12 (FFS)	P11 and P12 shall be such that measurement results for Cell 1 ($M1$) and Cell 2 ($M2$) satisfy entry condition for event A3 ($M2 - Hys > M1$).
T2	Ro	dBm	P21 (FFS)	P22 (FFS)	P21 and P22 shall be assigned values to satisfy $Srxlev_{Cell\ 1} > Srxlev_{Cell\ 2}$ and $Srxlev_{Cell\ 2} < 0$ such that selecting Cell 1 is guaranteed

Table 8.2.4.8.3.2-2: Main behaviour

St	Procedure	Message Sequence		TP	Verdict
		U - S	Message		
1	The SS transmits an <i>RRConnectionReconfiguration</i> message to setup intra frequency measurement.	<--	<i>RRConnectionReconfiguration</i>	-	-
2	The UE transmits an <i>RRConnectionReconfigurationComplete</i> message.	-->	<i>RRConnectionReconfigurationComplete</i>	-	-
3	The SS changes Cell 1 and Cell 2 parameters according to the row "T1" in table 8.2.4.8.3.2-1.	-	-	-	-
4	The UE transmits a <i>MeasurementReport</i> message to report event A3 with the measured RSRP value for Cell 2.	-->	<i>MeasurementReport</i>	-	-
5	The SS transmits an <i>RRConnectionReconfiguration</i> message to order the UE to perform intra frequency handover to Cell 2.	<--	<i>RRConnectionReconfiguration</i>	-	-
-	EXCEPTION: In parallel to the events described in step 6 the steps specified in Table 8.2.4.8.3.2-3 should take place.	-	-	-	-
6	The SS changes Cell 1 and Cell 2 parameters according to the row "T2" in table 8.2.4.8.3.2-1.	-	-	-	-
7	Check: Does the UE transmit an <i>RRConnectionReestablishmentRequest</i> message on Cell 1?	-->	<i>RRConnectionReestablishmentRequest</i>	1	P
8	The SS does not respond to any <i>RRConnectionReestablishmentRequest</i> message and waits for [X]s to ensure that T311 expires.	-	-	1	-
9	Check: Does the test result of CALL generic procedure indicate that the UE is in E-UTRA RRC_IDLE state on Cell 1?	-	-	1	-

Table 8.2.4.8.3.2-3: Parallel behaviour

St	Procedure	Message Sequence		TP	Verdict
		U - S	Message		
	EXCEPTION: The steps 1 and 2 below are repeated for the duration of T304	-	-	-	-
1	The UE attempts to perform the intra frequency handover using MAC Random Access Preamble on Cell 2	-	-	-	-
2	The SS does not respond.	-	-	-	-

8.2.4.8.3.3 Specific message contents

Editor's Note: To be updated according to agreed RRC message structure.

Table 8.2.4.8.3.3-1: RRCConnectionReconfiguration (step 1, Table 8.2.4.8.3.2-2)

Derivation path: 36.508 table 4.6.1-6			
Information Element	Value/Remark	Comment	Condition
RRCConnectionReconfiguration ::= SEQUENCE { criticalExtensions CHOICE { c1 CHOICE { rrcConnectionReconfiguration-r8 SEQUENCE { measurementConfiguration SEQUENCE { measObjectToRemoveList measObjectToAddModifyList SEQUENCE (SIZE (1..maxObjectId)) OF SEQUENCE { measObjectId[1] measObject[1] CHOICE { measObjectEUTRA } } reportConfigToRemoveList reportConfigToAddModifyList SEQUENCE (SIZE (1..maxReportConfigId)) OF SEQUENCE { reportConfigId[1] reportConfig[1] CHOICE { reportConfigEUTRA } } measIdToRemoveList measIdToAddModifyList SEQUENCE (SIZE (1..maxMeasId)) OF SEQUENCE { measId[1] measObjectId[1] reportConfigId[1] } quantityConfig measGapConfig s-Measure hrpd-PreRegistrationInfo mbsfn-NeighbourCellConfig speedDependentParameters } radioResourceConfiguration } } } } }	Not present 1 entry IdMeasObjectEUTRA-MO1 MeasObjectEUTRA-MO1 Not present 1 entry IdReportConfigEUTRA-RC1 ReportConfigEUTRA-RC1 Not present 1 entry 1 IdMeasObjectEUTRA-MO1 IdReportConfigEUTRA-RC1 FFS Not present Not present Not present Not present Not present Not present Not present		
MeasObjectEUTRA ::= SEQUENCE { eutra-CarrierInfo SEQUENCE { earfcn-DL } measurementBandwidth offsetFreq cellsToRemoveList cellsToAddModifyList blackListedCellsToRemoveList blackListedCellsToAddModifyList cellForWhichToReportCGI } }	MeasObjectEUTRA-MO1 Same downlink EARFCN as used for Cell 2 Not present dB0 Not present Not present Not present Not present Not present		
ReportConfigEUTRA ::= SEQUENCE { triggerType CHOICE { event SEQUENCE {	ReportConfigEUTRA-RC1		

<pre> eventId CHOICE { eventA3 SEQUENCE { a3-Offset } } hysteresis timeToTrigger } triggerQuantity reportQuantity maxReportCells reportInterval reportAmount ... } </pre>	<pre> FFS FFS FFS rsrp sameAsTriggerQuantity 8 Not present Not present </pre>		
---	---	--	--

Table 8.2.4.8.3.3-2: MeasurementReport (step 4, Table 8.2.4.8.3.2-2)

Derivation path: 36.508 table 4.6.1-3			
Information Element	Value/Remark	Comment	Condition
<pre> MeasurementReport ::= SEQUENCE { criticalExtensions CHOICE { c1 CHOICE { measurementReport-r8 SEQUENCE { measuredResults SEQUENCE { measId measResultServing mobilityMeasResults CHOICE { measResultListEUTRA SEQUENCE (SIZE (1..maxCellReport)) OF SEQUENCE { physicalCellIdentity[1] globalCellIdentity[1] measResultEUTRA[1] SEQUENCE { rsrpResult rsrqResult ... } } } } } } } } </pre>	<pre> 1 FFS 1 entry PhysicalCellIdentity of Cell 2 (see 36.508 clause 4.4.4.2) Not present FFS Not present </pre>		

Table 8.2.4.8.3.3-3: RRCConnectionReconfiguration (step 5, Table 8.2.4.8.3.2-2)

Derivation path: 36.508 table 4.6.1-6, condition RBC-HO			
Information Element	Value/Remark	Comment	Condition
<pre> RRCConnectionReconfiguration ::= SEQUENCE { criticalExtensions CHOICE { c1 CHOICE{ rrcConnectionReconfiguration-r8 SEQUENCE { mobilityControllInformation SEQUENCE { targetCellIdentity eutra-CarrierFreq } securityConfiguration ue-RelatedInformation } } } } </pre>	<p>MobilityControllInformation-HO PhysicalCellIdentity of Cell 2 (see 36.508 clause 4.4.4.2) Not present</p> <p>SecurityConfiguration-HO UE-RelatedInformation-HO</p>		

Table 8.2.4.8.3.3-5: RRCConnectionReestablishmentRequest (step 7, Table 8.2.4.8.3.2-2)

Derivation path: 36.508 table 4.6.1-12			
Information Element	Value/Remark	Comment	Condition
<pre> RRCConnectionReestablishmentRequest ::= SEQUENCE { criticalExtensions CHOICE { rrcConnectionReestablishmentRequest-r8 } SEQUENCE { reestablishmentCause } } </pre>	<p>handoverFailure</p>		

8.2.4.9 RRC Connection Reconfiguration / Handover (Inter band blind handover): Success

8.2.4.9.1 Test Purpose (TP)

(1)

```

with { UE having completed the radio bearer establishment and initial security activation procedure
and performed the inter frequency measurement}
ensure that {
  when { UE receives an RRCConnectionReconfiguration message including a mobilityControlInformation
indicating an E-UTRA frequency on different frequency band }
  then { UE transmits an RRCConnectionReconfigurationComplete message }
}
                    
```

8.2.4.9.2 Conformance requirements

References: The conformance requirements covered in the present TC are specified in: 3GPP TS 36.331 clauses 5.3.5.4, 5.3.10.4 and 5.3.10.6.

[TS 36.331, clause 5.3.5.4]

...

If the *RRCConnectionReconfiguration* message includes the *mobilityControlInformation* and the UE is able to comply with the configuration included in this message, the UE shall:

- 1> stop timer T310 and, if running;

1> start timer T304 with the timer value set to t_{304} , as included in the *mobilityControlInformation*;

1> if the *eutra-CarrierFreq* is included:

2> consider the target cell to be one on the frequency indicated by the *eutra-CarrierFreq* with a physical cell identity indicated by the *targetCellIdentity*;

1> else:

2> consider the target cell to be one on the current frequency with a physical cell identity indicated by the *targetCellIdentity*;

1> deactivate any semi-persistent scheduling resources, if active;

1> start synchronising to the DL of the target cell;

NOTE 2: The UE applies the new configuration, resulting after the following actions, upon switching to the target cell.

1> reset MAC;

1> request PDCP to initiate the PDCP Re-establishment procedure for all RBs that are established;

NOTE 3: The handling of the radio bearers after the successful completion of the PDCP re-establishment, e.g. the re-transmission of unacknowledged PDCP SDUs (as well as the associated status reporting), the handling of the SN and the HFN, is specified in [8].

1> reset MAC and re-establish RLC for all RBs that are established;

1> set the C-RNTI to the value of the *newUE-Identity*;

1> configure lower layers in accordance with the received *radioResourceConfigCommon*;

...

1> if the *keyChangeIndicator* received in the *securityConfiguration* is set to *TRUE*:

2> update the K_{eNB} key based on the latest available K_{ASME} key, as specified in [32];

1> else:

2> update the K_{eNB} key based on the K_{ASME} key to which the current K_{eNB} is associated, using the *nextHopChainingCount* value indicated in the *securityConfiguration*, as specified in [32];

1> store the *nextHopChainingCount* value;

1> if the *integrityProtAlgorithm* is included in the *securityConfiguration*:

2> derive the K_{RRCint} key associated with the *integrityProtAlgorithm*, as specified in [32];

1> else:

2> derive the K_{RRCint} key associated with the current integrity algorithm, as specified in [32];

1> if the *cipheringAlgorithm* is included in the *securityConfiguration*:

2> derive the K_{RRCenc} key and the K_{UPenc} key associated with the *cipheringAlgorithm*, as specified in [32];

1> else:

2> derive the K_{RRCenc} key and the K_{UPenc} key associated with the current ciphering algorithm, as specified in [32];

1> configure lower layers to apply the integrity protection algorithm and the K_{RRCint} key, i.e. the integrity protection configuration shall be applied to all subsequent messages received and sent by the UE, including the message used to indicate the successful completion of the procedure;

- 1> configure lower layers to apply the ciphering algorithm, the K_{RRCEnc} key and the K_{UPenc} key, i.e. the ciphering configuration shall be applied to all subsequent messages received and sent by the UE, including the message used to indicate the successful completion of the procedure;
 - 1> perform the measurement related actions as specified in 5.5.6.1;
- 1> if the *RRCCConnectionReconfiguration* message includes the *measurementConfiguration*:
 - 2> perform the measurement configuration procedure as specified in 5.5.2;
- 1> submit the *RRCCConnectionReconfigurationComplete* message to lower layers for transmission using the new configuration;
- 1> If MAC successfully completes the random access procedure:
 - 2> stop timer T304;
 - 2> if the UE needs the SFN of the target cell to apply the PUCCH and Sounding RS configuration:
 - 3> apply the PUCCH and Sounding RS configuration upon acquiring the SFN of the target cell;
 - 2> else:
 - 3> apply the PUCCH and Sounding RS configuration;
 - 2> the procedure ends.

...

[TS 36.331, clause 5.3.10.4]

The UE shall:

- 1> if the received *radioResourceConfiguration* includes the *mac-MainConfig*:
 - 2> if the *mac-MainConfig* is set to 'explicit'-Value:
 - 3> if the received *mac-MainConfig* includes the *dl-SCH-Configuration*:
 - 4> reconfigure the DL-SCH transport channel in accordance with the received *dl-SCH-Configuration*;
 - 3> if the received *mac-MainConfig* includes the *ul-SCH-Configuration*:
 - 4> reconfigure the UL-SCH transport channel in accordance with the received *ul-SCH-Configuration*;
 - 3> if the *mac-MainConfig* includes *drx-Configuration*:
 - 4> if the *drx-Configuration* is set to 'disable':
 - 5> disable the DRX functionality;
 - 5> release the DRX configuration.
 - 4> else if the *drx-Configuration* includes *shortDRX* and *shortDRX* is set to 'disable':
 - 5> disable the short DRX functionality;
 - 5> release short DRX configuration;
 - 3> if the *mac-MainConfig* includes *timeAlignmentTimerDedicated*:
 - 4> apply the *timeAlignmentTimerDedicated*;
 - 3> if the *mac-MainConfig* includes *phr-Configuration*:
 - 4> if the *phr-Configuration* is set to 'disable':

- 5> disable the power headroom reporting functionality;
- 2> else if the *mac-MainConfig* is set to 'default'-Value:
- 3> reconfigure the *mac-MainConfig* in accordance with the default configuration as specified in 9.2.2.

[TS 36.331, clause 5.3.10.6]

The UE shall:

- 1> if the received *radioResourceConfiguration* includes the *physicalConfigDedicated*:
 - 2> reconfigure the physical channel configuration in accordance with the received *physicalConfigDedicated*;
- 2> if the *antennaInformation* is included and set to 'explicitValue':
- 2> if the configured *transmissionMode* is not 'tm3' or 'tm4' release *ri-ConfigIndex* in *cqi-ReportPeriodic*, if previously configured;
- 1> else if the *antennaInformation* is included and set to 'defaultValue':
- 2> release *ri-ConfigIndex* in *cqi-ReportPeriodic*, if previously configured;

8.2.4.9.3 Test description

8.2.4.9.3.1 Pre-test conditions

System Simulator:

- Cell 1 and Cell 10.

UE:

None.

Preamble:

- The UE is in state Generic RB Established (state 3) on Cell 1 according to [18].

8.2.4.9.3.2 Test procedure sequence

Table 8.2.4.9.3.2-1: Main behaviour

St	Procedure	Message Sequence		TP	Verdict
		U - S	Message		
1	The SS transmits an <i>RRConnectionReconfiguration</i> message on Cell 1 to order the UE to perform inter band handover to Cell 10.	<--	<i>RRConnectionReconfiguration</i>	-	-
2	Check: Does the UE transmit an <i>RRConnectionReconfigurationComplete</i> message on Cell 10.	-->	<i>RRConnectionReconfigurationComplete</i>	1	P
3	Check: Does the test result of CALL generic procedure indicate that the UE is in E-UTRA RRC_CONNECTED state on Cell 10.	-	-	1	-

8.2.4.9.3.3 Specific message contents

Table 8.2.4.9.3.3-1: *RRConnectionReconfiguration* (step 1, Table 8.2.4.9.3.2-1)

Derivation Path: 36.508, Table 4.6.1-8, condition HO			
Information Element	Value/remark	Comment	Condition

Table 8.2.4.9.3.3-2: *MobilityControlInformation* (step 1, Table 8.2.4.9.3.2-2)

Derivation Path: 36.508, Table 4.6.5-1			
Information Element	Value/remark	Comment	Condition
MobilityControlInformation ::= SEQUENCE {			
targetCellIdentity	PhysicalCellIdentity of Cell 10		
eutra-CarrierFreq SEQUENCE {			
earfcn-DL	Same downlink EARFCN as used for Cell 10		
earfcn-UL	Not present		
}			
}			

8.3 Measurement Configuration Control and Reporting

8.3.1 Intra E-UTRAN measurements

8.3.1.1 Measurement configuration control and reporting / intra E-UTRAN measurements: event A1

8.3.1.1.1 Test Purpose (TP)

(1)

```
with { UE in E-UTRA RRC_CONNECTED state and measurement configured for event A1 with event based
periodical reporting }
ensure that {
  when { Serving cell becomes better than absolute threshold plus hysteresis }
  then { UE sends MeasurementReport message at regular intervals while entering conditions for
event A1 are satisfied }
}
```

(2)

```
with { UE in E-UTRA RRC_CONNECTED state and periodical measurement reporting triggered by event A1
ongoing}
ensure that {
  when { Serving cell becomes worse than absolute threshold minus hysteresis }
  then { UE stops sending MeasurementReport message }
}
```

8.3.1.1.2 Conformance requirements

References: The conformance requirements covered in the current TC are specified in: TS 36.331, clauses 5.3.5.3, 5.5.4.1, 5.5.4.2 and 5.5.5.

[TS 36.331, clause 5.3.5.3]

If the *RRConnectionReconfiguration* message does not include the *mobilityControlInfo* and the UE is able to comply with the configuration included in this message, the UE shall:

...

1> if the *RRConnectionReconfiguration* message includes the *measConfig*:

2> perform the measurement configuration procedure as specified in 5.5.2;

...

[TS 36.331, clause 5.5.4.1]

The UE shall:

1> for each *measId* included in the *measIdList* within *VarMeasConfig*:

...

- 2> else:
- ...
- 3> if the corresponding *measObject* concerns EUTRA:
- 4> consider any neighbouring cell detected on the associated frequency to be applicable when the concerned cell is not included in the *blackCellsToAddModList* defined within the *VarMeasConfig* for this *measId*;
- ...
- 2> if the *triggerType* is set to 'event' and if the entry condition applicable for this event, i.e. the event corresponding with the *eventId* of the corresponding *reportConfig* within *VarMeasConfig*, is fulfilled for one or more applicable cells for all measurements after layer 3 filtering taken during *timeToTrigger* defined for this event within the *VarMeasConfig*, while the *VarMeasReportList* does not include an entry for this *measId* (a first cell triggers the event):
- 3> include a measurement reporting entry within the *VarMeasReportList* for this *measId*;
- 3> set the *numberOfReportsSent* defined within the *VarMeasReportList* for this *measId* to 0;
- 3> include the concerned cell(s) in the *cellsTriggeredList* defined within the *VarMeasReportList* for this *measId*;
- 3> initiate the measurement reporting procedure, as specified in 5.5.5;
- 2> if the *triggerType* is set to 'event' and if the entry condition applicable for this event, i.e. the event corresponding with the *eventId* of the corresponding *reportConfig* within *VarMeasConfig*, is fulfilled for one or more applicable cells not included in the *cellsTriggeredList* for all measurements after layer 3 filtering taken during *timeToTrigger* defined for this event within the *VarMeasConfig* (a subsequent cell triggers the event):
- 3> set the *numberOfReportsSent* defined within the *VarMeasReportList* for this *measId* to 0;
- 3> include the concerned cell(s) in the *cellsTriggeredList* defined within the *VarMeasReportList* for this *measId*;
- 3> initiate the measurement reporting procedure, as specified in 5.5.5;
- 2> if the *triggerType* is set to 'event' and if the leaving condition applicable for this event is fulfilled for one or more of the cells included in the *cellsTriggeredList* defined within the *VarMeasReportList* for this *measId* for all measurements after layer 3 filtering taken during of *timeToTrigger* defined within the *VarMeasurementConfiguration* for this event:
- 3> remove the concerned cell(s) in the *cellsTriggeredList* defined within the *VarMeasReportList* for this *measId*;
- 3> if *reportOnLeave* is set to *TRUE* for the corresponding reporting configuration:
- 4> initiate the measurement reporting procedure, as specified in 5.5.5;
- 3> if the *cellsTriggeredList* defined within the *VarMeasReportList* for this *measId* is empty:
- 4> remove the measurement reporting entry within the *VarMeasReportList* for this *measId*;
- 4> stop the periodical reporting timer for this *measId*, if running;
- ...
- 2> upon expiry of the periodical reporting timer for this *measId*:
- 3> initiate the measurement reporting procedure, as specified in 5.5.5;
- ...

NOTE 2: The UE does not stop the periodical reporting with *triggerType* set to 'event' or to 'periodical' while the corresponding measurement is not performed due to the serving cell RSRP being equal to or better than *s-Measure* or due to the measurement gap not being setup.

...

[TS 36.331, clause 5.5.4.2]

The UE shall:

1> consider the entering condition for this event to be satisfied when condition A1-1, as specified below, is fulfilled;

1> consider the leaving condition for this event to be satisfied when condition A1-2, as specified below, is fulfilled;

InequalityA1-1 (Entering condition)

$$Ms - Hys > Thresh$$

InequalityA1-2 (Leaving condition)

$$Ms + Hys < Thresh$$

The variables in the formula are defined as follows:

Ms is the measurement result of the serving cell, not taking into account any offsets.

Hys is the hysteresis parameter for this event (i.e. *hysteresis* as defined within *reportConfigEUTRA* for this event).

Thresh is the threshold parameter for this event (i.e. *a1-Threshold* as defined within *reportConfigEUTRA* for this event).

Ms is expressed in dBm in case of RSRP, or in dB in case of RSRQ.

Hys is expressed in dB.

Thresh is expressed in the same unit as ***Ms***.

[TS 36.331, clause 5.5.5]

...

For the *measId* for which the measurement reporting procedure was triggered, the UE shall set the *measResults* within the *MeasurementReport* message as follows:

1> set the *measId* to the measurement identity that triggered the measurement reporting;

1> set the *measResultServCell* to include the quantities of serving cell;

1> if there is at least one applicable neighbouring cell to report:

...

1> increment the *numberOfReportsSent* as defined within the *VarMeasReportList* for this *measId* by 1;

1> stop the periodical reporting timer, if running;

1> if the *numberOfReportsSent* as defined within the *VarMeasReportList* for this *measId* is less than the *reportAmount* as defined within the corresponding *reportConfig* for this *measId*;

2> start the periodical reporting timer with the value of *reportInterval* as defined within the *reportConfig* for this *measId*;

...

1> submit the *MeasurementReport* message to lower layers for transmission, upon which the procedure ends.

8.3.1.1.3 Test description

8.3.1.1.3.1 Pre-test conditions

System Simulator:

- Cell 1

Preamble:

- The UE is in state Generic RB Established (state 3) according to [18].

8.3.1.1.3.2 Test procedure sequence

Table 8.3.1.1.3.2-1 illustrates the downlink power levels to be applied for Cell 1 at various time instants of the test execution. Row marked "T0" denotes the conditions after the preamble, while rows marked "T1" and "T2" are to be applied subsequently. The exact instants on which these values shall be applied are described in the texts in this clause.

Table 8.3.1.1.3.2-1: Power levels

	Parameter	Unit	Cell 1	Remark
T0			-85	Power level is such that $Ms + Hys < Thresh$
T1	Cell-specific RS EPRE	dBm/15 kHz	-59	Power level is such that entry condition for event A1 is satisfied $Ms - Hys > Thresh$
T2			-85	Power level is such that exit condition for event A1 is satisfied $Ms + Hys < Thresh$
Note:	The total test tolerance used is the sum of downlink signal level uncertainty (TS 36.508 clause 6.2.2.1) and absolute UE measurement accuracy (TS 36.133 clause 9).			

Table 8.3.1.1.3.2-2: Main behaviour

St	Procedure	Message Sequence		TP	Verdict
		U - S	Message		
1	SS transmits an <i>RRCCONNECTIONRECONFIGURATION</i> message including <i>MEASUREMENTCONFIGURATION</i> to setup intra LTE measurement and reporting for event A1.	<--	<i>RRCCONNECTIONRECONFIGURATION</i>	-	-
2	The UE transmits an <i>RRC CONNECTION RECONFIGURATION COMPLETE</i> message.	-->	<i>RRCCONNECTIONRECONFIGURATIONCOMPLETE</i>	-	-
3	SS re-adjusts the cell-specific reference signal level according to row "T1" in table 8.3.1.1.3.2.-1.	-	-	-	-
4	Check: does the UE transmit a <i>MEASUREMENTREPORT</i> message to report event A1 with the measured RSRP and RSRQ value for Cell 1?	-->	<i>MEASUREMENTREPORT</i>	1	P
	EXCEPTION: Step 5 below is repeated until 3 <i>MEASUREMENTREPORT</i> messages are received from the UE				
5	Check: does the UE transmit a <i>MEASUREMENTREPORT</i> message, with a measured RSRP and RSRQ value for Cell 1?	-->	<i>MEASUREMENTREPORT</i>	1	P
6	SS re-adjusts the cell-specific reference signal level according to row "T2" in table 8.3.1.1.3.2.-1.	-	-	-	-
7	SS waits [5s]. Note: the UE may send one or more <i>MEASUREMENTREPORT</i> which is ignored by the SS.	-	-	-	-
8	Check: does the UE attempt to transmit an uplink message within the next 10s?	-	-	2	F

8.3.1.1.3.3 Specific message contents

Table 8.3.1.1.3.3-1: RRCConnectionReconfiguration (step 1, Table 8.3.1.1.3.2-2)

Derivation Path: 36.508 clause 4.6.1 table 4.6.1-8 with condition MEAS

Table 8.3.1.1.3.3-2: MeasurementConfiguration (step 1, Table 8.3.1.1.3.2-2)

Derivation path: 36.508 clause 4.6.6 table 4.6.6-1			
Information Element	Value/Remark	Comment	Condition
measConfig ::= SEQUENCE { measObjectToAddModList SEQUENCE (SIZE (1..maxObjectId)) OF SEQUENCE { measObjectId[1] measObject[1] } reportConfigToAddModList SEQUENCE (SIZE (1..maxReportConfigId)) OF SEQUENCE { reportConfigId[1] reportConfig[1] } measIdToAddModList SEQUENCE (SIZE (1..maxMeasId)) OF SEQUENCE { measId[1] measObjectId[1] reportConfigId[1] } }	1 entry IdMeasObject-f1 MeasObjectEUTRA-GENERIC(f1) 1 entry IdReportConfig-A1 ReportConfig-A1-H 1 entry 1 IdMeasObject-f1 IdReportConfig-A1		

Table 8.3.1.1.3.3-3: ReportConfig-A1-H (step 1, Table 8.3.1.1.3.3-2)

Derivation path: 36.508 clause 4.6.6 table 4.6.6-4 ReportConfigEUTRA-A1(-72)			
Information Element	Value/Remark	Comment	Condition
ReportConfigEUTRA ::= SEQUENCE { triggerType CHOICE { event SEQUENCE { hysteresis } } }	6	3dB	

Table 8.3.1.1.3.3-4: MeasurementReport (steps 6, 7 and 9, Table 8.3.1.1.3.2-2)

Derivation path: 36.508 4.6.1 table 4.6.1-5			
Information Element	Value/Remark	Comment	Condition
MeasurementReport ::= SEQUENCE { criticalExtensions CHOICE { c1 CHOICE { measurementReport-r8 SEQUENCE { measResults ::= SEQUENCE { measId measResultServCell ::= SEQUENCE { rsrpResult rsrqResult } measResultNeighCells CHOICE {} } } } }	1 (0..97) (0..34) Not present	Report Cell 1	

8.3.1.2 Measurement configuration control and reporting / intra E-UTRAN measurements: event A2

8.8.3.1.2.1 Test Purpose (TP)

(1)

```
with { UE in E-UTRA RRC_CONNECTED state and measurement configured for event A2 with event based
periodical reporting }
ensure that {
  when { Serving cell becomes worse than absolute threshold minus hysteresis }
  then { UE sends MeasurementReport message at regular intervals while entering conditions for
event A2 are satisfied }
}
```

(2)

```
with { UE in E-UTRA RRC_CONNECTED state and periodical measurement reporting triggered by event A2
ongoing}
ensure that {
  when { Serving cell becomes better than absolute threshold plus hysteresis }
  then { UE stops sending MeasurementReport message }
}
```

8.3.1.2.2 Conformance requirements

References: The conformance requirements covered in the current TC are specified in: TS 36.331, clauses 5.3.5.3, 5.5.4.1, 5.5.4.3 and 5.5.5.

[TS 36.331, clause 5.3.5.3]

If the *RRCConnectionReconfiguration* message does not include the *mobilityControlInf* and the UE is able to comply with the configuration included in this message, the UE shall:

...

- 1> if the *RRCConnectionReconfiguration* message includes the *measConfig*:
- 2> perform the measurement configuration procedure as specified in 5.5.2;

...

[TS 36.331, clause 5.5.4.1]

The UE shall:

- 1> for each *measId* included in the *measIdList* within *VarMeasurementConfiguration*:

...

- 2> else:

...

- 3> if the corresponding *measObject* concerns EUTRA:

- 4> consider any neighbouring cell detected on the associated frequency to be applicable when the concerned cell is not included in the *blackCellsToAddModList* defined within the *VarMeasConfig* for this *measId*;

...

- 2> if the *triggerType* is set to 'event' and if the entry condition applicable for this event, i.e. the event corresponding with the *eventId* of the corresponding *reportConfig* within *VarMeasConfig*, is fulfilled for one or more applicable cells for all measurements after layer 3 filtering taken during *timeToTrigger* defined for this event within the *VarMeasConfig* while the *VarMeasReportList* does not include an entry for this *measId* (a first cell triggers the event):

- 3> include a measurement reporting entry within the *VarMeasReportList* for this *measId*;

- 3> set the *numberOfReportsSent* defined within the *VarMeasReportList* for this *measId* to 0;
- 3> include the concerned cell(s) in the *cellsTriggeredList* defined within the *VarMeasReportList* for this *measId*;
- 3> initiate the measurement reporting procedure, as specified in 5.5.5;
- 2> if the *triggerType* is set to 'event' and if the entry condition applicable for this event, i.e. the event corresponding with the *eventId* of the corresponding *reportConfig* within *VarMeasConfig*, is fulfilled for all measurements after layer 3 filtering taken during *timeToTrigger* defined for this event within the *VarMeasConfig* (a subsequent cell triggers the event):
 - 3> set the *numberOfReportsSent* defined within the *VarMeasReportList* for this *measId* to 0;
 - 3> include the concerned cell(s) in the *cellsTriggeredList* defined within the *VarMeasReportList* for this *measId*;
 - 3> initiate the measurement reporting procedure, as specified in 5.5.5;
- 2> if the *triggerType* is set to 'event' and if the leaving condition applicable for this event is fulfilled for one or more of the cells included in the *cellsTriggeredList* defined within the *VarMeasReportList* for this *measId* for all measurements after layer 3 filtering taken during of *timeToTrigger* defined within the *VarMeasurementConfiguration* for this event:
 - 3> remove the concerned cell(s) in the *cellsTriggeredList* defined within the *VarMeasReportList* for this *measId*;
 - 3> if *reportOnLeave* is set to *TRUE* for the corresponding reporting configuration:
 - 4> initiate the measurement reporting procedure, as specified in 5.5.5;
 - 3> if the *cellsTriggeredList* defined within the *VarMeasReportList* for this *measId* is empty:
- 4> remove the measurement reporting entry within the *VarMeasReportList* for this *measId*;
- 4> stop the periodical reporting timer for this *measId*, if running;
- ...
- 2> upon expiry of the periodical reporting timer for this *measId*:
 - 3> initiate the measurement reporting procedure, as specified in 5.5.5;
- ...

NOTE 2: The UE does not stop the periodical reporting with *triggerType* set to 'event' or to 'periodical' while the corresponding measurement is not performed due to the serving cell RSRP being equal to or better than *s-Measure* or due to the measurement gap not being active setup.

...

[TS 36.331, clause 5.5.4.3]

The UE shall:

- 1> consider the entering condition for this event to be satisfied when condition A2-1, as specified below, is fulfilled;
- 1> consider the leaving condition for this event to be satisfied when condition A2-2, as specified below, is fulfilled;

InequalityA2-1 (Entering condition)

$$Ms + Hys < Thresh$$

InequalityA2-2 (Leaving condition)

$$Ms - Hys > Thresh$$

The variables in the formula are defined as follows:

Ms is the measurement result of the serving cell, not taking into account any offsets.

Hys is the hysteresis parameter for this event (i.e. *hysteresis* as defined within the *reportConfigEUTRA* for this event).

Thresh is the threshold parameter for this event (i.e. *a2-Threshold* as defined within the *reportConfigEUTRA* for this event).

Ms is expressed in dBm in case of RSRP, or in dB in case of RSRQ.

Hys is expressed in dB.

Thresh is expressed in the same unit as *Ms*.

[TS 36.331, clause 5.5.5]

...

For the *measId* for which the measurement reporting procedure was triggered, the UE shall set the *measResults* within the *MeasurementReport* message as follows:

1> set the *measId* to the measurement identity that triggered the measurement reporting;

1> if there is at least one applicable neighbouring cell to report:

...

1> increment the *numberOfReportsSent* as defined within the *VarMeasReportList* for this *measId* by 1;

1> stop the periodical reporting timer, if running;

1> if the *numberOfReportsSent* as defined within the *VarMeasReportList* for this *measId* is less than the *reportAmount* as defined within the corresponding *reportConfig* for this *measId* :

2> start the periodical reporting timer with the value of *reportInterval* as defined within the *reportConfig* for this *measId*;

...

1> submit the *MeasurementReport* message to lower layers for transmission, upon which the procedure ends.

8.3.1.2.3 Test description

8.3.1.2.3.1 Pre-test conditions

System Simulator:

- Cell 1

Preamble:

- The UE is in state Generic RB Established (state 3) according to [18].

8.3.1.2.3.2 Test procedure sequence

Table 8.3.1.2.3.2-1 illustrates the downlink power levels to be applied for Cell 1 at various time instants of the test execution. Row marked "T0" denotes the conditions after the preamble, while rows marked "T1" and "T2" are to be applied subsequently. The exact instants on which these values shall be applied are described in the texts in this clause.

Table 8.3.1.2.3.2-1: Power levels

	Parameter	Unit	Cell 1	Remark
T0	Cell-specific RS EPRE	dBm/15 kHz	-70	Power level is such that $M_s > Thresh - Hys$
T1			-96	Power level is such that entry condition for event A2 is satisfied $M_s - Hys < Thres$
T2			-70	Power level is such that exit condition for event A2 is satisfied $M_s > Thresh - Hys$
Note:	The total tolerance used is the sum of downlink signal level uncertainty (TS 36.508 clause 6.2.2.1) and absolute UE measurement accuracy (TS 36.133 clause 9).			

Table 8.3.1.2.3.2-2: Main behaviour

St	Procedure	Message Sequence		TP	Verdict
		U - S	Message		
1	SS transmits an <i>RRCConnectionReconfiguration</i> message including <i>measurementConfiguration</i> to setup intra LTE measurement and reporting for event A2.	<--	<i>RRCConnectionReconfiguration</i>	-	-
2	The UE transmit an <i>RRCConnectionReconfigurationComplete</i> message.	-->	<i>RRCConnectionReconfigurationComplete</i>	-	-
3	SS re-adjusts the cell-specific reference signal level according to row "T1" in table 8.3.1.2.3.2.-1.	-	-	-	-
4	Check: does the UE transmit a <i>MeasurementReport</i> message to report event A2 with the measured RSRP and RSRQ value for Cell 1?	-->	<i>MeasurementReport</i>	1	P
	EXCEPTION: Step 5 below is repeated until 3 <i>MeasurementReport</i> messages are received from the UE				
5	Check: does the UE transmit a <i>MeasurementReport</i> message, with a measured RSRP and RSRQ value for Cell 1?	-->	<i>MeasurementReport</i>	1	P
6	SS re-adjusts the cell-specific reference signal level according to row "T2" in table 8.3.1.2.3.2.-1.	-	-	-	-
7	SS waits [5s]. Note: the UE may send one or more <i>MeasurementReport</i> which is ignored by the SS.	-	-	-	-
8	Check: does the UE attempt to transmit an uplink message within the next 10s?	-		2	F

8.3.1.2.3.3 Specific message contents

Table 8.3.1.2.3.3-1: *RRCConnectionReconfiguration* (step 1, table 8.3.1.2.3.2-2)

Derivation Path: 36.508 clause 4.6.1 table 4.6.1-8 with condition MEAS
--

Table 8.3.1.2.3.3-2: MeasurementConfiguration (step 1, Table 8.3.1.2.3.2-2)

Derivation path: 36.508 clause 4.6.6 table 4.6.6-1			
Information Element	Value/Remark	Comment	Condition
<pre> measConfig ::= SEQUENCE { measObjectToAddModList SEQUENCE (SIZE (1..maxObjectId)) OF SEQUENCE { measObjectId[1] measObject[1] } reportConfigToAddModList SEQUENCE (SIZE (1..maxReportConfigId)) OF SEQUENCE { reportConfigId[1] reportConfig[1] } measIdToAddModList SEQUENCE (SIZE (1..maxMeasId)) OF SEQUENCE { measId[1] measObjectId[1] reportConfigId[1] } } </pre>	<p>1 entry</p> <p>IdMeasObject-f1 MeasObjectEUTRA-GENERIC(f1)</p> <p>1 entry</p> <p>IdReportConfig-A2 ReportConfig-A2-H</p> <p>1 entry</p> <p>1 IdMeasObject-f1 IdReportConfig-A2</p>		

Table 8.3.1.2.3.3-3: ReportConfig-A2-H (step 1, Table 8.3.1.2.3.3-2)

Derivation path: 36.508 clause 4.6.6 table 4.6.6-5 ReportConfigEUTRA-A2(-83)			
Information Element	Value/Remark	Comment	Condition
<pre> ReportConfigEUTRA ::= SEQUENCE { triggerType CHOICE { event SEQUENCE { hysteresis } } } </pre>	6	3 dB	

Table 8.3.1.2.3.3-4: MeasurementReport (steps 6, 7 and 9, 8.3.1.2.3.2-2)

Derivation path: 36.508 table clause 4.6.1 table 4.6.1-5			
Information Element	Value/Remark	Comment	Condition
<pre> MeasurementReport ::= SEQUENCE { criticalExtensions CHOICE { c1 CHOICE { measurementReport-r8 SEQUENCE { measResults ::= SEQUENCE { measId measResultServCell ::= SEQUENCE { rsrpResult rsrqResult } measResultNeighCells CHOICE {} } } } } } </pre>	<p>1</p> <p>(0..97) (0..34)</p> <p>Not present</p>	Report Cell 1	

8.3.1.3 Measurement configuration control and reporting / intra E-UTRAN measurements: 2 simultaneous events A3 (intra and inter frequency measurements)

8.3.1.3.1 Test Purpose (TP)

(1)

```
with { UE in E-UTRA RRC_CONNECTED state and measurements configured for two event A3 at the same time }
ensure that {
  when { Entry condition for event A3 is not met }
  then { UE does not send MeasurementReport }
}
```

(2)

```
with { UE in E-UTRA RRC_CONNECTED state and measurements configured for two event A3 at the same time }
ensure that {
  when { Neighbour becomes offset better than serving }
  then { UE sends MeasurementReport with correct measId for event A3 }
}
```

8.3.1.3.2 Conformance requirements

References: The conformance requirements covered in the current TC are specified in: TS 36.331, clauses 5.3.5.3, 5.5.4.1, 5.5.4.4 and 5.5.5.

[TS 36.331, clause 5.3.5.3]

If the *RRConnectionReconfiguration* message does not include the *mobilityControlInformation* and the UE is able to comply with the configuration included in this message, the UE shall:

...

1> If the *RRConnectionReconfiguration* message includes the *measurementConfiguration*:

2> perform the Measurement configuration procedure as specified in 5.5.2;

...

[TS 36.331, clause 5.5.4.1]

The UE shall:

1> for each *measId* included in the *measIdList* within *VarMeasurementConfiguration*:

2> if the *triggerType* is set to 'event':

...

3> else if the corresponding *measObject* concerns EUTRA:

4> consider any neighbouring cell detected on the associated frequency to be applicable when the concerned cell is not included in the *blackListedCellsToAddModifyList* defined within the *VarMeasurementConfiguration* for this *measId*;

2> else consider a neighbouring cell on the associated frequency/ set of frequencies (GERAN) to be applicable as follows:

...

3> if the corresponding *reportingConfig* includes a purpose set to 'reportCGI':

4> consider any neighbouring cell detected on the associated frequency/ set of frequencies (GERAN) which has a *physicalCellIdentity* matching the value of the *cellForWhichToReportCGI* included in the corresponding *measObject* within the *VarMeasurementConfiguration* to be applicable

3> else:

...

4> else if the corresponding *measObject* concerns EUTRA:

5> consider any neighbouring cell detected on the associated frequency to be applicable when the concerned cell is not included in the *blackListedCellsToAddModifyList* defined within the *VarMeasurementConfiguration* for this *measId*;

2> if the *triggerType* is set to 'event' and if the entry condition applicable for this event, i.e. the event corresponding with the *eventId* of the corresponding *reportConfig* within *VarMeasurementConfiguration*, is fulfilled for one or more applicable cells for a duration exceeding the value of *timeToTrigger* defined for this event within the *VarMeasurementConfiguration* while the *VarMeasurementReports* does not include an entry for this *measId* (a first cell triggers the event):

3> include an entry within the *VarMeasurementReports* for this *measId*;

3> set the *numberOfReportsSent* defined within the *VarMeasurementReports* for this *measId* to 0;

3> include the concerned cell(s) in the *cellsTriggeredList* defined within the *VarMeasurementReports* for this *measId*, if not included;

3> initiate the measurement reporting procedure, as specified in 5.5.5;

...

2> if the *triggerType* is set to 'event' and if the entry condition applicable for this event, i.e. the event corresponding with the *eventId* of the corresponding *reportConfig* within *VarMeasurementConfiguration*, is fulfilled for one or more applicable cells not included in the *cellsTriggeredList* for a duration exceeding the value of *timeToTrigger* defined for this event within the *VarMeasurementConfiguration* (a subsequent cell triggers the event):

3> set the *numberOfReportsSent* defined within the *VarMeasurementReports* for this *measId* to 0;

3> include the concerned cell(s) in the *cellsTriggeredList* defined within the *VarMeasurementReports* for this *measId*, if not included;

3> initiate the measurement reporting procedure, as specified in 5.5.5;

2> Upon expiry of the periodical reporting timer for this *measId*:

3> initiate the measurement reporting procedure, as specified in 5.5.5;

2> upon expiry of the T321 for this *measId*:

3> initiate the measurement reporting procedure, as specified in 5.5.5;

2> if the *triggerType* is set to 'event' and if the leaving condition applicable for this event is fulfilled for one or more of the cells included in the *cellsTriggeredList* defined within the *VarMeasurementReports* for this *measId* for a duration exceeding the value of *timeToTrigger* defined within the *VarMeasurementConfiguration* for this event:

3> remove the concerned cell(s) in the *cellsTriggeredList* defined within the *VarMeasurementReports* for this *measId*;

3> if *reportOnLeave* is set for the corresponding reporting configuration:

4> initiate the measurement reporting procedure, as specified in 5.5.5;

3> if the *cellsTriggeredList* defined within the *VarMeasurementReports* for this *measId* is empty:

4> remove the entry within the *VarMeasurementReports* for this *measId*;

4> stop the periodical reporting timer for this *measId*, if running;

NOTE 2: The UE does not stop the periodical reporting with *triggerType* set to 'event' or to 'periodical' while the corresponding measurement is not performed due to the serving cell quality being better than *s-Measure* or due to the measurement gap not being active.

[TS 36.331, clause 5.5.4.4]

The UE shall:

- 1> apply inequality A3-1, as specified below, as the entry condition for this event;
- 1> apply inequality A3-2, as specified below, as the leaving condition for this event;

Inequality A3-1 (Entering condition)

$$Mn + Ofn + Ocn - Hys > Ms + Ofs + Ocs + Off$$

Inequality A3-2 (Leaving condition)

$$Mn + Ofn + Ocn + Hys < Ms + Ofs + Ocs + Off$$

The variables in the formula are defined as follows:

Mn is the measurement result of the neighbouring cell.

Ofn is the frequency specific offset of the frequency of the neighbour cell (equals *Ofs* for intra-frequency measurements and is included in *MeasObjectEUTRA* corresponding to the inter frequency as *offsetFreq* for inter-frequency measurements).

Ocn is the cell specific offset of the neighbour cell. If not configured zero offset shall be applied (included in *MeasObjectEUTRA* of the serving frequency as parameter *cellIndividualOffset* for intra-f measurements and included in *MeasObjectEUTRA* corresponding to the inter frequency as parameter *cellIndividualOffset* for inter-frequency measurements).

Ms is the measurement result of the serving cell, not taking into account any cell individual offset.

Ofs is the frequency specific offset of the serving frequency (i.e. *offsetFreq* within the *MeasObjectEUTRA* corresponding to the serving frequency).

Ocs is the cell specific offset of the serving cell (included in *MeasObjectEUTRA* of the serving frequency as parameter *cellIndividualOffset*).

Hys is the hysteresis parameter for this event (i.e. *hysteresis* as defined within the *VarMeasurementConfiguration* for this event).

Off is the offset parameter for this event (i.e. *a3-Offset* as defined within the *VarMeasurementConfiguration* for this event).

Mn*, *Ms are expressed in dBm in case of RSRP, or in dB in case of RSRQ.

Ofn, *Ocn*, *Ofs*, *Ocs*, *Hys*, *Off* are expressed in dB.

[TS 36.331, clause 5.5.5]

For the *measId* for which the measurement reporting procedure was triggered, the UE shall set the *measuredResults* within the *MeasurementReport* message as follows:

- 1> set the *measId* to the measurement identity that triggered the measurement reporting;
- 1> set the *neighbouringMeasResults* to include the best neighbouring cells up to *maxReportCells* in accordance with the following:
 - 2> if the *triggerType* is set to 'event':
 - 3> include the cells included in the *cellsTriggeredList* as defined within the *VarMeasurementReports* for this *measId*;
 - 2> else:

- 3> set the *neighbouringMeasResults* to include the applicable cells for which the requested *reportQuantity* has been available since the last periodical reporting or since the measurement was initiated or reset;
- 2> for each cell that is included in the *neighbouringMeasResults*, include the *physicalCellIdentity*;
- 2> if the *triggerType* is set to 'event'; or the *purpose* is set to 'reportStrongestCells' or to 'reportStrongestCellsForSON', ordered as follows:
 - 3> for each included cell include the filtered measured results in accordance with the *reportConfigList* defined in variable *VarMeasurementConfiguration* for that *measId* as follows:
 - 4> if the *measObject* associated with this *measId* concerns E-UTRA:
 - 5> if the *reportQuantity* within the concerned *reportConfig* is set to 'both' (E-UTRA):
 - 6> set the *measResult* to include both quantities (i.e. *rscpResult* and *rsrqResult*) in order of decreasing *triggerQuantity*, i.e. the best cell is included first;
 - 5> else:
 - 6> set the *measResult* to include the quantity as indicated by the *triggerQuantity* within the concerned *reportConfig* in order of decreasing *triggerQuantity*, i.e. the best cell is included first;
 - 4> else:
 - 5> set the *measResult* to the quantity as configured for the concerned RAT within the *quantityConfig* in order of decreasing quantity, i.e. the best cell is included first;
 - 2> else if the *purpose* is set to 'reportCGI':
 - 3> include the *globalCellIdentity* of the requested neighbouring cell;
- 1> increment the *numberOfReportsSent* as defined within the *VarMeasurementReports* for this *measId* by 1;
- 1> stop the periodical reporting timer, if running;
- 1> if the *numberOfReportsSent* as defined within the *VarMeasurementReports* for this *measId* is less than the *reportAmount* as defined within the corresponding *reportingConfiguration* as defined in the *VarMeasurementConfiguration*:
 - 2> stop the periodical reporting timer, if running;
 - 2> start the periodical reporting timer with the value of *reportInterval* as defined within the *VarMeasurementConfiguration* for this *measId*;
- 1> else if the *numberOfReportsSent* as defined within the *VarMeasurementReports* for this *measId* is equal to the *reportAmount* as defined within the corresponding *reportingConfiguration* as defined in the *VarMeasurementConfiguration*:
 - 2> if the *triggerType* is set to 'periodical':
 - 3> remove the entry within the *VarMeasurementReports* for this *measId*;

8.3.1.3.3 Test description

8.3.1.3.3.1 Pre-test conditions

System Simulator:

- Cell 1, Cell 2 and Cell 3

UE:

None.

Preamble:

- The UE is in state Generic RB Established (state 3) on Cell 1 according to [18].

8.3.1.3.3.2 Test procedure sequence

Table 8.3.1.3.3.2-1 illustrates the downlink power levels to be applied for Cell 1, Cell 2 and Cell 3 at various time instants of the test execution. Row marked "T0" denotes the conditions after the preamble, while rows marked "T1" and "T2" are to be applied subsequently. The exact instants on which these values shall be applied are described in the texts in this clause.

Table 8.3.1.3.3.2-1 : Power levels

	Parameter	Unit	Cell 1	Cell 2	Cell 3	Remark
T0	Cell-specific RS EPRE	dBm/15kHz	-80	-110	-110	Power levels are such that entry condition for event A3 (measId 1 & 2) is not satisfied: $Mn + Ofn + Ocn + Hys < Ms + Ofs + Ocs + Off$
T1	Cell-specific RS EPRE	dBm/15kHz	-80	-59	-110	Power levels are such that entry condition for event A3 (measId 1) is satisfied: $Mn + Ofn + Ocn - Hys > Ms + Ofs + Ocs + Off$
T2	Cell-specific RS EPRE	dBm/15kHz	-80	-110	-51	Power levels are such that entry condition for event A3 (measId 2) is satisfied: $Mn + Ofn + Ocn - Hys > Ms + Ofs + Ocs + Off$

Table 8.3.1.3.3.2-2: Main behaviour

St	Procedure	Message Sequence		TP	Verdict
		U - S	Message		
1	SS transmits an <i>RRCCConnectionReconfiguration</i> message including <i>measurementConfiguration</i> to setup intra E-UTRAN measurement and reporting for two event A3 (<i>measId 1</i> and <i>measId 2</i>) (intra and inter frequency measurement).	<--	<i>RRCCConnectionReconfiguration</i>	-	-
2	The UE transmits an <i>RCConnectionReconfigurationComplete</i> message.	-->	<i>RRCCConnectionReconfigurationComplete</i>	-	-
3	Check: does the UE transmit a <i>MeasurementReport</i> message within the next 10s?	-->	<i>MeasurementReport</i>	1	F
4	SS re-adjusts the cell-specific reference signal level according to row "T1" in table 8.3.1.3.3.2-1.	-	-	-	-
5	Check: does the UE transmit a <i>MeasurementReport</i> message to report event A3 (measId 1) with the measured RSRP value for Cell 2?	-->	<i>MeasurementReport</i>	2	P
6	SS re-adjusts the cell-specific reference signal level according to row "T2" in table 8.3.1.3.3.2-1.	-	-	-	-
7	Check: does the UE transmit a <i>MeasurementReport</i> message to report event A3 (<i>measId 2</i>) with the measured RSRP value for Cell 3?	-->	<i>MeasurementReport</i>	2	P

8.3.1.3.3.3 Specific message contents

Table 8.3.1.3.3.3-1: RRCCConnectionReconfiguration (step 1, Table 8.3.1.3.3.2-2)

Derivation Path: 36.508 clause 4.6.1 table 4.6.1-8 with condition MEAS

Table 8.3.1.3.3.3-4: MeasurementReport (step 5, Table 8.3.1.3.3.3-2)

Derivation path: 36.508 4.6.1 table 4.6.1-5			
Information Element	Value/Remark	Comment	Condition
MeasurementReport ::= SEQUENCE { criticalExtensions CHOICE { C1 CHOICE { measurementReport-r8 SEQUENCE { measuredResults ::= SEQUENCE { measId measResultServing ::= SEQUENCE { rsrpResult rsrqResult } neighbouringMeasResults CHOICE {} measResultListEUTRA ::= SEQUENCE (SIZE (1..maxCellReport)) OF SEQUENCE { physicalCellIdentity measResult SEQUENCE{ rsrpResult rsrqResult } } } } } } }	1 (0..97) (0..34) PhysicalCellIdentity of the Cell 2. (0..97) Not present	Report Cell 1 Report Cell 2	

Table 8.3.1.3.3.3-5: MeasurementReport (step 7, Table 8.3.1.3.3.3-2)

Derivation path: 36.508 4.6.1 table 4.6.1-5			
Information Element	Value/Remark	Comment	Condition
MeasurementReport ::= SEQUENCE { criticalExtensions CHOICE { C1 CHOICE { measurementReport-r8 SEQUENCE { measuredResults ::= SEQUENCE { measId measResultServing ::= SEQUENCE { rsrpResult rsrqResult } neighbouringMeasResults CHOICE {} measResultListEUTRA ::= SEQUENCE (SIZE (1..maxCellReport)) OF SEQUENCE { physicalCellIdentity measResult SEQUENCE{ rsrpResult rsrqResult } } } } } }	2 (0..97) (0..34) PhysicalCellIdentity of the Cell 3. (0..97) Not present	Report Cell 1 Report Cell 3	

8.3.1.4 Measurement configuration control and reporting / intra E-UTRAN measurements: Periodic reporting (intra and inter frequency measurements)

8.3.1.4.1 Test Purpose (TP)

(1)

```
with { UE in E-UTRA RRC_CONNECTED state and measurement configured for periodic reporting of intra
frequency cells and inter frequency cells on specified frequency }
ensure that {
  when { The UE receives reference signal power for cells on the serving frequency and cells on the
frequency where measurements are configured }
  then { UE sends MeasurementReport message at regular intervals for these cells }
}
```

(2)

```
with { UE in E-UTRA RRC_CONNECTED state and a MeasurementReport message for a configured periodic
measurement reporting of intra and inter frequency cells was sent }
ensure that {
  when { A previously reported cell become unavailable or the UE receives reference signal power on a
reported frequency for a cell which was previously not reported }
  then { UE sends MeasurementReport message at regular intervals for the available intra and inter
frequency cells }
}
```

(3)

```
with { UE in E-UTRA RRC_CONNECTED state and periodic measurement reporting ongoing}
ensure that {
  when { The UE receives a RRCConnectionReconfiguration message removing measIds for periodic
reporting }
  then { UE stops sending MeasurementReport messages for these measIds }
}
```

8.3.1.4.2 Conformance requirements

References: The conformance requirements covered in the current TC are specified in: TS 36.331, clauses 5.3.5.3, 5.5.2.2, 5.5.4.1 and 5.5.5.

[TS 36.331, clause 5.3.5.3]

If the *RRCConnectionReconfiguration* message does not include the *mobilityControlInfo* and the UE is able to comply with the configuration included in this message, the UE shall:

...

- 1> If the *RRCConnectionReconfiguration* message includes the *measConfig*:
- 2> perform the Measurement configuration procedure as specified in 5.5.2;

...

[TS 36.331, clause 5.5.2.2]

The UE shall:

- 1> for each *measId* value included in the received *measIdToRemoveList* that is part of the current UE configuration in *varMeasConfig*:
- 2> remove the entry with the matching *measId* from the *measIdList* within the *VarMeasConfig*;
- 2> remove the measurement reporting entry for this *measId* from the *VarMeasReportList*, if included;
- 2> stop the periodical reporting timer or timer T321, whichever one is running, and reset the associated information (e.g. *timeToTrigger*) for this *measId*;

...

[TS 36.331, clause 5.5.4.1]

The UE shall:

- 1> for each *measId* included in the *measIdList* within *VarMeasConfig*:
 - 2> else:
 - 3> if the corresponding *measObject* concerns E-UTRA:
 - 4> consider any neighbouring cell detected on the associated frequency to be applicable when the concerned cell is not included in the *blackCellsToAddModList* defined within the *VarMeasConfig* for this *measId*;

...

- 2> if the *purpose* is included and set to ‘*reportStrongestCells*’ or to ‘*reportStrongestCellsForSON*’ and if a (first) measurement result is available for one or more applicable cells:
 - 3> include a measurement reporting entry within the *VarMeasReportList* for this *measId*;
 - 3> set the *numberOfReportsSent* defined within the *VarMeasReportList* for this *measId* to 0;
 - 3> initiate the measurement reporting procedure, as specified in 5.5.5;

NOTE 1: If the *purpose* is set to ‘*reportStrongestCells*’, the UE initiates a first measurement report immediately after the quantity to be reported becomes available for at least either serving cell or one of the applicable cells. If the *purpose* is set to ‘*reportStrongestCellsForSON*’, the UE initiates a first measurement report when it has determined the strongest cells on the associated frequency.

- 2> upon expiry of the periodical reporting timer for this *measId*:
 - 3> initiate the measurement reporting procedure, as specified in 5.5.5;

...

NOTE 2: The UE does not stop the periodical reporting with *triggerType* set to ‘*event*’ or to ‘*periodical*’ while the corresponding measurement is not performed due to the serving cell RSRP being equal to or better than *s-Measure* or due to the measurement gap not being setup.

...

[TS 36.331, clause 5.5.5]

...

For the *measId* for which the measurement reporting procedure was triggered, the UE shall set the *measuredResults* within the *MeasurementReport* message as follows:

- 1> set the *measId* to the measurement identity that triggered the measurement reporting;
- 1> set the *measResultServCell* to include the quantities of serving cell;
- 1> if there is at least one applicable neighbouring cell to report:
 - 2> set the *measResultsNeighCells* to include the best neighbouring cells up to *maxReportCells* in accordance with the following:
 - 3> if the *triggerType* is set to ‘*event*’:
 - 4> include the cells included in the *cellsTriggeredList* as defined within the *VarMeasReportList* for this *measId*;
 - 3> else:
 - 4> include the applicable cells for which the new measurement results became available since the last periodical reporting or since the measurement was initiated or reset;

NOTE: The reliability of the report (i.e. the certainty it contains the strongest cells on the concerned frequency) depends on the measurement configuration i.e. the *reportInterval*. The related performance requirements are specified in TS 36.133 [16].

- 3> for each cell that is included in the *measResultsNeighCells*, include the *physCellId*;
- 3> if the *triggerType* is set to 'event'; or the *purpose* is set to 'reportStrongestCells' or to 'reportStrongestCellsForSON':
- 4> for each included cell, include the layer 3 filtered measured results in accordance with the *reportConfig* for this *measId*, ordered as follows:
 - 5> if the *measObject* associated with this *measId* concerns E-UTRA:
 - 6> set the *measResult* to include the quantity(ies) indicated in the *reportQuantity* within the concerned *reportConfig* in order of decreasing *triggerQuantity*, i.e. the best cell is included first;

...

- 1> increment the *numberOfReportsSent* as defined within the *VarMeasReportList* for this *measId* by 1;
- 1> stop the periodical reporting timer, if running;
- 1> if the *numberOfReportsSent* as defined within the *VarMeasReportList* for this *measId* is less than to *reportAmount* as defined corresponding *reportConfig* for this *measId*:
 - 2> start the periodical reporting timer with the value of *reportInterval* as defined within the corresponding *reportConfig* for this *measId*;

...

- 1> submit the MEASUREMENT REPORT message to lower layers for transmission, upon which the procedure ends.

8.3.1.4.3 Test description

8.3.1.4.3.1 Pre-test conditions

System Simulator:

- Cell 1, Cell 2, Cell 3, Cell 4 and Cell 6(FFS)

UE:

None.

Preamble:

- The UE is in state Generic RB Established (state 3) according to [18] on Cell 1.

8.3.1.4.3.2 Test procedure sequence

Table 8.3.1.4.3.2-1 illustrates the downlink power levels to be applied for the cells at various time instants of the test execution. Row marked "T0" denotes the conditions after the preamble, while rows marked "T1" and "T2" are to be applied subsequently. The exact instants on which these values shall be applied are described in the texts in this clause.

Table 8.3.1.4.3.2-1 : Power levels

	Parameter	Unit	Cell 1	Cell 2	Cell 3	Cell 4	Cell 6	Remark
T0	Cell-specific RS EPRE	dBm/ 15kHz	P01 (FFS)	P02 (FFS)	P03 (FFS)	off	off	Power levels shall be such that camping on Cell 1 is guaranteed
T1	Cell-specific RS EPRE	dBm/ 15kHz	P01 (FFS)	P02 (FFS)	P03 (FFS)	P02 (FFS)	P03 (FFS)	
T2	Cell-specific RS EPRE	dBm/ 15kHz	P01 (FFS)	off	off	P02 (FFS)	P03 (FFS)	

Table 8.3.1.4.3.2-2: Main behaviour

St	Procedure	Message Sequence		TP	Verdict
		U - S	Message		
1	SS transmits an <i>RRCCONNECTIONRECONFIGURATION</i> message including <i>MEASUREMENTCONFIGURATION</i> to setup intra LTE measurements and periodical reporting for intra and inter frequency cells.	<--	<i>RRCCONNECTIONRECONFIGURATION</i>	-	-
2	The UE transmits an <i>RRC CONNECTION RECONFIGURATION COMPLETE</i> message.	-->	<i>RRCCONNECTIONRECONFIGURATIONCOMPLETE</i>	-	-
	EXCEPTION: In parallel to events described in steps 3 to 4 the steps specified in table 8.3.1.4.3.2.-3 and table 8.3.1.4.3.2.-4 shall take place				
3	Wait for 30 s to ensure that the UE performs a periodical intra frequency reporting and a periodical inter frequency reporting.	-	-	1	-
4	SS sets the cell-specific reference signal levels and switches Cell 4 and Cell 6 on according to row "T1" in table 8.3.1.4.3.2.-1.	-	-	-	-
5	Wait and ignore <i>MEASUREMENTREPORT</i> messages for 5 s to allow for the switching of cells.	-	-	-	-
	EXCEPTION: In parallel to events described in steps 6 to 7 the steps specified in table 8.3.1.4.3.2.-5 and table 8.3.1.4.3.2.-6 shall take place				
6	Wait for 30 s to ensure that the UE performs a periodical intra frequency reporting and a periodical inter frequency reporting.	-	-	1, 2	-
7	SS sets the cell-specific reference signal levels and switches Cell 2 and Cell 3 off according to row "T2" in table 8.3.1.4.3.2.-1.	-	-	-	-
8	Wait and ignore <i>MEASUREMENTREPORT</i> messages for 5 s to allow for the switching of cells.	-	-	-	-
	EXCEPTION: In parallel to events described in steps 9 to 11 the steps specified in table 8.3.1.4.3.2.-7 and table 8.3.1.4.3.2.-8 shall take place				
9	Wait for 30 s to ensure that the UE performs a periodical intra frequency reporting and a periodical inter frequency reporting.	-	-	1, 2	-
10	SS transmits an <i>RRCCONNECTIONRECONFIGURATION</i> message including <i>MEASUREMENTCONFIGURATION</i> to remove measIds for periodical reporting.	<--	<i>RRCCONNECTIONRECONFIGURATION</i>	-	-
11	The UE transmits an <i>RRC CONNECTION RECONFIGURATION COMPLETE</i> message.	-->	<i>RRCCONNECTIONRECONFIGURATIONCOMPLETE</i>	-	-
12	Check: does the UE attempt to transmit an uplink message for the next 10s?	-	-	3	F

Table 8.3.1.4.3.2-3: Parallel behaviour

St	Procedure	Message Sequence		TP	Verdict
		U - S	Message		
	EXCEPTION: After the 1st message is received, step 1 below shall be repeated every time the duration indicated in the IE <i>reportInterval</i> has elapsed	-	-	-	-
1	Check: Does the UE transmit a <i>MeasurementReport</i> message to perform periodical intra frequency reporting for Cell 2?	-->	<i>MeasurementReport</i>	1	P

Table 8.3.1.4.3.2-4: Parallel behaviour

St	Procedure	Message Sequence		TP	Verdict
		U - S	Message		
	EXCEPTION: After the 1st message is received, step 1 below shall be repeated every time the duration indicated in the IE <i>reportInterval</i> has elapsed.	-	-	-	-
1	Check: Does the UE transmit a <i>MeasurementReport</i> message to perform periodical inter frequency reporting for Cell 3?	-->	<i>MeasurementReport</i>	1	P

Table 8.3.1.4.3.2-5: Parallel behaviour

St	Procedure	Message Sequence		TP	Verdict
		U - S	Message		
-	EXCEPTION: Step 1 below shall be repeated every time the duration indicated in the IE <i>reportInterval</i> has elapsed.	-	-	-	-
1	Check: Does the UE transmit a <i>MeasurementReport</i> message to perform periodical intra frequency reporting for Cell 2 and Cell 4?	-->	<i>MeasurementReport</i>	1, 2	P

Table 8.3.1.4.3.2-6: Parallel behaviour

St	Procedure	Message Sequence		TP	Verdict
		U - S	Message		
	EXCEPTION: Step 1 below shall be repeated every time the duration indicated in the IE <i>reportInterval</i> has elapsed.				
1	Check: Does the UE transmit a <i>MeasurementReport</i> message to perform periodical inter frequency reporting for Cell 3 and Cell 6?	-->	<i>MeasurementReport</i>	1, 2	P

Table 8.3.1.4.3.2-7: Parallel behaviour

St	Procedure	Message Sequence		TP	Verdict
		U - S	Message		
	EXCEPTION: Step 1 below shall be repeated every time the duration indicated in the IE <i>reportInterval</i> has elapsed.				
1	Check: Does the UE transmit a <i>MeasurementReport</i> message to perform periodical intra frequency reporting for Cell 4?	-->	<i>MeasurementReport</i>	1, 2	P

Table 8.3.1.4.3.2-8: Parallel behaviour

St	Procedure	Message Sequence		TP	Verdict
		U - S	Message		
	EXCEPTION: Step 1 below shall be repeated every time the duration indicated in the IE reportInterval has elapsed.				
1	Check: Does the UE transmit a <i>MeasurementReport</i> message to perform periodical inter frequency reporting for Cell 6?	-->	<i>MeasurementReport</i>	1, 2	P

Editor's note: The value and tolerance of the *reportInterval* is FFS.

8.3.1.4.3.3 Specific message contents

Table 8.3.1.4.3.3-1 RRCConnectionReconfiguration (step 1 and step 8, Table 8.3.1.4.3.2-2)

Derivation Path: 36.508 clause 4.6.1 table 4.6.1-8 with condition MEAS

Table 8.3.1.4.3.3-2 *MeasurementConfiguration* (step 1, Table 8.3.1.4.3.2-2)

Derivation Path: 36.508, Table 4.6.6-1			
Information Element	Value/remark	Comment	Condition
MeasConfig ::= SEQUENCE {			
measObjectToAddModList SEQUENCE (SIZE (1..maxObjectld)) OF SEQUENCE {	2 entries		
measObjectld[1]	ldMeasObject-f1		
measObject[1]	MeasObjectEUTRA-f1		
measObjectld[2]	ldMeasObject-f2		
measObject[2]	MeasObjectEUTRA-f2		
}			
reportConfigToAddModList SEQUENCE (SIZE (1..maxReportConfigld)) OF SEQUENCE {	1 entry		
reportConfigld[1]	ldReportConfig-P		
reportConfig[1]	ReportConfig-P		
}			
measldToAddModList SEQUENCE (SIZE (1..maxMeasld)) OF SEQUENCE {	2 entries		
measld[1]	1		
measObjectld[1]	ldMeasObject-f1		
reportConfigld[1]	ReportConfig-P		
measld[2]	2		
measObjectld[2]	ldMeasObject-f2		
reportConfigld[2]	ReportConfig-P		
}			
}			

Table 8.3.1.4.3.3-3 MeasObjectEUTRA-f1 (step 1, Table 8.3.1.4.3.2-2)

Derivation path: 36.508 table 4.6.6-2 MeasObjectEUTRA-GENERIC(f1)			
Information Element	Value/Remark	Comment	Condition
MeasObjectEUTRA-GENERIC(f1) ::= SEQUENCE {	MeasObjectEUTRA MO1		
carrierFreq		E-UTRA DL carrier frequency of the serving cell	
}			

Table 8.3.1.4.3.3-4 MeasObjectEUTRA-f2 (step 1, Table 8.3.1.4.3.2-2)

Derivation path: 36.508 table 4.6.6-2 MeasObjectEUTRA-GENERIC(f2)			
Information Element	Value/Remark	Comment	Condition
MeasObjectEUTRA-GENERIC(f2) ::= SEQUENCE {	MeasObjectEUTRA MO1		
carrierFreq		E-UTRA DL carrier frequency of the serving cell	
}			

Table 8.3.1.4.3.3-5 ReportConfig-P (step 1, Table 8.3.1.4.3.2-2)

Derivation path: 36.508 table 4.6.6-7 ReportConfigEUTRA-PERIODICAL			
Information Element	Value/Remark	Comment	Condition
ReportConfigEUTRA-PERIODICAL ::= SEQUENCE {	ReportConfigEUTRA RC1		
maxReportCells	4	Report Cell 2, Cell 3, Cell 4 and Cell 6	
}			

Table 8.3.1.4.3.3-6 MeasurementConfiguration (step 8, Table 8.3.1.4.3.2-2)

Derivation Path: 36.508, Table 4.6.6-1			
Information Element	Value/remark	Comment	Condition
MeasConfig ::= SEQUENCE {			
measIdToRemoveList SEQUENCE (SIZE (1..maxMeasId)) OF SEQUENCE {	2 entries		
MeasId[1]	1		
MeasId[2]	2		
}			
}			

Table 8.3.1.7.3.3-7: MeasurementReport (step 1, Table 8.3.1.4.3.2-3)

Derivation Path: 36.508 clause 4.6.1 table 4.6.1-5			
Information Element	Value/remark	Comment	Condition
MeasurementReport ::= SEQUENCE { criticalExtensions CHOICE { c1 CHOICE { measurementReport-r8 SEQUENCE { measResults ::= SEQUENCE { measId measResultServCell ::= SEQUENCE { rsrpResult rsrqResult } measResultNeighCells CHOICE { measResultListEUTRA ::= SEQUENCE (SIZE (1..maxCellReport)) OF SEQUENCE { physCellId [1] measResult [1] SEQUENCE { rsrpResult rsrqResult } } } } } } } } }	1 (0..97) (0..34) physicalCellId-Cell2 (0..97) (0..34)	Report Cell 1 Report Cell 2	

Derivation Path: 36.508 clause 4.6.1 table 4.6.1-5			
Information Element	Value/remark	Comment	Condition
MeasurementReport ::= SEQUENCE { criticalExtensions CHOICE { c1 CHOICE { measurementReport-r8 SEQUENCE { measResults ::= SEQUENCE { measId measResultServCell ::= SEQUENCE { rsrpResult rsrqResult } measResultNeighCells CHOICE { measResultListEUTRA ::= SEQUENCE (SIZE (1..maxCellReport)) OF SEQUENCE { physCellId [1] measResult [1] SEQUENCE { rsrpResult rsrqResult } } } } } }	2 (0..97) (0..34) physicalCellIdentity-Cell3 (0..97) (0..34)	Report Cell 1 Report Cell 3	

Table 8.3.1.7.3.3-11: MeasurementReport (step 1, Table 8.3.1.4.3.2-6)

Derivation Path: 36.508 clause 4.6.1 table 4.6.1-5			
Information Element	Value/remark	Comment	Condition
MeasurementReport ::= SEQUENCE { criticalExtensions CHOICE { c1 CHOICE { measurementReport-r8 SEQUENCE { measResults ::= SEQUENCE { measId measResultServCell ::= SEQUENCE { rsrpResult rsrqResult } measResultNeighCells CHOICE { measResultListEUTRA ::= SEQUENCE (SIZE (1..maxCellReport)) OF SEQUENCE { physCellId [1] measResult [1] SEQUENCE { rsrpResult rsrqResult } physCellId [2] measResult [2] SEQUENCE { rsrpResult rsrqResult } } } } } } }	2 (0..97) (0..34) physicalCellIdentity-Cell3 (0..97) (0..34) physicalCellIdentity-Cell6 (0..97) (0..34)	Report Cell 1 Report Cell 3 and Cell 6	

Table 8.3.1.4.3.3-12 MeasurementReport (step 1, Table 8.3.1.4.3.2-8)

Derivation Path: 36.508 clause 4.6.1 table 4.6.1-5			
Information Element	Value/remark	Comment	Condition
MeasurementReport ::= SEQUENCE { criticalExtensions CHOICE { c1 CHOICE { measurementReport-r8 SEQUENCE { measResults ::= SEQUENCE { measId measResultServCell ::= SEQUENCE { rsrpResult rsrqResult } measResultNeighCells CHOICE { measResultListEUTRA ::= SEQUENCE (SIZE (1..maxCellReport)) OF SEQUENCE { physCellId [1] measResult [1] SEQUENCE { rsrpResult rsrqResult } } } } }	2 (0..97) (0..34) physicalCellIdentity-Cell6 (0..97) (0..34)	Report Cell 1 Report Cell 6	

8.3.1.5 Measurement configuration control and reporting / intra E-UTRAN measurements: 2 simultaneous event A3 (intra frequency measurements)

8.3.1.5.1 Test Purpose (TP)

(1)

```
with { UE in E-UTRA RRC_CONNECTED state and measurements configured for two event A3 at the same time }
ensure that {
  when { Entry condition for event A3 is not met }
  then { UE does not send MeasurementReport }
}
```

(2)

```
with { UE in E-UTRA RRC_CONNECTED state and measurements configured for two event A3 at the same time }
ensure that {
  when { Neighbour becomes offset better than serving }
  then { UE sends MeasurementReport with correct measId for event A3 }
}
```

8.3.1.5.2 Conformance requirements

References: The conformance requirements covered in the current TC are specified in: TS 36.331, clauses 5.3.5.3, 5.5.4.1, 5.5.4.4 and 5.5.5.

[TS 36.331, clause 5.3.5.3]

If the *RRCCONNECTIONRECONFIGURATION* message does not include the *mobilityControlInformation* and the UE is able to comply with the configuration included in this message, the UE shall:

...

1> If the *RRCCONNECTIONRECONFIGURATION* message includes the *measurementConfiguration*:

2> perform the Measurement configuration procedure as specified in 5.5.2;

...

[TS 36.331, clause 5.5.4.1]

The UE shall:

1> for each *measId* included in the *measIdList* within *VarMeasurementConfiguration*:

2> if the *triggerType* is set to 'event':

...

3> else if the corresponding *measObject* concerns EUTRA:

4> consider any neighbouring cell detected on the associated frequency to be applicable when the concerned cell is not included in the *blackListedCellsToAddModifyList* defined within the *VarMeasurementConfiguration* for this *measId*;

2> else consider a neighbouring cell on the associated frequency/ set of frequencies (GERAN) to be applicable as follows:

...

3> if the corresponding *reportingConfig* includes a purpose set to 'reportCGI':

4> consider any neighbouring cell detected on the associated frequency/ set of frequencies (GERAN) which has a *physicalCellIdentity* matching the value of the *cellForWhichToReportCGI* included in the corresponding *measObject* within the *VarMeasurementConfiguration* to be applicable

3> else:

...

4> else if the corresponding *measObject* concerns EUTRA:

5> consider any neighbouring cell detected on the associated frequency to be applicable when the concerned cell is not included in the *blackListedCellsToAddModifyList* defined within the *VarMeasurementConfiguration* for this *measId*;

2> if the *triggerType* is set to 'event' and if the entry condition applicable for this event, i.e. the event corresponding with the *eventId* of the corresponding *reportConfig* within *VarMeasurementConfiguration*, is fulfilled for one or more applicable cells for a duration exceeding the value of *timeToTrigger* defined for this event within the *VarMeasurementConfiguration* while the *VarMeasurementReports* does not include an entry for this *measId* (a first cell triggers the event):

3> include an entry within the *VarMeasurementReports* for this *measId*;

3> set the *numberOfReportsSent* defined within the *VarMeasurementReports* for this *measId* to 0;

3> include the concerned cell(s) in the *cellsTriggeredList* defined within the *VarMeasurementReports* for this *measId*, if not included;

3> initiate the measurement reporting procedure, as specified in 5.5.5;

...

2> if the *triggerType* is set to 'event' and if the entry condition applicable for this event, i.e. the event corresponding with the *eventId* of the corresponding *reportConfig* within *VarMeasurementConfiguration*, is fulfilled for one or more applicable cells not included in the *cellsTriggeredList* for a duration exceeding the value of *timeToTrigger* defined for this event within the *VarMeasurementConfiguration* (a subsequent cell triggers the event):

3> set the *numberOfReportsSent* defined within the *VarMeasurementReports* for this *measId* to 0;

3> include the concerned cell(s) in the *cellsTriggeredList* defined within the *VarMeasurementReports* for this *measId*, if not included;

3> initiate the measurement reporting procedure, as specified in 5.5.5;

2> Upon expiry of the periodical reporting timer for this *measId*:

3> initiate the measurement reporting procedure, as specified in 5.5.5;

2> upon expiry of the T321 for this *measId*:

3> initiate the measurement reporting procedure, as specified in 5.5.5;

2> if the *triggerType* is set to 'event' and if the leaving condition applicable for this event is fulfilled for one or more of the cells included in the *cellsTriggeredList* defined within the *VarMeasurementReports* for this *measId* for a duration exceeding the value of *timeToTrigger* defined within the *VarMeasurementConfiguration* for this event:

3> remove the concerned cell(s) in the *cellsTriggeredList* defined within the *VarMeasurementReports* for this *measId*;

3> if *reportOnLeave* is set for the corresponding reporting configuration:

4> initiate the measurement reporting procedure, as specified in 5.5.5;

3> if the *cellsTriggeredList* defined within the *VarMeasurementReports* for this *measId* is empty:

4> remove the entry within the *VarMeasurementReports* for this *measId*;

4> stop the periodical reporting timer for this *measId*, if running;

NOTE 2: The UE does not stop the periodical reporting with *triggerType* set to 'event' or to 'periodical' while the corresponding measurement is not performed due to the serving cell quality being better than *s-Measure* or due to the measurement gap not being active.

[TS 36.331, clause 5.5.4.4]

The UE shall:

- 1> apply inequality A3-1, as specified below, as the entry condition for this event;
- 1> apply inequality A3-2, as specified below, as the leaving condition for this event;

Inequality A3-1 (Entering condition)

$$Mn + Ofn + Ocn - Hys > Ms + Of_s + Ocs + Off$$

Inequality A3-2 (Leaving condition)

$$Mn + Ofn + Ocn + Hys < Ms + Of_s + Ocs + Off$$

The variables in the formula are defined as follows:

Mn is the measurement result of the neighbouring cell.

Ofn is the frequency specific offset of the frequency of the neighbour cell (equals *Ofs* for intra-frequency measurements and is included in *MeasObjectEUTRA* corresponding to the inter frequency as *offsetFreq* for inter-frequency measurements).

Ocn is the cell specific offset of the neighbour cell. If not configured zero offset shall be applied (included in *MeasObjectEUTRA* of the serving frequency as parameter *cellIndividualOffset* for intra-f measurements and included in *MeasObjectEUTRA* corresponding to the inter frequency as parameter *cellIndividualOffset* for inter-frequency measurements).

Ms is the measurement result of the serving cell, not taking into account any cell individual offset.

Ofs is the frequency specific offset of the serving frequency (i.e. *offsetFreq* within the *MeasObjectEUTRA* corresponding to the serving frequency).

Ocs is the cell specific offset of the serving cell (included in *MeasObjectEUTRA* of the serving frequency as parameter *cellIndividualOffset*).

Hys is the hysteresis parameter for this event (i.e. *hysteresis* as defined within the *VarMeasurementConfiguration* for this event).

Off is the offset parameter for this event (i.e. *a3-Offset* as defined within the *VarMeasurementConfiguration* for this event).

Mn, ***Ms*** are expressed in dBm in case of RSRP, or in dB in case of RSRQ.

Ofn, ***Ocn***, ***Ofs***, ***Ocs***, ***Hys***, ***Off*** are expressed in dB.

[TS 36.331, clause 5.5.5]

For the *measId* for which the measurement reporting procedure was triggered, the UE shall set the *measuredResults* within the *MeasurementReport* message as follows:

- 1> set the *measId* to the measurement identity that triggered the measurement reporting;
- 1> set the *neighbouringMeasResults* to include the best neighbouring cells up to *maxReportCells* in accordance with the following:
 - 2> if the *triggerType* is set to 'event':
 - 3> include the cells included in the *cellsTriggeredList* as defined within the *VarMeasurementReports* for this *measId*;
 - 2> else:
 - 3> set the *neighbouringMeasResults* to include the applicable cells for which the requested *reportQuantity* has been available since the last periodical reporting or since the measurement was initiated or reset;

- 2> for each cell that is included in the *neighbouringMeasResults*, include the *physicalCellIdentity*;
- 2> if the *triggerType* is set to 'event'; or the *purpose* is set to 'reportStrongestCells' or to 'reportStrongestCellsForSON', ordered as follows:
 - 3> for each included cell include the filtered measured results in accordance with the *reportConfigList* defined in variable *VarMeasurementConfiguration* for that *measId* as follows:
 - 4> if the *measObject* associated with this *measId* concerns E-UTRA:
 - 5> if the *reportQuantity* within the concerned *reportConfig* is set to 'both' (E-UTRA):
 - 6> set the *measResult* to include both quantities (i.e. *rscpResult* and *rsrqResult*) in order of decreasing *triggerQuantity*, i.e. the best cell is included first;
 - 5> else:
 - 6> set the *measResult* to include the quantity as indicated by the *triggerQuantity* within the concerned *reportConfig* in order of decreasing *triggerQuantity*, i.e. the best cell is included first;
 - 4> else:
 - 5> set the *measResult* to the quantity as configured for the concerned RAT within the *quantityConfig* in order of decreasing quantity, i.e. the best cell is included first;
 - 2> else if the *purpose* is set to 'reportCGI':
 - 3> include the *globalCellIdentity* of the requested neighbouring cell;
- 1> increment the *numberOfReportsSent* as defined within the *VarMeasurementReports* for this *measId* by 1;
- 1> stop the periodical reporting timer, if running;
- 1> if the *numberOfReportsSent* as defined within the *VarMeasurementReports* for this *measId* is less than the *reportAmount* as defined within the corresponding *reportingConfiguration* as defined in the *VarMeasurementConfiguration*:
 - 2> stop the periodical reporting timer, if running;
 - 2> start the periodical reporting timer with the value of *reportInterval* as defined within the *VarMeasurementConfiguration* for this *measId*;
- 1> else if the *numberOfReportsSent* as defined within the *VarMeasurementReports* for this *measId* is equal to the *reportAmount* as defined within the corresponding *reportingConfiguration* as defined in the *VarMeasurementConfiguration*:
 - 2> if the *triggerType* is set to 'periodical':
- 3> remove the entry within the *VarMeasurementReports* for this *measId*;

8.3.1.5.3 Test description

8.3.1.5.3.1 Pre-test conditions

System Simulator:

- Cell 1 and Cell 2

UE:

None.

Preamble:

- The UE is in state Generic RB Established (state 3) on Cell 1 according to [18]

8.3.1.5.3.2 Test procedure sequence

Table 8.3.1.5.3.2-1 illustrates the downlink power levels to be applied for Cell 1 and Cell 2 at various time instants of the test execution. Row marked "T0" denotes the conditions after the preamble, while rows marked "T1" and "T2" are to be applied subsequently. The exact instants on which these values shall be applied are described in the texts in this clause.

Table 8.3.1.5.3.2-1 : Power levels

	Parameter	Unit	Cell 1	Cell 2	Remark
T0	Cell-specific RS EPRE	dBm/1 5kHz	-80	-110	Power levels are such that entry condition for event A3 (measId 1 & 2) is not satisfied: $Mn + Ofn + Ocn + Hys < Ms + Ofs + Ocs + Off$
T1	Cell-specific RS EPRE	dBm/1 5kHz	-80	-79	Power levels are such that entry condition for event A3 (measId 1) is satisfied: $Mn + Ofn + Ocn - Hys > Ms + Ofs + Ocs + Off$
T2	Cell-specific RS EPRE	dBm/1 5kHz	-80	-54	Power levels are such that entry condition for event A3 (measId 2) is satisfied: $Mn + Ofn + Ocn - Hys > Ms + Ofs + Ocs + Off$

Table 8.3.1.5.3.2-2: Main behaviour

St	Procedure	Message Sequence		TP	Verdict
		U - S	Message		
1	SS transmits an <i>RRConnectionReconfiguration</i> message including <i>measurementConfiguration</i> to setup intra E-UTRAN measurement and reporting for two event A3 (measId 1 and measId 2) with different parameters.	<--	<i>RRConnectionReconfiguration</i>	-	-
2	The UE transmits an <i>RCConnectionReconfigurationComplete</i> message.	-->	<i>RRConnectionReconfigurationComplete</i>	-	-
3	Check: does the UE transmit a <i>MeasurementReport</i> message within the next 10s?	-->	<i>MeasurementReport</i>	1	F
4	SS re-adjusts the cell-specific reference signal level according to row "T1" in table 8.3.1.5.3.2-1.	-	-	-	-
5	Check: does the UE transmit a <i>MeasurementReport</i> message to report event A3 (measId 1) with the measured RSRP value for Cell 2?	-->	<i>MeasurementReport</i>	2	P
6	SS re-adjusts the cell-specific reference signal level according to row "T2" in table 8.3.1.5.3.2-1.	-	-	-	-
7	Check: does the UE transmit a <i>MeasurementReport</i> message to report event A3 (measId 2) with the measured RSRP value for Cell 2?	-->	<i>MeasurementReport</i>	2	P

8.3.1.5.3.3 Specific message contents

Table 8.3.1.5.3.3-1: RRCConnectionReconfiguration (step 1, Table 8.3.1.5.3.2-2)

Derivation Path: 36.508 clause 4.6.1 table 4.6.1-8 with condition MEAS

Table 8.3.1.5.3.3-2: MeasurementConfiguration (step 1, Table 8.3.1.5.3.2-2)

Derivation path: 36.508 clause 4.6.6 table 4.6.6-1			
Information Element	Value/Remark	Comment	Condition
measurementConfiguration ::= SEQUENCE { measObjectToAddModifyList SEQUENCE (SIZE (1..maxObjectId)) OF SEQUENCE { measObjectId[1] measObject[1] } reportConfigToAddModifyList SEQUENCE (SIZE (1..maxReportConfigId)) OF SEQUENCE { reportConfigId[1] reportConfig[1] reportConfigId[2] reportConfig[2] } measIdToAddModifyList SEQUENCE (SIZE (1..maxMeasId)) OF SEQUENCE { measId[1] measObjectId[1] reportConfigId[1] measId[2] measObjectId[2] reportConfigId[2] } }	2 entries IdMeasObject-f1 MeasObjectEUTRA-GENERIC(f1) 1 entry 1 ReportConfig-A3-Lowerthreshold 2 ReportConfig-A3-Higherthreshold 2 entries 1 IdMeasObject-f1 IdReportConfig-A3-Lowerthreshold 2 IdMeasObject-f1 IdReportConfig-A3-Higherthreshold		

Table 8.3.1.5.3.3-3: ReportConfig-A3-Lowerthreshold (step 1, Table 8.3.1.5.3.3-2)

Derivation path: 36.508 clause 4.6.6 table 4.6.6-6 ReportConfigEUTRA-A3			
Information Element	Value/remark	Comment	Condition
ReportConfigEUTRA-A3 ::= SEQUENCE {			
triggerType CHOICE {			
event SEQUENCE {			
eventId CHOICE {			
eventA3 SEQUENCE {			
a3-Offset	-20	-10 dB	
}			
}			
timeToTrigger	ms0		
}			
reportQuantity	sameAsTriggerQuantity		
reportAmount	r1		
}			

Table 8.3.1.5.3.3-4: ReportConfig-A3-Higherthreshold (step 1, Table 8.3.1.5.3.3-2)

Derivation path: 36.508 clause 4.6.6 table 4.6.6-6 ReportConfigEUTRA-A3			
Information Element	Value/remark	Comment	Condition
ReportConfigEUTRA-A3 ::= SEQUENCE {			
triggerType CHOICE {			
event SEQUENCE {			
eventId CHOICE {			
eventA3 SEQUENCE {			
a3-Offset	30	15 dB	
}			
}			
timeToTrigger	ms0		
}			
reportQuantity	sameAsTriggerQuantity		
reportAmount	r1		
}			

Table 8.3.1.5.3.3-5: MeasurementReport (step 5, Table 8.3.1.5.3.3-2)

Derivation path: 36.508 4.6.1 table 4.6.1-5			
Information Element	Value/Remark	Comment	Condition
MeasurementReport ::= SEQUENCE {			
criticalExtensions CHOICE {			
C1 CHOICE {			
measurementReport-r8 SEQUENCE {			
measuredResults ::= SEQUENCE {			
measId	1		
measResultServing ::= SEQUENCE {		Report Cell 1	
rsrpResult	(0..97)		
rsrqResult	(0..34)		
}			
neighbouringMeasResults CHOICE {			
measResultListEUTRA ::= SEQUENCE (SIZE		Report Cell 2	
(1..maxCellReport)) OF SEQUENCE {			
physicalCellIdentity	PhysicalCellIdentity of		
measResult SEQUENCE{			
rsrpResult	(0..97)		
rsrqResult	Not present		
}			
}			
}			
}			
}			
}			

...

[TS 36.331, clause 5.5.4.1]

The UE shall:

- 1> for each *measId* included in the *measIdList* within *VarMeasurementConfiguration*:
 - 2> if the *triggerType* is set to 'event' consider a neighbouring cell on the associated frequency/ set of frequencies (GERAN) to be applicable as follows:

...

- 3> if the corresponding *measObject* concerns EUTRA: when the concerned cell is not included in the *blackListedCellsToAddModifyList* defined within the *VarMeasurementConfiguration* for this *measId*;
 - 2> else consider a neighbouring cell on the associated frequency to be applicable as follows:

...

- 3> if the corresponding *measObject* concerns EUTRA: when the concerned cell is not included in the *blackListedCellsToAddModifyList* defined within the *VarMeasurementConfiguration* for this *measId*;
 - 2> if the *triggerType* is set to 'event' and if the entry condition applicable for this event, i.e. the event corresponding with the *eventId* of the corresponding *reportConfig* within *VarMeasurementConfiguration*, is fulfilled for one or more applicable cells for a duration exceeding the value of *timeToTrigger* defined for this event within the *VarMeasurementConfiguration* or:
 - 2> if the *triggerType* is set to 'periodical' and a (first) measurement result is available:
 - 3> if the *VarMeasurementReports* does not include an entry for this *measId*:
 - 4> include an entry within the *VarMeasurementReports* for this *measId*;
 - 4> set the *numberOfReportsSent* defined within the *VarMeasurementReports* for this *measId* to 0;
 - 3> include the concerned cell(s) in the *cellsToReportList* defined within the *VarMeasurementReports* for this *measId*, if not included;
 - 3> initiate the measurement reporting procedure, as specified in 5.5.5;
 - 2> Upon expiry of the periodical reporting timer for this:
 - 3> if the *triggerType* is set to 'periodical':
 - 4> clear the *cellsToReportList* defined within the *VarMeasurementReports* for this *measId* and include the applicable cell(s) in the *cellsToReportList*;
 - 3> initiate the measurement reporting procedure, as specified in 5.5.5;
 - 2> if the leaving condition applicable for this event is fulfilled for one or more of the cells included in the *cellsToReportList* defined within the *VarMeasurementReports* for this *measId* for a duration exceeding the value of *timeToTrigger* defined within the *VarMeasurementConfiguration* for this event:
 - 3> remove the concerned cell(s) in the *cellsToReportList* defined within the *VarMeasurementReports* for this *measId*;

[TS 36.331, clause 5.5.4.3]

The UE shall:

- 1> apply inequality A2-1, as specified below, as the entry condition for this event;
- 1> apply inequality A2-2, as specified below, as the leaving condition for this event;

Inequality A2-1 (Entering condition)

$$M_s - H_{ys} < Thresh$$

Inequality A2-2 (Leaving condition)

$$Ms + Hys > Thresh$$

The variables in the formula are defined as follows:

Ms is the measurement result of the serving cell, not taking into account any cell individual offset.

Hys is the hysteresis parameter for this event (i.e. hysteresis as defined within the *VarMeasurementConfiguration* for this event)

Thresh is the threshold parameter for this event (i.e. a2-Threshold as defined within the *VarMeasurementConfiguration* for this event)

Ms is expressed in dBm in case of RSRP, or in dB in case of RSRQ

Hys is expressed in dB

Thresh is expressed in dBm in case **Ms** is expressed in dBm; otherwise it is expressed in dB

[TS 36.331, clause 5.5.4.4]

The UE shall:

1> apply inequality A3-1, as specified below, as the entry condition for this event;

1> apply inequality A3-2, as specified below, as the leaving condition for this event;

Inequality A3-1 (Entering condition)

$$Mn + Ofn + Ocn - Hys > Ms + OfS + Ocs + Off$$

Inequality A3-2 (Leaving condition)

$$Mn + Ofn + Ocn + Hys < Ms + OfS + Ocs + Off$$

The variables in the formula are defined as follows:

Mn is the measurement result of the neighbouring cell.

Ofn is the frequency specific offset of the frequency of the neighbour cell (equals *Ofs* for intra-frequency measurements and is included in *MeasObjectEUTRA* corresponding to the inter frequency as *offsetFreq* for inter-frequency measurements)

Ocn is the cell specific offset of the neighbour cell. If not configured zero offset shall be applied (included in *MeasObjectEUTRA* of the serving frequency as parameter *cellIndividualOffset* for intra-f measurements and included in *MeasObjectEUTRA* corresponding to the inter frequency as parameter *cellIndividualOffset* for inter-frequency measurements).

Ms is the measurement result of the serving cell, not taking into account any cell individual offset.

Ofs is the frequency specific offset of the serving frequency (i.e. *offsetFreq* within the *MeasObjectEUTRA* corresponding to the serving frequency)

Ocs is the cell specific offset of the serving cell (included in *MeasObjectEUTRA* of the serving frequency as parameter *cellIndividualOffset*)

Hys is the hysteresis parameter for this event (i.e. hysteresis as defined within the *VarMeasurementConfiguration* for this event)

Off is the offset parameter for this event (i.e. a3-Offset as defined within the *VarMeasurementConfiguration* for this event)

Mn, Ms are expressed in dBm in case of RSRP, or in dB in case of RSRQ

Ofn, Ocn, OfS, Ocs, Hys, Off are expressed in dB

[TS 36.331, clause 5.5.5]

For the *measId* for which the measurement reporting procedure was triggered, the UE shall set the *measuredResults* within the *MeasurementReport* message as follows:

- 1> set the IE *measId* to the measurement identity that triggered the measurement reporting;
- 1> set the *mobilityMeasResults* to include all cells included in the *cellsToReportList* as defined within the *VarMeasurementReports* for this *measId*
- 1> for each included cell include the filtered measured results in accordance with the *reportConfigList* defined in variable *VarMeasurementConfiguration* for that *measId*, ordered as follows:
 - 2> If for E-UTRA the *reportQuantity* is set as 'both':
 - 3> include the E-UTRA cells in order of decreasing *triggerQuantity*, i.e. the best cell is included first;
 - 2> else:
 - 3> include the cells in order of decreasing *reportQuantity*, i.e. the best cell is included first.

Editor's note: It is FFS whether, if multiple cells meet the criteria, ordering is also applied irrespective of the cells carrier frequency

- 1> increment the *numberOfReportsSent* as defined within the *VarMeasurementReports* for this *measId* by 1;
- 1> if the *numberOfReportsSent* as defined within the *VarMeasurementReports* for this *measId* is less than to *reportAmount* as defined within the reporting configuration for this event as defined in variable *VarMeasurementConfiguration*:
 - 2> start the periodical reporting timer with the value of *reportInterval* as defined within the *VarMeasurementConfiguration* for this *measId*;

...

- 1> submit the MEASUREMENT REPORT message to lower layers for transmission, upon which the procedure ends.

Editor's note: It is FFS which additional cells may be included in a report, e.g. cells of another type (e.g. best inter-frequency cell included in an intra-frequency report).

8.3.1.6.3 Test description

8.3.1.6.3.1 Pre-test conditions

System Simulator:

- Cell 1 and Cell 3

UE:

None.

Preamble:

- The UE is in state Generic RB Established (state 3) on Cell 1 according to [18].

8.3.1.6.3.2 Test procedure sequence

Table 8.3.1.6.3.2-1 illustrates the downlink power levels to be applied for Cell 1 and Cell 3 at various time instants of the test execution. Row marked "T0" denotes the conditions after the preamble, while rows marked "T1" and "T2" are to be applied subsequently. The exact instants on which these values shall be applied are described in the texts in this clause.

Table 8.3.1.6.3.2-1 : Power levels

	Parameter	Unit	Cell 1	Cell 3	Remark
T0	Cell-specific RS EPRE	dBm/1 5kHz	P01 (FFS)	P02 (FFS)	P01 and P02 shall be such that entry condition for event A2 and event A3 is not satisfied: $M_s + H_{ys} > Thresh$ AND $M_n + O_{fn} + O_{cn} + H_{ys} < M_s + O_{fs} + O_{cs} + Off$
T1	Cell-specific RS EPRE	dBm/1 5kHz	P11 (FFS)	P12 (FFS)	P11 shall be such that entry condition for event A2 is satisfied: $M_s - H_{ys} < Thresh$ AND P11 and P12 shall be such that entry condition for event A3 is not satisfied: $M_n + O_{fn} + O_{cn} + H_{ys} < M_s + O_{fs} + O_{cs} + Off$
T2	Cell-specific RS EPRE	dBm/1 5kHz	P21 (FFS)	P22(FFS)	P21 and P22 shall be such that entry condition for event A3 is satisfied: $M_n + O_{fn} + O_{cn} - H_{ys} > M_s + O_{fs} + O_{cs} + Off$

Table 8.3.1.6.3.2-2: Main behaviour

St	Procedure	Message Sequence		TP	Verdict
		U - S	Message		
1	SS transmits an <i>RRCCONNECTIONRECONFIGURATION</i> message including <i>MEASUREMENTCONFIGURATION</i> to setup intra LTE measurement and reporting for event A2 and event A3 (inter frequency measurement)	<--	<i>RRCCONNECTIONRECONFIGURATION</i>	-	-
2	The UE transmits an <i>RRC CONNECTION RECONFIGURATION COMPLETE</i> message.	-->	<i>RRCCONNECTIONRECONFIGURATIONCOMPLETE</i>	-	-
3	Check: does the UE transmit a <i>MEASUREMENTREPORT</i> message within the next 10s?	-->	<i>MEASUREMENTREPORT</i>	1	F
4	SS re-adjusts the cell-specific reference signal level according to row "T1" in table 8.3.1.6.3.2.-1.	-	-	-	-
5	Check: does the UE transmit a <i>MEASUREMENTREPORT</i> message to report event A2 with the measured RSRP value for Cell 1?	-->	<i>MEASUREMENTREPORT</i>	1	P
6	SS re-adjusts the cell-specific reference signal level according to row "T2" in table 8.3.1.6.3.2.-1.	-	-	-	-
7	Check: does the UE transmit a <i>MEASUREMENTREPORT</i> message to report event A3 with the measured RSRP value for Cell 3?	-->	<i>MEASUREMENTREPORT</i>	2	P
8	Check: Does the test result of CALL generic procedure indicate that the UE is in E-UTRA RRC_CONNECTED state on Cell 1?	-	-		

Editors note: When test tolerances in TS36.508 will cover measurements steps 4 and 6 above will take them into account.

Editor's note: It is FFS if Cell 3 is included in the MeasurementReport in step 5.

8.3.1.6.3.3 Specific message contents

Table 8.3.1.6.3.3-1 RRCConnectionReconfiguration (step 1): measurementConfiguration test specific information elements: FFS**Table 8.3.1.6.3.3-2 MeasurementReport (step 5): measuredResults test specific information elements: FFS****Table 8.3.1.6.3.3-3 MeasurementReport (step 7): measuredResults test specific information elements: FFS**

8.3.1.7 Measurement configuration control and reporting/ intra E-UTRAN measurements: blacklisting

8.3.1.7.1 Test Purpose (TP)

(1)

```
with { UE in E-UTRA RRC_CONNECTED state and measurement configured for event A3 reporting }
ensure that {
  when { Blacklisted neighbour cell satisfies entry condition for event A3 }
  then { It is not considered in event evaluation and UE does not send MeasurementReport message }
}
```

(2)

```
with { UE in E-UTRA RRC_CONNECTED state and measurement reporting triggered by event A3 is ongoing}
ensure that {
  when { Blacklisted neighbour cell satisfies entry condition for event A3 }
  then { It is not considered in measurement reporting }
}
```

8.3.1.7.2 Conformance requirements

References: The conformance requirements covered in the current TC are specified in: TS 36.331, clauses 5.5.1, 5.5.4.1, and 5.5.5.

[TS 36.331, clause 5.5.1]

The UE reports measurement information in accordance with the measurement configuration as provided by E-UTRAN. E-UTRAN provides the measurement configuration applicable for a UE in RRC_CONNECTED state by means of dedicated signalling, i.e. using the *RRCConnectionReconfiguration* message.

...

- For intra-frequency and inter-frequency measurements a measurement object is a single E-UTRA carrier frequency. Associated with this carrier frequency, E-UTRAN can configure a list of cell specific offsets and a list of 'blacklisted' cells. Blacklisted cells are not considered in event evaluation or measurement reporting.

...

[TS 36.331, clause 5.5.4.1]

The UE shall:

1> for each *measId* included in the *measIdList* within *VarMeasConfig*:

...

2> else:

...

3> else if the corresponding *measObject* concerns EUTRA:

- 4> consider any neighbouring cell detected on the associated frequency to be applicable when the concerned cell is not included in the *blackCellsToAddModList* defined within the *VarMeasConfig* for this *measId*;

...

- 2> if the *triggerType* is set to 'event' and if the entry condition applicable for this event, i.e. the event corresponding with the *eventId* of the corresponding *reportConfig* within *VarMeasConfig*, is fulfilled for one or more applicable cells for all measurements after layer 3 filtering taken during *timeToTrigger* defined for this event within the *VarMeasConfig* while the *VarMeasReportList* does not include an entry for this *measId* (a first cell triggers the event):
 - 3> include a measurement reporting entry within the *VarMeasReportList* for this *measId*;
 - 3> set the *numberOfReportsSent* defined within the *VarMeasReportList* for this *measId* to 0;
 - 3> include the concerned cell(s) in the *cellsTriggeredList* defined within the *VarMeasReportList* for this *measId*;
 - 3> initiate the measurement reporting procedure, as specified in 5.5.5;

...

- 2> if the *triggerType* is set to 'event' and if the entry condition applicable for this event, i.e. the event corresponding with the *eventId* of the corresponding *reportConfig* within *VarMeasConfig*, is fulfilled for one or more applicable cells not included in the *cellsTriggeredList* for all measurements after layer 3 filtering taken during *timeToTrigger* defined for this event within the *VarMeasConfig* (a subsequent cell triggers the event):
 - 3> set the *numberOfReportsSent* defined within the *VarMeasReportList* for this *measId* to 0;
 - 3> include the concerned cell(s) in the *cellsTriggeredList* defined within the *VarMeasReportList* for this *measId*;
 - 3> initiate the measurement reporting procedure, as specified in 5.5.5;

...

- 2> if the *triggerType* is set to 'event' and if the leaving condition applicable for this event is fulfilled for one or more of the cells included in the *cellsTriggeredList* defined within the *VarMeasReportList* for this *measId* for all measurements after layer 3 filtering taken during of *timeToTrigger* defined within the *VarMeasurementConfiguration* for this event:
 - 3> remove the concerned cell(s) in the *cellsTriggeredList* defined within the *VarMeasReportList* for this *measId*;
 - 3> if *reportOnLeave* is set to *TRUE* for the corresponding reporting configuration:
 - 4> initiate the measurement reporting procedure, as specified in 5.5.5;
 - 3> if the *cellsTriggeredList* defined within the *VarMeasReportList* for this *measId* is empty:
 - 4> remove the measurement reporting entry within the *VarMeasReportList* for this *measId*;
 - 4> stop the periodical reporting timer for this *measId*, if running;

...

[TS 36.331, clause 5.5.5]

...

For the *measId* for which the measurement reporting procedure was triggered, the UE shall set the *measResults* within the *MeasurementReport* message as follows:

- 1> set the IE *measId* to the measurement identity that triggered the measurement reporting;
- 1> set the *measResultServCell* to include the quantities of serving cell;
- 1> if there is at least one applicable neighbouring cell to report:

- 2> set the *measResultsNeighCells* to include the best neighbouring cells up to *maxReportCells* in accordance with the following:
- 3> if the *triggerType* is set to 'event':
- 4> include the cells included in the *cellsTriggeredList* as defined within the *VarMeasReportList* for this *measId*;
- ...
- 3> for each cell that is included in the *measResultsNeighCells*, include the *physCellId*;
- 3> if the *triggerType* is set to 'event'; or the *purpose* is set to 'reportStrongestCells' or to 'reportStrongestCellsForSON':
- 4> for each included cell include the layer 3 filtered measured results in accordance with the *reportConfigList* for this *measId*, ordered as follows:
- 5> if the *measObject* associated with this *measId* concerns E-UTRA:
- 6> set the *measResult* to include the quantity as indicated by the *triggerQuantity* within the concerned *reportConfig* in order of decreasing *triggerQuantity*, i.e. the best cell is included first;
- ...
- 1> increment the *numberOfReportsSent* as defined within the *VarMeasReportList* for this *measId* by 1;
- 1> stop the periodical reporting timer, if running;
- ...
- 1> submit the *MeasurementReport* message to lower layers for transmission, upon which the procedure ends.

8.3.1.7.3 Test description

8.3.1.7.3.1 Pre-test conditions

System Simulator:

- Cell 1, Cell 2 and Cell 4:
- Cell 1 is the serving cell
- Cell 2 and Cell 4 are intra-frequency neighbour cells

UE:

None.

Preamble:

- The UE is in state Generic RB Established (state 3) according to [18].

8.3.1.7.3.2 Test procedure sequence

Table 8.3.1.7.3.2-1 illustrates the downlink power levels to be applied for Cell 1, Cell 2 and Cell 4 at various time instants of the test execution. Row marked "T0" denotes the conditions after the preamble, while rows marked "T1" and "T2" are to be applied subsequently. The exact instants on which these values shall be applied are described in the texts in this clause.

Table 8.3.1.7.3.2-1 : Power level

	Parameter	Unit	Cell 1	Cell 2	Cell 4	Remark
T0	Cell-specific RS EPRE	dBm/ 15kHz z	-85	-97	-97	Power levels are such that that exit condition for event A3 is satisfied for all cells ($M2 + Hys < M1 + Off$ and $M4 + Hys < M1 + Off$) with all offset parameters set to 0 dB.
T1			-85	-70	-97	Power level of Cell 2 is set such that measurement results for Cell 1 ($M1$) and Cell 2 ($M2$) satisfy entry condition for event A3 ($M2 - Hys > M1 + Off$).
T2			-85	-70	-71	Power level of Cell 4 is set such that measurement results for Cell 1 ($M1$) and Cell 4 ($M4$) satisfy entry condition for event A3 ($M4 - Hys > M1 + Off$).

Editor's note: The limitations on power level settings for multiple cells need to be taken into account

Table 8.3.1.7.3.2-2 : Main behaviour

St	Procedure	Message Sequence		TP	Verdict
		U - S	Message		
1	SS transmits an <i>RRCCONNECTIONRECONFIGURATION</i> message including <i>MEASUREMENTCONFIGURATION</i> to setup intraLTE measurement and reporting for event A3.	<--	<i>RRCCONNECTIONRECONFIGURATION</i>	-	-
2	The UE transmits an <i>RRCCONNECTIONRECONFIGURATIONCOMPLETE</i> message.	-->	<i>RRCCONNECTIONRECONFIGURATIONCOMPLETE</i>	-	-
3	SS re-adjusts the cell-specific reference signal levels according to row "T1" in table 8.3.1.7.3.2.-1.	-	-	-	-
4	Check: does the UE transmit a <i>MEASUREMENTREPORT</i> messages within the next 10s?	-	<i>MEASUREMENTREPORT</i>	1	F
5	SS re-adjusts the cell-specific reference signal levels according to row "T2" in table 8.3.1.7.3.2.-1.	-	-	-	-
6	Check: does the UE transmit a <i>MEASUREMENTREPORT</i> message to report event A3 with the measured RSRP values for Cell 1 and Cell 4 without Cell 2 results?	-->	<i>MEASUREMENTREPORT</i>	2	P
7	SS transmits an <i>RRCCONNECTIONRECONFIGURATION</i> message including <i>MEASUREMENTCONFIGURATION</i> to remove Cell 2 from the blacklisted cell list.	<--	<i>RRCCONNECTIONRECONFIGURATION</i>	-	-
8	The UE transmits an <i>RRCCONNECTIONRECONFIGURATIONCOMPLETE</i> message	-->	<i>RRCCONNECTIONRECONFIGURATIONCOMPLETE</i>	-	-
9	Check: does the UE transmit a <i>MEASUREMENTREPORT</i> message to report event A3 with the measured RSRP values for Cell 1, Cell 2 and Cell 4?	-->	<i>MEASUREMENTREPORT</i>	1, 2	P

8.3.1.7.3.3 Specific message contents

Table 8.3.1.7.3.3-1: *RRCCONNECTIONRECONFIGURATION* (step 1 and step 7, Table 8.3.1.7.3.2-2)

Derivation Path: 36.508 clause 4.6.1 table 4.6.1-8 with condition MEAS
--

Table 8.3.1.7.3.3-2: MeasurementConfiguration (step 1, Table 8.3.1.7.3.2-2)

Derivation path: 36.508 clause 4.6.6 table 4.6.6-1			
Information Element	Value/remark	Comment	Condition
measConfig ::= SEQUENCE { measObjectToAddModList SEQUENCE (SIZE (1..maxObjectId)) OF SEQUENCE { measObjectId[1] measObject[1] } reportConfigToAddModList SEQUENCE (SIZE (1..maxReportConfigId)) OF SEQUENCE { reportConfigId[1] reportConfig[1] } measIdToAddModList SEQUENCE (SIZE (1..maxMeasId)) OF SEQUENCE { measId[1] measObjectId[1] reportConfigId[1] } }	1 entry IdMeasObject-f1 MeasObjectEUTRA-GENERIC(f1) 1 entry IdReportConfig-A3 ReportConfig-A3 1 entry 1 IdMeasObject-f1 IdReportConfig-A3		

Table 8.3.1.7.3.3-3; MeasObjectEUTRA-GENERIC (step 1, Table 8.3.1.7.3.2-2)

Derivation path: 36.508 clause 4.6.6 table 4.6.6-3 MeasObjectEUTRA-GENERIC(f1)			
Information Element	Value/remark	Comment	Condition
MeasObjectEUTRA-GENERIC(f1) ::= SEQUENCE { blackCellsToAddModList ::= SEQUENCE (SIZE (1..maxCellMeas)) OF SEQUENCE { cellIndex[1] physCellIdRange[1] } }	1 entry 1 physicalCellIdentity-Cell2	Add Cell 2	

Table 8.3.1.7.3.3-4: ReportConfig-A3 (step 1, Table 8.3.1.7.3.2-2)

Derivation path: 36.508 clause 4.6.6 table 4.6.6-6 ReportConfigEUTRA-A3			
Information Element	Value/remark	Comment	Condition
ReportConfigEUTRA-A3 ::= SEQUENCE { maxReportCells	3	Report Cell 1, Cell 2 and Cell 4	
reportInterval	Not present		
}			

Table 8.3.1.7.3.3-5: MeasurementConfiguration (step 7, Table 8.3.1.7.3.2-2)

Derivation Path: 36.508 clause 4.6.6 table 4.6.6-1			
Information Element	Value/remark	Comment	Condition
measConfig ::= SEQUENCE { measObjectToAddModList SEQUENCE (SIZE (1..maxObjectId)) OF SEQUENCE { measObjectId[1] measObject[1] } }	1 entry IdMeasObject-f1 MeasObjectEUTRA-GENERIC(f1)		

2> consider the target cell to be one on the frequency indicated by the *carrierFreq* with a physical cell identity indicated by the *targetPhysCellId*;

1> else:

2> consider the target cell to be one on the current frequency with a physical cell identity indicated by the *targetPhysCellId*;

1> start synchronising to the DL of the target cell;

NOTE 1: The UE should perform the handover as soon as possible following the reception of the RRC message triggering the handover, which could be before confirming successful reception (HARQ and ARQ) of this message.

1> reset MAC;

1> re-establish PDCP for all RBs that are established;

NOTE 2: The handling of the radio bearers after the successful completion of the PDCP re-establishment, e.g. the re-transmission of unacknowledged PDCP SDUs (as well as the associated status reporting), the handling of the SN and the HFN, is specified in TS 36.323 [8].

1> re-establish RLC for all RBs that are established;

1> apply the value of the *newUE-Identity* as the C-RNTI;

1> configure lower layers in accordance with the received *radioResourceConfigCommon*;

1> if the *RRCCONNECTIONRECONFIGURATION* message includes the *radioResourceConfigDedicated*:

2> perform the radio resource configuration procedure as specified in 5.3.10;

1> if the *keyChangeIndicator* received in the *securityConfigHO* is set to *TRUE*:

2> update the K_{eNB} key based on the K_{ASME} key taken into use with the previous successful NAS SMC procedure, as specified in TS 33.401 [32];

1> else:

2> update the K_{eNB} key based on the K_{ASME} key to which the current K_{eNB} is associated, using the *nextHopChainingCount* value indicated in the *securityConfigHO*, as specified in TS 33.401 [32];

1> store the *nextHopChainingCount* value;

1> if the *securityAlgorithmConfig* is included in the *securityConfigHO*:

2> derive the K_{RRcint} key associated with the *integrityProtAlgorithm*, as specified in TS 33.401 [32];

2> derive the K_{RRcenc} key and the K_{UPenc} key associated with the *cipheringAlgorithm*, as specified in TS 33.401 [32];

1> else:

2> derive the K_{RRcint} key associated with the current integrity algorithm, as specified in TS 33.401 [32];

2> derive the K_{RRcenc} key and the K_{UPenc} key associated with the current ciphering algorithm, as specified in TS 33.401 [32];

1> configure lower layers to apply the integrity protection algorithm and the K_{RRcint} key, i.e. the integrity protection configuration shall be applied to all subsequent messages received and sent by the UE, including the message used to indicate the successful completion of the procedure;

1> configure lower layers to apply the ciphering algorithm, the K_{RRcenc} key and the K_{UPenc} key, i.e. the ciphering configuration shall be applied to all subsequent messages received and sent by the UE, including the message used to indicate the successful completion of the procedure;

1> perform the measurement related actions as specified in 5.5.6.1;

- 1> if the *RRCConnectionReconfiguration* message includes the *measConfig*:
 - 2> perform the measurement configuration procedure as specified in 5.5.2;
- 1> submit the *RRCConnectionReconfigurationComplete* message to lower layers for transmission;
- 1> if MAC successfully completes the random access procedure:
 - 2> stop timer T304;
 - 2> apply the parts of the configuration that do not require the UE to know the SFN of the target cell;
 - 2> apply the parts of the measurement and the radio resource configuration that require the UE to know the SFN of the target cell (e.g. measurement gaps, periodic CQI reporting, scheduling request configuration, sounding RS configuration), if any, upon acquiring the SFN of the target cell;
 - 2> the procedure ends;

...

[TS 36.331, clause 5.5.2.2]

The UE shall:

- 1> for each *measId* included in the received *measIdToRemoveList* that is part of the current UE configuration in *varMeasConfig*:
 - 2> remove the entry with the matching *measId* from the *measIdList* within the *VarMeasConfig*;
 - 2> remove the measurement reporting entry for this *measId* from the *VarMeasReportList*, if included;

...

[TS 36.331, clause 5.5.2.6]

The UE shall:

- 1> for each *reportConfigId* included in the received *reportConfigToRemoveList* that is part of the current UE configuration in *varMeasConfig*:
 - 2> remove the entry with the matching *reportConfigId* from the *reportConfigList* within the *VarMeasConfig*;
 - 2> remove all *measId* associated with the *reportConfigId* from the *measIdList* within the *VarMeasConfig*, if any;
 - 2> if a *measId* is removed from the *measIdList*:
 - 3> remove the measurement reporting entry for this *measId* from the *VarMeasReportList*, if included;
 - 3> stop the periodical reporting timer or timer T321, whichever one is running, and reset the associated information (e.g. *timeToTrigger*) for this *measId*;

NOTE: The UE does not consider the message as erroneous if the *reportConfigToRemoveList* includes any *reportConfigId* value that is not part of the current UE configuration.

[TS 36.331, clause 5.5.4.4]

The UE shall:

- 1> consider the entering condition for this event to be satisfied when condition A3-1, as specified below, is fulfilled;
- 1> consider the leaving condition for this event to be satisfied when condition A3-2, as specified below, is fulfilled;

Inequality A3-1 (Entering condition)

$$Mn + Ofn + Ocn - Hys > Ms + Ofs + Ocs + Off$$

Inequality A3-2 (Leaving condition)

$$Mn + Ofn + Ocn + Hys < Ms + OfS + Ocs + Off$$

The variables in the formula are defined as follows:

Mn is the measurement result of the neighbouring cell, not taking into account any offsets.

Ofn is the frequency specific offset of the frequency of the neighbour cell (i.e. *offsetFreq* as defined within *measObjectEUTRA* corresponding to the frequency of the neighbour cell).

Ocn is the cell specific offset of the neighbour cell (i.e. *cellIndividualOffset* as defined within *measObjectEUTRA* corresponding to the frequency of the neighbour cell), and set to zero if not configured for the neighbour cell.

Ms is the measurement result of the serving cell, not taking into account any offsets.

Ofs is the frequency specific offset of the serving frequency (i.e. *offsetFreq* as defined within *measObjectEUTRA* corresponding to the serving frequency).

Ocs is the cell specific offset of the serving cell (i.e. *cellIndividualOffset* as defined within *measObjectEUTRA* corresponding to the serving frequency), and is set to zero if not configured for the serving cell.

Hys is the hysteresis parameter for this event (i.e. *hysteresis* as defined within *reportConfigEUTRA* for this event).

Off is the offset parameter for this event (i.e. *a3-Offset* as defined within *reportConfigEUTRA* for this event).

Mn, Ms are expressed in dBm in case of RSRP, or in dB in case of RSRQ.

Ofn, Ocn, OfS, Ocs, Hys, Off are expressed in dB.

8.3.1.8.3 Test description

8.3.1.8.3.1 Pre-test conditions

System Simulator:

- Cell 1 and Cell 2.

UE:

None.

Preamble:

- The UE is in state Generic RB Established (state 3) on Cell 1 according to [18].

8.3.1.8.3.2 Test procedure sequence

Table 8.3.1.8.3.2-1 illustrates the downlink power levels and other changing parameters to be applied for the cells at various time instants of the test execution. Row marked "T0" denotes the initial conditions, while columns marked "T1" is to be applied subsequently. The exact instants on which these values shall be applied are described in the texts in this clause.

Table 8.3.1.8.3.2-1: Time instances of cell power level and parameter changes

	Parameter	Unit	Cell 1	Cell 2	Remark
T0	Cell-specific RS EPRE	dBm/15k Hz	-70	-90	The power level values are such that measurement results for Cell 1 (M1) and Cell 2 (M2) satisfy exit condition for event A3 ($M2 + Hys < M1$).
T1	Cell-specific RS EPRE	dBm/15k Hz	-95	-70	The power level values are such that measurement results for Cell 1 (M1) and Cell 2 (M2) satisfy entry condition for event A3 ($M2 - Hys > M1$).

Table 8.3.1.8.3.2-2: Main behaviour

St	Procedure	Message Sequence		TP	Verdict
		U - S	Message		
1	The SS transmits an <i>RRConnectionReconfiguration</i> message on Cell 1 to setup intra frequency measurement.	<--	<i>RRConnectionReconfiguration</i>	-	-
2	The UE transmits an <i>RRConnectionReconfigurationComplete</i> message on Cell 1 to confirm the setup of intra frequency measurement.	-->	<i>RRConnectionReconfigurationComplete</i>	-	-
3	The SS changes Cell 1 and Cell 2 parameters according to the row "T1" in table 8.3.1.8.3.2-1.	-	-	-	-
4	The UE transmits a <i>MeasurementReport</i> message on Cell 1 to report event A3.	-->	<i>MeasurementReport</i>	-	-
5	The SS transmits an <i>RRConnectionReconfiguration</i> message with a <i>measConfig</i> on Cell 1 for removing event A3 reporting, to order the UE to perform intra frequency handover to Cell 2.	<--	<i>RRConnectionReconfiguration</i>	-	-
6	Check: Does the UE transmit an <i>RRConnectionReconfigurationComplete</i> message on Cell 2?	-->	<i>RRConnectionReconfigurationComplete</i>	1	P
7	The SS changes Cell 1 and Cell 2 parameters according to the row "T0" in table 8.3.1.8.3.2-1.	-	-	-	-
8	Check: Does the UE transmit a <i>MeasurementReport</i> message on Cell 2 to perform event A3 reporting during the next 30s?	-->	<i>MeasurementReport</i>	1	F
9	Check: Does the test result of CALL generic procedure indicate that the UE is in E-UTRA RRC_CONNECTED state on Cell 2?	-	-	1	-

8.3.1.8.3.3 Specific message contents

Table 8.3.1.8.3.3-1: *RRConnectionReconfiguration* (step 1, Table 8.3.1.8.3.2-2)

Derivation Path: 36.508, Table 4.6.1-8, condition MEAS

Table 8.3.1.8.3.3-2: *MeasConfig* (step 1, Table 8.3.1.8.3.2-2)

Derivation Path: 36.508, Table 4.6.6-1			
Information Element	Value/remark	Comment	Condition
<i>MeasConfig</i> ::= SEQUENCE {			
<i>measObjectToAddModList</i> SEQUENCE (SIZE (1..maxObjectld)) OF SEQUENCE {	1 entry		
<i>measObjectld</i> [1]	IdMeasObject-f1		
<i>measObject</i> [1]	MeasObjectEUTRA-GENERIC(f1)		
}			
<i>reportConfigToAddModList</i> SEQUENCE (SIZE (1..maxReportConfigld)) OF SEQUENCE {	1 entry		
<i>reportConfigld</i> [1]	IdReportConfig-A3		
<i>reportConfig</i> [1]	ReportConfigEUTRA-A3		
}			
<i>measldToAddModList</i> SEQUENCE (SIZE (1..maxMeasld)) OF SEQUENCE {	1 entry		
<i>measld</i> [1]	1		
<i>measObjectld</i> [1]	IdMeasObject-f1		
<i>reportConfigld</i> [1]	IdReportConfig-A3		
}			
}			

Table 8.3.1.8.3.3-3: MeasurementReport (step 4, Table 8.3.1.8.3.2-2)

Derivation Path: 36.508, Table 4.6.1-5			
Information Element	Value/remark	Comment	Condition
MeasurementReport ::= SEQUENCE {			
criticalExtensions CHOICE {			
c1 CHOICE{			
measurementReport-r8 SEQUENCE {			
measResults SEQUENCE {			
measId	1		
measResultServCell SEQUENCE {			
rsrpResult	(0..97)		
rsrqResult	(0..34)		
}			
measResultNeighCells CHOICE {			
measResultListEUTRA SEQUENCE (SIZE (1..maxCellReport)) OF SEQUENCE {	1 entry		
physCellId[1]	PhysicalCellIdentity of Cell 2		
cgi-Info[1]	Not present		
measResult SEQUENCE {			
rsrpResult	(0..97)		
rsrqResult	(0..34)		
}			
}			
}			
}			
}			
}			
}			

Table 8.3.1.8.3.3-4: RRCConnectionReconfiguration (step 5, Table 8.3.1.8.3.2-2)

Derivation Path: 36.508, Table 4.6.1-8, condition HO			
Information Element	Value/remark	Comment	Condition
RRCConnectionReconfiguration ::= SEQUENCE {			
criticalExtensions CHOICE {			
c1 CHOICE{			
rrcConnectionReconfiguration-r8 SEQUENCE {			
measConfig	MeasurementConfigurati on-DEFAULT		
}			
}			
}			
}			

Table 8.3.1.8.3.3-5: MeasConfig (step 5, Table 8.3.1.8.3.2-2)

Derivation Path: 36.508, Table 4.6.6-1			
Information Element	Value/remark	Comment	Condition
MeasConfig ::= SEQUENCE {			
measObjectToRemoveList	IdMeasObject-f1		
reportConfigToRemoveList SEQUENCE (SIZE (1..maxReportConfigId)) OF SEQUENCE {	1 entry		
ReportConfigId[1]	IdReportConfig-A3		
}			
measIdToRemoveList SEQUENCE (SIZE (1..maxMeasId)) OF SEQUENCE {	1 entry		
MeasId[1]	1		
}			
}			

Table 8.3.1.8.3.3-6: *MobilityControlInfo* (step 5, Table 8.3.1.8.3.2-2)

Derivation Path: 36.508, Table 4.6.5-1			
Information Element	Value/remark	Comment	Condition
MobilityControlInfo ::= SEQUENCE {			
targetPhysCellId	PhysicalCellId of Cell 2		
carrierFreq	Not present		
}			

8.3.1.9 Measurement configuration control and reporting / intra E-UTRAN measurements: intra-frequency handover (IE measurement configuration not present)

8.3.1.9.1 Test Purpose (TP)

(1)

```
with { UE having completed the radio bearer establishment, initial security activation procedure and
performed the intra frequency and inter frequency measurements }
ensure that {
  when { UE receives an RRCConnectionReconfiguration message including a mobilityControlInfo and not
including a measConfig }
  then { UE performs intra frequency handover, continues the intra frequency measurement and
continues inter frequency measurement after the activation of the measurement gaps }
}
```

8.3.1.9.2 Conformance requirements

References: The conformance requirements covered in the present TC are specified in: TS 36.331, clause 5.5.4.4 and 5.5.6.1.

[TS 36.331, clause 5.5.4.4]

The UE shall:

1> consider the entering condition for this event to be satisfied when condition A3-1, as specified below, is fulfilled;

1> consider the leaving condition for this event to be satisfied when condition A3-2, as specified below, is fulfilled;

Inequality A3-1 (Entering condition)

$$Mn + Ofn + Ocn - Hys > Ms + OfS + Ocs + Off$$

Inequality A3-2 (Leaving condition)

$$Mn + Ofn + Ocn + Hys < Ms + OfS + Ocs + Off$$

The variables in the formula are defined as follows:

Mn is the measurement result of the neighbouring cell, not taking into account any offsets.

Ofn is the frequency specific offset of the frequency of the neighbour cell (i.e. *offsetFreq* as defined within *measObjectEUTRA* corresponding to the frequency of the neighbour cell).

Ocn is the cell specific offset of the neighbour cell (i.e. *cellIndividualOffset* as defined within *measObjectEUTRA* corresponding to the frequency of the neighbour cell), and set to zero if not configured for the neighbour cell.

Ms is the measurement result of the serving cell, not taking into account any offsets.

Ofs is the frequency specific offset of the serving frequency (i.e. *offsetFreq* as defined within *measObjectEUTRA* corresponding to the serving frequency).

Ocs is the cell specific offset of the serving cell (i.e. *cellIndividualOffset* as defined within *measObjectEUTRA* corresponding to the serving frequency), and is set to zero if not configured for the serving cell.

Hys is the hysteresis parameter for this event (i.e. *hysteresis* as defined within *reportConfigEUTRA* for this event).

Off is the offset parameter for this event (i.e. *a3-Offset* as defined within *reportConfigEUTRA* for this event).

Mn, *Ms* are expressed in dBm in case of RSRP, or in dB in case of RSRQ.

Ofn, *Ocn*, *Ofs*, *Ocs*, *Hys*, *Off* are expressed in dB.

[TS 36.331, clause 5.5.6.1]

E-UTRAN applies the handover procedure as follows:

- when performing the handover procedure, as specified in 5.3.5.4, ensure that a *measObjectId* corresponding to the handover target carrier frequency is configured as a result of the procedures described in this sub-clause and in 5.3.5.4;

...

The UE shall:

- 1> for each *measId* included in the *measIdList* within *VarMeasConfig*:
 - 2> if the *triggerType* is set to 'periodical':
 - 3> remove this *measId* from the *measIdList* within *VarMeasConfig*:
- 1> if the procedure was triggered due to inter-frequency handover or successful re-establishment to an inter-frequency cell, update the *measId* values in the *measIdList* within *VarMeasConfig* as follows:
 - 2> if a *measObjectId* value corresponding to the target carrier frequency exists in the *measObjectList* within *VarMeasConfig*:
 - 3> for each *measId* value in the *measIdList*:
 - 4> if the *measId* value is linked to the *measObjectId* value corresponding to the source carrier frequency:
 - 5> link this *measId* value to the *measObjectId* value corresponding to the target carrier frequency;
 - 4> else if the *measId* value is linked to the *measObjectId* value corresponding to the target carrier frequency:
 - 5> link this *measId* value to the *measObjectId* value corresponding to the source carrier frequency;
 - 2> else:
 - 3> remove all *measId* values that are linked to the *measObjectId* value corresponding to the source carrier frequency;
 - 1> remove all measurement reporting entries within *VarMeasReportList*;
 - 1> reset the periodical reporting timer or timer T321, whichever one is running, as well as associated information (e.g. *timeToTrigger*) for all *measId*;
 - 1> release the measurement gaps, if activated;

NOTE: If the UE requires measurement gaps to perform inter-frequency or inter-RAT measurements, the UE resumes the inter-frequency and inter-RAT measurements after the E-UTRAN has setup the measurement gaps.

8.3.1.9.3 Test description

8.3.1.9.3.1 Pre-test conditions

System Simulator:

- Cell 1 and Cell 2, Cell 3.

UE:

None.

Preamble:

- The UE is in state Generic RB Established (state 3) on Cell 1 according to [18].

8.3.1.9.3.2 Test procedure sequence

Table 8.3.1.9.3.2-1 illustrates the downlink power levels and other changing parameters to be applied for the cells at various time instants of the test execution. Row marked "T0" denotes the initial conditions, while columns marked "T1", "T2", "T3" and "T4" are to be applied subsequently. The exact instants on which these values shall be applied are described in the texts in this clause.

Table 8.3.1.9.3.2-1: Time instances of cell power level and parameter changes

	Parameter	Unit	Cell 1	Cell 2	Cell 3	Remark
T0	Cell-specific RS EPRE	dBm/15 kHz	-70	-90	-90	The power level values are such that camping on Cell 1 is guaranteed.
T1	Cell-specific RS EPRE	dBm/15 kHz	-95	-95	-70	The power level values are such that measurement results for Cell 1 (M1) and Cell 3 (M3) satisfy entry condition for event A3 (M3 - Hys > M1).
T2	Cell-specific RS EPRE	dBm/15 kHz	-90	-70	-90	The power level values are such that measurement results for Cell 1 (M1) and Cell 2 (M2) satisfy entry condition for event A3 (M2 - Hys > M1).
T3	Cell-specific RS EPRE	dBm/15 kHz	-95	-95	-70	The power level values are such that measurement results for Cell 2 (M2) and Cell 3 (M3) satisfy entry condition for event A3 (M3 - Hys > M2).
T4	Cell-specific RS EPRE	dBm/15 kHz	-70	-90	-90	The power level values are such that measurement results for Cell 1 (M1) and Cell 2 (M2) satisfy entry condition for event A3 (M1 - Hys > M2).

Table 8.3.1.9.3.2-2: Main behaviour

St	Procedure	Message Sequence		TP	Verdict
		U - S	Message		
1	The SS transmits an <i>RRConnectionReconfiguration</i> message to setup intra and inter frequency measurements on Cell 1.	<--	<i>RRConnectionReconfiguration</i>	-	-
2	The UE transmits an <i>RRConnectionReconfigurationComplete</i> message to confirm the setup of intra and inter frequency measurements on Cell 1.	-->	<i>RRConnectionReconfigurationComplete</i>	-	-
-	EXCEPTION: Steps 3a1 to 3a2 describe behaviour that depends on the UE capability; the "lower case letter" identifies a step sequence that take place if a capability is supported.	-	-	-	-
3a1	IF <i>pc_FeatrGrp_25</i> THEN the SS changes Cell 1, Cell 2 and Cell 3 parameters according to the row "T1" in table 8.3.1.9.3.2-1.	-	-	-	-
3a2	The UE transmits a <i>MeasurementReport</i> message on Cell 1 to report event A3 for Cell 3.	-->	<i>MeasurementReport</i>	-	-
4	The SS changes Cell 1, Cell 2 and Cell 3 parameters according to the row "T2" in table 8.3.1.9.3.2-1.	-	-	-	-
5	The UE transmits a <i>MeasurementReport</i> message on Cell 1 to report event A3 for Cell 2.	-->	<i>MeasurementReport</i>	-	-
6	The SS transmits an <i>RRConnectionReconfiguration</i> message without a <i>measConfig</i> message on Cell 1, to order the UE to perform intra frequency handover to Cell 2.	<--	<i>RRConnectionReconfiguration</i>	-	-
7	Check: Does the UE transmit an <i>RRConnectionReconfigurationComplete</i> message on Cell 2?	-->	<i>RRConnectionReconfigurationComplete</i>	1	P
-	EXCEPTION: Steps 8a1 to 8a4 describe behaviour that depends on the UE capability; the "lower case letter" identifies a step sequence that take place if a capability is supported.	-	-	-	-
8a1	IF <i>pc_FeatrGrp_25</i> THEN the SS transmits an <i>RRConnectionReconfiguration</i> message to activate the measurement gaps on Cell 2.	<--	<i>RRConnectionReconfiguration</i>	-	-
8a2	The UE transmits an <i>RRConnectionReconfigurationComplete</i> message to confirm the activation of the measurement gaps on Cell 2.	-->	<i>RRConnectionReconfigurationComplete</i>	-	-
8a3	The SS changes Cell 1, Cell 2 and Cell 3 parameters according to the row "T3" in table 8.3.1.9.3.2-1.	-	-	-	-
8a4	Check: Does the UE transmit a <i>MeasurementReport</i> message on Cell 2 to report event A3 for Cell 3?	-->	<i>MeasurementReport</i>	1	P
9	The SS changes Cell 1, Cell 2 and Cell 3 parameters according to the row "T4" in table 8.3.1.9.3.2-1.	-	-	-	-
10	Check: Does the UE transmit a <i>MeasurementReport</i> message on Cell 2 to report event A3 for Cell 1?	-->	<i>MeasurementReport</i>	1	P
11	Check: Does the test result of CALL generic procedure indicate that the UE is in E-UTRA RRC_CONNECTED state on Cell 2.	-	-	1	-

8.3.1.9.3.3 Specific message contents

Table 8.3.1.9.3.3-1: RRCConnectionReconfiguration (step 1, Table 8.3.1.9.3.2-2)

Derivation Path: 36.508, Table 4.6.1-8, condition MEAS

Table 8.3.1.9.3.3-2: MeasConfig (step 1, Table 8.3.1.9.3.2-2)

Derivation Path: 36.508, Table 4.6.6-1, condition INTER-FREQ			
Information Element	Value/remark	Comment	Condition
MeasConfig ::= SEQUENCE {			
measObjectToAddModList SEQUENCE (SIZE (1..maxObjectId)) OF SEQUENCE {	1 entry or 2 entries	number of entry depending on the UE capability	
measObjectId[1]	IdMeasObject-f1		
measObject[1]	MeasObjectEUTRA-GENERIC(f1)		
measObjectId[2]	IdMeasObject-f2		pc_25
measObject[2]	MeasObjectEUTRA-GENERIC(f2)		pc_25
}			
reportConfigToAddModList SEQUENCE (SIZE (1..maxReportConfigId)) OF SEQUENCE {	1 entry		
reportConfigId[1]	IdReportConfig-A3		
reportConfig[1]	ReportConfigEUTRA-A3		
}			
measIdToAddModList SEQUENCE (SIZE (1..maxMeasId)) OF SEQUENCE {	1 entry or 2 entries	number of entry depending on the UE capability	
measId[1]	1	Intra frequency	
measObjectId[1]	IdMeasObject-f1		
reportConfigId[1]	IdReportConfig-A3		
measId[2]	2	Inter frequency	pc_25
measObjectId[2]	IdMeasObject-f2		pc_25
reportConfigId[2]	IdReportConfig-A3		pc_25
}			
}			

Table 8.3.1.9.3.3-3: MeasurementReport (step 3a2 and 8a4, Table 8.3.1.9.3.2-2)

Derivation Path: 36.508, Table 4.6.1-5			
Information Element	Value/remark	Comment	Condition
MeasurementReport ::= SEQUENCE {			
criticalExtensions CHOICE {			
c1 CHOICE{			
measurementReport-r8 SEQUENCE {			
measResults SEQUENCE {			
measId	2		
measResultServCell SEQUENCE {			
rsrpResult	(0..97)		
rsrqResult	(0..34)		
}			
measResultNeighCells CHOICE {			
measResultListEUTRA SEQUENCE (SIZE (1..maxCellReport)) OF SEQUENCE {	1 entry		
physCellId[1]	PhysicalCellIdentity of Cell 3		
cgi-Info[1]	Not present		
measResult[1] SEQUENCE {			
rsrpResult	(0..97)		
rsrqResult	(0..34)		
}			
}			
}			
}			
}			
}			
}			

Table 8.3.1.9.3.3-4: MeasurementReport (step 5, Table 8.3.1.9.3.2-2)

Derivation Path: 36.508, Table 4.6.1-5			
Information Element	Value/remark	Comment	Condition
MeasurementReport ::= SEQUENCE {			
criticalExtensions CHOICE {			
c1 CHOICE{			
measurementReport-r8 SEQUENCE {			
measResults SEQUENCE {			
measId	1		
measResultServCell SEQUENCE {			
rsrpResult	(0..97)		
rsrqResult	(0..34)		
}			
measResultNeighCells CHOICE {			
measResultListEUTRA SEQUENCE (SIZE (1..maxCellReport)) OF SEQUENCE {	1 entry		
physCellId[1]	PhysicalCellIdentity of Cell 2		
cgi-Info[1]	Not present		
measResult[1] SEQUENCE {			
rsrpResult	(0..97)		
rsrqResult	(0..34)		
}			
}			
}			
}			
}			
}			
}			

Table 8.3.1.9.3.3-5: RRCConnectionReconfiguration (step 6, Table 8.3.1.9.3.2-2)

Derivation Path: 36.508, Table 4.6.1-8, condition HO

Table 8.3.1.9.3.3-6: MobilityControlInfo (step 6, Table 8.1.3.9.3.2-2)

Derivation Path: 36.508, Table 4.6.5-1			
Information Element	Value/remark	Comment	Condition
MobilityControlInfo ::= SEQUENCE {			
targetPhysCellId	PhysicalCellId of Cell 2		
carrierFreq	Not present		
}			

Table 8.3.1.9.3.3-7: RRCConnectionReconfiguration (step 8a1, Table 8.3.1.9.3.2-2)

Derivation Path: 36.508, Table 4.6.1-8, condition MEAS

Table 8.3.1.9.3.3-8: MeasConfig (step 8a1, Table 8.1.3.9.3.2-2)

Derivation Path: 36.508, Table 4.6.6-1, condition INTER-FREQ

Table 8.3.1.9.3.3-9: MeasurementReport (step 10, Table 8.3.1.9.3.2-2)

Derivation Path: 36.508, Table 4.6.1-5			
Information Element	Value/remark	Comment	Condition
MeasurementReport ::= SEQUENCE {			
criticalExtensions CHOICE {			
c1 CHOICE{			
measurementReport-r8 SEQUENCE {			
measResults SEQUENCE {			
measId	1		
measResultServCell SEQUENCE {			
rsrpResult	(0..97)		
rsrqResult	(0..34)		
}			
MeasResultNeighCells CHOICE {			
measResultListEUTRA SEQUENCE (SIZE (1..maxCellReport)) OF SEQUENCE {	1 entry		
physCellId[1]	PhysicalCellId of Cell 1		
cgi-Info[1]	Not present		
measResult[1] SEQUENCE {			
rsrpResult	(0..97)		
rsrqResult	(0..34)		
}			
}			
}			
}			
}			

8.3.1.10 Measurement configuration control and reporting / intra E-UTRAN measurements: inter-frequency handover (IE measurement configuration not present)

8.3.1.10.1 Test Purpose (TP)

(1)

```
with { UE having completed the radio bearer establishment, initial security activation procedure and
performed the intra frequency and inter frequency measurements }
ensure that {
  when { UE receives an RRCConnectionReconfiguration message including a mobilityControlInfo
indicating a different E-UTRA frequency and not including a measConfig }
  then { UE performs inter frequency handover, continues the intra frequency measurement and
continues inter frequency measurement after the activation of the measurement gaps }
}
```

8.3.1.10.2 Conformance requirements

References: The conformance requirements covered in the present TC are specified in: TS 36.331, clause 5.5.6.1.

[TS 36.331, clause 5.5.6.1]

E-UTRAN applies the handover procedure as follows:

- when performing the handover procedure, as specified in 5.3.5.4, ensure that a *measObjectId* corresponding to the handover target carrier frequency is configured as a result of the procedures described in this subclause and in 5.3.5.4;

...

The UE shall:

- 1> for each *measId* included in the *measIdList* within *VarMeasConfig*:
 - 2> if the *triggerType* is set to 'periodical':
 - 3> remove this *measId* from the *measIdList* within *VarMeasConfig*:
 - 1> if the procedure was triggered due to inter-frequency handover or successful re-establishment to an inter-frequency cell, update the *measId* values in the *measIdList* within *VarMeasConfig* as follows:
 - 2> if a *measObjectId* value corresponding to the target carrier frequency exists in the *measObjectList* within *VarMeasConfig*
 - 3> for each *measId* value in the *measIdList*:
 - 4> if the *measId* value is linked to the *measObjectId* value corresponding to the source carrier frequency:
 - 5> link this *measId* value to the *measObjectId* value corresponding to the target carrier frequency;
 - 4> else if the *measId* value is linked to the *measObjectId* value corresponding to the target carrier frequency:
 - 5> link this *measId* value to the *measObjectId* value corresponding to the source carrier frequency;
 - 2> else:
 - 3> remove all *measId* values that are linked to the *measObjectId* value corresponding to the source carrier frequency;
 - 1> remove all measurement reporting entries within *VarMeasReportList*;
 - 1> reset the periodical reporting timer or timer T321, whichever one is running, as well as associated information (e.g. *timeToTrigger*) for all *measId*;
 - 1> release the measurement gaps, if activated.

NOTE: If the UE requires measurement gaps to perform inter-frequency or inter-RAT measurements, the UE resumes the inter-frequency and inter-RAT measurements after the E-UTRAN has setup

8.3.1.10.3 Test description

8.3.1.10.3.1 Pre-test conditions

System Simulator:

- Cell 1, Cell 2, Cell 3 and Cell 12.

UE:

None.

Preamble:

- The UE is in state Generic RB Established (state 3) on Cell 1 according to [18].

8.3.1.10.3.2 Test procedure sequence

Table 8.3.1.10.3.2-1 illustrates the downlink power levels and other changing parameters to be applied for the cells at various time instants of the test execution. Row marked "T0" denotes the initial conditions, while columns marked "T1", "T2", "T3", and "T4" are to be applied subsequently. The exact instants on which these values shall be applied are described in the texts in this clause.

Table 8.3.1.10.3.2-1: Time instances of cell power level and parameter changes

	Parameter	Unit	Cell 1	Cell 2	Cell 3	Cell 12	Remark
T0	Cell-specific RS EPRE	dBm/15 kHz	-70	-90	-90	"off"	The power level values are such that camping on Cell 1 is guaranteed. (NOTE 1).
T1	Cell-specific RS EPRE	dBm/15 kHz	-90	-70	-90	"off"	The power level values are such that measurement results for Cell 1 (M1) and Cell 2 (M2) satisfy entry condition for event A3 (M2 - Hys > M1). (NOTE 1).
T2	Cell-specific RS EPRE	dBm/15 kHz	-95	"off"	-70	-90	The power level values are such that camping on Cell 1 and measurement results for Cell 1 (M1) and Cell 3 (M3) satisfy entry condition for event A3 (M3 - Hys > M1). (NOTE 1).
T3	Cell-specific RS EPRE	dBm/15 kHz	-95	"off"	-95	-70	The power level values are such that measurement results for Cell 3 (M3) and Cell 12 (M12) satisfy entry condition for event A3 (M12 - Hys > M3). (NOTE 1).
T4	Cell-specific RS EPRE	dBm/15 kHz	-55	-97	-80	"off"	The power level values are such that measurement results for Cell 1 (M1) and Cell 3 (M3) satisfy entry condition for event A3 (M1 - Hys > M3). (NOTE 1).
NOTE 1: Power level "Off" is defined in TS36.508 Table 6.2.2.1-1.							

Table 8.3.1.10.3.2-2: Main behaviour

St	Procedure	Message Sequence		TP	Verdict
		U - S	Message		
1	The SS transmits an <i>RRCCONNECTIONRECONFIGURATION</i> message to setup intra and inter frequency measurements on Cell 1.	<--	<i>RRCCONNECTIONRECONFIGURATION</i>	-	-
2	The UE transmits an <i>RRCCONNECTIONRECONFIGURATIONCOMPLETE</i> message to confirm the setup of intra and inter frequency measurements on Cell 1.	-->	<i>RRCCONNECTIONRECONFIGURATIONCOMPLETE</i>	-	-
3	The SS changes Cell 1, Cell 2 and Cell 3 parameters according to the row "T1" in table 8.3.1.10.3.2-1.	-	-	-	-
4	The UE transmits a <i>MEASUREMENTREPORT</i> message on Cell 1 to perform event A3 intra frequency reporting for Cell 2 during the next 30 s.	-	<i>MEASUREMENTREPORT</i>	-	-
5	The SS changes Cell 1 and Cell 3 parameters, sets the cell-specific reference signal levels and switches Cell 12 on and Cell 2 off according to row "T2" in table 8.3.1.10.3.2-1.	-	-	-	-
6	The UE transmits a <i>MEASUREMENTREPORT</i> message on Cell 1 to perform event A3 inter frequency reporting for Cell 3 during the next 30 s.	-->	<i>MEASUREMENTREPORT</i>	-	-
7	The SS transmits an <i>RRCCONNECTIONRECONFIGURATION</i> message without a <i>MEASUREMENTCONFIG</i> , to order the UE to perform inter frequency handover to Cell 3.	<--	<i>RRCCONNECTIONRECONFIGURATION</i>	-	-
8	Check: Does the UE transmit an <i>RRCCONNECTIONRECONFIGURATIONCOMPLETE</i> message to Cell 3?	-->	<i>RRCCONNECTIONRECONFIGURATIONCOMPLETE</i>	1	P
9	The SS transmits an <i>RRCCONNECTIONRECONFIGURATION</i> message to activate the measurement gaps on Cell 3.	<--	<i>RRCCONNECTIONRECONFIGURATION</i>	-	-
10	The UE transmits an <i>RRCCONNECTIONRECONFIGURATIONCOMPLETE</i> message to confirm the activation of the measurement gaps on Cell 3.	-->	<i>RRCCONNECTIONRECONFIGURATIONCOMPLETE</i>	-	-
11	The SS changes Cell 1, Cell 3, and Cell 12 parameters according to the row "T3" in table 8.3.1.10.3.2-1.	-	-	-	-
12	Check: Does the UE transmit a <i>MEASUREMENTREPORT</i> message on Cell 3 to perform event A3 intra frequency reporting for Cell 12 during the next 30 s?	-->	<i>MEASUREMENTREPORT</i>	1	P
13	The SS changes Cell 1 and Cell 3 parameters, sets the cell-specific reference signal levels and switches Cell 2 on and Cell 12 off according to row "T4" in table 8.3.1.10.3.2-1.	-	-	-	-
14	Check: Does the UE transmit a <i>MEASUREMENTREPORT</i> message on Cell 3 to perform event A3 inter frequency reporting for Cell 1 during the next 30 s?	-->	<i>MEASUREMENTREPORT</i>	1	P
15	Check: Does the test result of CALL generic procedure indicate that the UE is in E-UTRA RRC_CONNECTED state on Cell 3?	-	-	1	-

8.3.1.10.3.3 Specific message contents

Table 8.3.1.10.3.3-1: RRCConnectionReconfiguration (step 1, Table 8.3.1.10.3.2-1)

Derivation Path: 36.508, Table 4.6.1-8, condition MEAS			
Information Element	Value/remark	Comment	Condition

Table 8.3.1.10.3.3-2: MeasConfig (step 1, Table 8.3.1.10.3.2-2)

Derivation Path: 36.508, Table 4.6.6-1, condition INTER-FREQ			
Information Element	Value/remark	Comment	Condition
MeasConfig ::= SEQUENCE {			
measObjectToAddModList SEQUENCE (SIZE (1..maxObjectId)) OF SEQUENCE {	2 entries		
measObjectId[1]	IdMeasObject-f1		
measObject[1]	MeasObjectEUTRA-GENERIC(f1)		
measObjectId[2]	IdMeasObject-f2		
measObject[2]	MeasObjectEUTRA-GENERIC(f2)		
}			
reportConfigToAddModList SEQUENCE (SIZE (1..maxReportConfigId)) OF SEQUENCE {	1 entry		
reportConfigId[1]	IdReportConfig-A3		
reportConfig[1]	ReportConfigEUTRA-A3		
}			
measIdToAddModList SEQUENCE (SIZE (1..maxMeasId)) OF SEQUENCE {	2 entries		
measId[1]	1		
measObjectId[1]	IdMeasObject-f1		
reportConfigId[1]	IdReportConfig-A3		
measId[2]	2		
measObjectId[2]	IdMeasObject-f2		
reportConfigId[2]	IdReportConfig-A3		
}			
}			

Table 8.3.1.3.3.3-3: ReportConfig-A3 (step 1, Table 8.3.1.10.3.2-2)

Derivation path: 36.508 clause 4.6.6 table 4.6.6-6 ReportConfigEUTRA-A3			
Information Element	Value/remark	Comment	Condition
ReportConfigEUTRA-A3 ::= SEQUENCE {			
reportQuantity	sameAsTriggerQuantity		
reportAmount	r1		
}			

Table 8.3.1.10.3.3-4: MeasurementReport (step 4, Table 8.3.1.10.3.2-2)

Derivation Path: 36.508, Table 4.6.1-5			
Information Element	Value/remark	Comment	Condition
MeasurementReport ::= SEQUENCE {			
criticalExtensions CHOICE {			
c1 CHOICE{			
measurementReport-r8 SEQUENCE {			
measResults SEQUENCE {			
measId	1		
measResultServCell SEQUENCE {			
rsrpResult	(0..97)		
rsrqResult	(0..34)		
}			
measResultNeighCells CHOICE {			
measResultListEUTRA SEQUENCE (SIZE (1..maxCellReport)) OF SEQUENCE {	1 entry		
physCellId[1]	PhysicalCellIdentity of Cell 2		
cgi-Info[1]	Not present		
measResult[1] SEQUENCE {			
rsrpResult	(0..97)		
rsrqResult	(0..34)		
}			
}			
}			
}			
}			
}			
}			

Table 8.3.1.10.3.3-5: MeasurementReport (step 6, Table 8.3.1.10.3.2-2)

Derivation Path: 36.508, Table 4.6.1-5			
Information Element	Value/remark	Comment	Condition
MeasurementReport ::= SEQUENCE {			
criticalExtensions CHOICE {			
c1 CHOICE{			
measurementReport-r8 SEQUENCE {			
measResults SEQUENCE {			
measId	2		
measResultServCell SEQUENCE {			
rsrpResult	(0..97)		
rsrqResult	(0..34)		
}			
measResultNeighCells CHOICE {			
measResultListEUTRA SEQUENCE (SIZE (1..maxCellReport)) OF SEQUENCE {	1 entry		
physCellId[1]	PhysicalCellIdentity of Cell 12		
cgi-Info[1]	Not present		
measResult[1] SEQUENCE {			
rsrpResult	(0..97)		
rsrqResult	(0..34)		
}			
}			
}			
}			
}			
}			
}			

Table 8.3.1.10.3.3-6: RRCConnectionReconfiguration (step 7, Table 8.3.1.10.3.2-2)

Derivation Path: 36.508, Table 4.6.1-8, condition HO

Table 8.3.1.10.3.3-7: MobilityControlInfo (step 7, Table 8.1.3.10.3.2-2)

Derivation Path: 36.508, Table 4.6.5-1			
Information Element	Value/remark	Comment	Condition
MobilityControlInfo ::= SEQUENCE {			
targetPhysCellId	PhysicalCellId of Cell 3		
carrierFreq	Not present		
}			

Table 8.3.1.10.3.3-8: RRCConnectionReconfiguration (step 9, Table 8.3.1.10.3.2-2)

Derivation Path: 36.508, Table 4.6.1-8, condition MEAS

Table 8.3.1.10.3.3-9: MeasConfig (step 9, Table 8.1.3.10.3.2-2)

Derivation Path: 36.508, Table 4.6.6-1, condition INTER-FREQ

Table 8.3.1.10.3.3-10: MeasurementReport (step 12, Table 8.3.1.10.3.2-2)

Derivation Path: 36.508, Table 4.6.1-5			
Information Element	Value/remark	Comment	Condition
MeasurementReport ::= SEQUENCE {			
criticalExtensions CHOICE {			
c1 CHOICE{			
measurementReport-r8 SEQUENCE {			
measResults SEQUENCE {			
measId	1		
measResultServCell SEQUENCE {			
rsrpResult	(0..97)		
rsrqResult	(0..34)		
}			
measResultNeighCells CHOICE {			
measResultListEUTRA SEQUENCE (SIZE (1..maxCellReport)) OF SEQUENCE {	1 entry		
physCellId[1]	PhysicalCellId of Cell 12		
cgi-Info[1]	Not present		
measResult[1] SEQUENCE {			
rsrpResult	(0..97)		
rsrqResult	(0..34)		
}			
}			
}			
}			
}			
}			
}			
}			
}			

Table 8.3.1.10.3.3-11: *MeasurementReport* (step 14, Table 8.3.1.10.3.2-2)

Derivation Path: 36.508, Table 4.6.1-5			
Information Element	Value/remark	Comment	Condition
MeasurementReport ::= SEQUENCE {			
criticalExtensions CHOICE {			
c1 CHOICE{			
measurementReport-r8 SEQUENCE {			
measResults SEQUENCE {			
measId	2		
measResultServCell SEQUENCE {			
rsrpResult	(0..97)		
rsrqResult	(0..34)		
}			
measResultNeighCells CHOICE {			
measResultListEUTRA SEQUENCE (SIZE (1..maxCellReport)) OF SEQUENCE {	1 entry		
physCellId[1]	PhysicalCellIdentity of Cell 1		
cgi-Info[1]	Not present		
measResult[1] SEQUENCE {			
rsrpResult	(0..97)		
rsrqResult	(0..34)		
}			
}			
}			
}			
}			
}			
}			

8.3.2 Inter RAT measurements

8.3.2.1 Measurement configuration control and reporting / inter RAT measurements: event B2 (measurement of GERAN cells)

8.3.2.1.1 Test Purpose (TP)

(1)

```
with { UE having completed the radio bearer establishment, initial security activation procedure and
performed the inter RAT measurement for GERAN cell and not detected entering condition for the event
B2 is met }
ensure that {
  when { UE detects entering condition for the event B2 is not met }
    then { UE does not transmit any MeasurementReport }
}
```

(2)

```
with { UE having completed the radio bearer establishment, initial security activation procedure and
performed the inter RAT measurement for GERAN cell and not detected entering condition for the event
B2 is met }
ensure that {
  when { UE detects entering condition for the event B2 is met }
    then { UE transmits a MeasurementReport }
}
```

(3)

```
with { UE having completed the radio bearer establishment, initial security activation procedure and
performed the inter RAT measurement for GERAN cell and detected entering condition for the event B2
is met }
ensure that {
  when { UE detects leaving condition for the event B2 is met }
    then { UE does not transmit any MeasurementReport }
}
```

8.3.2.1.2 Conformance requirements

References: The conformance requirements covered in the present TC are specified in: TS 36.331, clause 5.5.4.1, 5.5.4.8 and 5.5.5.

[TS 36.331, clause 5.5.4.1]

The UE shall:

- 1> for each *measId* included in the *measIdList* within *VarMeasConfig*:
 - ...
 - 2> else:
 - ...
 - 3> else if the corresponding *measObject* concerns GERAN:
 - 4> consider a neighbouring cell on the associated set of frequencies to be applicable when the concerned cell matches the *ncc-Permitted* defined within the *VarMeasConfig* for this *measId*;
 - 2> if the *triggerType* is set to 'event' and if the entry condition applicable for this event, i.e. the event corresponding with the *eventId* of the corresponding *reportConfig* within *VarMeasConfig*, is fulfilled for one or more applicable cells for all measurements after layer 3 filtering taken during *timeToTrigger* defined for this event within the *VarMeasConfig*, while the *VarMeasReportList* does not include an measurement reporting entry for this *measId* (a first cell triggers the event):
 - 3> include a measurement reporting entry within the *VarMeasReportList* for this *measId*;
 - 3> set the *numberOfReportsSent* defined within the *VarMeasReportList* for this *measId* to 0;
 - 3> include the concerned cell(s) in the *cellsTriggeredList* defined within the *VarMeasReportList* for this *measId*;
 - 3> initiate the measurement reporting procedure, as specified in 5.5.5;
 - 2> if the *triggerType* is set to 'event' and if the entry condition applicable for this event, i.e. the event corresponding with the *eventId* of the corresponding *reportConfig* within *VarMeasConfig*, is fulfilled for one or more applicable cells not included in the *cellsTriggeredList* for all measurements after layer 3 filtering taken during *timeToTrigger* defined for this event within the *VarMeasConfig* (a subsequent cell triggers the event):
 - 3> set the *numberOfReportsSent* defined within the *VarMeasReportList* for this *measId* to 0;
 - 3> include the concerned cell(s) in the *cellsTriggeredList* defined within the *VarMeasReportList* for this *measId*;
 - 3> initiate the measurement reporting procedure, as specified in 5.5.5;
 - 2> if the *triggerType* is set to 'event' and if the leaving condition applicable for this event is fulfilled for one or more of the cells included in the *cellsTriggeredList* defined within the *VarMeasReportList* for this *measId* for all measurements after layer 3 filtering taken during *timeToTrigger* defined within the *VarMeasConfig* for this event:
 - 3> remove the concerned cell(s) in the *cellsTriggeredList* defined within the *VarMeasReportList* for this *measId*;
 - 3> if *reportOnLeave* is set to *TRUE* for the corresponding reporting configuration:
 - 4> initiate the measurement reporting procedure, as specified in 5.5.5;
 - 3> if the *cellsTriggeredList* defined within the *VarMeasReportList* for this *measId* is empty:
 - 4> remove the measurement reporting entry within the *VarMeasReportList* for this *measId*;
 - 4> stop the periodical reporting timer for this *measId*, if running;

- 2> if the *purpose* is included and set to ‘*reportStrongestCells*’ or to ‘*reportStrongestCellsForSON*’ and if a (first) measurement result is available for one or more applicable cells:
 - 3> include a measurement reporting entry within the *VarMeasReportList* for this *measId*;
 - 3> set the *numberOfReportsSent* defined within the *VarMeasReportList* for this *measId* to 0;
 - 3> initiate the measurement reporting procedure, as specified in 5.5.5;

NOTE 1: If the *purpose* is set to ‘*reportStrongestCells*’, the UE initiates a first measurement report immediately after the quantity to be reported becomes available for at least either serving cell or one of the applicable cells. If the *purpose* is set to ‘*reportStrongestCellsForSON*’, the UE initiates a first measurement report when it has determined the strongest cells on the associated frequency.

- 2> upon expiry of the periodical reporting timer for this *measId*:
 - 3> initiate the measurement reporting procedure, as specified in 5.5.5;

...

NOTE 2: The UE does not stop the periodical reporting with *triggerType* set to ‘*event*’ or to ‘*periodical*’ while the corresponding measurement is not performed due to the serving cell RSRP being equal to or better than *s-Measure* or due to the measurement gap not being setup.

NOTE 3: If the UE is configured with DRX, the UE may delay the measurement reporting for event triggered and periodical triggered measurements until the Active Time, which is defined in TS 36.321 [6].

[TS 36.331, clause 5.5.4.8]

The UE shall:

- 1> for UTRA and CDMA2000, only trigger the event for cells included in the corresponding measurement object;
- 1> consider the entering condition for this event to be satisfied when both condition B2-1 and condition B2-2, as specified below, are fulfilled;
- 1> consider the leaving condition for this event to be satisfied when condition B2-3 or condition B2-4, i.e. at least one of the two, as specified below, is fulfilled;

Inequality B2-1 (Entering condition 1)

$$M_s + H_{ys} < Thresh_1$$

Inequality B2-2 (Entering condition 2)

$$M_n + Ofn - H_{ys} > Thresh_2$$

Inequality B2-3 (Leaving condition 1)

$$M_s - H_{ys} > Thresh_1$$

Inequality B2-4 (Leaving condition 2)

$$M_n + Ofn + H_{ys} < Thresh_2$$

The variables in the formula are defined as follows:

M_s is the measurement result of the serving cell, not taking into account any offsets.

M_n is the measurement result of the inter-RAT neighbour cell, not taking into account any offsets.

Ofn is the frequency specific offset of the frequency of the inter-RAT neighbour cell (i.e. *offsetFreq* as defined within the *measObject* corresponding to the frequency of the inter-RAT neighbour cell).

H_{ys} is the hysteresis parameter for this event (i.e. *hysteresis* as defined within *reportConfigInterRAT* for this event).

Thresh1 is the threshold parameter for this event (i.e. *b2-Threshold1* as defined within *reportConfigInterRAT* for this event).

Thresh2 is the threshold parameter for this event (i.e. *b2-Threshold2* as defined within *reportConfigInterRAT* for this event).

Ms is expressed in dBm in case of RSRP, or in dB in case of RSRQ.

Mn is expressed in dBm or dB, depending on the measurement quantity of the inter-RAT neighbour cell.

Ofn, Hys are expressed in dB.

Thresh1 is expressed in the same unit as **Ms**.

Thresh2 is expressed in the same unit as **Mn**.

[TS 36.331, clause 5.5.5]

For the *measId* for which the measurement reporting procedure was triggered, the UE shall set the *measResults* within the *MeasurementReport* message as follows:

- 1> set the *measId* to the measurement identity that triggered the measurement reporting;
 - 1> set the *measResultServCell* to include the quantities of serving cell;
 - 1> if there is at least one applicable neighbouring cell to report:
 - 2> set the *measResultsNeighCells* to include the best neighbouring cells up to *maxReportCells* in accordance with the following:
 - 3> if the *triggerType* is set to 'event':
 - 4> include the cells included in the *cellsTriggeredList* as defined within the *VarMeasReportList* for this *measId*;
 - 3> else:
 - 4> include the applicable cells for which the new measurement results became available since the last periodical reporting or since the measurement was initiated or reset;
- NOTE: The reliability of the report (i.e. the certainty it contains the strongest cells on the concerned frequency) depends on the measurement configuration i.e. the *reportInterval*. The related performance requirements are specified in TS 36.133 [16].
- 3> for each cell that is included in the *measResultsNeighCells*, include the *physCellId*;
 - 3> if the *triggerType* is set to 'event'; or the *purpose* is set to 'reportStrongestCells' or to 'reportStrongestCellsForSON':
 - 4> for each included cell, include the layer 3 filtered measured results in accordance with the *reportConfig* for this *measId*, ordered as follows:
 - 5> if the *measObject* associated with this *measId* concerns E-UTRA:
 - 6> set the *measResult* to include the quantity(ies) indicated in the *reportQuantity* within the concerned *reportConfig* in order of decreasing *triggerQuantity*, i.e. the best cell is included first;
 - 5> else:
 - 6> set the *measResult* to the quantity as configured for the concerned RAT within the *quantityConfig* in order of decreasing quantity, i.e. the best cell is included first;
- ...
- 1> increment the *numberOfReportsSent* as defined within the *VarMeasReportList* for this *measId* by 1;
 - 1> stop the periodical reporting timer, if running;

- 1> if the *numberOfReportsSent* as defined within the *VarMeasReportList* for this *measId* is less than the *reportAmount* as defined within the corresponding *reportConfig* for this *measId*;
- 2> start the periodical reporting timer with the value of *reportInterval* as defined within the corresponding *reportConfig* for this *measId*;
- ...
- 1> submit the *MeasurementReport* message to lower layers for transmission, upon which the procedure ends;

8.3.2.1.3 Test description

8.3.2.1.3.1 Pre-test conditions

System Simulator:

- Cell 1 and Cell 24.

UE:

None.

Preamble:

- The UE is in state Generic RB Established (state 3) on Cell 1 according to [18].

8.3.2.1.3.2 Test procedure sequence

Table 8.3.2.1.3.2-1 illustrates the downlink power levels and other changing parameters to be applied for the cells at various time instants of the test execution. Row marked "T0" denotes the initial conditions, while columns marked "T1" and "T2" are to be applied subsequently. The exact instants on which these values shall be applied are described in the texts in this clause.

Table 8.3.2.1.3.2-1: Time instances of cell power level and parameter changes

	Parameter	Unit	Cell 1	Cell 24	Remark
T0	Cell-specific RS EPRE	dBm/15k Hz	-60	-	The power level values are such that entering conditions for event B2 are not satisfied.
	RSSI	dBm	-	[-85]	
T1	Cell-specific RS EPRE	dBm/15k Hz	-80	-	The power level values are such that entering conditions for event B2 are satisfied.
	RSSI	dBm	-	[-65]	
T2	Cell-specific RS EPRE	dBm/15k Hz	-60	-	The power level values are such that leaving conditions for event B2 are not satisfied.
	RSSI	dBm	-	[-85]	

Table 8.3.2.1.3.2-2: Main behaviour

St	Procedure	Message Sequence		TP	Verdict
		U - S	Message		
1	The SS transmits an <i>RRCConnectionReconfiguration</i> message to setup inter RAT measurement on Cell 1.	<--	<i>RRCConnectionReconfiguration</i>	-	-
2	The UE transmits an <i>RRCConnectionReconfigurationComplete</i> message to confirm the setup of inter RAT measurement on Cell 1.	-->	<i>RRCConnectionReconfigurationComplete</i>	-	-
3	Check: Does the UE transmit a <i>MeasurementReport</i> message to report the event B2 during the next 10s?	-->	<i>MeasurementReport</i>	1	F
4	The SS changes Cell 1 and Cell 24 parameters according to the row "T1" in table 8.3.2.1.3.2-1.	-	-	-	-
5	Check: Does the UE transmit a <i>MeasurementReport</i> message to report the event B2 for Cell 24?	-->	<i>MeasurementReport</i>	2	P
6	The SS changes Cell 1 and Cell 24 parameters according to the row "T2" in table 8.3.2.1.3.2-1.	-	-	-	-
7	Wait and ignore <i>MeasurementReport</i> messages for 5 s to allow change of power levels for Cells 1 and Cell 24.	-	-	-	-
8	Check: Does the UE transmit a <i>MeasurementReport</i> message to report the event B2 during the next 10s?	-->	<i>MeasurementReport</i>	3	F
9	Check: Does the test result of CALL generic procedure indicate that the UE is in E-UTRA RRC_CONNECTED state on Cell 1?	-	-	-	-

8.3.2.1.3.3 Specific message contents

Table 8.3.2.1.3.3-1: *RRCConnectionReconfiguration* (step 1, Table 8.3.2.1.3.2-2)

Derivation Path: 36.508, Table 4.6.1-8, condition MEAS
--

Table 8.3.2.1.3.3-2: *MeasConfig* (step 1, Table 8.3.2.1.3.2-2)

Derivation Path: 36.508, Table 4.6.6-1, condition GERAN			
Information Element	Value/remark	Comment	Condition
MeasConfig ::= SEQUENCE {			
measObjectToAddModList SEQUENCE (SIZE (1..maxObjectId)) OF SEQUENCE {	1 entry		
measObjectId[1]	IdMeasObject-f11		
measObject[1]	MeasObjectGERAN- GENERIC(f11)		
}			
reportConfigToAddModList SEQUENCE (SIZE (1..maxReportConfigId)) OF SEQUENCE {	1 entry		
reportConfigId[1]	IdReportConfig-B2- GERAN		
reportConfig[1]	ReportConfigInterRAT- B2-GERAN(-69, [-79])		
}			
measIdToAddModList SEQUENCE (SIZE (1..maxMeasId)) OF SEQUENCE {	1 entry		
measId[1]	1		
measObjectId[1]	IdMeasObject-f11		
reportConfigId[1]	IdReportConfig-B2- GERAN		
}			
quantityConfig SEQUENCE {			
quantityConfigEUTRA	Not present		
quantityConfigUTRA	Not present		
quantityConfigGERAN SEQUENCE {			
measQuantityGERAN	rsi		
filterCoefficient	fc0		
}			
quantityConfigCDMA2000	Not present		
}			
}			

Table 8.3.2.1.3.3-3: *MeasurementReport* (step 5, Table 8.3.2.1.3.2-2)

Derivation Path: 36.508, Table 4.6.1-5			
Information Element	Value/remark	Comment	Condition
MeasurementReport ::= SEQUENCE {			
criticalExtensions CHOICE {			
c1 CHOICE{			
measurementReport-r8 SEQUENCE {			
measResults SEQUENCE {			
measId	1		
measResultServCell SEQUENCE {			
rsrpResult	(0..97)		
rsrqResult	(0..34)		
}			
measResultsNeighCells CHOICE {			
measResultListGERAN SEQUENCE (SIZE (1..maxCellReport)) OF SEQUENCE {	1 entry		
carrierFreq[1] SEQUENCE {			
Arfcn	Not checked		
bandIndicator	Not checked		
}			
physCellId[1]	PhysicalCellIdentity of Cell 24		
cgi-info[1]	Not present		
measResult[1] SEQUENCE {			
Rssi	(0..63)		
}			
}			
}			
}			
}			
}			
}			

8.3.2.3 Measurement configuration control and reporting / inter RAT measurements: event B2 (measurement of UTRAN cells)

8.3.2.3.1 Test Purpose (TP)

(1)

with { UE having completed the radio bearer establishment, initial security activation procedure and performed the inter RAT measurement for UTRA cell and not detected entering condition for the event B2 is met }

ensure that {
 when { UE detects entering condition for the event B2 is not met }
 then { UE does not transmit any *MeasurementReport* }
}

(2)

with { UE having completed the radio bearer establishment, initial security activation procedure and performed the inter RAT measurement for UTRA cell and not detected entering condition for the event B2 is met }

ensure that {
 when { UE detects entering condition for the event B2 is met }
 then { UE transmits a *MeasurementReport* }
}

(3)

with { UE having completed the radio bearer establishment, initial security activation procedure and performed the inter RAT measurement for UTRA cell and detected entering condition for the event B2 is met }

ensure that {
 when { UE detects leaving condition for the event B2 is met }
 then { UE does not transmit any *MeasurementReport* }
}

8.3.2.3.2 Conformance requirements

References: The conformance requirements covered in the present TC are specified in: TS 36.331, clause 5.5.4.1, 5.5.4.8 and 5.5.5.

[TS 36.331, clause 5.5.4.1]

The UE shall:

- 1> for each *measId* included in the *measIdList* within *VarMeasConfig*:
 - 2> if the corresponding *reportConfig* includes a purpose set to '*reportStrongestCellsForSON*':
 - ...
 - 2> else:
 - 3> if the corresponding *measObject* concerns E-UTRA:
 - ...
 - 3> else if the corresponding *measObject* concerns UTRA or CDMA2000:
 - 4> consider a neighbouring cell on the associated frequency to be applicable when the concerned cell is included in the *cellsToAddModList* defined within the *VarMeasConfig* for this *measId* (i.e. the cell is included in the white-list);
 - ...
 - 3> if the corresponding *measObject* concerns GERAN: when the concerned cell matches the *ncc-Permitted* defined within the *VarMeasurementConfiguration* for this *measId*;
 - 3> if the corresponding *measObject* concerns EUTRA: when the concerned cell is not included in the *blackListedCellsToAddModifyList* defined within the *VarMeasurementConfiguration* for this *measId*;
 - 2> else consider a neighbouring cell on the associated frequency to be applicable as follows:
 - 3> if the corresponding *measObject* concerns UTRA or CDMA2000: when the concerned cell is included in the *cellsToAddModifyList* defined within the *VarMeasurementConfiguration* for this *measId* (i.e. the cell is included in the white-list) or the corresponding reportingConfig includes a *purpose* set to '*reportStrongestCellsForSON*' or to '*reportCGI*';
 - 3> if the corresponding *measObject* concerns GERAN: when the concerned cell matches the *ncc-Permitted* defined within the *VarMeasurementConfiguration* for this *measId* or the corresponding reportingConfig includes a *purpose* set to '*reportStrongestCellsForSON*' or to '*reportCGI*';
 - 3> if the corresponding *measObject* concerns EUTRA: when the concerned cell is not included in the *blackListedCellsToAddModifyList* defined within the *VarMeasurementConfiguration* for this *measId*;
 - 2> if the *triggerType* is set to 'event' and if the entry condition applicable for this event, i.e. the event corresponding with the *eventId* of the corresponding *reportConfig* within *VarMeasConfig*, is fulfilled for one or more applicable cells for all measurements after layer 3 filtering taken during *timeToTrigger* defined for this event within the *VarMeasConfig*, while the *VarMeasReportList* does not include an measurement reporting entry for this *measId*: (a first cell triggers the event)
 - 4> include a measurement reporting entry within the *VarMeasReportList* for this *measId*;
 - 3> set the *numberOfReportsSent* defined within the *VarMeasReportList* for this *measId* to 0;
 - 3> include the concerned cell(s) in the *cellsTriggeredList* defined within the *VarMeasReportList* for this *measId*;
 - 3> initiate the measurement reporting procedure, as specified in 5.5.5;
 - 2> if the *triggerType* is set to 'event' and if the entry condition applicable for this event, i.e. the event corresponding with the *eventId* of the corresponding *reportConfig* within *VarMeasConfig*, is fulfilled for one or more applicable cells not included in the *cellsTriggeredList* for all measurements after layer 3 filtering

taken during *timeToTrigger* defined for this event within the *VarMeasConfig* (a subsequent cell triggers the event):

...

- 2> if the *triggerType* is set to 'event' and if the leaving condition applicable for this event is fulfilled for one or more of the cells included in the *cellsTriggeredList* defined within the *VarMeasReportList* for this *measId* for all measurements after layer 3 filtering taken during *timeToTrigger* defined within the *VarMeasConfig* for this event:
 - 3> remove the concerned cell(s) in the *cellsTriggeredList* defined within the *VarMeasReportList* for this *measId*;
 - 3> if *reportOnLeave* is set to *TRUE* for the corresponding reporting configuration:
 - 4> initiate the measurement reporting procedure, as specified in 5.5.5;
 - 3> if the *cellsTriggeredList* defined within the *VarMeasReportList* for this *measId* is empty:
 - 4> remove the measurement reporting entry within the *VarMeasReportList* for this *measId*;
 - 4> stop the periodical reporting timer for this *measId*, if running;
- 2> if the *purpose* is included and set to 'reportStrongestCells' or to 'reportStrongestCellsForSON' and if a (first) measurement result is available for one or more applicable cells:
 - 3> include a measurement reporting entry within the *VarMeasReportList* for this *measId*;
 - 3> set the *numberOfReportsSent* defined within the *VarMeasReportList* for this *measId* to 0;
 - 3> initiate the measurement reporting procedure, as specified in 5.5.5;

NOTE 1: If the *purpose* is set to 'reportStrongestCells', the UE initiates a first measurement report immediately after the quantity to be reported becomes available for at least either serving cell or one of the applicable cells. If the *purpose* is set to 'reportStrongestCellsForSON', the UE initiates a first measurement report when it has determined the strongest cells on the associated frequency.

- 2> upon expiry of the periodical reporting timer for this *measId*:
 - 3> initiate the measurement reporting procedure, as specified in 5.5.5;
- 2> if the *purpose* is included and set to 'reportCGI' and if the UE acquired the information needed to set all fields of *globalCellIdentity* for the requested cell:
 - 3> include a measurement reporting entry within the *VarMeasReportList* for this *measId*;
 - 3> set the *numberOfReportsSent* defined within the *VarMeasReportList* for this *measId* to 0;
 - 3> stop timer T321;
 - 3> initiate the measurement reporting procedure, as specified in 5.5.5;
- 2> upon expiry of the T321 for this *measId*:
 - 3> include a measurement reporting entry within the *VarMeasReportList* for this *measId*;
 - 3> set the *numberOfReportsSent* defined within the *VarMeasReportList* for this *measId* to 0;
 - 3> initiate the measurement reporting procedure, as specified in 5.5.5;

NOTE 2: The UE does not stop the periodical reporting with *triggerType* set to 'event' or to 'periodical' while the corresponding measurement is not performed due to the serving cell RSRP being equal to or better than *s-Measure* or due to the measurement gap not being setup.

- 4> clear the *cellsToReportList* defined within the *VarMeasurementReports* for this *measId* and include the applicable cell(s) in the *cellsToReportList*;
- 3> initiate the measurement reporting procedure, as specified in 5.5.5;

2> if the leaving condition applicable for this event is fulfilled for one or more of the cells included in the *cellsToReportList* defined within the *VarMeasurementReports* for this *measId* for a duration exceeding the value of *timeToTrigger* defined within the *VarMeasurementConfiguration* for this event:

3> remove the concerned cell(s) in the *cellsToReportList* defined within the *VarMeasurementReports* for this *measId* ;

...

[TS 36.331, clause 5.5.4.8]

The UE shall:

1> for UTRA and CDMA2000, only trigger the event for cells included in the corresponding measurement object;

1> consider the entering condition for this event to be satisfied when both condition B2-1 and condition B2-2, as specified below, are fulfilled;

1> consider the leaving condition for this event to be satisfied when condition B2-3 or condition B2-4, i.e. at least one of the two, as specified below, is fulfilled;

InequalityB2-1 (Entering condition 1)

$$Ms + Hys < Thresh1$$

InequalityB2-2 (Entering condition 2)

$$Mn + Ofn - Hys > Thresh2$$

InequalityB2-3 (Leaving condition 1)

$$Ms + Hys < Thresh1$$

InequalityB2-4 (Leaving condition 2)

$$Mn + Ofn + Hys < Thresh2$$

The variables in the formula are defined as follows:

Ms is the measurement result of the serving cell, not taking into account any offsets.

Mn is the measurement result of the inter-RAT neighbour cell, not taking into account any offsets.

Ofn is the frequency specific offset of the frequency of the inter-RAT neighbour cell (i.e. *offsetFreq* as defined within the *measObject* corresponding to the frequency of the inter-RAT neighbour cell)

Hys is the hysteresis parameter for this event (i.e. hysteresis as defined within *reportConfigInterRAT* for this event)

Thresh1 is the threshold parameter for this event (i.e. b2-Threshold1 as defined within *reportConfigInterRAT* for this event)

Thresh2 is the threshold parameter for this event (i.e. b2-Threshold2 as defined within *reportConfigInterRAT* for this event)

Ms is expressed in dBm in case of RSRP, or in dB in case of RSRQ

Mn is expressed in dBm or dB, depending on the measurement quantity of the inter-RAT neighbour cell

Ofn, ***Hys*** are expressed in dB

Thresh1 is expressed in the same unit as ***Ms***

Thresh2 is expressed in the same unit as ***Mn***

[TS 36.331, clause 5.5.5]

The purpose of this procedure is to transfer measurement results from the UE to E-UTRAN.

For the *measId* for which the measurement reporting procedure was triggered, the UE shall set the *measResults* within the *MeasurementReport* message as follows:

- 1> set the *measId* to the measurement identity that triggered the measurement reporting;
- 1> set the *measResultServCell* to include the quantities of serving cell;
- 1> if there is at least one applicable neighbouring cell to report:
 - 2> set the *measResultsNeighCells* to include the best neighbouring cells up to *maxReportCells* in accordance with the following:
 - 3> if the *triggerType* is set to 'event':
 - 4> include the cells included in the *cellsTriggeredList* as defined within the *VarMeasReportList* for this *measId*

3> else:

- 4> include the applicable for which the new measurement results became available since the last periodical reporting or since the measurement was initiated or reset;

NOTE: The reliability of the report (i.e. the certainty it contains the strongest cells on the concerned frequency) depends on the measurement configuration i.e. the *reportInterval*. The related performance requirements are specified in TS 36.133 [16].

- 3> for each cell that is included in the *measResultsNeighCells*, include the *physCellId*;
- 3> if the *triggerType* is set to 'event'; or the *purpose* is set to 'reportStrongestCells' or to 'reportStrongestCellsForSON':
 - 4> for each included cell include the layer 3 filtered measured results in accordance with the *reportConfig* for this *measId*, ordered as follows:
 - 5> if the *measObject* associated with this *measId* concerns E-UTRA:

...

5> else:

- 6> set the *measResult* to the quantity as configured for the concerned RAT within the *quantityConfig* in order of decreasing quantity, i.e. the best cell is included first;

...

- 1> increment the *numberOfReportsSent* as defined within the *VarMeasReportList* for this *measId* by 1;
- 1> stop the periodical reporting timer, if running;
- 1> if the *numberOfReportsSent* as defined within the *VarMeasReportList* for this *measId* is less than the *reportAmount* as defined within the corresponding *reportConfig* for this *measId*
 - 2> start the periodical reporting timer with the value of *reportInterval* as defined within the corresponding *reportConfig*
- 1> else:
 - 1> if the measured results are for CDMA:
 - 2> set the *preRegistrationStatus* to the UE's cdma upper layer's HRPD *preRegistrationStatus*;
 - 1> submit the *MeasurementReport* message to lower layers for transmission, upon which the procedure ends;

...

8.3.2.3.3 Test description

8.3.2.3.3.1 Pre-test conditions

System Simulator:

- Cell 1 and Cell 7.

UE:

None.

Preamble:

- The UE is in state Generic RB Established (state 3) on Cell 1 according to [18].

8.3.2.3.3.2 Test procedure sequence

Table 8.3.2.3.3.2-1 illustrates the downlink power levels and other changing parameters to be applied for the cells at various time instants of the test execution. Row marked "T0" denotes the initial conditions, while columns marked "T1" and "T2" are to be applied subsequently. The exact instants on which these values shall be applied are described in the texts in this clause.

Table 8.3.2.3.3.2-1: Time instances of cell power level and parameter changes

	Parameter	Unit	Cell 1	Cell 7	Remark
T0	Cell-specific RS EPRE	dBm/15k Hz	-60	-	The power level values are such that entering conditions for event B2 are not satisfied.
	CPICH_Ec/Io (Note 1) CPICH Ec = -83.5[dBm/3.84 MHz]	dB	-	-23.5	
T1	Cell-specific RS EPRE	dBm/15k Hz	-80	-	The power level values are such that entering conditions for event B2 are satisfied.
	CPICH_Ec/Io (Note 1) CPICH Ec = -72.3[dBm/3.84 MHz]	dB	-	-12.3	
T2	Cell-specific RS EPRE	dBm/15k Hz	-60	-	The power level values are such that leaving conditions for event B2 are satisfied.
	CPICH_Ec/Io (Note 1) CPICH Ec = -83.5[dBm/3.84 MHz]	dB	-	-23.5	

NOTE 1: This parameter is not directly settable, but are derived by calculation from the other parameters set by the SS.

Table 8.3.2.3.3.2-2: Main behaviour

St	Procedure	Message Sequence		TP	Verdict
		U - S	Message		
1	The SS transmits an <i>RRCCONNECTIONRECONFIGURATION</i> message to setup inter RAT measurement on Cell 1.	<--	<i>RRCCONNECTIONRECONFIGURATION</i>	-	-
2	The UE transmits an <i>RRCCONNECTIONRECONFIGURATIONCOMPLETE</i> message to confirm the setup of inter RAT measurement on Cell 1.	-->	<i>RRCCONNECTIONRECONFIGURATIONCOMPLETE</i>	-	-
3	Check: Does the UE transmit a <i>MEASUREMENTREPORT</i> message on Cell 1 to report the event B2 during the next 10s?	-->	<i>MEASUREMENTREPORT</i>	1	F
4	The SS changes Cell 1 and Cell 7 parameters according to the row "T1" in table 8.3.2.3.3.2-1.	-	-	-	-
5	Check: Does the UE transmit a <i>MEASUREMENTREPORT</i> message to report the event B2 for Cell 7?	-->	<i>MEASUREMENTREPORT</i>	2	P
6	The SS changes Cell 1 and Cell 7 parameters according to the row "T2" in table 8.3.2.3.3.2-1.	-	-	-	-
7	Check: Does the UE transmit a <i>MEASUREMENTREPORT</i> message on Cell 1 to report the event B2 during the next 10s?	-->	<i>MEASUREMENTREPORT</i>	3	F
8	Check: Does the test result of CALL generic procedure indicate that the UE is in E-UTRA RRC_CONNECTED state on Cell 1?	-	-	-	-

8.3.2.3.3.3 Specific message contents

Table 8.3.2.3.3.3-1: *RRCCONNECTIONRECONFIGURATION* (step 1, Table 8.3.2.3.3.2-2)

Derivation Path: 36.508, Table 4.6.1-8, condition MEAS
--

Table 8.3.2.3.3.3-2: *MeasConfig* (step 1, Table 8.3.2.3.3.2-2)

Derivation Path: 36.508, Table 4.6.6-1, condition UTRAN			
Information Element	Value/remark	Comment	Condition
MeasConfig ::= SEQUENCE {			
measObjectToAddModList SEQUENCE (SIZE (1..maxObjectId)) OF SEQUENCE {	1 entry		
measObjectId[1]	IdMeasObject-f8		
measObject[1]	MeasObjectUTRA-GENERIC(f8)		
}			
reportConfigToAddModList SEQUENCE (SIZE (1..maxReportConfigId)) OF SEQUENCE {	1 entry		
reportConfigId[1]	IdReportConfig-B2-UTRA		
reportConfig[1]	ReportConfigInterRAT-B2-UTRA(-69, -18)		
}			
measIdToAddModList SEQUENCE (SIZE (1..maxMeasId)) OF SEQUENCE {	1 entry		
measId[1]	1		
measObjectId[1]	IdMeasObject-f8		
reportConfigId[1]	IdReportConfig-B2-UTRA		
}			
quantityConfig SEQUENCE {			
quantityConfigEUTRA	Not present		
quantityConfigUTRA SEQUENCE {			
measQuantityUTRA-FDD	cpich-EcN0		UTRA-FDD
measQuantityUTRA-TDD	pccpch-RSCP		UTRA-TDD
filterCoefficient	fc0		
}			
quantityConfigGERAN	Not present		
quantityConfigCDMA2000	Not present		
}			
}			

Condition	Explanation
UTRA-FDD	UTRA FDD cell environment
UTRA-TDD	UTRA TDD cell environment

Table 8.3.2.3.3-3: ReportConfigInterRAT-B2-UTRA(EUTRA(step 1, Table 8.3.2.3.3-2))

Derivation path: 36.508 clause 4.6.6 table 4.6.6-8 ReportConfigInterRAT-B2-UTRA(EUTRA-Thres, UTRA-Thres)			
Information Element	Value/remark	Comment	Condition
ReportConfigInterRAT-B2-UTRA(EUTRA-Thres, UTRA-Thres) ::= SEQUENCE {			
reportAmount	r1		
}			

Table 8.3.2.3.3.3-4: MeasurementReport (step 5, Table 8.3.2.3.3.2-2)

Derivation Path: 36.508, Table 4.6.1-5			
Information Element	Value/remark	Comment	Condition
MeasurementReport ::= SEQUENCE {			
criticalExtensions CHOICE {			
c1 CHOICE{			
measurementReport-r8 SEQUENCE {			
measResults SEQUENCE {			
measId	1		
measResultServCell SEQUENCE {			
rsrpResult	(0..97)		
rsrqResult	(0..34)		
}			
measResultNeighCells CHOICE {			
measResultListUTRA SEQUENCE (SIZE (1..maxCellReport)) OF SEQUENCE {	1 entry		
physCellId[1]	PhysicalCellIdentity of Cell 7		
cgi-Info[1]	Not present		
measResult[1] SEQUENCE {			
utra-RSCP	(-5..91)		UTRA-TDD
utra-EcN0	(0..49)		UTRA-FDD
}			
}			
}			
}			
}			
}			
}			

Condition	Explanation
UTRA-FDD	UTRA FDD cell environment
UTRA-TDD	UTRA TDD cell environment

8.3.2.4 Measurement configuration control and reporting / inter RAT measurements: Periodic reporting (measurement of UTRAN cells)

8.3.2.4.1 Test Purpose (TP)

(1)

```
with { UE in E-UTRA RRC_CONNECTED state and measurement configured for periodic reporting of UTRA cells }
ensure that {
  when { The UE receives reference signal power for cells on the UTRA frequency where measurements are configured }
  then { UE sends MeasurementReport message at regular intervals for these UTRA cells }
}
```

(2)

```
with { UE in E-UTRA RRC_CONNECTED state and a Measurement Report message for a configured periodic measurement reporting of UTRA cells on a configured frequency were sent }
ensure that {
  when { A previously reported cell become unavailable or the UE receives reference signal power on a reported UTRA frequency for a cell which was previously not reported }
  then { UE sends MeasurementReport message at regular intervals for the available UTRA cells }
}
```

(3)

```
with { UE in E-UTRA RRC_CONNECTED state and periodic measurement reporting of UTRA cells ongoing }
ensure that {
  when { The UE receives a RRCConnectionReconfiguration message removing the measID of periodic reporting of UTRA cells }
  then { UE stops sending MeasurementReport message for UTRA cells }
}
```

}

8.3.2.4.2 Conformance requirements

References: The conformance requirements covered in the current TC are specified in: TS 36.331, clauses 5.3.5.3, 5.5.2.2, 5.5.4.1 and 5.5.5.

[TS 36.331, clause 5.3.5.3]

If the *RRConnectionReconfiguration* message does not include the *mobilityControlInfo* and the UE is able to comply with the configuration included in this message, the UE shall:

...

- 1> If the *RRConnectionReconfiguration* message includes the *measConfig*:
 - 2> perform the Measurement configuration procedure as specified in 5.5.2;

...

[TS 36.331, clause 5.5.2.2]

The UE shall:

- 1> for each *measId* value included in the received *measIdToRemoveList* that is part of the current UE configuration in *varMeasConfig*:
 - 2> remove the entry with the matching *measId* from the *measIdList* within the *VarMeasConfig*;
 - 2> remove the measurement reporting entry for this *measId* from the *VarMeasReportList*, if included;
 - 2> stop the periodical reporting timer or timer T321, whichever one is running, and reset the associated information (e.g. *timeToTrigger*) for this *measId*;

[TS 36.331, clause 5.5.4.1]

The UE shall:

- 1> for each *measId* included in the *measIdList* within *VarMeasConfig*:
 - ...
 - 2> else:
 - 3> if the corresponding *measObject* concerns E-UTRA:
 - 4> consider any neighbouring cell detected on the associated frequency to be applicable when the concerned cell is not included in the *blackCellsToAddModList* defined within the *VarMeasConfig* for this *measId*;
 - 3> else if the corresponding *measObject* concerns UTRA or CDMA2000:
 - 4> consider a neighbouring cell on the associated frequency to be applicable when the concerned cell is included in the *cellsToAddModList* defined within the *VarMeasConfig* for this *measId* (i.e. the cell is included in the white-list);...
 - 2> if the *purpose* is included and set to ‘*reportStrongestCells*’ or to ‘*reportStrongestCellsForSON*’ and if a (first) measurement result is available for one or more applicable cells:
 - 3> include a measurement reporting entry within the *VarMeasReportList* for this *measId*;
 - 3> set the *numberOfReportsSent* defined within the *VarMeasReportList* for this *measId* to 0;
 - 3> initiate the measurement reporting procedure, as specified in 5.5.5;

NOTE 1: If the *purpose* is set to ‘*reportStrongestCells*’, the UE initiates a first measurement report immediately after the quantity to be reported becomes available for at least either serving cell or one of

the applicable cells. If the purpose is set to *'reportStrongestCellsForSON'*, the UE initiates a first measurement report when it has determined the strongest cells on the associated frequency.

- 2> upon expiry of the periodical reporting timer for this *measId*:
- 3> initiate the measurement reporting procedure, as specified in 5.5.5;
- ...

NOTE 2: The UE does not stop the periodical reporting with *triggerType* set to *'event'* or to *'periodical'* while the corresponding measurement is not performed due to the serving cell RSRP being equal to or better than *s-Measure* or due to the measurement gap not being setup.

...

[TS 36.331, clause 5.5.5]

...

For the *measId* for which the measurement reporting procedure was triggered, the UE shall set the *measuredResults* within the *MeasurementReport* message as follows:

- 1> set the *measId* to the measurement identity that triggered the measurement reporting;
- 1> set the *measResultServCell* to include the quantities of serving cell;
- 1> if there is at least one applicable neighbouring cell to report:
 - 2> set the *measResultsNeighCells* to include the best neighbouring cells up to *maxReportCells* in accordance with the following:
 - 3> if the *triggerType* is set to *'event'*:
 - 4> include the cells included in the *cellsTriggeredList* as defined within the *VarMeasReportList* for this *measId*;
 - 3> else:
 - 4> include the applicable cells for which the new measurement results became available since the last periodical reporting or since the measurement was initiated or reset;

NOTE: The reliability of the report (i.e. the certainty it contains the strongest cells on the concerned frequency) depends on the measurement configuration i.e. the *reportInterval*. The related performance requirements are specified in TS 36.133 [16].

- 3> for each cell that is included in the *measResultsNeighCells*, include the *physCellId*;
- 3> if the *triggerType* is set to *'event'*; or the *purpose* is set to *'reportStrongestCells'* or to *'reportStrongestCellsForSON'*:
 - 4> for each included cell, include the layer 3 filtered measured results in accordance with the *reportConfig* for this *measId*, ordered as follows:
 - 5> if the *measObject* associated with this *measId* concerns E-UTRA:
 - 6> set the *measResult* to include the quantity(ies) indicated in the *reportQuantity* within the concerned *reportConfig* in order of decreasing *triggerQuantity*, i.e. the best cell is included first;
 - 5> else:
 - 6> set the *measResult* to the quantity as configured for the concerned RAT within the *quantityConfig* in order of decreasing quantity, i.e. the best cell is included first;
- ...1> increment the *numberOfReportsSent* as defined within the *VarMeasReportList* for this *measId* by 1;
- 1> stop the periodical reporting timer, if running;

1> if the numberOfReportsSent as defined within the *VarMeasReportList* for this measId is less than to reportAmount as defined corresponding *reportConfig* for this *measId*:

2> start the periodical reporting timer with the value of reportInterval as defined within the corresponding *reportConfig* for this measId;

...

1> submit the MEASUREMENT REPORT message to lower layers for transmission, upon which the procedure ends.

8.3.2.4.3 Test description

8.3.2.4.3.1 Pre-test conditions

System Simulator:

- Cell 1, Cell 5 and Cell 7

UE:

None.

Preamble:

- The UE is in state Generic RB Established (state 3) according to [18] on Cell 1.

8.3.2.4.3.2 Test procedure sequence

Table 8.3.2.4.3.2-1 illustrates the downlink power levels to be applied for the cells at various time instants of the test execution. Row marked "T0" denotes the initial conditions, while rows marked "T1" and "T2" are to be applied subsequently. The exact instants on which these values shall be applied are described in the texts in this clause.

Table 8.3.2.4.3.2-1: Power levels

	Parameter	Unit	Cell 1	Parameter	Unit	Cell 5	Cell 7	Remark
	E-UTRA Cell			UTRA Cells				
T0	Cell-specific RS EPRE	dBm/15kHz	P01 (FFS)	CPICH_Ec	dBm/3.84 MHz	P07 (FFS)	Off	Power levels shall be such that camping on Cell 1 is guaranteed
T1			P01 (FFS)			P07 (FFS)	P07 (FFS)	
T2			P01 (FFS)			Off	P07 (FFS)	

Table 8.3.2.4.3.2-2: Main behaviour

St	Procedure	Message Sequence		TP	Verdict
		U - S	Message		
1	SS transmits an <i>RRCCONNECTIONRECONFIGURATION</i> message including <i>MEASUREMENTCONFIGURATION</i> to setup measurements and periodical reporting for UTRA cells.	<--	<i>RRCCONNECTIONRECONFIGURATION</i>	-	-
2	The UE transmits an <i>RRCCONNECTIONRECONFIGURATIONCOMPLETE</i> message.	-->	<i>RRCCONNECTIONRECONFIGURATIONCOMPLETE</i>	-	-
	EXCEPTION: In parallel to events described in steps 3 to 4 the steps specified in table 8.3.2.4.3.2.-3 shall take place				
3	Wait for 30 s to ensure that the UE performs a periodical reporting of UTRA cells.	-	-	1	-
4	SS sets the cell-specific reference signal levels and switches Cell 8 on according to row "T1" in table 8.3.2.4.3.2.-1.	-	-	-	-
5	Wait and ignore <i>MEASUREMENTREPORT</i> messages for 5 s to allow for the switching of cells.	-	-	-	-
	EXCEPTION: In parallel to events described in steps 6 to 7 the steps specified in table 8.3.2.4.3.2.-4 shall take place				
6	Wait for 30 s to ensure that the UE performs a periodical reporting of UTRA cells.	-	-	1, 2	-
7	SS sets the cell-specific reference signal levels and switches Cell 7 off according to row "T2" in table 8.3.2.4.3.2.-1.	-	-	-	-
8	Wait and ignore <i>MEASUREMENTREPORT</i> messages for 5 s to allow for the switching of cells.	-	-	-	-
	EXCEPTION: In parallel to events described in steps 9 to 10 the steps specified in table 8.3.2.4.3.2.-5 shall take place				
9	Wait for 30 s to ensure that the UE performs a periodical reporting of UTRA cells.	-	-	1, 2	-
10	SS transmits an <i>RRCCONNECTIONRECONFIGURATION</i> message including <i>MEASUREMENTCONFIGURATION</i> to remove <i>measId</i> for periodic reporting.	<--	<i>RRCCONNECTIONRECONFIGURATION</i>	-	-
11	The UE transmits an <i>RRCCONNECTIONRECONFIGURATIONCOMPLETE</i> message	-->	<i>RRCCONNECTIONRECONFIGURATIONCOMPLETE</i>	-	-

Table 8.3.2.4.3.2-3: Parallel behaviour

St	Procedure	Message Sequence		TP	Verdict
		U - S	Message		
	EXCEPTION: After the 1st message is received, step 1 below shall be repeated every time the duration indicated in the IE <i>reportInterval</i> has elapsed.				
1	Check: Does the UE transmit a <i>MEASUREMENTREPORT</i> message to perform periodical intra frequency reporting for Cell 5?	-->	<i>MEASUREMENTREPORT</i>	1	P

Table 8.3.2.4.3.2-4: Parallel behaviour

St	Procedure	Message Sequence		TP	Verdict
		U - S	Message		
	EXCEPTION: Step 1 below shall be repeated every time the duration indicated in the IE <i>reportInterval</i> has elapsed.				
1	Check: Does the UE transmit a <i>MeasurementReport</i> message to perform periodical intra frequency reporting for Cell 5 and Cell 7?	-->	<i>MeasurementReport</i>	1, 2	P

Table 8.3.2.4.3.2-5: Parallel behaviour

St	Procedure	Message Sequence		TP	Verdict
		U - S	Message		
	EXCEPTION: Step 1 shall be repeated every time the duration indicated in the IE <i>reportInterval</i> has elapsed.				
1	Check: Does the UE transmit a <i>MeasurementReport</i> message to perform periodical intra frequency reporting for Cell 7?	-->	<i>MeasurementReport</i>	1, 2	P

8.3.2.4.3.3 Specific message contents

Table 8.3.2.4.3.3-1 RRCConnectionReconfiguration (step 1 and step 7, Table 8.3.2.4.3.2-2)

Derivation path: 36.508 table table 4.6.1-8 with condition MEAS

Table 8.3.1.4.3.3-2 MeasurementConfiguration (step 1, Table 8.3.1.4.3.2-2)

Derivation Path: 36.508, Table 4.6.6-1			
Information Element	Value/remark	Comment	Condition
MeasConfig ::= SEQUENCE {			
measObjectToAddModList SEQUENCE (SIZE (1..maxObjectId) OF SEQUENCE {	2 entries		
measObjectId[1]	IdMeasObject-f8		
measObject[1]	MeasObjectUTRA-f8	UTRA frequency	
}			
reportConfigToAddModList SEQUENCE (SIZE (1..maxReportConfigId) OF SEQUENCE {	1 entry		
reportConfigId[1]	IdReportConfig-P		
reportConfig[1]	ReportConfig-P		
}			
measIdToAddModList SEQUENCE (SIZE (1..maxMeasId) OF SEQUENCE {	2 entries		
measId[1]	1		
measObjectId[1]	IdMeasObject-f8		
reportConfigId[1]	IdReportConfig-P		
}			
}			

Table 8.3.1.4.3.3-3 MeasObjectUTRA-f8 (step 1, Table 8.3.1.4.3.2-2)

Derivation path: 36.508 table 4.6.6-3 MeasObjectUTRA-GENERIC(f8)			
Information Element	Value/Remark	Comment	Condition
MeasObjectUTRA-GENERIC(f8) ::= SEQUENCE {			
carrierFreq		UTRA DL carrier frequency of the serving cell	
cellsToAddModList CHOICE {			
cellsToAddModListUTRA-FDD ::= SEQUENCE (SIZE (1..maxMeasId)) OF SEQUENCE {			FDD
cellIndex [1]	1		
physCellId [1]	physicalCellIdentity – Cell 5		
cellIndex [2]	2		
physCellId [2]	physicalCellIdentity – Cell 7		
}			
cellsToAddModListUTRA-TDD ::= SEQUENCE (SIZE (1..maxMeasId)) OF SEQUENCE {			TDD
cellIndex [1]	1		
physCellId [1]	physicalCellIdentity – Cell 5		
cellIndex [2]	2		
physCellId [2]	physicalCellIdentity – Cell 7		
}			
}			
}			

Table 8.3.1.4.3.3-4 ReportConfig-P (step 1, Table 8.3.1.4.3.2-2)

Derivation path: 36.508 table 4.6.6-7 ReportConfigInterRAT-P-UTRA [TBD]			
Information Element	Value/Remark	Comment	Condition
ReportConfigInterRAT-P-UTRA ::= SEQUENCE {	ReportConfigUTRA-P		
maxReportCells	2	Report Cell 5 and Cell 7	
}			

Table 8.3.2.4.3.3-5: MeasurementConfiguration (step 10, Table 8.3.2.4.3.2-2)

Derivation Path: 36.508, Table 4.6.6-1			
Information Element	Value/remark	Comment	Condition
MeasConfig ::= SEQUENCE {			
measIdToRemoveList SEQUENCE (SIZE (1..maxMeasId)) OF SEQUENCE {	1entry		
measId[1]	1		
}			
}			

<pre> } } } } } } </pre>			
--------------------------	--	--	--

8.3.2.6 Measurement configuration control and reporting / inter RAT measurements: Simultaneous A2 and two B2 (measurements of E-UTRAN, UTRAN and GERAN cells)

8.3.2.6.1 Test Purpose (TP)

(1)

```

with { UE in E-UTRA RRC_CONNECTED state and measurements configured for A2 on E-UTRAN, B2 on UTRAN
and B2 on GERAN at the same time }
ensure that {
  when { UE detects entering condition for the events A2 and B2 are not met }
  then { UE does not transmit any MeasurementReport messages }
}

```

(2)

```

with { UE in E-UTRA RRC_CONNECTED state and measurements configured for A2 on E-UTRAN, B2 on UTRAN
and B2 on GERAN at the same time }
ensure that {
  when { UE detects entering condition for the event A2 is met }
  then { UE transmits a MeasurementReport message }
}

```

(3)

```

with { UE in E-UTRA RRC_CONNECTED state and measurements configured for A2 on E-UTRAN, B2 on UTRAN
and B2 on GERAN at the same time }
ensure that {
  when { UE detects entering condition for the event B2 for UTRAN is met }
  then { UE transmits a MeasurementReport message }
}

```

(4)

```

with { UE in E-UTRA RRC_CONNECTED state and measurements configured for A2 on E-UTRAN, B2 on UTRAN
and B2 on GERAN at the same time }
ensure that {
  when { UE detects entering condition for the event B2 for GERAN is met }
  then { UE transmits a MeasurementReport message }
}

```

8.3.2.6.2 Conformance requirements

References: The conformance requirements covered in the present TC are specified in: TS 36.331, clause 5.5.4.1, 5.5.4.3, 5.5.4.8 and 5.5.5.

[TS 36.331, clause 5.5.4.1]

The UE shall:

1> for each *measId* included in the *measIdList* within *VarMeasConfig*:

2> if the corresponding *reportConfig* includes a purpose set to '*reportStrongestCellsForSON*':

...

2> else:

3> if the corresponding *measObject* concerns E-UTRA:

4> consider any neighbouring cell detected on the associated frequency to be applicable when the concerned cell is not included in the *blackCellsToAddModList* defined within the *VarMeasConfig* for this *measId*;

- 3> else if the corresponding *measObject* concerns UTRA or CDMA2000:
 - 4> consider a neighbouring cell on the associated frequency to be applicable when the concerned cell is included in the *cellsToAddModList* defined within the *VarMeasConfig* for this *measId* (i.e. the cell is included in the white-list);
- 3> else if the corresponding *measObject* concerns GERAN:
 - 4> consider a neighbouring cell on the associated set of frequencies to be applicable when the concerned cell matches the *ncc-Permitted* defined within the *VarMeasConfig* for this *measId*;
- 2> if the *triggerType* is set to 'event' and if the entry condition applicable for this event, i.e. the event corresponding with the *eventId* of the corresponding *reportConfig* within *VarMeasConfig*, is fulfilled for one or more applicable cells for all measurements after layer 3 filtering taken during *timeToTrigger* defined for this event within the *VarMeasConfig*, while the *VarMeasReportList* does not include an measurement reporting entry for this *measId* (a first cell triggers the event):
 - 3> include a measurement reporting entry within the *VarMeasReportList* for this *measId*;
 - 3> set the *numberOfReportsSent* defined within the *VarMeasReportList* for this *measId* to 0;
 - 3> include the concerned cell(s) in the *cellsTriggeredList* defined within the *VarMeasReportList* for this *measId*;
 - 3> initiate the measurement reporting procedure, as specified in 5.5.5;

[TS 36.331, clause 5.5.4.3]

The UE shall:

- 1> consider the entering condition for this event to be satisfied when condition A2-1, as specified below, is fulfilled;
- 1> consider the leaving condition for this event to be satisfied when condition A2-2, as specified below, is fulfilled;

Inequality A2-1 (Entering condition)

$$Ms + Hys < Thresh$$

Inequality A2-2 (Leaving condition)

$$Ms - Hys > Thresh$$

The variables in the formula are defined as follows:

Ms is the measurement result of the serving cell, not taking into account any offsets.

Hys is the hysteresis parameter for this event (i.e. *hysteresis* as defined within *reportConfigEUTRA* for this event).

Thresh is the threshold parameter for this event (i.e. *a2-Threshold* as defined within *reportConfigEUTRA* for this event).

Ms is expressed in dBm in case of RSRP, or in dB in case of RSRQ.

Hys is expressed in dB.

Thresh is expressed in the same unit as ***Ms***.

[TS 36.331, clause 5.5.4.8]

The UE shall:

- 1> for UTRA and CDMA2000, only trigger the event for cells included in the corresponding measurement object;
- 1> consider the entering condition for this event to be satisfied when both condition B2-1 and condition B2-2, as specified below, are fulfilled;
- 1> consider the leaving condition for this event to be satisfied when condition B2-3 or condition B2-4, i.e. at least one of the two, as specified below, is fulfilled;

Inequality B2-1 (Entering condition 1)

$$M_s + H_{ys} < Thresh1$$

Inequality B2-2 (Entering condition 2)

$$M_n + Ofn - H_{ys} > Thresh2$$

Inequality B2-3 (Leaving condition 1)

$$M_s - H_{ys} > Thresh1$$

Inequality B2-4 (Leaving condition 2)

$$M_n + Ofn + H_{ys} < Thresh2$$

The variables in the formula are defined as follows:

M_s is the measurement result of the serving cell, not taking into account any offsets.

M_n is the measurement result of the inter-RAT neighbour cell, not taking into account any offsets.

Ofn is the frequency specific offset of the frequency of the inter-RAT neighbour cell (i.e. *offsetFreq* as defined within the *measObject* corresponding to the frequency of the inter-RAT neighbour cell).

H_{ys} is the hysteresis parameter for this event (i.e. *hysteresis* as defined within *reportConfigInterRAT* for this event).

Thresh1 is the threshold parameter for this event (i.e. *b2-Threshold1* as defined within *reportConfigInterRAT* for this event).

Thresh2 is the threshold parameter for this event (i.e. *b2-Threshold2* as defined within *reportConfigInterRAT* for this event).

M_s is expressed in dBm in case of RSRP, or in dB in case of RSRQ.

M_n is expressed in dBm or dB, depending on the measurement quantity of the inter-RAT neighbour cell.

Ofn, ***H_{ys}*** are expressed in dB.

Thresh1 is expressed in the same unit as ***M_s***.

Thresh2 is expressed in the same unit as ***M_n***.

[TS 36.331, clause 5.5.5]

For the *measId* for which the measurement reporting procedure was triggered, the UE shall set the *measResults* within the *MeasurementReport* message as follows:

1> set the *measId* to the measurement identity that triggered the measurement reporting;

1> set the *measResultServCell* to include the quantities of serving cell;

1> if there is at least one applicable neighbouring cell to report:

2> set the *measResultsNeighCells* to include the best neighbouring cells up to *maxReportCells* in accordance with the following:

3> if the *triggerType* is set to 'event':

4> include the cells included in the *cellsTriggeredList* as defined within the *VarMeasReportList* for this *measId*;

3> else:

...

3> for each cell that is included in the *measResultsNeighCells*, include the *physCellId*;

- 3> if the *triggerType* is set to 'event'; or the *purpose* is set to 'reportStrongestCells' or to 'reportStrongestCellsForSON':
 - 4> for each included cell, include the layer 3 filtered measured results in accordance with the *reportConfig* for this *measId*, ordered as follows:
 - 5> if the *measObject* associated with this *measId* concerns E-UTRA:
 - 6> set the *measResult* to include the quantity(ies) indicated in the *reportQuantity* within the concerned *reportConfig* in order of decreasing *triggerQuantity*, i.e. the best cell is included first;
 - 5> else:
 - 6> set the *measResult* to the quantity as configured for the concerned RAT within the *quantityConfig* in order of decreasing quantity, i.e. the best cell is included first;

...

1> submit the *MeasurementReport* message to lower layers for transmission, upon which the procedure ends;

8.3.2.6.3 Test description

8.3.2.6.3.1 Pre-test conditions

System Simulator:

- Cell 1, Cell 5 and Cell 24.

UE:

None.

Preamble:

- The UE is in state Generic RB Established (state 3) on Cell 1 according to [18].

8.3.2.6.3.2 Test procedure sequence

Table 8.3.2.6.3.2-1 illustrates the downlink power levels to be applied for the cells at various time instants of the test execution. Row marked "T0" denotes the initial conditions, while columns marked "T1" is to be applied subsequently. The exact instants on which these values shall be applied are described in the texts in this clause.

Table 8.3.2.6.3.2-1: Power levels

	Parameter	Unit	Cell 1	Cell 5	Cell 24	Remark
T0	RS EPRE	dBm/15kHz	-85	-	-	Entry conditions for A2 and B2 events are not fulfilled.
	CPICH_Ec	dBm/3.84 MHz	-	[FFS]	-	
	GERAN Cell Power	dBm	-	-	[FFS]	
T1	RS EPRE	dBm/15kHz	[FFS]	-	-	Entry conditions for A2 and B2 events are fulfilled.
	CPICH_Ec	dBm/3.84 MHz	-	[FFS]	-	
	GERAN Cell Power	dBm	-	-	[FFS]	

Table 8.3.2.6.3.2-2: Main behaviour

St	Procedure	Message Sequence		TP	Verdict
		U - S	Message		
1	The SS transmits an <i>RRConnectionReconfiguration</i> message to setup intra and inter RAT measurements on Cell 1.	<--	<i>RRConnectionReconfiguration</i>	-	-
2	The UE transmits an <i>RRConnectionReconfigurationComplete</i> message.	-->	<i>RRConnectionReconfigurationComplete</i>	-	-
3	Check: Does the UE transmit any <i>MeasurementReport</i> messages during the next 10s?	-->	<i>MeasurementReport</i>	1	F
4	The SS changes Cell 1, Cell 5 and Cell 24 parameters according to row "T1" in table 8.3.2.6.3.2-1.	-	-	-	-
-	EXCEPTION: In parallel to step 5 the steps specified in Table 8.3.2.6.3.2-3 shall take place.	-	-	-	-
5	The SS waits for 10s.	-	-	-	-
6	Check: Does the test result of CALL generic procedure indicate that the UE is in E-UTRA RRC_CONNECTED state on Cell 1?	-	-	-	-

Table 8.3.2.6.3.2-3: Parallel behaviour

St	Procedure	Message Sequence		TP	Verdict
		U - S	Message		
-	EXCEPTION: The steps 1-3 may occur in any order.	-	-	-	-
1	Check: Does the UE transmit a <i>MeasurementReport</i> message to report event A2 for Cell 1.	-->	<i>MeasurementReport</i>	2	P
2	Check: Does the UE transmit a <i>MeasurementReport</i> message to report event B2 for Cell 5.	-->	<i>MeasurementReport</i>	3	P
3	Check: Does the UE transmit a <i>MeasurementReport</i> message to report event B2 for Cell 24.	-->	<i>MeasurementReport</i>	4	P

8.3.2.6.3.3 Specific message contents

Table 8.3.2.6.3.3-1: *RRConnectionReconfiguration* (step 1, Table 8.3.2.6.3.2-2)

Derivation Path: 36.508 table 4.6.1-8 with condition MEAS

Table 8.3.2.6.3.3-2: MeasurementConfiguration (step 1, Table 8.3.2.6.3.2-2)

Derivation path: 36.508 table 4.6.6-1			
Information Element	Value/Remark	Comment	Condition
measConfig ::= SEQUENCE { measObjectToAddModList SEQUENCE (SIZE (1..maxObjectId)) OF SEQUENCE { measObjectId[1] measObject[1] measObjectId[2] measObject[2] measObjectId[2] measObject[2] } reportConfigToAddModList SEQUENCE (SIZE (1..maxReportConfigId)) OF SEQUENCE { reportConfigId[1] reportConfig[1] reportConfigId[2] reportConfig[2] reportConfigId[3] reportConfig[3] } measIdToAddModList SEQUENCE (SIZE (1..maxMeasId)) OF SEQUENCE { measId[1] measObjectId[1] reportConfigId[1] measId[2] measObjectId[2] reportConfigId[2] measId[3] measObjectId[3] reportConfigId[3] } quantityConfig SEQUENCE { quantityConfigEUTRA SEQUENCE { filterCoefficientRSRP filterCoefficientRSRQ } quantityConfigUTRA SEQUENCE { measQuantityUTRA-FDD measQuantityUTRA-TDD filterCoefficient } quantityConfigGERAN SEQUENCE { measQuantityGERAN filterCoefficient } quantityConfigCDMA2000 } measGapConfig ::= CHOICE { setup SEQUENCE { gapOffset CHOICE { gp0 gp1	3 entries IdMeasObject-EUTRA MeasObjectEUTRA- GENERIC(f1) IdMeasObject-UTRA MeasObjectUTRA- GENERIC(f8) IdMeasObject-GERAN MeasObjectGERAN- GENERIC(f11)		
	3 entries	Thres value FFS	
	IdReportConfig-A2 ReportConfigEUTRA- A2(FFS)	EUTRA-Thres and UTRA-Thres values FFS	
	IdReportConfig-B2-UTRA ReportConfigInterRAT- B2-UTRA(FFS)	EUTRA-Thres and GERAN-Thres values FFS	
	IdReportConfig-B2- GERAN ReportConfigInterRAT- B2-GERAN(EUTRA- Thres, GERAN-Thres)		
	3 entries		
	1 IdMeasObject-EUTRA IdReportConfig-A2		
	2 IdMeasObject-UTRA IdReportConfig-B2-UTRA		
	3 IdMeasObject-GERAN IdReportConfig-B2- GERAN		
	fc4 fc4		
	cpich-EcN0		UTRA- FDD UTRA- TDD
	pccpch-RSCP		
	fc4		
	rssi fc2		
	Not present		
	FFS FFS		

<pre> } } } } </pre>		
----------------------	--	--

Condition	Explanation
UTRA-FDD	UTRA FDD cell environment
UTRA-TDD	UTRA TDD cell environment

Table 8.3.2.6.3.3-3: ReportConfigEUTRA-A2(Thres) (step 1, Table 8.3.2.6.3.2-2)

Derivation Path: 36.508 table 4.6.6-5			
Information Element	Value/remark	Comment	Condition
ReportConfigEUTRA-A2(Thres) ::= SEQUENCE {			
reportAmount	1		
}			

Table 8.3.2.6.3.3-4: ReportConfigInterRAT-B2-UTRA(EUTRA-Thres, UTRA-Thres) (step 1, Table 8.3.2.6.3.2-2)

Derivation Path: 36.508 table 4.6.6-8			
Information Element	Value/remark	Comment	Condition
ReportConfigInterRAT-B2-UTRA(EUTRA-Thres, UTRA-Thres) ::= SEQUENCE {			
reportAmount	1		
}			

Table 8.3.2.6.3.3-5: ReportConfigInterRAT-B2-GERAN(EUTRA-Thres, GERAN-Thres) (step 1, Table 8.3.2.6.3.2-2)

Derivation Path: 36.508 table 4.6.6-7E			
Information Element	Value/remark	Comment	Condition
ReportConfigInterRAT-B2-UTRAGERAN(EUTRA-Thres, UTRAGERAN-Thres) ::= SEQUENCE {			
reportAmount	1		
}			

Table 8.3.2.6.3.3-6: MeasurementReport (step 1 Table 8.3.2.6.3.2-3)

Derivation path: 36.508 table 4.6.1-5			
Information Element	Value/Remark	Comment	Condition
MeasurementReport ::= SEQUENCE {			
criticalExtensions CHOICE {			
C1 CHOICE {			
measurementReport-r8 SEQUENCE {			
measResults ::= SEQUENCE {			
measId	1		
measResultServCell ::= SEQUENCE {			
rsrpResult	(0..97)		
rsrqResult	(0..34)	Report Cell 1	
}			
measResultNeighCells CHOICE {			
measResultListEUTRA	FFS		
}			
}			
}			
}			
}			

Table 8.3.2.6.3.3-7: MeasurementReport (step 2 Table 8.3.2.6.3.2-3)

Derivation path: 36.508 table 4.6.1-5			
Information Element	Value/Remark	Comment	Condition
MeasurementReport ::= SEQUENCE { criticalExtensions CHOICE { C1 CHOICE { measurementReport-r8 SEQUENCE { measResults ::= SEQUENCE { measId measResultServCell ::= SEQUENCE { rsrpResult rsrqResult } measResultNeighCells CHOICE { measResultListUTRA } } } } }	2 (0..97) (0..34) FFS	Report Cell 5	

Table 8.3.2.6.3.3-8: MeasurementReport (step 3 Table 8.3.2.6.3.2-3)

Derivation path: 36.508 table 4.6.1-5			
Information Element	Value/Remark	Comment	Condition
MeasurementReport ::= SEQUENCE { criticalExtensions CHOICE { C1 CHOICE { measurementReport-r8 SEQUENCE { measResults ::= SEQUENCE { measId measResultServCell ::= SEQUENCE { rsrpResult rsrqResult } measResultNeighCells CHOICE { measResultListGERAN } } } } }	3 (0..97) (0..34) FFS	Report Cell 24	

8.3.2.7 Measurement configuration control and reporting / inter-RAT measurements: event B2 (measurement HRPD cells)

8.3.2.7.1 Test Purpose (TP)

(1)

```
with { UE having completed the radio bearer establishment, initial security activation procedure and performed the inter RAT measurement for HRPD cell and not detected entering condition for the event B2 is met }
ensure that {
  when { UE detects entering condition for the event B2 is not met }
  then { UE does not transmit any MeasurementReport }
}
```

(2)

```
with { UE having completed the radio bearer establishment, initial security activation procedure and performed the inter RAT measurement for HRPD cell and not detected entering condition for the event B2 is met }
ensure that {
  when { UE detects entering condition for the event B2 is met }
```

```

then { UE transmits a MeasurementReport }
}

```

(3)

```

with { UE having completed the radio bearer establishment, initial security activation procedure and
performed the inter RAT measurement for HRPD cell and detected entering condition for the event B2
is met }
ensure that {
  when { UE detects leaving condition for the event B2 is met }
  then { UE does not transmit any MeasurementReport }
}

```

8.3.2.7.2 Conformance Requirements

References: The conformance requirements covered in the present TC are specified in: 3GPP TS 36.331 clauses 5.5.4.1, 5.5.4.8, and 5.5.5.

[TS 36.331, clause 5.5.4.1]

The UE shall:

- 1> for each *measId* included in the *measIdList* within *VarMeasurementConfiguration*:
 - 2> if the *triggerType* is set to 'event':
 - 3> if the corresponding *measObject* concerns UTRA or CDMA2000:
 - 4> consider a neighbouring cell on the associated frequency to be applicable when the concerned cell is included in the *cellsToAddModifyList* defined within the *VarMeasurementConfiguration* for this *measId* (i.e. the cell is included in the white-list);
 - ...
 - 2> if the *triggerType* is set to 'event' and if the entry condition applicable for this event, i.e. the event corresponding with the *eventId* of the corresponding *reportConfig* within *VarMeasurementConfiguration*, is fulfilled for one or more applicable cells for a duration exceeding the value of *timeToTrigger* defined for this event within the *VarMeasurementConfiguration* while the *VarMeasurementReports* does not include an entry for this *measId* (a first cell triggers the event):
 - 3> include an entry within the *VarMeasurementReports* for this *measId*;
 - 3> set the *numberOfReportsSent* defined within the *VarMeasurementReports* for this *measId* to 0;
 - 3> include the concerned cell(s) in the *cellsTriggeredList* defined within the *VarMeasurementReports* for this *measId*, if not included;
 - 3> initiate the measurement reporting procedure, as specified in 5.5.5;
 - ...
 - 2> if the *triggerType* is set to 'event' and if the entry condition applicable for this event, i.e. the event corresponding with the *eventId* of the corresponding *reportConfig* within *VarMeasurementConfiguration*, is fulfilled for one or more applicable cells not included in the *cellsTriggeredList* for a duration exceeding the value of *timeToTrigger* defined for this event within the *VarMeasurementConfiguration* (a subsequent cell triggers the event):
 - 3> set the *numberOfReportsSent* defined within the *VarMeasurementReports* for this *measId* to 0;
 - 3> include the concerned cell(s) in the *cellsTriggeredList* defined within the *VarMeasurementReports* for this *measId*, if not included;
 - 3> initiate the measurement reporting procedure, as specified in 5.5.5;
 - ...
 - 2> if the *triggerType* is set to 'event' and if the leaving condition applicable for this event is fulfilled for one or more of the cells included in the *cellsTriggeredList* defined within the *VarMeasurementReports* for this

measId for a duration exceeding the value of *timeToTrigger* defined within the *VarMeasurementConfiguration* for this event:

- 3> remove the concerned cell(s) in the *cellsTriggeredList* defined within the *VarMeasurementReports* for this *measId*;
- 3> if *reportOnLeave* is set for the corresponding reporting configuration:
 - 4> initiate the measurement reporting procedure, as specified in 5.5.5;
- 3> if the *cellsTriggeredList* defined within the *VarMeasurementReports* for this *measId* is empty:
 - 4> remove the entry within the *VarMeasurementReports* for this *measId*;
 - 4> stop the periodical reporting timer for this *measId*, if running;

NOTE 2: The UE does not stop the periodical reporting with *triggerType* set to 'event' or to 'periodical' while the corresponding measurement is not performed due to the serving cell quality being better than *s-Measure* or due to the measurement gap not being active.

[TS 36.331, clause 5.5.4.8]

The UE shall:

- 1> for UTRA and CDMA2000, only trigger the event for cells included in the corresponding measurement object;
- 1> apply inequality B2-1 and inequality B2-2 i.e. both have to be fulfilled, as specified below, as the entry condition for this event;
- 1> apply inequality B2-3 and inequality B2-4 i.e. at least one of the two has to be fulfilled, as specified below, as the leaving condition for this event;

Inequality B2-1 (Entering condition 1)

$$M_s + H_{ys} < Thresh1$$

Inequality B2-2 (Entering condition 2)

$$M_n + Ofn - H_{ys} > Thresh2$$

Inequality B2-3 (Leaving condition 1)

$$M_s - H_{ys} > Thresh1$$

Inequality B2-4 (Leaving condition 2)

$$M_n + Ofn + H_{ys} < Thresh2$$

The variables in the formula are defined as follows:

M_s is the measurement result of the serving cell, not taking into account any cell individual offset.

M_n is the measurement result of the neighbouring inter RAT cell.

Ofn is the frequency specific offset of the frequency of the neighbour cell.

H_{ys} is the hysteresis parameter for this event (i.e. *hysteresis* as defined within the *VarMeasurementConfiguration* for this event).

Thresh1 is the threshold parameter for this event (i.e. *b2-Threshold1* as defined within the *VarMeasurementConfiguration* for this event).

Thresh2 is the threshold parameter for this event (i.e. *b2-Threshold2* as defined within the *VarMeasurementConfiguration* for this event).

M_s is expressed in dBm in case of RSRP, or in dB in case of RSRQ.

M_n is expressed in dBm or dB, depending on the measurement quantity of the neighbouring inter RAT cell.

Ofn, *Hys* are expressed in dB.

Thresh1 is expressed in dBm in case *Ms* is expressed in dBm; otherwise it is expressed in dB.

Thresh2 is expressed in dBm in case *Mn* is expressed in dBm; otherwise it is expressed in dB.

[TS 36.331, clause 5.5.5]

For the *measId* for which the measurement reporting procedure was triggered, the UE shall set the *measuredResults* within the *MeasurementReport* message as follows:

- 1> set the *measId* to the measurement identity that triggered the measurement reporting;
- 1> set the *neighbouringMeasResults* to include the best neighbouring cells up to *maxReportCells* in accordance with the following:
 - 2> if the *triggerType* is set to 'event':
 - 3> include the cells included in the *cellsTriggeredList* as defined within the *VarMeasurementReports* for this *measId*;
 - ...
 - 2> for each cell that is included in the *neighbouringMeasResults*, include the *physicalCellIdentity*;
 - 2> if the *triggerType* is set to 'event'; or the *purpose* is set to 'reportStrongestCells' or to 'reportStrongestCellsForSON', ordered as follows:
 - 3> for each included cell include the filtered measured results in accordance with the *reportConfigList* defined in variable *VarMeasurementConfiguration* for that *measId* as follows:
 - 4> if the *measObject* associated with this *measId* concerns E-UTRA:
 - 5> if the *reportQuantity* within the concerned *reportConfig* is set to 'both' (E-UTRA):
 - 6> set the *measResult* to include both quantities (i.e. *rscpResult* and *rsrqResult*) in order of decreasing *triggerQuantity*, i.e. the best cell is included first;
 - 5> else:
 - 6> set the *measResult* to include the quantity as indicated by the *triggerQuantity* within the concerned *reportConfig* in order of decreasing *triggerQuantity*, i.e. the best cell is included first;
 - 4> else:
 - 5> set the *measResult* to the quantity as configured for the concerned RAT within the *quantityConfig* in order of decreasing quantity, i.e. the best cell is included first;
 - 1> increment the *numberOfReportsSent* as defined within the *VarMeasurementReports* for this *measId* by 1;
 - 1> stop the periodical reporting timer, if running;
 - 1> if the *numberOfReportsSent* as defined within the *VarMeasurementReports* for this *measId* is less than the *reportAmount* as defined within the corresponding *reportingConfiguration* as defined in the *VarMeasurementConfiguration*:
 - 2> stop the periodical reporting timer, if running;
 - 2> start the periodical reporting timer with the value of *reportInterval* as defined within the *VarMeasurementConfiguration* for this *measId*;
 - ...
 - 1> if the measured results are for CDMA 1xRTT:

2> set the *hrpdPreRegistrationStatus* to `0`;

1> submit the *MeasurementReport* message to lower layers for transmission, upon which the procedure ends.

8.3.2.7.3 Test description

8.3.2.7.3.1 Pre-test conditions

System Simulator:

- Cell 1 is high quality cell on E-UTRA
- Cell 20 and Cell 21 are high quality cell on HRPD.

UE:

None.

Preamble:

- The UE is in state Generic RB Established (state 3) on Cell 1 according to [18].

8.3.2.7.3.2 Test procedure sequence

Table 8.3.2.7.3.2-1 illustrates the downlink power levels and other changing parameters to be applied for the cells at various time instants of the test execution. Row marked "T0" denotes the initial conditions, while columns marked "T1", "T2", "T3" and "T4" are to be applied subsequently. The exact instants on which these values shall be applied are described in the texts in this clause.

Table 8.3.2.7.3.2-1: Time instances of cell power level and parameter changes

	Parameter	Unit	Cell 1	Cell 20	Cell 21	Remark
T0	Cell-specific RS EPRE	dBm/15k Hz	-60	-	-	The power level values are such that entering conditions for event B2 are not satisfied.
	Pilot_Ec/Io (Note 1)	dB	-	[-23.5]	[-23.5]	
T1	Cell-specific RS EPRE	dBm/15k Hz	-80	-	-	The power level values are such that entering conditions for event B2 are satisfied.
	Pilot_Ec/Io (Note 1)	dB	-	[-10]	[-23.5]	
T2	Cell-specific RS EPRE	dBm/15k Hz	-60	-	-	The power level values are such that entering conditions for event B2 are not satisfied.
	Pilot_Ec/Io (Note 1)	dB	-	[-23.5]	[-23.5]	
T3	Cell-specific RS EPRE	dBm/15k Hz	-80	-	-	The power level values are such that entering conditions for event B2 are satisfied.
	Pilot_Ec/Io (Note 1)	dB	-	[-10]	[-23.5]	
T4	Cell-specific RS EPRE	dBm/15k Hz	-60	-	-	The power level values are such that entering conditions for event B2 are not satisfied.
	Pilot_Ec/Io (Note 1)	dB	-	[-23.5]	[-23.5]	
Note 1: This parameter is not directly settable, but is derived by calculation from the other parameters set by the SS.						

Table 8.3.2.7.3.2-2: Main behaviour

St	Procedure	Message Sequence		TP	Verdict
		U - S	Message		
1	The SS transmits an <i>RRCCONNECTIONRECONFIGURATION</i> message to setup inter RAT measurement on Cell 1.	<--	<i>RRCCONNECTIONRECONFIGURATION</i>	-	-
2	The UE transmits an <i>RRCCONNECTIONRECONFIGURATIONCOMPLETE</i> message to confirm the setup of inter RAT measurement on Cell 1.	-->	<i>RRCCONNECTIONRECONFIGURATIONCOMPLETE</i>	-	-
3	Check: Does the UE transmit a <i>MEASUREMENTREPORT</i> message to report the event B2 during the next 10s?	-->	<i>MEASUREMENTREPORT</i>	1	F
4	The SS changes Cell 1, Cell 20 and Cell 21 parameters according to row "T1" in table 8.3.2.7.3.2-1.	-	-	-	-
5	Check: Does the UE transmit a <i>MEASUREMENTREPORT</i> message to report the event B2 for Cell 20, not including Cell 21?	-->	<i>MEASUREMENTREPORT</i>	2	P
6	Check: Does the UE transmit a <i>MEASUREMENTREPORT</i> message to report the event B2 for Cell 20, not including Cell 21?	-->	<i>MEASUREMENTREPORT</i>	2	P
7	The SS changes Cell 1, Cell 20 and Cell 21 parameters according to row "T2" in table 8.3.2.7.3.2-1.	-	-	-	-
8	Check: Does the UE transmit a <i>MEASUREMENTREPORT</i> message to report the event B2 during the next 10s?	-->	<i>MEASUREMENTREPORT</i>	3	F
9	The SS changes Cell 1, , Cell 20 and Cell 21 parameters according to row "T3" in table 8.3.2.7.3.2-1.	-	-	-	-
10	Check: Does the UE transmit a <i>MEASUREMENTREPORT</i> message to report the event B2 for Cell 20, not including Cell 21?	-->	<i>MEASUREMENTREPORT</i>	2	P
11	Check: Does the UE transmit a <i>MEASUREMENTREPORT</i> message to report the event B2 for Cell 20, not including Cell 21?	-->	<i>MEASUREMENTREPORT</i>	2	P
12	The SS changes Cell 1, Cell 20 and Cell 21 parameters according to row "T4" in table 8.3.2.7.3.2-1.	-	-	-	-
13	Check: Does the UE transmit a <i>MEASUREMENTREPORT</i> message to report the event B2 during the next 10s?	-->	<i>MEASUREMENTREPORT</i>	3	F
14	Check: Does the test result of CALL generic procedure indicate that the UE is in E-UTRA RRC_CONNECTED state on Cell 1?	-	-	-	-

8.3.2.7.3.3 Specific Message Contents

Table 8.3.2.7.3.3-1 *RRCCONNECTIONRECONFIGURATION* (step 1, Table 8.3.2.7.3.2-2):

Derivation Path: 36.508, Table 4.6.1-8, condition MEAS			
Information Element	Value/remark	Comment	Condition
<i>RRCCONNECTIONRECONFIGURATION</i> ::= SEQUENCE {			
criticalExtensions CHOICE {			
c1 CHOICE{			
rrcConnectionReconfiguration-r8 SEQUENCE {			
radioResourceConfiguration	Not present		
}			
}			
}			
}			

Table 8.3.2.7.3.3-3: *MeasurementReport* (steps 5, 6, 10 and 11, Table 8.3.2.7.3.2-2)

Derivation Path: 36.508, Table 4.6.1-5			
Information Element	Value/remark	Comment	Condition
MeasurementReport ::= SEQUENCE {			
criticalExtensions CHOICE {			
c1 CHOICE{			
measurementReport-r8 SEQUENCE {			
measuredResults SEQUENCE {			
measId	1		
measResultServing SEQUENCE {			
rsrpResult	(0..97)		
rsrqResult	(0..34)		
}			
neighbouringMeasResults CHOICE {			
measResultsCDMA2000 ::=SEQUENCE {			
hrpdPreRegistrationStatus	FALSE		
measResultListCDMA2000 ::=SEQUENCE	1 entry		
(SIZE (1..maxCellReport)) OF SEQUENCE {			
physicalCellIdentity[1]	PhysicalCellIdentity of Cell 20		
globalCellIdentity[1]	Not present		
measResult[1] SEQUENCE {			
pilotStrength	(0..63)		
}			
}			
}			
}			
}			
}			
}			

8.3.2.8 Measurement configuration control and reporting / inter RAT measurements: Periodic reporting (measurement of HRPD cells)

8.3.2.8.1 Test Purpose (TP)

(1)

```
with { UE in E-UTRA RRC_CONNECTED state and measurement configured for periodic reporting of HRPD cells }
ensure that {
  when { The UE receives reference signal power for cells on the HRPD frequency where measurements are configured }
  then { UE sends MeasurementReport message at regular intervals for these HRPD cells }
}
```

(2)

```
with { UE in E-UTRA RRC_CONNECTED state and a Measurement Report message for a configured periodic measurement reporting of HRPD cells on a configured frequency were sent }
ensure that {
  when { A previously reported cell become unavailable or the UE receives reference signal power on a reported HRPD frequency for a cell which was previously not reported }
  then { UE sends MeasurementReport message at regular intervals for the available HRPD cells }
}
```

(3)

```
with { UE in E-UTRA RRC_CONNECTED state and periodic measurement reporting of HRPD cells ongoing}
ensure that {
  when { The UE receives a RRCConnectionReconfiguration message removing the measID of periodic reporting of HRPD cells }
  then { UE stops sending MeasurementReport message for HRPD cells }
}
```

8.3.2.8.2 Conformance Requirements

References: The conformance requirements covered in the present TC are specified in: 3GPP TS 36.331 clauses 5.3.5.3, 5.5.2.2, 5.5.4.1 and 5.5.5.

[TS 36.331, clause 5.3.5.3]

If the *RRConnectionReconfiguration* message does not include the *mobilityControlInformation* and the UE is able to comply with the configuration included in this message, the UE shall:

.....

1> if the *RRConnectionReconfiguration* message includes the *measurementConfiguration*:

2> perform the measurement configuration procedure as specified in 5.5.2;

[TS 36.331, clause 5.5.2.2]

The UE shall:

1> for each *measId* value included in the *measIdToRemoveList*:

2> remove the entry, from the parameter *measIdList* within *VarMeasurementConfiguration*, with the corresponding *measId* value;

2> remove the entry within the *VarMeasurementReports* for this *measId*, if included;

2> reset the periodical reporting timer or timer T321, whichever one is running, as well as associated information (e.g. *timeToTrigger*) for this *measId*.

[TS 36.331, clause 5.5.4.1]

The UE shall:

1> for each *measId* included in the *measIdList* within *VarMeasurementConfiguration*:

2> if the *triggerType* is set to 'event':

3> if the corresponding *measObject* concerns UTRA or CDMA2000:

4> consider a neighbouring cell on the associated frequency to be applicable when the concerned cell is included in the *cellsToAddModifyList* defined within the *VarMeasurementConfiguration* for this *measId* (i.e. the cell is included in the white-list);

3> else if the corresponding *measObject* concerns GERAN:

4> consider a neighbouring cell on the associated set of frequencies to be applicable when the concerned cell matches the *ncc-Permitted* defined within the *VarMeasurementConfiguration* for this *measId*;

3> else if the corresponding *measObject* concerns EUTRA:

4> consider any neighbouring cell detected on the associated frequency to be applicable when the concerned cell is not included in the *blackListedCellsToAddModifyList* defined within the *VarMeasurementConfiguration* for this *measId*;

2> else consider a neighbouring cell on the associated frequency/ set of frequencies (GERAN) to be applicable as follows:

3> if the corresponding *reportingConfig* includes a purpose set to 'reportStrongestCellsForSON':

4> consider any neighbouring cell detected on the associated frequency to be applicable

3> if the corresponding *reportingConfig* includes a purpose set to 'reportCGI':

4> consider any neighbouring cell detected on the associated frequency/ set of frequencies (GERAN) which has a *physicalCellIdentity* matching the value of the *cellForWhichToReportCGI* included in the corresponding *measObject* within the *VarMeasurementConfiguration* to be applicable

3> else:

4> if the corresponding *measObject* concerns UTRA or CDMA2000:

5> consider a neighbouring cell on the associated frequency to be applicable when the concerned cell is included in the *cellsToAddModifyList* defined within the *VarMeasurementConfiguration* for this *measId* (i.e. the cell is included in the white-list);

.....

2> if the *triggerType* is set to 'periodical' and a (first) measurement result is available for one or more applicable cells:

3> include an entry within the *VarMeasurementReports* for this *measId*;

3> set the *numberOfReportsSent* defined within the *VarMeasurementReports* for this *measId* to 0;

3> initiate the measurement reporting procedure, as specified in 5.5.5;

NOTE 1: If the *purpose* is set to 'reportStrongestCells' or to 'reportStrongestCellsForSON', the UE initiates a first measurement report immediately after the requested *reportQuantity* becomes available for at least either serving cell or one of the applicable cells

2> Upon expiry of the periodical reporting timer for this *measId*:

3> initiate the measurement reporting procedure, as specified in 5.5.5;

2> upon expiry of the T321 for this *measId*:

3> initiate the measurement reporting procedure, as specified in 5.5.5;

[TS 36.331, clause 5.5.5]

For the *measId* for which the measurement reporting procedure was triggered, the UE shall set the *measuredResults* within the *MeasurementReport* message as follows:

1> set the *measId* to the measurement identity that triggered the measurement reporting;

1> set the *neighbouringMeasResults* to include the best neighbouring cells up to *maxReportCells* in accordance with the following:

2> if the *triggerType* is set to 'event':

3> include the cells included in the *cellsTriggeredList* as defined within the *VarMeasurementReports* for this *measId*;

2> else:

3> set the *neighbouringMeasResults* to include the applicable cells for which the requested *reportQuantity* has been available since the last periodical reporting or since the measurement was initiated or reset;

2> for each cell that is included in the *neighbouringMeasResults*, include the *physicalCellIdentity*;

1> increment the *numberOfReportsSent* as defined within the *VarMeasurementReports* for this *measId* by 1;

1> stop the periodical reporting timer, if running;

1> if the *numberOfReportsSent* as defined within the *VarMeasurementReports* for this *measId* is less than the *reportAmount* as defined within the corresponding *reportingConfiguration* as defined in the *VarMeasurementConfiguration*:

2> stop the periodical reporting timer, if running;

2> start the periodical reporting timer with the value of *reportInterval* as defined within the *VarMeasurementConfiguration* for this *measId*;

1> else if the *numberOfReportsSent* as defined within the *VarMeasurementReports* for this *measId* is equal to the *reportAmount* as defined within the corresponding *reportingConfiguration* as defined in the *VarMeasurementConfiguration*:

2> if the *triggerType* is set to 'periodical':

3> remove the entry within the *VarMeasurementReports* for this *measId*;

1> if the measured results are for CDMA HRPD:

2> set the *hrpdPreRegistrationStatus* to the UE's CDMA upper layer's HRPD *preRegistrationStatus*;

1> if the measured results are for CDMA 1xRTT:

2> set the *hrpdPreRegistrationStatus* to '0';

1> submit the *MeasurementReport* message to lower layers for transmission, upon which the procedure ends.

8.3.2.8.3 Test description

8.3.2.8.3.1 Pre-test conditions

System Simulator:

- Cell 1 is high quality cell on E-UTRA
- Cell 20 and Cell 21 are high quality cell on HRPD

UE:

None.

Preamble:

- The UE is brought to state Generic RB Established (state 3) according to [18] on Cell 1

8.3.2.8.3.2 Test procedure sequence

Table 8.3.2.8.3.2-1 illustrates the downlink power levels and other changing parameters to be applied for the cells at various time instants of the test execution. Row marked "T0" denotes the initial conditions, while columns marked "T1" and "T2" are to be applied subsequently. The exact instants on which these values shall be applied are described in the texts in this clause.

Table 8.3.2.8.3.2-1: Time instances of cell power level and parameter changes

	Parameter	Unit	Cell 1	Cell 20	Cell 21	Remark
T0	Cell-specific RS EPRE	dBm/15k Hz	-60	-	-	Power levels shall be such that camping on Cell 1 is guaranteed
	CPICH_Ec/lo (Note 1)	dB	-	[-10]	[-23.5]	
T1	Cell-specific RS EPRE	dBm/15k Hz	-60	-	-	
	CPICH_Ec/lo (Note 1)	dB	-	[-10]	[-10]	
T2	Cell-specific RS EPRE	dBm/15k Hz	-60	-	-	
	CPICH_Ec/lo (Note 1)	dB	-	[-23.5]	[-10]	

NOTE 1: This parameter is not directly settable, but are derived by calculation from the other parameters set by the SS.

Table 8.3.2.8.3.2-2: Main behaviour

St	Procedure	Message Sequence		TP	Verdict
		U - S	Message		
	The SS setup Cell 1, Cell 15 and Cell 16 parameters according to the row "T0" in Table 8.3.2.8.3.2-1.	-	-	-	-
1	The SS transmits an <i>RRCCONNECTIONRECONFIGURATION</i> message including measurementConfiguration to setup measurements and periodical reporting for HRPD cells.	<--	<i>RRCCONNECTIONRECONFIGURATION</i>	-	-
2	The UE transmits an <i>RRCCONNECTIONRECONFIGURATIONCOMPLETE</i> message to confirm measurement on Cell 20.	-->	<i>RRCCONNECTIONRECONFIGURATIONCOMPLETE</i>	-	-
	EXCEPTION: In parallel to events described in steps 4 and 5, the steps specified in table 8.3.2.8.3.2.-3 shall take place				
3	Wait for 30 s to ensure that the UE performs a periodical reporting of HRPD cells.			1	-
4	SS sets the cell-specific reference signal levels for Cell 1, Cell 20 and Cell 21 according to row "T1" in table 8.3.2.8.3.2.-1.	-	-	-	-
5	Wait and ignore <i>MEASUREMENTREPORT</i> messages for 5 s to allow for the switching of cells.	-	-	-	-
	EXCEPTION: In parallel to events described in steps 6 to 7 the steps specified in table 8.3.2.8.3.2.-4 shall take place				
6	Wait for 30 s to ensure that the UE performs a periodical reporting of HRPD cells.	-	-	1, 2	-
7	SS sets the cell-specific reference signal levels for Cell 1, Cell 20 according to row "T2" in table 8.3.2.4.3.2.-1.	-	-	-	-
8	Wait and ignore <i>MEASUREMENTREPORT</i> messages for 5 s to allow for the switching of cells.	-	-	-	-
	EXCEPTION: In parallel to events described in steps 9 to 10 the steps specified in table 8.3.2.8.3.2.-5 shall take place				
9	Wait for 30 s to ensure that the UE performs a periodical reporting of HRPD cells.	-	-	1, 2	-
10	SS transmits an <i>RRCCONNECTIONRECONFIGURATION</i> message including measurementConfiguration to remove measId for periodic reporting.	<--	<i>RRCCONNECTIONRECONFIGURATION</i>	-	-
11	The UE transmits an <i>RRCCONNECTIONRECONFIGURATIONCOMPLETE</i> message	-->	<i>RRCCONNECTIONRECONFIGURATIONCOMPLETE</i>	-	-

Table 8.3.2.8.3.2-3: Parallel behaviour

St	Procedure	Message Sequence		TP	Verdict
		U - S	Message		
	EXCEPTION: After the 1st message is received, step 1 below shall be repeated every time the duration indicated in the IE <i>reportInterval</i> has elapsed.				
1	Check: Does the UE transmit a <i>MEASUREMENTREPORT</i> message to perform periodical intra frequency reporting for Cell 20?	-->	<i>MEASUREMENTREPORT</i>	1	P

Table 8.3.2.8.3.2-4: Parallel behaviour

St	Procedure	Message Sequence		TP	Verdict
		U - S	Message		
	EXCEPTION: Step 1 below shall be repeated every time the duration indicated in the IE <i>reportInterval</i> has elapsed.				
1	Check: Does the UE transmit a <i>MeasurementReport</i> message to perform periodical intra frequency reporting for Cell 20 and Cell 21?	-->	<i>MeasurementReport</i>	1, 2	P

Table 8.3.2.8.3.2-5: Parallel behaviour

St	Procedure	Message Sequence		TP	Verdict
		U - S	Message		
	EXCEPTION: Step 1 shall be repeated every time the duration indicated in the IE <i>reportInterval</i> has elapsed.				
1	Check: Does the UE transmit a <i>MeasurementReport</i> message to perform periodical intra frequency reporting for Cell 21?	-->	<i>MeasurementReport</i>	1, 2	P

Editor’s note: The value and tolerance of the *reportInterval* is FFS.

8.3.2.8.3.3 Specific message contents

Editors note: When default message contents of *RRCCONNECTIONRECONFIGURATION* in TS36.508 will cover measurement configuration the tables for specific message contents below will be updated accordingly.

Table 8.3.2.8.3.3-1: RRCCONNECTIONRECONFIGURATION (step 1 Table 8.3.2.8.3.2-2)

Derivation Path: 36.508, Table 4.6.1-8, condition MEAS			
Information Element	Value/remark	Comment	Condition
RRCCONNECTIONRECONFIGURATION ::= SEQUENCE {			
criticalExtensions CHOICE {			
c1 CHOICE{			
rrcConnectionReconfiguration-r8 SEQUENCE {			
radioResourceConfiguration	Not present		
}			
}			
}			
}			

Table 8.3.2.8.3.3-5 MeasurementReport (step 1 Table 8.3.2.8.3.2-3, Table 8.3.2.8.3.2-4, Table 8.3.2.8.3.2-5)

Derivation Path: 36.508, Table 4.6.1-5			
Information Element	Value/remark	Comment	Condition
MeasurementReport ::= SEQUENCE {			
criticalExtensions CHOICE {			
c1 CHOICE{			
measurementReport-r8 SEQUENCE {			
measuredResults SEQUENCE {			
measId	1		
measResultServing SEQUENCE {			
rsrpResult	(0..97)		
rsrqResult	(0..34)		
}			
neighbouringMeasResults CHOICE {			
measResultsCDMA2000 ::=SEQUENCE {			
hrpdPreRegistrationStatus	FALSE		
measResultListCDMA2000 ::=SEQUENCE	1 entry		Table
(SIZE (1..maxCellReport)) OF SEQUENCE {			8.3.2.8.3.2-
physicalCellId[1]	PhysicalCellId of		3
globalCellId[1]	Cell 20		
measResult[1] SEQUENCE {	Not present		
pilotStrength	(0..63)		
}			
}			
measResultListCDMA2000 ::=SEQUENCE	2 entries		Table
(SIZE (1..maxCellReport)) OF SEQUENCE {			8.3.2.8.3.2-
physicalCellId[1]	PhysicalCellId of		4
globalCellId[1]	Cell 20		
measResult[1] SEQUENCE {	Not present		
pilotStrength	(0..63)		
}			
}			
measResultListCDMA2000 ::=SEQUENCE	1 entry		Table
(SIZE (1..maxCellReport)) OF SEQUENCE {			8.3.2.8.3.2-
physicalCellId[1]	PhysicalCellId of		5
globalCellId[1]	Cell 21		
measResult[1] SEQUENCE {	Not present		
pilotStrength	(0..63)		
}			
}			
}			
}			
}			
}			
}			

8.3.2.9 Measurement configuration control and reporting / inter RAT measurements: event B2 (measurement of 1xRTT cells)

8.3.2.9.1 Test Purpose (TP)

(1)

```
with { UE having completed the radio bearer establishment, initial security activation procedure and
performed the inter RAT measurement for 1xRTT cell and not detected entering condition for the event
B2 is met }
ensure that {
  when { UE detects entering condition for the event B2 is not met }
    then { UE does not transmit any MeasurementReport }
}
```

(2)

```
with { UE having completed the radio bearer establishment, initial security activation procedure and
performed the inter RAT measurement for 1xRTT cell and not detected entering condition for the event
B2 is met }
ensure that {
  when { UE detects entering condition for the event B2 is met }
    then { UE transmits a MeasurementReport }
}
```

(3)

```
with { UE having completed the radio bearer establishment, initial security activation procedure and
performed the inter RAT measurement for 1xRTT cell and detected entering condition for the event B2
is met }
ensure that {
  when { UE detects leaving condition for the event B2 is met }
    then { UE does not transmit any MeasurementReport }
}
```

8.3.2.9.2 Conformance requirements

References: The conformance requirements covered in the present TC are specified in: TS 36.331, clause 5.5.4.1, 5.5.4.8 and 5.5.5.

[TS 36.331, clause 5.5.4.1]

The UE shall:

- 1> for each *measId* included in the *measIdList* within *VarMeasurementConfiguration*:
 - 2> if the *triggerType* is set to 'event':
 - 3> if the corresponding *measObject* concerns UTRA or CDMA2000:
 - 4> consider a neighbouring cell on the associated frequency to be applicable when the concerned cell is included in the *cellsToAddModifyList* defined within the *VarMeasurementConfiguration* for this *measId* (i.e. the cell is included in the white-list);
 - ...
 - 2> if the *triggerType* is set to 'event' and if the entry condition applicable for this event, i.e. the event corresponding with the *eventId* of the corresponding *reportConfig* within *VarMeasurementConfiguration*, is fulfilled for one or more applicable cells for a duration exceeding the value of *timeToTrigger* defined for this event within the *VarMeasurementConfiguration* while the *VarMeasurementReports* does not include an entry for this *measId* (a first cell triggers the event):
 - 3> include an entry within the *VarMeasurementReports* for this *measId*;
 - 3> set the *numberOfReportsSent* defined within the *VarMeasurementReports* for this *measId* to 0;
 - 3> include the concerned cell(s) in the *cellsTriggeredList* defined within the *VarMeasurementReports* for this *measId*, if not included;
 - 3> initiate the measurement reporting procedure, as specified in 5.5.5;

...

2> if the *triggerType* is set to 'event' and if the entry condition applicable for this event, i.e. the event corresponding with the *eventId* of the corresponding *reportConfig* within *VarMeasurementConfiguration*, is fulfilled for one or more applicable cells not included in the *cellsTriggeredList* for a duration exceeding the value of *timeToTrigger* defined for this event within the *VarMeasurementConfiguration* (a subsequent cell triggers the event):

3> set the *numberOfReportsSent* defined within the *VarMeasurementReports* for this *measId* to 0;

3> include the concerned cell(s) in the *cellsTriggeredList* defined within the *VarMeasurementReports* for this *measId*, if not included;

3> initiate the measurement reporting procedure, as specified in 5.5.5;

...

2> if the *triggerType* is set to 'event' and if the leaving condition applicable for this event is fulfilled for one or more of the cells included in the *cellsTriggeredList* defined within the *VarMeasurementReports* for this *measId* for a duration exceeding the value of *timeToTrigger* defined within the *VarMeasurementConfiguration* for this event:

3> remove the concerned cell(s) in the *cellsTriggeredList* defined within the *VarMeasurementReports* for this *measId*;

3> if *reportOnLeave* is set for the corresponding reporting configuration:

4> initiate the measurement reporting procedure, as specified in 5.5.5;

3> if the *cellsTriggeredList* defined within the *VarMeasurementReports* for this *measId* is empty:

4> remove the entry within the *VarMeasurementReports* for this *measId*;

4> stop the periodical reporting timer for this *measId*, if running;

NOTE 2: The UE does not stop the periodical reporting with *triggerType* set to 'event' or to 'periodical' while the corresponding measurement is not performed due to the serving cell quality being better than *s-Measure* or due to the measurement gap not being active.

[TS 36.331, clause 5.5.4.8]

The UE shall:

1> for UTRA and CDMA2000, only trigger the event for cells included in the corresponding measurement object;

1> apply inequality B2-1 and inequality B2-2 i.e. both have to be fulfilled, as specified below, as the entry condition for this event;

1> apply inequality B3-3 and inequality B2-4 i.e. at least one of the two has to be fulfilled, as specified below, as the leaving condition for this event;

Inequality B2-1 (Entering condition 1)

$$M_s + H_{ys} < Thresh1$$

Inequality B2-2 (Entering condition 2)

$$M_n + O_{fn} - H_{ys} > Thresh2$$

Inequality B2-3 (Leaving condition 1)

$$M_s - H_{ys} > Thresh1$$

Inequality B2-4 (Leaving condition 2)

$$M_n + O_{fn} + H_{ys} < Thresh2$$

The variables in the formula are defined as follows:

Ms is the measurement result of the serving cell, not taking into account any cell individual offset.

Mn is the measurement result of the neighbouring inter RAT cell.

Ofn is the frequency specific offset of the frequency of the neighbour cell.

Hys is the hysteresis parameter for this event (i.e. *hysteresis* as defined within the *VarMeasurementConfiguration* for this event).

Thresh1 is the threshold parameter for this event (i.e. *b2-Threshold1* as defined within the *VarMeasurementConfiguration* for this event).

Thresh2 is the threshold parameter for this event (i.e. *b2-Threshold2* as defined within the *VarMeasurementConfiguration* for this event).

Ms is expressed in dBm in case of RSRP, or in dB in case of RSRQ.

Mn is expressed in dBm or dB, depending on the measurement quantity of the neighbouring inter RAT cell.

Ofn, ***Hys*** are expressed in dB.

Thresh1 is expressed in dBm in case ***Ms*** is expressed in dBm; otherwise it is expressed in dB.

Thresh2 is expressed in dBm in case ***Mn*** is expressed in dBm; otherwise it is expressed in dB.

[TS 36.331, clause 5.5.5]

For the *measId* for which the measurement reporting procedure was triggered, the UE shall set the *measuredResults* within the *MeasurementReport* message as follows:

- 1> set the *measId* to the measurement identity that triggered the measurement reporting;
- 1> set the *neighbouringMeasResults* to include the best neighbouring cells up to *maxReportCells* in accordance with the following:
 - 2> if the *triggerType* is set to 'event':
 - 3> include the cells included in the *cellsTriggeredList* as defined within the *VarMeasurementReports* for this *measId*;
 - ...
 - 2> for each cell that is included in the *neighbouringMeasResults*, include the *physicalCellIdentity*;
 - 2> if the *triggerType* is set to 'event'; or the *purpose* is set to 'reportStrongestCells' or to 'reportStrongestCellsForSON', ordered as follows:
 - 3> for each included cell include the filtered measured results in accordance with the *reportConfigList* defined in variable *VarMeasurementConfiguration* for that *measId* as follows:
 - 4> if the *measObject* associated with this *measId* concerns E-UTRA:
 - 5> if the *reportQuantity* within the concerned *reportConfig* is set to 'both' (E-UTRA):
 - 6> set the *measResult* to include both quantities (i.e. *rscpResult* and *rsrqResult*) in order of decreasing *triggerQuantity*, i.e. the best cell is included first;
 - 5> else:
 - 6> set the *measResult* to include the quantity as indicated by the *triggerQuantity* within the concerned *reportConfig* in order of decreasing *triggerQuantity*, i.e. the best cell is included first;
 - 4> else:

5> set the *measResult* to the quantity as configured for the concerned RAT within the *quantityConfig* in order of decreasing quantity, i.e. the best cell is included first;

...

1> increment the *numberOfReportsSent* as defined within the *VarMeasurementReports* for this *measId* by 1;

1> stop the periodical reporting timer, if running;

1> if the *numberOfReportsSent* as defined within the *VarMeasurementReports* for this *measId* is less than the *reportAmount* as defined within the corresponding *reportingConfiguration* as defined in the *VarMeasurementConfiguration*:

2> stop the periodical reporting timer, if running;

2> start the periodical reporting timer with the value of *reportInterval* as defined within the *VarMeasurementConfiguration* for this *measId*;

...

1> if the measured results are for CDMA 1xRTT:

2> set the *hrpdPreRegistrationStatus* to `0`;

1> submit the *MeasurementReport* message to lower layers for transmission, upon which the procedure ends.

8.3.2.9.3 Test description

8.3.2.9.3.1 Pre-test conditions

System Simulator:

- Cell 1, Cell 20 and Cell 21.

UE:

None.

Preamble:

- The UE is in state Generic RB Established (state 3) on Cell 1 according to [18].

8.3.2.9.3.2 Test procedure sequence

Table 8.3.2.9.3.2-1 illustrates the downlink power levels and other changing parameters to be applied for the cells at various time instants of the test execution. Row marked "T0" denotes the initial conditions, while rows marked "T1", "T2" and "T3" are to be applied subsequently. The exact instants on which these values shall be applied are described in the texts in this clause.

Table 8.3.2.9.3.2-1: Time instances of cell power level and parameter changes

	Parameter	Unit	Cell 1	Cell 20	Cell 21	Remark
T0	Cell-specific RS EPRE	dBm/15 kHz	-60	-	-	The power level values are such that entering conditions for event B2 are not satisfied.
	Pilot_Ec/Io (Note 1)	dB	-	[-23.5]	[-23.5]	
T1	Cell-specific RS EPRE	dBm/15 kHz	-80	-	-	The power level values are such that entering conditions for event B2 are satisfied.
	Pilot_Ec/Io (Note 1)	dB	-	[-10.0]	[-23.5]	
T2	Cell-specific RS EPRE	dBm/15 kHz	-60	-	-	The power level values are such that leaving conditions for event B2 are satisfied.
	Pilot_Ec/Io (Note 1)	dB	-	[-23.5]	[-23.5]	
T3	Cell-specific RS EPRE	dBm/15 kHz	-80	-	-	The power level values are such that entering conditions for event B2 are satisfied.
	Pilot_Ec/Io (Note 1)	dB	-	[-10.0]	[-23.5]	
T4	Cell-specific RS EPRE	dBm/15 kHz	-60	-	-	The power level values are such that leaving conditions for event B2 are satisfied.
	Pilot_Ec/Io (Note 1)	dB	-	[-23.5]	[-23.5]	
Note 1: This parameter is not directly settable, but is derived by calculation from the other parameters set by the SS.						

Table 8.3.2.9.3.2-2: Main behaviour

St	Procedure	Message Sequence		TP	Verdict
		U - S	Message		
1	The SS transmits an <i>RRConnectionReconfiguration</i> message to setup inter RAT measurement on Cell 1.	<--	<i>RRConnectionReconfiguration</i>	-	-
2	The UE transmits an <i>RRConnectionReconfigurationComplete</i> message to confirm the setup of inter RAT measurement on Cell 1.	-->	<i>RRConnectionReconfigurationComplete</i>	-	-
3	Check: Does the UE transmit a <i>MeasurementReport</i> message to report the event B2 during the next 10s?	-->	<i>MeasurementReport</i>	1	F
4	The SS changes Cell 1, Cell 20 and Cell 21 parameters according to row "T1" in table 8.3.2.9.3.2-1.	-	-	-	-
5	Check: Does the UE transmit a <i>MeasurementReport</i> message to report the event B2 for Cell 20, not including Cell 21?	-->	<i>MeasurementReport</i>	2	P
6	Check: Does the UE transmit a <i>MeasurementReport</i> message to report the event B2 for Cell 20, not including Cell 21?	-->	<i>MeasurementReport</i>	2	P
7	The SS changes Cell 1, Cell 20 and Cell 21 parameters according to row "T2" in table 8.3.2.9.3.2-1.	-	-	-	-
8	Check: Does the UE transmit a <i>MeasurementReport</i> message to report the event B2 during the next 10s?	-->	<i>MeasurementReport</i>	3	F
9	The SS changes Cell 1, Cell 20 and Cell 21 parameters according to row "T3" in table 8.3.2.9.3.2-1.	-	-	-	-
10	Check: Does the UE transmit a <i>MeasurementReport</i> message to report the event B2 for Cell 20, not including Cell 21?	-->	<i>MeasurementReport</i>	2	P
11	Check: Does the UE transmit a <i>MeasurementReport</i> message to report the event B2 for Cell 20, not including Cell 21?	-->	<i>MeasurementReport</i>	2	P
12	The SS changes Cell 1, Cell 20 and Cell 21 parameters according to row "T4" in table 8.3.2.9.3.2-1.	-	-	-	-
13	Check: Does the UE transmit a <i>MeasurementReport</i> message to report the event B2 during the next 10s?	-->	<i>MeasurementReport</i>	3	F
14	Check: Does the test result of CALL generic procedure indicate that the UE is in E-UTRA RRC_CONNECTED state on Cell 1?	-	-	-	-

8.3.2.9.3.3 Specific message contents

Table 8.3.2.9.3.3-1: *RRConnectionReconfiguration* (step 1, Table 8.3.2.9.3.2-2)

Derivation Path: 36.508, Table 4.6.1-8, condition MEAS			
Information Element	Value/remark	Comment	Condition
<i>RRConnectionReconfiguration</i> ::= SEQUENCE {			
criticalExtensions CHOICE {			
c1 CHOICE{			
rrcConnectionReconfiguration-r8 SEQUENCE {			
radioResourceConfiguration	Not present		
}			
}			
}			
}			

Table 8.3.2.9.3.3-3: MeasurementReport (steps 5, 6, 10 and 11 Table 8.3.2.9.3.2-2)

Derivation Path: 36.508, Table 4.6.1-5			
Information Element	Value/remark	Comment	Condition
MeasurementReport ::= SEQUENCE {			
criticalExtensions CHOICE {			
c1 CHOICE{			
measurementReport-r8 SEQUENCE {			
measuredResults SEQUENCE {			
measId	1		
measResultServing SEQUENCE {			
rsrpResult	(0..97)		
rsrqResult	(0..34)		
}			
neighbouringMeasResults CHOICE {			
measResultsCDMA2000 ::=SEQUENCE {			
hrpdPreRegistrationStatus	FALSE		
measResultListCDMA2000 ::=SEQUENCE	1 entry	Note 1	
(SIZE (1..maxCellReport)) OF SEQUENCE {			
physicalCellIdentity[1]	PhysicalCellIdentity of Cell 20		
globalCellIdentity[1]	Not present		
measResult[1] SEQUENCE {			
pilotStrength	Not checked		
}			
physicalCellIdentity[2]	PhysicalCellIdentity of Cell 21		
globalCellIdentity[2]	Not present		
measResult[1] SEQUENCE {			
pilotStrength	(0..63)		
}			
}			
}			
}			
}			
}			
}			
Note 1: Cell measured results for Cells 20 and 21 may appear in either order (i.e. Cell 20 then Cell 21 or Cell 21 then Cell 20).			

8.3.3 Measurements for Self Optimized Networks

8.3.3.1 Measurement configuration control and reporting / SON / ANR: CGI reporting of LTE cell

8.3.3.1.1 Test Purpose (TP)

(1)

```
with { UE in E-UTRA RRC_CONNECTED state }
ensure that {
  when { Neighbour becomes offset better than serving }
  then { UE sends MeasurementReport for event A3 }
}
```

(2)

```
with { UE in E-UTRA RRC_CONNECTED state }
ensure that {
  when { UE is commanded to report the global cell identity of the neighbour cell }
  then { UE determines the global cell identity of the cell included in the associated measurement object by acquiring the relevant system information from the concerned cell and reports the global cell identity in the MeasurementReport }
}
```

8.3.3.1.2 Conformance requirements

References: The conformance requirements covered in the current TC are specified in: TS 36.331, clauses 5.3.5.3, 5.5.2.3, 5.5.3, 5.5.4.1, 5.5.4.4 and 5.5.5.

[TS 36.331, clause 5.3.5.3]

If the *RRConnectionReconfiguration* message does not include the *mobilityControlInformation* and the UE is able to comply with the configuration included in this message, the UE shall:

...

1> If the *RRConnectionReconfiguration* message includes the *measurementConfiguration*:

2> perform the Measurement configuration procedure as specified in 5.5.2;

...

[TS 36.331, clause 5.5.2.3]

The UE shall:

...

2> if the *triggerType* is set to '*periodical*' and the *purpose* is set to '*reportCGI*' in the corresponding *reportConfig* within *VarMeasurementConfiguration*:

3> if the *measObject* associated with this *measId* concerns E-UTRA:

4> start timer T321 with the timer value set to 1 second for this *measId*;

[TS 36.331, clause 5.5.3]

The UE supports measurements using a reporting configuration with the purpose set to '*reportCGI*', if the network provides sufficient idle periods.

The UE shall:

1> for each *measId* included in the *measIdList* within *VarMeasurementConfiguration*:

2> if the measurement gap configuration is active; or

2> the UE does not require measurement gaps to perform the concerned measurement:

3> if *s-Measure* is not configured; or

3> if *s-Measure* is configured and the serving cell RSRP is lower than this value:

4> perform the corresponding measurements of neighbouring cells on the frequencies and RATs indicated in the concerned *measObject*;

2> perform the evaluation of reporting criteria as specified in section 5.5.4;

1> if a measurement is configured which the UE should attempt to perform during idle periods:

2> if for one of the measurements *purpose* within the *reportConfig* is set to '*reportCGI*' and

2> if timer T321 is running:

3> determine the global cell identity of the cell included in the associated *measObject* by acquiring the relevant system information from the concerned cell;

...

[TS 36.331, clause 5.5.4.1]

The UE shall:

1> for each *measId* included in the *measIdList* within *VarMeasurementConfiguration*:

2> if the *triggerType* is set to 'event':

...

3> else if the corresponding *measObject* concerns EUTRA:

4> consider any neighbouring cell detected on the associated frequency to be applicable when the concerned cell is not included in the *blackListedCellsToAddModifyList* defined within the *VarMeasurementConfiguration* for this *measId*;

2> else consider a neighbouring cell on the associated frequency/ set of frequencies (GERAN) to be applicable as follows:

...

3> if the corresponding *reportingConfig* includes a purpose set to 'reportCGI':

4> consider any neighbouring cell detected on the associated frequency/ set of frequencies (GERAN) which has a *physicalCellIdentity* matching the value of the *cellForWhichToReportCGI* included in the corresponding *measObject* within the *VarMeasurementConfiguration* to be applicable

3> else:

...

4> else if the corresponding *measObject* concerns EUTRA:

5> consider any neighbouring cell detected on the associated frequency to be applicable when the concerned cell is not included in the *blackListedCellsToAddModifyList* defined within the *VarMeasurementConfiguration* for this *measId*;

2> if the *triggerType* is set to 'event' and if the entry condition applicable for this event, i.e. the event corresponding with the *eventId* of the corresponding *reportConfig* within *VarMeasurementConfiguration*, is fulfilled for one or more applicable cells for a duration exceeding the value of *timeToTrigger* defined for this event within the *VarMeasurementConfiguration* while the *VarMeasurementReports* does not include an entry for this *measId* (a first cell triggers the event):

3> include an entry within the *VarMeasurementReports* for this *measId*;

3> set the *numberOfReportsSent* defined within the *VarMeasurementReports* for this *measId* to 0;

3> include the concerned cell(s) in the *cellsTriggeredList* defined within the *VarMeasurementReports* for this *measId*, if not included;

3> initiate the measurement reporting procedure, as specified in 5.5.5;

...

2> if the *triggerType* is set to 'event' and if the entry condition applicable for this event, i.e. the event corresponding with the *eventId* of the corresponding *reportConfig* within *VarMeasurementConfiguration*, is fulfilled for one or more applicable cells not included in the *cellsTriggeredList* for a duration exceeding the value of *timeToTrigger* defined for this event within the *VarMeasurementConfiguration* (a subsequent cell triggers the event):

3> set the *numberOfReportsSent* defined within the *VarMeasurementReports* for this *measId* to 0;

3> include the concerned cell(s) in the *cellsTriggeredList* defined within the *VarMeasurementReports* for this *measId*, if not included;

3> initiate the measurement reporting procedure, as specified in 5.5.5;

2> Upon expiry of the periodical reporting timer for this *measId*:

- 3> initiate the measurement reporting procedure, as specified in 5.5.5;
- 2> upon expiry of the T321 for this *measId*:
 - 3> initiate the measurement reporting procedure, as specified in 5.5.5;
 - 2> if the *triggerType* is set to 'event' and if the leaving condition applicable for this event is fulfilled for one or more of the cells included in the *cellsTriggeredList* defined within the *VarMeasurementReports* for this *measId* for a duration exceeding the value of *timeToTrigger* defined within the *VarMeasurementConfiguration* for this event:
 - 3> remove the concerned cell(s) in the *cellsTriggeredList* defined within the *VarMeasurementReports* for this *measId*;
 - 3> if *reportOnLeave* is set for the corresponding reporting configuration:
 - 4> initiate the measurement reporting procedure, as specified in 5.5.5;
 - 3> if the *cellsTriggeredList* defined within the *VarMeasurementReports* for this *measId* is empty:
 - 4> remove the entry within the *VarMeasurementReports* for this *measId*;
 - 4> stop the periodical reporting timer for this *measId*, if running;

NOTE 2: The UE does not stop the periodical reporting with *triggerType* set to 'event' or to 'periodical' while the corresponding measurement is not performed due to the serving cell quality being better than *s-Measure* or due to the measurement gap not being active.

[TS 36.331, clause 5.5.4.4]

The UE shall:

- 1> apply inequality A3-1, as specified below, as the entry condition for this event;
- 1> apply inequality A3-2, as specified below, as the leaving condition for this event;

Inequality A3-1 (Entering condition)

$$Mn + Ofn + Ocn - Hys > Ms + Of_s + Ocs + Off$$

Inequality A3-2 (Leaving condition)

$$Mn + Ofn + Ocn + Hys < Ms + Of_s + Ocs + Off$$

The variables in the formula are defined as follows:

Mn is the measurement result of the neighbouring cell.

Ofn is the frequency specific offset of the frequency of the neighbour cell (equals *Ofs* for intra-frequency measurements and is included in *MeasObjectEUTRA* corresponding to the inter frequency as *offsetFreq* for inter-frequency measurements).

Ocn is the cell specific offset of the neighbour cell. If not configured zero offset shall be applied (included in *MeasObjectEUTRA* of the serving frequency as parameter *cellIndividualOffset* for intra-f measurements and included in *MeasObjectEUTRA* corresponding to the inter frequency as parameter *cellIndividualOffset* for inter-frequency measurements).

Ms is the measurement result of the serving cell, not taking into account any cell individual offset.

Ofs is the frequency specific offset of the serving frequency (i.e. *offsetFreq* within the *MeasObjectEUTRA* corresponding to the serving frequency).

Ocs is the cell specific offset of the serving cell (included in *MeasObjectEUTRA* of the serving frequency as parameter *cellIndividualOffset*).

Hys is the hysteresis parameter for this event (i.e. *hysteresis* as defined within the *VarMeasurementConfiguration* for this event).

Off is the offset parameter for this event (i.e. *a3-Offset* as defined within the *VarMeasurementConfiguration* for this event).

Mn, *Ms* are expressed in dBm in case of RSRP, or in dB in case of RSRQ.

Ofn, Ocn, Ofs, Ocs, Hys, Off are expressed in dB.

[TS 36.331, clause 5.5.5]

For the *measId* for which the measurement reporting procedure was triggered, the UE shall set the *measuredResults* within the *MeasurementReport* message as follows:

- 1> set the *measId* to the measurement identity that triggered the measurement reporting;
- 1> set the *neighbouringMeasResults* to include the best neighbouring cells up to *maxReportCells* in accordance with the following:
 - 2> if the *triggerType* is set to 'event':
 - 3> include the cells included in the *cellsTriggeredList* as defined within the *VarMeasurementReports* for this *measId*;
 - 2> else:
 - 3> set the *neighbouringMeasResults* to include the applicable cells for which the requested *reportQuantity* has been available since the last periodical reporting or since the measurement was initiated or reset;
 - 2> for each cell that is included in the *neighbouringMeasResults*, include the *physicalCellIdentity*;
 - 2> if the *triggerType* is set to 'event'; or the *purpose* is set to 'reportStrongestCells' or to 'reportStrongestCellsForSON', ordered as follows:
 - 3> for each included cell include the filtered measured results in accordance with the *reportConfigList* defined in variable *VarMeasurementConfiguration* for that *measId* as follows:
 - 4> if the *measObject* associated with this *measId* concerns E-UTRA:
 - 5> if the *reportQuantity* within the concerned *reportConfig* is set to 'both' (E-UTRA):
 - 6> set the *measResult* to include both quantities (i.e. *rscpResult* and *rsrqResult*) in order of decreasing *triggerQuantity*, i.e. the best cell is included first;
 - 5> else:
 - 6> set the *measResult* to include the quantity as indicated by the *triggerQuantity* within the concerned *reportConfig* in order of decreasing *triggerQuantity*, i.e. the best cell is included first;
 - 4> else:
 - 5> set the *measResult* to the quantity as configured for the concerned RAT within the *quantityConfig* in order of decreasing quantity, i.e. the best cell is included first;
 - 2> else if the *purpose* is set to 'reportCGI':
 - 3> include the *globalCellIdentity* of the requested neighbouring cell;
 - 1> increment the *numberOfReportsSent* as defined within the *VarMeasurementReports* for this *measId* by 1;
 - 1> stop the periodical reporting timer, if running;
 - 1> if the *numberOfReportsSent* as defined within the *VarMeasurementReports* for this *measId* is less than the *reportAmount* as defined within the corresponding *reportingConfiguration* as defined in the *VarMeasurementConfiguration*:
 - 2> stop the periodical reporting timer, if running;

2> start the periodical reporting timer with the value of *reportInterval* as defined within the *VarMeasurementConfiguration* for this *measId*;

1> else if the *numberOfReportsSent* as defined within the *VarMeasurementReports* for this *measId* is equal to the *reportAmount* as defined within the corresponding *reportingConfiguration* as defined in the *VarMeasurementConfiguration*:

2> if the *triggerType* is set to 'periodical':

3> remove the entry within the *VarMeasurementReports* for this *measId*;

...

8.3.3.1.3 Test description

8.3.3.1.3.1 Pre-test conditions

System Simulator:

- Cell 1 and Cell 2

Preamble:

- The UE is in state Generic RB Established (state 3) on Cell 1 according to [18].

8.3.3.1.3.2 Test procedure sequence

Table 8.3.3.1.3.2-1 illustrates the downlink power levels to be applied for Cell 1 and Cell 2 at various time instants of the test execution. Row marked "T0" denotes the conditions after the preamble, while row marked "T1" is to be applied subsequently. The exact instants on which these values shall be applied are described in the texts in this clause.

Table 8.3.3.1.3.2-1: Power levels

	Parameter	Unit	Cell 1	Cell 2	Remark
T0	Cell-specific RS EPRE	dBm/ 15kHz z	-80	-110	Power levels are shall be such that entry condition for event A3 is not satisfied: $Mn + Ofn + Ocn + Hys < Ms + Ofs + Ocs + Off$
T1	Cell-specific RS EPRE	dBm/ 15kHz z	-80	-59	Power levels are shall be such that entry condition for event A3 is satisfied: $Mn + Ofn + Ocn - Hys > Ms + Ofs + Ocs + Off$

Table 8.3.3.1.3.2-2: Main behaviour

St	Procedure	Message Sequence		TP	Verdict
		U - S	Message		
1	SS transmits an <i>RRCCONNECTIONRECONFIGURATION</i> message including <i>MEASUREMENTCONFIGURATION</i> to setup intra LTE measurement and reporting for event A3 (intra frequency measurement).	<--	<i>RRCCONNECTIONRECONFIGURATION</i>	-	-
2	The UE transmits an <i>RRC CONNECTION RECONFIGURATION COMPLETE</i> message.	-->	<i>RRCCONNECTIONRECONFIGURATIONCOMPLETE</i>	-	-
3	SS re-adjusts the cell-specific reference signal level according to row "T1" in table 8.3.3.1.3.2.-1.	-	-	-	-
4	Check: Does the UE transmit a <i>MEASUREMENTREPORT</i> message to report event A3 with the measured RSRP value for Cell 2.	-->	<i>MEASUREMENTREPORT</i>	1	P
5	SS transmits an <i>RRCCONNECTIONRECONFIGURATION</i> message including <i>MEASUREMENTCONFIGURATION</i> including <i>REPORTCGI</i> for Cell 2 and sufficient idle periods for UE to acquire the relevant system information from Cell 2.	<--	<i>RRCCONNECTIONRECONFIGURATION</i>	-	-
6	The UE transmits an <i>RRC CONNECTION RECONFIGURATION COMPLETE</i> message.	-->	<i>RRCCONNECTIONRECONFIGURATIONCOMPLETE</i>	-	-
7	Check: Does the UE transmit a <i>MEASUREMENTREPORT</i> message with globalCellIdentity of Cell 2 within 1 sec.	-->	<i>MEASUREMENTREPORT</i>	2	P

8.3.3.1.3.3 Specific message contents

Table 8.3.3.1.3.3-1: SystemInformationBlockType2 for Cell 1 (preamble and all the steps in Table 8.3.3.1.3.2-2)

Derivation Path: 36.508 clause 4.4.3.3-1			
Information Element	Value/remark	Comment	Condition
SystemInformationBlockType2 ::= SEQUENCE {			
RadioResourceConfigCommonSIB-DEFAULT ::= SEQUENCE {			
pcch-Configuration	PCCH-Configuration-LONGCYCLE		
}			
PCCH-Configuration-LONGCYCLE ::= SEQUENCE {			
defaultPagingCycle	rf256		
}			
}			

Table 8.3.3.1.3.3-2: RRCConnectionReconfiguration (step 1, Table 8.3.3.1.3.2-2)

Derivation Path: 36.508 clause 4.6.1 table 4.6.1-8 with condition MEAS

Table 8.3.3.1.3.3-3 MeasurementConfiguration (step 1, Table 8.3.3.1.3.2-2)

Derivation Path: 36.508 clause 4.6.6 table 4.6.6-1			
Information Element	Value/remark	Comment	Condition
MeasurementConfiguration ::= SEQUENCE {			
MeasIdToAddModifyList ::= SEQUENCE (SIZE (1..maxMeasId)) OF SEQUENCE {	1 entry		
measId	1		
measObjectId	IdMeasObject-f1		
reportConfigId	IdReportConfig-A3		
}			
MeasObjectToAddModifyList ::= SEQUENCE (SIZE (1..maxObjectId)) OF SEQUENCE {	1 entry		
measObjectId	IdMeasObject-f1		
measObject CHOICE {			
measObjectEUTRA	MeasObjectEUTRA-GENERIC(f1)		
}			
ReportConfigToAddModifyList ::= SEQUENCE (SIZE (1..maxReportConfigId)) OF SEQUENCE {	1 entry		
reportConfigId	IdReportConfig-A3		
reportConfig CHOICE {			
reportConfigEUTRA	ReportConfig-A3-H		
}			
}			
}			

Table 8.3.3.1.3.3-4 ReportConfig-A3-H (step 1, Table 8.3.3.1.3.2-2)

Derivation path: 36.508 clause 4.6.6 table 4.6.6-6 ReportConfigEUTRA-A3			
Information Element	Value/remark	Comment	Condition
ReportConfigEUTRA-A3 ::= SEQUENCE {			
triggerType CHOICE {			
event SEQUENCE {			
eventId CHOICE {			
eventA3 SEQUENCE {			
a3-Offset	20	10 dB	
}			
}			
timeToTrigger	ms0		
}			
reportQuantity	sameAsTriggerQuantity		
reportAmount	r1		
}			

Table 8.3.3.1.3.3-7 MeasurementConfiguration (step 5, Table 8.3.3.1.3.2-2)

Derivation Path: 36.508 clause 4.6.6 table 4.6.6-1			
Information Element	Value/remark	Comment	Condition
MeasurementConfiguration ::= SEQUENCE {			
MeasIdToAddModifyList ::= SEQUENCE (SIZE (1..maxMeasId)) OF SEQUENCE {	1 entry		
measId	2		
measObjectId	IdMeasObject-f1-CGI		
reportConfigId	ReportConfigId-CGI		
}			
MeasObjectToAddModifyList ::= SEQUENCE (SIZE (1..maxObjectId)) OF SEQUENCE {	1 entry		
measObjectId	IdMeasObject-f1-CGI		
measObject CHOICE {			
measObjectEUTRA	MeasObjectEUTRA-CGI		
}			
ReportConfigToRemoveList ::= SEQUENCE (SIZE (1..maxReportConfigId)) OF SEQUENCE {			
reportConfigId	IdReportConfig-A3		
}			
ReportConfigToAddModifyList ::= SEQUENCE (SIZE (1..maxReportConfigId)) OF SEQUENCE {			
reportConfigId	ReportConfigId-CGI		
reportConfig CHOICE {			
reportConfigEUTRA	ReportConfig-CGI		
}			
}			

Table 8.3.3.1.3.3-8: MeasObjectEUTRA-CGI (step 5, Table 8.3.3.1.3.2-2)

Derivation Path: 36.508 clause 4.6.6 table 4.6.6-2			
Information Element	Value/remark	Comment	Condition
MeasObjectEUTRA-CGI ::= SEQUENCE {			
eutra-CarrierInfo SEQUENCE {}	Downlink EARFCN for f1		
cellForWhichToReportCGI	PhysicalCellIdentity of the Cell 2.		
}			

Table 8.3.3.1.3.3-9: ReportConfig-CGI (step 5, Table 8.3.3.1.3.2-2)

Derivation Path: 36.331 clause 6.3.5 IE ReportConfigEUTRA			
Information Element	Value/remark	Comment	Condition
ReportConfigEUTRA ::= SEQUENCE {			
triggerType CHOICE {			
periodical SEQUENCE {			
purpose CHOICE {			
reportCGI			
}			
}			
}			

Table 8.3.3.1.3.3-10: RadioResourceConfigDedicated-DRX (step 5, Table 8.3.3.1.3.2-2)

Derivation Path: 36.508 clause 4.6.3.19			
Information Element	Value/remark	Comment	Condition
RadioResourceConfigDedicated-DRX ::= SEQUENCE {			
mac-MainConfig CHOICE {			
explicitValue	MAC-MainConfiguration-RBC using condition DRX_L	See sub clause 4.8.2 of [18].	
}			
physicalConfigDedicated	Not present		
}			

Table 8.3.3.1.3.3-11: MeasurementReport (step 7, Table 8.3.3.1.3.2-2)

Derivation path: 36.508 4.6.1 table 4.6.1-5			
Information Element	Value/remark	Comment	Condition
MeasuredResults ::= SEQUENCE {			
measId	2		
measResultServing SEQUENCE {		Report Cell 1	
rsrpResult	(0..97)		
rsrqResult	(0..34)		
}			
}			
MeasResultListEUTRA ::= SEQUENCE (SIZE (1..maxCellReport)) OF SEQUENCE {			
physicalCellIdentity	PhysicalCellIdentity of Cell 2		
globalCellIdentity SEQUENCE {			
globalCellID-EUTRA	GlobalCellId of Cell 2		
tac-ID	Not checked		
plmn-IdentityList	Not checked		
}			
}			

8.4 Inter RAT Handover

8.4.1.8 CS fallback caused by addition of CS service / from E-UTRA(Data) to UTRA(PS+CS)

8.4.1.8.1 Test Purpose (TP)

(1)

```
with { UE in E-UTRA RRC_CONNECTED state having requested CS call setup }
ensure that {
  when { UE receives a MobilityFromEUTRACommand message containing csFallbackIndicator and targetRAT-Type with utran }
  then { UE transmits a HANDOVER TO UTRAN COMPLETE message }
}
```

8.4.1.8.2 Conformance requirements

References: The conformance requirements covered in the present TC are specified in: TS 36.331, clause 5.4.3.3.

[TS 36.331, clause 5.4.3.3]

The UE shall be able to receive a *MobilityFromEUTRACommand* message and perform a cell change order to GERAN, even if no prior UE measurements have been performed on the target cell.

The UE shall:

- 1> stop timer T310, if running

- 1> if the *MobilityFromEUTRACommand* message includes the *purpose* set to 'handover':
 - 2> if the *targetRAT-Type* is set to 'utran' or 'geran':
 - 3> consider inter-RAT mobility as initiated towards the RAT indicated by the *targetRAT-Type* included in the *MobilityFromEUTRACommand* message;
 - 3> access the target cell indicated in the inter-RAT message in accordance with the specifications of the target RAT;

...

8.4.1.8.3 Test description

8.4.1.8.3.1 Pre-test conditions

System Simulator:

- Cell 1 and Cell 5.

UE:

None.

Preamble:

- The UE is in state Generic RB Established (state 3) on Cell 1 according to [18].
- The UE has a valid TMSI (TMSI-1) and is registered in LAI-1.

8.4.1.8.3.2 Test procedure sequence

Table 8.4.1.8.3.2-1: Main behaviour

St	Procedure	Message Sequence		TP	Verdict
		U - S	Message		
1	Make the UE initiate an outgoing call.	-	-	-	-
2	The UE transmits an <i>ULInformationTransfer</i> message on Cell 1. This message includes a SERVICE REQUEST message.	-->	<i>ULInformationTransfer</i>	-	-
3	The SS transmits a <i>MobilityFromEUTRACommand</i> message on Cell 1.	<--	<i>MobilityFromEUTRACommand</i>	-	-
4	Check: Does the UE transmit a HANDOVER TO UTRAN COMPLETE message on Cell 5?	-->	HANDOVER TO UTRAN COMPLETE	1	P
5	The UE transmits an INITIAL DIRECT TRANSFER message on Cell 5. This message includes a CM SERVICE REQUEST message.	-->	INITIAL DIRECT TRANSFER	-	-
6	The SS transmits a DOWNLINK DIRECT TRANSFER message on Cell 5. This message includes an AUTHENTICATION REQUEST message.	<--	DOWNLINK DIRECT TRANSFER	-	-
7	The UE transmits an UPLINK DIRECT TRANSFER message on Cell 5. This message includes an AUTHENTICATION RESPONSE message.	-->	UPLINK DIRECT TRANSFER	-	-
8	The SS transmits a SECURITY MODE COMMAND message on Cell 5.	<--	SECURITY MODE COMMAND	-	-
9	The UE transmits a SECURITY MODE COMPLETE message on Cell 5.	-->	SECURITY MODE COMPLETE	-	-
10	The UE transmits an UPLINK DIRECT TRANSFER message on Cell 5. This message includes a SETUP message.	-->	UPLINK DIRECT TRANSFER	-	-
11	The SS transmits a DOWNLINK DIRECT TRANSFER message on Cell 5. This message includes a CALL PROCEEDING message.	<--	DOWNLINK DIRECT TRANSFER	-	-
12	The SS transmits a RADIO BEARER SETUP message on Cell 5.	<--	RADIO BEARER SETUP	-	-
13	The UE transmits a RADIO BEARER SETUP COMPLETE message on Cell 5.	-->	RADIO BEARER SETUP COMPLETE	-	-
14	The SS transmits a DOWNLINK DIRECT TRANSFER message on Cell 5. This message includes an ALERTING message.	<--	DOWNLINK DIRECT TRANSFER	-	-
15	The SS transmits a DOWNLINK DIRECT TRANSFER message on Cell 5. This message includes a CONNECT message.	<--	DOWNLINK DIRECT TRANSFER	-	-
16	The UE transmits an UPLINK DIRECT TRANSFER message on Cell 5. This message includes a CONNECT ACKNOWLEDGE message.	-->	UPLINK DIRECT TRANSFER	-	-
17	The UE transmits an INITIAL DIRECT TRANSFER message on Cell 5. This message includes a ROUTING AREA UPDATE REQUEST message.	-->	INITIAL DIRECT TRANSFER	-	-
18	The SS transmits a DOWNLINK DIRECT TRANSFER message on Cell 5. This message includes an AUTHENTICATION AND CIPHERING REQUEST message.	<--	DOWNLINK DIRECT TRANSFER	-	-
19	The UE transmits an UPLINK DIRECT TRANSFER message on Cell 5. This message includes an AUTHENTICATION AND CIPHERING RESPONSE message.	-->	UPLINK DIRECT TRANSFER	-	-
20	The SS transmits a SECURITY MODE	<--	SECURITY MODE COMMAND	-	-

	COMMAND message on Cell 5.				
21	The UE transmits a SECURITY MODE COMPLETE message on Cell 5.	-->	SECURITY MODE COMPLETE	-	-
22	The SS transmits a DOWNLINK DIRECT TRANSFER message on Cell 5. This message includes a ROUTING AREA UPDATE ACCEPT message.	<--	DOWNLINK DIRECT TRANSFER	-	-
23	The UE transmits an UPLINK DIRECT TRANSFER message on Cell 5. This message includes a ROUTING AREA UPDATE COMPLETE message.	-->	UPLINK DIRECT TRANSFER	-	-

8.4.1.8.3.3 Specific message contents

Editor's Note: Specific message contents transmitted/received on the UTRA cell are FFS.

Table 8.4.1.8.3.3-1: MobilityFromEUTRACommand (step 3, Table 8.4.1.8.3.2-1)

Derivation Path: 36.508, Table 4.6.1-6			
Information Element	Value/remark	Comment	Condition
MobilityFromEUTRACommand ::= SEQUENCE {			
criticalExtensions CHOICE {			
c1 CHOICE{			
mobilityFromEUTRACommand-r8 SEQUENCE {			
csFallbackIndicator	true		
purpose CHOICE{			
handover SEQUENCE {			
targetRAT-Type	utran		
targetRAT-MessageContainer		HANDOVER TO UTRAN COMMAND(UTRA RRC message)	
nas-SecurityParamFromEUTRA	The 4 least significant bits of the NAS downlink COUNT value		
}			
}			
}			
}			
}			
}			

8.5 RRC Others

8.5.1 Radio Link Failure

8.5.1.1 RRC Connection Re-establishment: Success (after Radio Link Failure)

8.5.1.1.1 Test Purpose (TP)

(1)
with { UE in E-UTRA RRC_CONNECTED state }
ensure that {
when { UE detecting physical layer problems }
then { UE shall start timer T310 and UE does not initiate any RRC Connection re-establishment procedure before expiring of timer T310 }
}

(2)
with { UE in E-UTRA RRC_CONNECTED state }
ensure that {
when { UE detecting radio link failure on expiring of timer T310 }
then { UE starts timer T311 and UE initiates the RRC Connection re-establishment procedure }
}

(3)
with { UE in E-UTRA RRC_CONNECTED state }
ensure that {

```

when { UE successfully completes the RRC Connection re-establishment procedure }
then { UE is in E-UTRA RRC_CONNECTED state }
}

```

8.5.1.1.2 Conformance requirements

References: The conformance requirements covered in the current TC are specified in TS 36.331, clauses 5.3.7.2, 5.3.10.1, 5.3.10.3 and 5.3.10.4.

[TS 36.331 clause 5.3.7.2]

The UE shall only initiate the procedure when security has been activated. The UE initiates the procedure when one of the following conditions is met:

- 1> upon re-entry of the service area after having detected radio link failure, in accordance with 5.3.10; or
- 1> upon handover failure, in accordance with 5.3.6.3; or
- 1> when lower layers detect problems, as specified in TS 36.322 [7].

Upon initiation of the procedure, the UE shall:

- 1> reset MAC and re-establish RLC for all RBs that are established;
- ...
- 1> start timer T301;
- 1> initiate transmission of the *RRCConnectionReestablishmentRequest* message in accordance with 5.3.7.3;
- ...

[TS 36.331 clause 5.3.10.1]

Upon detecting physical layer problems, the UE shall:

The criteria for detecting physical layer problems are FFS i.e. whether RRC considers this condition to be met upon receiving a certain number of physical layer failure indications within a predefined time-period.

It is FFS if a counter will be used instead of timer T310.

Upon receiving a Random Access problem indication from the MAC, the UE shall:

- 1> start a timer T312.
- ...

[TS 36.331 clause 5.3.10.3]

Upon T310 or T312 expiry, the UE detects radio link failure and shall:

- 1> If security is not activated:
 - 2> perform the actions upon moving from RRC_CONNECTED to RRC_IDLE as specified in 5.3.11;
- 1> else:
 - 2> stop timer T310, if running;
 - 2> stop timer T312, if running;
 - 2> start timer T311;
 - 2> select a suitable cell in accordance with the cell selection process as specified in [4].
- ...

[TS 36.331 clause 5.3.10.4]

Upon selecting an E-UTRA cell while T311 is running, the UE shall:

1> stop timer T311;

1> initiate the Connection re-establishment procedure as specified in 5.3.7.

NOTE This procedure applies also if the UE returns to the source cell

The criteria for re-entry of service area, i.e. for detecting 'in service' are FFS.

...

8.5.1.1.3 Test description

8.5.1.1.3.1 Pre-test conditions

System Simulator:

- 2 cells on same E-UTRA frequency:
 - Cell 1 (default parameters) serving cell
 - Cell 2 (TBD parameters) intra-frequency cell

UE:

None.

Preamble:

- The UE is in state Generic RB Established (state 3) according to [18] on cell 1.

8.5.1.1.3.2 Test procedure sequence

Table 8.5.1.1.3.2-1: Main behaviour

St	Procedure	Message Sequence		TP	Verdict
		U - S	Message		
1	SS reduces DL RS TX power level of Cell 1 below $Q_{rxlevmin}$ and sends erroneous physical layer frames so that UE is detecting physical layer problems on Cell 1.	-			
2	Check: Does the UE initiate an RRC connection re-establishment procedure on Cell 1 or Cell 2. This is checked during the time $T=T310$.	-		1	F
3	Check: does the UE send RRC connection re-establishment message on Cell 2?	-->	<i>RRCCoNNECTIONReestablishmentRequest</i>	2	P
4	The SS transmits <i>RRCCoNNECTIONReestablishment</i> message.	<--	<i>RRCCoNNECTIONReestablishment</i>		
5	The UE transmits <i>RRCCoNNECTIONReestablishmentComplete</i> message.	-->	<i>RRCCoNNECTIONReestablishmentComplete</i>		
6	The SS transmits an <i>RRCCoNNECTIONReconfiguration</i> message to resume existing radio bearer.	<--	<i>RRCCoNNECTIONReconfiguration</i>		
7	The UE transmits a <i>RRCCoNNECTIONReconfigurationComplete</i> message.	-->	<i>RRCCoNNECTIONReconfigurationComplete</i>		
8	Check: The test result of CALL generic procedure indicates that the UE is in E-UTRA RRC_CONNECTED state on Cell 2.	-		3	P

8.5.1.1.3.3 Specific message contents

FFS

8.5.1.2 RRC Connection Re-establishment: End of procedure after T301 expiry (after Radio Link Failure)

8.5.1.2.1 Test Purpose (TP)

(1)

```
with { UE in E-UTRA RRC_CONNECTED state }
ensure that {
  when { UE receiving a Random Access problem indication from MAC }
  then { UE shall start timer T312 and shall continue the Random Access procedure until timer T312
is expired }
}
```

(2)

```
with { UE in E-UTRA RRC_CONNECTED state }
ensure that {
  when { UE detecting radio link failure on expiring of timer T312 }
  then { UE starts timer T311 and UE selects a suitable cell in accordance with the cell selection
process }
}
```

(3)

```
with { UE in E-UTRA RRC_CONNECTED state }
ensure that {
  when { UE having sent an RRCCConnectionReestablishment message on starting of timer T301 }
  then { UE re-sends RRCCConnectionReestablishment messages until timer T301 is expired }
}
```

(4)

```
with { UE in E-UTRA RRC_CONNECTED state }
ensure that {
  when { UE having sent an RRCCConnectionReestablishment message on starting of timer T301 }
  then { UE does not send any RRCCConnectionReestablishment messages after timer T301 is expired }
}
```

8.5.1.2.2 Conformance requirements

References: The conformance requirements covered in the current TC are specified in TS 36.331, clauses 5.3.7.2, 5.3.10.1, 5.3.10.3 and 5.3.10.4. The following represent an extraction of the requirements relevant to the test purpose.

[TS 36.331 clause 5.3.7.2]

The UE shall only initiate the procedure when security has been activated. The UE initiates the procedure when one of the following conditions is met:

- 1> upon re-entry of the service area after having detected radio link failure, in accordance with 5.3.10; or
- 1> upon handover failure, in accordance with 5.3.6.3; or
- 1> when lower layers detect problems, as specified in TS 36.322 [7].

Upon initiation of the procedure, the UE shall:

- 1> reset MAC and re-establish RLC for all RBs that are established;
- ...
- 1> start timer T301;
- 1> initiate transmission of the *RRCCConnectionReestablishmentRequest* message in accordance with 5.3.7.3;
- ...

[TS 36.331 clause 5.3.10.1]

Upon detecting physical layer problems, the UE shall:

- 1> start a timer T310.

The criteria for detecting physical layer problems are FFS i.e. whether RRC considers this condition to be met upon receiving a certain number of physical layer failure indications within a predefined time-period.

It is FFS if a counter will be used instead of timer T310.

Upon receiving a Random Access problem indication from the MAC, the UE shall:

- 1> start a timer T312.

...

[TS 36.331 clause 5.3.10.3]

Upon T310 or T312 expiry, the UE detects radio link failure and shall:

- 1> If security is not activated:
 - 2> perform the actions upon moving from RRC_CONNECTED to RRC_IDLE as specified in 5.3.11;
- 1> else:
 - 2> stop timer T310, if running;
 - 2> stop timer T312, if running;
 - 2> start timer T311;
 - 2> select a suitable cell in accordance with the cell selection process as specified in [4].

...

[TS 36.331 clause 5.3.10.4]

Upon selecting an E-UTRA cell while T311 is running, the UE shall:

- 1> stop timer T311;
- 1> initiate the Connection re-establishment procedure as specified in 5.3.7.

NOTE This procedure applies also if the UE returns to the source cell

The criteria for re-entry of service area, i.e. for detecting 'in service' are FFS.

...

8.5.1.2.3 Test description

8.5.1.2.3.1 Pre-test conditions

System Simulator:

- 2 cells on same E-UTRA frequency:
 - Cell 1 (default parameters) serving cell
 - Cell 2 (TBD parameters) intra-frequency cell

UE:

None.

Preamble:

- The UE is brought to UE test state Generic RB Established (state 3) on cell 1.

8.5.1.2.3.2 Test procedure sequence

Table 8.5.1.2.3.2-1: Main behaviour

St	Procedure	Message Sequence		TP	Verdict
		U - S	Message		
1	The SS triggers the Random Access Resource procedure on transmit of a <i>PDCCH order providing</i> Random Access Preamble. UE initiates the Random Access procedure and transmits Random Access Preambles.	-			
2	SS does not respond to the Random Access Preambles sent by the UE until condition <i>PREAMBLE_TRANSMISSION_COUNTER = PREAMBLE_TRANS_MAX + 1</i> is fulfilled.	-			
4	SS sets Cell 1 to serving cell and Cell 2 to suitable neighbour cell (FFS).	-			
5	Check: UE shall transmit Random Access Preambles on Cell 1 and shall not perform cell reselection on Cell 2 until timer T312 is expired.	-		1	P
6	SS does not respond to the Random Access Preambles sent by the UE on Cell 1 in step 5.	-			
7	Check: The UE shall send RRC connection re-establishment message on Cell 2.	-->	<i>RRCCoReestablishment Request</i>	2	P
8	The SS does not respond to any <i>RRCCoReestablishment</i> messages	-			
9	Check: The UE shall send RRC connection re-establishment messages on Cell 2 during timer T3=T301.	-->	<i>RRCCoReestablishment Request</i>	3	P
10	Check: The UE shall not send any RRC connection re-establishment messages on Cell 2 after timer T301 is expired.	-		4	P

8.5.1.2.3.3 Specific message contents

FFS

8.5.1.3 RRC Connection Re-establishment; Failure: T311 Expiry (after Radio Link Failure)

8.5.1.3.1 Test Purpose (TP)

(1)

```
with { UE in E-UTRA RRC_CONNECTED state with default bearer established and radio link failure was
detected and UE attempts to select a suitable E-UTRA cell to re-establish the RRC connection }
ensure that {
  when { UE can not find a suitable cell for T311 }
  then { UE does not try to re-establish the RRC connection and goes to RRC_IDLE }
}
```

8.5.1.3.2 Conformance requirements

The conformance requirements covered in the current test case are specified in TS 36.331 clause 5.3.7.2, 5.3.7.6 and 5.3.12.

[TS 36.331 clause 5.3.7.2]

...

Upon initiation of the procedure, the UE shall:

1> stop timer T310, if running;

1> start timer T311;

...

[TS 36.331 clause 5.3.7.6]

Upon T311 expiry, the UE shall:

- 1> perform the actions upon leaving RRC_CONNECTED as specified in 5.3.12, with release cause ‘RRC connection failure’.

[TS 36.331 clause 5.3.12]

Upon leaving RRC_CONNECTED, the UE shall:

- 1> reset MAC;
- 1> stop all timers that are running except T320;
- 1> release all radio resources, including release of the RLC entity, the MAC configuration and the associated PDCP entity for all established RBs;
- 1> indicate the release of the RRC connection to upper layers with the release cause;
- 1> if leaving RRC_CONNECTED was not triggered by reception of the *MobilityFromEUTRACommand* message:
 - 2> enter RRC_IDLE by performing cell selection in accordance with the cell selection process, defined for the case of leaving RRC_CONNECTED, as specified in TS 36.304 [4].

8.5.1.3.3 Test description

8.5.1.3.3.1 Pre-test conditions

System simulator:

- Cell 1

UE:

None.

Preamble:

- The UE is in state Generic RB established according to [18].

8.5.1.3.3.2 Test procedure sequence

Table 8.5.1.3.3.2-1: Main behaviour

St	Procedure	Message Sequence		TP	Verdict
		U - S	Message		
1	The SS drops Cell 1 DL RS TX power level below Qrxlevmin and sends erroneous physical layer frames to the UE during 1s (i.e. T310).	-	-	-	-
2	The SS waits for 10s (i.e. T311 transmitted in SIB2) and then raises Cell 1 DL RS TX power level to the original level.	-	-	-	-
3	Check: does the UE transmit a <i>RRCCoReestablishmentRequest</i> messages within the next 60s?	-->	<i>RRCCoReestablishmentRequest</i>	1	F

NOTE: The RRC_IDLE state is not checked because the UE may have started to scan other frequencies, bands or RATs during the out of coverage period in step 2, so it can not be ensured that it will respond to paging.

8.5.1.3.3.3 Specific message contents

None.

8.5.1.4 RRC Connection Re-establishment; Failure: Reject (after Radio Link Failure)

8.5.1.4.1 Test Purpose (TP)

(1)

```
with { UE in E-UTRA RRC_CONNECTED state with default bearer established and radio link failure was
detected and UE initiates the re-establishment procedure}
ensure that {
  when { the UE receives a RRCConnectionReestablishmentReject message }
  then { UE goes to RRC_IDLE }
}
```

8.5.1.4.2 Conformance requirements

The conformance requirements covered in the current test case are specified in TS 36.331 clause 5.3.7.8 and 5.3.12.

[TS 36.331 clause 5.3.7.8]

Upon receiving the *RRCConnectionReestablishmentReject* message, the UE shall:

- 1> perform the actions upon leaving RRC_CONNECTED as specified in 5.3.12, with release cause 'RRC connection failure'.

[TS 36.331 clause 5.3.12]

Upon leaving RRC_CONNECTED, the UE shall:

- 1> reset MAC;
- 1> stop all timers that are running except T320;
- 1> release all radio resources, including release of the RLC entity, the MAC configuration and the associated PDCP entity for all established RBs;
- 1> indicate the release of the RRC connection to upper layers together with the release cause;
- 1> if leaving RRC_CONNECTED was not triggered by reception of the *MobilityFromEUTRACommand* message:
 - 2> enter RRC_IDLE by performing cell selection in accordance with the cell selection process, defined for the case of leaving RRC_CONNECTED, as specified in TS 36.304 [4];

8.5.1.4.3 Test description

8.5.1.4.3.1 Pre-test conditions

System simulator:

- Cell 1

UE:

None.

Preamble:

- The UE is in state Generic RB established state according to [18].

8.5.1.4.3.2 Test procedure sequence

Table 8.5.1.3.3.2-1: Main behaviour

St	Procedure	Message Sequence		TP	Verdict
		U - S	Message		
1	The SS sends erroneous physical layer frames during T310.	-	-	-	-
2	UE transmits an <i>RRCConnectionReestablishmentRequest</i> message	-->	<i>RRCConnectionReestablishmentRequest</i>	-	-
3	The SS transmits a <i>RRCConnectionReestablishmentReject</i> message	<--	<i>RRCConnectionReestablishmentReject</i>	-	-
4	Check: the test result of CALL generic procedure indicates that UE is in E-UTRA RRC_IDLE state.	-	-	1	P

8.5.1.4.3.3 Specific message contents

None.

8.5.1.5 Radio Link Recovery while T310 is running

8.5.1.5.1 Test Purpose (TP)

(1)

```
with { UE in E-UTRA RRC_CONNECTED state }
ensure that {
  when { UE detecting physical layer recovery while T310 was running }
  then { the UE resumes the RRC connection without explicit signalling }
}
```

8.5.1.5.2 Conformance requirements

References: The conformance requirements covered in the present TC are specified in: TS 36.331 clause 5.3.11.1 and 5.3.11.2.

[TS 36.331, clause 5.3.11.1]

The UE shall:

- 1> upon receiving N310 consecutive "out of sync" indications from lower layers while neither T300, T301, T304 nor T311 is running:
- 2> start timer T310.

[TS 36.331, clause 5.3.11.2]

Upon receiving N311 consecutive "in-sync" indications from lower layers while T310 is running, the UE shall:1> stop timer T310.

NOTE 1: In this case, the UE resumes the RRC connection without explicit signalling, i.e. the UE resumes the entire radio resource configuration.

NOTE 2: Periods in time where neither "in-sync" nor "out-of-sync" is reported by layer 1 do not affect the evaluation of the number of consecutive "in-sync" or "out-of-sync" indications

8.5.1.5.3 Test description

8.5.1.5.3.1 Pre-test conditions

System Simulator:

- Cell 1

UE:

None.

Preamble:

- The UE is in state Generic RB Established (state 3) according to [18].

8.5.1.5.3.2 Test procedure sequence

Table 8.5.1.5.3.2-1 illustrates the downlink power level to be applied for the cell at various time instants of the test execution. Row marked "T0" denotes the initial condition, while column marked "T1" and "T2" are applied according the procedure.

Table 8.5.1.5.3.2-1: Time instances of cell power level

	Parameter	Unit	Cell 1	Remark
T0	RS EPRE	dBm/ 15kH z	P_{default}	Power level from 36.508 clause 6.2.2.1. P_{default} as serving cell.
T1	RS EPRE	dBm/ 15kH z	P_{off}	P_{off} as as non-suitable "Off" cell.
T2	RS EPRE	dBm/ 15kH z	P_{default}	P_{default} as serving cell.

Table 8.5.1.5.3.2-2: Main behaviour

St	Procedure	Message Sequence		TP	Verdict
		U - S	Message		
1	The SS changes Cell 1 level according to the row "T1" in table 8.5.1.5.3.2-1.	-	-	-	-
2	SS waits for 1.5s. The T310 is 2s.	-	-	-	-
3	The SS changes Cell 1 level according to the row "T2" in table 8.5.1.5.3.2-1.	-	-	-	-
4	SS waits for 5s.	-	-	1	P
5	Check: Does the test result of CALL generic procedure indicate that UE is in E-UTRA RRC_CONNECTED state?	-	-	1	-

8.5.1.5.3.3 Specific message contents

Table 8.5.1.5.3.3-1: SystemInformationBlockType2

Derivation path: 36.508 table 4.4.3.3-1			
Information Element	Value/Remark	Comment	Condition
SystemInformationBlockType2 ::= SEQUENCE {			
ue-TimersAndConstants {			
t310	ms2000		
}			
}			

8.5.4 UE capability transfer

8.5.4.1 UE capability transfer / Success

8.5.4.1.1 Test Purpose (TP)

(1)

```
with { UE in RRC_CONNECTED state }
ensure that {
  when { UE receives an UECapabilityEnquiry message before AS security is activated }
```

```

    then { UE transmits an UECapabilityInformation message including UE radio access capability
information corresponding to the ue-RadioAccessCapRequest variable }
}

```

(2)

```

with { UE in RRC_CONNECTED state }
ensure that {
  when { UE receives an UECapabilityEnquiry message after AS security is activated }
  then { UE transmits an UECapabilityInformation message including UE radio access capability
information corresponding to the ue-RadioAccessCapRequest variable }
}

```

8.5.4.1.2 Conformance requirements

References: The conformance requirements covered in the present TC are specified in: TS 36.331, clause 5.6.3.3.

[TS 36.331, clause 5.6.3.3]

The UE shall:

- 1> set the contents of *UECapabilityInformation* message as follows:
 - 2> If the *ue-CapabilityRequest* includes 'eutra':
 - 3> include the *UE-EUTRA-Capability* within a *ue-CapabilityRAT-Container* and with the *rat-Type* set to 'eutra';
 - 2> If the *ue-CapabilityRequest* includes 'geran-cs' and if the UE supports GERAN CS domain:
 - 3> include the UE radio access capabilities for GERAN CS within a *ue-CapabilityRAT-Container* and with the *rat-Type* set to 'geran-cs';
 - 2> if the *ue-CapabilityRequest* includes 'geran-ps' and if the UE supports GERAN PS domain:
 - 3> include the UE radio access capabilities for GERAN PS within a *ue-CapabilityRAT-Container* and with the *rat-Type* set to 'geran-ps';
 - 2> If the *ue-CapabilityRequest* includes 'utra' and if the UE supports UTRA:
 - 3> include the UE radio access capabilities for UTRA within a *ueCapabilityRAT-Container* and with the *rat-Type* set to 'utra';
 - 2> If the *ue-CapabilityRequest* includes 'cdma2000-1XRTT' and if the UE supports CDMA2000-1xRTT:
 - 3> include the UE band class radio access capabilities for CDMA 2000 within a *ueCapabilityRAT-Container* and with the *rat-Type* set to 'cdma2000-1XRTT';
- 1> submit the *UECapabilityInformation* message to lower layers for transmission, upon which the procedure ends.

8.5.4.1.3 Test description

8.5.4.1.3.1 Pre-test conditions

System Simulator:

- Cell 1

UE:

None.

Preamble:

- The UE is in state Switched OFF (state 1) according to [18].

8.5.4.1.3.2 Test procedure sequence

Table 8.5.4.1.3.2-1: Main behaviour

St	Procedure	Message Sequence		TP	Verdict
		U - S	Message		
1	The UE is switched on.	-	-	-	-
2	The UE transmits an <i>RRCCoordinateRequest</i> message.	-->	<i>RRCCoordinateRequest</i>	-	-
3	The SS transmits an <i>RRCCoordinateSetup</i> message.	<--	<i>RRCCoordinateSetup</i>	-	-
4	The UE transmits an <i>RRCCoordinateSetupComplete</i> . This message includes an ATTACH REQUEST and a PDN CONNECTIVITY REQUEST message.	-->	<i>RRCCoordinateSetupComplete</i>	-	-
5	The SS transmits a <i>DLInformationTransfer</i> message. This message includes an AUTHENTICATION REQUEST message.	<--	<i>DLInformationTransfer</i>	-	-
6	The UE transmits an <i>ULInformationTransfer</i> message. This message includes an AUTHENTICATION RESPONSE message.	-->	<i>ULInformationTransfer</i>	-	-
7	The SS transmits a <i>DLInformationTransfer</i> message. This message includes a SECURITY MODE COMMAND message.	<--	<i>DLInformationTransfer</i>	-	-
8	The UE transmits an <i>ULInformationTransfer</i> message. This message includes a SECURITY MODE COMPLETE message.	-->	<i>ULInformationTransfer</i>	-	-
9	The SS transmits an <i>UECapabilityEnquiry</i> message to request UE radio access capability information for E UTRA only.	<--	<i>UECapabilityEnquiry</i>	-	-
10	Check: Does the UE transmit an <i>UECapabilityInformation</i> message?	-->	<i>UECapabilityInformation</i>	1	P
11	The SS transmits a <i>SecurityModeCommand</i> message to activate AS security.	<--	<i>SecurityModeCommand</i>	-	-
12	The UE transmits a <i>SecurityModeComplete</i> message and establishes the initial security configuration.	-->	<i>SecurityModeComplete</i>	-	-
-	EXCEPTION: Steps 13a1 to 13a2 describe behaviour that depends on UE configuration; the "lower case letter" identifies a step sequence that take place if the UE has ESM information which needs to be transferred after SECURITY MODE COMPLETE message.	-	-	-	-
13a 1	IF the UE sets the ESM information transfer flag in the last PDN CONNECTIVITY REQUEST message THEN the SS transmits a <i>DLInformationTransfer</i> message. This message includes an ESM INFORMATION REQUEST message.	<--	<i>DLInformationTransfer</i>	-	-
13a 2	The UE transmits an <i>ULInformationTransfer</i> message. This message includes an ESM INFORMATION RESPONSE message.	-->	<i>ULInformationTransfer</i>	-	-
14	The SS transmits an <i>RRCCoordinateReconfiguration</i> message to establish a data radio bearer.	<--	<i>RRCCoordinateReconfiguration</i>	-	-
15	The UE transmits an <i>RRCCoordinateReconfigurationComplete</i> .	-->	<i>RRCCoordinateReconfigurationComplete</i>	-	-
16	The UE transmits an <i>ULInformationTransfer</i> message. This message includes an ATTACH COMPLETE message.	-->	<i>ULInformationTransfer</i>	-	-
17	The SS transmits an <i>UECapabilityEnquiry</i>	<--	<i>UECapabilityEnquiry</i>	-	-

	message to request UE radio access capability information for E UTRA only.				
18	Check: Does the UE transmit an <i>UECapabilityInformation</i> message?	-->	<i>UECapabilityInformation</i>	2	P
-	EXCEPTION: Steps 19a1 to 19a2 describe behaviour that depends on the UE capability.	-	-	-	-
19a 1	IF pc_FDD, pc_TDD_HCR, pc_TDD_LCR, pc_TDD_VHCR, pc_UMTS_GSM, pc_1xRTT or pc_HRPD THEN the SS transmits an <i>UECapabilityEnquiry</i> message to request UE radio access capability information for every other supported RATs.	<--	<i>UECapabilityEnquiry</i>	-	-
19a 2	Check: Does the UE transmit an <i>UECapabilityInformation</i> message?	-->	<i>UECapabilityInformation</i>	2	P

8.5.4.1.3.3 Specific message contents

Table 8.5.4.1.3.3-1: UECapabilityEnquiry (step 9 and 17, Table 8.5.4.1.3.2-1)

Derivation path: 36.508 clause 4.6.1 table 4.6.1-22			
Information Element	Value/Remark	Comment	Condition
<pre> UECapabilityEnquiry ::= SEQUENCE { criticalExtensions CHOICE { c1 CHOICE { ueCapabilityEnquiry-r8 SEQUENCE { ue-RadioAccessCapRequest } } } } </pre>	Eutra	E-UTRA only	

Table 8.5.4.1.3.3-3: UEcapabilityEnquiry (step 19a1, Table 8.5.4.1.3.2-1)

Derivation path: 36.508 clause 4.6.1 table 4.6.1-22			
Information Element	Value/Remark	Comment	Condition
UECapabilityEnquiry ::= SEQUENCE { criticalExtensions CHOICE { c1 CHOICE { ueCapabilityEnquiry-r8 SEQUENCE { ue-RadioAccessCapRequest[i1] ue-RadioAccessCapRequest[i2] ue-RadioAccessCapRequest[i3] nonCriticalExtension SEQUENCE {} } } } }	Numbering of entries is according to conditions met utran geran cdma2000-1xrttBandClass Not present	According to inter-RAT capabilities of UE This entry is present if the UE is capable of any mode (FDD/TDD) in UMTS.	pc_FDD, pc_TDD_HCR, pc_TDD_LCR, pc_TDD_VHCR pc_UMTS_GSM pc_1xRTT, pc_HRPD

Table 8.5.4.1.3.3-4: UECapabilityInformation (step 19a2, Table 8.5.4.1.3.2-1)

Derivation path: 36.508 clause 4.6.1 table 4.6.1-23			
Information Element	Value/Remark	Comment	Condition
UECapabilityInformation ::= SEQUENCE { criticalExtensions CHOICE { c1 CHOICE{ ueCapabilityInformation-r8 SEQUENCE { SIZE (1..maxRAT-Capabilities)) OF SEQUENCE {			
rat-Type[i1]	utran	Stated capability shall be compatible with 3GPP TS 36.523-2 (ICS statements) and the user settings	pc_FDD, pc_TDD_H CR, pc_TDD_L CR, pc_TDD_V HCR
ueCapabilitiesRAT-Container[i1] OCTET STRING {}	FFS	The encoding of UE capabilities is defined in IE [FFS] TS 25.331 [19].	pc_FDD, pc_TDD_H CR, pc_TDD_L CR, pc_TDD_V HCR
rat-Type[i2]	geran		pc_UMTS_ GSM
ueCapabilitiesRAT-Container [i2] OCTET STRING {}	FFS	The encoding of UE capabilities is defined in IE [FFS] [24.008 and/or 44.018; FFS].	pc_UMTS_ GSM
rat-Type[i3]	cdma2000- 1xrttBandClass		pc_1xRTT, pc_HRPD
ueCapabilitiesRAT-Container [i3] OCTET STRING {}	FFS	The encoding of UE capabilities is defined in IE [A.S.0008; FFS]	pc_1xRTT, pc_HRPD
nonCriticalExtension SEQUENCE {} } } }	Not present		

9 EPS Mobility Management

Editor's note: The contents of this section are aligned with 3GPP TS 24.301 v0.4.0.

9.1 EMM common procedures

9.1.1 GUTI reallocation procedures

9.1.1.1 GUTI reallocation procedure

9.1.1.1.1 Test Purpose (TP)

(1)

```
with { UE in EMM-REGISTERED state / EMM-CONNECTED mode }
ensure that {
  when { UE receives a GUTI REALLOCATION COMMAND message allocating a new GUTI and a new TAI list }
  then { UE transmits a GUTI REALLOCATION COMPLETE and UE considers the new GUTI as valid and the
old GUTI as invalid and UE considers the new TAI list as valid and the old TAI list as invalid }
}
```

9.1.1.1.2 Conformance requirements

References: The conformance requirements covered in the present TC are specified in: TS 24.301, clauses 5.4.1.1, 5.4.1.2 and 5.4.1.3.

[TS 24.301, clause 5.4.1.1]

The purpose of the GUTI reallocation procedure is to allocate a GUTI and optionally to provide a new TAI list to a particular UE.

The reallocation of a GUTI is performed by the unique procedure defined in this subclause. This procedure can only be initiated by the MME in state EMM-REGISTERED.

The GUTI can also be implicitly reallocated at attach or tracking area updating procedures. The implicit reallocation of a GUTI is described in the subclauses which specify these procedures (see subclause 5.5.1 and 5.5.3).

The PLMN identity in the GUTI indicates the current registered PLMN.

NOTE 1: The GUTI reallocation procedure is usually performed in ciphered mode.

NOTE 2: Normally, the GUTI reallocation will take place in conjunction with another mobility management procedure, e.g. as part of tracking area updating.

[TS 24.301, clause 5.4.1.2]

The MME shall initiate the GUTI reallocation procedure by sending a GUTI REALLOCATION COMMAND message to the UE and starting the timer T3450 (see figure 5.4.1.2.1).

The GUTI REALLOCATION COMMAND message shall include a GUTI and may include a TAI list.

...

[TS 24.301, clause 5.4.1.3]

Upon receipt of the GUTI REALLOCATION COMMAND message, the UE shall store the GUTI and the TAI list, and send a GUTI REALLOCATION COMPLETE message to the MME. The UE considers the new GUTI as valid and the old GUTI as invalid. If the UE receives a new TAI list in the GUTI REALLOCATION COMMAND message, the UE shall consider the new TAI list as valid and the old TAI list as invalid; otherwise, the UE shall consider the old TAI list as valid

9.1.1.1.3 Test description

9.1.1.1.3.1 Pre-test conditions

System Simulator:

- Cell 1 and Cell 3:
 - Cell 1 is the serving cell with TAI1 (PLMN1+TAC1);
 - Cell 3 is a neighbour with TAI4 (PLMN1+TAC4).

UE:

None.

Preamble:

- UE in EMM-REGISTERED state / EMM-CONNECTED mode (state 2) according to [18] on cell 1.

Editor's note: No such state is defined, state 2 is "Registered, Idle mode".

- The UE has a valid GUTI1 and a valid TAI_list_1 {TAI1, TAI2 (PLMN1 + TAC2), TAI3 (PLMN1 + TAC3)} for EPS service.

9.1.1.1.3.2 Test procedure sequence

Table 9.1.1.1.3.2-1: Main behaviour

St	Procedure	Message Sequence		TP	Verdict
		U - S	Message		
1	The SS transmits a GUTI REALLOCATION COMMAND message as specified.	<--	GUTI REALLOCATION COMMAND	-	-
2	Check: Does the UE transmit a GUTI REALLOCATION COMPLETE as specified?	-->	GUTI REALLOCATION COMPLETE	1	P
3	The SS releases the RRC connection.	-	-	-	-
4	The SS transmits a Paging on cell 1 with S-TMSI1	-	-	-	-
5	Check: Does the UE perform a random access on cell 1 in the next 5s?	-	-	1	F
6	Check: Does the test results of CALL generic procedure [18] indicate that the UE is in E-UTRA EMM-REGISTERED state on cell 1 with PagingUE-Identity = S-TMSI2?	-	-	1	-
7	Set the cell type of cell 3 to the "Serving cell". Set the cell type of cell 1 to the "Suitable neighbour cell".	-	-	-	-
8	Check: Does the UE perform a random access on cell 3 in the next 5s?	-	-	1	F
9	Check: Does the test results of CALL generic procedure [18] indicate that the UE is in E-UTRA EMM-REGISTERED state on cell 3 with PagingUE-Identity = S-TMSI2?	-	-	1	-

NOTE 1: It is assumed in the test procedure sequence that the UE initially has a valid GUTI.

NOTE 2: NAS security procedures are checked in this TC, especially integrity procedures.

9.1.1.1.3.3 Specific message contents

Table 9.2.1.1.1.3.3-1: Message GUTI REALLOCATION COMMAND (step 1, Table 9.2.1.1.1.3.2-1)

Derivation path: 36.508 table 4.7.2-13			
Information Element	Value/Remark	Comment	Condition
Security header type	0000	No security protection	
GUTI	GUTI2	New GUTI	
TAI list	present	TAI1, TAI4	
Length of tracking area identity list contents	00001010	10 octets	
Partial tracking area identity list 1		TAI1, TAI4	
Type of list	000	Non consecutive TACs	
Number of elements	2		
MCC	PLMN1's MCC		
MNC	PLMN1's NCC		
TAC 1	TAC1	Cell 1	
TAC 2	TAC4	Cell 3	

NOTE: This message is a SECURITY PROTECTED NAS MESSAGE with Security header type = 0001(Security protected NAS message).

Table 9.2.1.1.1.3.3-2: Message GUTI REALLOCATION COMPLETE (step 2, Table 9.2.1.1.1.3.2-1)

Derivation path: 36.508 table 4.7.3-14			
Information Element	Value/Remark	Comment	Condition
Security header type	0000	No security protection	

NOTE: This message is a SECURITY PROTECTED NAS MESSAGE with Security header type = 0001(Security protected NAS message).

9.1.1.2 GUTI reallocation procedure, no TAI list

9.1.1.2.1 Test Purpose (TP)

(1)

```
with { UE in EMM-REGISTERED state / EMM-CONNECTED mode }
ensure that {
  when { UE receives a GUTI REALLOCATION COMMAND message allocating a new GUTI and no TAI list }
  then { UE transmits a GUTI REALLOCATION COMPLETE and UE considers the new GUTI as valid and the
old GUTI as invalid and UE considers the old TAI list as valid }
}
```

9.1.1.2.2 Conformance requirements

References: The conformance requirements covered in the present TC are specified in: TS 24.301, clauses 5.4.1.1, 5.4.1.2 and 5.4.1.3.

[TS 24.301, clause 5.4.1.1]

The purpose of the GUTI reallocation procedure is to allocate a GUTI and optionally to provide a new TAI list to a particular UE.

The reallocation of a GUTI is performed by the unique procedure defined in this subclause. This procedure can only be initiated by the MME in state EMM-REGISTERED.

The GUTI can also be implicitly reallocated at attach or tracking area updating procedures. The implicit reallocation of a GUTI is described in the subclauses which specify these procedures (see subclause 5.5.1 and 5.5.3).

The PLMN identity in the GUTI indicates the current registered PLMN.

NOTE 1: The GUTI reallocation procedure is usually performed in ciphered mode.

NOTE 2: Normally, the GUTI reallocation will take place in conjunction with another mobility management procedure, e.g. as part of tracking area updating.

[TS 24.301, clause 5.4.1.2]

The MME shall initiate the GUTI reallocation procedure by sending a GUTI REALLOCATION COMMAND message to the UE and starting the timer T3450 (see figure 5.4.1.2.1).

The GUTI REALLOCATION COMMAND message shall include a GUTI and may include a TAI list.

...

[TS 24.301, clause 5.4.1.3]

Upon receipt of the GUTI REALLOCATION COMMAND message, the UE shall store the GUTI and the TAI list, and send a GUTI REALLOCATION COMPLETE message to the MME. The UE considers the new GUTI as valid and the old GUTI as invalid. If the UE receives a new TAI list in the GUTI REALLOCATION COMMAND message, the UE shall consider the new TAI list as valid and the old TAI list as invalid; otherwise, the UE shall consider the old TAI list as valid

9.1.1.2.3 Test description

9.1.1.2.3.1 Pre-test conditions

System Simulator:

- Cell 1 and Cell 3:
 - Cell 1 is the serving cell A with TAI1 (PLMN1+TAC1);
 - Cell 3 is a neighbour cell B with TAI3 (PLMN1+TAC3).

UE:

None.

Preamble:

- UE in EMM-REGISTERED state / EMM-CONNECTED mode (state 2) according to [18] on cell A.

Editor's note: No such state is defined, state 2 is "Registered, Idle mode".

- The UE has a valid GUTI1 and a valid TAI_list_1 {TAI1, TAI2 (PLMN1, TAC2), TAI3} for EPS service.

9.1.1.2.3.2 Test procedure sequence

Table 9.1.1.2.3.2-1: Main behaviour

St	Procedure	Message Sequence		TP	Verdict
		U - S	Message		
1	The SS transmits a GUTI REALLOCATION COMMAND message as specified.	<--	GUTI REALLOCATION COMMAND		
2	Check: Does the UE transmit a GUTI REALLOCATION COMPLETE as specified?	-->	GUTI REALLOCATION COMPLETE	1	P
3	The SS releases the RRC connection.	-	-	-	-
4	The SS transmits a Paging on cell 1 with S-TMSI1.	-	-	-	-
5	Check: Does the UE perform a random access on cell 1 in the next 5s?	-	-	1	F
6	Check: Does the test results of CALL generic procedure indicate that the UE is in E-UTRA EMM-REGISTERED state on cell A with PagingUE-Identity = S-TMSI2?	-	-	1	-
7	Set the cell type of cell 3 to the "Serving cell". Set the cell type of cell 1 to the "Suitable neighbour cell".	-	-	-	-
8	Check: Does the UE perform a generic TRACKING AREA UPDATE procedure [18] indicating that the UE is in E-UTRA EMM-REGISTERED state on cell 3 with TAI3 within 10 seconds?	-	-	1	-

NOTE 1: It is assumed in the test procedure sequence that the UE initially has a valid GUTI.

NOTE 2: NAS security procedures are checked in this TC, especially integrity procedures.

9.1.1.2.3.3 Specific message contents

Table 9.2.1.1.2.3.3-1: Message GUTI REALLOCATION COMMAND (step 1, Table 9.2.1.1.2.3.2-1)

Derivation path: 36.508 table 4.7.2-13			
Information Element	Value/Remark	Comment	Condition
Security header type	0000	No security protection	
GUTI	GUTI2	New GUTI	
TAI list	Not present	No TAI list	

NOTE: This message is a SECURITY PROTECTED NAS MESSAGE with Security header type = 0001(Security protected NAS message).

Table 9.2.1.1.2.3.3-2: Message GUTI REALLOCATION COMPLETE (step 2, Table 9.2.1.1.2.3.2-1)

Derivation path: 36.508 table xxx			
Information Element	Value/Remark	Comment	Condition
Security header type	0000	No security protection	

NOTE: This message is a SECURITY PROTECTED NAS MESSAGE with Security header type = 0001(Security protected NAS message).

9.1.2 Authentication procedure

9.1.2.1 Authentication accepted

9.1.2.1.1 Test Purpose (TP)

(1)

```
with { UE in EMM-REGISTERED state / EMM-CONNECTED mode }
ensure that {
  when { the UE receives an AUTHENTICATION REQUEST message }
  then { the UE establishes correct EPS security context and responds with a correct
AUTHENTICATION RESPONSE message }
}
```

9.1.2.1.2 Conformance requirements

References: The conformance requirements covered in the current TC are specified in: TS 24.301, clauses 5.4.2.1 and 5.4.2.3 and TS 33.401, clause 6.1.1.

[TS 24.301, clause 5.4.2.1]

The UE shall only support the EPS authentication challenge if a USIM is present.

An EPS security context is established in the UE and the network when an EPS authentication is successfully performed. During a successful EPS authentication, the CK and IK keys are computed. CK and IK are then used as key material to compute a new key, K_{ASME} . K_{ASME} is stored in the EPS security contexts (see 3GPP TS 33.401 [19]) of both the network and the UE, and is the root for the EPS integrity protection and ciphering key hierarchy.

[TS 24.301, clause 5.4.2.3]

The UE shall respond to an AUTHENTICATION REQUEST message. With the exception of the cases described in subclause 5.4.2.6, the UE shall process the authentication challenge data and respond with an AUTHENTICATION RESPONSE message to the network.

Upon a successful EPS authentication challenge, the new K_{ASME} calculated from the authentication challenge data shall be stored in a new EPS security context.

[TS 33.401, clause 6.1.1]

UE shall compute K_{ASME} from CK, IK, and serving network's identity (SN id) using the KDF as specified in Annex A. SN id binding implicitly authenticates the serving network's identity when the derived keys from K_{ASME} are successfully used.

...

UE shall respond with User authentication response message including RES in case of successful AUTN verification as described in TS 33.102[4] and successful AMF verification as described above. Otherwise UE shall send User authentication reject message with a proper CAUSE value.

9.1.2.1.3 Test description

9.1.2.1.3.1 Pre-test conditions

System Simulator:

- Cell A

UE:

- The test USIM contains a valid GUTI-1 and TAI-1, and EPS update status is "EU1: UPDATED"; EPS security context has been established and taken into use.

Preamble:

- UE in state Switched OFF (State 1) according to [18].

9.1.2.1.3.2 Test procedure sequence

Table 9.1.2.1.3.2-1: Main behaviour

St	Procedure	Message Sequence		TP	Verdict
		U - S	Message		
1	Switch the UE on	-	-	-	-
2	The UE transmit an ATTACH REQUEST	-->	ATTACH REQUEST	-	-
3	SS transmits an AUTHENTICATION REQUEST message, KSI_{ASME} value is different to the KSI_{ASME} value provided in the ATTACH REQUEST	<--	AUTHENTICATION REQUEST	-	-
4	Check: Does the UE respond with AUTHENTICATION RESPONSE message within 6 seconds and the included RES is equal to the XRES calculated in the SS?	-->	AUTHENTICATION RESPONSE	1	P
5	SS transmits a NAS SECURITY MODE COMMAND message including the KSI_{ASME} of the new EPS security context (as provided in step 3)	<--	SECURITY MODE COMMAND	-	-
6	Check: Does the UE respond with NAS SECURITY MODE COMPLETE message integrity protected and ciphered with the new EPS security context identified by the KSI_{ASME} received in the SECURITY MODE COMMAND message in step 5	-->	SECURITY MODE COMPLETE	1	P
7	SS responds with ATTACH ACCEPT message	<--	ATTACH ACCEPT	-	-
8	The UE transmits an ATTACH COMPLETE message	-->	ATTACH COMPLETE	-	-
9	SS releases the RRC connection	-	-	-	-
10	SS pages the UE using S-TMSI	-	-	-	-
11	Check: Does the UE respond with SERVICE REQUEST message providing KSI_{ASME} value that equals the value provided in the AUTHENTICATION REQUEST message in Step 3, and, integrity protected with new EPS security context?	-->	SERVICE REQUEST	1	P
12	SS transmits SERVICE REJECT message with EMM cause "Congestion" to complete the procedure Note: The EMM cause chosen is just for convenience, to ensure that UE will abort the procedure without side effects.	<--	SERVICE REJECT	-	-

9.1.2.1.3.3 Specific message contents

Table 9.1.2.1.3.3-1: AUTHENTICATION RESPONSE (step 4, Table 9.1.2.1.3.2-1)

Derivation Path: 36.508, Table 4.7.2-8			
Information Element	Value/remark	Comment	Condition
Authentication response parameter	RES equal to the XRES calculated in the SS with the parameters provided/indicated in the AUTHENTICATION REQUEST		

Table 9.1.2.1.3.3-2: SERVICE REJECT (step 12, Table 9.1.2.1.3.2-1)

Derivation Path: 36.508, Table 4.7.2-22			
Information Element	Value/remark	Comment	Condition
EMM cause	00010110	Congestion	

9.1.2.2 Authentication not accepted by the network, GUTI used, identification procedure and authentication restart

9.1.2.2.1 Test Purpose (TP)

(1)

```
with { UE having sent an initial NAS message with type of identity GUTI and responded to an
Authentication procedure initiated by the network }
ensure that {
  when { the network initiates an identification procedure due to finding problems with the
authentication response returned by the UE }
  then { the UE provides its IMSI in an IDENTITY RESPONSE message and is able to complete
successfully a restarted by the network authentication procedure with correct parameters }
}
```

9.1.2.2.2 Conformance requirements

References: The conformance requirements covered in the current TC are specified in: TS 24.301, clauses 5.4.2.5.

[TS 24.301, clause 5.4.2.5]

If the authentication response returned by the UE is not valid, the network response depends upon the type of identity used by the UE in the initial NAS message, that is:

- if the GUTI was used; or
- if the IMSI was used.

If the GUTI was used, the network should initiate an identification procedure. If the IMSI given by the UE during the identification procedure differs from the IMSI the network had associated with the GUTI, the authentication should be restarted with the correct parameters.

9.1.2.2.3 Test description

9.1.2.2.3.1 Pre-test conditions

System Simulator:

- 1 cell, default parameters

UE:

- The test USIM contains a valid GUTI1 and TAI1, and EPS update status is "EU1: UPDATED".

Preamble:

- The UE is in state Switched OFF (State 1) according to [18].

9.1.2.2.3.2 Test procedure sequence

Table 9.1.2.2.3.2-1: Main Behaviour

St	Procedure	Message Sequence		TP	Verdict
		U - S	Message		
1	Switch the UE on	-	-	-	-
2	The UE transmit an ATTACH REQUEST message including a GUTI-1 and a PDN CONNECTIVITY REQUEST message	-->	ATTACH REQUEST	-	-
3	The SS transmits an AUTHENTICATION REQUEST message to initiate the EPS authentication and AKA procedure.	<--	AUTHENTICATION REQUEST	-	-
4	The UE transmits an AUTHENTICATION RESPONSE (Note 1)	-->	AUTHENTICATION RESPONSE	-	-
5	SS transmits an IDENTITY REQUEST message requesting IMSI in the IE Identity type (Note 1)	<--	IDENTITY REQUEST	-	-
6	Check: Does the UE respond with a correct IDENTITY RESPONSE message providing its IMSI in the IE Mobile Identity (Note 1)	-->	IDENTITY RESPONSE	1	P
7	The SS re-starts the authentication procedure and transmits an AUTHENTICATION REQUEST. (Note 1)	<--	AUTHENTICATION REQUEST	-	-
8	Check: Does the UE respond with a correct AUTHENTICATION RESPONSE message	-->	AUTHENTICATION RESPONSE	1	P
9	The SS transmits a NAS SECURITY MODE COMMAND message to activate NAS security.	<--	SECURITY MODE COMMAND	-	-
10	The UE transmits a NAS SECURITY MODE COMPLETE message and establishes the initial security configuration.	-->	SECURITY MODE COMPLETE	-	-
11	SS responds with ATTACH ACCEPT message with a new GUTI-2 included in the EPS mobile identity IE	<--	ATTACH ACCEPT	-	-
12	The UE transmits an ATTACH COMPLETE message	-->	ATTACH COMPLETE	-	-
Note 1: This TC verifies the UE behaviour in case of Authentication failure due to incorrect IMSI the network had associated with the GUTI which was provided by the UE in the initial NAS message. Because it is impossible to force the UE into this invalid behaviour the test procedure simulates network behaviour pretending that the UE behaviour was incorrect.					

9.1.2.2.3.3 Specific message contents

Table 9.1.2.2.3.3-1: SERVICE REJECT (step 16, Table 9.1.2.2.3.2-1)

Derivation Path: 36.508, Table 4.7.2-22			
Information Element	Value/remark	Comment	Condition
EMM cause	00010110	Congestion	

9.1.2.3 Authentication not accepted by the network, GUTI used, authentication reject and re-authentication

9.1.2.3.1 Test Purpose (TP)

(1)

```

with { UE having sent an initial NAS message with type of identity GUTI }
ensure that {
  when { as a result of failure of an Authentication procedure initiated by the network the UE
receives an AUTHENTICATION REJECT message }
  then { the UE shall set the update status to EU3 ROAMING NOT ALLOWED, delete the stored GUTI,
TAI list, last visited registered TAI and KSIASME and enter state EMM-DEREGISTERED }
}

```

9.1.2.3.2 Conformance requirements

References: The conformance requirements covered in the current TC are specified in: TS 24.301, clauses 5.4.2.5.

[TS 24.301, clause 5.4.2.5]

Upon receipt of an AUTHENTICATION REJECT message, the UE shall set the update status to EU3 ROAMING NOT ALLOWED, delete the stored GUTI, TAI list, last visited registered TAI and KSI_{ASME}. The USIM shall be considered invalid until switching off the UE or the UICC containing the USIM is removed.

If the AUTHENTICATION REJECT message is received by the UE, the UE shall abort any EMM signalling procedure, stop any of the timers T3410, T3417 or T3430 (if running) and enter state EMM-DEREGISTERED.

9.1.2.3.3 Test description

9.1.2.3.3.1 Pre-test conditions

System Simulator:

- Cell A

UE:

- The test USIM contains a valid GUTI-1 and TAI-1, and EPS update status is "EU1: UPDATED"; EPS security context has been established and taken into use.

Preamble:

- The UE is in state Switched OFF (state 1) according to [18].

9.1.2.3.3.2 Test procedure sequence

Table 9.1.2.3.3.2-1: Main behaviour

St	Procedure	Message Sequence		TP	Verdict
		U - S	Message		
1	Switch the UE on	-	-	-	-
2	The UE transmit an ATTACH REQUEST message	-->	ATTACH REQUEST	-	-
3	The SS transmits an AUTHENTICATION REQUEST message	<--	AUTHENTICATION REQUEST	-	-
4	The UE transmits an AUTHENTICATION RESPONSE.	-->	AUTHENTICATION RESPONSE	-	-
5	The SS transmits an AUTHENTICATION REJECT message	<--	AUTHENTICATION REJECT	-	-
6	SS releases the RRC connection	-	-	-	-
7	Check: Does the UE transmit an ATTACH REQUEST message in the next 30 seconds?	-->	ATTACH REQUEST	1	F
8	Check: Does the test result of CALL generic procedure "Test procedure for no response to paging (for NAS testing)" indicates that the UE does not respond to paging when paged with GUTI-1 and with CN domain indicator set to "PS"?	-	-	1	-
9	Check: Does the test result of CALL generic procedure "Test procedure for no response to paging (for NAS testing)" indicates that the UE does not respond to paging when paged with IMSI and with CN domain indicator set to "PS" ?	-	-	1	-
10	Switch the UE off	-	-	-	-
11	Switch the UE on	-	-	-	-
12	Check: Does UE transmit a NOTintegrity protected ATTACH REQUEST message including IMSI and a PDN CONNECTIVITY REQUEST message?	-->	ATTACH REQUEST	1	P
13	The SS transmits an AUTHENTICATION REQUEST message	<--	AUTHENTICATION REQUEST	-	-
14	The UE transmits an AUTHENTICATION RESPONSE message	-->	AUTHENTICATION RESPONSE	-	-
15	The SS transmits a NAS SECURITY MODE COMMAND message including the KSI _{ASME} of the new EPS security context	<--	SECURITY MODE COMMAND	-	-
16	The UE transmits a NAS SECURITY MODE COMPLETE message and ciphered with the new EPS security context identified by the KSI _{ASME} received in the SECURITY MODE COMMAND message in step 14	-->	SECURITY MODE COMPLETE	-	-
17	SS responds with ATTACH ACCEPT message	<--	ATTACH ACCEPT	-	-
18	The UE transmits an ATTACH COMPLETE message	-->	ATTACH COMPLETE	-	-

9.1.2.3.3.3 Specific message contents

Table 9.1.2.3.3.3-1: ATTACH REQUEST (step 12, Table 9.1.2.3.3.2-1)

Derivation Path: 36.508, Table 4.7.2-4			
Information Element	Value/remark	Comment	Condition
NAS key set identifier	'111'B	no key is available	
Old GUTI or IMSI	IMSI		
Last visited registered TAI	Not Present		

9.1.2.4 Authentication not accepted by the UE, MAC code failure

9.1.2.4.1 Test Purpose (TP)

(1)

```
with { UE in EMM-REGISTERED state / EMM-CONNECTED mode}
ensure that {
  when { the UE receives an AUTHENTICATION REQUEST message with invalid MAC code }
  then { the UE shall send an AUTHENTICATION FAILURE message to the network, with the reject cause
#20 "MAC failure" }
}
```

9.1.2.4.2 Conformance requirements

References: The conformance requirements covered in the current TC are specified in: TS 24.301, clauses 5.4.2.6.

[TS 24.301, clause 5.4.2.6]

In an EPS authentication challenge, the UE shall check the authenticity of the core network by means of the AUTN parameter received in the AUTHENTICATION REQUEST message. This enables the UE to detect a false network.

During an EPS authentication procedure, the UE may reject the core network due to an incorrect AUTN parameter (see 3GPP TS 33.401 [19]). This parameter contains two possible causes for authentication failure:

a) MAC code failure:

If the UE finds the MAC code (supplied by the core network in the AUTN parameter) to be invalid, the UE shall send an AUTHENTICATION FAILURE message to the network, with the EMM cause #20 "MAC failure". The UE shall then follow the procedure described in subclause 5.4.2.7, item c.

...

If the UE returns an AUTHENTICATION FAILURE message to the network, the UE shall delete any previously stored RAND and RES and shall stop timer T3416, if running.

[TS 24.301, clause 5.4.2.7]

c) Authentication failure (EMM cause #20 "MAC failure"):

The UE shall send an AUTHENTICATION FAILURE message, with EMM cause #20 "MAC failure" according to subclause 5.4.2.6, to the network and start timer T3418 (see example in figure 5.4.2.7.1). Furthermore, the UE shall stop any of the retransmission timers that are running (e.g. T3410, T3417, T3421 or T3430). Upon the first receipt of an AUTHENTICATION FAILURE message from the UE with EMM cause #20 "MAC failure", the network may initiate the identification procedure described in subclause 5.4.4. This is to allow the network to obtain the IMSI from the UE. The network may then check that the GUTI originally used in the authentication challenge corresponded to the correct IMSI. Upon receipt of the IDENTITY REQUEST message from the network, the UE shall send the IDENTITY RESPONSE message.

...

If the GUTI/IMSI mapping in the network was incorrect, the network should respond by sending a new AUTHENTICATION REQUEST message to the UE. Upon receiving the new AUTHENTICATION REQUEST message from the network, the UE shall stop the timer T3418, if running, and then process the challenge information as normal.

9.1.2.4.3 Test description

9.1.2.4.3.1 Pre-test conditions

System Simulator:

- Cell A

UE:

- None.

Preamble:

- UE is in state Switched OFF (State 1) according to [18].

9.1.2.4.3.2 Test procedure sequence

Table 9.1.2.4.3.2-1: Main behaviour

St	Procedure	Message Sequence		TP	Verdict
		U - S	Message		
1	Switch the UE on	-	-	-	-
2	The UE transmits an ATTACH REQUEST message	-->	ATTACH REQUEST	-	-
3	SS transmits an AUTHENTICATION REQUEST message which contains an invalid MAC code	<--	AUTHENTICATION REQUEST	-	-
4	Check: Does the UE respond with a AUTHENTICATION FAILURE message, with reject cause "MAC failure"?	-->	AUTHENTICATION FAILURE	1	P
5	SS transmits an IDENTITY REQUEST message requesting IMSI in the IE Identity type	<--	IDENTITY REQUEST	-	-
6	The UE responds with a correct IDENTITY RESPONSE message providing its IMSI in the IE Mobile Identity	-->	IDENTITY RESPONSE	-	-
7	SS transmits a correct AUTHENTICATION REQUEST message, RAND different to the one send in Step 3	<--	AUTHENTICATION REQUEST	-	-
8	Check: Does the UE respond with a correct AUTHENTICATION RESPONSE message withis equal to the XRES calculated in the SS RES that ?	-->	AUTHENTICATION RESPONSE	1	P
9	SS transmits a NAS SECURITY MODE COMMAND message including the KSI _{ASME} of the new EPS security context (as provided in step 8)	<--	SECURITY MODE COMMAND	-	-
10	UE transmits a NAS SECURITY MODE COMPLETE message integrity protected and ciphered with the new EPS security context identified by the KSI _{ASME} received in the SECURITY MODE COMMAND message in step 9	-->	SECURITY MODE COMPLETE	1	P
11	SS responds with ATTACH ACCEPT	<--	ATTACH ACCEPT	-	-
12	The UE transmits an ATTACH COMPLETE message	-->	ATTACH COMPLETE	-	-

9.1.2.4.3.3 Specific message contents

Table 9.1.2.4.3.3-1: AUTHENTICATION REQUEST (step 3, Table 9.1.2.4.3.2-1)

Derivation Path: 36.508, Table 4.7.2-7			
Information Element	Value/remark	Comment	Condition
Authentication parameter AUTN	Invalid MAC	SS shall calculate the correct MAC value as specified in TS 33.102 and use any different value, e.g. correct_MAC+5.	

Table 9.1.2.4.3.3-2: AUTHENTICATION RESPONSE (step 8, Table 9.1.2.4.3.2-1)

Derivation Path: 36.508, Table 4.7.2-8			
Information Element	Value/remark	Comment	Condition
Authentication response parameter	RES equal to the XRES calculated in the SS with the parameters provided/indicated in the AUTHENTICATION REQUEST		

9.1.2.5 Authentication not accepted by the UE, SQN failure

9.1.2.5.1 Test Purpose (TP)

(1)

```
with { UE in EMM-REGISTERED state / EMM-CONNECTED mode }
ensure that {
  when { the UE receives an AUTHENTICATION REQUEST message with SQN out of range }
  then { the UE sends an AUTHENTICATION FAILURE message to the network, with EMM cause "synch failure" and a re-synchronization token }
}
```

(2)

```
with { UE having sent an AUTHENTICATION FAILURE message to the network, with EMM cause "synch failure" }
ensure that {
  when { the UE receives a new correct AUTHENTICATION REQUEST message while T3420 is running }
  then { the UE sends a correct AUTHENTICATION RESPONSE message }
}
```

9.1.2.5.2 Conformance requirements

References: The conformance requirements covered in the current TC are specified in: TS 24.301, clauses 5.4.2.6 and 5.4.2.7.

[TS 24.301, clause 5.4.2.6]

In an EPS authentication challenge, the UE shall check the authenticity of the core network by means of the AUTN parameter received in the AUTHENTICATION REQUEST message. This enables the UE to detect a false network.

During an EPS authentication procedure, the UE may reject the core network due to an incorrect AUTN parameter (see 3GPP TS 33.401 [19]). This parameter contains three possible causes for authentication failure:

...

c) SQN failure:

If the UE finds the SQN (supplied by the core network in the AUTN parameter) to be out of range, the UE shall send an AUTHENTICATION FAILURE message to the network, with the EMM cause #21 "synch failure" and a re-synchronization token AUTS provided by the USIM (see 3GPP TS 33.102 [18]). The UE shall then follow the procedure described in subclause 5.4.2.7, item d.

[TS 24.301, clause 5.4.2.7]

e) Authentication failure (EMM cause #21 "synch failure"):

The UE shall send an AUTHENTICATION FAILURE message, with EMM cause #21 "synch failure", to the network and start the timer T3420 (see example in figure 5.4.2.7.2). Furthermore, the UE shall stop any of the retransmission timers that are running (e.g. T3410, T3417, T3421 or T3430). Upon the first receipt of an AUTHENTICATION FAILURE message from the UE with the EMM cause #21 "synch failure", the network shall use the returned AUTS parameter from the authentication failure parameter IE in the AUTHENTICATION FAILURE message, to re-synchronise. The re-synchronisation procedure requires the MME to delete all unused authentication vectors for that IMSI and obtain new vectors from the HSS. When re-synchronisation is complete,

the network shall initiate the authentication procedure. Upon receipt of the AUTHENTICATION REQUEST message, the UE shall stop the timer T3420, if running.

...

If the network is validated successfully (a new AUTHENTICATION REQUEST is received which contains a valid SQN and MAC) while T3420 is running, the UE shall send the AUTHENTICATION RESPONSE message to the network and shall start any retransmission timers (e.g. T3410, T3417, T3421 or T3430), if they were running and stopped when the UE received the first failed AUTHENTICATION REQUEST message.

9.1.2.5.3 Test description

9.1.2.5.3.1 Pre-test conditions

System Simulator:

- Cell A1

UE:

- The test USIM contains a valid GUTI-1 and TAI-1, and EPS update status is "EU1: UPDATED"; EPS security context has been established and taken into use

Preamble:

- The UE is in state Switched OFF (State 1) according to [18].

9.1.2.5.3.2 Test procedure sequence

Table 9.1.2.5.3.2-1: Main behaviour

St	Procedure	Message Sequence		TP	Verdict
		U - S	Message		
1	Switch the UE on	-	-	-	-
2	The UE transmits an ATTACH REQUEST message	-->	ATTACH REQUEST	-	-
3	SS transmits AUTHENTICATION REQUEST message with the AMF field in the IE "Authentication parameter AUTN" set to "AMF _{RESYNCH} " value to trigger SQN re-synchronisation procedure in test USIM	<--	AUTHENTICATION REQUEST	-	-
4	Check: Does the UE respond with a AUTHENTICATION FAILURE message, with EMM cause "synch failure"?	-->	AUTHENTICATION FAILURE	1	P
5	SS transmits an IDENTITY REQUEST message requesting IMSI in the IE Identity type	<--	IDENTITY REQUEST	-	-
6	The UE responds with IDENTITY RESPONSE message providing its IMSI in the IE Mobile Identity	-->	IDENTITY RESPONSE	-	-
7	SS transmits AUTHENTICATION REQUEST message (Note 1)	<--	AUTHENTICATION REQUEST	-	-
8	Check: Does the UE respond with AUTHENTICATION RESPONSE message with RES that is equal to the XRES calculated in the SS?	-->	AUTHENTICATION RESPONSE	2	P
9	SS transmits a NAS SECURITY MODE COMMAND message including the KSI _{ASME} of the new EPS security context (as provided in step 8)	<--	SECURITY MODE COMMAND	-	-
10	UE transmits a NAS SECURITY MODE COMPLETE message integrity protected and ciphered with the new EPS security context identified by the KSI _{ASME} received in the SECURITY MODE COMMAND message in step 9	-->	SECURITY MODE COMPLETE	-	-
11	SS responds with ATTACH ACCEPT	<--	ATTACH ACCEPT	-	-
12	The UE transmits an ATTACH COMPLETE message	-->	ATTACH COMPLETE	-	-
Note 1: The SS shall ensure that the AUTHENTICATION REQUEST message sent in step 7 is sent less than (T3420-10%) sec after the message sent in step 4 otherwise it cannot be ensured that the UE will behave as specified in step 8.					

9.1.2.5.3.3 Specific message contents

Table 9.1.2.5.3.3-1: AUTHENTICATION REQUEST (step 3, Table 9.1.2.5.3.2-1)

Derivation Path: 36.508, Table 4.7.2-7			
Information Element	Value/remark	Comment	Condition
Authentication parameter AUTN	AMF field set to "AMF _{RESYNCH} "		

Table 9.1.2.5.3.3-2: AUTHENTICATION FAILURE (step 4, Table 9.1.2.5.3.2-1)

Derivation Path: 36.508, Table 4.7.2-5			
Information Element	Value/remark	Comment	Condition
EMM cause	'0001 0101'B	Synch failure	
Authentication failure parameter	'1111 1111 1111 1111'B	AMF _{RESYNCH} see TS 34.108, 8.1.2.2	

Table 9.1.2.5.3.3-3: AUTHENTICATION RESPONSE (step 8, Table 9.1.2.5.3.2-1)

Derivation Path: 36.508, Table 4.7.2-8			
Information Element	Value/remark	Comment	Condition
Authentication response parameter	RES equal to the XRES calculated in the SS with the parameters provided/indicated in the AUTHENTICATION REQUEST		

9.1.3 Security mode control procedure

9.1.3.1 NAS security mode command accepted by the UE

9.1.3.1.1 Test Purpose (TP)

(1)

```
with { successful completion of EPS authentication and key agreement (AKA) procedure }
ensure that {
  when { UE receives an integrity protected SECURITY MODE COMMAND message including replayed
security capabilities and IMEISV request }
  then { UE sends an integrity protected and ciphered SECURITY MODE COMPLETE message including
IMEISV and starts applying the NAS Security in both UL and DL }
```

(2)

```
with { NAS Security Activated and EPS Authentication and key agreement procedure is executed for new
Key generation}
ensure that {
  when { UE receives an integrity protected SECURITY MODE COMMAND message corresponding to NAS count
reset to zero including replayed security capabilities and IMEISV request }
  then { UE sends integrity protected and ciphered SECURITY MODE COMPLETE message [with NAS count
set to zero] including IMEISV and starts applying the NAS Security in both UL and DL}
}
```

9.1.3.1.2 Conformance requirements

References: The conformance requirements covered in the current TC are specified in: TS 24.301 clause 4.4.3.1, 5.4.3.1, 5.4.3.2 and 5.4.3.3.

[TS 24.301, clause 4.4.3.1]

There are two separate counters NAS COUNT: one related to uplink NAS messages and one related to downlink NAS messages. The NAS COUNT counters use 24 bit internal representation and are independently maintained by UE and MME. The NAS COUNT is constructed as a NAS sequence number (least significant bits) concatenated with a NAS overflow counter (most significant bits).

When NAS COUNT is input to NAS ciphering or NAS integrity algorithms it is considered to be a 32-bit entity where the most significant bits are padded with zeros.

The network NAS COUNT shall be initialized to zero in the first SECURITY MODE COMMAND when a new security context is activated following a successful authentication and key agreement (AKA) procedure. The UE NAS COUNT shall be initialized to zero when the UE receives the first SECURITY MODE COMMAND message after a successful AKA procedure and uses it in the following SECURITY MODE COMPLETE message.

Editor's note: How the NAS COUNT shall be handled after handover from UTRAN/GERAN to E-UTRAN is FFS.

The NAS sequence number part of the NAS COUNT is exchanged between the UE and the MME as part of the NAS signalling. After each new or retransmitted outbound NAS message, the sender shall always increase the NAS COUNT number by one. Specifically, the NAS sequence number is increased by one, and if the result is zero (due to wrap around), the NAS overflow counter is also incremented by one (see subclause 4.4.3.5). The receiving side estimates the NAS COUNT used by the sending side. Specifically, if the NAS sequence number wraps around, the NAS overflow counter is incremented by one.

Editor's note: Other general details are FFS.

[TS 24.301, clause 5.4.3.1]

The purpose of the NAS security mode control procedure is to take an EPS security context into use, and initialise and start NAS signalling security between the UE and the MME with the corresponding NAS keys and security algorithms.

[TS 24.301, clause 5.4.3.2]

The MME initiates the NAS security mode control procedure by sending a SECURITY MODE COMMAND message to the UE and starting timer T3460 (see example in figure 5.4.3.2.1).

The MME shall send the SECURITY MODE COMMAND message unciphered, but shall integrity protect the message with the NAS integrity key based on K_{ASME} included by the KSI_{ASME} indicated in the message. The MME shall set the security header type of the message to "integrity protected with new EPS security context".

...

The MME shall include the replayed security capabilities of the UE (including the security capabilities with regard to NAS, RRC and UP (user plane) ciphering as well as NAS, RRC integrity, and other possible target network security capabilities, i.e. UTRAN/GERAN if UE included them in the message to network), the replayed $nonce_{UE}$ if the UE included it in the message to the network, the selected NAS ciphering and integrity algorithms and the Key Set Identifier (KSI_{ASME} or KSI_{SGSN}). A SECURITY MODE COMMAND that follows a successful execution of the authentication procedure shall use a NAS COUNT reset to zero.

Additionally, the MME may request the UE to include its IMEISV in the SECURITY MODE COMPLETE message.

NOTE: The AS and NAS security capabilities will be the same, i.e. if the UE supports one algorithm for NAS it is also supported for AS.

[TS 24.301, clause 5.4.3.3]

Upon receipt of the SECURITY MODE COMMAND message, the UE shall check whether the security mode command can be accepted or not. This is done by performing the integrity check of the message and by checking that the received UE security capabilities and the received $nonce_{UE}$ have not been altered compared to what the UE provided in the initial layer 3 message that triggered this procedure.

If the security mode command can be accepted and the KSI_{ASME} was included in the SECURITY MODE COMMAND message, the UE shall send a SECURITY MODE COMPLETE message integrity protected with the selected NAS integrity algorithm and the NAS integrity key based on the K_{ASME} indicated by the KSI_{ASME} . If the SECURITY MODE COMMAND message includes KSI_{SGSN} , $nonce_{MME}$ and $nonce_{UE}$, the UE shall generate K'_{ASME} from both nonces as indicated in 3GPP TS 33.401 [19] to check whether the SECURITY MODE COMMAND can be accepted or not. The UE shall cipher the SECURITY MODE COMPLETE message with the selected NAS ciphering algorithm and the NAS ciphering key based on the K_{ASME} indicated by the KSI_{ASME} or fresh K'_{ASME} . The UE shall set the security header type of the message to "integrity protected and ciphered with new EPS security context". A SECURITY MODE COMPLETE that follows a successful execution of the authentication procedure shall use a NAS COUNT reset to zero.

From this time onwards the UE shall cipher and integrity protect all NAS signalling messages with the selected NAS ciphering and NAS integrity algorithms.

If the MME indicated in the SECURITY MODE COMMAND message that the IMEISV is requested, the UE shall include its IMEISV in the SECURITY MODE COMPLETE message.

9.1. 3.1.3 Test description

9.1.3.1.3.1 Pre-test conditions

System Simulator:

- Cell 1

Preamble:

- The UE is in state Switched OFF (state 1) according to [18].

9.1.3.1.3.2 Test procedure sequence

Table 9.1.3.1.3.2-1: Main behaviour

St	Procedure	Message Sequence		TP	Verdict
		U - S	Message		
1	The UE is switched on.	-	-	-	-
2	The UE transmits an ATTACH REQUEST message	-->	ATTACH REQUEST	-	-
3	The SS transmits an AUTHENTICATION REQUEST message to initiate the EPS authentication and AKA procedure.	<--	AUTHENTICATION REQUEST	-	-
4	The UE transmits an AUTHENTICATION RESPONSE message and establishes mutual authentication.	-->	AUTHENTICATION RESPONSE	-	-
5	The SS transmits a SECURITY MODE COMMAND message to activate NAS security. It is integrity protected and includes request to include IMEISV	<--	SECURITY MODE COMMAND	-	-
6	Check: Does the UE transmit a SECURITY MODE COMPLETE message and does it establish the initial security configuration?	-->	SECURITY MODE COMPLETE	1	P
7	The SS transmits an ATTACH ACCEPT message.	<--	ATTACH ACCEPT	-	-
8	The UE transmits an ATTACH COMPLETE message	-->	ATTACH COMPLETE	-	-
9	The SS Transmits an IDENTITY REQUEST message [Security protected]	<-	IDENTITY REQUEST	-	-
10	Check: Does the UE transmit an IDENTITY RESPONSE message [Security Protected]?	->	IDENTITY RESPONSE	1	P
11	The SS transmits an AUTHENTICATION REQUEST message to initiate the EPS authentication and AKA procedure for new key set generation.	<--	AUTHENTICATION REQUEST	-	-
12	The UE transmits an AUTHENTICATION RESPONSE message and establishes mutual authentication.	-->	AUTHENTICATION RESPONSE	-	-
13	SS resets UL and DL NAS Count to zero	-	-	-	-
14	The SS transmits a SECURITY MODE COMMAND message to activate NAS security. It is integrity protected and includes request to include IMEISV	<--	SECURITY MODE COMMAND	-	-
15	The UE transmits a NAS SECURITY MODE COMPLETE message and establishes the initial security configuration.	-->	SECURITY MODE COMPLETE	2	P
	Exception : Steps 16 and 17 are executed 100 times to check UE is applying security correctly				
16	The SS transmits an IDENTITY REQUEST message [Security protected]	<-	IDENTITY REQUEST	-	-
17	Check: Does the UE transmit an IDENTITY RESPONSE message [Security Protected]?	->	IDENTITY RESPONSE	2	P

9.1.3.1.3.3 Specific message contents

Table 9.1.3.1.3.3-1: SECURITY MODE COMMAND (Steps 5 and 14)

Derivation path: 36.508 table 4.7.2-19			
Information Element	Value/Remark	Comment	Condition
IMEISV request	Present		

Table 9.1.3.1.3.3-2: SECURITY MODE COMPLETE (Steps 6 and 15)

Derivation path: 36.508 table 4.7.2-20			
Information Element	Value/Remark	Comment	Condition
IMEISV	Present		

9.1.3.2 NAS security mode command not accepted by the UE

9.1.3.2.1 Test Purpose (TP)

(1)

```
with { successful completion of EPS authentication and key agreement (AKA) procedure[ ]
ensure that {
  when { UE receives an integrity protected SECURITY MODE COMMAND message including not matching
  replayed security capabilities}
  then { UE sends SECURITY MODE REJECT and does not start applying the NAS security in both UL and
DL}
}
```

9.1.3.2.2 Conformance requirements

References: The conformance requirements covered in the current TC are specified in: TS 24.301 clause 5.4.3.1, 5.4.3.2, 5.4.3.3 and 5.4.3.5.

[TS 24.301, clause 5.4.3.1]

The purpose of the NAS security mode control procedure is to take an EPS security context into use, and initialise and start NAS signalling security between the UE and the MME with the corresponding NAS keys and security algorithms.

[TS 24.301, clause 5.4.3.2]

The MME initiates the NAS security mode control procedure by sending a SECURITY MODE COMMAND message to the UE and starting timer T3460 (see example in figure 5.4.3.2.1).

If the security mode control procedure is initiated further to a successful execution of the authentication procedure, the MME shall use the reset downlink NAS COUNT to integrity protect the SECURITY MODE COMMAND message.

The MME shall send the SECURITY MODE COMMAND message unciphered, but shall integrity protect the message with the NAS integrity key based on K_{ASME} or mapped K'_{ASME} indicated by the eKSI included in the message. The MME shall set the security header type of the message to "integrity protected with new EPS security context".

...

The MME shall include the replayed security capabilities of the UE (including the security capabilities with regard to NAS, RRC and UP (user plane) ciphering as well as NAS, RRC integrity, and other possible target network security capabilities, i.e. UTRAN/GERAN if UE included them in the message to network), the replayed nonce_{UE} if the UE included it in the message to the network, the selected NAS ciphering and integrity algorithms and the Key Set Identifier (eKSI). A SECURITY MODE COMMAND that follows a successful execution of the authentication procedure shall use a NAS COUNT reset to zero.

Additionally, the MME may request the UE to include its IMEISV in the SECURITY MODE COMPLETE message.

NOTE: The AS and NAS security capabilities will be the same, i.e. if the UE supports one algorithm for NAS it is also be supported for AS.

[TS 24.301, clause 5.4.3.3]

Upon receipt of the SECURITY MODE COMMAND message, the UE shall check whether the security mode command can be accepted or not. This is done by performing the integrity check of the message and by checking that the received UE security capabilities and the received nonce_{UE} have not been altered compared to what the UE provided in the initial layer 3 message that triggered this procedure.

[TS 24.301, clause 5.4.3.5]

If the security mode command cannot be accepted, the UE shall send a SECURITY MODE REJECT message, which shall not be integrity protected. The SECURITY MODE REJECT message contains an EMM cause that typically indicates one of the following cause values:

#23: UE security capabilities mismatch;

#24: security mode rejected, unspecified.

Upon receipt of the SECURITY MODE REJECT message, the MME shall stop timer T3460. The MME shall also abort the ongoing procedure that triggered the initiation of the NAS security mode control procedure.

9.1.3.2.3 Test description

9.1.3.2.3.1 Pre-test conditions

System Simulator:

- Cell 1

Preamble:

- The UE is in state Switched OFF (state 1) according to [18].

9.1.3.2.3.2 Test procedure sequence

Table 9.1.3.2.3.2-1: Main behaviour

St	Procedure	Message Sequence		TP	Verdict
		U - S	Message		
1	The UE is switched on.	-	-	-	-
2	The UE transmits an ATTACH REQUEST message	-->	ATTACH REQUEST	-	-
3	The SS transmits an AUTHENTICATION REQUEST message to initiate the EPS authentication and AKA procedure.	<--	AUTHENTICATION REQUEST	-	-
4	The UE transmits an AUTHENTICATION RESPONSE message and establishes mutual authentication.	-->	AUTHENTICATION RESPONSE	-	-
5	The SS transmits a NAS SECURITY MODE COMMAND message to activate NAS security. It is integrity protected and includes un matched replayed security capabilities.	<--	SECURITY MODE COMMAND	-	-
6	Check: Does the UE transmit a NAS SECURITY MODE REJECT message with cause'#23: UE security capabilities mismatch'?	-->	SECURITY MODE REJECT	1	P
7	The SS Transmits an IDENTITY REQUEST message for IMSI (Security not applied]	<-	IDENTITY REQUEST	-	-
8	The UE Transmits an IDENTIY RESPONSE message (Security not applied)	->	IDENTITY RESPONSE	1	P
9	The SS transmits a SECURITY MODE COMMAND message to activate NAS security. It is integrity protected and includes request to include IMEISV	<--	SECURITY MODE COMMAND	-	-
10	The UE transmits a SECURITY MODE COMPLETE message and establishes the initial security configuration.	-->	SECURITY MODE COMPLETE	-	-
11	The SS transmits an ATTACH ACCEPT message	<--	ATTACH ACCEPT	-	-
12	The UE transmits an ATTACH COMPLETE message	-->	ATTACH COMPLETE	-	-

9.1.3.2.3.3 Specific message contents

Table 9.1.3.1.3.3-1: SECURITY MODE COMMAND (Step 5)

Derivation path: 36.508 table 4.7.2-19			
Information Element	Value/Remark	Comment	Condition
Replayed UE security capabilities	Set to mismatch the security capability of UE under test		

Table 9.1.3.1.3.3-2: SECURITY MODE REJECT (Step 6)

Derivation path: 36.508 table 4.7.2-21			
Information Element	Value/Remark	Comment	Condition
EMM cause	#23		

9.1.4 Identification procedure

9.1.4.1 Void

9.2 EMM specific procedures

9.2.1 Attach procedure

9.2.1.1 Attach procedure for EPS services

9.2.1.1.1 Attach Procedure / Success (valid GUTI)

9.2.1.1.1.1 Test Purpose (TP)

(1)

```
with { the UE is switched-off with a valid USIM inserted and the USIM contains a valid GUTI and last
visited registered TAI }
ensure that {
  when { UE is powered on in a cell not belonging to the last visited registered TAI }
  then { the UE establishes the RRC connection without S-TMSI and with registeredMME }
}
```

(2)

```
with { UE is switched-off with a valid USIM inserted and the USIM contains a valid GUTI and last
visited registered TAI }
ensure that {
  when { UE is powered on in a cell not belonging to the last visited registered TAI }
  then { the UE transmits an ATTACH REQUEST message with the EPS attach type set to "EPS attach",
including the GUTI and last visited registered TAI copied from the USIM, and, a PDN CONNECTIVITY
REQUEST message with the request type set to "initial request" and not including APN }
}
```

(3)

```
with { UE has sent an ATTACH REQUEST message }
ensure that {
  when { UE receives an ATTACH ACCEPT message with EPS attach result matching the requested
service(s), the TAI list the UE is registered to and including an ACTIVATE DEFAULT EPS CONTEXT
BEARER message with IE EPS Bearer Identity for the default EPS bearer context activated for the UE }
  then { UE accepts the allocated GUTI, deletes the old TAI list and transmits an ATTACH COMPLETE
message, together with ACTIVATE DEFAULT EPS BEARER CONTEXT ACCEPT message and enters EMM-REGISTERED
state }
}
```

9.2.1.1.1.2 Conformance requirements

References: The conformance requirements covered in the current TC are specified in: TS 24.301, clauses 5.3.1.1, 5.5.1.2.1, 5.5.1.2.2 and 5.5.1.2.4, and TS36.331, clauses 5.3.3.3 and 5.3.3.4.

[TS 24.301, clause 5.3.1.1]

...

For the routing of the initial NAS message to the appropriate MME, the UE NAS provides the lower layers with either the S-TMSI or the registered globally unique MME identifier (GUMMEI) that consists of the PLMN ID, the MME group ID, and the MME code (see 3GPP TS 23.003 [2]).

- When the UE is registered in the tracking area of the current cell during the NAS signalling connection establishment, the UE NAS shall provide the lower layers with the S-TMSI, but shall not provide the registered MME identifier to the lower layers. Exceptionally, when the UE in EMM-IDLE mode initiates a tracking area updating procedure for load balancing purposes, the UE NAS shall provide the lower layers with neither S-TMSI nor registered MME identifier.
- When the UE is not registered in the tracking area of the current cell during the NAS signalling connection establishment, the UE NAS does not provide the lower layers with the S-TMSI. If the UE has a valid registered MME identifier from a previous registration, the UE NAS shall provide the lower layers with the registered MME identifier.

[TS 24.301, clause 5.5.1.1]

The attach procedure is used to attach to an EPC for packet services in EPS.

The attach procedure is used for two purposes:

- by a UE in PS mode of operation to attach for EPS services only; or
- by a UE in CS/PS mode 1 or CS/PS mode 2 of operation to attach for both EPS and non-EPS services.

With a successful attach procedure, a context is established for the UE in the MME, and a default bearer is established between the UE and the PDN GW, thus enabling always-on IP connectivity to the UE. The network may also initiate the activation of dedicated bearers as part of the attach procedure.

...

[TS 24.301, clause 5.5.1.2.1]

This procedure is used by a UE to attach for EPS services only. When the UE initiates the EPS attach procedure, the UE shall indicate "EPS attach" in the EPS attach type IE.

[TS 24.301, clause 5.5.1.2.2]

In state EMM-DEREGISTERED, the UE initiates the attach procedure by sending an ATTACH REQUEST message to the MME, starting timer T3410 and entering state EMM-REGISTERED-INITIATED (see example in figure 5.5.1.2.2.1). If timer T3402 is currently running, the UE shall stop timer T3402. If timer T3411 is currently running, the UE shall stop timer T3411.

If the UE supports neither A/Gb mode nor Iu mode, the UE shall handle the Old GUTI or IMSI IE in the ATTACH REQUEST message as follows:

- The UE shall include in the ATTACH REQUEST message a valid GUTI together with the last visited registered TAI, if available. If there is no valid GUTI available, the UE shall include the IMSI in the ATTACH REQUEST message.

...

The UE shall send the ATTACH REQUEST message together with a PDN CONNECTIVITY REQUEST message contained in the ESM message container information element to request PDN connectivity.

...

If a valid NAS security context exists, the UE shall integrity protect the ATTACH REQUEST message combined with the PDN CONNECTIVITY REQUEST message. When the UE does not have a valid NAS security context, the ATTACH REQUEST message combined with the PDN CONNECTIVITY REQUEST message is not integrity protected.

...

[TS 24.301, clause 5.5.1.2.4]

...

If the ATTACH ACCEPT message contains a GUTI, the UE shall use this GUTI as the new temporary identity. The UE shall delete its old GUTI and store the new assigned GUTI. If no GUTI has been included by the MME in the ATTACH ACCEPT message, the old GUTI, if any available, shall be kept.

...

When the UE receives the ATTACH ACCEPT message combined with the ACTIVATE DEFAULT EPS BEARER CONTEXT REQUEST message, it shall forward the ACTIVATE DEFAULT EPS BEARER CONTEXT REQUEST message to the ESM sublayer. Upon receipt of an indication from the ESM sublayer that the default EPS bearer context has been activated, the UE shall send an ATTACH COMPLETE message together with an ACTIVATE DEFAULT EPS BEARER CONTEXT ACCEPT message contained in the ESM message container information element to the network.

...

[TS 24.301, clause 6.2.2]

The UE shall set the PDN type IE in the PDN CONNECTIVITY REQUEST message based on its IP stack configuration as follows:

- a) A UE, which is IPv6 and IPv4 capable and
 - has not been allocated an IP address for this APN, shall set the PDN type IE to IPv4v6.
 - has been allocated an IPv4 address for this APN and received the SM cause #52, "single address bearers only allowed", and is requesting an IPv6 address, shall set the PDN type IE to IPv6.
 - has been allocated an IPv6 address for this APN and received the SM cause #52, "single address bearers only allowed", and is requesting an IPv4 address, shall set the PDN type IE to IPv4.
- b) A UE, which is only IPv4 capable, shall set the PDN type IE to IPv4.
- c) A UE, which is only IPv6 capable, shall set the PDN type IE to IPv6.
- d) When the IP version capability of the UE is unknown in the UE (as in the case when the MT and TE are separated and the capability of the TE is not known in the MT), the UE shall set the PDN type IE to IPv4v6.

...

[TS 24.301, clause 6.4.1.3]

Upon receipt of the ACTIVATE DEFAULT EPS BEARER CONTEXT REQUEST message, the UE shall send an ACTIVATE DEFAULT EPS BEARER CONTEXT ACCEPT message and enter the state BEARER CONTEXT ACTIVE. When the default bearer is activated as part of the attach procedure, the UE shall send the ACTIVATE DEFAULT EPS BEARER CONTEXT ACCEPT message together with ATTACH COMPLETE message. When the default bearer is activated as the response to the stand-alone PDN CONNECTIVITY REQUEST message, the UE shall send the ACTIVATE DEFAULT EPS BEARER CONTEXT ACCEPT message alone.

The UE checks the PTI in the ACTIVATE DEFAULT EPS BEARER CONTEXT REQUEST message to identify the UE requested PDN connectivity procedure to which the default bearer context activation is related (see subclause 6.5.1).

...

[TS 24.301, clause 6.5.1.2]

When the PDN CONNECTIVITY REQUEST message is sent together with an ATTACH REQUEST message, the UE shall not include the APN.

NOTE: If the UE needs to provide PCO which require ciphering or provide an APN, or both, during the attach procedure, the ESM information transfer flag is included in the PDN CONNECTIVITY REQUEST. The MME then at a later stage in the PDN connectivity procedure initiates the ESM information request procedure in which the UE can provide the MME with PCO or APN or both.

...

The UE shall set the request type to "initial request" when the UE is establishing connectivity to a PDN for the first time, i.e. when it is an initial attach to that PDN. The UE shall set the request type to "handover" when the connectivity to a PDN is established upon handover from a non-3GPP access network and the UE was connected to that PDN before the handover to the 3GPP access network.

...

[TS 24.301, clause 8.3.18.3]

This IE is included in the message when the UE wishes to request network connectivity as defined by a certain access point name. This IE shall not be included when the PDN CONNECTIVITY REQUEST message is included in an ATTACH REQUEST message.

[TS 36.331, clause 5.3.3.3 “Actions related to transmission of *RRConnectionRequest* message”]

The UE shall set the contents of *RRConnectionRequest* message as follows:

- 1> set the *ue-Identity* as follows:
 - 2> if upper layers provide an S-TMSI:
 - 3> set the *ue-Identity* to the value received from upper layers;
 - 2> else
 - 3> draw a random value and set the *ue-Identity* to this value;

NOTE 1 Upper layers provide the S-TMSI if the UE is registered in the TA of the current cell.

- 1> Set the *establishmentCause* in accordance with the information received from upper layers;

[TS 24.301/36.331 clause 5.3.3.4]

...

The UE shall:

...

- 1> set the content of *RRConnectionSetupComplete* message as follows:
 - 2> set the *selectedPLMN-Identity* to the PLMN selected by upper layers (see TS 23.122 [11], TS 24.301 [35]) from the PLMN(s) included in the *plmn-IdentityList* in *SystemInformationBlockType1*;
 - 2> if upper layers provide the ‘Registered MME’, include and set the *registeredMME* as follows:
 - 3> if the PLMN identity of the ‘Registered MME’ is different from the PLMN selected by the upper layers:
 - 4> include the *plmnIdentity* in the *registeredMME* and set it to the value of the PLMN identity in the ‘Registered MME’ received from upper layers;
 - 3> set the *mmegi* and the *mmec* to the value received from upper layers;

...

- 2> submit the *RRConnectionSetupComplete* message to lower layers for transmission, upon which the procedure ends;

9.2.1.1.1.3 Test description

9.2.1.1.1.3.1 Pre-test conditions

System Simulator:

- Cell A
- Cell A is a cell with TAI-1 (PLMN-1 + TAC-1).
- The cell power levels are such that Cell A is guaranteed to become the serving cell

UE:

- The test USIM contains a valid GUTI-1 and TAI-2, and EPS update status is "EU1: UPDATED".

Preamble:

- The UE is in state Switched OFF (state 1) according to [18].

9.2.1.1.1.3.2 Test procedure sequence

Table 9.2.1.1.1.3.2-1: Main behaviour

St	Procedure	Message Sequence		TP	Verdict
		U - S	Message		
1	The UE is switched on.	-	-	-	-
2	Check: Does the UE transmit an <i>RRCCONNECTIONREQUEST</i> message not including S-TMSI?	-	-	1	P
3	The SS transmits a <i>RRCCONNECTIONSETUP</i> message.	-	-	-	-
4	Check: does the UE transmit an <i>RRCCONNECTIONSETUPCOMPLETE</i> message including MME group ID and MME code with ATTACH REQUEST message including a GUTI and a PDN CONNECTIVITY REQUEST message?	-->	ATTACH REQUEST	2	P
5	The SS transmits an AUTHENTICATION REQUEST message to initiate the EPS authentication and AKA procedure.	<--	AUTHENTICATION REQUEST	-	-
6	The UE transmits an AUTHENTICATION RESPONSE message and establishes mutual authentication.	-->	AUTHENTICATION RESPONSE	-	-
7	The SS transmits a NAS SECURITY MODE COMMAND message to activate NAS security.	<--	SECURITY MODE COMMAND	-	-
8	The UE transmits a NAS SECURITY MODE COMPLETE message and establishes the initial security configuration.	-->	SECURITY MODE COMPLETE	-	-
-	EXCEPTION: Steps 9a1 to 9a2 describe behaviour that depends on UE configuration.	-	-	-	-
9a1	IF the UE sets the ESM information transfer flag in the last PDN CONNECTIVITY REQUEST message THEN the SS transmits an ESM INFORMATION REQUEST message to initiate exchange of protocol configuration options and/or APN.	<--	ESM INFORMATION REQUEST	-	-
9a2	The UE transmits an ESM INFORMATION RESPONSE message to transfer protocol configuration options and/or APN.	-->	ESM INFORMATION RESPONSE	-	-
10	SS responds with ATTACH ACCEPT message including a valid TAI list. The ACTIVATE DEFAULT EPS BEARER CONTEXT REQUEST message is piggybacked in ATTACH ACCEPT message Note: The IP addresses of the UE are not allocated in this test so PDN address is not included in the message..	<--	ATTACH ACCEPT	-	-
11	Check: does the UE transmit an ATTACH COMPLETE message including an ACTIVATE DEFAULT EPS BEARER CONTEXT ACCEPT message?	-->	ATTACH COMPLETE	2	P
12	IPv4 and/or IPv6 address allocation (e.g. DHCP) may occur on the user plane.	-	-	-	-
13	After the IP address(es) have been allocated, the SS releases the RRC connection.	-	-	-	-
14	Check: Does the test result of CALL generic procedure [18] indicate that the UE is in E-UTRA EMM-REGISTERED state on Cell A?	-	-	3	-

9.2.1.1.3.3 Specific message contents

Table 9.2.1.1.1.3.3-1: Message *RRConnectionRequest* (step 2, Table 9.2.1.1.1.3.2-1)

Derivation path: 36.508 table 4.6.1-16			
Information Element	Value/Remark	Comment	Condition
RRConnectionRequest ::= SEQUENCE { criticalExtensions CHOICE { rrcConnectionRequest-r8 SEQUENCE { ue-Identity CHOICE { randomValue } establishmentCause } } }	Not checked mo-Signalling		

Table 9.2.1.1.1.3.3-2: Message *RRConnectionSetupComplete* (step 2, Table 9.2.1.1.1.3.2-2)

Derivation path: 36.508 table 4.6.1-18			
Information Element	Value/Remark	Comment	Condition
RRConnectionSetupComplete ::= SEQUENCE { criticalExtensions CHOICE { c1 CHOICE { rrcConnectionSetupComplete-r8 SEQUENCE { registeredMME { plmn-Identity mmeqi mmec } } } }	PLMN ID of PLMN 1 16 bits (bit 23 to bit 8) of GUTI-1 8 bits (bit 7 to bit 0) of GUTI-1	Bit 0 is LSB Bit 0 is LSB	

Table 9.2.1.1.1.3.3-3: Message ATTACH REQUEST (step 4, Table 9.2.1.1.1.3.2-1)

Derivation path: TS 36.508 table 4.7.2.-4			
Information Element	Value/Remark	Comment	Condition
Old GUTI or IMSI	GUTI-1	GUTI copied from USIM Old and valid GUTI is included by the UE	
ESM message container	PDN CONNECTIVITY REQUEST message as specified in table 9.2.1.1.1.3.3-3.		
Last visited registered TAI	TAI-2	GUTI copied from USIM If available, the last TAI is included by UE and will be used to establish a good list of TAIs in subsequent ATTACH ACCEPT message.	

Table 9.2.1.1.1.3.3-4: Message PDN CONNECTIVITY REQUEST (step 4, Table 9.2.1.1.1.3.2-1)

Derivation path: TS 36.508 table 4.7.3.-20			
Information Element	Value/Remark	Comment	Condition
Protocol discriminator	ESM		
EPS bearer identity	0000	0 is used when the value is not yet assigned by the network.	
Procedure transaction identity	PTI-1	UE assigns a particular PTI between 1 and 254	
PDN type	Not checked.	The UE may request a PDN for IPv4 only or IPv6 only even if it supports dual stack.	
ESM information transfer flag	Any allowed value	Present if the UE has protocol configuration options that need to be transferred security protected or wishes to provide an access point name for the PDN connection to be established during the attach procedure	
Access point name	Not present	The UE shall not include any APN for the first time.	
Protocol configuration options	Not checked		

Table 9.2.1.1.1.3.3-5: Message ATTACH ACCEPT (step 10, Table 9.2.1.1.1.3.2-1)

Derivation path: TS 36.508 table 4.7.3-1			
Information Element	Value/Remark	Comment	Condition
ESM message container	Contains the ACTIVATE DEFAULT EPS BEARER CONTEXT REQUEST message specified in table 9.2.1.1.1.3.3-6.		

Table 9.2.1.1.1.3.3-6: Message ACTIVATE DEFAULT EPS BEARER CONTEXT REQUEST (step 10, Table 9.2.1.1.1.3.2-1)

Derivation path: TS 36.508 table 4.7.3-6			
Information Element	Value/Remark	Comment	Condition
EPS bearer identity	Default EBId	SS assigns a Default EPS bearer ID between 5 and 15.	
Procedure transaction identity	PTI-1	Same value as in in PDN CONNECTIVITY REQUEST	
EPS QoS	According to reference default EPS bearer context #1 - see [18]	SS defines a Default EPS QoS	
Access point name	Arbitrary name	SS defines a Default APN or, if the step 7 exception occurred, uses the value sent in step 7a2	
PDN address			
Length of PDN address contents	7 octets		pc_IPv4
PDN type value	'001'b	IPv4	pc_IPv4
PDN address information	0.0.0.0	DHCPv4 is to be used to allocate the IPv4 address,	pc_IPv4
Length of PDN address contents	11 octets		pc_IPv6
PDN type value	'010'b	IPv6	pc_IPv6
PDN address information	IPv6 interface identifier		pc_IPv6
Length of PDN address contents	15 octets		pc_IPv4v6
PDN type value	'011'b	IPv4v6	pc_IPv4v6
PDN address information	IPv6 interface identifier 0.0.0.0	- DHCPv4 is to be used to allocate the IPv4 address,	pc_IPv4v6
Negotiated QoS	Not present	If the UE supports A/Gb mode or lu mode or both, the network may include the corresponding pre Rel-8 QoS parameter values of a PDP context.	
Negotiated LLC SAPI	Not present	If the UE supports A/Gb mode, the network may include this IE	
Radio priority	Not present	If the UE supports A/Gb mode, the network may include this IE.	
Packet flow Identifier	Not present	If the UE supports A/Gb mode, the network may include this IE. If the UE indicated in the UE Network Capability it does not support BSS packet flow procedures, then	

		the MME shall not include this IE.	
ESM cause	Not present		
Protocol configuration options	Not present		

Table 9.2.1.1.1.3.3-7: Message ACTIVATE DEFAULT EPS BEARER CONTEXT ACCEPT (step 11, Table 9.2.1.1.1.3.2-1)

Derivation path: TS 36.508 table 4.7.3-4			
Information Element	Value/Remark	Comment	Condition
EPS bearer identity	Default EBId	Same value as in ACTIVATE DEFAULT EPS BEARER CONTEXT REQUEST	
Procedure transaction identity	PTI-1	Same value as in PDN CONNECTIVITY REQUEST	

9.2.1.1.1a Attach Procedure / Success (last visited TAI, TAI list and equivalent PLMN list handling)

9.2.1.1.1a.1 Test Purpose (TP)

(1)

```
with { UE attached to the network with a valid USIM inserted and a valid GUTI }
ensure that {
  when { UE is powered off and then powered on }
  then { the UE transmits an ATTACH REQUEST message with the EPS attach type set to "initial EPS attach", including GUTI and last visited registered TAI and a PDN CONNECTIVITY REQUEST message with the request type set to "initial attach" and not including APN }
}
```

(2)

```
with { UE having a valid NAS security context and the UE switched-off }
ensure that {
  when { UE is powered on }
  then { the UE transmits an integrity protected ATTACH REQUEST message combined with the PDN CONNECTIVITY REQUEST message }
}
```

(3)

```
with { UE has sent an ATTACH REQUEST message }
ensure that {
  when { UE receives an ATTACH ACCEPT message with EPS attach result matching the requested service(s), the TAI list the UE is registered to, a set of equivalent PLMNs matching the PLMNs within the TAI list, and including an ACTIVATE DEFAULT EPS CONTEXT BEARER message with IE EPS Bearer Identity for the default EPS bearer context activated for the UE }
  then { UE deletes the old TAI list, stores the new TAI list, and does not perform a TAU while moving within this set of TAs }
}
```

(4)

```
with { UE has sent an ATTACH REQUEST message }
ensure that {
  when { UE receives an ATTACH ACCEPT message with EPS attach result matching the requested service(s), the TAI list the UE is registered to, a set of equivalent PLMNs matching the PLMNs within the TAI list, and including an ACTIVATE DEFAULT EPS CONTEXT BEARER message with IE EPS Bearer Identity for the default EPS bearer context activated for the UE }
  then { UE deletes the old TAI list, stores the new TAI list, and performs a TAU when moving out of this set of TAs }
}
```

(5)

```

with { UE has received a set of equivalent PLMNs in an ATTACH ACCEPT message }
ensure that {
  when { the UE has been switched off; then switched on; and then the UE receives an ATTACH_ACCEPT
message with a new set of equivalent PLMNs}
  then { UE deletes the old equivalent PLMN list, and uses the new equivalent PLMN list}
}

```

Editor's note: the intention is to check the RRC connection setup's RRC parameters in the intersystem tests, e.g. 9.2.3.3.4.

9.2.1.1.1a.2 Conformance requirements

References: The conformance requirements covered in the current TC are specified in: TS 24.301, clauses 5.3.3, 5.5.1.2.2, 5.5.1.2.4, 6.5.1.2 and 9.9.3.33, and TS 36.304 clause 4.3.

[TS 24.301, clause 5.3.3]

The UE shall store a list of equivalent PLMNs. These PLMNs shall be regarded by the UE as equivalent to each other for PLMN selection and cell selection/re-selection. The same list is used by EMM, GMM and MM.

The UE shall update or delete this list at the end of each attach or tracking area updating procedure. The stored list consists of a list of equivalent PLMNs as downloaded by the network plus the PLMN code of the registered PLMN that downloaded the list. When the UE is switched off, it shall keep the stored list so that it can be used for PLMN selection after switch on. The UE shall delete the stored list if the USIM is removed. The maximum number of possible entries in the stored list is 16.

[TS 24.301, clause 5.5.1.2.2]

In state EMM-DEREGISTERED, the UE initiates the attach procedure by sending an ATTACH REQUEST message to the MME, starting timer T3410 and entering state EMM-REGISTERED-INITIATED (see figure 5.5.1.2.2.1).

...

The UE shall include in the ATTACH REQUEST message a valid GUTI together with the last visited registered TAI, if available. If there is no valid GUTI available, the UE shall include the IMSI in the ATTACH REQUEST message.

The UE shall send the ATTACH REQUEST message together with a PDN CONNECTIVITY REQUEST message to request PDN connectivity to the default PDN (see subclause 6.5.1).

...

If a valid NAS security context exists, the UE shall integrity protect the ATTACH REQUEST message combined with the PDN CONNECTIVITY REQUEST message.

...[TS 24.301, clause 5.5.1.2.4]

...

The MME shall assign and include the TAI list the UE is registered to in the ATTACH ACCEPT message. The UE, upon receiving an ATTACH ACCEPT message, shall delete its old TAI list and store the received TAI list.

...

If the ATTACH ACCEPT message contains a GUTI, the UE shall use this GUTI as the new temporary identity and set its TIN to "GUTI". The UE shall delete its old GUTI and store the new assigned GUTI. If no GUTI has been included by the MME in the ATTACH ACCEPT message, the old GUTI, if any available, shall be kept.

...

The MME may also include a list of equivalent PLMNs in the ATTACH ACCEPT message. Each entry in the list contains a PLMN code (MCC+MNC). The UE shall store the list as provided by the network, after having removed from the list any PLMN code that is already in the list of forbidden PLMNs. In addition, the UE shall add to the stored list the PLMN code of the registered PLMN that sent the list. The UE shall replace the stored list on each receipt of the

ATTACH ACCEPT message. If the ATTACH ACCEPT message does not contain a list, then the UE shall delete the stored list.

...

[TS 24.301, clause 5.5.3.2.2, "Normal and periodic tracking area updating procedure initiation"]

The UE in state EMM-REGISTERED shall initiate the tracking area updating procedure by sending a TRACKING AREA UPDATE REQUEST message to the MME,

- a) when the UE detects entering a tracking area that is not in the list of tracking areas that the UE previously registered in the MME;

...

[TS 24.301, clause 6.5.1.2, "UE requested PDN connectivity procedure initiation"]

In order to request connectivity to the default PDN, the UE shall not include any APN in the PDN CONNECTIVITY REQUEST message.

...

[TS 24.301, clause 9.9.3.33, "Tracking area identity list"]

...

The Tracking area identity list is a type 4 information element, with a minimum length of 8 octets and a maximum length of 98 octets. The list can contain a maximum of 16 different tracking area identities.

...

The value part of the Tracking area identity list information element consists of one or several partial tracking area identity lists. The length of each partial tracking area identity list can be determined from the 'type of list' field and the 'number of elements' field in the first octet of the partial tracking area identity list.

...

Partial tracking area identity list: Type of list (octet 1) Bits 7 6 0 0 list of TACs belonging to one PLMN, with non-consecutive TAC values 0 1 list of TACs belonging to one PLMN, with consecutive TAC values 1 0 list of TAIs belonging to different PLMNs
--

...

For type of list = "001" and number of elements = k: octet 2 to 4 contain the MCC+MNC, and octet 5 and 6 contain the TAC of the first TAI belonging to the partial list. The TAC values of the other k-1 TAIs are TAC+1, TAC+2, ..., TAC+k-1.
--

...

The MNC shall consist of 2 or 3 digits.

...

[TS 36.304, clause 4.3]

...

suitable cell:

A "suitable cell" is a cell on which the UE may camp on to obtain normal service. Such a cell shall fulfil all the following requirements.

- The cell is part of either:

- the selected PLMN, or:
- the registered PLMN, or:
- a PLMN of the Equivalent PLMN list

according to the latest information provided by NAS:

...

9.2.1.1.1a.3 Test description

9.2.1.1.1a.3.1 Pre-test conditions

System Simulator:

NOTE: while this test describes the uses of 8 cells, it is intended that this test only requires 2 cells to be active at any one instant.

Table 9.2.1.1a-1: Cell TAI values

Cell	MCC	MNC	TAC (hex)	Remark
101	001	01	0000	2 digit MNC
102	310	102	0000	3 digit MNC
103	001	01	0001	
104	001	01	0027	
105	004	07	fff0	
106	004	07	fff9	
107	316	002	0003	3 digit MNC
108	004	02	0003	

- these cells are not labelled A to G because their parameters are different to those defined in table 6.3.2.2-1 of TS 36.508 [18].
- With the exception of the Physical Cell Identity, all other parameters for these cells are the same as defined for cell 1 in TS 36.508 [18]
- The power level of Cell 101 is the Serving Cell level defined in table 6.2.2.1-1 of TS 36.508 [18].
- The power levels of Cells 102 to 108 are set to the Non-suitable "Off" level defined in table 6.2.2.1-1 of TS 36.508 [18].

UE:

- The test USIM contains a valid GUTI1 and TAI1, and EPS update status is "EU1: UPDATED".

Preamble:

- The UE is in state Switched OFF (state 1) according to TS 36.508, [18].

9.2.1.1.1a.3.2 Test procedure sequence

Table 9.2.1.1.1a.3.2-1: Main behaviour

St	Procedure	Message Sequence		TP	Verdict
		U – S	Message		
1	The UE is switched on.	-	-	-	-
2	The UE transmits an ATTACH REQUEST message on cell 1 including a PDN CONNECTIVITY REQUEST message	-->	ATTACH REQUEST		
3	The SS transmits an AUTHENTICATION REQUEST message to initiate the EPS authentication and AKA procedure.	<--	AUTHENTICATION REQUEST	-	-
4	The UE transmits an AUTHENTICATION RESPONSE message and establishes mutual authentication.	-->	AUTHENTICATION RESPONSE	-	-
5	The SS transmits a NAS SECURITY MODE COMMAND message to activate NAS security.	<--	SECURITY MODE COMMAND	-	-
6	The UE transmits a NAS SECURITY MODE COMPLETE message and establishes the initial security configuration.	-->	SECURITY MODE COMPLETE	-	-
-	EXCEPTION: Steps 7a1 to 7a2 are executed if the ESM information transfer flag was included by the UE in the PDN CONNECTIVITY MESSAGE sent in step 2.	-	-	-	-
7a1	the SS sends the ESM INFORMATION REQUEST message	<--	ESM INFORMATION REQUEST	-	-
7a2	The UE transmits the ESM INFORMATION REQUEST message	-->	ESM INFORMATION RESPONSE	-	-
8	SS responds with ATTACH ACCEPT message including a valid TAI list containing the TAIs of Cell 1 and Cell 2; with PLMN ID of Cell 1 included in the GUTI; and with the PLMN ID of Cell 2 included in the Equivalent PLMNs IE. The ACTIVATE DEFAULT EPS BEARER CONTEXT REQUEST message is piggybacked in ATTACH ACCEPT message	<--	ATTACH ACCEPT	-	-
9	The UE transmits an ATTACH COMPLETE message including an ACTIVATE DEFAULT EPS BEARER CONTEXT ACCEPT message.	-->	ATTACH COMPLETE	-	-
10	IPv4 and/or IPv6 address allocation (e.g. DHCP) may occur on the user plane.	<->	Optional IP address allocation	-	-
11	The SS releases the RRC connection.	-	-	-	-
12	The signal strength of Cell 2 is raised to that of the Serving Cell and that of Cell 1 is lowered to that of a Suitable Neighbour Cell as defined in table 6.2.2.1-1 of TS 36.508 [18]. Note: Cell 1 is still suitable but the UE shall select Cell 2				
13	Wait [10] seconds for mobile to camp on cell 2				
14	The UE is switched off				
15	Check: does the UE send DETACH on cell 2?	-->	DETACH REQUEST	3	P
16	Cells 1 and 2 are set to the Non-suitable "Off" level and cell 3 is set to the Serving Cell level.				
17	The UE is switched on				
18	Check: does the UE send an ATTACH REQUEST message on cell 3 (including a PDN CONNECTIVITY REQUEST message) with the last visited TAI correctly indicating the TAI of cell 2; the GUTI allocated in step 8 and the KSI _{ASME} allocated in step 3?	-->	ATTACH REQUEST	1, 2	P
-	EXCEPTION: Steps 18a1 to 18a2 are executed if the ESM information transfer flag was included by the UE in the PDN CONNECTIVITY MESSAGE sent in step 17.	-	-	-	-
18a	the SS sends the ESM INFORMATION	<--	ESM INFORMATION REQUEST	-	-

1	REQUEST message				
18a 2	The UE transmits the ESM INFORMATION REQUEST message	-->	ESM INFORMATION RESPONSE	-	-
19	The SS sends an ATTACH ACCEPT message allocating 16 TAIs and an aligned set of equivalent PLMNs	<--	ATTACH ACCEPT		
20	The UE sends ATTACH COMPLETE	-->	ATTACH COMPLETE		
21	IPv4 and/or IPv6 address allocation (e.g. DHCP) may occur on the user plane	<->	Optional IP address allocation		
22	After the IP address(es) have been allocated, the SS releases the RRC connection.	-	-	-	-
23	The SS waits [5] seconds	-	-	-	-
-	EXCEPTION steps 24 to 26 are repeated for N = 3 to N = 7				
24	Cell N-1 is set to the Non-suitable "Off" level. The signal strength of Cell N+1 is raised to that of the Serving Cell and the strength of Cell N is lowered to that of a Suitable Neighbour Cell such that the UE shall select Cell N+1				
25	Check: does the UE transmit a TRACKING AREA UPDATE REQUEST message in the next 15 seconds?	-->	TRACKING AREA UPDATE REQUEST	3	F
26	Using the procedure of clause 6.4.2.2 of TS 36.508 [18], Check: does the UE camp on cell N+1?			3	P
27	Cell 7 is set to the Non-suitable "Off" level. The signal strength of Cell 8 is lowered to that of a Suitable Neighbour Cell and that of Cell 2 is raised to the Serving Cell level. Note: the new list of equivalent PLMNs allocated in step 19 means that list of equivalent PLMNs allocated in step 8 should have been deleted. Hence the PLMN of cell 2 shall not be selected by a cell reselection process, and the UE shall remain camped on cell 8.				
28	Check: Does the UE transmit a TRACKING AREA UPDATE REQUEST message on cell 2 in the next 15 seconds?	-->	TRACKING AREA UPDATE REQUEST	5	F
29	Using the procedure of clause 6.4.2.2 of TS 36.508 [18], page the UE on cells 8 and 2. Check: Does the UE camp on cell 8 and not on cell 2?			5	P
30	Cell 2 is set to the Non-suitable "Off" level. The signal strength of Cell 1 is raised to the Serving Cell level such that that the UE shall select Cell 1.				
31	Check: Does the UE transmit a TRACKING AREA UPDATE REQUEST message on cell 1 with the last visited TAI set to the TAI of cell 8; the GUTI allocated in step 8 and the KSI _{ASME} allocated in step 3?	-->	TRACKING AREA UPDATE REQUEST	4	P

Editors Note: Open issues in the test procedure sequence:

Step 7a2: [36.508 table 4.7.3-14 does not permit the APN to be included. Is 36.508 correct ?]

Step 10 and step 21: Optional IP address allocation: in the ATTACH REQUEST, the mobile can request either an IPv4, or an IPv6, or a “dual stack” IPv4v6, default bearer. For IPv4, the SS can allocate the IP address in the NAS signalling. However for IPv6 (and potentially for the case of a data device in a laptop using DHCP) the SS cannot allocate the IP address in the NAS signalling. In these latter cases, the mobile will need to send/receive user plane packets in order to obtain its IP address(es). If the RRC connection is released before the mobile has obtained its IP address(es) then the behaviour of the mobile is uncertain – probably it should send a Service Request message to re-establish the user plane, but, it might re-attempt the Attach procedure. The overall intention of step 10 (and step 21) is to just ensure that the test procedure runs smoothly, not to test the IP address allocation mechanisms.

Step 18: Check: does the UE correctly integrity protect this message?

9.2.1.1.1a.3.3 Specific message contents

Table 9.2.1.1.1a.3.3-1: Message ATTACH ACCEPT (step 8, Table 9.2.1.1.1a.3.2-1)

Derivation path: 36.508 table 4.7.2-1			
Information Element	Value/Remark	Comment	Condition
TAI list		List of 2 TAIs	
Length of tracking area identity list contents	11	The value in the length field	
Number of elements	2		
Type of list	010	More than one PLMN	
Partial tracking area identity list	First TAI = TAI of Cell 2; Second TAI = TAI of Cell 1		
GUTI	MCC=001, MNC=01, MMEGI = 1, MMEC= 1, M-TMSI arbitrarily allocated but compliant to rules of TS 23.003 sub clause 2.8	Includes PLMN ID of cell 1	
Equivalent PLMNs	MCC=310, MNC=102	PLMN ID of cell 2	

Table 9.2.1.1.1a.3.3-2: Message ATTACH REQUEST (step 18, Table 9.2.1.1.1a.3.2-1)

Derivation path: 36.508 table 4.7.2-4			
Information Element	Value/Remark	Comment	Condition
Sent in SECURITY PROTECTED NAS MESSAGE with valid integrity check			P
Old GUTI or IMSI	GUTI allocated in step 8		P
NAS key set identifier	KSI allocated in step 3		P
Last visited registered TAI	TAI of cell 2		P

Table 9.2.1.1a.3.3-3: Message ATTACH ACCEPT (step 19, Table 9.2.1.1a.3.2-1)

Derivation path: 36.508 table 4.7.2-1			
Information Element	Value/Remark	Comment	Condition
TAI list		Contains 3 separate partial tracking area ID lists	
Length of tracking area identity list contents	32	The decimal value of the value in the length field	
Type of first partial tracking area identity list	010	More than one PLMN	
Number of elements	00010	3 elements	
First TAI	MCC = 004, MNC = 02, TAC = 0003		
Second TAI	MCC = 005, MNC = 002, TAC = 0003		
Third TAI	MCC = 004, MNC = 03, TAC = 0003		
Type of second partial tracking area identity list	001	Consecutive TACs on same PLMN	
Number of consecutive TACS	01001	10 elements	
TAI	MCC = 004 MNC = 07 TAC = fff0	TAI with lowest numbered TAC	
Type of third partial tracking area identity list	000	Individual TACs on same PLMN	
Number of elements	00010	3	
MCC	MCC = 001		
MNC	MNC = 01		
First TAC	TAC = 0001		
Second TAC	TAC = 0002		
Third TAC	TAC = 0027		
GUTI	MCC=001, MNC = 01, MMEGI = 64000, MMEC= 127, M-TMSI arbitrarily allocated but compliant to rules of TS 23.003 sub clause 2.8	Includes PLMN ID of cell 3.	
Equivalent PLMNs	MCC=004, MNC=02; MCC=004, MNC=03; MCC=004, MNC=07; MCC=316, MNC=002;	4 equivalent PLMNs	

Table 9.2.1.1a.3.3-4: Message TRACKING AREA UPDATE REQUEST (step 37, Table 9.2.1.1a.3.2-1)

Derivation path: 36.508 table 4.7.2-27			
Information Element	Value/Remark	Comment	Condition
Old GUTI	GUTI allocated in step 19		P
NAS key set identifier <small>ASME</small>	Same as allocated in step 3		P
Last visited registered TAI	TAI of cell 8		P

9.2.1.1.2 Attach Procedure / Success / With IMSI, GUTI reallocation

9.2.1.1.2.1 Test Purpose (TP)

(1)

with { UE in EMM-DEREGISTERED state }

```

ensure that {
  when { there is no valid GUTI available in UE }
  then { UE sends ATTACH REQUEST message, containing IMSI as the EPS mobile identity }
}

```

(2)

```

with { UE having received reallocated GUTI in the ATTACH ACCEPT message }
ensure that {
  when { UE detaches from the EPS services }
  then { UE sends DETACH REQUEST message, containing GUTI as the EPS mobile identity }
}

```

9.2.1.1.2.2 Conformance requirements

References: The conformance requirements covered in the current TC are specified in: TS 24.301, clause 5.5.1.2.

[TS 24.301, clause 5.5.1.2.2]

In state EMM-DEREGISTERED, the UE initiates the attach procedure by sending an ATTACH REQUEST message to the MME, starting timer T3410 and entering state EMM-REGISTERED-INITIATED (see figure 5.5.1.2.2.1). If timer T3402 is currently running, the UE shall stop timer T3402. If timer T3411 is currently running, the UE shall stop timer T3411. The UE shall include in the ATTACH REQUEST message a valid GUTI together with the last visited registered TAI, if available. If there is no valid GUTI available, the UE shall include the IMSI in the ATTACH REQUEST message.

[TS 24.301, clause 5.5.1.2.4]

If the attach request is accepted by the network, the MME shall send an ATTACH ACCEPT message to the UE and start timer T3450. The MME shall send the ATTACH ACCEPT message together with the ACTIVATE DEFAULT EPS BEARER CONTEXT REQUEST message to activate the default bearer (see subclause 6.4.1). The network may also initiate the activation of dedicated bearers towards the UE by invoking the dedicated EPS bearer context activation procedure (see subclause 6.4.2).

The MME shall assign and include the TAI list the UE is registered to in the ATTACH ACCEPT message. The UE, receiving an ATTACH ACCEPT message, shall delete its old TAI list and store the received TAI list.

Upon receiving the ATTACH ACCEPT message, the UE shall stop timer T3410, reset the attach attempt counter and tracking area updating attempt counter, enter state EMM-REGISTERED and set the EPS update status to EU1 UPDATED.

The GUTI reallocation may be part of the attach procedure. When the ATTACH REQUEST message includes the IMSI, the MME considers the GUTI provided by the UE is invalid, or the GUTI provided by the UE was assigned by another MME, the MME shall allocate a new GUTI to the UE. The MME shall include in the ATTACH ACCEPT message the new assigned GUTI together with the assigned TAI list. In this case the MME shall enter state EMM-COMMON-PROCEDURE-INITIATED as described in subclause 5.4.1.

For a shared network, the TAIs included in the TAI list can contain different PLMN identities.

If the ATTACH ACCEPT message contains a GUTI, the UE shall use this GUTI as the new temporary identity and set its TIN to "GUTI". The UE shall delete its old GUTI and store the new assigned GUTI. If no GUTI has been included by the MME in the ATTACH ACCEPT message, the old GUTI, if any available, shall be kept.

9.2.1.1.2.3 Test description

9.2.1.1.2.3.1 Pre-test conditions

System Simulator:

- Cell 1

UE:

None.

Preamble:

- The UE is in state Registered, Idle Mode (State 2) according to [18].

9.2.1.1.2.3.2 Test procedure sequence

Table 9.2.1.1.2.3.2-1: Main behaviour

St	Procedure	Message Sequence		TP	Verdict
		U - S	Message		
1	The SS transmits Paging on cell 1 with IMSI. Upon reception of paging with IMSI the UE shall locally deactivate any EPS bearer context(s), locally detach from EPS and delete the GUTI-1. After local detach the UE shall perform an EPS attach procedure.	-	-	-	-
2	Check: Does the UE transmit an ATTACH REQUEST message including IMSI in the EPS mobile identity IE?	-->	ATTACH REQUEST	1	P
3	The SS transmits an AUTHENTICATION REQUEST message to initiate the EPS authentication and AKA procedure.	<--	AUTHENTICATION REQUEST	-	-
4	The UE transmits an AUTHENTICATION RESPONSE message and establishes mutual authentication.	-->	AUTHENTICATION RESPONSE	-	-
5	The SS transmits a NAS SECURITY MODE COMMAND message to activate NAS security.	<--	SECURITY MODE COMMAND	-	-
6	The UE transmits a NAS SECURITY MODE COMPLETE message and establishes the initial security configuration.	-->	SECURITY MODE COMPLETE	-	-
7	SS responds with ATTACH ACCEPT message with a new GUTI-2 included in the EPS mobile identity IE	<--	ATTACH ACCEPT	-	-
8	The UE transmits an ATTACH COMPLETE message	-->	ATTACH COMPLETE	-	-
9	Cause UE to detach from the EPS services	-	-	-	-
10	Check: Does the UE transmit a DETACH REQUEST message including GUTI-2 in the EPS mobile identity IE?	-->	DETACH REQUEST	2	P
11	SS responds with DETACH ACCEPT message	<--	DETACH ACCEPT	-	-

9.2.1.1.2.3.3 Specific message contents

FFS

9.2.1.1.5 Attach procedure / Success / ATTACH ACCEPT message includes the PDN address assigned to the UE

9.2.1.1.5.1 Test Purpose (TP)

(1)

```

with { UE has sent an ATTACH REQUEST message together with a PDN CONNECTIVITY REQUEST message }
ensure that {
  when { UE receives an ATTACH ACCEPT message with EPS attach result matching the requested
service(s) and including an ACTIVATE DEFAULT EPS BEARER CONTEXT REQUEST message with IE EPS Bearer
Identity matching the ATTACH REQUEST message and including a PDN address and an APN }
  then { UE transmits an ATTACH COMPLETE message together with ACTIVATE DEFAULT EPS BEARER CONTEXT
ACCEPT and enters EMM-REGISTERED state }
}

```

(2)

```

with { UE is in EMM-REGISTERED state and a PDN address for an active default EPS bearer was received
in an ACTIVATE DEFAULT EPS BEARER CONTEXT REQUEST message }
ensure that {
  when { UE receives an ACTIVATE DEDICATED EPS BEARER CONTEXT REQUEST message linked to the existing
default EPS bearer }
  then { UE transmits an ACTIVATE DEDICATED EPS BEARER CONTEXT ACCEPT messages }
}

```

9.2.1.1.5.2 Conformance requirements

References: The conformance requirements covered in the present TC are specified in: TS 24.301, clauses 5.5.1.1, 5.5.1.2.1, 5.5.1.2.2, 5.5.1.2.4, 6.2.2, 6.4.1.3 and 6.5.1.2.

[TS 24.301, clause 5.5.1.1]

The attach procedure is used to attach to an EPC for packet services in EPS.

The attach procedure is used for two purposes:

- by a UE in PS mode of operation to attach for EPS services only; or
- by a UE in CS/PS mode 1 or CS/PS mode 2 of operation to attach for both EPS and non-EPS services.

With a successful attach procedure, a context is established for the UE in the MME, and a default bearer is established between the UE and the PDN GW, thus enabling always-on IP connectivity to the UE. The network may also initiate the activation of dedicated bearers as part of the attach procedure.

...

[TS 24.301, clause 5.5.1.2.1]

This procedure is used by a UE to attach for EPS services only. When the UE initiates the EPS attach procedure, the UE shall indicate "EPS attach" in the EPS attach type IE.

[TS 24.301, clause 5.5.1.2.2]

In state EMM-DEREGISTERED, the UE initiates the attach procedure by sending an ATTACH REQUEST message to the MME, starting timer T3410 and entering state EMM-REGISTERED-INITIATED (see example in figure 5.5.1.2.2.1).

...

If the UE supports neither A/Gb mode nor Iu mode, the UE shall handle the Old GUTI or IMSI IE in the ATTACH REQUEST message as follows:

- The UE shall include in the ATTACH REQUEST message a valid GUTI together with the last visited registered TAI, if available. If there is no valid GUTI available, the UE shall include the IMSI in the ATTACH REQUEST message.

...

The UE shall send the ATTACH REQUEST message together with a PDN CONNECTIVITY REQUEST message contained in the ESM message container information element to request PDN connectivity.

If UE supports A/Gb mode or Iu mode or if the UE wants to indicate its UE specific DRX parameter to the network, the UE shall include the UE specific DRX parameter in the DRX parameter IE in the ATTACH REQUEST message.

If a valid NAS security context exists, the UE shall integrity protect the ATTACH REQUEST message combined with the PDN CONNECTIVITY REQUEST message. When the UE does not have a valid NAS security context, the ATTACH REQUEST message combined with the PDN CONNECTIVITY REQUEST message is not integrity protected.

[TS 24.301, clause 5.5.1.2.4]

...

If the ATTACH ACCEPT message contains a GUTI, the UE shall use this GUTI as the new temporary identity. The UE shall delete its old GUTI and store the new assigned GUTI. If no GUTI has been included by the MME in the ATTACH ACCEPT message, the old GUTI, if any available, shall be kept.

...

When the UE receives the ATTACH ACCEPT message combined with the ACTIVATE DEFAULT EPS BEARER CONTEXT REQUEST message, it shall forward the ACTIVATE DEFAULT EPS BEARER CONTEXT REQUEST message to the ESM sublayer. Upon receipt of an indication from the ESM sublayer that the default EPS bearer context

has been activated, the UE shall send an ATTACH COMPLETE message together with an ACTIVATE DEFAULT EPS BEARER CONTEXT ACCEPT message contained in the ESM message container information element to the network.

...

[TS 24.301, clause 6.2.2]

The UE shall set the PDN type IE in the PDN CONNECTIVITY REQUEST message based on its IP stack configuration as follows:

- a) A UE, which is IPv6 and IPv4 capable and
 - has not been allocated an IP address for this APN, shall set the PDN type IE to IPv4v6.
 - has been allocated an IPv4 address for this APN and received the SM cause #52, "single address bearers only allowed", and is requesting an IPv6 address, shall set the PDN type IE to IPv6.
 - has been allocated an IPv6 address for this APN and received the SM cause #52, "single address bearers only allowed", and is requesting an IPv4 address, shall set the PDN type IE to IPv4.
- b) A UE, which is only IPv4 capable, shall set the PDN type IE to IPv4.
- c) A UE, which is only IPv6 capable, shall set the PDN type IE to IPv6.
- d) When the IP version capability of the UE is unknown in the UE (as in the case when the MT and TE are separated and the capability of the TE is not known in the MT), the UE shall set the PDN type IE to IPv4v6.

If the UE wants to use DHCPv4 for IPv4 address assignment, it shall indicate that to the network within the Protocol Configuration Options IE in the PDN CONNECTIVITY REQUEST.

...

[TS 24.301, clause 6.4.1.3]

Upon receipt of the ACTIVATE DEFAULT EPS BEARER CONTEXT REQUEST message, the UE shall send an ACTIVATE DEFAULT EPS BEARER CONTEXT ACCEPT message and enter the state BEARER CONTEXT ACTIVE. When the default bearer is activated as part of the attach procedure, the UE shall send the ACTIVATE DEFAULT EPS BEARER CONTEXT ACCEPT message together with ATTACH COMPLETE message.

...

The UE checks the PTI in the ACTIVATE DEFAULT EPS BEARER CONTEXT REQUEST message to identify the UE requested PDN connectivity procedure to which the default bearer context activation is related (see subclause 6.5.1).

...

[TS 24.301, clause 6.4.2.3]

Upon receipt of the ACTIVATE DEDICATED EPS BEARER CONTEXT REQUEST message, the UE shall first check the received TFT before taking it into use. Then the UE shall send an ACTIVATE DEDICATED EPS BEARER CONTEXT ACCEPT message and enter the state BEARER CONTEXT ACTIVE. The ACTIVATE DEDICATED EPS BEARER CONTEXT ACCEPT message shall include the EPS bearer identity.

The linked EPS bearer identity included in the ACTIVATE DEDICATED EPS BEARER CONTEXT REQUEST message indicates to the UE to which default bearer, IP address and PDN the dedicated bearer is linked.

...

The UE shall use the received TFT to apply mapping of uplink traffic flows to the radio bearer if the TFT contains packet filters for the uplink direction.

...

[TS 24.301, clause 6.5.1.2]

When the PDN CONNECTIVITY REQUEST message is sent together with an ATTACH REQUEST message, the UE shall not include the APN.

NOTE: If the UE needs to provide PCO which require ciphering or provide an APN, or both, during the attach procedure, the ESM information transfer flag is included in the PDN CONNECTIVITY REQUEST. The MME then at a later stage in the PDN connectivity procedure initiates the ESM information request procedure in which the UE can provide the MME with PCO or APN or both.

In order to request connectivity to a PDN using the default APN, the UE includes the access point name IE in the PDN CONNECTIVITY REQUEST message or, when applicable, in the ESM INFORMATION RESPONSE message, according to the following conditions:

- if use of a PDN using the default APN requires PAP/CHAP, then the UE should include the access point name IE; and
- in all other conditions, the UE need not include the access point name IE.

...

The UE shall set the request type to "initial request " when the UE is establishing connectivity to a PDN for the first time, i.e. when it is an initial attach to that PDN. The UE shall set the request type to "handover" when the connectivity to a PDN is established upon handover from a non-3GPP access network and the UE was connected to that PDN before the handover to the 3GPP access network.

...

9.2.1.1.5.3 Test description

9.2.1.1.5.3.1 Pre-test conditions

System Simulator:

- Cell A

UE:

- The test USIM contains GUTI-1 and TAI-1, and EPS update status is "EU1: UPDATED".

Preamble:

- The UE is in state Switched OFF (state 1) according to [18].

NOTE: The PDN type (IPv4, IPv6 or both) of the UE is determined by the PICS.

9.2.1.1.5.3.2 Test procedure sequence

Table 9.2.1.1.5.3.2-1: Main behaviour

St	Procedure	Message Sequence		TP	Verdict
		U - S	Message		
1	The UE is switched on.	-	-	-	-
2	The UE transmit an ATTACH REQUEST message including a PDN CONNECTIVITY REQUEST message.	-->	ATTACH REQUEST	-	-
3	The SS transmits an AUTHENTICATION REQUEST message to initiate the EPS authentication and AKA procedure.	<--	AUTHENTICATION REQUEST	-	-
4	The UE transmits an AUTHENTICATION RESPONSE message and establishes mutual authentication.	-->	AUTHENTICATION RESPONSE	-	-
5	The SS transmits a SECURITY MODE COMMAND message to activate NAS security.	<--	SECURITY MODE COMMAND	-	-
6	The UE transmits a SECURITY MODE COMPLETE message and establishes the initial security configuration.	-->	SECURITY MODE COMPLETE	-	-
-	EXCEPTION: Steps 7a1 to 7a2 describe behaviour that depends on UE configuration.	-	-	-	-
7a1	IF the UE sets the ESM information transfer flag in the last PDN CONNECTIVITY REQUEST message THEN the SS transmits an ESM INFORMATION REQUEST message to initiate exchange of protocol configuration options and/or APN.	<--	ESM INFORMATION REQUEST	-	-
7a2	The UE transmits an ESM INFORMATION RESPONSE message to transfer protocol configuration options and/or APN.	-->	ESM INFORMATION RESPONSE	-	-
8	The SS transmits an ATTACH ACCEPT message including an ACTIVATE DEFAULT EPS BEARER CONTEXT REQUEST message. Note: in the DEFAULT EBC REQUEST message, the SS allocates a PDN address of a PDN type which is compliant with the PDN type requested by the UE.	<--	ATTACH ACCEPT	-	-
9	Check: Does the UE transmit an ATTACH COMPLETE message including ACTIVATE DEFAULT EPS BEARER CONTEXT ACCEPT message as specified?	-->	ATTACH COMPLETE	1	P
10	The SS transmits an ACTIVATE DEDICATED EPS BEARER CONTEXT REQUEST. Note: the same PDN address is applicable because the linked EPS bearer ID refers to the default EBC allocated in step 8.	<--	ACTIVATE DEDICATED EPS BEARER CONTEXT REQUEST	-	-
11	Check: Does the UE transmit an ACTIVATE DEDICATED EPS BEARER CONTEXT ACCEPT message as specified?	-->	ACTIVATE DEDICATED EPS BEARER CONTEXT ACCEPT	2	P
12	The SS releases the RRC connection.	-	-	-	-
13	Check: Does the test results of CALL generic procedure indicate that the UE is in E-UTRA EMM-REGISTERED state with S-TMSI2?	-	-	1	-

9.2.1.1.5.3.3 Specific message contents

Table 9.2.1.1.5.3.3-1: Message ACTIVATE DEFAULT EPS BEARER CONTEXT REQUEST (step 8, Table 9.2.1.1.5.3.2-1)

Derivation path: 36.508 table 4.7.3-6			
Information Element	Value/Remark	Comment	Condition
EPS bearer identity	Default EBId	SS assigns a Default EPS bearer ID between 5 and 15.	
PDN address PDN type	Same value like the "PDN type" in the PDN CONNECTIVITY REQUEST message in step 2 or 011 is it was unknown		
PDN address (octet 4 to 11) and IPv4 Address (octet 12 to 15) according to PDN type above	IPv4 Address (octet 4 to 7), IPv6 Address (octet 4 to 11) or IPv6 Address SS assigns private IPv6/IPv4 address(es)		

Table 9.2.1.1.5.3.3-2: Message ACTIVATE DEDICATED EPS BEARER CONTEXT REQUEST (step 10, Table 9.2.1.1.5.3.2-1)

Derivation path: 36.508 table 4.7.3-3			
Information Element	Value/Remark	Comment	Condition
EPS bearer identity	EBId-1	SS assigns an EPS bearer ID between 5 and 15 different from Default EBId.	
Procedure transaction identity	0	No procedure transaction identity assigned	
Linked EPS bearer identity	Default EBId (same value like in table 9.2.1.1.5.3.3-1)		
EPS QoS	According to reference dedicated EPS bearer context #1 - see [18]	SS defines a Default dedicated EPS QoS	
TFT	According to reference dedicated EPS bearer context #1 - see [18]		

Table 9.2.1.1.5.3.3-3: Message ACTIVATE DEDICATED EPS BEARER CONTEXT ACCEPT (step 11, Table 9.2.1.1.5.3.2-1)

Derivation path: 36.508 table 4.7.3-1			
Information Element	Value/Remark	Comment	Condition
EPS bearer identity	EBId-1	Same value as in ACTIVATE DEDICATED EPS BEARER CONTEXT REQUEST	
Procedure transaction identity	0	No procedure transaction identity assigned	

9.2.1.1.7 Attach Procedure / Success / list of equivalent PLMNs in the ATTACH ACCEPT message

9.2.1.1.7.1 Test Purpose (TP)

(1)

```
with { UE in EMM-REGISTERED-INITIATED state }
ensure that {
  when { the UE receives ATTACH ACCEPT message including a list of equivalent PLMNs }
  then { the UE stores correctly the list and does not consider forbidden PLMNs as equivalent PLMNs }
}
```

(2)

```
with { UE in EMM-REGISTERED-INITIATED state }
ensure that {
  when { the UE receives ATTACH ACCEPT message without a list of equivalent PLMNs }
  then { the UE deletes the stored list and applies a normal PLMN selection process }
}
```

9.2.1.1.7.2 Conformance requirements

References: The conformance requirements covered in the current TC are specified in: TS 24.301, clause 5.5.1.2.4.

[TS 24.301, clause 5.5.1.2.4]

The MME may also include a list of equivalent PLMNs in the ATTACH ACCEPT message. Each entry in the list contains a PLMN code (MCC+MNC). The UE shall store the list as provided by the network, after having removed from the list any PLMN code that is already in the list of forbidden PLMNs. In addition, the UE shall add to the stored list the PLMN code of the registered PLMN that sent the list. The UE shall replace the stored list on each receipt of the ATTACH ACCEPT message. If the ATTACH ACCEPT message does not contain a list, then the UE shall delete the stored list.

9.2.1.1.7.3 Test description

9.2.1.1.7.3.1 Pre-test conditions

System Simulator:

- Cell A (PLMN1), Cell F (PLMN2) and Cell I (PLMN3) are configured according to Table 6.3.2.2-1 in [18].

UE:

- The "forbidden PLMN list" contains PLMN3

Preamble:

- The UE is in state Switched OFF (state 1) according to [18].

9.2.1.1.7.3.2 Test procedure sequence

Table: 9.2.1.1.7.3.2-1: Main behaviour

St	Procedure	Message Sequence		TP	Verdict
		U - S	Message		
1	The SS configures: - Cell A as the "Serving cell". - Cell F as a "Non-Suitable cell". - Cell I as a "Non-Suitable cell".	-	-	-	-
2	The UE is switched on.	-	-	-	-
3	The UE transmits an ATTACH REQUEST message.	-->	ATTACH REQUEST	-	-
4	The SS transmits an AUTHENTICATION REQUEST message to initiate the EPS authentication and AKA procedure.	<--	AUTHENTICATION REQUEST	-	-
5	The UE transmits an AUTHENTICATION RESPONSE message and establishes mutual authentication.	-->	AUTHENTICATION RESPONSE	-	-
6	The SS transmits a NAS SECURITY MODE COMMAND message to activate NAS security.	<--	SECURITY MODE COMMAND	-	-
7	The UE transmits a NAS SECURITY MODE COMPLETE message and establishes the initial security configuration.	-->	SECURITY MODE COMPLETE	-	-
8	SS responds with ATTACH ACCEPT message including PLMN2 and PLMN3 in the list of equivalent PLMNs.	<--	ATTACH ACCEPT	-	-
9	The UE transmits an ATTACH COMPLETE message	-->	ATTACH COMPLETE		
10	The UE is switched off.	-	-	-	-
11	The SS configures: - Cell A as the "Non-Suitable cell". - Cell F as a "Suitable cell". - Cell I as a "Serving cell". Note: Cell 3 belongs to the forbidden PLMN.	-	-	-	-
12	The UE is switched on.	-	-	-	-
13	Check: Does the UE transmit an ATTACH REQUEST message on PLMN2?	-->	ATTACH REQUEST	1	-
14	The SS transmits an ATTACH ACCEPT message including PLMN1 and PLMN3 in the list of equivalent PLMNs.	<--	ATTACH ACCEPT	-	-
15	Check: Does the UE transmit an ATTACH COMPLETE message on PLMN2?	-->	ATTACH COMPLETE	1	P
16	The UE is switched to manual PLMN selection mode and is made to select PLMN3. The SS shall accept the TAU on PLMN3 (this removes Cell 3 from the forbidden PLMN list). The UE is switched back to automatic PLMN selection mode.	-	-	-	-
17	The UE is switched off.	-	-	-	-
18	The SS configures: - Cell A as the "Suitable cell". - Cell F as a "Non-Suitable cell". - Cell I as a "Serving cell".	-	-	-	-
19	The UE is switched on.	-	-	-	-
20	Check: Does the UE transmit an ATTACH REQUEST message on PLMN3?	-->	ATTACH REQUEST	1	-
21	The SS transmits an ATTACH ACCEPT message without the Equivalent PLMNs list.	<--	ATTACH ACCEPT	-	-
22	Check: Does the UE transmit an ATTACH COMPLETE message on PLMN3?	-->	ATTACH COMPLETE	1	P
23	The SS configures: - Cell A as the "Non-Suitable cell". - Cell F as a "Serving cell". - Cell I as a "Suitable cell".				
24	Check: Does the UE transmit an ATTACH	-->	ATTACH REQUEST	2	P

	REQUEST message on PLMN2?				
25	The SS transmits an ATTACH REJECT message with EMM cause PLMN not allowed.	<--	ATTACH REJECT	-	-
26	Check: Does the UE transmit an ATTACH REQUEST message on PLMN3?	-->	ATTACH REQUEST	2	P
27	The SS transmits an ATTACH REJECT message with EMM cause PLMN not allowed.	<--	ATTACH REJECT	-	-

9.2.1.1.7.3.3 Specific message contents

Table 9.2.1.1.7.3.3-1: Message ATTACH ACCEPT (step 8, Table 9.2.1.1.7.3.2-1)

Derivation path: 36.508 table 4.7.2-1			
Information Element	Value/Remark	Comment	Condition
Equivalent PLMNs	-	Includes MCC and MNC digits for PLMN2 and PLMN3.	

Table 9.2.1.1.7.3.3-2: Message ATTACH ACCEPT (step 14, Table 9.2.1.1.7.3.2-1)

Derivation path: 36.508 table 4.7.2-1			
Information Element	Value/Remark	Comment	Condition
Equivalent PLMNs	-	Includes MCC and MNC digits for PLMN1 and PLMN3.	

Table 9.2.1.1.7.3.3-3: Message ATTACH REJECT (steps 25 and 27, Table 9.2.1.1.7.3.2-1)

Derivation path: 36.508 table 4.7.2-3			
Information Element	Value/Remark	Comment	Condition
EMM cause	00001100	Tracking area not allowed	

9.2.1.1.9 Attach / rejected / IMSI invalid

9.2.1.1.9.1 Test Purpose (TP)

(1)

```
with { UE has sent an ATTACH REQUEST message including a PDN CONNECTIVITY REQUEST message }
ensure that {
  when { UE receives an ATTACH REJECT message with the reject cause set to "Illegal UE" }
  then { UE considers the USIM as invalid for EPS services and non-EPS services and enters state
EMM-DEREGISTERED }
}
```

9.2.1.1.9.2 Conformance requirements

References: The conformance requirements covered in the present TC are specified in: TS 24.301, clause 5.5.1.2.5.

[TS 24.301, clause 5.5.1.2.5]

...

Upon receiving the ATTACH REJECT message, the UE shall stop timer T3410 and take the following actions depending on the reject cause value received.

#3 (Illegal UE); or

...

The UE shall set the EPS update status to EU3 ROAMING NOT ALLOWED (and shall store it according to subclause 5.1.3.3) and shall delete any GUTI, last visited registered TAI and KSI. The UE shall consider the

USIM as invalid for EPS services and non-EPS services until switching off or the UICC containing the USIM is removed. Additionally, the UE shall delete the list of equivalent PLMNs and enter state EMM-DEREGISTERED.

...

9.2.1.1.9.3 Test description

9.2.1.1.9.3.1 Pre-test conditions

System Simulator:

- Cell A, Cell B (home PLMN, different TAs) and Cell G (another PLMN)

- UE:

- The test USIM contains IMSI1, GUTI1 and TAI1, and EPS update status is "EU1: UPDATED".

Preamble:

- The UE is in state Switched OFF (state 1) according to clause [18].

9.2.1.1.9.3.2 Test procedure sequence

Table 9.2.1.1.9.3.2-1: Main behaviour

St	Procedure	Message Sequence		TP	Verdict
		U - S	Message		
1	The SS configures: - Cell A as the "Serving cell". - Cell B as a "Non-Suitable cell". - Cell Gas a "Non-Suitable cell".	-	-	-	-
2	The UE is switched on.	-	-	-	-
3	The UE transmits an ATTACH REQUEST message including a PDN CONNECTIVITY REQUEST message on cell 1.	-->	ATTACH REQUEST	-	-
4	The SS transmits an ATTACH REJECT message with EMM cause = "Illegal UE" as specified.	<--	ATTACH REJECT	-	-
5	The SS releases the RRC connection.	-	-	-	-
6	The SS configures: - Cell A as a "Non-Suitable cell". - Cell B as the "Serving cell".	-	-	-	-
7	Check: Does the UE transmit an ATTACH REQUEST message in the next 30 seconds on cell B or on cell A? Note: Cell B belongs to the same PLMN where the UE was rejected but a different TA	-->	ATTACH REQUEST	1	F
8	The operator initiates an attach by MMI or by AT command.	-	-	-	-
9	Check: Does the UE transmit an ATTACH REQUEST message in the next 30 seconds on cell B or on cell A?	-->	ATTACH REQUEST	1	F
10	Check: Does the test result of CALL generic procedure indicate that the UE ignores paging on cell B for PS domain with IMSI1?	-	-	1	-
11	Check: Does the test result of CALL generic procedure indicate that the UE ignores paging on cell B for PS domain with GUTI1?	-	-	1	-
12	The SS configures: - Cell B as a "Non-Suitable cell". - Cell Gas the "Serving cell".	-	-	-	-
13	Check: Does the UE transmit an ATTACH REQUEST message in the next 30 seconds on cell C or on cell B? Note: Cell G belongs to a PLMN which is not the same like the one on which the UE was rejected.	-->	ATTACH REQUEST	1	F
14	The user initiates an attach by MMI or by AT command.	-	-	-	-
15	Check : Does the UE transmit an ATTACH REQUEST message in the next 30 seconds on cell C or on cell B?	-->	ATTACH REQUEST	1	F

9.2.1.1.9.3.3 Specific message contents

Table 9.2.1.1.9.3.3-1: Message ATTACH REJECT (step 4, Table 9.2.1.1.9.3.2-1)

Derivation path: 36.508 table 4.7.2.3			
Information Element	Value/Remark	Comment	Condition
Security header type	0000	" Plain NAS message, not security protected "	
EMM cause	00000011	#3 "Illegal UE"	
ESM message container	Not present		

9.2.1.1.10 Attach / rejected / illegal ME

9.2.1.1.10.1 Test Purpose (TP)

(1)

```

with { UE has sent an ATTACH REQUEST message including a PDN CONNECTIVITY REQUEST message }
ensure that {
  when { UE receives an ATTACH REJECT message with the reject cause set to "Illegal ME" }
  then { UE considers the USIM as invalid for EPS services and non-EPS services and enters state EMM-DEREGISTERED }
}

```

9.2.1.1.10.2 Conformance requirements

References: The conformance requirements covered in the present TC are specified in: TS 24.301, clause 5.5.1.2.5.

[TS 24.301, clause 5.5.1.2.5]

...

Upon receiving the ATTACH REJECT message, the UE shall stop timer T3410 and take the following actions depending on the reject cause value received.

#6 (Illegal ME);

The UE shall set the EPS update status to EU3 ROAMING NOT ALLOWED (and shall store it according to subclause 5.1.3.3) and shall delete any GUTI, last visited registered TAI and KSI. The UE shall consider the USIM as invalid for EPS services and non-EPS services until switching off or the UICC containing the USIM is removed. Additionally, the UE shall delete the list of equivalent PLMNs and enter state EMM-DEREGISTERED.

...

9.2.1.1.10.3 Test description

The test description is identical to the one of subclause 9.2.1.1.9 except that the reject cause #3 "Illegal UE" is replaced with the reject cause #6 "Illegal ME".

9.2.1.1.11 Attach / rejected / GPRS services and non-GPRS services not allowed

9.2.1.1.11.1 Test Purpose (TP)

(1)

```

with { UE has sent an ATTACH REQUEST message including a PDN CONNECTIVITY REQUEST message }
ensure that {
  when { UE receives an ATTACH REJECT message with the reject cause set to "Illegal ME" }
  then { UE considers the USIM as invalid for EPS services and non-EPS services and enters state EMM-DEREGISTERED }
}

```

9.2.1.1.11.2 Conformance requirements

References: The conformance requirements covered in the present TC are specified in: TS 24.301, clause 5.5.1.2.5.

[TS 24.301, clause 5.5.1.2.5]

...

Upon receiving the ATTACH REJECT message, the UE shall stop timer T3410 and take the following actions depending on the reject cause value received.

#8 (GPRS services and non-GPRS services not allowed);

The UE shall set the EPS update status to EU3 ROAMING NOT ALLOWED (and shall store it according to subclause 5.1.3.3) and shall delete any GUTI, last visited registered TAI and KSI. The UE shall consider the USIM as invalid for EPS services and non-EPS services until switching off or the UICC containing the USIM is removed. Additionally, the UE shall delete the list of equivalent PLMNs and enter state EMM-DEREGISTERED.

...

9.2.1.1.11.3 Test description

The test description is identical to the one of subclause 9.2.1.1.9 except that the reject cause #3 "Illegal MS" is replaced with the reject cause #8 "GPRS services and non-GPRS services not allowed".

9.2.1.1.12 Attach / rejected / GPRS services not allowed

9.2.1.1.12.1 Test Purpose (TP)

(1)

```
with { UE has sent an ATTACH REQUEST message including a PDN CONNECTIVITY REQUEST message }
ensure that {
  when { UE receives an ATTACH REJECT message with the reject cause set to "GPRS services not
allowed" }
    then { UE deletes the GUTI and the last visited registered TAI and KSI and considers the USIM as
invalid for EPS services until switching off or the UICC containing the USIM is removed and deletes
the list of equivalent PLMNs and UE enters state EMM-DEREGISTERED }
}
```

9.2.1.1.12.2 Conformance requirements

References: The conformance requirements covered in the present TC are specified in: TS 24.301, clauses 5.5.1.2.2 and 5.5.1.2.5.

[TS 24.301, clause 5.5.1.2.2]

In state EMM-DEREGISTERED, the UE initiates the attach procedure by sending an ATTACH REQUEST message to the MME, starting timer T3410 and entering state EMM-REGISTERED-INITIATED (see example in figure 5.5.1.2.2.1). If timer T3402 is currently running, the UE shall stop timer T3402. If timer T3411 is currently running, the UE shall stop timer T3411.

If the UE supports neither A/Gb mode nor Iu mode, the UE shall handle the Old GUTI or IMSI IE in the ATTACH REQUEST message as follows:

- The UE shall include in the ATTACH REQUEST message a valid GUTI together with the last visited registered TAI, if available. If there is no valid GUTI available, the UE shall include the IMSI in the ATTACH REQUEST message.

...

[TS 24.301, clause 5.5.1.2.5]

If the attach request cannot be accepted by the network, the MME shall send an ATTACH REJECT message to the UE including an appropriate reject cause value.

...

Upon receiving the ATTACH REJECT message, the UE shall stop timer T3410 and take the following actions depending on the reject cause value received.

#7 (GPRS services not allowed);

The UE shall set the EPS update status to EU3 ROAMING NOT ALLOWED (and shall store it according to subclause 5.1.3.3) and shall delete any GUTI, last visited registered TAI and KSI. The UE shall consider the USIM as invalid for EPS services until switching off or the UICC containing the USIM is removed. Additionally, the UE shall delete the list of equivalent PLMNs and enter state EMM-DEREGISTERED.

If A/Gb mode or Iu mode is supported by the UE, the UE shall in addition handle the GMM parameters GMM state, GPRS update status, P-TMSI, P-TMSI signature, RAI and GPRS ciphering key sequence number as specified in 3GPP TS 24.008 [6] for the case when the normal attach procedure is rejected with this cause value.

9.2.1.1.12.3 Test description

9.2.1.1.12.3.1 Pre-test conditions

System Simulator:

- Cell A, Cell B and Cell G:
 - Cell A and Cell B (HPLMN, different TAs),
 - Cell G (another PLMN).
- If pc_GERAN or pc_UTRAN supported by UE, Cell 24 (GERAN) or 8 (UTRAN) with MCC1/MNC2 – NMO2
- The different cells may not be simultaneously activated.

UE:

- The test USIM contains IMSI-1, GUTI-1 and TAI-1, and EPS update status is "EU1: UPDATED".
- If pc_GERAN or pc_UTRAN supported by UE, the test USIM contains P-TMSI-1, P-TMSI signature1 and RAI-1, and GPRS update status is "GU1: UPDATED".

Preamble:

- The UE is in state Switched OFF (state 1) according to clause [18].

9.2.1.1.12.3.2 Test procedure sequence

Table 9.2.1.1.12.3.2-1: Main behaviour

St	Procedure	Message Sequence		TP	Verdict
		U - S	Message		
1	The SS configures: - Cell A as the "Serving cell". - Cell B as a "Non-Suitable cell". - Cell G as a "Non-Suitable cell". IF pc_GERAN or pc_UTRAN THEN the SS configures (GERAN) or 8 (UTRAN) Cell as "Non-Suitable cell".	-	-	-	-
-	The following messages are sent and shall be received on cell A.	-	-	-	-
2	The user switches the UE on.	-	-	-	-
3	The UE transmit an ATTACH REQUEST message including a PDN CONNECTIVITY REQUEST message.	-->	ATTACH REQUEST	-	-
4	The SS transmits an ATTACH REJECT message with EMM cause = "GPRS services not allowed".	<--	ATTACH REJECT	-	-
5	The SS releases the RRC connection.	-	-	-	-
6	The SS reconfigures: Cell A as a "Non-Suitable cell". Cell B as the "Serving cell". Note: Cell A and Cell B are in different TAIs – same PLMN.	-	-	-	-
-	The following messages are sent and shall be received on cell B.	-	-	-	-
7	Check: Does the UE transmit an ATTACH REQUEST message in the next 30 seconds?	-->	ATTACH REQUEST	1	F
8	The user initiates an attach by MMI or by AT command.	-	-	-	-
9	Check: Does the UE transmit an ATTACH REQUEST message in the next 30 seconds?	-->	ATTACH REQUEST	1	F
-	EXCEPTION: Steps 11a1 to 11a6 describe behaviour that depends on the UE capability.	-	-	-	-
10a 1	IF pc_UTRAN or pc_GERAN THEN the SS configures - Cell B as a "Non-Suitable cell". - Cell 24 (GERAN) or 8 (UTRAN) as the "Serving cell". Note: Cell B and Cell 24 (GERAN) or 8 (UTRAN) are in different PLMNs	-	-	-	-
10a 2	The following messages are sent and shall be received on cell A.	-	-	-	-
10a 3	IF pc_CS THEN the UE registers on CS domain – See TS 34.108 or TS 51.010 Note: This is applied only for UE in UE operation mode A or in class A or in class B.	-	-	-	-
10a 4	Check: Does the UE transmit an ATTACH REQUEST message in the next 2 minutes?	-->	ATTACH REQUEST	1	F
10a 5	The user initiates an attach by MMI or by AT command.	-	-	-	-
10a 6	Check : Does the UE transmit an ATTACH REQUEST message in the next 30 seconds?	-->	ATTACH REQUEST	1	F
11	The SS configures: - Cell B as a "Non-Suitable cell". - Cell G as the "Serving cell". Note: Cell B and Cell G are different PLMNs.	-	-	-	-
-	The following messages are sent and shall be	-	-	-	-

	received on cell C.				
12	Check: Does the UE transmit an ATTACH REQUEST message in the next 30 seconds?	-->	ATTACH REQUEST	1	F
13	The operator initiates an attach by MMI or by AT command.	-	-	-	-
14	Check: Does the UE transmit an ATTACH REQUEST message in the next 30 seconds?	-->	ATTACH REQUEST	1	F

9.2.1.1.12.3.3 Specific message contents

Table 9.2.1.1.12.3.3-1: Message ATTACH REJECT (step 4, Table 9.2.1.1.12.3.2-1)

Derivation path: 36.508 table 4.7.2.3 (This message is transmitted as a "plain NAS message")			
Information Element	Value/Remark	Comment	Condition
Security header type	0000	"Plain NAS message, not security protected"	
EMM cause	00000111	#7 "GPRS services not allowed"	
ESM message container	Not present		

9.2.1.1.13 Attach / rejected / PLMN not allowed

9.2.1.1.13.1 Test Purpose (TP)

(1)

```
with { UE has sent an ATTACH REQUEST message including a PDN CONNECTIVITY REQUEST message }
ensure that {
  when { UE receives an ATTACH REJECT message with the reject cause set to "PLMN not allowed" }
  then { UE deletes the GUTI, the last visited registered TAI and KSI and UE deletes the list of
equivalent PLMNs and UE enters state EMM-DEREGISTERED.PLMN-SEARCH and UE stores the PLMN in the
"forbidden PLMN list" }
}
```

(2)

```
with { UE is switched off and a PLMN is stored in the "forbidden PLMN list" }
ensure that {
  when { UE is powered on this PLMN }
  then { UE doesn't perform an attach procedure }
}
```

(3)

```
with { UE in E-UTRA EMM-DEREGISTERED.PLMN-SEARCH state and a PLMN is stored in the "forbidden PLMN
list" }
ensure that {
  when { UE enters a PLMN which is not in the "forbidden PLMN list" }
  then { UE performs an attach procedure }
}
```

(4)

```
with { UE in E-UTRA EMM-DEREGISTERED.PLMN-SEARCH state and a PLMN is stored in the "forbidden PLMN
list" }
ensure that {
  when { UE is in the rejected PLMN and when that PLMN is selected manually }
  then { UE performs an attach procedure }
}
```

9.2.1.1.13.2 Conformance requirements

References: The conformance requirements covered in the present TC are specified in: TS 24.301, clauses 5.5.1.2.2 and 5.5.1.2.5.

[TS 24.301, clause 5.5.1.2.2]

In state EMM-DEREGISTERED, the UE initiates the attach procedure by sending an ATTACH REQUEST message to the MME, starting timer T3410 and entering state EMM-REGISTERED-INITIATED (see figure 5.5.1.2.2.1). If timer T3402 is currently running, the UE shall stop timer T3402. If timer T3411 is currently running, the UE shall stop timer T3411. The UE shall include in the ATTACH REQUEST message a valid GUTI together with the last visited registered TAI, if available. If there is no valid GUTI available, the UE shall include the IMSI in the ATTACH REQUEST message.

The UE shall send the ATTACH REQUEST message together with a PDN CONNECTIVITY REQUEST message to request PDN connectivity to the default PDN (see subclause 6.5.1).

...

[TS 24.301, clause 5.5.1.2.5]

If the attach request cannot be accepted by the network, the MME shall send an ATTACH REJECT message to the UE including an appropriate reject cause value.

...

Upon receiving the ATTACH REJECT message, the UE shall stop timer T3410 and take the following actions depending on the reject cause value received.

#11 (PLMN not allowed);

The UE shall set the EPS update status to EU3 ROAMING NOT ALLOWED (and shall store it according to subclause 5.1.3.3) and shall delete any GUTI, last visited registered TAI and KSI. Additionally, the UE shall delete the list of equivalent PLMNs, reset the attach attempt counter, and enter state EMM-DEREGISTERED.PLMN-SEARCH.

The UE shall store the PLMN identity in the "forbidden PLMN list".

The UE shall perform a PLMN selection according to 3GPP TS 23.122 [3].

If A/Gb mode or Iu mode is supported by the UE, the UE shall in addition handle the MM parameters update status, TMSI, LAI, ciphering key sequence number and location update attempt counter, and the GMM parameters GMM state, GPRS update status, P-TMSI, P-TMSI signature, RAI, GPRS ciphering key sequence number and GPRS attach attempt counter as specified in 3GPP TS 24.008 [6] for the case when the normal attach procedure is rejected with this cause value and no RR connection exists.

9.2.1.1.13.3 Test description

9.2.1.1.13.3.1 Pre-test conditions

System Simulator:

- Cell 1, Cell 2, Cell 3, and Cell 4
 - Cell 1 in MCC1/MNC2/TAC1 (TAI-1)
 - Cell 2 in MCC1/MNC2/TAC1 (TAI-1),
 - Cell 3 in MCC1/MNC2/TAC2 (TAI-2),
 - Cell 4 in MCC2/MNC1/TAC1 (TAI-3).
- MCC1/MNC2 and MCC2/MNC1 are not HPLMN of the UE.
- The cells may not be simultaneously activated.

UE:

- The test USIM contains IMSI1, GUTI1 and TAI1, and EPS update status is "EU1: UPDATED".
- The "forbidden PLMN list" is empty.

Preamble:

- The UE is in state Switched OFF (state 1) according to clause [18].

9.2.1.1.13.3.2 Test procedure sequence

Table 9.2.1.1.13.3.2-1: Main behaviour

St	Procedure	Message Sequence		TP	Verdict
		U - S	Message		
1	The SS configures: - Cell 1 as the "Serving cell". - Cell 2 as a "Non-Suitable cell". - Cell 3 as a "Non-Suitable cell". - Cell 4 as a "Non-Suitable cell".	-	-	-	-
2	The following messages are sent and shall be received on cell 1.	-	-	-	-
3	The UE is switched on.	-	-	-	-
4	The UE transmits an ATTACH REQUEST message including a PDN CONNECTIVITY REQUEST message.	-->	ATTACH REQUEST	-	-
5	The SS transmits an ATTACH REJECT message including EMM cause = "PLMN not allowed".	<--	ATTACH REJECT	-	-
6	The SS releases the RRC connection.	-	-	-	-
7	Check: Does the UE transmit an ATTACH REQUEST message in the next 30 seconds?	-	-	1	F
8	If possible (see ICS) switch off is performed. Otherwise the power is removed.	-	-	-	-
9	The SS configures: - Cell 1 as a "Non-Suitable cell". - Cell 2 as the "Serving cell". Note: Cell 1 and Cell 2 are in the same TAI – same PLMN.	-	-	-	-
10	The following messages are sent and shall be received on cell 2.	-	-	-	-
11	Check: Does the UE transmit an ATTACH REQUEST message in the next 30 seconds?	-->	ATTACH REQUEST	3	F
12	The user initiates an attach by MMI or by AT command.	-	-	-	-
13	Check: Does the UE transmit an ATTACH REQUEST message in the next 30 seconds?	-->	ATTACH REQUEST	1	F
14	The SS configures: Cell 2 as a "Non-Suitable cell". Cell 3 as the "Serving cell". Note: Cell 2 and Cell 3 are in the different TAI – same PLMN.	-	-	-	-
15	The following messages are sent and shall be received on cell 3.	-	-	-	-
16	Check: Does the UE transmit an ATTACH REQUEST message in the next 30 seconds?	-->	ATTACH REQUEST	2	F
17	The user initiates an attach by MMI or by AT command.	-	-	-	-
18	Check: Does the UE transmit an ATTACH REQUEST message in the next 30 seconds?	-->	ATTACH REQUEST	1	F
19	The SS configures: Cell 3 as a "Non-Suitable cell". Cell 4 as the "Serving cell". Note: Cell 3 and Cell 4 are different PLMNs.	-	-	-	-
20	The following messages are sent and shall be received on cell 4.	-	-	-	-
21	Check: Does the UE transmit an ATTACH REQUEST message including a PDN CONNECTIVITY REQUEST message as specified?	-->	ATTACH REQUEST	4	P
22	The SS transmits an AUTHENTICATION REQUEST message to initiate the EPS authentication and AKA procedure.	<--	AUTHENTICATION REQUEST	-	-

23	The UE transmits an AUTHENTICATION RESPONSE message.	-->	AUTHENTICATION REQUEST	-	-
24	The SS starts integrity protection and ciphering	<--	SECURITY MODE COMMAND	-	-
25	The UE responds to the SS.	-->	SECURITY MODE COMPLETE	-	-
26	The SS transmits an ATTACH ACCEPT message including an ACTIVATE DEFAULT EPS BEARER CONTEXT REQUEST message.	<--	ATTACH ACCEPT	-	-
27	The UE transmits an ATTACH COMPLETE message including an ACTIVATE DEFAULT EPS BEARER CONTEXT ACCEPT message.	-->	ATTACH COMPLETE	-	-
28	The SS releases the RRC connection.	-	-	-	-
29	The user switches the UE off.	-	-	-	-
30	The UE transmits a DETACH REQUEST message.	-->	DETACH REQUEST	-	-
31	The SS configures: Cell 1 as the "Serving cell". Cell 4 as a "Non-suitable cell". Note: Cell 1 belong to the forbidden PLMN.	-	-	-	-
32	The user switches the UE on.	-	-	-	-
33	The following messages are sent and shall be received on cell 1.	-	-	-	-
34	The user sets the UE in manual PLMN selection mode or requests a PLMN search.	-	-	-	-
35	The user selects PLMN (MCC=1, MNC=2)	-	-	-	-
36	Check: Does the UE transmit an ATTACH REQUEST message including a PDN CONNECTIVITY REQUEST message as specified?	-->	ATTACH REQUEST	5	P
37	The SS transmits an AUTHENTICATION REQUEST message to initiate the EPS authentication and AKA procedure.	<--	AUTHENTICATION REQUEST	-	-
38	The UE transmits an AUTHENTICATION RESPONSE message.	-->	AUTHENTICATION REQUEST	-	-
39	The SS starts integrity protection and ciphering	<--	SECURITY MODE COMMAND	-	-
40	The UE responds to the SS.	-->	SECURITY MODE COMPLETE	-	-
41	The SS transmits an ATTACH ACCEPT message including an ACTIVATE DEFAULT EPS BEARER CONTEXT REQUEST message.	<--	ATTACH ACCEPT	-	-
42	The UE transmits an ATTACH COMPLETE message including an ACTIVATE DEFAULT EPS BEARER CONTEXT ACCEPT message.	-->	ATTACH COMPLETE	-	-

9.2.1.1.13.3.3 Specific message contents

Table 9.2.1.1.13.3.3-1: Message ATTACH REJECT (step 5, Table 9.2.1.1.13.3.2-1)

Derivation path: 36.508 table 4.7.2.3 (Plain NAS message)			
Information Element	Value/Remark	Comment	Condition
Security header type	0000	"No security protection" #11 "PLMN not allowed"	
EMM cause	00001011		
ESM message container	Not present		

Table 9.2.1.1.13.3-2: Message ATTACH REQUEST (step 21, Table 9.2.1.1.13.3.2-1)

Derivation path: 36.508 table 4.7.2.4			
Information Element	Value/Remark	Comment	Condition
Old GUTI or IMSI	IMSI1	GUTI has been deleted after receiving ATTACH REJECT at step 5; only IMSI is available. TAI has been deleted after receiving ATTACH REJECT at step 5.	
Last visited registered TAI	Not present		

9.2.1.1.14 Attach / rejected / tracking area not allowed

9.2.1.1.14.1 Test Purpose (TP)

(1)

```
with { UE has sent an ATTACH REQUEST message including a PDN CONNECTIVITY REQUEST message }
ensure that {
  when { UE receives an ATTACH REJECT message with the reject cause set to "Tracking area not allowed" }
  then { UE sets the EPS update status to EU3 ROAMING NOT ALLOWED, UE deletes the GUTI, last visited registered TAI and KSI, UE enters the state EMM-DEREGISTERED.LIMITED-SERVICE and UE stores the current TAI in the list of "forbidden tracking areas for regional provision of service" }
}
```

(2)

```
with { UE is in EMM-DEREGISTERED.LIMITED-SERVICE state and the current TAI in the list of "forbidden tracking areas for regional provision of service" }
ensure that {
  when { serving cell belongs to TAI where UE was rejected }
  then { UE does not attempt to attach on any other cell }
}
```

(3)

```
with { UE is in EMM-DEREGISTERED.LIMITED-SERVICE state and the current TAI in the list of "forbidden tracking areas for regional provision of service" }
ensure that {
  when { UE re-selects a new cell in the same TAI it was already rejected }
  then { UE does not attempt to attach }
}
```

(4)

```
with { UE is in EMM-DEREGISTERED.LIMITED-SERVICE state and the current TAI in the list of "forbidden tracking areas for regional provision of service" }
ensure that {
  when { UE enters a cell belonging to a tracking area not in the list of "forbidden tracking areas for regional provision of service" }
  then { UE attempts to attach with IMSI }
}
```

(5)

```
with { UE is in EMM-DEREGISTERED.LIMITED-SERVICE state and the list of "forbidden tracking areas for regional provision of service" contains more than one TAI }
ensure that {
  when { UE re-selects a cell belonging to one of the TAIs in the list of "forbidden tracking areas for regional provision of service" }
  then { UE does not attempt to attach }
}
```

(6)

```
with { UE is switched off }
ensure that {
```

```
when { UE is powered on in the cell belonging to the TAI which was in the list of "forbidden
tracking areas for regional provision of service" before the UE was swithed off }
then { UE performs registration on that cell }
}
```

9.2.1.1.14.2 Conformance requirements

References: The conformance requirements covered in the present TC are specified in: TS 24.301, clauses 5.3.2, 5.5.1.2.2, 5.5.1.2.5, 5.2.2.3.2, Annex C and TS 36.304 clause 4.3.

[TS 24.301, clause 5.3.2]

The UE shall store a list of "forbidden tracking areas for roaming", as well as a list of "forbidden tracking areas for regional provision of service". These lists shall be erased when the UE is switched off or when the USIM is removed, and periodically (with a period in the range 12 to 24 hours).

...

In S1 mode, the UE shall update the suitable list whenever an ATTACH REJECT, TRACKING AREA UPDATE REJECT, SERVICE REJECT or DETACH REQUEST message is received with the EMM cause #13 "roaming not allowed in this tracking area", #12 "tracking area not allowed", or #15 "no suitable cells in tracking area".

Each list shall accommodate 40 or more TAIs. When the list is full and a new entry has to be inserted, the oldest entry shall be deleted.

[TS 24.301, clause 5.5.1.2.2]

In state EMM-DEREGISTERED, the UE initiates the attach procedure by sending an ATTACH REQUEST message to the MME, starting timer T3410 and entering state EMM-REGISTERED-INITIATED (see figure 5.5.1.2.2.1).

...

The UE shall include in the ATTACH REQUEST message a valid GUTI together with the last visited registered TAI, if available. If there is no valid GUTI available, the UE shall include the IMSI in the ATTACH REQUEST message.

...

The UE shall send the ATTACH REQUEST message together with a PDN CONNECTIVITY REQUEST message contained in the ESM message container information element to request PDN connectivity.

...

[TS 24.301, clause 5.5.1.2.5]

If the attach request cannot be accepted by the network, the MME shall send an ATTACH REJECT message to the UE including an appropriate EMM cause value.

...

Upon receiving the ATTACH REJECT message, the UE shall stop timer T3410 and take the following actions depending on the reject cause value received.

...

#12 (Tracking area not allowed);

The UE shall set the EPS update status to EU3 ROAMING NOT ALLOWED (and shall store it according to subclause 5.1.3.3) and shall delete any GUTI, last visited registered TAI and KSI. Additionally, the UE shall reset the attach attempt counter.

In S1 mode, the UE shall store the current TAI in the list of "forbidden tracking areas for regional provision of service" and enter the state EMM-DEREGISTERED.LIMITED-SERVICE.

...

[TS 24.301, clause 5.2.2.3.2]

The UE shall perform an attach procedure when entering a cell which provides normal service.

[TS 24.301, Annex C (normative)]

The following EMM parameters shall be stored on the USIM if the corresponding file is present:

- GUTI;
- last visited registered TAI;
- EPS update status;
- Allowed CSG list; and
- EPS security context parameters.

The presence and format of corresponding files on the USIM is specified in 3GPP TS 31.102 [17].

If the corresponding file is not present on the USIM, these EMM parameters are stored in a non-volatile memory in the ME together with the IMSI from the USIM. These EMM parameters can only be used if the IMSI from the USIM matches the IMSI stored in the non-volatile memory; else the UE shall delete the EMM parameters.

...

[TS 36.304, clause 4.3]

...

suitable cell:

...

Following exceptions to these definitions are applicable for UEs:

- camped on a cell that belongs to a registration area that is forbidden for regional provision of service; a cell that belongs to a registration area that is forbidden for regional provision service ([5], [16]) is suitable but provides only limited service.

...

9.2.1.1.14.3 Test description

9.2.1.1.14.3.1 Pre-test conditions

System Simulator:

- Cell A and Cell B are configured according to Table 6.3.2.2-1 in [18] and belong to the same frequency as specified in [20]:
 - Cell A in (home PLMN),
 - Cell B in (home PLMN, another TA),

UE:

The USIM contains GUTI-1 and TAI-1, and EPS update status is "EU1: UPDATED"..

Preamble:

- The UE is in state Switched OFF (state 1) according to clause [18].

9.2.1.1.14.3.2 Test procedure sequence

Table 9.2.1.1.14.3.2-1: Main behaviour

St	Procedure	Message Sequence		TP	Verdict
		U - S	Message		
1	The SS configures: Cell A as the "Serving cell". Cell B as a " Suitable cell",	-	-	-	-
2	The UE is switched on.	-	-	-	-
3	The UE transmits an ATTACH REQUEST message including a PDN CONNECTIVITY REQUEST message as specified on Cell A.	-->	ATTACH REQUEST	-	-
4	The SS transmits an ATTACH REJECT message, EMM cause = "Tracking area not allowed". (The list of "forbidden tracking areas for regional provision of service " in the UE should now contain TAI-1)	<--	ATTACH REJECT	-	-
5	The SS releases the RRC connection.	-	-	-	-
6	Check: Does the UE transmit the ATTACH REQUEST message in the next 30 seconds on Cell B?	-->	ATTACH REQUEST	2	F
7	The user initiates an attach by MMI or by AT command.	-	-	-	-
8	Check: Does the UE transmit the ATTACH REQUEST message in the next 30 seconds on Cell A?	-->	ATTACH REQUEST	1	F
9	The SS reconfigures: Cell A as a "Suitable cell", Cell B as the "Serving cell".	-	-	-	-
10	Check: Does the UE transmit the ATTACH REQUEST message including a PDN CONNECTIVITY REQUEST message as specified on Cell B?	-->	ATTACH REQUEST	1,4	P
11	The SS transmits an ATTACH REJECT message, EMM cause = "Tracking area not allowed". (The list of "forbidden tracking areas for regional provision of service " in the UE should now contain TAI-1 and TAI-2)	<--	ATTACH REJECT	-	-
12	The SS releases the RRC connection.	-	-	-	-
13	The SS reconfigures: Cell A as the "Serving cell". Cell B as a " Suitable cell",	-	-	-	-
14	Check: Does the UE transmit the ATTACH REQUEST message in the next 30 seconds?	-->	ATTACH REQUEST	1, 3, 5	F
15	If possible (see ICS) switch off is performed. Otherwise the power is removed.	-	-	-	-
16	The SS reconfigures: Cell A as the "Serving cell", Cell B as a "Non-Suitable cell".	-	-	-	-
17	The UE is brought back to operation.	-	-	-	-
18	The following message is sent on Cell A.	-	-	-	-
19	Check: Does the UE transmit the ATTACH REQUEST message including a PDN CONNECTIVITY REQUEST message as specified?	-->	ATTACH REQUEST	6	P
20	The SS transmits an AUTHENTICATION REQUEST message to initiate the EPS authentication and AKA procedure.	<--	AUTHENTICATION REQUEST	-	-
21	The UE transmits an AUTHENTICATION RESPONSE message.	-->	AUTHENTICATION RESPONSE	-	-
22	The SS starts integrity protection and ciphering	-	-	-	-

23	The SS transmits an ATTACH ACCEPT message including an ACTIVATE DEFAULT EPS BEARER CONTEXT REQUEST message.	<--	ATTACH ACCEPT	-	-
24	The UE transmits an ATTACH COMPLETE message including an ACTIVATE DEFAULT EPS BEARER CONTEXT ACCEPT message.	-->	ATTACH COMPLETE	-	-

9.2.1.1.14.3.3 Specific message contents

Table 9.2.1.1.14.3.3-1: Message ATTACH REJECT (steps 4 and 11, Table 9.2.1.1.14.3.2-1)

Derivation path: 36.508 table 4.7.2.3			
Information Element	Value/Remark	Comment	Condition
Security header type	0000	"No security protection" #12 "Tracking area not allowed"	
EMM cause	00001100		
ESM message container	Not present		

Table 9.2.1.1.14.3.3-2: Message ATTACH REQUEST (steps 10 and 18 Table 9.2.1.1.14.3.2-1)

Derivation path: 36.508 table 4.7.2.4			
Information Element	Value/Remark	Comment	Condition
Old GUTI or IMSI	IMSI1	GUTI has been deleted after receiving ATTACH REJECT at step 4; only IMSI is available. TAI has been deleted after receiving ATTACH REJECT at step 4.	
Last visited registered TAI	Not present		

9.2.1.1.15 Attach / rejected / roaming not allowed in this tracking area

9.2.1.1.15.1 Test Purpose (TP)

(1)

```
with { the UE has sent an ATTACH REQUEST message including a PDN CONNECTIVITY REQUEST message }
ensure that {
  when { the UE receives an ATTACH REJECT message with the reject cause set to "roaming not allowed in this tracking area" }
  then { the UE sets the EPS update status to EUI3 ROAMING NOT ALLOWED and the UE deletes the GUTI, the last visited registered TAI and KSI and the UE enters the state EMM-DEREGISTERED.LIMITED-SERVICE or optionally EMM-DEREGISTERED.PLMN-SEARCH and the UE stores the current TAI in the list of "forbidden tracking areas for roaming" }
}
```

(2)

```
with { the UE is in EMM-DEREGISTERED.LIMITED-SERVICE or EMM-DEREGISTERED.PLMN-SEARCH state and the current TAI in the list of "forbidden tracking areas for roaming" }
ensure that {
  when { the serving cell belongs to TAI where UE was rejected }
  then { the UE does not attempt to attach }
}
```

(3)

```
with { the UE is in EMM-DEREGISTERED.LIMITED-SERVICE or EMM-DEREGISTERED.PLMN-SEARCH state and the current TAI in the list of "forbidden tracking areas for roaming" }
ensure that {
  when { the UE re-selects a new cell in the same TA where it was rejected }
  then { the UE does not attempt to attach }
}
```

(4)

```

with { the UE is in EMM-DEREGISTERED.LIMITED-SERVICE or EMM-DEREGISTERED.PLMN-SEARCH state and the
TAI of the current cell belongs to the list of "forbidden tracking areas for roaming" }
ensure that {
  when { the UE enters a cell belonging to a tracking area not in the list of "forbidden tracking
areas for roaming" }
    then { the UE attempts to attach with IMSI }
}

```

(5)

```

with { the UE is in EMM-DEREGISTERED.LIMITED-SERVICE or EMM-DEREGISTERED.PLMN-SEARCH state and the
list of "forbidden tracking areas for roaming" contains more than one TAI }
ensure that {
  when { the UE selects a cell belonging to one of the TAIs in the list of "forbidden tracking areas
for roaming" }
    then { the UE does not attempt to attach }
}

```

(6)

```

with { the UE is switched off or the UICC containing the USIM is removed }
ensure that {
  when { UE is powered on in the cell belonging to the TAI which was in the list of "forbidden
tracking areas for roaming" before the UE was switched off or the USIM is inserted again on that cell
}
    then { UE performs registration on that cell }
}

```

(7)

```

with { a cell of the HPLMN is available }
ensure that {
  when { the UE performs a PLMN selection }
    then { the UE returns to a cell of the HPLMN }
}

```

(8)

```

with { the UE has sent an ATTACH REQUEST message including a PDN CONNECTIVITY REQUEST message }
ensure that {
  when { the UE receives an ATTACH REJECT message with the reject cause set to "roaming not allowed
in this tracking area" }
    then { the UE deletes RAI, P-TMSI, P-TMSI signature and GPRS ciphering key sequence number and
sets the GPRS update status to GU3 ROAMING NOT ALLOWED }
}

```

9.2.1.1.15.2 Conformance requirements

References: The conformance requirements covered in the present TC are specified in: TS 24.301, clauses 5.3.2, 5.5.1.2.2, 5.5.1.2.5 and in TS 24.008 clause 4.7.3.2.4.

[TS 24.301, clause 5.3.2]

The UE shall store a list of "forbidden tracking areas for roaming", as well as a list of "forbidden tracking areas for regional provision of service". These lists shall be erased when the UE is switched off or when the USIM is removed, and periodically (with a period in the range 12 to 24 hours).

...

In S1 mode, the UE shall update the suitable list whenever an ATTACH REJECT, TRACKING AREA UPDATE REJECT, SERVICE REJECT or DETACH REQUEST message is received with the EMM cause #13 "roaming not allowed in this tracking area", #12 "tracking area not allowed", or #15 "no suitable cells in tracking area".

Each list shall accommodate 40 or more TAIs. When the list is full and a new entry has to be inserted, the oldest entry shall be deleted.

[TS 24.301, clause 5.5.1.2.2]

In state EMM-DEREGISTERED, the UE initiates the attach procedure by sending an ATTACH REQUEST message to the MME, starting timer T3410 and entering state EMM-REGISTERED-INITIATED (see example in figure 5.5.1.2.2.1).

...

The UE shall include in the ATTACH REQUEST message a valid GUTI together with the last visited registered TAI, if available. If there is no valid GUTI available, the UE shall include the IMSI in the ATTACH REQUEST message

...

.The UE shall send the ATTACH REQUEST message together with a PDN CONNECTIVITY REQUEST message contained in the ESM message container information element to request PDN connectivity

...

[TS 24.301, clause 5.5.1.2.5]

If the attach request cannot be accepted by the network, the MME shall send an ATTACH REJECT message to the UE including an appropriate EMM cause value.

...

Upon receiving the ATTACH REJECT message, the UE shall stop timer T3410 and take the following actions depending on the reject cause value received.

...

#13 (Roaming not allowed in this tracking area);

The UE shall set the EPS update status to EU3 ROAMING NOT ALLOWED (and shall store it according to subclause 5.1.3.3) and shall delete any GUTI, last visited registered TAI and KSI. The UE shall delete the list of equivalent PLMNs and reset the attach attempt counter.

In S1 mode, the UE shall store the current TAI in the list of "forbidden tracking areas for roaming". Additionally, the UE shall enter the state EMM-DEREGISTERED.LIMITED-SERVICE or optionally EMM-DEREGISTERED.PLMN-SEARCH. The UE shall perform a PLMN selection according to 3GPP TS 23.122 [6].

...

If A/Gb mode or Iu mode is supported by the UE, the UE shall in addition handle the GMM parameters GMM state, GPRS update status, P-TMSI, P-TMSI signature, RAI, GPRS ciphering key sequence number and GPRS attach attempt counter as specified in 3GPP TS 24.008 [13] for the case when the normal attach procedure is rejected with the GMM cause with the same value.

...

[TS 24.008 subclause 4.7.3.2.4]

...

The MS shall then take one of the following actions depending upon the reject cause:

...

13 (Roaming not allowed in this location area);

The MS shall delete any RAI, P-TMSI, P-TMSI signature and GPRS ciphering key sequence number, shall set the GPRS update status to GU3 ROAMING NOT ALLOWED (and shall store it according to clause 4.1.3.2) and shall reset the GPRS attach attempt counter. The state is changed to GMM-DEREGISTERED.LIMITED-SERVICE or optionally to GMM-DEREGISTERED.PLMN-SEARCH.

The MS shall set the update status to U3 ROAMING NOT ALLOWED, reset the location update attempt counter and shall delete any TMSI, LAI and ciphering key sequence number. The new MM state is MM IDLE.

...

9.2.1.1.15.3 Test description

9.2.1.1.15.3.1 Pre-test conditions

System Simulator:

- Cell C, Cell I, Cell K, Cell L and if pc_UTRAN Cell 5 and if (NOT pc_UTRAN AND pc_GERAN) Cell 24 are configured according to Table 6.3.2.2-1 in [18], but at most two cells are simultaneously activated:
 - Cell I and Cell K (visited PLMN, same TA),
 - Cell L (same visited PLMN, another TA),
 - Cell C (home PLMN).
- if pc_UTRAN, Cell 5 (only active when stated)
 - same PLMN like visited PLMN above
 - RAI-1 (RAC & LAC values chosen by SS)
 - System information indicate that NMO 1 is used
- if pc_GERAN and NOT pc_UTRAN, Cell 23 (only active when stated)
 - same PLMN like visited PLMN above
 - RAC-1 (RAC & LAC values chosen by SS)
 - System information indicate that NMO 1 is used

NOTE 1: Cell K is present to confirm that UE does not attempt attach to the cell in same TAI after reject from the SS.

NOTE 2: Cell C is present to confirm that UE does attempt attach to the cell in HPLMN after reject from the SS.

NOTE 3: The requirement in 3GPP TS 24.301 to store at least 40 entries in the list of "forbidden tracking areas for roaming" is not fully tested.

NOTE 4: Different types of UE may use different methods to periodically clear the list of forbidden areas (e.g. every day at 12 am) for roaming. If the list is cleared while the test is being run, it may be necessary to re-run the test.

UE:

- The test USIM contains IMSI-1, GUTI-1 and TAI-1, and EPS update status is "EU1: UPDATED".
- The test USIM contains P-TMSI-1 (belonging to RAI-1) and the update status is "U1: UPDATED"

Preamble:

- The UE is in state Switched OFF (state 1) according to [18].

9.2.1.1.15.3.2 Test procedure sequence

Table 9.2.1.1.15.3.2-1: Main behaviour

St	Procedure	Message Sequence		TP	Verdict
		U - S	Message		
1	The SS configures: Cell I as the "Serving cell", Cell K as a "Non-Suitable cell", Cell L as a "Non-Suitable cell", Cell C as a "Non-Suitable cell".	-	-	-	-
2	The UE is switched on.	-	-	-	-
3	The UE transmits an ATTACH REQUEST message including a PDN CONNECTIVITY REQUEST message on Cell I.	-->	ATTACH REQUEST	-	-
4	The SS transmits an ATTACH REJECT message, EMM cause = "roaming not allowed in this tracking area". (The list of "forbidden tracking areas for roaming" in the UE should now contain TAI-9)	<--	ATTACH REJECT	-	-
5	The SS releases the RRC connection.	-	-	-	-
6	Check: Does the UE transmit an ATTACH REQUEST message in the next 30 seconds on Cell I?	-->	ATTACH REQUEST	1,5	F
7	The user initiates an attach by MMI or by AT command.	-	-	-	-
8	Check: Does the UE transmit an ATTACH REQUEST message in the next 30 seconds on Cell I?	-->	ATTACH REQUEST	1,5	F
9	The SS reconfigures: Cell I as a "Suitable cell", Cell K as the "Serving cell", Cell L as a "Non-Suitable cell", Cell C as a "Non-Suitable cell".	-	-	-	-
10	Check: Does the UE transmit an ATTACH REQUEST message in the next 30 seconds on any cell?	-->	ATTACH REQUEST	3	F
11	The SS reconfigures: Cell I as a "Non-Suitable cell", Cell K as a "Suitable cell", Cell L as the "Serving cell", Cell C as a "Non-Suitable cell".	-	-	-	-
12	Check: Does the UE transmit an ATTACH REQUEST message including a PDN CONNECTIVITY REQUEST message on Cell L as specified?	-->	ATTACH REQUEST	4	P
13	The SS transmits an ATTACH REJECT message, EMM cause = "roaming not allowed in this tracking area". (The list of "forbidden tracking areas for roaming" in the UE should now contain TAI-9 and TAI-11)	<--	ATTACH REJECT	-	-
14	The SS releases the RRC connection.	-	-	-	-
15	Check: Does the UE transmit an ATTACH REQUEST message in the next 30 seconds on Cell L or Cell K?	-->	ATTACH REQUEST	1,5	F
16	The SS reconfigures: Cell I as a "Serving cell", Cell K as a " Non-Suitable cell", Cell L as a "Suitable cell", Cell C as the "Non-Suitable cell".	-	-	-	-
17	Check: Does the UE transmit an ATTACH REQUEST message in the next 30 seconds on any cell?	-->	ATTACH REQUEST	3,5	F
	EXCEPTION: if pc_UTRAN or pc_GERAN; , steps 18a1 and 18a2 are executed				
18a 1	The SS reconfigures: Cell I as "Serving cell"	-	-	-	-

	Cell K as "Non-suitable cell" if pc_UTRAN Cell 5 as "Suitable cell" if pc_GERAN Cell 23 as "Suitable cell"				
18a 2	Check: Does the UE transmit an ATTACH REQUEST message without P-TMSI, P-TMSI signature, RAI, TMSI as specified and on Cell 5 if pc_UTRAN or Cell 23 if pc_GERAN?	-->	ATTACH REQUEST		P
19	If possible (see ICS) switch off is performed or the USIM is removed. Otherwise the power is removed.	-	-	-	-
20	The SS reconfigures: Cell I as the "Serving cell", Cell K as a "Non-Suitable cell", Cell L as a "Non-Suitable cell", Cell C as a "Non-Suitable cell".	-	-	-	-
21	The UE is brought back to operation or the USIM is inserted.	-	-	-	-
22	The UE transmits an ATTACH REQUEST message including a PDN CONNECTIVITY REQUEST message as specified on Cell I.	-->	ATTACH REQUEST	6	P
23	The SS transmits an ATTACH REJECT message, EMM cause = "roaming not allowed in this tracking area". (The list of "forbidden tracking areas for roaming" in the UE should now contain TAI-9)	<--	ATTACH REJECT	-	-
24	The SS reconfigures: Cell I as the "Serving cell", Cell K as a "Non-Suitable cell", Cell L as a "Non-Suitable cell", Cell C as a "Suitable cell".	-	-	-	-
25	Check: Does the UE transmit an ATTACH REQUEST message including a PDN CONNECTIVITY REQUEST message as specified on cell C?	-->	ATTACH REQUEST	7	P
26	The SS transmits an AUTHENTICATION REQUEST message to initiate the EPS authentication and AKA procedure.	<--	AUTHENTICATION REQUEST	-	-
27	The UE transmits an AUTHENTICATION RESPONSE message.	-->	AUTHENTICATION RESPONSE	-	-
28	The SS starts integrity protection and ciphering	<--	SECURITY MODE COMMAND	-	-
29	The UE responds to the SS.	-->	SECURITY MODE COMPLETE	-	-
30	The SS transmits an ATTACH ACCEPT message including an ACTIVATE DEFAULT EPS BEARER CONTEXT REQUEST message.	<--	ATTACH ACCEPT	-	-
31	The UE transmits an ATTACH COMPLETE message including an ACTIVATE DEFAULT EPS BEARER CONTEXT ACCEPT message.	-->	ATTACH COMPLETE	-	-

Editor's note: It was noticed that step 7 does not match with TP1 or 5, and is not clearly supported by conformance requirements quoted in this test case. Therefore, it is necessary to investigate it further and correct it (either to correct the TP and conformance requirement or to remove step 7).

9.2.1.1.15.3.3 Specific message contents

Table 9.2.1.1.15.3.3-1: Message ATTACH REJECT (steps 4, 13 and 23 in table 9.2.1.1.15.3.2-1)

[Note for the editor: cell borders are added to the table below]

Derivation path: 36.508 table 4.7.2.3			
Information Element	Value/Remark	Comment	Condition
Security header type	0000	"No security protection" #13 " roaming not allowed in this tracking area "	
EMM cause	00001101		
ESM message container	Not present		

Table 9.2.1.1.15.3.3-2: Message ATTACH REQUEST (steps 12 and 22 in table 9.2.1.1.15.3.2-1)

[Note for the editor: cell borders are added to the table below]

Derivation path: 36.508 table 4.7.2.4			
Information Element	Value/Remark	Comment	Condition
Old GUTI or IMSI	IMSI1	GUTI has been deleted after receiving ATTACH REJECT at step 4; only IMSI is available. TAI has been deleted after receiving ATTACH REJECT at step 4.	
Last visited registered TAI	Not present		

Table 9.2.1.1.15.3.3-3: Message ATTACH REQUEST (steps 18a2 and 18b2 in table 9.2.1.1.15.3.2-1)

Derivation path: 24.008 table 9.4.1			
Information Element	Value/Remark	Comment	Condition
MS network capability	Not checked		
Attach type	Not checked		
GPRS ciphering key sequence number	111	"No key is available"	
DRX parameter	Not checked		
P-TMSI or IMSI	IMSI-1		
Old routing area identification	All bits of octets 5 and 6 are set to 1, except bit 1 of octet 6 which is set to 0. Other bits are not checked.		
MS Radio Access capability	Not checked		
Old P-TMSI signature	Not present		
TMSI status	0 (' no valid TMSI available')		
PS LCS Capability	Not checked		
Mobile station classmark 2	Not checked		
Mobile station classmark 3	Not checked		
Supported Codecs	Not checked		
UE network capability	Not checked		
Additional mobile identity	Not checked		
Additional old routing area identification	Not checked		

9.2.1.1.17 Attach / rejected / no suitable cells in tracking area

9.2.1.1.17.1 Test Purpose (TP)

(1)

```
with { UE has sent an ATTACH REQUEST message including a PDN CONNECTIVITY REQUEST message }
ensure that {
  when { UE receives an ATTACH REJECT message with the EMM cause set to "No suitable cells in tracking area" }
```

```

    then { UE set the EPS update status to EU3 ROAMING NOT ALLOWED, UE deletes any GUTI, last
    visited registered TAI and KSI, UE enters the state EMM-DEREGISTERED.LIMITED-SERVICE and UE stores
    the current TAI in the list of "forbidden tracking areas for roaming" }
  }

```

(2)

```

with { UE is in EMM-DEREGISTERED.LIMITED-SERVICE state and the current TAI in the list of "forbidden
tracking areas for roaming" }
ensure that {
  when { UE re-selects a cell that belongs to the TAI where UE was rejected }
  then { UE does not attempt to attach }
}

```

(3)

```

with { UE is in EMM-DEREGISTERED.LIMITED-SERVICE state and the current TAI in the list of "forbidden
tracking areas for roaming" and KSI was deleted }
ensure that {
  when { in the same PLMN, UE enters a cell which provides normal service and belongs to the
tracking area not in the list of "forbidden tracking areas for roaming" }
  then { UE attempts to attach with IMSI indicated that no key is available }
}

```

(4)

```

with { UE is in EMM-DEREGISTERED.LIMITED-SERVICE state and the current TAI in the list of "forbidden
tracking areas for roaming" }
ensure that {
  when { there are cells in the same PLMN and other PLMN that provide normal service and belong to
the tracking area not in the list of "forbidden tracking areas for roaming" }
  then { UE attempts to attach to the cell in the same PLMN }
}

```

(5)

```

with { UE is in EMM-DEREGISTERED.LIMITED-SERVICE state and the list of "forbidden tracking areas for
roaming" contains more than one TAI }
ensure that {
  when { UE re-selects a cell that belongs to one of the TAIs in the list of "forbidden tracking
areas for roaming" }
  then { UE does not attempt to attach }
}

```

(6)

```

with { UE is swithched off }
ensure that {
  when { UE is powered on in the cell belonging to the TAI which was in the list of "forbidden
tracking areas for roaming" before the UE was swithched off }
  then { UE attempts to attach }
}

```

9.2.1.1.17.2 Conformance requirements

References: The conformance requirements covered in the present TC are specified in: TS 24.301, clauses 5.3.2, 5.5.1.2.2 and 5.5.1.2.5.

[TS 24.301, clause 5.3.2]

The UE shall store a list of "forbidden tracking areas for roaming", as well as a list of "forbidden tracking areas for regional provision of service". These lists shall be erased when the UE is switched off or when the USIM is removed, and periodically (with a period in the range 12 to 24 hours).

...

In S1 mode, the UE shall update the suitable list whenever an ATTACH REJECT, TRACKING AREA UPDATE REJECT, SERVICE REJECT or DETACH REQUEST message is received with the EMM cause #13 "roaming not allowed in this tracking area", #12 "tracking area not allowed", or #15 "no suitable cells in tracking area".

Each list shall accommodate 40 or more TAIs. When the list is full and a new entry has to be inserted, the oldest entry shall be deleted.

...

[TS 24.301, clause 5.5.1.2.2]

In state EMM-DEREGISTERED, the UE initiates the attach procedure by sending an ATTACH REQUEST message to the MME, starting timer T3410 and entering state EMM-REGISTERED-INITIATED (see example in figure 5.5.1.2.2.1).

...

The UE shall include in the ATTACH REQUEST message a valid GUTI together with the last visited registered TAI, if available. If there is no valid GUTI available, the UE shall include the IMSI in the ATTACH REQUEST message.

...

The UE shall send the ATTACH REQUEST message together with a PDN CONNECTIVITY REQUEST message contained in the ESM message container information element to request PDN connectivity.

...

[TS 24.301, clause 5.5.1.2.5]

If the attach request cannot be accepted by the network, the MME shall send an ATTACH REJECT message to the UE including an appropriate EMM cause value.

...

Upon receiving the ATTACH REJECT message, the UE shall stop timer T3410 and take the following actions depending on the EMM cause value received.

...

#15 (No suitable cells in tracking area);

The UE shall set the EPS update status to EU3 ROAMING NOT ALLOWED (and shall store it according to subclause 5.1.3.3) and shall delete any GUTI, last visited registered TAI and KSI. Additionally, the UE shall reset the attach attempt counter.

In S1 mode, the UE shall store the current TAI in the list of "forbidden tracking areas for roaming" and enter the state EMM-DEREGISTERED.LIMITED-SERVICE.

The UE shall search for a suitable cell in another tracking area or in another location area in the same PLMN according to 3GPP TS 36.304 [21].

...

9.2.1.1.17.3 Test description

9.2.1.1.17.3.1 Pre-test conditions

System Simulator:

- Cell I, Cell J, Cell K and Cell L are configured according to Table 6.3.2.2-1 in [18] (maximum 3 cells are simultaneously active):
 - Cell I and Cell K (visited PLMN, same TA)
 - Cell L (same visited PLMN, another TA)
 - Cell J (another VPLMN).

NOTE 1: Cell L is present to confirm that UE searches in the same PLMN after reject from the SS

NOTE 2: Cell K is present to confirm that UE shall not attempt attach to the cell in same TAI it was once rejected from.

NOTE 3: The requirement in 3GPP TS 24.301 to store at least 40 entries in the list of "forbidden tracking areas for roaming" is not fully tested.

NOTE 4: Different types of UE may use different methods to periodically clear the list of forbidden areas (e.g. every day at 12 am) for roaming. If the list is cleared while the test is being run, it may be necessary to re-run the test.

UE:

- The USIM contains IMSI-1, GUTI-1 and TAI-1 (MCC1/MNC1/TAC1), and EPS update status is "EU1: UPDATED".

Preamble:

- The UE is in state Switched OFF (state 1) according to clause [18].

9.2.1.1.17.3.2 Test procedure sequence

Table 9.2.1.1.17.3.2-1: Main behaviour

St	Procedure	Message Sequence		TP	Verdict
		U - S	Message		
1	The SS configures: Cell I as the "Serving cell", Cell K as a "Suitable cell", Cell L as a "Non-Suitable cell", Cell J as a "Non-Suitable cell".	-	-	-	-
2	The UE is switched on.	-	-	-	-
3	The UE transmits an ATTACH REQUEST message including a PDN CONNECTIVITY REQUEST message as specified on Cell I.	-->	ATTACH REQUEST	-	-
4	The SS transmits an ATTACH REJECT message, EMM cause = "No suitable cells in tracking area". (The list of "forbidden tracking areas for roaming" in the UE should now contain TAI-9)	<--	ATTACH REJECT	-	-
5	The SS releases the RRC connection.	-	-	-	-
6	Check: Does the UE transmit an ATTACH REQUEST message in the next 30 seconds on Cell I or Cell K?	-->	ATTACH REQUEST	1	F
7	The SS reconfigures: Cell I as a "Suitable cell", Cell K as the "Serving cell", Cell L as a "Non-Suitable cell", Cell J as a "Non-Suitable cell".	-	-	-	-
8	Check: Does the UE transmit an ATTACH REQUEST message in the next 30 seconds on Cell K or Cell I?	-->	ATTACH REQUEST	2	F
9	The SS reconfigures: Cell I as a " Non-Suitable cell", Cell K is the "Serving cell", Cell L as a "Suitable cell", Cell J as a "Suitable cell".	-	-	-	-
10	Check: Does the UE transmit an ATTACH REQUEST message including a PDN CONNECTIVITY REQUEST message as specified on Cell L?	-->	ATTACH REQUEST	3, 4	P
11	The SS transmits an ATTACH REJECT message, EMM cause = "Tracking area not allowed". (The list of "forbidden tracking areas for roaming" in the UE should now contain TAI-9 and TAI-11)	<--	ATTACH REJECT	-	-
12	The SS releases the RRC connection.	-	-	-	-
13	The SS reconfigures: Cell I as the "Serving cell". Cell K as a "Non-Suitable cell", Cell L as a " Suitable cell", Cell J as a "Non-Suitable cell".	-	-	-	-
14	Check: Does the UE transmit the ATTACH REQUEST message in the next 30 seconds?	-->	ATTACH REQUEST	5	F
15	If possible (see ICS) switch off is performed. Otherwise the power is removed.	-	-	-	-
16	The UE is brought back to operation.	-	-	-	-
17	The following message is sent on Cell I.	-	-	-	-
18	Check: Does the UE transmit an ATTACH REQUEST message including a PDN CONNECTIVITY REQUEST message as specified on Cell I?	-->	ATTACH REQUEST	6	P
19	The SS transmits an AUTHENTICATION REQUEST message to initiate the EPS authentication and AKA procedure.	<--	AUTHENTICATION REQUEST	-	-

20	The UE transmits an AUTHENTICATION RESPONSE message.	-->	AUTHENTICATION RESPONSE	-	-
21	The SS transmits a NAS SECURITY MODE COMMAND message to activate NAS security.	<--	SECURITY MODE COMMAND	-	-
22	The UE transmits a NAS SECURITY MODE COMPLETE message and establishes the initial security configuration.	-->	SECURITY MODE COMPLETE	-	-
23	The SS transmits an ATTACH ACCEPT message including an ACTIVATE DEFAULT EPS BEARER CONTEXT REQUEST message.	<--	ATTACH ACCEPT	-	-
24	The UE transmits an ATTACH COMPLETE message including an ACTIVATE DEFAULT EPS BEARER CONTEXT ACCEPT message.	-->	ATTACH COMPLETE	-	-

9.2.1.1.17.3.3 Specific message contents

Table 9.2.1.1.17.3.3-1: Message ATTACH REJECT (step 4 and 11 Table 9.2.1.1.17.3.2-1)

Derivation Path: TS 36.508 Table 4.7.2.3			
Information Element	Value/remark	Comment	Condition
Security header type	0000	"No security protection"	
EMM cause	0000 1111	#15 "No suitable cells in tracking area"	
ESM message container	Not present		

Table 9.2.1.1.17.3.3-2: Message ATTACH REQUEST (step 10 Table 9.2.1.1.17.3.2-1)

Derivation Path: TS 36.508 Table 4.7.2.4			
Information Element	Value/remark	Comment	Condition
NAS key set identifier	111	"No key is available"	
Old GUTI or IMSI	IMSI1	GUTI has been deleted after receiving ATTACH REJECT at step 4; only IMSI is available.	
Last visited registered TAI	Not present	TAI has been deleted after receiving ATTACH REJECT at step 4.	

9.2.1.1.19 Attach / Abnormal case / Failure due to non integrity protection

9.2.1.1.19.1 Test Purpose (TP)

(1)

```
with { UE has not performed NAS security mode control procedure }
ensure that {
  when { UE receives an ATTACH ACCEPT messages without NAS integrity protection }
  then { UE discards this message }
}
```

(2)

```
with { a valid NAS security context exists and the NAS security mode control procedure has been
successfully completed in the network and the UE }
ensure that {
  when { UE receives a NAS signalling message without integrity protection }
  then { UE discards this NAS signalling message }
}
```

9.2.1.1.19.2 Conformance requirements

References: The conformance requirements covered in the present TC are specified in: TS 24.301, clauses 4.4.3.1, 4.4.3.2 and 5.5.2.2.1.

[TS 24.301, clause 4.4.3.1]

Integrity protected signalling is mandatory for the NAS messages once a valid NAS security context exists and the NAS security mode control procedure has been successfully completed in the network and the UE. Integrity protection of all NAS signalling messages is the responsibility of the NAS layer. It is the network which activates integrity protection.

[TS 24.301, clause 4.4.3.2]

Except the messages listed below, no NAS signalling messages shall be processed by the receiving EMM entity or forwarded to the ESM entity, unless the NAS security mode control procedure has been successfully completed:

- EMM messages:
- IDENTITY REQUEST (if requested identification parameter is IMSI);
- AUTHENTICATION REQUEST;
- AUTHENTICATION REJECT;
- ATTACH REJECT;
- DETACH REQUEST;
- DETACH ACCEPT (for non switch off);
- TRACKING AREA UPDATE REJECT;
- SERVICE REJECT.

NOTE: These messages are accepted by the UE without integrity protection, as in certain situations they are sent by the network before security can be activated.

Editor's note: The messages in this list need to fulfil one or several SA3 requirement(s) as follows: the message may be sent before the security mode control procedure is performed, or when too much complexity would be involved if the message were received with integrity protection.

Once integrity protection is activated, the receiving EMM or ESM entity in the UE shall not process any NAS signalling messages unless they have been successfully integrity checked by the NAS layer. If NAS signalling messages, having not successfully passed the integrity check, are received, then the NAS layer in the UE shall discard that message. If any NAS signalling message is received, as not integrity protected even though the integrity protection has been activated in the UE by the network, then the NAS layer shall discard this message.

[TS 24.301, clause 5.5.2.2.1]

...

If the UE is to be switched off, the UE shall try for a period of 5 seconds to send the DETACH REQUEST message. During this period, the UE may be switched off as soon as the DETACH REQUEST message has been sent. After transmission of the message, the UE shall delete the KSI, if any.

...

9.2.1.1.19.3 Test description

9.2.1.1.19.3.1 Pre-test conditions

System Simulator:

- Cell 1

UE:

- The test USIM contains GUTI1 and TAI1, and EPS update status is "EU1: UPDATED".

Preamble:

- The UE is in state Switched OFF (state 1) according to [18].

9.2.1.1.19.3.2 Test procedure sequence

Table 9.2.1.1.19.3.2-1: Main behaviour

St	Procedure	Message Sequence		TP	Verdict
		U - S	Message		
1	The UE is switched on.	-	-	-	-
2	The UE transmits an ATTACH REQUEST message including a PDN CONNECTIVITY REQUEST message. Note: The ATTACH REQUEST message shall be sent as a plain NAS message (see TS 24.301 – clause 9.1).	-->	ATTACH REQUEST	-	-
3	The SS transmits an ATTACH ACCEPT although UE has not successfully completed any NAS security mode control procedure. Note: The ATTACH ACCEPT message is sent as a plain NAS message (see TS 24.301 – clause 9.1).	<--	ATTACH ACCEPT	-	-
4	Check: Does the UE transmit an ATTACH COMPLETE message within the next 1s? Note: the UE discards ATTACH ACCEPT message without security protection	-->	ATTACH COMPLETE	1	F
5	The SS transmits an AUTHENTICATION REQUEST message to initiate the EPS authentication and AKA procedure.	<--	AUTHENTICATION REQUEST	-	-
6	The UE transmits an AUTHENTICATION RESPONSE message to establish mutual authentication.	-->	AUTHENTICATION RESPONSE	-	-
7	The SS transmits a SECURITY MODE COMMAND message to activate NAS security.	<--	SECURITY MODE COMMAND	-	-
8	The UE transmits a SECURITY MODE COMPLETE message and establishes the initial security configuration.	-->	SECURITY MODE COMPLETE	-	-
9	The SS transmits an ATTACH ACCEPT without integrity protection. Note: The ATTACH ACCEPT message is sent as a plain NAS message (see TS 24.301 – clause 9.1).	<--	ATTACH ACCEPT	-	-
10	Check: Does the UE transmit an ATTACH COMPLETE message within the next 1s? Note: the UE discards ATTACH ACCEPT message without security protection	-->	ATTACH COMPLETE	2	F
11	The SS transmits an ATTACH ACCEPT message including an ACTIVATE DEFAULT EPS BEARER CONTEXT REQUEST. Note: The ATTACH ACCEPT message is sent as a security protected NAS message (see TS 24.301 – clause 9.1). Nota 1: SS allocates a PDN address of a PDN type which is compliant with from the PDN type requested by the UE.	<--	ATTACH ACCEPT	-	-
12	Check: Does the UE transmit an ATTACH COMPLETE message including a ACTIVATE DEFAULT EPS BEARER CONTEXT ACCEPT message as specified? Note: The ATTACH COMPLETE message is sent as a security protected NAS message (see TS 24.301 – clause 9.1).	-->	ATTACH COMPLETE	2	P
13	The SS releases the RRC connection.	-	-	-	-
14	Check : Does the test results of CALL generic	-	-	1, 2	-

	<p>procedure [18] indicate that the UE is in E-UTRA EMM-REGISTERED state with S-TMSI3?</p> <p>Note: This step verifies that the UE has dropped the GUTI2 which was included in the unprotected ATTACH ACCEPT messages.</p>				
--	--	--	--	--	--

9.2.1.1.19.3.3 Specific message contents

Table 9.2.1.1.19.3.3-1: Message ATTACH ACCEPT (steps 3 and 9, Table 9.2.1.1.19.3.2-1)

Derivation path: 36.508 table 4.7.2-1 (Plain NAS message)			
Information Element	Value/Remark	Comment	Condition
Security header type	0000	"no security protection"	NOT pc_CSfallb ack
EPS attach result	001	"EPS only"	
	010	"combined EPS/IMSI attach"	pc_CSfallb ack
Spare half octet	0000		
TAI list		List of 3 TAIs	
Length of tracking area identity list contents	12		
Number of elements	3		
Type of list	000	One PLMN with non-consecutive TACs	
Partial tracking area identity list	PLMN = PLMN1 TAC1 = TAC1 TAC2 = TAC2 TAC3 = TAC3	3 TACs including the TAI including "Last visited registered TAI" if present	
GUTI	GUTI2	The SS chooses a value different from GUTI1.	
Location area identification	Not present		
MS identity	Not Present		
EMM cause	Not present		

NOTE: This message is voluntarily sent as a plain NAS message (see TS 24.301 – clause 9.1).

Table 9.2.1.1.19.3.3-2: Message ATTACH ACCEPT (step 11, Table 9.2.1.1.19.3.2-1)

Derivation path: 36.508 table 4.7.2-1 (Security protected NAS message)			
Information Element	Value/Remark	Comment	Condition
Security header type	0000	"no security protection"	
EPS attach result	001	"EPS only"	NOT
	010	"combined EPS/IMSI attach"	pc_CSfallb ack
Spare half octet	0000		pc_CSfallb ack
TAI list		List of 3 TAIs	
Length of tracking area identity list contents	12		
Number of elements	3		
Type of list	000	One PLMN with non-consecutive TACs	
Partial tracking area identity list	PLMN = PLMN1 TAC1 = TAC1 TAC2 = TAC2 TAC3 = TAC3	3 TACs including the TAI including "Last visited registered TAI" if present	
GUTI	GUTI3	The SS chooses a value different from GUTI1 and GUTI2.	
Location area identification	Not present		
MS identity	Not Present		
EMM cause	Not present		

9.2.1.1.20 Attach / Abnormal case / Access barred because of access class barring or NAS signalling connection establishment rejected by the network

9.2.1.1.20.1 Test Purpose (TP)

(1)

```
with { UE switched-on, and not yet attached to EPS }
ensure that {
  when { Access is barred for signalling in the cell UE is camping [Access Class barred in System information] }
  then { the UE will not initiate any Attach procedure }
}
```

(2)

```
with { UE switched-on, and not yet attached to EPS }
ensure that {
  when { Access is barred for signalling in the cell UE is camping [T302 runing due to RRCConnectionReject message reception] }
  then { the UE will not initiate any Attach procedure }
}
```

(3)

```
with { UE switched-on, and not yet attached to EPS }
ensure that {
  when { Access is not barred for signalling in the cell UE is camping }
  then { the UE will initiate Attach procedure }
}
```

9.2.1.1.20.2 Conformance requirements

References: The conformance requirements covered in the current TC are specified in: TS 24.301, clause 5.5.1.2.6 and TS 36.331, clause 5.3.3.2

[TS 24.301, clause 5.5.1.2.6]

The following abnormal cases can be identified:

- a) Access barred because of access class barring or NAS signalling connection establishment rejected by the network

If access is barred for "signalling" (see 3GPP TS 36.331 [22]), the attach procedure shall not be started. The UE stays in the current serving cell and applies the normal cell reselection process. The attach procedure is started as soon as possible, i.e. when access for "signalling" is granted on the current cell or when the UE moves to a cell where access for "signalling" is granted.

[TS 36.331, clause 5. 3.3.2]

- 1> else (the UE is establishing the RRC connection for mobile originating signalling):
 - 2> if timer T302 or T305 is running:
 - 3> consider access to the cell as barred;
 - 2> else if *SystemInformationBlockType2* includes the *ac-BarringInformation* and the *ac-BarringForMO-Signalling* is present:
 - 3> if the UE has one or more Access Classes, as stored on the USIM, with a value in the range 11..15, which is valid for the UE to use according to TS 22.011 [10] and TS 23.122 [11], and
 - 3> for at least one of these Access Classes the corresponding bit in the *ac-BarringForSpecialAC* contained in *ac-BarringForMO-Signalling* is set to zero:
 - 4> consider access to the cell as not barred;
 - 3> else:
 - 4> draw a random number '*rand*' uniformly distributed in the range: $0 \leq rand < 1$;
 - 4> if '*rand*' is lower than the value indicated by *accessProbabilityFactor* included in *accessBarringForSignalling*:
 - 5> consider access to the cell as not barred;
 - 4> else:
 - 5> consider access to the cell as barred;
 - 2> else:
 - 3> consider access to the cell as not barred;

9.2.1.1.20.3 Test description

9.2.1.1.20.3.1 Pre-test conditions

System Simulator:

- Cell A
- Cell A is the serving cell with TAI1 (PLMN1+TAC1);

UE:

- The test USIM contains a valid GUTI1 and TAI1, and EPS update status is "EU1: UPDATED".

Preamble:

- The UE is in state Switched OFF (state 1) according to [18].

9.2.1.1.20.3.2 Test procedure sequence

Table 9.2.1.1.1.3.2-1: Main behaviour

St	Procedure	Message Sequence		TP	Verdict
		U - S	Message		
1	The UE is switched on.	-	-	-	-
2	Check: for 5 seconds if UE initiates Attach procedure and hence transmits RRC Connection Request?	-	-	1	F
3	The SS transmits a Paging message including systemInfoModification.	-	-	-	-
4	The SS changes SystemInformationBlockType2 parameters to default parameters defined in [18].	-	-	-	-
5	The UE transmits RRC Connection Request	-	-	-	-
6	SS responds with <i>RRCCConnectionReject</i> message with IE <i>waitTime</i> set to 10 seconds(Max Value).	-	-	-	-
7	Check: for 10 seconds if UE initiates Attach procedure and hence transmits RRC Connection Request?	-	-	2	F
8	Check: Does the UE transmit an ATTACH REQUEST message including a PDN CONNECTIVITY REQUEST message?	-->	ATTACH REQUEST	3	P
9	The SS transmits an AUTHENTICATION REQUEST message to initiate the EPS authentication and AKA procedure.	<--	AUTHENTICATION REQUEST	-	-
10	The UE transmits an AUTHENTICATION RESPONSE message and establishes mutual authentication.	-->	AUTHENTICATION RESPONSE	-	-
11	The SS transmits a NAS SECURITY MODE COMMAND message to activate NAS security.	<--	SECURITY MODE COMMAND	-	-
12	The UE transmits a NAS SECURITY MODE COMPLETE message and establishes the initial security configuration.	-->	SECURITY MODE COMPLETE	-	-
13	SS responds with ATTACH ACCEPT message including a valid TAI list. The ACTIVATE DEFAULT EPS BEARER CONTEXT REQUEST message is piggybacked in ATTACH ACCEPT message Note: The IP addresses of the UE are not allocated in this test so PDN address is not included in the message..	<--	ATTACH ACCEPT	-	-
14	Check: does the UE transmit an ATTACH COMPLETE message including an ACTIVATE DEFAULT EPS BEARER CONTEXT ACCEPT message?	-->	ATTACH COMPLETE	-	-
15	The SS releases the RRC connection.	-	-	-	-

9.2.1.1.20.3 Specific message contents

Table 9.2.1.1.20.3.3-1: SystemInformationBlockType2 for Cell A (preamble)

Derivation Path: 36.508, Table 4.4.3.3-1			
Information Element	Value/remark	Comment	Condition
SystemInformationBlockType2 ::= SEQUENCE {			
accessBarringInformation SEQUENCE {			
accessBarringForEmergencyCalls	FALSE		
accessBarringForSignalling SEQUENCE {			
accessProbabilityFactor	p00		
accessBarringTime	s4		
accessClassBarringList SEQUENCE (SIZE (maxAC)) OF SEQUENCE {	5 entries		
accessClassBarring[1]	TRUE		
accessClassBarring[2]	TRUE		
accessClassBarring[3]	TRUE		
accessClassBarring[4]	TRUE		
accessClassBarring[5]	TRUE		
}			
}			
accessBarringForOriginatingCalls	Not present		
}			
}			

9.2.1.1.25 Attach / Abnormal case / Mobile originated detach required

9.2.1.1.25.1 Test Purpose (TP)

(1)

```

with { UE in EMM-REGISTERED-INITIATED state }
ensure that {
  when { the UE initiates mobile originated detach }
  then { the UE aborts the attach procedure }
}

```

9.2.1.1.25.2 Conformance requirements

References: The conformance requirements covered in the current TC are specified in: TS 24.301, clause 5.5.1.2.6.

[TS 24.301, clause 5.5.1.2.6]

The following abnormal cases can be identified:

- f) Mobile originated detach required

The attach procedure shall be aborted, and the UE initiated detach procedure shall be performed.

9.2.1.1.25.3 Test description

9.2.1.1.25.3.1 Pre-test conditions

System Simulator:

- Cell 1

UE:

- None

Preamble:

- The UE is in state Switched OFF (state 1) according to [18].

- The UE has a valid GUTI-1.

9.2.1.1.25.3.2 Test procedure sequence

Table 9.2.1.1.25.3.2-1: Main behaviour

St	Procedure	Message Sequence		TP	Verdict
		U - S	Message		
1	The UE is switched on.	-	-	-	-
2	The UE transmits an ATTACH REQUEST message.	-->	ATTACH REQUEST	-	-
3	The SS transmits an AUTHENTICATION REQUEST message to initiate the EPS authentication and AKA procedure.	<--	AUTHENTICATION REQUEST	-	-
4	The UE transmits an AUTHENTICATION RESPONSE message and establishes mutual authentication.	-->	AUTHENTICATION RESPONSE	-	-
5	The SS transmits a NAS SECURITY MODE COMMAND message to activate NAS security.	<--	SECURITY MODE COMMAND	-	-
6	The UE transmits a NAS SECURITY MODE COMPLETE message and establishes the initial security configuration.	-->	SECURITY MODE COMPLETE	-	-
7	The SS does not respond to ATTACH REQUEST message.	-	-	-	-
8	Check: Does the UE initiate mobile originated detach and abort the attach procedure while T3410 is running.	-->	DETACH REQUEST	1	P
9	The SS transmits DETACH ACCEPT message.	<--	DETACH ACCEPT	-	-
10	The SS starts a paging procedure using the previously allocated identifiers.	-	-	-	-
11	Check: does the UE respond to the paging?	-	-	1	F

Note: T3410 value is specified as 15s in TS 24.301.

9.2.1.1.25.3.3 Specific message contents

Table 9.2.1.1.25.3.3-1: Message DETACH REQUEST (step 8, Table 9.2.1.1.25.3.2-1)

Derivation path: 36.508 table 4.7.2-11			
Information Element	Value/Remark	Comment	Condition
Detach type	0001	Normal EPS detach	

9.2.1.2 Combined attach procedure for EPS services and non-EPS services

9.2.1.2.1 Combined attach procedure / Success /EPS and non-EPS services

9.2.1.2.1.1 Test Purpose (TP)

(1)

```
with { UE in state EMM-DEREGISTERED and is switched off }
ensure that {
  when { UE is powered up or switched on }
  then { UE sends ATTACH REQUEST message with EPS attach type IE 'combined EPS/IMSI attach' }
}
```

(2)

```
with { UE in state EMM-REGISTERED-INITIATED }
ensure that {
  when { UE receives ATTACH ACCEPT message with EPS attach result 'combined EPS/IMSI attach' }
  then { UE sends ATTACH COMPLETE message and enters EMM state EMM-REGISTERED and MM state MM-IDLE }
}
```

9.2.1.2.1.2 Conformance requirements

References: The conformance requirements covered in the present TC are specified in: 3GPP TS 24.301 clauses 5.5.1.3.2, 5.5.1.3.4.1 and 5.5.1.3.4.2.

[TS24.301 clause5.5.1.3.2]

If the UE is in EMM state EMM-DEREGISTERED, the UE initiates the combined attach procedure by sending an ATTACH REQUEST message to the network, starting timer T3410 and entering state EMM-REGISTERED-INITIATED (see figure 5.5.1.2.2.1).

The UE shall include a valid GUTI together with the last visited registered TAI in the ATTACH REQUEST message. If there is no valid GUTI available, the IMSI shall be included instead of the GUTI.

[TS24.301 clause5.5.1.3.4.1]

Depending on the value of the EPS attach result IE received in the ATTACH ACCEPT message, two different cases can be distinguished:

- 1) The EPS attach result IE value indicates "combined EPS/IMSI attach": attach for EPS and non-EPS services have been successful.

...

[TS24.301 clause5.5.1.3.4.2]

The description for attach for EPS services as specified in subclause 5.5.1.2.4 shall be followed. In addition, the following description for attach for non-EPS services applies.

The TMSI reallocation may be part of the combined attach procedure. The TMSI allocated is then included in the ATTACH ACCEPT message, together with the location area identification (LAI). In this case the MME shall start timer T3450 and enter state EMM-COMMON-PROCEDURE-INITIATED as described in subclause 5.4.1.

The UE, receiving an ATTACH ACCEPT message, stores the received location area identification, stops timer T3410, resets the location update attempt counter and sets the update status to U1 UPDATED. If the message contains a mobile identity, the MS shall use this mobile identity as the new temporary identity. The UE shall delete its old mobile identity and shall store the new mobile identity. If no mobile identity has been included by the network in the ATTACH ACCEPT message, the old mobile identity, if any available, shall be kept. The UE shall enter EMM state EMM-REGISTERED and MM state MM-IDLE.

Upon receiving an ATTACH COMPLETE message, the MME shall stop timer T3450 and consider the new TMSI sent in the ATTACH ACCEPT message as valid.

9.2.1.2.1.3 Test description

9.2.1.2.1.3.1 Pre-test conditions

System Simulator:

- Cell 1
 - Cell 1 belongs to TAI-1(MCC1/MNC1/TAC1)..

UE:

- The UE has a valid GUTI (GUTI-1).

Preamble:

- The UE is in state Switched OFF (state 1) according to [18].

9.2.1.2.1.3.2 Test procedure sequence

Table 9.2.1.2.1.3.2-1: Main Behaviour

St	Procedure	Message Sequence		TP	Verdict
		U - S	Message		
1	The UE is powered up or switched on.			-	-
2	The UE transmits ATTACH REQUEST message with a PDN CONNECTIVITY REQUEST message to request PDN connectivity to the default PDN. EPS attach type = "combined EPS/IMSI attach"	-->	ATTACH REQUEST	1	P
3	The SS starts an authentication procedure	<--	AUTHENTICATION REQUEST	-	-
4	The UE responds properly to the authentication procedure	-->	AUTHENTICATION RESPONSE	-	-
5	The SS starts a NAS security mode command procedure to perform NAS integrity protection.	<--	SECURITY MODE COMMAND	-	-
6	The UE responds properly to the NAS security mode command procedure	-->	SECURITY MODE COMPLETE	-	-
7	The SS sends ATTACH ACCEPT message with the ACTIVATE DEFAULT EPS BEARER CONTEXT REQUEST message.	<--	ATTACH ACCEPT	-	-
8	Check: Does the UE send ATTACH COMPLETE message with the ACTIVATE DEFAULT EPS BEARER CONTEXT ACCEPT message.	-->	ATTACH COMPLETE	2	P
9	The SS releases the RRC connection.			-	-
10	The SS sends Paging message with S-TMSI2 in GUTI-2 to the UE.	-	-	-	-
11	Check: Does the UE initiates RRC Connection establishment?	-	-	2	P
12	The SS sends Paging message with TMSI-1 to the UE (FFS).	<--	Paging	-	-
13	Check: Does the UE perform CS fallback? (FFS)			2	P

9.2.1.2.1.3.3 Specific message contents

Editor's note: this subclause is not complete yet.

Table 9.2.1.2.1.3.3-1: Message ATTACH REQUEST (step 2, Table 9.2.1.2.1.3.2-1)

Derivation path: 36.508 table xxx			
Information Element	Value/Remark	Comment	Condition
Old GUTI or IMSI	GUTI-1		
EPS attach type	combined EPS/IMSI attach		

Table 9.2.1.2.1.3.3-2: Message ATTACH ACCEPT (step 7, Table 9.2.1.2.1.3.2-1)

Derivation path: 36.508 table xxx			
Information Element	Value/Remark	Comment	Condition
EPS attach result	combined EPS/IMSI attach		
GUTI	GUTI-2		
LAI	LAI-1		
MS identity	TMSI-1		

9.2.1.2.2 Combined attach procedure / Success / EPS services only / IMSI unknown in HSS

9.2.1.2.2.1 Test Purpose (TP)

(1)

```
with { CS fallback capable UE in state EMM-DEREGISTERED and is switched off }
ensure that {
  when { the UE is powered up or switched on }
  then { the UE transmits an ATTACH REQUEST message with the EPS attach type set to "combined
EPS/IMSI attach" and enters EMM-REGISTERED-INITIATED state }
}
```

(2)

```
with { CS fallback capable UE in state EMM-REGISTERED-INITIATED }
ensure that {
  when { UE receives an ATTACH ACCEPT message with EPS attach result set to "EPS only" and EMM
reject cause set to "IMSI unknown in HSS" }
  then { the UE transmits an ATTACH COMPLETE message and enters EMM-REGISTERED state }
}
```

(3)

```
with { CS fallback capable UE in E-UTRA EMM-REGISTERED state and USIM is invalidated by network for
non-EPS services }
ensure that {
  when { the UE receives a paging message for non-EPS service including GUTI or IMSI }
  then { the UE doesn't answer to paging }
}
```

9.2.1.2.2.2 Conformance requirements

References: The conformance requirements covered in the present TC are specified in: TS 24.301, clauses 4.3, 5.5.1.2.2, 5.5.1.2.4, 5.5.1.3.1, 5.5.1.3.2, 5.5.1.3.4.1, 5.5.1.3.4.2, and 5.5.1.3.4.3.

[TS24.301 clause 4.3]

A UE attached for EPS services may operate in one of the following operation modes:

...

- CS/PS mode 1 of operation: the UE is CS fallback capable and configured to use CS fallback, and non-EPS services are preferred. The UE registers to both EPS and non-EPS services; and
- CS/PS mode 2 of operation: the UE is CS fallback capable and configured to use CS fallback, and EPS services are preferred. The UE registers to both EPS and non-EPS services.

[TS 24.301, clause 5.5.1.2.2]

In state EMM-DEREGISTERED, the UE initiates the attach procedure by sending an ATTACH REQUEST message to the MME, starting timer T3410 and entering state EMM-REGISTERED-INITIATED (see example in figure 5.5.1.2.2.1). If timer T3402 is currently running, the UE shall stop timer T3402. If timer T3411 is currently running, the UE shall stop timer T3411. The UE shall include in the ATTACH REQUEST message a valid GUTI together with the last visited registered TAI, if available. If there is no valid GUTI available, the UE shall include the IMSI in the ATTACH REQUEST message.

...

[TS 24.301, clause 5.5.1.2.4]

If the attach request is accepted by the network, the MME shall send an ATTACH ACCEPT message to the UE and start timer T3450. The MME shall send the ATTACH ACCEPT message together with an ACTIVATE DEFAULT EPS BEARER CONTEXT REQUEST message contained in the ESM message container information element to activate the default bearer (see subclause 6.4.1). The network may also initiate the activation of dedicated bearers towards the UE by invoking the dedicated EPS bearer context activation procedure (see subclause 6.4.2).

...

The MME shall assign and include the TAI list the UE is registered to in the ATTACH ACCEPT message. The UE, upon receiving an ATTACH ACCEPT message, shall delete its old TAI list and store the received TAI list.

Upon receiving the ATTACH ACCEPT message, the UE shall stop timer T3410.

The GUTI reallocation may be part of the attach procedure. When the ATTACH REQUEST message includes the IMSI, or the MME considers the GUTI provided by the UE is invalid, or the GUTI provided by the UE was assigned by another MME, the MME shall allocate a new GUTI to the UE. The MME shall include in the ATTACH ACCEPT message the new assigned GUTI together with the assigned TAI list. In this case the MME shall enter state EMM-COMMON-PROCEDURE-INITIATED as described in subclause 5.4.1.

...

If the ATTACH ACCEPT message contains a GUTI, the UE shall use this GUTI as the new temporary identity. The UE shall delete its old GUTI and store the new assigned GUTI. If no GUTI has been included by the MME in the ATTACH ACCEPT message, the old GUTI, if any available, shall be kept.

If A/Gb mode or Iu mode is supported in the UE, the UE shall set its TIN to "GUTI" when receiving the ATTACH ACCEPT message.

...

When the UE receives the ATTACH ACCEPT message combined with the ACTIVATE DEFAULT EPS BEARER CONTEXT REQUEST message, it shall forward the ACTIVATE DEFAULT EPS BEARER CONTEXT REQUEST message to the ESM sublayer. Upon receipt of an indication from the ESM sublayer that the default EPS bearer context has been activated, the UE shall send an ATTACH COMPLETE message together with an ACTIVATE DEFAULT EPS BEARER CONTEXT ACCEPT message contained in the ESM message container information element to the network.

Additionally, the UE shall reset the attach attempt counter and tracking area updating attempt counter, enter state EMM-REGISTERED and set the EPS update status to EU1 UPDATED.

Upon receiving an ATTACH COMPLETE message, the MME shall stop timer T3450, enter state EMM-REGISTERED and consider the GUTI sent in the ATTACH ACCEPT message as valid.

[TS 24.301, clause 5.5.1.3.1]

The combined EPS attach procedure is used by a UE in CS/PS mode 1 or CS/PS mode 2 of operation to attach for both EPS and non-EPS services.

When the UE initiates a combined EPS attach procedure, the UE shall indicate "combined EPS/IMSI attach" in the EPS attach type IE.

The combined EPS attach procedure follows the attach procedure for EPS described in subclause 5.5.1.2.

[TS 24.301, clause 5.5.1.3.2]

If the UE is in EMM state EMM-DEREGISTERED, the UE initiates the combined attach procedure by sending an ATTACH REQUEST message to the network, starting timer T3410 and entering state EMM-REGISTERED-INITIATED (see example in figure 5.5.1.2.2.1).

The UE shall include the TMSI status IE if no valid TMSI is available. Furthermore, if the UE has stored a valid location area identification, the UE shall include it in the Old location area identification IE in the ATTACH REQUEST message.

[TS 24.301, clause 5.5.1.3.4.1]

Depending on the value of the EPS attach result IE received in the ATTACH ACCEPT message, two different cases can be distinguished:

...

- 2) The EPS attach result IE value indicates "EPS only": attach for EPS services has been successful but attach for non-EPS services has failed.

[TS 24.301, clause 5.5.1.3.4.2]

The description for attach for EPS services as specified in subclause 5.5.1.2.4 shall be followed. In addition, the following description for attach for non-EPS services applies.

...

[TS 24.301, clause 5.5.1.3.4.3]

The description for attach for EPS services as specified in subclause 5.5.1.2.4 shall be followed. In addition, the following description for attach for non-EPS services applies.

The UE receiving the ATTACH ACCEPT message takes one of the following actions depending on the EMM cause value:

#2 (IMSI unknown in HSS)

The UE shall stop T3410 if still running. The UE shall set the update status to U3 ROAMING NOT ALLOWED and shall delete any TMSI, LAI and ciphering key sequence number. The UE shall enter state EMM-REGISTERED.NORMAL-SERVICE. The new MM state is MM IDLE. The USIM shall be considered as invalid for non-EPS services until switching off or the UICC containing the USIM is removed.

...

Other reject cause values and the case that no EMM cause IE was received are considered as abnormal cases. The combined attach procedure shall be considered as failed for EPS and non-EPS services. The behaviour of the UE in those cases is specified in subclause 5.5.1.3.6.

9.2.1.2.2.3 Test description

9.2.1.2.2.3.1 Pre-test conditions

System Simulator:

- Cell A is configured according to Table 6.3.2.2-1 in [18].

UE:

- The USIM contains IMSI-1, GUTI-1 and TAI-1, and EPS update status is "EU1: UPDATED", and also P-TMSI signature1.
- The USIM contains TMSI-1 and LAI-1 for CS service, and Location update status is "U1: UPDATED".

Preamble:

- The UE is in state Switched OFF (state 1) according to [18].

NOTE: The PDN type (IPv4, IPv6 or both) of the UE is determined by the PICS.

9.2.1.2.2.3.2 Test procedure sequence

Table 9.2.1.2.2.3.2-1: Main behaviour

St	Procedure	Message Sequence		TP	Verdict
		U - S	Message		
1	The UE is powered up or switched on.	-	-	-	-
2	The UE transmits ATTACH REQUEST message with a PDN CONNECTIVITY REQUEST message to request PDN connectivity to the default PDN with EPS attach type set to "combined EPS/IMSI attach"	-->	ATTACH REQUEST	1	P
3	The SS starts an authentication procedure	<--	AUTHENTICATION REQUEST	-	-
4	The UE transmits an AUTHENTICATION RESPONSE message and establishes mutual authentication.	-->	AUTHENTICATION RESPONSE	-	-
5	The SS starts a NAS security mode command procedure to perform NAS integrity protection.	<--	SECURITY MODE COMMAND	-	-
6	The UE transmits a NAS SECURITY MODE COMPLETE message and establishes the initial security configuration.	-->	SECURITY MODE COMPLETE	-	-
7	The SS transmits ATTACH ACCEPT message with EPS Attach result IE set to "EPS only" including the ACTIVATE DEFAULT EPS BEARER CONTEXT REQUEST message as specified. Note: the SS allocates a PDN address of a PDN type which is compliant with from the PDN type requested by the UE.	<--	ATTACH ACCEPT	-	-
8	Check: Does the UE transmit an ATTACH COMPLETE message including an ACTIVATE DEFAULT EPS BEARER CONTEXT ACCEPT message as specified?	-->	ATTACH COMPLETE	2	P
9	The SS releases the RRC connection.	-	-	-	-
10	Check: Does the UE ignore paging for CS domain with IMSI-1 (generic procedure)? This is verified during 3s.	-	-	3	-
11	Check: Does the UE ignore paging for CS domain with GUTI-2 (generic procedure)?	-	-	3	-
12	Check: Does the UE answer to paging for PS services with GUTI-2 ?	-	-	2	-

NOTE 1: It is assumed in the test procedure sequence that the UE initially has a valid GUTI, hence it is included in ATTACH REQUEST message in step 2. However, it is not important for the test procedure sequence.

NOTE 2: NAS security procedures are not checked in this TC.

9.2.1.2.2.3.3 Specific message contents

Table 9.2.1.2.2.3.3-1: Message ATTACH REQUEST (step 2, Table 9.2.1.2.2.3.2-1)

Derivation path: 36.508 table 4.7.2-4			
Information Element	Value/Remark	Comment	Condition
Old GUTI or IMSI	GUTI-1		
EPS attach type	010	"combined EPS/IMSI attach"	
Last visited registered TAI	TAI-1		
Old location area identification	LAI-1		
TMSI status	1	"valid TMSI available"	

Table 9.2.1.2.3.3-3: Message ATTACH ACCEPT (step 7, Table 9.2.1.2.3.2-1)

Derivation path: 36.508 table 4.7.2-1			
Information Element	Value/Remark	Comment	Condition
EPS attach result	001	"EPS only" The SS accepts Combined attach for EPS services only.	
GUTI	GUTI-2	The SS assigns a new GUTI	
LAI	Not present		
MS identity	Not Present	No TMSI is assigned	
EMM cause	00000010	#2 "IMSI unknown in HSS"	

9.2.1.2.3 Successful combined attach procedure, EPS service only / MSC temporarily not reachable

9.2.1.2.3.1 Test Purpose (TP)

(1)

```
with { the UE has sent a combined ATTACH REQUEST message }
ensure that {
  when { the UE receives an ATTACH ACCEPT message with EPS attach result set to "EPS only" and EMM reject cause set to "MSC temporarily not reachable" or "Network failure" or "Congestion" and including an ACTIVATE DEFAULT EPS BEARER CONTEXT REQUEST message with IE EPS Bearer Identity matching the ATTACH REQUEST message and including a PDN address, an APN and an uplink TFT }
  then { UE transmits an ATTACH COMPLETE message, containing the EPS bearer identity, together with ACTIVATE DEFAULT EPS BEARER CONTEXT ACCEPT message and the UE resets the attach attempt counter and tracking area updating attempt counter and the UE increments tracking area updating attempt counter and starts timer T3411 and enters EMM-REGISTERED.ATTEMPTING-TO-UPDATE-MM state }
}
```

(2)

```
with { the UE is in E-UTRA EMM-REGISTERED.ATTEMPTING-TO-UPDATE-MM state }
ensure that {
  when { timer T3411 expires or timer T3402 expires }
  then { the UE initiates a combined tracking area update procedure indicating "combined TA/LA updating with IMSI attach" }
}
```

(3)

```
with { the UE is in E-UTRA EMM-REGISTERED.ATTEMPTING-TO-UPDATE-MM state }
ensure that {
  when { UE receives a TRACKING AREA UPDATE ACCEPT with EPS update result set to "EPS only" and EMM reject cause set to "MSC temporarily not reachable" or "Network failure" or "Congestion" }
  then { UE increments tracking area updating attempt counter unless it was already set to 5 and starts timer T3411 if tracking area updating attempt counter is less than 5 or starts timer T3402 if tracking area updating attempt counter is equal to 5 }
}
```

9.2.1.2.3.2 Conformance requirements

References: The conformance requirements covered in the present TC are specified in: TS 24.301, clauses 5.5.1.2.4, 5.5.1.3.1, 5.5.1.3.2, 5.5.1.3.4.1, 5.5.1.3.4.2, 5.5.1.3.4.3, and 5.5.3.3.4.3.

[TS 24.301, clause 5.5.1.2.4]

If the attach request is accepted by the network, the MME shall send an ATTACH ACCEPT message to the UE and start timer T3450. The MME shall send the ATTACH ACCEPT message together with an ACTIVATE DEFAULT EPS BEARER CONTEXT REQUEST message contained in the ESM message container information element to activate the default bearer (see subclause 6.4.1). The network may also initiate the activation of dedicated bearers towards the UE by invoking the dedicated EPS bearer context activation procedure (see subclause 6.4.2).

If the attach request is accepted by the network, the MME shall delete the stored UE radio capability information, if any.

If the UE has included the UE network capability IE or the MS network capability IE or both in the ATTACH REQUEST message, the MME shall store all octets received from the UE, up to the maximum length defined for the respective information element.

NOTE: This information is forwarded to the new MME during inter-MME handover or to the new SGSN during inter-system handover to A/Gb mode or Iu mode.

The MME shall assign and include the TAI list the UE is registered to in the ATTACH ACCEPT message. The UE, upon receiving an ATTACH ACCEPT message, shall delete its old TAI list and store the received TAI list.

Upon receiving the ATTACH ACCEPT message, the UE shall stop timer T3410.

The GUTI reallocation may be part of the attach procedure. When the ATTACH REQUEST message includes the IMSI, or the MME considers the GUTI provided by the UE is invalid, or the GUTI provided by the UE was assigned by another MME, the MME shall allocate a new GUTI to the UE. The MME shall include in the ATTACH ACCEPT message the new assigned GUTI together with the assigned TAI list. In this case the MME shall enter state EMM-COMMON-PROCEDURE-INITIATED as described in subclause 5.4.1.

...

If the ATTACH ACCEPT message contains a GUTI, the UE shall use this GUTI as the new temporary identity. The UE shall delete its old GUTI and store the new assigned GUTI. If no GUTI has been included by the MME in the ATTACH ACCEPT message, the old GUTI, if any available, shall be kept.

If A/Gb mode or Iu mode is supported in the UE, the UE shall set its TIN to "GUTI" when receiving the ATTACH ACCEPT message.

...

When the UE receives the ATTACH ACCEPT message combined with the ACTIVATE DEFAULT EPS BEARER CONTEXT REQUEST message, it shall forward the ACTIVATE DEFAULT EPS BEARER CONTEXT REQUEST message to the ESM sublayer. Upon receipt of an indication from the ESM sublayer that the default EPS bearer context has been activated, the UE shall send an ATTACH COMPLETE message together with an ACTIVATE DEFAULT EPS BEARER CONTEXT ACCEPT message contained in the ESM message container information element to the network.

Additionally, the UE shall reset the attach attempt counter and tracking area updating attempt counter, enter state EMM-REGISTERED and set the EPS update status to EU1 UPDATED.

Upon receiving an ATTACH COMPLETE message, the MME shall stop timer T3450, enter state EMM-REGISTERED and consider the GUTI sent in the ATTACH ACCEPT message as valid.

[TS 24.301, clause 5.5.1.3.1]

The combined EPS attach procedure is used by a UE in CS/PS mode 1 or CS/PS mode 2 of operation to attach for both EPS and non-EPS services.

When the UE initiates a combined EPS attach procedure, the UE shall indicate "combined EPS/IMSI attach" in the EPS attach type IE.

The combined EPS attach procedure follows the attach procedure for EPS described in subclause 5.5.1.2.

[TS 24.301, clause 5.5.1.3.2]

If the UE is in EMM state EMM-DEREGISTERED, the UE initiates the combined attach procedure by sending an ATTACH REQUEST message to the network, starting timer T3410 and entering state EMM-REGISTERED-INITIATED (see example in figure 5.5.1.2.2.1).

The UE shall include the TMSI status IE if no valid TMSI is available. Furthermore, if the UE has stored a valid location area identification, the UE shall include it in the Old location area identification IE in the ATTACH REQUEST message.

[TS 24.301, clause 5.5.1.3.4.1]

Depending on the value of the EPS attach result IE received in the ATTACH ACCEPT message, two different cases can be distinguished:

- 1) The EPS attach result IE value indicates "combined EPS/IMSI attach": attach for EPS and non-EPS services have been successful.
- 2) The EPS attach result IE value indicates "EPS only": attach for EPS services has been successful but attach for non-EPS services has failed.

[TS 24.301, clause 5.5.1.3.4.2]

The description for attach for EPS services as specified in subclause 5.5.1.2.4 shall be followed. In addition, the following description for attach for non-EPS services applies.

...

[TS 24.301, clause 5.5.1.3.4.3]

The description for attach for EPS services as specified in subclause 5.5.1.2.4 shall be followed. In addition, the following description for attach for non-EPS services applies.

The UE receiving the ATTACH ACCEPT message takes one of the following actions depending on the EMM cause value:

...

- #16 (MSC temporarily not reachable);
- #17 (Network failure); or
- #22 (Congestion)

The UE shall stop timer T3410 if still running. The tracking area updating attempt counter shall be incremented, unless it was already set to 5.

If the tracking area updating attempt counter is less than 5:

- the UE shall start timer T3411, shall set the EPS update status to EU1 UPDATED and shall enter state EMM-REGISTERED.ATTEMPTING-TO-UPDATE-MM. When timer T3411 expires the combined tracking area updating procedure indicating "combined TA/LA updating with IMSI attach" is triggered.

If the tracking area updating attempt counter is equal to 5:

- the UE shall start timer T3402, shall set the EPS update status to EU1 UPDATED and shall enter state EMM-REGISTERED.ATTEMPTING-TO-UPDATE-MM. When timer T3402 expires the combined tracking area updating procedure indicating "combined TA/LA updating with IMSI attach" is triggered;
- a UE operating in CS/PS mode 1 of operation shall select GERAN or UTRAN radio access technology and proceed with appropriate MM or GMM specific procedures.

Editor's note: the conditions for the UE to reselect E-UTRAN radio access technology are FFS.

...

Other reject cause values and the case that no EMM cause IE was received are considered as abnormal cases. The combined attach procedure shall be considered as failed for EPS and non-EPS services. The behaviour of the UE in those cases is specified in subclause 5.5.1.3.6.

[TS 24.301, clause 5.5.3.3.4.3]

The description for tracking area for EPS services as specified in subclause 5.5.3.2.4 shall be followed. In addition, the following description for location updating for non-EPS services applies.

The UE receiving the TRACKING AREA UPDATE ACCEPT message takes one of the following actions depending on the reject cause:

...

- #16 (MSC temporarily not reachable);
- #17 (Network failure); or
- #22 (Congestion)

The UE shall stop timer T3430 if still running. The tracking area updating attempt counter shall be incremented, unless it was already set to 5.

If the tracking area updating attempt counter is less than 5:

- the UE shall start timer T3411, shall set the EMM update status to EU1 UPDATED and shall enter state EMM-REGISTERED.ATTEMPTING-TO-UPDATE-MM. When timer T3411 expires the combined tracking area updating procedure indicating "combined TA/LA updating with IMSI attach" is triggered again.

If the tracking area updating attempt counter is equal to 5:

- the UE shall start timer T3402, shall set the EPS update status to EU1 UPDATED and shall enter state EMM-REGISTERED.ATTEMPTING-TO-UPDATE-MM. When timer T3402 expires the combined tracking area updating procedure indicating "combined TA/LA updating with IMSI attach" is triggered again;
- a UE operating in CS/PS mode 1 of operation shall select GERAN or UTRAN radio access technology and proceed with appropriate MM or GMM specific procedures.

Editor's note: the conditions for the UE to reselect E-UTRAN radio access technology are FFS.

...

9.2.1.2.3.3 Test description

9.2.1.2.3.3.1 Pre-test conditions

System Simulator:

- Cell A
- T3402 is set to default (12 min.).

UE:

- The USIM contains GUTI-1 and TAI-1, and EPS update status is "EU1: UPDATED", and also P-TMSI signature1.
- The USIM contains TMSI-1 and LAI-1 for CS service, and Location update status is "U1: UPDATED".

Preamble:

- The UE is in state Switched OFF (state 1) according to clause [18].

NOTE: The PDN type (IPv4, IPv6 or both) of the UE is determined by the PICS.

9.2.1.2.3.3.2 Test procedure sequence

The sequence is executed for execution counter k = 1, 2, 3.

Table 9.2.1.2.3.3.2-1: Main behaviour

St	Procedure	Message Sequence		TP	Verdict
		U - S	Message		
1	The UE is switched on.	-	-	-	-
2	The UE transmit a combined ATTACH REQUEST message including a PDN CONNECTIVITY REQUEST message as specified.	-->	ATTACH REQUEST	-	-
3	The SS transmits an AUTHENTICATION REQUEST message to initiate the EPS authentication and AKA procedure.	<--	AUTHENTICATION REQUEST	-	-
4	The UE transmits an AUTHENTICATION RESPONSE message and establishes mutual authentication.	-->	AUTHENTICATION RESPONSE	-	-
5	The SS transmits a NAS SECURITY MODE COMMAND message to activate NAS security.	<--	SECURITY MODE COMMAND	-	-
6	The UE transmits a NAS SECURITY MODE COMPLETE message and establishes the initial security configuration.	-->	SECURITY MODE COMPLETE	-	-
7	The SS transmits an ATTACH ACCEPT message with IE EPS Bearer Identity set to default EPS bearer context. The ACTIVATE DEFAULT EPS BEARER CONTEXT REQUEST message is piggybacked in ATTACH ACCEPT. Note 1: SS allocates a PDN address of a PDN type which is compliant with from the PDN type requested by the UE.	<--	ATTACH ACCEPT	-	-
8	Check: Does the UE transmit an ATTACH COMPLETE message including a ACTIVATE DEFAULT EPS BEARER CONTEXT ACCEPT message as specified?	-->	ATTACH COMPLETE	1	P
9	The SS releases the RRC connection.	-	-	-	-
10	Check1: Does the UE transmit a TRACKING AREA UPDATE REQUEST message with "combined TA/LA updating with IMSI attach"? Check2: Is the time between the previous ATTACH ACCEPT and TRACKING AREA UPDATE REQUEST equal to T3411? Note: Tracking area updating attempt counter=2	-->	TRACKING AREA UPDATE REQUEST	1,2	P
11	SS transmits a TRACKING AREA UPDATE ACCEPT message.	<--	TRACKING AREA UPDATE ACCEPT	-	-
12	Check1: Does the UE transmit a TRACKING AREA UPDATE REQUEST message with "combined TA/LA updating with IMSI attach"? Check2: Is the time between the previous TRACKING AREA UPDATE ACCEPT and TRACKING AREA UPDATE REQUEST equal to T3411? Note: Tracking area updating attempt counter=3	-->	TRACKING AREA UPDATE REQUEST	2,3	P
13	SS transmits a TRACKING AREA UPDATE ACCEPT message.	<--	TRACKING AREA UPDATE ACCEPT	-	-
14	Check1: Does the UE transmit a TRACKING AREA UPDATE REQUEST message with "combined TA/LA updating with IMSI attach"? Check2: Is the time between the previous TRACKING AREA UPDATE ACCEPT and TRACKING AREA UPDATE REQUEST equal	-->	TRACKING AREA UPDATE REQUEST	2,3	P

	to T3411? Note: Tracking area updating attempt counter=4				
15	SS transmits a TRACKING AREA UPDATE ACCEPT message	<--	TRACKING AREA UPDATE ACCEPT	-	-
16	Check1: Does the UE transmit a TRACKING AREA UPDATE REQUEST message with "combined TA/LA updating with IMSI attach"? Check2: Is the time between the previous TRACKING AREA UPDATE ACCEPT and TRACKING AREA UPDATE REQUEST equal to T3411? Note: Tracking area updating attempt counter=5	-->	TRACKING AREA UPDATE REQUEST	2,3	P
17	SS transmits a TRACKING AREA UPDATE ACCEPT message	<--	TRACKING AREA UPDATE ACCEPT	-	-
18	Check1: Does the UE send TRACKING AREA UPDATE REQUEST message with "combined TA/LA updating with IMSI attach"? Check2: Is the time between the previous TRACKING AREA UPDATE ACCEPT and TRACKING AREA UPDATE REQUEST equal to T3402? Note: Tracking area updating attempt counter=5	-->	TRACKING AREA UPDATE REQUEST	2,3	P
19	SS transmits a TRACKING AREA UPDATE ACCEPT message	<--	TRACKING AREA UPDATE ACCEPT	-	-
20	Check: Does the UE answer to paging with S-TMSI2 (associated with GUTI2) for PS domain (generic procedure)?	-	-	3	-

9.2.1.2.3.3.3 Specific message contents

Table 9.2.1.2.3.3.3-1: Message ATTACH REQUEST (step 2, Table 9.2.1.2.3.3.2-1)

Derivation Path: TS 36.508 Table 4.7.2-4			
Information Element	Value/remark	Comment	Condition
EPS attach type	010	"combined EPS/IMSI attach"	
Old GUTI or IMSI	GUTI-1		
Last visited registered TAI	TAI-1		
Old location area identification	LAI-1		
TMSI status	1	"valid TMSI available"	

Table 9.2.1.2.3.3.3-2: Message ATTACH ACCEPT (step 7, Table 9.2.1.2.3.3.2-1)

Derivation Path: TS 36.508 Table 4.7.2-1			
Information Element	Value/remark	Comment	Condition
EPS attach result	001	"EPS only"	
GUTI	Not present		
Location area identification	Not present	SS doesn't provide LAI	
MS identity	Not Present	SS doesn't provide TMSI	
EMM cause	00010000 for k=1 or 00010001 for k=2 or 00010110 for k=3	#16 (MSC temporarily not reachable) for k=1 #17 (Network failure) for k=2 #22 (Congestion) for k=3	

Table 9.2.1.2.3.3.3-3: Message TRACKING AREA UPDATE REQUEST (steps 10-12-14-16-18, Table 9.2.1.2.3.3.2-1)

Derivation Path: TS 36.508 Table 4.7.2-27			
Information Element	Value/remark	Comment	Condition
EPS update type	010	"combined TA/LA updating with IMSI attach"	
Old GUTI	GUTI1		
Old P-TMSI signature	P-TMSI signature1	This IE is included because the UE holds a valid P-TMSI signature.	
Additional GUTI	Not present	TIN = 'GUTI'	
Last visited registered TAI	TAI-1		
Old location area identification	LAI-1		
TMSI status	1	"valid TMSI available"	

Table 9.2.1.2.3.3.3-4: Message TRACKING AREA UPDATE ACCEPT (steps 11-13-15-17-19, Table 9.2.1.2.3.3.2-1)

Derivation Path: TS 36.508 Table 4.7.2-24			
Information Element	Value/remark	Comment	Condition
EPS update result	000	"TA updated" SS accepts Combined TAU for EPS services only.	
GUTI	Not present		
Location area identification	Not present	SS doesn't provide LAI	
MS identity	Not Present	SS doesn't provide TMSI	
EMM cause	00010000 for k=1 or 00010001 for k=2 or 00010110 for k=3	#16 (MSC temporarily not reachable) for k=1 #17 (Network failure) for k=2 #22 (Congestion) for k=3	

9.2.1.2.4 Successful combined attach procedure, EPS service only / CS domain not available

9.2.1.2.4.1 Test Purpose (TP)

(1)

```
with { UE is switched-off }
ensure that {
  when { UE is powered on and a valid GUTI is available }
  then { the UE transmits an ATTACH REQUEST message with the EPS attach type set to "combined
EPS/IMSI attach", including GUTI, last visited registered TAI and a PDN CONNECTIVITY REQUEST message
with the request type set to "initial attach" and not including APN }
}
```

(2)

```
with { UE has sent a combined ATTACH_REQUEST message including a PDN CONNECTIVITY REQUEST message }
ensure that {
  when { UE receives an ATTACH_ACCEPT message including EPS attach result set to "EPS only" and EMM
reject cause set to "CS domain not available" and including an ACTIVATE DEFAULT EPS BEARER CONTEXT
REQUEST message with IE EPS Bearer Identity matching the ATTACH REQUEST message and including a PDN
address, an APN and an uplink TFT }
  then { UE transmits ATTACH_COMPLETE message, containing the EPS bearer identity, including an
ACTIVATE DEFAULT EPS BEARER CONTEXT ACCEPT message and sets the update status to U2 NOT UPDATED and
enters EMM-REGISTERED state }
}
```

(3)

```
with { UE in E-UTRA EMM-REGISTERED state and UE in MM U2 NOT UPDATED }
ensure that {
  when { UE enters in a new TAI }
  then { UE initiates a combined tracking area update procedure indicating "combined TA/LA
updating with IMSI attach" without valid LAI, TMSI, GSM ciphering key, UMTS integrity key, UMTS
ciphering key or ciphering key sequence number }
}
```

9.2.1.2.4.2 Conformance requirements

References: The conformance requirements covered in the present TC are specified in: TS 24.301, clauses 5.5.1.2.4, 5.5.1.3.1, 5.5.1.3.2, 5.5.1.3.4.1, 5.5.1.3.4.2 and 5.5.1.3.4.3, and TS 24.008, clause 4.1.2.2.

[TS 24.301, clause 5.5.1.2.4]

If the attach request is accepted by the network, the MME shall send an ATTACH ACCEPT message to the UE and start timer T3450. The MME shall send the ATTACH ACCEPT message together with an ACTIVATE DEFAULT EPS BEARER CONTEXT REQUEST message contained in the ESM message container information element to activate the default bearer (see subclause 6.4.1). The network may also initiate the activation of dedicated bearers towards the UE by invoking the dedicated EPS bearer context activation procedure (see subclause 6.4.2).

If the attach request is accepted by the network, the MME shall delete the stored UE radio capability information, if any.

If the UE has included the UE network capability IE or the MS network capability IE or both in the ATTACH REQUEST message, the MME shall store all octets received from the UE, up to the maximum length defined for the respective information element.

NOTE: This information is forwarded to the new MME during inter-MME handover or to the new SGSN during inter-system handover to A/Gb mode or Iu mode.

The MME shall assign and include the TAI list the UE is registered to in the ATTACH ACCEPT message. The UE, upon receiving an ATTACH ACCEPT message, shall delete its old TAI list and store the received TAI list.

Upon receiving the ATTACH ACCEPT message, the UE shall stop timer T3410.

The GUTI reallocation may be part of the attach procedure. When the ATTACH REQUEST message includes the IMSI, or the MME considers the GUTI provided by the UE is invalid, or the GUTI provided by the UE was assigned by another MME, the MME shall allocate a new GUTI to the UE. The MME shall include in the ATTACH ACCEPT

message the new assigned GUTI together with the assigned TAI list. In this case the MME shall enter state EMM-COMMON-PROCEDURE-INITIATED as described in subclause 5.4.1.

...

If the ATTACH ACCEPT message contains a GUTI, the UE shall use this GUTI as the new temporary identity. The UE shall delete its old GUTI and store the new assigned GUTI. If no GUTI has been included by the MME in the ATTACH ACCEPT message, the old GUTI, if any available, shall be kept.

If A/Gb mode or Iu mode is supported in the UE, the UE shall set its TIN to "GUTI" when receiving the ATTACH ACCEPT message.

...

When the UE receives the ATTACH ACCEPT message combined with the ACTIVATE DEFAULT EPS BEARER CONTEXT REQUEST message, it shall forward the ACTIVATE DEFAULT EPS BEARER CONTEXT REQUEST message to the ESM sublayer. Upon receipt of an indication from the ESM sublayer that the default EPS bearer context has been activated, the UE shall send an ATTACH COMPLETE message together with an ACTIVATE DEFAULT EPS BEARER CONTEXT ACCEPT message contained in the ESM message container information element to the network.

Additionally, the UE shall reset the attach attempt counter and tracking area updating attempt counter, enter state EMM-REGISTERED and set the EPS update status to EU1 UPDATED.

Upon receiving an ATTACH COMPLETE message, the MME shall stop timer T3450, enter state EMM-REGISTERED and consider the GUTI sent in the ATTACH ACCEPT message as valid.

[TS 24.301, clause 5.5.1.3.1]

The combined EPS attach procedure is used by a UE in CS/PS mode 1 or CS/PS mode 2 of operation to attach for both EPS and non-EPS services.

When the UE initiates a combined EPS attach procedure, the UE shall indicate "combined EPS/IMSI attach" in the EPS attach type IE.

The combined EPS attach procedure follows the attach procedure for EPS described in subclause 5.5.1.2.

[TS 24.301, clause 5.5.1.3.2]

...

The UE shall include the TMSI status IE if no valid TMSI is available. Furthermore, if the UE has stored a valid location area identification, the UE shall include it in the Old location area identification IE in the ATTACH REQUEST message.

[TS 24.301, clause 5.5.1.3.4.1]

Depending on the value of the EPS attach result IE received in the ATTACH ACCEPT message, two different cases can be distinguished:

- 1) The EPS attach result IE value indicates "combined EPS/IMSI attach": attach for EPS and non-EPS services have been successful.
- 2) The EPS attach result IE value indicates "EPS only": attach for EPS services has been successful but attach for non-EPS services has failed.

[TS 24.301, clause 5.5.1.3.4.2]

The description for attach for EPS services as specified in subclause 5.5.1.2.4 shall be followed. In addition, the following description for attach for non-EPS services applies.

...

[TS 24.301, clause 5.5.1.3.4.3]

The description for attach for EPS services as specified in subclause 5.5.1.2.4 shall be followed. In addition, the following description for attach for non-EPS services applies.

The UE receiving the ATTACH ACCEPT message takes one of the following actions depending on the EMM cause value:

...

#18 (CS domain not available)

The UE shall stop timer T3410 if still running, shall set the EPS update status to EU1 UPDATED and shall enter state EMM-REGISTERED.NORMAL-SERVICE.

The UE shall set the update status to U2 NOT UPDATED.

A UE in CS/PS mode 1 of operation shall select GERAN or UTRAN radio access technology and proceed with appropriate MM or GMM specific procedures. The UE shall not reselect E-UTRAN radio access technology for the duration the UE is on the PLMN or an equivalent PLMN.

Other EMM cause values and the case that no EMM cause IE was received are considered as abnormal cases. The combined attach procedure shall be considered as failed for EPS and non-EPS services. The behaviour of the UE in those cases is specified in subclause 5.5.1.3.6.

[TS 24.008, clause 4.1.2.2]

In parallel with the sublayer states described in subclause 4.1.2.1 and which control the MM sublayer protocol, an update status exists.

The update status pertains to a specific subscriber embodied by a SIM/USIM. This status is defined even when the subscriber is not activated (SIM/USIM removed or connected to a switched-off ME). It is stored in a non volatile memory in the SIM/USIM. The update status is changed only as a result of a location updating procedure attempt (with the exception of an authentication failure and of some cases of CM service rejection). In some cases, the update status is changed as a result of a GPRS attach, GPRS routing area update, service request or network initiated GPRS detach procedure.

...

U2 NOT UPDATED

The last location updating attempt made failed procedurally (no significant answer was received from the network, including the cases of failures or congestion inside the network).

For this status, the SIM/USIM does not contain any valid LAI, TMSI, GSM ciphering key, UMTS integrity key, UMTS ciphering key or ciphering key sequence number. For compatibility reasons, all these fields must be set to the "deleted" value at the moment the status is set to NOT UPDATED. However the presence of other values shall not be considered an error by the mobile station. The "Location update status" stored on the SIM/USIM shall be "not updated".

...

9.2.1.2.4.3 Test description

9.2.1.2.4.3.1 Pre-test conditions

System Simulator:

- 2 Cells, belonging to 2 different TAIs: cell A in TAI1, cell B in TAI2

UE:

- The test USIM contains GUTI1 and TAI1, and EPS update status is "EU1: UPDATED", and also P-TMSI signature1.
- The test USIM contains TMSI1 and LAI1 for CS service, and Location update status is "U1: UPDATED".

Preamble:

- The UE is in state Switched OFF (state 1) according to [18].

NOTE: The PDN type (IPv4, IPv6 or both) of the UE is determined by the PICS.

9.2.1.2.4.3.2 Test procedure sequence

Table 9.2.1.2.4.3.2-1: Main Behaviour

St	Procedure	Message Sequence		TP	Verdict
		U - S	Message		
1	Set the cell type of cell A to the "Serving cell" Set the cell type of cell B to the "Non-suitable cell"	-	-	-	-
2	The UE is switched on.	-	-	-	-
3	Check : Does the UE transmit a combined ATTACH REQUEST message including a PDN CONNECTIVITY REQUEST message as specified on cell A?	-->	ATTACH REQUEST	1	P
4	The SS transmits an AUTHENTICATION REQUEST message to initiate the EPS authentication and AKA procedure.	<--	AUTHENTICATION REQUEST	-	-
5	The UE transmits an AUTHENTICATION RESPONSE message and establishes mutual authentication.	-->	AUTHENTICATION RESPONSE	-	-
6	The SS transmits a NAS SECURITY MODE COMMAND message to activate NAS security.	<--	SECURITY MODE COMMAND	-	-
7	The UE transmits a NAS SECURITY MODE COMPLETE message and establishes the initial security configuration.	-->	SECURITY MODE COMPLETE	-	-
8	SS responds with ATTACH ACCEPT message with IE EPS Bearer Identity set to default EPS bearer context. The ACTIVATE DEFAULT EPS BEARER CONTEXT REQUEST message is piggybacked in ATTACH ACCEPT. Note 1: SS allocates a PDN address of a PDN type which is compliant with from the PDN type requested by the UE.	<--	ATTACH ACCEPT	-	-
9	Check: Does the UE transmit an ATTACH COMPLETE message including a ACTIVATE DEFAULT EPS BEARER CONTEXT ACCEPT message as specified?	-->	ATTACH COMPLETE	2	P
10	The SS releases the RRC connection.	-	-	-	-
11	Check 1: Does the test results of CALL generic procedure [18] indicate that the UE is in E-UTRA EMM-REGISTERED state ?	-	-	2	-
12	Set the cell type of cell B to the "Serving cell" Set the cell type of cell A to the "Non-suitable cell"	-	-	-	-
13	Check: Does the UE transmit TRACKING AREA UPDATE REQUEST message as specified on cell B?	-->	TRACKING AREA UPDATE REQUEST	3	P
14	SS responds with TRACKING AREA UPDATE ACCEPT message	<--	TRACKING AREA UPDATE ACCEPT	-	-
15	UE sends TRACKING AREA UPDATE COMPLETE	-->	TRACKING AREA UPDATE COMPLETE	-	-

9.2.1.2.4.3.3 Specific message contents

Table 9.2.1.2.4.3.3-1: Message ATTACH REQUEST (step 3, Table 9.2.1.2.4.3.2-1)

Derivation Path: TS 36.508 Table 4.7.2-4			
Information Element	Value/remark	Comment	Condition
EPS attach type	010	"combined EPS/IMSI attach"	
Old GUTI or IMSI	GUTI-1		
Last visited registered TAI	TAI-1		
Old location area identification	LAI-1		
TMSI status	1	"valid TMSI available"	

Table 9.2.1.2.4.3.3-2: Message ATTACH ACCEPT (step 8, Table 9.2.1.2.4.3.2-1)

Derivation Path: TS 36.508 Table 4.7.2-1			
Information Element	Value/remark	Comment	Condition
EPS attach result	001	"EPS only"	
GUTI	Not Present		
Location area identification	Not present	SS doesn't provide LAI	
MS identity	Not Present	SS doesn't provide TMSI	
EMM cause	00010010	#18 "CS domain not available"	

Table 9.2.1.2.4.3.3-3: Message TRACKING AREA UPDATE REQUEST (step 14, Table 9.2.1.2.4.3.2-1)

Derivation Path: TS 36.508 Table 4.7.2-27			
Information Element	Value/remark	Comment	Condition
EPS update type	010		
Old GUTI	GUTI-1		
Old P-TMSI signature	P-TMSI signature1		
Additional GUTI	Present	TIN="GUTI"	
Last visited registered TAI	TAI-1	If available, the last TAI is included by UE and will be used to establish a good list of TAIs in subsequent ATTACH ACCEPT message.	
Old location area identification	Not present	Entering in U2 NOT UPDATED state, UE deletes LAI	
TMSI status	Not present	Entering in U2 NOT UPDATED state, UE deletes TMSI	

Table 9.2.1.2.4.3.3-4: Message TRACKING AREA UPDATE ACCEPT (step 15, Table 9.2.1.2.4.3.2-1)

Derivation Path: TS 36.508 Table 4.7.2-24			
Information Element	Value/remark	Comment	Condition
EPS update result	000	"TA only"	
GUTI	GUTI-2		
Location area identification	Not present	SS doesn't provide LAI	
MS identity	Not Present	SS doesn't provide TMSI	
EMM cause	00010010	#18 "CS domain not available"	

9.2.1.2.6 Combined attach / rejected / Illegal ME

9.2.1.2.6.1 Test Purpose (TP)

(1)

```
with { UE has sent an ATTACH REQUEST message including a PDN CONNECTIVITY REQUEST message }
ensure that {
  when { UE receives an ATTACH REJECT message with the reject cause set to "Illegal ME" }
  then { UE considers the USIM as invalid for EPS services and non-EPS services and enters state
EMM-DEREGISTERED }
}
```

9.2.1.2.6.2 Conformance requirements

References: The conformance requirements covered in the present TC are specified in: TS 24.301, clause 5.5.1.3.5.

[TS 24.301, clause 5.5.1.3.5]

...

Upon receiving the ATTACH REJECT message, the UE shall stop timer T3410, enter MM state MM IDLE, and take the following actions depending on the EMM cause value received.

...

#6 (Illegal ME); or

...

The UE shall set the EPS update status to EU3 ROAMING NOT ALLOWED (and shall store it according to subclause 5.1.3.3) and shall delete any GUTI, last visited registered TAI and KSI.

The UE shall consider the USIM as invalid for EPS and non-EPS services until switching off or the UICC containing the USIM is removed. Additionally, the UE shall delete the list of equivalent PLMNs and shall enter the state EMM-DEREGISTERED.

If A/Gb mode or Iu mode is supported by the UE, the UE shall in addition handle the MM parameters update status, TMSI, LAI and ciphering key sequence number, and the GMM parameters GMM state, GPRS update status, P-TMSI, P-TMSI signature, RAI and GPRS ciphering key sequence number as specified in 3GPP TS 24.008 [13] for the case when the combined attach procedure is rejected with this cause value.

...

9.2.1.2.6.3 Test description

9.2.1.2.6.3.1 Pre-test conditions

System Simulator:

- Cell A and Cell B
- If pc_UTRAN supported by UE, Cell 5

UE:

- The test USIM contains IMSI1, GUTI1 and TAI1, and EPS update status is "EU1: UPDATED".

Preamble:

- The UE is in state Switched OFF (state 1) according to clause [18].

9.2.1.2.6.3.2 Test procedure sequence

Table 9.2.1.2.6.3.2-1: Main behaviour

St	Procedure	Message Sequence		TP	Verdict
		U - S	Message		
1	The SS configures: - Cell A as the "Serving cell". - Cell B as a "Non-Suitable cell". - Cell 5 as a "Non-Suitable cell".	-	-	-	-
2	The UE is switched on.	-	-	-	-
-	The following messages are sent and shall be received on Cell A.	-	-	-	-
3	The UE transmits an ATTACH REQUEST message including a PDN CONNECTIVITY REQUEST message.	-->	ATTACH REQUEST	-	-
4	The SS transmits an ATTACH REJECT message with EMM cause = "Illegal ME" as specified.	<--	ATTACH REJECT	-	-
5	The SS releases the RRC connection.	-	-	-	-
6	The SS configures: - Cell A as a "Non-Suitable cell". - Cell B as the "Serving cell".	-	-	-	-
7	Check: Does the UE transmit an ATTACH REQUEST message in the next 30 seconds on Cell B or on Cell A?	-->	ATTACH REQUEST	1	F
8	The operator initiates an attach by MMI or by AT command.	-	-	-	-
9	Check: Does the UE transmit an ATTACH REQUEST message in the next 30 seconds on Cell B or on Cell A?	-->	ATTACH REQUEST	1	F
-	EXCEPTION: Steps 10a1 to 10a5 describe behaviour that depends on the UE capability; the "lower case letter" identifies a step sequence that take place if a capability is supported	-	-	-	-
10a1	IF pc_UTRAN THEN the SS configures: - Cell B as a "Non-Suitable cell". - Cell 5 as the "Serving cell".	-	-	-	-
10a2	The following messages are sent and shall be received on cell 5.	-	-	-	-
10a3	Check: Does the UE transmit an ATTACH REQUEST message in the next 30 seconds?	-->	ATTACH REQUEST	1	F
10a4	The user initiates an attach by MMI or by AT command.	-	-	-	-
10a5	Check: Does the UE transmit an ATTACH REQUEST message in the next 30 seconds?	-->	ATTACH REQUEST	1	F

9.2.1.2.6.3.3 Specific message contents

Table 9.2.1.2.6.3.3-1: Message ATTACH REJECT (step 4, Table 9.2.1.2.6.3.2-1)

Derivation Path: TS 36.508 Table 4.7.2-3			
Information Element	Value/remark	Comment	Condition
EMM cause	'0000 0110'B	Illegal ME	

9.2.1.2.8 Combined attach / rejected / EPS services not allowed

9.2.1.2.8.1 Test Purpose (TP)

(1)

```

with { UE has sent an ATTACH REQUEST message including a PDN CONNECTIVITY REQUEST message }
ensure that {
  when { UE receives an ATTACH REJECT message with the reject cause set to "EPS services not
allowed" }
  then { UE considers the USIM as invalid for EPS services and enters state EMM-DEREGISTERED and
UE does not attempt to attach on any other cell }
}

```

9.2.1.2.8.2 Conformance requirements

References: The conformance requirements covered in the present TC are specified in: TS 24.301, clause 5.5.1.3.5.

[TS 24.301, clause 5.5.1.3.5]

...

Upon receiving the ATTACH REJECT message, the UE shall stop timer T3410, enter MM state MM IDLE, and take the following actions depending on the EMM cause value received.

...

#7 (EPS services not allowed);

The UE shall set the EPS update status to EU3 ROAMING NOT ALLOWED (and shall store it according to subclause 5.1.3.3) and shall delete any GUTI, last visited registered TAI and KSI. The UE shall consider the USIM as invalid for EPS services until switching off or the UICC containing the USIM is removed. Additionally, the UE shall delete the list of equivalent PLMNs and shall enter the state EMM-DEREGISTERED.

If A/Gb mode or Iu mode is supported by the UE, the UE shall in addition handle the GMM parameters GMM state, GPRS update status, P-TMSI, P-TMSI signature, RAI and GPRS ciphering key sequence number as specified in 3GPP TS 24.008 [13] for the case when the combined attach procedure is rejected with this cause value.

A UE which is not yet IMSI attached for non-EPS services shall select GERAN or UTRAN radio access technology and perform an IMSI attach for non-EPS services, using the MM IMSI attach procedure as described in 3GPP TS 24.008 [13]. The UE shall not reselect E-UTRAN radio access technology until switching off or the UICC containing the USIM is removed.

A UE which is already attached for non-EPS services is still attached for non-EPS services in the network. The UE shall select GERAN or UTRAN radio access technology and shall proceed with the appropriate MM specific procedure according to the MM service state. The UE shall not reselect E-UTRAN radio access technology until switching off or the UICC containing the USIM is removed.

NOTE: Some interaction is required with the access stratum to disable E-UTRAN cell reselection.

If A/Gb mode or Iu mode is supported by the UE, the UE shall in addition handle the GMM parameters GMM state, GPRS update status, P-TMSI, P-TMSI signature, RAI and GPRS ciphering key sequence number as specified in 3GPP TS 24.008 [13] for the case when the combined attach procedure is rejected with the GMM cause with the same value.

...

9.2.1.2.8.3 Test description

9.2.1.2.8.3.1 Pre-test conditions

System Simulator:

- Cell A and Cell B
- If pc_UTRAN supported by UE, Cell 5

UE:

- The test USIM contains IMSI1, GUTI1 and TAI1, and EPS update status is "EU1: UPDATED".

Preamble:

- The UE is in state Switched OFF (state 1) according to clause [18].

9.2.1.2.8.3.2 Test procedure sequence

Table 9.2.1.2.8.3.2-1: Main behaviour

St	Procedure	Message Sequence		TP	Verdict
		U - S	Message		
1	The SS configures: - Cell A as the "Serving cell". - Cell B as a "Suitable neighbour cell". - Cell 5 as a "Suitable neighbour cell".	-	-	-	-
2	The UE is switched on.	-	-	-	-
-	The following messages are sent and shall be received on Cell A.	-	-	-	-
3	The UE transmits an ATTACH REQUEST message including a PDN CONNECTIVITY REQUEST message.	-->	ATTACH REQUEST	-	-
4	The SS transmits an ATTACH REJECT message with EMM cause = "EPS services not allowed" as specified.	<--	ATTACH REJECT	-	-
5	The SS releases the RRC connection.	-	-	-	-
-	EXCEPTION: Steps 6a1 to 6a3 describe behaviour that depends on the UE capability; the "lower case letter" identifies a step sequence that take place if a capability is supported	-	-	-	-
6a1	IF pc_UTRAN THEN the following messages are sent and shall be received on cell 5.	-	-	-	-
6a2	Check: Does the UE transmit a LOCATION UPDATING REQUEST message on Cell 5?	-->	LOCATION UPDATING REQUEST	1	P
6a3	The SS transmits a LOCATION UPDATING ACCEPT message with Location updating type = "IMSI attach" as specified in 3GPP TS 24.008.	<--	LOCATION UPDATING ACCEPT	-	-
7	The SS configures: - Cell 5 as a "Non-Suitable cell". - Cell A as the "Suitable neighbour cell". - Cell B as the "Suitable neighbour cell".	-	-	-	-
8	Check: Does the UE transmit an ATTACH REQUEST message in the next 30 seconds on Cell A or on Cell B?	-->	ATTACH REQUEST	1	F

9.2.1.2.8.3.3 Specific message contents

Table 9.2.1.2.8.3.3-1: Message ATTACH REJECT (step 4, Table 9.2.1.2.8.3.2-1)

Derivation Path: TS 36.508 Table 4.7.2-3			
Information Element	Value/remark	Comment	Condition
EMM cause	'0000 0111'B	EPS services not allowed	

9.2.1.2.9 Combined attach / rejected / PLMN not allowed

9.2.1.2.9.1 Test Purpose (TP)

(1)

with { UE has sent an ATTACH REQUEST message including a PDN CONNECTIVITY REQUEST message }

```

ensure that {
  when { UE receives an ATTACH REJECT message with the reject cause set to "PLMN not allowed" }
  then { UE deletes the GUTI, the last visited registered TAI and KSI and UE deletes the list of
equivalent PLMNs and UE enters state EMM-DEREGISTERED.PLMN-SEARCH and UE stores the PLMN in the
"forbidden PLMN list" }
}

```

(2)

```

with { UE is switched off and a PLMN is stored in the "forbidden PLMN list" }
ensure that {
  when { UE is powered on this PLMN }
  then { UE does not attempt to attach on the cell }
}

```

(3)

```

with { UE in E-UTRA EMM-DEREGISTERED.PLMN-SEARCH state and a PLMN is stored in the "forbidden PLMN
list" }
ensure that {
  when { UE enters a PLMN which is not in the "forbidden PLMN list" }
  then { UE attempts to attach on the cell }
}

```

9.2.1.2.9.2 Conformance requirements

References: The conformance requirements covered in the present TC are specified in: TS 24.301, clause 5.5.1.3.5.

[TS 24.301, clause 5.5.1.3.5]

...

Upon receiving the ATTACH REJECT message, the UE shall stop timer T3410, enter MM state MM IDLE, and take the following actions depending on the EMM cause value received.

...

#11 (PLMN not allowed);

The UE shall set the EPS update status to EU3 ROAMING NOT ALLOWED (and shall store it according to subclause 5.1.3.3) and shall delete any GUTI, last visited registered TAI, and KSI, and reset the attach attempt counter. The UE shall delete the list of equivalent PLMNs and enter the state EMM-DEREGISTERED.PLMN-SEARCH.

The UE shall store the PLMN identity in the "forbidden PLMN list".

The UE shall perform a PLMN selection according to 3GPP TS 23.122 [6].

If A/Gb mode or Iu mode is supported by the UE, the UE shall in addition handle the MM parameters update status, TMSI, LAI, ciphering key sequence number and location update attempt counter, and the GMM parameters GMM state, GPRS update status, P-TMSI, P-TMSI signature, RAI, GPRS ciphering key sequence number and GPRS attach attempt counter as specified in 3GPP TS 24.008 [13] for the case when the combined attach procedure is rejected with the GMM cause with the same value and no RR connection exists.

...

9.2.1.2.9.3 Test description

9.2.1.2.9.3.1 Pre-test conditions

System Simulator:

- Cell I and Cell G
- If pc_UTRAN supported by UE, Cell 5

UE:

- The test USIM contains IMSI1, GUTI1 and TAI1, and EPS update status is "EU1: UPDATED".

- The "forbidden PLMN list" is empty.

Preamble:

- The UE is in state Switched OFF (state 1) according to clause [18].

9.2.1.2.9.3.2 Test procedure sequence

Table 9.2.1.2.9.3.2-1: Main behaviour

St	Procedure	Message Sequence		TP	Verdict
		U - S	Message		
1	The SS configures: - Cell I as the "Serving cell". - Cell G as a "Non-Suitable cell". - Cell 5 as a "Non-Suitable cell".	-	-	-	-
2	The UE is switched on.	-	-	-	-
-	The following messages are sent and shall be received on Cell I.	-	-	-	-
3	The UE transmits an ATTACH REQUEST message including a PDN CONNECTIVITY REQUEST message.	-->	ATTACH REQUEST	-	-
4	The SS transmits an ATTACH REJECT message with EMM cause = "PLMN not allowed".	<--	ATTACH REJECT	-	-
5	The SS releases the RRC connection.	-	-	-	-
6	Check: Does the UE transmit an ATTACH REQUEST message in the next 30 seconds?	-	ATTACH REQUEST	1	F
7	The UE is powered off or switched off.	-	-	-	-
8	The UE is powered on or switched on.	-	-	-	-
-	EXCEPTION: Steps 9a1 to 9a3 describe behaviour that depends on the UE capability; the "lower case letter" identifies a step sequence that take place if a capability is supported	-	-	-	-
9a1	IF pc_UTRAN THEN the SS configures: - Cell I as a "Non-Suitable cell". - Cell 5 as the "Serving cell". Note: Cell I and Cell 5 are in the same PLMN.	-	-	-	-
9a2	The following messages are sent and shall be received on cell 5.	-	-	-	-
9a3	Check: Does the UE transmit an ATTACH REQUEST message in the next 30 seconds?	-->	ATTACH REQUEST	2	F
10	The SS configures: Cell I as a "Non-Suitable cell". Cell G as the "Serving cell". Note: Cell G belongs to PLMN different from PLMN belonging to Cell I.	-	-	-	-
-	The following messages are sent and shall be received on Cell G.	-	-	-	-
11	Check: Does the UE transmit an ATTACH REQUEST message including a PDN CONNECTIVITY REQUEST message as specified?	-->	ATTACH REQUEST	1,3	P
12	The SS transmits an AUTHENTICATION REQUEST message to initiate the EPS authentication and AKA procedure.	<--	AUTHENTICATION REQUEST	-	-
13	The UE transmits an AUTHENTICATION RESPONSE message.	-->	AUTHENTICATION RESPONSE	-	-
14	The SS starts integrity protection and ciphering	<--	SECURITY MODE COMMAND	-	-
15	The UE responds to the SS.	-->	SECURITY MODE COMPLETE	-	-
16	The SS transmits an ATTACH ACCEPT message including an ACTIVATE DEFAULT EPS BEARER CONTEXT REQUEST message.	<--	ATTACH ACCEPT	-	-
17	The UE transmits an ATTACH COMPLETE message including an ACTIVATE DEFAULT EPS BEARER CONTEXT ACCEPT message.	-->	ATTACH COMPLETE	-	-

9.2.1.2.9.3.3 Specific message contents

Table 9.2.1.2.9.3.3-1: Message ATTACH REJECT (step 4, Table 9.2.1.2.9.3.2-1)

Derivation Path: TS 36.508 Table 4.7.2-3			
Information Element	Value/remark	Comment	Condition
EMM cause	'0000 1011'B	PLMN not allowed	

Table 9.2.1.2.9.3.3-2: Message ATTACH REQUEST (step 11, Table 9.2.1.2.9.3.2-1)

Derivation Path: TS 36.508 Table 4.7.2-4			
Information Element	Value/remark	Comment	Condition
NAS key set identifier			
NAS key set identifier	'111'B	no key is available	
TSC	Any allowed value	TSC does not apply for NAS key set identifier value "111".	
Old GUTI or IMSI	IMSI1		
Last visited registered TAI	Not present		

Table 9.2.1.2.9.3.3-3: Message ATTACH ACCEPT (step 16, Table 9.2.1.2.9.3.2-1)

Derivation Path: TS 36.508 Table 4.7.2-1 condition CombinedAttach			
---	--	--	--

9.2.1.2.10 Combined attach / rejected / Tracking area not allowed

9.2.1.2.10.1 Test Purpose (TP)

(1)

```

with { UE has sent an ATTACH REQUEST message including a PDN CONNECTIVITY REQUEST message }
ensure that {
  when { UE receives an ATTACH REJECT message with the reject cause set to "Tracking area not allowed" }
  then { UE deletes the GUTI, last visited registered TAI and KSI, UE enters the state EMM-DEREGISTERED.LIMITED-SERVICE and UE stores the current TAI in the list of "forbidden tracking areas for regional provision of service" }
}

```

(2)

```

with { UE is in EMM-DEREGISTERED.LIMITED-SERVICE state and the current TAI in the list of "forbidden tracking areas for regional provision of service" }
ensure that {
  when { serving cell belongs to TAI where UE was rejected }
  then { UE does not attempt to attach on any cell }
}

```

(3)

```

with { UE is in EMM-DEREGISTERED.LIMITED-SERVICE state and the current TAI in the list of "forbidden tracking areas for regional provision of service" }
ensure that {
  when { UE re-selects a new cell in the same TAI it was rejected }
  then { UE does not attempt to attach on the cell }
}

```

(4)

```

with { UE is switched off }
ensure that {
  when { UE is powered on in the cell belonging to the TAI which was in the list of "forbidden tracking areas for regional provision of service" before the UE was switched off }
  then { UE attempts to attach on the cell }
}

```

9.2.1.2.10.2 Conformance requirements

References: The conformance requirements covered in the present TC are specified in: TS 24.301, clause 5.5.1.3.5.

[TS 24.301, clause 5.5.1.3.5]

...

Upon receiving the ATTACH REJECT message, the UE shall stop timer T3410, enter MM state MM IDLE, and take the following actions depending on the EMM cause value received.

...

#12 (Tracking area not allowed);

The UE shall set the EPS update status to EU3 ROAMING NOT ALLOWED (and shall store it according to subclause 5.1.3.3) and shall delete any GUTI, last visited registered TAI and KSI. The UE shall reset the attach attempt counter and enter the state EMM-DEREGISTERED.LIMITED-SERVICE.

The UE shall store the current TAI in the list of "forbidden tracking areas for regional provision of service".

If A/Gb mode or Iu mode is supported by the UE, the UE shall in addition handle the MM parameters update status, TMSI, LAI, ciphering key sequence number and location update attempt counter, and the GMM parameters GMM state, GPRS update status, P-TMSI, P-TMSI signature, RAI, GPRS ciphering key sequence number and GPRS attach attempt counter as specified in 3GPP TS 24.008 [13] for the case when the combined attach procedure is rejected with the GMM cause with the same value.

...

9.2.1.2.10.3 Test description

9.2.1.2.10.3.1 Pre-test conditions

System Simulator:

- Cell A, Cell B and Cell M

UE:

- The test USIM contains IMSI1, GUTI1 and TAI1, and EPS update status is "EU1: UPDATED".

Preamble:

- The UE is in state Switched OFF (state 1) according to clause [18].

9.2.1.2.10.3.2 Test procedure sequence

Table 9.2.1.2.10.3.2-1: Main behaviour

St	Procedure	Message Sequence		TP	Verdict
		U - S	Message		
1	The SS configures: - Cell A as the "Serving cell". - Cell B as a "Suitable neighbour cell". - Cell M as a "Non-Suitable cell".	-	-	-	-
2	The UE is switched on.	-	-	-	-
-	The following messages are sent and shall be received on Cell A.	-	-	-	-
3	The UE transmits an ATTACH REQUEST message including a PDN CONNECTIVITY REQUEST message.	-->	ATTACH REQUEST	-	-
4	The SS transmits an ATTACH REJECT message with EMM cause = "Tracking area not allowed".	<--	ATTACH REJECT	-	-
5	The SS releases the RRC connection.	-	-	-	-
6	Check: Does the UE transmit the ATTACH REQUEST message in the next 30 seconds on Cell A or Cell B?	-	ATTACH REQUEST	1,2	F
7	The SS configures: - Cell A as the "Non-Suitable cell". - Cell B as a "Non-Suitable cell". - Cell M as a "Serving cell".	-	-	-	-
8	Check: Does the UE transmit the ATTACH REQUEST message in the next 30 seconds on Cell M?	-	ATTACH REQUEST	3	F
9	The UE is powered off or switched off.	-	-	-	-
10	The UE is powered on or switched on.	-	-	-	-
-	The following messages are sent and shall be received on Cell M.	-	-	-	-
11	Check: Does the UE transmit an ATTACH REQUEST message including a PDN CONNECTIVITY REQUEST message as specified?	-->	ATTACH REQUEST	1,4	P
12	The SS transmits an AUTHENTICATION REQUEST message to initiate the EPS authentication and AKA procedure.	<--	AUTHENTICATION REQUEST	-	-
13	The UE transmits an AUTHENTICATION RESPONSE message.	-->	AUTHENTICATION RESPONSE	-	-
14	The SS starts integrity protection and ciphering	<--	SECURITY MODE COMMAND	-	-
15	The UE responds to the SS.	-->	SECURITY MODE COMPLETE	-	-
16	The SS transmits an ATTACH ACCEPT message including an ACTIVATE DEFAULT EPS BEARER CONTEXT REQUEST message.	<--	ATTACH ACCEPT	-	-
17	The UE transmits an ATTACH COMPLETE message including an ACTIVATE DEFAULT EPS BEARER CONTEXT ACCEPT message.	-->	ATTACH COMPLETE	-	-

9.2.1.2.10.3.3 Specific message contents

Table 9.2.1.2.10.3.3-1: Message ATTACH REJECT (step 4, Table 9.2.1.2.10.3.2-1)

Derivation Path: TS 36.508 Table 4.7.2-3			
Information Element	Value/remark	Comment	Condition
EMM cause	'0000 1100'B	Tracking Area not allowed	

Table 9.2.1.2.10.3.3-2: Message ATTACH REQUEST (step 11, Table 9.2.1.2.10.3.2-1)

Derivation Path: TS 36.508 Table 4.7.2-4			
Information Element	Value/remark	Comment	Condition
NAS key set identifier			
NAS key set identifier	'111'B	no key is available	
TSC	Any allowed value	TSC does not apply for NAS key set identifier value "111".	
Old GUTI or IMSI	IMSI1		
Last visited registered TAI	Not present		

Table 9.2.1.2.10.3.3-3: Message ATTACH ACCEPT (step 16, Table 9.2.1.2.10.3.2-1)

Derivation Path: TS 36.508 Table 4.7.2-1 condition CombinedAttach

9.2.2 Detach procedure

9.2.2.1 UE initiated detach procedure

9.2.2.1.1 UE initiated detach / UE switched off

9.2.2.1.1.1 Test Purpose (TP)

(1)

```
with { UE in any EMM state }
ensure that {
  when { the UE is switched off }
  then { the UE sends DETACH REQUEST message, deletes the KSI, if any, and deactivates the EPS
bearer context(s) locally }
}
```

9.2.2.1.1.2 Conformance requirements

References: The conformance requirements covered in the present TC are specified in: 3GPP TS 24.301 clauses and 5.5.2.2.1 and 5.5.2.2.2.

[TS24.301 clause 5.5.2.2.1]

The detach procedure is initiated by the UE by sending a DETACH REQUEST message. The Detach type IE included in the message indicates whether detach is due to a "switch off" or not. The Detach type IE also indicates whether the detach is for EPS services only, for non-EPS services only, or for both.

...

If the UE is to be switched off, the UE shall try for a period of 5 seconds to send the DETACH REQUEST message. During this period, the UE may be switched off as soon as the DETACH REQUEST message has been sent. After transmission of the message, the UE shall delete the KSI, if any.

[TS24.301 clause 5.5.2.2.2]

When the DETACH REQUEST message is received by the network, the network shall send a DETACH ACCEPT message to the UE, if the Detach type IE does not indicate "switch off". Otherwise, the procedure is completed when the network receives the DETACH REQUEST message. On reception of a DETACH REQUEST message indicating "switch off", the MME shall delete the KSI, if any.

The network and the UE shall deactivate the EPS bearer context(s) for this UE locally without peer-to-peer signalling between the UE and the MME.

The UE, when receiving the DETACH ACCEPT message, shall stop timer T3421.

The UE is marked as inactive in the network for EPS services. State EMM-DEREGISTERED is entered in the UE and the network.

9.2.2.1.1.3 Test description

9.2.2.1.1.3.1 Pre-test conditions

System Simulator:

- Cell 1

UE:

None.

Preamble:

- The UE is in EMM-REGISTERED state (State 2) according to [18].

Editor's note: No such state is defined, state 2 is "Registered, Idle mode".

- UE has a valid GUTI-1 and is registered in TAI-1

NOTE: Detach due "switch off" can be done in any state but for testing purposes EMM-REGISTERED has been chosen as a representative state.

9.2.2.1.1.3.2 Test procedure sequence

Table 9.2.2.1.1.3.2-1: Main behaviour

St	Procedure	Message Sequence		TP	Verdict
		U - S	Message		
1	Cause switch off or remove power from the UE				
2	Check: does the UE transmit a DETACH REQUEST with the Detach Type IE indicating "switch off"?	-->	DETACH REQUEST	1	P
3	Check: does the send any further DETACH REQUEST messages within the next 5s?	-->	DETACH REQUEST	1	F
4	The SS starts an authentication procedure using the previously allocated KSI	<--	AUTHENTICATION REQUEST		
5	Check: does the UE transmit an AUTHENTICATION RESPONSE message within the next 6s?	-->	AUTHENTICATION RESPONSE	1	F
6	The SS starts the EPS bearer context modification procedure using the previously allocated EPS bearer identity	<--	MODIFY EPS BEARER CONTEXT REQUEST		
7	Check: does the UE transmit a MODIFY EPS BEARER CONTEXT ACCEPT message within the next FFS s?	-->	MODIFY EPS BEARER CONTEXT ACCEPT	1	F

9.2.2.1.1.3.3 Specific message contents

FFS.

9.2.2.1.2 UE initiated detach / USIM removed from the UE

9.2.2.1.2.1 Test Purpose (TP)

(1)

```
with { UE in any EMM state }
ensure that {
  when { the USIM is removed from the UE }
  then { the UE sends DETACH REQUEST message and indicates that the detach is for both EPS services
and non-EPS services }
}
```

9.2.2.1.2.2 Conformance requirements

References: The conformance requirements covered in the present TC are specified in: 3GPP TS 24.301 clauses and 5.5.2.2.1 and 5.5.2.2.3.

[TS24.301 clause 5.5.2.2.1]

The detach procedure is initiated by the UE by sending a DETACH REQUEST message. The Detach type IE included in the message indicates whether detach is due to a "switch off" or not. The Detach type IE also indicates whether the detach is for EPS services only, for non-EPS services only, or for both.

If the detach is not due to switch off and the UE is in the state EMM-REGISTERED, timer T3421 shall be started in the UE after the DETACH REQUEST message has been sent. If the detach type indicates that the detach is for non-EPS services only the UE shall enter the state EMM-REGISTERED.IMSI-DETACH-INITIATED, otherwise the UE shall enter the state EMM-DEREGISTERED-INITIATED. If the detach type indicates that the detach is for non-EPS services or both EPS and non-EPS services, the UE shall enter the state MM IMSI DETACH PENDING.

[TS24.301 clause 5.5.2.2.3]

When the DETACH REQUEST message is received by the network, a DETACH ACCEPT message shall be sent to the UE, if the Detach type IE value indicates that the detach request has not been sent due to switching off. Depending on the value of the Detach type IE the following applies:

- combined EPS/IMSI detach:

The UE is marked as inactive in the network for EPS and for non-EPS services. The states EMM-DEREGISTERED and MM-NUL are entered in both the UE and the network.

9.2.2.1.2.3 Test description

9.2.2.1.2.3.1 Pre-test conditions

System Simulator:

- Cell 1 (FDD or TDD).

UE:

None.

Preamble:

- UE is brought to EMM-REGISTERED state (State 2) according to [18]
- UE has a valid GUTI-1 and is registered in TAI-1
- Does UE support USIM removal without power down Y/N

NOTE: Detach due "USIM removal" can be done in any state but for testing purposes EMM-REGISTERED has been chosen as a representative state.

9.2.2.1.2.3.2 Test procedure sequence

Table 9.2.2.1.2.3.2-1: Main behaviour

St	Procedure	Message Sequence		TP	Verdict
		U - S	Message		
1	Cause removal of USIM from the UE without powering down	-	-	-	-
2	Check: does the UE transmit a DETACH REQUEST with the Detach Type IE indicating "normal detach" and "combined EPS/IMSI detach"?	-->	DETACH REQUEST	1	P
3	SS responds with DETACH ACCEPT message	<--	DETACH ACCEPT	-	-
4	The SS starts a paging procedure using the previously allocated identifiers	-	-	-	-
5	Check: does the UE respond to the paging?	-->		1	F

9.2.2.1.2.3.3 Specific message contents

FFS.

9.2.2.1.6 UE initiated detach / Abnormal case / local detach after 5 attempts due to no network response

9.2.2.1.6.1 Test Purpose (TP)

(1)

```
with { UE in EMM-REGISTERED state }
ensure that {
  when { the UE receives no response to the UE initiated DETACH REQUEST }
  then { the UE re-transmits the DETACH REQUEST up to 4 times on the expiry of timer T3421 }
}
```

(2)

```
with { UE in EMM-REGISTERED state }
ensure that {
  when { the UE receives no response to the UE initiated DETACH REQUEST }
  then { the UE aborts the detach procedure and perform local detach on the 5th expiry of timer T3421 }
}
```

9.2.2.1.6.2 Conformance requirements

References: The conformance requirements covered in the current TC are specified in: TS 24.301, clause 5.5.2.2.

[TS 24.301, clause 5.5.2.2.1]

The detach procedure is initiated by the UE by sending a DETACH REQUEST message. The Detach type IE included in the message indicates whether detach is due to a "switch off" or not. The Detach type IE also indicates whether the detach is for EPS services only, for non-EPS services only, or for both.

If the detach is not due to switch off and the UE is in the state EMM-REGISTERED, timer T3421 shall be started in the UE after the DETACH REQUEST message has been sent. If the detach type indicates that the detach is for non-EPS services only the UE shall enter the state EMM-REGISTERED.IMSI-DETACH-INITIATED, otherwise the UE shall enter the state EMM-DEREGISTERED-INITIATED. If the detach type indicates that the detach is for non-EPS services or both EPS and non-EPS services, the UE shall enter the state MM IMSI DETACH PENDING.

[TS 24.301, clause 5.5.2.2.4 c)]

The following abnormal cases can be identified:

...

c) T3421 timeout

On the first four expiries of the timer, the UE shall retransmit the DETACH REQUEST message and shall reset and restart timer T3421. On the fifth expiry of timer T3421, the detach procedure shall be aborted and the UE shall change to state:

- EMM-REGISTERED.NORMAL-SERVICE and MM-NULL if "IMSI detach" was requested;
- EMM-DEREGISTERED if "EPS detach" was requested;
- EMM-DEREGISTERED and MM-NULL if "combined EPS/IMSI detach" was requested.

9.2.2.1.6.3 Test description

9.2.2.1.6.3.1 Pre-test conditions

System Simulator:

- 1 cell

UE:

None.

Preamble:

- The UE is in state Registered, Idle Mode (State 2) according to [18].

9.2.2.1.6.3.2 Test procedure sequence

Table 9.2.2.1.6.3.2-1: Main behaviour

St	Procedure	Message Sequence		TP	Verdict
		U - S	Message		
1	Cause UE to initiate detach from the EPS services only.	-	-	-	-
2	The UE transmits a DETACH REQUEST message with the Detach type IE indicating "EPS detach" and "normal detach"? The UE starts timer T3421.	-->	DETACH REQUEST	-	-
3	The SS does not respond to the DETACH REQUEST message.	-	-	-	-
4	Check: When the timer T3421 expires does the UE re-transmit DETACH REQUEST message. Timer T3421 is re-started (1 st expiry).	-->	DETACH REQUEST	1	P
5	The SS does not respond to the DETACH REQUEST message.	-	-	-	-
6	Check: When the timer T3421 expires does the UE re-transmit DETACH REQUEST message. Timer T3421 is re-started (2 nd expiry).	-->	DETACH REQUEST	1	P
7	The SS does not respond to the DETACH REQUEST message.	-	-	-	-
8	Check: When the timer T3421 expires does the UE re-transmit DETACH REQUEST message. Timer T3421 is re-started (3 rd expiry).	-->	DETACH REQUEST	1	P
9	The SS does not respond to the DETACH REQUEST message.	-	-	-	-
10	Check: When the timer T3421 expires does the UE re-transmit DETACH REQUEST message. Timer T3421 is re-started (4 th expiry).	-->	DETACH REQUEST	1	P
11	The SS does not respond to the DETACH REQUEST message.	-	-	-	-
12	When the timer T3421 expires the UE aborts the detach procedure and performs a local detach (5 th expiry).	-	-	2	P
13	The SS starts the EPS bearer context modification procedure using the previously allocated EPS bearer identity	<--	MODIFY EPS BEARER CONTEXT REQUEST	-	-
14	Check: does the UE transmit a MODIFY EPS BEARER CONTEXT ACCEPT message within the next [FFS] s?	-->	MODIFY EPS BEARER CONTEXT ACCEPT	2	F

Note: T3421 value is specified as 15s in TS 24.301.

9.2.2.1.6.3.3 Specific message contents

FFS

9.2.2.2 Network initiated detach procedure

9.2.2.2.1 NW initiated detach / re-attach required

9.2.2.2.1.1 Test Purpose (TP)

(1)

with { UE in EMM-REGISTERED state }

```

ensure that {
  when { SS sends DETACH REQUEST message with the Detach type IE "re-attach required" }
  then { UE sends DETACH ACCEPT message and UE initiates an attach procedure with the current EPS
security context}
}
    
```

9.2.2.2.1.2 Conformance requirements

References: The conformance requirement covered in the present TC is specified in: 3GPP TS 24.301 clauses 5.5.2.3.2. [TS24.301 clause5.5.2.3.2]

When receiving the DETACH REQUEST message and the Detach type IE indicates "re-attach required", the UE shall deactivate the EPS bearer context(s) including the default EPS bearer context locally without peer-to-peer signalling between the UE and the MME. If the Detach type IE indicates "re-attach required", the UE shall store the current EPS security context. The UE shall then send a DETACH ACCEPT message to the network and enter state EMM-DEREGISTERED. The UE shall, after the completion of the detach procedure, and the existing NAS signalling connection has been released, initiate an attach procedure..

A UE which receives a DETACH REQUEST message with detach type indicating "re-attach required" or "re-attach not required" and no EMM cause IE, is detached only for EPS services.

...If the detach type IE indicates "IMSI detach" or "re-attach required" then the UE shall ignore the EMM cause IE if received.

9.2.2.2.1.3 Test description

9.2.2.2.1.3.1 Pre-test conditions

System Simulator:

- Cell A
- Cell A belongs to TAI-1 (home PLMN).

UE:

- The UE has a valid GUTI (GUTI-1), a valid NAS security context and is registered in TAI-1

Preamble:

- The UE is in state Generic RB established (state 3) on Cell A according to [18].

9.2.2.2.1.3.2 Test procedure sequence

Table 9.2.2.2.1.3.2-1: Main behaviour

St	Procedure	Message Sequence		TP	Verdict
		U - S	Message/PDU/SDU		
1	The SS initiates Detach procedure with the Detach Type IE "re-attach required"	<--	DETACH REQUEST	-	-
2	Check: Does the UE send DETACH ACCEPT message?	-->	DETACH ACCEPT	1	P
3	The SS releases RRC connection.				
4	Check: Does the UE send ATTACH REQUEST message?	-->	ATTACH REQUEST	1	P
5	The SS sends ATTACH ACCEPT to assign the new GUTI (GUTI-2).	<--	ATTACH ACCEPT	-	-
6	Check: Does the UE send ATTACH COMPLETE message?	-->	ATTACH COMPLETE	1	P

9.2.2.2.1.3.3 Specific message contents

Table 9.2.2.2.1.3.3-1: Message DETACH REQUEST (step 1, Table 9.2.2.2.1.3.2-1)

Derivation path: 36.508 table 4.7.2-12			
Information Element	Value/Remark	Comment	Condition
Detach type	'001'B	"re-attach required"	

Table 9.2.2.2.1.3.3-2: Message ATTACH REQUEST (step 4, Table 9.2.2.2.1.3.2-1)

Derivation path: 36.508 table 4.7.2-4			
Information Element	Value/Remark	Comment	Condition
NAS key set identifier			
TSC	'0'B	native security context	
NAS key set identifier	The value is a same value to be allocated by SS in Preamble.		
Old GUTI or IMSI	GUTI-1		

NOTE: This message is sent within the SECURITY NAS PROTECTED MESSAGE in Table 9.2.2.2.1.3.3-3.

Table 9.2.2.2.1.3.3-3: Message SECURITY PROTECTED NAS MESSAGE (step 4, Table 9.2.2.2.1.3.2-1)

Derivation Path: 36.508 Table 4.7.1-1			
Information Element	Value/remark	Comment	Condition
Security header type	'0001'B	Integrity protected	
NAS message	'01000001'B	"ATTACH REQUEST"	

Table 9.2.2.2.1.3.3-4: Message ATTACH ACCEPT (step 5, Table 9.2.2.2.1.3.2-1)

Derivation path: 36.508 table 4.7.2-1			
Information Element	Value/Remark	Comment	Condition
TAI list			
Length of tracking area identity list contents	'00001000'B	8 octets	
Number of elements	'00000'B	1 element	
Type of list	'00'B	"list of TACs belonging to one PLMN, with non-consecutive TAC values"	
Partial tracking area identity list	TAI-1		
GUTI	GUTI-2		

9.2.2.2.2 NW initiated detach / IMSI detach

9.2.2.2.2.1 Test Purpose (TP)

(1)

```

with { UE in EMM-REGISTERED state }
ensure that {
  when { UE receives DETACH REQUEST message with the Detach type IE = "IMSI detach" }
  then { UE sends TRACKING AREA UPDATE REQUEST message with EPS update type IE = "Combined TA/LA updating with IMSI attach" }
}

```

(2)

```

with { UE in EMM-TRACKING-AREA-UPDATING-INITIATED state }
ensure that {
  when { UE receives TRACKING AREA UPDATE ACCEPT message }
  then { UE enters EMM-REGISTERED and enters MM IDLE and sends TRACKING AREA UPDATE COMPLETE message }
}

```

}

9.2.2.2.2.2 Conformance requirements

References: The conformance requirement covered in the present TC is specified in: 3GPP TS 24.301 clauses 5.5.2.3.2. [TS24.301 clause5.5.2.3.2]

...

When receiving the DETACH REQUEST message and the Detach type IE indicates "IMSI detach", the UE shall not deactivate the EPS bearer context(s) including the default EPS bearer context. The UE shall set the MM update status to U2 NOT UPDATED. A UE may send a DETACH ACCEPT message to the network, and shall re-attach to non-EPS services by performing the combined tracking area updating procedure according to subclause 5.5.3.3, sending a TRACKING AREA UPDATE REQUEST message with EPS update type IE indicating "combined TA/LA updating with IMSI attach".

...

If the detach type IE indicates "IMSI detach" or "re-attach required", then the UE shall ignore the EMM cause IE if received.

...

9.2.2.2.2.3 Test description

9.2.2.2.2.3.1 Pre-test conditions

System Simulator:

- Cell A is configured according to Table 6.3.2.2-1 in [18].
- Cell A belongs to TAI-1.

UE:

- UE has a valid GUTI (GUTI-1) and is registered in TAI-1
- The UE has a valid TMSI (TMSI-1).
- The UE is IMSI attached for non-EPS service and is registered in LAI-1(MCC1/MNC1/LAC1).

Preamble:

- UE is in state Generic RB established (state 3) on Cell A according to [18].

9.2.2.2.2.3.2 Test procedure sequence

Table 9.2.2.2.3.2-1: Main Behaviour

St	Procedure	Message Sequence		TP	Verdict
		U - S	Message/PDU/SDU		
1	Force the SS to initiate Detach procedure with the Detach Type IE "IMSI detach"	<--	DETACH REQUEST	-	-
2	The UE may send DETACH ACCEPT message.(Optional)	-->	DETACH ACCEPT	-	-
3	Check: Does the UE send TRACKING AREA UPDATE REQUEST message?	-->	TRACKING AREA UPDATE REQUEST	1	P
4	The SS starts a NAS security mode command procedure to perform NAS integrity protection.	<--	SECURITY MODE COMMAND	-	-
5	The UE responds properly to the NAS security mode command procedure.	-->	SECURITY MODE COMPLETE	-	-

6	The SS sends TRACKING AREA UPDATE ACCEPT message.	<--	TRACKING AREA UPDATE ACCEPT	-	-
7	Check: Does the UE send TRACKING AREA UPDATE COMPLETE message.	-->	TRACKING AREA UPDATE COMPLETE	2	P
8	The SS releases the RRC connection.	-		-	-
9	Check: Does the UE respond to paging on cell A with S-TMSI2 for CS domain?	-		2	-
10	Check: Does the UE respond to paging on cell A with S-TMSI2 for PS domain?	-		2	-

9.2.2.2.3.3 Specific message contents

Table 9.2.2.2.3.3-1: Message DETACH REQUEST (step 1, Table 9.2.2.2.3.2-1)

Derivation path: 36.508 table 4.7.2-12			
Information Element	Value/Remark	Comment	Condition
Detach type	'011'B	"IMSI detach"	

Table 9.2.2.2.3.3-2: Message TRACKING AREA UPDATE REQUEST (step 3, Table 9.2.2.2.3.2-1)

Derivation path: 36.508 table 4.7.2-27			
Information Element	Value/Remark	Comment	Condition
EPS update type			
EPS update type value	'010'B	"Combined TA/LA updating with IMSI attach"	
Old GUTI	GUTI-1		
Last visited registered TAI	TAI-1		
Old location area identification	LAI-1		
TMSI status	'1'B	"valid TMSI available"	

Table 9.2.2.2.3.3-3: Message TRACKING AREA UPDATE ACCEPT (step 6, Table 9.2.2.2.3.2-1)

Derivation path: 36.508 table 4.7.2-24			
Information Element	Value/Remark	Comment	Condition
EPS update result	'001'B	"combined TA/LA updated "	
GUTI	GUTI-2		
TAI list			
Length of tracking area identity list contents	'00001000'B		
Number of elements	'00000'B		
Type of list	'00'B	"list of TACs belonging to one PLMN, with non-consecutive TAC values"	
Partial tracking area identity list	TAI-1	TAI-1	
Location area identification	LAI-1		
MS identity	TMSI-1		

9.2.2.2.4 Void

9.2.2.2.6 Void

9.2.2.2.7 Void

9.2.2.2.8 Void

9.2.3 Tracking area updating procedure (S1 mode only)

9.2.3.1 Normal and periodic tracking area updating

9.2.3.1.1 Normal tracking area update / accepted

9.2.3.1.1.1 Test Purpose (TP)

(1)

```
with { UE in state EMM-REGISTERED and EMM-IDLE mode}
ensure that {
  when { UE detects entering a new tracking area already included in the TAI list }
  then { UE does not send TRACKING AREA UPDATE REQUEST message }
}
```

(2)

```
with { UE in state EMM-REGISTERED and EMM-IDLE mode}
ensure that {
  when { UE detects entering a new tracking area not included in the TAI list }
  then { UE sends TRACKING AREA UPDATE REQUEST message with 'EPS update type = TA updating' }
}
```

(3)

```
with { UE in state EMM-REGISTERED and EMM-IDLE mode and has a valid TAI value }
ensure that {
  when { UE detects entering a new tracking area not included in the TAI list }
  then { UE sends TRACKING AREA UPDATE REQUEST message with the TAI value in 'Last visited
registered TAI' IE }
}
```

9.2.3.1.1.2 Conformance requirements

References: The conformance requirements covered in the present TC are specified in: 3GPP TS 24.301 clauses 5.5.3.1, 5.5.3.2.2 and 5.5.3.2.4.

[TS24.301 clause5.5.3.1]

The tracking area updating procedure is always initiated by the UE and is used for the following purposes:

- normal tracking area updating to update the registration of the actual tracking area of a UE in the network;

...

[TS24.301 clause5.5.3.2.2]

The UE in state EMM-REGISTERED shall initiate the tracking area updating procedure by sending a TRACKING AREA UPDATE REQUEST message to the MME,

- a) when the UE detects entering a tracking area that is not in the list of tracking areas that the UE previously registered in the MME;

...

After sending the TRACKING AREA UPDATE REQUEST message to the MME, the UE shall start timer T3430 and enter state EMM-TRACKING-AREA-UPDATING-INITIATED (see example in figure 5.5.3.2.2). If timer T3402 is currently running, the UE shall stop timer T3402. If timer T3411 is currently running, the UE shall stop timer T3411. If timer T3442 is currently running, the UE shall stop timer T3442.

If the UE supports A/Gb mode or Iu mode, the UE shall handle the Old GUTI IE as follows:

- If the TIN indicates "P-TMSI" and the UE holds a valid P-TMSI and RAI, the UE shall map the P-TMSI and RAI into the Old GUTI IE. Additionally, if the UE holds a valid GUTI, the UE shall indicate the GUTI in the Additional GUTI IE.

NOTE: The mapping of the P-TMSI and RAI to the GUTI is specified in 3GPP TS 23.003 [2].

- If the TIN indicates "GUTI" or "RAT-related TMSI" and the UE holds a valid GUTI, the UE shall indicate the GUTI in the Old GUTI IE.

...

[TS24.301 clause5.5.3.2.4]

...

Upon receiving a TRACKING AREA UPDATE ACCEPT message, the UE shall stop timer T3430, reset the routing area updating attempt counter, enter state EMM-REGISTERED and set the EPS update status to EU1 UPDATED. If the message contains a GUTI, the UE shall use this GUTI as new temporary identity for EPS services and shall store the new GUTI. If no GUTI was included by the MME in the TRACKING AREA UPDATE ACCEPT message, the old GUTI shall be used. If the UE receives a new TAI list in the TRACKING AREA UPDATE ACCEPT message, the UE shall consider the new TAI list as valid and the old TAI list as invalid; otherwise, the UE shall consider the old TAI list as valid.

...

If the TRACKING AREA UPDATE ACCEPT message contained a GUTI, the UE shall return a TRACKING AREA UPDATE COMPLETE message to the MME to acknowledge the received GUTI.

9.2.3.1.1.3 Test description

9.2.3.1.1.3.1 Pre-test conditions

System Simulator:

- Cell A, Cell C and Cell D are configured according to Table 6.3.2.2-1 in [18].
 - Cell A belongs to TAI-1(home PLMN) and is set to "Serving cell"
 - Cell C belongs to TAI-3(home PLMN, another TAC) and is set to "Non- Suitable cell"
 - Cell D belongs to TAI-4 (home PLMN, another TAC) and is set to "Non- Suitable cell"

UE:

- The UE has a valid GUTI (GUTI-1).
- The UE is registered on TAI-1.

Preamble:

- UE is in state Registered, Idle Mode (state 2) on Cell A according to [18].

9.2.3.1.1.3.2 Test procedure sequence

Table 9.2.3.1.1.3.2-1: Main behaviour

St	Procedure	Message Sequence		TP	Verdict
		U - S	Message		
	The following messages are sent and shall be received on cell C.	-	-	-	-
1	Set the cell type of cell A to the "Non-Suitable cell". Set the cell type of cell C to the "Serving cell"	-	-	-	-
2	Check: Does the UE transmit a TRACKING AREA UPDATE REQUEST message?	-->	TRACKING AREA UPDATE REQUEST	2, 3	P
3	The SS transmits a TRACKING AREA UPDATE ACCEPT message.	<--	TRACKING AREA UPDATE ACCEPT	-	-
4	Check: Does the UE transmit a TRACKING AREA UPDATE COMPLETE message?	-->	TRACKING AREA UPDATE COMPLETE	2	P
5	The SS releases the RRC connection.			-	-
6	Check: Does the UE respond to paging on cell C with S-TMSI2 for PS domain? (Generic Procedure)	-	-	2	-
7	Set the cell type of cell C to the "Non-Suitable cell". Set the cell type of cell D to the "Serving cell"	-	-	-	-
8	Check: Does the UE transmit a TRACKING AREA UPDATE REQUEST message in the next 30 seconds?	-	-	1	F
9	Check: Does the UE respond to paging on cell D with S-TMSI1 for PS domain?(Generic Procedure)	-	-	1	-
	The following messages are sent and shall be received on cell A.	-	-	-	-
10	Set the cell type of cell D to the "Non-Suitable cell". Set the cell type of cell A to the "Serving cell"	-	-	-	-
11	Check: Does the UE transmit a TRACKING AREA UPDATE REQUEST message?	-->	TRACKING AREA UPDATE REQUEST	2, 3	P
12	The SS transmits a TRACKING AREA UPDATE ACCEPT message.	<--	TRACKING AREA UPDATE ACCEPT	-	-
13	The UE transmits a TRACKING AREA UPDATE COMPLETE message?	-->	TRACKING AREA UPDATE COMPLETE	-	-
14	The SS releases the RRC connection.	-	-	-	-

9.2.3.1.1.3.3 Specific message contents

Table 9.2.3.1.1.3.3-2: Message TRACKING AREA UPDATE REQUEST (step 2, Table 9.2.3.1.2.3.2-1)

Derivation path: 36.508 table 4.7.2-27			
Information Element	Value/Remark	Comment	Condition
EPS update type EPS update type value Old GUTI	'000'B GUTI-1	"TA updating" "Old GUTI is included by UE if valid, IMSI otherwise"	
Last visited registered TAI TAI	1		

Table 9.2.3.1.1.3.3-3: Message TRACKING AREA UPDATE ACCEPT (step 3, Table 9.2.3.1.2.3.2-1)

Derivation path: 36.508 table 4.7.2-24			
Information Element	Value/Remark	Comment	Condition
EPS update result	'000'B	"TA updated"	
GUTI	GUTI-2		
TAI list			
Length of tracking area identity list contents	'00001000'B		
Partial tracking area identity list			
Number of elements	'00000'B		
Type of list	'00'B	"list of TACs belonging to one PLMN, with non-consecutive TAC values"	
MCC	PLMN= MCC/MNC	"PLMN is set to the same MCC/MNC stored in EF _{IMSI} "	
MNC	TAC 1=3	"TAI-3"	
TAC 1	TAC 2=4	"TAI-4"	

Table 9.2.3.1.1.3.3-4: Message TRACKING AREA UPDATE REQUEST (step 11, Table 9.2.3.1.2.3.2-1)

Derivation path: 36.508 table 4.7.2-27			
Information Element	Value/Remark	Comment	Condition
EPS update type			
EPS update type value	'000'B	"TA updating"	
Old GUTI	GUTI-2		
Last visited registered TAI	TAI-4		

Table 9.2.3.1.1.3.3-5: Message TRACKING AREA UPDATE ACCEPT (step 12, Table 9.2.3.1.2.3.2-1)

Derivation path: 36.508 table 4.7.2-24			
Information Element	Value/Remark	Comment	Condition
EPS update result	'000'B	"TA updated"	
GUTI	GUTI-3		
TAI list			
Length of tracking area identity list contents	'00001000'B		
Partial tracking area identity list			
Number of elements	'00000'B		
Type of list	'00'B	"list of TACs belonging to one PLMN, with non-consecutive TAC values"	
MCC	PLMN= MCC/MNC	"PLMN is set to the same MCC/MNC stored in EF _{IMSI} "	
MNC	TAC 1=1	"TAI-1"	
TAC 1	TAC 2=2	"TAI-2"	

9.2.3.1.2 Normal tracking area update / accepted / "Active" flag set

9.2.3.1.2.1 Test Purpose (TP)

(1)

```

with { UE in state EMM-SERVICE-REQUEST-INITIATED and EMM-CONNECTED }
ensure that {
  when { UE detects entering a new tracking area already not included in the TAI list }
  then { UE sends TRACKING AREA UPDATE REQUEST message }
}

```

(2)

```

with { UE in state EMM-REGISTERED and EMM-CONNECTED }
ensure that {
  when { UE sends TRACKING AREA UPDATE COMPLETE to NW }
  then { UE establishes the user plane and keeps the NAS signalling connection }
}

```

9.2.3.1.2.2 Conformance requirements

References: The conformance requirements covered in the present TC are specified in: 3GPP TS 24.301 clauses 5.5.3.1, 5.5.3.2.2, 5.5.3.2.4 and 5.6.1.5.

[TS24.301 clause5.5.3.1]

The tracking area updating procedure is always initiated by the UE and is used for the following purposes:

- normal tracking area updating to update the registration of the actual tracking area of a UE in the network;

...

[TS24.301 clause5.5.3.2.2]

The UE in state EMM-REGISTERED shall initiate the tracking area updating procedure by sending a TRACKING AREA UPDATE REQUEST message to the MME,

- i) when the UE detects entering a tracking area that is not in the list of tracking areas that the UE previously registered in the MME;

..

After sending the TRACKING AREA UPDATE REQUEST message to the MME, the UE shall start timer T3430 and enter state EMM-TRACKING-AREA-UPDATING-INITIATED (see figure 5.5.3.2.2). If timer T3402 is currently running, the UE shall stop timer T3402. If timer T3411 is currently running, the UE shall stop timer T3411.

In the TRACKING AREA UPDATE REQUEST message the UE shall include a GUTI and the last visited registered TAI, the update type indicating the type of the tracking area updating. If the UE's TIN indicates "P-TMSI" the UE shall map the valid P-TMSI and RAI into the old GUTI. If a UE in EMM-IDLE mode has uplink user data pending when it initiates the tracking area updating procedure, or uplink signalling not related to the tracking area updating procedure, it may also set an "active" flag in the TRACKING AREA UPDATE REQUEST message to indicate the request to establish the user plane to the network and to keep the NAS signalling connection after the completion of the tracking area updating procedure.

...

When the tracking area updating procedure is initiated in EMM-IDLE mode, the UE may also include an EPS bearer context status IE in the TRACKING AREA UPDATE REQUEST message, indicating which EPS bearer contexts are active in the UE.

[TS24.301 clause5.5.3.2.4]

...

If the "active" flag is included in the TRACKING AREA UPDATE REQUEST message, the MME shall re-establish the radio and S1 bearers for all active EPS bearer contexts.

Upon receiving a TRACKING AREA UPDATE ACCEPT message, the UE shall stop timer T3430, reset the tracking area updating attempt counter, enter state EMM-REGISTERED and set the EPS update status to EU1 UPDATED. If the message contains a GUTI, the UE shall use this GUTI as new temporary identity for EPS services and shall store the new GUTI. If no GUTI was included by the MME in the TRACKING AREA UPDATE ACCEPT message, the old GUTI shall be used. If the UE receives a new TAI list in the TRACKING AREA UPDATE ACCEPT message, the UE shall consider the new TAI list as valid and the old TAI list as invalid; otherwise, the UE shall consider the old TAI list as valid.

...

If the TRACKING AREA UPDATE ACCEPT message contained a GUTI, the UE shall return a TRACKING AREA UPDATE COMPLETE message to the MME to acknowledge the received GUTI.

...

[TS24.301 clause 5.6.1.5]

...

- e) Tracking area updating procedure is triggered

The UE shall abort the service request procedure, stop timer T3417 and perform the tracking area updating procedure. The "active" flag shall be set in the TRACKING AREA UPDATE REQUEST message.

...

- j) Transmission failure of SERVICE REQUEST message indication with TAI change from lower layers

If the current TAI is not in the TAI list, the service request procedure shall be aborted to perform the tracking area updating procedure. The "active" flag shall be set in the TRACKING AREA UPDATE REQUEST message.

If the current TAI is still part of the TAI list, the UE shall restart the service request procedure.

...

9.2.3.1.2.3 Test description

9.2.3.1.2.3.1 Pre-test conditions

System Simulator:

- Cell A (TAI-1:MCC1/MNC1/TAC1)
- Cell B(TAI-2:MCC1/MNC1/TAC2)
- Cell A is set to the "Serving cell" and Cell B is set to the "Non-suitable cell".

UE:

- The UE has a valid GUTI (GUTI-1) and is registered on TAI-1.

Preamble:

- The UE is in state Registered, Idle Mode (state 2) on Cell A according to [18].

9.2.3.1.2.3.2 Test procedure sequence

Table 9.2.3.1.2.3.2-1: Main behaviour

St	Procedure	Message Sequence		TP	Verdict
		U - S	Message		
1	Force the UE to initiate uplink user data.(Note1)	-	-	-	-
2	The UE transmits SERVICE REQUEST message.	-->	SERVICE REQUEST	-	-
3	The SS does not perform a radio bearer establishment procedure.(Note2)	-	-	-	-
	The following messages are sent and shall be received on cell B.			-	-
4	Set the cell type of cell A to the "Non-suitable cell". Set the cell type of cell B to the "Serving cell".	-	-	-	-
5	Check: Does the UE transmit a TRACKING AREA UPDATE REQUEST message with "Active" flag?	-->	TRACKING AREA UPDATE REQUEST	1	P
7	The SS starts a NAS security mode command procedure to perform NAS integrity protection.	<--	SECURITY MODE COMMAND	-	-
8	The UE responds to the NAS security mode command procedure.	-->	SECURITY MODE COMPLETE	-	-
9	The SS transmits a TRACKING AREA UPDATE ACCEPT message.	<--	TRACKING AREA UPDATE ACCEPT	-	-
10	Check: Does the UE transmit a TRACKING AREA UPDATE COMPLETE message?	-->	TRACKING AREA UPDATE COMPLETE	1	P
11	The SS waits 10seconds (T3440).				
12	Check: does the test result of the above procedure indicate that UE is in EMM_CONNECTED state?(FFS)	-	-	2	P

Note1: This could be done by e.g. MMI or by AT command.
 Note2: The SS does not send any AS or NAS messages to UE.

9.2.3.1.2.3.3 Specific message contents

Table 9.2.3.1.2.3.3-1: Message TRACKING AREA UPDATE REQUEST (step 3, Table 9.2.3.1.2.3.2-1)

Derivation path: 36.508 table 4.7.2-27			
Information Element	Value/Remark	Comment	Condition
EPS update type "Active" flag	'1'B	Bearer establishment requested	
EPS update type value Old GUTI	'000'B GUTI-1	"TA updating" Old GUTI is included by UE if valid, IMSI otherwise.	

Table 9.2.3.1.2.3.3-2: Message TRACKING AREA UPDATE ACCEPT (step 6, Table 9.2.3.1.2.3.2-1)

Derivation path: 36.508 table 4.7.2-24			
Information Element	Value/Remark	Comment	Condition
EPS update result	'000'B	"TA updated"	
GUTI	GUTI-2		
TAI list			
Length of tracking area identity list contents	'00001000'B	8 octets	
Number of elements	'00000'B	1 element	
Type of list	'00'B	"list of TACs belonging to one PLMN, with non-consecutive TAC values"	
Partial tracking area identity list	TAI-2		

9.2.3.1.4 Normal tracking area update / list of equivalent PLMNs in the TRACKING AREA UPDATE ACCEPT message

9.2.3.1.4.1 Test Purpose (TP)

(1)

```
with { UE in EMM-TRACKING-AREA-UPDATING-INITIATED state }
ensure that {
  when { the UE receives TRACKING AREA UPDATE ACCEPT message including a list of equivalent PLMNs }
  then { the UE stores correctly the list and considers a forbidden PLMN if the forbidden PLMN is included in the equivalent list }
}
```

(2)

```
with { UE in EMM-TRACKING-AREA-UPDATING-INITIATED state }
ensure that {
  when { the UE receives TRACKING AREA UPDATE ACCEPT message without a list of equivalent PLMNs }
  then { the UE deletes the stored list and applies a normal PLMN selection process }
}
```

9.2.3.1.4.2 Conformance requirements

References: The conformance requirements covered in the current TC are specified in: TS 24.301, clause 5.5.3.2.4.

[TS 24.301, clause 5.5.3.2.4]

The MME may also include of list of equivalent PLMNs in the TRACKING AREA UPDATE ACCEPT message. Each entry in the list contains a PLMN code (MCC+MNC). The UE shall store the list as provided by the network, after having removed from the list any PLMN code that is already in the list of forbidden PLMNs. In addition, the UE shall add to the stored list the PLMN code of the registered PLMN that sent the list. The UE shall replace the stored list on each receipt of the TRACKING AREA UPDATE ACCEPT message. If the TRACKING AREA UPDATE ACCEPT message does not contain a list, then the UE shall delete the stored list.

9.2.3.1.4.3 Test description

9.2.3.1.4.3.1 Pre-test conditions

System Simulator:

- Cell A, Cell B, Cell G, Cell I and Cell J are configured according to Table 6.3.2.2-1 in [18].
- Cell A belongs to TAI-1 (PLMN1).
- Cell B belongs to TAI-2 (PLMN1).
- Cell G belongs to TAI-7 (PLMN2).
- Cell I belongs to TAI-9 (PLMN3).

- Cell J belongs to TAI-10 (PLMN4).

UE:

- The UE has a valid GUTI (GUTI-1).
- The "forbidden PLMN list" contains PLMN3

Preamble:

UE is in state Registered, Idle Mode (state 2) on Cell A according to [18].

9.2.3.1.4.3.2 Test procedure sequence

Table 9.2.3.1.4.3.2-1: Main behaviour

St	Procedure	Message Sequence		TP	Verdict
		U - S	Message		
1	Set the cell type of cell A to the "Non-Suitable cell". Set the cell type of cell B to the "Serving cell". Set the cell type of cell G to the " Non-Suitable cell" Set the cell type of cell I to the " Non-Suitable cell" Set the cell type of cell J to the " Non-Suitable cell"	-	-	-	-
2	The UE transmits a TRACKING AREA UPDATE REQUEST message.	-->	TRACKING AREA UPDATE REQUEST	-	-
3	The SS transmits a NAS SECURITY MODE COMMAND message to activate NAS security.	<--	SECURITY MODE COMMAND	-	-
4	The UE transmits a NAS SECURITY MODE COMPLETE message and establishes the initial security configuration.	-->	SECURITY MODE COMPLETE	-	-
5	SS responds with a TRACKING AREA UPDATE ACCEPT message including PLMN2 and PLMN3 in the list of equivalent PLMNs.	<--	TRACKING AREA UPDATE ACCEPT	-	-
6	The UE transmits a TRACKING AREA UPDATE COMPLETE message	-->	TRACKING AREA UPDATE COMPLETE	-	-
7	Set the cell type of cell B to the "Non-Suitable cell". Set the cell type of cell G to the " Suitable cell" Set the cell type of cell J to the " Suitable cell"	-	-	-	-
8	Check: Does the UE transmit a TRACKING AREA UPDATE REQUEST message on cell G (PLMN2)?	-->	TRACKING AREA UPDATE REQUEST	1	P
9	The SS transmits a NAS SECURITY MODE COMMAND message to activate NAS security.	<--	SECURITY MODE COMMAND	-	-
10	The UE transmits a NAS SECURITY MODE COMPLETE message and establishes the initial security configuration.	-->	SECURITY MODE COMPLETE	-	-
11	The SS transmits a TRACKING AREA UPDATE ACCEPT message including PLMN1 and PLMN3 in the list of equivalent PLMNs.	<--	TRACKING AREA UPDATE ACCEPT	-	-
12	Check: Does the UE transmit a TRACKING AREA UPDATE COMPLETE message?	-->	TRACKING AREA UPDATE COMPLETE	1	P
13	Set the cell type of cell G to the "Non-Suitable cell" Set the cell type of cell I to the " Serving cell" Set the cell type of cell J to the " Non-Suitable cell" Note: Cell I (PLMN3) belongs to the forbidden PLMN.	-	-	-	-
14	Check: Does the UE transmit a TRACKING AREA UPDATE REQUEST message on cell I (PLMN3) in next 30 seconds?	-->	TRACKING AREA UPDATE REQUEST	1	F
15	The UE is switched to manual PLMN selection mode and is made to select PLMN3 in order to remove PLMN3 in the forbidden PLMN list in the UE.	-	-	-	-
16	Check: The UE transmits a TRACKING AREA UPDATE REQUEST message on cell I (PLMN3).	-->	TRACKING AREA UPDATE REQUEST	-	-
17	The SS transmits a NAS SECURITY MODE COMMAND message to activate NAS security.	<--	SECURITY MODE COMMAND	-	-
18	The UE transmits a NAS SECURITY MODE COMPLETE message and establishes the initial security configuration.	-->	SECURITY MODE COMPLETE	-	-
19	The SS transmits a TRACKING AREA	<--	TRACKING AREA UPDATE	-	-

	UPDATE ACCEPT message without the list of equivalent PLMNs.		ACCEPT		
20	Check: Does the UE transmit a TRACKING AREA UPDATE COMPLETE message?	-->	TRACKING AREA UPDATE COMPLETE	1	P
21	The UE is switched back to automatic PLMN selection mode.	-	-	-	-
22	Set the cell type of cell B to the "Suitable cell" Set the cell type of cell G to the "Serving cell" Set the cell type of cell I to the " Non-Suitable cell"	-	-	-	-
23	Check: Does the UE transmit a TRACKING AREA UPDATE REQUEST message on Cell G (PLMN2)?	-->	TRACKING AREA UPDATE REQUEST	2	P
24	The SS transmits a TRACKING AREA UPDATE REJECT message with EMM cause "No suitable cells in tracking area".	<--	TRACKING AREA UPDATE REJECT	-	-
25	Check: Does the UE transmit a TRACKING AREA UPDATE REQUEST message on Cell B (PLMN1)?	-->	TRACKING AREA UPDATE REQUEST	2	P
26	The SS transmits a TRACKING AREA UPDATE REJECT message with EMM cause "No suitable cells in tracking area".	<--	TRACKING AREA UPDATE REJECT	-	-

9.2.3.1.4.3.3 Specific message contents

Table 9.2.3.1.4.3.3-1: Message TRACKING AREA UPDATE ACCEPT (step 5, Table 9.2.3.1.4.3.2-1)

Derivation path: 36.508 table 4.7.2-24			
Information Element	Value/Remark	Comment	Condition
Equivalent PLMNs	-	Includes MCC and MNC digits for PLMN2 and PLMN3.	

Table 9.2.3.1.4.3.3-2: Message TRACKING AREA UPDATE ACCEPT (step 11, Table 9.2.3.1.4.3.2-1)

Derivation path: 36.508 table 4.7.2-24			
Information Element	Value/Remark	Comment	Condition
Equivalent PLMNs	-	Includes MCC and MNC digits for PLMN1 and PLMN3.	

Table 9.2.3.1.4.3.3-3: Message TRACKING AREA UPDATE REJECT (steps 24 and 26, Table 9.2.3.1.4.3.2-1)

Derivation path: 36.508 table 4.7.2-26			
Information Element	Value/Remark	Comment	Condition
EMM cause	'00001111' B	No suitable cells in tracking area	

9.2.3.1.5 Periodic tracking area update / accepted

9.2.3.1.5.1 Test Purpose (TP)

(1)

```
with { UE in state EMM-REGISTERED and EMM-IDLE mode}
ensure that {
  when { the periodic tracking area updating timer T3412 expires }
  then { UE sends TRACKING AREA UPDATE REQUEST message with EPS update type = 'Periodic updating' }
}
```

(2)

```

with { UE in 'out of E-UTRAN coverage' and the periodic tracking area updating timer T3412 expires }
ensure that {
  when { the UE enters E-UTRAN coverage }
  then { UE sends TRACKING AREA UPDATE REQUEST message with EPS update type = 'Periodic updating' }
}

```

9.2.3.1.5.2 Conformance requirements

References: The conformance requirements covered in the present TC are specified in: 3GPP TS23.401 clause 4.3.5.2 and TS 24.301 clauses 5.3.5, 5.5.3.2.1, 5.5.3.2.2 and 5.5.3.2.4.

[TS23.401 clause 4.3.5.2]

...

An EMM-REGISTERED UE performs periodic Tracking Area Updates with the network after the expiry of the periodic TAU timer.

If the UE is out of E-UTRAN coverage (including the cases when the UE is camped on 2G/3G cells) when its periodic TAU update timer expires, and ISR is activated the UE shall start the E-UTRAN Deactivate ISR timer. After the E-UTRAN Deactivate ISR timer expires the UE shall deactivate ISR by setting its TIN to "P-TMSI". The EMM-REGISTERED UE shall remember it has to perform a Tracking Area Update when it next returns to E-UTRAN coverage.

[TS24.301 clause 5.3.5]

Periodic tracking area updating is used to periodically notify the availability of the UE to the network. The procedure is controlled in the UE by the periodic tracking area update timer (timer T3412). The value of timer T3412 is sent by the network to the UE in the ATTACH ACCEPT message and can be sent in the TRACKING AREA UPDATE ACCEPT message. The UE shall apply this value in all tracking areas of the list of tracking areas assigned to the UE, until a new value is received.

The timer T3412 is reset and started with its initial value, when the UE goes from EMM-CONNECTED to EMM-IDLE mode. The timer T3412 is stopped when the UE enters EMM-CONNECTED mode or EMM-DEREGISTERED state.

When timer T3412 expires, the periodic tracking area updating procedure shall be started and the timer shall be set to its initial value for the next start.

If the UE is in another state than EMM-REGISTERED.NORMAL-SERVICE when the timer expires the periodic tracking area updating procedure is delayed until the UE returns to EMM-REGISTERED.NORMAL-SERVICE.

...

The mobile reachable timer shall be reset and started with its initial value, when the MME releases the NAS signalling connection for the UE. The mobile reachable timer shall be stopped when a NAS signalling connection is established for the UE.

....

[TS24.301 clause 5.5.3.2.1]

The periodic tracking area updating procedure is controlled in the UE by timer T3412. When timer T3412 expires, the periodic tracking area updating procedure is started. Start and reset of timer T3412 is described in subclause 5.5.3.2.

[TS24.301 clause 5.5.3.2.2]

The UE in state EMM-REGISTERED shall initiate the tracking area updating procedure by sending a TRACKING AREA UPDATE REQUEST message to the MME,

...

- b) when the periodic tracking area updating timer T3412 expires;

...

After sending the TRACKING AREA UPDATE REQUEST message to the MME, the UE shall start timer T3430 and enter state EMM-TRACKING-AREA-UPDATING-INITIATED (see example in figure 5.5.3.2.2). If timer T3402 is currently running, the UE shall stop timer T3402. If timer T3411 is currently running, the UE shall stop timer T3411. If timer T3442 is currently running, the UE shall stop timer T3442.

If the UE supports A/Gb mode or Iu mode, the UE shall handle the Old GUTI IE as follows:

- If the TIN indicates "P-TMSI" and the UE holds a valid P-TMSI and RAI, the UE shall map the P-TMSI and RAI into the Old GUTI IE. Additionally, if the UE holds a valid GUTI, the UE shall indicate the GUTI in the Additional GUTI IE.

NOTE: The mapping of the P-TMSI and RAI to the GUTI is specified in 3GPP TS 23.003 [2].

- If the TIN indicates "GUTI" or "RAT-related TMSI" and the UE holds a valid GUTI, the UE shall indicate the GUTI in the Old GUTI IE.

...

When the tracking area updating procedure is initiated in EMM-IDLE mode, the UE may also include an EPS bearer context status IE in the TRACKING AREA UPDATE REQUEST message, indicating which EPS bearer contexts are active in the UE.

[TS24.301 clause 5.5.3.2.4]

...

Upon receiving a TRACKING AREA UPDATE ACCEPT message, the UE shall stop timer T3430, reset the routing area updating attempt counter, enter state EMM-REGISTERED and set the EPS update status to EU1 UPDATED. If the message contains a GUTI, the UE shall use this GUTI as new temporary identity for EPS services and shall store the new GUTI. If no GUTI was included by the MME in the TRACKING AREA UPDATE ACCEPT message, the old GUTI shall be used. If the UE receives a new TAI list in the TRACKING AREA UPDATE ACCEPT message, the UE shall consider the new TAI list as valid and the old TAI list as invalid; otherwise, the UE shall consider the old TAI list as valid.

...

If the TRACKING AREA UPDATE ACCEPT message contained a GUTI, the UE shall return a TRACKING AREA UPDATE COMPLETE message to the MME to acknowledge the received GUTI.

9.2.3.1.5.3 Test description

9.2.3.1.5.3.1 Pre-test conditions

System Simulator:

- Cell A is configured according to Table 6.3.2.2-1 in [18].
- Cell A belongs to TAI-1. (home PLMN)

UE:

- The UE has no valid GUTI.

Preamble:

- The UE is in state Switched OFF (state 1) according to [18].

9.2.3.1.5.3.2 Test procedure sequence

Table 9.2.3.1.5.3.2-1: Main behaviour

St	Procedure	Message Sequence		TP	Verdict
		U - S	Message		
1	The UE is powered up or switched on.	-		-	-
2	The UE transmits an ATTACH REQUEST message with a PDN CONNECTIVITY REQUEST message to request PDN connectivity to the default PDN	-->	ATTACH REQUEST	-	-
3	The SS starts an authentication procedure	<--	AUTHENTICATION REQUEST	-	-
4	The UE responds to the authentication procedure	-->	AUTHENTICATION RESPONSE	-	-
5	The SS starts a NAS security mode command procedure to perform NAS integrity protection.	<--	SECURITY MODE COMMAND	-	-
6	The UE responds to the NAS security mode command procedure	-->	SECURITY MODE COMPLETE	-	-
7	The SS transmits an ATTACH ACCEPT message with GUTI-1 and with the ACTIVATE DEFAULT EPS BEARER CONTEXT REQUEST message.	<--	ATTACH ACCEPT	-	-
8	The UE transmits an ATTACH COMPLETE message with the ACTIVATE DEFAULT EPS BEARER CONTEXT ACCEPT message	-->	ATTACH COMPLETE	-	-
9	The SS releases the RRC connection.			-	-
10	The SS waits 6minutes. (Expire of T3412)	-			
11	Check: Does the UE send TRACKING AREA UPDATE REQUEST message.	-->	TRACKING AREA UPDATE REQUEST	1	P
12	The SS sends TRACKING AREA UPDATE ACCEPT.	<--	TRACKING AREA UPDATE ACCEPT	-	-
13	Check: Does the UE send TRACKING AREA UPDATE COMPLETE message?	-->	TRACKING AREA UPDATE COMPLETE	1	P
14	The SS releases the RRC connection.			-	-
15	Check: Does the UE respond to paging on cell A with S-TMSI2 for PS domain?(Generic procedure)	-		1	-
16	Set the cell type of cell A to the "non-Suitable cell".	-		-	-
17	The SS waits 8minutes.	-		-	-
18	Set the cell type of cell A to the "Serving cell".	-		-	-
19	Check: Does the UE send TRACKING AREA UPDATE REQUEST message?	-->	TRACKING AREA UPDATE REQUEST	2	P
20	The SS sends TRACKING AREA UPDATE ACCEPT.	<--	TRACKING AREA UPDATE ACCEPT	-	-
21	Check: Does the UE send TRACKING AREA UPDATE COMPLETE message?	-->	TRACKING AREA UPDATE COMPLETE	2	P
22	The SS releases the RRC connection.	-		-	-
23	Check: Does the UE respond to paging on cell A with S-TMSI3 for PS domain?(Generic procedure)	-		2	-

9.2.3.1.5.3.3 Specific message contents

Table 9.2.3.1.1.3.3-1: Message ATTACH ACCEPT (step 7, Table 9.2.3.1.1.3.2-1)

Derivation path: 36.508 table 4.7.2-1			
Information Element	Value/Remark	Comment	Condition
T3412 value			
Unit	'010'	"value is incremented in multiples of decihours"	
Timer value	'00001'	"6munites"	
TAI list			
Length of tracking area identity list contents	'00001010'B		
Partial tracking area identity list			
Number of elements	'00001'B		
Type of list	'00'B	"list of TACs belonging to one PLMN, with non-consecutive TAC values"	
MCC MNC TAC 1	TAI-1		
GUTI	GUTI-1		

Table 9.2.3.1.1.3.3-2: Message TRACKING AREA UPDATE REQUEST (step 11, Table 9.2.3.1.2.3.2-1)

Derivation path: 36.508 table 4.7.2-27			
Information Element	Value/Remark	Comment	Condition
EPS update type EPS update type value	'011'B	"Periodic updating"	
Old GUTI	GUTI-1		

Table 9.2.3.1.1.3.3-3: Message TRACKING AREA UPDATE ACCEPT (step 12, Table 9.2.3.1.2.3.2-1)

Derivation path: 36.508 table 4.7.2-24			
Information Element	Value/Remark	Comment	Condition
EPS update result	'000'B	"TA updated"	
T3412 value			
Unit	'010'	"value is incremented in multiples of decihours"	
Timer value	'00001'	"6munites"	
GUTI	GUTI-2		
TAI list			
Length of tracking area identity list contents	'00001000'B		
Partial tracking area identity list			
Number of elements	'00001'B		
Type of list	'00'B	"list of TACs belonging to one PLMN, with non-consecutive TAC values"	
MCC MNC TAC 1	TAI-1		

Table 9.2.3.1.1.3.3-4: Message TRACKING AREA UPDATE REQUEST (step 19, Table 9.2.3.1.2.3.2-1)

Derivation path: 36.508 table 4.7.2-27			
Information Element	Value/Remark	Comment	Condition
EPS update type EPS update type value	'011'B	"Periodic updating"	
Old GUTI	GUTI-2		

Table 9.2.3.1.1.3.3-5: Message TRACKING AREA UPDATE ACCEPT (step 20, Table 9.2.3.1.2.3.2-1)

Derivation path: 36.508 table 4.7.2-24			
Information Element	Value/Remark	Comment	Condition
EPS update result GUTI TAI list Length of tracking area identity list contents	'000'B GUTI-3 '00001000'B	"TA updated"	
Partial tracking area identity list Number of elements	'00001'B		
Type of list	'00'B	"list of TACs belonging to one PLMN, with non-consecutive TAC values"	
MCC MNC TAC 1	TAI-1		

9.2.3.1.8 UE receives an indication that the RRC connection was released with cause "load balancing TAU required"

9.2.3.1.8.1 Test Purpose (TP)

(1)

```
with { UE in state EMM-REGISTERED and EMM-CONNECTED mode}
ensure that {
  when { UE receives RRC CONNECTION RELEASE message with cause "load balancing TAU required" and
    enters EMM-REGISTERED and EMM-IDLE mode}
  then { UE sends TRACKING AREA UPDATE REQUEST message with EPS update type = "TA updating" }
}
```

9.2.3.1.8.2 Conformance requirements

References: The conformance requirements covered in the present TC are specified in: 3GPP TS 24.301 clauses 5.5.3.1, 5.5.3.2.2 and 5.5.3.2.4.

[TS24.301 clause5.5.3.1]

The tracking area updating procedure is always initiated by the UE and is used for the following purposes:

...

- MME load balancing;

...

[TS24.301 clause5.5.3.2.2]

The UE in state EMM-REGISTERED shall initiate the tracking area updating procedure by sending a TRACKING AREA UPDATE REQUEST message to the MME,

...

- e) when the UE receives an indication from the lower layers that the RRC connection was released with cause "load balancing TAU required";

...
 ...

[TS24.301 clause 5.5.3.2.4]

If the tracking area update request has been accepted by the network, the MME shall send a TRACKING AREA UPDATE ACCEPT message to the UE. If the MME assigns a new GUTI for the UE, a GUTI shall be included in the TRACKING AREA UPDATE ACCEPT message. In this case, the MME shall start timer T3450 and enter state EMM-COMMON-PROCEDURE-INITIATED as described in subclause 5.4.1. The MME may include a new TAI list for the UE in the TRACKING AREA UPDATE ACCEPT message.

...

Upon receiving a TRACKING AREA UPDATE ACCEPT message, the UE shall stop timer T3430, reset the tracking area updating attempt counter, enter state EMM-REGISTERED and set the EPS update status to EU1 UPDATED. If the message contains a GUTI, the UE shall use this GUTI as new temporary identity for EPS services and shall store the new GUTI. If no GUTI was included by the MME in the TRACKING AREA UPDATE ACCEPT message, the old GUTI shall be used. If the UE receives a new TAI list in the TRACKING AREA UPDATE ACCEPT message, the UE shall consider the new TAI list as valid and the old TAI list as invalid; otherwise, the UE shall consider the old TAI list as valid.

...

If the TRACKING AREA UPDATE ACCEPT message contained a GUTI, the UE shall return a TRACKING AREA UPDATE COMPLETE message to the MME to acknowledge the received GUTI.

9.2.3.1.8.3 Test description

9.2.3.1.8.3.1 Pre-test conditions

System Simulator:

- Cell A is configured according to Table 6.3.2.2-1 in [18].
- Cell A belongs to TAI-1(home PLMN)

UE:

- The UE has a valid GUTI (GUTI-1).
- The UE is registered on TAI-1.

Preamble:

- UE is in state Generic RB established (state 3) on Cell A according to [18].

9.2.3.1.8.3.2 Test procedure sequence

Table 9.2.3.1.8.3.2-1: Main behaviour

St	Procedure	Message Sequence		TP	Verdict
		U - S	Message		
1	The SS transmits <i>RRCConnectionRelease</i> with cause "load balancing TAU required".	-	-	-	-
2	Check: Does the UE send TRACKING AREA UPDATE REQUEST message.	-->	TRACKING AREA UPDATE REQUEST	1	P
3	The SS sends TRACKING AREA UPDATE ACCEPT. (Note)	<--	TRACKING AREA UPDATE ACCEPT	-	-
4	Check: Does the UE send TRACKING AREA UPDATE COMPLETE message?	-->	TRACKING AREA UPDATE COMPLETE	-	-

Note: The SS assigns a different MME Identifier (MMEI) value in a GUTI.

9.2.3.1.8.3.3 Specific message contents

Table 9.2.3.1.8.3.3-1: Message TRACKING AREA UPDATE ACCEPT (step 3, Table 9.2.3.1.2.3.2-1)

Derivation path: 36.508 table 4.7.2-24			
Information Element	Value/Remark	Comment	Condition
EPS update result	'000'B	"TA updated"	
GUTI	GUTI-2		

9.2.3.1.10 Normal tracking area update / rejected / IMSI invalid

9.2.3.1.10.1 Test Purpose (TP)

(1)

```
with { UE has sent a TRACKING AREA UPDATE REQUEST message}
ensure that {
  when { UE receives a TRACKING AREA UPDATE REJECT message with the reject cause set to 'Illegal
UE' }
  then { UE considers the USIM as invalid for EPS services and non-EPS services and enters state
EMM-DEREGISTERED }
```

(2)

```
with { The UE is in the state EMM-DEREGISTERED }
ensure that {
  when { UE is powered up }
  then { UE send ATTACH REQUEST message with Old GUTI or IMSI IE = 'IMSI' }
```

9.2.3.1.10.2 Conformance requirements

References: The conformance requirements covered in the present TC are specified in: 3GPP TS 24.301 clauses 5.5.3.2.5.

[TS24.301 clause5.5.3.2.5]

If the tracking area updating cannot be accepted by the network, the MME sends a TRACKING AREA UPDATE REJECT message to the UE including an appropriate EMM cause value.

Upon receiving the TRACKING AREA UPDATE REJECT message, the UE shall stop timer T3430, stop any transmission of user data, and take the following actions depending on the EMM cause value received.

#3 (Illegal UE); or

....

The UE shall set the EPS update status to EU3 ROAMING NOT ALLOWED (and shall store it according to subclause 5.1.3.3) and shall delete any GUTI, last visited registered TAI, TAI list and KSI. The UE shall consider the USIM as invalid for EPS services until switching off or the UICC containing the USIM is removed. The UE shall delete the list of equivalent PLMNs and shall enter the state EMM-DEREGISTERED.

If A/Gb mode or Iu mode is supported by the UE, the UE shall handle the GMM parameters GMM state, GPRS update status, P-TMSI, P-TMSI signature, RAI and GPRS ciphering key sequence number and the MM parameters update status, TMSI, LAI and ciphering key sequence number as specified in 3GPP TS 24.008 [13] for the case when the normal routing area updating procedure is rejected with the GMM cause with the same value. The USIM shall be considered as invalid also for non-EPS services until switching off or the UICC containing the USIM is removed.

9.2.3.1.10.3 Test description

9.2.3.1.10.3.1 Pre-test conditions

System Simulator:

- Cell A, Cell B and Cell G are configured according to Table 6.3.2.2-1 in [18].
- Cell A belongs to TAI-1(home PLMN) and is set to "Serving cell"

- Cell B belongs to TAI-2(home PLMN, another TAC) and is set to "Non- Suitable cell"
- Cell G belongs to TAI-7(visited PLMN) and is set to "Non- Suitable cell"
- Cell 5 (UTRAN) or Cell 24 (GERAN).
 - Cell 5 and Cell 24 belong to RAI-1 as specified TS34.123-1 clause 12 and is set to "Non- Suitable cell"

UE:

- The UE has a valid GUTI (GUTI-1).
- The UE is registered on TAI-1.
- IF pc_GERAN or pc_UTRAN THEN the UE has a valid P-TMSI.

Preamble:

- UE is in state Registered, Idle Mode (state 2) on Cell A according to [18].

9.2.3.1.10.3.2 Test procedure sequence

Table 9.2.3.1.10.3.2-1: Main behaviour

St	Procedure	Message Sequence		TP	Verdict
		U - S	Message		
1	Set the cell type of cell A to the "Non-Suitable cell". Set the cell type of cell B to the "Serving cell".	-	-	-	-
2	The UE transmits a TRACKING AREA UPDATE REQUEST on Cell B.	-->	TRACKING AREA UPDATE REQUEST	-	-
3	The SS transmits a TRACKING AREA UPDATE REJECT message with EMM cause = "Illegal UE" as specified.	<--	TRACKING AREA UPDATE REJECT	-	-
4	The SS releases the RRC connection.	-	-	-	-
5	Set the cell type of cell A to the "Serving cell". Set the cell type of cell B to the "Non-Suitable cell".	-	-	-	-
6	Check: Does the UE transmit an ATTACH REQUEST message in the next 30 seconds on cell A? Note: Cell A belongs to the same PLMN where the UE was rejected but a different TAC	-->	ATTACH REQUEST	1	F
7	The user initiates an attach by MMI or by AT command.	-	-	-	-
8	Check: Does the UE transmit an ATTACH REQUEST message in the next 30 seconds on cell A?	-->	ATTACH REQUEST	1	F
9	Set the cell type of cell A to the " Non-Suitable cell". Set the cell type of cell G to the "Serving cell".	-	-	-	-
10	Check: Does the UE transmit an ATTACH REQUEST message in the next 30 seconds on cell G? Note: Cell G belongs to a PLMN which is not the same like the one on which the UE was rejected.	-->	ATTACH REQUEST	1	F
11	The user initiates an attach by MMI or by AT command.	-	-	-	-
12	Check: Does the UE transmit an ATTACH REQUEST message in the next 30 seconds on cell G?	-->	ATTACH REQUEST	1	F
13	Set the cell type of cell G to the "Non-Suitable cell". Set the cell type of cell 5 or 24 to the "Serving cell".				
	EXCEPTION: Steps 14a1 to 14a2 describe behaviour that depends on the UE capability; the "lower case letter" identifies a step sequence that take place if a capability is supported				
14a1	IF pc_GERAN or pc_UTRAN THEN the user initiates an attach by MMI or by AT command.	-	-	-	-
14a2	Check: Does the UE transmit an ATTACH REQUEST message in the next 30 seconds on cell 5 or 24?	-->	ATTACH REQUEST	1	F
15	The UE is switched off.	-	-	-	-
16	Set the cell type of cell A to the "Serving cell". Set the cell type of cell G to the "Non-Suitable cell".	-	-	-	-

	Set the cell type of cell 5 or 24 to the "Non-Suitable cell".				
17	The UE is powered up or switched on.	-	-	-	-
18	Check: Does the UE transmit an ATTACH REQUEST message in the next 30 seconds on cell A?	-->	ATTACH REQUEST	2	P

9.2.3.1.10.3.3 Specific message contents

Table 9.2.3.1.10.3.3-1: Message TRACKING AREA UPDATE REQUEST (step 2, Table 9.2.3.1.10.3.2-1)

Derivation path: 36.508 table 4.7.2-27			
Information Element	Value/Remark	Comment	Condition
Old GUTI	GUTI-1		
Old P-TMSI signature	P-TMSI Signature-1		

Table 9.2.3.1.10.3.3-2: Message TRACKING AREA UPDATE REJECT (step 3, Table 9.2.3.1.10.3.2-1)

Derivation path: 36.508 table 4.7.2-24			
Information Element	Value/Remark	Comment	Condition
EMM cause	00000011	#3 "Illegal UE"	

Table 9.2.3.1.10.3.3-3: Message ATTACH REQUEST (step 18, Table 9.2.3.1.10.3.2-1)

Derivation path: 36.508 table 4.7.2-4			
Information Element	Value/Remark	Comment	Condition
Old GUTI or IMSI	IMSI		

9.2.3.1.11 Normal tracking area update / rejected / illegal ME

9.2.3.1.11.1 Test Purpose (TP)

(1)

```
with { UE has sent a TRACKING AREA UPDATE REQUEST message}
ensure that {
  when { UE receives a TRACKING AREA UPDATE REJECT message with the reject cause set to "Illegal ME"
}
  then { UE considers the USIM as invalid for EPS services and non-EPS services and enters state
EMM-DEREGISTERED }
```

(2)

```
with { The UE is in the state EMM-DEREGISTERED }
ensure that {
  when { UE is powered up }
  then { UE send ATTACH REQUEST message with Old GUTI or IMSI IE = ''IMSI''}
```

9.2.3.1.11.2 Conformance requirements

References: The conformance requirements covered in the present TC are specified in: 3GPP TS 24.301 clauses 5.5.3.2.5.

[TS24.301 clause5.5.3.2.5]

If the tracking area updating cannot be accepted by the network, the MME sends a TRACKING AREA UPDATE REJECT message to the UE including an appropriate EMM cause value.

Upon receiving the TRACKING AREA UPDATE REJECT message, the UE shall stop timer T3430, stop any transmission of user data, and take the following actions depending on the EMM cause value received.

...

#6 (Illegal ME);

The UE shall set the EPS update status to EU3 ROAMING NOT ALLOWED (and shall store it according to subclause 5.1.3.3) and shall delete any GUTI, last visited registered TAI, TAI list and KSI. The UE shall consider the USIM as invalid for EPS services until switching off or the UICC containing the USIM is removed. The UE shall delete the list of equivalent PLMNs and shall enter the state EMM-DEREGISTERED.

If A/Gb mode or Iu mode is supported by the UE, the UE shall handle the GMM parameters GMM state, GPRS update status, P-TMSI, P-TMSI signature, RAI and GPRS ciphering key sequence number and the MM parameters update status, TMSI, LAI and ciphering key sequence number as specified in 3GPP TS 24.008 [13] for the case when the normal routing area updating procedure is rejected with the GMM cause with the same value. The USIM shall be considered as invalid also for non-EPS services until switching off or the UICC containing the USIM is removed.

9.2.3.1.11.3 Test description

The test description is identical to the one of subclause 9.2.3.1.10 except that the reject cause #3 "Illegal UE" is replaced with the reject cause #6 "Illegal ME".

9.2.3.1.12 Normal tracking area update / rejected / EPS service not allowed

9.2.3.1.12.1 Test Purpose (TP)

(1)

```
with { UE has sent a TRACKING AREA UPDATE REQUEST message }
ensure that {
  when { UE receives a TRACKING AREA UPDATE REJECT message with the reject cause set to 'EPS
service not allowed' }
    then { UE considers the USIM as invalid for EPS services and enters state EMM-DEREGISTERED }
```

(2)

```
with { The UE is in the state EMM-DEREGISTERED }
ensure that {
  when { UE is powered up or switched on }
    then { UE sends ATTACH REQUEST message with 'Old GUTI or IMSI IE = 'IMSI'' }
```

9.2.3.1.12.2 Conformance requirements

References: The conformance requirements covered in the present TC are specified in: 3GPP TS 24.301 clauses 5.5.3.2.5.

[TS24.301 clause5.5.3.2.5]

If the tracking area updating cannot be accepted by the network, the MME sends a TRACKING AREA UPDATE REJECT message to the UE including an appropriate EMM cause value.

Upon receiving the TRACKING AREA UPDATE REJECT message, the UE shall stop timer T3430, stop any transmission of user data, and take the following actions depending on the EMM cause value received.

...

#7 (EPS services not allowed);

The UE shall set the EPS update status to EU3 ROAMING NOT ALLOWED (and shall store it according to subclause 5.1.3.3) and shall delete any GUTI, last visited registered TAI, TAI list and KSI. The UE shall consider the USIM as invalid for EPS services until switching off or the UICC containing the USIM is removed. The UE shall delete the list of equivalent PLMNs and shall enter the state EMM-DEREGISTERED.

If A/Gb mode or Iu mode is supported by the UE, the UE shall handle the GMM parameters GMM state, GPRS update status, P-TMSI, P-TMSI signature, RAI and GPRS ciphering key sequence number as specified in 3GPP TS 24.008 [13] for the case when the normal routing area updating procedure is rejected with the GMM cause with the same value.

9.2.3.1.12.3 Test description

9.2.3.1.12.3.1 Pre-test conditions

System Simulator:

- Cell A, Cell B and Cell G are configured according to Table 6.3.2.2-1 in [18].
- Cell A belongs to TAI-1(home PLMN) and is set to "Serving cell"
- Cell B belongs to TAI-2(home PLMN, another TAC) and is set to "Non- Suitable cell"
- Cell G belongs to TAI-7(visited PLMN) and is set to "Non- Suitable cell"
- Cell 5 (UTRAN) or Cell 24 (GERAN).
- Cell 5 and Cell 24 belong to RAI-1 as specified TS34.123-1 clause 12 and is set to "Non- Suitable cell"

UE:

- The UE has GUTI-1.
- The UE is registered on TAI-1.
- IF pc_GERAN or pc_UTRAN THEN the UE has P-TMSI-1 and P-TMSI signature-1.

Preamble:

- UE is in state Registered, Idle Mode (state 2) on Cell A according to [18].

9.2.3.1.12.3.2 Test procedure sequence

Table 9.2.3.1.12.3.2-1: Main behaviour

St	Procedure	Message Sequence		TP	Verdict
		U - S	Message		
1	Set the cell type of cell A to the "Non-Suitable cell". Set the cell type of cell B to the "Serving cell".	-	-	-	-
2	The UE transmits a TRACKING AREA UPDATE REQUEST on Cell B.	-->	TRACKING AREA UPDATE REQUEST	-	-
3	The SS transmits a TRACKING AREA UPDATE REJECT message with EMM cause = "EPS services not allowed" as specified.	<--	TRACKING AREA UPDATE REJECT	-	-
4	The SS releases the RRC connection.	-	-	-	-
5	Set the cell type of cell A to the "Serving cell". Set the cell type of cell B to the "Non-Suitable cell".	-	-	-	-
6	Check: Does the UE transmit an ATTACH REQUEST message in the next 30 seconds on cell A? Note: Cell A belongs to the same PLMN where the UE was rejected but a different TAC	-->	ATTACH REQUEST	1	F
7	The user initiates an attach by MMI or by AT command.	-	-	-	-
8	Check: Does the UE transmit an ATTACH REQUEST message in the next 30 seconds on cell A?	-->	ATTACH REQUEST	1	F
9	Set the cell type of cell A to the " Non-Suitable cell". Set the cell type of cell G to the "Serving cell".	-	-	-	-
10	Check: Does the UE transmit an ATTACH REQUEST message in the next 30 seconds on cell G? Note: Cell G belongs to a PLMN which is not the same like the one on which the UE was rejected.	-->	ATTACH REQUEST	1	F
11	The user initiates an attach by MMI or by AT command.	-	-	-	-
12	Check: Does the UE transmit an ATTACH REQUEST message in the next 30 seconds on cell G?	-->	ATTACH REQUEST	1	F
13	Set the cell type of cell G to the "Non-Suitable cell". Set the cell type of cell 5 or 24 to the "Serving cell".	-	-	-	-
	EXCEPTION: Steps 14a1 to 14b2 describe behaviour that depends on the UE capability; the "lower case letter" identifies a step sequence that take place if a capability is supported				
14a1	IF pc_CS THEN the UE registers on CS domain – See TS 34.108 or TS 51.010	-	-	-	-
14b1	IF pc_GERAN or pc_UTRAN THEN the user initiates an attach by MMI or by AT command.	-	-	-	-
14b2	Check: Does the UE transmit an ATTACH REQUEST message in the next 30 seconds on cell 5 or 24?	-->	ATTACH REQUEST	1	F
15	The UE is switched off.	-	-	-	-
16	Set the cell type of cell A to the "Serving	-	-	-	-

	cell". Set the cell type of cell G to the "Non-Suitable cell". Set the cell type of cell 5 or 24 to the "Non-Suitable cell".				
17	The UE is powered up or switched on.	-	-	-	-
18	Check: Does the UE transmit an ATTACH REQUEST message in the next 30 seconds on cell A?	-->	ATTACH REQUEST	2	P

9.2.3.1.12.3.3 Specific message contents

Table 9.2.3.1.12.3.3-1: Message TRACKING AREA UPDATE REQUEST (step 2, Table 9.2.3.1.12.3.2-1)

Derivation path: 36.508 table 4.7.2-27			
Information Element	Value/Remark	Comment	Condition
Old GUTI	GUTI-1		
Old P-TMSI signature	P-TMSI Signature-1		

Table 9.2.3.1.12.3.3-2: Message TRACKING AREA UPDATE REJECT (step 3, Table 9.2.3.1.12.3.2-1)

Derivation path: 36.508 table 4.7.2-24			
Information Element	Value/Remark	Comment	Condition
EMM cause	'00000111'B	#7 "EPS service not allowed"	

Table 9.2.3.1.12.3.3-3: Message ATTACH REQUEST (step 18, Table 9.2.3.1.12.3.2-1)

Derivation path: 36.508 table 4.7.2-4			
Information Element	Value/Remark	Comment	Condition
Old GUTI or IMSI	IMSI		

9.2.3.1.13 Normal tracking area update / rejected / UE identity cannot be derived by the network

9.2.3.1.13.1 Test Purpose (TP)

(1)

```
with { UE has sent a TRACKING AREA UPDATE REQUEST message}
ensure that {
  when { UE receives a TRACKING AREA UPDATE REJECT message with the reject cause set to 'UE
identity cannot be derived by the network' }
  then { UE deletes any GUTI, last visited registered TAI, TAI list and KSI and enters the state
EMM-DEREGISTERED and subsequently, UE automatically initiates the attach procedure}
```

9.2.3.1.13.2 Conformance requirements

References: The conformance requirements covered in the present TC are specified in: 3GPP TS 24.301 clauses 5.5.3.2.5.

[TS24.301 clause5.5.3.2.5]

If the tracking area updating cannot be accepted by the network, the MME sends a TRACKING AREA UPDATE REJECT message to the UE including an appropriate EMM cause value.

Upon receiving the TRACKING AREA UPDATE REJECT message, the UE shall stop timer T3430, stop any transmission of user data, and take the following actions depending on the EMM cause value received.

...

#9 (UE identity cannot be derived by the network);

The UE shall set the EPS update status to EU2 NOT UPDATED (and shall store it according to subclause 5.1.3.3) and shall delete any GUTI, last visited registered TAI, TAI list and KSI. The UE shall delete the list of equivalent PLMNs and shall enter the state EMM-DEREGISTERED.

Subsequently, the UE shall automatically initiate the attach procedure.

If A/Gb mode or Iu mode is supported by the UE, the UE shall handle the GMM parameters GMM state, GPRS update status, P-TMSI, P-TMSI signature, RAI and GPRS ciphering key sequence number as specified in 3GPP TS 24.008 [13] for the case when the normal routing area updating procedure is rejected with the GMM cause with the same value.

9.2.3.1.13.3 Test description

9.2.3.1.13.3.1 Pre-test conditions

System Simulator:

- Cell A and Cell B are configured according to Table 6.3.2.2-1 in [18].
- Cell A belongs to TAI-1(home PLMN) and is set to "Serving cell"
- Cell B belongs to TAI-2(home PLMN, another TAC) and is set to "Non- Suitable cell"

UE:

- The UE has GUTI-1.
- The UE is registered on TAI-1.
- IF pc_GERAN or pc_UTRAN THEN the UE has P-TMSI-1 and P-TMSI signature-1.

Preamble:

- UE is in state Registered, Idle Mode (state 2) on Cell A according to [18].

9.2.3.1.13.3.2 Test procedure sequence

Table 9.2.3.1.13.3.2-1: Main behaviour

St	Procedure	Message Sequence		TP	Verdict
		U - S	Message		
1	Set the cell type of cell A to the "Non-Suitable cell". Set the cell type of cell B to the "Serving cell".	-	-	-	-
2	The UE transmits a TRACKING AREA UPDATE REQUEST on Cell B.	-->	TRACKING AREA UPDATE REQUEST	-	-
3	The SS transmits a TRACKING AREA UPDATE REJECT message with EMM cause = " UE identity cannot be derived by the network " as specified.	<--	TRACKING AREA UPDATE REJECT	-	-
4	The SS releases the RRC connection.	-	-	-	-
5	Check: Does the UE transmit an ATTACH REQUEST message in the next 30 seconds on cell B?	-->	ATTACH REQUEST	1	P
6	The SS transmits ATTACH REJECT message.	<--	ATTACH REJECT	-	-

9.2.3.1.13.3.3 Specific message contents

Table 9.2.3.1.13.3.3-1: Message TRACKING AREA UPDATE REQUEST (step 2, Table 9.2.3.1.13.3.2-1)

Derivation path: 36.508 table 4.7.2-27			
Information Element	Value/Remark	Comment	Condition
Old GUTI	GUTI-1		
Old P-TMSI signature	P-TMSI signature-1		pc_GERAN or pc_UTRAN

Table 9.2.3.1.13.3.3-2: Message TRACKING AREA UPDATE REJECT (step 3, Table 9.2.3.1.13.3.2-1)

Derivation path: 36.508 table 4.7.2-24			
Information Element	Value/Remark	Comment	Condition
EMM cause	'00001001'B	#9 "UE identity cannot be derived by the network"	

Table 9.2.3.1.13.3.3-3: Message ATTACH REQUEST (step 5, Table 9.2.3.1.13.3.2-1)

Derivation path: 36.508 table 4.7.2-4			
Information Element	Value/Remark	Comment	Condition
Old GUTI or IMSI	IMSI		
Old P-TMSI signature	Not present		pc_GERAN or pc_UTRAN
Last visited registered TAI	Not present		

Table 9.2.3.1.13.3.3-4: Message ATTACH REJECT (step 6, Table 9.2.3.1.13.3.2-1)

Derivation Path: 36.508 table 4.7.2-3			
Information Element	Value/remark	Comment	Condition
EMM cause	'0000 1111'B	#15 "No suitable cells in tracking area"	

9.2.3.1.14 Normal tracking area update / rejected / UE implicitly detached

9.2.3.1.14.1 Test Purpose (TP)

(1)

```
with { UE has sent a TRACKING AREA UPDATE REQUEST message}
ensure that {
  when { UE receives a TRACKING AREA UPDATE REJECT message with the reject cause set to 'UE
implicitly detached' }
  then { UE enters the state EMM-DEREGISTERED.NORMAL-SERVICE and sends ATTACH REQUEST message}
```

9.2.3.1.14.2 Conformance requirements

References: The conformance requirements covered in the present TC are specified in: 3GPP TS 24.301 clauses 5.5.3.2.5.

[TS24.301 clause5.5.3.2.5]

If the tracking area updating cannot be accepted by the network, the MME sends a TRACKING AREA UPDATE REJECT message to the UE including an appropriate EMM cause value.

Upon receiving the TRACKING AREA UPDATE REJECT message, the UE shall stop timer T3430, stop any transmission of user data, and take the following actions depending on the EMM cause value received.

...

#10 (Implicitly detached);

The UE shall delete the list of equivalent PLMNs and shall enter the state EMM-DEREGISTERED.NORMAL-SERVICE. The UE shall then perform a new attach procedure.

If A/Gb mode or Iu mode is supported by the UE, the UE shall handle the GMM state as specified in 3GPP TS 24.008 [13] for the case when the normal routing area updating procedure is rejected with the GMM cause with the same value.

9.2.3.1.14.3 Test description

9.2.3.1.14.3.1 Pre-test conditions

System Simulator:

- Cell A and Cell B are configured according to Table 6.3.2.2-1 in [18].
- Cell A belongs to TAI-1(home PLMN) and is set to "Serving cell"
- Cell B belongs to TAI-2(home PLMN, another TAC) and is set to "Non- Suitable cell"

UE:

- The UE has GUTI-1.
- The UE is registered on TAI-1.
- IF pc_GERAN or pc_UTRAN THEN the UE has P-TMSI-1 and P-TMSI signature-1.

Preamble:

- UE is in state Registered, Idle Mode (state 2) on Cell A according to [18].

9.2.3.1.14.3.2 Test procedure sequence

Table 9.2.3.1.14.3.2-1: Main behaviour

St	Procedure	Message Sequence		TP	Verdict
		U - S	Message		
1	Set the cell type of cell A to the "Non-Suitable cell". Set the cell type of cell B to the "Serving cell".	-	-	-	-
2	The UE transmits a TRACKING AREA UPDATE REQUEST on Cell B.	-->	TRACKING AREA UPDATE REQUEST	-	-
3	The SS transmits a TRACKING AREA UPDATE REJECT message with EMM cause = "UE implicitly detached" as specified.	<--	TRACKING AREA UPDATE REJECT	-	-
4	Check: Does the UE transmit an ATTACH REQUEST message in the next 30 seconds on cell B?	-->	ATTACH REQUEST	1	P
5	The SS transmits ATTACH REJECT message.	<--	ATTACH REJECT	-	-

9.2.3.1.14.3.3 Specific message contents

Table 9.2.3.1.14.3.3-1: Message TRACKING AREA UPDATE REQUEST (step 2, Table 9.2.3.1.14.3.2-1)

Derivation path: 36.508 table 4.7.2-27			
Information Element	Value/Remark	Comment	Condition
Old GUTI	GUTI-1		
Old P-TMSI signature	P-TMSI signature-1		pc_GERAN or pc_UTRAN

Table 9.2.3.1.14.3.3-2: Message TRACKING AREA UPDATE REJECT (step 3, Table 9.2.3.1.14.3.2-1)

Derivation path: 36.508 table 4.7.2-24			
Information Element	Value/Remark	Comment	Condition
EMM cause	'00001010'B	#10 "UE implicitly detached"	

Table 9.2.3.1.14.3.3-3: Message ATTACH REQUEST (step 4, Table 9.2.3.1.14.3.2-1)

Derivation path: 36.508 table 4.7.2-4			
Information Element	Value/Remark	Comment	Condition
Old GUTI or IMSI	GUTI-1		
Old P-TMSI signature	P-TMSI signature-1		pc_GERAN or pc_UTRAN
Last visited registered TAI	TAI-1		

Table 9.2.3.1.14.3.3-4: Message ATTACH REJECT (step 5, Table 9.2.3.1.14.3.2-1)

Derivation Path: 36.508 table 4.7.2-3			
Information Element	Value/remark	Comment	Condition
EMM cause	'0000 1111'B	#15 "No suitable cells in tracking area"	

9.2.3.1.15 Normal tracking area update / rejected / PLMN not allowed

9.2.3.1.15.1 Test Purpose (TP)

(1)

```
with { UE has sent a TRACKING AREA UPDATE REQUEST message }
ensure that {
  when { UE receives a TRACKING AREA UPDATE REJECT message with the reject cause set to ' PLMN not allowed' }
  then { UE deletes the GUTI, the last visited registered TAI and KSI and UE deletes the list of equivalent PLMNs and UE enters state EMM-DEREGISTERED.PLMN-SEARCH and UE stores the PLMN in the "forbidden PLMN list" }
```

(2)

```
with { UE is switched off and a PLMN is stored in the "forbidden PLMN list" }
ensure that {
  when { UE is powered on this PLMN }
  then { UE doesn't perform an attach procedure }
```

(3)

```
with { UE in EMM-DEREGISTERED.PLMN-SEARCH state and a PLMN is stored in the "forbidden PLMN list" }
ensure that {
  when { UE enters a cell which is not in the "forbidden PLMN list" }
  then { UE initiates an attach procedure }
```

(4)

```
with { UE in E-UTRA EMM-DEREGISTERED.PLMN-SEARCH state and a PLMN is stored in the "forbidden PLMN list" }
ensure that {
  when { UE is in a forbidden PLMN cells and when the PLMN is selected manually }
  then { UE initiates an attach procedure }
```

9.2.3.1.15.2 Conformance requirements

References: The conformance requirements covered in the present TC are specified in: 3GPP TS 24.301 clauses 5.5.3.2.5.

[TS24.301 clause5.5.3.2.5]

If the tracking area updating cannot be accepted by the network, the MME sends a TRACKING AREA UPDATE REJECT message to the UE including an appropriate EMM cause value.

Upon receiving the TRACKING AREA UPDATE REJECT message, the UE shall stop timer T3430, stop any transmission of user data, and take the following actions depending on the EMM cause value received.

...

#11 (PLMN not allowed);

The UE shall set the EPS update status to EU3 ROAMING NOT ALLOWED (and shall store it according to subclause 5.1.3.3) and shall delete any GUTI, last visited registered TAI, TAI list and KSI. The UE shall reset the tracking area updating attempt counter, delete the list of equivalent PLMNs and enter the state EMM-DEREGISTERED.PLMN-SEARCH.

The UE shall store the PLMN identity in the "forbidden PLMN list".

The UE shall perform a PLMN selection according to 3GPP TS 23.122 [6].

If A/Gb mode or Iu mode is supported by the UE, the UE shall handle the GMM parameters GMM state, GPRS update status, P-TMSI, P-TMSI signature, RAI, GPRS ciphering key sequence number and routing area updating attempt counter and the MM parameters update status, TMSI, LAI, ciphering key sequence number and the location update attempt counter as specified in 3GPP TS 24.008 [13] for the case when the normal routing area updating procedure is rejected with the GMM cause with the same value and no RR connection exists.

9.2.3.1.15.3 Test description

9.2.3.1.15.3.1 Pre-test conditions

System Simulator:

- Cell G, Cell H and Cell I are configured according to Table 6.3.2.2-1 in [18].
- Cell G belongs to TAI-7(visited PLMN) and is set to "Serving cell"
- Cell H belongs to TAI-8(visited PLMN, another TAC) and is set to "Non- Suitable cell"
- Cell I belongs to TAI-9(visited PLMN, another PLMN) and is set to "Non-Suitable cell"

PLMN in Cell G, Cell H and Cell I are not HPLMN of the UE.

- Cell 5 (UTRAN) or Cell 24 (GERAN).
 - Cell 5 and Cell 24 belong to RAI-1 as specified TS34.123-1 clause 12 and is set to "Non- Suitable cell"

UE:

- The UE has GUTI-7.
- The UE is registered on TAI-7.
- IF pc_GERAN or pc_UTRAN THEN the UE has P-TMSI-1 and P-TMSI signature-1.

Preamble:

- UE is in state Registered, Idle Mode (state 2) on Cell G according to [18].

9.2.3.1.15.3.2 Test procedure sequence

Table 9.2.3.1.15.3.2-1: Main behaviour

St	Procedure	Message Sequence		TP	Verdict
		U - S	Message		
1	Set the cell type of cell G to the "Non-Suitable cell". Set the cell type of cell H to the "Serving cell".	-	-	-	-
2	The UE transmits a TRACKING AREA UPDATE REQUEST on Cell H.	-->	TRACKING AREA UPDATE REQUEST	-	-
3	The SS transmits a TRACKING AREA UPDATE REJECT message with EMM cause = "PLMN not allowed" as specified.	<--	TRACKING AREA UPDATE REJECT	-	-
4	The SS releases the RRC connection.				
5	Check: Does the UE transmit an ATTACH REQUEST message in the next 30 seconds on cell H?	-->	ATTACH REQUEST	1	F
6	The UE is switched off.	-	-	-	-
7	Set the cell type of cell G to the "Serving cell". Set the cell type of cell H to the "Non-Suitable cell". Note: cell G and cell H are in the same PLMN.	-	-	-	-
8	The UE is powered up or switched on.	-	-	-	-
9	Check: Does the UE transmit an ATTACH REQUEST message in the next 30 seconds on cell G?	-->	ATTACH REQUEST	2	F
10	The user initiates an attach by MMI or by AT command.	-	-	-	-
11	Check: Does the UE transmit an ATTACH REQUEST message in the next 30 seconds on cell G?	-->	ATTACH REQUEST	2	F
12	Set the cell type of cell G to the "Non-Suitable cell". Set the cell type of cell 5 or 24 to the "Serving cell". Note: Cell G and Cell 5 or 24 are in the same PLMN.	-	-	-	-
	EXCEPTION: Steps 13a1 to 13a2 describe behaviour that depends on the UE capability; the "lower case letter" identifies a step sequence that take place if a capability is supported				
13a1	IF pc_GERAN or pc_UTRAN THEN the user initiates an attach by MMI or by AT command.	-	-	-	-
13a2	Check: Does the UE transmit an ATTACH REQUEST message in the next 30 seconds on cell 5 or 24?	-->	ATTACH REQUEST	1	F
14	The following messages are sent and shall be received on cell I.	-	-	-	-
15	Set the cell type of cell 5 or 24 to the " Non-Suitable cell". Set the cell type of cell I to the "Serving cell". Note: cell 5 or 24 and cell I are in different PLMNs.	-	-	-	-
16	The UE transmits ATTACH REQUEST message with a PDN CONNECTIVITY REQUEST message to request PDN connectivity to the default PDN.	-->	ATTACH REQUEST	3	P
17	The SS starts an authentication procedure	<--	AUTHENTICATION REQUEST	-	-
18	The UE responds properly to the authentication procedure	-->	AUTHENTICATION RESPONSE	-	-
19	The SS starts a NAS security mode command procedure to perform NAS integrity protection.	<--	SECURITY MODE COMMAND	-	-
20	The UE responds properly to the NAS security	-->	SECURITY MODE COMPLETE	-	-

	mode command procedure				
21	The SS sends ATTACH ACCEPT message with the ACTIVATE DEFAULT EPS BEARER CONTEXT REQUEST message.	<--	ATTACH ACCEPT	-	-
22	The UE transmits an ATTACH COMPLETE message.	-->	ATTACH COMPLETE	-	-
23	The SS releases the RRC connection.	-	-	-	-
24	The UE is switched off.	-	-	-	-
25	The UE transmit a DETACH REQUEST.	-->	DETACH REQUEST	-	-
26	The following messages are sent and shall be received on cell G.				
27	Set the cell type of cell G to the " Serving cell". Set the cell type of cell I to the " Non-Suitable cell". Note: Cell G belongs to the forbidden PLMN.				
28	The UE is powered up or switched on.	-	-	-	-
29	The UE is switched to manual PLMN selection mode and is made to select the forbidden PLMN cell.				
30	The UE transmits ATTACH REQUEST message with a PDN CONNECTIVITY REQUEST message to request PDN connectivity to the default PDN.	-->	ATTACH REQUEST	4	P
31	The SS starts an authentication procedure	<--	AUTHENTICATION REQUEST	-	-
32	The UE responds properly to the authentication procedure	-->	AUTHENTICATION RESPONSE	-	-
33	The SS starts a NAS security mode command procedure to perform NAS integrity protection.	<--	SECURITY MODE COMMAND	-	-
34	The UE responds properly to the NAS security mode command procedure	-->	SECURITY MODE COMPLETE	-	-
35	The SS sends ATTACH ACCEPT message with the ACTIVATE DEFAULT EPS BEARER CONTEXT REQUEST message.	<--	ATTACH ACCEPT	-	-
36	The UE transmits an ATTACH COMPLETE message.	-->	ATTACH COMPLETE	-	-
37	The SS releases the RRC connection.	-	-	-	-

9.2.3.1.15.3.3 Specific message contents

Table 9.2.3.1.15.3.3-1: Message TRACKING AREA UPDATE REQUEST (step 2, Table 9.2.3.1.15.3.2-1)

Derivation path: 36.508 table 4.7.2-27			
Information Element	Value/Remark	Comment	Condition
Old GUTI	GUTI-7		
Old P-TMSI signature	P-TMSI signature-1		pc_GERAN or pc_UTRAN

Table 9.2.3.1.15.3.3-2: Message TRACKING AREA UPDATE REJECT (step 3, Table 9.2.3.1.15.3.2-1)

Derivation path: 36.508 table 4.7.2-24			
Information Element	Value/Remark	Comment	Condition
EMM cause	'00001011'B	#11 " PLMN not allowed "	

Table 9.2.3.1.15.3.3-3: Message ATTACH REQUEST (step 16, Table 9.2.3.1.15.3.2-1)

Derivation path: 36.508 table 4.7.2-4			
Information Element	Value/Remark	Comment	Condition
Old GUTI or IMSI	IMSI		
Old P-TMSI signature	Not present		pc_GERAN or pc_UTRAN
Last visited registered TAI	Not present		

Table 9.2.3.1.15.3.3-4: Message ATTACH ACCEPT (step 21, Table 9.2.3.1.15.3.2-1)

Derivation path: 36.508 table 4.7.2-1			
Information Element	Value/Remark	Comment	Condition
EPS attach result	'001'B	"EPS only"	
TAI list			
Number of elements	'00001'B		
Type of list	'00'B	"list of TACs belonging to one PLMN, with non-consecutive TAC values"	
MCC MNC TAC 1	PLMN= 002/101 TAC 1=1	"TAI-9"	
GUTI	GUTI-9		

Table 9.2.3.1.15.3.3-5: Message ATTACH REQUEST (step 30, Table 9.2.3.1.15.3.2-1)

Derivation path: 36.508 table 4.7.2-4			
Information Element	Value/Remark	Comment	Condition
Old GUTI or IMSI	GUTI-9		
Last visited registered TAI	TAI-9		

9.2.3.1.16 Normal tracking area update / rejected / Tracking area not allowed

9.2.3.1.16.1 Test Purpose (TP)

(1)

```
with { UE has sent a TRACKING AREA UPDATE REQUEST message }
ensure that {
  when { UE receives a TRACKING AREA UPDATE REJECT message with the reject cause set to "Tracking area not allowed" }
  then { shall delete any GUTI, last visited registered TAI, TAI list and KSI. The UE shall reset the tracking area updating attempt counter and shall enter the state EMM-DEREGISTERED.LIMITED-SERVICE and store the current TAI in the list of "forbidden tracking areas for regional provision of service" }
```

(2)

```
with { UE is in EMM-DEREGISTERED.LIMITED-SERVICE state and has a TAI in the list of "forbidden tracking areas for regional provision of service" }
ensure that {
  when { UE is in the serving cell which the UE is rejected }
  then { UE does not attempt an attach procedure on any other cell }
}
```

(3)

```
with { UE is in EMM-DEREGISTERED.LIMITED-SERVICE state and the current TAI in the list of "forbidden tracking areas for regional provision of service" }
ensure that {
  when { UE enters a new cell in the same TAI it was rejected }
  then { UE does not initiate an attach procedure }
}
```

(4)

```
with { UE is in EMM-DEREGISTERED.LIMITED-SERVICE state and the current TAI in the list of "forbidden tracking areas for regional provision of service"}
ensure that {
  when { UE enters a new cell with defferent TAI without in the list of "forbidden tracking areas for regional provision of service"}
  then { UE initiates attach procedure with IMSI }
}
```

(5)

```
with { UE is switched off }
ensure that {
  when { UE is powered on and enters the cell with "forbidden tracking areas for regional provision of service" before the UE was swithed off }
  then { UE initiates attach procedure on the cell }
```

9.2.3.1.16.2 Conformance requirements

References: The conformance requirements covered in the present TC are specified in: 3GPP TS 24.301 clauses 5.5.3.2.5.

[TS24.301 clause5.5.3.2.5]

If the tracking area updating cannot be accepted by the network, the MME sends a TRACKING AREA UPDATE REJECT message to the UE including an appropriate EMM cause value.

Upon receiving the TRACKING AREA UPDATE REJECT message, the UE shall stop timer T3430, stop any transmission of user data, and take the following actions depending on the EMM cause value received.

...

#12 (Tracking area not allowed);

The UE shall set the EPS update status to EU3 ROAMING NOT ALLOWED (and shall store it according to subclause 5.1.3.3) and shall delete any GUTI, last visited registered TAI, TAI list and KSI. The UE shall reset the tracking area updating attempt counter and shall enter the state EMM-DEREGISTERED.LIMITED-SERVICE.

The UE shall store the current TAI in the list of "forbidden tracking areas for regional provision of service".

If A/Gb mode or Iu mode is supported by the UE, the UE shall handle the GMM parameters GMM state, GPRS update status, P-TMSI, P-TMSI signature, RAI, GPRS ciphering key sequence number and routing area updating attempt counter as specified in 3GPP TS 24.008 [13] for the case when the normal routing area updating procedure is rejected with the GMM cause with the same value.

9.2.3.1.16.3 Test description

9.2.3.1.16.3.1 Pre-test conditions

System Simulator:

- Cell A, Cell B, Cell G, Cell H and Cell M are configured according to Table 6.3.2.2-1 in [18].
- Cell A and Cell M belong to TAI-1(home PLMN, same TAC) and are set to "Non Suitable cell"
- Cell B belongs to TAI-2(home PLMN, another TAC) and is set to "Serving cell"
- Cell G belongs to TAI-7(visited PLMN) and is set to "Non-Suitable cell"
- Cell H belongs to TAI-8(visited PLMN) and is set to "Non-Suitable cell"

UE:

- The UE has GUTI-2.
- The UE is registered on TAI-2.

Preamble:

- UE is in state Registered, Idle Mode (state 2) on Cell B according to [18].

9.2.3.1.16.3.2 Test procedure sequence

Table 9.2.3.1.16.3.2-1: Main behaviour

St	Procedure	Message Sequence		TP	Verdict
		U - S	Message		
1	Set the cell type of cell A to the "Serving cell". Set the cell type of cell B to the "Non-Suitable cell". Set the cell type of cell G to the "Suitable neighbour cell". Set the cell type of cell H to the "Suitable neighbour cell".	-	-	-	-
2	The UE transmits a TRACKING AREA UPDATE REQUEST on Cell A.	-->	TRACKING AREA UPDATE REQUEST	-	-
3	The SS transmits a TRACKING AREA UPDATE REJECT message with EMM cause = "Tracking area not allowed" as specified.	<--	TRACKING AREA UPDATE REJECT	-	-
4	The SS releases the RRC connection.	-	-	-	-
5	Check: Does the UE transmit an ATTACH REQUEST message in the next 30 seconds on cell G and H?	-->	ATTACH REQUEST	2	F
6	The user initiates an attach by MMI or by AT command.	-	-	-	-
7	Check: Does the UE transmit an ATTACH REQUEST message in the next 30 seconds on cell A?	-->	ATTACH REQUEST	1	F
8	Set the cell type of cell A to the " Non-Suitable cell ". Set the cell type of cell M to the "Serving cell".	-	-	-	-
9	Check: Does the UE transmit an ATTACH REQUEST message in the next 30 seconds on cell M?	-->	ATTACH REQUEST	3	F
10	Set the cell type of cell G to the "Serving cell". Set the cell type of cell M to the "Non-Suitable cell ".	-	-	-	-
11	Check: Does the UE transmit an ATTACH REQUEST message in the next 30 seconds on cell G?	-->	ATTACH REQUEST	4	P
12	The SS starts an authentication procedure	<--	AUTHENTICATION REQUEST	-	-
13	The UE responds properly to the authentication procedure	-->	AUTHENTICATION RESPONSE	-	-
14	The SS starts a NAS security mode command procedure to perform NAS integrity protection.	<--	SECURITY MODE COMMAND	-	-
15	The UE responds properly to the NAS security mode command procedure	-->	SECURITY MODE COMPLETE	-	-
16	The SS sends ATTACH ACCEPT message with the ACTIVATE DEFAULT EPS BEARER CONTEXT REQUEST message.	<--	ATTACH ACCEPT	-	-
17	The UE transmits an ATTACH COMPLETE message.	-->	ATTACH COMPLETE	-	-
18	The SS releases the RRC connection.	-	-	-	-
19	The UE is switched off.	-	-	-	-
20	The UE transmit a DETACH REQUEST.	-->	DETACH REQUEST	-	-
21	The following messages are sent and shall be received on cell A.	-	-	-	-
22	Set the cell type of cell A to the " Serving cell". Set the cell type of cell G to the " Non-Suitable cell".	-	-	-	-
23	The UE is powered up or switched on.	-	-	-	-
24	The UE transmits ATTACH REQUEST message with a PDN CONNECTIVITY REQUEST message to request PDN connectivity to the default PDN.	-->	ATTACH REQUEST	5	P
25	The SS sends ATTACH REJECT message.	<--	ATTACH REJECT	-	-

26	The SS releases the RRC connection.	-	-	-	-
----	-------------------------------------	---	---	---	---

9.2.3.1.16.3.3 Specific message contents

Table 9.2.3.1.16.3.3-1: Message TRACKING AREA UPDATE REQUEST (step 2, Table 9.2.3.1.16.3.2-1)

Derivation path: 36.508 table 4.7.2-27			
Information Element	Value/Remark	Comment	Condition
Old GUTI	GUTI-7		
Old P-TMSI signature	P-TMSI signature-1		pc_GERAN or pc_UTRAN

Table 9.2.3.1.16.3.3-2: Message TRACKING AREA UPDATE REJECT (step 3, Table 9.2.3.1.16.3.2-1)

Derivation path: 36.508 table 4.7.2-24			
Information Element	Value/Remark	Comment	Condition
EMM cause	'00001100'B	#12 "Tracking area not allowed"	

Table 9.2.3.1.16.3.3-3: Message ATTACH REQUEST (step 11, Table 9.2.3.1.16.3.2-1)

Derivation path: 36.508 table 4.7.2-4			
Information Element	Value/Remark	Comment	Condition
Old GUTI or IMSI	IMSI		
Old P-TMSI signature	Not present		pc_GERAN or pc_UTRAN
Last visited registered TAI	Not present		

Table 9.2.3.1.16.3.3-4: Message ATTACH ACCEPT (step 16, Table 9.2.3.1.16.3.2-1)

Derivation path: 36.508 table 4.7.2-1			
Information Element	Value/Remark	Comment	Condition
EPS attach result	'001'B	"EPS only"	
TAI list			
Number of elements	'00001'B		
Type of list	'00'B	"list of TACs belonging to one PLMN, with non-consecutive TAC values"	
MCC MNC TAC 1	PLMN= MCC/02 TAC 1=1	"MCC is set to the same MCC stored in EF _{IMSI} " "TAI-7"	
GUTI	GUTI-7		

Table 9.2.3.1.16.3.3-5: Message ATTACH REQUEST (step 24, Table 9.2.3.1.16.3.2-1)

Derivation path: 36.508 table 4.7.2-4			
Information Element	Value/Remark	Comment	Condition
Old GUTI or IMSI	GUTI-7		
Last visited registered TAI	TAI-7		

Table 9.2.3.1.16.3.3-6: Message ATTACH REJECT (step 25, Table 9.2.3.1.16.3.2-1)

Derivation path: 36.508 table 4.7.2.3			
Information Element	Value/Remark	Comment	Condition
EMM cause	'00001100'B	#12 "Tracking area not allowed"	

9.2.3.2 Combined tracking area updating

9.2.3.2.1 Combined tracking area update / successful

9.2.3.2.1.1 Test Purpose (TP)

(1)

```
with { a combined EPS/IMSI attached UE in state EMM-REGISTERED and EMM-IDLE mode }
ensure that {
  when { UE enters a tracking area included in the TAI list }
  then { UE does not transmit a TRACKING AREA UPDATE REQUEST message }
}
```

(2)

```
with { a combined EPS/IMSI attached UE in state EMM-REGISTERED and EMM-IDLE mode }
ensure that {
  when { UE enters a tracking area not included in the TAI list }
  then { UE transmits a TRACKING AREA UPDATE REQUEST message with "EPS update type = combined TA/LA updating" }
}
```

(3)

```
with { UE has sent a combined TRACKING AREA UPDATE REQUEST message }
ensure that {
  when { UE receives a TRACKING AREA UPDATE ACCEPT message containing a GUTI and/or a mobile identity }
  then { UE transmits a TRACKING AREA UPDATE COMPLETE message and enters EMM-REGISTERED state }
}
```

9.2.3.2.1.2 Conformance requirements

References: The conformance requirements covered in the present TC are specified in: TS 24.301, clauses 5.5.3.1, 5.5.3.2.2, 5.5.3.2.4, 5.5.3.3.1, 5.5.3.3.2, 5.5.3.3.4.1 and 5.5.3.3.4.2.

[TS24.301 clause 5.5.3.1]

The tracking area updating procedure is always initiated by the UE and is used for the following purposes:

- normal tracking area updating to update the registration of the actual tracking area of a UE in the network;

...

[TS24.301 clause 5.5.3.2.2]

The UE in state EMM-REGISTERED shall initiate the tracking area updating procedure by sending a TRACKING AREA UPDATE REQUEST message to the MME,

- i) when the UE detects entering a tracking area that is not in the list of tracking areas that the UE previously registered in the MME;

...

After sending the TRACKING AREA UPDATE REQUEST message to the MME, the UE shall start timer T3430 and enter state EMM-TRACKING-AREA-UPDATING-INITIATED (see figure 5.5.3.2.2). If timer T3402 is currently running, the UE shall stop timer T3402. If timer T3411 is currently running, the UE shall stop timer T3411.

In the TRACKING AREA UPDATE REQUEST message the UE shall include a GUTI and the last visited registered TAI, the update type indicating the type of the tracking area updating. If the UE's TIN indicates "P-TMSI" the UE shall map the valid P-TMSI and RAI into the old GUTI. If a UE in EMM-IDLE mode has uplink user data pending when it initiates the tracking area updating procedure, or uplink signalling not related to the tracking area updating procedure, it

may also set an "active" flag in the TRACKING AREA UPDATE REQUEST message to indicate the request to establish the user plane to the network and to keep the NAS signalling connection after the completion of the tracking area updating procedure.

When the tracking area updating procedure is initiated in EMM-IDLE mode, the UE may also include an EPS bearer context status IE in the TRACKING AREA UPDATE REQUEST message, indicating which EPS bearer contexts are active in the UE.

[TS24.301 clause 5.5.3.2.4]

...

Upon receiving a TRACKING AREA UPDATE ACCEPT message, the UE shall stop timer T3430, reset the routing area updating attempt counter, enter state EMM-REGISTERED and set the EPS update status to EU1 UPDATED. If the message contains a GUTI, the UE shall use this GUTI as new temporary identity for EPS services and shall store the new GUTI. If no GUTI was included by the MME in the TRACKING AREA UPDATE ACCEPT message, the old GUTI shall be used. If the UE receives a new TAI list in the TRACKING AREA UPDATE ACCEPT message, the UE shall consider the new TAI list as valid and the old TAI list as invalid; otherwise, the UE shall consider the old TAI list as valid.

...

If the TRACKING AREA UPDATE ACCEPT message contained a GUTI, the UE shall return a TRACKING AREA UPDATE COMPLETE message to the MME to acknowledge the received GUTI.

[TS24.301 clause 5.5.3.3.1]

Within a combined tracking area updating procedure the messages TRACKING AREA UPDATE ACCEPT and TRACKING AREA UPDATE COMPLETE carry information for the tracking area updating and the location area updating.

The combined attach procedure basically follows the normal tracking area updating procedure described in subclause 5.5.3.2.

[TS24.301 clause 5.5.3.3.2]

To initiate a combined tracking area updating procedure the UE sends the message TRACKING AREA UPDATE REQUEST to the network, starts timer T3430 and changes to state EMM-TRACKING-AREA-UPDATING-INITIATED. The value of the EPS update type IE in the message shall indicate "combined TA/LA updating" unless explicitly specified otherwise.

[TS24.301 clause 5.5.3.3.4.1]

Depending on the value of the EPS update result IE received in the TRACKING AREA UPDATE ACCEPT message, two different cases can be distinguished:

- 1) The EPS update result IE value indicates "combined TA/LA": Tracking and location area updating is successful;

...

A TRACKING AREA UPDATE COMPLETE message shall be returned to the network if the TRACKING AREA UPDATE ACCEPT message contains a GUTI and/or a mobile identity.

[TS24.301 clause 5.5.3.3.4.2]

The description for normal tracking area update as specified in subclause 5.5.3.2.4 shall be followed. In addition, the following description for location area updating applies.

The TMSI reallocation may be part of the combined tracking area updating procedure. The TMSI allocated is then included in the TRACKING AREA UPDATE ACCEPT message together with the location area identification (LAI). In this case the MME shall change to state EMM-COMMON-PROCEDURE-INITIATED and shall start the timer T3450 as described in subclause 5.4.1. The LAI may be included in the TRACKING AREA UPDATE ACCEPT message without TMSI.

The UE, receiving a TRACKING AREA UPDATE ACCEPT message, stores the received location area identification, resets the location update attempt counter, sets the update status to U1 UPDATED and enters MM state MM IDLE.

How to handle the old TMSI stored in the UE depends on the mobile identity included in the TRACKING AREA UPDATE ACCEPT message.

- If the TRACKING AREA UPDATE ACCEPT message contains an IMSI, the UE is not allocated any TMSI, and shall delete any old TMSI accordingly.
- If the TRACKING AREA UPDATE ACCEPT message contains a TMSI, the UE shall use this TMSI as new temporary identity. The UE shall delete its old TMSI and shall store the new TMSI. In this case, a TRACKING AREA UPDATE COMPLETE message is returned to the network to confirm the received TMSI.
- If neither a TMSI nor an IMSI has been included by the network in the TRACKING AREA UPDATE ACCEPT message, the old TMSI, if any is available, shall be kept.

The network receiving a TRACKING AREA UPDATE COMPLETE message stops timer T3450, changes to state EMM-REGISTERED and considers the new TMSI as valid.

9.2.3.2.1.3 Test description

9.2.3.2.1.3.1 Pre-test conditions

System Simulator:

- Cell 1, Cell 2 and Cell 4
- Cell 1 belongs to TAI-1, Cell2 belongs to TAI-2 and Cell4 belongs to TAI-4.
- Cell A (UTRA FDD or UTRA TDD or GSM or CDMA2000).

UE:

- The test USIM contains GUTI-1 and a valid TAI-1 for EPS service, and EPS update status is "EU1: UPDATED".
- The test USIM contains TMSI-1 and a valid LAI-1 for CS service, and Location update status is " U1: UPDATED".

Preamble:

- The UE is in state switched OFF (state 1) according to [18].

9.2.3.2.1.3.2 Test procedure sequence

Table 9.2.3.2.1.3.2-1: Main Behaviour

St	Procedure	Message Sequence		TP	Verdict
		U - S	Message		
	The following messages are sent and shall be received on cell 1.	-	-	-	-
1	Set the cell type of cell 1 to the "Serving cell". Set the cell type of cell 2 to the "Suitable neighbour cell". Set the cell type of cell 4 to the "Suitable neighbour cell".	-	-	-	-
2	The UE is powered up or switched on.	-	-	-	-
3	The UE transmits an ATTACH REQUEST message with a PDN CONNECTIVITY REQUEST message to request PDN connectivity to the default PDN.	-->	ATTACH REQUEST	-	-
4	The SS starts an authentication procedure.	<--	AUTHENTICATION REQUEST	-	-
5	The UE responds to the authentication procedure.	-->	AUTHENTICATION RESPONSE	-	-
6	The SS starts a NAS security mode command procedure to perform NAS integrity protection.	<--	SECURITY MODE COMMAND	-	-
7	The UE responds to the NAS security mode command procedure.	-->	SECURITY MODE COMPLETE	-	-
8	The SS transmits ATTACH ACCEPT message including a ACTIVATE DEFAULT EPS BEARER CONTEXT REQUEST message. EPS Attach result = "combined EPS/IMSI attach"	<--	ATTACH ACCEPT	-	-
9	The UE transmits an ATTACH COMPLETE message including an ACTIVATE DEFAULT EPS BEARER CONTEXT ACCEPT message.	-->	ATTACH COMPLETE	-	-
10	The SS releases the RRC connection.	-	-	-	-
11	Set the cell type of cell 1 to the "non-Suitable cell". Set the cell type of cell 2 to the "Serving cell"	-	-	-	-
12	Check: Does the UE transmit a TRACKING AREA UPDATE REQUEST message in the next 30seconds?	-	-	1	F
13	Check: Does the test results of CALL generic procedure [18] indicate that the UE is in E-UTRA EMM-REGISTERED state on cell 2 with PagingUE-Identity = S-TMSI1?	-	-	1	-
	The following messages are sent and shall be received on cell 4.	-	-	-	-
14	Set the cell type of cell 2 to the " non-Suitable cell ". Set the cell type of cell 4 to the " Serving cell"	-	-	-	-
15	Check: Does the UE transmit a combined TRACKING AREA UPDATE REQUEST message as specified?	-->	TRACKING AREA UPDATE REQUEST	2	P
16	The SS sends TRACKING AREA UPDATE ACCEPT message. Note: GUTI present and MS identity not present	<--	TRACKING AREA UPDATE ACCEPT	-	-
17	Check: Does the UE transmit a TRACKING AREA UPDATE COMPLETE message.	-->	TRACKING AREA UPDATE COMPLETE	2,3	P
18	The SS releases the RRC connection.	-	-	-	-
19	Check: Does the test results of CALL generic procedure [18] indicate that the UE is in E-UTRA EMM-REGISTERED state on cell 4 with PagingUE-Identity = S-TMSI2?	-	-	2	-
	The following messages are sent and shall be received on cell 1.	-	-	-	-
20	Set the cell type of cell 4 to the " non-Suitable cell ". Set the cell type of cell 1 to the " Serving cell"	-	-	-	-
21	Check: Does the UE transmit a combined	-->	TRACKING AREA UPDATE	2	P

	TRACKING AREA UPDATE REQUEST message?		REQUEST		
22	The SS sends TRACKING AREA UPDATE ACCEPT message. Note: GUTI not present and MS identity present	<--	TRACKING AREA UPDATE ACCEPT	-	-
23	Check: Does the UE send TRACKING AREA UPDATE COMPLETE message.	-->	TRACKING AREA UPDATE COMPLETE	2,3	P
24	The SS releases the RRC connection.	-	-	-	-
25	The SS pages the UE with S-TMSI2 associated with GUTI-2 (or TMSI-3) for non-EPS service.	-	-	-	-
26	Check: Does the UE initiates a connection on cell A? (FFS)	-	-	2	P

Editor's note: The definitions for "Non-Suitable cell", "Suitable neighbour cell" and "Serving cell" are FFS and should be specified in TS36.508.

NOTE 1: It is assumed in the test procedure sequence that the UE initially has a valid GUTI.

NOTE 2: NAS security procedures are not checked in this TC.

9.2.3.2.1.3.3 Specific message contents

Table 9.2.3.2.1.3.3-1: Message TRACKING AREA UPDATE REQUEST (step 15, Table 9.2.3.2.1.3.2-1)

Derivation path: 36.508 table 4.7.2-27			
Information Element	Value/Remark	Comment	Condition
MS network capability	(FFS)	Cf TS 24.008 clause 10.5.5.12	
EPS update type	001	"combined TA/LA updating" The combined EPS attach procedure is used by a CS fallback capable UE to attach for both EPS and non-EPS services.	
Spare half octet	0000		
Old GUTI	GUTI-1	Old GUTI is included by UE if if valid, IMSI otherwise.	
NAS key set identifier _{ASME}	FFS		
NAS key set identifier _{SGSN}	FFS		
Last visited registered TAI	TAI-2	If available, the last TAI is included by UE and will be used to establish a good list of TAIs in subsequent ATTACH ACCEPT message.	
EPS bearer context status	Not checked		
Old P-TMSI signature	Not present		
Nonce _{UE}	FFS		
Old LAI (FFS)	LAI-1		
TMSI status (FFS)	1	"valid TMSI available"	

Table 9.2.3.2.1.3.3-2: Message TRACKING AREA UPDATE ACCEPT (step 16, Table 9.2.3.2.1.3.2-1)

Derivation path: 36.508 table 4.7.2-24			
Information Element	Value/Remark	Comment	Condition
EPS update result	001	"combined TA/LA"	
Spare half octet	0000		
T3412 value	Not present		
GUTI	GUTI-2	This IE may be included to assign a new GUTI	
TAI list			
Length of tracking area identity list contents	00001000	8 octets	
Number of elements	000001	1 element	
Type of list	000	One PLMN with non-consecutive TACs	
Partial tracking area identity list	PLMN = PLMN1 TAC 1 = TAC-4	TAI-4	
EPS bearer context status	Same value as in TRACKING AREA UPDATE REQUEST message		
ISR indication	FFS		
LAI	LAI-2		
MS identity	Not Present	SS doesn't provide TMSI	
T3402 value	Not present		
Equivalent PLMNs	Not present		
EMM cause (FFS)	Not present		

Table 9.2.3.2.1.3.3-3: Message TRACKING AREA UPDATE REQUEST (step 21, Table 9.2.3.2.1.3.2-1)

Derivation path: 36.508 table 4.7.2-27			
Information Element	Value/Remark	Comment	Condition
MS network capability	(FFS)	Cf TS 24.008 clause 10.5.5.12	
EPS update type	001	"combined TA/LA updating" The combined EPS attach procedure is used by a CS fallback capable UE to attach for both EPS and non-EPS services.	
Spare half octet	0000		
Old GUTI	GUTI-2	Old GUTI is included by UE if if valid, IMSI otherwise.	
NAS key set identifierASME	FFS		
NAS key set identifierSGSN	FFS		
Last visited registered TAI	TAI-4	If available, the last TAI is included by UE and will be used to establish a good list of TAIs in subsequent ATTACH ACCEPT message.	
EPS bearer context status	Not checked		
Old P-TMSI signature	Not present		
NonceUE	FFS		
Old LAI (FFS)	LAI-2		
TMSI status (FFS)	1	"valid TMSI available"	

Table 9.2.3.2.1.3.3-4: Message TRACKING AREA UPDATE ACCEPT (step 22, Table 9.2.3.2.1.3.2-1)

Derivation path: 36.508 table 4.7.2-24			
Information Element	Value/Remark	Comment	Condition
EPS update result	001	"combined TA/LA"	
Spare half octet	0000		
T3412 value	Not present		
GUTI	Not present	The SS doesn't assign a new GUTI	
TAI list			
Length of tracking area identity list contents	00001000	8 octets	
Number of elements	000001	1 element	
Type of list	000	One PLMN with non-consecutive TACs	
Partial tracking area identity list	PLMN = PLMN1 TAC 1 = TAC-1	TAI-1	
EPS bearer context status	Same value as in TRACKING AREA UPDATE REQUEST message		
ISR indication	FFS		
LAI	Not present		
MS identity	TMSI-3	SS provides a new TMSI	
T3402 value	Not present		
Equivalent PLMNs	Not present		
EMM cause (FFS)	Not present		

9.2.3.2.3 Combined tracking area update / successful for EPS services only / MSC temporarily not reachable

9.2.3.2.3.1 Test Purpose (TP)

(1)

```
with { UE having sent a TRACKING AREA UPDATE REQUEST message with EPS update type set to 'Combined TA/LA updating' or 'Combined TA/LA updating with IMSI attach' and having the tracking area updating attempt counter set to the value less than four }
ensure that {
  when { UE receives a TRACKING AREA UPDATE ACCEPT message with the EPS update result set to 'TA updated' and the EMM cause set to 'MSC temporarily not reachable' }
  then { UE sends TRACKING AREA UPDATE REQUEST message after T3411 expiry }
}
```

(2)

```
with { UE having sent a TRACKING AREA UPDATE REQUEST message with EPS update type set to 'Combined TA/LA updating with IMSI attach' and having the tracking area updating attempt counter set to four }
ensure that {
  when { UE receives a TRACKING AREA UPDATE ACCEPT message with the EPS update result set to 'TA updated' and the EMM cause set to 'MSC temporarily not reachable' }
  then { UE sends TRACKING AREA UPDATE REQUEST message after T3402 expiry }
}
```

9.2.3.2.3.2 Conformance requirements

References: The conformance requirements covered in the present TC are specified in: TS 24.301, clause 5.5.3.3.4.3.

[TS 24.301, clause 5.5.3.3.4.3]

The description for tracking area for EPS services as specified in subclause 5.5.3.2.4 shall be followed. In addition, the following description for location updating for non-EPS services applies.

The UE receiving the TRACKING AREA UPDATE ACCEPT message takes one of the following actions depending on the EMM cause value:

...

#16 (MSC temporarily not reachable);

#17 (Network failure); or

#22 (Congestion)

The UE shall stop timer T3430 if still running. The tracking area updating attempt counter shall be incremented, unless it was already set to 5.

If the tracking area updating attempt counter is less than 5:

- the UE shall start timer T3411, shall set the EMM update status to EU1 UPDATED and shall enter state EMM-REGISTERED.ATTEMPTING-TO-UPDATE-MM. When timer T3411 expires the combined tracking area updating procedure indicating "combined TA/LA updating with IMSI attach" is triggered again.

If the tracking area updating attempt counter is equal to 5:

- the UE shall start timer T3402, shall set the EPS update status to EU1 UPDATED and shall enter state EMM-REGISTERED.ATTEMPTING-TO-UPDATE-MM. When timer T3402 expires the combined tracking area updating procedure indicating "combined TA/LA updating with IMSI attach" is triggered again;
- a UE operating in CS/PS mode 1 of operation shall select GERAN or UTRAN radio access technology and proceed with appropriate MM or GMM specific procedures.

...

9.2.3.2.3.3 Test description

9.2.3.2.3.3.1 Pre-test conditions

System Simulator:

- Cell A and Cell B

UE:

None.

Preamble:

- The UE is in state Registered, Idle mode (state 2) with condition CombinedAttach on Cell A according to [18].

9.2.3.2.3.3.2 Test procedure sequence

Table 9.2.3.2.3.3.2-1: Main behaviour

St	Procedure	Message Sequence		TP	Verdict
		U - S	Message		
1	Set the cell type of Cell A to the "non-Suitable cell". Set the cell type of Cell B to the "Serving cell".	-	-	-	-
-	The following messages are sent and shall be received on Cell B.	-	-	-	-
2	Check: Does the UE transmit a TRACKING AREA UPDATE REQUEST message?	-->	TRACKING AREA UPDATE REQUEST	1	P
3	The SS starts a NAS security mode command procedure to perform NAS integrity protection.	<--	SECURITY MODE COMMAND	-	-
4	The UE responds to the NAS security mode command procedure.	-->	SECURITY MODE COMPLETE	-	-
5	The SS transmits a TRACKING AREA UPDATE ACCEPT message.	<--	TRACKING AREA UPDATE ACCEPT	-	-
6	The UE transmits a TRACKING AREA UPDATE COMPLETE message.	-->	TRACKING AREA UPDATE COMPLETE	-	-
7	The SS releases the RRC connection.	-	-	-	-
-	EXCEPTION: The step 8 to 13 shall be repeated 4 times.	-	-	-	-
8	Wait for 10s (T3411).	-	-	-	-
9	Check: Does the UE transmit a TRACKING AREA UPDATE REQUEST message at the time which T3411 expired?	-->	TRACKING AREA UPDATE REQUEST	1	P
10	The SS starts a NAS security mode command procedure to perform NAS integrity protection.	<--	SECURITY MODE COMMAND	-	-
11	The UE responds to the NAS security mode command procedure.	-->	SECURITY MODE COMPLETE	-	-
12	The SS transmits a TRACKING AREA UPDATE ACCEPT message.	<--	TRACKING AREA UPDATE ACCEPT	-	-
13	The SS releases the RRC connection.	-	-	-	-
14	Wait for 12 min (T3402).	-	-	-	-
15	Check: Does the UE transmit a TRACKING AREA UPDATE REQUEST message?	-->	TRACKING AREA UPDATE REQUEST	2	P
16	The SS starts a NAS security mode command procedure to perform NAS integrity protection.	<--	SECURITY MODE COMMAND	-	-
17	The UE responds to the NAS security mode command procedure.	-->	SECURITY MODE COMPLETE	-	-
18	The SS transmits a TRACKING AREA UPDATE ACCEPT message.	<--	TRACKING AREA UPDATE ACCEPT	-	-
19	The UE transmits a TRACKING AREA UPDATE COMPLETE message.	-->	TRACKING AREA UPDATE COMPLETE	-	-

9.2.3.2.3.3.3 Specific message contents

Table 9.2.3.2.3.3.3-1: TRACKING AREA UPDATE ACCEPT (step 5, Table 9.2.3.2.3.3.2-1)

Derivation Path: 36.508, Table 4.7.2-24			
Information Element	Value/remark	Comment	Condition
GUTI	GUTI-2		
EMM cause	'0001 0000'B	MSC temporarily not reachable	

Table 9.2.3.2.3.3-2: TRACKING AREA UPDATE REQUEST (step 9 and 15, Table 9.2.3.2.3.3.2-1)

Derivation Path: 36.508, Table 4.7.2-27			
Information Element	Value/remark	Comment	Condition
EPS update type			
EPS update type value	'010'B	Combined TA/LA updating with IMSI attach	

Table 9.2.3.2.3.3-3: TRACKING AREA UPDATE ACCEPT (step 12, Table 9.2.3.2.3.3.2-1)

Derivation Path: 36.508, Table 4.7.2-24			
Information Element	Value/remark	Comment	Condition
GUTI	Not present		
EMM cause	'0001 0000'B	MSC temporarily not reachable	

Table 9.2.3.2.3.3-4: TRACKING AREA UPDATE ACCEPT (step 18, Table 9.2.3.2.3.3.2-1)

Derivation Path: 36.508, Table 4.7.2-24, condition CombinedTAU			
Information Element	Value/remark	Comment	Condition
GUTI	Not present		
Location area identification	LAI-1		
MS identity	TMSI-1		

9.2.3.2.6 Combined tracking area update / rejected / Illegal ME

9.2.3.2.6.1 Test Purpose (TP)

(1)

```

with { UE having sent a TRACKING AREA UPDATE REQUEST message with EPS update type set to 'Combined
TA/LA updating' }
ensure that {
  when { UE receives a TRACKING AREA UPDATE REJECT message with the EMM cause set to 'Illegal ME' }
  then { UE considers the USIM as invalid for EPS services and non-EPS services and enters state
EMM-DEREGISTERED }
}

```

9.2.3.2.6.2 Conformance requirements

References: The conformance requirements covered in the present TC are specified in: TS 24.301, clause 5.5.3.3.5.

[TS 24.301, clause 5.5.3.3.5]

If the combined tracking area updating cannot be accepted by the network, the MME shall send a TRACKING AREA UPDATE REJECT message to the UE including an appropriate EMM cause value.

Upon receiving the TRACKING AREA UPDATE REJECT message, the UE shall stop timer T3430, stop any transmission of user data, enter state MM IDLE, and take the following actions depending on the EMM cause value received.

...

#6 (Illegal ME); or

...

The UE shall set the EPS update status to EU3 ROAMING NOT ALLOWED (and shall store it according to subclause 5.1.3.3) and shall delete any GUTI, last visited registered TAI, TAI List and KSI.

The UE shall consider the USIM as invalid for EPS and non-EPS services until switching off or the UICC containing the USIM is removed. Additionally, the UE shall delete the list of equivalent PLMNs and shall enter the state EMM-DEREGISTERED.

If A/Gb mode or Iu mode is supported by the UE, the UE shall handle the MM parameters update status, TMSI, LAI and ciphering key sequence number, and the GMM parameters GMM state, GPRS update status, P-TMSI, P-TMSI signature, RAI and GPRS ciphering key sequence number as specified in 3GPP TS 24.008 [13] for the case when the combined routing area updating procedure is rejected with this cause value.

...

9.2.3.2.6.3 Test description

9.2.3.2.6.3.1 Pre-test conditions

System Simulator:

- Cell A, Cell B and Cell C.
- If pc_UTRAN supported by UE, Cell 5.
- Cell A is "Serving cell" and Cell B, Cell C and Cell 5 is "non-Suitable cell".

UE:

None.

Preamble:

- The UE is in state Registered, Idle mode (state 2) with condition CombinedAttach on Cell A according to [18].

9.2.3.2.6.3.2 Test procedure sequence

Table 9.2.3.2.6.3.2-1: Main behaviour

St	Procedure	Message Sequence		TP	Verdict
		U - S	Message		
1	Set the cell type of Cell A to the "non-Suitable cell". Set the cell type of Cell B to the "Serving cell".	-	-	-	-
-	The following messages are sent and shall be received on Cell B.	-	-	-	-
2	The UE transmits a TRACKING AREA UPDATE REQUEST message.	-->	TRACKING AREA UPDATE REQUEST	-	-
3	The SS transmits a TRACKING AREA UPDATE REJECT message with the EMM cause set to 'Illegal ME'.	<--	TRACKING AREA UPDATE REJECT	-	-
4	The SS releases the RRC connection.	-	-	-	-
5	Set the cell type of Cell B to the "non-Suitable cell". Set the cell type of Cell C to the "Serving cell".	-	-	-	-
-	The following messages are sent and shall be received on Cell C.	-	-	-	-
6	Check: Does the UE transmit an ATTACH REQUEST message in the next 30 seconds?	-->	ATTACH REQUEST	1	F
-	EXCEPTION: Steps 7a1 to 7a3 describe behaviour that depends on the UE capability; the "lower case letter" identifies a step sequence that take place if a capability is supported	-	-	-	-
7a1	IF pc_UTRAN THEN the SS sets the cell type of the cell other than Cell 5 to the "non-Suitable cell" and sets the cell type of Cell 5 to the "Serving cell".	-	-	-	-
7a2	The following messages are sent and shall be received on Cell 5.	-	-	-	-
7a3	Check: Does the UE transmit an ATTACH REQUEST message in the next 30 seconds?	-->	ATTACH REQUEST	1	F
-	The following messages are sent and shall be received on Cell A.	-	-	-	-
8	Set the cell type of the cell other than Cell A to the "non-Suitable cell". Set the cell type of Cell A to the "Serving cell".	-	-	-	-
9	Check: Does the UE transmit an ATTACH REQUEST message in the next 30 seconds?	-->	ATTACH REQUEST	1	F

9.2.3.2.6.3.3 Specific message contents

Table 9.2.3.2.6.3.3-1: TRACKING AREA UPDATE REJECT (step 3, Table 9.2.3.2.6.3.2-1)

Derivation Path: 36.508, Table 4.7.2-26			
Information Element	Value/remark	Comment	Condition
EMM cause	'0000 0110'B	Illegal ME	

9.2.3.2.10 Combined tracking area update / rejected / UE implicitly detached

9.2.3.2.10.1 Test Purpose (TP)

(1)

```

with { UE having sent a TRACKING AREA UPDATE REQUEST message with EPS update type set to 'Combined
TA/LA updating' }
ensure that {
  when { UE receives a TRACKING AREA UPDATE REJECT message with the EMM cause set to 'Implicitly
detached' }
    then { UE sends an ATTACH REQUEST message }
}

```

9.2.3.2.10.2 Conformance requirements

References: The conformance requirements covered in the present TC are specified in: TS 24.301, clause 5.5.3.3.5.

[TS 24.301, clause 5.5.3.3.5]

If the combined tracking area updating cannot be accepted by the network, the MME shall send a TRACKING AREA UPDATE REJECT message to the UE including an appropriate EMM cause value.

Upon receiving the TRACKING AREA UPDATE REJECT message, the UE shall stop timer T3430, stop any transmission of user data, enter state MM IDLE, and take the following actions depending on the EMM cause value received.

...

#10 (Implicitly detached);

The UE shall delete the list of equivalent PLMNs and shall enter the state EMM-DEREGISTERED.NORMAL-SERVICE. The UE shall then perform a new attach procedure.

...

9.2.3.2.10.3 Test description

9.2.3.2.10.3.1 Pre-test conditions

System Simulator:

- Cell A and Cell B
- Cell A is set to the "Serving cell" and Cell B is set to the "non-Suitable cell".

UE:

None.

Preamble:

- The UE is in state Registered, Idle mode (state 2) with condition CombinedAttach on Cell A according to [18].

9.2.3.2.10.3.2 Test procedure sequence

Table 9.2.3.2.10.3.2-1: Main behaviour

St	Procedure	Message Sequence		TP	Verdict
		U - S	Message		
1	Set the cell type of Cell A to the "non-Suitable cell". Set the cell type of Cell B to the "Serving cell".	-	-	-	-
-	The following messages are sent and shall be received on Cell B.	-	-	-	-
2	The UE transmits a TRACKING AREA UPDATE REQUEST message.	-->	TRACKING AREA UPDATE REQUEST	-	-
3	The SS transmits a TRACKING AREA UPDATE REJECT message with the EMM cause set to 'Implicitly detached'.	<--	TRACKING AREA UPDATE REJECT	-	-
4	Check: Does the UE transmit an ATTACH REQUEST message?	-->	ATTACH REQUEST	1	P
5	The SS transmits an IDENTITY REQUEST message requesting IMSI in the IE Identity type	<--	IDENTITY REQUEST	-	-
6	The UE transmits an IDENTITY RESPONSE message.	-->	IDENTITY RESPONSE	-	-
7	The SS transmits an AUTHENTICATION REQUEST message to initiate the EPS authentication and AKA procedure.	<--	AUTHENTICATION REQUEST	-	-
8	The UE transmits an AUTHENTICATION RESPONSE message and establishes mutual authentication.	-->	AUTHENTICATION RESPONSE	-	-
9	The SS transmits a NAS SECURITY MODE COMMAND message to activate NAS security.	<--	SECURITY MODE COMMAND	-	-
10	The UE transmits a NAS SECURITY MODE COMPLETE message and establishes the initial security configuration.	-->	SECURITY MODE COMPLETE	-	-
11	The SS transmits ATTACH ACCEPT message.	<--	ATTACH ACCEPT	-	-
12	The UE transmits an ATTACH COMPLETE message.	-->	ATTACH COMPLETE	-	-

9.2.3.2.10.3.3 Specific message contents

Table 9.2.3.2.10.3.3-1: TRACKING AREA UPDATE REJECT (step 3, Table 9.2.3.2.10.3.2-1)

Derivation Path: TS 36.508 Table 4.7.2-26			
Information Element	Value/remark	Comment	Condition
EMM cause	'0000 1010'B	Implicitly detached	

Table 9.2.3.2.10.3.3-2: ATTACH ACCEPT (step 11, Table 9.2.3.2.10.3.2-1)

Derivation Path: TS 36.508 Table 4.7.2-1, condition CombinedAttach
--

9.2.3.2.12 Combined tracking area update / rejected / Tracking area not allowed

9.2.3.2.12.1 Test Purpose (TP)

(1)

```

with { UE having sent a TRACKING AREA UPDATE REQUEST message with EPS update type set to 'Combined
TA/LA updating' }
ensure that {
  when { UE receives a TRACKING AREA UPDATE REJECT message with the EMM cause set to 'Tracking Area
not allowed' }
  then { UE sets the EPS update status to EU3 ROAMING NOT ALLOWED, deletes any GUTI, last visited
registered TAI, TAI List and KSI, enters the state EMM-DEREGISTERED.LIMITED-SERVICE and stores the
current TAI in the list of "forbidden tracking areas for regional provision of service" }
}

```

(2)

```

with { UE in EMM-DEREGISTERED.LIMITED-SERVICE state having the list of "forbidden tracking areas for regional provision of service" }
ensure that {
  when { serving cell belongs to TAI where UE was rejected }
  then { UE does not attempt to attach }
}

```

(3)

```

with { UE in EMM-DEREGISTERED.LIMITED-SERVICE state having the list of "forbidden tracking areas for regional provision of service" }
ensure that {
  when { UE reselects a new cell which belongs to the TAI in the list of "forbidden tracking areas for regional provision of service" }
  then { UE does not attempt to attach }
}

```

(4)

```

with { UE is powered off or switched off }
ensure that {
  when { UE is powered on or switched on in the cell belonging to the TAI which was in the list of "forbidden tracking areas for regional provision of service" before the UE was powered off or switched off }
  then { UE attempts to attach }
}

```

9.2.3.2.12.2 Conformance requirements

References: The conformance requirements covered in the present TC are specified in: TS 24.301, clause 5.5.3.3.5.

[TS 24.301, clause 5.5.3.3.5]

If the combined tracking area updating cannot be accepted by the network, the MME shall send a TRACKING AREA UPDATE REJECT message to the UE including an appropriate EMM cause value.

Upon receiving the TRACKING AREA UPDATE REJECT message, the UE shall stop timer T3430, stop any transmission of user data, enter state MM IDLE, and take the following actions depending on the EMM cause value received.

...

#12 (Tracking area not allowed);

The UE shall set the EPS update status to EU3 ROAMING NOT ALLOWED (and shall store it according to subclause 5.1.3.3) and shall delete any GUTI, last visited registered TAI, TAI List and KSI. The UE shall reset the tracking area updating attempt counter and shall enter the state EMM-DEREGISTERED.LIMITED-SERVICE.

The UE shall store the current TAI in the list of "forbidden tracking areas for regional provision of service".

If A/Gb mode or Iu mode is supported by the UE, the UE shall handle the MM parameters update status, TMSI, LAI, ciphering key sequence number and the location update attempt counter, and the GMM parameters GMM state, GPRS update status, P-TMSI, P-TMSI signature, RAI, GPRS ciphering key sequence number and routing area updating attempt counter as specified in 3GPP TS 24.008 [13] for the case when the combined routing area updating procedure is rejected with the GMM cause with the same value.

...

9.2.3.2.12.3 Test description

9.2.3.2.12.3.1 Pre-test conditions

System Simulator:

- Cell A, Cell B and Cell M.
- Cell A is set to the "Serving cell", and Cell B and Cell M is set to the "non-Suitable cell".

UE:

None.

Preamble:

- The UE is in state Registered, Idle mode (state 2) with condition CombinedAttach on Cell A according to [18].

9.2.3.2.12.3.2 Test procedure sequence

Table 9.2.3.2.12.3.2-1: Main behaviour

St	Procedure	Message Sequence		TP	Verdict
		U - S	Message		
1	Set the cell type of Cell A to the "Suitable neighbour cell". Set the cell type of Cell B to the "Serving cell".	-	-	-	-
-	The following messages are sent and shall be received on Cell B.	-	-	-	-
2	The UE transmits a TRACKING AREA UPDATE REQUEST message.	-->	TRACKING AREA UPDATE REQUEST	-	-
3	The SS transmits a TRACKING AREA UPDATE REJECT message with the EMM cause set to 'Tracking Area not allowed'.	<--	TRACKING AREA UPDATE REJECT	-	-
4	The SS releases the RRC connection.	-	-	-	-
5	Check: Does the UE transmit an ATTACH REQUEST message in the next 30 seconds on Cell A or Cell B?	-->	ATTACH REQUEST	1,2	F
6	Set the cell type of Cell A to the "non-Suitable cell". Set the cell type of Cell B to the "non-Suitable cell". Set the cell type of Cell M to the "Serving cell".	-	-	-	-
-	The following messages are sent and shall be received on Cell M.	-	-	-	-
7	Check: Does the UE transmit an ATTACH REQUEST message in the next 30 seconds?	-->	ATTACH REQUEST	3	F
8	Set the cell type of Cell A to the "Serving cell". Set the cell type of Cell M to the "non-Suitable cell".	-	-	-	-
-	The following messages are sent and shall be received on Cell A.	-	-	-	-
9	Check: Does the UE transmit an ATTACH REQUEST message in the next 30 seconds?	-->	ATTACH REQUEST	3	F
10	The UE is powered off or switched off.	-	-	-	-
11	The UE is powered on or switched on.	-	-	-	-
12	Check: Does the UE transmit an ATTACH REQUEST message?	-->	ATTACH REQUEST	1,4	P
13	The SS transmits an AUTHENTICATION REQUEST message to initiate the EPS authentication and AKA procedure.	<--	AUTHENTICATION REQUEST	-	-
14	The UE transmits an AUTHENTICATION RESPONSE message and establishes mutual authentication.	-->	AUTHENTICATION RESPONSE	-	-
15	The SS transmits a NAS SECURITY MODE COMMAND message to activate NAS security.	<--	SECURITY MODE COMMAND	-	-
16	The UE transmits a NAS SECURITY MODE COMPLETE message and establishes the initial security configuration.	-->	SECURITY MODE COMPLETE	-	-
17	The SS transmits ATTACH ACCEPT message.	<--	ATTACH ACCEPT	-	-
18	The UE transmits an ATTACH COMPLETE message.	-->	ATTACH COMPLETE	-	-

9.2.3.2.12.3.3 Specific message contents

Table 9.2.3.2.12.3.3-1: TRACKING AREA UPDATE REJECT (step 3, Table 9.2.3.2.12.3.2-1)

Derivation Path: 36.508, Table 4.7.2-26			
Information Element	Value/remark	Comment	Condition
EMM cause	'0000 1100'B	Tracking Area not allowed	

Table 9.2.3.2.12.3.3-2: ATTACH REQUEST (step 12, Table 9.2.3.2.12.3.2-1)

Derivation Path: 36.508, Table 4.7.2-4			
Information Element	Value/remark	Comment	Condition
NAS key set identifier			
NAS key set identifier	'111'B	no key is available	
TSC	Any allowed value	TSC does not apply for NAS key set identifier value "111".	
Old GUTI or IMSI	IMSI of the UE		
Last visited registered TAI	Not present		

Table 9.2.3.2.12.3.3-3: ATTACH ACCEPT (step 17, Table 9.2.3.2.12.3.2-1)

Derivation Path: TS 36.508 Table 4.7.2-1, condition CombinedAttach
--

9.2.3.2.15 Combined tracking area update / rejected / No suitable cells in tracking area

9.2.3.2.15.1 Test Purpose (TP)

(1)

```

with { UE having sent a TRACKING AREA UPDATE REQUEST message with EPS update type set to 'Combined
TA/LA updating' }
ensure that {
  when { UE receives a TRACKING AREA UPDATE REJECT message with the EMM cause set to 'No Suitable
Cells In tracking area' }
  then { UE selects a suitable cell in another tracking area in the same PLMN and performs the
tracking area updating procedure with EPS update type set to 'combined TA/LA updating with IMSI
attach' }
}

```

9.2.3.2.15.2 Conformance requirements

References: The conformance requirements covered in the present TC are specified in: TS 24.301, clause 5.5.3.3.5.

[TS 24.301, clause 5.5.3.3.5]

If the combined tracking area updating cannot be accepted by the network, the MME shall send a TRACKING AREA UPDATE REJECT message to the UE including an appropriate EMM cause value.

Upon receiving the TRACKING AREA UPDATE REJECT message, the UE shall stop timer T3430, stop any transmission of user data, enter state MM IDLE, and take the following actions depending on the EMM cause value received.

...

#15 (No suitable cells in tracking area);

The UE shall set the EPS update status to EU3 ROAMING NOT ALLOWED (and shall store it according to subclause 5.1.3.3). The UE shall reset the tracking area updating attempt counter and shall enter the state EMM-REGISTERED.LIMITED-SERVICE.

The UE shall store the current TAI in the list of "forbidden tracking areas for roaming" and shall remove the current TAI from the stored TAI list if present.

The UE shall search for a suitable cell in another tracking area or in another location area in the same PLMN according to 3GPP TS 36.304 [21].

The UE shall indicate the Update type IE "combined TA/LA updating with IMSI attach" when performing the tracking area updating procedure.

If A/Gb mode or Iu mode is supported by the UE, the UE shall handle the MM parameters update status and the location update attempt counter, and the GMM parameters GMM state, GPRS update status and routing area

updating attempt counter as specified in 3GPP TS 24.008 [13] for the case when the combined routing area updating procedure is rejected with this cause value.

...

9.2.3.2.15.3 Test description

9.2.3.2.15.3.1 Pre-test conditions

System Simulator:

- Cell A, Cell B and Cell C.
- Cell A is set to the "Serving cell" and Cell B and Cell C is set to the "non-Suitable cell".

UE:

None.

Preamble:

- The UE is in state Registered, Idle mode (state 2) with condition CombinedAttach on Cell A according to [18].

9.2.3.2.15.3.2 Test procedure sequence

Table 9.2.3.2.15.3.2-1: Main behaviour

St	Procedure	Message Sequence		TP	Verdict
		U - S	Message		
1	Set the cell type of Cell A to the "non-Suitable cell". Set the cell type of Cell B to the "Serving cell". Set the cell type of Cell C to the "Suitable neighbour cell".	-	-	-	-
-	The following messages are sent and shall be received on Cell B.	-	-	-	-
2	The UE transmits a TRACKING AREA UPDATE REQUEST message.	-->	TRACKING AREA UPDATE REQUEST	-	-
3	The SS transmits a TRACKING AREA UPDATE REJECT message with the EMM cause set to 'No Suitable Cells In tracking area'.	<--	TRACKING AREA UPDATE REJECT	-	-
4	The SS releases the RRC connection.	-	-	-	-
-	The following messages are sent and shall be received on Cell C.	-	-	-	-
5	Check: Does the UE transmit a TRACKING AREA UPDATE REQUEST message with EPS update type set to 'combined TA/LA updating with IMSI attach'?	-->	TRACKING AREA UPDATE REQUEST	1	P
6	The SS transmits a NAS SECURITY MODE COMMAND message to activate NAS security.	<--	SECURITY MODE COMMAND	-	-
7	The UE transmits a NAS SECURITY MODE COMPLETE message and establishes the initial security configuration.	-->	SECURITY MODE COMPLETE	-	-
8	The SS transmits a TRACKING AREA UPDATE ACCEPT message.	<--	TRACKING AREA UPDATE ACCEPT	-	-
9	The UE transmits a TRACKING AREA UPDATE COMPLETE message.	-->	TRACKING AREA UPDATE COMPLETE	-	-

9.2.3.2.15.3.3 Specific message contents

Table 9.2.3.2.15.3.3-1: TRACKING AREA UPDATE REJECT (step 3, Table 9.2.3.2.15.3.2-1)

Derivation Path: 36.508, Table 4.7.2-26			
Information Element	Value/remark	Comment	Condition
EMM cause	'0000 1111'B	No Suitable Cells In tracking area	

Table 9.2.3.2.15.3.3-2: TRACKING AREA UPDATE REQUEST (step 5, Table 9.2.3.2.15.3.2-1)

Derivation Path: 36.508, Table 4.7.2-27			
Information Element	Value/remark	Comment	Condition
EPS update type			
EPS update type value	'010'B	Combined TA/LA updating with IMSI attach	

Table 9.2.3.2.15.3.3-3: TRACKING AREA UPDATE ACCEPT (step 8, Table 9.2.3.2.15.3.2-1)

Derivation Path: TS 36.508 Table 4.7.2-24, condition CombinedTAU
--

9.2.3.3.1 First lu mode to S1 mode intersystem change after attach; go to E-UTRAN RRC idle; RAU to UTRAN

9.2.3.3.1.1 Test Purpose (TP)

(1)

```
with { UE attached to UTRAN with a PDP context active, and, E-UTRAN NAS and Security parameters
stored on the USIM }
ensure that {
  when { UE performs a Tracking Area Update in idle mode }
  then { the UE encodes the RRC parameters in the RRC Connection Establishment messages with (ie.
.....) }
}
```

(2)

```
with { UE attached to UTRAN with a PDP context active, and, E-UTRAN NAS and Security parameters
stored on the USIM }
ensure that {
  when { UE performs a Tracking Area Update in idle mode }
  then { the UE encodes the parameters in the TRACKING AREA UPDATE REQUEST with (ie. ....) }
}
```

(3)

```
with { UE powered on in UTRAN }
ensure that {
  when { UE makes its first Tracking Area Update to E-UTRAN }
  then { UE sends the UE radio capability information update needed IE }
}
```

(4)

```
with { UE registered in E-UTRAN, and, UTRAN NAS and Security parameters available in the UE }
ensure that {
  when { UE performs a Routeing Area Update in idle mode }
  then { the UE encodes the parameters in the IDNNS IE with (ie. ....) }
}
```

(5)

```
with { UE registered in E-UTRAN, and, UTRAN NAS and Security parameters available in the UE }
ensure that {
  when { UE performs a Routeing Area Update in idle mode }
  then { the UE encodes the parameters in the ROUTEING AREA UPDATE REQUEST with (ie. ....) }
}
```

9.2.3.3.1.2 Conformance requirements

References: The conformance requirements covered in the current TC are specified in: TS 23.003 clause 2.8.2; TS 23.401 clauses 5.3.3.1 and 5.3.3.3; TS 25.331 clauses 8.1.8.2 and 10.3.1.6 (on IDNNS); TS 24.008 [NAS msg contents]; TS 24.301 clause 5.5.3.2.2; and TS 36.331 clauses 5.3.3.3 and 5.3.3.4.

[TS 23.003, clause 2.8.2 “Mapping between Temporary and Area Identities for the EUTRAN and the UTRAN/GERAN based systems”]

The mapping of the GUTI shall be done to the combination of RAI of GERAN / UTRAN and the P-TMSI:

E-UTRAN <MCC> maps to GERAN/UTRAN <MCC>

E-UTRAN <MNC> maps to GERAN/UTRAN <MNC>

E-UTRAN <MME Group ID> maps to GERAN/UTRAN <LAC>

- E-UTRAN <MME Code> maps to GERAN/UTRAN <RAC> and is also copied into the 8 most significant bits of the NRI field within the P-TMSI;

E-UTRAN <S-TMSI> maps as follows:

- 22 bits of the E-UTRAN <M-TMSI> starting at bit 30 and down to bit 9 are mapped into the remaining 22 bits of the GERAN/UTRAN <P-TMSI>;
- and the remaining 8 bits of the E-UTRAN <M-TMSI> are copied into 8 bits of the <P-TMSI signature> field.

For UTRAN, the 10-bit long NRI bits are masked out from the P-TMSI and also supplied to the RAN node as IDNNS (Intra Domain NAS Node Selector).

The mapping of P-TMSI (TLLI) and RAI in GERAN/UTRAN to GUTI in E-UTRAN shall be performed as follows:

GERAN/UTRAN <MCC> maps to E-UTRAN <MCC>

GERAN/UTRAN <MNC> maps to E-UTRAN <MNC>

GERAN/UTRAN <LAC> maps to E-UTRAN <MME Group ID>

GERAN/UTRAN <RAC> maps to 8 bits of the M-TMSI

The 8 most significant bits of GERAN/UTRAN <NRI> map to the MME code.

GERAN/UTRAN <P-TMSI or TLLI> excluding the 8 most significant bits at the NRI position maps to the remaining bits of the M-TMSI.

[TS 23.401, clause 5.3.3.1, step 2, “Tracking Area Update procedure with Serving GW change”]

....

If the UE's TIN indicates "P-TMSI" and the UE holds a valid P-TMSI and related RAI then these two elements are indicated as the old GUTI.

...

[TS 23.401, clause 5.3.3.3, step 2, “Routeing Area Update with MME interaction and without S-GW change”]

...

If the UE's internal TIN indicates "GUTI" and the UE holds a valid GUTI then the UE indicates the GUTI as the old P-TMSI and old RAI

...

[TS 24.301, clause 5.5.3.2.2 “Normal and periodic tracking area updating procedure initiation”]

...

When initiating a tracking area updating procedure as a result of an Iu mode to S1 mode or A/Gb mode to S1 mode inter-system change, the UE shall handle the GUTI as follows:

- if the TIN indicates "P-TMSI" and the UE holds a valid P-TMSI and RAI, the UE shall map the P-TMSI and RAI into the old GUTI IE. Additionally, if the UE holds a valid GUTI, the UE shall indicate the GUTI in the Additional GUTI IE.

NOTE: Mapping the P-TMSI and RAI to the GUTI is specified in Annex H of 3GPP TS 23.401 [10].

- if the TIN indicates "GUTI" or "RAT-related TMSI" and the UE holds a valid GUTI, the UE shall indicate the GUTI in the Old GUTI IE.

...

When the tracking area updating procedure is initiated to perform an inter-system change from A/Gb mode or Iu mode to S1 mode, the UE shall include the KSI_{ASME} in the TRACKING AREA UPDATE REQUEST message if the UE has a cached EPS security context. Otherwise, the UE shall set the KSI_{ASME} to the value "no key is available".

When the tracking area updating procedure is initiated in EMM-IDLE mode to perform an inter-system change from A/Gb mode or Iu mode to S1 mode, the UE shall include the KSI_{SGSN} in the TRACKING AREA UPDATE REQUEST message. If the UE does not have a cached EPS security context, the UE shall include the $Nonce_{UE}$ IE in the TRACKING AREA UPDATE REQUEST message. The TRACKING AREA UPDATE REQUEST message shall be integrity protected with the cached EPS security context if the UE has one. If the UE does not have a cached EPS security context, the TRACKING AREA UPDATE REQUEST message shall not be integrity protected.

...

When the tracking area updating procedure is initiated in EMM-IDLE mode to perform an inter-system change from A/Gb mode or Iu mode to S1 mode, the UE shall include the KSI_{SGSN} in the TRACKING AREA UPDATE REQUEST message. If the UE does not have a cached EPS security context, the UE shall include the $Nonce_{UE}$ IE in the TRACKING AREA UPDATE REQUEST message. The TRACKING AREA UPDATE REQUEST message shall be integrity protected with the cached EPS security context if the UE has one. If the UE does not have a cached EPS security context, the TRACKING AREA UPDATE REQUEST message shall not be integrity protected.

...

If the UE initiates the first tracking area updating procedure following an attach in A/Gb mode or Iu mode, the UE shall include a UE radio capability information update needed IE in the TRACKING AREA UPDATE REQUEST message.

...

[TS 36.331, clause 5.3.3.3 "Actions related to transmission of *RRConnectionRequest* message"]

The UE shall set the contents of *RRConnectionRequest* message as follows:

- 1> set the *ue-Identity* as follows:
 - 2> if upper layers provide an S-TMSI:
 - 3> set the *ue-Identity* to the value received from upper layers;
 - 2> else
 - 3> draw a random value and set the *ue-Identity* to this value;

NOTE 1 Upper layers provide the S-TMSI if the UE is registered in the TA of the current cell.

- 1> Set the *establishmentCause* in accordance with the information received from upper layers;

.

[TS 36.331, clause 5.3.3.4 "Reception of the *RRConnectionSetup* by the UE"]

...

- 1> set the content of *RRCConnectionSetupComplete* message as follows:
 - 2> set the *selectedPLMN-Identity* to the PLMN selected by upper layers [TS 23.122, TS 24.008] from the PLMN(s) included in the *plmn-IdentityList* in *SystemInformationBlockType1*, in the cell where the RRC connection was established;
 - 2> if upper layers provide the 'Registered MME', set the *registeredMME* as follows:
 - 3> if the PLMN identity of the 'Registered MME' is different from the PLMN selected by the upper layers:
 - 4> include the *plmnIdentity* in the *registeredMME* and set it to the value of the PLMN identity in the 'Registered MME' received from upper layers;
 - 3> set the *mmegi* and the *mmec* to the value received from upper layers;
 - 2> set the *nas-DedicatedInformation* to include the information received from upper layers;

...

9.2.3.3.1.3 Test description

9.2.3.3.1.3.1 Pre-test conditions

System Simulator:

Note: while this test describes the uses of 3 cells, it is intended that this test only requires 2 cells to be active at any one instant.

As defined in table 4.4.2-1 of TS 36.508 [18], cell 5 and cell 7 are UTRA cells.

As defined in table 4.4.2-1 of TS 36.508 [18], cell 1 is an E-UTRAN cell

[cells 5 and 7 are in the same Routing Area and hence are in the same LA.]

[UMTS is NOT using Gs interface.] -> does this matter for CSFB mobiles?

- The power level of Cell 5 is the Serving Cell level defined in table 6.2.2.1-1 of TS 36.508 [18].
- The power levels of Cells 1 and 7 are set to the Non-suitable "Off" level defined in table 6.2.2.1-1 of TS 36.508 [18].

UE:

- The test USIM contains a valid GUTI1 and TAI2, valid EPS security parameters, and EPS update status is "EU1: UPDATED".

Preamble:

- The UE is in state Switched OFF (state 1) according to TS 36.508, [18].

9.2.3.3.1.3.2 Test procedure sequence

Table 9.2.3.3.1.3.2-1: Main behaviour

St	Procedure	Message Sequence		TP	Verdict
		U – S	Message		
1	The UE is switched on.	-	-	-	-
2	The UE transmits an ATTACH REQUEST message on Cell 5	-->	ATTACH REQUEST (24.008)		
3	The SS transmits an AUTHENTICATION AND CIPHERING REQUEST message.	<--	AUTHENTICATION AND CIPHERING REQUEST	-	-
4	The UE transmits an AUTHENTICATION AND CIPHERING RESPONSE message.	-->	AUTHENTICATION AND CIPHERING RESPONSE	-	-
8	SS responds with ATTACH ACCEPT message including a valid P-TMSI and RAI	<--	ATTACH ACCEPT (24.008)	-	-
9	The UE transmits an ATTACH COMPLETE message.	-->	ATTACH COMPLETE (24.008)	-	-
10	The UE transmits an ACTIVATE PDP CONTEXT REQUEST message	-->	ACTIVATE PDP CONTEXT REQUEST	-	-
11	The SS responds with an ACTIVATE PDP CONTEXT ACCEPT message	<--	ACTIVATE PDP CONTEXT ACCEPT	-	-
12	IPv4 and/or IPv6 address allocation (e.g. DHCP) may occur on the user plane.	<->	Optional IP address allocation	-	-
13	After the IP address(es) have been allocated, the SS releases the RRC connection.	-	-	-	-
14	The signal strength of Cell 1 is raised to that of the Serving Cell and that of Cell 5 is lowered to that of a Suitable Neighbour Cell as defined in table 6.2.2.1-1 of TS 36.508 [18]. Note: Cell 5 is still suitable but the UE shall select Cell 1.				
15	Check: does the UE send an RRCConnectionRequest; is the <i>InitialUE-Identity</i> set to "randomValue" and the <i>establishmentcause</i> set to <i>MO-signalling</i> ?	-	-	1	-
16	The SS responds with RRCConnectionSetup	-	-		
17	Check: does the UE send an RRCConnectionSetupComplete containing a TRACKING AREA UPDATE REQUEST as the NAS PDU; is the <i>selectedPLMN-identity</i> set to the value of the registered MME (i.e. to the value from the mapped RAI), and, the <i>mmegi</i> and <i>mmec</i> are set to the values derived from the mapped RAI and P-TMSI; are the contents of the TRACKING AREA UPDATE REQUEST message as described in the specific message contents?	-->	TRACKING AREA UPDATE REQUEST	1, 2, 3	P
18	The SS sends TRACKING AREA UPDATE ACCEPT allocating a new GUTI and TAI list	<--	TRACKING AREA UPDATE ACCEPT		
19	the SS releases the RRC connection	-			
20	Cell 5 is switched off	-			
21	The signal strength of Cell 7 is raised to that of the Serving Cell and that of Cell 1 is lowered to that of a Suitable Neighbour Cell as defined in table 6.2.2.1-1 of TS 36.508 [18]. Note: Cell 1 is still suitable but the UE shall select Cell 7.	-			
22	The UE and SS establish an RRC Connection	-			
23	Check: does the UE send an Initial DT message containing an RA UPDATE REQUEST; the IDNNS coding and the RAU message parameters?	-->	Initial DT	4, 5	P
24	The SS sends RAU ACCEPT (no new P-TMSI nor RAI)	<--	RAU ACCEPT		
25	UE sends RAU ACCEPT COMPLETE	-->	RAU ACCEPT COMPLETE (FFS)		

	message (FFS)				
26	The SS releases the RRC connection	-			

9.2.3.3.1.3.3 Specific message contents

Table 9.2.3.3.1.3.3-1: Message RRCConnectionRequest (step 15, Table 9.2.3.3.1.3.2-1)

Derivation path: 36.508 table 4.6.1-16			
Information Element	Value/Remark	Comment	Condition
InitialUE-Identity CHOICE {			
random-Value	Any allowed value		
}			
establishmentCause	Mo-Signalling		

Table 9.2.3.3.1.3.3-2: Message RRCConnectionSetupComplete (step 17, Table 9.2.3.3.1.3.2-1)

Derivation path: 36.508 table 4.6.1-18			
Information Element	Value/Remark	Comment	Condition
Details to be added			

Table 9.2.3.3.1.3.3-3: Message TRACKING AREA UPDATE REQUEST (step 17, Table 9.2.3.3.1.3.2-1)

Derivation path: 36.508 table 4.7.2-xx			
Information Element	Value/Remark	Comment	Condition
Sent in SECURITY PROTECTED NAS MESSAGE with valid integrity check			P
Details to be added			

Other message details to be added.

9.2.3.4.1 TAU/RAU procedure for inter-system cell re-selection between A/Gb and S1 modes

9.2.3.4.1.1 Test Purpose (TP)

(1)

```
with { UE attached to GERAN with a PDP context active, and, E-UTRAN NAS and Security parameters stored on the USIM }
ensure that {
  when { UE performs a cell reselection to E-UTRAN and performs a Tracking Area Update }
  then { the UE encodes the RRC parameters in the RRC Connection Establishment messages correctly (i.e. in the RRCConnectionRequest message, the InitialUE-Identity is set to "randomValue" and the establishmentCause is set to MO-signalling; and, in the RRCConnectionSetupComplete message the selectedPLMN-identity, mmegi and mmec indicate the value of the registered MME (e.g. as retrieved from the USIM at power-on, or, as received in the last TRACKING AREA UPDATE ACCEPT message) }
}
```

(2)

```
with { UE attached to GERAN with a PDP context active, and, E-UTRAN NAS and EPS Security parameters stored on the USIM, and ISR not activated }
ensure that {
  when { UE performs a cell reselection to E-UTRAN and performs a Tracking Area Update }
  then { the UE encodes the parameters in the TRACKING AREA UPDATE REQUEST correctly i.e.:
    - the NAS key set identifierASME IE is set to the value stored in the USIM/allocated in the last TRACKING AREA UPDATE ACCEPT message;
    - the Old GUTI IE is derived from the mapped P-TMSI and RAI;
    - the Additional GUTI IE is set to the GUTI stored in the USIM/allocated in the last TRACKING AREA UPDATE ACCEPT message; and
    - the DRX parameter IE is not included. }
}
```

(3)

```

with { UE powered on in GERAN }
ensure that {
  when { UE makes its first Tracking Area Update to E-UTRAN}
    then { UE sends the UE radio capability information update needed IE }
}

```

(4)

```

with { UE registered in E-UTRAN, and, GERAN NAS and Security parameters available in the UE and ISR
not activated }
ensure that {
  when { UE performs a cell reselection to E-UTRAN and performs a Routeing Area Update }
    then { the UE derives the TLLI parameter in the RLC/MAC header from the GUTI allocated in the
TRACKING AREA UPDATE ACCEPT message }
}

```

(5)

```

with { UE registered in E-UTRAN, and, GERAN NAS and GERAN Security parameters available in the UE,
and ISR not activated }
ensure that {
  when { UE performs a cell reselection to E-UTRAN and performs a Routeing Area Update }
    then { the UE encodes the parameters in the ROUTING AREA UPDATE REQUEST with i.e.:
      - [the GPRS ciphering key sequence number IE is set to the value allocated in the
previous AUTHENTICATION AND CIPHERING REQUEST message;] (* Editor's Note: core
specs seem unclear on KSI *)
      - the Old routing area identification IE, the Old P-TMSI signature IE, and P-TMSI IE are
mapped from the GUTI allocated in the TRACKING AREA UPDATE ACCEPT message;
      - the Additional mobile identity IE contains the P-TMSI allocated in the last received
ATTACH ACCEPT/ROUTING AREA UPDATE ACCEPT message;
      - the Additional old routing area identification IE contains the RAI allocated in the
last received ATTACH ACCEPT/ROUTING AREA UPDATE ACCEPT message; and
      - [the DRX parameter IE is not included]. (* Editor's Note: rel 8, 24.008 probably needs
correction to align with 23.060 on DRX parameter handling *) }
}

```

(6)

```

with { UE registered }
ensure that {
  when { UE makes its second Tracking Area Update to E-UTRAN}
    then { UE does not send the UE radio capability information update needed IE }
}

```

9.2.3.4.1.2 Conformance requirements

References: The conformance requirements covered in the current TC are specified in: TS 23.003 clauses 2.8.2.1 and 2.8.2.2; TS 23.401 clauses 4.3.5.6, 5.3.3.1 and 5.3.3.3; TS 24.008 clauses 4.7.1.4.1 and 4.7.5.1.1; and TS 24.301 clauses 5.3.1.1 and 5.5.3.2.2.

[TS 23.003, clause 2.8.2.1 “Mapping from GUTI to RAI, P-TMSI and P-TMSI signature”]

The mapping of the GUTI shall be done to the combination of RAI of GERAN / UTRAN and the P-TMSI:

E-UTRAN <MCC> maps to GERAN/UTRAN <MCC>

E-UTRAN <MNC> maps to GERAN/UTRAN <MNC>

E-UTRAN <MME Group ID> maps to GERAN/UTRAN <LAC>

E-UTRAN <MME Code> maps to GERAN/UTRAN <RAC> and is also copied into the 8 most significant bits of the NRI field within the P-TMSI;

E-UTRAN <M-TMSI> maps as follows:

- 6 bits of the E-UTRAN <M-TMSI> starting at bit 29 and down to bit 24 are mapped into bit 29 and down to bit 24 of the GERAN/UTRAN <P-TMSI>;

- 16 bits of the E-UTRAN <M-TMSI> starting at bit 15 and down to bit 0 are mapped into bit 15 and down to bit 0 of the GERAN/UTRAN <P-TMSI>;
- and the remaining 8 bits of the E-UTRAN <M-TMSI> are mapped into the 8 MBS bits of the <P-TMSI signature> field.

For UTRAN, the 10-bit long NRI bits are masked out from the P-TMSI and also supplied to the RAN node as IDNNS (Intra Domain NAS Node Selector). However, the RAN configured NRI length should not exceed 8 bits.

[TS 23.003, clause 2.8.2.2 “Mapping from RAI and P-TMSI to GUTI”]

The mapping of P-TMSI (TLLI) and RAI in GERAN/UTRAN to GUTI in E-UTRAN shall be performed as follows:

- GERAN/UTRAN <MCC> maps to E-UTRAN <MCC>
- GERAN/UTRAN <MNC> maps to E-UTRAN <MNC>
- GERAN/UTRAN <LAC> maps to E-UTRAN <MME Group ID>
- GERAN/UTRAN <RAC> maps into bit 23 and down to bit 16 of the M-TMSI

The 8 most significant bits of GERAN/UTRAN <NRI> map to the MME code.

GERAN/UTRAN <P-TMSI> maps as follows:

- 6 bits of the GERAN/UTRAN <P-TMSI> starting at bit 29 and down to bit 24 are mapped into bit 29 and down to bit 24 of the E-UTRAN <M-TMSI>;
- 16 bits of the GERAN/UTRAN <P-TMSI> starting at bit 15 and down to bit 0 are mapped into bit 15 and down to bit 0 of the E-UTRAN <M-TMSI>.

...

[TS 23.401, clause 4.3.5.6, “Idle mode signalling reduction function”]

The TIN can take one of the three values, "P-TMSI", "GUTI" or "RAT-related TMSI". The UE shall set the TIN when receiving an Attach Accept, a TAU Accept or RAU Accept message according to the rules in table 4.3.5.6-1.

Table 4.3.5.6-1: Setting of the TIN

Message received by UE	Current TIN value stored by UE	TIN value to be set by the UE when receiving message
Attach Accept via E-UTRAN (never indicates ISR activation)	Any value	GUTI
Attach Accept via GERAN/UTRAN (never indicates ISR activation)	Any value	P-TMSI
TAU Accept not indicating ISR	Any value	GUTI
TAU Accept indicating ISR	GUTI P-TMSI or RAT-related TMSI	GUTI RAT-related TMSI
RAU Accept not indicating ISR	Any value	P-TMSI
RAU Accept indicating ISR	P-TMSI GUTI or RAT-related TMSI	P-TMSI RAT-related TMSI

[TS 23.401, clause 5.3.3.1, step 2, “Tracking Area Update procedure with Serving GW change”]

....

If the UE's TIN indicates "P-TMSI" and the UE holds a valid P-TMSI and related RAI then these two elements are indicated as the old GUTI.

...

[TS 23.401, clause 5.3.3.3, step 2, “Routeing Area Update with MME interaction and without S-GW change”]

...

If the UE's internal TIN indicates "GUTI" and the UE holds a valid GUTI then the UE indicates the GUTI as the old P-TMSI and old RAI

...

[TS 24.008, clause 4.7.1.4.1, "Radio resource sublayer address handling (A/Gb mode only)"]

For an MS supporting S1 mode, the following five cases can be distinguished:

- a) the TIN indicates "P-TMSI" or "RAT-related TMSI" and the MS holds a valid P-TMSI and a RAI;
- b) the TIN indicates "GUTI" and the MS holds a valid GUTI;
- c) the TIN is deleted and the UE holds a valid P-TMSI and RAI;
- d) the TIN is deleted and the UE holds a valid GUTI, but no valid P-TMSI and RAI; or
- e) none of the previous cases is fulfilled.

In case a) the MS shall derive a foreign TLLI from the P-TMSI and proceed as specified for case i) above.

In case b), the MS shall derive a P-TMSI from the GUTI and then a foreign TLLI from this P-TMSI and proceed as specified for case i) above.

...

[TS 24.008, clause 4.7.5.1.1, "Normal and periodic routing area updating procedure initiation"]

To initiate the normal routing area updating procedure, the MS sends the message ROUTING AREA UPDATE REQUEST to the network, starts timer T3330 and changes to state GMM-ROUTING-AREA-UPDATING-INITIATED.

If the MS supports S1 mode, the MS shall handle the P-TMSI IE as follows:

- If the TIN indicates "GUTI" and the MS holds a valid GUTI, the MS shall map the GUTI into a P-TMSI, P-TMSI signature and RAI as specified in 3GPP TS 23.003 [4]. The MS shall include the mapped RAI in the Old routing area identification IE and the mapped P-TMSI signature in the P-TMSI signature IE. When the routing area updating procedure is initiated in Iu mode, the MS shall also include the mapped P-TMSI in the P-TMSI IE. Additionally, in Iu mode and A/Gb mode, if the MS holds a valid P-TMSI and RAI, the MS shall indicate the P-TMSI in the Additional mobile identity IE and the RAI in the Additional old routing area identification IE.
- If the TIN indicates "P-TMSI" or "RAT-related TMSI" and the MS holds a valid P-TMSI and RAI, the MS shall indicate the RAI in the Old routing area identification IE. When the routing area updating procedure is initiated in Iu mode, the MS shall also include the P-TMSI in the P-TMSI IE.

If the routing area updating procedure is not initiated by the MS due to an S1 mode to Iu mode or S1 mode to A/Gb mode intersystem change, the message ROUTING AREA UPDATE REQUEST shall contain the P-TMSI signature when received within a previous ATTACH ACCEPT or ROUTING AREA UPDATE ACCEPT message.

If the routing area updating procedure is initiated by the MS due to an S1 mode to Iu mode or S1 mode to A/Gb mode inter-system change in idle mode and the MS does not have a valid current UMTS security context, the message ROUTING AREA UPDATE REQUEST shall include a P-TMSI signature filled with a NAS token as specified in 3GPP TS 33.401 [119]. If the MS has a valid current UMTS security context, the MS shall indicate it in the GPRS ciphering key sequence number IE.

NOTE: If the TIN indicates "GUTI", 8 bits of the NAS token will be filled with bits from the M-TMSI (see 3GPP TS 23.003 [4]).

If the routing area updating procedure is initiated by the MS due to the S1 mode to Iu mode or S1 mode to A/Gb mode inter-system change in connected mode or in idle mode if the MS does not have a valid current security context, the MS shall derive CK' and IK' from the K_{ASME} and the NAS downlink COUNT value corresponding to the NAS token derived as specified in 3GPP TS 33.401 [119]. The MS shall indicate the eKSI value in the CKSN field of the GPRS ciphering key sequence number IE in the ROUTING AREA UPDATE REQUEST message. Then, the MS shall reset the START value and store the mapped UMTS security context replacing the current UMTS security context.

...

In order to indicate the new DRX parameter while in GERAN or UTRAN coverage, the MS shall send the ROUTING AREA UPDATE REQUEST message containing the DRX parameter in the DRX parameter IE to the network, with the exception of the case if the MS had indicated its UE specific DRX parameter (3GPP TS 24.301 [120]) to the network while in E-UTRAN coverage. In this case, when the MS enters GERAN or UTRAN coverage and initiates a routing area updating procedure, the MS shall not include the DRX parameter in the DRX parameter IE in the ROUTING AREA UPDATE REQUEST message.

[TS 24.301, clause 5.3.1.1 "Establishment of the NAS signalling connection"]

For the routing of the initial NAS message to the appropriate MME, the UE NAS provides the lower layers with either the S-TMSI or the registered globally unique MME identifier (GUMMEI) that consists of the PLMN ID, the MME group ID, and the MME code (see 3GPP TS 23.003 [2]).

- When the UE is registered in the tracking area of the current cell during the NAS signalling connection establishment, the UE NAS shall provide the lower layers with the S-TMSI, but shall not provide the registered MME identifier to the lower layers. Exceptionally, when the UE in EMM-IDLE mode initiates a tracking area updating procedure for load balancing purposes, the UE NAS shall provide the lower layers with neither S-TMSI nor registered MME identifier.
- When the UE is not registered in the tracking area of the current cell during the NAS signalling connection establishment, the UE NAS does not provide the lower layers with the S-TMSI. If the UE has a valid registered MME identifier from a previous registration, the UE NAS shall provide the lower layers with the registered MME identifier.

[TS 24.301, clause 5.5.3.2.2 "Normal and periodic tracking area updating procedure initiation"]

...

In order to indicate its UE specific DRX parameter while in E-UTRAN coverage, the UE shall send the TRACKING AREA UPDATE REQUEST message containing the UE specific DRX parameter in the DRX parameter IE to the network, with the exception of the case if the UE had indicated its DRX parameter (3GPP TS 24.008 [13]) to the network while in GERAN or UTRAN coverage. In this case, when the UE enters E-UTRAN coverage and initiates a tracking area updating procedure, the UE shall not include the UE specific DRX parameter in the DRX parameter IE in the TRACKING AREA UPDATE REQUEST message.

...

When initiating a tracking area updating procedure as a result of an Iu mode to S1 mode or A/Gb mode to S1 mode inter-system change, the UE shall handle the GUTI as follows:

- if the TIN indicates "P-TMSI" and the UE holds a valid P-TMSI and RAI, the UE shall map the P-TMSI and RAI into the old GUTI IE. Additionally, if the UE holds a valid GUTI, the UE shall indicate the GUTI in the Additional GUTI IE.

NOTE: Mapping the P-TMSI and RAI to the GUTI is specified in Annex H of 3GPP TS 23.401 [10].

- if the TIN indicates "GUTI" or "RAT-related TMSI" and the UE holds a valid GUTI, the UE shall indicate the GUTI in the Old GUTI IE.

...

When the tracking area updating procedure is initiated to perform an inter-system change from A/Gb mode or Iu mode to S1 mode, the UE shall include the KSI_{ASME} in the TRACKING AREA UPDATE REQUEST message if the UE has a cached EPS security context. Otherwise, the UE shall set the KSI_{ASME} to the value "no key is available".

When the tracking area updating procedure is initiated in EMM-IDLE mode to perform an inter-system change from A/Gb mode or Iu mode to S1 mode, the UE shall include the KSI_{SGSN} in the TRACKING AREA UPDATE REQUEST message. If the UE does not have a cached EPS security context, the UE shall include the $Nonce_{UE}$ IE in the TRACKING AREA UPDATE REQUEST message. The TRACKING AREA UPDATE REQUEST message shall be integrity protected with the cached EPS security context if the UE has one. If the UE does not have a cached EPS security context, the TRACKING AREA UPDATE REQUEST message shall not be integrity protected.

...

When the tracking area updating procedure is initiated in EMM-IDLE mode to perform an inter-system change from A/Gb mode or Iu mode to S1 mode, the UE shall include the KSI_{SGSN} in the TRACKING AREA UPDATE REQUEST message. If the UE does not have a cached EPS security context, the UE shall include the $Nonce_{UE}$ IE in the TRACKING AREA UPDATE REQUEST message. The TRACKING AREA UPDATE REQUEST message shall be integrity protected with the cached EPS security context if the UE has one. If the UE does not have a cached EPS security context, the TRACKING AREA UPDATE REQUEST message shall not be integrity protected.

...

If the UE initiates the first tracking area updating procedure following an attach in A/Gb mode or Iu mode, the UE shall include a UE radio capability information update needed IE in the TRACKING AREA UPDATE REQUEST message.

...

9.2.3.4.1.3 Test description

9.2.3.4.1.3.1 Pre-test conditions

System Simulator:

NOTE: while this test describes the uses of 3 cells, it is intended that this test only requires 2 cells to be active at any one instant.

As defined in table 4.4.2-1 of TS 36.508 [18], cell 24 and cell 26 are GERAN cells.

Editor's Note: it is suggested that AND, THIS TEST ASSUMES THAT, TS 36.508 specifies that Cells 24/25/26 take the default cell parameters specified for Cells A/B/C in respectively clauses 40.1.1/2/3 of TS 51.010 with the exception that the MCC and MNC are set to the values of Cell A in table 6.3.2.2-1 of TS 35.508 [18].

As defined in table 6.3.2.2-1 of TS 36.508 [18], cell A is an E-UTRAN cell.

Cells 24 and 26 are in the same Routeing Area.

Cells 24 and 26 are configured with the same MCC and MNC as cell A.

[As defined in clause 40.1 of TS 51.010 [xx]], the GERAN cells are configured to use Network Mode of Operation I.

- The power level of Cell 24 is the Serving Cell level [NOT YET] defined in table 6.2.2.1-1 of TS 36.508 [18].
- The power levels of Cells A and 26 are set to the Non-suitable "Off" level [NOT YET for cell 26] defined in table 6.2.2.1-1 of TS 36.508 [18].

UE:

- The test USIM contains a valid GUTI = GUTIx (stored in EF_{EPSLOC}), valid EPS security parameters (stored in EF_{EPSNSC}), and EPS update status is "EU1: UPDATED". GUTIx has MNC=987, MCC= 65, MMEGI = 'fedc' hex, MMEC = 'ba' hex, and arbitrary M-TMSI.

Preamble:

- The UE is in state Switched OFF (state 1) according to TS 36.508, [18].

9.2.3.4.1.3.2 Test procedure sequence

Table 9.2.3.4.1.3.2-1: Main behaviour

St	Procedure	Message Sequence		TP	Verdict
		U – S	Message		
1	The UE is switched on.	-	-	-	-
-	The following messages are sent on Cell 24	-	-	-	-
2	The UE transmits an ATTACH REQUEST message on Cell 24	-->	ATTACH REQUEST	-	-
3	The SS transmits an AUTHENTICATION AND CIPHERING REQUEST message.	<--	AUTHENTICATION AND CIPHERING REQUEST	-	-
4	The UE transmits an AUTHENTICATION AND CIPHERING RESPONSE message.	-->	AUTHENTICATION AND CIPHERING RESPONSE	-	-
8	SS responds with ATTACH ACCEPT message including valid TMSI, P-TMSI and RAI Editor's Note: the default message contents in 51.010 clause 40.2.4.3 allocate a Negotiated READY timer value of 32 seconds.	<--	ATTACH ACCEPT	-	-
9	The UE transmits an ATTACH COMPLETE message.	-->	ATTACH COMPLETE	-	-
10	The UE transmits an ACTIVATE PDP CONTEXT REQUEST message	-->	ACTIVATE PDP CONTEXT REQUEST	-	-
11	The SS responds with an ACTIVATE PDP CONTEXT ACCEPT message	<--	ACTIVATE PDP CONTEXT ACCEPT	-	-
12	IPv4 and/or IPv6 address allocation (e.g. DHCP) may occur on the user plane.	-	-	-	-
13	The signal strength of Cell A is raised to that of the Serving Cell and that of Cell 24 is lowered to that of a Suitable Neighbour Cell as defined in table 6.2.2.1-1 of TS 36.508 [18]. Note: Cell 24 is still suitable but the UE is expected to select Cell A.	-	-	-	-
14	-	-	-	-	-
-	The following messages are sent on Cell A	-	-	-	-
15	Check: does the UE send an RRCConnectionRequest with the <i>InitialUE-Identity</i> set to "randomValue" and the <i>establishmentcause</i> set to <i>MO-signalling</i> ? Editor's Note: Cell reselection to E-UTRAN might not occur until the GPRS READY timer has expired. Hence this step might occur up to 40 seconds after step 13.	-->	RRCConnectionRequest	1	-
16	The SS responds with RRCConnectionSetup	<--	RRCConnectionSetup		
17	Check: does the UE send an RRCConnectionSetupComplete with the <i>selectedPLMN-identity</i> set to the value of the registered MME (i.e. to the value in the GUTI stored on the USIM in EF _{EPSLOC1}), and, the <i>mmegi</i> and <i>mmec</i> are set to the values derived from the GUTI stored on the USIM in EF _{EPSLOC1} ; Check: are the contents of the TRACKING AREA UPDATE REQUEST with the correct parameters?	-->	RRCConnectionSetupComplete(RRC parameters, TRACKING AREA UPDATE REQUEST)	1, 2, 3	P
18	The SS sends TRACKING AREA UPDATE ACCEPT Note: the default message contents cause the allocation of a new GUTI and new TAI list	<--	TRACKING AREA UPDATE ACCEPT	-	-
19	The UE sends TRACKING AREA UPDATE	-->	TRACKING AREA UPDATE	-	-

	COMPLETE		COMPLETE		
20	the SS releases the RRC connection	-	-	-	-
21	Cell 24 is switched off	-	-	-	-
22	The signal strength of Cell 26 is raised to that of the Serving Cell and that of Cell A is lowered to that of a Suitable Neighbour Cell as defined in table 6.2.2.1-1 of TS 36.508 [18]. Note: Cell A is still suitable but the UE is expected to select Cell 26.	-	-	-	-
-	The following messages are sent on Cell 26	-	-	-	-
23	Check: does the UE send an RLC/MAC header with the TLLI derived from the P-TMSI that is derived from the GUTI allocated in step 18?	-	-	4	P
24	Check: does the UE send a ROUTING AREA UPDATE REQUEST with the correct parameters?	-->	ROUTING AREA UPDATE REQUEST	5	P
25	The SS sends ROUTING AREA UPDATE ACCEPT (without the allocated P-TMSI IE, but with the Requested MS Information IE indicating "E-UTRAN inter RAT information container IE requested").	<--	ROUTING AREA UPDATE ACCEPT	-	-
26	UE sends ROUTING AREA UPDATE COMPLETE message	-->	ROUTING AREA UPDATE COMPLETE	-	-
27	The signal strength of Cell A is raised to that of the Serving Cell and that of Cell 26 is lowered to that of a Suitable Neighbour Cell as defined in table 6.2.2.1-1 of TS 36.508 [18]. Note: Cell 26 is still suitable but the UE is expected to select Cell A.	-	-	-	-
-	The following messages are sent on Cell A	-	-	-	-
28	Check: does the UE send an RRCConnectionSetupComplete with the <i>selectedPLMN-identity</i> indicating the registered MME (i.e. the PLMN in the GUTI allocated in step 18), and, the <i>mmegi</i> and <i>mmec</i> are set to the values in the GUTI allocated in step 18; Check: does the UE send a TRACKING AREA UPDATE REQUEST with the correct parameters?	-->	RRCConnectionSetupComplete(RRC parameters, TRACKING AREA UPDATE REQUEST)	1, 2, 6	P
29	The SS sends TRACKING AREA UPDATE ACCEPT Note: the default message contents cause the allocation of a new GUTI.	<--	TRACKING AREA UPDATE ACCEPT	-	-
30	The UE sends TRACKING AREA UPDATE COMPLETE	-->	TRACKING AREA UPDATE COMPLETE	-	-
31	the SS releases the RRC connection	-	-	-	-

9.2.3.4.1.3.3 Specific message contents

Editor's note: will the messages for steps 2-11 defined/referenced in TS 36.508 [18] – because the default messages in 51.010 section 40 only define the SS to UE messages?

Table 9.2.3.4.1.3.3-1: Message RRCConnectionRequest (step 15, Table 9.2.3.4.1.3.2-1)

Derivation path: 36.508 table 4.6.1-16			
Information Element	Value/Remark	Comment	Condition
InitialUE-Identity CHOICE {			
random-Value	Any allowed value		
}			
establishmentCause	Mo-Signalling		

Table 9.2.3.4.1.3.3-2: Message RRCConnectionSetupComplete (step 17, Table 9.2.3.4.1.3.2-1)

Derivation path: 36.508 table 4.6.1-18			
Information Element	Value/remark	Comment	Condition
RRCConnectionSetupComplete ::= SEQUENCE {			
rrc-TransactionIdentifier	RRC-TransactionIdentifier-UL		
criticalExtensions CHOICE {			
c1 CHOICE {			
rrcConnectionSetupComplete-r8 SEQUENCE {			
selectedPLMN-Identity	Indicates the PLMN of cell 24.		
registeredMME SEQUENCE {			
plmn-Identity	987-65	From GUTIx, stored on the USIM in EF _{EPSLOC1} .	
Mmegi	'1111 1110 1101 1100' B	'fedc' hex, from GUTIx stored on the USIM in EF _{EPSLOC1} .	
Mmec	'1011 1010' B	'ba' hex, from GUTIx stored on the USIM in EF _{EPSLOC1} .	
}			
nas-DedicatedInformation	Not checked at RRC layer		
nonCriticalExtension SEQUENCE {}	Not checked		
}			
}			
}			

Table 9.2.3.4.1.3.3-3: Message TRACKING AREA UPDATE REQUEST (step 17, Table 9.2.3.4.1.3.2-1)

Derivation path: 36.508 table 4.7.2-27			
Information Element	Value/Remark	Comment	Condition
Sent in SECURITY PROTECTED NAS MESSAGE with valid integrity check			
NAS key set identifier _{ASME}			
NAS key set identifier	The valid NAS key set identifier KSI _{ASME} of the UE	As stored on the USIM in EF _{EPSNSC}	
TSC	'0'B	native security context	

Old GUTI	Mapped from the P-TMSI and RAI allocated in step 8		
Additional GUTI	GUTI1	Set to the value stored in the USIM in EF _{EPSLOC1}	
DRX parameter	Not present		
UE radio capability information update needed	'1'B	UE radio capability information update needed	

Table 9.2.3.4.1.3.3-4: Message ROUTING AREA UPDATE REQUEST (step 24, Table 9.2.3.4.1.3.2-1)

Derivation path: 36.508 table 4.7.2-???? (Editor's Note: GERAN RAU message is different to UMTS RAU message)			
Information Element	Value/Remark	Comment	Condition
Protocol discriminator	GMM		
Skip indicator	'0000'		
Routing area update request message identity	'0000 1000' B		
Update type	Any allowed value		
GPRS ciphering key sequence number	set to the value allocated in the AUTHENTICATION AND CIPHERING REQUEST message in step 3	Editor's note: is this correct? Or should it be the ksi asme that was used on E-UTRAN (i.e. the one stored on the USIM ?)	
Old routing area identification	Mapped from the GUTI received in step 18.		
MS Radio Access capability	Any allowed value		
Old P-TMSI signature	Mapped from the GUTI received in step 18.		
Requested READY timer value	If present, any allowed value.		
DRX parameter	Not present	Shall be absent	
TMSI status	If present, any allowed value.		
P-TMSI	Mapped from the GUTI received in step 18.		
MS network capability	Any allowed value.		
PDP context status	If present, any allowed value.		
PS LCS Capability	If present, any allowed value.		
MBMS context status	If present, any allowed value.		
UE network capability	Any allowed value.		
Additional mobile identity	Set to the P-TMSI allocated in step 8		
Additional old routing area identification	Set to the RAI allocated in step 8		
Mobile station classmark 2	If present, any allowed value.		
Mobile station classmark 3	If present, any allowed value.		
Supported Codecs	If present, any allowed value.		

Table 9.2.3.4.1.3.3-5: Message ROUTING AREA UPDATE ACCEPT (step 25, Table 9.2.3.4.1.3.2-1)

Derivation path: 36.508 table 4.7.2-???? (GERAN message)			
Information Element	Value/Remark	Comment	Condition
allocated P-TMSI	Absent		
Requested MS Information	'0100' B	E-UTRAN inter RAT information container IE requested	

Table 9.2.3.4.1.3.3-6: Message ROUTING AREA UPDATE COMPLETE (step 26, Table 9.2.3.4.1.3.2-1)

Derivation path: 36.508 table 4.7.2-???? GERAN message			
Information Element	Value/Remark	Comment	Condition
E-UTRAN inter RAT handover information	Any allowed value		

Table 9.2.3.4.1.3.3-7: Message RRCConnectionSetupComplete (step 28, Table 9.2.3.4.1.3.2-1)

Derivation path: 36.508 table 4.6.1-18			
Information Element	Value/remark	Comment	Condition
RRCConnectionSetupComplete ::= SEQUENCE {			
Rrc-TransactionIdentifier	RRC-TransactionIdentifier-UL		
criticalExtensions CHOICE {			
C1 CHOICE {			
rrcConnectionSetupComplete-r8 SEQUENCE {			
selectedPLMN-Identity	Indicates the PLMN of cell 24.		
registeredMME SEQUENCE {			
plmn-Identity	Not present	Shall be absent because the registered MME is the same as the selected PLMN.	
Mmegi	The MMEGI part of the GUTI in the TRACKING AREA UPDATE ACCEPT message sent in step 18		
Mmec	The MMEC part of the GUTI in the TRACKING AREA UPDATE ACCEPT message sent in step 18		
}			
nas-DedicatedInformation	Not checked at RRC layer		
nonCriticalExtension SEQUENCE {}	Not checked		
}			
}			
}			
}			
}			

Table 9.2.3.4.1.3.3-8: Message TRACKING AREA UPDATE REQUEST (step 28, Table 9.2.3.4.1.3.2-1)

Derivation path: 36.508 table 4.7.2-27			
Information Element	Value/Remark	Comment	Condition
Sent in SECURITY PROTECTED NAS MESSAGE with valid integrity check			
NAS key set identifier _{ASME}			
NAS key set identifier	The valid NAS key set identifier KSI _{ASME} of the UE	As stored on the USIM in EF _{EPSNSC} in the pre-test conditions	
TSC	'0'B	native security context	
Old GUTI	Mapped from the P-TMSI and RAI allocated in step 8		
Additional GUTI	GUTI1	Set to the value allocated in step 18	
DRX parameter	Not present		
UE radio capability information update needed	Not present		

9.3 EMM connection management procedures (S1 mode only)

9.3.1 Service Request Procedure

9.3.1.1 Service Request initiated by UE for user data

9.3.1.1.1 Test Purpose (TP)

(1)

```
with { UE in EMM-REGISTERED state and EMM-IDLE mode }
ensure that {
  when { UE has user data pending }
  then { UE sends a SERVICE REQUEST message }
}
```

9.3.1.1.2 Conformance requirements

The conformance requirements covered in the current TC are specified in: TS 24.301 clauses 5.1.3.2.2.4, 5.3.1.1, 5.6.1.1, 5.6.1.2 and 5.6.1.4.

[TS 24.301 clause 5.1.3.2.2.4]

In the state EMM-REGISTERED an EMM context has been established and a default EPS bearer context has been activated in the UE.

...

The UE may initiate sending and receiving user data and signalling information and reply to paging. Additionally, tracking area updating procedure is performed (see subclause 5.5.3).

[TS 24.301 clause 5.3.1.1]

In S1 mode, when the RRC connection has been established successfully, the UE shall enter EMM-CONNECTED mode and consider the NAS signalling connection established.

[TS 24.301 clause 5.6.1.1]

The purpose of the service request procedure is to transfer the EMM mode from EMM-IDLE to EMM-CONNECTED mode and establish the radio and S1 bearers when uplink user data or signalling is to be sent.

...

The UE shall invoke the service request procedure when:

....

b) the UE, in EMM-IDLE mode, has pending user data to be sent;

[TS 24.301 clause 5.6.1.2]

If the UE has pending uplink data or uplink signalling in EMM-IDLE mode to be transmitted or it responds to paging with CN domain indicator set to "PS", the UE initiates the service request procedure by sending a SERVICE REQUEST message to the MME, starts the timer T3417, and enters the state EMM-SERVICE-REQUEST-INITIATED.

[TS 24.301 clause 5.6.1.4]

For cases a, b and c in subclause 5.6.1.1, the UE shall treat the indication from the lower layers that the user plane radio bearer is set up as successful completion of the procedure.

....

Upon successful completion of the procedure, the UE shall stop the timer T3417 and enter the state EMM-REGISTERED.

9.3.1.1.3 Test description

9.3.1.1.3.1 Pre-test conditions

System Simulator:

- Cell A

UE:

- None.

Preamble:

- The UE is in state Loopback Activated (State 4) according to [18] using the specific message content of CLOSE UE TEST LOOP message in table 9.3.1.1.3.3-1.

9.3.1.1.3.2 Test procedure sequence

Table 9.3.1.1.3.2-1: Main behaviour

St	Procedure	Message Sequence		TP	Verdict
		U - S	Message		
1	The SS transmits one IP Packet to the UE.	<--	IP packet	-	-
2	The SS transmits an <i>RRCCConnectionRelease</i> message.	-	-	-	-
3	Check: Does the UE transmit a SERVICE REQUEST message? (Note 1)	-->	SERVICE REQUEST	1	P
Note 1: Triggered when timer T _{delay_modeB} (IP PDU delay time) expires and pending uplink data exist in buffered PDCP SDUs according to [25] clause 5.4.4.3.					

9.3.1.1.3.3 Specific message contents

Table 9.3.1.1.3.3-1: ACTIVATE TEST MODE (preamble)

Derivation Path: 36.508, Table 4.7A-1, condition UE TEST LOOP MODE B
--

Table 9.3.1.1.3.3-2: CLOSE UE TEST LOOP (preamble)

Derivation Path: 36.508, Table 4.7A-3, condition UE TEST LOOP MODE B			
Information Element	Value/remark	Comment	Condition
UE test loop mode B LB setup			
IP PDU delay	0 0 0 0 1 0 1	5 seconds	

9.3.1.2 Service Request initiated by UE for uplink signalling

9.3.1.2.1 Test Purpose (TP)

(1)

```
with { UE in EMM-REGISTERED state and EMM-IDLE mode }
ensure that {
  when { UE has uplink signalling pending }
  then { UE sends a SERVICE REQUEST message }
}
```

9.3.1.2.2 Conformance requirements

The conformance requirements covered in the current TC are specified in: 3GPP TS 24.301 clause 5.6.1.1, 5.6.1.2 and 5.6.1.4.

[TS 24.301 clause 5.6.1.1]

...

The UE shall invoke the service request procedure when:

...

- c) the UE, in EMM-IDLE mode, has uplink signalling pending.

...

[TS 24.301 clause 5.6.1.2]

If the UE has pending uplink data or uplink signalling in EMM-IDLE mode to be transmitted or it responds to paging with CN domain indicator set to "PS", the UE initiates the service request procedure by sending a SERVICE REQUEST message to the MME, starts the timer T3417, and enters the state EMM-SERVICE-REQUEST-INITIATED.

...

[TS 24.301 clause 5.6.1.4]

For cases a, b, c and h in subclause 5.6.1.1, the UE shall treat the indication from the lower layers that the user plane radio bearer is set up as successful completion of the procedure. The UE shall stop the timer T3417 and enter the state EMM-REGISTERED.

Upon successful completion of the procedure, the UE shall stop the timer T3417 and enter the state EMM-REGISTERED.

9.3.1.2.3 Test description

9.3.1.2.3.1 Pre-test conditions

System Simulator:

- Cell A is configured according to Table 6.3.2.2-1 in [18].

UE:

- The USIM contains GUTI-1 and TAI-1, and EPS update status is "EU1: UPDATED".

Preamble:

- The UE is in state Registered, Idle Mode (State 2) according to [18].

NOTE: The PDN type (IPv4, IPv6 or both) of the UE is determined by the PICS.

9.3.1.2.3.2 Test procedure sequence

Editor's Note: The feasibility of the initial trigger in step 1 below and its details are to be confirmed.

Table 9.3.1.2.3.2-1: Main behaviour

St	Procedure	Message Sequence		TP	Verdict
		U - S	Message		
1	The operator initiates the activation of a new EPS bearer context based on the default PDN, in order to initiate transmission of uplink signalling (Note 1).	-	-	-	-
2	Check: Does UE transmit a SERVICE REQUEST message?	-->	SERVICE REQUEST	1	P
3	The UE transmits a BEARER RESOURCE MODIFICATION REQUEST message.	-->	BEARER RESOURCE MODIFICATION REQUEST	-	-
4	The SS transmits a ACTIVATE DEDICATED EPS BEARER CONTEXT REQUEST message activating a new EPS bearer context. This message is included in a <i>RRConnectionReconfiguration</i> message to setup the new radio bearer associated with the dedicated EPS bearer context activated by the NAS message.	<--	ACTIVATE DEDICATED EPS BEARER CONTEXT REQUEST	-	-
5	The UE transmits a <i>RRConnectionReconfigurationComplete</i> message. (Note 2)	-	-	-	-
6	The UE transmits an ACTIVATE DEDICATE EPS BEARER CONTEXT ACCEPT message.	-->	ACTIVATE DEDICATE EPS BEARER CONTEXT ACCEPT	-	-
Note 1: This can be done using MMI or an AT command. Note 2: After a correct SERVICE REQUEST message is received then the SS performs the Radio Bearer Establishment procedure. The UE transmission of the <i>RRConnectionReconfigurationComplete</i> message indicates the completion of the radio bearer establishment procedure and that the UE has changed EMM mode from EMM-IDLE to EMM-CONNECTED.					

9.3.1.2.3.3 Specific message contents

Table 9.3.1.2.3.3-1: Message BEARER RESOURCE MODIFICATION REQUEST (step 3, Table 9.3.1.2.3.2-1)

Derivation path: 36.508 table 4.7.3-8			
Information Element	Value/Remark	Comment	Condition
Linked EPS bearer identity	EBId	SS uses an EPS bearer identity of the default EPS bearer context.	
ESM cause	Not present		

Table 9.3.1.2.3.3-2: Message ACTIVATE DEDICATED EPS BEARER CONTEXT REQUEST (step 4, Table 9.3.1.2.3.2-1)

Derivation path: 36.508 table 4.7.3-3			
Information Element	Value/Remark	Comment	Condition
Procedure transaction identity	The same value as the value set in BEARER RESOURCE MODIFICATION REQUEST message		UE-INITIATED
Linked EPS bearer identity	EBId	SS uses an EPS bearer identity of the default EPS bearer context.	

9.3.1.3 Service Request / Mobile originating CS fallback

9.3.1.3.1 Test Purpose (TP)

(1)

```
with { UE in state EMM-REGISTERED and EMM-CONNECTED mode}
ensure that {
  when { UE initiates mobile originating CS fallback }
  then { UE sends EXTENDED SERVICE REQUEST message }
}
```

(2)

```
with { UE in state EMM-REGISTERED and EMM-IDLE mode}
ensure that {
  when { UE initiates mobile originating CS fallback }
  then { UE sends EXTENDED SERVICE REQUEST message }
}
```

9.3.1.3.2 Conformance requirements

References: The conformance requirements covered in the present TC are specified in: 3GPP TS 24.301 clauses 5.6.1.1 and 5.6.1.2.

[TS24.301 clause5.6.1.1]

The purpose of the service request procedure is to transfer the EMM mode from EMM-IDLE to EMM-CONNECTED mode and establish the radio and S1 bearers when uplink user data or signalling is to be sent. Another purpose of this procedure is to invoke MO/MT CS fallback procedures.

This procedure is used when:

...

- the UE in EMM-IDLE or EMM-CONNECTED mode has requested to perform mobile originating/terminating CS fallback; or

...

The service request procedure is initiated by the UE, however, for the downlink transfer of signalling or user data in EMM-IDLE mode, the trigger is given by the network by means of the paging procedure (see subclause 5.6.2).

The UE shall invoke the service request procedure when:

...

- d) the UE, in EMM-IDLE or EMM-CONNECTED mode, has a mobile originating CS fallback request;

...

[TS24.301 clause5.6.1.2]

If the UE has pending uplink data or uplink signalling in EMM-IDLE mode to be transmitted or it responds to paging with CN domain indicator set to "PS", the UE initiates the service request procedure by sending a SERVICE REQUEST message to the MME, starts the timer T3417, and enters the state EMM-SERVICE-REQUEST-INITIATED.

The UE shall send an EXTENDED SERVICE REQUEST message,

- regardless of the EMM mode, if the UE has a mobile originating CS fallback request; and

...

9.3.1.3.3 Test description

9.3.1.3.3.1 Pre-test conditions

System Simulator:

- Cell A is configured according to Table 6.3.2.2-1 in [18].
- Cell A belongs TAI-1.
- Cell A is set to the "Serving cell".

UE:

- The UE has a valid GUTI (GUTI-1).
- The UE is registered on TAI-1.
- The UE is IMSI attached for non-EPS services.

Preamble:

- UE is in state Generic RB established (state 3) on Cell A according to [18].

9.3.1.3.3.2 Test procedure sequence

Table 9.3.1.3.3.2-1: Main behaviour

St	Procedure	Message Sequence		TP	Verdict
		U - S	Message		
1	Force the UE to initiate CS Voice call. (Note 1)	-		-	-
2	Check: Does the UE transmit EXTENDED SERVICE REQUEST message?	-->	EXTENDED SERVICE REQUEST	1	P
3	The SS sends SERVICE REJECT message in order that the UE enters EMM-REGISTERED.NORMAL-SERVICE.	<--	SERVICE REJECT	-	-
4	The SS releases the RRC connection	-		-	-
5	Force the UE to initiate CS Voice call. (Note1)	-		-	-
6	Check: Does the UE transmit EXTENDED SERVICE REQUEST message?	-->	EXTENDED SERVICE REQUEST	2	P

Note 1: This could be done by e.g. MMI or by AT command.

9.3.1.3.3.3 Specific message contents

Table 9.3.1.3.3.3-1: Message EXTENDED SERVICE REQUEST (step 2/6, Table 9.3.1.3.3.2-1)

Derivation Path: 36.508 clause 4.7.2-14A			
Information Element	Value/remark	Comment	Condition
Service type	'0000'B	"mobile originating CS fallback"	
M-TMSI	M-TMSI1		

Table 9.3.1.3.3.3-2: Message SERVICE REJECT (step 3, Table 9.3.1.3.3.2-1)

Derivation Path: 36.508 clause 4.7.2-22			
Information Element	Value/remark	Comment	Condition
EMM cause	'0010 0110'	"CS fallback call establishment not allowed"	

9.3.1.4 Service Request / Rejected / IMSI invalid

9.3.1.4.1 Test Purpose (TP)

(1)

```
with { UE having sent a SERVICE REQUEST message }
ensure that {
  when { UE receives a SERVICE REJECT message with the EMM cause set to 'Illegal UE' }
  then { UE sets the EPS update status to EU3 ROAMING NOT ALLOWED, deletes any GUTI, last visited
registered TAI, TAI list and KSI, considers the USIM as invalid for EPS services until switching off
or the UICC containing the USIM is removed, enters the state EMM-DEREGISTERED and handles the GMM
parameters GMM state, GPRS update status, P-TMSI, P-TMSI signature, RAI and GPRS ciphering key
sequence number and the MM parameters update status, TMSI, LAI and ciphering key sequence number }
}
```

9.3.1.4.2 Conformance requirements

References: The conformance requirements covered in the present TC are specified in: TS 24.301, clause 5.6.1.5.

[TS 24.301, clause 5.6.1.5]

If the service request cannot be accepted, the network shall return a SERVICE REJECT message to the UE including an appropriate EMM cause value. When the EMM cause value is #39 "CS domain temporarily not available", the MME shall include a value for timer T3442 in the SERVICE REJECT message.

On receipt of the SERVICE REJECT message, the UE shall stop timer T3417 and take the following actions depending on the received EMM cause value.

#3 (Illegal UE); or

...

The UE shall set the EPS update status to EU3 ROAMING NOT ALLOWED (and shall store it according to subclause 5.1.3.3) and shall delete any GUTI, last visited registered TAI, TAI list and KSI. The UE shall consider the USIM as invalid for EPS services until switching off or the UICC containing the USIM is removed. The UE shall enter the state EMM-DEREGISTERED.

If A/Gb mode or Iu mode is supported by the UE, the UE shall handle the GMM parameters GMM state, GPRS update status, P-TMSI, P-TMSI signature, RAI and GPRS ciphering key sequence number and the MM parameters update status, TMSI, LAI and ciphering key sequence number as specified in 3GPP TS 24.008 [13] for the case when the service request procedure is rejected with the GMM cause with the same value. The USIM shall be considered as invalid also for non-EPS services until switching off or the UICC containing the USIM is removed.

NOTE 1: The possibility to configure a UE so that the radio transceiver for a specific radio access technology is not active, although it is implemented in the UE, is out of scope of the present specification.

...

9.3.1.4.3 Test description

9.3.1.4.3.1 Pre-test conditions

System Simulator:

- Cell A and Cell B.
- Cell A is "Serving cell" and Cell B is "non-Suitable cell".

UE:

None.

Preamble:

- The UE is in state Registered, Idle mode (state 2) on Cell A according to [18].

9.3.1.4.3.2 Test procedure sequence

Table 9.3.1.4.3.2-1: Main behaviour

St	Procedure	Message Sequence		TP	Verdict
		U - S	Message		
1	The SS pages the UE using S-TMSI with CN domain indicator set to "PS".	-	-	-	-
-	The following messages are sent and shall be received on Cell A.	-	-	-	-
2	The UE transmits a SERVICE REQUEST message.	-->	SERVICE REQUEST	-	-
3	The SS transmits a SERVICE REJECT message with the EMM cause set to 'Illegal UE'.	<--	SERVICE REJECT	-	-
4	The SS releases the RRC connection.	-	-	-	-
5	Set the cell type of Cell A to the "non-Suitable cell". Set the cell type of Cell B to the "Serving cell".	-	-	-	-
-	The following messages are sent and shall be received on Cell B.	-	-	-	-
6	Check: Does the UE transmit an ATTACH REQUEST message in the next 30 seconds?	-->	ATTACH REQUEST	1	F
7	Set the cell type of the Cell B to the "non-Suitable cell". Set the cell type of Cell A to the "Serving cell".	-	-	-	-
-	The following messages are sent and shall be received on Cell A.	-	-	-	-
8	Check: Does the UE transmit an ATTACH REQUEST message in the next 30 seconds?	-->	ATTACH REQUEST	1	F
9	The SS pages the UE using same S-TMSI in the step 1 with CN domain indicator set to "PS".	-	-	-	-
10	Check: Does the UE transmit a SERVICE REQUEST message in the next 30 seconds?	-->	SERVICE REQUEST	1	F
11	The UE is powered off or switched off.	-	-	-	-
12	The UE is powered on or switched on.	-	-	-	-
13	Check: Does the UE transmit an ATTACH REQUEST message?	-->	ATTACH REQUEST	1	P
14	The SS transmits an AUTHENTICATION REQUEST message to initiate the EPS authentication and AKA procedure.	<--	AUTHENTICATION REQUEST	-	-
15	The UE transmits an AUTHENTICATION RESPONSE message and establishes mutual authentication.	-->	AUTHENTICATION RESPONSE	-	-
16	The SS transmits a NAS SECURITY MODE COMMAND message to activate NAS security.	<--	SECURITY MODE COMMAND	-	-
17	The UE transmits a NAS SECURITY MODE COMPLETE message and establishes the initial security configuration.	-->	SECURITY MODE COMPLETE	-	-
18	The UE transmits an ATTACH ACCEPT message.	<--	ATTACH ACCEPT	-	-
19	The UE transmits an ATTACH COMPLETE message.	-->	ATTACH COMPLETE	-	-
20	The SS releases the RRC connection.	-	-	-	-
21	Set the cell type of Cell A to the "non-Suitable cell". Set the cell type of Cell B to the "Serving cell".	-	-	-	-
-	The following messages are sent and shall be received on Cell B.	-	-	-	-
22	Check: Does the UE transmit a TRACKING AREA UPDATE REQUEST message?	-->	TRACKING AREA UPDATE REQUEST	1	P
23	The SS transmits a NAS SECURITY MODE COMMAND message to activate NAS security.	<--	SECURITY MODE COMMAND	-	-
24	The UE transmits a NAS SECURITY MODE COMPLETE message and establishes the initial security configuration.	-->	SECURITY MODE COMPLETE	-	-

25	The SS transmits a TRACKING AREA UPDATE ACCEPT message.	<--	TRACKING AREA UPDATE ACCEPT	-	-
26	The UE transmits a TRACKING AREA UPDATE COMPLETE message.	-->	TRACKING AREA UPDATE COMPLETE	-	-

9.3.1.4.3.3 Specific message contents

Table 9.3.1.4.3.3-1: SERVICE REJECT (step 3, Table 9.3.1.4.3.2-1)

Derivation Path: TS 36.508 Table 4.7.2-22			
Information Element	Value/remark	Comment	Condition
EMM cause	'0000 0011'B	Illegal UE	

Table 9.3.1.4.3.3-2: ATTACH REQUEST (step 13, Table 9.3.1.4.3.2-1)

Derivation Path: 36.508, Table 4.7.2-4			
Information Element	Value/remark	Comment	Condition
NAS key set identifier			
NAS key set identifier	'111'B	no key is available	
TSC	Any allowed value	TSC does not apply for NAS key set identifier value "111".	
Old GUTI or IMSI	IMSI of the UE		
Last visited registered TAI	Not present		
Old location area identification	Not present		
TMSI status	Not present		
	'0'B	no valid TMSI available	pc_CSfallb ack

9.3.1.7a Service Request / Rejected / UE implicitly detached

9.3.1.7a.1 Test Purpose (TP)

(1)

```
with { UE having sent a SERVICE REQUEST message }
ensure that {
  when { UE receives a SERVICE REJECT message with the EMM cause set to 'Implicitly detached' }
  then { UE enters the state EMM-DEREGISTERED.NORMAL-SERVICE, delete the EPS mapped EPS security context if any and performs a new attach procedure }
}
```

9.3.1.7a.2 Conformance requirements

References: The conformance requirements covered in the present TC are specified in: TS 24.301, clause 5.6.1.5.

[TS 24.301, clause 5.6.1.5]

If the service request cannot be accepted, the network shall return a SERVICE REJECT message to the UE including an appropriate EMM cause value.

...

On receipt of the SERVICE REJECT message, the UE shall stop timer T3417 and take the following actions depending on the received EMM cause value.

...

#10 (Implicitly detached);

The UE shall enter the state EMM-DEREGISTERED.NORMAL-SERVICE. The UE shall delete the EPS mapped EPS security context if any. The UE shall then perform a new attach procedure.

If A/Gb mode or Iu mode is supported by the UE, the UE shall handle the GMM state as specified in 3GPP TS 24.008 [13] for the case when the service request procedure is rejected with the GMM cause with the same value.

A UE operating in CS/PS mode 1 or CS/PS mode 2 of operation is still IMSI attached for non-EPS services.

...

9.3.1.7a.3 Test description

9.3.1.7a.3.1 Pre-test conditions

System Simulator:

- Cell A.

UE:

None.

Preamble:

- The UE is in state Registered, Idle mode (state 2) on Cell A according to [18].

9.3.1.7a.3.2 Test procedure sequence

Table 9.3.1.7a.3.2-1: Main behaviour

St	Procedure	Message Sequence		TP	Verdict
		U - S	Message		
1	The SS pages the UE using S-TMSI with CN domain indicator set to "PS".	-	-	-	-
2	The UE transmits a SERVICE REQUEST message.	-->	SERVICE REQUEST	-	-
3	The SS transmits a SERVICE REJECT message with the EMM cause set to 'Implicitly detached'.	<--	SERVICE REJECT	-	-
4	Check: Does the UE transmit an ATTACH REQUEST message?	-->	ATTACH REQUEST	1	P
5	The SS transmits an AUTHENTICATION REQUEST message to initiate the EPS authentication and AKA procedure.	<--	AUTHENTICATION REQUEST	-	-
6	The UE transmits an AUTHENTICATION RESPONSE message and establishes mutual authentication.	-->	AUTHENTICATION RESPONSE	-	-
7	The SS transmits a NAS SECURITY MODE COMMAND message to activate NAS security.	<--	SECURITY MODE COMMAND	-	-
8	The UE transmits a NAS SECURITY MODE COMPLETE message and establishes the initial security configuration.	-->	SECURITY MODE COMPLETE	-	-
9	The UE transmits an ATTACH ACCEPT message.	<--	ATTACH ACCEPT	-	-
10	The UE transmits an ATTACH COMPLETE message.	-->	ATTACH COMPLETE	-	-
11	The SS releases the RRC connection.	-	-	-	-

9.3.1.7a.3.3 Specific message contents

Table 9.3.1.7a.3.3-1: SERVICE REJECT (step 3, Table 9.3.1.7a.3.2-1)

Derivation Path: TS 36.508 Table 4.7.2-22			
Information Element	Value/remark	Comment	Condition
EMM cause	'0000 1010'B	Implicitly detached	

Table 9.3.1.7a.3.3-2: ATTACH REQUEST (step 4, Table 9.3.1.7a.3.2-1)

Derivation Path: 36.508, Table 4.7.2-4			
Information Element	Value/remark	Comment	Condition
NAS key set identifier			
NAS key set identifier	'111'B	no key is available	
TSC	Any allowed value	TSC does not apply for NAS key set identifier value "111".	
Old GUTI or IMSI	GUTI allocated to UE during previous attach on Cell A.		
Last visited registered TAI	TAI-1		
Old location area identification	Not present		
TMSI status	Not present		
	'0'B	no valid TMSI available	pc_CSfallb ack

9.3.2 Paging procedure

9.3.2.1 Paging procedure

9.3.2.1.1 Test Purpose (TP)

(1)

```
with { UE in ECM-IDLE }
ensure that {
  when { the network initiates a paging procedure for EPS services using S-TMSI }
  then { the UE responds to the paging with a SERVICE REQUEST message }
}
```

9.3.2.1.2 Conformance requirements

References: The conformance requirements covered in the current TC are specified in: TS 24.301, clause 5.6.2.2.1, TS 33.401 clause 7.2.6.2.

[TS 24.301, clause 5.6.2.2.1]

To initiate the procedure the EMM entity in the network requests the lower layer to start paging (see 3GPP TS 36.300 [20], 3GPP TS 36.413 [23]) and starts the timer T3413 for this paging procedure. Upon reception of a paging indication, the UE shall respond to the paging with a SERVICE REQUEST message (see 3GPP TS 23.401 [10] and 3GPP TS 36.413 [23]). If the paging for EPS services was received during an ongoing UE initiated EMM specific procedure or service request procedure, then the UE shall ignore the paging and the UE and the network shall proceed with the EMM specific procedure or the service request procedure.

[TS 33.401 clause 7.2.6.2]

The procedure the UE uses to transit from ECM-IDLE to ECM-CONNECTED when in EMM-REGISTERED state is initiated by a NAS Service Request message from the UE to the MME. As the UE is in EMM-REGISTERED state, a EPS security context exists in the UE and the MME, and this EPS security context further contains uplink and downlink NAS COUNTs. The NAS Service Request message sent in EMM-REGISTERED shall be integrity protected and contain the uplink NAS sequence number.

9.3.2.1.3 Test description

9.3.2.1.3.1 Pre-test conditions

System Simulator:

- 1 cell, default parameters

UE:

- None.

Preamble:

- The UE is in Registered, Idle Mode (state 2) according to [18].

9.3.2.1.3.2 Test procedure sequence

Table 9.3.2.1.3.2-1: Main bBehaviour

St	Procedure	Message Sequence		TP	Verdict
		U - S	Message		
1	SS pages the UE using S-TMSI with CN domain indicator set to "PS"	-	-	-	-
2	Check: Does the UE respond with a SERVICE REQUEST message. Check: Does the UE provide correct S-TMSI in the <i>RRConnectionRequest</i> .	-->	SERVICE REQUEST	1	P
3	SS transmits an AUTHENTICATION REQUEST message	<--	AUTHENTICATION REQUEST	-	-
4	UE responds with an AUTHENTICATION RESPONSE message	-->	AUTHENTICATION RESPONSE	-	-
5	SS transmits a SECURITY MODE COMMAND message	<--	SECURITY MODE COMMAND	-	-
6	UE transmits a SECURITY MODE COMPLETE message integrity protected with the selected NAS integrity algorithm and the NAS integrity key based on the K_{ASME} indicated by the KSI_{ASME}	-->	SECURITY MODE COMPLETE	-	-

9.3.2.1.3.3 Specific message contents

None.

9.3.2.2 Paging for CS fallback / Idle mode

9.3.2.2.1 Test Purpose (TP)

(1)

```
with { UE in state EMM-REGISTERED and EMM-IDLE mode}
ensure that {
  when { UE received Paging for mobile termination CS fallback from NW }
  then { UE sends EXTENDED SERVICE REQUEST message }
}
```

9.3.2.2.2 Conformance requirements

References: The conformance requirements covered in the present TC are specified in: 3GPP TS 24.301 clauses 5.6.1.1 and 5.6.2.3.

[TS24.301 clause5.6.1.1]

The purpose of the service request procedure is to transfer the EMM mode from EMM-IDLE to EMM-CONNECTED mode and establish the radio and S1 bearers when uplink user data or signalling is to be sent. Another purpose of this procedure is to invoke MO/MT CS fallback procedures.

This procedure is used when:

...

- the UE in EMM-IDLE or EMM-CONNECTED mode has requested to perform mobile originating/terminating CS fallback; or

...

The service request procedure is initiated by the UE, however, for the downlink transfer of signalling or user data in EMM-IDLE mode, the trigger is given by the network by means of the paging procedure (see subclause 5.6.2).

The UE shall invoke the service request procedure when:

...

- e) the UE, in EMM-IDLE or EMM-CONNECTED mode, has a CS fallback response to be sent to the network; or

...

[TS24.301 clause5.6.2.3]

The network may initiate the paging procedure for non-EPS services when the UE is IMSI attached for non-EPS services.

To initiate the procedure when no NAS signalling connection exists, the EMM entity in the network requests the lower layer to start paging (see 3GPP TS 36.300 [2012], 3GPP TS 36.413 [2315]) and starts the timer T3413 for this paging procedure. The paging message includes a CN domain indicator set to "CS" in order to indicate that this is paging for CS fallback. Upon reception of a paging indication, the UE may respond to the paging immediately or may request upper layers input i.e. to accept or reject CS fallback. The response is indicated in the CSFB response information element in the EXTENDED SERVICE REQUEST message in both EMM-IDLE and EMM-CONNECTED modes.

The network shall stop the timer T3413 for the paging procedure when a response is received from the UE.

To notify the UE about an incoming mobile terminating CS service when a NAS signalling connection exists, the EMM entity in the network shall send a CS SERVICE NOTIFICATION message.

9.3.2.2.3 Test description

9.3.2.2.3.1 Pre-test conditions

System Simulator:

- Cell A is configured according to Table 6.3.2.2-1 in [18].
- Cell A belongs TAI-1.
- Cell A is set to the "Serving cell".

UE:

- The UE has a valid GUTI (GUTI-1)
- The UE is registered on TAI-1.
- The UE is IMSI attached for non-EPS services.

Preamble:

- UE is in state Registered, Idle Mode (state 2) on Cell A according to [18].

9.3.2.2.3.2 Test procedure sequence

Table 9.3.2.2.3.2-1: Main behaviour

St	Procedure	Message Sequence		TP	Verdict
		U - S	Message		
1	The SS sends a paging message which CN domain indicates "CS" domain to the UE.	-		-	-
2	The UE accepts CS fallback	-		-	-
3	Check: Does the UE transmit EXTENDED SERVICE REQUEST message?	-->	EXTENDED SERVICE REQUEST	1	P
4	The SS sends SERVICE REJECT message in order that the UE enters EMM-REGISTERED.NORMAL-SERVICE.	<--	SERVICE REJECT	-	-

9.3.2.2.3.3 Specific message contents

Table 9.3.2.2.3.3-1: Message EXTENDED SERVICE REQUEST (step 3, Table 9.3.2.2.3.2-1)

Derivation Path: 36.508 clause 4.7.2-14A			
Information Element	Value/remark	Comment	Condition
Service type	'0001'B	"mobile terminating CS fallback"	
M-TMSI	M-TMSI1		
CSFB response	'001'B	"CS fallback accepted by the UE"	

Table 9.3.2.2.3.3-2: Message SERVICE REJECT (step 4, Table 9.3.2.2.3.2-1)

Derivation Path: 36.508 clause 4.7.2-22			
Information Element	Value/remark	Comment	Condition
EMM cause	'0010 0110'B	"CS fallback call establishment not allowed"	

9.4 NAS Security

9.4.1 Integrity protection: Correct functionality of EPS NAS integrity algorithm (SNOW3G)

9.4.1.1 Test Purpose (TP)

(1)

```
with { successful completion of EPS authentication and key agreement (AKA) procedure }
ensure that {
  when { UE receives a an integrity protected SECURITY MODE COMMAND message instructing to start
integrity protection using algorithm SNOW3G }
  then { UE transmits an integrity protected SECURITY MODE COMPLETE using SNOW3G and starts
applying the NAS Integrity protection in both UL and DL }
```

(2)

```
with { Integrity protection succesfull started by executing Security Mode Procedure}
ensure that {
  when { UE receives an IDENTITY REQUEST message without integrity protected }
  then { UE foes not transmit an IDENTITY RESPONSE message }
}
```

9.4.1.2 Conformance requirements

References: The conformance requirements covered in the current TC are specified in: TS 24.301 clause 4.4.4.1, 4.4.4.2, 5.4.3.1, 5.4.3.2 and 5.4.3.3.

[TS 24.301, clause 4.4.4.1]

For the UE, integrity protected signalling is mandatory for the NAS messages once a valid EPS security context exists and has been taken into use. For the network, integrity protected signalling is mandatory for the NAS messages once a secure exchange of NAS messages has been established for the NAS signalling connection. Integrity protection of all NAS signalling messages is the responsibility of the NAS. It is the network which activates integrity protection.

[TS 24.301, clause 4.4.4.2]

Once the secure exchange of NAS messages has been established, the receiving EMM or ESM entity in the UE shall not process any NAS signalling messages unless they have been successfully integrity checked by the NAS. If NAS signalling messages, having not successfully passed the integrity check, are received, then the NAS in the UE shall discard that message. If a NAS signalling message is received as not integrity protected even though the secure exchange of NAS messages has been established by the network, then the NAS shall discard this message.

[TS 24.301, clause 5.4.3.1]

The purpose of the NAS security mode control procedure is to take an EPS security context into use, and initialise and start NAS signalling security between the UE and the MME with the corresponding NAS keys and security algorithms.

[TS 24.301, clause 5.4.3.2]

The MME initiates the NAS security mode control procedure by sending a SECURITY MODE COMMAND message to the UE and starting timer T3460 (see example in figure 5.4.3.2.1).

If the security mode control procedure is initiated further to a successful execution of the authentication procedure, the MME shall use the reset downlink NAS COUNT to integrity protect the SECURITY MODE COMMAND message.

The MME shall send the SECURITY MODE COMMAND message unciphered, but shall integrity protect the message with the NAS integrity key based on K_{ASME} or mapped K'_{ASME} indicated by the eKSI included in the message. The MME shall set the security header type of the message to "integrity protected with new EPS security context".

...

The MME shall include the replayed security capabilities of the UE (including the security capabilities with regard to NAS, RRC and UP (user plane) ciphering as well as NAS, RRC integrity, and other possible target network security capabilities, i.e. UTRAN/GERAN if UE included them in the message to network), the replayed nonce_{UE} if the UE included it in the message to the network, the selected NAS ciphering and integrity algorithms and the Key Set Identifier (eKSI).

Additionally, the MME may request the UE to include its IMEISV in the SECURITY MODE COMPLETE message.

NOTE: The AS and NAS security capabilities will be the same, i.e. if the UE supports one algorithm for NAS it is also be supported for AS.

[TS 24.301, clause 5.4.3.3]

Upon receipt of the SECURITY MODE COMMAND message, the UE shall check whether the security mode command can be accepted or not. This is done by performing the integrity check of the message and by checking that the received UE security capabilities and the received nonce_{UE} have not been altered compared to what the UE provided in the initial layer 3 message that triggered this procedure.

If the type of security context flag is set to "native security context" and if the KSI matches a valid native EPS security context held in the UE while the UE has a mapped EPS security context as the current security context, the UE shall take the native EPS security context into use.

If the security mode command can be accepted, the UE shall reset the uplink NAS COUNT and the UE shall take the new EPS security context into use when:

- a) the SECURITY MODE COMMAND message is received further to a successful execution of the authentication procedure; or
- b) the type of security context flag is set to "mapped security context" in the NAS KSI IE included in the SECURITY MODE COMMAND message

If the security mode command can be accepted and the eKSI was included in the SECURITY MODE COMMAND message, the UE shall send a SECURITY MODE COMPLETE message integrity protected with the selected NAS integrity algorithm and the NAS integrity key based on the K_{ASME} or mapped K'_{ASME} if the type of security context flag is set to "mapped security context" indicated by the eKSI. If the SECURITY MODE COMMAND message includes the type of security context flag set to "mapped security context" in the NAS KSI IE, nonce_{MME} and nonce_{UE}, the UE shall generate K'_{ASME} from both nonces as indicated in 3GPP TS 33.401 [19] and reset the downlink NAS COUNT to check whether the SECURITY MODE COMMAND can be accepted or not. The UE shall cipher the SECURITY MODE COMPLETE message with the selected NAS ciphering algorithm and the NAS ciphering key based on the K_{ASME} indicated by the KSI_{ASME} or mapped K'_{ASME} . The UE shall set the security header type of the message to "integrity protected and ciphered with new EPS security context".

From this time onward the UE shall cipher and integrity protect all NAS signalling messages with the selected NAS ciphering and NAS integrity algorithms.

If the MME indicated in the SECURITY MODE COMMAND message that the IMEISV is requested, the UE shall include its IMEISV in the SECURITY MODE COMPLETE message.

9.4.1.3 Test description

9.4.1.3.1 Pre-test conditions

System Simulator:

- Cell 1

UE:

None.

Preamble:

- The UE is in state Switched OFF (state 1) according to [18].

9.4.1.3.2 Test procedure sequence

Table 9.4.1.3.2-1: Main behaviour

St	Procedure	Message Sequence		TP	Verdict
		U - S	Message		
1	The UE is switched on.	-	-	-	-
2	The UE transmits an ATTACH REQUEST message	-->	ATTACH REQUEST	-	-
3	The SS transmits an AUTHENTICATION REQUEST message to initiate the EPS authentication and AKA procedure.	<--	AUTHENTICATION REQUEST	-	-
4	The UE transmits an AUTHENTICATION RESPONSE message and establishes mutual authentication.	-->	AUTHENTICATION RESPONSE	-	-
5	The SS transmits a NAS SECURITY MODE COMMAND message to activate NAS security. It is integrity protected.	<--	SECURITY MODE COMMAND	-	-
6	Check: does the UE transmit a NAS SECURITY MODE COMPLETE message and starts applying the NAS Integrity protection in both UL and DL?	-->	SECURITY MODE COMPLETE	1	P
7	The SS transmits with an ATTACH ACCEPT message	<--	ATTACH ACCEPT	-	-
8	The UE transmits an ATTACH COMPLETE message	-->	ATTACH COMPLETE	-	-
9	The SS Transmits an IDENTITY REQUEST message (Integrity protected)	<-	IDENTITY REQUEST	-	-
10	Check: does the UE transmit an IDENTITY RESPONSE message [Integrity Protected]?	->	IDENTITY RESPONSE	1	P
11	The SS Transmits an IDENTITY REQUEST message (not Integrity protected)	<-	IDENTITY REQUEST	-	-
12	Check: does the UE transmits an IDENTITY RESPONSE message within the next 5 seconds?	->	IDENTITY RESPONSE	2	F

9.4.1.3.3 Specific message contents

Table 9.4.1.3.3-1: SECURITY MODE COMMAND (Step 5)

Derivation path: 36.508 table 4.7.2-19			
Information Element	Value/Remark	Comment	Condition
Selected NAS security algorithms			
- Type of integrity protection algorithm	001	EPS integrity algorithm 128-EIA1[SNOW3G]	

9.4.2 Integrity protection: Correct functionality of EPS NAS integrity algorithm (AES)

9.4.2.1 Test Purpose (TP)

(1)

```
with { successful completion of EPS authentication and key agreement (AKA) procedure }
ensure that {
  when { UE receives an integrity protected SECURITY MODE COMMAND message, to start integrity
  protection using algorithm AES }
  then { UE sends SECURITY MODE COMPLETE, integrity protected with AES and starts applying the NAS
  Integrity protection in both UL and DL}
```

(2)

```
with { Integrity protection succesfull started by executing Security Mode Procedure}
ensure that {
  when { UE receives a IDENTITY REQUEST message (requested identification parameter is not IMSI),
  without integrity protected }
  then { UE Does not transmit IDENTITY Response}
}
```

9.4.2.2 Conformance requirements

Same Conformance requirements as in clause 9.4.1.2

9.4.2.3 Test description

9.4.2.3.1 Pre-test conditions

Same Pre-test conditions as in clause 9.4.1.3.1

9.4.2.3.2 Test procedure sequence

Same Test procedure sequence as in table 9.4.1.3.2.1, except the integrity protection algorithm is AES.

9.4.2.3.3 Specific message contents

Table 9.4.2.3.3-1: SECURITY MODE COMMAND (Step 6)

Derivation path: 36.508 table 4.7.2-19			
Information Element	Value/Remark	Comment	Condition
Selected NAS security algorithms - Type of integrity protection algorithm	010	EPS integrity algorithm 128-EIA2 (AES)	

9.4.3 Ciphering and Deciphering: Correct functionality of EPS NAS encryption algorithm (SNOW3G)

9.4.3.1 Test Purpose (TP)

(1)

```
with { successful completion of EPS authentication and key agreement (AKA) procedure }
ensure that {
  when { UE receives a SECURITY MODE COMMAND instructing to start ciphering using algorithm SNOW3G }
  then { UE sends a SECURITY MODE COMPLETE message ciphered with SNOW3G and starts applying the
  NAS ciphering in both UL and DL}
}
```

9.4.3.2 Conformance requirements

References: The conformance requirements covered in the current TC are specified in: TS 24.301 clause 5.4.3.1, 5.4.3.2 and 5.4.3.3.

[TS 24.301, clause 5.4.3.1]

The purpose of the NAS security mode control procedure is to take an EPS security context into use, and initialise and start NAS signalling security between the UE and the MME with the corresponding NAS keys and security algorithms.

[TS 24.301, clause 5.4.3.2]

The MME initiates the NAS security mode control procedure by sending a SECURITY MODE COMMAND message to the UE and starting timer T3460 (see example in figure 5.4.3.2.1).

If the security mode control procedure is initiated further to a successful execution of the authentication procedure, the MME shall use the reset downlink NAS COUNT to integrity protect the SECURITY MODE COMMAND message.

The MME shall send the SECURITY MODE COMMAND message unciphered, but shall integrity protect the message with the NAS integrity key based on K_{ASME} or mapped K'_{ASME} indicated by the eKSI included in the message. The MME shall set the security header type of the message to "integrity protected with new EPS security context".

...

The MME shall include the replayed security capabilities of the UE (including the security capabilities with regard to NAS, RRC and UP (user plane) ciphering as well as NAS, RRC integrity, and other possible target network security capabilities, i.e. UTRAN/GERAN if UE included them in the message to network), the replayed $nonce_{UE}$ if the UE included it in the message to the network, the selected NAS ciphering and integrity algorithms and the Key Set Identifier (eKSI).

Additionally, the MME may request the UE to include its IMEISV in the SECURITY MODE COMPLETE message.

NOTE: The AS and NAS security capabilities will be the same, i.e. if the UE supports one algorithm for NAS it is also be supported for AS.

[TS 24.301, clause 5.4.3.3]

Upon receipt of the SECURITY MODE COMMAND message, the UE shall check whether the security mode command can be accepted or not. This is done by performing the integrity check of the message and by checking that the received UE security capabilities and the received $nonce_{UE}$ have not been altered compared to what the UE provided in the initial layer 3 message that triggered this procedure.

If the type of security context flag is set to "native security context" and if the KSI matches a valid native EPS security context held in the UE while the UE has a mapped EPS security context as the current security context, the UE shall take the native EPS security context into use.

If the security mode command can be accepted, the UE shall reset the uplink NAS COUNT and the UE shall take the new EPS security context into use when:

- a) the SECURITY MODE COMMAND message is received further to a successful execution of the authentication procedure; or
- b) the type of security context flag is set to "mapped security context" in the NAS KSI IE included in the SECURITY MODE COMMAND message

If the security mode command can be accepted and the KSI was included in the SECURITY MODE COMMAND message, the UE shall send a SECURITY MODE COMPLETE message sent with the selected NAS integrity unciphered, but shall integrity protect the message algorithm and the NAS integrity key based or mapped K'_{ASME} on the K_{ASME} or mapped K'_{ASME} if the type of security context flag is set to "mapped security context" indicated by the e. If the SECURITY MODE COMMAND message includes the type of security context flag set to "mapped security context" in the NAS KSI IE, $nonce_{MME}$ and $nonce_{UE}$, the UE shall generate K'_{ASME} from both nonces as included in 3GPP TS 33.401 [19] and reset the downlink NAS COUNT to check whether the SECURITY MODE COMMAND can be accepted or not. The UE shall cipher the SECURITY MODE COMPLETE message with the selected NAS ciphering algorithm and the NAS ciphering key based on the K_{ASME} indicated by the KSI_{ASME} or mapped K'_{ASME} . The UE shall set the security header type of the message to "integrity protected and ciphered with new EPS security context".

From this time onward the UE shall cipher and integrity protect all NAS signalling messages with the selected NAS ciphering and NAS integrity algorithms.

If the MME indicated in the SECURITY MODE COMMAND message that the IMEISV is requested, the UE shall include its IMEISV in the SECURITY MODE COMPLETE message.

9.4.3.3 Test description

9.4.3.3.1 Pre-test conditions

System Simulator:

- Cell 1

UE:

None.

Preamble:

- The UE is in state Switched OFF (state 1) according to [18].

9.4.3.3.2 Test procedure sequence

Table 9.4.3.3.2-1: Main behaviour

St	Procedure	Message Sequence		TP	Verdict
		U - S	Message		
1	The UE is switched on.	-	-	-	-
2	The UE transmits an ATTACH REQUEST message	-->	ATTACH REQUEST	-	-
3	The SS transmits an AUTHENTICATION REQUEST message to initiate the EPS authentication and AKA procedure.	<--	AUTHENTICATION REQUEST	-	-
4	The UE transmits an AUTHENTICATION RESPONSE message and establishes mutual authentication.	-->	AUTHENTICATION RESPONSE	-	-
5	The SS transmits a SECURITY MODE COMMAND message to activate NAS security.	<--	SECURITY MODE COMMAND	-	-
6	Check: does the UE transmit a SECURITY MODE COMPLETE message ciphered and starts applying the NAS ciphering in both UL and DL?	-->	SECURITY MODE COMPLETE	1	P
7	The SS transmits with an ATTACH ACCEPT message	<--	ATTACH ACCEPT	-	-
8	The UE transmits an ATTACH COMPLETE message	-->	ATTACH COMPLETE	-	-
9	The SS Transmits an IDENTITY REQUEST message Ciphered	<-	IDENTITY REQUEST	-	-
10	Check: does the UE transmit an IDENTITY RESPONSE message Ciphered?	->	IDENTITY RESPONSE	1	P

9.4.3.3.3 Specific message contents

Table 9.4.3.3.3-1: SECURITY MODE COMMAND (Step 5)

Derivation path: 36.508 table 4.7.2-19			
Information Element	Value/Remark	Comment	Condition
Selected NAS security algorithms			
- Type of ciphering algorithm	001	EPS encryption algorithm 128-EEA1 [SNOW3G]	

9.4.4 Cipherng and Decipherng: Correct functionality of EPS NAS encryption algorithm (AES)

9.4.4.1 Test Purpose (TP)

(1)

```
with { succesful completion of EPS authentication and key agreement (AKA) procedure }
ensure that {
  when { UE receives a SECURITY MODE COMMAND, to start encryption using algorithm AES}
  then { UE sends SECURITY MODE COMPLETE, encrypted with AES and starts applying the NAS
  encryption in both UL and DL }
}
```

9.4.4.2 Conformance requirements

Same Conformance requirements as in clause 9.4.3.2

9.4.4.3 Test description

9.4.4.3.1 Pre-test conditions

Same Pre-test conditions as in clause 9.4.3.3.1

9.4.4.3.2 Test procedure sequence

Same Test procedure sequence as in Table 9.4.3.3.2-1, except the integrity cipherng algorithm is AES.

9.4.4.3.3 Specific message contents

Table 9.4.1.3.3-1: SECURITY MODE COMMAND (Step 6)

Derivation path: 36.508 table 4.7.2-19			
Information Element	Value/Remark	Comment	Condition
Selected NAS security algorithms - Type of cipherng algorithm	002	EPS encryption algorithm 128-EEA2 (AES)	

10 EPS Session Management

10.2.1 Dedicated EPS bearer context activation / Success

10.2.1.1 Test Purpose (TP)

(1)

```
with { UE is in EMM-REGISTERED state and a PDN address for an active default EPS bearer was received
in an ACTIVATE DEFAULT EPS BEARER CONTEXT REQUEST message }
ensure that {
  when { UE receives an ACTIVATE DEDICATED EPS BEARER CONTEXT REQUEST message linked to the existing
default EPS bearer }
    then { UE transmits an ACTIVATE DEDICATED EPS BEARER CONTEXT ACCEPT message }
}
```

10.2.1.2 Conformance requirements

References: The conformance requirements covered in the present TC are specified in: TS 24.301, clause 6.4.2.3.

[TS 24.301, clause 6.4.2.3]

Upon receipt of the ACTIVATE DEDICATED EPS BEARER CONTEXT REQUEST message, the UE shall first check the received TFT before taking it into use. Then the UE shall send an ACTIVATE DEDICATED EPS BEARER CONTEXT ACCEPT message and enter the state BEARER CONTEXT ACTIVE. The ACTIVATE DEDICATED EPS BEARER CONTEXT ACCEPT message shall include the EPS bearer identity.

The linked EPS bearer identity included in the ACTIVATE DEDICATED EPS BEARER CONTEXT REQUEST message indicates to the UE to which default bearer, IP address and PDN the dedicated bearer is linked.

If the PTI is included in the ACTIVATE DEDICATED EPS BEARER CONTEXT REQUEST message, the UE uses the PTI to identify the UE requested bearer resource modification procedure to which the dedicated bearer context activation is related (see subclause 6.5.3 and subclause 6.5.4).

If the PTI is included in the ACTIVATE DEDICATED EPS BEARER CONTEXT REQUEST message and the PTI is associated to the UE requested bearer resource modification procedure, the UE shall release the traffic flow aggregate associated to the PTI value provided.

The UE shall use the received TFT to apply mapping of uplink traffic flows to the radio bearer if the TFT contains packet filters for the uplink direction.

Upon receipt of the ACTIVATE DEDICATED EPS BEARER CONTEXT ACCEPT message, the MME shall stop the timerT3485 and enter the state BEARER CONTEXT ACTIVE.

10.2.1.3 Test description

10.2.1.3.1 Pre-test conditions

System Simulator:

- Cell A is configured according to Table 6.3.2.2-1 in [18].

UE:

- The USIM contains GUTI-1 and TAI-1, and EPS update status is "EU1: UPDATED".

Preamble:

- The UE is in Registered, Idle Mode state (state 2) according to [18].
- A default EPS bearer context (with default EBIId) is defined for the UE.

NOTE: The PDN type (IPv4, IPv6 or both) of the UE is determined by the PICS.

10.2.1.3.2 Test procedure sequence

Table 10.2.1.3.2-1: Main behaviour

St	Procedure	Message Sequence		TP	Verdict
		U - S	Message		
1	The SS pages the UE in order to establish a dedicated EPS bearer context.	-	-	-	-
2	The UE transmits a SERVICE REQUEST for downlink signalling.	-->	SERVICE REQUEST	-	-
3	The SS transmits an ACTIVATE DEDICATED EPS BEARER CONTEXT REQUEST with particular settings (use Reference dedicated EPS bearer context #1 – see TS 36.508) (See Note 1). Note: The SS implicitly reuses the PDN address defined in ACTIVATE DEFAULT EPS BEARER CONTEXT REQUEST message.	<--	ACTIVATE DEDICATED EPS BEARER CONTEXT REQUEST	-	-
4	Check: Does the UE transmit an ACTIVATE DEDICATED EPS BEARER CONTEXT ACCEPT message as specified?	-->	ACTIVATE DEDICATED EPS BEARER CONTEXT ACCEPT	1	P
5	Check: Does the test results of CALL generic procedure indicate that the UE accepts a modification of the newly activated EPS bearer context ? (clause 6.4.2.6 in [18])	-	-	1	-
Note 1: The ACTIVATE DEDICATED EPS BEARER CONTEXT REQUEST message is included in a RRCConnectionReconfiguration message including a DRB setup for the same EPS bearer ID					

10.2.1.3.3 Specific message contents

Table 10.2.1.3.3-1: Message ACTIVATE DEDICATED EPS BEARER CONTEXT REQUEST (step 3, Table 10.2.1.3.2-1)

Derivation path: 36.508 table 4.7.3-3			
Information Element	Value/Remark	Comment	Condition
EPS bearer identity	EBId-1	SS defines a dedicated bearer Id different from default EBId and between 5 and 15.	
Procedure transaction identity	0	"No procedure transaction identity assigned"	
Linked EPS bearer identity	Default EBId	SS re-uses the EPS bearer identity of the default EPS bearer context.	
EPS QoS	According to reference dedicated EPS bearer context #1 - see [18]		
TFT	According to reference dedicated EPS bearer context #1- see [18]		

Table 10.2.1.3.3-2: Message ACTIVATE DEDICATED EPS BEARER CONTEXT ACCEPT (step 4, Table 10.2.1.3.2-1)

Derivation path: 36.508 table 4.7.3-1			
Information Element	Value/Remark	Comment	Condition
EPS bearer identity	EBId-1	Same value as in ACTIVATE DEDICATED EPS BEARER CONTEXT REQUEST	
Procedure transaction identity	0	"No procedure transaction identity assigned"	

10.3 EPS bearer context modification

10.3.1 EPS bearer context modification / Success

10.3.1.1 Test Purpose (TP)

(1)

```
with { the UE is in BEARER CONTEXT ACTIVE STATE state and in EMM-CONNECTED mode }
ensure that {
  when { the UE receives a MODIFY EPS BEARER CONTEXT REQUEST message }
  then { the UE transmits a MODIFY EPS BEARER CONTEXT ACCEPT }
}
```

10.3.1.2 Conformance requirements

References: The conformance requirements covered in the present TC are specified in: TS 24.301, clause 6.4.3.3, and 6.4.4.3.

[TS 24.301, clause 6.4.3.3]

Upon receipt of the MODIFY EPS BEARER CONTEXT REQUEST message, the UE shall first check the received uplink TFT before taking it into use and then send a MODIFY EPS BEARER CONTEXT ACCEPT message to the MME.

If the PTI is included in the MODIFY EPS BEARER CONTEXT REQUEST message, the UE uses the PTI to identify the UE requested bearer resource modification procedure to which the EPS bearer context modification is related.

The UE shall use the received uplink TFT to apply mapping of uplink traffic flows to the radio bearer.

Upon receipt of the MODIFY EPS BEARER CONTEXT ACCEPT message, the MME shall stop the timer T3486 and enter the state BEARER CONTEXT ACTIVE.

10.3.1.3 Test description

10.3.1.3.1 Pre-test conditions

System Simulator:

- Cell A is configured according to Table 6.3.2.2-1 in [18].

UE:

- The USIM contains GUTI-1 and TAI-1, and EPS update status is "EU1: UPDATED".

Preamble:

- The UE is in Dedicated RB established (state 5) according to [18] on Cell A.
- A default EPS bearer (with default EBId) and a dedicated bearer (with EBId-1) are established between the default PDN and the UE.

NOTE: The PDN type (IPv4, IPv6 or both) of the UE is determined by the PICS.

10.3.1.3.2 Test procedure sequence

Table 10.3.1.3.2-1: Main behaviour

St	Procedure	Message Sequence		TP	Verdict
		U - S	Message		
1	The SS transmits a MODIFY EPS BEARER CONTEXT REQUEST message with new UL TFT.	<--	MODIFY EPS BEARER CONTEXT REQUEST	-	-
2	Check: Does the UE transmit a MODIFY EPS BEARER CONTEXT ACCEPT message as specified?	-->	MODIFY EPS BEARER CONTEXT ACCEPT	1	P
3	Check: Does the test results of CALL generic procedure indicate that the UE has taken into account the modified EPS bearer context ? (procedure is FFS)	-	-	1	-

10.3.1.3.3 Specific message contents

Table 10.3.1.3.3-1: Message MODIFY EPS BEARER CONTEXT REQUEST (step 1, Table 10.3.1.3.2-1)

Derivation path: 36.508 table 4.7.3-16			
Information Element	Value/Remark	Comment	Condition
EPS bearer identity	EBId-1	SS assigns the current dedicated EPS bearer context.	
Procedure transaction identity	0	"No procedure transaction identity assigned"	
TFT	FFS (new TFT settings)	SS modifies the current packet filters of the dedicated EPS bearer context.	

Table 10.3.1.3.3-2: Message MODIFY EPS BEARER CONTEXT ACCEPT (step 2, Table 10.3.1.3.2-1)

Derivation path: 36.508 table 4.7.3-14			
Information Element	Value/Remark	Comment	Condition
EPS bearer identity	EBId-1	Same value as in MODIFY EPS BEARER CONTEXT REQUEST	
Procedure transaction identity	0	"No procedure transaction identity assigned"	

10.4 EPS bearer context deactivation

10.4.1 EPS bearer context deactivation / Success

10.4.1.1 Test Purpose (TP)

(1)

```

with { UE is in BEARER CONTEXT ACTIVE STATE state and in EMM-CONNECTED mode }
ensure that {
  when { UE receives a DEACTIVATE EPS BEARER CONTEXT REQUEST message }
  then { UE deletes the EPS bearer context identified by the EPS bearer identity and transmits a
DEACTIVATE EPS BEARER CONTEXT ACCEPT }
}

```

(2)

```

with { UE is in BEARER CONTEXT ACTIVE STATE state and in EMM-CONNECTED mode }
ensure that {
  when { UE receives a DEACTIVATE EPS BEARER CONTEXT REQUEST message indicating the EPS bearer
identity of the default bearer to a PDN }
  then { UE deletes all EPS bearer contexts identified to the PDN and transmits a DEACTIVATE EPS
BEARER CONTEXT ACCEPT }
}

```

(3)

```

with { UE is in BEARER CONTEXT ACTIVE STATE state and in EMM-CONNECTED mode }
ensure that {
  when { UE receives a DEACTIVATE EPS BEARER CONTEXT REQUEST message that does not point to an
existing EPS bearer context }
  then { UE transmits a DEACTIVATE EPS BEARER CONTEXT ACCEPT with EPS bearer identity set to the
received EPS bearer identity }
}

```

(4)

```

with { UE is in BEARER CONTEXT ACTIVE STATE state and in EMM-IDLE mode }
ensure that {
  when { UE initiates an EMM-IDLE to EMM-CONNECTED transition (i.e. SERVICE REQUEST, TRACKING AREA
UPDATE REQUEST) }
  then { UE only synchronises EPS bearer context state(s) which are explicitly activated by SS in
signalling messages }
}

```

10.4.1.2 Conformance requirements

References: The conformance requirements covered in the present TC are specified in: TS 24.301, clauses 6.4.4.2, 5.6.1.4 and 6.4.4.3.

[TS 24.301, clause 6.4.4.2]

...

If no NAS signalling connection exists when the MME initiates the EPS bearer context deactivation, the ESM entity in the MME shall locally deactivate the EPS bearer context towards the UE without any peer-to-peer ESM signalling between the MME and the UE.

NOTE: The EPS bearer context state(s) can be synchronized between the UE and the MME at the next EMM-IDLE to EMM-CONNECTED transition, e.g. during a service request or tracking area updating procedure.

[TS 24.301, clause 5.6.1.4]

...

The UE shall locally deactivate the EPS bearer contexts that do not have a user plane radio bearer established after the successful completion of the service request procedure.

...

[TS 24.301, clause 6.4.4.3]

Upon receipt of the DEACTIVATE EPS BEARER CONTEXT REQUEST message, the UE shall delete the EPS bearer context identified by the EPS bearer identity. After deactivating the identified EPS bearer context, the UE shall respond to the MME with the DEACTIVATE EPS BEARER CONTEXT ACCEPT.

If the EPS bearer identity indicated in the DEACTIVATE EPS BEARER CONTEXT REQUEST does not point to an existing EPS bearer context, the UE shall respond with a DEACTIVATE EPS BEARER CONTEXT ACCEPT with the EPS bearer identity set to the received EPS bearer identity.

If the EPS bearer identity indicated in the DEACTIVATE EPS BEARER CONTEXT REQUEST is that of the default bearer to a PDN, the UE shall delete all EPS bearer contexts associated to the PDN. After deactivating all EPS bearer contexts, the UE shall respond to the MME with the DEACTIVATE EPS BEARER CONTEXT ACCEPT.

Upon sending the DEACTIVATE EPS BEARER CONTEXT ACCEPT message, the UE shall enter the state BEARER CONTEXT INACTIVE

If the PTI is included in the DEACTIVATE EPS BEARER CONTEXT REQUEST message, the UE uses the PTI to identify the UE requested bearer resource modification procedure to which the EPS bearer context deactivation is related (see and subclause 6.5.4).

If the PTI is included in the DEACTIVATE EPS BEARER CONTEXT REQUEST message, the UE shall release the traffic flow aggregate associated to the PTI value provided.

...

10.4.1.3 Test description

10.4.1.3.1 Pre-test conditions

System Simulator:

- Cell A, Cell B (home PLMN, different TAs).

UE:

- The test USIM contains GUTI1 and TAI1, and EPS update status is "EU1: UPDATED".

Preamble:

- The UE is in state Registered, Idle mode (state 2) according to [18] on Cell 1.

Note: The PDN type (IPv4, IPv6 or both) of the UE is determined by the PICS.

10.4.1.3.2 Test procedure sequence

Table 10.4.1.3.2-1: Main behaviour

St	Procedure	Message Sequence		TP	Verdict
		U – S	Message		
-	Cell A is the serving cell Cell B is a suitable cell	-	-	-	-
1	Cause the UE to request connectivity to an additional PDN (see note 1)	-	-	-	-
1a	The UE transmits a SERVICE REQUEST	-->	SERVICE REQUEST	-	-
2	The UE transmits a PDN CONNECTIVITY REQUEST message as specified to request an additional PDN.	-->	PDN CONNECTIVITY REQUEST	-	-
3	The SS transmits an ACTIVATE DEFAULT EPS BEARER CONTEXT REQUEST message with IE EPS Bearer Identity set to new EPS bearer context. Note: the SS allocates a PDN address of a PDN type which is compliant with the PDN type requested by the UE.	<--	ACTIVATE DEFAULT EPS BEARER CONTEXT REQUEST	-	-
4	The UE transmits an ACTIVATE DEFAULT EPS BEARER CONTEXT ACCEPT message as specified.	-->	ACTIVATE DEFAULT EPS BEARER CONTEXT ACCEPT	-	-
5	The SS transmits an ACTIVATE DEDICATED EPS BEARER CONTEXT REQUEST relative to the additional PDN. Note: the same PDN address is applicable because the linked EPS bearer ID refers to the default EBC allocated in step 3.	<--	ACTIVATE DEDICATED EPS BEARER CONTEXT REQUEST	-	-
6	The UE transmits an ACTIVATE DEDICATED EPS BEARER CONTEXT ACCEPT message as specified.	-->	ACTIVATE DEDICATED EPS BEARER CONTEXT ACCEPT	-	-
7	The SS releases the RRC connection.	-	-	-	-
8	Cause the UE to transmit data to the additional PDN (see note 1).	-	-	-	-
9	The UE transmits the SERVICE REQUEST message in order to transmit data to the additional PDN.	-->	SERVICE REQUEST	-	-
10	The SS transmits a DEACTIVATE EPS BEARER CONTEXT REQUEST including the EPS bearer identity of the dedicated EPS bearer to the additional PDN.	<--	DEACTIVATE EPS BEARER CONTEXT REQUEST	-	-
11	Check: Does the UE transmit a DEACTIVATE EPS BEARER CONTEXT ACCEPT?	-->	DEACTIVATE EPS BEARER CONTEXT ACCEPT	1	P
12	The SS transmits an ACTIVATE DEDICATED EPS BEARER CONTEXT REQUEST relative to the additional PDN. Note: the same PDN address is applicable because the linked EPS bearer ID refers to the default EBC allocated in step 3.	<--	ACTIVATE DEDICATED EPS BEARER CONTEXT REQUEST	-	-
13	The UE transmits an ACTIVATE DEDICATED EPS BEARER CONTEXT ACCEPT message as specified.	-->	ACTIVATE DEDICATED EPS BEARER CONTEXT ACCEPT	-	-
14	The SS transmits a DEACTIVATE EPS BEARER CONTEXT REQUEST including the EPS bearer identity of the default EPS bearer to the additional PDN.	<--	DEACTIVATE EPS BEARER CONTEXT REQUEST	-	-
15	Check: Does the UE transmit a DEACTIVATE EPS BEARER CONTEXT ACCEPT?	-->	DEACTIVATE EPS BEARER CONTEXT ACCEPT	2	P
16	-	-	-	-	-
17	-	-	-	-	-
18	The SS transmits a DEACTIVATE EPS BEARER CONTEXT REQUEST that does not	<--	DEACTIVATE EPS BEARER CONTEXT REQUEST	-	-

	point an existing EPS bearer context.				
19	Check: Does the UE transmit a DEACTIVATE EPS BEARER CONTEXT ACCEPT?	-->	DEACTIVATE EPS BEARER CONTEXT ACCEPT	3	P
20	The SS releases the RRC connection.	-	-	-	-
21	Cause the UE to request connectivity to an additional PDN (see note 1)	-	-	-	-
21a	The UE transmits a SERVICE REQUEST	-->	SERVICE REQUEST	-	-
22	The UE transmits a PDN CONNECTIVITY REQUEST message as specified to request an additional PDN.	-->	PDN CONNECTIVITY REQUEST	-	-
23	The SS transmits an ACTIVATE DEFAULT EPS BEARER CONTEXT REQUEST message with IE EPS Bearer Identity set to new EPS bearer context.	<--	ACTIVATE DEFAULT EPS BEARER CONTEXT REQUEST	-	-
24	The UE transmit an ACTIVATE DEFAULT EPS BEARER CONTEXT ACCEPT message as specified.	-->	ACTIVATE DEFAULT EPS BEARER CONTEXT ACCEPT	-	-
25	The SS transmits an ACTIVATE DEDICATED EPS BEARER CONTEXT REQUEST relative to additional PDN. Note: the same PDN address is applicable because the linked EPS bearer ID refers to the default EBC allocated in step 3.	<--	ACTIVATE DEDICATED EPS BEARER CONTEXT REQUEST	-	-
26	The UE transmit an ACTIVATE DEDICATED EPS BEARER CONTEXT ACCEPT message as specified.	-->	ACTIVATE DEDICATED EPS BEARER CONTEXT ACCEPT	-	-
27	The SS releases the RRC connection.	-	-	-	-
28	Cause the UE to transmit data to the additional PDN (see note 1).	-	-	-	-
29	The UE transmits SERVICE REQUEST message in order to transmit data to the additional PDN	-->	SERVICE REQUEST	-	-
30	The SS performs a radio bearer establishment procedure. (Note 2) The RRCConnectionReconfiguration message doesn't include the EPS bearer ID of the additional PDN.	-	-	-	-
31	Check: Does UE transmit a RRCConnectionReconfigurationComplete message? (Note 2)	-	-	4	P
32		-	-	-	-
33	The SS releases the RRC connection.	-	-	-	-
34	Cause the UE to request connectivity to an additional PDN (see note 1)	-	-	-	-
34a	The UE transmits a SERVICE REQUEST	-->	SERVICE REQUEST	-	-
35	The UE transmits a PDN CONNECTIVITY REQUEST message as specified to request an additional PDN.	-->	PDN CONNECTIVITY REQUEST	-	-
36	The SS transmits an ACTIVATE DEFAULT EPS BEARER CONTEXT REQUEST message with IE EPS Bearer Identity set to new EPS bearer context. Note: SS allocates a PDN address of a PDN type which is compliant with the PDN type requested by the UE.	<--	ACTIVATE DEFAULT EPS BEARER CONTEXT REQUEST	-	-
37	The UE transmits an ACTIVATE DEFAULT EPS BEARER CONTEXT ACCEPT message as specified.	-->	ACTIVATE DEFAULT EPS BEARER CONTEXT ACCEPT	-	-
38	The SS transmits an ACTIVATE DEDICATED EPS BEARER CONTEXT REQUEST relative to additional PDN. Note: the same PDN address is applicable because the linked EPS bearer ID refers to the	<--	ACTIVATE DEDICATED EPS BEARER CONTEXT REQUEST	-	-

	default EBC allocated in step 3.				
39	The UE transmits an ACTIVATE DEDICATED EPS BEARER CONTEXT ACCEPT message as specified.	-->	ACTIVATE DEDICATED EPS BEARER CONTEXT ACCEPT	-	-
40	The SS releases the RRC connection.	-	-	-	-
41	Cell A is a suitable cell Cell B is the serving cell	-	-	-	-
42	The UE transmit a TRACKING AREA UPDATE REQUEST message as specified on Cell B.	-->	TRACKING AREA UPDATE REQUEST		
43	The SS transmits a TRACKING AREA UPDATE ACCEPT indicating only one EPS bearer active in the EPS bearer context status IE. The EPS bearer ID linked to the additional PDN is deactivated by SS.	<--	TRACKING AREA UPDATE ACCEPT	-	-
44	The SS releases the RRC connection.	-	-	-	-
45	Cause the UE to transmit data to the additional PDN (see note 1).	-	-	-	-
46	Check: Does the UE transmit SERVICE REQUEST and data to additional PDN?	-->	SERVICE REQUEST	4	F
<p>Note 1: The request of connectivity to an additional PDN and the sending of data may be performed by MMI or AT command.</p> <p>Note 2: After a correct SERVICE REQUEST is received then the SS performs the Radio Bearer Establishment procedure. The UE transmission of the RRCConnectionReconfigurationComplete message indicates the completion of the radio bearer establishment procedure and that the UE has changed EMM mode from EMM-IDLE to EMM-CONNECTED.</p>					

10.4.1.3.3 Specific message contents

Table 10.4.1.3.3-1: Message PDN CONNECTIVITY REQUEST (step 2, Table 10.4.1.3.2-1)

Derivation path: 36.508 table 4.7.3-20			
Information Element	Value/Remark	Comment	Condition
Procedure transaction identity	PTI-1	UE assigns a particular PTI not yet used between 1 and 254	

Table 10.4.1.3.3-2: Message ACTIVATE DEFAULT EPS BEARER CONTEXT REQUEST (step 3, Table 10.4.1.3.2-1)

Derivation path: 36.508 table 4.7.3-6			
Information Element	Value/Remark	Comment	Condition
EPS bearer identity	Default EBId +1	SS assigns an additional EPS Bearer Id different from default EPS Bearer Id between 5 and 15.	
Procedure transaction identity	PTI-1	SS re-uses the particular PTI defined by UE for this present additional PDN connectivity request procedure.	

Table 10.4.1.3.3-3: Message ACTIVATE DEFAULT EPS BEARER CONTEXT ACCEPT (step 4, Table 10.4.1.3.2-1)

Derivation path: 36.508 table 4.7.3-4			
Information Element	Value/Remark	Comment	Condition
EPS bearer identity	Default EBId +1	Same value as in ACTIVATE DEFAULT EPS BEARER CONTEXT REQUEST	
Procedure transaction identity	0	No procedure transaction identity assigned	

Table 10.4.1.3.3-4: Message ACTIVATE DEDICATED EPS BEARER CONTEXT REQUEST (step 5, Table 10.4.1.3.2-1)

Derivation path: 36.508 table 4.7.3-3			
Information Element	Value/Remark	Comment	Condition
EPS bearer identity	EBId-2	SS assigns a dedicated bearer Id different from default EBId and additional EBId and between 5 and 15.	
Procedure transaction identity	0	No procedure transaction identity assigned	
Linked EPS bearer identity	Default EBId +1 (same value like in table 10.4.1.3.3-2)		

Table 10.4.1.3.3-5: Message ACTIVATE DEDICATED EPS BEARER CONTEXT ACCEPT (step 6, Table 10.4.1.3.2-1)

Derivation path: 36.508 table 4.7.3-1			
Information Element	Value/Remark	Comment	Condition
EPS bearer identity	EBId-2	Same value as in ACTIVATE DEDICATED EPS BEARER CONTEXT REQUEST [this is in 36.508]	
Procedure transaction identity	0	No procedure transaction identity assigned	

Table 10.4.1.3.3-6: Message DEACTIVATE EPS BEARER CONTEXT REQUEST (step 10, Table 10.4.1.3.2-1)

Derivation path: 36.508 table 4.7.3-12			
Information Element	Value/Remark	Comment	Condition
EPS bearer identity	EBId-2	Same value as in ACTIVATE DEDICATED EPS BEARER CONTEXT REQUEST of step 5	
Procedure transaction identity	0	No procedure transaction identity assigned	
ESM cause	00101011	"Unknown EPS bearer context"	
Protocol configuration options	Not present		

Table 10.4.1.3.3-7: Message DEACTIVATE EPS BEARER CONTEXT ACCEPT (step 11, Table 10.4.1.3.2-1)

Derivation path: 36.508 table 4.7.3-11			
Information Element	Value/Remark	Comment	Condition
EPS bearer identity	EBId-2	Same value as in ACTIVATE DEDICATED EPS BEARER CONTEXT REQUEST of step 5	
Procedure transaction identity	0	No procedure transaction identity assigned	

Table 10.4.1.3.3-8: Message DEACTIVATE EPS BEARER CONTEXT REQUEST (step 14, Table 10.4.1.3.2-1)

Derivation path: 36.508 table 4.7.3-12			
Information Element	Value/Remark	Comment	Condition
EPS bearer identity	Default EBId +1	Same value as in ACTIVATE DEFAULT EPS BEARER CONTEXT REQUEST of step 3	
Procedure transaction identity	0	No procedure transaction identity assigned	
ESM cause	00101011	"Unknown EPS bearer context"	
Protocol configuration options	Not present		

Table 10.4.1.3.3-9: Message DEACTIVATE EPS BEARER CONTEXT ACCEPT (step 15, Table 10.4.1.3.2-1)

Derivation path: 36.508 table 4.7.3-11			
Information Element	Value/Remark	Comment	Condition
EPS bearer identity	Default EBId +1	Same value as in ACTIVATE DEFAULT EPS BEARER CONTEXT REQUEST of step 3	
Procedure transaction identity	0	No procedure transaction identity assigned	

Table 10.4.1.3.3-6: Message DEACTIVATE EPS BEARER CONTEXT REQUEST (step 18, Table 10.4.1.3.2-1)

Derivation path: 36.508 table 4.7.3-12			
Information Element	Value/Remark	Comment	Condition
EPS bearer identity	EBId-3	This value does not refer to an existing EPS bearer	
Procedure transaction identity	0	No procedure transaction identity assigned	
ESM cause	00101011	"Unknown EPS bearer context"	
Protocol configuration options	Not present		

Table 10.4.1.3.3-7: Message DEACTIVATE EPS BEARER CONTEXT ACCEPT (step 19, Table 10.4.1.3.2-1)

Derivation path: 36.508 table 4.7.3-11			
Information Element	Value/Remark	Comment	Condition
EPS bearer identity	EBId-3	Same value as in DEACTIVATE EPS BEARER CONTEXT REQUEST of step 16	
Procedure transaction identity	0	No procedure transaction identity assigned	

Table 10.4.1.3.3-8: Message TRACKING AREA UPDATE REQUEST (step 42, Table 10.4.1.3.2-1)

Derivation path: 36.508 table 4.7.2-27			
Information Element	Value/Remark	Comment	Condition
EPS bearer context status	optional	This IE may be present	
EPS bearer context status IEI	57		
Length of EPS bearer context status contents	4	4 octets	
EBI(0)-EBI(4)	0		
EBI(5)-EBI(15)	Default EBI and EBI-n	Same value as in ACTIVATE DEFAULT EPS BEARER CONTEXT REQUEST of the ATTACH procedure and same value as in ACTIVATE DEFAULT EPS BEARER CONTEXT REQUEST of step 36	

Table 10.4.1.3.3-9: Message TRACKING AREA UPDATE ACCEPT (step 43, Table 10.4.1.3.2-1)

Derivation path: 36.508 table 4.7.2-24			
Information Element	Value/Remark	Comment	Condition
EPS bearer context status	present	The SS deactivates the EPS bearer Id of the additional PDN given at step 30.	
EPS bearer context status IEI	57		
Length of EPS bearer context status contents	4	4 octets	
EBI(0)-EBI(4)	0		
EBI(5)-EBI(15)	Only Default EBI	Same value as in ACTIVATE DEFAULT EPS BEARER CONTEXT REQUEST of the ATTACH procedure	

10.5 UE requested PDN connectivity

10.5.1 UE requested PDN connectivity accepted by the network

10.5.1.1 Test Purpose (TP)

(1)

```
with { UE is in EMM-REGISTERED mode }
ensure that {
  when { UE is triggered to request connectivity to an additional PDN }
  then { the UE transmits a PDN CONNECTIVITY REQUEST message with the request type set to "initial request" and including APN }
}
```

(2)

```
with { UE has sent a PDN CONNECTIVITY REQUEST message }
ensure that {
```

```

when { UE receives an ACTIVATE DEFAULT EPS BEARER CONTEXT REQUEST message with IE Procedure
transaction identity matching the PDN CONNECTIVITY REQUEST message, providing an EPS bearer identity
and including a PDN address }
  then { UE transmits an ACTIVATE DEFAULT EPS BEARER CONTEXT ACCEPT message, containing the EPS
bearer identity and enters EMM-REGISTERED state }
}

```

(3)

```

with { UE is in EMM-REGISTERED state and a PDN address for an active additional EPS bearer was
received in an ACTIVATE DEFAULT EPS BEARER CONTEXT REQUEST message }
ensure that {
  when { UE receives an ACTIVATE DEDICATED EPS BEARER CONTEXT REQUEST message linked to the existing
additional EPS bearer }
    then { UE transmits an ACTIVATE DEDICATED EPS BEARER CONTEXT ACCEPT messages }
}

```

10.5.1.2 Conformance requirements

References: The conformance requirements covered in the present TC are specified in: TS 24.301, clauses 6.2.2, 6.4.1.3, 6.4.2.3 and 6.5.1.2.

[TS 24.301, clause 6.2.2]

The UE shall set the PDN type IE in the PDN CONNECTIVITY REQUEST message based on its IP stack configuration as follows:

- a) A UE, which is IPv6 and IPv4 capable and
 - i) - has not been allocated an IP address for this APN, shall set the PDN type IE to IPv4v6.
 - ii) - has been allocated an IPv4 address for this APN and received the SM cause #52, "single address bearers only allowed", and is requesting an IPv6 address, shall set the PDN type IE to IPv6.
 - iii) - has been allocated an IPv6 address for this APN and received the SM cause #52, "single address bearers only allowed", and is requesting an IPv4 address, shall set the PDN type IE to IPv4.
- b) A UE, which is only IPv4 capable, shall set the PDN type IE to IPv4.
- c) A UE, which is only IPv6 capable, shall set the PDN type IE to IPv6.
- d) When the IP version capability of the UE is unknown in the UE (as in the case when the MT and TE are separated and the capability of the TE is not known in the MT), the UE shall set the PDN type IE to IPv4v6.

...

[TS 24.301, clause 6.4.1.3]

Upon receipt of the ACTIVATE DEFAULT EPS BEARER CONTEXT REQUEST message, the UE shall send an ACTIVATE DEFAULT EPS BEARER CONTEXT ACCEPT message and enter the state BEARER CONTEXT ACTIVE. When the default bearer is activated as part of the attach procedure, the UE shall send the ACTIVATE DEFAULT EPS BEARER CONTEXT ACCEPT message together with ATTACH COMPLETE message. When the default bearer is activated as the response to the stand-alone PDN CONNECTIVITY REQUEST message, the UE shall send the ACTIVATE DEFAULT EPS BEARER CONTEXT ACCEPT message alone.

The UE checks the PTI in the ACTIVATE DEFAULT EPS BEARER CONTEXT REQUEST message to identify the UE requested PDN connectivity procedure to which the default bearer context activation is related (see subclause 6.5.1).

...

[TS 24.301, clause 6.4.2.3]

Upon receipt of the ACTIVATE DEDICATED EPS BEARER CONTEXT REQUEST message, the UE shall first check the received TFT before taking it into use. Then the UE shall send an ACTIVATE DEDICATED EPS BEARER CONTEXT ACCEPT message and enter the state BEARER CONTEXT ACTIVE. The ACTIVATE DEDICATED EPS BEARER CONTEXT ACCEPT message shall include the EPS bearer identity.

The linked EPS bearer identity included in the ACTIVATE DEDICATED EPS BEARER CONTEXT REQUEST message indicates to the UE to which default bearer, IP address and PDN the dedicated bearer is linked.

If the PTI is included in the ACTIVATE DEDICATED EPS BEARER CONTEXT REQUEST message, the UE uses the PTI to identify the UE requested bearer resource modification procedure to which the dedicated bearer context activation is related (see subclause 6.5.3 and subclause 6.5.4).

If the PTI is included in the ACTIVATE DEDICATED EPS BEARER CONTEXT REQUEST message and the PTI is associated to the UE requested bearer resource modification procedure, the UE shall release the traffic flow aggregate associated to the PTI value provided.

The UE shall use the received TFT to apply mapping of uplink traffic flows to the radio bearer if the TFT contains packet filters for the uplink direction.

...

[TS 24.301, clause 6.5.1.2]

...

In order to request connectivity to a PDN using the default APN, the UE includes the access point name IE in the PDN CONNECTIVITY REQUEST message or, when applicable, in the ESM INFORMATION RESPONSE message, according to the following conditions:

- if use of a PDN using the default APN requires PAP/CHAP, then the UE should include the access point name IE; and
- in all other conditions, the UE need not include the access point name IE.

In order to request connectivity to an additional PDN, the UE shall send a PDN CONNECTIVITY REQUEST message including a requested APN to the MME, start timer T3482 and enter the state PROCEDURE TRANSACTION PENDING (see example in figure 6.5.1.2.1). In the PDN type information element the UE shall indicate the IP version capability of the IP stack associated with the UE as specified in subclause 6.4.1

The UE shall set the request type to "initial request" when the UE is establishing connectivity to a PDN for the first time, i.e. when it is an initial attach to that PDN. The UE shall set the request type to "handover" when the connectivity to a PDN is established upon handover from a non-3GPP access network and the UE was connected to that PDN before the handover to the 3GPP access network.

...

10.5.1.3 Test description

10.5.1.3.1 Pre-test conditions

System Simulator:

- Cell A

UE:

- The test USIM contains GUTI-1 and TAI-1, and EPS update status is "EU1: UPDATED".

Preamble:

- The UE is in state Registered, Idle mode (state 2) according to [18].

Note: The PDN type (IPv4, IPv6 or both) of the UE is determined by the PICS.

10.5.1.3.2 Test procedure sequence

Table 10.5.1.3.2-1: Main Behaviour

St	Procedure	Message Sequence		TP	Verdict
		U - S	Message		
1	Cause the UE to request connectivity to an additional PDN (see note)	-	-	-	-
1a	The UE transmits a SERVICE REQUEST	-->	SERVICE REQUEST	-	-
2	Check: Does the UE transmit a PDN CONNECTIVITY REQUEST message as specified to request an additional PDN?	-->	PDN CONNECTIVITY REQUEST	1	P
3	The SS transmits an ACTIVATE DEFAULT EPS BEARER CONTEXT REQUEST message with IE EPS Bearer Identity set to new EPS bearer context. Note: SS allocates a PDN address of a PDN type which is compliant with the PDN type requested by the UE.	<--	ACTIVATE DEFAULT EPS BEARER CONTEXT REQUEST	-	-
4	Check: Does the UE transmit an ACTIVATE DEFAULT EPS BEARER CONTEXT ACCEPT message as specified?	-->	ACTIVATE DEFAULT EPS BEARER CONTEXT ACCEPT	2	P
5	The SS transmits an ACTIVATE DEDICATED EPS BEARER CONTEXT REQUEST relative to additional PDN. Note: the same PDN address is applicable because the linked EPS bearer ID refers to the default EBC allocated in step 3.	<--	ACTIVATE DEDICATED EPS BEARER CONTEXT REQUEST		
6	Check: Does the UE transmit an ACTIVATE DEDICATED EPS BEARER CONTEXT ACCEPT message as specified?	-->	ACTIVATE DEDICATED EPS BEARER CONTEXT ACCEPT	3	P
7	The SS releases the RRC connection.	-	-	-	-
8	Check: Does the test results of CALL generic procedure [18] over the additional PDN indicate that the UE is additional in E-UTRA EMM-REGISTERED state?	-	-	2	-
Note: The request of connectivity to an additional PDN may be performed by MMI or AT command.					

10.5.1.3.3 Specific message contents

Table 10.5.1.3.3-1: Message PDN CONNECTIVITY REQUEST (step 2, Table 10.5.1.3.2-1)

Derivation Path: TS 36.508 Table 4.7.3-20			
Information Element	Value/remark	Comment	Condition
EPS bearer identity	0000		
Procedure transaction identity	PTI-1	UE assigns a particular PTI not yet used between 0 and 255	
PDN type	001	UE requests an IPv4 address	pc_IPv4
PDN type	010	UE requests an IPv6 type	pc_IPv6
PDN type	011	UE requests an IPv4 address and an IPv6 address.	pc_IPv4v6
ESM information transfer flag	Not present	This IE is only used during an attach procedure.	
Access point name	New PDN name	The requested PDN is different from default PDN	
Protocol Configuration options	Content is optional	The UE may request IP parameters as DNS server addresses	

Table 10.5.1.3.3-2: Message ACTIVATE DEFAULT EPS BEARER CONTEXT REQUEST (step 3, Table 10.5.1.3.2-1)

Derivation Path: TS 36.508 Table 4.7.3-6			
Information Element	Value/remark	Comment	Condition
EPS bearer identity	Default EBIId +1	SS assigns an additional EPS Bearer Id different from default EPS Bearer Id between 5 and 15.	
Procedure transaction identity	PTI-1	SS re-uses the particular PTI defined by UE for this present additional PDN connectivity request procedure.	
PDN address			pc_IPv4
PDN type	001	IPv4	
PDN address	IPv4 Address (octet 4 to 7)	SS assigns a private IPv4 address	
PDN address			pc_IPv6
PDN type	010	IPv6	
PDN address	IPv6 Address (octet 4 to 11)	SS assigns a private IPv6 address	
PDN address			pc_IPv4v6
PDN type	011	IPv4v6	
PDN address	IPv6 Address (octet 4 to 11) IPv4 Address (octet 12 to 15)		
Protocol Configuration options	Content is optional	The SS replies with the options requested by the UE.	

Table 10.5.1.3.3-3: Message ACTIVATE DEFAULT EPS BEARER CONTEXT ACCEPT (step 4, Table 10.5.1.3.2-1)

Derivation Path: TS 36.508 Table 4.7.3-4			
Information Element	Value/remark	Comment	Condition
EPS bearer identity	Default EBIId +1	Same value as in ACTIVATE DEFAULT EPS BEARER CONTEXT REQUEST	
Procedure transaction identity	0	No procedure transaction identity assigned	

Table 10.5.1.3.3-4: Message ACTIVATE DEDICATED EPS BEARER CONTEXT REQUEST (step 5, Table 10.5.1.3.2-1)

Derivation Path: TS 36.508 Table 4.7.3-3			
Information Element	Value/remark	Comment	Condition
EPS bearer identity	EBId-2	SS assigns a dedicated bearer Id different from default EBId and additional EBId and between 5 and 15.	
Procedure transaction identity	0	No procedure transaction identity assigned	
Linked EPS bearer identity	Default EBId +1 (same value like in table 10.5.1.3.3-2)		
EPS QoS	According to reference dedicated EPS bearer context #2 - see [18]	SS defines an additional dedicated EPS QoS	
TFT	According to reference dedicated EPS bearer context #2 - see [18]		

Table 10.5.1.3.3-5: Message ACTIVATE DEDICATED EPS BEARER CONTEXT ACCEPT (step 6, Table 10.5.1.3.2-1)

Derivation Path: TS 36.508 Table 4.7.3-1			
Information Element	Value/remark	Comment	Condition
EPS bearer identity	EBId-2	Same value as in ACTIVATE DEDICATED EPS BEARER CONTEXT REQUEST [this is in 36.508]	
Procedure transaction identity	0	No procedure transaction identity assigned	

10.5.2 UE requested PDN connectivity accepted by the network / no PDN address allocated

10.5.2.1 Test Purpose (TP)

(1)

```
with { UE is in EMM-REGISTERED state and RRC-IDLE mode }
ensure that {
  when { UE is triggered to request connectivity to an additional PDN including PCO information to use DHCPv4 for IPv4 address assignment }
  then { the UE transmits a PDN CONNECTIVITY REQUEST message with the request type set to "initial request" and including APN and PDN type set to IPv4 and PCO IE to use DHCPv4 }
}
```

(2)

```
with { UE has sent a PDN CONNECTIVITY REQUEST message including PCO IE to use DHCPv4 for IPv4 address assignment }
ensure that {
  when { UE receives an ACTIVATE DEFAULT EPS BEARER CONTEXT REQUEST message with IE Procedure transaction identity matching the PDN CONNECTIVITY REQUEST message, providing an EPS bearer identity and allocating PDN address set to 0.0.0.0 }
  then { UE transmits an ACTIVATE DEFAULT EPS BEARER CONTEXT ACCEPT message, containing the EPS bearer identity and enters EMM-REGISTERED state }
}
```

}

(3)

```

with { UE is in EMM-REGISTERED state and RRC-IDLE mode }
ensure that {
  when { UE is triggered to request connectivity to an additional PDN including PCO information to
  use DHCPv6 for IPv6 address assignment }
  then { the UE transmits a PDN CONNECTIVITY REQUEST message with the request type set to "initial
  request" and including APN and PDN type set to IPv6 }
}

```

(4)

```

with { UE has sent a PDN CONNECTIVITY REQUEST message including PDN type set to IPv6 }
ensure that {
  when { UE receives an ACTIVATE DEFAULT EPS BEARER CONTEXT REQUEST message with IE EPS Bearer
  Identity matching the PDN CONNECTIVITY REQUEST message and allocating PDN address set to interface
  identifier for IPv6 }
  then { UE transmits an ACTIVATE DEFAULT EPS BEARER CONTEXT ACCEPT message, containing the EPS
  bearer identity and enters EMM-REGISTERED state }
}

```

10.5.2.2 Conformance requirements

References: The conformance requirements covered in the present TC are specified in: TS 24.301, clauses 6.2.2, 6.4.1.3, 6.4.2.3, 6.5.1.2 and 6.6.1.3.

[TS 24.301, clause 6.2.2]

The UE shall set the PDN type IE in the PDN CONNECTIVITY REQUEST message based on its IP stack configuration as follows:

- a) A UE, which is IPv6 and IPv4 capable and
 - iv) - has not been allocated an IP address for this APN, shall set the PDN type IE to IPv4v6.
 - v) - has been allocated an IPv4 address for this APN and received the SM cause #52, "single address bearers only allowed", and is requesting an IPv6 address, shall set the PDN type IE to IPv6.
 - vi) - has been allocated an IPv6 address for this APN and received the SM cause #52, "single address bearers only allowed", and is requesting an IPv4 address, shall set the PDN type IE to IPv4.
- b) A UE, which is only IPv4 capable, shall set the PDN type IE to IPv4.
- c) A UE, which is only IPv6 capable, shall set the PDN type IE to IPv6.
- d) When the IP version capability of the UE is unknown in the UE (as in the case when the MT and TE are separated and the capability of the TE is not known in the MT), the UE shall set the PDN type IE to IPv4v6.

If the UE wants to use DHCPv4 for IPv4 address assignment, it shall indicate that to the network within the Protocol Configuration Options IE in the PDN CONNECTIVITY REQUEST.

...

[TS 24.301, clause 6.4.1.3]

Upon receipt of the ACTIVATE DEFAULT EPS BEARER CONTEXT REQUEST message, the UE shall send an ACTIVATE DEFAULT EPS BEARER CONTEXT ACCEPT message and enter the state BEARER CONTEXT ACTIVE. When the default bearer is activated as part of the attach procedure, the UE shall send the ACTIVATE DEFAULT EPS BEARER CONTEXT ACCEPT message together with ATTACH COMPLETE message. When the default bearer is activated as the response to the stand-alone PDN CONNECTIVITY REQUEST message, the UE shall send the ACTIVATE DEFAULT EPS BEARER CONTEXT ACCEPT message alone.

The UE checks the PTI in the ACTIVATE DEFAULT EPS BEARER CONTEXT REQUEST message to identify the UE requested PDN connectivity procedure to which the default bearer context activation is related (see subclause 6.5.1).

...

[TS 24.301, clause 6.4.2.3]

Upon receipt of the ACTIVATE DEDICATED EPS BEARER CONTEXT REQUEST message, the UE shall first check the received TFT before taking it into use. Then the UE shall send an ACTIVATE DEDICATED EPS BEARER CONTEXT ACCEPT message and enter the state BEARER CONTEXT ACTIVE. The ACTIVATE DEDICATED EPS BEARER CONTEXT ACCEPT message shall include the EPS bearer identity.

The linked EPS bearer identity included in the ACTIVATE DEDICATED EPS BEARER CONTEXT REQUEST message indicates to the UE to which default bearer, IP address and PDN the dedicated bearer is linked.

If the PTI is included in the ACTIVATE DEDICATED EPS BEARER CONTEXT REQUEST message, the UE uses the PTI to identify the UE requested bearer resource modification procedure to which the dedicated bearer context activation is related (see subclause 6.5.3 and subclause 6.5.4).

If the PTI is included in the ACTIVATE DEDICATED EPS BEARER CONTEXT REQUEST message and the PTI is associated to the UE requested bearer resource modification procedure, the UE shall release the traffic flow aggregate associated to the PTI value provided.

The UE shall use the received TFT to apply mapping of uplink traffic flows to the radio bearer if the TFT contains packet filters for the uplink direction.

...

[TS 24.301, clause 6.5.1.2]

...

In order to request connectivity to a PDN using the default APN, the UE includes the access point name IE in the PDN CONNECTIVITY REQUEST message or, when applicable, in the ESM INFORMATION RESPONSE message, according to the following conditions:

- if use of a PDN using the default APN requires PAP/CHAP, then the UE should include the access point name IE; and
- in all other conditions, the UE need not include the access point name IE.

In order to request connectivity to an additional PDN, the UE shall send a PDN CONNECTIVITY REQUEST message including a requested APN to the MME, start timer T3482 and enter the state PROCEDURE TRANSACTION PENDING (see example in figure 6.5.1.2.1). In the PDN type information element the UE shall indicate the IP version capability of the IP stack associated with the UE as specified in subclause 6.4.1

The UE shall set the request type to "initial request" when the UE is establishing connectivity to a PDN for the first time, i.e. when it is an initial attach to that PDN. The UE shall set the request type to "handover" when the connectivity to a PDN is established upon handover from a non-3GPP access network and the UE was connected to that PDN before the handover to the 3GPP access network.

...

[TS 24.301, clause 6.6.1.3]

The UE may include a Protocol configuration options IE on EPS bearer context activation, EPS bearer context deactivation, EPS bearer context modification, PDN connectivity request, PDN disconnect request, and bearer resource modification request if the UE wishes to transmit (protocol) data (e.g. configuration parameters, error codes or messages/events) to the PDN-GW.

...

10.5.2.3 Test description

10.5.2.3.1 Pre-test conditions

System Simulator:

- Cell A.

UE:

- The test USIM contains GUTI-1 and TAI-1, and EPS update status is "EU1: UPDATED".

Preamble:

- The UE is in state Registered, Idle mode (state 2) according to [18].

Note: The PDN type (IPv4, IPv6 or both) of the UE is determined by the PICS.

10.5.2.3.2 Test procedure sequence

Table 10.5.2.3.2-1: Main behaviour

St	Procedure	Message Sequence		TP	Verdict
		U - S	Message		
1	Cause the UE to request connectivity to an additional PDN (see note)	-	-	-	-
1a	The UE transmits a SERVICE REQUEST	-->	SERVICE REQUEST	-	-
2	Check: Does the UE transmit a PDN CONNECTIVITY REQUEST message as specified to request an additional PDN?	-->	PDN CONNECTIVITY REQUEST	1,3	P
3	The SS transmits an ACTIVATE DEFAULT EPS BEARER CONTEXT REQUEST message with IE EPS Bearer Identity set to new EPS bearer context. Note: SS doesn't allocate a PDN address but is compliant with the PDN type requested by the UE.	<--	ACTIVATE DEFAULT EPS BEARER CONTEXT REQUEST	-	-
4	Check: Does the UE transmit an ACTIVATE DEFAULT EPS BEARER CONTEXT ACCEPT message as specified?	-->	ACTIVATE DEFAULT EPS BEARER CONTEXT ACCEPT	2,4	P
-	EXCEPTION: If the UE wants to configure IPv4 address and other IPv4 parameters via DHCPv4 without Rapid Commit option, steps 5a1 to 5a4 can take place.	-	-	-	-
5a1	The UE transmits DHCPDISCOVER message without Rapid Commit option (RFC 2131) on User Plane.	-	-	-	-
5a2	The SS transmits a DHCPOFFER message	-	-	-	-
5a3	The UE transmits a DHCPREQUEST message	-	-	-	-
5a4	The SS transmits a DHCPACK message	-	-	-	-
-	EXCEPTION: If the UE wants to configure IPv4 address and other IPv4 parameters via DHCPv4 with Rapid Commit option, steps 5b1 to 5b2 can take place.	-	-	-	-
5b1	The UE transmits DHCPDISCOVER message with Rapid Commit option (RFC 4039) on User Plane.	-	-	-	-
5b2	The SS transmits a DHCPACK message with Rapid Commit option	-	-	-	-
-	EXCEPTION: If the UE wants to configure IPv6 address and other IPv6 parameters via DHCPv6, steps 5c1 to 5c3 can take place.	-	-	-	-
5c1	The UE can transmit a Router Solicitation message (RFC 4862) on User Plane.	-	-	-	-
5c2	The SS periodically transmits a Router Advertisement message as soon as the default bearer has been established.	-	-	-	-
5c3	The UE may send a DHCPv6 Information-Request message including the options it wishes to receive (RFC 3736)	-	-	-	-
Note: The request of connectivity to an additional PDN may be performed by MMI or AT command.					

10.5.2.3.3 Specific message contents

Table 10.5.2.3.3-1: Message PDN CONNECTIVITY REQUEST (step 2, Table 10.5.2.3.2-1)

Derivation Path: TS 36.508 Table 4.7.3-20			
Information Element	Value/remark	Comment	Condition
EPS bearer identity	0000		
Procedure transaction identity	PTI-1	UE assigns a particular PTI not yet used between 1 and 254	
PDN type	001	UE requests an IPv4 address	pc_IPv4
PDN type	010	UE requests an IPv6 type	pc_IPv6
PDN type	011	UE requests an IPv4 address and an IPv6 address.	pc_IPv4v6
ESM information transfer flag	Not present	This IE is only used during an attach procedure.	
Access point name	New PDN name	The requested PDN is different from default PDN	
Protocol configuration options	Content is FFS - DHCPv4	The UE requests DHCPv4 in PCO IE at least.	pc_IPv4 pc_IPv4v6
Protocol configuration options	Optional	The MS may request for DNS server IPv6 addresses and other parameters.	pc_IPv6

Table 10.5.2.3.3-2: Message ACTIVATE DEFAULT EPS BEARER CONTEXT REQUEST (step 3, Table 10.5.2.3.2-1)

Derivation Path: TS 36.508 Table 4.7.3-6			
Information Element	Value/remark	Comment	Condition
EPS bearer identity	Default EBIId +1	SS assigns an additional EPS Bearer Id different from default EPS Bearer Id between 5 and 15.	
Procedure transaction identity	PTI-1	SS re-uses the particular PTI defined by UE for this present additional PDN connectivity request procedure.	
PDN address		The network shall set the PDN address information to 0.0.0.0 if DHCPv4 is used.	pc_IPv4
PDN type	001	IPv4	
PDN address	0.0.0.0 (IPv4) (octet 4 to 7)	SS doesn't assign a private IPv4 address (0.0.0.0)	
PDN address		The network shall include the interface identifier if IPv6 is used.	pc_IPv6
PDN type	010	IPv6	
PDN address	Default transaction identifier of IPv6 Address (octet 4 to 11)	The network only assigns the interface identifier that the UE shall use for the link local address.	
PDN address		The network shall include the interface identifier together with IPv4 address if IPv4v6 is used.	pc_IPv4v6
PDN type	011	IPv4v6	
PDN address	Default transaction identifier of IPv6 Address (octet 4 to 11) 0.0.0.0 (IPv4) (octet 12 to 15)	The network only assigns the interface identifier for IPv6 and doesn't assign a private IPv4 address (0.0.0.0).	
Protocol configuration options	Content is FFS	The SS replies with the options requested by the UE at step 2 (e.g. DNS server address, ...).	

Table 10.5.2.3.3-3: Message ACTIVATE DEFAULT EPS BEARER CONTEXT ACCEPT (step 4, Table 10.5.2.3.2-1)

Derivation Path: TS 36.508 Table 4.7.3-4			
Information Element	Value/remark	Comment	Condition
EPS bearer identity	Default EBId +1	Same value as in ACTIVATE DEFAULT EPS BEARER CONTEXT REQUEST	
Procedure transaction identity	0	No procedure transaction identity assigned	
Protocol configuration options	Content is FFS	The UE may use this IE to request new IP parameters to the SS.	

10.5.3 UE requested PDN connectivity not accepted

10.5.3.1 Test Purpose (TP)

(1)

```

with { the UE has sent a PDN CONNECTIVITY REQUEST message to an additional PDN }
ensure that {
  when { the UE receives an PDN CONNECTIVITY REJECT message with PTI matching the PDN CONNECTIVITY
REQUEST message and including a cause value }
  then { the UE enters the state PROCEDURE TRANSACTION INACTIVE }
}

```

10.5.3.2 Conformance requirements

References: The conformance requirements covered in the present TC are specified in: TS 24.301, clauses 6.2.2, 6.4.1.3, 6.4.2.3 and 6.5.1.2.

[TS 24.301, clause 6.2.2]

The UE shall set the PDN type IE in the PDN CONNECTIVITY REQUEST message based on its IP stack configuration as follows:

- a) A UE, which is IPv6 and IPv4 capable and
 - has not been allocated an IP address for this APN, shall set the PDN type IE to IPv4v6.
 - has been allocated an IPv4 address for this APN and received the SM cause #52, "single address bearers only allowed", and is requesting an IPv6 address, shall set the PDN type IE to IPv6.
 - has been allocated an IPv6 address for this APN and received the SM cause #52, "single address bearers only allowed", and is requesting an IPv4 address, shall set the PDN type IE to IPv4.
- b) A UE, which is only IPv4 capable, shall set the PDN type IE to IPv4.
- c) A UE, which is only IPv6 capable, shall set the PDN type IE to IPv6.
- d) When the IP version capability of the UE is unknown in the UE (as in the case when the MT and TE are separated and the capability of the TE is not known in the MT), the UE shall set the PDN type IE to IPv4v6.

...

[TS 24.301, clause 6.5.1.2]

...

In order to request connectivity to an additional PDN, the UE shall send a PDN CONNECTIVITY REQUEST message including a requested APN to the MME, start timer T3482 and enter the state PROCEDURE TRANSACTION PENDING (see example in figure 6.5.1.2.1). In the PDN type information element the UE shall indicate the IP version capability of the IP stack associated with the UE as specified in subclause 6.4.1

The UE shall set the request type to "initial request" when the UE is establishing connectivity to a PDN for the first time, i.e. when it is an initial attach to that PDN. The UE shall set the request type to "handover" when the connectivity to a PDN is established upon handover from a non-3GPP access network and the UE was connected to that PDN before the handover to the 3GPP access network.

...

[TS 24.301, clause 6.5.1.4]

...

Upon receipt of the PDN CONNECTIVITY REJECT message, the UE shall stop timer T3482 and enter the state PROCEDURE TRANSACTION INACTIVE.

The PDN CONNECTIVITY REJECT message contains an ESM cause that typically indicates one of the following cause values:

- #8: operator determined barring;
- #26: insufficient resources;
- #27: missing or unknown APN;
- #28: unknown PDN type;
- #29: user authentication failed;
- #30: activation rejected by Serving GW or PDN GW;
- #31: activation rejected, unspecified;
- #32: service option not supported;
- #33: requested service option not subscribed;
- #34: service option temporarily out of order;
- #35: PTI already in use;
- #38: network failure;
- #50: PDN type IPv4 only allowed;
- #51: PDN type IPv6 only allowed;
- #52: single address bearers only allowed;
- #53: ESM information not received;
- #54: PDN connection does not exist;
- #55: Multiple PDN connections for a given APN not allowed;
- #95 – 111: protocol errors;
- #112: APN restriction value incompatible with active EPS bearer context.

10.5.3.3 Test description

10.5.3.3.1 Pre-test conditions

System Simulator:

- Cell A.

UE:

- The test USIM contains GUTI-1 and TAI-1, and EPS update status is "EU1: UPDATED".

Preamble:

- The UE is in state Registered, Idle mode (state 2) according to [18] (1 default EPS bearer context is active).

Note: The PDN type (IPv4, IPv6 or both) of the UE is determined by the PICS.

10.5.3.3.2 Test procedure sequence

Table 10.5.3.3.2-1: Main behaviour

St	Procedure	Message Sequence		TP	Verdict
		U - S	Message		
1	Cause the UE to request connectivity to an additional PDN (see note)	-	-	-	-
1a	The UE transmits a SERVICE REQUEST	-->	SERVICE REQUEST	-	-
2	The UE transmit a PDN CONNECTIVITY REQUEST message as specified to request an additional PDN.	-->	PDN CONNECTIVITY REQUEST		
3	The SS transmits a PDN CONNECTIVITY REJECT message.	<--	PDN CONNECTIVITY REJECT	-	-
4	The SS transmits an ACTIVATE DEFAULT EPS BEARER CONTEXT REQUEST with a PTI matching with the PDN CONNECTIVITY REQUEST.	<--	DEFAULT EPS BEARER CONTEXT REQUEST	-	-
5	Check: Does the UE transmit transmit an ACTIVATE DEFAULT EPS BEARER CONTEXT REJECT message?	-->	DEFAULT EPS BEARER CONTEXT REJECT	1	P

Note: The request of connectivity to an additional PDN may be performed by MMI or AT command.

10.5.3.3.3 Specific message contents

Table 10.5.3.3.3-1: Message PDN CONNECTIVITY REQUEST (step 2, Table 10.5.3.3.2-1)

Derivation Path: TS 36.508 Table 4.7.3-20			
Information Element	Value/remark	Comment	Condition
EPS bearer identity	0000		
Procedure transaction identity	PTI-1	UE assigns a particular PTI not yet used between 1 and 254	
PDN type	001	UE requests an IPv4 address	pc_IPv4
PDN type	010	UE requests an IPv6 type	pc_IPv6
PDN type	011	UE requests an IPv4 address and an IPv6 address.	pc_IPv4v6
ESM information transfer flag	Not present	This IE is only activable during an attach procedure.	
Access point name	New PDN name	The requested PDN is different from default PDN	

Table 10.5.3.3.2: Message PDN CONNECTIVITY REJECT (step 3, Table 10.5.3.3.2-1)

Derivation Path: TS 36.508 Table 4.7.3-19			
Information Element	Value/remark	Comment	Condition
EPS bearer identity	0000		
Procedure transaction identity	PTI-1	The SS indicates the same value like received in the PDN CONNECTIVITY REQUEST	
ESM cause	01101111	"Protocol error, unspecified"	
Protocol configuration options	Not present		

Table 10.5.3.3.3: Message ACTIVATE DEFAULT EPS BEARER CONTEXT REQUEST (step 4, Table 10.5.3.3.2-1)

Derivation path: 36.508 table 4.7.3-6			
Information Element	Value/Remark	Comment	Condition
EPS bearer identity	Arbitrary value different from the EPS bearer context identify allocated in step 14 of UE Registration procedure in TS 36.508 [18].subclause 4.5.2.3		
Procedure transaction identity	PTI-1	The SS indicates the same value like received in the PDN CONNECTIVITY REQUEST	
Access point name	Arbitrary value different from the EPS bearer context identify allocated in step 14 of UE Registration procedure in TS 36.508 [18].subclause 4.5.2.3		
PDN address	Not present		
Transaction identifier	Not present		
Negotiated QoS	Not present		
Negotiated LLC SAPI	Not present		
Radio priority	Not present		
Packet flow Identifier	Not present		
ESM cause	Not present		

10.6 UE requested PDN disconnect

10.6.1 UE requested PDN disconnect procedure accepted by the network

10.6.1.1 Test Purpose (TP)

(1)

```
with { UE is in BEARER CONTEXT ACTIVE STATE state }
ensure that {
  when { UE is triggered to disconnect from a PDN }
  then { UE sends a PDN DISCONNECT REQUEST message including the default EPS bearer identity associated with this PDN }
}
```

(2)

```
with { UE is in PROCEDURE TRANSACTION PENDING state }
```

```

ensure that {
  when { UE receives a DEACTIVATE EPS BEARER CONTEXT REQUEST message with any valid ESM cause }
  then { UE deactivates the default EPS bearer context for this PDN connection between the UE and
the SS }
}

```

10.6.1.2 Conformance requirements

References: The conformance requirements covered in the present TC are specified in: TS 24.301, clauses 6.5.2.2, and 6.5.2.4.

[TS 24.301, clause 6.5.2.2]

In order to request PDN disconnection from a PDN, the UE shall send a PDN DISCONNECT REQUEST message to the MME, start the timer T3492 and enter the state PROCEDURE TRANSACTION PENDING (see example in figure 6.5.2.2.1). The PDN DISCONNECT REQUEST message shall include the EPS bearer identity of the default bearer associated with the PDN to disconnect from as the linked EPS bearer identity in the PDN DISCONNECT REQUEST message. The UE shall also set the EPS bearer identity in the PDN DISCONNECT REQUEST message to the value "no EPS bearer identity assigned" and include a procedure transaction identity (PTI).

...

[TS 24.301, clause 6.5.2.3]

...

Upon receipt of the DEACTIVATE EPS BEARER CONTEXT REQUEST message, the UE shall stop the timer T3492 and enter the state PROCEDURE TRANSACTION INACTIVE. The behaviour of the UE is described in subclause 6.4.4.

...

[TS 24.301, clause 6.4.4.2]

If a NAS signalling connection exists when the MME initiates the EPS bearer context deactivation procedure, the MME shall initiate the EPS bearer context deactivation procedure by sending a DEACTIVATE EPS BEARER CONTEXT REQUEST message to the UE, start the timer T3495, and enter the state BEARER CONTEXT INACTIVE PENDING (see example in figure 6.4.4.2.1). The DEACTIVATE EPS BEARER CONTEXT REQUEST message contains an ESM cause typically indicating one of the following:

- #8: operator determined barring;
- #36: regular deactivation;
- #38: network failure; or
- #112: APN restriction value incompatible with active EPS bearer context.

The procedure transaction identity (PTI) shall also be included if the deactivation is triggered by a UE initiated bearer resource modification procedure.

...

10.6.1.3 Test description

10.6.1.3.1 Pre-test conditions

System Simulator:

- Cell A is configured according to Table 6.3.2.2-1 in [18].

UE:

None.

Preamble:

- The UE is in state Registered, Idle mode (state 2) according to [18] on Cell A.
- Two default EPS bearer context are activated and present on UE side (a first PDN obtained during the attach procedure and an additional PDN).

10.6.1.3.2 Test procedure sequence

Table 10.6.1.3.2-1: Main behaviour

St	Procedure	Message Sequence		TP	Verdict
		U - S	Message		
1	Cause the UE to request disconnection from the additional PDN (see note 1)	-	-	-	-
1a	The UE transmits a SERVICE REQUEST	-->	SERVICE REQUEST	-	-
2	Check: Does the UE transmit a PDN DISCONNECT REQUEST message as specified (to disconnect from the additional PDN)?	-->	PDN DISCONNECT REQUEST	1	P
3	The SS transmits a DEACTIVATE EPS BEARER CONTEXT REQUEST message.	<--	DEACTIVATE EPS BEARER CONTEXT REQUEST	-	-
4	The UE transmits a DEACTIVATE EPS BEARER CONTEXT ACCEPT message.	-->	DEACTIVATE EPS BEARER CONTEXT ACCEPT	-	-
5	Check: Does the UE send a PDN DISCONNECT REQUEST message in the next 10 seconds? Note: This confirms that the PDN disconnection procedure is performed in the UE	-->	PDN DISCONNECT REQUEST	2	F
5a	The SS releases the RRC connection.	-	-	-	-
6	Cause the UE to transmit data to the additional PDN (see note 1).	-	-	-	-
7	Check: Does the UE transmit SERVICE REQUEST and data to the additional PDN?	-->	SERVICE REQUEST	2	F
Note 1: The request to disconnection to from a PDN and the sending of data may be performed by MMI or AT command.					

10.6.1.3.3 Specific message contents

Table 10.6.1.3.3-1: Message PDN DISCONNECT REQUEST (step 2, Table 10.6.1.3.2-1)

Derivation Path: TS 36.508 Table 4.7.3-22			
Information Element	Value/remark	Comment	Condition
EPS bearer identity	'0000'	"no EPS bearer identity assigned"	
Procedure transaction identity	PTI-1	UE assigns a particular PTI not yet used between 1 and 254	
Linked EPS bearer identity	Default EBId-1	UE assigns the EPS Bearer Id of the default EPS bearer context to disconnect (between 5 and 15).	

Table 10.6.1.3.3-2: Message DEACTIVATE EPS BEARER CONTEXT REQUEST (step 3, Table 10.6.1.3.2-1)

Derivation Path: TS 36.508 Table 4.7.3-12			
Information Element	Value/remark	Comment	Condition
EPS bearer identity	Default EBIId-1	SS re-uses the EPS Bearer Id of the default EPS bearer context to disconnect	
Procedure transaction identity	PTI-1	SS re-uses the particular PTI defined by UE for this present PDN disconnection procedure.	UE-INITIATED
ESM cause	#36	regular deactivation	

Table 10.6.1.3.3-3: Message DEACTIVATE EPS BEARER CONTEXT ACCEPT (step 4, Table 10.6.1.3.2-1)

Derivation Path: TS 36.508 Table 4.7.3-11			
Information Element	Value/remark	Comment	Condition
EPS bearer identity	Default EBIId-1	The same value as the value set in DEACTIVATE EPS BEARER CONTEXT REQUEST message.	
Procedure transaction identity	0	No procedure transaction identity assigned	

10.6.2 UE requested PDN disconnect procedure not accepted by the network

10.6.2.1 Test Purpose (TP)

(1)

```
with { UE is in BEARER CONTEXT ACTIVE STATE state }
ensure that {
  when { UE is triggered for PDN disconnection from a requested PDN }
  then { UE sends a PDN DISCONNECT REQUEST message including the default EPS bearer identity
associated with the PDN to disconnect from }
}
```

(2)

```
with { UE is in PROCEDURE TRANSACTION PENDING state }
ensure that {
  when { UE receives a PDN DISCONNECT REJECT message with a valid ESM cause except ESM cause
#49:last PDN disconnection not allowed }
  then { UE aborts the PDN disconnection procedure and deactivates default EPS bearer context for
this PDN connection locally without peer-to-peer signalling between the UE and the SS }
}
```

10.6.2.2 Conformance requirements

References: The conformance requirements covered in the present TC are specified in: TS 24.301, clauses 6.5.2.2, and 6.5.2.4.

[TS 24.301, clause 6.5.2.2]

In order to request PDN disconnection from a PDN, the UE shall send a PDN DISCONNECT REQUEST message to the MME, start the timer T3492 and enter the state PROCEDURE TRANSACTION PENDING (see example in figure 6.5.2.2.1). The PDN DISCONNECT REQUEST message shall include the EPS bearer identity of the default bearer associated with the PDN to disconnect from as the linked EPS bearer identity in the PDN DISCONNECT REQUEST message. The UE shall also set the EPS bearer identity in the PDN DISCONNECT REQUEST message to the value "no EPS bearer identity assigned" and include a procedure transaction identity (PTI).

...

[TS 24.301, clause 6.5.2.4]

Upon receipt of the PDN DISCONNECT REQUEST message, if it is not accepted by the network, the MME shall send a PDN DISCONNECT REJECT message to the UE. The PDN DISCONNECT REJECT message shall contain the PTI and an ESM cause that typically indicates one of the following cause values:

- #35: PTI already in use;
- #43: unknown EPS bearer context;
- #49: last PDN disconnection not allowed;
- #95 – 111: protocol errors.

Upon receipt of the PDN DISCONNECT REJECT message, the UE shall stop the timer T3492, enter the state PROCEDURE TRANSACTION INACTIVE and abort the PDN disconnection procedure. Additionally, in all cases with the exception of the UE having received cause value #49, the UE shall deactivate all EPS bearer contexts for this PDN connection locally without peer-to-peer signalling between the UE and the MME.

10.6.2.3 Test description

10.6.2.3.1 Pre-test conditions

System Simulator:

- Cell A

UE:

None.

Preamble:

- The UE is in state Registered, Idle mode (state 2) according to [18] on Cell 1.
- Two default EPS bearer context are activated and present on UE side (a first PDN obtained during the attach procedure and an additional PDN).

10.6.2.3.2 Test procedure sequence

Table 10.6.2.3.2-1: Main behaviour

St	Procedure	Message Sequence		TP	Verdict
		U - S	Message		
1	Cause the UE to request PDN disconnection from the additional PDN (see note 1)	-	-	-	-
1a	The UE transmits a SERVICE REQUEST	-->	SERVICE REQUEST	-	-
2	Check: Does the UE transmit a PDN DISCONNECT REQUEST message as specified to disconnect the additional PDN?	-->	PDN DISCONNECT REQUEST	1	P
3	The SS transmits a PDN DISCONNECT REJECT message with ESM cause #95. Note: The UE shall abort the PDN disconnection procedure and locally deactivate the EPS bearer context for the additional PDN.	<--	PDN DISCONNECT REJECT	-	-
4	Check: Does the UE send a PDN DISCONNECT REQUEST message in the next 10 seconds? Note: This confirms that the PDN disconnection procedure is aborted in the UE	-->	PDN DISCONNECT REQUEST	2	F
4a	The SS releases the RRC connection.	-	-	-	-
5	Cause the UE to transmit data to the additional PDN (see note 1).	-	-	-	-
6	Check: Does the UE transmit SERVICE REQUEST and data to the additional PDN?	-->	SERVICE REQUEST	2	F
Note 1: The request of disconnection to a PDN and the sending of data may be performed by MMI or AT command.					

10.6.2.3.3 Specific message contents

Table 10.6.2.3.3-1: Message PDN DISCONNECT REQUEST (step 2, Table 10.6.2.3.2-1)

Derivation Path: TS 36.508 Table 4.7.3-22			
Information Element	Value/remark	Comment	Condition
EPS bearer identity	'0000'	"no EPS bearer identity assigned"	
Procedure transaction identity	PTI-1	UE assigns a particular PTI not yet used between 1 and 254	
Linked EPS bearer identity	Default EBI-1	UE assigns the EPS Bearer Id of the default EPS bearer context to disconnect (between 5 and 15).	

Table 10.6.2.3.3-2: Message PDN DISCONNECT REJECT (step 3, Table 10.6.2.3.2-1)

Derivation Path: TS 36.508 Table 4.7.3-21			
Information Element	Value/remark	Comment	Condition
EPS bearer identity	'0000'	"no EPS bearer identity assigned"	
Procedure transaction identity	PTI-1	SS re-uses the particular PTI defined by UE for this present PDN disconnection procedure.	
ESM cause	#95	protocol error	

10.7.1 UE requested bearer resource modification accepted by the network / new EPS bearer context

10.7.1.1 Test Purpose (TP)

(1)

```
with { UE in PROCEDURE TRANSACTION INACTIVE state and in EMM-CONNECTED mode }
ensure that {
  when { UE is requested to make an outgoing call for the specific QoS }
  then { UE sends a BEARER RESOURCE MODIFICATION REQUEST message }
}
```

(2)

```
with { UE having sent the BEARER RESOURCE MODIFICATION REQUEST message }
ensure that {
  when { UE receives an ACTIVATE DEDICATED EPS BEARER CONTEXT REQUEST message with the procedure
transaction identity (PTI) indicated in the BEARER RESOURCE MODIFICATION REQUEST message }
  then { UE sends an ACTIVATE DEDICATED EPS BEARER CONTEXT ACCEPT message }
}
```

10.7.1.2 Conformance requirements

References: The conformance requirements covered in the present TC are specified in: TS 24.301, clause 6.4.2.3, 6.5.4.2 and 6.5.4.3.

[TS 24.301, clause 6.4.2.3]

...

The linked EPS bearer identity included in the ACTIVATE DEDICATED EPS BEARER CONTEXT REQUEST message indicates to the UE to which default bearer, IP address and PDN the dedicated bearer is linked.

If the PTI is included in the ACTIVATE DEDICATED EPS BEARER CONTEXT REQUEST message, the UE uses the PTI to identify the UE requested bearer resource modification procedure to which the dedicated bearer context activation is related (see subclause 6.5.3 and subclause 6.5.4).

...

[TS 24.301, clause 6.5.4.2]

In order to request the modification of bearer resources for one traffic flow aggregate, the UE shall send a BEARER RESOURCE MODIFICATION REQUEST message to the MME, start timer T3481 and enter the state PROCEDURE TRANSACTION PENDING (see example in figure 6.5.3.2.1).

...

[TS 24.301, clause 6.5.4.3]

Upon receipt of the BEARER RESOURCE MODIFICATION REQUEST message, the MME checks whether the resources requested by the UE can be established, modified or released by verifying the EPS bearer identity given in the Linked EPS bearer identity for packet filter IE.

If the bearer resource modification requested is accepted by the network, the MME shall initiate either a dedicated EPS bearer context activation procedure, an EPS bearer context modification procedure or an EPS bearer context deactivation procedure. Upon receipt of an ACTIVATE DEDICATED EPS BEARER CONTEXT REQUEST, MODIFY EPS BEARER CONTEXT REQUEST or DEACTIVATE EPS BEARER CONTEXT REQUEST with a PTI which matches the value used for the BEARER RESOURCE MODIFICATION REQUEST, the UE shall stop timer T3481 and enter the state PROCEDURE TRANSACTION INACTIVE.

If the ACTIVATE DEDICATED EPS BEARER CONTEXT REQUEST is received, the UE shall enter the state BEARER CONTEXT ACTIVE and verify that the EPS bearer identity given in the EPS bearer identity IE is not already used by any dedicated EPS bearer contexts associated with the included linked EPS bearer identity. The UE shall then proceed as described in subclause 6.4.2.3 or subclause 6.4.2.4.

...

10.7.1.3 Test description

10.7.1.3.1 Pre-test conditions

System Simulator:

- Cell A

UE:

None.

Preamble:

- The UE is in state Generic RB Established (state 3) according to [18].

10.7.1.3.2 Test procedure sequence

Table 10.7.1.3.2-1: Main behaviour

St	Procedure	Message Sequence		TP	Verdict
		U - S	Message		
1	Make the UE initiate an outgoing call.	-	-	-	-
2	Check: Does the UE transmit a BEARER RESOURCE MODIFICATION REQUEST message?	-->	BEARER RESOURCE MODIFICATION REQUEST	1	P
3	The SS transmits an ACTIVATE DEDICATED EPS BEARER CONTEXT REQUEST message.	<--	ACTIVATE DEDICATED EPS BEARER CONTEXT REQUEST	-	-
4	Check: Does the UE transmit an ACTIVATE DEDICATED EPS BEARER CONTEXT ACCEPT message?	-->	ACTIVATE DEDICATED EPS BEARER CONTEXT ACCEPT	2	P

10.7.1.3.3 Specific message contents

None.

11 General Tests

12 E-UTRA Radio Bearer Tests

12.1 Generic E-UTRA radio bearer test procedure

12.1.1 Generic E-UTRA radio bearer test procedure – one layer of spatial multiplexing layer

12.1.1.1 Test Purpose (TP)

(1)

```
with { UE in E-UTRA RRC_CONNECTED state }
ensure that {
  when { UE receives a PDCP SDU on each configured AM and UM DRB within the same TTI }
  then { UE forward the received PDCP SDUs to upper layer }
}
```

(2)

```
with { UE in E-UTRA RRC_CONNECTED state }
ensure that {
  when { UE has pending data in the transmission buffer corresponding to a complete PDCP SDU on each
  configured AM and UM DRB and UE receives an UL Grant allowing UE to transmit all pending data }
  then { UE transmits a PDCP SDU on each configured AM and UM DRB within the same TTI }
}
```

12.1.1.2 Conformance requirements

References: The conformance requirements covered in the present TC are specified in: 3GPP TS 36-series Layer 1, Layer 2 and Layer 3 core specifications.

Editor's note: It is FFS if any specific conformance requirements need to be specified. The test purpose is to verify the complete data transfer through L1 and L2 for DRBs.

12.1.1.3 Test description

12.1.1.3.1 Pre-test conditions

System Simulator

- Cell 1

UE:

- None

Preamble

- The UE is in state Loopback Activated (state 4) according to [18].
- Radio bearer for combination SRB1 and SRB2 for n x AM DRB + m x UM DRB is used where n and m are specified in the test case.

12.1.1.3.2 Test procedure sequence

Table 12.1.1.3-1: Main behaviour

St	Procedure	Message Sequence		TP	Verdict
		U - S	Message		
1	The SS ignores scheduling requests and does not allocate any uplink grant.	-	-	-	-
2	The SS transmits a PDCP SDU of size [TBD] on each configured AM DRB and a PDCP SDU of size [TBD] on each configured UM DRB in the same TTI	<--	PDCP SDUs	-	-
3	The SS waits 1s	-	-	-	-
4	The SS sends an uplink grant of size [TBD] bits. (Note 1)	<--	(UL grant)	-	-
5	Check: Does UE transmit a PDCP SDU on each configure AM and UM DRB of the same size and content as transmitted by the SS in step 2?	-->	PDCP SDUs	1,2	P
6	The SS release the connection	-	-	-	-

Note 1. The SS set uplink grant to a value enabling the UE to return all data in one TTI.

12.1.1.3.3 Specific Message Contents

None

12.2 Data transfer of E-UTRA radio bearer combinations – one layer DL spatial multiplexing

12.2.1 Test Purpose (TP)

See 12.1.1.1

12.2.2 Conformance requirements

See 12.1.1.2

12.2.3 Test description

12.2.3.1 Pre-test conditions

System Simulator

- See 12.1.3.1

UE:

- See 12.1.3.1

Preamble

- The number of AM data radio bearers (n) and UM data radio bearers (m) for each execution is specified in table 12.2.3.1-1.

Table 12.2.3.1-1: Test parameters (m,n) for each execution (k)

Execution K	Number of AM DRBs n	Number of UM DRBs M	Number of spatial multiplexing layers in DL	Radio bearer combination
1	1	-	1	SRB1 and SRB2 for DCCH + 1xAM DRB
2	1	1	1	SRB1 and SRB2 for DCCH + 1xAM DRB + 1xUM DRB
3	2	-	1	SRB1 and SRB2 for DCCH + 2xAM DRB
4	2	1	1	SRB1 and SRB2 for DCCH + 2xAM DRB + 1xUM DRB
5	2	2	1	SRB1 and SRB2 for DCCH + 2xAM DRB + 2xUM DRB
6	3	-	1	SRB1 and SRB2 for DCCH + 3xAM DRB
7	3	1	1	SRB1 and SRB2 for DCCH + 3xAM DRB + 1xUM DRB
8	3	2	1	SRB1 and SRB2 for DCCH + 3xAM DRB + 2xUM DRB
9	4	-	1	SRB1 and SRB2 for DCCH + 4xAM DRB
10	4	1	1	SRB1 and SRB2 for DCCH + 4xAM DRB + 1xUM DRB
11	4	2	1	SRB1 and SRB2 for DCCH + 4xAM DRB + 2xUM DRB
12	5	3	1	SRB1 and SRB2 for DCCH + 5xAM DRB + 3xUM DRB
13	8	-	1	SRB1 and SRB2 for DCCH + 8xAM DRB

12.2.3.2 Test procedure sequence

Table 12.2.4.1-1: Main behaviour

St	Procedure	Message Sequence		TP	Verdict
		U - S	Message		
	EXCEPTION: Step 1 is repeated for execution counter k=1 to 13	-	-	-	-
1	Generic test procedure in 12.1.1 is executed for execution k with number of AM DRB (n) and number of UM DRB (m) as specified in table 12.2.3.1-1.	-	-	-	-

12.2.3.3 Specific Message Contents

None

Annex A (informative): Change history

Date	TSG #	TSG Doc.	CR	Rev	Subject/Comment	Version Old	Version New
2007-08		R5-072514			Initial version		0.0.1
2007-11					Template updated	0.0.1	0.0.2
2008-02					Addition 6 new RRC test cases	0.0.2	0.1.0
2008-04					Addition of new RRC and PDCP test cases agreed in RAN5#39. Alignment with latest core specifications.	0.1.0	0.2.0
2008-07					Addition of new MAC, RLC, RRC and EMM test cases and corrections agreed in RAN5#39bis. Alignment with latest core specifications.	0.2.0	0.3.0
2008-09					Addition of new MAC, RLC, PDCP and RRC test cases and corrections agreed in RAN5#40.	0.3.0	1.0.0
2008-10					Addition of new test cases agreed by email after RAN5#40 and at RAN5#40bis.	1.0.0	1.1.0
2008-11					Addition of new test cases and test case corrections agreed at RAN5#41.	1.1.0	2.0.0
2008-12	RAN#42	R5-080969			Approval of version 2.0.0 at RAN#42, then put to version 8.0.0.	2.0.0	8.0.0
2008-01					Editorial corrections	8.0.0	8.0.1
2009-03	RAN#43	R5-090102	0060	-	Correction to E-UTRA RLC test case 7.2.3.1	8.0.1	8.1.0
2009-03	RAN#43	R5-090103	0061	-	Correction to E-UTRA RLC test case 7.2.3.2	8.0.1	8.1.0
2009-03	RAN#43	R5-090124	0062	-	Batch 2 - Update to test case 7.2.2.8	8.0.1	8.1.0
2009-03	RAN#43	R5-090125	0063	-	Batch 1B - Update to test case 7.2.2.9	8.0.1	8.1.0
2009-03	RAN#43	R5-090128	0064	-	Batch 1A - Update to test case 8.1.1.1	8.0.1	8.1.0
2009-03	RAN#43	R5-090132	0065	-	Batch 1A - Update to test case 8.2.4.1	8.0.1	8.1.0
2009-03	RAN#43	R5-090133	0066	-	Batch 2 - Update to test case 8.2.4.2	8.0.1	8.1.0
2009-03	RAN#43	R5-090136	0067	-	Batch 2 - Update to test case 8.2.4.6	8.0.1	8.1.0
2009-03	RAN#43	R5-090137	0068	-	Batch 2 - Update to test case 8.2.4.7	8.0.1	8.1.0
2009-03	RAN#43	R5-090138	0069	-	Batch 2 - Update to test case 8.2.4.9	8.0.1	8.1.0
2009-03	RAN#43	R5-090144	0070	-	Batch 2 - Addition of new test case 8.4.1.8	8.0.1	8.1.0
2009-03	RAN#43	R5-090145	0071	-	Batch 2 - Correction to Idle mode test method	8.0.1	8.1.0
2009-03	RAN#43	R5-090146	0072	-	Batch 1A - Update to test case 8.5.4.1	8.0.1	8.1.0
2009-03	RAN#43	R5-090151	0073	-	Batch 2 - Addition of new test case 9.2.3.2.10	8.0.1	8.1.0
2009-03	RAN#43	R5-090153	0074	-	Batch 2 - Addition of new test case 9.2.3.2.15	8.0.1	8.1.0
2009-03	RAN#43	R5-090199	0075	-	Removal of EMM test cases 9.2.2.2.4, 9.2.2.2.6, 9.2.2.2.7 and 9.2.2.2.8.	8.0.1	8.1.0
2009-03	RAN#43	R5-090201	0076	-	Batch 1: Corrections to MAC test case 7.1.2.1	8.0.1	8.1.0
2009-03	RAN#43	R5-090203	0077	-	Batch 1: Corrections to MAC test case 7.1.2.4	8.0.1	8.1.0
2009-03	RAN#43	R5-090230	0078	-	Batch 1: Corrections to MAC test case 7.1.2.5	8.0.1	8.1.0
2009-03	RAN#43	R5-090235	0079	-	Batch 1: Corrections to MAC test case 7.1.3.6	8.0.1	8.1.0
2009-03	RAN#43	R5-090236	0080	-	Batch 1: Corrections to MAC test case 7.1.4.11	8.0.1	8.1.0
2009-03	RAN#43	R5-090347	0081	-	Batch 2 - Update to MAC test case 7.1.4.3	8.0.1	8.1.0
2009-03	RAN#43	R5-090453	0082	-	Batch 1A - Update of E-UTRA RLC (AM) test case 7.2.3.5	8.0.1	8.1.0
2009-03	RAN#43	R5-090455	0083	-	Batch 2 - Update of E-UTRA RLC (AM) test case 7.2.3.16	8.0.1	8.1.0
2009-03	RAN#43	R5-090498	0084	-	Batch 1B: Correction to E-UTRA RLC test case 7.2.2.7	8.0.1	8.1.0

2009-03	RAN#43	R5-090511	0085	-	Addition of a new LTE test case "7.3.3.2 Correct functionality of EPS UP encryption algorithms (SNOW 3G)"	8.0.1	8.1.0
2009-03	RAN#43	R5-090512	0086	-	Addition of a new LTE test case "7.3.3.1 Correct functionality of EPS AS encryption algorithms (SNOW 3G)"	8.0.1	8.1.0
2009-03	RAN#43	R5-090513	0087	-	Addition of a new LTE test case "7.3.3.3 Correct functionality of EPS AS encryption algorithms (AES)"	8.0.1	8.1.0
2009-03	RAN#43	R5-090514	0088	-	Addition of a new LTE test case "7.3.3.4 Correct functionality of EPS UP encryption algorithms (AES)"	8.0.1	8.1.0
2009-03	RAN#43	R5-090552	0089	-	Batch 1:Corrections to MAC test case 7.1.2.7	8.0.1	8.1.0
2009-03	RAN#43	R5-090553	0090	-	Batch 1:Corrections to MAC test case 7.1.2.8	8.0.1	8.1.0
2009-03	RAN#43	R5-090554	0091	-	.Batch 1:Corrections to MAC test case 7.1.3.4	8.0.1	8.1.0
2009-03	RAN#43	R5-090555	0092	-	Batch 1:Corrections to MAC test case 7.1.3.5	8.0.1	8.1.0
2009-03	RAN#43	R5-090556	0093	-	Batch 1:Corrections to MAC test case 7.1.4.15	8.0.1	8.1.0
2009-03	RAN#43	R5-090557	0094	-	Batch 1:Corrections to MAC test case 7.1.4.16	8.0.1	8.1.0
2009-03	RAN#43	R5-090570	0095	-	Update of 36.523-1 Reference list	8.0.1	8.1.0
2009-03	RAN#43	R5-090605	0096	-	Batch 2: Update of LTE TC 8.1.2.3 RRC - RRC Connection Establishment in RRC Idle state: return to idle state after T300 timeout	8.0.1	8.1.0
2009-03	RAN#43	R5-090607	0097	-	Batch 2: Addition of EMM TC 9.2.1.2.4 for Successful combined attach procedure, EPS service only / CS domain not available.	8.0.1	8.1.0
2009-03	RAN#43	R5-090611	0098	-	Batch 1:Corrections to EMM test case 9.1.3.1	8.0.1	8.1.0
2009-03	RAN#43	R5-090631	0099	-	Batch 1B: Correction to E-UTRA RLC test case 7.2.2.3	8.0.1	8.1.0
2009-03	RAN#43	R5-090645	0100	-	Batch 1B: Update of E-UTRAN test case 6.1.1.1	8.0.1	8.1.0
2009-03	RAN#43	R5-090649	0101	-	Batch-1B: Introduction of a new EMM test case, 9.2.3.1.4 Normal tracking area update / list of equivalent PLMNs in the TRACKING AREA UPDATE ACCEPT message	8.0.1	8.1.0
2009-03	RAN#43	R5-090651	0102	-	Batch 1:Corrections to MAC test case 7.1.2.2	8.0.1	8.1.0
2009-03	RAN#43	R5-090653	0103	-	Batch 1: Addition of new MAC test case 7.1.3.9 : MAC reset	8.0.1	8.1.0
2009-03	RAN#43	R5-090654	0104	-	Batch 1: Addition of new MAC test case 7.1.4.12 : MAC reset	8.0.1	8.1.0
2009-03	RAN#43	R5-090655	0105	-	Batch 1A - Update of E-UTRA MAC test case: 7.1.3.3	8.0.1	8.1.0
2009-03	RAN#43	R5-090656	0106	-	Batch 2 - Update of E-UTRA MAC test case: 7.1.2.9	8.0.1	8.1.0
2009-03	RAN#43	R5-090665	0107	-	Batch 1B - New E-UTRA PDCP test case - 7.3.1.2 Maintenance of PDCP sequence numbers (user plane, RLC UM)	8.0.1	8.1.0
2009-03	RAN#43	R5-090666	0108	-	Batch 1B - Correction to E-UTRA PDCP test case 7.3.1.1	8.0.1	8.1.0
2009-03	RAN#43	R5-090667	0109	-	Batch 1B - New E-UTRA PDCP test case - 7.3.1.3 Maintenance of PDCP sequence numbers (user plane, RLC UM, long PDCP SN (12 bits))	8.0.1	8.1.0
2009-03	RAN#43	R5-090669	0110	-	Batch 1B -Update to test case 7.2.2.4	8.0.1	8.1.0
2009-03	RAN#43	R5-090670	0111	-	Batch 1A -Update to test case 7.2.3.3	8.0.1	8.1.0
2009-03	RAN#43	R5-090671	0112	-	Batch 1A -Update to test case 7.2.3.4	8.0.1	8.1.0
2009-03	RAN#43	R5-090672	0113	-	Removal of TC 7.3.5.1	8.0.1	8.1.0

2009-03	RAN#43	R5-090674	0114	-	Batch 1A - Update of E-UTRA RLC (AM) test case 7.2.3.17	8.0.1	8.1.0
2009-03	RAN#43	R5-090675	0115	-	Batch 1A - Update of E-UTRA RLC (AM) test case 7.2.3.15	8.0.1	8.1.0
2009-03	RAN#43	R5-090676	0116	-	Batch 1B - Update of test case 8.2.2.1	8.0.1	8.1.0
2009-03	RAN#43	R5-090677	0117	-	Update of RRC batch 1B test case 8.2.2.2 RRC Connection Reconfiguration / SRB/DRB Reconfiguration: Success	8.0.1	8.1.0
2009-03	RAN#43	R5-090678	0118	-	Batch-1: Update to RRC part 3 test case 8.3.3.1	8.0.1	8.1.0
2009-03	RAN#43	R5-090679	0119	-	Batch 1A - TC 9.1.2.1 Authentication accepted - Update of conformance requirements	8.0.1	8.1.0
2009-03	RAN#43	R5-090680	0120	-	Batch 1A - TC 9.3.2.1 Paging procedure revisited	8.0.1	8.1.0
2009-03	RAN#43	R5-090685	0121	-	Batch 1A -Update to test case 6.1.2.5	8.0.1	8.1.0
2009-03	RAN#43	R5-090688	0122	-	Update of TC 7.3.6.1 PDCP Discard	8.0.1	8.1.0
2009-03	RAN#43	R5-090689	0123	-	Addition of new TC 7.3.5.4	8.0.1	8.1.0
2009-03	RAN#43	R5-090690	0124	-	Batch 2 - Update of LTE TC 8.5.1.3 RRC - RRC Connection Re-establishment: Failure: T311 Expiry	8.0.1	8.1.0
2009-03	RAN#43	R5-090691	0125	-	Batch 2 -Update to test case 8.1.2.5	8.0.1	8.1.0
2009-03	RAN#43	R5-090692	0126	-	Batch 1A -Update to test case 8.1.2.7	8.0.1	8.1.0
2009-03	RAN#43	R5-090693	0127	-	Batch 1A -Update to test case 8.1.3.5	8.0.1	8.1.0
2009-03	RAN#43	R5-090694	0128	-	Batch 2 - Update to test case 8.2.4.3	8.0.1	8.1.0
2009-03	RAN#43	R5-090695	0129	-	Batch 1B - Update to test case 8.2.4.5	8.0.1	8.1.0
2009-03	RAN#43	R5-090707	0130	-	Batch 1A - Update of test case 8.2.4.1	8.0.1	8.1.0
2009-03	RAN#43	R5-090709	0131	-	Batch 2: Update of RRC part1 TC 8.1.3.6 RRC Connection Release: redirection from E-UTRAN to UTRAN	8.0.1	8.1.0
2009-03	RAN#43	R5-090710	0132	-	Batch 2: Update of RRC part3 TC 8.3.1.7 Measurement configuration control and reporting / intra E-UTRAN measurements: blacklisting	8.0.1	8.1.0
2009-03	RAN#43	R5-090711	0133	-	Corrections to LTE idle mode test cases	8.0.1	8.1.0
2009-03	RAN#43	R5-090712	0134	-	Batch 1B: Update of test case 6.1.2.6	8.0.1	8.1.0
2009-03	RAN#43	R5-090713	0135	-	Batch 2: Update of LTE TC 8.1.2.2 RRC, Reject with wait time	8.0.1	8.1.0
2009-03	RAN#43	R5-090714	0136	-	Update to test case 8.1.3.1	8.0.1	8.1.0
2009-03	RAN#43	R5-090715	0137	-	Batch 1B: update of E-UTRA PDCP test case 7.3.6.1	8.0.1	8.1.0
2009-03	RAN#43	R5-090716	0138	-	Batch 1B: update of E-UTRA PDCP test case 7.3.6.1	8.0.1	8.1.0
2009-03	RAN#43	R5-090717	0139	-	Batch 2 - Update to test case 8.3.1.8	8.0.1	8.1.0
2009-03	RAN#43	R5-090720	0140	-	Batch-2: Update to RRC part 3 test case 8.3.1.3	8.0.1	8.1.0
2009-03	RAN#43	R5-090721	0141	-	Batch-2: Update to RRC part 3 test case 8.3.1.5	8.0.1	8.1.0
2009-03	RAN#43	R5-090722	0142	-	Batch 2: Addition of new EMM TC 9.2.1.2.3: Successful combined attach procedure, EPS service only / MSC temporarily not reachable	8.0.1	8.1.0
2009-03	RAN#43	R5-090730	0143	-	Batch 1:Corrections to MAC test case 7.1.2.3	8.0.1	8.1.0
2009-03	RAN#43	R5-090732	0144	-	Batch 2 - Addition of new test case 9.2.1.2.6	8.0.1	8.1.0
2009-03	RAN#43	R5-090733	0145	-	Batch 2 - Addition of new test case 9.2.3.2.6	8.0.1	8.1.0
2009-03	RAN#43	R5-090734	0146	-	Batch 1:Corrections to MAC test case 7.1.4.2	8.0.1	8.1.0
2009-03	RAN#43	R5-090735	0147	-	Batch 1:Corrections to MAC test case 7.1.3.2	8.0.1	8.1.0
2009-03	RAN#43	R5-090736	0148	-	Batch 2: Update of RRC part1 TC 8.1.3.4 RRC Connection Release: redirection to another E-UTRAN frequency	8.0.1	8.1.0
2009-03	RAN#43	R5-090740	0149	4	Batch 1A - Update of E-UTRA RLC (AM) test case 7.2.3.18	8.0.1	8.1.0

2009-05	RAN#44	R5-092052	0150	-	GCF Priority 1 - Update of 9.1.2.1 test procedure sequence and editorials	8.1.0	8.2.0
2009-05	RAN#44	R5-092053	0151	-	GCF Priority 2 - Update of TC 9.1.2.3 Authentication not accepted by the network, GUTI used, authentication reject and re-authentication	8.1.0	8.2.0
2009-05	RAN#44	R5-092054	0152	-	GCF Priority 2 - Update TC 9.1.2.4 Authentication not accepted by the UE MAC code failure	8.1.0	8.2.0
2009-05	RAN#44	R5-092055	0153	-	GCF Priority 2 - New TC 9.1.2.5 Authentication not accepted by the UE, SQN failure	8.1.0	8.2.0
2009-05	RAN#44	R5-092061	0154	-	GCF Priority 1 - Update of RRC test case 9.3.1.1	8.1.0	8.2.0
2009-05	RAN#44	R5-092076	0155	-	GCF Priority 2: First lu mode to S1 mode intersystem change after attach: go to E-UTRAN RRC idle: RAU to UTRAN (9.2.3.3.1)	8.1.0	8.2.0
2009-05	RAN#44	R5-092077	0156	-	Batch 2: Addition of 8.1.3.9 RRC Redirection from E-UTRAN to HRPD	8.1.0	8.2.0
2009-05	RAN#44	R5-092078	0157	-	Batch 2: Addition of 8.1.3.10 RRC Redirection from E-UTRAN to CDMA2000-1XRTT	8.1.0	8.2.0
2009-05	RAN#44	R5-092107	0158	-	GCF Priority 1 - Update of E-UTRA MAC test case 7.1.3.1	8.1.0	8.2.0
2009-05	RAN#44	R5-092108	0159	-	GCF Priority 1 - Update of E-UTRA MAC test case 7.1.4.1	8.1.0	8.2.0
2009-05	RAN#44	R5-092109	0160	-	GCF Priority 1 - Update of E-UTRA MAC test case 7.1.4.4	8.1.0	8.2.0
2009-05	RAN#44	R5-092110	0161	-	GCF Priority 1 - Update of E-UTRA MAC test case 7.1.4.5	8.1.0	8.2.0
2009-05	RAN#44	R5-092112	0162	-	GCF Priority 1 - Update of E-UTRA MAC test case 7.1.4.8	8.1.0	8.2.0
2009-05	RAN#44	R5-092113	0163	-	GCF Priority 1 - Update of E-UTRA MAC test case 7.1.4.10	8.1.0	8.2.0
2009-05	RAN#44	R5-092114	0164	-	GCF Priority 1 - Update of E-UTRA MAC test case 7.1.4.13	8.1.0	8.2.0
2009-05	RAN#44	R5-092115	0165	-	GCF Priority 1 - Proposal to remove E-UTRA RLC test case 7.2.3.19	8.1.0	8.2.0
2009-05	RAN#44	R5-092181	0166	-	GCF Priority 2 - Update of test case 8.5.1.5	8.1.0	8.2.0
2009-05	RAN#44	R5-092185	0167	-	GCF Priority 1 - Update of test case 8.2.3.1	8.1.0	8.2.0
2009-05	RAN#44	R5-092190	0168	-	GCF Priority 1 - Update of E-UTRA RLC (AM) test case 7.2.3.1	8.1.0	8.2.0
2009-05	RAN#44	R5-092191	0169	-	GCF Priority 1 - Update of E-UTRA RLC (AM) test case 7.2.3.2	8.1.0	8.2.0
2009-05	RAN#44	R5-092192	0170	-	GCF Priority 1 - Update of E-UTRA RLC (AM) test case 7.2.3.18	8.1.0	8.2.0
2009-05	RAN#44	R5-092200	0171	-	GCF Priority 1 - Update of E-UTRA RLC (AM) test case 7.2.3.18	8.1.0	8.2.0
2009-05	RAN#44	R5-092213	0172	-	Addition of new RRC test case 8.3.2.9	8.1.0	8.2.0
2009-05	RAN#44	R5-092228	0173	-	GCF Priority 2 - Update to test case 6.1.2.15	8.1.0	8.2.0
2009-05	RAN#44	R5-092229	0174	-	GCF Priority 1 - Update to test case 6.1.2.4	8.1.0	8.2.0
2009-05	RAN#44	R5-092230	0175	-	GCF Priority 2 - Update to test case 6.1.2.5	8.1.0	8.2.0
2009-05	RAN#44	R5-092234	0176	-	GCF Priority 1 - Update to test case 8.1.1.1	8.1.0	8.2.0
2009-05	RAN#44	R5-092242	0177	-	GCF Priority 2 - Update to test case 8.1.3.5	8.1.0	8.2.0
2009-05	RAN#44	R5-092245	0178	-	GCF Priority-2: A new EMM test case, 9.2.3.1.8 UE receives an indication that the RRC connection was released with cause 'load balancing TAU required'	8.1.0	8.2.0
2009-05	RAN#44	R5-092247	0179	-	Introduction of new EMM test cases,	8.1.0	8.2.0

					9.2.3.1.10 and 9.2.3.1.11 Normal tracking area update / Rejected		
2009-05	RAN#44	R5-092248	0180	-	Introduction of 9.2.3.1.12 ' Normal tracking area update / rejected / EPS service not allowed'	8.1.0	8.2.0
2009-05	RAN#44	R5-092249	0181	-	Introduction of 9.2.3.1.13 'Normal tracking area update / rejected / UE identity cannot be derived by the network'	8.1.0	8.2.0
2009-05	RAN#44	R5-092250	0182	-	GCF Priority 2 - Addition of a new test case 6.1.2.11 Inter-frequency cell reselection	8.1.0	8.2.0
2009-05	RAN#44	R5-092251	0183	-	Introduction of 9.2.3.1.14 ' Normal tracking area update / rejected / UE implicitly detached'	8.1.0	8.2.0
2009-05	RAN#44	R5-092252	0184	-	Introduction of 9.2.3.1.15 ' Normal tracking area update / rejected / PLMN not allowed'	8.1.0	8.2.0
2009-05	RAN#44	R5-092253	0185	-	Introduction of 9.2.3.1.16 ' Normal tracking area update / rejected / Tracking area not allowed'	8.1.0	8.2.0
2009-05	RAN#44	R5-092258	0186	-	GCF Priority 2 - Update of RRC part1 TC 8.1.3.4 RRC Connection Release: redirection to another E-UTRAN frequency	8.1.0	8.2.0
2009-05	RAN#44	R5-092260	0187	-	GCF Priority 2 - Update of RRC part1 TC 8.1.3.6 RRC Connection Release: redirection from E-UTRAN to UTRAN	8.1.0	8.2.0
2009-05	RAN#44	R5-092262	0188	-	GCF Priority 2 - Correction to idle mode test cases 6.1.2.3 and 6.1.2.6	8.1.0	8.2.0
2009-05	RAN#44	R5-092272	0189	-	LTE-SIG:TDD related updates in RRC sections	8.1.0	8.2.0
2009-05	RAN#44	R5-092276	0190	-	"GCF priority 1 - Update of the LTE test caseö 7.3.3.1 Correct functionality of EPS AS encryption algorithms (SNOW 3G)ö"	8.1.0	8.2.0
2009-05	RAN#44	R5-092278	0191	-	GCF priority 1 - Update of test caseö 7.3.3.2 Correct functionality of EPS UP encryption algorithms (SNOW 3G)ö	8.1.0	8.2.0
2009-05	RAN#44	R5-092280	0192	-	GCF Priority 2 - Update to test case 8.2.4.2	8.1.0	8.2.0
2009-05	RAN#44	R5-092281	0193	-	GCF Priority 2 - Update to test case 8.2.4.3	8.1.0	8.2.0
2009-05	RAN#44	R5-092283	0194	-	GCF Priority 2 - Update to test case 8.2.4.5	8.1.0	8.2.0
2009-05	RAN#44	R5-092284	0195	-	GCF Priority 2 - Update to test case 8.2.4.6	8.1.0	8.2.0
2009-05	RAN#44	R5-092285	0196	-	GCF Priority 2 - Update to test case 8.2.4.7	8.1.0	8.2.0
2009-05	RAN#44	R5-092288	0197	-	GCF Priority 2 - Update to test case 8.3.1.8	8.1.0	8.2.0
2009-05	RAN#44	R5-092295	0198	-	Addition of new test case 9.2.1.2.8	8.1.0	8.2.0
2009-05	RAN#44	R5-092296	0199	-	Addition of new test case 9.2.1.2.9	8.1.0	8.2.0
2009-05	RAN#44	R5-092297	0200	-	Addition of new test case 9.2.1.2.10	8.1.0	8.2.0
2009-05	RAN#44	R5-092299	0201	-	Addition of new test case 9.2.3.2.12	8.1.0	8.2.0
2009-05	RAN#44	R5-092300	0202	-	Addition of new test case 9.3.1.4	8.1.0	8.2.0
2009-05	RAN#44	R5-092301	0203	-	Addition of new test case to test case 10.X.X	8.1.0	8.2.0
2009-05	RAN#44	R5-092327	0204	-	GCF Priority 1: Update E-UTRA PDCP TC 7.3.4.1	8.1.0	8.2.0
2009-05	RAN#44	R5-092328	0205	-	GCF Priority 1: Update E-UTRA PDCP TC 7.3.4.2	8.1.0	8.2.0
2009-05	RAN#44	R5-092329	0206	-	GCF Priority 2: Update E-UTRA PDCP TC 7.3.5.2	8.1.0	8.2.0
2009-05	RAN#44	R5-092330	0207	-	GCF Priority 2: Update E-UTRA PDCP TC 7.3.5.3	8.1.0	8.2.0
2009-05	RAN#44	R5-092331	0208	-	GCF Priority 2: Update E-UTRA PDCP TC 7.3.5.5	8.1.0	8.2.0
2009-05	RAN#44	R5-092367	0209	-	GCF Priority 1 - Update of E-UTRA MAC test case 7.1.4.6	8.1.0	8.2.0

2009-05	RAN#44	R5-092396	0210	-	GCF Priority 2 - Addition of new test case 6.2.2.3	8.1.0	8.2.0
2009-05	RAN#44	R5-092397	0211	-	GCF Priority 2 - Addition of new test case 6.2.3.7	8.1.0	8.2.0
2009-05	RAN#44	R5-092398	0212	-	GCF Priority 2 - Addition of new test case 6.2.3.8	8.1.0	8.2.0
2009-05	RAN#44	R5-092406	0213	-	"GCF Priority 2 - Addition of new LTE test case 7.2.2.11 UM RLC / RLC re-establishment procedure"	8.1.0	8.2.0
2009-05	RAN#44	R5-092417	0214	-	GCF Priority 2:Corrections to EMM test case 9.1.3.2	8.1.0	8.2.0
2009-05	RAN#44	R5-092418	0215	-	GCF Priority 1:Corrections to MAC test case 7.1.3.4	8.1.0	8.2.0
2009-05	RAN#44	R5-092419	0216	-	GCF Priority 1:Corrections to MAC test case 7.1.3.5	8.1.0	8.2.0
2009-05	RAN#44	R5-092420	0217	-	GCF Priority 1:Corrections to MAC test case 7.1.4.1	8.1.0	8.2.0
2009-05	RAN#44	R5-092421	0218	-	GCF Priority 2: Attach / Abnormal case / Access barred because of access class barring or NAS signalling connection establishment rejected by the network	8.1.0	8.2.0
2009-05	RAN#44	R5-092422	0219	-	GCF Priority 2: Corrections to EMM test case 9.4.1	8.1.0	8.2.0
2009-05	RAN#44	R5-092423	0220	-	GCF Priority 2:Corrections to EMM test case 9.4.3	8.1.0	8.2.0
2009-05	RAN#44	R5-092430	0221	-	GCF Priority 1:Corrections to MAC test case 7.1.1.2	8.1.0	8.2.0
2009-05	RAN#44	R5-092451	0222	-	Update of RSRP / RSRQ measurement result checking to the RRC part 3 test cases	8.1.0	8.2.0
2009-05	RAN#44	R5-092471	0223	-	GCF Priority 2-Correction of the EMM test case 9.2.3.1.4	8.1.0	8.2.0
2009-05	RAN#44	R5-092480	0224	-	GCF Priority 1:Corrections to MAC test case 7.1.2.1	8.1.0	8.2.0
2009-05	RAN#44	R5-092481	0225	-	GCF Priority 1:Corrections to MAC test case 7.1.2.2	8.1.0	8.2.0
2009-05	RAN#44	R5-092484	0226	-	GCF Priority 1:Corrections to MAC test case 7.1.2.5	8.1.0	8.2.0
2009-05	RAN#44	R5-092485	0227	-	GCF Priority 1:Corrections to MAC test case 7.1.2.7	8.1.0	8.2.0
2009-05	RAN#44	R5-092486	0228	-	GCF Priority 1:Corrections to MAC test case 7.1.2.8	8.1.0	8.2.0
2009-05	RAN#44	R5-092500	0229	-	GCF priority 2: Update of 10.2.1 for Dedicated EPS bearer context activation / Success	8.1.0	8.2.0
2009-05	RAN#44	R5-092501	0230	-	GCF priority 2: Addition of TC 10.4.1 for EPS bearer context deactivation / Success	8.1.0	8.2.0
2009-05	RAN#44	R5-092502	0231	-	GCF priority 2: Addition of TC 10.5.1 for UE requested PDN connectivity accepted by the network	8.1.0	8.2.0
2009-05	RAN#44	R5-092504	0232	-	GCF priority TBC: Addition of TC 10.5.2 for UE requested PDN connectivity accepted by the network / no PDN address allocated	8.1.0	8.2.0
2009-05	RAN#44	R5-092505	0233	-	GCF priority 3: Addition of TC 10.5.3 for UE requested PDN connectivity not accepted	8.1.0	8.2.0
2009-05	RAN#44	R5-092506	0234	-	GCF priority 2: Addition of ESM TC 10.6.1 for UE requested PDN disconnect procedure accepted by the network	8.1.0	8.2.0
2009-05	RAN#44	R5-092507	0235	-	GCF Priority 3: Addition of ESM TC 10.6.2 for UE requested PDN disconnect procedure not accepted by the network	8.1.0	8.2.0
2009-05	RAN#44	R5-092510	0236	-	GCF priority 2 - Update of 9.2.1.1.17 Attach / rejected / no suitable cells in tracking area	8.1.0	8.2.0

2009-05	RAN#44	R5-092512	0237	-	GCF priority 1: Update of EMM TC 9.3.1.2 Service Request initiated by UE for uplink signalling	8.1.0	8.2.0
2009-05	RAN#44	R5-092513	0238	-	GCF priority 2: Update of 9.2.1.1.17 Attach / rejected / no suitable cells in tracking area	8.1.0	8.2.0
2009-05	RAN#44	R5-092514	0239	-	GCF priority 1: Update of 9.2.1.1.1 Attach Procedure / Success (valid GUTI)	8.1.0	8.2.0
2009-05	RAN#44	R5-092515	0240	-	GCF priority 2: Update of 9.2.1.1.5 Attach Procedure/ Success / ATTACH ACCEPT includes the PDN address assigned to the UE	8.1.0	8.2.0
2009-05	RAN#44	R5-092516	0241	-	GCF priority 2: Update of 9.2.1.1.9 Attach / rejected / IMSI invalid	8.1.0	8.2.0
2009-05	RAN#44	R5-092517	0242	-	GCF priority 2: Update of 9.2.1.1.10 Attach / rejected / illegal ME	8.1.0	8.2.0
2009-05	RAN#44	R5-092518	0243	-	GCF priority TBC: Update of 9.2.1.1.12 Attach / rejected / GPRS services not allowed	8.1.0	8.2.0
2009-05	RAN#44	R5-092539	0244	-	GCF Priority 1 - Update of RLC section	8.1.0	8.2.0
2009-05	RAN#44	R5-092567	0245	-	GCF Priority 2 - Addition of a new test case 6.2.3.5 Inter-RAT Cell Reselection / from E-UTRA RRC_IDLE to UTRA_Idle	8.1.0	8.2.0
2009-05	RAN#44	R5-092569	0246	-	GCF Priority 2: Inter-RAT cell Selection / from E-UTRA RRC_IDLE to UTRA_Idle, serving cell becomes non-suitable (SServingCell<0,barred)	8.1.0	8.2.0
2009-05	RAN#44	R5-092570	0247	-	GCF Priority 2: Inter-RAT cell Selection / from E-UTRA RRC_IDLE to GSM_Idle/GPRS Packet_idle, serving cell becomes non-suitable (SServingCell<0,barred)	8.1.0	8.2.0
2009-05	RAN#44	R5-092571	0248	-	GCF Priority 1 - New E-UTRA MAC test case - 7.1.7.1.1 DL-SCH Transport Block Size support / DCI format 1 / RA type 0	8.1.0	8.2.0
2009-05	RAN#44	R5-092575	0249	-	GCF Priority 1 - New E-UTRA MAC test case 7.1.7.1.2 - DL-SCH Transport Block Size selection / DCI format 1 / RA type 1	8.1.0	8.2.0
2009-05	RAN#44	R5-092577	0250	-	GCF Priority 1 - New E-UTRA MAC test case 7.1.7.2.1 - UL-SCH Transport Block Size selection / DCI format 0	8.1.0	8.2.0
2009-05	RAN#44	R5-092578	0251	-	GCF priority 2: New MAC test case: 7.1.6.1 DRX Operation / (short cycle not configured) /Parameters configured by RRC (radio resource configuration)	8.1.0	8.2.0
2009-05	RAN#44	R5-092579	0252	-	GCF Priority 2 - New RRC part1 TC 8.1.3.8 RRC Connection Release: redirection from E-UTRAN to GERAN	8.1.0	8.2.0
2009-05	RAN#44	R5-092580	0253	-	GCF Priority 2 - Update of test case 8.2.1.3	8.1.0	8.2.0
2009-05	RAN#44	R5-092583	0254	-	GCF Priority 2: Attach Procedure / Success (last visited TAI, TAI list and equivalent PLMN list handling) 9.2.1.1.1a	8.1.0	8.2.0
2009-05	RAN#44	R5-092584	0255	-	GCF Priority 1 - Update of test case 8.2.1.1	8.1.0	8.2.0
2009-05	RAN#44	R5-092589	0256	-	GCF Priority 2 - Addition of new EMM test case 9.3.1.7a	8.1.0	8.2.0
2009-05	RAN#44	R5-092593	0257	-	GCF priority 2 - Update of 9.2.1.1.15 Attach / rejected / roaming not allowed in this tracking area	8.1.0	8.2.0
2009-05	RAN#44	R5-092595	0258	-	GCF Priority 1:Corrections to MAC test case 7.1.1.1	8.1.0	8.2.0
2009-05	RAN#44	R5-092596	0259	-	GCF Priority 1:Corrections to MAC test case 7.1.4.12	8.1.0	8.2.0
2009-05	RAN#44	R5-092597	0260	-	GCF Priority 1 - Update to test case 8.2.4.1	8.1.0	8.2.0
2009-05	RAN#44	R5-092700	0261	-	GCF Priority 2 - Addition of new test case	8.1.0	8.2.0

					8.3.2.1		
2009-05	RAN#44	R5-092701	0262	-	GCF Priority-1: Correction to 9.2.3.1.1 'Normal tracking area update / accepted'	8.1.0	8.2.0
2009-05	RAN#44	R5-092702	0263	-	GCF Priority-1: Correction to 9.2.3.1.5'Periodic tracking area update / accepted'	8.1.0	8.2.0
2009-05	RAN#44	R5-092703	0264	-	GCF Priority 2 - Addition of E-UTRAN test case 6.1.2.7 for Cell reselection: Equivalent PLMN	8.1.0	8.2.0
2009-05	RAN#44	R5-092706	0265	-	GCF Priority 1 - Update to RRC test cases	8.1.0	8.2.0
2009-05	RAN#44	R5-092712	0266	-	GCF Priority 2: New MAC test case 7.1.4.14	8.1.0	8.2.0
2009-05	RAN#44	R5-092713	0267	-	GCF Priority 2 - Update to test case 8.1.2.5	8.1.0	8.2.0
2009-05	RAN#44	R5-092714	0268	-	GCF Priority 2 - Update to test case 8.1.2.7	8.1.0	8.2.0
2009-05	RAN#44	R5-092715	0269	-	GCF Priority 2 - Addition of RRC test case 8.3.2.6	8.1.0	8.2.0
2009-05	RAN#44	R5-092716	0270	-	GCF Priority 1 - Update of E-UTRA MAC test case 7.1.4.7	8.1.0	8.2.0
2009-05	RAN#44	R5-092717	0271	-	GCF Priority 1 - New E-UTRA MAC test case 7.1.7.1.4 - DL-SCH Transport Block Size selection / DCI format 1A / RA type 2 / Distributed VRB	8.1.0	8.2.0
2009-05	RAN#44	R5-092718	0272	-	GCF Priority 1 - New E-UTRA MAC test case 7.1.7.1.3 - DL-SCH Transport Block Size selection / DCI format 1A / RA type 2 / Localised VRB	8.1.0	8.2.0
2009-05	RAN#44	R5-092730	0273	-	GCF priority 2: New MAC test case: 7.1.6.2 DRX Operation / Parameters (short cycle not configured) / DRX command MAC control element reception	8.1.0	8.2.0
2009-05	RAN#44	R5-092731	0274	-	GCF Priority 2 - Updates to E-UTRAN Idle Mode test case 6.1.2.9	8.1.0	8.2.0
2009-05	RAN#44	R5-092732	0275	-	GCF Priority 2 - Updates to E-UTRAN Idle Mode test case 6.1.2.8	8.1.0	8.2.0
2009-05	RAN#44	R5-092741	0276	-	GCF Priority 1 - Update to idle mode test cases	8.1.0	8.2.0
2009-05	RAN#44	R5-092751	0277	-	Addition of new idle mode test case for ignoring CSG cells in cell selection when Allowed CSG list is empty or not supported	8.1.0	8.2.0
2009-05	RAN#44	R5-092752	0278	-	GCF Priority 2: New idle mode test case 6.2.3.1	8.1.0	8.2.0
2009-05	RAN#44	R5-092755	0279	-	GCF Priority 2 - Update to test case 8.3.1.10	8.1.0	8.2.0
2009-05	RAN#44	R5-092756	0280	-	GCF Priority 2 - Update to test case 8.3.2.3	8.1.0	8.2.0
2009-05	RAN#44	R5-092758	0281	-	GCF Priority 2 - Updates to E-UTRAN test case 6.1.1.1	8.1.0	8.2.0
2009-05	RAN#44	R5-092760	0282	-	GCF Priority 2: New idle mode test case 6.2.3.2	8.1.0	8.2.0
2009-05	RAN#44	R5-092761	0283	-	Move common test procedure from sections 6.0.1, 6.0.2, 6.0.3 to TS 36.508	8.1.0	8.2.0
2009-05	RAN#44	R5-092762	0284	-	Batch 2 - Addition of new RRC test case 8.3.2.7	8.1.0	8.2.0
2009-05	RAN#44	R5-092763	0285	-	Batch 2 - Addition of new RRC test case 8.3.2.8	8.1.0	8.2.0
2009-05	RAN#44	R5-092764	0286	-	LTE-SIG:TDD related updates in MAC sections	8.1.0	8.2.0
2009-05	RAN#44	R5-092768	0287	-	GCF Priority-1: Correction to 9.2.2.2.1 'NW initiated detach / re-attach required'	8.1.0	8.2.0
2009-05	RAN#44	R5-092784	0288	-	GCF Priority 2 - Update to test case 8.3.1.9	8.1.0	8.2.0
2009-05	RAN#44	R5-092483	0289	-	GCF Priority 1:Corrections to MAC test case 7.1.2.4	8.1.0	8.2.0
2009-05	RAN#44	R5-092528	0290	4	GCF Priority 1 - Update of E-UTRA MAC	8.1.0	8.2.0

					test case 7.1.2.3		
2009-05	RAN#44	R5-092785	0291	-	GCF priority 2: A/Gb mode READY state to S1 mode cell reselection and E-UTRAN - GERAN RAU (9.2.3.4.1, 9.2.3.4.2)	8.1.0	8.2.0
2009-05	RAN#44	R5-092786	0292	-	GCF Priority 2 - Update of TC 9.2.1.1.14 Attach / rejected / tracking area not allowed	8.1.0	8.2.0
-	-	-	-	-	Editorial corrections and split into sections	8.2.0	8.2.1

History

Document history		
V8.0.1	January 2009	Publication
V8.1.0	April 2009	Publication
V8.2.1	August 2009	Publication